



MODEL

9143i, 9480i, 9480i CT
and 67xxi Series Phones

SIP IP PHONE

41-001160-04

Rev 00

Administrator Guide

Release 2.5



Aastra Telecom will not accept liability for any damages and/or long distance charges, which result from unauthorized and/or unlawful use. While every effort has been made to ensure accuracy, Aastra Telecom will not be liable for technical or editorial errors or omissions contained within this documentation. The information contained in this documentation is subject to change without notice.



Copyright 2009 Aastra Telecom. www.aastratelecom.com
All Rights Reserved.

Software License Agreement

Aastra Telecom Inc., hereinafter known as "Seller", grants to Customer a personal, worldwide, non-transferable, non-sublicenseable and non-exclusive, restricted use license to use Software in object form solely with the Equipment for which the Software was intended. This Product may integrate programs, licensed to Aastra by third party Suppliers, for distribution under the terms of this agreement. These programs are confidential and proprietary, and are protected as such by copyright law as unpublished works and by international treaties to the fullest extent under the applicable law of the jurisdiction of the Customer. In addition, these confidential and proprietary programs are works conforming to the requirements of Section 401 of title 17 of the United States Code. Customer shall not disclose to any third party such confidential and proprietary programs and information and shall not export licensed Software to any country except in accordance with United States Export laws and restrictions.

Customer agrees to not reverse engineer, decompile, disassemble or display Software furnished in object code form. Customer shall not modify, copy, reproduce, distribute, transcribe, translate or reduce to electronic medium or machine readable form or language, derive source code without the express written consent of the Seller and its Suppliers, or disseminate or otherwise disclose the Software to third parties. All Software furnished hereunder (whether or not part of firmware), including all copies thereof, are and shall remain the property of Seller and its Suppliers and are subject to the terms and conditions of this agreement. All rights reserved.

Customer's use of this software shall be deemed to reflect Customer's agreement to abide by the terms and conditions contained herein. Removal or modification of trademarks, copyright notices, logos, etc., or the use of Software on any Equipment other than that for which it is intended, or any other material breach of this Agreement, shall automatically terminate this license. If this Agreement is terminated for breach, Customer shall immediately discontinue use and destroy or return to Seller all licensed software and other confidential or proprietary information of Seller. In no event shall Seller or its suppliers or licensors be liable for any damages whatsoever (including without limitation, damages for loss of business profits, business interruption, loss of business information, other pecuniary loss, or consequential damages) arising out of the use of or inability to use the software, even if Seller has been advised of the possibility of such damages.

Contents



Software License Agreement iii

Preface

About this guide vii
 Introductionxvii
 Audiencexvii
 Documentation xviii
 Chapters and appendixes in this guide xix

Chapter 1

Overview

About this chapter1-1
 IP Phone Models1-3
 Description1-3
 Model 9143i IP Phone1-7
 Model 9480i and 9480i CT IP Phones 1-11
 Model 6730i IP Phone 1-16
 Model 6731i IP Phone 1-19
 Model 6751i IP Phone1-22
 Model 6753i IP Phone1-25
 Model 6755i IP Phone1-28
 Model 6757i and 6757i CT IP Phones1-32
 Firmware Installation Information1-38
 Description1-38
 Installation Considerations1-38
 Installation Requirements1-39
 Configuration Server Requirement1-40
 Firmware and Configuration Files1-41
 Description1-41
 Configuration File Precedence1-43

Installing the Firmware/Configuration Files	1-44
Multiple Configuration Server Support 	1-45

Chapter 2

Configuration Interface Methods

About this chapter	2-1
Configuration Methods	2-2
Description	2-2
IP Phone UI	2-2
Aastra Web UI	2-6
Configuration Files (Administrator Only)	2-17

Chapter 3

Administrator Options

About this chapter	3-1
Administrator Level Options	3-3
Description	3-3
IP Phone UI Options	3-3
Aastra Web UI Options	3-6
Configuration File Options	3-8
Phone Status	3-9
Restarting Your Phone	3-13
Set Phone to Factory Defaults/Erase Local Configuration	3-15
Basic Settings	3-19
Account Configuration	3-35
Network Settings	3-37
Line Settings	3-70
Softkeys, Programmable Keys, Expansion Module Keys	3-71
Action URI	3-72
Configuration Server Settings	3-75
Firmware Update Features	3-84
TLS Support	3-85
802.1x Support	3-89
Troubleshooting	3-92





Chapter 4**Configuring Network and Session Initiation Protocol (SIP) Features**

About this chapter	4-1
Overview	4-3
Network Settings	4-4
Basic Network Settings	4-4
Advanced Network Settings	4-30
Global SIP Settings	4-70
Description	4-70
Basic SIP Settings	4-71
Advanced SIP Settings (optional)	4-86
Real-time Transport Protocol (RTP) Settings	4-95
RTCP Summary Reports	4-105
Autodial Settings	4-107
Configuration Server Protocol	4-112
Configuring the Configuration Server Protocol	4-112

Chapter 5**Configuring Operational Features**

About this chapter	5-1
Operational Features	5-5
Description	5-5
User Passwords	5-5
Administrator Passwords	5-9
Locking/Unlocking the Phone	5-10
Defining an Emergency Dial Plan	5-16
Time and Date	5-19
Backlight Mode (6755i, 6757i, and 6757i CT only)	5-30
Live Dial Pad*	5-33
Language 	5-34
Locking IP Phone Keys	5-49
Locking/Unlocking the SAVE and DELETE keys (6753i)	5-50
Local Dial Plan	5-53
Park Calls/Pick Up Parked Calls	5-59
Suppressing DTMF Playback	5-63

Display DTMF Digits	5-65
Call Waiting/Call Waiting Tone	5-67
Stuttered Dial Tone	5-70
XML Beep Support	5-72
Status Scroll Delay	5-74
Incoming Call Interrupts Dialing	5-76
Switch Focus to Ringing Line	5-79
Preferred Line and Preferred Line Timeout	5-81
Goodbye Key Cancels Incoming Call	5-85
UPnP Mapping Lines (for remote phones)	5-88
Message Waiting Indicator Line	5-90
DND Key Mode	5-92
Call Forward Mode	5-94
Link Layer Discovery Protocol for Media Endpoint Devices (LLDP-MED) and Emergency Location Identification Number (ELIN)	5-98
Incoming/Outgoing Intercom with Auto-Answer and Barge In	5-103
Group Paging RTP Settings	5-108
Key Mapping	5-114
Ring Tones and Tone Sets 	5-118
Priority Alerting	5-123
Directed Call Pickup (BLF or XML Call Interception)	5-130
Softkeys/Programmable Keys/Feature Keys/Expansion Module Keys	5-142
Customizing the Key Type List in the Aastra Web UI	5-163
Speeddial Prefixes	5-166
Enabling/Disabling Ability to Add or Edit a Speeddial Key	5-167
Busy Lamp Field (BLF)	5-168
BLF Subscription Period	5-174
BLF/Xfer and Speeddial/Xfer Keys	5-176
Speeddial/Conference Key (not applicable to the 6751i)	5-182
Automatic Call Distribution (ACD) (for Sylanro Servers)	5-186
ACD Subscription Period	5-196
BLA Subscription Period	5-198
Directed Call Pickup/Group Call Pickup (for Sylanro Servers)	5-200
Do Not Disturb (DND)	5-207
Bridged Line Appearance (BLA)	5-218

BLA Support for Third Party Registration	5-225
P-Preferred Identity Header for BLA Accounts	5-226
BLA Support for Message Waiting Indicator (MWI) 	5-227
Shared Call Appearance (SCA) Call Bridging 	5-230
Park/Pick Up Key (not applicable to the 6751i)	5-234
Last Call Return (lcr) (Sylantro Servers)	5-245
Call Forwarding	5-249
SIP Phone Diversion Display 	5-288
Displaying Call Destination for Incoming Calls 	5-290
Callers List	5-293
Customizable Callers List and Services Keys	5-299
Missed Calls Indicator	5-300
Directory List	5-302
Voicemail (not applicable to 6751i)	5-313
XML Customized Services	5-316
XML Override for a Locked Phone	5-360
Audio Transmit and Receive Gain Adjustments	5-361
Centralized Conferencing (for Sylantro and Broadsoft Servers)	5-363
“SIP Join” Feature for 3-Way Conference (not applicable to the 6751i)	5-367
Conference Ends and Transfers Remaining Parties 	5-368
Transferring Two Existing Calls 	5-369
Authentication Support for HTTP/HTTPS Download Methods, used with Broadsoft Client Management System (CMS)	5-370
Customizing the Display Columns on the M675i Expansion Module	5-373

Chapter 6
Configuring Advanced Operational Features

About this chapter	6-1
Advanced Operational Features	6-3
Description	6-3
MAC Address/Line Number in REGISTER Messages	6-5
SIP Message Sequence for Blind Transfer	6-7
Update Caller ID During a Call	6-8
Boot Sequence Recovery Mode	6-9
Auto-discovery Using mDNS	6-10

Single Call Restriction (6757i CT and 9480i CT only)	6-11
Missed Call Summary Subscription	6-13
As-Feature-Event Subscription	6-17
Blacklist Duration	6-22
Whitelist Proxy	6-24
Transport Layer Security (TLS)	6-26
802.1x Support	6-31
Symmetric UDP Signaling	6-41
Removing UserAgent and Server SIP Headers	6-42
GRUU and sip.instance Support	6-43
Multi-Stage Digit Collection (Billing Codes) Support (for Sylanro Servers)	6-44
Configurable DNS Queries	6-47
Ignore Out of Sequence Errors	6-49
“Early-Only” Parameter in Replaces Header RFC3891	6-50
Reason Header Field in SIP Message	6-50
Configurable “Allow” and “Allow-Event” Optional Headers	6-50
Configurable SIP P-Asserted Identity (PAI) 	6-51

Chapter 7

Encrypted Files on the IP Phone

About this chapter	7-1
Encrypted Files on the IP Phone	7-2
Configuration File Encryption Method	7-2
Procedure to Encrypt Configuration Files	7-4
Vendor Configuration File Encryption	7-6

Chapter 8

Upgrading the Firmware

About this chapter	8-1
Upgrading the Firmware	8-2
Using the “Firmware Update” Page in the Aastra Web UI	8-2
Using the Restart Feature	8-5
Using the Auto-Resync Feature	8-7

Chapter 9

Troubleshooting







About this chapter	9-1
Troubleshooting	9-3
Log Settings	9-3
Module/Debug Level Settings	9-4
Support Information	9-7
WatchDog Task Feature	9-12
Error Messages Display	9-15
Troubleshooting Solutions	9-19
Description	9-19
Why does my phone display “Application missing”?	9-19
Why does my phone display the “No Service” message?	9-20
Why does my phone display "Bad Encrypted Config"?	9-20
Why is my phone not receiving the TFTP IP address from the DHCP Server?	9-21
How do I restart the IP phone?	9-22
How do I set the IP phone to factory default?	9-23
How do I erase the phone’s local configuration?	9-24
How to reset a user’s password?	9-25
How do I lock and unlock the phone?	9-27

Appendix A

Configuration Parameters

About this appendix	A-1
Setting Parameters in Configuration Files	A-6
Operational, Basic, and Advanced Parameters	A-7
Simplified IP Phone UI Options Menu	A-7
Network Settings	A-8
DHCP Option Settings	A-13
Password Settings	A-15
Emergency Dial Plan Settings	A-16
Aastra Web UI Settings	A-17
Configuration Server Settings	A-18
Multiple Configuration Server Settings 	A-29
Network Address Translation (NAT) Settings	A-31
Rport Setting	A-33

Local SIP UDP/TCP Port Setting	A-34
Local SIP TLS Port	A-34
HTTPS Client and Server Settings	A-35
HTTPS Server Certificate Validation Settings	A-37
UPnP Settings	A-41
Virtual Local Area Network (VLAN) Settings	A-42
RTCP Summary Reports 	A-47
Type of Service (ToS)/DSCP Settings	A-51
Time and Date Settings	A-52
Time Server Settings	A-59
Custom Time Zone and DST Settings	A-61
Backlight Mode Settings (6755i, 6757i, 6757i CT)	A-70
Live Dialpad Settings	A-71
SIP Local Dial Plan Settings	A-72
SIP Outbound Support	A-75
Dynamic SIP for Registration and Subscription 	A-76
SIP Basic, Global Settings	A-77
SIP Basic, Per-Line Settings	A-86
BLA Support for MWI 	A-97
Shared Call Appearance (SCA) Call Bridging 	A-98
Centralized Conferencing Settings	A-99
SIP Join Feature for 3-Way Conference	A-101
HTTP/HTTPS Authentication Support for Broadsoft CMS	A-102
Advanced SIP Settings	A-103
Missed Call Summary Subscription Settings	A-112
As-Feature-Event Subscription Settings	A-115
Transport Layer Security (TLS) Settings	A-116
802.1x Support Settings	A-125
RTP, Codec, DTMF Global Settings	A-133
Autodial Settings	A-138
Voicemail Settings	A-141
Directory Settings	A-143
Callers List Settings	A-145
Customize Callers List and Services Key	A-146

Call Forward Settings	A-147
Call Forward Key Mode Settings	A-148
LLDP-MED and ELIN Settings	A-150
Missed Calls Indicator Settings	A-152
XML Settings	A-153
Action URI Settings	A-156
XML SIP Notify Settings	A-162
Polling Action URI Settings	A-163
Ring Tone and Tone Set Global Settings 	A-164
Ring Tone Per-Line Settings 	A-166
Incoming Call Interrupts Dialing Setting	A-167
Status Code on Ignoring Incoming Calls 	A-168
Switch Focus to Ringing Line	A-169
Preferred Line and Preferred Line Timeout	A-170
Goodbye Key Cancels Incoming Call	A-171
Stuttered Dial Tone Setting	A-172
Call Waiting Settings	A-173
Message Waiting Indicator Settings	A-174
DND Key Mode Settings	A-175
Priority Alert Settings	A-176
Bellcore Cadence Settings	A-181
SIP Diversion Display 	A-183
Display of Call Destination for Incoming Calls 	A-184
Language Settings 	A-185
Language Pack Settings 	A-187
Suppress DTMF Playback Setting	A-197
Display DTMF Digits Setting	A-198
Intercom, Auto-Answer, and Barge In Settings	A-199
Group Paging RTP Settings	A-203
Audio Transmit and Receive Gain Adjustment Settings	A-204
Directed Call Pickup (BLF or XML Call Interception) Settings	A-208
ACD Auto-Available Timer Settings	A-210
Park and Pickup Global Settings (not applicable to 6751i)	A-211
Mapping Key Settings	A-213

Softkey/Programmable Key/Feature Key/Expansion Module Key Parameters	A-216
Softkey Settings for 8 and 11-Line LCD phones	A-218
Programmable Key Settings for 9143i, 6730i, 6731i, 6753i, and 6755i	A-227
Top Softkey Settings for 6757i and 6757i CT	A-232
Handset Feature Key Settings (9480i CT and 6757i CT)	A-239
Expansion Module Key Settings for M670i (6753i, 6755i, 6757i, 6757i CT) and M675i (for 6755i, 6757i, 6757i CT)	A-241
Customizing the Key Type List	A-248
Locking Softkeys and Programmable Keys	A-251
Locking the SAVE and DELETE Keys (6753i)	A-254
Enabling/Disabling Ability to Add/Edit Speeddial Keys	A-255
BLF List URI Settings	A-255
Customizing M675i Expansion Module Column Display	A-256
Expansion Module 1 through 3	A-256
Advanced Operational Parameters	A-258
Blind Transfer Setting	A-258
Update Caller ID Setting.	A-258
Boot Sequence Recovery Mode Settings.	A-259
Single Call Restriction Setting	A-260
Blacklist Duration Setting	A-261
Whitelist Proxy Setting	A-261
XML Key Redirection Settings (for Redial, Xfer, Conf, Icom, Voicemail)	A-262
Options Key Redirection Setting (Services key on 6751i)	A-264
Off-Hook and XML Application Interaction Setting	A-264
XML Override for a Locked Phone Setting	A-265
Symmetric UDP Signaling Setting	A-265
User-Agent Setting	A-266
GRUU and sip.instance Support	A-266
DNS Query Setting	A-267
Ignore Out of Order SIP Requests	A-268
Optional “Allow” and “Allow-Event” Headers 	A-268
P-Asserted Identity (PAI) 	A-269
Configuration Encryption Setting	A-270
Troubleshooting Parameters	A-271
Log Settings	A-271

WatchDog Settings	A-274
Appendix B	
Configuring the IP Phone at the Asterisk IP PBX	
About this appendix	B-1
IP Phone at the Asterisk IP PBX	B-2
Appendix C	
Sample Configuration Files	
About this appendix	C-1
Sample Configuration Files	C-2
6757i Sample Configuration File	C-2
6757i CT Sample Configuration File	C-12
6753i Sample Configuration File	C-29
Appendix D	
Sample BLF Softkey Settings	
About this appendix	D-1
Sample BLF Softkey Settings	D-2
Asterisk BLF	D-2
BroadSoft BroadWorks BLF	D-3
Appendix E	
Sample Multiple Proxy Server Configuration	
About this appendix	E-1
Multiple Proxy Server Configuration	E-2
Limited Warranty	
Index	
Third Party Copyright Compliance	

About this guide

Introduction

This *SIP IP Phone Administrator Guide* provides information on the basic network setup, operation, and maintenance of the IP phones, Models 9143i, 9480i, 9480i CT and the 67xxi Series IP Phones (6730i, 6731i, 6751i, 6753i, 6755i, 6757i, and 6757i CT). It also includes details on the functioning and configuration of the IP phones.



Note: Features, characteristics, requirements, and configuration that are specific to a particular IP phone model are indicated where required in this guide.

Audience

This guide is for network administrators, system administrators, developers and partners who need to understand how to operate and maintain the IP phone on a SIP network. It also provides some user-specific information.

This guide contains information that is at a technical level, more suitable for system or network administrators. Prior knowledge of IP Telephony concepts is recommended.

Documentation

The IP phone documentation consists of:

- *<Model-specific> SIP IP Phone Installation Guide* – contains installation and set-up instructions, information on general features and functions, and basic options list customization. Included with the phone.
- *Model 9143i, 9480i, 9480i CT, and 67xxi Series SIP IP Phone Administrator Guide* – explains how to set the phone up on the network, as well as advanced configuration instructions for the SIP IP phone. This guide contains information that is at a technical level more suitable for a system or network administrator.
- *<Model-specific> SIP IP Phone User Guides* – explains the most commonly used features and functions for an end user.

This Administrator Guide complements the Aastra product-specific Installation Guide and the Aastra product-specific User Guide.

Chapters and appendixes in this guide

This guide contains the following chapters and appendixes:

For	Go to
An overview of the IP Phones and the IP Phone firmware installation information	Chapter 1
IP Phone interface methods	Chapter 2
Administrator options information	Chapter 3
Configuring the Network and Global SIP Features on the IP Phone	Chapter 4
Configuring operational information on the IP Phones	Chapter 5
Configuring advanced operational information on the IP Phones	Chapter 6
Encryption information	Chapter 7
Firmware upgrade information	Chapter 8
Troubleshooting solutions	Chapter 9
Configuration parameters	Appendix A
Configuring the IP Phones at the Asterisk PBX	Appendix B
Sample configuration files	Appendix C
Sample BLF softkey settings	Appendix D
Sample multiple proxy server configuration	Appendix E
Creating XML applications	Appendix F

Chapter 1

Overview

About this chapter

Introduction

This chapter briefly describes the IP Phone Models, and provides information about installing the IP phone firmware. It also describes the firmware and configuration files that the IP phone models use for operation.

Topics

This chapter covers the following topics:

Topic	Page
IP Phone Models	page 1-3
Model 9143i IP Phone	page 1-7
Model 9480i and 9480i CT IP Phones	page 1-11
Model 6731i IP Phone	page 1-19
Model 6751i IP Phone	page 1-22
Model 6755i IP Phone	page 1-28
Model 6757i and 6757i CT IP Phones	page 1-32
Firmware Installation Information	page 1-38
Installation Considerations	page 1-38
Installation Requirements	page 1-39
Configuration Server Requirement	page 1-40

About this chapter

Topic	Page
Firmware and Configuration Files	page 1-41
Configuration File Precedence	page 1-43
Installing the Firmware/Configuration Files	page 1-44

IP Phone Models

Description

All Aastra SIP IP Phone Models communicate over an IP network allowing you to receive and place calls in the same manner as a regular business telephone.

All phone models support the Session Initiation Protocol (SIP). The 9480i CT and 6757i CT offers the base phone along with a cordless extension.

References

For more information about the features and installation requirements, see the *SIP IP Phone Installation Guide* for your specific model.

The following illustrations show the types of IP Phone Models.

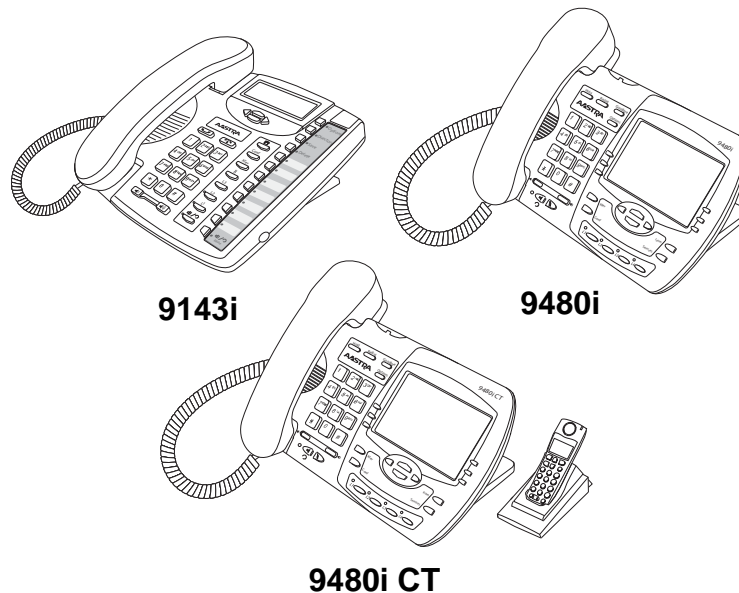

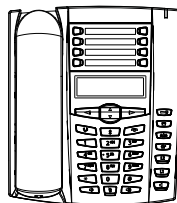

6730i

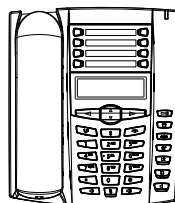

6731i

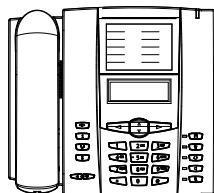

6751i

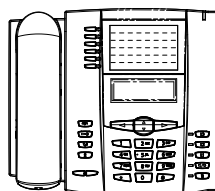

6753i

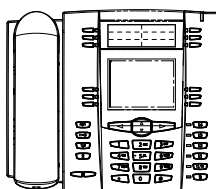

6755i

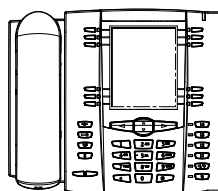

6757i

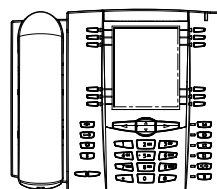

6757i CT



Optional Accessories (for all 9xxxi and 67xxi IP Phones)

The following are optional accessories for the IP Phones.

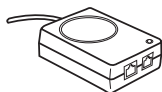

**Power over Ethernet (PoE)
Inline Power Injector**

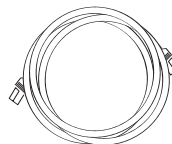

**Additional Ethernet Cable
(category 5/5e straight through
cable)**

A Power over Ethernet (PoE) inline power injector supplies 48V power to the IP phone through the Ethernet cable on pins 4 & 5 and 7 & 8.



Warning: Do not use this inline PoE power injector to power other devices. See your phone-specific Installation Guide for more information.

Reference

For more information about installing the PoE and additional Ethernet cable, see your phone-specific Installation Guide.

Optional Accessories (for 6731i and 6751i IP Phones)

The following are optional accessories for the 6731i and 6751i IP Phones.

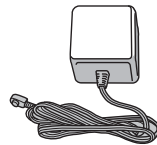

Power Adapter

Optional Accessories (for 6753i, 6755i, 6757i, and 6757i CT IP Phones)

The following are optional accessories for the 6753i, 6755i, 6757i, and 6757i CT IP Phones.

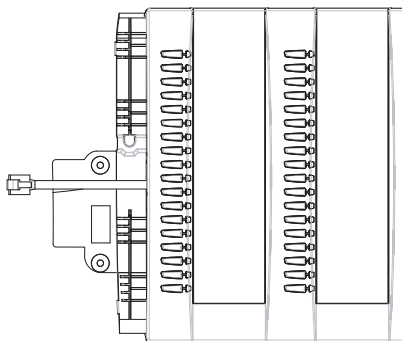

**M670i Expansion Module
for 6753i, 6755i, 6757i, and 6757i CT**

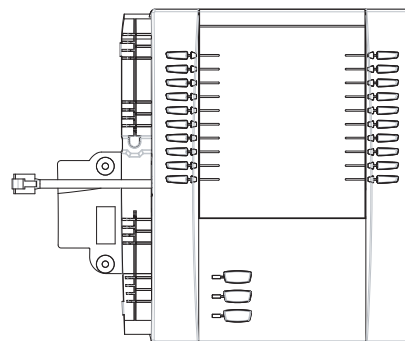

**M675i Expansion Module
for 6755i, 6757i, and 6757i CT**

The M670i module adds 36 additional softkeys to the IP phone models 6753i, 6755i, 6757i, and 6757i CT. The M670i provides paper labels for each softkey. Up to 3 modules can be piggy-backed to provide up to 108 additional softkeys for the phone.

The M675i module adds 60 additional softkeys to the IP phone models 6755i, 6757i, and 6757i CT (using the 3 function keys on the bottom right of the unit). The M675i module provides an LCD display for display softkey labels. Up to 3 modules can be piggy-backed to provide up to 180 additional softkeys for the phone.

Reference

For more information about installing and using the expansion modules, see your phone-specific Installation Guide and phone-specific User Guide.

Model 9143i IP Phone

This section provides brief information about the Model 9143i IP Phone. It includes a list of features and describes the hard keys on the 9143i.

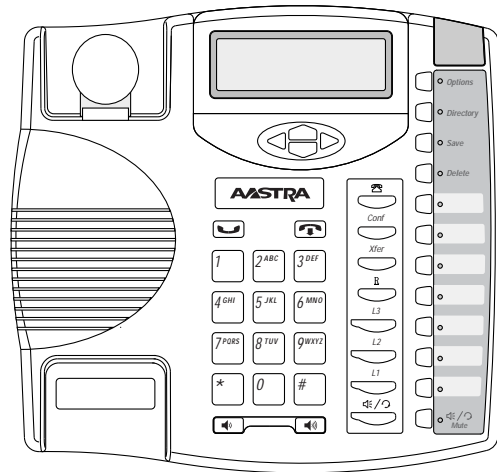













9143i Phone Features

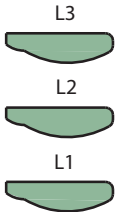
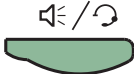

- 3-line LCD screen
- 3 call appearance lines with LEDs
- 7 programmable keys
- Press-and-Hold speeddial key configuration feature
- Full-duplex speakerphone for handsfree calls
- Supports up to 9 call lines
- Headset support (modular connector)
- Built-in two-port, 10/100 Ethernet ports - lets you share a connection with your computer
- Inline power support (based on 802.3af standard) which eliminates power adapters.
- AC power adapter (included)
- Enhanced busy lamp fields*
- Set paging*

*Availability of feature dependant on your phone system or service provider.

9143i Symbol Key Descriptions*

Keys	Key Description
	<p>Navigation keys - Pressing the UP and DOWN arrow keys lets you view different status and text messages on the LCD display (if there is more than 1 line of status/text messages). These buttons also let you scroll through menu selections, such as the Options List.</p> <p>Pressing the LEFT and RIGHT arrow keys lets you view the different line/call appearances. While in the Options List, these keys allow you to exit or enter the current option. When you are editing entries on the display, pressing the LEFT arrow key erases the character on the left; pressing the RIGHT arrow key sets the option.</p>
	<p>Goodbye key - Ends an active call. The Goodbye key also exits an open list, such as the Options List, without saving changes.</p>
	<p>Hold key - Places an active call on hold. To retrieve a held call, press the call appearance button beside the light that is flashing.</p>
	<p>Volume control key - Adjusts the volume for the handset, headset, ringer, and handsfree speaker.</p>
	<p>Callers List key - Allows you to access the Callers List that stores up to 200 of the last calls received.</p>
<p>Conf</p> 	<p>Conference key - Allows you to begin a conference call with up to 3 active call parties.</p>
<p>Xfer</p> 	<p>Transfer key - Allows you to perform blind or consultative transfer of an active call to another number. In blind transfer, you transfer the call without waiting for the far end to answer. In consultative transfer, you wait for the far end to answer before transferring the call.</p>
<p>R</p> 	<p>Redial key - Redials a previously dialed number. The Redial key stores up to 100 previously dialed numbers you can select from. Pressing the Redial key twice simultaneously redials the last dialed number.</p>

Keys	Key Description
	<p>Line/Call Appearance key - Connects you to a line or call. The Aastra 9143i IP Phone supports up to 3 line keys.</p>
	<p>Handsfree key - Activates Handsfree for making and receiving calls without lifting the handset. When the audio mode option is set, this key is used to switch between a headset and the handsfree speakerphone.</p>
 Options	<p>Options key - Accesses options to customize your phone. Specific options are available to your System Administrator only and are password protected. Contact your System Administrator for more information.</p>
 Directory	<p>Directory key - Accesses the Directory on the phone. The Directory List is your personal phone book, conveniently stored within your phone. You can enter up to 200 entries into the 9143i Directory by adding them manually, or by saving the number and name from other lists stored on your phone. Each entry can contain a maximum of 16 letters and numbers.</p>
 Save	<p>Save key - Allows you to save entries when storing numbers and names in Directory. Also allows you to save Option settings when using the programmable keys.</p>
 Delete	<p>Delete key - Allows you to remove entries from the Redial, Directory, or Callers Lists.</p>

Keys	Key Description
	<p>Programmable keys - Allows you to use the feature configured for that key. You can program up to 7 keys with a specific function. By default, there are no functions configured on the programmable keys (keys are configured as "None").</p> <p>Note: For more information about configuring the programmable keys 1 through 7 to perform specific functions, see Chapter 5, "Configuring Operational Features" the section, "Softkeys/Programmable Keys/Feature Keys/Expansion Module Keys" on page 5-142.</p>
	<p>Mute key - Mutes the microphone so that your caller cannot hear you (the light indicator flashes when the microphone is on mute).</p>

*See the Aastra 9143i User Guide for more information about each of these keys.

Model 9480i and 9480i CT IP Phones

This section provides brief information about the Models 9480i and 9480i CT IP Phones. It includes a list of features and describes the hard keys on these models.

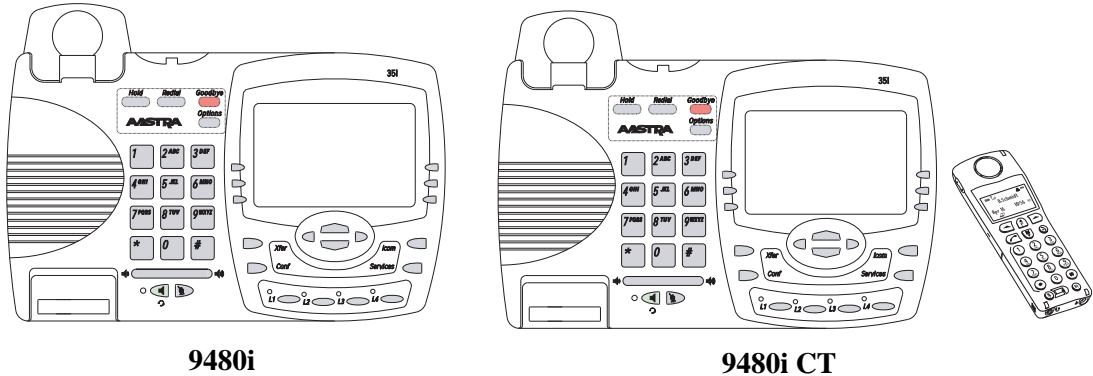









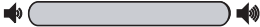

9480i and 9480i CT Phone Features

- 5 line graphical LCD screen with large backlit display
- 6 multi-functional, state-based softkeys
- Press-and-Hold speeddial key configuration feature
- 4 call appearance lines with LEDs
- Supports up to 9 call lines
- Speakerphone for handsfree calls
- Headset support (modular connector)
- Built-in-two-port, 10/100 Ethernet switch - lets you share a connection with your computer.
- Inline power support (based on 802.3af standard) which eliminates power adapters.
- AC power adapter (included)
- Enhanced busy lamp fields*
- Set paging*

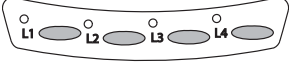
*Availability of feature dependant on your phone system or service provider.

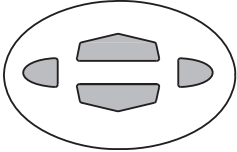
9480i and 9480i CT Key Descriptions*

Keys	Key Description
<p style="text-align: center;">Goodbye</p> 	<p>Goodbye key - Ends an active call. The Goodbye key also exits an open list, such as the Options List, without saving changes.</p>
<p style="text-align: center;">Options</p> 	<p>Options key - Accesses options to customize your phone. Your System Administrator may have already customized some of your settings. Check with your System Administrator before changing the administrator-only options.</p>
<p style="text-align: center;">Hold</p> 	<p>Hold key - Places an active call on hold. To retrieve a held call, press the call appearance button beside the light that is flashing.</p>
<p style="text-align: center;">Redial</p> 	<p>Redial key - Redials up to 100 previously dialed numbers. Pressing the Redial key twice simultaneously redials the last dialed number.</p>
	<p>Volume control key - Adjusts the volume for the handset, headset, ringer, and handsfree speaker.</p>
	<p>Handsfree key - Activates Handsfree for making and receiving calls without lifting the handset. When the audio mode option is set, this key is used to switch between a headset and the handsfree speakerphone.</p>
	<p>Mute key - Mutes the microphone so that your caller cannot hear you (the light indicator flashes when the microphone is on mute).</p>
	<p>Line/Call Appearance key - Connects you to a line or call. The Aastra 9480i and 9480i CT IP phones support up to 4 line keys.</p>

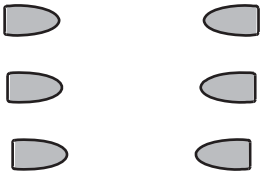
Keys	Key Description
	<p>Navigation keys - Pressing the UP and DOWN arrow keys lets you view different status and text messages on the LCD display (if there is more than 1 line of status/text messages). These buttons also let you scroll through menu selections, such as the Options List.</p> <p>Pressing the LEFT and RIGHT arrow keys lets you view the different line/call appearances. While in the Options List, these keys allow you to exit or enter the current option. When you are editing entries on the display, pressing the LEFT arrow key erases the character on the left; pressing the RIGHT arrow key sets the option.</p>
	<p>Transfer key - Transfers an active call to another number.</p>
	<p>Conference key - Begins a conference call with the active call.</p>
	<p>Icom key - Begins an intercom call to a remote extension and answers incoming intercom calls. The 9480i and 9480i CT IP Phones also have default softkey 4 configured as Icom.</p>
	<p>Services key - Displays a list of Services available to your phone, if specific services have been configured. The available Aastra services include Directory & Callers Log. The 9480i and 9480i CT IP Phones also have default softkey 1 configured as Services.</p> <p>Note: Availability of the services feature is dependant on your phone system and/or service provider.</p>
	<p>Softkeys - 6 state-based softkeys on the 9480i and 9480i CT IP Phones.</p> <p>When you pick up the handset, the following displays on key 1: Dial - After entering a phone number from the keypad, you can press the Dial softkey to immediately dial the number.</p> <p>Note: For more information about configuring softkeys 1 through 6 to perform specific functions, see Chapter 5, "Configuring Operational Features" the section, "Softkeys/Programmable Keys/Feature Keys/Expansion Module Keys" on page 5-142.</p>

*See the Aastra 9480i and 9480i CT User Guides for more information about each of these keys.

9480i CT Cordless Handset Features

- 5 line backlit display screen
- 2 multi-functional softkeys
- Programmable function key supports up to 14 functions
- Vibration Alerter
- Headset Jack
- Desk charging stand

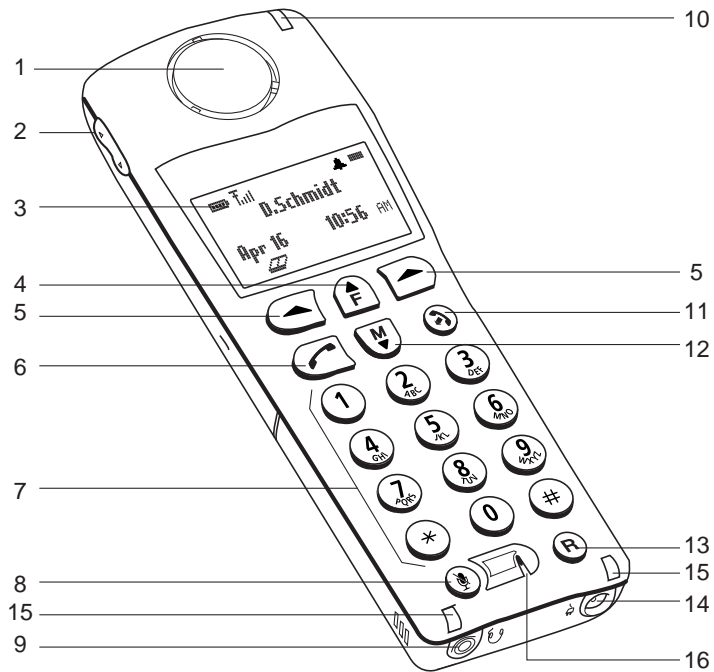

9480i CT Cordless Handset Key Descriptions*

Function #	Function Description
1	Receiver
2	Volume key During Ringing: Adjusts ringer volume During a call: Adjusts receiver volume During text mode (not in a call): Moves cursor right/left
3	Display
4	Features <i>f</i> Key List Access key to the programmed Feature Key List Scrolls up when in the various lists Adds a space during editing
5	Softkeys Activates feature or option shown on the display above the keys
6	Call key Used to obtain dial tone Also used as a Hold key
7	Dial Pad
8	Mute Key When used, prevents the caller from hearing you
9	Headset Jack
10	Status Light
11	Release key To end calls and go on hook Exits Menu and the various lists
12	Menu Key Access key to the different Options Scrolls down when in the various lists Used as Backspace during editing
13	Redial Key Displays the last 10 numbers dialed
14	Charging Jack
15	Charging Contacts
16	Microphone

*See the Aastra 9480i CT User Guide for more information about each of these keys.

Model 6730i IP Phone

This section provides brief information about the Model 6730i IP Phone. It includes a list of features and describes the hard keys on the 6730i. The 6730i is available with a symbol keypad or a text keypad.

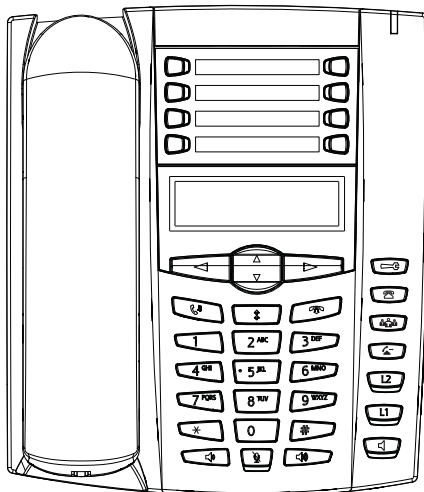













6730i with Symbol or Text Keys

6730i Phone Features (Symbol and Text)

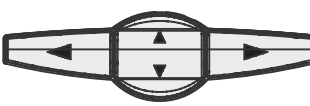













- 3-line LCD screen
- 8 programmable top keys
- Press-and-hold speeddial key configuration feature
- Supports up to 6 call lines with LEDs
- Full-duplex speakerphone for handsfree calls
- Headset mode support (via handset jack)
- AC power adapter (included)
- Enhanced busy lamp fields*
- Set paging*

*Availability of feature dependant on your phone system or service provider.

6730i Symbol and Text Key Descriptions*

Symbol Keys	Text Keys	Key Description
		Hold key - Places an active call on hold. To retrieve a held call, press the call appearance button beside the light that is flashing.
		Redial key - Redials up to 100 previously dialed numbers. Pressing the Redial key twice redials the last dialed number.
		Goodbye key - Ends an active call. The Goodbye key also exits an open list, such as the Options List, without saving changes.
		Volume control key - Adjusts the volume for the handset, ringer, and handsfree speaker.
		Navigation keys - Pressing the UP and DOWN arrow keys lets you view different status and text messages on the LCD display (if there is more than 1 line of status/text messages). These buttons also let you scroll through menu selections, such as the Options List. Pressing the LEFT and RIGHT arrow keys lets you view the different line/call appearances. While in the Options List, these keys allow you to exit or enter the current option. When you are editing entries on the display, pressing the LEFT arrow key erases the character on the left; pressing the RIGHT arrow key sets the option.
		Speaker key - Transfers the active call to the speaker, allowing handsfree use of the phone. Switched between headset and speaker depending on audio mode setting.
		Options key - Accesses services and options to customize your phone. Your System Administrator may have already customized some of your settings.
		Callers List key - Accesses the last 200 calls received.

IP Phone Models

Symbol Keys	Text Keys	Key Description
		Conference key - Begins a conference call with the active call.
		Transfer key - Transfers the active call to another number.
 		Line/Call Appearance keys - Connect you to a line or call. The Aastra 6730i IP phone supports 2 line keys, each with LED indicator lights. Additional lines (up to 6 in total) can be added to the programmable keys.
 1  2  3  4	 5  6  7  8	<p>Programmable keys - 8 Top Keys - all 8 keys are programmable. Keys 5 and 6 are designated as the SAVE and DELETE keys, respectively. These keys must be made configurable by the System Administrator before they can be changed.</p> <p>The following are the default functions for the programmable keys on the 6730i IP phone:</p> <p>1 - None 2 - None 3 - None 4 - None 5 - SAVE - Allows you to save numbers (preconfigured)and/or names to the Directory. Using this key, you enter the number, name, and line (or speeddial key) to record in the Directory List. 6 - DELETE - Allows you to delete entries (preconfigured)from the Directory List and Callers List. (Must enter the Directory or Callers list and select an entry, then press twice to delete entry). 7 - DIRECTORY - Displays up to 200 names (preconfigured)and phone numbers (stored in alphabetical order) 8 - SERVICES - Accesses enhanced features (preconfigured)and services through the Services menu.</p> <p>Note: For more information about configuring the programmable keys 1 through 8 to perform specific functions, see Chapter 5, "Configuring Operational Features" the section, "Softkeys/Programmable Keys/Feature Keys/Expansion Module Keys" on page 5-142.</p>

*See the Aastra 6730i User Guide for more information about each of these keys.

Model 6731i IP Phone

This section provides brief information about the Model 6731i IP Phone. It includes a list of features and describes the hard keys on the 6731i. The 6731i is available with a symbol keypad or a text keypad.

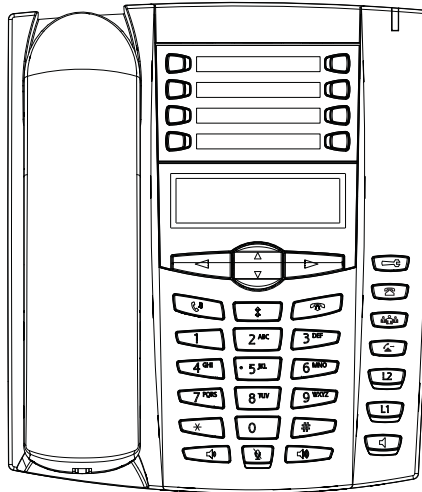













6731i with Symbol or Text Keys















6731i Phone Features (Symbol and Text)

- 3-line LCD screen
- 8 programmable top keys
- Press-and-hold speeddial key configuration feature
- Supports up to 6 call lines with LEDs
- Full-duplex speakerphone for handsfree calls
- Headset mode support (via handset jack)
- Built-in two-port, 10/100 Ethernet ports - lets you share a connection with your computer
- Inline power support (based on 802.3af standard) which eliminates power adapters
- AC power adapter (optional equipment - not included)
- Enhanced busy lamp fields*
- Set paging*

*Availability of feature dependant on your phone system or service provider.

6731i Symbol and Text Key Descriptions*

Symbol Keys	Text Keys	Key Description
		Hold key - Places an active call on hold. To retrieve a held call, press the call appearance button beside the light that is flashing.
		Redial key - Redials up to 100 previously dialed numbers. Pressing the Redial key twice redials the last dialed number.
		Goodbye key - Ends an active call. The Goodbye key also exits an open list, such as the Options List, without saving changes.
		Volume control key - Adjusts the volume for the handset, ringer, and handsfree speaker.
		Navigation keys - Pressing the UP and DOWN arrow keys lets you view different status and text messages on the LCD display (if there is more than 1 line of status/text messages). These buttons also let you scroll through menu selections, such as the Options List. Pressing the LEFT and RIGHT arrow keys lets you view the different line/call appearances. While in the Options List, these keys allow you to exit or enter the current option. When you are editing entries on the display, pressing the LEFT arrow key erases the character on the left; pressing the RIGHT arrow key sets the option.
		Speaker key - Transfers the active call to the speaker, allowing handsfree use of the phone. Switched between headset and speaker depending on audio mode setting.
		Options key - Accesses services and options to customize your phone. Your System Administrator may have already customized some of your settings.
		Callers List key - Accesses the last 200 calls received.

Symbol Keys	Text Keys	Key Description
		Conference key - Begins a conference call with the active call.
		Transfer key - Transfers the active call to another number.
 		Line/Call Appearance keys - Connect you to a line or call. The Aastra 6730i IP phone supports 2 line keys, each with LED indicator lights. Additional lines (up to 6 in total) can be added to the programmable keys.
 1  2  3  4	 5  6  7  8	<p>Programmable keys - 8 Top Keys - all 8 keys are programmable. Keys 5 and 6 are designated as the SAVE and DELETE keys, respectively. These keys must be made configurable by the System Administrator before they can be changed.</p> <p>The following are the default functions for the programmable keys on the 6730i IP phone:</p> <p>1 - None 2 - None 3 - None 4 - None 5 - SAVE - Allows you to save numbers (preconfigured)and/or names to the Directory. Using this key, you enter the number, name, and line (or speeddial key) to record in the Directory List. 6 - DELETE - Allows you to delete entries (preconfigured)from the Directory List and Callers List. (Must enter the Directory or Callers list and select an entry, then press twice to delete entry). 7 - DIRECTORY - Displays up to 200 names (preconfigured)and phone numbers (stored in alphabetical order) 8 - SERVICES - Accesses enhanced features (preconfigured)and services through the Services menu.</p> <p>Note: For more information about configuring the programmable keys 1 through 8 to perform specific functions, see Chapter 5, "Configuring Operational Features" the section, "Softkeys/Programmable Keys/Feature Keys/Expansion Module Keys" on page 5-142.</p>

*See the Aastra 6751i User Guide for more information about each of these keys.

Model 6751i IP Phone

This section provides brief information about the Model 6751i IP Phone. It includes a list of features and describes the hard keys on the 6751i. The 6751i is available with a symbol keypad or a text keypad.

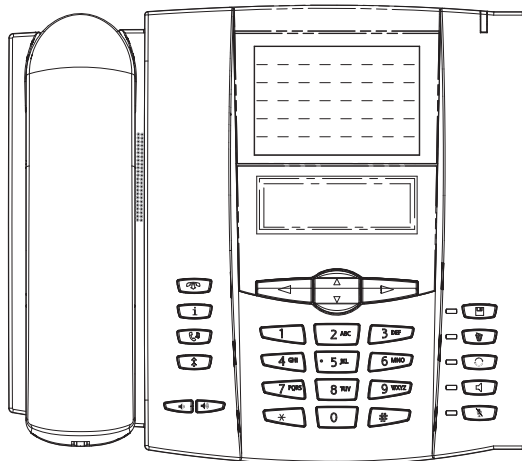

















6751i with Symbol or Text Keys



6751i Phone Features (Symbol and Text)

- 3-line LCD screen
- 1 call appearance line
- Press-and-Hold speeddial key configuration feature
- Supports 1 call line with transfer capabilities
- Full-duplex speakerphone for hands-free calls
- Built-in two-port, 10/100 Ethernet ports - lets you share a connection with your computer
- AC power adapter (sold separately)
- Set paging*

*Availability of feature dependant on your phone system or service provider.

6751i Symbol and Text Key Descriptions*

Symbol Keys	Text Keys	Key Description
		Goodbye key - Ends an active call. The Goodbye key also exits an open list, such as the Options List, without saving changes.
		Services key - Accesses services and options to customize your phone. This keys also access the Directory List and Callers List. Your System Administrator may have already customized some of your settings. Check with your System Administrator before changing the administrator-only options.
		Hold key - Places an active call on hold. To retrieve a held call, press the Hold key again.
		Redial key - Redials up to 100 previously dialed numbers. Pressing the Redial key twice simultaneously redials the last dialed number.
		Volume control key - Adjusts the volume for the handset, ringer, and handsfree speaker.
		Save key - Saves names and numbers to the Directory List. Also saves names and numbers from the Callers List to the Directory List.
		Delete key - Deletes individual or all entries from the Directory List and Callers List. Deletes all entries from the Redial List. You can also use this key to backspace and delete a character when entering values for speedial softkeys.
		Swap key - If you are on an active call and a second call comes in, you can press the Swap key. This key places the first call on hold and answers the second call. Pressing the Swap key again toggles between the two active calls. The Swap key works with two active calls only. A third call cannot be accepted.
		Speaker key - Activates Handsfree for receiving calls without lifting the handset. Can be used on active calls to switch from the handset to handsfree.

Symbol Keys	Text Keys	Key Description
		<p>Mute key - Mutes the microphone so that your caller cannot hear you.</p>
		<p>Navigation keys - Pressing the UP and DOWN arrow keys lets you view different status and text messages on the LCD display (if there is more than 1 line of status/text messages). These buttons also let you scroll through menu selections, such as the Options List.</p> <p>UP Arrow - This key also acts as a Transfer Key, allowing you to transfer calls when required.</p> <p>DOWN Arrow - This key also acts as a Conference Key, allowing you to join conferences when required.</p> <p>Pressing the UP and DOWN arrow keys lets you view the lines on the LCD. While in the Options List, the navigation keys allow you to exit or enter the current option. When you are editing entries on the display, pressing the LEFT arrow key erases the character on the left; pressing the RIGHT arrow key sets the option.</p>

*See the Aastra 6751i User Guide for more information about each of these keys.

Model 6753i IP Phone

This section provides brief information about the Model 6753i IP Phone. It includes a list of features, and describes the hard keys and default programmable keys on the 6753i.

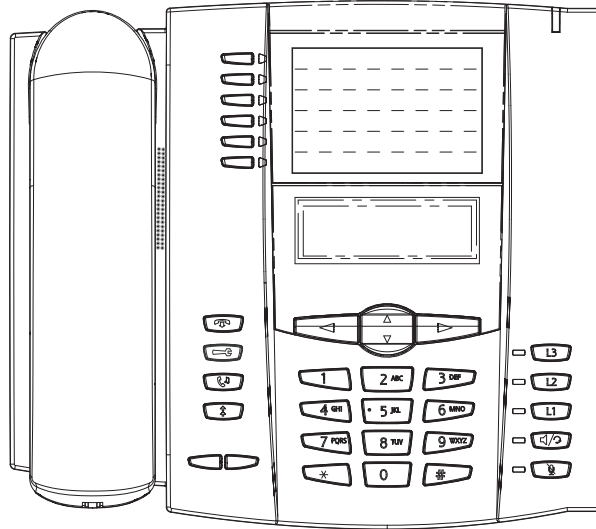











6753i Phone Features

- 3-line LCD screen
- 6 programmable top keys
- 3 call appearance lines with LEDs
- Press-and-Hold speeddial key configuration feature
- Supports up to 9 call lines
- Full-duplex speakerphone for handsfree calls
- Headset support (modular connector)
- Built-in two-port, 10/100 Ethernet ports - lets you share a connection with your computer
- AC power adapter (included)
- Enhanced busy lamp fields*
- Set paging*

*Availability of feature dependant on your phone system or service provider.

6753i Key Descriptions*

Keys	Key Description
	Goodbye key - Ends an active call. The Goodbye key also exits an open list, such as the Options List, without saving changes.
	Options key - Accesses options to customize your phone. Your System Administrator may have already customized some of your settings. Check with your System Administrator before changing the administrator-only options.
	Hold key - Places an active call on hold. To retrieve a held call, press the call appearance button beside the light that is flashing.
	Redial key - Redials up to 100 previously dialed numbers. Pressing the Redial key twice simultaneously redials the last dialed number.
	Volume control key - Adjusts the volume for the handset, headset, ringer, and handsfree speaker.
	Line/Call Appearance key - Connects you to a line or call. The Aastra 6753i IP phone supports up to 3 line keys.
	Handsfree key - Activates Handsfree for making and receiving calls without lifting the handset. When the audio mode option is set, this key is used to switch between a headset and the handsfree speakerphone.
	Mute key - Mutes the microphone so that your caller cannot hear you (the light indicator flashes when the microphone is on mute).

Keys	Key Description
	<p>Navigation keys - Pressing the UP and DOWN arrow keys lets you view different status and text messages on the LCD display (if there is more than 1 line of status/text messages). These buttons also let you scroll through menu selections, such as the Options List.</p> <p>Pressing the LEFT and RIGHT arrow keys lets you view the different line/call appearances. While in the Options List, these keys allow you to exit or enter the current option. When you are editing entries on the display, pressing the LEFT arrow key erases the character on the left; pressing the RIGHT arrow key sets the option.</p>
	<p>Programmable keys - 6 Top Keys - all 6 keys are programmable. Keys 1 and 2 are designated as the SAVE and DELETE keys, respectively. These keys are locked but can be unlocked and made configurable if required by the System Administrator.</p> <p>The following are the default functions for the programmable keys on the 6753i IP phone:</p> <p>1 - SAVE Allows you to save numbers and/or names to the Directory. Using this key, you enter the number, name, and line (or speeddial key) to record in the Directory List.</p> <p>2 - DELETE Allows you to delete a single entry or all entries from the Directory List and Callers List.</p> <p>3 - DIRECTORY Displays up to 200 names and phone numbers (stored in alphabetical order).</p> <p>4 - CALLERS LIST Accesses the last 200 calls received.</p> <p>5 - TRANSFER Transfers the active call to another number.</p> <p>6 - CONFERENCE Begins a conference call with the active call.</p> <p>Notes:</p> <ol style="list-style-type: none"> For more information about programming the SAVE and DELETE keys, see “Locking/Unlocking the SAVE and DELETE keys (6753i)” on page 5-50. For more information about configuring keys 1 thru 6 to perform specific functions, see Chapter 5 the section, “Softkeys/Programmable Keys/Feature Keys/Expansion Module Keys” on page 5-142.

*See the Aastra 6753i User Guide for more information about each of these keys.

Model 6755i IP Phone

This section provides brief information about the Model 6755i IP Phone. It includes a list of features, and describes the hard keys, default programmable keys, and default softkeys on the 6755i.

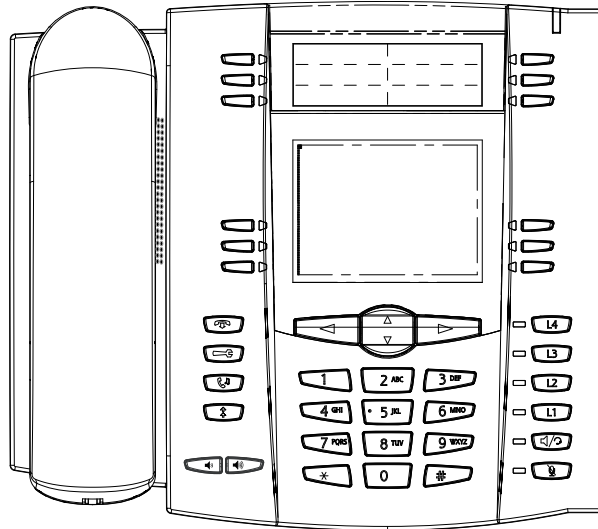









6755i Phone Features

- 8 line graphical LCD screen (144 x 75 pixels) with white backlight
- 12 programmable keys
 - 6 programmable hard keys on the top
 - 6 programmable state-based softkeys on the bottom
- 4 call appearance lines with LEDs
- Press-and-Hold speeddial key configuration feature
- Supports up to 9 call lines
- Full-duplex speakerphone for handsfree calls
- Headset support (modular connector)
- Built-in-two-port, 10/100 Ethernet switch - lets you share a connection with your computer.



- Inline power support (based on 802.3af standard) which eliminates power adapters.
- AC power adapter (included)
- Enhanced busy lamp fields*
- Set paging*

*Availability of feature dependant on your phone system or service provider.

6755i Key Descriptions*

Keys	Key Description
	Goodbye key - Ends an active call. The Goodbye key also exits an open list, such as the Options List, without saving changes.
	Options key - Accesses options to customize your phone. Your System Administrator may have already customized some of your settings. Check with your System Administrator before changing the administrator-only options.
	Hold key - Places an active call on hold. To retrieve a held call, press the call appearance button beside the light that is flashing.
	Redial key - Redials up to 100 previously dialed numbers. Pressing the Redial key twice simultaneously redials the last dialed number.
	Volume control key - Adjusts the volume for the handset, headset, ringer, and handsfree speaker.
   	Line/Call Appearance key - Connects you to a line or call. The Aastra 6755i IP phone supports up to 4 line keys.

IP Phone Models

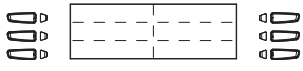
Keys	Key Description												
	<p>Handsfree key - Activates Handsfree for making and receiving calls without lifting the handset. When the audio mode option is set, this key is used to switch between a headset and the handsfree speakerphone.</p>												
	<p>Mute key - Mutes the microphone so that your caller cannot hear you (the light indicator flashes when the microphone is on mute).</p>												
	<p>Navigation keys - Pressing the UP and DOWN arrow keys lets you view different status and text messages on the LCD display (if there is more than 1 line of status/text messages). These buttons also let you scroll through menu selections, such as the Options List.</p> <p>Pressing the LEFT and RIGHT arrow keys lets you view the different line/call appearances. While in the Options List, these keys allow you to exit or enter the current option. When you are editing entries on the display, pressing the LEFT arrow key erases the character on the left; pressing the RIGHT arrow key sets the option.</p>												
	<p>Programmable keys - 6 Top keys: programmable hard keys (up to 6 programmable functions)</p> <p>By default, the top keys 1 through 4 are assigned as Services, Directory, Callers List, and Intercom, respectively. Keys 5 and 6 have no assigned functions. All 6 keys are programmable and can be assigned to perform specific functions.</p> <p>The following are the default functions for the programmable keys on the 6755i IP phone:</p> <table border="0"> <tr> <td style="vertical-align: top;">1 - SERVICES</td> <td>Accesses enhanced features and services such as XML applications and voicemail, provided by third parties.</td> </tr> <tr> <td style="vertical-align: top;">2 - DIRECTORY</td> <td>Displays up to 200 names and phone numbers (stored in alphabetical order).</td> </tr> <tr> <td style="vertical-align: top;">3 - CALLERS LIST</td> <td>Accesses the last 200 calls received.</td> </tr> <tr> <td style="vertical-align: top;">4 - ICOM</td> <td>Accesses another extension on the network.</td> </tr> <tr> <td style="vertical-align: top;">5 - NONE</td> <td>No assigned function.</td> </tr> <tr> <td style="vertical-align: top;">6 - NONE</td> <td>No assigned function.</td> </tr> </table> <p>Note: For more information about configuring the programmable keys 1 through 6 to perform specific functions, see Chapter 5, "Configuring Operational Features" the section, "Softkeys/Programmable Keys/Feature Keys/Expansion Module Keys" on page 5-142.</p>	1 - SERVICES	Accesses enhanced features and services such as XML applications and voicemail, provided by third parties.	2 - DIRECTORY	Displays up to 200 names and phone numbers (stored in alphabetical order).	3 - CALLERS LIST	Accesses the last 200 calls received.	4 - ICOM	Accesses another extension on the network.	5 - NONE	No assigned function.	6 - NONE	No assigned function.
1 - SERVICES	Accesses enhanced features and services such as XML applications and voicemail, provided by third parties.												
2 - DIRECTORY	Displays up to 200 names and phone numbers (stored in alphabetical order).												
3 - CALLERS LIST	Accesses the last 200 calls received.												
4 - ICOM	Accesses another extension on the network.												
5 - NONE	No assigned function.												
6 - NONE	No assigned function.												

Keys	Key Description
	<p>Softkeys - 6 Bottom keys: programmable state-based softkeys (up to 20 programmable functions).</p> <p>By default, the bottom softkeys 2 through 6 have no assigned functions. You can configure all 6 bottom softkeys to perform specific functions on the 6755i IP phone. However, after you lift the handset, there are specific static softkeys that display that cannot be changed. These are as follows:</p> <p>1 - DIAL Allows you to dial out on the phone. 2 - CONF Begins a conference call with the active phone. 3 - XFER Transfers the active call to another number.</p> <p>Note: For more information about configuring softkeys 1 through 6 to perform specific functions, see Chapter 5, "Configuring Operational Features" the section, "Softkeys/Programmable Keys/Feature Keys/Expansion Module Keys" on page 5-142.</p>

*See the Aastra 6755i User Guide for more information about each of these keys.

Model 6757i and 6757i CT IP Phones

This section provides brief information about the 6757i IP Phone. It includes a list of features, and describes the hard keys and default softkeys on the 6757i.

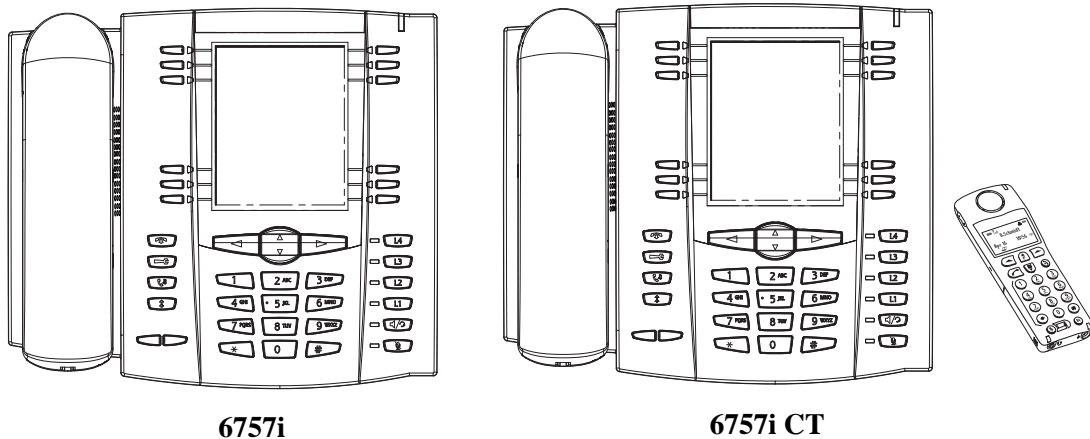









6757i and 6757i CT Phone Features

- 11 line graphical LCD screen (144 x 128 pixels) with white backlight
- 12 multi-functional softkeys
 - 6 Top Keys: programmable static softkeys
 - 6 Bottom Keys: programmable state-based softkeys
- 4 call appearance lines with LEDs
- Press-and-Hold speeddial key configuration feature
- Supports up to 9 call lines
- Full-duplex speakerphone for handsfree calls
- Headset support (modular connector)
- Built-in-two-port, 10/100 Ethernet switch - lets you share a connection with your computer.



- Inline power support (based on 802.3af standard) which eliminates power adapters.
- AC power adapter (included)
- Enhanced busy lamp fields*
- Set paging*

*Availability of feature dependant on your phone system or service provider.

6757i and 6757i CT Key Descriptions*

Keys	Key Description
	Goodbye key - Ends an active call. The Goodbye key also exits an open list, such as the Options List, without saving changes.
	Options key - Accesses options to customize your phone. Your System Administrator may have already customized some of your settings. Check with your System Administrator before changing the administrator-only options.
	Hold key - Places an active call on hold. To retrieve a held call, press the call appearance button beside the light that is flashing.
	Redial key - Redials up to 100 previously dialed numbers. Pressing the Redial key twice simultaneously redials the last dialed number.
	Volume control key - Adjusts the volume for the handset, headset, ringer, and handsfree speaker.
   	Line/Call Appearance key - Connects you to a line or call. The Aastra 6757i IP phone supports up to 4 line keys.

IP Phone Models

Keys	Key Description
	Handsfree key - Activates Handsfree for making and receiving calls without lifting the handset. When the audio mode option is set, this key is used to switch between a headset and the handsfree speakerphone.
	Mute key - Mutes the microphone so that your caller cannot hear you (the light indicator flashes when the microphone is on mute).
	Navigation keys - Pressing the UP and DOWN arrow keys lets you view different status and text messages on the LCD display (if there is more than 1 line of status/text messages). These buttons also let you scroll through menu selections, such as the Options List. Pressing the LEFT and RIGHT arrow keys lets you view the different line/call appearances. While in the Options List, these keys allow you to exit or enter the current option. When you are editing entries on the display, pressing the LEFT arrow key erases the character on the left; pressing the RIGHT arrow key sets the option.

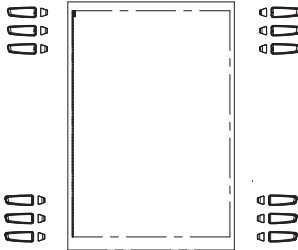
Keys	Key Description																				
	<p>Softkeys - 12 softkeys on the 6757i IP Phone.</p> <ul style="list-style-type: none"> - 6 Top Keys: programmable static softkeys (up to 10 programmable functions) - 6 Bottom Keys: programmable state-based softkeys (up to 20 programmable functions) <p>By default, the top softkeys 1 through 4 are assigned as Services, Directory, Callers List, and Intercom, respectively. Keys 5 and 6 have no assigned functions. All 6 keys are programmable and can be assigned to perform specific functions.</p> <p>The following are the default functions for the top softkeys on the 6757i IP phone:</p> <table border="0"> <tr> <td style="vertical-align: top;">1 - SERVICES</td> <td>Accesses enhanced features and services such as XML applications and voicemail, provided by third parties.</td> </tr> <tr> <td style="vertical-align: top;">2 - DIRECTORY</td> <td>Displays up to 200 names and phone numbers (stored in alphabetical order).</td> </tr> <tr> <td style="vertical-align: top;">3 - CALLERS LIST</td> <td>Accesses the last 200 calls received.</td> </tr> <tr> <td style="vertical-align: top;">4 - ICOM</td> <td>Accesses another extension on the network.</td> </tr> <tr> <td style="vertical-align: top;">5 - NONE</td> <td>No assigned function.</td> </tr> <tr> <td style="vertical-align: top;">6 - NONE</td> <td>No assigned function.</td> </tr> <tr> <td style="vertical-align: top;">7 - NONE</td> <td>No assigned function.</td> </tr> </table> <p>By default, the bottom softkeys 8 through 12 have no assigned functions. You can configure all 6 bottom softkeys to perform specific functions on the 6757i IP phone. However, after you lift the handset, there are specific static softkeys that display that cannot be changed. These are as follows:</p> <table border="0"> <tr> <td style="vertical-align: top;">7- DIAL</td> <td>Allows you to dial out on the phone.</td> </tr> <tr> <td style="vertical-align: top;">8- CONF</td> <td>Begins a conference call with the active phone.</td> </tr> <tr> <td style="vertical-align: top;">9- XFER</td> <td>Transfers the active call to another number.</td> </tr> </table> <p>Note: For more information about programming the softkeys to perform specific functions, see Chapter 5, "Configuring Operational Features" the section, "Softkeys/Programmable Keys/Feature Keys/Expansion Module Keys" on page 5-142.</p>	1 - SERVICES	Accesses enhanced features and services such as XML applications and voicemail, provided by third parties.	2 - DIRECTORY	Displays up to 200 names and phone numbers (stored in alphabetical order).	3 - CALLERS LIST	Accesses the last 200 calls received.	4 - ICOM	Accesses another extension on the network.	5 - NONE	No assigned function.	6 - NONE	No assigned function.	7 - NONE	No assigned function.	7- DIAL	Allows you to dial out on the phone.	8- CONF	Begins a conference call with the active phone.	9- XFER	Transfers the active call to another number.
1 - SERVICES	Accesses enhanced features and services such as XML applications and voicemail, provided by third parties.																				
2 - DIRECTORY	Displays up to 200 names and phone numbers (stored in alphabetical order).																				
3 - CALLERS LIST	Accesses the last 200 calls received.																				
4 - ICOM	Accesses another extension on the network.																				
5 - NONE	No assigned function.																				
6 - NONE	No assigned function.																				
7 - NONE	No assigned function.																				
7- DIAL	Allows you to dial out on the phone.																				
8- CONF	Begins a conference call with the active phone.																				
9- XFER	Transfers the active call to another number.																				

*See the Aastra 6757i or 6757i CT User Guide for more information about each of these keys.

6757i CT Cordless Handset Features

- 5 line backlit display screen
- 2 multi-functional softkeys
- Programmable function key supports up to 14 functions
- Vibration Alerter
- Headset Jack
- Desk charging stand

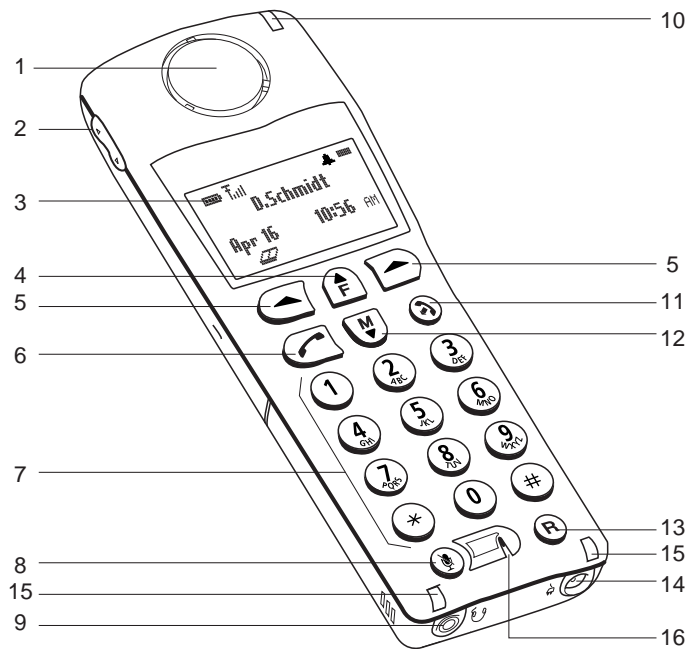

6757i CT Cordless Handset Key Descriptions

Function #	Function Description
1	Receiver
2	Volume key During Ringing: Adjusts ringer volume During a call: Adjusts receiver volume During text mode (not in a call): Moves cursor right/left
3	Display
4	Features <i>f</i> Key List Access key to the programmed Feature Key List Scrolls up when in the various lists Adds a space during editing
5	Softkeys Activates feature or option shown on the display above the keys
6	Call key Used to obtain dial tone Also used as a Hold key
7	Dial Pad
8	Mute Key When used, prevents the caller from hearing you
9	Headset Jack
10	Status Light
11	Release key To end calls and go on hook Exits Menu and the various lists
12	Menu Key Access key to the different Options Scrolls down when in the various lists Used as Backspace during editing
13	Redial Key Displays the last 10 numbers dialed
14	Charging Jack
15	Charging Contacts
16	Microphone

Firmware Installation Information

Description

The firmware setup and installation for the IP phone can be done using any of the following:

- Phone User Interface via the keypad (Phone UI)
- Aastra Web-based user interface (Aastra Web UI)

When the IP phone is initialized for the first time, DHCP is enabled by default. Depending on the type of configuration server setup you may have, the IP phone may download a firmware version automatically, or you may need to download it manually.

Installation Considerations

The following considerations must be made before connecting the IP phone to the network:

- If you are planning on using dynamic IP addresses, make sure a DHCP server is enabled and running on your network.
- If you are not planning on using dynamic IP addresses, see Chapter 4, the section, “[Configuring Network Settings Manually](#)” on [page 4-24](#) for manually setting up an IP address.

To install the IP phone hardware and cabling, refer to the model-specific *SIP IP Phone Installation Guide*.

Installation Requirements

The following are general requirements for setting up and using your SIP IP phone:

- SIP-based IP PBX system or network installed and running with a SIP account created for the IP phone.
- Ethernet/Fast Ethernet LAN (10/100 Mb)
- Category 5/5e straight through cabling
- Power source
 - For Ethernet networks that supply in-line power to the phone (IEEE 802.3af):
 - For power, use the Ethernet cable (supplied) to connect from the phone directly to the network for power. (No power adapter required.)
 - For Ethernet networks that DO NOT supply power to the phone:
 - For power, use the Power Adapter to connect from the DC power port on the phone to a power source.
 - or
 - (optional) - For power, use a Power over Ethernet (PoE) power injector. A PoE power injector is available as an optional accessory from Aastra Telecom. Contact your Reseller for more information.

Configuration Server Requirement

A basic requirement for setting up the IP phone is to have a configuration server. The configuration server allows you to:

- Store the firmware images that you need to download to your IP phone.
- Stores configuration files for the IP phone

Reference

To set the protocol for your configuration server, see [Chapter 4](#), the section, “[Configuring the Configuration Server Protocol](#)” on page 4-112.

To update the firmware on your phone, see [Chapter 8](#), “[Upgrading the Firmware](#)”.

Firmware and Configuration Files

Description

By default on startup, the phone downloada its firmware and configuration files from the configuration server you have set; or you can manually download the firmware from the configuration server. The phone supports TFTP, FTP, HTTP and HTTPS configuration servers.



Note: Automatic download is dependant on your configuration server setup. For more information about manual and automatic download of firmware, see [Chapter 8, “Upgrading the Firmware.”](#) For more information on changing the download protocol on your phone, see [Chapter 4, the section, “Configuring the Configuration Server Protocol”](#) on page 4-112.

The IP Phone firmware file (*.st*) include all the necessary files you need for your phone.

The firmware consists of the following file:

- *<phone model>.st* - This file contains information about the specific IP Phone model and contains the language packs to load to the phone.

The configuration files consist of two files called:

- *aastra.cfg* - This file contains configuration information about the IP Phone.
- *<MAC>.cfg* (for example, 00085D1610DE.cfg) - This file contains configuration information about the IP Phone.

The following table provides the files that the phone requests from the configuration server during bootup of the phone:

IP Phone Model	Associated Firmware	Configuration Files	Language Files
9143i	9143i.st	aastra.cfg	lang_de.txt (German)
9480i	9480i.st	<MAC>.cfg (for example, 00085D1610DE.cfg)	lang_es.txt (Spanish)
9480i CT	9480iCT.st		lang_es_mx.txt (Mexican Spanish)
6730i	6730i.st		lang_fr.txt (French)
6731i	6731i.st		lang_fr_ca.txt (Canadian French)
6751i	51i.st		lang_it.txt (Italian)
6753i	53i.st		lang_pt.txt (Portuguese)
6755i	55i.st		lang_pt_br.txt (Brazilian Portuguese)
6757i	57i.st		
6757i CT	57iCT.st		

Reference

For more information about loading language files and using the various languages on the IP phone, see Chapter 5, the section, “[Language](#)” on [page 5-34](#).

Configuration File Precedence

Aastra IP phones can accept two sources of configuration data:

- The server configuration most recently downloaded/cached from the configuration server files, *aastra.cfg/<mac>.cfg* (or the *aastra.tuz/<mac>.tuz* encrypted equivalents).
- Local configuration changes stored on the phone that were entered using either the IP phone UI or the Aastra Web UI

In the event of conflicting values set by the different methods, values are applied in the following sequence:

1. Default values hard-coded in the phone software
2. Values downloaded from the configuration server
3. Values stored locally on the phone

The last values to be applied to the phone configuration are the values that take effect.

For example, if a parameter's value is set in the local configuration (via Aastra Web UI or IP phone UI) and the same value was also set differently in one of the *<mac>.cfg/aastra.cfg* files on the configuration server, the local configuration value is the value that takes effect because that is the last value applied to the configuration.

Installing the Firmware/Configuration Files

The following procedure describes how to install the firmware and configuration files.

Step	Action
1	If DHCP is disabled, manually enter the configuration server's IP address. For details on manually setting DHCP, see Chapter 4, the section "DHCP" on page 4-4 .
2	Copy the firmware file <i><phone model>.st</i> to the root directory of the configuration server. The IP phone accepts the new firmware file only if it is different from the firmware currently loaded on the IP phone. Note: The <i><phone model></i> attribute is the IP phone model (i.e., 9143i.st, 9480i.st, 9480iCT.st, 6730i.st, 6731i.st, 51i.st, 53i.st, 55i.st, 57i.st, 57iCT.st).
3	Copy the Aastra configuration files (<i>aastra.cfg</i> and <i><mac>.cfg</i>) to the root directory of the configuration server. Note: The <i><mac></i> attribute represents the actual MAC address of your phone. (i.e., <i>00085D030996.cfg</i>).
4	Note: Restart the IP phone as described in Chapter 3, "Restarting Your Phone" on page 3-13 .

Multiple Configuration Server Support

An Administrator has the option of specifying whether the phones get their firmware file, directory files, language packs, TLS certificate files, 802.1x certificate files, and HTTPS files from the original configuration server or from another server in the network. This feature allows you to specify the URL of other servers from which the phone can get this information.

Firmware Files and Multiple Configuration Servers

The firmware file for the phones can be downloaded from the original configuration server or from another server specified by a URL. You can specify a valid URL (server IP address) from which the phones get the firmware using a new parameter called, “**firmware server**” in the configuration files. If a URL is specified for this parameter, the phones in the network get the *security.tuz*, *<mac>.cfg*, and *aastra.cfg* files from the original configuration server, and the firmware files from the server specified in the URL.



Note: The default method for the download of all files and firmware to the phones is from the original configuration server. The Administrator must **specify a correct server URL** for the phones to get their firmware information from that server. If the URL is incorrect, no firmware download occurs to the phones from the specified server.

Examples

To download all configuration and firmware files from the original configuration server:

```
firmware server:
```

Leaving this parameter blank downloads all configuration and firmware files from the original configuration server.

To download all firmware files from another specified server:

```
firmware server: tftp://10.30.102.158/test1
```

The above example uses TFTP to download all firmware files that exist in the “test1” directory on the specified server, to the phones.



Note: Specifying the download of a “.st” file is not supported. For example, the following filename should NEVER be entered as a value string for the “**firmware server**” parameter:

firmware server: tftp://10.30.102.158/test1/**57i.st**

Specifying a Server to Download Firmware Files

You can use the following parameter to specify a server other than the original configuration server from which the phones get their firmware:

- **firmware server.**



Configuration Files

For the specific parameter you can set in the configuration files, see Appendix A, the section, “[Multiple Configuration Server Settings](#)” on [page A-29](#).

Directory Files, Language Packs, TLS Certificates, 802.1x Certificates, HTTPS Files and Multiple Configuration Servers

The directory files, language packs, TLS certificate files, 802.1x certificate files, and HTTPS files can also be downloaded to the phone from a server other than the configuration server. For each of these types of files, you can specify a URL (server IP address) from which the phone gets these files. You can use existing parameters on the phone to specify the URL. For applicable parameters, see [“Specifying a Server Using Existing Parameters on the IP Phones”](#) on page 1-48.

The following table specifies the files that the original configuration server downloads, and the files that another server can download to the phone.

Files always downloaded from original configuration server are, by order:	All files that can be downloaded from original configuration server OR another specified server are, by order:
<p><i>security.tuz</i> <i><mac>.cfg/<mac>.tuz</i> <i>aastra.cfg/aastra.tuz</i></p>	<p>Directory Files</p> <ul style="list-style-type: none"> • directory 1 • directory 2 <p>Language Pack Files</p> <ul style="list-style-type: none"> • language 1 • language 2 • language 3 • language 4 <p>Transport Layer Security (TLS) Certificate Files</p> <ul style="list-style-type: none"> • sips root and intermediate certificates • sips local certificate • sips private key • sips trusted certificates <p>802.1x Security Authentication Certificate Files</p> <ul style="list-style-type: none"> • 802.1x root and intermediate certificates: • 802.1x local certificate: • 802.1x trusted certificates <p>HTTPS Files</p> <ul style="list-style-type: none"> • https user certificates

Specifying a Server Using Existing Parameters on the IP Phones

The following table provides the parameters on the phone that you can use to download directory files, language packs, TLS certificates, 802.1x certificates, and HTTPS files from the original configuration server OR from another server in the network.

Type of File	Parameters that support the Multiple Configuration Server feature are:
Directory Files	directory 1: directory 2:
Language Pack Files	language 1: language 2: language 3: language 4: Valid files names you can specify for languages are: lang_de.txt (German)* lang_es.txt (Spanish) lang_es_mx.txt (Mexican Spanish) lang_fr.txt (French) lang_fr_ca.txt (Canadian French) lang_it.txt (Italian) lang_pt.txt (Portuguese) lang_pt_br.txt (Brazilian Portuguese)
Transport Layer Security (TLS) Certificate Files	sips root and intermediate certificates: sips local certificate: sips private key: sips trusted certificates:
802.1x Security Authentication Certificate Files	802.1x root and intermediate certificates: 802.1x local certificate: 802.1x trusted certificates:
HTTPS Files	https user certificates

Reference

For more information on each of these parameters, refer to [Appendix A, “Configuration Parameters.”](#)

Examples

- **Phone Directory Files**

The following example downloads no directory:

```
directory 1:
```

The following example downloads a company directory from the original configuration server:

```
directory 1:companylist.csv
```

The following example downloads a company directory file from the specified server in the “path” directory:

```
directory 1: tftp://10.30.102.158/path/companylist.csv
```



Note: To download a specific file, the string value **MUST HAVE A FILENAME** at the end of the string. For example:

```
directory 1: tftp://10.30.102.158/path/companylist.csv
```

where “**path**” is the directory and “**companylist.csv**” is the filename. If you do not specify a filename, the download fails.

- **Language Pack Files**

The following example downloads no language pack file:

```
language 1:
```

The following example downloads the German language pack to the phones from the original configuration server:

```
language 1: lang_de.txt
```

The following example uses FTP to download the firmware file “lang_de.txt” (German language pack) from the “path” directory on server 1.2.3.4 using port 50:

```
language 1:ftp://admin:admin!@1.2.3.4:50/path/lang_de.txt
```

- **Transport Layer Security (TLS) Certificate Files**

The following example downloads no local certificate file:

```
sips local certificate:
```

The following example downloads the local certificate file from the original configuration server.

```
sips local certificate: phonesLocalCert.pem
```

The following example uses FTP to download the firmware file “phonesLocalCert.pem” (local certificate file) from the “path” directory on server 1.2.3.4 using port 50.

```
sips local certificate:ftp://admin:admin!@1.2.3.4:50/path/  
phonesLocalCert.pem
```

- **802.1x Security Authentication Certificate Files**

The following example downloads no 802.1x local certificate file:

```
802.1x local certificate:
```

The following example downloads the 802.1x local certificate for the phone from the original configuration server.

```
802.1x local certificate: 8021xlocalCert.pem
```

The following example uses FTP to download the firmware file “8021xlocalCert.pem” (802.1x local certificate file) from the “path” directory on server 1.2.3.4 using port 50.

```
802.1x local certificate:ftp://admin:admin!@1.2.3.4:50/path/  
8021xlocalCert.pem
```

- **HTTPS User Certificate Files**

The following example downloads no HTTPS user certificate files:

```
https user certificates:
```

The following example downloads the HTTPS user certificates for the phone from the original configuration server.

```
https user certificates: trustedCerts.pem
```

The following example uses FTP to download the firmware file “user.crt.pem” (https user certificate file) from the “test1” directory on server 12.43.33.234 using port 50.

```
https user certificates: ftp://test:password@12.43.33.234:50/test1/  
user.crt.pem
```

Chapter 2

Configuration Interface Methods

About this chapter

Introduction

This chapter describes the methods you, as an Administrator, can use to configure the IP phones.



Note: Features, characteristics, requirements, and configuration that are specific to a particular phone model are indicated where required in this guide.

Topics

This chapter covers the following topics:

Topic	Page
Configuration Methods	page 2-2
IP Phone UI	page 2-2
Aastra Web UI	page 2-6
Configuration Files (Administrator Only)	page 2-17

Configuration Methods

Description

You can use the following to setup and configure the IP phone:

- IP phone UI
- Aastra Web UI
- Configuration files



Note: Not all parameters are available from all three methods. For more information about configuring the phone, see [Chapter 4](#), [Chapter 5](#), and [Chapter 6](#).

The following paragraphs describe each method of configuring the IP Phone.

IP Phone UI

The IP Phone User Interface (UI) provides an easy way to access features and functions for using and configuring the IP phone. Access to specific features and functions are restricted to the Administrator. A User can configure a subset of these features and functions. Users of the IP phones should see their *Model-specific User's Guide* for available features and functions.

Reference

Refer to [Chapter 1](#), the section “[IP Phone Models](#)” on [page 1-3](#) for keys specific to your phone model.

For more information about using the hard keys on each phone, see [Chapter 5](#), the section, “[Locking IP Phone Keys](#)” on [page 5-49](#).

For more information about the softkeys/programmable keys, see [Chapter 5](#), the section, “[Softkeys/Programmable Keys/Feature Keys/Expansion Module Keys](#)” on [page 5-142](#).

Options Key

The Options key allows you to access the "Options List" on the IP phone. Accessible options in this list are for both User and Administrator use. The Administrator must enter a password for administrator options.



Note: An Administrator can apply a simplified options menu to the IP phones. An Administrator can also enable and disable the use of an Administrator password protection in the IP phone UI. These features are configurable using the configuration files only.

For more information about these features, see Chapter 3, the section, ["Simplified IP Phone UI Options Menu"](#) on page [page 3-5](#), and Chapter 5, the section, ["Administrator Passwords"](#) on [page 5-9](#).

This document describes the administrator options only. For a description of the user options in the "Options List", see your model-specific *SIP IP Phone User Guide*.

The following illustrations indicate the location of the Options Key on each phone model.

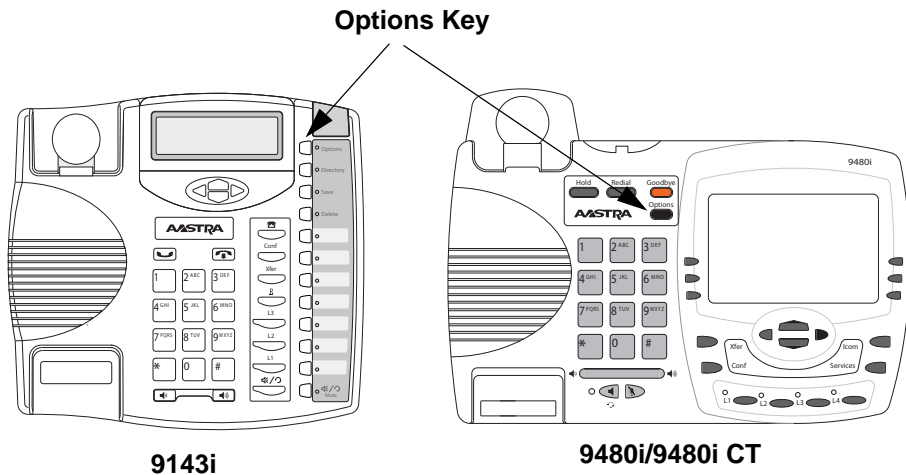

Options Key

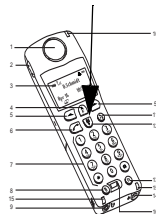

9480i CT Handset

Options Key

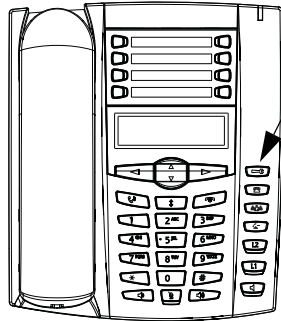

6730i

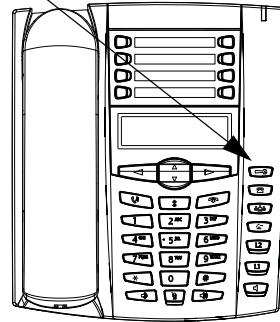

6731i

Options Key

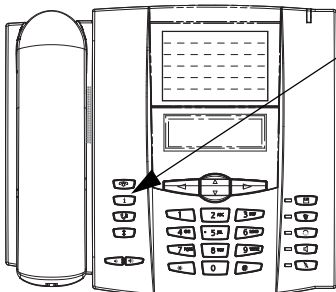

6751i

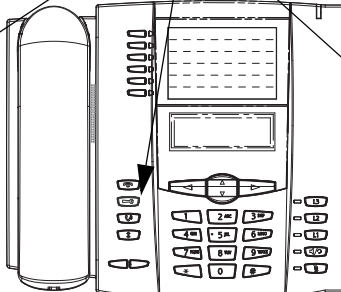

6753i

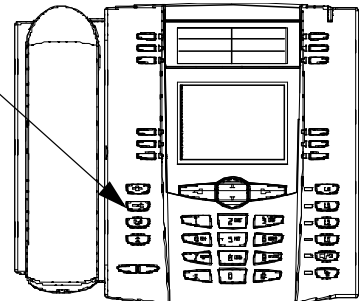

6755i

Options Key

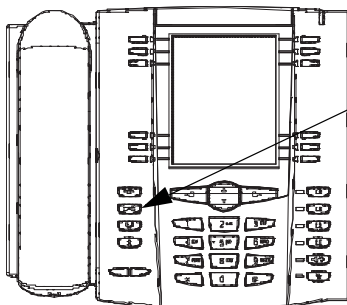

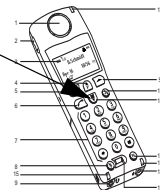

6757i/6757i CT



6757i CT Handset

Using the Options Key

Step	Action
1	Press the Options key on the phone to enter the Options List. Note: Press the Services key on the 6751i and then select Options from the list.
2	Use the r and s to scroll through the list of options.
3	On 3-line LCD phones: To select an option, press the Enter softkey, or select the number on the keypad that corresponds to the option in the Option List. On 8 and 11-line LCD phones: To select an option, press the Select softkey, press 4, or select the number on the keypad that corresponds to the option in the Option List.
4	On 3-line LCD phones: Use the Set softkey after making a change to an option, to save the change. On 8 and 11-line LCD phones: Use the Change softkey to change a selected option.
5	Press the Done softkey at any time to save the changes and exit the current option.
6	Press the Cancel softkey, press 3, press  , or press  any time to exit without saving changes.

From the CT handsets:

Step	Action
1	Press the Å key to enter the Options List when the phone is not in use.
2	Use the scroll keys Å and Ï to scroll the options.
3	To select and change an option, press the r keys.
4	Press y when done.

Aastra Web UI

An administrator can setup and configure the IP phone using the **Aastra Web UI**. The **Aastra Web UI** supports Internet Explorer and Gecko engine-based browsers like Firefox, Mozilla or Netscape.



Note: An Administrator can enable or disable the Aastra Web UI for a single phone or all phones in a network. For more information about enabling/disabling the Aastra Web UI, see [“Enabling/Disabling the Aastra Web UI”](#) on page 2-16.

HTTP/HTTPS Support

The Aastra Web UI supports both Hypertext Transfer Protocol (HTTP) and Hypertext Transfer Protocol over Secure Socket Layer (HTTPS) client and server protocols.

HTTP is the set of rules for transferring files (text, graphic images, sound, video, and other multimedia files) over the Internet. When you open your Web browser, you are indirectly making use of HTTP. HTTP is an application protocol that runs on top of the TCP/IP suite of protocols (the foundation protocols for the Internet).

HTTPS is a Web protocol that encrypts and decrypts user page requests as well as the pages that are returned by the Web server. HTTPS uses Secure Socket Layer (SSL) or Transport Layer Security (TLS) as a sublayer under its regular HTTP application layering. SSL is a commonly-used protocol for managing the security of a message transmission on the Internet. It uses a 40-bit key size for the RC4 stream encryption algorithm, which is considered an adequate degree of encryption for commercial exchange. TLS is a protocol that ensures privacy between communicating applications and their users on the Internet. When a server and client communicate, TLS ensures that no third party may eavesdrop or tamper with any message. TLS is the successor to SSL.



Note: HTTPS uses port 443 instead of HTTP port 80 in its interactions with the TCP/IP lower layer. Both the HTTP and HTTPS port numbers are configurable using the configuration files, the IP Phone UI, the Aastra Web UI and DHCP Option 66. For more information about configuring these ports, see Chapter 4, the section, [“Configuring the Configuration Server Protocol”](#) on page 4-112.

HTTP/HTTPS Client and Server Support

The Aastra IP phones allow for HTTP request processing and associated data transfers to perform over a secure connection (HTTPS). The IP phones support the following:

- Transfer of firmware images, configuration files, script files, and web page content over a secure connection.
- Web browser phone configuration over a secure connection.
- TLS 1.0 or SSL 3.0 methods for both client and server

HTTPS Client

When an HTTPS client opens and closes its TCP socket, the SSL software respectively handshakes upon opening and disconnects upon closing from the HTTPS server. The main HTTPS client functions are:

- Downloading of configuration files and firmware images.
- Downloading of script files based on an “HTTPS://” URL supplied by a softkey definition.

HTTPS Server

The HTTPS server provides HTTP functionality over secure connections. It coexists with the HTTP server but has its own set of tasks. The main HTTPS server functions are:

- Delivery of web page content to a browser client over a secure connection.
- Execution of HTTP GET and POST requests received over a secure connection

Non-Blocking HTTP Connections

The IP Phones support a non-blocking HTTP connection feature. This feature allows the user to continue using the phone when there is a delay during an HTTP connection while the phone is waiting for the HTTP server to respond. This feature also allows a user to abort the connection and perform other operations on the phone (which will abort the HTTP connection automatically). A user can also abort the HTTP loading by pressing the GOODBYE key while the phone is displaying “Loading Page.....”.



Note: This feature impacts only the HTTP calls triggered by a phone key (softkey or programmable key); the HTTP calls performed by action URIs are still blocking.

Authentication Support for HTTP/HTTPS Download Methods for Broadsoft Client Management System (CMS)

The IP Phones have authentication support per RFC 2617 when using HTTP or HTTPS as download protocols. If a 5i Series phone is challenged by an HTTP or HTTPS server when the server attempts to download the *aastra.cfg* file, the phone automatically sends "aastra" as the default Username and Password back to the server. For more information about this feature, see Chapter 5, the section, [“Authentication Support for HTTP/HTTPS Download Methods, used with Broadsoft Client Management System \(CMS\)”](#) on page 5-370.

Using HTTPS via the Aastra Web UI

HTTPS is enabled by default on the IP phones. When you open a browser window and enter an IP address or host name for a phone using HTTP, a server redirection occurs which automatically converts an HTTP connection to an HTTPS connection. After the redirection, a “Security Alert” certificate window displays alerting the user that information exchanged with the phone cannot be viewed or changed by others. Accepting the certificate then forwards you to the phone’s Web UI.



Notes:

1. The private key and certificate generate outside the phone and embed in the phone firmware for use by the HTTPS server during the SSL handshake.
2. Using the configuration files, the IP phone UI, or the Aastra Web UI, you can configure the following regarding HTTPS:
 - Specify HTTPS security client method to use (TLS 1.0 or SSL 3.0)
 - Enable or disable HTTP to HTTPS server redirect function
 - HTTPS server blocking of XML HTTP POSTS to the phone



Reference

For more information on configuring the HTTPS protocol, see Chapter 4, the sections:

- [“Configuring the Configuration Server Protocol”](#) on page 4-112
- [“HTTPS Client/Server Configuration”](#) on page 4-40

Accessing the Aastra Web UI

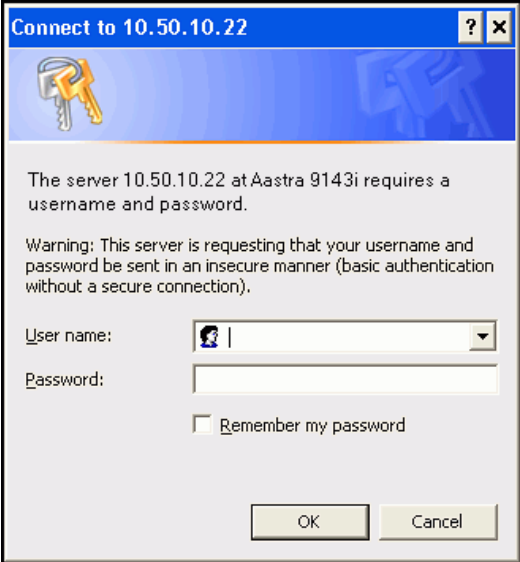
Use the following procedure to access the Aastra Web UI.

Step	Action
1	<p data-bbox="225 387 1215 444">Open your web browser and enter the phone's IP address or host name into the address field. The following is an example of the Login screen that displays.</p> <div data-bbox="268 461 1165 1263"><p data-bbox="268 552 428 609">IP address or host name →</p></div>

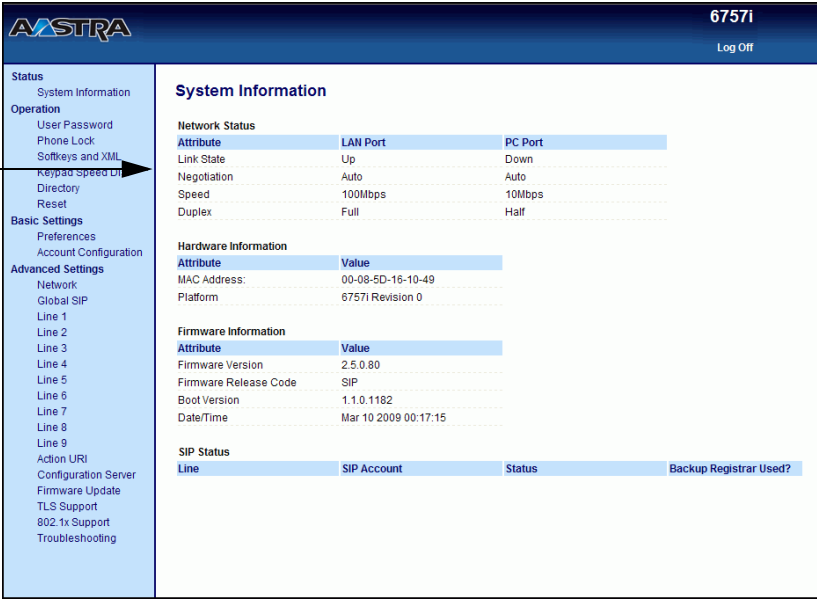
Step	Action
2	<p>Enter your username and password and click  .</p> <p>Note: For an administrator, the default username is “admin” and the password is “22222”. For a user, the default username is “user” and the password field is left blank. The IP phones accept numeric passwords only.</p> <p>The Network Status window displays for the IP phone you are accessing. The following illustration is an example of a Network Status screen for the 6757i IP phone.</p> <div data-bbox="225 505 1232 1107">  <p>6757i Network Status Window</p> </div>
3	<p>You can logout of the Aastra Web UI at any time by clicking LOGOFF.</p>

Depending on the model phone you are accessing, the following categories display in the side menu of the Aastra Web UI: **Status, Operation, Basic Settings, Advanced Settings.**



Note: Programmable Keys apply to the 9143i, 6730i, 6731i, 6753i, and 6755i. Softkeys apply to the 9480i, 9480i CT, 6755i, 6757i, and 6757i CT. Expansion Modules apply to the 6753i, 6755i, 6757i, and 6757i CT only.

Status

The **Status** section displays the network status and the MAC address of the IP phone. It also displays hardware and firmware information about the IP phone. The status window also displays the SIP Account information for each account on the phone. The information in the Network Status window is read-only.

Operation

The **Operation** section provides the following options:

Heading	Description
User Password	Allows you to change user password. (Applicable to User and Administrator)
Phone Lock	Allows you to assign an emergency dial plan to the phone, lock the phone to prevent any changes to the phone and to prevent use of the phone, and reset the user password. Note: You can also configure a softkey to use for locking/unlocking the phone. (Applicable to User and Administrator)
Programmable Keys	9143i - 7 multi-functional programmable keys 6730i - 8 Top, multi-functional programmable keys 6731i - 8 Top, Multi-functional programmable keys 6753i - 6 Top, multi-functional, programmable keys 6755i - 6 Top multi-functional, programmable keys (Applicable to User and Administrator)

Heading	Description
Softkeys and XML	9480i/9480i CT 6 state-based, multi-functional softkeys 6755i 6 Bottom, state-based, multi-functional softkeys 6757i/6757i CT 6 Top, multi-functional, static softkeys 6 Bottom, state-based, multi-functional softkeys (Applicable to User and Administrator)
Expansion Module <N>	The M670i has up to 36 configurable keys. The M675i has up to 60 configurable keys. You can have up to 3 expansion modules attached to a single phone allowing you to configure keys for Expansion Module 1, Expansion Module 2, and Expansion Module 3. See your <i>Model-specific User Guide</i> for applicable expansion modules for your model phone. Note: Expansion Modules apply to the 6753i, 6755i, 6757i, and 6757i CT only. (Applicable to User and Administrator)
Handset Keys (9480i CT and 6757i CT only)	Allows you to configure up to 15 softkeys on the handset. (Applicable to User and Administrator)
Keypad Speed Dial	Allows you to configure up to 9 speeddial keys. These fields map to the keypad digits 1 through 9 on the phone. You can also configure additional speeddials on the programmable keys, softkeys and expansion modules. See your model-specific User Guide for more information about this feature. (Applicable to User and Administrator)
Directory	Allows you to copy the Callers List and Directory List from your IP phone to your PC. (Applicable to User and Administrator)
Reset	Allows you to restart the IP phone when required. (Applicable to User and Administrator). This setting also allows you to set the IP phone back to its factory default settings or remove the local configuration. (Applicable Administrator only)

Basic Settings

The **Basic Settings** section provides the following options:

Heading	Description
Preferences	<p>Allows you to set the following General specifications on the IP phone.</p> <ul style="list-style-type: none"> • Local Dial Plan (Admin Only) • Send Dial Plan Terminator (Admin Only) • Digit Timeout (Admin Only) • Park Call (not available on the 6751i) • Pickup Parked Call (not available on the 6751i) • Suppress DTMF Playback • Display DTMF Digits • Call Waiting • Play Call Waiting Tone • Stuttered Dial Tone • XML Beep Support • Status Scroll Delay • Incoming Call Interrupts Dialing • Switch Focus to Ringing Line • Preferred Line • Preferred Line Timeout (seconds) • Goodbye Key Cancels Incoming Call • UPnP Mapping Lines • Message Waiting Indicator Line • DND Key Mode • Call Forward Key Mode • Use LLDP ELIN <p>This section also allows you to set:</p> <ul style="list-style-type: none"> • Incoming Intercom Settings • Outgoing Intercom Settings (Admin Only; Administrator can enable these for a User if required) • Group Paging RTP Settings • Key Mapping (Admin Only) • Ring Tones • Priority Alert Settings (Admin Only) • Directed Call Pickup Settings (Admin Only) • Auto Call Distribution Settings (Admin Only) • Time and Date Settings • Language Settings (Only the Admin can specify the language pack names to load to the phone). Both the Admin and User can select the language type to display for the Web UI.
Account Configuration	<p>Allows you to configure DND (Do Not Disturb) and/or Call Forwarding by specific account or by all accounts. Also allows you to enable/disable specific states for each account, specify different phone numbers for call forwarding, and specify number of rings for a "No Answer" state.</p>

Advanced Settings (Applicable to Administrator Only)

The **Advanced Settings** section provides the following options:

Heading	Description
Network	Allows you to set Basic Network Settings, Advanced Network Settings, HTTPS Settings, Type of Service DSCP, and VLAN settings.
Global SIP	Allows you to set global Basic SIP Authentication Settings, Basic SIP Network Settings, Advanced SIP Settings, Real-time Transport Protocol (RTP) settings, Codec Preference List Settings, and Autodial Settings that apply to all lines on the IP phone.
Lines 1 through 9	Allows you to set per-line Basic SIP Authentication Settings, Basic SIP Network Settings, Advanced SIP Settings, Real-time Transport Protocol (RTP) settings, and Autodial Settings that apply to specific lines on the IP phone.
Action URI	Allows an administrator to specify a uniform resource identifier (URI) that triggers a GET when certain events occur. An Administrator can also specify a URI to be called, enable polling for the URI, and specify the interval between polls. (Applicable to Administrator Only)
Configuration Server	Allows you to set the protocol to use on the configuration server (TFTP (default), FTP, HTTP, or HTTPS), configure automatic firmware and configuration file updates, enable/disable auto-resync, and assign an XML push server list. (Applicable to Administrator Only)
Firmware Update	Allows you to manually perform a firmware update on the IP phone from the configuration server using any of the IP Phones supported protocols. (Applicable to Administrator Only)
TLS Support	Allows you to specify SIP Root and Intermediate Certificate files, local certificate files, private key filename, and/or trusted certificate filename to use when the phone uses the TLS transport protocol to setup a call. (Applicable to Administrator Only)

Heading	Description
802.1x Support	Allows you to enable/disable the 802.1x Protocol (Extensible Authentication Protocol (EAP)) to use on the IP phones for authentication purposes. Applicable choices are EAP-MD5 or EAP-TLS. (Applicable to Administrator Only)
Troubleshooting	Allows you to perform troubleshooting tasks whereby the results can be forwarded to Aastra Technical Support for analyzing and troubleshooting. (Applicable to Administrator Only)

Enabling/Disabling the Aastra Web UI

The Aastra Web UI is enabled by default on the IP phones. A System Administrator can disable the Aastra Web UI on a single phone or on all phones if required using the configuration files. Use the following procedure to enable and disable the Aastra Web UI.

To disable the Aastra Web UI:

 Configuration Files	
Step	Action
1	Using a text-based editing application, open the <code><mac>.cfg</code> file if you want to disable the Web UI on a single phone. Open the <code>aastra.cfg</code> file to disable the Web UI on all phones
2	Enter the following parameter: <code>web interface enabled: 0</code> Note: A value of zero (0) disables the Web UI on the phone. A value of 1 enables the Web UI.
3	Save the changes and close the <code><mac>.cfg</code> or the <code>aastra.cfg</code> file.
4	Restart the phone to apply the changes. The Aastra Web UI is disabled for a single IP phone or for all phones.

Configuration Files (Administrator Only)

A system administrator can enter specific parameters in the configuration files to configure the IP phones. All parameters in configuration files can only be set by an administrator.

You can enter specific configuration parameters in either of the following configuration files:

- *aastra.cfg*
- *<mac>.cfg*

References

For information about configuration file precedence, see [Chapter 1, “Overview.”](#)

For a description of each configuration file parameter, see [Appendix A, “Configuration Parameters.”](#)

Using the Configuration Files

When you use the configuration files to configure the IP phones, you must use a text-based editing application to open the configuration file (*aastra.cfg* or *<mac>.cfg*).

Use the following procedure to add, delete, or change parameters and their settings in the configuration files.



Note: Apply this procedure wherever this Administrator Guide refers to configuring parameters using the configuration files.



Configuration files

Step	Action
1	Using a text-based editing application, open the configuration file for the phone, for which you want to configure the directory list (either aastra.cfg, <mac>.cfg or both).
2	Enter the required configuration parameters followed by the applicable value. For example, <code>directory 1: company_directory</code> <code>directory 2: my_personal_directory</code>
3	Save the changes and close the configuration file.
4	If the parameter requires the phone to be restarted in order for it to take affect, use the IP Phone UI or the Aastra Web UI to restart the phone.

Locking Parameters in the Configuration File

The IP Phones allow you to lock individual configuration parameters to prevent an end user from changing the configuration on the phone. This feature allows service providers to prevent the end-user from changing the values of specific parameters that would affect the service they provide.

An Administrator can lock parameters on the phone by placing an **exclamation mark (!)** before the parameter in the configuration file. For example,

```
!admin password: 22222  
!emergency dial plan: 911|999
```

You can lock parameters on the phone using the configuration files only. Once the parameters are locked, they cannot be changed at all during the phones run-time. The parameters appear as read-only when accessing the Aastra Web UI and the IP Phone UI. In the Aastra Web UI, they appear grayed out. In the IP Phone UI the ability to change the parameters is removed. In addition, when parameters are locked, they cannot be changed via XML.



Notes:

1. The “parameter locking” feature applies to Release 2.4 and up. Any phones that have a previous release loaded on the phone will not be able to use the locking functionality in the configuration file.
 2. Any parameter duplicated in the *mac.cfg* from the *aastra.cfg* is overwritten by the locking status and the value of the parameter found in the *mac.cfg* file.
-

Limitations

- A User possessing the Administrator password can bypass the locking of configuration server details by defaulting the phone.
- Parameters cannot be locked using XML.
- Configuration files that include locked parameters are not backwards compatible

Chapter 3

Administrator Options

About this chapter

Introduction

The IP phones provide specific options on the IP Phone that only an Administrator can access. These options are password protected and allow an Administrator to change or set features and configuration information as required. For all models, an Administrator can use the IP Phone UI, the Aastra Web UI, or the configuration files to enter and change values.



Note: Specific options are configurable only via the IP Phone UI, and/or Aastra Web UI, and/or configuration files.

This chapter provides information about the available Administrator options.

Topics

This chapter covers the following topics:

Topic	Page
Administrator Level Options	page 3-3
IP Phone UI Options	page 3-3
Aastra Web UI Options	page 3-6
Configuration File Options	page 3-8
Phone Status	page 3-9
Restarting Your Phone	page 3-13

About this chapter

Topic	Page
Set Phone to Factory Defaults/Erase Local Configuration	page 3-15
Basic Settings	page 3-19
Account Configuration	page 3-35
Network Settings	page 3-37
Line Settings	page 3-70
Softkeys, Programmable Keys, Expansion Module Keys	page 3-71
Action URI	page 3-72
Configuration Server Settings	page 3-75
Firmware Update Features	page 3-84
TLS Support	page 3-85
802.1x Support	page 3-89
Troubleshooting	page 3-92

Administrator Level Options

Description

There are options on the IP phone that both a User and Administrator can access. However, there are specific options that an Administrator can access only. These options allow the Administrator to configure and manage local and/or remote IP phones in a network.

An Administrator can access and manage these options using the IP Phone UI, the Aastra Web UI, or the configuration files.

IP Phone UI Options

Using the IP Phone UI, you can access the Administrator options at **Options->Administrator Menu** using the default password of "22222"

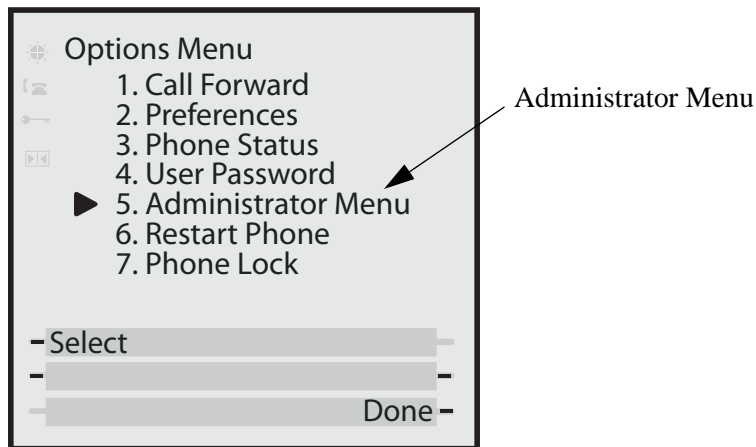

Note: An administrator has the option of enabling and disabling the use of password protection in the IP phone UI. This is configurable using the configuration files only. For more information about this feature, see Appendix A, the section "[Password Settings](#)" on [page A-15](#)

The following are administrator options in the "**Options List**" on the IP phone UI:

- **Administrator Menu**
 - Configuration Server
 - Network Settings
 - SIP Settings
 - Factory Default
 - Erase Local Config.

References

For information about all other user options in the "**Options Menu**", see your model-specific *SIP IP Phone User Guide*.

For procedures on configuring Administrator Options on the IP phone via the IP phone UI, see:

[Chapter 4, "Configuring Network and Session Initiation Protocol \(SIP\) Features"](#)

[Chapter 5, "Configuring Operational Features"](#)

[Chapter 6, "Configuring Advanced Operational Features"](#)

Simplified IP Phone UI Options Menu

An Administrator can replace the existing options menu on the Phone UI with a more simplified options menu. In the configuration files, the “**options simple menu**” parameter allows you to display either the full menu (if set to 0), or the simplified menu (if set to 1). The following table illustrates the differences between the full menu and the simplified menu.

When setting the “**options simple menu**” parameter, the menu changes in the Phone UI only. The Aastra Web UI is not affected.

Full Options Menu	Simplified Options Menu
Call Forward	Call Forward
Preferences	Preferences
Phone Status	Phone Status
User Password	Removed
Administrator Menu	Removed
Restart Phone	Removed
Phone Lock	Phone Lock



Warning: When using the simplified menu, you cannot change the Network settings from the IP Phone UI. If the network settings become misconfigured, you must “factory default” the phone and use the full menu to recover the network settings from the Phone UI **OR** use the Aastra Web UI to configure the network settings.

Configuring the Simplified IP Phone UI Options Menu

You can enable the simplified IP Phone UI Options menu using the configurations files only.



Configuration Files

For the specific parameter you can set in the configuration files, see Appendix A, the section, “[Simplified IP Phone UI Options Menu](#)” on [page A-7](#).

Aastra Web UI Options

An Administrator can configure specific options using the Aastra Web UI. These options display after an Administrator logs into the Web UI using a Web browser and entering the Admin username and password at the login prompt (The default username is "admin" and the default password is "22222". The IP phones accept numeric passwords only.) The column on the left side of the screen indicates the configurable options. A User has limited configuration options as shown in the following illustrations.

Administrator Web UI Menu

Status System Information	Operation User Password Phone Lock Softkeys and XML Keypad Speed Dial Directory Reset	Basic Settings Preferences Account Configuration	Advanced Settings Network Global SIP Line 1 Line 2 Line 3 Line 4 Line 5 Line 6 Line 7 Line 8 Line 9 Action URI Configuration Server Firmware Update TLS Support 802.1x Support Troubleshooting	Network Status
Attribute Link State Negotiation Speed Duplex MAC Address:				
Hardware Information				Attribute Platform
Firmware Information				Attribute Firmware Version Firmware Release Code Boot Version Date/Time
SIP Status				Line

User Web UI Menu

Status System Information	Operation User Password Phone Lock Softkeys and XML Keypad Speed Dial Directory Reset	Basic Settings Preferences Account Configuration	Network Status
Attribute Link State Negotiation Speed Duplex MAC Address:			
Hardware Information			Attribute Platform
Firmware Information			Attribute Firmware Version Firmware Release Code Boot Version Date/Time
SIP Status			Line

The following are options that an Administrator can configure in the Aastra Web UI (and are not available for the User to configure):

- **Operation->Reset**
 - Restore to Factory Defaults
 - Remove Local Configuration Settings
- **Basic Settings->Preferences->General**
 - Local Dial Plan
 - Send Dial Plan Terminator
 - Digit Timeout (seconds)
- **Basic Settings->Preferences->Outgoing Intercom Settings** (User can configure this via the Aastra Web UI if enabled by an Administrator)
- **Basic Settings->Preferences->Key Mapping**
- **Basic Settings->Preferences->Priority Alerting Settings**
- **Basic Settings->Preferences->Directed Call Pickup Settings**
- **Basic Settings->Preferences->Auto Call Distribution Settings**
- **Basic Settings->Preferences->Language Settings**
 - Language 1 (entering language pack filename)
 - Language 2 (entering language pack filename)
 - Language 3 (entering language pack filename)
 - Language 4 (entering language pack filename)
- **Advanced Settings**
 - Network
 - Global SIP
 - Line 1 through 9 Settings
 - Action URI
 - Configuration Server
 - Firmware Update
 - TLS Support
 - 802.1x Support
 - Troubleshooting

References

For information about options available to a User AND Administrator in the Aastra Web UI, see your Model-specific *User Guide*.

For procedures to Restart your phone or restore factory defaults, see [“Restarting Your Phone”](#) on page 3-13, and [“Set Phone to Factory Defaults/Erase Local Configuration”](#) on page 3-15.

For more information about Advanced Settings for the IP Phone, see [Chapter 4, “Configuring Network and Session Initiation Protocol \(SIP\) Features.”](#)

For procedures on configuring the Basic Settings for the IP Phone, see [Chapter 5, “Configuring Operational Features.”](#)

Configuration File Options

An Administrator can enter specific parameters in the configuration files to configure the IP phones. All parameters in configuration files can only be set by an administrator.

References

For a procedure on using the configuration files, see [Chapter 2](#), the section, [“Configuration Files \(Administrator Only\)”](#) on page 2-1.

For a description of each parameter you can enter in the configuration files, see [Appendix A, “Configuration Parameters.”](#)

Phone Status

The **Phone Status** on the IP Phone displays the network status and firmware version of the IP phone.

You can display phone status using the IP phone UI or the Aastra Web UI.

Phone Status via IP Phone UI

In the IP phone UI, the Phone Status options are available to the user and the administrator and do not require a password entry.

The following options display for phone status on the IP phone UI:

Phone Status Screen for 3-Line LCD Display Phones

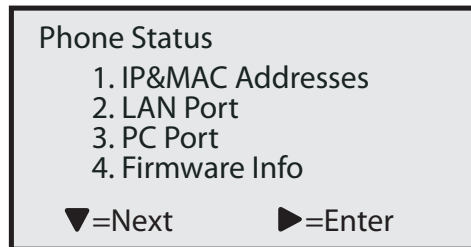

Phone Status Screen for 8 and 11-Line LCD Display Phones

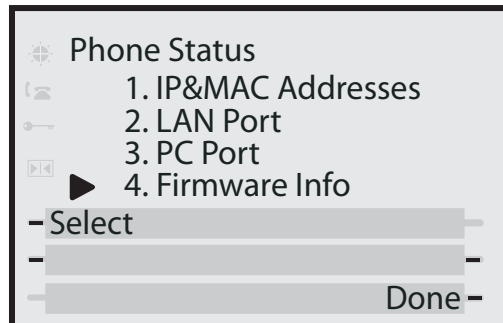

- **IP&MAC Addresses**
 Displays the IP address and MAC address of the phone.
- **LAN Port**
 Displays the Link State, Negotiation Method, Speed, and Duplex Method that the phone uses on its LAN port.
- **PC Port**
 Displays the Link State, Negotiation Method, Speed, and Duplex Method that the phone uses on its PC Port.
- **Firmware Info**
 Displays information about the firmware that is currently installed on the IP phone.

Phone Status via Aastra Web UI

The first screen that displays after logging into the Aastra Web UI for a phone is the Network Status screen. This screen also displays when selecting **Status->System Information**. The information on this screen is available to the user and the administrator as read-only.

<ul style="list-style-type: none"> Status System Information Operation User Password Phone Lock Softkeys and XML Keypad Speed Dial Directory Reset Basic Settings Preferences Account Configuration Advanced Settings Network Global SIP Line 1 Line 2 Line 3 Line 4 Line 5 Line 6 Line 7 Line 8 Line 9 Action URI Configuration Server Firmware Update TLS Support 802.1x Support Troubleshooting 	Network Status			
	Attribute	LAN Port	PC Port	
	Link State	Up	Down	
	Negotiation	Auto	Auto	
	Speed	100Mbps	10Mbps	
	Duplex	Full	Half	
	MAC Address:	00-08-5D-16-10-49		
	Hardware Information			
	Attribute	Value		
	Platform	57i Revision 0		
	Firmware Information			
	Attribute	Value		
	Firmware Version	2.2.0.157		
	Firmware Release Code	SIP		
	Boot Version	1.1.0.1182		
	Date/Time	Feb 13 2008 05:19:55		
	SIP Status			
	Line	SIP Account	Status	Backup Registrar Used?
	1	9057604603@anasipproxy.aastra.com:5060	Registered	Yes
	2	9057604603@anasipproxy.aastra.com:5060	Registered	Yes
	3	9057604603@anasipproxy.aastra.com:5060	Registered	Yes
	4	9057604601@anasipproxy.aastra.com:5060	401	No

The following is a description of the information on the Network Status screen:

- **Network Attributes**
Displays the network status of the Ethernet ports at the back of the phone. You can also view the phone's IP and MAC addresses. Information in this field includes Link State, Negotiation, Speed, and Duplex for Port 0 and Port 1.
- **Hardware Information**
Displays the current IP phone platform and the revision number.
- **Firmware Information**
Displays information about the firmware that is currently installed on the IP phone. Information in this field includes Firmware Version, Firmware Release Code, Boot Version, Release Date/Time.
- **SIP Status**
Displays information about the SIP registration status of the phone. If there are accounts configured on the IP Phone, their SIP status displays in this field. The 6751i displays only one status line. All other model phones display the status of up to 9 lines.

The following table describes the status conditions that can display for an account(s).

Status Condition	Description								
Registered	<p>Displays this status on accounts that HAVE been registered with the SIP proxy server.</p> <p>Example:</p> <table border="0" data-bbox="418 470 1262 579"> <thead> <tr> <th>Line</th> <th>SIP Account</th> <th>Status</th> <th>Backup Registrar Used?</th> </tr> </thead> <tbody> <tr> <td>1</td> <td>9057604603@anasiproxy.aastra.com:5060</td> <td>Registered</td> <td>Yes</td> </tr> </tbody> </table> <p>where Account Number is "1" SIP Account is "9057604603@anasiproxy.aastra.com" on port "5060" Status is "Registered" Backup registrar is used ("Yes")</p>	Line	SIP Account	Status	Backup Registrar Used?	1	9057604603@anasiproxy.aastra.com:5060	Registered	Yes
Line	SIP Account	Status	Backup Registrar Used?						
1	9057604603@anasiproxy.aastra.com:5060	Registered	Yes						
SIP Error Number	<p>Displays on accounts when registration fails with the SIP proxy server.</p> <p>Example:</p> <table border="0" data-bbox="418 843 1262 953"> <thead> <tr> <th>Line</th> <th>SIP Account</th> <th>Status</th> <th>Backup Registrar Used?</th> </tr> </thead> <tbody> <tr> <td>4</td> <td>9057604601@anasiproxy.aastra.com:5060</td> <td>401</td> <td>No</td> </tr> </tbody> </table> <p>where Account Number is "4" SIP Account is "9057604601@anasiproxy.aastra.com" on port "5060" Status is "401" - Unregistered if SIP registration fails. Backup registrar is used ("No")</p>	Line	SIP Account	Status	Backup Registrar Used?	4	9057604601@anasiproxy.aastra.com:5060	401	No
Line	SIP Account	Status	Backup Registrar Used?						
4	9057604601@anasiproxy.aastra.com:5060	401	No						



Note: The IP Phones can register with multiple server using the same user name. So the SIP Status information on the Network Status screen may display the same account with different registrar and proxy IP addresses. For more information, see

Restarting Your Phone

As System Administrator, there may be times when you need to restart a phone. The Restart option allows you reboot the phone when required. A reset may be necessary when:



- There is a change in your network, **OR**
- To re-load modified configuration files, **OR**
- If the settings for the IP phone on the IP PBX system have been modified.

You can restart the phone using the IP Phone UI or the Aastra Web UI.

Restarting the Phone Using the IP Phone UI

 IP Phone UI	
Step	Action
1	Press the Options key on the phone to enter the Options List.
2	Select Restart Phone .
3	<p>For 3-Line LCD Displays: Press # to confirm.</p> <p>Note: To cancel the Restart, press the 3 key.</p> <p>For 8 and 11-Line LCD Displays: Press Restart.</p> <p>Note: To cancel the Restart, press Cancel.</p>

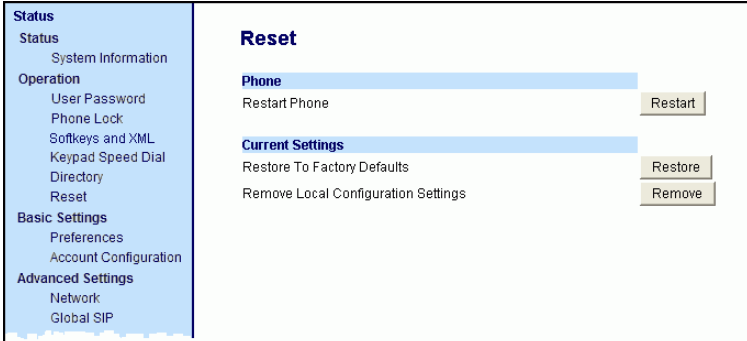
Restarting the Phone Using the Aastra Web UI

Aastra Web UI	
1	<p>Click on Operation->Reset->Phone.</p> 
2	<p>Click  to restart the phone.</p>

Set Phone to Factory Defaults/Eraser Local Configuration

You can set phones to their factory default setting or remove a local phone's configuration using the IP Phone UI or the Aastra Web UI.



Setting Factory Defaults on the Phone

Factory default settings are the settings that reside on the phone after it has left the factory. The factory default settings on the phone sets the factory defaults for all of the settings in the *aastra.cfg*, *<mac>.cfg*, and local configuration. Performing this action results in losing all user-modified settings. You can reset a phone to factory defaults using the IP Phone UI or the Aastra Web UI.

Setting Factory Defaults Using the IP Phone UI

 IP Phone UI	
Step	Action
1	Press the Options key on the phone to enter the Options List.
2	Select Administrator Menu and enter your Administrator Password (default is 22222).
3	Select Factory Default .
4	<p>For 3-Line LCD Displays:: The "Restore Defaults?" prompt displays. Press # to confirm.</p> <p>For 8 and 11-Line LCD Phones: The "Reset phone to factory defaults?" prompt displays. Press Default to confirm.</p>

Settings Factory Defaults Using the Aastra Web UI

Aastra Web UI	
Step	Action
1	<p>Click on Operation->Reset->Current Settings.</p> 
2	<p>In the "Restore to Factory Defaults" field, click  .</p> <p>This restores all factory defaults, and removes any saved configuration and directory list files.</p>



Erasing the Phone's Local Configuration

You can reset the IP Phone's local configuration if required. The local configuration is the last updated configuration you performed using the IP Phone UI or the Aastra Web UI. Performing this action results in losing all recently user-modified settings. For more information about local configuration, see Chapter 1, the section, "[Configuration File Precedence](#)" on [page 1-43](#).

Erasing the Phone's Local Configuration Using the IP Phone UI

 IP Phone UI	
Step	Action
1	Press the Options key on the phone to enter the Options List.
2	Select Administrator Menu and enter your Administrator Password (default is 22222).
3	Select Erase Local Config .
4	<p><i>For 3-Line LCD Displays::</i> The "<i>Erase local config?</i>" prompt displays. Press # to confirm.</p> <p><i>For 8 and 11-Line LCD Displays::</i> The "<i>Erase local config?</i>" prompt displays. Press Erase to confirm.</p>

Erasing the Phone's Local Configuration Using the Aastra Web UI

Aastra Web UI	
Step	Action
1	<p>Click on Operation->Reset->Current Settings.</p> 
2	<p>In the "Remove Local Configuration Settings" field, click  .</p> <p>This removes the last customized configuration settings made on the phone.</p>

Basic Settings

An Administrator has access to specific Basic Setting options to configure and manage the IP Phone in the network. The following sections identify the options available to an Administrator only, or where indicated, to a User and Administrator. These tables also identify whether you can configure them using the Aastra Web UI, IP Phone UI, or the configuration files.

General Settings

Parameter in Aastra Web UI	Parameter in Configuration Files	Description
Local Dial Plan	sip dial plan	<p>A dial plan that describes the number and pattern of digits that a user dials to reach a particular telephone number. Dial Plan field accepts up to 512 characters.</p> <p>For more information on this feature, see “Local Dial Plan” on page 5-53.</p>
Send Dial Plan Terminator	sip dial plan terminator	<p>Allows you to enable or disable a dial plan terminator. When you configure the dial plan on the phone to use a dial plan terminator (such as the pound symbol (#)), the phone waits 4 or 5 seconds after you pick up the handset or after dialing the number on the keypad before making the call.</p> <p>For more information on this feature, see “SIP Dial Plan Terminator” on page 5-55.</p>
Digit Timeout	sip digit timeout	<p>Represents the time, in seconds, to configure the timeout between consecutive key presses.</p> <p>For more information on this feature, see “Digit Timeout” on page 5-55.</p>

Parameter in Aastra Web UI	Parameter in Configuration Files	Description
Park Call Note: This option can be set by both Users and Administrators.	sprecode	The parking of a live call to a specific extension. This feature on the Basic Preferences screen is available on all phones EXCEPT the 9143i, 6751i, and 6753i. To configure the Park feature on a global basis, see Chapter 5, the section, “ Park Calls/Pick Up Parked Calls ” on page 5-59 . To configure the Park feature on a key, see Chapter 5, the section, “ Park/Pick Up Key (not applicable to the 6751i) ” on page 5-234 .
Pick Up Parked Call Note: This option can be set by both Users and Administrators.	pickupsprecode	Picking up a parked call at the specified extension. This feature on the Basic Preferences screen is available on all phones EXCEPT the 9143i, 6751i, and 6753i. To configure the Pickup feature on a global basis, see Chapter 5, the section, “ Park Calls/Pick Up Parked Calls ” on page 5-59 . To configure the Pickup feature on a key, see Chapter 5, the section, “ Park/Pick Up Key (not applicable to the 6751i) ” on page 5-234 .
Suppress DTMF Playback Note: This option can be set by both Users and Administrators.	suppress dtmf playback	Enables and disables suppression of DTMF playback when a number is dialed from the softkeys or programmable keys. For more information on this feature, see. “ Suppressing DTMF Playback ” on page 5-63 .
Display DTMF Digits Note: This option can be set by both Users and Administrators.	display dtmf digits	Enables and disables the display of DTMF digits on the IP phone display during a connected state. For more information on this feature, see. “ Display DTMF Digits ” on page 5-65 .

Parameter in Aastra Web UI	Parameter in Configuration Files	Description
Call Waiting Note: This option can be set by both Users and Administrators.	call waiting	Enable or disables Call Waiting on the IP Phone. For more information on this feature, see. “Call Waiting/Call Waiting Tone” on page 5-67 .
Play Call Waiting Tone Note: This option can be set by both Users and Administrators.	call waiting tone	Enable or disables the playing of a call waiting tone when a caller is on an active call and a new call comes into the phone. For more information on this feature, see. “Call Waiting/Call Waiting Tone” on page 5-67 .
Stuttered Dial Tone Note: This option can be set by both Users and Administrators.	stutter disabled	Enable or disables the playing of a stuttered dial tone when there is a message waiting on the IP phone. For more information on this feature, see. “Stuttered Dial Tone” on page 5-70 .
XML Beep Support Note: This option can be set by both Users and Administrators.	xml beep notification	Enables or disables the playing of a beep to indicate a status on the phone. When the phone receives a status message, the BEEP notifies the user that the message is displaying. For more information on this feature, see “XML Beep Support” on page 5-72 .
Status Scroll Delay (seconds) Note: This option can be set by both Users and Administrators.	xml status scroll delay	Allows you to set the time delay, in seconds, between the scrolling of each status message on the phone. For more information on this feature, see “Status Scroll Delay” on page 5-74 .
Incoming Call Interrupts Dialing Note: This option can be set by both Users and Administrators.	incoming call interrupts dialing	Enable or disables how the phone handles incoming calls while the phone is dialing out. For more information on this feature, see “Incoming Call Interrupts Dialing” on page 5-76 .
Switch Focus to Ringing Line Note: This option can be set by both Users and Administrators.	switch focus to ringing line	Enables or disables whether or not the UI focus is switched to a ringing line while the phone is in the connected state. For more information on this feature, see “Switch Focus to Ringing Line” on page 5-79 .

Parameter in Aastra Web UI	Parameter in Configuration Files	Description
Preferred Line Note: This option can be set by both Users and Administrators.	preferred line	Specifies the preferred line to switch focus back to when incoming or outgoing calls end on the phone. For more information on this feature, see “Preferred Line and Preferred Line Timeout” on page 5-81.
Preferred Line Timeout (seconds) Note: This option can be set by both Users and Administrators.	preferred line timeout	Specifies the time, in seconds, that the phone switches back to the preferred line after a call (incoming or outgoing) ends on the phone, or after a duration of inactivity on an active line. For more information on this feature, see “Preferred Line and Preferred Line Timeout” on page 5-81.
Goodbye Key Cancels Incoming Call Note: This option can be set by both Users and Administrators.	goodbye key cancels incoming call	Enable or disables the behavior of the Goodbye Key on the IP phone. For more information on this feature, see “Goodbye Key Cancels Incoming Call” on page 5-85.
UPnP Mapping Lines Note: This option can be set by both Users and Administrators.	upnp mapping lines	Enables or disables the use of Universal Plug and Play (UPnP) on a specific line on the IP phone. For more information on this feature, see “UPnP Mapping Lines (for remote phones)” on page 5-88.
Message Waiting Indicator Line Note: This option can be set by both Users and Administrators.	mwi led line	Allows you to enable the Message Waiting Indicator (MWI) on a single line or on all lines on the phone. For example, if you set this parameter to 3, the LED illuminates if a voice mail is pending on line 3. If you set this parameter to 0, the LED illuminates if a voice mail is pending on any line on the phone (lines 1 through 9). For more information on this feature, see “Message Waiting Indicator Line” on page 5-90.
DND Key Mode Note: This option can be set by both Users and Administrators.	dnd key mode	Allows you to configure the DND mode to use on the phone (Account, Phone, Custom) when the DND key is pressed. You can configure DND for all accounts or a specific account. For more information on this feature, see “DND Key Mode” on page 5-92. Also see Chapter 5, the section, “Do Not Disturb (DND)” on page 5-207.

Parameter in Aastra Web UI	Parameter in Configuration Files	Description
Call Forward Key Mode Note: This option can be set by both Users and Administrators.	call forward key mode	Allows you to configure the Call Forward mode to use on the phone (Account, Phone, or Custom). You can configure Call Forward for all accounts or a specific account. For more information on this feature, see “Call Forward Mode” on page 5-94. Also see Chapter 5, the section, “Call Forwarding” on page 5-249.
Use LLDP ELIN Note: This option can be set by both Users and Administrators.	use lldp elin	Enables or disables the use of an Emergency Location Identification Number (ELIN) received from LLDP as a caller ID for emergency numbers. Caution: In Release 2.3 and later, LLDP is enabled by default. If LLDP is enabled on your network, the phones may come up with different network settings. For more information on this feature, see “Link Layer Discovery Protocol for Media Endpoint Devices (LLDP-MED) and Emergency Location Identification Number (ELIN)” on page 5-98.

Incoming/Outgoing Intercom Calls

The Incoming/Outgoing Intercom Call settings on the IP Phone specify whether the IP phone or the server is responsible for notifying the recipient that an Intercom call is being placed. These settings also specify the prefix code for server-side Intercom calls, and specifies the configuration to use when making the Intercom call.

Parameter in Aastra Web UI	Parameter in Configuration Files	Description
<i>Incoming Intercom Settings (all models)</i>		
Auto-Answer Note: This option can be set by both Users and Administrators.	sip allow auto answer	Enables or disables the IP phone to allow automatic answering for an Intercom call. If auto-answer is enabled on the IP phone, the phone plays a tone to alert the user before answering the intercom call. If auto-answer is disabled, the phone rejects the incoming intercom call and sends a busy signal to the caller. For more information on this feature, see “Incoming/Outgoing Intercom with Auto-Answer and Barge In” on page 5-103.
Microphone Mute Note: This option can be set by both Users and Administrators.	sip intercom mute mic	Enables or disables the microphone on the IP phone for Intercom calls made by the originating caller. For more information on this feature, see “Incoming/Outgoing Intercom with Auto-Answer and Barge In” on page 5-103.
Play Warning Tone Note: This option can be set by both Users and Administrators.	sip intercom warning tone	Enables or disables a warning tone to play when the phone receives an incoming intercom call on an active line. For more information on this feature, see “Incoming/Outgoing Intercom with Auto-Answer and Barge In” on page 5-103.
Allow Barge In Note: This option can be set by both Users and Administrators.	sip intercom allow barge in	Enable or disables how the phone handles incoming intercom calls while the phone is on an active call. For more information on this feature, see “Incoming/Outgoing Intercom with Auto-Answer and Barge In” on page 5-103.

Parameter in Aastra Web UI	Parameter in Configuration Files	Description
<i>Outgoing Intercom Settings (8 and 11-Line LCD phones)</i>		
Type	sip intercom type	<p>Determines whether the IP phone or the server is responsible for notifying the recipient that an Intercom call is being placed. Applicable settings are Phone-Side, Server-Side, OFF.</p> <p>For more information on this feature, see “Incoming/Outgoing Intercom with Auto-Answer and Barge In” on page 5-103.</p>
Prefix Code	sip intercom prefix code	<p>The prefix to add to the phone number for server-side outgoing Intercom calls. This parameter is required for all server-side Intercom calls.</p> <p>For more information on this feature, see “Incoming/Outgoing Intercom with Auto-Answer and Barge In” on page 5-103.</p>
Line	sip intercom line	<p>Specifies the line for which the IP phone uses the configuration from, when making the Intercom call. The IP phone uses the first available line for physically making the call but uses the configuration from the line you set for this parameter.</p> <p>Note: The "<i>sip intercom type</i>" parameter must be set with the Server-Side option to enable the "<i>sip intercom line</i>" parameter.</p> <p>For more information on this feature, see “Incoming/Outgoing Intercom with Auto-Answer and Barge In” on page 5-103.</p>

Group Paging RTP Settings

Parameter in Aastra Web UI	Parameter in Configuration Files	Description
Paging listen addresses Note: This option can be set by both Users and Administrators.	paging group listening	Allows you to specify up to 5 listening multicast addresses to send/receive a Real Time Transport Protocol (RTP) stream to/from these pre-configured multicast address(es) without involving SIP signaling. For more information on this feature, see “Group Paging RTP Settings” on page 5-108 .

Key Mapping

Parameter in Aastra Web UI	Parameter in Configuration Files	Description
Map Redial Key To	map redial key to	Sets the Redial key as a speeddial key if a value is entered for this parameter. If you leave this parameter blank, the Redial key returns to its original functionality. Note: If you configure the Redial key for speeddialing on the 9480i CT or 6757i CT Base Stations, the Redial key on the 9480i CT and 6757i CT handsets retain their original functionality. The Redial key on the handset is not configured for speeddial. For more information on this feature, see “Key Mapping” on page 5-114 .
Map Conf Key To	map conf key to	Sets the Conf key as a speeddial key if a value is entered for this parameter. If you leave this parameter blank, the Conf key returns to its original functionality. Note: If you configure the Conf key for speeddialing on the 9480i CT or 6757i CT Base Stations, the Conf key on the 9480i CT and 6757i CT handsets retain their original functionality. The Conf key on the handset is not configured for speeddial. For more information on this feature, see “Key Mapping” on page 5-114 .

Ring Tones

Parameter in IP Phone UI	Parameter in Aastra Web UI	Parameter in Configuration Files	Description
Tone Set Note: This option can be set by both Users and Administrators.	Tone Set	tone set	Globally sets a tone set for a specific country For more information on this feature, see "Ring Tones and Tone Sets" on page 5-118.
Ring Tone Note: This option can be set by both Users and Administrators.	Global Ring Tone	ring tone	Globally sets the type of ring tone on the IP phone. Ring tone can be set to one of six distinct rings. For more information on this feature, see "Ring Tones and Tone Sets" on page 5-118.
N/A	LineN Note: This option can be set by both Users and Administrators.	lineN ring tone	Sets the type of ring tone on the IP phone on a per-line basis. Ring tone can be set to one of six distinct rings. For more information on this feature, see "Ring Tones and Tone Sets" on page 5-118.

Priority Alerting Settings

Parameter in Aastra Web UI	Parameter in Configuration Files	Description
Enable Priority Alerting	priority alerting enabled	Enables and disables distinctive ringing on the IP phone for incoming calls and call-waiting calls. For more information on this feature, see "Priority Alerting" on page 5-123.
Group	alert group	When an "alert group" keyword appears in the header of the INVITE request, the configured Bellcore ring tone is applied to the IP phone. For more information on this feature, see "Priority Alerting" on page 5-123.

Parameter in Aastra Web UI	Parameter in Configuration Files	Description
External	alert external	<p>When an "alert external" keyword appears in the header of the INVITE request, the configured Bellcore ring tone is applied to the IP phone.</p> <p>For more information on this feature, see "Priority Alerting" on page 5-123.</p>
Internal	alert internal	<p>When an "alert-internal" keyword appears in the header of the INVITE request, the configured Bellcore ring tone is applied to the IP phone.</p> <p>For more information on this feature, see "Priority Alerting" on page 5-123.</p>
Emergency	alert emergency	<p>When an "alert emergency" keyword appears in the header of the INVITE request, the configured Bellcore ring tone is applied to the IP phone.</p> <p>For more information on this feature, see "Priority Alerting" on page 5-123.</p>
Priority	alert priority	<p>When an "alert priority" keyword appears in the header of the INVITE request, the configured Bellcore ring tone is applied to the IP phone.</p> <p>For more information on this feature, see "Priority Alerting" on page 5-123.</p>
Auto Call Distribution	alert auto call distribution	<p>When an "alert-acd" keyword appears in the header of the INVITE request, the configured Bellcore ring tone is applied to the IP phone.</p> <p>For more information on this feature, see "Priority Alerting" on page 5-123.</p>
Community 1 thru Community 4	alert community 1 alert community 2 alert community 3 alert community 4	<p>When an "alert community-#" keyword appears in the header of the INVITE request, the configured Bellcore ring tone is applied to the IP phone. Available Bellcore tones are:</p> <ul style="list-style-type: none"> 0 Normal ringing (default) 1 Bellcore-dr2 2 Bellcore-dr3 3 Bellcore-dr4 4 Bellcore-dr5 5 Silent <p>For more information on this feature, see "Priority Alerting" on page 5-123.</p>

Directed Call Pickup (DCP)

Parameter in Aastra Web UI	Parameters in Configuration Files	Description
Directed Call Pickup	directed call pickup	Enables or disables the use of "directed call pickup" feature. For more information on this feature, see "Directed Call Pickup (BLF or XML Call Interception)" on page 5-130.
Directed Call Pickup Prefix	directed call pickup prefix	Allows you to specify a prefix to use for "directed call pickup" that you can use with a BLF or BLF List softkey. For more information on this feature, see "Directed Call Pickup (BLF or XML Call Interception)" on page 5-130.
Play a Ring Splash	play a ring splash	Enables or disables the playing of a short "ring splash tone" when there is an incoming call on the BLF monitored extension. If the host tone is idle, the tone plays a "ring splash". For more information on this feature, see "Directed Call Pickup (BLF or XML Call Interception)" on page 5-130.

Auto Call Distribution (ACD) Settings

Parameter in Aastra Web UI	Parameters in Configuration Files	Description
Auto Available	acd auto available	Enables or disables the use of the ACD Auto-Available Timer. For more information on this feature, see “Automatic Call Distribution (ACD) (for Sylanro Servers)” on page 5-186.
Auto Available Timer	acd auto available timer	Specifies the length of time, in seconds, before the IP phone status switches back to “available.” For more information on this feature, see “Automatic Call Distribution (ACD) (for Sylanro Servers)” on page 5-186.

Time and Date

Parameter in IP Phone UI	Parameter in Aastra Web UI	Parameters in Configuration Files	Description
Time Format Note: This option can be set by both Users and Administrators.	Time Format	time format	This parameter changes the time to 12 hour or 24 hour format. Use "0" for the 12 hour format and "1" for the 24 hour format. For more information on this feature, see "Time and Date" on page 5-19 .
Date Format Note: This option can be set by both Users and Administrators.	Date Format	date format	This parameter allows the user to change the date to various formats. For more information on this feature, see "Time and Date" on page 5-19 .
Time Zone Note: This option can be set by both Users and Administrators.	N/A	time zone name Custom Parameters: <ul style="list-style-type: none"> • time zone minutes • dst minutes • dst [start end] relative date • dst start month • dst end month • dst start week • dst end week • dst start day • dst end day • dst start hour • dst end hour 	This parameter allows you to set the time zone code or customize the time zone for their area as required. For more information on this feature, see "Time Zone & DST" on page 5-20 .
Time Servers Note: This option can be set by both Users and Administrators.	NTP Time Servers	time server disabled	This parameter allows you to enable or disable the Network Time Server (NTP) to set the time on the phone. For more information on this feature, see "Time Servers" on page 5-27 .

Parameter in IP Phone UI	Parameter in Aastra Web UI	Parameters in Configuration Files	Description
Time Server 1 Note: This option can be set by both Users and Administrators.	Time Server 1	time server1	This parameter allows you to set the IP address of Time Server 1 in dotted decimal format. For more information on this feature, see “Time Servers” on page 5-27 .
Time Server 2 Note: This option can be set by both Users and Administrators.	Time Server 2	time server2	This parameter allows you to set the IP address of Time Server 2 in dotted decimal format. For more information on this feature, see “Time Servers” on page 5-27 .
Time Server 3 Note: This option can be set by both Users and Administrators.	Time Server 3	time server3	This parameter allows you to set the IP address of Time Server 3 in dotted decimal format. For more information on this feature, see “Time Servers” on page 5-27 .

Live Dialpad

Parameter in IP Phone UI	Parameter in Aastra Web UI	Parameters in Configuration Files	Description
Live Dialpad Note: This option can be set by a User via the IP Phone UI and by an Administrator via the IP Phone UI and the configuration files.	N/A	live dialpad	This parameter turns the “Live Dialpad” feature ON or OFF. For more information on this feature, see “Live Dial Pad*” on page 5-33 .

Language

Parameter in Aastra Web UI	Parameter in Configuration Files	Description
WebPage Language Note: This option can be set by both Users and Administrators.	language	The language you want to display in the IP Phone UI and the Aastra Web UI. Valid values for all models are: 0 (English) 1 (French) 2 (Spanish) 3 (German) 4 (Italian) Valid values for the CT handsets are: 0 (English) 1 (French) 2 (Spanish) Note: All languages may not be available for selection. The available languages are dependant on the language packs currently loaded to the IP phone. For more information about loading language packs, see “Loading Language Packs” on page 5-34 . For more information on specifying a language to use on the IP Phone, see “Specifying the Language to Use” on page 5-37 .

Parameter in Aastra Web UI	Parameter in Configuration Files	Description
<p>Input Language</p> <p>Note: This option can be set by both Users and Administrators.</p>	<p>input language</p>	<p>Allows you to specify the language to use for inputs on the IP Phone. Entering a language value for this parameter allows users to enter text and characters in the IP Phone UI, Aastra Web UI, and in XML applications via the keypad on the phone, in the language(s) specified.</p> <p>Valid values are:</p> <ul style="list-style-type: none"> • English • French • Français • German • Deutsch • Italian • Italiano • Spanish • Español <p>For more information on this feature, see “Specifying the Input Language to Use” on page 5-41.</p>
<p>Language 1 thru 4</p>	<p>language N</p>	<p>The language pack you want to load to the IP phone.</p> <p>Valid values are:</p> <p>lang_fr.txt lang_fr_ca.txt lang_es.txt lang_es_mx.txt lang_de.txt lang_it.txt</p> <p>Notes:</p> <ol style="list-style-type: none"> 1. The languages packs you load are dependant on available language packs from the configuration server. 2. You must reboot the phone to load a language pack. <p>For more information on this feature, see “Loading Language Packs” on page 5-34.</p>

Account Configuration

The IP phones have a DND and CFWD feature that allows an Administrator and User to configure “do not disturb” and “call forwarding” by account. You can set specific modes for the way you want the phone to handle DND and CFWD. The three modes you can set on the phone for these features are:

- **Account**
- **Phone**
- **Custom**

You can set the modes for DND and CFWD in the Aastra Web UI at the path *Basic Settings->Preferences->General*, or using the following parameters in the configurations files:

- **dnd key mode**
- **call forward key mode**

The following table describes the behavior of the mode settings for DND and CFWD.

Modes	DND	CFWD
Account	Sets DND for a specific account. A pre-configured DND key toggles the account in focus on the IP Phone UI, to ON or OFF.	Sets CFWD on a per account basis. Pressing a pre-configured CFWD key applies to the account in focus

Modes	DND	CFWD
Phone	Sets DND ON for all accounts on the phone. A pre-configured DND key toggles all accounts on the phone to ON or OFF.	Sets the same CFWD configuration for all accounts (All , Busy , and/or No Answer). When you configure the initial account, the phone applies the configuration to all other accounts. (In the Aastra Web UI, only the account you configured is enabled. All other accounts are grayed out but set to the same configuration.) Using the Aastra Web UI, if you make changes to that initial account, the changes apply to all accounts on the phone.
Custom	Sets the phone to display custom screens after pressing a pre-configured DND key, that list the account(s) on the phone. The user can select a specific account for DND, turn DND ON for all accounts, or turn DND OFF for all accounts	Sets CFWD for a specific account or all accounts. You can configure a specific mode (All , Busy , and/or No Answer) for each account independently or all accounts. On the 3-line LCD phones, you can set all accounts to ALL On or ALL Off . On the 8 and 11-line LCD phones, you can set all accounts to All On , All Off , or copy the configuration for the account in focus to all other accounts using a CopytoAll softkey.

References

For more information about account configuration of DND and CFWD on the IP Phones, see Chapter 5, the sections:

For DND:

- [“DND Key Mode”](#) on page 5-92.
- [“Do Not Disturb \(DND\)”](#) on page 5-207.

For CFWD:

- [“Call Forward Mode”](#) on page 5-94.
- [“Call Forwarding”](#) on page 5-249.

Network Settings

The following paragraphs describe the network parameters you can configure on the IP phone. Network settings are in two categories:

- Basic network settings
- Advanced network settings



Note: Specific parameters are configurable using the Aastra Web UI only and are indicated where applicable.

Basic Network Settings

If Dynamic Host Configuration Protocol (DHCP) is enabled, the IP phone automatically configures all of the Network settings. If the phone cannot populate the Network settings, or if DHCP is disabled, you can set the Network options manually.

Parameter In IP Phone UI	Parameter in Aastra Web UI	Parameters in Configuration Files	Description
DHCP	DHCP	dhcp	<p>Enables or disables DHCP. Enabling DHCP populates the required network information. The DHCP server serves the network information that the IP phone requires. If the IP phone is unable to get any required information, then you must enter it manually. DHCP populates the following network information: IP Address, Subnet Mask, Gateway, Domain Name Servers (DNS), TFTP, HTTP HTTPS, and FTP servers, and Timer Servers.</p> <p>Note: For DHCP to automatically populate the IP address or qualified domain name for the TFTP server, your DHCP server must support Option 66. The IP phones also support Option 60 and 43.</p> <p>For more information, see "DHCP" on page 4-4.</p>
IP Address	IP Address	ip	<p>IP address of the IP phone. To assign a static IP address, disable DHCP.</p> <p>For more information, see "Configuring Network Settings Manually" on page 4-24.</p>

Parameter In IP Phone UI	Parameter in Aastra Web UI	Parameters in Configuration Files	Description
Subnet Mask	Subnet Mask	subnet mask	<p>Subnet mask defines the IP address range local to the IP phone. To assign a static subnet mask, disable DHCP.</p> <p>For more information, see "Configuring Network Settings Manually" on page 4-24.</p>
Gateway	Gateway	default gateway	<p>The IP address of the network's gateway or default router IP address. To assign a static Gateway IP address, disable DHCP.</p> <p>For more information, see "Configuring Network Settings Manually" on page 4-24.</p>
Primary DNS	Primary DNS	dns1	<p>Primary domain name server IP address. For any of the IP address settings on the IP phone a domain name value can be entered instead of an IP address. With the help of the domain name servers the domain names for such parameters can then be resolved to their corresponding IP addresses. To assign static DNS addresses, disable DHCP.</p> <p>Note: If a host name is configured on the IP phone, you must also set a DNS.</p> <p>For more information, see "Configuring Network Settings Manually" on page 4-24.</p>

Parameter In IP Phone UI	Parameter in Aastra Web UI	Parameters in Configuration Files	Description
Secondary DNS	Secondary DNS	dns2	<p>A service that translates domain names into IP addresses. To assign static DNS addresses, disable DHCP.</p> <p>For more information, see "Configuring Network Settings Manually" on page 4-24.</p>
Hostname	Hostname	hostname	<p>Specifies the hostname DHCP Option 12 that the phone sends with the DHCP Request packet.</p> <p>For more information, see "Using Option 12 Hostname on the IP Phone" on page 4-11.</p>
Ethernet LAN Port Link PC Port Link PC Port Enabled (3-Line LCD Phones) Enable PassThru Port (8 and 11-Line LCD Phones)	N/A LAN Port PC Port PC Port PassThru Enable/Disable (3-Line LCD Phones) PC Port PassThru Enable/Disable (8 and 11-Line LCD Phones)	ethernet port 0 ethernet port 1 pc port passthrough enabled	<p>The send (TX) and receive (RX) negotiation to use on the Ethernet LAN Port and Ethernet PC Port for transmitting and receiving data over the LAN or to/from your PC, respectively.</p> <p>For more information on configuring the LAN and PC port negotiation, see "Configuring LAN and PC Port Negotiation" on page 4-24.</p> <p>Note: The PC Port parameters are not applicable to the 6730i IP Phone.</p>

Advanced Network Settings

Parameter In IP Phone UI	Parameter in Aastra Web UI	Parameters in Configuration Files	Description
DHCP User Class	DHCP User Class	dhcp userclass	<p>Specifies the User Class DHCP Option 77 that the phone sends to the configuration server with the DHCP Request packet.</p> <p>Note: If you specify a value for this parameter, you must restart your phone for the change to take affect. Any change in its value during start-up results in an automatic reboot.</p> <p>For more information, see “Using Option 77 User Class on the IP Phone” on page 4-14.</p>
Download Options	DHCP Download Options	dhcp config option override	<p>The value specified for this parameter overrides the precedence order for determining a configuration server. Valid values are:</p> <ul style="list-style-type: none"> -1 (Disabled - ignores all DHCP configuration options). 0 (Any) 43 66 159 160 <p>Notes:</p> <ol style="list-style-type: none"> 1. If the DHCP server supplies Options 159 and 160, the phones will attempt to contact the configuration server given in these options. 2. You must restart the IP Phone for this parameter to take affect. <p>For more information, see “Using Options 159 and 160 on the IP Phone” on page 4-17. For more information about setting DHCP download preference, see “Configuration Server Download Precedence” on page 4-20.</p>

Parameter In IP Phone UI	Parameter in Aastra Web UI	Parameters in Configuration Files	Description
LLDP Support	LLDP	lldp	<p>Enables or disables Link Layer Discovery Protocol for Media Endpoint Devices (LLDP-MED) on the IP Phone.</p> <p>Caution: In Release 2.3 and later, LLDP is enabled by default. If LLDP is enabled on your network, the phones may come up with different network settings.</p> <p>For more information on this feature, see “Link Layer Discovery Protocol for Media Endpoint Devices (LLDP-MED) and Emergency Location Identification Number (ELIN)” on page 5-98.</p>
N/A	LLDP Packet Interval	lldp interval	<p>The amount of time, in seconds, between the transmission of LLDP Data Unit (LLDPDU) packets. The value of zero (0) disables this parameter.</p> <p>Caution: In Release 2.3 and later, LLDP is enabled by default. If LLDP is enabled on your network, the phones may come up with different network settings.</p> <p>For more information on this feature, see “Link Layer Discovery Protocol for Media Endpoint Devices (LLDP-MED) and Emergency Location Identification Number (ELIN)” on page 5-98.</p>

Parameter In IP Phone UI	Parameter in Aastra Web UI	Parameters in Configuration Files	Description
UPnP	UPnP	upnp manager	<p>Enables or disables Universal Plug and Play (UPnP) on the IP phone. If you set this parameter to "0", you can manually configure NAT on the IP phone and the UPnP manager will not start.</p> <p>For more information, see Chapter 4, "Universal Plug and Play (UPnP) (for remote phones)" on page 4-50.</p>
N/A	N/A	upnp gateway	<p>IP address or fully qualified Domain Name of the Internet gateway or router. This parameter stores the IP address of the gateway or router in the event that only non-default UPnP gateways get discovered on the network. The UPnP port mappings are saved to this IP address so even if the phone reboots, it will still have the correct port mappings.</p> <p>For more information, see Chapter 4, "Universal Plug and Play (UPnP) (for remote phones)" on page 4-50.</p>
NAT IP	NAT IP	sip nat ip	<p>IP address the network device that enforces NAT.</p> <p>For more information, see Chapter 4, "Configuring NAT Address and Port (optional)" on page 4-35.</p>
NAT SIP Port	NAT SIP Port	sip nat port	<p>Port number of the network device that enforces NAT.</p> <p>For more information, see Chapter 4, "Configuring NAT Address and Port (optional)" on page 4-35.</p>

Parameter In IP Phone UI	Parameter in Aastra Web UI	Parameters in Configuration Files	Description
NAT RTP Port	NAT RTP Port	sip nat rtp port	<p>Indicates the port through which the RTP packets are sent. This value must specify the beginning of the RTP port range on the gateway or router.</p> <p>The RTP port is used for sending DTMF tones and for the audio stream. Your network administrator may close some ports for security reasons. You may want to use this parameter to send RTP data using a different port.</p> <p>For more information, see Chapter 4, “Configuring NAT Address and Port (optional)” on page 4-35.</p>
Nortel NAT	Nortel NAT Traversal Enabled	sip nortel nat support	<p>Enables or disables the phone to operate while connected to a network device that enforces NAT.</p> <p>For more information, see Chapter 4, “Configuring Nortel NAT (optional)” on page 4-32.</p>
N/A	Nortel NAT Timer (seconds)	sip nortel nat timer	<p>The interval, in seconds, that the phone sends SIP ping requests to the Nortel proxy.</p> <p>For more information, see Chapter 4, “Configuring Nortel NAT (optional)” on page 4-32.</p>
N/A	Rport (RFC 3581)	sip rport	<p>Allows you to enable (1) or disable (0) the use of Rport on the IP phone.</p> <p>“Rport” in RFC 3581, allows a client to request that the server send the response back to the source IP address and the port from which the request came.</p> <p>For more information, see Chapter 4, “RPORT” on page 4-65.</p>

Parameter In IP Phone UI	Parameter in Aastra Web UI	Parameters in Configuration Files	Description
N/A	NTP Time Servers	time server disabled	<p>Enables or disables the time server. This parameter affects the time server1, time server2, and time server3 parameters. Setting this parameter to 0 allows the use of the configured Time Server(s). Setting this parameter to 1 prevents the use of the configured Time Server(s).</p> <p>For more information, see Chapter 4, “Network Time Servers” on page 4-67.</p>
N/A	Time Servers 1, 2, and 3	time server1 time server2 time server3 time server4	<p>The 1st, 2nd, 3rd, and 4th time server's IP address or qualified domain name. If the time server is enabled, the value for time server1 will be used to request the time from.</p> <p>For more information, see Chapter 4, “Network Time Servers” on page 4-67.</p>

HTTPS Settings

Advanced Network Settings includes HTTPS settings for the IP Phones.

Parameter In IP Phone UI	Parameter in Aastra Web UI	Parameters in Configuration Files	Description
HTTPS	HTTPS Server - Redirect HTTP to HTTPS	https redirect http get	<p>Allows or disallows redirection from the HTTP server to the HTTPS server.</p> <p>For more information, see Chapter 4, "HTTPS Client/Server Configuration" on page 4-40.</p>
XML HTTP POSTs	HTTPS Server - Block XML HTTP POSTs	https block http post xml	<p>Enables or disables the blocking of XML scripts from HTTP POSTs.</p> <p>Some client applications use HTTP POSTs to transfer XML scripts. The phones's HTTP server accepts these POSTs even if server redirection is enabled, effectively bypassing the secure connection. When this parameter is enabled (blocking is enabled), receipt of an HTTP POST containing an XML parameter header results in the following response: "403 Forbidden". This forces the client to direct the POSTs to the HTTPS server through use of the "https://" URL.</p> <p>For more information, see Chapter 4, "HTTPS Client/Server Configuration" on page 4-40.</p>

Parameter In IP Phone UI	Parameter in Aastra Web UI	Parameters in Configuration Files	Description
Client Method	HTTPS Client Method	https client method	<p>Defines the security method that the client advertises to the server during the Secure Socket Layer (SSL) handshake. Available options are:</p> <p>TLS 1.0 - Transport Layer Security version 1 (TLS 1.0) is a protocol that ensures privacy between communicating applications and their users on the Internet. TLS is the successor to SSL.</p> <p>SSL 3.0 - Secure Socket Layer version 3 (SSL 3.0) is a commonly-used protocol for managing the security of a message transmission on the Internet.</p> <p>For more information, see Chapter 4, "HTTPS Client/Server Configuration" on page 4-40.</p>

Parameter In IP Phone UI	Parameter in Aastra Web UI	Parameters in Configuration Files	Description
Cert Validation	Validate Certificates	https validate certificates	<p>Enables or disables the HTTPS validation of certificates on the phone. When this parameter is set to 1, the HTTPS client performs validation on SSL certificates before accepting them.</p> <p>Notes:</p> <ol style="list-style-type: none"> 1. If you are using HTTPS as a configuration method, and use a self signed certificate, you must set this parameter to "0" (disabled) before upgrading to Release 2.3 or later of the IP Phones. 2. If you are using HTTPS and the certificates are not valid or are not signed by Verisign, Thawte, or GeoTrust, the phones fail to download configuration files. <p>For more information, see Chapter 4, "HTTPS Server Certificate Validation" on page 4-44.</p>
Check Expires	Check Certificate Expiration	https validate expires	<p>Enables or disables the HTTPS validation of the expiration of the certificates. When this parameter is set to 1, the HTTPS client verifies whether or not a certificate has expired prior to accepting the certificate.</p> <p>Note: If the "https validate expires" parameter is set to enable, the clock on the phone must be set for the phone to accept the certificates.</p> <p>For more information, see Chapter 4, "HTTPS Server Certificate Validation" on page 4-44.</p>

Parameter In IP Phone UI	Parameter in Aastra Web UI	Parameters in Configuration Files	Description
Check Hostnames	Check Certificate Hostnames	https validate hostnames	<p>Enables or disables the HTTPS validation of hostnames on the phone.</p> <p>For more information, see Chapter 4, “HTTPS Server Certificate Validation” on page 4-44.</p>
N/A	Trusted Certificates Filename	https user certificates	<p>Specifies a file name for a .PEM file located on the configuration server. This file contains the User-provided certificates in PEM format. These certificates are used to validate peer certificates.</p> <p>Note: You must disable the “https validate certificates” parameter in order for the phone to accept the User-provided certificates.</p> <p>For more information, see Chapter 4, “HTTPS Server Certificate Validation” on page 4-44.</p>

Type of Service (ToS), DSCP

Advanced Network Settings include Type of Service (ToS) and Differentiated Services Code Point (DSCP) for the IP phones.

Parameter In IP Phone UI	Parameter in Aastra Web UI	Parameters in Configuration Files	Description
Type of Service SIPt	SIP	tos sip	The Differentiated Services Code Point (DSCP) for SIP packets. For more information, see Chapter 4, "Type of Service (ToS), Quality of Service (QoS), and DiffServ QoS" on page 4-54.
Type of Service RTP	RTP	tos rtp	The Differentiated Services Code Point (DSCP) for RTP packets. For more information, see Chapter 4, "Type of Service (ToS), Quality of Service (QoS), and DiffServ QoS" on page 4-54.
Type of Service RTCP	RTCP	tos rtcp	The Differentiated Services Code Point (DSCP) for RTCP packets. For more information, see Chapter 4, "Type of Service (ToS), Quality of Service (QoS), and DiffServ QoS" on page 4-54.

VLAN

You can enable or disable VLAN and set specific VLAN IDs and priorities under Network Settings.

Parameter In IP Phone UI	Parameter in Aastra Web UI	Parameters in Configuration Files	Description
Global Settings			
VLAN Enable	VLAN Enable	tagging enabled	Enables or disables VLAN on the IP phones. For more information, see Chapter 4, “Virtual LAN (optional)” on page 4-54.
Other Priority	Priority, Non-IP Packet	priority non-ip	Specifies the priority value for non-IP packets. For more information, see Chapter 4, “Virtual LAN (optional)” on page 4-54.
LAN Port Settings (Port 0)			
Phone VLAN ID	VLAN ID	VLAN id	VLAN is a feature on the IP phone that allows for multiple logical Ethernet interfaces to send outgoing RTP packets over a single physical Ethernet as described in IEEE Std 802.3. On the IP phone, you configure a VLAN ID that associates with the physical Ethernet Port 0. For more information, see Chapter 4, “Virtual LAN (optional)” on page 4-54.

Parameter In IP Phone UI	Parameter in Aastra Web UI	Parameters in Configuration Files	Description
SIP Priority RTP Priority RTCP Priority	SIP Priority RTP Priority RTCP Priority	tos priority map	<p>This parameter is based on the Type of Service (ToS), Differentiated Services Code Point (DSCP) setting for SIP (tos sip parameter), RTP (tos rtp parameter) and RTCP (tos rtp parameter). It is the mapping between the DSCP value and the VLAN priority value for SIP, RTP, and RTCP packets.</p> <p>You enter the tos priority map value as follows: (DSCP_1,Priority_1)(DSCP_2,Priority_2).....(DSCP_64,Priority_64)</p> <p>where the DSCP value range is 0-63 and the priority range is 0-7. Mappings not enclosed in parentheses and separated with a comma, or with values outside the ranges, are ignored.</p> <p>For more information, see Chapter 4, “Virtual LAN (optional)” on page 4-54.</p>

Parameter In IP Phone UI	Parameter in Aastra Web UI	Parameters in Configuration Files	Description
PC Port Settings (Port 1)			
PC Port VLAN ID	VLAN ID	VLAN id port 1	<p>Specifies the VLAN ID used to pass packets through to a PC via Port 1.</p> <p>Note: If you set the PC Port VLAN ID (Port 1) to 4095, all untagged packets are sent to this port. The following is an example of configuring the phone on a VLAN where all untagged packets are sent to the passthrough port.</p> <p>Example You enable tagging on the LAN Port (VLAN id) as normal but set the PC Port (VLAN id port 1) to 4095. The following example sets the phone to be on VLAN 3 on the LAN Port but the PC Port is configured as untagged.</p> <pre>tagging enabled: 1 VLAN id: 3 VLAN id port 1: 4095</pre> <p>For more information, see Chapter 4, “Virtual LAN (optional)” on page 4-54.</p> <p>Note: The PC Port parameters are not applicable to the 6730i IP Phone.</p>
PC Port Priority	Priority	QoS eth port 1 priority	<p>Specifies the priority value used for passing VLAN packets through to a PC via Port 1.</p> <p>For more information, see Chapter 4, “Virtual LAN (optional)” on page 4-54.</p>

SIP Settings

The following paragraphs describe the SIP parameters you can configure on the IP phone. SIP configuration consists of configuring:

- **Basic SIP Authentication Settings**
- **Basic SIP Network Settings**
- **Advanced SIP settings**
- **RTP Settings**
- **Autodial Settings**



Notes:

1. Specific parameters are configurable on a global and per-line basis. You can also configure specific parameters using the IP Phone UI, the Aastra Web UI, or the configuration files. If you have a proxy server or have a SIP registrar present at a different location than the PBX server, the SIP parameters may need to be changed.
 2. The IP phones allow you to define different SIP lines with the same account information (i.e., same user name) but with different registrar and proxy IP addresses. This feature works with Registration, Subscription, and Notify processing. This feature also works with the following types of calls: incoming, outgoing, Broadsoft Shared Call Appearance (SCA), Bridged Line Appearance (BLA), conference, transfer, blind transfer.
-

Basic SIP Authentication Settings

Parameter In IP Phone UI	Parameter in Aastra Web UI	Parameters in Configuration Files	Description
Screen Name	Screen Name (Global and Per-Line)	sip screen name (global) sip lineN screen name (per-line)	Name that displays on the idle screen. Valid values are up to 20 alphanumeric characters. For more information, see Chapter 4, "Basic SIP Settings" on page 4-71.
N/A	Screen Name 2 (Global and Per-Line)	sip screen name 2 (global) sip lineN screen name 2 (per-line)	Custom text message that displays on the idle screen. Valid values are up to 20 alphanumeric characters. For more information, see Chapter 4, "Basic SIP Settings" on page 4-71.
User Name	Phone Number (Global and Per-Line)	sip user name (global) sip lineN user name (per-line)	User name used in the name field of the SIP URI for the IP phone and for registering the phone at the registrar. Valid values are up to 20 alphanumeric characters. For more information, see Chapter 4, "Basic SIP Settings" on page 4-71.
Display Name	Caller ID (Global and Per-Line)	sip display name (global) sip lineN display name (per-line)	Name used in the display name field of the "From SIP" header field. Some IP PBX systems use this as the caller's ID, and some may overwrite this with the string that is set at the PBX system. Valid values are up to 20 alphanumeric characters. For more information, see Chapter 4, "Basic SIP Settings" on page 4-71.

Parameter In IP Phone UI	Parameter in Aastra Web UI	Parameters in Configuration Files	Description
Auth Name	Authentication Name (Global and Per-Line)	sip auth name (global) sip lineN auth name (per-line)	Authorization name used in the username field of the Authorization header field of the SIP REGISTER request. Valid values are up to 20 alphanumeric characters. For more information, see Chapter 4, “Basic SIP Settings” on page 4-71.
Password	Password (Global and Per-Line)	sip password (global) sip lineN password (per-line)	Password used to register the IP phone with the SIP proxy. Valid values are up to 20 numeric characters. Passwords are encrypted and display as asterisks when entering. For more information, see Chapter 4, “Basic SIP Settings” on page 4-71.
N/A	BLA Number (Global and Per-Line)	sip bla number (global) sip lineN bla number (per-line)	Phone number that you assign to BLA lines that is shared across all phones (global configuration) or shared on a per-line basis (per-line configuration). For more information, see Chapter 4, “Basic SIP Settings” on page 4-71. For more information about BLA, see Chapter 5, the section, “Bridged Line Appearance (BLA)” on page 5-218.
N/A	Line Mode (Global and Per-Line)	sip mode (global) sip lineN mode (per-line)	The mode-type that you assign to the IP phone. Valid values are Generic (0), BroadSoft SCA (1), Nortel (2), or BLA (3). Default is Generic (0). For more information, see Chapter 4, “Basic SIP Settings” on page 4-71.

Basic SIP Network Settings

Parameter In IP Phone UI	Parameter in Aastra Web UI	Parameters in Configuration Files	Description
Proxy Server	Proxy Server (Global and Per-Line)	sip proxy ip (global) sip lineN proxy ip (per-line)	IP address of the SIP proxy server. Up to 64 alphanumeric characters. For more information, see Chapter 4, “Basic SIP Settings” on page 4-71.
Proxy Port	Proxy Port (Global and Per-Line)	sip proxy port (global) sip lineN proxy port (per-line)	SIP proxy server’s port number. Default is 0. For more information, see Chapter 4, “Basic SIP Settings” on page 4-71.
N/A	Backup Proxy Server (Global and Per-Line)	sip backup proxy server (global) sip lineN backup proxy server (per-line)	The IP address of the backup SIP proxy server for which the IP phone uses when the primary SIP proxy is unavailable. For more information, see Chapter 4, “Basic SIP Settings” on page 4-71.
N/A	Backup Proxy Port (Global and Per-Line)	sip backup proxy port (global) sip lineN backup proxy port (per-line)	The port number of the backup SIP proxy server for which the IP phone uses when the primary SIP proxy port is unavailable. For more information, see Chapter 4, “Basic SIP Settings” on page 4-71.

Parameter In IP Phone UI	Parameter in Aastra Web UI	Parameters in Configuration Files	Description
N/A	Outbound Proxy Server (Global and Per-Line)	<p>sip outbound proxy server (global)</p> <p>sip lineN outbound proxy server (per-line)</p>	<p>Address of the outbound proxy server. All SIP messages originating from the phone are sent to this server. For example, if you have a Session Border Controller in your network, then you would normally set its address here. Default is 0.0.0.0.</p> <p>For more information, see Chapter 4, “Basic SIP Settings” on page 4-71.</p>
N/A	Outbound Proxy Port (Global and Per-Line)	<p>sip outbound proxy port (global)</p> <p>sip lineN outbound proxy port (per-line)</p>	<p>The proxy port on the proxy server to which the IP phone sends all SIP messages. Default is 0.</p> <p>For more information, see Chapter 4, “Basic SIP Settings” on page 4-71.</p>
Registrar Server	Registrar Server (Global and Per-Line)	<p>sip registrar ip (global)</p> <p>sip lineN registrar ip (per-line)</p>	<p>IP address of the SIP registrar. Up to 64 alphanumeric characters. Enables or disables the phone to be registered with the Registrar. When Register is disabled globally, the phone is still active and you can dial using username and IP address of the phone. A message "No Service" displays on the idle screen and the LED is steady ON. If Register is disabled for a single line, no messages display and LEDs are OFF.</p> <p>For more information, see Chapter 4, “Basic SIP Settings” on page 4-71.</p>
Registrar Port	Registrar Port (Global and Per-Line)	<p>sip registrar port (global)</p> <p>sip lineN registrar port (per-line)</p>	<p>SIP registrar's port number. Default is 0.</p> <p>For more information, see Chapter 4, “Basic SIP Settings” on page 4-71.</p>

Parameter In IP Phone UI	Parameter in Aastra Web UI	Parameters in Configuration Files	Description
N/A	Backup Registrar Server (Global and Per-Line)	sip backup registrar ip (global) sip lineN backup registrar ip (per-line)	The address of the backup registrar (typically, the backup SIP proxy) for which the IP phone uses to send <i>REGISTER</i> requests if the primary registrar is unavailable. For more information, see Chapter 4, “Basic SIP Settings” on page 4-71.
N/A	Backup Registrar Port (Global and Per-Line)	sip backup registrar port (global) sip lineN backup registrar port	The backup registrar's (typically the backup SIP proxy) port number. For more information, see Chapter 4, “Basic SIP Settings” on page 4-71.
N/A	Registration Period (Global and Per-Line)	sip registration period (global) sip lineN registration period (per-line)	The requested registration period, in seconds, from the registrar. For more information, see Chapter 4, “Basic SIP Settings” on page 4-71.
N/A	Conference Server URI (Global and Per-Line)	sip centralized conf (global) sip lineN centralized conf (per-line)	Globally enables or disables SIP centralized conferencing for an IP phone. For more information, see Chapter 4, “Centralized Conferencing (for Sylantro and Broadsoft Servers)” on page 5-363.

Advanced SIP Settings

In addition to the basic SIP settings, you can also configure the following advanced SIP parameters. These parameters are configurable via the Aastra Web UI and the configuration files on a global basis only.

Parameter in Aastra Web UI	Parameters in Configuration Files	Description
Explicit MWI Subscription	sip explicit mwi subscription	<p>If the IP phone has a message waiting subscription with the Service Provider, a Message Waiting Indicator (MWI) (LED or display icon) tells the user there is a message on the IP Phone. You can enable and disable MWI by setting this parameter to 0 (disable) or 1 (enable) in the configuration files or by checking the box for this field in the Aastra Web UI. Default is disabled.</p> <p>For more information, see Chapter 4, “Advanced SIP Settings (optional)” on page 4-86.</p>
Explicit MWI Subscription Period	sip explicit mwi subscription period	<p>The requested duration, in seconds, before the MWI subscription times out. The phone re-subscribes to MWI before the subscription period ends.</p> <p>For more information, see Chapter 4, “Advanced SIP Settings (optional)” on page 4-86.</p>
Missed Call Summary Subscription (Global and Per-Line)	sip missed call summary subscription (global) sip lineN missed call summary subscription (per-line)	<p>Enables or disables the Missed Call Summary Subscription feature. This feature allows missed calls that have been redirected by the server, to be incremented in the missed calls indicator on the phone it was initially directed to. Default is disabled.</p> <p>For more information about this parameter, see Chapter 6, the section, “Missed Call Summary Subscription” on page 6-13.</p>

Parameter in Aastra Web UI	Parameters in Configuration Files	Description
Missed Call Summary Subscription Period	sip missed call summary subscription period	<p>Specifies the amount of time, in seconds, that the phone uses the Missed Calls Summary Subscription feature. This parameter is always enabled with a default value of 86400 seconds. When the phone reaches the limit set for this parameter, it sends the subscription again.</p> <p>For more information about this parameter, see Chapter 6, the section, "Missed Call Summary Subscription" on page 6-13.</p>
AS-Feature-Event Subscription (Global and Per-Line)	sip as-feature-event subscription (global) sip lineN as-feature-event subscription (per-line)	<p>Enables or disables the specified line with the BroadSoft's server-side DND, CFWD, or ACD features.</p> <p>For more information about this parameter, see Chapter 6, the section, "As-Feature-Event Subscription" on page 6-17.</p>
AS-Feature-Event Subscription Period	sip as-feature-event subscription period	<p>Specifies the amount of time, in seconds, between resubscribing. If the phone does not resubscribe in the time specified for this parameter, it loses subscription.</p> <p>For more information about this parameter, see Chapter 6, the section, "As-Feature-Event Subscription" on page 6-17.</p>
Send MAC Address in REGISTER Message	sip send mac	<p>Adds an "Aastra-Mac:" header to the SIP REGISTER messages sent from the phone to the call server, where the value is the MAC address of the phone.</p> <p>For more information about this parameter, see Chapter 6, the section, "MAC Address/ Line Number in REGISTER Messages" on page 6-5.</p>

Parameter in Aastra Web UI	Parameters in Configuration Files	Description
Send Line Number in REGISTER Message	sip send line	<p>Adds an "Aastra-Line:" header to the SIP REGISTER messages sent from the phone to the call server, where the value is the line number that is being registered.</p> <p>For more information about this parameter, see Chapter 6, the section, "MAC Address/ Line Number in REGISTER Messages" on page 6-5.</p>
Session Timer	sip session timer	<p>The time, in seconds, that the IP phone uses to send periodic re-INVITE requests to keep a session alive. The proxy uses these re-INVITE requests to maintain the status' of the connected sessions. See RFC4028 for details. Default is 0.</p> <p>For more information, see Chapter 4, "Advanced SIP Settings (optional)" on page 4-86.</p>
Timer 1 and Timer 2	sip T1 timer sip T2 timer	<p>These timers are SIP transaction layer timers defined in RFC 3261. Timer 1 is an estimate, in milliseconds, of the round-trip time (RTT). Timer 2 represents the amount of time, in milliseconds, a non-INVITE server transaction takes to respond to a request.</p> <p>For more information, see Chapter 4, "Advanced SIP Settings (optional)" on page 4-86.</p>
Transaction Timer	sip transaction timer	<p>The amount of time, in milliseconds that the phone allows the callserver (registrar/proxy) to respond to SIP messages that it sends. If the phone does not receive a response in the amount of time designated for this parameter, the phone assumes the message has timed out.</p> <p>For more information, see Chapter 4, "Advanced SIP Settings (optional)" on page 4-86.</p>

Parameter in Aastra Web UI	Parameters in Configuration Files	Description
Transport Protocol	sip transport protocol	<p>The protocol that the Real-Time Transport Protocol (RTP) port on the IP phone uses to send out SIP signaling packets.</p> <p>Notes:</p> <ol style="list-style-type: none"> 1. If you set the value of this parameter to 4 (TLS), the phone checks to see if the “sips persistent tls” is enabled. If it is enabled, the phone uses Persistent TLS on the connection. If “sips persistent tls” is disabled, then the phone uses TLS on the connection. If TLS is used, you must specify the Root and Intermediate Certificates, the Local Certificate, the Private Key, and the Trusted Certificates. 2. If the phone uses Persistent TLS, you MUST specify the Trusted Certificates; the Root and Intermediate Certificates, the Local Certificate, and the Private Key are optional. <p>For more information, see Chapter 4, “Advanced SIP Settings (optional)” on page 4-86.</p>
Local SIP UDP/TCP Port	sip local port	<p>Specifies the local source port (UDP/TCP) from which the phone sends SIP messages.</p> <p>Notes:</p> <ol style="list-style-type: none"> 1. It is recommended that you avoid the conflict RTP port range in case of a UDP transport. 2. By default, the IP phones use symmetric UDP signaling for outgoing UDP SIP messages. When symmetric UDP is enabled, the IP phone generates and listens for UDP messages using port 5060. If symmetric UDP signaling is disabled, the phone sends from random ports but it listens on the configured SIP local port. <p>For more information, see Chapter 4, “SIP and TLS Source Ports for NAT Traversal” on page 4-37.</p>

Parameter in Aastra Web UI	Parameters in Configuration Files	Description
Local SIP TLS Port	sip local tls port	<p>Specifies the local source port (SIPS/TLS) from which the phone sends SIP messages.</p> <p>Note: It is recommended that you avoid the conflict with any TCP ports being used. For example: WebUI HTTP server on 80/tcp and HTTPS on 443/tcp.</p> <p>For more information, see Chapter 4, “SIP and TLS Source Ports for NAT Traversal” on page 4-37.</p>
Registration Failed Retry Timer	sip registration retry timer	<p>Specifies the time, in seconds, that the phone waits between registration attempts when a registration is rejected by the registrar.</p> <p>For more information, see Chapter 4, “Advanced SIP Settings (optional)” on page 4-86.</p>
Registration Timeout Retry Timer	sip registration timeout retry timer	<p>Specifies the length of time, in seconds, that the phone waits until it re-attempts to register after a REGISTER message times out.</p> <p>If this parameter is set lower than 30 seconds, the phone uses a minimum timer of 30 seconds.</p> <p>For more information, see Chapter 4, “Advanced SIP Settings (optional)” on page 4-86.</p>
Registration Renewal Timer	sip registration renewal timer	<p>The length of time, in seconds, prior to expiration, that the phone renews registrations.</p> <p>For example, if the value is set to 20, then 20 seconds before the registration is due to expire, a new REGISTER message is sent to the registrar to renew the registration.</p> <p>For more information, see Chapter 4, “Advanced SIP Settings (optional)” on page 4-86.</p>

Parameter in Aastra Web UI	Parameters in Configuration Files	Description
BLF Subscription Period	sip blf subscription period	<p>Specifies the time period, in seconds, that the IP phone resubscribes the BLF subscription service after a software/firmware upgrade or after a reboot of the IP phone.</p> <p>For more information, see Chapter 4, “Advanced SIP Settings (optional)” on page 4-86.</p>
ACD Subscription Period	sip acd subscription period	<p>Specifies the time period, in seconds, that the IP phone resubscribes the Automatic Call Distribution (ACD) subscription service after a software/firmware upgrade or after a reboot of the IP phone.</p> <p>For more information, see Chapter 4, “Advanced SIP Settings (optional)” on page 4-86.</p>
BLA Subscription Period	sip bla subscription period	<p>Specifies the amount of time, in seconds, that the phone waits to receive a BLA subscribe message from the server. If you specify zero (0), the phone uses the value specified for the BLA expiration in the subscribe message received from the server. If no value is specified, the phone uses the default value of 300 seconds.</p> <p>For more information, see Chapter 4, “Advanced SIP Settings (optional)” on page 4-86.</p>
Blacklist Duration	sip blacklist duration	<p>Specifies the length of time, in seconds, that a failed server remains on the server blacklist. The IP phone avoids sending a SIP message to a failed server (if another server is available) for this amount of time.</p> <p>For more information about Blacklist Duration, see Chapter 6, the section, “Blacklist Duration” on page 6-22.</p>

Parameter in Aastra Web UI	Parameters in Configuration Files	Description
Whitelist Proxy	sip whitelist	<p>This parameter enables/disables the whitelist proxy feature, as follows:</p> <ul style="list-style-type: none"> • Set to 0 to disable the feature. • Set to 1 to enable the feature. When this feature is enabled, an IP phone accepts call requests from a trusted proxy server <i>only</i>. The IP phone rejects any call requests from an untrusted proxy server. <p>For more information about Whitelist Proxy see Chapter 6, the section, "Whitelist Proxy" on page 6-24.</p>
XML SIP Notify	sip xml notify event	<p>Enables or disables the phone to accept or reject an aastra-xml SIP NOTIFY message.</p> <p>Note: To ensure the SIP NOTIFY is coming from a trusted source, it is recommended that you enable the Whitelist feature (Whitelist Proxy parameter) on the IP phone. If enabled, and the phone receives a SIP NOTIFY from a server that is NOT on the whitelist (i.e. untrusted server), the phone rejects the message.</p> <p>For more information about XML SIP Notify see Chapter 6, the section, "XML SIP Notify Events" on page 5-344.</p>

RTP Settings

You can configure the following RTP settings.

Parameter In IP Phone UI	Parameter in Aastra Web UI	Parameters in Configuration Files	Description
RTP Port Base	RTP Port	sip rtp port	<p>The RTP port is used for sending DTMF tones and for the audio stream. Your network administrator may close some ports for security reasons. You may want to use this parameter to send RTP data using a different port. Default is 3000.</p> <p>For more information, see Chapter 4, “Real-time Transport Protocol (RTP) Settings” on page 4-95.</p>
N/A	Basic Codecs (G.711 u-Law, G.711 a-Law, G.729)	sip use basic codecs	<p>Enables or disables basic codecs. Enabling this parameter allows the IP phone to use the basic Codecs when sending/receiving RTP packets. Valid values are 0 (disabled) and 1 (enabled). Default is 0 (disabled).</p> <p>For more information, see Chapter 4, “Real-time Transport Protocol (RTP) Settings” on page 4-95.</p>
N/A	Force RFC2833 Out of Band DTMF	sip out-of-band dtmf	<p>Enables or disables out-of-band DTMF. Enabling this parameter forces the IP phone to use out-of-band DTMF according to RFC2833. Valid values are 0 (disabled) and 1 (enabled). Default is 1 (enabled).</p> <p>For more information, see Chapter 4, “Real-time Transport Protocol (RTP) Settings” on page 4-95.</p>

Parameter In IP Phone UI	Parameter in Aastra Web UI	Parameters in Configuration Files	Description
N/A	Customized Codec Preference List	sip customized codec	<p>Specifies a customized Codec preference list which allows you to use the preferred Codecs for this IP phone.</p> <p>For more information, see Chapter 4, “Real-time Transport Protocol (RTP) Settings” on page 4-95.</p>
N/A	DTMF Method (Global and Per-Line)	sip dtmf method (global) sip lineN dtmf method (per-line)	<p>Sets the dual-tone multifrequency (DTMF) method to use on the IP phone on a global or per-line basis. Valid values are 0 (RTP), 1 (SIP INFO), or 2 (BOTH). Default is 0 (RTP).</p> <p>For more information, see Chapter 4, “Real-time Transport Protocol (RTP) Settings” on page 4-95.</p>
N/A	RTP Encryption (Global and Per-Line)	sip srtp mode (global) sip lineN srtp mode (per-line)	<p>This parameter determines if SRTP is enabled on this IP phone, as follows:</p> <ul style="list-style-type: none"> • If set to 0, then disable SRTP. • If set to 1 then SRTP calls are preferred. • If set to 2, then SRTP calls only are generated/accepted. <p>For more information, see Chapter 4, “Real-time Transport Protocol (RTP) Settings” on page 4-95.</p>
N/A	Silence Suppression	sip silence suppression	<p>Silence suppression is enabled by default on the IP phones. The phone negotiates whether or not to use silence suppression. Disabling this feature forces the phone to ignore any negotiated value.</p> <p>For more information, see Chapter 4, “Real-time Transport Protocol (RTP) Settings” on page 4-95.</p>

Autodial Settings

You can configure the following Autodial settings.

Parameter In IP Phone UI	Parameter in Aastra Web UI	Parameters in Configuration Files	Description
N/A	Autodial Number (Global and Per-Line)	sip autodial number sip lineN autodial number	Globally or on a per-line basis, specifies the SIP phone number that the IP phone autodials when the handset is lifted from the phone cradle. An empty (blank) value disables autodial on the phone. For more information, see Chapter 4, “Autodial Settings” on page 4-107.
N/A	Autodial Timeout (Global and Per-Line)	sip autodial timeout sip lineN autodial timeout	Globally or on a per-line basis, specifies the time, in seconds, that the phone waits to dial a preconfigured number after the handset is lifted from the IP phone cradle. If this parameter is set to 0 (hotline), the phone immediately dials a preconfigured number when you lift the handset. If this parameter is set to a value greater than 0, the phone waits the specified number of seconds before dialing the preconfigured number (warmline) when you lift the handset. Default is 0 (hotline). For more information, see Chapter 4, “Autodial Settings” on page 4-107.
N/A	Use Global Settings (Per-line configurations only)	N/A	For each line, this parameter specifies to use the global autodial settings of “Autodial Number” and “Autodial Timeout”. For more information, see Chapter 4, “Autodial Settings” on page 4-107.

Line Settings

An administrator can configure multiple lines on the IP phone with the same SIP network configuration (global) or a different SIP network configuration (per-line). The following table provides the number of lines available for each IP phone model.

IP Phone Model	Available Lines
9143i	9
9480i	9
9480i CT	9
6730i	6
6731i	6 -
6751i	1
6753i	9
6755i	9
6757i	9
6757i CT	9

On the IP Phones, you can configure the following on a per-line basis using the configuration files or the Aastra Web UI:

- **Basic SIP Authentication Settings**
- **Basic SIP Network Settings**
- **Advanced SIP Settings** (Missed Call Summary Subscription only)
- **RTP Settings** (DTMF Method and RTP Encryption only)
- **Autodial Settings** (On a per-line basis, you can also enable/disable the “Use Global Settings” parameter.)

References

For more information about configuring the features listed above on a per-line basis, see Chapter 4, the sections:

- [“Basic SIP Settings” on page 4-71](#)
- [“Advanced SIP Settings \(optional\)” on page 4-86](#)
- [“Real-time Transport Protocol \(RTP\) Settings” on page 4-95](#)
- [“Autodial Settings” on page 4-107](#)

Softkeys, Programmable Keys, Expansion Module Keys

A user or administrator can assign specific functions to softkeys, programmable keys, or expansion module keys. The available keys for configuration depend on the IP phone model as shown in the following table.

IP Phone Model	Softkeys	Expansion Module Keys	Programmable Keys
9143i	-	Not Applicable	7
9480i	6	Not Applicable	-
9480i CT	6	Not Applicable	-
6730i	-	Not Applicable	8
6731i	-	Not Applicable	8
6751i	-	Not Applicable	-
6753i	-	36 to 108* (Model M670i)	6
6755i	6	36 to 108* (Model M670i) 60 to 180** (Model M675i)	6
6757i	12	36 to 108* (Model M670i) 60 to 180** (Model M675i)	-
6757i CT	12	36 to 108* on Base Station (Model M670i) 60 to 180** on Base Station (Model M675i)	-

*The M670i expansion module consists of 36 softkeys. You can have up to 3 expansion modules on an IP phone totaling 108 softkeys. Valid for 6753i, 6755i, 6757i, and 6757i CT phones.

**The M675i expansion module consists of 60 softkeys. You can have up to 3 expansion modules on an IP phone totaling 180 softkeys. Valid for 6755i, 6757i, and 6757i CT phones.

The softkey, programmable key, or expansion module key can be set to use a specific function. Available functions depend on the IP phone model.

Reference

For more information about key functions see Appendix A, the section, [“Softkey/Programmable Key/Feature Key/Expansion Module Key Parameters”](#) on page A-216.

For information about configuring softkeys, programmable keys, and expansion module keys, see Chapter 5, the section, “[Softkeys/Programmable Keys/Feature Keys/Expansion Module Keys](#)” on page 5-142.

Action URI

The IP phones have a feature that allows an administrator to specify a uniform resource identifier (URI) that triggers a GET when certain XML events occur. The Action URI feature prevents the phones from hanging if the Action URIs should fail. The phones also support transparent, non-blocking, XML post execute item URIs.

The IP phone XML events that support this feature are defined in the following table.

Action URI	Description
Startup	Specifies the URI for which the phone executes a GET on when a startup event occurs.
Successful Registration	Specifies the URI for which the phone executes a GET on when a successful registration event occurs.
Registration Event	Specifies the URI for when registration events occur or when there are registration state changes. Note: This action URI is not called when the same event is repeated (for example, a timeout occurs again when registration is already in a timeout state.)
Incoming Call	Specifies the URI for which the phone executes a GET on when an incoming call event occurs.
Outgoing Call	Specifies the URI for which the phone executes a GET on when an outgoing call event occurs.
Offhook	Specifies the URI for which the phone executes a GET on when an offhook event occurs.
Onhook	Specifies the URI for which the phone executes a GET on when an onhook event occurs.
Disconnected	Specifies the URI that the phone executes a GET on, when it transitions from the incoming, outgoing, calling, or connected state into the idle state.
XML SIP Notify	Specifies the URI to be called when an empty XML SIP NOTIFY is received by the phone.

Action URI	Description
Poll	Specifies the URI to be called every "action uri poll interval" seconds.
Poll Interval	Specifies the interval, in seconds, between calls from the phone to the "action uri poll".

You can set these parameters using the configuration files or the Aastra Web UI.

Reference

For more information about setting the Action URIs for XML applications, see [“XML Action URIs”](#) on [page 5-330](#).

Action URI Disconnected

The phones allow an Administrator to specify a URI to allow a disconnect event to occur when the phone transitions from any active state (outgoing, incoming, connected, or calling) to an idle state.

Reference

For more information about configuring the Action URI Disconnected parameter, see [“Action URI Disconnected”](#) on [page 5-341](#).

XML SIP Notify Events and Action URIs

In order for an XML push to bypass the NAT/firewall, the phone supports a proprietary SIP NOTIFY event (aastra-xml) with or without XML content.

If XML content is provided in the SIP NOTIFY, it is processed directly by the phone as it is done for an XML PUSH.

Reference

For more information about enabling the XML SIP Notify on the IP Phones, see Chapter 5, the section, [“XML SIP Notify Events”](#) on [page 5-344](#).

Polling Action URIs

Another way to reach a phone behind a NAT/firewall is to have the phone make an XML call at periodic intervals. An Administrator can use the **action uri poll** to command the phone to perform an XML call at configurable intervals.

An Administrator can specify the URI to be called and specify the interval between polls. Configuration of this feature is dynamic (no reboot required).

Reference

For more information about configuring the polling and polling interval of Action URIs, see [“Polling Action URIs”](#) on [page 5-339](#).

Configuration Server Settings

The configuration server stores the firmware images, configuration files, and software when performing software upgrades to the IP phone. An administrator can configure the following parameters for the configuration server:

Parameter In IP Phone UI	Parameter in Aastra Web UI	Parameters in Configuration Files	Description
Download Protocol Settings			
Download Protocol	Download Protocol	download protocol	<p>Protocol to use for downloading new versions of software to the IP phone. Valid values are: TFTP FTP HTTP HTTPS</p> <p>Note: For DHCP to automatically populate the IP address or domain name for the download servers, your DHCP server must support Option 66. The IP phones also support Option 60 and 43. For more information, see Chapter 4, the section, “DHCP” on page 4-4.</p> <p>For more information about download protocols on the IP Phone, see Chapter 4, “Configuration Server Protocol” on page 4-112.</p>

Parameter In IP Phone UI	Parameter in Aastra Web UI	Parameters in Configuration Files	Description
Primary TFTP	TFTP Server	tftp server	<p>The TFTP server's IP address or qualified domain name. If DHCP is enabled and the DHCP server provides the information, this field is automatically populated. Use this parameter to change the IP address or domain name of the TFTP server. This will become effective after this configuration file has been downloaded into the phone.</p> <p>For more information, see Chapter 4, "Configuration Server Protocol" on page 4-112.</p>
Primary TFTP Path	TFTP Path	tftp path	<p>Specifies the path name for which the configuration files reside on the TFTP server for downloading to the IP Phone.</p> <p>If the IP phone's configuration and firmware files are located in a sub-directory beneath the server's root directory, the relative path to that sub-directory should be entered in this field.</p> <p>Note: Enter the path name in the form <i>folderX\folderX\folderX</i>. For example, <i>ipphone67571\configfiles</i>.</p> <p>For more information, see Chapter 4, "Configuration Server Protocol" on page 4-112.</p>
Alternate TFTP	Alternate TFTP	alternate tftp server	<p>The alternate TFTP server's IP address or qualified domain name. This will become effective after this configuration file has been downloaded into the phone.</p> <p>For more information, see Chapter 4, "Configuration Server Protocol" on page 4-112.</p>

Parameter In IP Phone UI	Parameter in Aastra Web UI	Parameters in Configuration Files	Description
Alternate TFTP Path	Alternate TFTP Path	alternate tftp path	<p>Specifies the path name for which the configuration files reside on the Alternate TFTP server for downloading to the IP Phone.</p> <p>If the IP phone's configuration and firmware files are located in a sub-directory beneath the server's root directory, the relative path to that sub-directory should be entered in this field.</p> <p>For more information, see Chapter 4, "Configuration Server Protocol" on page 4-112.</p>
Select TFTP	Use Alternate TFTP	use alternate tftp	<p>Enables or disables the alternate TFTP server. Valid values are "0" disabled and "1" enabled.</p> <p>For more information, see Chapter 4, "Configuration Server Protocol" on page 4-112.</p>
FTP Server	FTP Server	ftp server	<p>The FTP server's IP address or network host name. This will become effective after this configuration file has been downloaded into the phone.</p> <p>Optional: You can also assign a username and password for access to the FTP server. See the following parameters for setting username and password.</p> <p>For more information, see Chapter 4, "Configuration Server Protocol" on page 4-112.</p>

Parameter In IP Phone UI	Parameter in Aastra Web UI	Parameters in Configuration Files	Description
FTP Path	FTP Path	ftp path	<p>Specifies the path name for which the configuration files reside on the FTP server for downloading to the IP Phone.</p> <p>If the IP phone's configuration and firmware files are located in a sub-directory beneath the server's root directory, the relative path to that sub-directory should be entered in this field.</p> <p>For more information, see Chapter 4, "Configuration Server Protocol" on page 4-112.</p>
FTP Username	FTP Username	ftp username	<p>The username to enter for accessing the FTP server. This will become effective after this configuration file has been downloaded into the phone.</p> <p>Note: The IP Phones support usernames containing dots (".").</p> <p>For more information, see Chapter 4, "Configuration Server Protocol" on page 4-112.</p>
FTP Password	FTP Password	ftp password	<p>The password to enter for accessing the FTP server. This will become effective after this configuration file has been downloaded into the phone.</p> <p>For more information, see Chapter 4, "Configuration Server Protocol" on page 4-112.</p>

Parameter In IP Phone UI	Parameter in Aastra Web UI	Parameters in Configuration Files	Description
HTTP Server	HTTP Server	http server	<p>The HTTP server's IP address. This will become effective after this configuration file has been downloaded into the phone.</p> <p>Optional: You can also assign an HTTP relative path to the HTTP server. See the next parameter (http path).</p> <p>For more information, see Chapter 4, "Configuration Server Protocol" on page 4-112.</p>
HTTP Path	HTTP Path	http path	<p>Specifies the path name for which the configuration files reside on the HTTP server for downloading to the IP Phone.</p> <p>If the IP phone's configuration and firmware files are located in a sub-directory beneath the server's root directory, the relative path to that sub-directory should be entered in this field.</p> <p>For more information, see Chapter 4, "Configuration Server Protocol" on page 4-112.</p>
HTTP Port	HTTP Port	http port	<p>Specifies the HTTP port that the server uses to load the configuration to the phone over HTTP.</p> <p>For more information, see Chapter 4, "Configuration Server Protocol" on page 4-112.</p>

Parameter In IP Phone UI	Parameter in Aastra Web UI	Parameters in Configuration Files	Description
Download Server	HTTPS Server	https server	<p>The HTTPS server's IP address. This will become effective after this configuration file has been downloaded into the phone.</p> <p>Optional: You can also assign an HTTPS relative path to the HTTPS server. See the next parameter (https path).</p> <p>For more information, see Chapter 4, "Configuration Server Protocol" on page 4-112.</p>
Download Path	HTTPS Path	https path	<p>Specifies the path name for which the configuration files reside on the HTTPS server for downloading to the IP Phone.</p> <p>If the IP phone's configuration and firmware files are located in a sub-directory beneath the server's root directory, the relative path to that sub-directory should be entered in this field.</p> <p>For more information, see Chapter 4, "Configuration Server Protocol" on page 4-112.</p>
Download Port	HTTPS Port	https port	<p>Specifies the HTTP port that the server uses to load the configuration to the phone over HTTP.</p> <p>For more information, see Chapter 4, "Configuration Server Protocol" on page 4-112.</p>

Parameter In IP Phone UI	Parameter in Aastra Web UI	Parameters in Configuration Files	Description
Auto-Resync Settings			
N/A	Mode	auto resync mode	<p>Enables and disables the phone to be updated automatically once a day at a specific time in a 24-hour period. This parameter works with TFTP, FTP, and HTTP servers.</p> <p>Notes:</p> <ol style="list-style-type: none"> 1. If a user is accessing the Aastra Web UI, they are not informed of an auto-reboot. 2. Any changes made using the Aastra Web UI or the IP phone UI are not overwritten by an auto-resync update. Auto-resync affects the configuration files only. However, the settings in the Aastra Web UI take precedence over the IP phone UI and the configuration files. 3. The resync time is based on the local time of the IP phone. 4. If the IP phone is in use (not idle) at the time of the resync check, the reboot occurs when the phone becomes idle. 5. The automatic update feature works with both encrypted and plain text configuration files. <p>For more information, see Chapter 8, the section, "Using the Auto-Resync Feature" on page 8-7.</p>

Parameter In IP Phone UI	Parameter in Aastra Web UI	Parameters in Configuration Files	Description
N/A	Time (24-hour)	auto resync time	<p>Sets the time of day in a 24-hour period for the IP phone to be automatically updated. This parameter works with TFTP, FTP, and HTTP servers.</p> <p>Notes:</p> <ol style="list-style-type: none"> 1. The resync time is based on the local time of the IP phone. 2. The value of 00:00 is 12:00 A.M. 3. When selecting a value for this parameter in the Aastra Web UI, the values are in 30-minute increments only. 4. When entering a value for this parameter using the configuration files, the value can be entered using minute values from 00 to 59 (for example, the auto resync time can be entered as 02:56). <p>For more information, see Chapter 8, the section, “Using the Auto-Resync Feature” on page 8-7.</p>
N/A	Maximum Delay	auto resync max delay	<p>Specifies the maximum time, in minutes, the phone waits past the scheduled time before starting a checksync.</p> <p>For more information, see Chapter 8, the section, “Using the Auto-Resync Feature” on page 8-7.</p>

Parameter In IP Phone UI	Parameter in Aastra Web UI	Parameters in Configuration Files	Description
N/A	Days	auto resync days	<p>Specifies the amount of days that the phone waits between checksync operations.</p> <p>Note: A value of 0 causes the phone to checksync every time the clock reads the proper time. A value of 1 forces the phone to wait 24 hours prior to doing the first checksync.</p> <p>For more information, see Chapter 8, the section, "Using the Auto-Resync Feature" on page 8-7.</p>
XML Push Server List (Approved IP Addresses)			
N/A	XML Push Server List (Approved IP Addresses)	xml application post list	<p>The HTTP server that is pushing XML applications to the IP phone.</p> <p>For more information, see Chapter 5, the section, "XML Push Requests" on page 5-323.</p>

Firmware Update Features

The IP phones support the protocols, TFTP, FTP, HTTP or HTTPS to download configuration files and upgrade firmware to the phones from a configuration server.

You can download the firmware stored on the configuration server in one of three ways:

- Using the “**Firmware Update**” page in the Aastra Web UI at the location *Advanced Settings->Firmware Update*.
- Using the IP Phone UI or the Aastra Web UI to **restart** the phone. The phone automatically looks for firmware updates and configuration files during the boot process.
- Setting an **Auto-Resync** feature to automatically update the firmware, configuration files, or both at a specific time in a 24-hour period). (Feature can be enabled using the configuration files or the Aastra Web UI).

Reference

For more information about firmware update, see [Chapter 8, “Upgrading the Firmware.”](#)

TLS Support

The IP Phones support a transport protocol called **Transport Layer Security (TLS)** and **Persistent TLS**. TLS is a protocol that ensures communication privacy between the SIP phones and the Internet. TLS ensures that no third party may eavesdrop or tamper with any message. An Administrator can configure the following parameters for TLS Support.

Parameter In IP Phone UI	Parameter in Aastra Web UI	Parameters in Configuration Files	Description
N/A	Transport Protocol	sip transport protocol	<p>Specifies the protocol that the RTP port on the IP phone uses to send out SIP signaling packets. Default is USP.</p> <p>Notes:</p> <ol style="list-style-type: none"> 1. If you set the value of this parameter to 4 (TLS), the phone checks to see if the “sips persistent tls” is enabled. If it is enabled, the phone uses Persistent TLS on the connection. If “sips persistent tls” is disabled, then the phone uses TLS on the connection. If TLS is used, you must specify the Root and Intermediate Certificates, the Local Certificate, the Private Key, and the Trusted Certificates. 2. If the phone uses Persistent TLS, you MUST specify the Trusted Certificates; the Root and Intermediate Certificates, the Local Certificate, and the Private Key are optional. <p>For more information, see Chapter 6, the section, “Transport Layer Security (TLS)” on page 6-26.</p>

Parameter In IP Phone UI	Parameter in Aastra Web UI	Parameters in Configuration Files	Description
N/A	N/A	sips persistent tls	<p>Enables or disables the use of Persistent Transport Layer Security (TLS).</p> <p>Persistent TLS sets up the connection to the server once and re-uses that connection for all calls from the phone. The setup connection for Persistent TLS is established during the registration of the phone. If the phones are set to use Persistent TLS, and a call is made from the phone, this call and all subsequent calls use the same authenticated connection. This significantly reduces the delay time when placing a call.</p> <p>Notes:</p> <ol style="list-style-type: none"> 1. Persistent TLS requires the outbound proxy server and outbound proxy port parameters be configured in either the configuration files or the Aastra Web UI (<i>Advanced Settings->Global SIP->Basic SIP Network Settings</i>). There can be only one persistent TLS connection created per phone. The phone establishes the TLS connection to the configured outbound proxy. 2. If you configure the phone to use Persistent TLS, you must also specify the Trusted Certificate file to use. The Root and Intermediate Certificates, Local Certificate, and Private Key files are optional. <p>For more information, see Chapter 6, the section, "Transport Layer Security (TLS)" on page 6-26.</p>

Parameter In IP Phone UI	Parameter in Aastra Web UI	Parameters in Configuration Files	Description
N/A	Root and Intermediate Certificates Filename	sips root and intermediate certificates	<p>Allows you to specify the SIP Root and Intermediate Certificate files to use when the phone uses the TLS transport protocol to setup a call.</p> <p>The Root and Intermediate Certificate files contain one root certificate and zero or more intermediate certificates which must be placed in order of certificate signing with root certificate being the first in the file. If the local certificate is signed by some well known certificate authority, then that authority provides the user with the Root and Intermediate Certificate files (most likely just CA root certificate).</p> <p>This parameter is required when configuring TLS (optional for Persistent TLS.)</p> <p>Note: The certificate files must use the format “.pem”. To create custom certificate files to use on your IP phone, contact Aastra Technical Support.</p> <p>For more information, see Chapter 6, the section, “Transport Layer Security (TLS)” on page 6-26.</p>
N/A	Local Certificate Filename	sips local certificate	<p>Allows you to specify the Local Certificate file to use when the phone uses the TLS transport protocol to setup a call.</p> <p>This parameter is required when configuring TLS (optional for Persistent TLS.)</p> <p>Note: The certificate file must use the format “.pem”. To create specific certificate files to use on your IP phone, contact Aastra Technical Support.</p> <p>For more information, see Chapter 6, the section, “Transport Layer Security (TLS)” on page 6-26.</p>

Parameter In IP Phone UI	Parameter in Aastra Web UI	Parameters in Configuration Files	Description
N/A	Private Key Filename	sips private key	<p>Allows you to specify a Private Key file to use when the phone uses the TLS transport protocol to setup a call.</p> <p>This parameter is required when configuring TLS (optional for Persistent TLS.)</p> <p>Note: The key file must use the format “.pem”. To create specific private key files to use on your IP phone, contact Aastra Technical Support.</p> <p>For more information, see Chapter 6, the section, “Transport Layer Security (TLS)” on page 6-26.</p>
N/A	Trusted Certificates Filename	sips trusted certificates	<p>Allows you to specify the Trusted Certificate files to use when the phone uses the TLS transport protocol to setup a call.</p> <p>The Trusted Certificate files define a list of trusted certificates. The phone’s trusted list must contain the CA root certificates for all the servers it is connecting to. For example, if the phone is connecting to server A which has a certificate signed by CA1, and server B which has a certificate signed by CA2, the phone must have CA1 root certificate and CA2 root certificate in its Trusted Certificate file.</p> <p>This parameter is required when configuring TLS or Persistent TLS.</p> <p>Note: The certificate files must use the format “.pem”. To create custom certificate files to use on your IP phone, contact Aastra Technical Support.</p> <p>For more information, see Chapter 6, the section, “Transport Layer Security (TLS)” on page 6-26.</p>

802.1x Support

The IP phones support the IEEE 802.1x Protocol. The 802.1x Protocol is a standard for passing Extensible Authentication Protocol (EAP) over a wired or wireless Local Area Network (LAN).

The 802.1x Protocol on the IP phone facilitates media-level access control, and offers the capability to permit or deny network connectivity, control LAN access, and apply traffic policy, based on user or endpoint identity. This feature supports both the EAP-MD5 and EAP-TLS Protocols.



Note: If configuring 802.1x using the IP Phone UI, the certificates and private keys must already be configured and stored on the phone. Use the configuration files or the Aastra Web UI to load certificates and private keys.

An Administrator can configure the following parameters for the 802.1x Protocol.

Parameter In IP Phone UI	Parameter in Aastra Web UI	Parameters in Configuration Files	Description
EAP-MD5			
802.1x Mode	EAP Type	eap-type	Specifies the type of authentication to use on the IP Phone. For more information, see Chapter 6, the section, "802.1x Support" on page 6-31 .
Identity	Identity	identity	Specifies the identity or username used for authenticating the phone. Note: The value you enter for this parameter also displays in the Aastra Web UI at the path Advanced Settings->802.1x Support->General->Identity For more information, see Chapter 6, the section, "802.1x Support" on page 6-31 .

Parameter In IP Phone UI	Parameter in Aastra Web UI	Parameters in Configuration Files	Description
MD5 Password	MD5 Password	md5 password	<p>Specifies the password used for the MD5 authentication of the phone.</p> <p>Note: The value you enter for this parameter also displays in the Aastra Web UI at the path Advanced Settings-> 802.1x Support->EAP-MD5 Settings->MD5 Password. The password displays as "*****".</p> <p>For more information, see Chapter 6, the section, "802.1x Support" on page 6-31.</p>
EAP-TLS			
802.1x Mode	EAP Type	eap type	<p>Specifies the type of authentication to use on the IP Phone.</p> <p>For more information, see Chapter 6, the section, "802.1x Support" on page 6-31.</p>
Identity	Identity	identity	<p>Specifies the identity or username used for authenticating the phone.</p> <p>Note: The value you enter for this parameter also displays in the Aastra Web UI at the path Advanced Settings-> 802.1x Support->General->Identity</p> <p>For more information, see Chapter 6, the section, "802.1x Support" on page 6-31.</p>
N/A	Root and Intermediate Certificates Filename	802.1x root and intermediate certificates	<p>Specifies the file name that contains the root and intermediate certificates related to the local certificate.</p> <p>For more information, see Chapter 6, the section, "802.1x Support" on page 6-31.</p>
N/A	Local Certificate Filename	802.1x local certificate	<p>Specifies the file name that contains the local certificate.</p> <p>For more information, see Chapter 6, the section, "802.1x Support" on page 6-31.</p>

Parameter In IP Phone UI	Parameter in Aastra Web UI	Parameters in Configuration Files	Description
N/A	Private Key Filename	802.1x private key	Specifies the file name that contains the private key. For more information, see Chapter 6, the section, "802.1x Support" on page 6-31.
N/A	Trusted Certificates Filename	802.1x trusted certificates	Specifies the file name that contains the trusted certificates. For more information, see Chapter 6, the section, "802.1x Support" on page 6-31.

Troubleshooting

The Troubleshooting feature in the Aastra Web UI provides tasks that a system administrator can perform on the IP phones for troubleshooting purposes. Using this feature, a system administrator can:

- Assign an IP address and IP port in which to save log files
- Filter the logs according to severity that get reported to log files
- Save the current local configuration file to a specified location
- Save the current server configuration file to a specified location
- Show task and stack status (including “Free Memory” and “Maximum Memory Block Size”)
- Enable/disable a WatchDog task
- View Error Messages

Aastra Technical Support can then use the information gathered to perform troubleshooting tasks.

Reference

For more information about troubleshooting on the IP Phones, see [Chapter 9, “Troubleshooting.”](#)

Chapter 4

Configuring Network and Session Initiation Protocol (SIP) Features

About this chapter

Introduction

This chapter provides the information required to configure the Network and Global SIP features on the IP Phone. These features are password protected on the IP Phone UI and the Aastra Web UI. This chapter also includes procedures for configuring the Network and Global SIP features via the configuration files, the IP Phone UI, and the Aastra Web UI where applicable.



Note: The IP Phone User Interface (UI) procedures in the remainder of this Guide use the keys on the 9480i, 9480i CT, 6755i, 6757i, and/or 6757i CT when configuring Administrator Options. For information on using the 9143i, 6730i, 6731i, 6751i, and 6753i keys to configure the Administrator Options, see Chapter 2, the section, [“Using the Options Key”](#) on [page 2-5](#).

Topics

This chapter covers the following topics:

Topic	Page
Overview	page 4-3
Network Settings	page 4-4
Basic Network Settings	page 4-4
Advanced Network Settings	page 4-30
Global SIP Settings	page 4-70
Basic SIP Settings	page 4-71
Advanced SIP Settings (optional)	page 4-86
Real-time Transport Protocol (RTP) Settings	page 4-95
RTCP Summary Reports	page 4-105
Autodial Settings	page 4-107
Configuration Server Protocol	page 4-112
Configuring the Configuration Server Protocol	page 4-112

Overview

An administrator can configure the IP Phone Network and SIP options from the phone UI, from the Aastra Web UI, or the configuration files. Administrator level options are password protected in both the IP phone UI and the Aastra Web UI.



Note: An administrator has the option of enabling and disabling the use of password protection in the IP phone UI. This is configurable using the configuration files only. For more information about this feature, see Appendix A, the section “[Password Settings](#)” on [page A-15](#).

The procedures in this section include configuring from the IP phone UI and the Aastra Web UI. To configure the IP phones using the configuration files, see [Appendix A, “Configuration Parameters.”](#)

To configure the phone using the IP phone UI, you must enter an administrator password. To configure the phone using the Aastra Web UI, you must enter an administrator username and password.



Note: In the IP phone UI, the default password is “**22222**”. In the Aastra Web UI, the default admin username is “**Admin**” and the default password is “**22222**”.

References

For configuring the IP phone at the Asterisk IP PBX, see [Appendix B, “Configuring the IP Phone at the Asterisk IP PBX.”](#)

For sample configuration files, see [Appendix C, “Sample Configuration Files.”](#) These sample files include basic parameters required to register the IP phone at the PBX.

Network Settings

This section describes the basic network settings on the IP phone which include configuring for:

- DHCP
- IP Address (of phone)
- Subnet Mask (of phone)
- Gateway
- Primary DNS
- Secondary DNS
- LAN Port
- PC Port

Basic Network Settings

DHCP

The IP phone is capable of querying a DHCP server, allowing a network administrator a centralized and automated method of configuring various network parameters for the phone. If DHCP is enabled, the IP phone requests the following network information:

- Subnet Mask
- Gateway (i.e. router)
- Domain Name Server (DNS)
- Network Time Protocol Server
- IP Address
- TFTP Server or Alternate TFTP Server if enabled on the phone
- TFTP Path or Alternate TFTP Path if enabled on the phone
- FTP Server

- FTP Path
- HTTP Server
- HTTP Path
- HTTP Port
- HTTPS Server
- HTTPS Path
- HTTPS Port

The network administrator chooses which of these parameters (if any) are supplied to the IP phone by the DHCP server. The administrator must configure the phone manually to provide any required network parameters not supplied by the DHCP server.

Enabling/Disabling DHCP Using the Configuration Files

Use the following procedure to enable/disable DHCP on the phone using the configuration files.





Configuration Files

For specific parameters you can set in the configuration files, see Appendix A, the section, "[Network Settings](#)" on [page A-8](#).

Enabling/Disabling DHCP Using the IP Phone UI

Use the following procedure to enable/disable DHCP on the phone using the IP Phone UI.

 IP Phone UI	
Step	Action
1	Press  on the phone to enter the Options List.
2	Select Administrator Menu .
3	Enter your Administrator password. Note: The IP Phones accept numeric passwords only.
4	Select Network Settings .
5	Select option DHCP .
6	Press Change to set "Use DHCP?" to "Yes" (enable) or "No" (disable).
7	Press Done to save the changes.

Enabling/Disabling DHCP Using the Aastra Web UI

Use the following procedure to enable/disable DHCP using the Aastra Web UI.

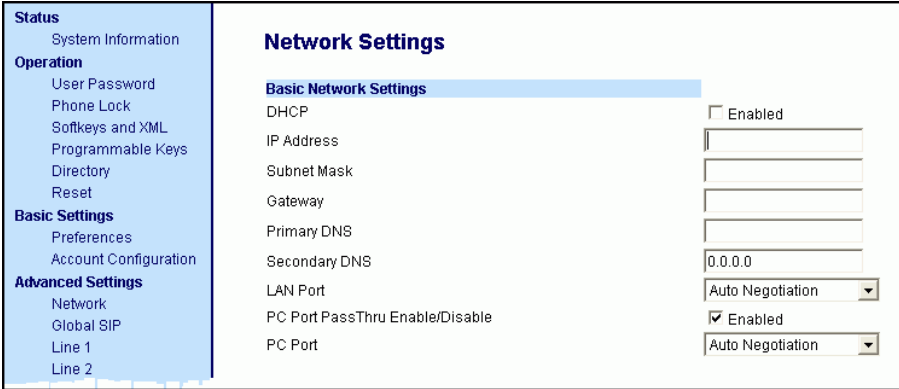
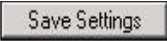
Aastra Web UI	
Step	Action
1	<p>Click on Advanced Settings->Network->Basic Network Settings.</p> 
2	Enable the " DHCP " field by checking the check box. (Disable this field by unchecking the box).
3	Click  to save your settings.

DHCP Options 60, 66, and 43 Server Configurations

Option 66

The IP Phones support download protocols according to RFC2131 and RFC1541 (TFTP, FTP, HTTP, HTTPS) to support DHCP option 66. Option 66 is part of the DHCP Offer message that the DHCP server generates to tell the phone which configuration server it should use to download new firmware and configuration files.

For DHCP to automatically populate the IP address or domain name for the servers, your DHCP server must support Option 66. Option 66 is responsible for forwarding the server's IP address or domain name to the phone automatically. If your DHCP server does not support Option 66, you must manually enter the IP address or domain name for your applicable configuration server into your IP phone configuration.

Options 60 and 43

The Aastra phones also support Option 60 and Option 43 as per RFC 2132.

Option 60 (Vendor Class Identifier) provides the DHCP server with a unique identifier for each phone model. This enables a system administrator to send the phone a customized Server Configuration in option 43.

The table below lists the identifier values for each phone model.

Model	Identifier Value
9143i	AastralPPhone9143i
9480i	AastralPPhone9480i
9480i CT	AastralPPhone9480iCT
6730i	AastralPPhone6730i
6731i	AastralPPhone6731i
6751i	AastralPPhone51i
6753i	AastralPPhone53i
6755i	AastralPPhone55i
6757i	AastralPPhone57i
6757i CT	AastralPPhone57iCT

The System administrator can use the Vendor Class Identifier to send the phone a customized Server Configuration in option 43 (Vendor-Specific information).



Note: If Aastra IP Phones receive the server configuration from both DHCP Option 66 and DHCP Option 43, then Option 43 takes precedence over Option 66.

Using Option 43 to Customize the IP Phone

A System Administrator can customize the IP Phone(s) in the network by entering a text string in the phone's configuration files. The following is an Option 43 example using Linux.

On the startup of the phones, when the DHCP server receives the request with the information in this example, it allows the 6757i phones to use FTP and the 6757i CT phones to use TFTP from the same server.

Linux Example

A System Administrator can enter the following in the Aastra IP Phone configuration file:

```
option space AastraIPPhone57i;
option AastraIPPhone57i.cfg-server-name code 02 = text;

option space AastraIPPhone57iCT;
option AastraIPPhone57iCT.cfg-server-name code 02 = text;

Subnet 192.168.1.0 netmask 255.255.255.0 {

    class "vendor-class-57i" {
        match if option vendor-class-identifier="AastraIPPhone57i";
        vendor-option-space AastraIPPhone57i;
        option AastraIPPhone57i.cfg-server-name "ftp://
username:password@10.10.10.1";
    }
    class "vendor-class-57iCT" {
        match if option vendor-class-identifier="AastraIPPhone57iCT";
        vendor-option-space AastraIPPhone57iCT;
        option AastraIPPhone57iCT.cfg-server-name "tftp://10.10.10.1";
    }
}
```

Your DHCP server configuration file, such as the *dhcpd.conf* file, may include one of these lines to configure the configuration server protocol and the server details.

Protocol	Format	Examples
HTTP	http://<server>/<path>	option tftp-server-name "http://192.168.1.45"; option tftp-server-name "http://192.168.1.45/path"; option tftp-server-name "http://httpsvr.example.com/path";
HTTPS	https://<server>/<path>	option tftp-server-name "https://192.168.1.45"; option tftp-server-name "https://192.168.1.45/path"; option tftp-server-name "https://httpssvr.example.com/path";
FTP	ftp://user:password@ftpsvr	option tftp-server-name "ftp://192.168.1.45"; option tftp-server-name "ftp://ftpsvr.example.com"; (for anonymous user) option tftp-server-name "ftp://userID:password@ftpsvr.example.com";
TFTP	tftp://tftpsvr	option tftp-server-name "192.168.1.45"; option tftp-server-name "tftpsvr.example.com"; option tftp-server-name "tftp://tftpsvr.example.com";

Using Option 12 Hostname on the IP Phone

If you set the phone to use DHCP Option 12, the phone automatically sends this option to the configuration server. This option specifies the hostname (name of the client). The name may or may not be qualified with the local domain name (based on RFC 2132). See RFC 1035 for character set restrictions.



Notes:

1. The hostname of [<model><MAC address>] automatically populates the field on initial startup of the phone. For example, for a 6753i, the “Hostname” field is automatically populated as “53i00085D164435”, where the model number is “6753i” and the MAC address is “00085D164435”.
2. If the configuration server sends the hostname back to the phone in a DHCP Reply Packet, the hostname is ignored.

An Administrator can change the “Hostname” for the DHCP Option 12 via the configuration files, the IP Phone UI, and the Aastra Web UI.

Configuring DHCP Option 12 Hostname on the IP Phone

Use the following procedures to configure DHCP Option 12 Hostname on the IP Phone.



Configuration Files

For specific parameters you can set in the configuration files, see Appendix A, the section, “[DHCP Option Settings](#)” on [page A-13](#).



Aastra IP Phone UI

Step	Action
1	<p>Press Options, and then select Administrator Menu.</p> <p><i>On the 6751i:</i></p> <p>Press Services, and then select Options->Administrator Menu.</p>
2	Select Network Settings .
3	Select Hostname .
4	<p>By default, the "Hostname" field is automatically populated with [<Model><MAC address>] of your phone (for example, 53i00085D164435).</p> <p>If you want to change the hostname, enter a hostname for your phone in the "Hostname" field, then press DONE.</p> <p>Valid values are up to 64 alpha-numeric characters. You can use a fully qualified domain name if required.</p>
5	Restart the phone for the change to take affect.

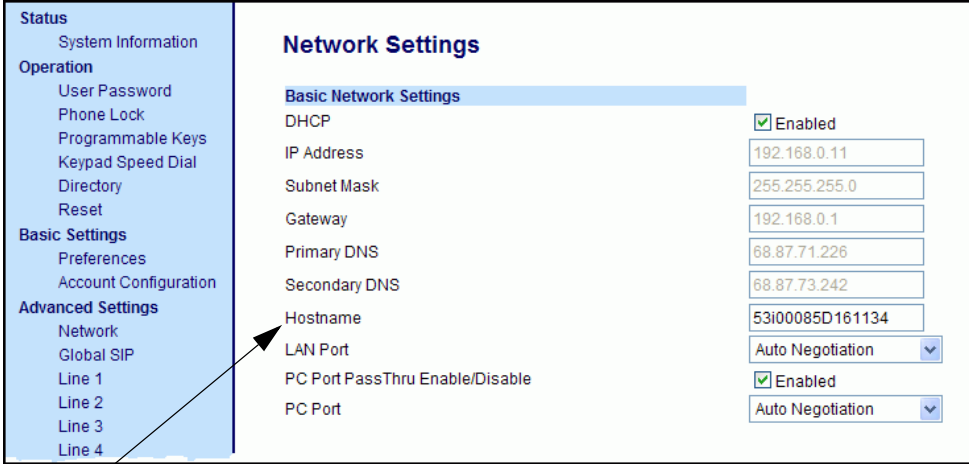
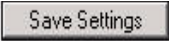
Aastra Web UI	
1	<p>Click on Advanced Settings->Network->Basic Network Settings.</p>  <p>Hostname</p>
2	<p>By default, the “Hostname” field is automatically populated with [<Model><MAC address>] of your phone (for example, 53i00085D164435).</p> <p>If you want to change the hostname, enter a hostname for your phone in the “Hostname” field. Valid values are up to 64 alpha-numeric characters. You can use a fully qualified domain name if required.</p>
3	<p>Click  to save your changes.</p> <p>Note: Changing the “Hostname” field requires a reboot of your phone.</p>
4	<p>Click on Operation->Reset, and click RESTART.</p>

Using Option 77 User Class on the IP Phone

DHCP Option 77 User Class is sent in DHCP request packets from the phone to the configuration server. This Option 77 defines specific User Class identifiers to convey information about a phone's software configuration or about its user's preferences. For example, you can use the User Class option to configure all phones in the Accounting Department with different user preferences than the phones in the Marketing Department. A DHCP server uses the User Class option to choose the address pool for which it allocates an address from, and/or to select any other configuration option.



Notes:

1. If the User Class is not specified (left blank) in the DHCP request packet, the phone does not send the User Class DHCP Option 77.
2. Multiple User Classes inside a DHCP Option 77 are not supported.
3. DHCP Option 77 may affect the precedence of DHCP Options, dependent on the DHCP Server.

An Administrator can configure the DHCP Option 77 User Class via the configuration files, the IP Phone UI, and the Aastra Web UI.

Configuring DHCP Option 77 User Class on the IP Phone

Use the following procedures to configure DHCP Option 77 User Class on the IP Phone.



Configuration Files

For specific parameters you can set in the configuration files, see Appendix A, the section, "[DHCP Option Settings](#)" on [page A-13](#).

**Aastra IP Phone UI**

Step	Action
1	Press Options , and then select Administrator Menu . <i>On the 6751i:</i> Press Services , and then select Options->Administrator Menu .
2	Select Network Settings .
3	Select DHCP Settings .
4	Select DHCP User Class .
5	In the " DHCP User Class " field, enter a DHCP User Class to apply to your phones, then press DONE . Valid values are up to 64 alpha-numeric characters. For example, " admin ".
6	Restart the phone for the change to take affect.

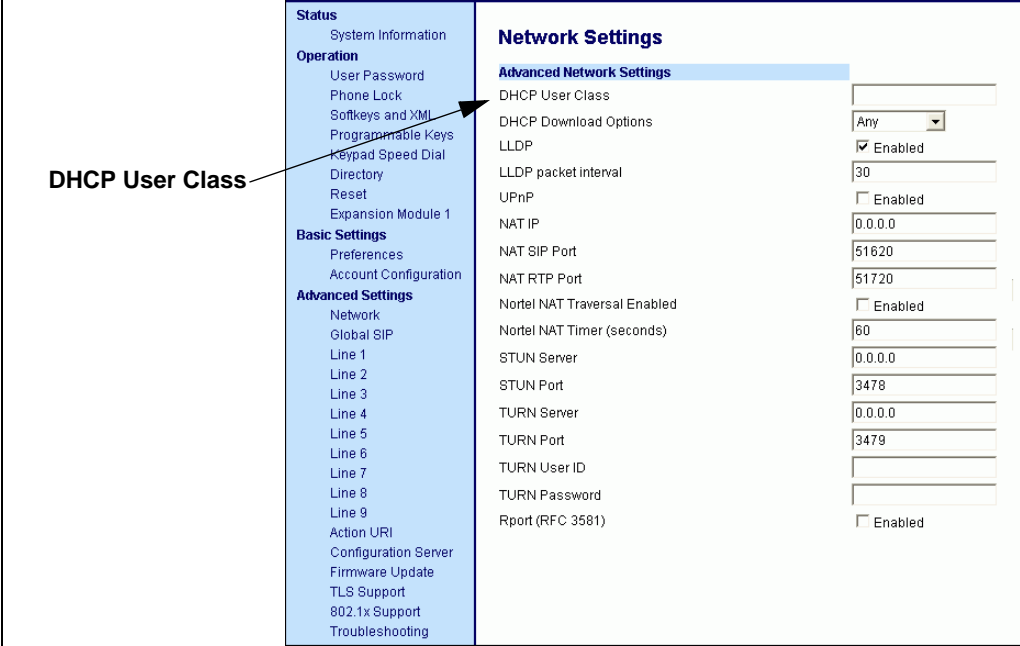
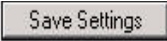
 Aastra Web UI	
1	<p>Click on Advanced Settings->Network->Advanced Network Settings.</p> <div style="border: 1px solid black; padding: 10px; margin: 10px 0;">  </div>
2	<p>In the “DHCP User Class” field, enter a DHCP User Class to apply to your phones. For example, “admin”. Valid values are up to 64 alpha-numeric characters.</p>
3	<p>Click  to save your changes.</p> <p>Note: Entering a value in the “DHCP User Class” field requires a reboot of your phone.</p>
4	<p>Click on Operation->Reset, and click RESTART.</p>

Using Options 159 and 160 on the IP Phone

In addition to DHCP options 43 and 66 already supported on the IP Phones, the phones also support DHCP Options 159 and 160. The IP Phones use the following order of precedence when deriving the configuration server parameters: 43, 160, 159, 66.

In addition, an administrator can override this order of precedence by setting a configuration parameter called, **dhcp config option override** (configuration files), **DHCP Download Options** (Aastra Web UI), or **Download Options** (IP Phone UI). Setting this parameter results in the phone only using the chosen DHCP option and ignoring the other options.

For more information about setting DHCP download preference, see [“Configuration Server Download Precedence”](#) on [page 4-20](#)..



Warning: Administrators should review the updated IP phone DHCP option precedence order and configuration options to avoid potential impact to existing Aastra IP phone deployments.

Configuring DHCP Download Options on the IP Phones

Use the following procedures to configure DHCP Option Override on the IP Phone.



Configuration Files

For specific parameters you can set in the configuration files, see Appendix A, the section, [“DHCP Option Settings”](#) on [page A-13](#).



Aastra IP Phone UI

Step	Action
1	Press Options , and then select Administrator Menu . <i>On the 6751i:</i> Press Services , and then select Options->Administrator Menu .
2	Enter you Administrator password and press Enter .
3	Select Network Settings .
4	Select DHCP Settings .
5	Select Download Options . The following list displays: <ul style="list-style-type: none">• Any (default) - no override - uses normal precedence order of 43, 160, 159, 66.• Option 43• Option 66• Option 159• Option 160• Disabled (Ignores all DHCP configuration options (43, 66, 159, 160))
6	Choose an option that you want to use to override the DHCP normal precedence order, and press DONE .
7	Restart the phone for the selection to take affect.

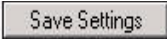
 Aastra Web UI			
1	<p>Click on Advanced Settings->Network->Advanced Network Settings.</p> <div style="display: flex; align-items: center;"> <div style="margin-right: 20px;"> <p>DHCP Download Options Parameter</p> </div> <div style="border: 1px solid black; padding: 5px;"> <table border="1" style="width: 100%; border-collapse: collapse;"> <tr> <td style="width: 30%; padding: 5px;"> <p>Status</p> <ul style="list-style-type: none"> System Information <p>Operation</p> <ul style="list-style-type: none"> User Password Phone Lock Softkeys and XML Programmable Keys Keypad Speed Dial Directory Reset Expansion Module 1 <p>Basic Settings</p> <ul style="list-style-type: none"> Preferences Account Configuration <p>Advanced Settings</p> <ul style="list-style-type: none"> Network Global SIP Line 1 Line 2 Line 3 Line 4 Line 5 Line 6 Line 7 Line 8 Line 9 Action URI Configuration Server Firmware Update TLS Support 802.1x Support Troubleshooting </td> <td style="padding: 5px;"> <p>Network Settings</p> <p>Advanced Network Settings</p> <ul style="list-style-type: none"> DHCP User Class DHCP Download Options LLDP LLDP packet interval UPnP NAT IP NAT SIP Port NAT RTP Port Nortel NAT Traversal Enabled Nortel NAT Timer (seconds) STUN Server STUN Port TURN Server TURN Port TURN User ID TURN Password Rport (RFC 3581) </td> </tr> </table> </div> </div>	<p>Status</p> <ul style="list-style-type: none"> System Information <p>Operation</p> <ul style="list-style-type: none"> User Password Phone Lock Softkeys and XML Programmable Keys Keypad Speed Dial Directory Reset Expansion Module 1 <p>Basic Settings</p> <ul style="list-style-type: none"> Preferences Account Configuration <p>Advanced Settings</p> <ul style="list-style-type: none"> Network Global SIP Line 1 Line 2 Line 3 Line 4 Line 5 Line 6 Line 7 Line 8 Line 9 Action URI Configuration Server Firmware Update TLS Support 802.1x Support Troubleshooting 	<p>Network Settings</p> <p>Advanced Network Settings</p> <ul style="list-style-type: none"> DHCP User Class DHCP Download Options LLDP LLDP packet interval UPnP NAT IP NAT SIP Port NAT RTP Port Nortel NAT Traversal Enabled Nortel NAT Timer (seconds) STUN Server STUN Port TURN Server TURN Port TURN User ID TURN Password Rport (RFC 3581)
<p>Status</p> <ul style="list-style-type: none"> System Information <p>Operation</p> <ul style="list-style-type: none"> User Password Phone Lock Softkeys and XML Programmable Keys Keypad Speed Dial Directory Reset Expansion Module 1 <p>Basic Settings</p> <ul style="list-style-type: none"> Preferences Account Configuration <p>Advanced Settings</p> <ul style="list-style-type: none"> Network Global SIP Line 1 Line 2 Line 3 Line 4 Line 5 Line 6 Line 7 Line 8 Line 9 Action URI Configuration Server Firmware Update TLS Support 802.1x Support Troubleshooting 	<p>Network Settings</p> <p>Advanced Network Settings</p> <ul style="list-style-type: none"> DHCP User Class DHCP Download Options LLDP LLDP packet interval UPnP NAT IP NAT SIP Port NAT RTP Port Nortel NAT Traversal Enabled Nortel NAT Timer (seconds) STUN Server STUN Port TURN Server TURN Port TURN User ID TURN Password Rport (RFC 3581) 		
2	<p>In the “DHCP Download Options” field, select an option to use to override the normal precedence order. Valid values are:</p> <ul style="list-style-type: none"> • Any (default) - no override - uses normal precedence order of 43, 160, 159, 66. • Option 43 • Option 66 • Option 159 • Option 160 • Disabled (Ignores all DHCP configuration options (43, 66, 159, 160)) 		
3	<p>Click  to save your changes.</p>		
4	<p>Click on Operation->Reset, and restart the phone for the changes to take affect.</p>		

Configuration Server Download Precedence

An Administrator can set the phone's download precedence to ignore DHCP, **(only during the boot when the remote configuration server is contacted)** and use the following precedence instead:

1. Configuration URI,
2. DHCP, and then
3. Direct configuration.

To configure the download precedence, you use the option value (-1) as the value for the **“dhcp config option override”** parameter in the configuration files. Setting this parameter to “-1” causes all DHCP configuration options to be ignored.

Configuring a Download Precedence Using the Configuration Files

Use the following procedure to configure the DHCP download precedence using the configuration files.



Configuration Files

For specific parameters you can set in the configuration files, see Appendix A, the section, [“DHCP Option Settings”](#) on [page A-13](#).



Configuring a Download Precedence Using the IP Phone UI

Use the following procedure to configure a download precedence using the IP Phone UI.

 Aastra IP Phone UI	
Step	Action
1	Press Options , and then select Administrator Menu . <i>On the 6751i:</i> Press Services , and then select Options->Administrator Menu .
2	Enter you Administrator password and press Enter .
3	Select Network Settings .
4	Select DHCP Settings .
5	Select Download Options . <ul style="list-style-type: none"> • Disabled (Ignores all DHCP configuration options (43, 66, 159, 160))
6	Select the Disabled option and press Enter . Note: The “ Disabled ” download option performs the same function as the “-1” in the configuration files (ignores DHCP options).
7	Restart the phone for the selection to take affect.

Configuring a Download Precedence Using the Aastra Web UI

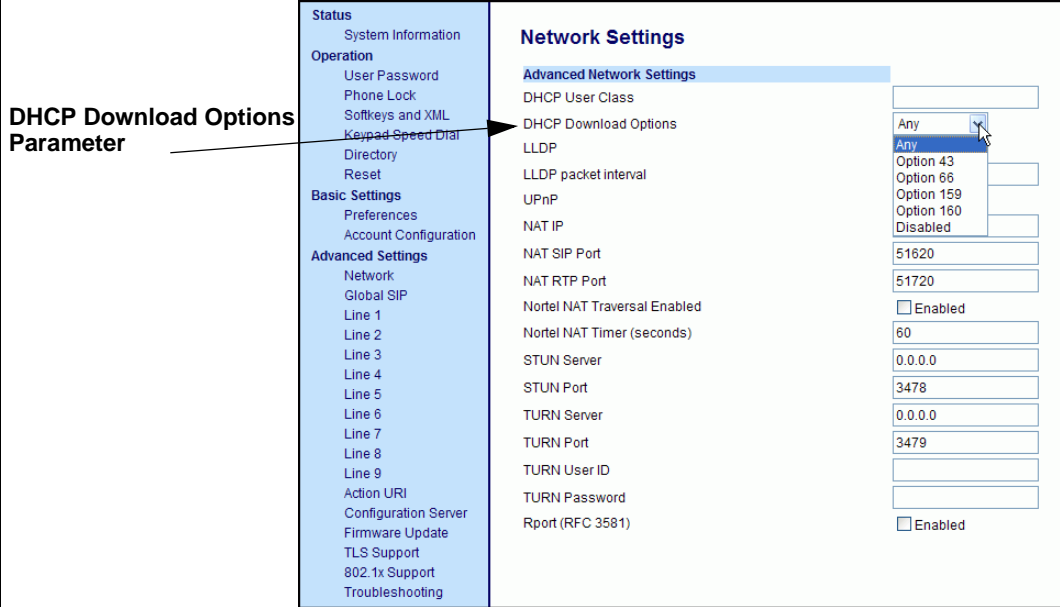
Use the following procedure to configure a download precedence using the Aastra Web UI.

Aastra Web UI	
1	<p>Click on Advanced Settings->Network->Advanced Network Settings.</p>  <p>DHCP Download Options Parameter</p>
2	<p>In the "DHCP Download Options" field, select "Disabled" from the list of options.</p> <p>Note: In the Aastra Web UI, the "Disabled" download option performs the same function as the "-1" in the configuration files (ignores DHCP options).</p>
3	<p>Click  to save your setting.</p>
4	<p>Select Operation->Reset, and click Restart to reboot the phone.</p>

Multiple DHCP Servers

The IP Phones can receive messages from multiple DHCP servers.

After the phone receives its first DHCP message, it listens for a specific time period, for more DHCP messages. If the first DHCP offer contains configuration server information (Options 43, 66, 159 or 160), then the phone times out and continues using the first DHCP offer, without listening for more DHCP offers. If the first DHCP message contains no configuration server information, the phone continues to listen for other DHCP messages. If the second DHCP message contains configuration server information and other conditions, the phone chooses the second DHCP message over the initial DHCP message.



Note: If the **DHCP Download Options** parameter is enabled with a value (Option 43, Option 66, Option 159, or Option 160), the phone checks the override option setting before timing out.

IMPORTANT NOTE

Users currently using multiple DHCP servers on a single network could be affected by this feature.

DNS Caching

The IP phones have the ability to cache DNS requests according to RFC1035 and RFC2181. The phone caches DNS lookups according to the TTL field, so that the phone only performs another lookup for an address when the TTL expires.

Configuring Network Settings Manually

If you disable DHCP on your phone, you need to configure the following network settings manually:

- IP Address
- Subnet Mask
- Gateway
- Primary DNS
- Secondary DNS



Note: If you disable DHCP on the phone, the phone uses the TFTP protocol as the default server protocol. If you want to specify a different protocol to use, see [“Configuration Server Protocol”](#) on page 4-112.

You can configure the network settings using the configuration files, the IP phone UI, or the Aastra Web UI.



Configuration Files

For specific parameters you can set in the configuration files, see Appendix A, the section, [“Network Settings”](#) on page A-8.



IP Phone UI

Step	Action
1	Press  on the phone to enter the Options List.
2	Select Administrator Menu .
3	Enter your Administrator password. Note: The IP Phones accept numeric passwords only.
4	Select Network Settings .
5	Select IP Address and enter the IP address of the phone.
6	Select Subnet Mask and enter the subnet mask.

**IP Phone UI**

Step	Action
7	Select Gateway and enter the gateway address.
8	Select DNS and enter a Primary and/or Secondary DNS server.
9	Press Done to save the changes. The IP phone is manually configured.

**Aastra Web UI**

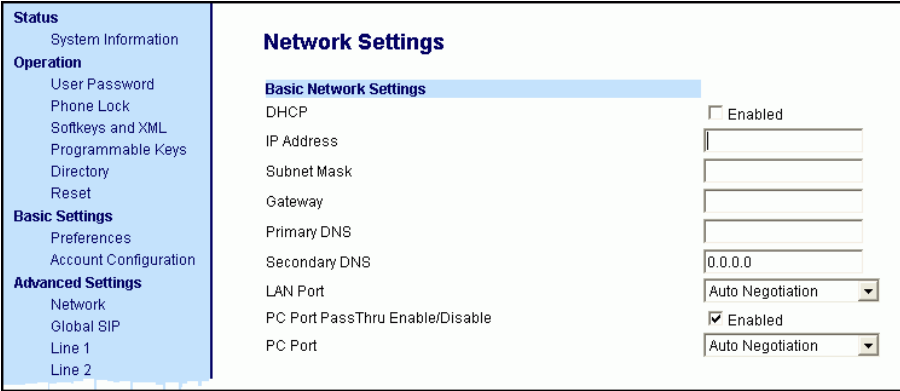
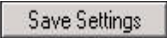
Step	Action
1	Click on Advanced Settings->Network->Basic Network Settings . 
2	Enter an IP address of the phone in the IP Address field.
3	Enter a subnet mask in the Subnet Mask field.
4	Enter a gateway address in the Gateway field.
5	Enter a Primary DNS in the Primary DNS field, and/or a secondary DNS in the Secondary DNS field.
6	Click  to save your settings. The IP phone is manually configured.

Configuring LAN and PC Port Negotiation

Ethernet is the computer networking technology for local area networks (LANs). You use the LAN Port to connect to a LAN using a twisted pair 10BASE-T cable to transmit 10BASE-T Ethernet. You use the PC Port to connect to the configuration server (your PC).

There are two Ethernet ports on the rear of the IP phones: LAN Port and PC Port. Using the Aastra Web UI, you can select the type of transmission you want these ports to use to communicate over the LAN. The IP phones support each of the following methods of transmission:

- Auto-negotiation
- Half-duplex (10Mbps or 100 Mbps)
- Full-duplex (10Mbps or 100Mbps)



Note: The PC Port parameters are not applicable to the 6730i IP Phone.

Auto-negotiation

Auto-negotiation is when two connected devices choose common transmission parameters. In the auto-negotiation process, the connected devices share their speed and duplex capabilities and connect at the highest common denominator (HCD). Auto-negotiation can be used by devices that are capable of different transmission rates (such as 10Mbit/sec and 100Mbit/sec), different duplex modes (half duplex and full duplex) and/or different standards at the same speed. You can set the LAN and PC Ports on the IP phones to auto-negotiate during transmission.

Half-Duplex (10Mbps or 100Mbps)

Half-duplex data transmission means that data can be transmitted in both directions on a signal carrier, but not at the same time. For example, on a LAN using a technology that has half-duplex transmission, one device can send data on the line and then immediately receive data on the line from the same direction in which data was just transmitted. Half-duplex transmission implies a bidirectional line (one that can carry data in both directions). On the IP phones, you can set the half-duplex transmission to transmit in 10Mbps or in 100Mbps.

Full-Duplex (10Mbps or 100Mbps)

Full-duplex data transmission means that data can be transmitted in both directions on a signal carrier at the same time. For example, on a LAN with a technology that has full-duplex transmission, one device can be sending data on the line while another device is receiving data. Full-duplex transmission implies a bidirectional line (one that can move data in both directions). On the IP phones, you can set the full-duplex transmission to transmit in 10Mbps or in 100Mbps.

Configuring the LAN Port and PC Port

You can configure the Ethernet port transmission method to use on the IP phones using the configuration files, the IP Phone UI, or the Aastra Web UI.





Configuration Files



For specific parameters you can set in the configuration files, see Appendix A, the section, “[Network Settings](#)” on [page A-8](#).



IP Phone UI

Step	Action
1	Press  on the phone to enter the Options List.
2	Select Administrator Menu .
3	Enter your Administrator password. Note: The IP Phones accept numeric passwords only.
4	Select Network Settings .
5	Select Ethernet .
6	Select LAN Port Link .

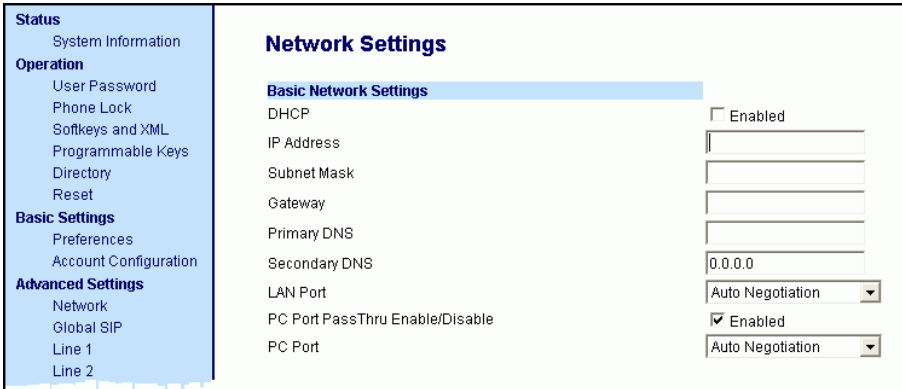
 IP Phone UI	
Step	Action
7	Select a negotiation method to use on port 0 and press Done . Valid values are: <ul style="list-style-type: none">• AutoNegotiation• FullDuplex 10Mbps• FullDuplex 100Mbps• HalfDuplex 10Mbps• HalfDuplex 100Mbps Default is AutoNegotiation .
8	Select PC Port Link . Note: PC Port Link parameters are not applicable to the 6730i IP Phone.
9	Select a negotiation method to use on port 1 and press Done . Valid values are: <ul style="list-style-type: none">• AutoNegotiation• FullDuplex 10Mbps• FullDuplex 100Mbps• HalfDuplex 10Mbps• HalfDuplex 100Mbps Default is AutoNegotiation .
10	Press Done (3 times) to finish configuring the configuration server protocol for the IP phone. Note: The session prompts you to restart the IP phone to apply the configuration settings.
11	Select Restart .

Aastra Web UI	
Step	Action
1	<p>Click on Advanced Settings->Network->Basic Network Settings.</p> 
2	<p>In the “LAN Port” field, select a negotiation method to use on port 0. Valid values are:</p> <ul style="list-style-type: none"> • Auto Negotiation • Full Duplex, 10Mbps • Full Duplex, 100Mbps • Half Duplex, 10Mbps • Half Duplex, 100Mbps <p>Default is Auto Negotiation.</p>
3	<p>In the “PC Port” field, select a negotiation method to use on port 1. Valid values are:</p> <ul style="list-style-type: none"> • Auto Negotiation • Full Duplex, 10Mbps • Full Duplex, 100Mbps • Half Duplex, 10Mbps • Half Duplex, 100Mbps <p>Default is Auto Negotiation.</p>
4	<p>Click  to save your settings.</p>

Advanced Network Settings

You can set advanced network settings on the IP phone such as, Network Address Translation (NAT), Nortel NAT, Network Time Protocol (NTP) Time Servers, Virtual LAN (VLAN), and Quality of Service (QoS), and Universal Plug and Play (UPnP) using the Aastra Web UI or the configuration files.



Note: The available advanced network parameters via the IP phone UI are NAT, Nortel NAT, UPnP, VLAN, and QoS only.

Network Address Translation (NAT)

The protocols used by all IP phones do not interoperate completely with Network Address Translation (NAT). For the IP Phones, specific configuration parameters allow the phone to operate while connected to a network device that enforces NAT. The following is a sample network using a NAT proxy and relevant IP phone configuration parameters.

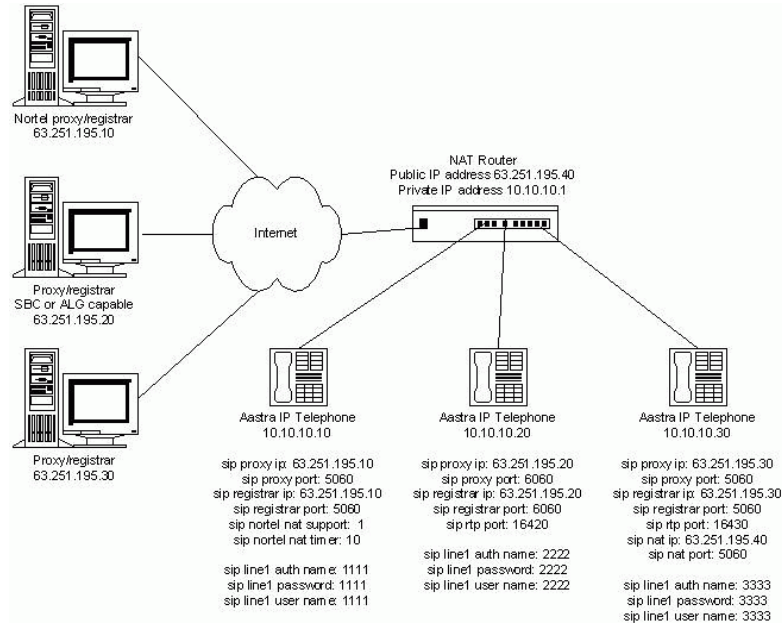

Nortel Proxy/Registrar

The phone at IP address 10.10.10.10 is configured to register with the proxy at 63.251.195.10. Because it is a Nortel proxy, the configuration must additionally include the "sip nortel nat support" and "sip nortel nat timer" settings, telling the firmware to enhance the protocols with Nortel specific content.



Note: This IP phone uses RTP port 3000 (the default value) since an RTP port was not explicitly configured.

SBC or ALG proxy/registrar

The phone at IP address 10.10.10.20 is configured to register with the proxy at 63.251.195.20. Because the proxy/registrar has session border control (SBC) or application layer gateway (ALG) functionality, no additional IP phone configuration is required.

Other proxy/registrars

The phone at IP address 10.10.10.30 is configured to register with the proxy at 63.251.195.30. Because this proxy/registrar is not a Nortel proxy and has no SBC or ALG functionality, the configuration must additionally include the "sip nat ip" and "sip nat port" settings that contain the public ip address of the NAT router and the port used for call signaling messages. This information is embedded in protocol messages to allow the proxy/registrar to reach the IP phone on the NAT router private network.

NAT router configuration

You must configure the NAT router to allow signaling or media packets containing the various UDP port values to flow between the private and public networks that are separated by the NAT router. In the sample network, the NAT router must not filter packets using ports 3000, 5060, 6060, 16420, and 16430.

Nortel Networks NAT

Nortel Networks provides a proprietary solution to support connectivity to their proxies from phones placed behind devices (such as routers or firewalls) that use NAT. Nortel uses the SIP ping request/reply between the Nortel proxy and the phone in order to keep the connection through the router or firewall active. A SIP Nortel NAT timer is the interval, in seconds (default is 60), that the phone sends SIP ping requests to the Nortel proxy.

When you use NAT in your network, a network device (usually a router) provides a “firewall” division between the public network (usually the Internet) and the private network, to which the IP Phones are connected. The firewall protects the network by translating port numbers within packets between the public and private networks. When using NAT, and an RTP packet arrives at the public side of the firewall, it is expected to have the NAT RTP port within the packet. If the packet contains the proper port number, the firewall changes the NAT RTP port number in the packet to the RTP port number that the phone recognizes, and then forwards it onto the private network. Often the router/firewall automatically discovers these various port numbers and other information concerning public and private sides of the network with the use of the Universal Plug and Play (UPnP) Protocol between the phone and the router/firewall.



Configuring Nortel NAT (optional)



You can configure Nortel NAT using the configuration files, the IP phone UI, or the Aastra Web UI.



Configuration Files

For specific parameters you can set in the configuration files, see Appendix A, the section, “[Network Address Translation \(NAT\) Settings](#)” on [page A-31](#).

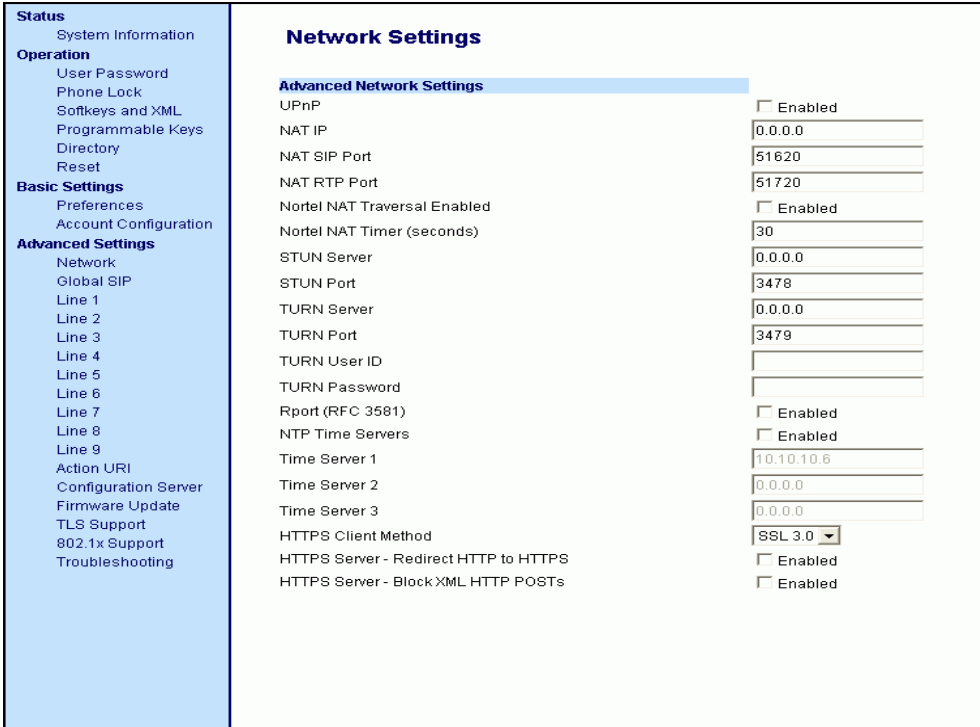
 IP Phone UI	
Step	Action
1	Press  on the phone to enter the Options List.
2	Select Administrator Menu .
3	Enter your Administrator password. Note: The IP Phones accept numeric passwords only.
4	Select Network Settings .
5	Select NAT Settings .
6	Select Nortel NAT .
7	Press Change to set either “ Enabled ” or “ Disabled ”.
8	Press Done (3 times) to finish. Note: The session prompts you to restart the IP phone to apply the configuration settings.
9	Select Restart .

Aastra Web UI	
Step	Action
1	<p>Click on Advanced Settings->Network->Advanced Network Settings.</p> 
2	Select Yes (enable) or No (disable) in the " Nortel NAT Traversal Enabled " field to enable or disable NAT for a Nortel network.
3	Enter a time, in seconds, in the " Nortel NAT timer " field. Valid values are 0 to 2147483647. Default is 60.
4	Click  to save your settings.

Configuring NAT Address and Port (optional)

You can also configure a specific NAT address and port on the IP phone using the configuration files, IP Phone UI, or Aastra Web UI.





Configuration Files

For specific parameters you can set in the configuration files, see Appendix A, the section, "[Network Address Translation \(NAT\) Settings](#)" on [page A-31](#).

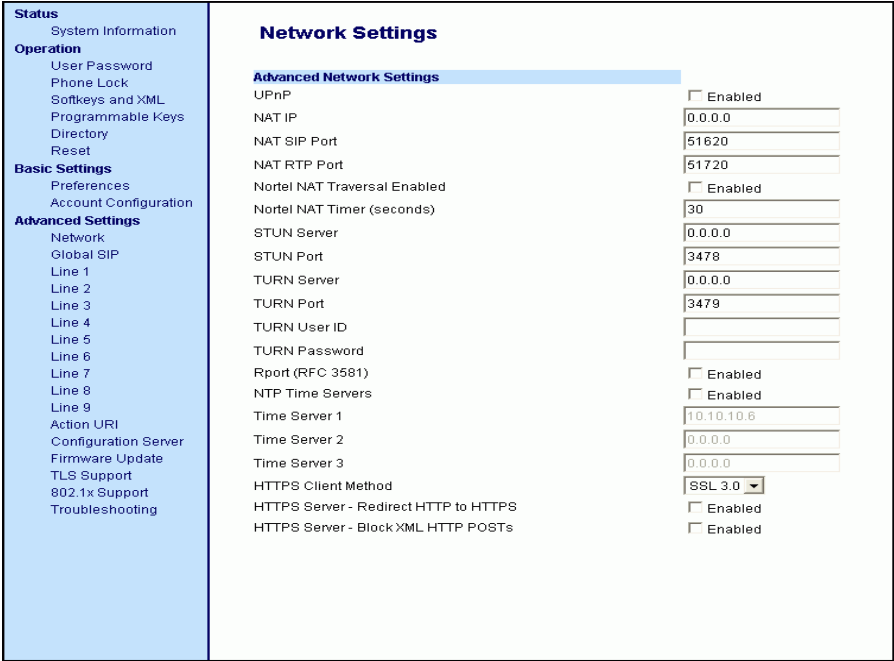

IP Phone UI

Step	Action
1	Press  on the phone to enter the Options List.
2	Select Administrator Menu .
3	Enter your Administrator password. Note: The IP Phones accept numeric passwords only.
4	Select Network Settings .
5	Select Static NAT .
6	Select NAT IP .
7	Enter a public IP address of your NAT device in dotted-decimal format.
8	Press Done to save the setting.
9	Select NAT SIP Port . Default is 51620 .
10	Enter the public SIP signalling port number of your NAT device.
11	Press Done to save the setting.
12	Select NAT RTP Port .
13	Enter the RTP Port number of your NAT device. Default is 51720 .
14	Press Done (4 times) to finish. Note: The session prompts you to restart the IP phone to apply the configuration settings.
15	Select Restart .

Aastra Web UI	
Step	Action
1	<p>Click on Advanced Settings->Network->Advanced Network Settings.</p> 
2	<p>Enter a NAT IP address in the "NAT IP" field. The value must be entered in dotted decimal format. For example, 0.0.0.0. The "NAT IP" is the public IP address of your NAT device.</p>
3	<p>Enter a NAT port in the "NAT SIP Port" field. Default is 51620. The "NAT SIP Port" is the public SIP signalling port number of your NAT device.</p>
4	<p>Enter a NAT port in the "NAT RTP Port" field. Default is 51720. The "NAT RTP Port" is the RTP Port number of your NAT device.</p>
5	<p>Click  to save your settings.</p>

SIP and TLS Source Ports for NAT Traversal

A System Administrator can configure the SIP and TLS source ports on the IP Phone. Previously, the IP phone used default values (**5060** for UDP/TCP and **5061** for TLS). The two new parameters for configuring the SIP and TLS source ports are:

- **sip local port**
- **sip local tls port**

You can configure the SIP and TLS source ports using the configuration files or the Aastra Web UI. **After configuring these parameters, you must reboot the phone.**

If NAT is disabled, the port number also shows in the VIA and Contact SIP headers.

If you enable NAT, the phone uses the NAT port number (and NAT IP address) in the Via and Contact SIP headers of SIP messages, but still use the configured source port.



Note: By default, the IP phones use symmetric UDP signaling for outgoing UDP SIP messages. When symmetric UDP is enabled, the IP phone generates and listens for UDP messages using port 5060. If symmetric UDP signaling is disabled, the phone sends from random ports but it listens on the configured SIP local port.

Configuring SIP and TLS Source Ports Using the Configuration Files

You use the following parameters to configure SIP and TLS ports for NAT traversal:

- **sip local port**
- **sip local tls port**



Configuration Files

For specific parameters you can set in the configuration files, see Appendix A, the sections:



- [“Local SIP UDP/TCP Port Setting” on page A-34.](#)
- [“Local SIP TLS Port” on page A-34.](#)

Configuring SIP and TLS Source Ports Using the Aastra Web UI

Use the following procedure to configure SIP and TLS source ports using the Aastra Web UI.

Aastra Web UI

1	<p>Click on Advanced Settings->Global SIP->Advanced SIP Settings.</p> <div style="border: 1px solid black; padding: 10px; margin: 10px auto; width: 80%;"> <div style="display: flex;"> <div style="width: 25%; background-color: #e6f2ff; padding: 5px;"> <p>Status</p> <p>System Information</p> <p>Operation</p> <p>User Password</p> <p>Phone Lock</p> <p>Softkeys and XML</p> <p>Directory</p> <p>Reset</p> <p>Basic Settings</p> <p>Preferences</p> <p>Account Configuration</p> <p>Advanced Settings</p> <p>Network</p> <p>Global SIP</p> <p>Line 1</p> <p>Line 2</p> <p>Line 3</p> <p>Line 4</p> <p>Line 5</p> <p>Line 6</p> <p>Line 7</p> <p>Line 8</p> <p>Line 9</p> <p>Action URI</p> <p>Configuration Server</p> <p>Firmware Update</p> <p>TLS Support</p> <p>802.1x Support</p> <p>Troubleshooting</p> </div> <div style="width: 75%; padding: 5px;"> <p style="text-align: center;">Global SIP Settings</p> <p>Advanced SIP Settings</p> <p>Explicit MWI Subscription <input type="checkbox"/> Enabled</p> <p>Explicit MWI Subscription Period <input type="text" value="86400"/></p> <p>Missed Call Summary Subscription <input type="checkbox"/> Enabled</p> <p>Missed Call Summary Subscription Period <input type="text" value="86400"/></p> <p>AS-Feature-Event Subscription Period <input type="text" value="3600"/></p> <p>Send MAC Address in REGISTER Message <input type="checkbox"/> Enabled</p> <p>Send Line Number in REGISTER Message <input type="checkbox"/> Enabled</p> <p>Session Timer <input type="text" value="0"/></p> <p>T1 Timer <input type="text" value="0"/></p> <p>T2 Timer <input type="text" value="0"/></p> <p>Transaction Timer <input type="text" value="4000"/></p> <p>Transport Protocol <input type="text" value="UDP"/></p> <p>Local SIP UDP/TCP Port <input type="text" value="5060"/></p> <p>Local SIP TLS Port <input type="text" value="5061"/></p> <p>Registration Failed Retry Timer <input type="text" value="1800"/></p> <p>Registration Timeout Retry Timer <input type="text" value="120"/></p> <p>Registration Renewal Timer <input type="text" value="15"/></p> <p>BLF Subscription Period <input type="text" value="3600"/></p> <p>ACD Subscription Period <input type="text" value="3600"/></p> <p>Blacklist Duration <input type="text" value="300"/></p> <p>Whitelist Proxy <input type="checkbox"/> Enabled</p> <p>XML SIP Notify <input type="checkbox"/> Enabled</p> </div> </div> <div style="display: flex; justify-content: space-around; margin-top: 10px;"> <div style="text-align: center;"> <p>“Local SIP UDP/TCP Port” Parameter</p> </div> <div style="text-align: center;"> <p>“Local SIP TLS Port” Parameter</p> </div> </div> </div>
2	<p>The “Local SIP UDP/TCP Port” field has a default value of 5060. Change this value if required to a value greater than 1024 and less than 65535.</p> <p>Note: It is recommended that you avoid the conflict RTP port range in case of a UDP transport.</p>

 Aastra Web UI	
3	The “ Local SIP TLS Port ” field has a default value of 5061 . Change this value if required to a value greater than 1024 and less than 65535. Note: It is recommended that you avoid the conflict with any TCP ports being used. For example: WebUI HTTP server on 80/tcp and HTTPS on 443/tcp.
4	Click  to save your changes.

HTTPS Client/Server Configuration

HTTPS is a Web protocol that encrypts and decrypts user page requests as well as the pages that are returned by the Web server. HTTPS uses Secure Socket Layer (SSL) or Transport Layer Security (TLS) as a sublayer under its regular HTTP application layering. SSL is a commonly-used protocol for managing the security of a message transmission on the Internet. It uses a 40-bit key size for the RC4 stream encryption algorithm, which is considered an adequate degree of encryption for commercial exchange. TLS is a protocol that ensures privacy between communicating applications and their users on the Internet. When a server and client communicate, TLS ensures that no third party may eavesdrop or tamper with any message. TLS is the successor to SSL.



Note: HTTPS uses port 443 instead of HTTP port 80 in its interactions with the TCP/IP lower layer.

When an HTTPS client opens and closes its TCP socket, the SSL software respectively handshakes upon opening and disconnects upon closing from the HTTPS server. The main HTTPS client functions are:

- Downloading of configuration files and firmware images.
- Downloading of script files based on an “HTTPS://” URL supplied by a softkey definition.

The HTTPS server provides HTTP functionality over secure connections. It coexists with the HTTP server but has its own set of tasks. The main HTTPS server functions are:

- Delivery of web page content to a browser client over a secure connection.
- Execution of HTTP GET and POST requests received over a secure connection.

Using the configuration files, the IP phone UI, or the Aastra Web UI, you can configure the following regarding HTTPS:

- Specify HTTPS security client method to use (TLSv1 or SSLv3)
- Enable or disable HTTP to HTTPS server redirect function
- HTTPS server blocking of XML HTTP POSTS to the phone

Configuring HTTPS Client and Server Settings

Use the following procedures to configure the HTTPS client and server for the IP phones.







Note: To enable or disable the IP phones to use the HTTPS protocol as the configuration server, see the section, “[Configuring the Configuration Server Protocol](#)” on [page 4-112](#).



Configuration Files

For specific parameters you can set in the configuration files, see Appendix A, the section, “[HTTPS Client and Server Settings](#)” on [page A-35](#).

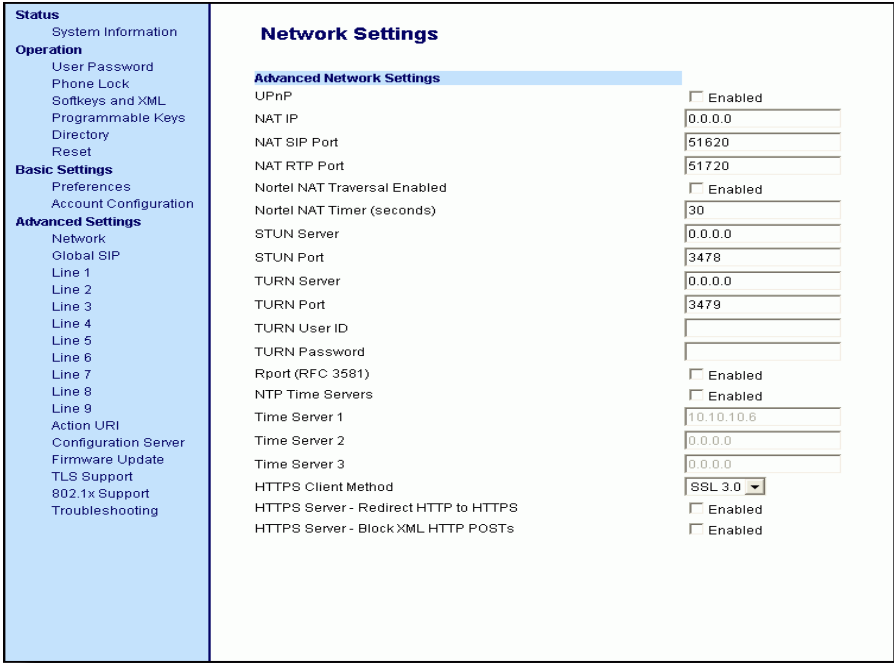
 IP Phone UI	
Step	Action
1	Press  on the phone to enter the Options List.
2	Select Administrator Menu .
3	Enter your Administrator password. Note: The IP Phones accept numeric passwords only.
4	Select Configuration Server .
5	Select HTTPS Settings .
Configure HTTPS Client	
6	Select HTTPS Client .
7	Select Client Method .
8	Press Change to select a client method to use for HTTPS. Valid values are: <ul style="list-style-type: none"> • SSL 3.0 (default) • TLS 1.0
9	Press Done to save the changes.
Configure HTTPS Server	
10	Select HTTPS Server .
11	Select HTTP->HTTPS .
12	Press Change to select “ Yes ” or “ No ”. Default is “ No ”. Enabling this feature redirects the HTTP protocol to HTTPS.
13	Press Done to save the changes.
14	Select XML HTTP POSTs .
15	Press Change to select “ Yes ” or “ No ”. Default is “ No ”. Enabling this feature blocks XML HTTP POSTs from the IP Phone.
16	Press Done (4 times) to finish. Note: The session prompts you to restart the IP phone to apply the configuration settings.
17	Select Restart .

Aastra Web UI	
Step	Action
1	<p>Click on Advanced Settings->Network->Advanced Network Settings.</p> 
2	<p>Select an HTTPS client method to use from the HTTPS Client Method field. Valid values are:</p> <p>SSL 3.0 (default) TSL 1.0</p>
3	<p>Enable HTTP to HTTPS redirect by checking the HTTPS Server - Redirect HTTP to HTTPS field check box. (Disable this field by unchecking the check box). Default is disabled.</p>
4	<p>Enable the blocking of XML HTTP POSTs by the HTTPS server by checking the HTTPS Server - Block XML HTTP POSTs field check box. (Disable this field by unchecking the check box). Default is disabled.</p>
5	<p>Click  to save your settings.</p>

HTTPS Server Certificate Validation

The HTTPS client on the IP Phones support validation of HTTPS certificates. This feature supports the following:

- Verisign, GeoTrust, and Thawte signed certificates
- User-provided certificates
- Checking of hostnames
- Checking of certificate expiration
- Ability to disable any or all of the validation steps
- Phone displays a message when a certificate is rejected (except on check-sync operations)

All validation options are enabled by default.

Certificate Management

Aastra Provided Certificates

The phones come with root certificates from Verisign, GeoTrust, and Thawte pre-loaded.

User Provided Certificates

The administrator has the option to upload their own certificates onto the phone. The phone downloads these certificates in a file of .PEM format during boot time after configuration downloads. The user-provided certificates are saved on the phone between firmware upgrades but are deleted during a factory default. The download of the User-provided certificates are based on a filename specified in the configuration parameter, **https user certificates (Trusted Certificates Filename)** in the Aastra Web UI; User-provided certificates are not configurable via the IP Phone UI).



Note: Certificates that are signed by providers other than Verisign, GeoTrust or Thwate do not verify on the phone by default. The user can overcome this by adding the root certificate of their certificate provider to the use-provided certificate .PEM file.

Certificate Validation

Certificate validation is enabled by default. Validation occurs by checking that the certificates are well formed and signed by one of the certificates in the trusted certificate set. It then checks the expiration date on the certificate, and finally, compares the name in the certificate with the address for which it was connected.

If any of these validation steps fail, the connection is rejected. Certificate validation is controlled by three parameters which you can configure via the configuration files, the IP Phone UI, or the Aastra Web UI:

- **https validate certificates** - Enables/disables validation
- **https validate hostname** - Enables/disables the checking of the certificate commonName against the server name.
- **https validate expires** - Enables/disables the checking of the expiration date on the certificate.

User Interface

Certificate Rejection

When the phone rejects a certificate, it displays, "**Bad Certificate**" on the LCD.

An Administrator can configure HTTPS Server Certificate Validation using the configuration files, the IP Phone UI, or the Aastra Web UI.

Configuring HTTPS Server Certificate Validation

Use the following procedures to configure the HTTPS server certificate validation on the IP phones.



Configuration Files

For specific parameters you can set in the configuration files, see Appendix A, the section, "[HTTPS Server Certificate Validation Settings](#)" on [page A-37](#).





Aastra IP Phone UI

Step	Action
1	Press Options , and then select Administrator Menu . <i>On the 6751i:</i> Press Services , and then select Options->Administrator Menu .
2	Select Configuration Server .
3	Select HTTPS Settings->Cert. Validation . The following list displays: <ul style="list-style-type: none">• Enable• Check Expires• Check Hostnames
Enable/Disable HTTPS Server Certificate Validation	
4	Select Enable .
5	Press Change to toggle the “ Enable ” field to “ Yes ” or “ No ”. Note: If you are using HTTPS as a configuration method, and use a self signed certificate, you must set this field to “ No ” before upgrading to Release 2.3 of the IP Phones.
6	Press DONE to save the change and return to the Certificates screen. Note: This change is immediately applied after pressing DONE .
Enable/Disable HTTPS Validate Certificate Expiration	
7	Select Check Expires .
8	Press Change to toggle the “ Check Expires ” field to “ Yes ” or “ No ”. Notes: <ol style="list-style-type: none">1. This change is immediately applied after pressing DONE.2. If the “Check Expires” parameter is set to Yes, the clock on the phone must be set for the phone to accept the certificates.

**Aastra IP Phone UI**

Step	Action
9	Press DONE to save the change and return to the Certificates screen. Note: This change is immediately applied after pressing DONE .
<i>Enable/Disable HTTPS Validate Hostnames</i>	
10	Select Check Hostnames .
11	Press Change to toggle the “ Check Hostnames ” field to “ Yes ” or “ No ”.
12	Press DONE to save the change and return to the Certificates screen. Note: This change is immediately applied after pressing DONE .
13	Press  to exit the Options Menu and return to the idle screen.

 Aastra Web UI	
1	<p>Click on Advanced Settings->Network->HTTPS Settings.</p> <div style="display: flex; align-items: center; margin-top: 20px;"> <div style="margin-right: 20px;"> <p>HTTPS Validation Certificate Parameters</p> </div> <div style="border: 1px solid black; padding: 5px; width: 60%;"> <p>HTTPS Settings</p> <p>HTTPS Server - Redirect HTTP to HTTPS <input type="checkbox"/> Enabled</p> <p>HTTPS Server - Block XML HTTP POSTs <input type="checkbox"/> Enabled</p> <p>HTTPS Client Method <input type="text" value="SSL 3.0"/></p> <p>Validate Certificates <input checked="" type="checkbox"/> Enabled</p> <p>Check Certificate Expiration <input checked="" type="checkbox"/> Enabled</p> <p>Check Certificate Hostnames <input checked="" type="checkbox"/> Enabled</p> <p>Trusted Certificates Filename <input type="text"/></p> </div> </div>
2	<p>The “Validate Certificates” field is enabled by default. To disable validation of certificates, click the check mark in the box to clear the check mark.</p> <p>When this parameter is enabled, the HTTPS client performs validation on SSL certificates before accepting them.</p> <p>Notes:</p> <ol style="list-style-type: none"> 1. This parameter is immediately applied after clicking the SAVE SETTINGS button. 2. If you are using HTTPS as a configuration method, and use a self signed certificate, you must disable (uncheck) this field before upgrading to Release 2.3 of the IP Phones.
3	<p>The “Check Certificate Expiration” field is enabled by default. To disable validation of certificate expiration, click the check mark in the box to clear the check mark.</p> <p>When this parameter is enabled, the HTTPS client verifies whether or not a certificate has expired prior to accepting the certificate.</p> <p>Notes:</p> <ol style="list-style-type: none"> 1. This parameter is immediately applied after clicking the SAVE SETTINGS button. 2. If the “Check Certificates Expiration” parameter is set to Yes, the clock on the phone must be set for the phone to accept the certificates.
4	<p>The “Check Certificate Hostnames” field is enabled by default. To disable validation of hostnames, click the check mark in the box to clear the check mark.</p> <p>Note: This parameter is immediately applied after clicking the SAVE SETTINGS button.</p>

 Aastra Web UI	
5	<p>If you require the download of User-provided certificates in a .PEM formatted file, enter the file name in the format <filename.pem> in the “Trusted Certificates Filename” field. For example:</p> <p style="text-align: center;">trustedCerts.pem</p> <p>This parameter specifies a file name for a .PEM file located on the configuration server. This file contains the User-provided certificates in PEM format. These certificates are used to validate peer certificates.</p> <p>Notes:</p> <ol style="list-style-type: none"> 1. You must disable the “Validate Certificates” field in order for the phone to accept the User-provided certificates. 2. This parameter requires you restart the phone in order for it to take affect.
6	<p>Click  to save your changes.</p>
7	<p>If you entered a filename in the “Trusted Certificates Filename” field, click on Operation->Reset, and restart the phone for the changes to take affect.</p>

Universal Plug and Play (UPnP) (for remote phones)

UPnP is a standard that uses Internet protocols to enable devices to be plugged into a network and automatically know about each other. With UPnP, when a user plugs a device into the network, the device configures itself, acquires a TCP IP address, and uses a discovery protocol based on the Internet's HTTP or HTTPS URL to announce its presence on the network to other devices.

This method of device discovery on a network is called “Universal Plug and Play” or UPnP. If you enable UPnP, and the phone is discovered on the network, port mappings are set up between the phone and the Internet Gateway Device (IGD). The phone controls the opening, closing, and polling of ports on the IGD. HTTP and SIP use a single port each. RTP/RTCP uses a range of ports.

The UPnP manager performs its functions when you set the phone to remote mode. When you switch the phone back to local mode, the UPnP manager removes any open port mappings and shuts itself down. If you boot the phone in remote mode, the UPnP manager initializes after the phone obtains an IP address and before a SIP registration is sent out. If you want to manually configure your NAT, you must disable UPnP on the remote mode phone.



Note: Enabling UPnP allows the IP phones to access the Internet even if a firewall has been set on the IGD. This allows the phone to send and receive SIP calls and XML pushes without interruption. UPnP does not work with multiple firewalls.

You can enable UPnP on remote IP phones using the configuration files, the IP Phone UI, or the Aastra Web UI. Using the configuration files, you can enable UPnP using the following parameters:

- **upnp manager**
- **upnp gateway**
- **sip nat rtp port**

The “**upnp manager**” parameter enables or disables UPnP. The “**upnp gateway**” parameter is the IP address or qualified domain name of the Internet gateway or router that stores the port mappings. In the event a phone using UPnP is rebooted, it will still have the previously set port mappings on the gateway. The “**sip nat rtp port**” parameter specifies the RTP port range on the gateway.

A User or Administrator can specify UPnP on specific lines using the configuration files (using the “**upnp mapping lines**” parameter) or the Aastra Web UI (at the path **Basic Settings->Preferences->UPnP Mapping Lines**).

Reference

For more information about enabling/disabling UPnP Mapping on specific lines, see Chapter 5, the section, “[UPnP Mapping Lines \(for remote phones\)](#)” on [page 5-88](#).

Configuring UPnP (optional)

Use the following procedures to configure UPnP on the IP phones.





Configuration Files

For specific parameters you can set in the configuration files, see Appendix A, the section, “[UPnP Settings](#)” on [page A-41](#).





IP Phone UI

Step	Action
1	Press  on the phone to enter the Options List.
2	Select Administrator Menu .
3	Enter your Administrator password. Note: The IP Phones accept numeric passwords only.
4	Select Network Settings .
5	Select NAT Settings .
6	Select UPnP .
7	Press Change to select “ Yes ” or “ No ”. Default is “ No ”. This field enables or disables the use of UPnP on the IP Phone.

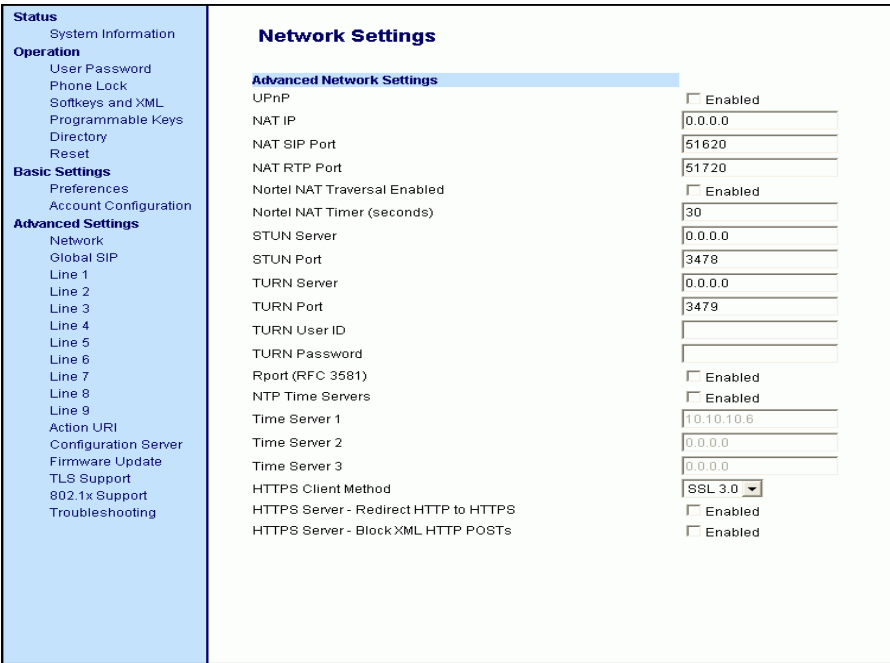
 IP Phone UI	
Step	Action
8	Press Done (3 times) to save the changes. Note: The session prompts you to restart the IP phone to apply the configuration settings
9	Select Restart .

 Aastra Web UI	
Step	Action
1	Click on Advanced Settings->Network->Advanced Network Settings . 

 Aastra Web UI	
Step	Action
2	The “UPnP” field is disabled by default. To enable UPnP, place a check in the “ Enabled ” box. Uncheck the box to disable this field. This field enables and disable UPnP on the IP phone.
3	Click  to save your settings.

Virtual LAN (optional)

Virtual Local Area Network (VLAN) is a feature on the IP phone that allows for multiple logical Ethernet interfaces to send outgoing RTP packets over a single physical Ethernet as described in IEEE Std 802.3. On the IP phone, you configure a VLAN ID that associates with the physical Ethernet port.

By configuring specific VLAN parameters, the IP phones have the capability of adding and removing tags, and processing the ID and priority information contained within the tag.



Note: All latest VLAN functionality is backwards compatible with IP Phone Releases 1.3 and 1.3.1.

VLAN on the IP phones is disabled by default. When you enable VLAN, the IP phone provides defaults for all VLAN parameters. If you choose to change these parameters, you can configure them using the configuration files, the IP Phone UI, or the Aastra Web UI.

The following sections describe the VLAN features you can configure on the IP phones.

Type of Service (ToS), Quality of Service (QoS), and DiffServ QoS

ToS is an octet as a field in the standard IP header. It is used to classify the traffic of the different QoSs.

QoS provides service differentiation between IP packets in the network. This service differentiation is noticeable during periods of network congestion (for example, in case of contention for resources) and results in different levels of network performance.

Port 0 is the Ethernet LAN Port connected to the network. Port 1 is the Ethernet PC Port used for passthrough to a PC.

Differentiated Service (DiffServ) QoS is class-based where some classes of traffic receive preferential handling over other traffic classes.

The Differentiated Services Code Point (DSCP) value is stored in the first six bits of the ToS field. Each DSCP specifies a particular per-hop behavior that is applied to a packet.

The following parameters allow an administrator to configure ToS, QoS, and DiffServ QoS for VLAN:

Parameters in Configuration Files	Parameters in Aastra Web UI
Global	
tagging enabled	VLAN enable
priority non-ip	Priority, Non-IP Packet
LAN Port	
vlan id	VLAN ID
tos priority map	SIP Priority
tos priority map	RTP Priority
tos priority map	RTCP Priority
PC Port	
vlan id port 1	VLAN ID
QoS eth port 1 priority	Priority



Notes:

1. In order for the software to successfully maintain connectivity with a network using VLAN functionality, the IP phone reboots if you modify the "**tagging enabled**" (**VLAN Enable** in the Web UI), "**vlan id**", or "**vlan id port 1**" parameters.

2. When the LAN Port (**vlan id**) and the PC Port (**vlan id port 1**) parameters have the same value, VLAN functionality is compatible with earlier IP phone software releases.

If you set the PC Port (**vlan id port 1**) to **4095**, all untagged packets are sent to this port. For configuring this feature via the Phone UI and the Aastra Web UI, see "[Configuring VLAN \(optional\)](#)" on [page 4-60](#). For configuring this feature using the configuration files, see Appendix A, the section, "[Virtual Local Area Network \(VLAN\) Settings](#)" on [page A-42](#).

DSCP Range/VLAN Priority Mapping

DSCP bits in the ToS field of the IP header are set for RTP, RTCP, and SIP packets using either the default values or the values configured via the "**tos sip**", "**tos rtp**", and "**tos rtcp**" parameters.

When the VLAN global configuration parameter, "**tagging enabled**" is set to **1**, VLAN priority for IP packets is mapped to the DSCP value instead of a single priority for all packets. An administrator can also configure VLAN priority for non-IP packets using the "**priority non-ip**" parameter.

Since the default DSCP settings for SIP, RTP, and RTCP are 26, 46, and 46 respectively, this results in corresponding default VLAN priorities of 3 for SIP, 4 for RTP, and 4 for RTCP (based on the settings in the table "[DSCP Range/VLAN Priority](#)" on [page 4-56](#)).

You can change the default parameters by modifying just the DSCP values, just the VLAN priority values, or by modifying all values.

The following table shows the DSCP range/VLAN priority mapping.

DSCP Range/VLAN Priority

DSCP Range	VLAN Priority
0-7	0
8-15	1
16-23	2
24-31	3
32-39	4
40-47	5
48-55	6
56-63	7

The following table identifies the default DSCP of protocols.

Protocol Name	Default DSCP Values in the ToS Field
sip	26
rtp	46
rtcp	46

Configuring Type of Service (ToS)/DSCP (optional)

Use the following procedures to configure ToS/DSCP on the IP phone.



Note: ToS/DSCP is enabled by default. The SIP, RTP, and RTCP parameters show defaults of 26, 46, and 46, respectively. Use the following procedures to change these settings if required.



Configuration Files



For specific parameters you can set in the configuration files, see Appendix A, the section, “[Type of Service \(ToS\)/DSCP Settings](#)” on [page A-51](#).



IP Phone UI

Step	Action
1	Press on the phone to enter the Options List.
2	Select Administrator Menu .
3	Enter your Administrator password. Note: The IP Phones accept numeric passwords only.
4	Select Network Settings .
5	Select Type of Service DSCP .

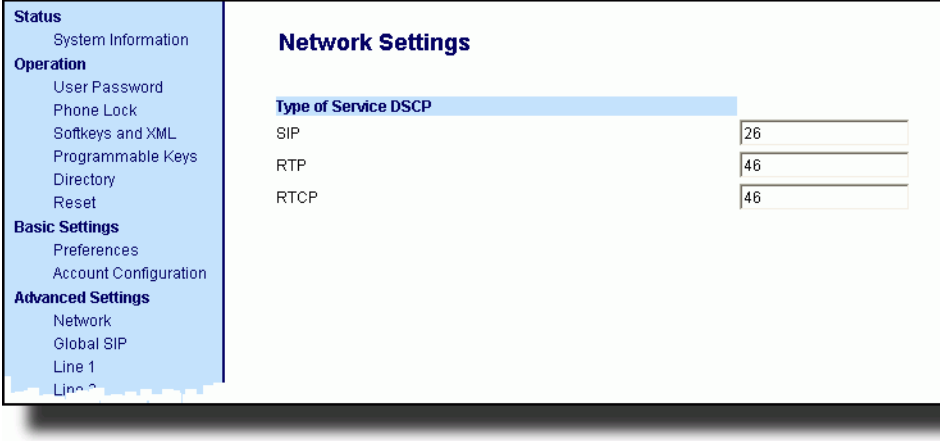
 IP Phone UI	
Step	Action
6	Select Type of Service SIP . or Select Type of Service RTP . or Select Type of Service RTCP .
7	Enter a value for " Type of Service SIP ". Default is 26 . or Enter a value for " Type of Service RTP ". Default is 46 . or Enter a value for " Type of Service RTCP ". Default is 46 . Valid values are 0 to 63 . Note: If you change the ToS/DSCP setting for a Protocol, and VLAN is enabled, you will need to map the applicable priority to the Protocol setting as shown in the table " DSCP Range/VLAN Priority " on page 4-56 For more information, see the section " Configuring VLAN (optional) " on page 4-60 .
8	Press Done (3 times) to save the changes. Note: The session prompts you to restart the IP phone to apply the configuration settings
9	Select Restart .

Aastra Web UI	
Step	Action
1	<p>Click on Advanced Settings->Network->Type of Service,DSCP.</p> 
2	<p>Select a Protocol field:</p> <ul style="list-style-type: none"> • “SIP” <p>or</p> <ul style="list-style-type: none"> • “RTP” <p>or</p> <ul style="list-style-type: none"> • “RTCP”
3	<p>Enter a value from 0 to 63. Default values are as follows:</p> <p>SIP = 26 RTP = 46 RTCP = 46</p> <p>Note: If you change the ToS/DSCP setting for a Protocol, and VLAN is enabled, you will need to map the applicable priority to the Protocol setting as shown in the table “DSCP Range/VLAN Priority” on page 4-60 For more information, see the section “Configuring VLAN (optional)” on page 4-60.</p>
4	<p>Click  to save your settings.</p>

Configuring VLAN (optional)

Use the following procedures to configure VLAN on the IP phone.



Notes:

1. VLAN is disabled by default. When you enable VLAN, the IP phones use the default settings for each VLAN parameter. You can change the default settings if required using the following procedure.
2. PC Port parameters are not applicable to the 6730i IP Phone.



Configuration Files

For specific parameters you can set in the configuration files, see Appendix A, the section, “[Virtual Local Area Network \(VLAN\) Settings](#)” on [page A-42](#).





IP Phone UI

Step	Action
1	Press on the phone to enter the Options List.
2	Select Administrator Menu .
3	Enter your Administrator password. Note: The IP Phones accept numeric passwords only.
4	Select Network Settings .
5	Select VLAN Settings .
To globally enable/disable VLAN and set priority for non-IP packets:	
6	Select VLAN Enable .
7	Press Change to set VLAN Enable to “ Yes ” to enable or “ No ” to disable. Default is “ No ”.
8	Press Done to save the changes.
9	Select Phone VLAN .
10	Select VLAN Priority .
11	Select Other and enter a non-IP priority value from 0 to 7 for non-IP packets. Default for this field is 5 .

 IP Phone UI	
Step	Action
12	Press Done (3 times) to return to the VLAN Settings menu.
To set VLAN ID and priority for LAN Port (Port 0):	
13	Select Phone VLAN .
14	Select Phone VLAN ID and enter a value from 1 to 4094 to specify the VLAN ID for the LAN Port. Default is 1 .
15	Press Done to save the change.
16	Select VLAN Priority .
17	Select one of the following VLAN Protocols: <ul style="list-style-type: none"> • SIP Priority • RTP Priority • RTCP Priority
18	Enter a VLAN priority value from 0 to 7 for the associated Protocol. Default values for each Protocol are: SIP Priority = 3 RTP Priority = 5 RTCP Priority = 5
19	Press Done (3 times) to return to the VLAN Settings menu.
To set VLAN ID and priority for PC Port (Port 1):	
20	Select PC Port VLAN . Note: PC Port parameters are not applicable to the 6730i IP Phone.
21	Select PC Port VLAN ID .

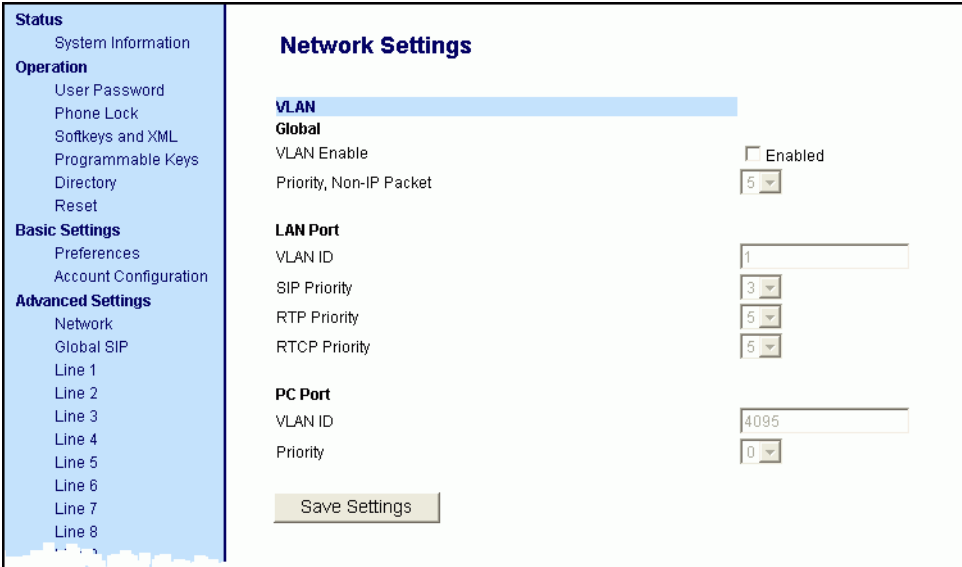
 IP Phone UI	
Step	Action
22	<p>Enter a value from 1 to 4095 to specify the VLAN ID for the PC Port. Default is 1.</p> <p>Note: If you set the PC Port VLAN ID (Port 1) to 4095, all untagged packets are sent to this port. The following is an example of configuring the phone on a VLAN where all untagged packets are sent to the PC Port (passthrough port).</p> <p>Example You enable tagging on the phone port as normal but set the passthrough port (PC Port) to 4095. The following example sets the phone to be on VLAN 3 but the passthrough port is configured as untagged.</p> <pre>VLAN Settings->VLAN Enable: Yes VLAN Settings->Phone VLAN->Phone VLAN ID: 3 VLAN Settings->PC Port VLAN->PC Port VLAN ID: 4095</pre>
23	Press Done to save the change.
24	Select PC Port Priority .
25	Select a PC Port VLAN priority value from 0 to 7 for the PC Port. Default is 0 .
26	<p>Press Done (4 times) to save the changes.</p> <p>Note: The session prompts you to restart the IP phone to apply the configuration settings</p>
27	Select Restart .

Aastra Web UI	
Step	Action
1	<p>Click on Advanced Settings->Network->VLAN.</p> 
To globally enable/disable VLAN and set priority for non-IP packets:	
2	Enable VLAN by checking the VLAN Enable field check box. (Disable this field by unchecking the check box).
3	With VLAN enabled, select the priority (0 to 7) for non-IP packets in the Priority, Non-IP Packet field.
To set VLAN ID and priority for the LAN Port (Port 0):	
4	Enter a VLAN ID value from 1 to 4094 in the VLAN ID field. Default is 1 .
5	Choose a VLAN Protocol (SIP Priority, RTP Priority, and/or RTCP Priority), and select a priority for the associated Protocol. Valid values are 0 to 7 , Defaults are as follows: SIP Priority = 3 RTP Priority = 5 RTCP Priority = 5

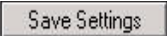
 Aastra Web UI	
Step	Action
To set VLAN ID and priority for the PC Port (Port 1):	
6	<p>Enter a VLAN ID value from 1 to 4095 in the VLAN ID field. Default is 1.</p> <p>Note: If you set the PC Port VLAN ID (Port 1) to 4095, all untagged packets are sent to this PC Port. The following is an example of configuring the phone on a VLAN where all untagged packets are sent to the passthrough port.</p> <p>Example You enable tagging as normal, enter a value for the LAN Port VLAN ID, and then set the PC Port VLAN ID to 4095. The following example sets the phone to be on VLAN 3 but the PC Port VLAN ID is configured as untagged..</p> <div style="border: 1px solid black; padding: 10px; margin: 10px 0;"> <p>VLAN</p> <p>Global</p> <p>VLAN Enable <input checked="" type="checkbox"/> Enabled</p> <p>Priority, Non-IP Packet 5 ▾</p> <p>LAN Port</p> <p>VLAN ID 3</p> <p>SIP Priority 3 ▾</p> <p>RTP Priority 5 ▾</p> <p>RTCP Priority 5 ▾</p> <p>PC Port</p> <p>VLAN ID 4095</p> <p>Priority 0 ▾</p> </div>
7	Select a VLAN priority value from 0 to 7 for the PC Port in the Priority field. Default is 0 .
8	Click  to save your settings.

RPORT

The Session Initiation Protocol (SIP) operates over UDP and TCP. When used with UDP, responses to requests are returned to the source address from which the request came, and returned to the port written into the topmost “Via” header of the request. However, this behavior is not desirable when the client is behind a Network Address Translation (NAT) or firewall.

A parameter created for the “Via” header called “**Rport**” in RFC 3581, allows a client to request that the server send the response back to the source IP address **and** the port from which the request came.

When you enable “Rport, the phone always uses symmetric signaling (listens on the port used for sending requests.)



Note: Configuring the Rport parameter is recommended for clients behind a Network Address Translation (NAT) or firewall since this parameter allows a client to request that the server send the response back to the source IP address and the port from which the request came.

An Administrator can configure “**Rport**” using the configuration files or the Aastra Web UI.

Configuring Rport Using the Configuration Files

Use the following procedures to configure Rport on your phone.





Configuration Files

For specific parameters you can set in the configuration files, see Appendix A, the section, “[Rport Setting](#)” on [page A-33](#).

Configuring Rport Using the Aastra Web UI

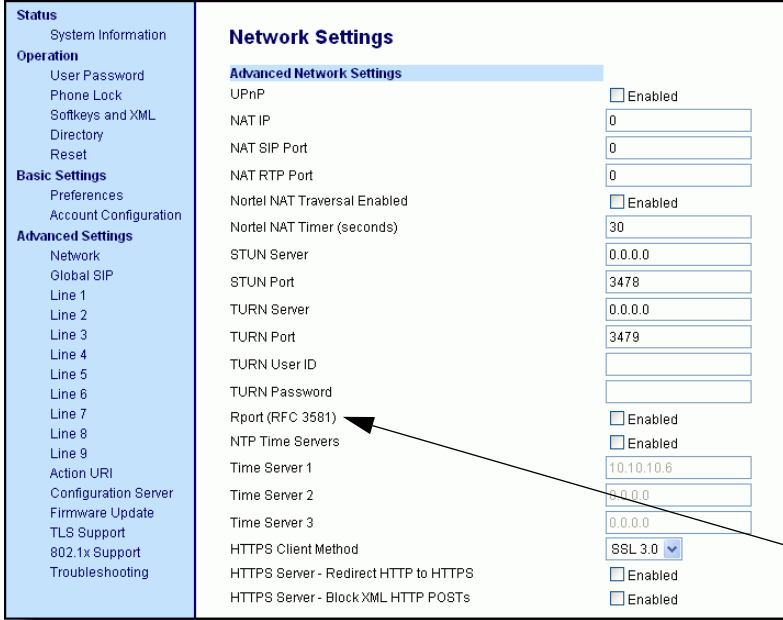
Use the following procedure to configure Rport on your phone using the Aastra Web UI.

Aastra Web UI	
1	<p>Click on Advanced Settings->Network->Advanced Network Settings.</p>  <p>The screenshot shows the 'Advanced Network Settings' page in the Aastra Web UI. The 'Rport (RFC 3581)' checkbox is checked, and an arrow points to it from the label 'Rport Parameter'.</p>
2	<p>In the "Advanced Network Settings" section, enable the "Rport (RFC3581)" field by checking the check box. (Disable Rport by unchecking the box).</p> <p>"Rport" in RFC 3581, allows a client to request that the server send the response back to the source IP address and the port from which the request came.</p>
3	<p>Click  to save your changes.</p>

Network Time Servers

Network Time Protocol (NTP) is a protocol that the IP phone uses to synchronize the phone clock time with a computer (configuration server) in the network.

To use NTP, you must enable it using the configuration files or the Aastra Web UI. You can specify up to three time servers in your network.



Note: The IP phones support NTP version 1.

Configuring NTP Servers (optional)

Use the following procedure to enable/disable and configure the NTP servers using the configuration files.



Configuration Files

For specific parameters you can set in the configuration files, see Appendix A, the section, “[Time Server Settings](#)” on [page A-59](#).

Use the following procedure to enable/disable the NTP server using the IP Phone UI.





IP Phone UI

Step	Action
1	Press  on the phone to enter the Options List.
2	Select Preferences .
3	Select Time and Date .
4	Select Time Server .
5	Enter your Administrator password. Note: The IP Phones accept numeric passwords only.
6	Select Timer Server 1 , Timer Server 2 , or Time Server 3 . Note: The Time Servers are disabled by default.
7	To set a Time Server, press Enable . (Press Disable to disable a Time Server.)

 IP Phone UI	
Step	Action
8	Enter the IP Address (in dotted decimal) or qualified domain name for the Time Server.
9	Press Done to save the change.

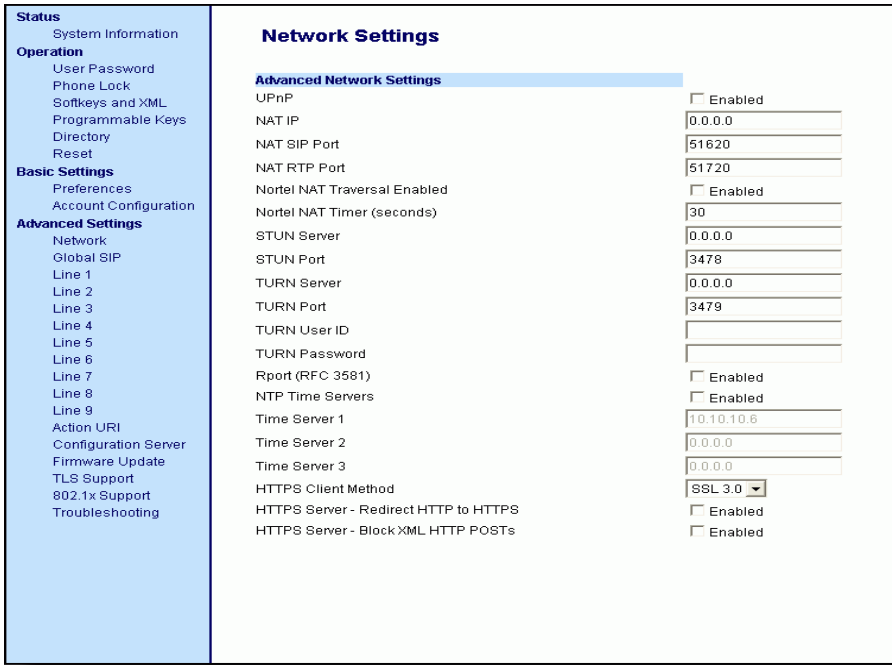
Use the following procedure to enable/disable and configure the NTP Servers using the Aastra Web UI.

 Aastra Web UI	
Step	Action
1	<p>Click on Advanced Settings->Network->Advanced Network Settings.</p> 
2	<p>Enable the "NTP Time Servers" field by checking the check box. (Disable this field by unchecking the box). Default is disabled.</p>

 Aastra Web UI	
Step	Action
3	Enter an IP address or qualified domain name in the " Time Server 1 ", " Time Server 2 ", and/or " Time Server 3 " field(s) to specify the location of the NTP time server.
4	Click  to save your changes.

Global SIP Settings

Description

The IP phone uses the information in the Global Session Initiation Protocol (SIP) settings to register at the IP PBX.

The IP phone configuration defines network and user account parameters that apply **globally** to all SIP lines. Since not all SIP lines are necessarily hosted using the same IP-PBX/server or user account, additional sets of **per-line** parameters can also be defined for network and user account.

You configure and modify these parameters and associated values using the configuration files, the IP phone UI, or the Aastra Web UI. The Aastra Web UI and configuration file methods configure global and per-line SIP settings on the IP phone. The IP phone UI configures global SIP settings only.

On the IP Phones, you can configure Basic and Advanced SIP Settings. The Basic SIP Settings include authentication and network settings. The Advanced SIP Settings include other features you can configure on the IP Phone.

Reference

For more information about Basic SIP Settings (for authentication and network), see [“Basic SIP Settings”](#) on page 4-71.

For more information about Advanced SIP Settings, see [“Advanced SIP Settings \(optional\)”](#) on page 4-86.

Basic SIP Settings

Specific parameters are configurable on a global and per-line basis. You can also configure specific parameters using the IP Phone UI, the Aastra Web UI, or the configuration files. If you have a proxy server or have a SIP registrar present at a different location than the PBX server, the SIP parameters may need to be changed.

The IP phones allow you to define different SIP lines with the same account information (i.e., same user name) but with different registrar and proxy IP addresses. This feature works with Registration, Subscription, and Notify processing. This feature also works with the following types of calls: incoming, outgoing, Broadsoft Shared Call Appearance (SCA), Bridged Line Appearance (BLA), conference, transfer, blind transfer.

The following tables identify the SIP global and per-line, authentication and network parameters on the IP phones.

SIP Global Parameters

IP Phone UI Parameters	Aastra Web UI Parameters	Configuration File Parameters
SIP Global Authentication Parameters		
<ul style="list-style-type: none"> • Screen Name • N/A • User Name • Display Name • Auth Name • Password • N/A • N/A 	<ul style="list-style-type: none"> • Screen Name • Screen Name 2 • Phone Number • Caller ID • Authentication Name • Password • BLA Number • Line Mode 	<ul style="list-style-type: none"> • sip screen name • sip screen name 2 • sip user name • sip display name • sip auth name • sip password • sip bla number • sip mode • sip vmail
SIP Global Network Parameters		
<ul style="list-style-type: none"> • Proxy Server • Proxy Port • N/A • N/A • N/A • N/A • Registrar Server • Registrar Port • N/A • N/A • N/A • N/A 	<ul style="list-style-type: none"> • Proxy Server • Proxy Port • Backup Proxy Server • Backup Proxy Port • Outbound Proxy Server • Outbound Proxy Port • Registrar Server • Registrar Port • Backup Registrar Server • Backup Registrar Port • Registration Period • Conference Server URI (see Chapter 5) 	<ul style="list-style-type: none"> • sip proxy ip • sip proxy port • sip backup proxy ip • sip backup proxy port • sip outbound proxy • sip outbound proxy port • sip registrar ip • sip registrar port • sip backup registrar ip • sip backup registrar port • sip registration period • sip centralized conf (see Chapter 5)

Reference

For more information about centralized conferencing, see Chapter 5, the section, “[Centralized Conferencing \(for Sylantrö and Broadsoft Servers\)](#)” on page 5-363.

SIP Per-Line Parameters

IP Phone UI Parameters	Aastra Web UI Parameters	Configuration File Parameters
SIP Per-Line Authentication Parameters		
<ul style="list-style-type: none"> • Screen Name • N/A • User Name • Display Name • Auth Name • Password • N/A • N/A 	<ul style="list-style-type: none"> • Screen Name • Screen Name 2 • Phone Number • Caller ID • Authentication Name • Password • BLA Number • Line Mode 	<ul style="list-style-type: none"> • sip lineN screen name • sip lineN screen name 2 • sip lineN user name • sip lineN display name • sip lineN auth name • sip lineN password • sip lineN bla number • sip lineN mode • sip lineN vm ail
SIP Per-Line Network Parameters		
<ul style="list-style-type: none"> • Proxy Server • Proxy Port • N/A • N/A • N/A • N/A • Registrar Server • Registrar Port • N/A • N/A • N/A • N/A 	<ul style="list-style-type: none"> • Proxy Server • Proxy Port • Backup Proxy Server • Backup Proxy Port • Outbound Proxy Server • Outbound Proxy Port • Registrar Server • Registrar Port • Backup Registrar Server • Backup Registrar Port • Registration Period • Conference Server URI (see Chapter 5) 	<ul style="list-style-type: none"> • sip lineN proxy ip • sip lineN proxy port • sip lineN backup proxy ip • sip lineN backup proxy port • sip lineN outbound proxy • sip lineN outbound proxy port • sip lineN registrar ip • sip lineN registrar port • sip lineN backup registrar ip • sip lineN backup registrar port • sip lineN registration period • sip lineN centralized conf • (see Chapter 5)

Reference

For more information about centralized conferencing, see Chapter 5, the section, “[Centralized Conferencing \(for Sylantrö and Broadsoft Servers\)](#)” on page 5-363.



Note: The "sip vm ail" and "sip lineN vm ail" parameters are configurable using the configuration files only. To configure voicemail see Chapter 5, the section, “[Voicemail \(not applicable to 6751i\)](#)” on page 5-313.

Specific sets of SIP parameters are inter-dependent with each other. To prevent conflicting parameter values from being applied, per-line values always take precedence over the corresponding set of global values.

For example, if a parameter value is configured for one of the per-line sets, all parameters from that set are applied and all parameters from the corresponding global section are ignored, even if some of the parameters within the global set are not defined in the per-line set.

SIP Precedence Example

The following example shows the SIP proxy feature and example schema for storage and parsing of the SIP configuration parameters.

The following SIP configuration is assumed:

```
# SIP network block
sip proxy ip: 10.30.11.154
sip proxy port: 5060
sip registrar ip: 10.44.122.37
sip registrar port: 4020
sip line3 proxy ip: siparator.vonage.com
sip line3 proxy port: 0
```

Line3 specifies per-line values for proxy IP address and proxy port, so the phone uses those parameter values for SIP calls made on that line. However, because those parameters are part of the SIP network block, the phone does not apply any of the global SIP network block parameters. So even though the global parameters configure a SIP registrar, Line3 on the phone ignores all global network block parameters. Since line3 does not contain a per-line SIP registrar entry, the phone does not use a registrar for that line.



Note: Global SIP parameters apply to all lines unless overridden by a per-line configuration.

Per-line settings are configurable for lines 1 through 7.

Backup Proxy/Registrar Support

The IP phones support a backup SIP proxy and backup SIP registrar feature. If the primary server is unavailable, the phone automatically switches to the backup server allowing the user's phone to remain in service.

How it Works

All SIP registration messages are sent to the primary registrar first. If the server is unavailable, then a new registration request is sent to the backup registrar. This also applies to registration renewal messages, which try the primary server before the backup.

Similarly, any outgoing calls attempt to use the primary proxy first, then the backup if necessary. In addition, subscriptions for BLF, BLA, and explicit MWI can also use the backup proxy when the primary fails. Outgoing calls and the previously mentioned subscriptions behave the same as registrations, where the primary proxy is tried before the backup.

You can configure the backup SIP proxy on a global or per-line basis via the configuration files or the Aastra Web UI.

SIP Outbound Support

The IP Phones support draft-ietf-sip-outbound-15. That specification describes how a SIP User Agent (UA) behind a firewall, reuses an existing connection (usually the REGISTER outbound connection) for the inbound request if the proxy supports it. The UA uses keep-alive packets to monitor the connection status.

An Administrator can enable or disable this feature using the following parameter in the configuration files:

- **sip outbound support**



Note: TLS and TCP both support this feature. If the Global SIP parameter “Persistent TLS” is set on the phone, then only one TLS persistent connection can be established since the phone uses the local port 5061 for connection. If the Global SIP parameter “TLS” is set on the phone, more than one connection can be setup since the phone uses a random local port for connection.

Enabling/Disabling SIP Outbound Draft 15 Support.

Use the following procedure to enable/disable SIP outbound Draft 15 support.



Configuration Files

For the specific parameter you can set in the configuration files, see Appendix A, the section, [“SIP Outbound Support”](#) on page A-75.

Limitations

The following are limitations to this feature:

- SIP outbound on the phones is only supported for TLS and TCP based messages. UDP is not supported.
- The “keep-alive” only works with REGISTER connections.

SIP Server (SRV) Lookup

The SIP SRV Lookup feature allows you to configure the IP phone to perform a DNS server lookup on a SIP proxy, a SIP registrar, or a SIP outbound proxy.

The IP phone performs an SRV lookup when the IP address of the server is FQDN and the corresponding port is 0.

For example, if the phone is configured with **sip proxy ip of "ana.aastra.com"**, and **sip proxy port of "0"**, the SRV lookup may return multiple servers, based on the priorities if one is selected as primary and others are selected as secondary.

However, if the IP address is an FQDN and the corresponding server port is non-zero, then the phone performs a DNS "A" Name Query to resolve the FQDN into dot notation form.

If the IP address is a valid dot notation and the port is zero, then a default port 5060 is used.

You can configure SRV lookup using the configuration files (*aastra.cfg* and *<mac>.cfg*) only. The parameters to use are:

- **sip proxy ip**
- **sip proxy port**

Dynamic SIP Registration and Subscription

A feature on the IP Phones allow an Administrator to change the account information on a phone and have it dynamically update to the phone when the phone is inactive (phone not being used) without having to reboot the phone. This feature tracks the use of the phone's account so that when the phone becomes inactive, the new information can be applied. To support this feature, an Administrator can enable or disable a new parameter called “**dynamic sip**” in the configuration files. If enabled, an Administrator can change information such as, new registrar servers or outbound proxy servers, if required, and apply the changes without having to reboot the end-user's phone. This feature facilitates load balancing on a network.



Note: This feature does not support adding and removing accounts.

When this feature is enabled, an Administrator can update the following parameters on a phone, and the information is dynamically applied to the phone when the phone becomes inactive:

- Registrar
- Registrar Port
- Proxy
- Proxy Port
- Authentication Name
- Username
- Password
- Outbound Proxy
- Outbound Proxy Port
- Backup Proxy
- Backup Proxy Port
- Backup Registrar
- Backup Registrar Port

When new account information is applied to the phone, it unsubscribes the old subscription service. When the phone dynamically re-registers, the subscription service also dynamically re-subscribes.



Note: ONLY BLF and MWI events support dynamic subscription on the phones.

How it Works

When an Administrator updates account parameters for a phone from the configuration server (using the configuration file), the changes are compared to the existing account parameters on the phone. If the parameters are the same, the account information sent from the server is deleted and the account on the phone remains unchanged. If the parameters are different, the new account information is linked to the old account information and the old account is unregistered and the phone unsubscribes from the subscription service. The new account is then applied and the phone dynamically re-subscribes to the subscription services (BLF and/or MWI supported only).



Note: The dynamic SIP feature performs without having to reboot the phone.

If an Administrator changes the account information via the Aastra Web UI, the IP Phone UI, or via an XML Push, the phone checks if dynamic SIP is enabled. If dynamic SIP is enabled, the dynamic SIP feature proceeds as described in the previous paragraph. If it is disabled, the user is prompted to reboot the phone upon the user saving an LCD page or leaving a menu.

An Administrator can enable or disable the Dynamic SIP feature using the following parameter in the configuration files:

- **dynamic sip**

Limitations

The following are limitations of the dynamic SIP feature:

- This feature does not support the addition and deletion of accounts.
- This feature does not effect the DND and CFWD state of a line.

Enabling/Disabling the Dynamic SIP Feature

Use the following procedure to enable/disable the Dynamic SIP feature.



Configuration Files

For the specific parameter you can set in the configuration files, see Appendix A, the section, "[Dynamic SIP for Registration and Subscription](#)" on [page A-76](#).

Configuring Basic SIP Network Settings (optional)

You can configure SIP settings using the configuration files, the IP Phone UI, or the Aastra Web UI.



Note: To configure the SIP settings per-line, use the configuration files or the Aastra Web UI.





Configuration Files

For specific parameters you can set in the configuration files, see Appendix A, the section, “[SIP Basic, Global Settings](#)” on [page A-77](#) or “[SIP Basic, Per-Line Settings](#)” on [page A-86](#)



Note: You can set global configuration only using the IP Phone UI.

 IP Phone UI	
Step	Action
1	Press  on the phone to enter the Options List.
2	Select Administrator Menu .
3	Enter your Administrator password. Note: The IP Phones accept numeric passwords only.
4	Select SIP Settings .
Configuring Proxy IP and Proxy Port	
5	Select Proxy IP/Port .
6	Enter an IP address or fully qualified host name in the Proxy Server field. Default is 0.0.0.0 .
7	Enter a Proxy Port number in the Proxy Port field for accessing the SIP proxy server. Default is 0 .
8	Press Done to save the changes.
Configuring Registrar IP and Registrar Port	
9	Select Registrar IP/Port .
10	Enter an IP address or fully qualified host name in the Registrar Server field. Default is 0.0.0.0 . A global value of 0.0.0.0 disables registration. However, the phone is still active and you can dial using username@ip address of the phone. If the Registrar IP address is set to 0.0.0.0 for a per-line basis (i.e, line 1, line 2, etc.), then the register request is not sent, the "No Service" message does not display, and the message waiting indicator (MWI) does not come on.
11	Enter a Registrar Port number in the Registrar Port field for accessing the SIP registrar server. Default is 0 .
12	Press Done to save the changes.
Enabling/Disabling the Use of the Registrar Server	
13	Select SIP Register .
14	Press Change to set Register to " Yes " (enable) or " No " (disable). Default is " Yes ". This parameter enables/disables the IP phone to register on the network.
15	Press Done to save the changes.

 IP Phone UI	
Step	Action
16	Select User Name to enter the username in the name field of the SIP URI for the IP phone, and for registering the phone at the registrar. Note: The IP phones allow usernames containing dots ("."). You can also enter the same user name for different registrar and proxy IP addresses.
17	Press Done to save the changes.
18	Select Display Name to enter the name used in the display name field of the "From SIP" header field.
19	Press Done to save the changes.
20	Select Screen Name and enter the name to display on the idle screen.
21	Press Done to save the changes.
22	Select Authentication Name to enter the authorization name used in the username field of the Authorization header field of the SIP REGISTER request.
23	Press Done to save the changes.
24	Select Password to enter the password used to register the IP phone with the SIP proxy. Note: The IP phones accept numeric passwords only.
25	Press Done (3 times) to save the changes. Note: The session prompts you to restart the IP phone to apply the configuration settings
26	Select Restart .



Aastra Web UI																																											
Step	Action																																										
1	<p>For global configuration, click on Advanced Settings->Global SIP->Basic SIP Settings.</p> <div style="border: 1px solid black; padding: 10px;"> <table border="1"> <tr> <td style="background-color: #e6f2ff; vertical-align: top;"> <ul style="list-style-type: none"> Status System Information Operation User Password Phone Lock Softkeys and XML Programmable Keys Directory Reset Basic Settings Preferences Account Configuration Advanced Settings Network Global SIP Line 1 Line 2 Line 3 Line 4 Line 5 Line 6 Line 7 Line 8 Line 9 Action URI Configuration Server Firmware Update TLS Support 802.1x Support Troubleshooting </td> <td style="padding: 10px;"> <h3 style="margin: 0;">Global SIP Settings</h3> <p>Basic SIP Authentication Settings</p> <table border="1" style="width: 100%; border-collapse: collapse;"> <tr><td>Screen Name</td><td>SIP Phone 55i</td></tr> <tr><td>Screen Name 2</td><td></td></tr> <tr><td>Phone Number</td><td>22222</td></tr> <tr><td>Caller ID</td><td>SIP Phone 55i</td></tr> <tr><td>Authentication Name</td><td></td></tr> <tr><td>Password</td><td></td></tr> <tr><td>BLA Number</td><td></td></tr> <tr><td>Line Mode</td><td>Generic</td></tr> </table> <p>Basic SIP Network Settings</p> <table border="1" style="width: 100%; border-collapse: collapse;"> <tr><td>Proxy Server</td><td>0.0.0.0</td></tr> <tr><td>Proxy Port</td><td>0</td></tr> <tr><td>Backup Proxy Server</td><td>0.0.0.0</td></tr> <tr><td>Backup Proxy Port</td><td>0</td></tr> <tr><td>Outbound Proxy Server</td><td>0.0.0.0</td></tr> <tr><td>Outbound Proxy Port</td><td>0</td></tr> <tr><td>Registrar Server</td><td>0.0.0.0</td></tr> <tr><td>Registrar Port</td><td>0</td></tr> <tr><td>Backup Registrar Server</td><td>0.0.0.0</td></tr> <tr><td>Backup Registrar Port</td><td>0</td></tr> <tr><td>Registration Period</td><td>0</td></tr> <tr><td>Conference Server URI</td><td></td></tr> </table> </td> </tr> </table> </div>	<ul style="list-style-type: none"> Status System Information Operation User Password Phone Lock Softkeys and XML Programmable Keys Directory Reset Basic Settings Preferences Account Configuration Advanced Settings Network Global SIP Line 1 Line 2 Line 3 Line 4 Line 5 Line 6 Line 7 Line 8 Line 9 Action URI Configuration Server Firmware Update TLS Support 802.1x Support Troubleshooting 	<h3 style="margin: 0;">Global SIP Settings</h3> <p>Basic SIP Authentication Settings</p> <table border="1" style="width: 100%; border-collapse: collapse;"> <tr><td>Screen Name</td><td>SIP Phone 55i</td></tr> <tr><td>Screen Name 2</td><td></td></tr> <tr><td>Phone Number</td><td>22222</td></tr> <tr><td>Caller ID</td><td>SIP Phone 55i</td></tr> <tr><td>Authentication Name</td><td></td></tr> <tr><td>Password</td><td></td></tr> <tr><td>BLA Number</td><td></td></tr> <tr><td>Line Mode</td><td>Generic</td></tr> </table> <p>Basic SIP Network Settings</p> <table border="1" style="width: 100%; border-collapse: collapse;"> <tr><td>Proxy Server</td><td>0.0.0.0</td></tr> <tr><td>Proxy Port</td><td>0</td></tr> <tr><td>Backup Proxy Server</td><td>0.0.0.0</td></tr> <tr><td>Backup Proxy Port</td><td>0</td></tr> <tr><td>Outbound Proxy Server</td><td>0.0.0.0</td></tr> <tr><td>Outbound Proxy Port</td><td>0</td></tr> <tr><td>Registrar Server</td><td>0.0.0.0</td></tr> <tr><td>Registrar Port</td><td>0</td></tr> <tr><td>Backup Registrar Server</td><td>0.0.0.0</td></tr> <tr><td>Backup Registrar Port</td><td>0</td></tr> <tr><td>Registration Period</td><td>0</td></tr> <tr><td>Conference Server URI</td><td></td></tr> </table>	Screen Name	SIP Phone 55i	Screen Name 2		Phone Number	22222	Caller ID	SIP Phone 55i	Authentication Name		Password		BLA Number		Line Mode	Generic	Proxy Server	0.0.0.0	Proxy Port	0	Backup Proxy Server	0.0.0.0	Backup Proxy Port	0	Outbound Proxy Server	0.0.0.0	Outbound Proxy Port	0	Registrar Server	0.0.0.0	Registrar Port	0	Backup Registrar Server	0.0.0.0	Backup Registrar Port	0	Registration Period	0	Conference Server URI	
<ul style="list-style-type: none"> Status System Information Operation User Password Phone Lock Softkeys and XML Programmable Keys Directory Reset Basic Settings Preferences Account Configuration Advanced Settings Network Global SIP Line 1 Line 2 Line 3 Line 4 Line 5 Line 6 Line 7 Line 8 Line 9 Action URI Configuration Server Firmware Update TLS Support 802.1x Support Troubleshooting 	<h3 style="margin: 0;">Global SIP Settings</h3> <p>Basic SIP Authentication Settings</p> <table border="1" style="width: 100%; border-collapse: collapse;"> <tr><td>Screen Name</td><td>SIP Phone 55i</td></tr> <tr><td>Screen Name 2</td><td></td></tr> <tr><td>Phone Number</td><td>22222</td></tr> <tr><td>Caller ID</td><td>SIP Phone 55i</td></tr> <tr><td>Authentication Name</td><td></td></tr> <tr><td>Password</td><td></td></tr> <tr><td>BLA Number</td><td></td></tr> <tr><td>Line Mode</td><td>Generic</td></tr> </table> <p>Basic SIP Network Settings</p> <table border="1" style="width: 100%; border-collapse: collapse;"> <tr><td>Proxy Server</td><td>0.0.0.0</td></tr> <tr><td>Proxy Port</td><td>0</td></tr> <tr><td>Backup Proxy Server</td><td>0.0.0.0</td></tr> <tr><td>Backup Proxy Port</td><td>0</td></tr> <tr><td>Outbound Proxy Server</td><td>0.0.0.0</td></tr> <tr><td>Outbound Proxy Port</td><td>0</td></tr> <tr><td>Registrar Server</td><td>0.0.0.0</td></tr> <tr><td>Registrar Port</td><td>0</td></tr> <tr><td>Backup Registrar Server</td><td>0.0.0.0</td></tr> <tr><td>Backup Registrar Port</td><td>0</td></tr> <tr><td>Registration Period</td><td>0</td></tr> <tr><td>Conference Server URI</td><td></td></tr> </table>	Screen Name	SIP Phone 55i	Screen Name 2		Phone Number	22222	Caller ID	SIP Phone 55i	Authentication Name		Password		BLA Number		Line Mode	Generic	Proxy Server	0.0.0.0	Proxy Port	0	Backup Proxy Server	0.0.0.0	Backup Proxy Port	0	Outbound Proxy Server	0.0.0.0	Outbound Proxy Port	0	Registrar Server	0.0.0.0	Registrar Port	0	Backup Registrar Server	0.0.0.0	Backup Registrar Port	0	Registration Period	0	Conference Server URI			
Screen Name	SIP Phone 55i																																										
Screen Name 2																																											
Phone Number	22222																																										
Caller ID	SIP Phone 55i																																										
Authentication Name																																											
Password																																											
BLA Number																																											
Line Mode	Generic																																										
Proxy Server	0.0.0.0																																										
Proxy Port	0																																										
Backup Proxy Server	0.0.0.0																																										
Backup Proxy Port	0																																										
Outbound Proxy Server	0.0.0.0																																										
Outbound Proxy Port	0																																										
Registrar Server	0.0.0.0																																										
Registrar Port	0																																										
Backup Registrar Server	0.0.0.0																																										
Backup Registrar Port	0																																										
Registration Period	0																																										
Conference Server URI																																											

 Aastra Web UI			
Step	Action		
	<p>Or, for per-line configuration, click on Advanced Settings->Line N (1-9).</p> <div style="border: 1px solid black; padding: 10px; margin: 10px 0;"> <table style="width: 100%; border-collapse: collapse;"> <tr> <td style="width: 25%; vertical-align: top; border-right: 1px solid black; padding-right: 5px;"> <ul style="list-style-type: none"> Status System Information Operation User Password Phone Lock Softkeys and XML Programmable Keys Directory Reset Basic Settings Preferences Account Configuration Advanced Settings Network Global SIP Line 1 Line 2 Line 3 Line 4 Line 5 Line 6 Line 7 Line 8 Line 9 Action URI Configuration Server Firmware Update TLS Support 802.1x Support Troubleshooting </td> <td style="padding-left: 5px;"> <p style="margin: 0;">Configuration Line 1</p> <p style="margin: 0;">Basic SIP Authentication Settings</p> <p>Screen Name <input style="width: 100%;" type="text"/></p> <p>Screen Name 2 <input style="width: 100%;" type="text"/></p> <p>Phone Number <input style="width: 100%;" type="text"/></p> <p>Caller ID <input style="width: 100%;" type="text"/></p> <p>Authentication Name <input style="width: 100%;" type="text"/></p> <p>Password <input style="width: 100%;" type="text"/></p> <p>BLA Number <input style="width: 100%;" type="text"/></p> <p>Line Mode <input style="width: 100%;" type="text" value="Generic"/></p> <p style="margin: 0;">Basic SIP Network Settings</p> <p>Proxy Server <input style="width: 100%;" type="text" value="0.0.0.0"/></p> <p>Proxy Port <input style="width: 100%;" type="text" value="0"/></p> <p>Backup Proxy Server <input style="width: 100%;" type="text" value="0.0.0.0"/></p> <p>Backup Proxy Port <input style="width: 100%;" type="text" value="0"/></p> <p>Outbound Proxy Server <input style="width: 100%;" type="text" value="0.0.0.0"/></p> <p>Outbound Proxy Port <input style="width: 100%;" type="text" value="0"/></p> <p>Registrar Server <input style="width: 100%;" type="text" value="0.0.0.0"/></p> <p>Registrar Port <input style="width: 100%;" type="text" value="0"/></p> <p>Backup Registrar Server <input style="width: 100%;" type="text" value="0.0.0.0"/></p> <p>Backup Registrar Port <input style="width: 100%;" type="text" value="0"/></p> <p>Registration Period <input style="width: 100%;" type="text" value="0"/></p> <p>Conference Server URI <input style="width: 100%;" type="text"/></p> </td> </tr> </table> </div>	<ul style="list-style-type: none"> Status System Information Operation User Password Phone Lock Softkeys and XML Programmable Keys Directory Reset Basic Settings Preferences Account Configuration Advanced Settings Network Global SIP Line 1 Line 2 Line 3 Line 4 Line 5 Line 6 Line 7 Line 8 Line 9 Action URI Configuration Server Firmware Update TLS Support 802.1x Support Troubleshooting 	<p style="margin: 0;">Configuration Line 1</p> <p style="margin: 0;">Basic SIP Authentication Settings</p> <p>Screen Name <input style="width: 100%;" type="text"/></p> <p>Screen Name 2 <input style="width: 100%;" type="text"/></p> <p>Phone Number <input style="width: 100%;" type="text"/></p> <p>Caller ID <input style="width: 100%;" type="text"/></p> <p>Authentication Name <input style="width: 100%;" type="text"/></p> <p>Password <input style="width: 100%;" type="text"/></p> <p>BLA Number <input style="width: 100%;" type="text"/></p> <p>Line Mode <input style="width: 100%;" type="text" value="Generic"/></p> <p style="margin: 0;">Basic SIP Network Settings</p> <p>Proxy Server <input style="width: 100%;" type="text" value="0.0.0.0"/></p> <p>Proxy Port <input style="width: 100%;" type="text" value="0"/></p> <p>Backup Proxy Server <input style="width: 100%;" type="text" value="0.0.0.0"/></p> <p>Backup Proxy Port <input style="width: 100%;" type="text" value="0"/></p> <p>Outbound Proxy Server <input style="width: 100%;" type="text" value="0.0.0.0"/></p> <p>Outbound Proxy Port <input style="width: 100%;" type="text" value="0"/></p> <p>Registrar Server <input style="width: 100%;" type="text" value="0.0.0.0"/></p> <p>Registrar Port <input style="width: 100%;" type="text" value="0"/></p> <p>Backup Registrar Server <input style="width: 100%;" type="text" value="0.0.0.0"/></p> <p>Backup Registrar Port <input style="width: 100%;" type="text" value="0"/></p> <p>Registration Period <input style="width: 100%;" type="text" value="0"/></p> <p>Conference Server URI <input style="width: 100%;" type="text"/></p>
<ul style="list-style-type: none"> Status System Information Operation User Password Phone Lock Softkeys and XML Programmable Keys Directory Reset Basic Settings Preferences Account Configuration Advanced Settings Network Global SIP Line 1 Line 2 Line 3 Line 4 Line 5 Line 6 Line 7 Line 8 Line 9 Action URI Configuration Server Firmware Update TLS Support 802.1x Support Troubleshooting 	<p style="margin: 0;">Configuration Line 1</p> <p style="margin: 0;">Basic SIP Authentication Settings</p> <p>Screen Name <input style="width: 100%;" type="text"/></p> <p>Screen Name 2 <input style="width: 100%;" type="text"/></p> <p>Phone Number <input style="width: 100%;" type="text"/></p> <p>Caller ID <input style="width: 100%;" type="text"/></p> <p>Authentication Name <input style="width: 100%;" type="text"/></p> <p>Password <input style="width: 100%;" type="text"/></p> <p>BLA Number <input style="width: 100%;" type="text"/></p> <p>Line Mode <input style="width: 100%;" type="text" value="Generic"/></p> <p style="margin: 0;">Basic SIP Network Settings</p> <p>Proxy Server <input style="width: 100%;" type="text" value="0.0.0.0"/></p> <p>Proxy Port <input style="width: 100%;" type="text" value="0"/></p> <p>Backup Proxy Server <input style="width: 100%;" type="text" value="0.0.0.0"/></p> <p>Backup Proxy Port <input style="width: 100%;" type="text" value="0"/></p> <p>Outbound Proxy Server <input style="width: 100%;" type="text" value="0.0.0.0"/></p> <p>Outbound Proxy Port <input style="width: 100%;" type="text" value="0"/></p> <p>Registrar Server <input style="width: 100%;" type="text" value="0.0.0.0"/></p> <p>Registrar Port <input style="width: 100%;" type="text" value="0"/></p> <p>Backup Registrar Server <input style="width: 100%;" type="text" value="0.0.0.0"/></p> <p>Backup Registrar Port <input style="width: 100%;" type="text" value="0"/></p> <p>Registration Period <input style="width: 100%;" type="text" value="0"/></p> <p>Conference Server URI <input style="width: 100%;" type="text"/></p>		
To configure SIP authentication settings:			
2	In the " Screen Name " field, enter the screen name that displays on the idle screen.		

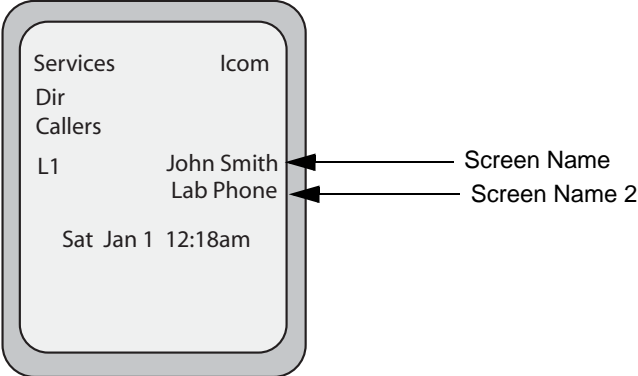
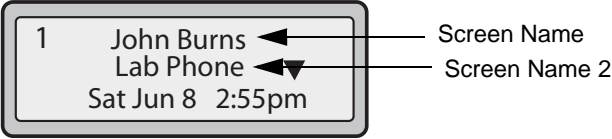
 **Aastra Web UI**

Step	Action
3	<p>In the "Screen Name 2" field, enter the text you want to display on the phone under the "Screen Name" on the idle screen.</p> <p>Notes:</p> <ol style="list-style-type: none"> 1. If other status messages display on the phone, such as "Network Disconnected", the Screen Name 2 value does not display. 2. Symbol characters are allowed (such as "#"). 3. If the text is longer than the display width, than the display truncates the text to fit the display. <div style="display: flex; justify-content: space-around; align-items: center;"> <div data-bbox="334 647 511 748" style="text-align: center;"> <p>Figure 1 8 and 11-Line LCD Displays</p> </div> <div data-bbox="544 626 1176 1003" style="border: 1px solid gray; padding: 10px; text-align: center;">  </div> </div> <div style="display: flex; justify-content: space-around; align-items: center; margin-top: 20px;"> <div data-bbox="319 1065 496 1166" style="text-align: center;"> <p>Figure 2 3-Line LCD Displays</p> </div> <div data-bbox="532 1055 1139 1194" style="border: 1px solid gray; padding: 10px; text-align: center;">  </div> </div>
4	In the " Phone Number " field, enter the phone number of the IP phone.
5	In the " Caller ID " field, enter the phone number of the IP phone.
6	In the " Authentication Name " field, enter the name used in the username field of the Authorization header of the SIP REGISTER request.
7	In the " Password " field, enter the password used to register the IP phone with the SIP proxy. Note: The IP phones accept numeric passwords only.
8	In the " BLA Number " field, enter the Bridge Line Appearance (BLA) number to be shared across all IP phones.

 Aastra Web UI	
Step	Action
9	In the " Line Mode " field, select "Generic" for normal mode, "BroadSoft SCA" for a BroadWorks network, or "Nortel" for a Nortel network.
To configure SIP network settings:	
10	In the " Proxy Server " field, enter an IP address or fully qualified host name of the SIP proxy server.
11	In the " Proxy Port " field, enter a port number for accessing the SIP proxy server.
12	In the " Backup Proxy Server " field, enter an IP address or fully qualified host name for the backup proxy server.
13	In the " Backup Proxy Port " field, enter a port number for accessing the backup proxy server.
14	<p>In the "Outbound Proxy Server" field, enter the SIP outbound proxy server IP address or fully qualified domain name. This parameter allows all SIP messages originating from a line on the IP phone, to be sent to an outbound proxy server.</p> <p>Note: If you configure an outbound proxy and registrar for a specific line, and you also configure a global outbound proxy and registrar, the IP phone uses the global configuration for all lines except line 1. Line 1 uses the outbound proxy and registrar that you configured for that line.</p>
15	In the " Outbound Proxy Port " field, enter the port on the IP phone that allows SIP messages to be sent to the outbound proxy server.
16	<p>In the "Registrar Server" field, enter an IP address or fully qualified host name for the SIP registrar server. A global value of 0.0.0.0 disables registration. However, the phone is still active and you can dial using username@ip address of the phone.</p> <p>If the Registrar IP address is set to 0.0.0.0 for a per-line basis (i.e., line 1, line 2, etc.), then the register request is not sent, the "No Service" message does not display, and the message waiting indicator (MWI) does not come on.</p>
17	In the " Registrar Port " field, enter the port number associated with the Registrar.
18	<p>In the "Backup Registrar Server" field, enter an IP address or fully qualified host name for the backup registrar server. A global value of 0.0.0.0 disables registration. However, the phone is still active and you can dial using username@ip address of the phone.</p> <p>If the Backup Registrar IP address is set to 0.0.0.0 for a per-line basis (i.e., line 1, line 2, etc.), then the register request is not sent, the "No Service" message does not display, and the message waiting indicator (MWI) does not come on.</p>
19	In the " Backup Registrar Port " field, enter the port number associated with the backup registrar.
20	In the " Registration Period " field, enter the requested registration period, in seconds, from the registrar.

 Aastra Web UI	
Step	Action
21	To enter a value in the “ Conference Server URI ” field, see Chapter 5, the section, “ Centralized Conferencing (for Sylantra and Broadsoft Servers) ” on page 5-363 .
22	Click  to save your changes.

Advanced SIP Settings (optional)

Advanced SIP Settings on the IP Phone allow you to configure specific features on the phone. The following table provides a list of Advanced SIP Settings that you can configure using the Aastra Web UI or the configuration files.

Aastra Web UI Parameters	Configuration File Parameters
Explicit MWI Subscription Explicit MWI Subscription Period	sip explicit mwi subscription sip explicit mwi subscription period
MWI for BLA Account	sip mwi for bla account (see Chapter 5)
Missed Call Summary Subscription (global) Missed Call Summary Subscription (per-line) (see Chapter 6)	sip missed call summary subscription (global) sip lineN missed call summary subscription (per-line) (see Chapter 6)
Missed Call Summary Subscription Period (see Chapter 6)	sip missed call summary subscription period (see Chapter 6)
AS-Feature-Event Subscription (global) AS-Feature-Event Subscription (per-line) (see Chapter 6)	sip as-feature-event subscription (global) sip lineN as-feature-event subscription (per-line) (see Chapter 6)
AS-Feature Event Subscription Period (see Chapter 6)	sip as-feature-event subscription period (see Chapter 6)
Send MAC Address in REGISTER Message (see Chapter 6)	sip send mac (see Chapter 6)
Send Line Number in REGISTER Message (see Chapter 6)	sip send line (see Chapter 6)
Session Timer	sip session timer
T1 Timer T2 Timer	sip T1 timer sip T2 timer
Transaction Timer	sip transaction timer
Transport Protocol	sip transport protocol
Local SIP UDP/TCP Port (see page 4-37)	sip local port (see page 4-37)
Local SIP TLS Port (see page 4-37)	sip local tls port (see page 4-37)
Registration Failed Retry Timer	sip registration retry timer
Registration Timeout Retry Timer	sip registration timeout retry timer
Registration Renewal Timer	sip registration renewal timer

Aastra Web UI Parameters	Configuration File Parameters
BLF Subscription Period (see Chapter 5)	sip blf subscription period (see Chapter 5)
ACD Subscription Period (see Chapter 5)	sip acd subscription period (see Chapter 5)
BLA Subscription Period (see Chapter 5)	sip acd subscription period (see Chapter 5)
Blacklist Duration (see Chapter 6)	sip blacklist duration (see Chapter 6)
Whitelist Proxy (see Chapter 6)	sip whitelist (see Chapter 6)
XML SIP Notify (see Chapter 6)	XML SIP Notify (see Chapter 6)

Reference

Refer to Appendix A, “[Advanced SIP Settings](#)” on [page A-103](#) for a description of each of the above parameters.

For more information about Blacklist Duration and Whitelist Proxy, see [Chapter 6, “Configuring Advanced Operational Features.”](#)

Configuring Advanced SIP Settings

Use the following procedures to configure the advanced SIP settings on the IP phone.



Configuration Files

For specific parameters you can set in the configuration files, see Appendix A, the section, “[Advanced SIP Settings](#)” on [page A-103](#).

 **Aastra Web UI**

Step	Action
------	--------

For Global configuration, click on **Advanced Settings->Global SIP->Advanced SIP Settings**.

<p>Status</p> <ul style="list-style-type: none"> System Information <p>Operation</p> <ul style="list-style-type: none"> User Password Phone Lock Softkeys and XML Keypad Speed Dial Directory Reset <p>Basic Settings</p> <ul style="list-style-type: none"> Preferences Account Configuration <p>Advanced Settings</p> <ul style="list-style-type: none"> Network Global SIP Line 1 Line 2 Line 3 Line 4 Line 5 Line 6 Line 7 Line 8 Line 9 Action URI Configuration Server Firmware Update TLS Support 802.1x Support Troubleshooting 	<p>Global SIP Settings</p> <p>Advanced SIP Settings</p> <ul style="list-style-type: none"> Explicit MWI Subscription <input type="checkbox"/> Enabled Explicit MWI Subscription Period <input type="text" value="86400"/> MWI for BLA account <input type="checkbox"/> Enabled Missed Call Summary Subscription <input type="checkbox"/> Enabled Missed Call Summary Subscription Period <input type="text" value="86400"/> AS-Feature-Event Subscription <input type="checkbox"/> Enabled AS-Feature-Event Subscription Period <input type="text" value="3600"/> Send MAC Address in REGISTER Message <input type="checkbox"/> Enabled Send Line Number in REGISTER Message <input type="checkbox"/> Enabled Session Timer <input type="text" value="0"/> T1 Timer <input type="text" value="0"/> T2 Timer <input type="text" value="0"/> Transaction Timer <input type="text" value="4000"/> Transport Protocol <input type="text" value="UDP"/> <input type="button" value="v"/> Local SIP UDP/TCP Port <input type="text" value="5060"/> Local SIP TLS Port <input type="text" value="5061"/> Registration Failed Retry Timer <input type="text" value="1800"/> Registration Timeout Retry Timer <input type="text" value="120"/> Registration Renewal Timer <input type="text" value="15"/> BLF Subscription Period <input type="text" value="3600"/> ACD Subscription Period <input type="text" value="3600"/> BLA Subscription Period <input type="text" value="300"/> Blacklist Duration <input type="text" value="300"/> Whitelist Proxy <input type="checkbox"/> Enabled XML SIP Notify <input type="checkbox"/> Enabled
---	---

1 For per-line configuration, click on **Advanced Settings->Line N**.

<p>Status</p> <ul style="list-style-type: none"> System Information <p>Operation</p> <ul style="list-style-type: none"> User Password Phone Lock Softkeys and XML Programmable Keys Directory Reset <p>Basic Settings</p> <ul style="list-style-type: none"> Preferences Account Configuration <p>Advanced Settings</p> <ul style="list-style-type: none"> Network Global SIP Line 1 Line 2 Line 3 Line 4 Line 5 Line 6 	<p>Global SIP Settings</p> <p>Advanced SIP Settings</p> <ul style="list-style-type: none"> Missed Call Summary Subscription <input type="checkbox"/> Enabled AS-Feature-Event Subscription <input type="checkbox"/> Enabled
--	---

 Aastra Web UI	
Step	Action
2	<p>Enable the "Explicit MWI Subscription" field by checking the check box. (Disable this field by unchecking the check box. Default is disabled).</p> <p>If the IP phone has a message waiting subscription with the Service Provider, a Message Waiting Indicator (MWI) (LED or display icon) tells the user there is a message on the IP Phone.</p>
3	<p>If you enable the "Explicit MWI Subscription" field, then in the "Explicit MWI Subscription Period" field, enter the requested duration, in seconds, before the MWI subscription times out. The phone re-subscribes to MWI before the subscription period ends. Default is 86400.</p>
4	<p>Enable the "MWI for BLA Account" to enable or disable a BLA configured line to send an MWI SUBSCRIBE message for the BLA account.</p> <p>Notes:</p> <ol style="list-style-type: none"> 1. If you change the setting on this parameter, you must reboot the phone for it to take affect. 2. Both the "sip explicit mwi subscription" and "sip mwi for bla account" parameters must be enabled in order for the MWI subscription for BLA to occur. 3. The MWI re-subscription for the BLA account uses the value set for the "sip explicit mwi subscription period" parameter to re-subscribe. 4. Whether or not the "sip mwi for bla account" parameter is enabled, the priority for displaying MWI does not change.
5	<p>Enable the "Missed Call Summary Subscription" field by checking the check box. (Disable this field by unchecking the check box. Default is disabled).</p> <p>This feature allows missed calls that have been redirected by the server, to be incremented in the missed calls indicator on the phone it was initially directed to.</p> <p>For more information about this feature, see Chapter 6, the section, "Missed Call Summary Subscription" on page 6-13.</p> <p>Note: The "Missed Call Summary Subscription" feature is configurable on a global or per-line basis.</p>
6	<p>If you enable the "Missed Call Summary Subscription" field, then in the "Missed Call Summary Subscription Period" field, enter the amount of time, in seconds, that the phone uses the Missed Calls Summary Subscription feature. Default is 86400.</p> <p>For more information about this feature, see Chapter 6, the section, "Missed Call Summary Subscription" on page 6-13.</p> <p>Note: The "Missed Call Summary Subscription Period" is configurable on a global basis only.</p>

 Aastra Web UI	
Step	Action
7	<p>Enable the “AS-Feature-Event Subscription” field by checking the check box. (Disable this field by unchecking the check box. Default is disabled).</p> <p>This feature enables or disables the specified line with the BroadSoft’s server-side DND, CFWD, or ACD features.</p> <p>For more information about this feature, see Chapter 6, the section, “As-Feature-Event Subscription” on page 6-17.</p> <p>Note: The “AS-Feature-Event Subscription ” feature is configurable on a global or per-line basis.</p>
8	<p>If you enable the “AS-Feature-Event Subscription” field, then in the “AS-Feature-Event Subscription Period” field, enter the amount of time, in seconds, between resubscribing. If the phone does not resubscribe in the time specified for this parameter, it loses subscription. Default is 3600.</p> <p>For more information about this feature, see Chapter 6, the section, “As-Feature-Event Subscription” on page 6-17.</p>
9	<p>Enable the “Send MAC Address in REGISTER Message” and the “Send Line Number in REGISTER Message” fields by checking the check boxes. (Disable these fields by unchecking the check boxes. Default is disabled for both fields).</p> <p>For more information about these message features, see Chapter 6, the section, “MAC Address/Line Number in REGISTER Messages” on page 6-5.</p> <p>Note: The “AS-Feature-Event Subscription Period” feature is configurable on a global basis only</p>
10	<p>In the “Session Timer” field, enter the time, in seconds, that the IP phone uses to send periodic re-<i>INVITE</i> requests to keep a session alive. The proxy uses these re-<i>INVITE</i> requests to maintain the status' of the connected sessions. See RFC4028 for details.</p>
11	<p>In the “Timer 1” and “Timer 2” fields, enter a time, in milliseconds, that will apply to an IP phone session. These timers are SIP transaction layer timers defined in RFC 3261.</p> <p>Timer 1 is an estimate of the round-trip time (RTT). Default is 500 msec. Timer 2 represents the amount of time a non-<i>INVITE</i> server transaction takes to respond to a request. Default is 4 seconds.</p>
12	<p>In the “Transaction Timer” field, enter the amount of time, in milliseconds, that the phone allows the call server (registrar/proxy) to respond to SIP messages that it sends. Valid values are 4000 to 64000. Default is 4000.</p> <p>Note: If the phone does not receive a response in the amount of time designated for this parameter, the phone assumes the message has timed out.</p>

 Aastra Web UI	
Step	Action
13	In the " Transport Protocol " field, select a transport protocol to use when sending SIP Real-time Transport Protocol (RTP) packets. Valid values are User Datagram Protocol (UDP) and Transmission Control Protocol (TCP), UDP, TCP, Transport Layer Security (TLS) or Persistent TLS. The value " UDP " is the default. For more information about TLS, see " RTP Encryption " on page 4-99 and Chapter 6, the section, " Transport Layer Security (TLS) " on page 6-26 .
14	In the " Local SIP UDP/TCP Port " field, specify the local source port (UDP/TCP) from which the phone sends SIP messages. Default is 5060. For more information about this feature, see the section, " SIP and TLS Source Ports for NAT Traversal " on page 4-37 .
15	In the " Local SIP TLS Port " field, specify the local source port (SIPS/TLS) from which the phone sends SIP messages. Default is 5061. For more information about this feature, see the section, " SIP and TLS Source Ports for NAT Traversal " on page 4-37 .
16	In the " Registration Failed Retry Timer " field, enter the amount of time, in seconds, that the phone waits between registration attempts when a registration is rejected by the registrar. Valid values are 30 to 1800. Default is 1800.
17	In the " Registration Timeout Retry Timer " field, enter the amount of time, in seconds, that the phone waits until it re-attempts to register after a REGISTER message times out. Valid values are 30 to 214748364. Default is 120.
18	In the " Registration Renewal Timer " field, enter the length of time, in seconds, prior to expiration, that the phone renews registrations. For example, if the value is set to 20, then 20 seconds before the registration is due to expire, a new REGISTER message is sent to the registrar to renew the registration. Valid values are 0 to 214748364. Default is 15.
19	The " BLF Subscription Period " field is enabled by default with a value of 3600 seconds. This feature sets the time period, in seconds, that the IP phone resubscribes the BLF subscription service after a software/firmware upgrade or after a reboot of the IP phone. For information about setting the "BLF Subscription Period", see Chapter 5, the section, " BLF Subscription Period " on page 5-174 .

 Aastra Web UI	
Step	Action
20	<p>(For Sylanro Servers) The “ACD Subscription Period” field is enabled by default with a value of 3600 seconds.</p> <p>This feature sets the time period, in seconds, that the IP phone resubscribes the BLF subscription service after a software/firmware upgrade or after a reboot of the IP phone. For information about setting the “ACD Subscription Period”, see Chapter 5, the section, “ACD Subscription Period” on page 5-196.</p>
21	<p>The “BLA Subscription Period” field is enabled by default with a value of 300 seconds.</p> <p>This feature sets the amount of time, in seconds, that the phone waits to receive a BLA subscribe message from the server. If you specify zero (0), the phone uses the value specified for the BLA expiration in the subscribe message received from the server. If no value is specified, the phone uses the default value of 300 seconds. For information about setting the “BLA Subscription Period”, see Chapter 5, the section, “BLA Subscription Period” on page 5-196.</p>
22	<p>(For Broadsoft Servers) The “Blacklist Duration” field is enabled by default with a value of 300 seconds (5 minutes). Valid values are 0 to 9999999.</p> <p>This feature sets the time period, in seconds, that the IP phone resubscribes the BLF subscription service after a software/firmware upgrade or after a reboot of the IP phone.</p> <p>Note: The value of “0” disables the blacklist feature.</p> <p>For information about setting the “Blacklist Duration”, see Chapter 6, the section, “Blacklist Duration” on page 6-22.</p>
23	<p>Enable the “Whitelist Proxy” field by checking the check box. (Disable this field by unchecking the check box. Default is disabled).</p> <p>When this feature is enabled, an IP phone accepts call requests from a trusted proxy server <i>only</i>. The IP phone rejects any call requests from an untrusted proxy server.</p> <p>For information about setting the “Whitelist Proxy”, see Chapter 6, the section, “Whitelist Proxy” on page 6-24.</p>



Aastra Web UI

Step	Action
24	<p>Enable the "XML SIP Notify" field by checking the check box. (Disable this field by unchecking the check box. Default is disabled).</p> <p>Enabling this parameter allows the phone to accept or reject an aastra-xml SIP NOTIFY message.</p> <p>Note: To ensure the SIP NOTIFY is coming from a trusted source, it is recommended that you enable the Whitelist feature (Whitelist Proxy parameter) on the IP phone. If enabled, and the phone receives a SIP NOTIFY from a server that is NOT on the whitelist (i.e. untrusted server), the phone rejects the message.</p> <p>For information about setting this feature, see Chapter 5, the section, "XML SIP Notify Events" on page 5-344.</p>
25	Click  to save your changes.

Real-time Transport Protocol (RTP) Settings

Real-time Transport Protocol (RTP) is used as the bearer path for voice packets sent over the IP network. Information in the RTP header tells the receiver how to reconstruct the data and describes how the bit streams are packetized (i.e. which codec is in use). Real-time Transport Control Protocol (RTCP) allows endpoints to monitor packet delivery, detect and compensate for any packet loss in the network. Session Initiation Protocol (SIP) and H.323 both use RTP and RTCP for the media stream, with User Datagram Protocol (UDP) as the transport layer encapsulation protocol.



Note: If RFC2833 relay of DTMF tones is configured, it is sent on the same port as the RTP voice packets. The phones support decoding and playing out DTMF tones sent in SIP INFO requests. The following DTMF tones are supported:

- Support signals 0-9, #, *
- Support durations up to 5 seconds

You can set the following parameters for RTP on the IP Phones:

Aastra Web UI Parameters	Configuration File Parameters
RTP Port	sip rtp port
Basic Codecs (G.711 u-Law, G.711 a-Law, G.729)	sip use basic codecs
Force RFC2833 Out-of-Band DTMF	sip out-of-band dtmf
Customized Codec Preference List	sip customized codec
DTMF Method (global and per-line settings)	sip dtmf method (global and per-line settings)
RTP Encryption (global and per-line settings)	sip srtp mode (global and per-line settings)
Silence Suppression	sip silence suppression

RTP Port

RTP is described in RFC1889. The UDP port used for RTP streams is traditionally an even-numbered port, and the RTCP control is on the next port up. A phone call therefore uses one pair of ports for each media stream.

The RTP port is assigned to the first line on the phone, and is then incremented for each subsequent line available within the phone to provide each line a unique RTP port for its own use.

On the IP phone, the initial port used as the starting point for RTP/RTCP port allocation can be configured using "**RTP Port Base**". The default RTP base port on the IP phones is 3000.

For example, if the RTP base port value is 5000, the first voice patch sends RTP on port 5000 and RTCP on port 5001. Additional calls would then use ports 5002, 5003, etc.

You can configure the RTP port on a global-basis only, using the configuration files, the IP Phone UI, or the Aastra Web UI.

Basic Codecs (G.711 u-Law, G.711 a-Law, G.729)

CODEC is an acronym for **CO**mpress-**DE**compress. It consists of a set of instructions that together implement one or more algorithms. In the case of IP telephony, these algorithms are used to compress the sampled speech data, to decrease the content's file size and bit-rate (the amount of network bandwidth in kilobits per second) required to transfer the audio. With smaller file sizes and lower bit rates, the network equipment can store and stream digital media content over a network more easily.

Aastra IP phones support the International Telecommunications Union (ITU) transmission standards for the following CODECs:

- **Waveform CODECs:** G.711 pulse code modulation (PCM) with a-Law or u-Law companding
- **Parametric CODEC:** G.729a conjugate structure - algebraic code excited linear prediction (CS_ACELP).

All Codecs have a sampling rate of 8,000 samples per second, and operate and operate in the 300 Hz to 3,700 Hz audio range. The following table lists the default settings for bit rate, algorithm, packetization time, and silence suppression for each Codec, based on a minimum packet size.

Default Codec Settings.

CODEC	Bit Rate	Algorithm	Packetization Time	Silence Suppression
G.711 a-law	64 Kb/s	PCM	30 ms	enabled
G.711 u-law	64 Kb/s	PCM	30 ms	enabled
G.729a	8 Kb/s	CS-ACELP	30 ms	enabled

You can enable the IP phones to use a default "basic codec" set, which consists of the set of codecs and packet sizes shown above.

Or you can instead configure a custom set of codecs and attributes instead of using the defaults.



Note: The basic and custom codec parameters apply to all calls, and are configured on a global-basis only using the configuration files or the Aastra Web UI.

Customized Codec Preference List

You can also configure the IP phones to use preferred Codecs. To do this, you must enter the payload value (**payload**), the packetization time in milliseconds (**ptime**), and enable or disable silence suppression (**silsupp**).

Payload is the codec type to be used. This represents the data format carried within the RTP packets to the end user at the destination. You can enter payload values for G.711 a-law, G.711 u-law, and G.729a.

Ptime (packetization time) is a measurement of the duration of PCM data within each RTP packet sent to the destination, and hence defines how much network bandwidth is used for transfer of the RTP stream. You enter the ptime values for the customized Codec list in milliseconds. (See table below).

Silsupp is used to enable or disable silence suppression. Voice Activity Detection (VAD) on the IP phones is used to determine whether each individual packet contains useful speech data. Enabling **silsupp** results in decreased network bandwidth, by avoiding sending RTP packets for any frame where no voice energy was detected by the VAD.

You must enter the values for this feature in list form as shown in the following example:

```
payload=8;ptime=10;silsupp=on,payload=0;ptime=10;silsupp=off
```

The valid values for creating a Codec preference list are as follows.

Customized Codec Settings

Attribute	Value
payload	0 for G.711 u-Law 8 for G.711 a-Law 18 for G.729a
ptime (in milliseconds)	5, 10, 15, 20.....90
silsupp	on off

You can specify a customized Codec preference list on a global-basis using the configuration files or the Aastra Web UI.

Out-of-Band DTMF

The IP phones support out-of-band Dual-Tone Multifrequency (DTMF) mode according to RFC2833. In the Aastra Web UI, you can enable or disable this feature as required. The "out-of-band DTMF" is enabled by default.

In out-of-band mode, the DTMF audio is automatically clamped (muted) and DTMF digits are not sent in the RTP packets.

You can configure out-of-band DTMF on a global-basis using the configuration files or the Aastra Web UI.

DTMF Method

A feature on the IP phone allows you to select the DTMF method that the phone uses to send DTMF digits from the IP phone via INFO messages. You can set the DTMF method as Real-Time Transport Protocol (RTP), SIP info, or both.

You can configure the DTMF method on a global or per-line basis using the configuration files or the Aastra Web UI.

RTP Encryption

The IP Phones include support for Secure Real-time Transfer Protocol (SRTP), using Session Description Protocol Security (SDES) key negotiation, for encryption and authentication of RTP/RTCP messages sent and received by the Aastra IP phones on your network.

As administrator, you specify the global SRTP setting for all lines on the IP phone. You can choose among three levels of SRTP encryption, as follows:

- **SRTP Disabled (default):** IP phone generates and receives nonsecured RTP calls. If the IP phone gets called from SRTP enabled phone, it ignores SRTP tries to answer the call using RTP. If the receiving phone has SRTP only enabled, the call fails; however, if it has SRTP preferred enabled, it will accept RTP call.
- **SRTP Preferred:** IP phone generates RTP secured calls, and accepts both secured and non-secured RTP calls. If the receiving phone is not SRTP enabled, it sends non-secured RTP calls instead.
- **SRTP Only:** IP phone generates and accepts RTP secured calls only; all other calls are rejected (fail).

You can override the global setting as necessary, configuring SRTP support on a per-line basis. This allows IP phone users to have both secured and unsecured lines operating on the same phone.

If an SRTP enabled IP phone initiates a call, and the receiving phone is also SRTP enabled, the IP Phone UI displays a “lock” icon, indicating that the call is secure. If the receiving phone does not support SRTP, the IP phone will send unsecured RTP messages instead of SRTP encrypted messages. However in this case, the IP Phone UI does not display the lock icon - indicating a non-secure call.



Note: If you enable SRTP, then you should also enable Transport Layer Security (TLS). This prevents capture of the key used for SRTP encryption. To enable TLC, set the **Transport Protocol** parameter (located on the Global SIP Settings menu) to **TLS**.

You can configure SRTP on a global or per-line basis using the configuration files or the Aastra Web UI.

Silence Suppression

In IP telephony, silence on a line (lack of voice) uses up bandwidth when sending voice over a packet-switched system. Silence suppression is encoding that starts and stops the times of silence in order to eliminate that wasted bandwidth.

Silence suppression is enabled by default on the IP phones. The phone negotiates whether or not to use silence suppression. Disabling this feature forces the phone to ignore any negotiated value.

You can configure silence suppression on a global-basis using the configuration files or the Aastra Web UI.

Configuring RTP Features

Use the following procedures to configure the RTP features on the IP phone.



Configuration Files

For specific parameters you can set for RTP features in the configuration files, see Appendix A, the section, “RTP, Codec, DTMF Global Settings” on [page A-133](#).



IP Phone UI

Step	Action
1	Press  on the phone to enter the Options List.
2	Select Administrator Menu .
3	Enter your Administrator password. Note: The IP Phones accept numeric passwords only.
4	Select SIP Settings .
5	Select RTP Port Base to change the RTP port base setting. Default is 3000 .
6	Press Done (2 times) to save the change. Note: The session prompts you to restart the IP phone to apply the configuration settings
7	Select Restart .

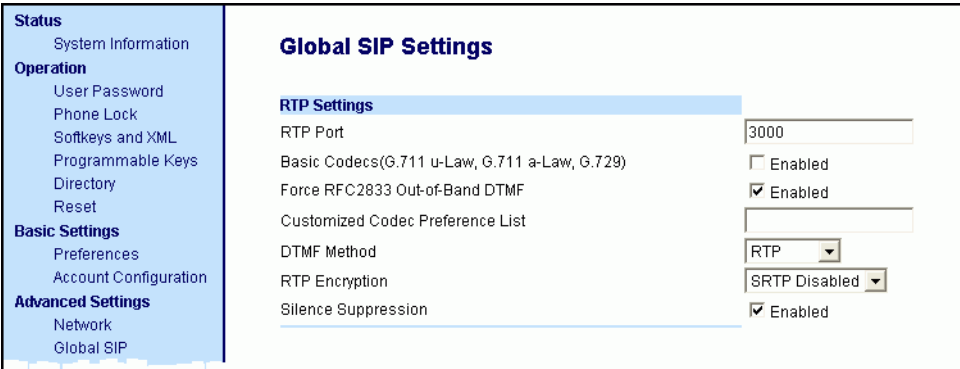
Aastra Web UI	
Step	Action
1	<p>Click on Advanced Settings->Global SIP->RTP Settings. Global Settings.</p> 

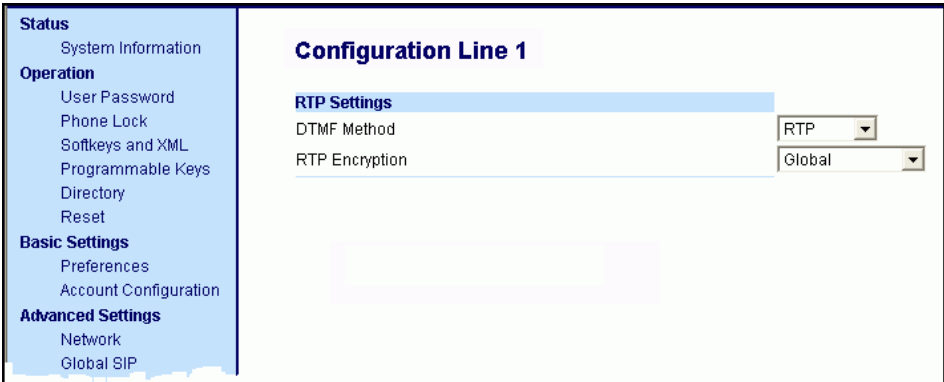
	<p>Click on Advanced Settings->Line <N>->RTP Settings. Per-Line Settings.</p> 
--	---

**Aastra Web UI**

Step	Action								
2	<p>Enter an RTP Port Base in the RTP Port field. Default is 3000.</p> <p>The RTP Port indicates the port through which the RTP packets are sent. This value must specify the beginning of the RTP port range on the gateway or router. The RTP port is used for sending DTMF tones and for the audio stream. Your network administrator may close some ports for security reasons. You may want to use this parameter to send RTP data using a different port.</p> <p>Note: The phones support decoding and playing out DTMF tones sent in SIP INFO requests. The following DTMF tones are supported:</p> <ul style="list-style-type: none"> • Support signals 0-9, #, * • Support durations up to 5 seconds 								
3	<p>Enable the "Basic Codecs (G.711 u-Law, G.711 a-Law, G.729)" field by checking the check box. (Disable this field by unchecking the box. Default is disabled).</p> <p>Enabling this parameter allows the IP phone to use the basic Codecs when sending/receiving RTP packets.</p>								
4	<p>The "Force RFC2833 Out-of-Band DTMF" field is enabled by default. Disable this field by unchecking the box.</p> <p>Enabling this parameter forces the IP phone to use out-of-band DTMF according to RFC2833.</p>								
5	<p>Enter a "Customized Codec Preference List". For example,</p> <pre>payload=8;ptime=10; silsupp=on, payload=0;ptime=10; silsupp=off</pre> <p>Valid values are:</p> <table border="1"> <thead> <tr> <th>Attribute</th> <th>Value</th> </tr> </thead> <tbody> <tr> <td>payload</td> <td>0 for G.711 u-Law 8 for G.711 a-Law 18 for G.729a</td> </tr> <tr> <td>ptime (in milliseconds)</td> <td>5, 10, 15, 20.....90</td> </tr> <tr> <td>silsupp</td> <td>on off</td> </tr> </tbody> </table> <p>For this parameter, you specify a customized codec list which allows you to use the preferred Codecs for this IP phone. Default for the "Customized Codec Preference List" is blank.</p>	Attribute	Value	payload	0 for G.711 u-Law 8 for G.711 a-Law 18 for G.729a	ptime (in milliseconds)	5, 10, 15, 20.....90	silsupp	on off
Attribute	Value								
payload	0 for G.711 u-Law 8 for G.711 a-Law 18 for G.729a								
ptime (in milliseconds)	5, 10, 15, 20.....90								
silsupp	on off								



Aastra Web UI

Step	Action
6	<p>Select a method to use from the “DTMF Method” list box. Valid values are RTP, SIP Info, Both. Default is RTP.</p> <p>Note: You can configure the DTMF Method on a global or per-line basis.</p>
7	<p>Select the type of RTP encryption to use from the “RTP Encryption” list box. Valid values are SRTP Disabled, SRTP Preferred, or SRTP Only. Default is SRTP Disabled.</p> <p>Note: You can configure RTP Encryption on a global or per-line basis.</p>
8	<p>The “Silence Suppression” field is enabled by default. Disable this field by unchecking the check box.</p> <p>When enabled, the phone negotiates whether or not to use silence suppression. Disabling this feature forces the phone to ignore any negotiated value.</p>
9	<p>Click  to save your changes.</p>

RTCP Summary Reports

The IP phones include the capability of enabling/disabling the generation of RTCP summary reports using the SIP vq-rtcpxr event package. These RTCP summary reports include voice quality statistics according to draft-ietf-sipping-rtcp-summary-05 specifications including packet loss, jitter, and delay statistics, as well as call quality scores. When this feature is enabled, an RTCP summary report is sent at the end of each call via a PUBLISH message to the configuration server.

In addition to enabling/disabling the generation of these reports, you must specify the hostname and port of the entity, known as the collector, receiving the reports. Similar to the other IP Phone SIP account parameters, the RTCP summary report parameters can be set on a global or a per-line basis using the configuration files only.

The RTCP summary report parameters are:

- **sip rtcp summary reports**
- **sip LineN rtcp summary reports**
- **sip rtcp summary report collector**
- **sip LineN rtcp summary report collector**
- **sip rtcp summary report collector port**
- **sip LineN rtcp summary report collector port**

Limitations

The following is a limitation when enabling RTCP summary reports on the phone:

- The call must be at least 5 seconds long in order to generate the RTCP extended reports.

Configuring RTCP Summary Reports

Use the following procedure to configure RTCP summary reports.



Configuration Files

For specific parameters you can set in the configuration files, see Appendix A, the section, "[RTCP Summary Reports](#)" on [page A-47](#).

Autodial Settings

The IP phones include a feature called “Autodial”. When you configure Autodial on an IP phone, the phone automatically dials a preconfigured number whenever it is off-hook. Depending on the configuration you specify, the Autodial functions as either a “**hotline**”, or as a “**warmline**,” as follows:

- **Hotline (default):** The IP phone immediately dials a preconfigured number when you lift the handset.
- **Warmline:** The IP phone waits for a specified amount of time after you lift the handset before dialing a preconfigured number. If you do not dial a number within the time allotted, then the IP phone begins to dial the number.

By default, the Autodial feature functions as a hotline. If you want Autodial to function as a warmline, you can use the Autodial “time-out” parameter to specify the length of time (in seconds) the IP phone waits before dialing a preconfigured number.

As administrator, you configure Autodial globally, or on a per-line basis, for an IP phone. The line setting overrides the global setting. For example, you can disable Autodial on a specific line simply by setting the line’s autodial number parameter to empty (blank).



Note: IMPORTANT INFORMATION before configuring Autodial on your IP phone:

- Any speeddial numbers that you configure on an IP phone are not affected by autodial settings.
 - If you configure autodial on your IP phone, any lines that function as hotlines do not accept conference calls, transferred calls, and/or intercom calls.
-

Configuring AutoDial Using the Configuration Files

You use the following parameters to configure Autodial using the configuration files:

Global Configuration

- `sip autodial number`
- `sip autodial timeout`

Per-Line Configuration

- `sip lineN autodial number`
- `sip lineN autodial timeout`



Configuration Files

For specific parameters you can set in the configuration files, see Appendix A, the section, "[Autodial Settings](#)" on [page A-138](#).

Configuring Autodial Using the Aastra Web UI

Use the following procedure to configure Autodial using the Aastra Web UI.

By default, your IP phone uses the global settings you specify for Autodial for all lines on your IP phone. However, you can also configure Autodial on a per-line basis.

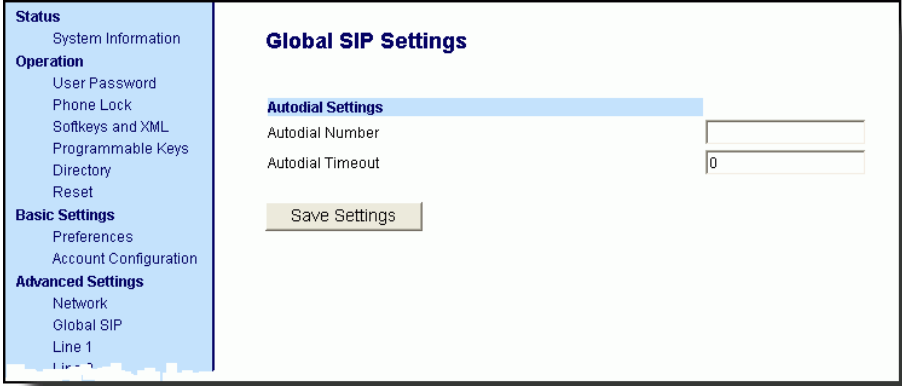
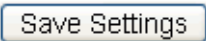
 Aastra Web UI	
Global Configuration	
1	<p>Click on Advanced Settings->Global SIP->Autodial Settings.</p> 
2	<p>In the “Autodial Number” field, specify the SIP number that the IP phone dials whenever the IP phone is off-hook. An empty (blank) value disables autodial on the phone.</p> <p>For example: 8500</p>
3	<p>In the “Autodial Timeout” field, specify a value, in seconds, for the timer as follows:</p> <ul style="list-style-type: none"> • If you want the IP phone to autodial the number immediately (hotline) whenever the IP phone is off-hook, accept the default value of 0. • If you want to specify a length of time for the IP phone to wait before dialing the number, enter the length of time (in seconds). For example: 30 <p>Valid values are 0 to 120.</p>
4	<p>Click  to save your changes.</p>

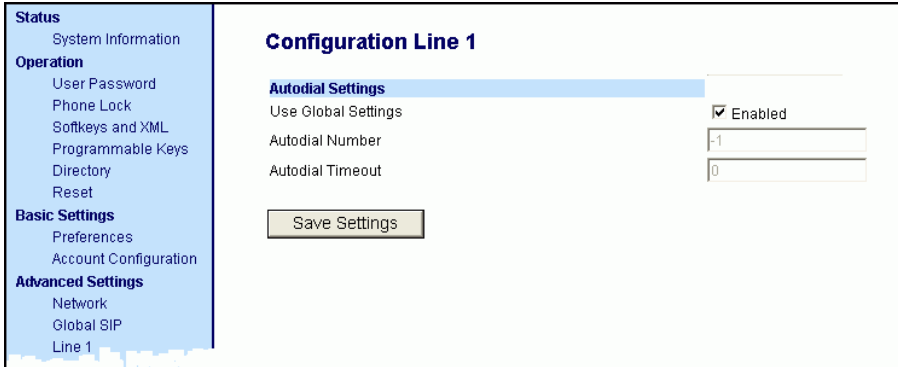
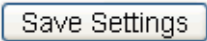
Aastra Web UI	
Per-Line Configuration	
1	<p>Click on Advanced Settings->Line <1 - 9>->Autodial Settings.</p> 
2	<p>Do one of the following actions:</p> <ul style="list-style-type: none">• To allow this line to use the global autodial settings, click on the Use Global Settings parameter to enable it, then click  to save your changes.• To specify a different autodial configuration for this specific line, disable the Use Global Settings parameter. Then proceed to step 3.
3	<p>In the “Autodial Number” field, specify the SIP number for this line that the IP phone dials whenever the IP phone is off-hook as follows:</p> <ul style="list-style-type: none">• If set to -1, then the global autodial settings for this IP phone to this line.• If set to empty (blank), then disable Autodial on this line.• If set to a valid SIP number, dial the SIP number specified for this line. For example: 8500

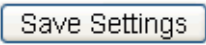

Aastra Web UI

4	<p>In the “Autodial Timeout” field, specify a value, in seconds, for the timer for this line as follows:</p> <ul style="list-style-type: none">• If you want the IP phone to autodial the number immediately (hotline) whenever the IP phone is off-hook, accept the default value of 0.• If you want to specify a length of time for the IP phone to wait before dialing the number, enter the length of time (in seconds). For example: 30 <p>Valid values are 0 to 120.</p>
5	<p>Click  to save your changes.</p>

Configuration Server Protocol

You can download new versions of firmware and configuration files from the configuration server to the IP phone using any of the following types of protocols: TFTP, FTP, HTTP, and HTTPS. For each Protocol, you can specify the path for which the configuration files are located on the server. For HTTP and HTTPS, you can also specify the port number to use for downloading the phone configuration. For FTP, you can configure a Username and Password that are authenticated by the FTP server.

The TFTP setting is the default download protocol. You can configure the type of protocol that the IP phones use by setting it in the configuration files, the IP phone UI, or the Aastra Web UI.



Note: For DHCP to automatically populate the IP address or domain name for the TFTP, FTP, HTTP, or HTTPS server, your DHCP server must support download protocol according to RFC2131 and RFC1541 for Option 66. For more information, see this chapter, the section, “[DHCP](#)” on [page 4-4](#).



Configuring the Configuration Server Protocol

Use the following procedure to configure the configuration server protocol.



Configuration Files

For specific parameters you can set in the configuration files, see Appendix A, the section, “[Configuration Server Settings](#)” on [page A-18](#).

 IP Phone UI	
Step	Action
1	Press  on the phone to enter the Options List.
2	Select Administrator Menu .
3	Enter your Administrator password. Note: The IP Phones accept numeric passwords only.
4	Select Configuration Server .
5	Select Download Protocol .
6	<p>Select from the following:</p> <ul style="list-style-type: none"> • Use TFTP • Use FTP • Use HTTP • Use HTTPS <p>Default is “Use TFTP”.</p> <p>The IP phone uses the protocol you select to download new firmware and configuration files from the configuration server.</p>
7	Press Done (8 and 11-Line LCD phones) or Set (3-Line LCD phones) to save the changes.
8	<p>From the Configuration Server menu, select from the following. This selection is dependent on the Download Protocol you selected in step 6.</p> <p>TFTP Settings FTP Settings HTTP Settings HTTPS Settings</p>

 IP Phone UI					
Step	Action				
9	<p>Enter the IP address of the protocol server (in dotted decimal format). Use the following table to configure the applicable server.</p> <table border="1" style="width: 100%; border-collapse: collapse;"> <thead> <tr> <th style="background-color: #ADD8E6;">TFTP Settings</th> </tr> </thead> <tbody> <tr> <td> <ul style="list-style-type: none"> - Select Primary TFTP - Enter the IP address or fully qualified domain name of the primary TFTP server. - Press Done or Set to save the change. - Select Pri TFTP Path. - Enter the path name for which the configuration files reside on the TFTP server for downloading to the IP Phone. If the IP phone's files are located in a sub-directory beneath the server's root directory, the relative path to that sub-directory should be entered in this field. Enter the path name in the form <i>folderXfolderXfolderX</i>. For example, <i>ipphone6757i\configfiles</i>. <p>Optional: You can also configure an Alternate TFTP server and Alternate TFTP Path if required by selecting the "Alternate TFTP" and the "Alt TFTP Path" parameters.</p> <ul style="list-style-type: none"> - From the TFTP Settings menu, select Alternate TFTP and press Enter. - Enter the IP address or fully qualified domain name of the alternate TFTP server. - Press Done or Set to save the change. - Select Alt TFTP Path. - Enter the path name for which the configuration files reside on the Alternate TFTP server for downloading to the IP Phone. If the IP phone's files are located in a sub-directory beneath the server's root directory, the relative path to that sub-directory should be entered in this field. Enter the path name in the form <i>folderXfolderXfolderX</i>. For example, <i>ipphone6757i\configfiles</i>. </td> </tr> <tr> <th style="background-color: #ADD8E6;">FTP Settings</th> </tr> <tr> <td> <ul style="list-style-type: none"> - Select FTP Server. - Enter the IP address or fully qualified domain name of the FTP server. - Press Done or Set to save the change. - Select FTP Path. - Enter the path name for which the configuration files reside on the FTP server for downloading to the IP Phone. If the IP phone's files are located in a sub-directory beneath the server's root directory, the relative path to that sub-directory should be entered in this field. Enter the path name in the form <i>folderXfolderXfolderX</i>. For example, <i>ipphone6757i\configfiles</i>. <p>Optional: You can enter a username and password for accessing the FTP server if required:</p> <ul style="list-style-type: none"> - Select FTP Username. - Enter a username for accessing the FTP server. - Press Done. - Select FTP Password. - Enter a password for accessing the FTP server. - Press Done or Set. </td> </tr> </tbody> </table>	TFTP Settings	<ul style="list-style-type: none"> - Select Primary TFTP - Enter the IP address or fully qualified domain name of the primary TFTP server. - Press Done or Set to save the change. - Select Pri TFTP Path. - Enter the path name for which the configuration files reside on the TFTP server for downloading to the IP Phone. If the IP phone's files are located in a sub-directory beneath the server's root directory, the relative path to that sub-directory should be entered in this field. Enter the path name in the form <i>folderXfolderXfolderX</i>. For example, <i>ipphone6757i\configfiles</i>. <p>Optional: You can also configure an Alternate TFTP server and Alternate TFTP Path if required by selecting the "Alternate TFTP" and the "Alt TFTP Path" parameters.</p> <ul style="list-style-type: none"> - From the TFTP Settings menu, select Alternate TFTP and press Enter. - Enter the IP address or fully qualified domain name of the alternate TFTP server. - Press Done or Set to save the change. - Select Alt TFTP Path. - Enter the path name for which the configuration files reside on the Alternate TFTP server for downloading to the IP Phone. If the IP phone's files are located in a sub-directory beneath the server's root directory, the relative path to that sub-directory should be entered in this field. Enter the path name in the form <i>folderXfolderXfolderX</i>. For example, <i>ipphone6757i\configfiles</i>. 	FTP Settings	<ul style="list-style-type: none"> - Select FTP Server. - Enter the IP address or fully qualified domain name of the FTP server. - Press Done or Set to save the change. - Select FTP Path. - Enter the path name for which the configuration files reside on the FTP server for downloading to the IP Phone. If the IP phone's files are located in a sub-directory beneath the server's root directory, the relative path to that sub-directory should be entered in this field. Enter the path name in the form <i>folderXfolderXfolderX</i>. For example, <i>ipphone6757i\configfiles</i>. <p>Optional: You can enter a username and password for accessing the FTP server if required:</p> <ul style="list-style-type: none"> - Select FTP Username. - Enter a username for accessing the FTP server. - Press Done. - Select FTP Password. - Enter a password for accessing the FTP server. - Press Done or Set.
TFTP Settings					
<ul style="list-style-type: none"> - Select Primary TFTP - Enter the IP address or fully qualified domain name of the primary TFTP server. - Press Done or Set to save the change. - Select Pri TFTP Path. - Enter the path name for which the configuration files reside on the TFTP server for downloading to the IP Phone. If the IP phone's files are located in a sub-directory beneath the server's root directory, the relative path to that sub-directory should be entered in this field. Enter the path name in the form <i>folderXfolderXfolderX</i>. For example, <i>ipphone6757i\configfiles</i>. <p>Optional: You can also configure an Alternate TFTP server and Alternate TFTP Path if required by selecting the "Alternate TFTP" and the "Alt TFTP Path" parameters.</p> <ul style="list-style-type: none"> - From the TFTP Settings menu, select Alternate TFTP and press Enter. - Enter the IP address or fully qualified domain name of the alternate TFTP server. - Press Done or Set to save the change. - Select Alt TFTP Path. - Enter the path name for which the configuration files reside on the Alternate TFTP server for downloading to the IP Phone. If the IP phone's files are located in a sub-directory beneath the server's root directory, the relative path to that sub-directory should be entered in this field. Enter the path name in the form <i>folderXfolderXfolderX</i>. For example, <i>ipphone6757i\configfiles</i>. 					
FTP Settings					
<ul style="list-style-type: none"> - Select FTP Server. - Enter the IP address or fully qualified domain name of the FTP server. - Press Done or Set to save the change. - Select FTP Path. - Enter the path name for which the configuration files reside on the FTP server for downloading to the IP Phone. If the IP phone's files are located in a sub-directory beneath the server's root directory, the relative path to that sub-directory should be entered in this field. Enter the path name in the form <i>folderXfolderXfolderX</i>. For example, <i>ipphone6757i\configfiles</i>. <p>Optional: You can enter a username and password for accessing the FTP server if required:</p> <ul style="list-style-type: none"> - Select FTP Username. - Enter a username for accessing the FTP server. - Press Done. - Select FTP Password. - Enter a password for accessing the FTP server. - Press Done or Set. 					



IP Phone UI

Step	Action
<p>9 (Cont'd)</p>	<div data-bbox="258 378 1253 418" style="border: 1px solid black; background-color: #e6f2ff; padding: 2px;">HTTP Settings</div> <ul style="list-style-type: none"> - Select HTTP Server - Enter the IP address of the HTTP server. - Press Done or Set. - Select HTTP Path. - Enter the path name for which the configuration files reside on the HTTP server for downloading to the IP Phone. If the IP phone's files are located in a sub-directory beneath the server's root directory, the relative path to that sub-directory should be entered in this field. Enter the path name in the form <i>folderX\folderX\folderX</i>. For example, <i>ipphone67571\configfiles</i>. - Select HTTP Port. - Enter the HTTP port that the server uses to load the configuration to the phone over HTTP. Default is 80. - Press Done or Set. <div data-bbox="258 777 1253 817" style="border: 1px solid black; background-color: #e6f2ff; padding: 2px;">HTTPS Settings</div> <ul style="list-style-type: none"> - Select HTTP Client. - Select Download Server. - Enter the IP address of the HTTPS server. - Press Done or Set. - Select Download Path. - Enter the path name for which the configuration files reside on the HTTPS server for downloading to the IP Phone. If the IP phone's files are located in a sub-directory beneath the server's root directory, the relative path to that sub-directory should be entered in this field. Enter the path name in the form <i>folderX\folderX\folderX</i>. For example, <i>ipphone67571\configfiles</i>. - Press Done or Set. - Select Client Method. - Select the client method to use for downloading the configuration files (SSI 3.0 or TLS 1.0). For more information about which client method to use, see the section, "HTTPS Client/Server Configuration" on page 4-40. - Select Download Port. - Enter the HTTPS port that the server uses to load the configuration to the phone over HTTPS. Default is 443.

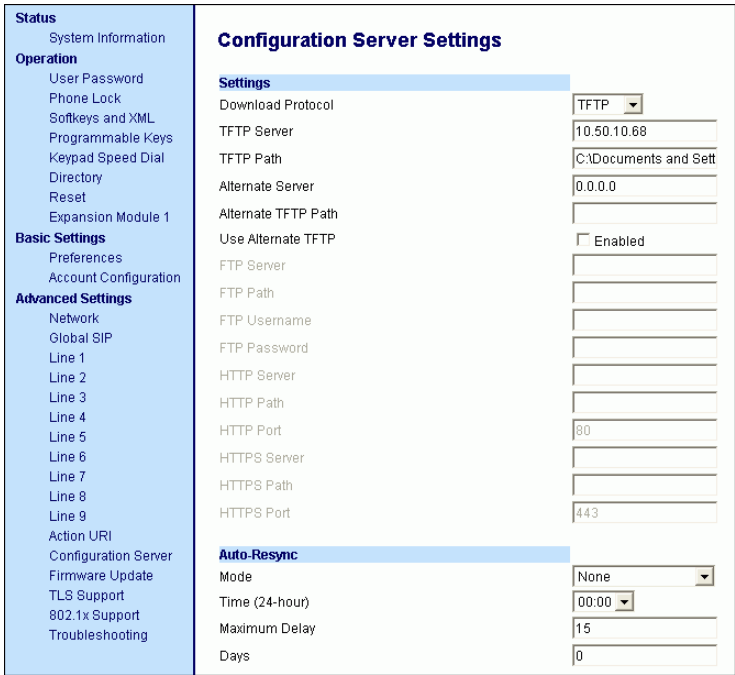

 IP Phone UI	
Step	Action
9 (Cont'd)	<div style="border: 1px solid black; padding: 5px;"> <p>HTTPS Settings (Continued)</p> <ul style="list-style-type: none"> - Select HTTPS Server. - Select HTTP->HTTPS. - For 3-Line LCD Displays:: Press Change to select "Do not redirect" or "Redirect". Default is "Do not redirect". Enabling this feature redirects the HTTP protocol to HTTPS. Press Set. - For 8 and 11-Line LCD Displays:: Press Change to select "Yes" and redirect HTTP to HTTPS. Select "No" to not direct HTTPS to HTTPS, Default is "No". Enabling this feature redirects the HTTP protocol to HTTPS. Press Done. - Select XML HTTP POSTs. - For 3-Line LCD Displays:: Press Change to select "Do not block" or "Block". Enabling this feature blocks XML HTTP POSTs from the IP Phone. - For 8 and 11-Line LCD Displays:: Press Change to select "Yes" and block XML HTTP Posts. Select "No" to unblock XML HTTP Posts. Default is "No". Enabling this feature blocks XML HTTP POSTs from the IP Phone. </div> <p>Reference For more information on configuring the HTTPS security method, HTTP to HTTPS redirect, and HTTPS server blocking for HTTP XML POSTs, see the section, "HTTPS Client/Server Configuration" on page 4-40.</p>
10	Press Done or Set repeatedly until the session prompts you to restart the IP phone to apply the configuration settings.
11	Select Restart .

 Aastra Web UI	
Step	Action
1	<p>Click on Advanced Settings->Configuration Server.</p> <div data-bbox="325 418 1053 1095" data-label="Form">  </div>



Aastra Web UI

Step	Action				
2	<p>Select the protocol from the "Download Protocol" list box. Valid values are TFTP, FTP, HTTP, and HTTPS. Default is TFTP.</p> <p>The IP phone uses the protocol you select to download new firmware and configuration files from the configuration server. Use the following table to configure the applicable server.</p> <table border="1" data-bbox="229 494 1233 1209"> <thead> <tr> <th data-bbox="229 494 1233 534">TFTP</th> </tr> </thead> <tbody> <tr> <td data-bbox="229 534 1233 824"> <ul style="list-style-type: none"> - Enter an IP address or fully qualified domain name in the "TFTP Server" field. - Enter the path name in the "TFTP Path" field for which the configuration files reside on the TFTP server for downloading to the IP Phone. If the IP phone's files are located in a sub-directory beneath the server's root directory, the relative path to that sub-directory should be entered in this field. Enter the path name in the form <i>folderX\folderX\folderX</i>. For example, <i>ipphone67571\configfiles</i>. <p>Optional: You can also configure an alternate TFTP server if required. If "Use Alternate TFTP" is enabled, you must also enter an IP address or qualified domain name for the alternate server in the "Alternate TFTP" field. You can also enter a path name for the alternate TFTP server in the "Alternate TFTP Path" field.</p> </td> </tr> <tr> <th data-bbox="229 824 1233 864">FTP</th> </tr> <tr> <td data-bbox="229 864 1233 1209"> <ul style="list-style-type: none"> - Enter an IP address or fully qualified domain name in the "FTP Server" field. - Enter the path name in the "FTP Path" field for which the configuration files reside on the FTP server for downloading to the IP Phone. If the IP phone's files are located in a sub-directory beneath the server's root directory, the relative path to that sub-directory should be entered in this field. Enter the path name in the form <i>folderX\folderX\folderX</i>. For example, <i>ipphone67571\configfiles</i>. <p>Optional: You can enter a username and password for accessing the FTP server if required.</p> <ul style="list-style-type: none"> - Enter a username for a user that will access the FTP server in the "FTP User Name" field. - Enter a password for a user that allows access to the FTP server in the "FTP Password" field. </td> </tr> </tbody> </table>	TFTP	<ul style="list-style-type: none"> - Enter an IP address or fully qualified domain name in the "TFTP Server" field. - Enter the path name in the "TFTP Path" field for which the configuration files reside on the TFTP server for downloading to the IP Phone. If the IP phone's files are located in a sub-directory beneath the server's root directory, the relative path to that sub-directory should be entered in this field. Enter the path name in the form <i>folderX\folderX\folderX</i>. For example, <i>ipphone67571\configfiles</i>. <p>Optional: You can also configure an alternate TFTP server if required. If "Use Alternate TFTP" is enabled, you must also enter an IP address or qualified domain name for the alternate server in the "Alternate TFTP" field. You can also enter a path name for the alternate TFTP server in the "Alternate TFTP Path" field.</p>	FTP	<ul style="list-style-type: none"> - Enter an IP address or fully qualified domain name in the "FTP Server" field. - Enter the path name in the "FTP Path" field for which the configuration files reside on the FTP server for downloading to the IP Phone. If the IP phone's files are located in a sub-directory beneath the server's root directory, the relative path to that sub-directory should be entered in this field. Enter the path name in the form <i>folderX\folderX\folderX</i>. For example, <i>ipphone67571\configfiles</i>. <p>Optional: You can enter a username and password for accessing the FTP server if required.</p> <ul style="list-style-type: none"> - Enter a username for a user that will access the FTP server in the "FTP User Name" field. - Enter a password for a user that allows access to the FTP server in the "FTP Password" field.
TFTP					
<ul style="list-style-type: none"> - Enter an IP address or fully qualified domain name in the "TFTP Server" field. - Enter the path name in the "TFTP Path" field for which the configuration files reside on the TFTP server for downloading to the IP Phone. If the IP phone's files are located in a sub-directory beneath the server's root directory, the relative path to that sub-directory should be entered in this field. Enter the path name in the form <i>folderX\folderX\folderX</i>. For example, <i>ipphone67571\configfiles</i>. <p>Optional: You can also configure an alternate TFTP server if required. If "Use Alternate TFTP" is enabled, you must also enter an IP address or qualified domain name for the alternate server in the "Alternate TFTP" field. You can also enter a path name for the alternate TFTP server in the "Alternate TFTP Path" field.</p>					
FTP					
<ul style="list-style-type: none"> - Enter an IP address or fully qualified domain name in the "FTP Server" field. - Enter the path name in the "FTP Path" field for which the configuration files reside on the FTP server for downloading to the IP Phone. If the IP phone's files are located in a sub-directory beneath the server's root directory, the relative path to that sub-directory should be entered in this field. Enter the path name in the form <i>folderX\folderX\folderX</i>. For example, <i>ipphone67571\configfiles</i>. <p>Optional: You can enter a username and password for accessing the FTP server if required.</p> <ul style="list-style-type: none"> - Enter a username for a user that will access the FTP server in the "FTP User Name" field. - Enter a password for a user that allows access to the FTP server in the "FTP Password" field. 					

 Aastra Web UI	
Step	Action
3	<div style="border: 1px solid black; padding: 5px;"> <p>HTTP</p> <ul style="list-style-type: none"> - Enter an IP address or fully qualified domain name in the "HTTP Server" field. - Enter the path name in the "HTTP Path" field for which the configuration files reside on the HTTP server for downloading to the IP Phone. If the IP phone's files are located in a sub-directory beneath the server's root directory, the relative path to that sub-directory should be entered in this field. Enter the path name in the form <i>folderX\folderX\folderX</i>. For example, <i>ipphone6757\configfiles</i>. - Enter the HTTP port number in the "HTTP Port" field that the server uses to load the configuration to the phone over HTTP. <p>Optional: You can enter a list of users to be authenticated when they access the HTTP server in the "XML Push Server List (Approved IP Addresses)" field.</p> <hr/> <p>HTTPS</p> <ul style="list-style-type: none"> - Enter an IP address or fully qualified domain name in the "HTTPS Server" field. - Enter the path name in the "HTTPS Path" field for which the configuration files reside on the HTTP server for downloading to the IP Phone. If the IP phone's files are located in a sub-directory beneath the server's root directory, the relative path to that sub-directory should be entered in this field. Enter the path name in the form <i>folderX\folderX\folderX</i>. For example, <i>ipphone6757\configfiles</i>. - Enter the HTTPS port number in the "HTTPS Port" field that the server uses to load the configuration to the phone over HTTPS. <p>Optional: You can enter a list of users to be authenticated when they access the HTTP server in the "XML Push Server List (Approved IP Addresses)" field.</p> </div> <p>Reference: For more information on configuring the HTTPS security method, HTTP to HTTPS redirect, and HTTPS server blocking for HTTP XML POSTs, see the section, "HTTPS Client/Server Configuration" on page 4-40.</p>
4	<p>Click  to save your settings.</p> <p>Note: The session prompts you to restart the IP phone to apply the configuration settings.</p>
5	<p>Select Operation->Reset and click .</p>

Chapter 5

Configuring Operational Features

About this chapter

Introduction

The IP phones have specific operational features you can configure to customize your IP phone. This chapter describes each feature and provides procedures for configuring your phone to use these features.

Topics

This chapter covers the following topics:

Topic	Page
Operational Features	page 5-5
User Passwords	page 5-5
Administrator Passwords	page 5-9
Locking/Unlocking the Phone	page 5-10
Defining an Emergency Dial Plan	page 5-16
Time and Date	page 5-19
Time Zone & DST	page 5-20
Time Servers	page 5-27
Backlight Mode (6755i, 6757i, and 6757i CT only)	page 5-30
Live Dial Pad*	page 5-33
Language	page 5-34
Locking IP Phone Keys	page 5-49

About this chapter

Topic	Page
Locking/Unlocking the SAVE and DELETE keys (6753i)	page 5-50
Local Dial Plan	page 5-53
Park Calls/Pick Up Parked Calls	page 5-59
Suppressing DTMF Playback	page 5-63
Display DTMF Digits	page 5-65
Call Waiting/Call Waiting Tone	page 5-67
Stuttered Dial Tone	page 5-70
XML Beep Support	page 5-72
Status Scroll Delay	page 5-74
Incoming Call Interrupts Dialing	page 5-76
Switch Focus to Ringing Line	page 5-79
Preferred Line and Preferred Line Timeout	page 5-81
Goodbye Key Cancels Incoming Call	page 5-85
UPnP Mapping Lines (for remote phones)	page 5-88
Message Waiting Indicator Line	page 5-90
DND Key Mode	page 5-92
Call Forward Mode	page 5-94
Link Layer Discovery Protocol for Media Endpoint Devices (LLDP-MED) and Emergency Location Identification Number (ELIN)	page 5-98
Incoming/Outgoing Intercom with Auto-Answer and Barge In	page 5-103
Group Paging RTP Settings	page 5-108
Key Mapping	page 5-114
Ring Tones and Tone Sets	page 5-118
Priority Alerting	page 5-123
Directed Call Pickup (BLF or XML Call Interception)	page 5-130
Softkeys/Programmable Keys/Feature Keys/Expansion Module Keys	page 5-142
Customizing the Key Type List in the Aastra Web UI	page 5-163
Speedial Prefixes	page 5-166
Enabling/Disabling Ability to Add or Edit a Speedial Key	page 5-167
Busy Lamp Field (BLF)	page 5-168
BLF Subscription Period	page 5-174

Topic	Page
BLF/Xfer and Speeddial/Xfer Keys	page 5-176
Speeddial/Conference Key (not applicable to the 6751i)	page 5-182
Automatic Call Distribution (ACD) (for Sylanro Servers)	page 5-186
ACD Subscription Period	page 5-196
BLA Subscription Period	page 5-198
Directed Call Pickup/Group Call Pickup (for Sylanro Servers)	page 5-200
Do Not Disturb (DND)	page 5-207
Bridged Line Appearance (BLA)	page 5-218
BLA Support for Third Party Registration	page 5-225
P-Preferred Identity Header for BLA Accounts	page 5-226
BLA Support for Message Waiting Indicator (MWI)	page 5-227
Shared Call Appearance (SCA) Call Bridging	page 5-230
Park/Pick Up Key (not applicable to the 6751i)	page 5-234
Last Call Return (lcr) (Sylanro Servers)	page 5-245
Call Forwarding	page 5-249
SIP Phone Diversion Display	page 5-288
Displaying Call Destination for Incoming Calls	page 5-290
Callers List	page 5-293
Customizable Callers List and Services Keys	page 5-299
Missed Calls Indicator	page 5-300
Directory List	page 5-302
Voicemail (not applicable to 6751i)	page 5-313
XML Customized Services	page 5-316
Creating Customized XML Services on the IP Phones	page 5-316
Configuring the Phone to use XML	page 5-322
XML Get Timeout	page 5-322
Configuring for XML on the IP Phone	page 5-323
Using the XML Customized Service	page 5-328
XML Action URIs	page 5-330
Polling Action URIs	page 5-339
Action URI Disconnected	page 5-341

About this chapter

Topic	Page
XML SIP Notify Events	page 5-344
XML Softkey URI	page 5-350
XML Key Redirection	page 5-356
Options Key Redirection (for Options Menu on all phones and Services Menu on 6751i)	page 5-357
XML Applications and Off-Hook Interaction	page 5-359
XML URI for Key Press Simulation	page 5-359
XML Override for a Locked Phone	page 5-360
Audio Transmit and Receive Gain Adjustments	page 5-361
Centralized Conferencing (for Sylanro and Broadsoft Servers)	page 5-363
"SIP Join" Feature for 3-Way Conference (not applicable to the 6751i)	page 5-367
Conference Ends and Transfers Remaining Parties	page 5-368
Transferring Two Existing Calls	page 5-369
Authentication Support for HTTP/HTTPS Download Methods, used with Broadsoft Client Management System (CMS)	page 5-370
Customizing the Display Columns on the M675i Expansion Module	page 5-373

Operational Features

Description

This section describes the operational features managed and configured by a System Administrator.

User Passwords

A user or an administrator can change the user passwords on the phone using the configuration files, the IP phone UI, or the Aastra Web UI.

Use the following procedures to change the user password.



Note: The IP phones support numeric characters only in passwords. If you enter a password with alpha characters, the phone uses the default password instead.

Configuring a User Password





Configuration Files



For specific parameters you can set in the configuration files, see Appendix A, the section, “[Password Settings](#)” on [page A-15](#).

IP Phone UI

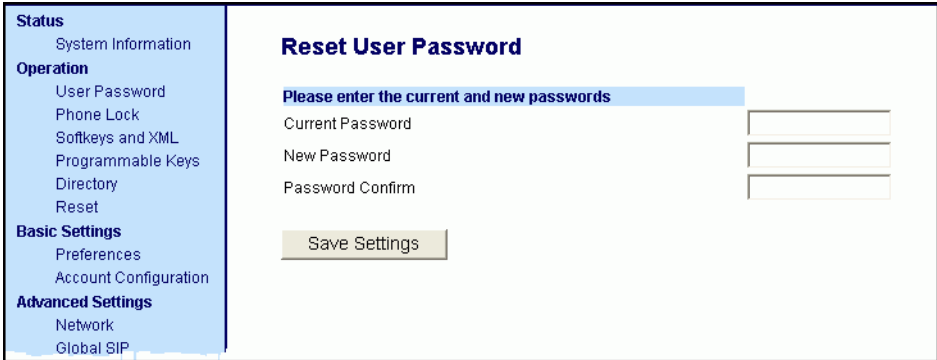

- | | |
|---|---|
| 1 | Press  on the phone to enter the Options List. |
| 2 | Select User Password . |
| 3 | Enter the current user password. |
| 4 | Press Enter . |

 IP Phone UI	
5	Enter the new user password. Note: The IP phones support numeric characters only in passwords. If you enter a password with alpha characters, the phone uses the default password instead.
6	Press Enter .
7	Re-enter the new user password.
8	Press Enter . A message, "Password Changed" displays on the screen.

 Aastra Web UI	
1	Click on Operation->User Password . 
2	In the " Current Password " field, enter the current user password.
3	In the " New Password " field, enter the new user password. Note: The IP phones support numeric characters only in passwords. If you enter a password with alpha characters, the phone uses the default password instead.
4	In the " Password Confirm " field, enter the new user password again.
5	Click  to save your changes.

Resetting a User Password

If a user forgets his password, either the user or an administrator can reset it so a new password can be entered. The reset user password feature resets the password to the factory default which is blank (no password).

You can reset a user password using the Aastra Web UI only at the path *Operation->Phone Lock*. Use the following procedure to reset a user password.

Aastra Web UI

1 Click on **Operation->Phone Lock**.

Status
System Information

Operation
User Password
Phone Lock
Softkeys and XML
Programmable Keys
Directory
Reset

Basic Settings
Preferences
Account Configuration

Advanced Settings
Network
Global SIP



Phone Lock

Lock or unlock the phone

Emergency Dial Plan

Lock the phone?

Reset User Password

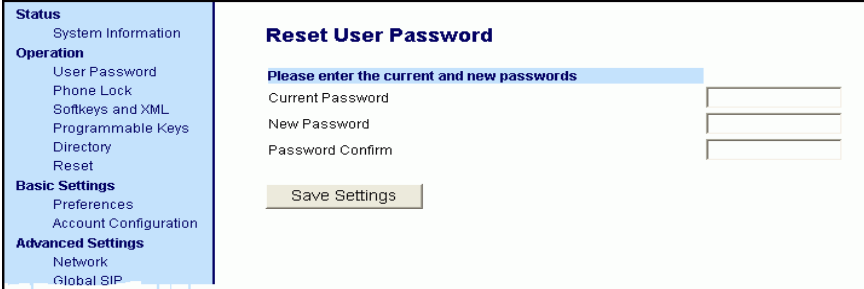
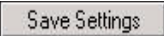
 Aastra Web UI	
2	<p>In the “Reset User Password” field, click  .</p> <p>The following screen displays:</p> 
3	<p>In the “Current Password” field, leave this blank.</p>
4	<p>In the “New Password” field, enter a new password for the user.</p> <p>Note: The IP phones support numeric characters only in passwords. If you enter a password with alpha characters, the phone uses the default password instead.</p>
5	<p>In the “Password Confirm” field, re-enter the new user password.</p>
6	<p>Click  to save the new user password and perform the next procedure.</p>

Administrator Passwords

An administrator can change the administrator passwords on the phone using the configuration files only.

An administrator can also assign a password for using the Options key on the IP phone. You turn this feature on and off by entering the "**options password enabled**" parameter followed by a valid value in the configuration files. Valid values are **0** (false; Options key not password protected), or **1** (true; Options key password protected). If this parameter is set to 1, a user has to enter a password at the IP phone UI. If the password is entered correctly, the user is allowed to gain access to the Options Menu and no more password prompts display for other password protected screens. If the user fails to enter the correct password in three attempts, access to the Options Menu is denied and the IP phone returns to the idle screen.

Procedure

Use the following procedure to change the administrator password.



Configuration Files

For specific parameters you can set in the configuration files, see Appendix A, the section, "[Password Settings](#)" on [page A-15](#).

Locking/Unlocking the Phone

A user or administrator can lock a phone to prevent it from being used or configured. Once the phone is locked, the user or administrator can enter their password to unlock the phone.

You can lock/unlock a phone using the configuration files, the IP Phone UI, or the Aastra Web UI.

You can use any of the following methods to lock/unlock a phone:



- Using the IP Phone UI via the “Phone Lock” option in the Options Menu.
- Using the Aastra Web UI via the path *Operation->Phone Lock*.
- Using the configuration files to configure a key as “phonelock”, and then pressing the key to lock/unlock the phone.
- Using the Aastra Web UI to configure a key as “Phone Lock”, and then pressing the key to lock/unlock the phone.



Note: All of the methods above configure locking/unlocking of the phone dynamically. Once configured, the feature takes affect immediately. To unlock the phone, a user or administrator must enter their password.

Locking/Unlocking the Phone Using the IP Phone UI

Use the following IP Phone UI procedure to lock/unlock an IP phone and prevent it from being used or configured.

 IP Phone UI	
Step	Action
<i>Lock the phone:</i>	
1	Press  on the phone to enter the Options List.
2	Select Phone Lock . The prompt, " <i>Lock the phone?</i> " displays.
3	Press Lock to lock the phone.
<i>Unlock the phone:</i>	
1	Press  on the phone to enter the Options List. The prompt, " <i>To unlock the phone...Password:</i> "
2	Enter the user or administrator password and press Enter . The phone unlocks.

Locking/Unlocking the Phone Using the Aastra Web UI

Use the following Aastra Web UI procedure to lock/unlock an IP phone and prevent it from being used or configured.

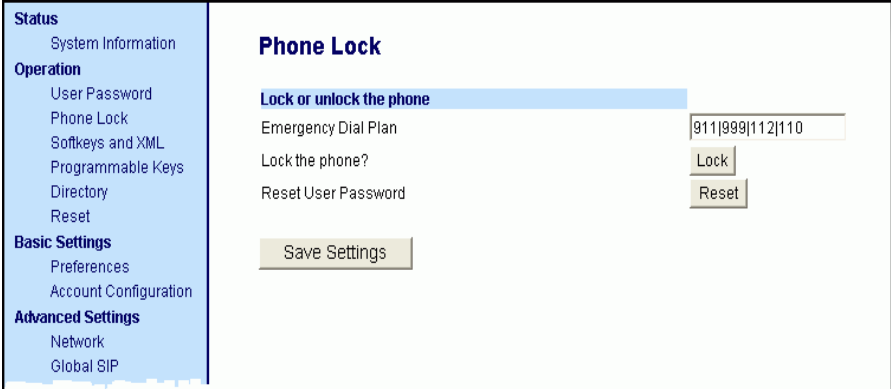
Aastra Web UI	
1	<p>Click on Operation->Phone Lock.</p> 
Lock the phone:	
2	<p>In the “Lock the Phone?” field, click <input type="button" value="Lock"/> .</p> <p>The phone locks dynamically and displays the following message: “<i>Phone is locked</i>”.</p>
Unlock the phone:	
3	<p>Click on Operation->Phone Lock.</p>
4	<p>In the “Unlock the Phone?” field, click <input type="button" value="Unlock"/> .</p> <p>The phone unlocks dynamically and displays the following message: “<i>Phone is unlocked</i>”.</p>

Configuring a Lock/Unlock Key Using the Configuration Files

Using the configuration files, you can configure a key on the phone (softkey, programmable key, or expansion module key) to use as a lock/unlock key. In the configuration files, you assign the function of the key as “**phonelock**”.

Use the following procedure to configure a key as a lock/unlock key using the configuration files.



Configuration Files

To configure a softkey/programmable key as a lock/unlock key using the configuration files, see Appendix A, the section, “[Softkey/Programmable Key/Feature Key/Expansion Module Key Parameters](#)” on [page A-216](#).

Reference

To use the lock/unlock softkey or programmable key, see “[Using the Configured Lock/Unlock Key on the IP Phone](#)” on [page 5-15](#).

Configuring a Lock/Unlock Key using the Aastra Web UI

Using the Aastra Web UI, you can configure a key on the phone (softkey, programmable key, expansion module key) to use as a lock/unlock key. In the Aastra Web UI, you assign the function of the as “**Phone Lock**”.

Use the following procedure to configure a key as a lock/unlock key using the Aastra Web UI.

1
Aastra Web UI

Click on **Operation->Softkeys and XML**
or
 Click on **Operation->Programmable Keys**
or
 Click on **Operation->Expansion Module <N>**.

Note: Depending on your phone-model, the key configuration screen displays. The 6757i Key Screen is shown as an example.

Key	Type	Label	Value	Line	Idle	Connected	Incoming	Outgoing	Busy
1	Directory		12345	1	<input checked="" type="checkbox"/>	<input checked="" type="checkbox"/>	<input checked="" type="checkbox"/>	<input checked="" type="checkbox"/>	<input checked="" type="checkbox"/>
2	None			1	<input type="checkbox"/>	<input type="checkbox"/>	<input type="checkbox"/>	<input type="checkbox"/>	<input type="checkbox"/>
3	Speedial	Sub	22222	1	<input checked="" type="checkbox"/>	<input checked="" type="checkbox"/>	<input checked="" type="checkbox"/>	<input checked="" type="checkbox"/>	<input checked="" type="checkbox"/>
4	None			1	<input type="checkbox"/>	<input type="checkbox"/>	<input type="checkbox"/>	<input type="checkbox"/>	<input type="checkbox"/>
5	None			1	<input type="checkbox"/>	<input type="checkbox"/>	<input type="checkbox"/>	<input type="checkbox"/>	<input type="checkbox"/>
6	None			1	<input type="checkbox"/>	<input type="checkbox"/>	<input type="checkbox"/>	<input type="checkbox"/>	<input type="checkbox"/>
7	None			1	<input type="checkbox"/>	<input type="checkbox"/>	<input type="checkbox"/>	<input type="checkbox"/>	<input type="checkbox"/>
8	None			1	<input type="checkbox"/>	<input type="checkbox"/>	<input type="checkbox"/>	<input type="checkbox"/>	<input type="checkbox"/>
9	None			1	<input type="checkbox"/>	<input type="checkbox"/>	<input type="checkbox"/>	<input type="checkbox"/>	<input type="checkbox"/>
10	None			1	<input type="checkbox"/>	<input type="checkbox"/>	<input type="checkbox"/>	<input type="checkbox"/>	<input type="checkbox"/>
11	None			1	<input type="checkbox"/>	<input type="checkbox"/>	<input type="checkbox"/>	<input type="checkbox"/>	<input type="checkbox"/>
12	None			1	<input type="checkbox"/>	<input type="checkbox"/>	<input type="checkbox"/>	<input type="checkbox"/>	<input type="checkbox"/>
13	None			1	<input type="checkbox"/>	<input type="checkbox"/>	<input type="checkbox"/>	<input type="checkbox"/>	<input type="checkbox"/>
14	None			1	<input type="checkbox"/>	<input type="checkbox"/>	<input type="checkbox"/>	<input type="checkbox"/>	<input type="checkbox"/>
15	None			1	<input type="checkbox"/>	<input type="checkbox"/>	<input type="checkbox"/>	<input type="checkbox"/>	<input type="checkbox"/>
16	None			1	<input type="checkbox"/>	<input type="checkbox"/>	<input type="checkbox"/>	<input type="checkbox"/>	<input type="checkbox"/>
17	None			1	<input type="checkbox"/>	<input type="checkbox"/>	<input type="checkbox"/>	<input type="checkbox"/>	<input type="checkbox"/>
18	None			1	<input type="checkbox"/>	<input type="checkbox"/>	<input type="checkbox"/>	<input type="checkbox"/>	<input type="checkbox"/>
19	None			1	<input type="checkbox"/>	<input type="checkbox"/>	<input type="checkbox"/>	<input type="checkbox"/>	<input type="checkbox"/>
20	None			1	<input type="checkbox"/>	<input type="checkbox"/>	<input type="checkbox"/>	<input type="checkbox"/>	<input type="checkbox"/>



Services

XML Application URI:

XML Application Title:

BLF List URI:

2 Select a key you want to configure for locking/unlocking the phone.

 Aastra Web UI	
3	In the “ Type ” field, select Phone Lock from the list of options.
4	Click  to save your changes.

Using the Configured Lock/Unlock Key on the IP Phone

After configuring a key as a lock/unlock key, refer to the following procedure to use the key on the IP phone.

 IP Phone UI	
Step	Action
<i>Lock the phone:</i>	
1	Press the LOCK softkey. The phone locks. The LED for the softkey AND the Message Waiting Lamp illuminate steady ON. An “ Unlock ” label appears next to the softkey you just pressed.
<i>Unlock the phone:</i>	
1	Press the UNLOCK softkey. A password prompt displays.
2	Enter the user or administrator password and press ENTER. The phone unlocks. The LED for the softkey AND the Message Waiting Lamp go OFF. The “ Lock ” label appears next to the softkey you just pressed.

Defining an Emergency Dial Plan

Public telephone networks in countries around the world have a single emergency telephone number (emergency services number), that allows a caller to contact local emergency services for assistance when required. The emergency telephone number may differ from country to country. It is typically a three-digit number so that it can be easily remembered and dialed quickly. Some countries have a different emergency number for each of the different emergency services.

You can specify the digits to dial on the IP phone for contacting emergency services. Once you specify the emergency number(s) on the phone, you can dial those numbers directly on the dial pad when required and the phone automatically dials to those emergency services.



Note: Contact your local phone service provider for available emergency numbers in your area.

The following table describes the default emergency numbers on the IP phones.

Emergency Number	Description
911	A United States emergency number
999	A United Kingdom emergency number
112	An international emergency telephone number for GSM mobile phone networks. In all European Union countries it is also the emergency telephone number for both mobile and fixed-line telephones.
110	A police and/or fire emergency number in Asia, Europe, Middle East, and South America.

Emergency Dial Plan and Pattern Matching

The IP Phones support emergency dialing using pattern matching and prepend dial plan functionality.

There are two ways to dial a number on the phone:

- dialing digit-by-digit (i.e., select line and dial)
- dialing by string (i.e., pre-dial then go off-hook)

When a user dials digit-by-digit, the phone adds every digit to a dialed string and checks against the dial plan. If the phone is not locked, it checks against the regular dial plan. If the phone is locked, it checks against the emergency dial plan.

When a user dials by string, (pre-dial, speed-dial, etc., and then goes off-hook), and the phone is not locked, it checks to see if the number matches the emergency dial plan. If it doesn't match, it blocks the call from going through. If the phone is locked, and the number matches the emergency dial plan it allows the call to go through.

Adding a pre-pend to a dial plan also works with both dialing digit-by-digit and dialing by string.

Limitation

The following is a limitation for emergency dial plans with pattern matching:

- Secondary dial tone is not supported.

You can set the emergency dial plan via the configuration files or the Aastra Web UI.



Configuring an Emergency Dial Plan

Use the following procedures to specify the numbers to use on your phone for dialing emergency services in your area.

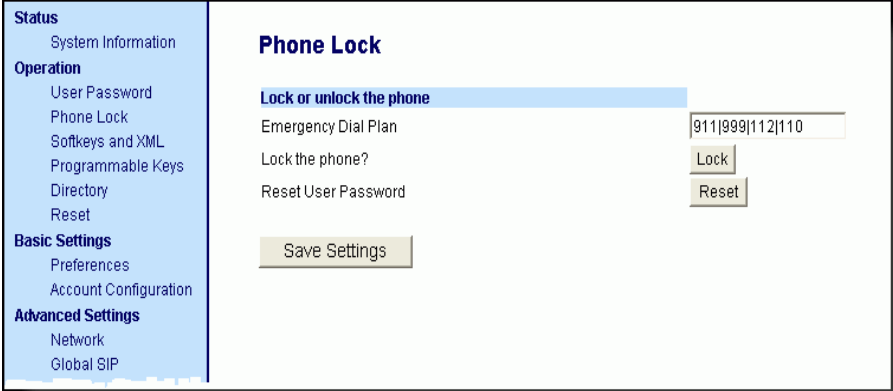

Configuration Files

For specific parameters you can set in the configuration files, see Appendix A, the section, "[Emergency Dial Plan Settings](#)" on [page A-16](#).

Aastra Web UI	
1	<p>Click on Operation->Phone Lock.</p> 
2	<p>In the Emergency Dial Plan field, enter the number used in your local area to contact emergency services. For multiple numbers, enter a " " between each emergency number.</p> <p>For example: 911 110.</p> <p>Default for this field is "x+# xx+*". You can enter up to 512 characters in this field.</p>
3	<p>Click  to save the emergency dial plan to your phone.</p>

Time and Date

In addition to enabling/disabling the time server, you can also set the time and date, set the time and date format, set the time zone, and set daylight savings time on the IP phones. You configure these features using the configuration files, the IP Phone UI, or the Aastra Web UI. The following table identifies which method of configuration applies to each feature.

Feature	Method of configuration
Set Time	IP Phone UI
Set Time Format	Configuration Files IP Phone UI Aastra Web UI
Set Date	IP Phone UI
Set Date Format	Configuration Files IP Phone UI Aastra Web UI
Set Time Zone	IP Phone UI Configuration Files
Set Daylight Savings Time	IP Phone UI Configuration Files

Daylight Savings Time (DST) Information

The Aastra IP Phones incorporate the federally mandated DST observance change. This change became affective starting in 2007.

The US has made a change to its daylight savings time observance starting in 2007. The Energy Policy Act of 2005 mandates that DST will now begin at 2:00 A.M. on the second Sunday in March and revert to Standard time on the first Sunday in November.



Note: In previous years, the DST began on the first Sunday of April and ended on the first Sunday of October.

The changes to daylight savings time applies to the U.S. and Canada, but may impact other countries outside North America.

Time Zone & DST

There are two ways you can set the time zone on the IP Phones.

First Method - You can set a time zone using the **Time Zone** option in the IP Phone UI or you can use the “**time zone name**” parameter in the configuration files. Both methods allow you to enter a value from the Time Zone table. The list of time zone names is provided in the table in Appendix A, the section, “[Time Zone Name/Time Zone Code Table](#)” on [page A-54](#). The following is an example:

```
time zone name: US-Eastern
```

Second Method - You can use the “**time zone name**” parameter in the configuration files, and specify a value of “**custom**” for this parameter. This method allows you to customize the time zone for your area using additional configuration parameters. The following is an example using relative time for EST:

```
time zone name: custom
```

The following table identifies the additional parameters you can enter in the configuration files if you want to customize your time zone.

Custom Configuration File Parameter	Description	Example
time zone minutes	The number of minutes the time zone is offset from UTC (Coordinated Universal Time). This can be positive (West of the Prime Meridian) or negative (East of the Prime Meridian). Eastern Standard Time (EST) has a value of 300.	custom time zone minutes: 300
dst minutes	The number of minutes to add during Daylight Saving Time. Valid values are a positive integer between 0 to 60.	dst minutes: 60
dst [start end] relative date	Specifies how to interpret the start and end day, month, and week parameters - absolute (0) or relative (1).	dst [start end] relative date: 1

Custom Configuration File Parameter	Description	Example
<i>Absolute Time (not applicable to Eastern Standard Time (EST))</i>		
dst start month	The month that DST starts. Valid values are 1 to 12 (January to December).	dst start month: 3
dst end month	The month that DST ends. Valid values are 1 to 12 (January to December).	dst end month: 4
dst [start end] week	Not applicable to absolute time.	N/A
dst start day	The day of the month that DST starts. Valid values are 1 to 31.	dst start day: 15
dst end day	The day of the month that DST ends. Valid values are 1 to 31.	dst end day: 31
dst start hour	The hour that DST starts. Valid values are an integer from 0 (midnight) to 23.	dst start hour: 5
dst end hour	The hour that DST ends. Valid values are an integer from 0 (midnight) to 23.	dst end hour: 23
<i>Relative Time</i>		
dst start month	The month that DST starts. Valid values are 1 to 12 (January to December).	dst start month: 4
dst end month	The month that DST ends. Valid values are 1 to 12 (January to December).	dst end month: 5
dst start week	The week in the specified month in which DST starts. Valid value is a positive or negative integer from 1 to 5. 1 = first full week of month -1 = last occurrence "dst start day" in the month 2 = second full week of month -2 =second last occurrence "dst start day" in the month . . . 5 = fifth full week of month -5 = fifth last occurrence "dst start day" in the month	dst start week: 2

Custom Configuration File Parameter	Description	Example
dst end week	<p>The week in the specified month in which DST ends. Valid value is a positive or negative integer from 1 to 5.</p> <p>1 = first full week of month -1 = last occurrence "dst start day" in the month 2 = second full week of month -2 = second last occurrence "dst start day" in the month . . . 5 = fifth full week of month -5 = fifth last occurrence "dst start day" in the month</p>	dst end week: -1
dst start day	<p>The day of the specified week in the specified month that DST starts on. Valid values are an integer from 1 to 7.</p> <p>1 = Sunday 2 = Monday . . . 7 = Saturday</p>	dst start day: 2
dst end day	<p>The day of the specified week in the specified month that DST ends on. Valid values are an integer from 1 to 7.</p> <p>1 = Sunday 2 = Monday . . . 7 = Saturday</p>	dst end day: 7
dst start hour	The hour that DST starts. Valid values are an integer from 0 (midnight) to 23.	dst start hour: 10
dst end hour	The hour that DST ends. Valid values are an integer from 0 (midnight) to 23.	dst end hour: 23

Example 1

The following is an example of a custom time zone configuration in the configuration files using relative time (for EST):

```
time zone name: custom
dst [start|end] relative date: 1 #relative
time zone minutes: 300
dst minutes: 60
```

Example 2

The following is an example of a custom time zone configuration in the configuration files using absolute time:

```
time zone name: custom
dst [start|end] relative date: 0 #absolute
```

#start of DST

```
dst start month: 3 #March
dst start week: 2 #second full week
dst start day: 1 #Sunday
```

#End of DST

```
dst end month: 11 #November
dst end week: 1 #first full week
dst end day: 1 #Sunday
```

Configuring Time and Date Using the Configuration Files

Use the following information to set a time and date, time and date format, time zone, and daylight savings time using the configuration files..





Configuration Files

For specific parameters you can set in the configuration files, see Appendix A, the section, "[Time and Date Settings](#)" on [page A-52](#).

Configuring Time and Date Using the IP Phone UI

Use the following procedure to set a time and date, time and date format, time zone, and daylight savings time using the IP Phone UI.

 IP Phone UI	
Step	Action
1	Press  on the phone to enter the Options List.
Set Time and Time Format:	
2	Select Time and Date .
3	Select Set Time .
4	Using the keys on the keypad, enter a time to set on the IP phone.
5	Press Done to save the time you entered.
6	Select Time Format . Valid values are 12hr and 24hr . Note: The default Time Format is 12hr .
7	Press Change to toggle between 24hr and 12hr format.
8	Press Done to save the Time Format you selected.
Set Date and Date Format:	
9	Select Set Date .
10	Using the keys on the keypad, enter a date to set on the IP phone.
11	Press Done to save the date you entered.
12	Select Date Format .





IP Phone UI

Step	Action
13	<p>Select a date format from the list of options.</p> <p>Valid values are:</p> <ul style="list-style-type: none"> • WWW MMM DD (default) • DD-MMM-YY • YYYY-MM-DD • DD/MM/YYYY • DD/MM/YY • DD-MM-YY • MM/DD/YY • MMM DD • DD MMM YYYY • WWW DD MMM • DD MMM • DD.MM.YYYY <p>Note: The default Date Format is WWW MMM DD (Day of Week, Month, Day).</p>
14	Press Done to save the Date Format.
Set Time Zone:	
15	Select Time Zone .
16	<p>For 3-Line LCD Displays::</p> <p>Press * to display a list of Time Zone options.</p>
17	<p>Select a Time Zone from the list of options.</p> <p>For valid values, see Appendix A, the section, “Time and Date Settings” on page A-52.</p> <p>Note: The default Time Zone is US-Eastern.</p>
18	Press Done to save the Time Zone you selected.
Set Daylight Savings Time:	
19	Select Daylight Savings .
20	<p>Select a Daylight Savings time from the list of options.</p> <p>Valid values are:</p> <ul style="list-style-type: none"> • OFF • 30 min summertime • 1 hr summertime • automatic <p>Note: The default for Daylight Savings is Automatic.</p>
21	Press Done to save the Daylight Savings value you selected.

Configuring Time and Date Using the Aastra Web UI

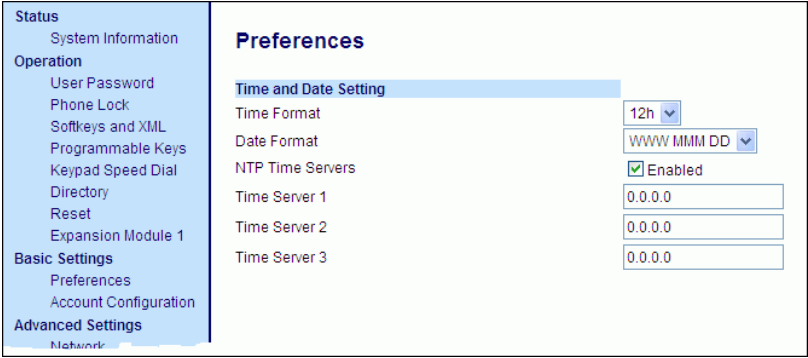
Use the following procedure to set a time and date, time and date format, time zone, and daylight savings time using the Aastra Web UI.

 Aastra Web UI	
1	<p>Click on Basic Settings->Preferences->Time and Date Setting.</p> 
2	<p>In the “Time Format” field, select the time format you want to use on your phone. Valid values are:</p> <ul style="list-style-type: none">• 12h (12 hour format) (default)• 24h (24 hour format). <p>Note: The time displays on the phone’s idle screen in the format you select for this field.</p>
3	<p>In the “Date Format” field, select the date format you want to use on your phone. Valid values are:</p> <ul style="list-style-type: none">• WWW MMM DD (default)• DD-MMM-YY• YYYY-MM-DD• DD/MM/YYYY• DD/MM/YY• DD-MM-YY• MM/DD/YY• MMM DD• DD MMM YYYY• WWW DD MMM• DD MMM• DD.MM.YYYY <p>Note: The date displays on the phone’s idle screen in the format you select for this field.</p>
4	<p>Click  to save your changes.</p>

Time Servers

A time server is a computer server that reads the actual time from a reference clock and distributes this information to the clients in a network. The time server may be a local network time server or an internet time server. The Network Time Protocol (NTP) is the most widely used protocol that distributes and synchronizes time in the network with the time on the time server.

On the IP phones, you can enable or disable a Time Server to be used to synchronize time on the phones with the Timer Server you specify. An Administrator can use the IP Phone UI, Aastra Web UI, or configuration files to enable/disable the Time Server and specify a Time Server 1, Timer Server 2, and/or Time Server 3. A User can enable/disable the Time Server using the IP Phone UI or Aastra Web UI only. The Time Server is enabled by default.

Setting Time Server Using the Configuration Files

Use the following procedure to enable/disable the Time Server and optionally set the IP Address of Time Servers 1, 2, and/or 3.



Configuration Files

For specific parameters you can set in the configuration files, see Appendix A, the section, “[Time Server Settings](#)” on [page A-59](#).



Setting Time Server Using the IP Phone UI

Use the following procedure to set the Time Server and optionally set the IP Address of Time Servers 1, 2, and/or 3.



IP Phone UI

Step	Action
<i>Enable/the Time Server by specifying Time Server 1, 2, and/or 3:</i>	
1	Press  on the phone to enter the Options List.
2	Select Preferences->Time and Date->Time Server .
3	Select Timer Server 1, Time Server 2, and/or Time Server 3 .

 IP Phone UI	
Step	Action
4	Enter the IP address of the Time Server, in dotted decimal format. Use the available softkeys to help you enter the information.
5	Click  to save your changes.

Setting Time Server Using the Aastra Web UI

Use the following procedure to set the Time Server and optionally set the IP Address of Time Servers 1, 2, and/or 3.

 Aastra Web UI	
1	<p>Click on Basic Settings->Preferences->Time and Date Setting.</p> <div data-bbox="348 812 1148 1170" data-label="Image"> </div>
To enable/disable Time Server:	
2	The "NTP Time Server" field is enabled by default. If you need to disable the Time Server, uncheck the box. The Time Server 1, 2, and 3 fields are grayed out when disabled.



Aastra Web UI

To set Time Server 1, 2, and/or 3:

3

Note: The “Time Server” field must be enabled to enter values in the “Time Server 1, 2, and 3” fields.

In the “Time Server 1”, “Time Server 2”, and/or “Time Server 3” field(s), enter the IP address of the Time Server 1, 2, and/or 3 in your network, in dotted decimal format. Default for this field is **0.0.0.0**. For example, 132.234.5.4

4

Click  to save your changes.

Backlight Mode (6755i, 6757i, and 6757i CT only)

The 6755i, 6757i, and 6757i CT have a backlight feature that allows you to turn the backlight on the LCD:

- **Off** - Backlight is always OFF.
- **Auto** (Default)- Automatically turns ON the backlight when the phone is in use, and then automatically turns OFF the backlight when the phone is idle after a specified length of time.

“The Auto” setting sets the phone to turn off the backlighting after a period of inactivity. The period of time that the phone waits before turning the backlight off is also configurable.

You can set this backlight feature using the configuration files and the IP Phone UI.

Configuring the Backlight Mode Using the Configuration Files

Use the following information to set the backlight mode and backlight timer on the IP Phones.



Configuration Files

For specific parameters you can set in the configuration files, see Appendix A, the section, “[Backlight Mode Settings \(6755i, 6757i, 6757i CT\)](#)” on [page A-70](#).

Note: Using the configuration files, you can set the backlight to Off (always off) or Auto (On and then off after a period of inactivity).

Configuring the Backlight Mode Using the IP Phone UI

Use the following procedure to set the backlight mode and backlight timer on the IP Phone using the IP Phone UI.



IP Phone UI

Step	Action
1	Press  on the phone to enter the Options List.
2	Select Preferences .

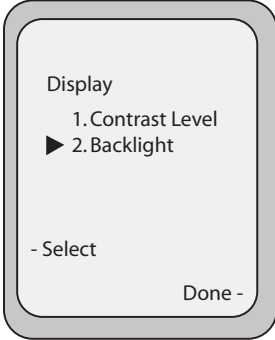
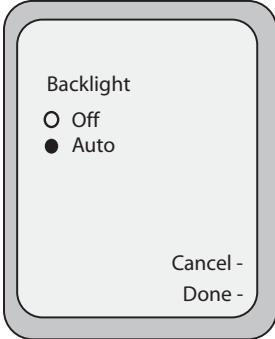
 IP Phone UI	
Step	Action
3	Select Display .
4	Select Backlight . <div style="text-align: center; margin: 20px 0;">  </div>
5	Use the UP and DOWN arrow keys to select the Backlight status for your phone. Default is " Auto ". Valid options are: <ul style="list-style-type: none"> • Off • Auto (Default) <p>Note: Setting the Backlight to "Auto" displays an ADVANCED button for you to set the Auto timer.</p> <div style="text-align: center; margin: 20px 0;">  </div>
6	If you select " Off ", press Done to save your setting.

 IP Phone UI	
Step	Action
7	<p>If you select “Auto”, press the Advanced softkey to set the automatic timer.</p> <div style="text-align: center; border: 1px solid gray; border-radius: 10px; padding: 10px; width: fit-content; margin: 10px auto;"> <p>Backlight</p> <p><input type="radio"/> Off</p> <p><input checked="" type="radio"/> Auto</p> <p style="text-align: right;">Advanced - Cancel - Done -</p> </div>
8	<p>Using the keypad, enter the amount of seconds you want the phone to stay backlit when the phone is idle. Valid values are 1 to 7200 seconds. Default is 600 seconds (equals 10 minutes). When this period of time is reached, the phone turns OFF the backlight. Use the “Backspace” and/or “Clear” softkeys to delete entries if required.</p> <div style="text-align: center; border: 1px solid gray; border-radius: 10px; padding: 10px; width: fit-content; margin: 10px auto;"> <p>Backlight On Time</p> <p>10 seconds</p> <p>- Backspace Cancel - - Clear Done -</p> </div>
9	<p>Press Done to save your setting. The setting applies immediately to the phone.</p>

Live Dial Pad*

The "Live Dialpad" option on the IP phone turns the Live Dial Pad mode ON or OFF. With live dial pad ON, the IP phone automatically dials out and turns ON Handsfree mode as soon as a dial pad key or softkey is pressed. With live dial pad OFF, if you dial a number while the phone is on-hook, lifting the receiver or pressing the  initiates a call to that number.

*Availability of feature dependant on your phone system or service provider.

A User can turn the "Live Dialpad" ON and OFF using the IP Phone UI only. A System Administrator can turn it ON and OFF using the IP Phone UI or the configuration files.

Enabling/Disabling Live Dialpad Using the Configuration Files

Use the following procedure to enable/disable Live Dialpad on the IP Phones.



Configuration Files

For specific parameters you can set in the configuration files, see Appendix A, the section, "Live Dialpad Settings" on page A-71.

Enabling/Disabling Live Dialpad Using the IP Phone UI

Use the following procedure to enable/disable Live Dialpad on the IP Phones.



IP Phone UI

Step	Action
1	Press  on the phone to enter the Options List.
2	Select Preferences .
3	Select Live Dialpad .
4	<p>On 3-Line LCD phones: Press the UP and DOWN arrow keys to toggle the live dialpad setting ON or OFF.</p> <p>On 8 and 11-Line LCD phones: Press Change to toggle the live dialpad setting ON or OFF.</p>
5	Press Done to save the setting.

Language

The IP phones support several different languages. You can have the IP phone UI and the Aastra Web UI display in a specific language as required. When you set the language to use, all of the display screens (menus, services, options, configuration parameters, etc.) display in that language. The IP phones support the following languages:

Available Language	Associated Language File (included in the firmware file when downloaded from configuration server)
English	Default (resides on the phone)
German	lang_de.txt (German)*
Spanish	lang_es.txt (Spanish)
Mexican Spanish	lang_es_mx.txt (Mexican Spanish)
French	lang_fr.txt (French)
Canadian French	lang_fr_ca.txt (Canadian French)
Italian	lang_it.txt (Italian)*

*German and Italian languages are not applicable to the 6757i CT cordless handset.

Loading Language Packs

You make languages available to use on the phone by loading language packs from the configuration server to the local <MAC>.cfg configuration file. You can use the configuration files or the Aastra Web UI to perform the download. Each language pack consists of the IP Phone UI and Aastra Web UI translated in a specific language.

Loading Language Packs via the Configuration File (<mac>.cfg)

Using the configuration files, you specify a language pack to load in the following format:

```
lang_<ISO 639>_<ISO 3166>.txt  
or  
lang_<ISO 639>.txt
```

where <ISO 639> is the language code specified in Standard ISO 639 (see Appendix A, the section, [Language Codes \(from Standard ISO 639\)](#) on [page A-189](#)) and <ISO 3166> is the country code specified in Standard ISO 3166 (see [Country Codes \(from Standard ISO 3166\)](#) on [page A-189](#)).

The <ISO 3166> attribute is optional.



Note: Adding/changing language packs can only be done at bootup of the IP phone. The default language (English) cannot be changed or removed.

Example

The following is an example of the parameters you would enter in the <MAC>.cfg file to load a French, Italian, German, and Spanish language pack to the IP phone.

```
language 1: lang_fr_ca.txt
language 2: lang_it.txt
language 3: lang_de.txt
language 4: lang_es_mx.txt
```

The above entries in the <MAC>.cfg file tells the phone which language packs to load. When the language pack(s) have loaded, you must then use the configuration files IP Phone UI to specify which language to display on the IP phone. You must use the Aastra Web UI to specify the language to use in the Web UI.

References

For more information about specifying the language to use, see the section, [“Specifying the Language to Use”](#) on [page 5-37](#).

For more information about language codes and country codes, see Appendix A, the section, [“Language Pack Settings”](#) on [page A-187](#).

Loading Language Packs via the Aastra Web UI

Using the Aastra Web UI, you can specify a language pack to load using the parameters at *Basic Settings->Preferences->Language Settings*.

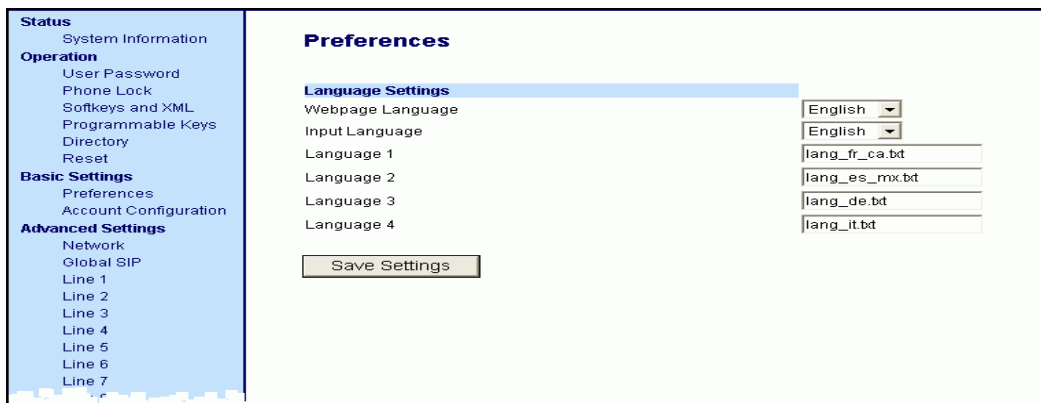

You use the following fields in the Aastra Web UI to specify which language packs to load:

Language 1	<input type="text" value="lang_de.bt"/>
Language 2	<input type="text"/>
Language 3	<input type="text"/>
Language 4	<input type="text"/>

Once the language pack is loaded to the phone, it is available for selection from either the configuration files, the IP Phone UI or the Aastra Web UI.

Specifying the Language to Use

Once the language pack(s) have loaded, you must then specify which language to use on the phone. After the phone has booted up, you can specify which language(s) to use. You can use the configuration files and the IP Phone UI to specify the language for the IP Phone UI. You can use the Aastra Web UI to specify the files for the Aastra Web UI.

Use the following procedures to specify the language to use on the IP phone.



Configuration Files

For specific parameters you can set in the configuration files, see Appendix A, the section, “[Language Settings](#)” on [page A-185](#) and “[Language Pack Settings](#)” on [page A-187](#).



Notes:

1. If you specify the language to use on the phone via the configuration files, you must reboot the phone for the changes to take affect.
 2. All languages may not be available for selection. The available languages are dependant on the language packs currently loaded to the IP phone.
-



IP Phone UI

Step	Action
1	Press  on the phone to enter the Options List.
2	Select Language .
3	Select English (English), Français (French), Español (Spanish), Deutsch (German), Italiano (Italian). Notes: 1. Valid values for the 6757i CT cordless handset are English, French, and Spanish only. 2. All languages may not be available for selection. The available languages are dependant on the language packs currently loaded to the IP phone. English is the default language and cannot be changed or removed. For more information about loading language packs, see " Loading Language Packs " on page 5-34 .
4	Press Done to save the changes. The change is dynamic. The IP phone UI displays all menu items in the language you chose.

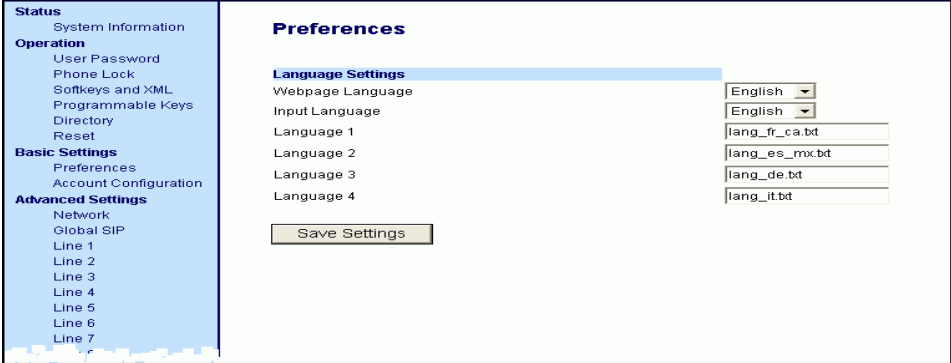
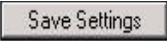
 Aastra Web UI	
1	<p>Click on Basic Settings->Preferences->Language Settings.</p> <div style="border: 1px solid black; padding: 10px; margin: 10px 0;">  </div>
Loading the Language Pack	
2	<p>In the “Language N” fields, enter the file name of the language pack you want to use to display a specific language in the Aastra Web UI. For example, you could enter the following in the “Language 1”, “Language 2”, “Language 3”, and “Language 4” fields to display the Aastra Web UI in French, Spanish, German, and Italian:</p> <pre style="margin: 10px 0;">lang_de.txt lang_es.txt lang_es_mx.txt lang_fr.txt lang_fr_ca.txt lang_it.txt</pre> <p>Note: You must have the language pack(s) already loaded to your phone in order to use them. For more information about loading language packs, see “Loading Language Packs” on page 5-34. For more information about language codes and country codes, see Appendix A, the section, “Language Pack Settings” on page A-187.</p>
3	<p>Click  to save your changes.</p>
Specifying the Language to Use in the Aastra Web UI	
4	<p>After restarting your phone, log back in using the Aastra Web UI.</p>
5	<p>Click on Basic Settings->Preferences->Language Settings.</p>

**Aastra Web UI**

6	<p>In the “Webpage Language” field, select a language to apply to the Aastra Web UI. The IP phone supports the following languages:</p> <ul style="list-style-type: none">• English (default)• French (European French and Canadian French)• Spanish (European Spanish and Mexican Spanish)• German• Italian <p>Notes:</p> <ol style="list-style-type: none">1. Valid values for the 6757i CT cordless handset are English, French, and Spanish only.2. All languages may not be available for selection. The available languages are dependant on the language packs currently loaded to the IP phone. English is the default language and cannot be changed or removed.
7	<p>Click  to save your changes.</p> <p>The Aastra Web UI displays all screens in the language you chose.</p>

Specifying the Input Language to Use

The 5i Series phones support text and character inputs in various languages (English, German, French, Spanish, and Italian).

Inputting textual or character information into the IP Phone UI, Aastra Web UI, and XML scripts can now be done in various languages using the keypad on the phone. The System Administrator and User can enable this feature using the Aastra Web UI or the IP Phone UI. An Administrator can also use the configuration files to enable this feature. Users can then use text and characters in a specific language when performing inputs on the phone.

The following tables identify the language characters that a User can enter on the 5i Series phones that support the Input Language feature.

Keypad Input Alphabet Tables

English

Key	Uppercase Characters	Lowercase Characters
0	0	0
1	1.;=,-'&()	1.;=,-'&()
2	ABC2	abc2
3	DEF3	def3
4	GHI4	ghi4
5	JKL5	jkl5
6	MNO6	mno6
7	PQRS7	pqrs7
8	TUV8	tuv8
9	WXYZ9	wxyz9
*	* <SPACE>	* <SPACE>
#	#\@	#\@

French

Key	Uppercase Characters	Lowercase Characters
0	0	0
1	1.;;=,-'&()	1.;;=,-'&()
2	ABC2ÀÂÇÁÀÆ	abc2ââçáâæ
3	DEF3ÉÊÈË	def3éèèè
4	GHI4Ï	ghi4ï
5	JKL5	jkl5
6	MNO6ÑÓÒÔÖ	mno6ñóòôö
7	PQRS7	pqrs7
8	TUV8ÚÛÜÛ	tuv8úúúú
9	WXYZ9	wxyz9
*	* <SPACE>	* <SPACE>
#	#\@	#\@

Spanish

Key	Uppercase Characters	Lowercase Characters
0	0	0
1	1.;;=,-'&()	1.;;=,-'&()
2	ABC2ÁÂÇ	abc2áâç
3	DEF3ÉÈ	def3éè
4	GHI4Ï	ghi4í
5	JKL5	jkl5
6	MNO6ÑÓÒ	mno6ñóò
7	PQRS7	pqrs7
8	TUV8ÚÛ	tuv8úú
9	WXYZ9	wxyz9
*	* <SPACE>	* <SPACE>
#	#\@	#\@

German

Key	Uppercase Characters	Lowercase Characters
0	0	0
1	1.;;=,-'&()	1.;;=,-'&()
2	ABC2ÄÄ	abc2ää
3	DEF3É	def3é
4	GHI4	ghi4
5	JKL5	jkl5
6	MNO6Ö	mno6ö
7	PQRS7ß	pqrs7ß
8	TUV8Ü	tuv8ü
9	WXYZ9	wxyz9
*	* <SPACE>	* <SPACE>
#	#^@	#^@

Italian

Key	Uppercase Characters	Lowercase Characters
0	0	0
1	1.;;=,-'&()	1.;;=,-'&()
2	ABC2ÀÇ	abc2àç
3	DEF3ÉÈÈ	def3éèè
4	GHI4	ghi4
5	JKL5	jkl5
6	MNO6ÓÒ	mno6óò
7	PQRS7	pqrs7
8	TUV8Ù	tuv8ù
9	WXYZ9	wxyz9
*	* <SPACE>	* <SPACE>
#	#^@	#^@

Configuring Language Input Using the Configuration Files

An Administrator can specify the input language to use by entering a specific parameter in the configuration files. An Administrator must enter the following parameter to enable this feature:

- **input language**

Use the following procedures to specify the input language to use on the IP phone.



Configuration Files

For specific parameters you can set in the configuration files, see Appendix A, the section, “[Language Settings](#)” on [page A-185](#).

Configuring Language Input Using the IP Phone UI

Once “Language Input” is enabled, an Administrator or User can change the input language on the phone using the IP Phone UI. The “**Input Language**” option appears under the Language option in the IP Phone UI.

Example

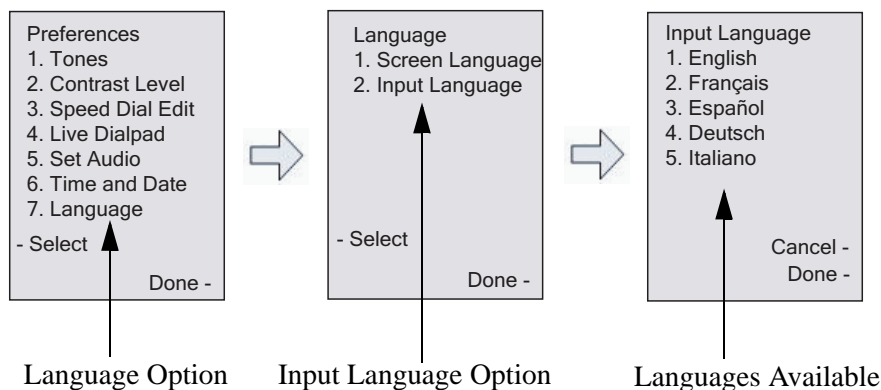



Use the following procedure to change the input language using the IP Phone UI.

 Aastra IP Phone UI	
Step	Action
1	Press the Options key.
2	Select Language from the Options List.
3	Select Input Language from the Language List.
4	<p>Select the language you want to use on the IP phone for inputting text and characters. Valid values are:</p> <ul style="list-style-type: none"> • English (default) • Français (French) • Español (Spanish) • Deutsch (German) (not applicable to 6757i CT cordless handset) • Italiano (Italian) (not applicable to 6757i CT cordless handset) • <p>Note: Available input languages are dependent on the configuration enabled by your System Administrator.</p>
5	Press Done when you have selected a language.

Configuring Language Input Using the Aastra Web UI

Once “Language Input” is enabled, an Administrator or User can also change the input language on the phone using the Aastra Web UI. The “**Input Language**” option appears at the path **Basic Settings->Preferences->Language Settings**.

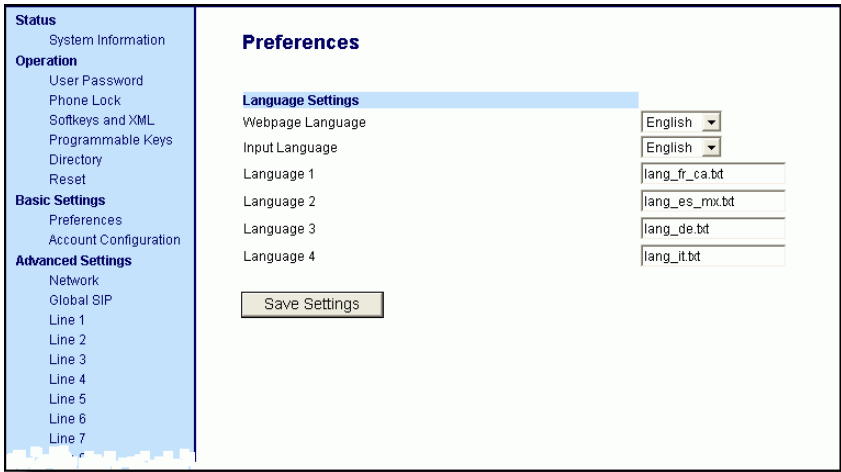
Use the following procedure to set the input language using the Aastra Web UI.

Aastra Web UI	
1	<p>Click on Basic Settings-> Preferences->Language Settings.</p>  <p>The screenshot shows the Aastra Web UI interface. On the left is a navigation menu with categories: Status (System Information), Operation (User Password, Phone Lock, Softkeys and XML, Programmable Keys, Directory, Reset), Basic Settings (Preferences, Account Configuration), and Advanced Settings (Network, Global SIP, Line 1-7). The main content area is titled 'Preferences' and has a sub-section 'Language Settings' highlighted in blue. Under 'Language Settings', there are six rows: 'Webpage Language' (dropdown: English), 'Input Language' (dropdown: English), 'Language 1' (text: lang_fr_ca.bt), 'Language 2' (text: lang_es_mx.bt), 'Language 3' (text: lang_de.bt), and 'Language 4' (text: lang_it.bt). A 'Save Settings' button is located below these fields.</p>
2	<p>Select a language from the "Input Language" field. Setting this field allows you to specify the language to use when entering text in the Aastra Web UI, IP Phone UI, or in XML applications on the phone. Valid values are:</p> <ul style="list-style-type: none">• English (default)• Français (French)• Español (Spanish)• Deutsch (German) (not applicable to 6757i CT cordless handset)• Italiano (Italian) (not applicable to 6757i CT cordless handset) <p>Note: Available input languages are dependent on the configuration enabled by your System Administrator.</p>
3	<p>Click  to save your changes.</p>

Configuring Language Input for an XML Application

A System Administrator can enable input languages in XML applications using the <AastraIPPhoneInputScreen> object and the “inputLanguage” attribute.

Reference

For more information about using XML objects for defining input language, contact Aastra Telecom Customer Support regarding the “Aastra XML Development Guide.”

UTF- 8 Codec for Multi-National Language Support

The IP Phones and expansion modules include support for ISO 8859-2 (Latin2) of multi-national languages when displaying and inputting in the IP Phone UI and the Aastra Web UI.



Note: This feature is not applicable to the handsets on the 6757i CT and the 9480i CT.

UTF-8 is also compatible with XML encoding on the IP Phones.

The following table illustrates the Latin 2 character set now used on the IP Phones.

	-0	-1	-2	-3	-4	-5	-6	-7	-8	-9	-A	-B	-C	-D	-E	-F	
A-	NBSF 00A0 160	À 0104 161	Á 02D8 162	Â 0141 163	Ã 00A4 164	Ä 013D 165	Å 015A 166	Æ 00A7 167	Ç 00A8 168	È 0160 169	É 015E 170	Ê 0164 171	Ë 0179 172	Ë 00AD 173	Ï 017D 174	Ï 017B 175	
B-	° 00B0 176	à 0105 177	á 02DB 178	â 0142 179	ã 00B4 180	ä 013E 181	å 015B 182	æ 02C7 183	ç 00B8 184	è 0161 185	é 015F 186	ê 0165 187	ë 017A 188	ë 02DD 189	ï 017E 190	ï 017C 191	
C-	Ř 0154 192	Á 00C1 193	Â 00C2 194	Ă 0102 195	Ä 00C4 196	Ĺ 0139 197	Ć 0106 198	Ç 00C7 199	Č 010C 200	É 00C9 201	Ę 0118 202	Ë 00CB 203	Ě 011A 204	Í 00CD 205	Î 00CE 206	Ď 010E 207	
D-	Đ 0110 208	Ñ 0143 209	Ń 0147 210	Ó 00D3 211	Ô 00D4 212	Õ 0150 213	Ö 00D6 214	× 00D7 215	Ř 0158 216	Ů 016E 217	Ú 00DA 218	Ů 0170 219	Û 00DC 220	Ü 00DD 221	Ý 0162 222	Ť 00DF 223	ß
E-	í 0155 224	á 00E1 225	â 00E2 226	ă 0103 227	ä 00E4 228	Í 013A 229	ć 0107 230	ç 00E7 231	č 010D 232	é 00E9 233	ę 0119 234	ë 00EB 235	ě 011B 236	í 00ED 237	î 00EE 238	đ 010F 239	
F-	đ 0111 240	ń 0144 241	ñ 0148 242	ó 00F3 243	ô 00F4 244	õ 0151 245	ö 00F6 246	÷ 00F7 247	ř 0159 248	ů 016F 249	ú 00FA 250	ű 0171 251	ü 00FC 252	ý 00FD 253	ț 0163 254	· 02D9 255	

Locking IP Phone Keys

The IP phones allow you to lock or unlock programmable keys, softkeys, hard keys, cordless handset keys, and expansion keys (for expansion modules). When key locking is enabled, the phone uses the server settings and ignores any previous local configuration. A user cannot override the configuration of a locked key.

You can lock and unlock keys using the configuration files, the IP Phone UI, or the Aastra Web UI. When viewing the locked key via the Aastra Web UI, the key is grayed out (disabled) and cannot be changed. Locking is dynamic for XML pushes.

You use the following “locking” parameters in the configuration files to lock the softkeys and/or programmable keys on all the phones except the 6751i. The locking parameters impact existing softkey and programmable key parameters as shown in the table below.

Locking Parameter	Impacted Parameters	Phone Model Affected
softkeyN locked	softkeyN type softkeyN label softkeyN value softkeyN line softkeyN states	9480i 9480i CT 6755i 6757i 6757i CT
topsoftkeyN locked	topsoftkeyN type topsoftkeyN label topsoftkeyN value topsoftkeyN line	6757i 6757i CT
prgkeyN locked	prgkeyN type prgkeyN value prgkeyN line	9143i 6730i 6731i 6753i 6755i
featurekeyN locked	featurekeyN type featurekeyN label	9480i CT 6757i CT
expmodX keyN locked	expmodX keyN type expmodX keyN value expmodX keyN line	5-series phones only (not applicable to the 6730i, 6731i, and 6751i)



Note: The 3-Line LCD phones prevent users from setting a speed dial key via the Phone UI on a key that has been locked.

Locking the IP Phone Keys

Use the following procedures to lock the softkeys and programmable keys on the IP phone.



Configuration Files

For specific parameters you can set in the configuration files, see Appendix A, the section, [“Locking Softkeys and Programmable Keys”](#) on [page A-251](#).

Reference

For more information about locking/unlocking the phones using the Phone UI and Aastra Web UI, see your applicable phone-specific *User Guide*.

Locking/Unlocking the SAVE and DELETE keys (6753i)

There are 4 programmable keys on the 6753i phone located to the left of the paper label. Two additional keys (SAVE and DELETE) can be made programmable by the Administrator, providing a total of 6 programmable keys if required.

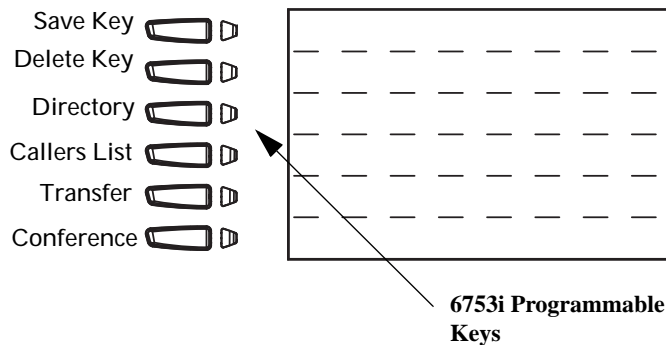

If a System Administrator unlocks the **SAVE** and **DELETE** keys, these keys can be configured with the same functions that are available for the other programmable keys. Only the System Administrator can unlock these keys.

The **Save** key allows you to save entries to the Directory and perform a Save-To from the Callers List. It also allows you to save speeddial information to a programmable key. You can also use the **Save** key while using specific XML applications.

The **Delete** key allows you to remove entries from the Directory List and Callers List. (Must enter the Directory or Callers list and select an entry, then press twice to delete entry).

By default, the **Save** and **Delete** keys are locked so that a user can use them for saving and deleting only. An Administrator can unlock these keys using the configuration files, allowing the keys to be programmed with other functions if required. An Administrator can use the following parameters in the configuration file to lock and unlock the **Save** and **Delete** keys:

- `prgkey1 locked`
- `prgkey2 locked`

The value of "0" unlocks the keys, and the value of "1" locks the keys. The default is "1" (lock).

The following is an example of unlocking the **Save** and **Delete** keys using the configuration files:

Example:

- `prgkey1 locked: 0`
- `prgkey2 locked: 0`

Once the **Save** and **Delete** keys are unlocked, a User can change the function of the keys using the Aastra Web UI. An Administrator can change the function of the keys using the Aastra Web UI or the configuration files.

IMPORTANT: If you change the functions of the **Save** and **Delete** keys, and then an Administrator locks Keys 1 and 2, the functions are automatically set back to the default settings of "**Save**" and "**Delete**".



Note: The **Save** and **Delete** functions are limited to Key 1 and Key 2 on the 6753i IP phone only.

Locking and Unlocking the Save and Delete Keys using the Configuration Files.



Configuration Files

For the specific parameter you can set in the configuration files, see Appendix A, the section, "[Locking the SAVE and DELETE Keys \(6753i\)](#)" on [page A-254](#).

Local Dial Plan

A dial plan describes the number and pattern of digits that a user dials to reach a particular telephone number. Access codes, area codes, specialized codes, and combinations of the number of digits dialed are all part of a dial plan. For instance, the North American Public Switched Telephone Network (PSTN) uses a 10-digit dial plan that includes a 3-digit area code and a 7-digit telephone number. Most PBXs support variable length dial plans that use 3 to 11 digits. Dial plans must comply with the telephone networks to which they connect. Only totally private voice networks that are not linked to the PSTN or to other PBXs can use any dial plan.

The Dial Plan field accepts up to 512 characters. If a User enters a dial plan longer than 512 characters, or a parsing error occurs, the phone uses the default dial plan of “x+#|xx+*”. You configure the SIP Local Dial Plan using the Aastra Web UI or the configuration files.

The IP phone SIP local dial plan available symbols are as follows:

Symbol	Description
0, 1, 2, 3, 4, 5, 6, 7, 8, 9	Digit symbol
;	Allows a secondary dial tone to be audible before dialing a number.
X	Match any digit symbol (wildcard)
*, #, .	Other keypad symbol
	Expression inclusive OR
+	0 or more of the preceding digit symbol or [] expression
[]	Symbol inclusive OR
-	Used only with [], represent a range of acceptable symbols; For example, [2-8]
;	Used when a secondary dial tone is required on the phone. (For example, “9;xxxxxx”, when a user has to dial “9” to get and outside line and needs a secondary dial one presented

Dial Plan Example

An example of a SIP Local Dial Plan is:

```
[ 01 ]xxx | [ 2-8 ]xxxx | 91xxxxxxx
xxxx | x+ . | *xx
```

The dial plan in the above example can accept any 4-digit dial strings that begin with a '0' or '1', any 5-digit dial strings that begin with a '2' up to '8', any 12-digit dial strings that begin with '91', any non-empty digit string that ends with a '.' or any 2-digit code that begins with a '*'.

Prefix Dialing

The IP phones support a prefix dialing feature for outgoing calls.

You can manually dial a number or dial a number from a list. The phone automatically maps the pre-configured prepended digit in the configuration, to the outgoing number. When a match is found, the prepended digits are added to the beginning of the dial string and the call is dialed.



Note: The prepend digits are also added if the dialing times-out on a partial match.

You can enable this feature by adding a prepend digit(s) to the end of the **Local Dial Plan** parameter string in the configuration files or the Aastra Web UI at **Basic Settings->Preferences->General**.

For example, if you add a prepend map of “[2-9]XXXXXXXX,91”, the IP phone adds the digits “91” to any 10-digit number beginning with any digit from 2 to 9 that is dialed out. Other examples of prepend mappings are:

- **1X+#,9** (Prepends 9 to any digit string beginning with “1” and terminated with “#”.)
 - **6XXX,579** (Prepends “579” to any 4-digit string starting with “6”.)
 - **[4-6]XXXXXX,78** (Prepends “78” to any 7-digit string starting with “4”, “5”, or “6”.)
-



Note: You can configure a local dial plan via the configuration files or the Aastra Web UI.

Example

If you enter the following dial string for a local dial plan:

```
sip dial plan: 1+#,9
```

where “9” is the prepended digit, and you dial the following number:

15551212

the IP phone automatically adds the “9” digit to the beginning of the dialed number before the number is forwarded as **915551212**.



Note: You can configure a local dial plan via the configuration files or the Aastra Web UI.

SIP Dial Plan Terminator

The IP phone allows you to enable or disable the use of the “dial plan terminator”. When you configure the phone’s dial plan to use a dial plan terminator or timeout (such as the pound symbol (#)) the phone waits 4 or 5 seconds after you pick up the handset or after you finish dialing the numbers on the keypad before making the call.

You can enable or disable the dial plan terminator using Aastra Web UI or the configuration files.

Digit Timeout

The IP phone allows you to configure a “**Digit Timeout**” feature on the IP phone. The Digit Timeout is the time, in seconds, between consecutive key presses on the IP phone’s keypad. The default for this parameter is 4 seconds. If you press a key on the phone and wait 4 seconds before pressing the next key, the key times out and cancels the digit selection. You must press consecutive keys before the timeout occurs.

Secondary Dial Tone

The IP phones now support a feature that allows the user to dial a predefined dial string, obtain a dial tone, and continue dialing. A User or Administrator can configure this using the existing Dial Plan feature on the phone.

You can enter a new character string in the dial plan that allows you to configure the secondary dial tone. The character string is of the form ".:;" , where the period indicates an arbitrary number of digits and the semicolon indicates that the phone is to present a dial tone after the previous dialed digit. For example, in the string:

"9;xxxxx"

the user dials "9" to get the outside line, listens for the dial tone, and continues to dial the applicable number. The ";" tells the phone to present a second dial tone after the previously dialed digit. The "xxxxx" in the example tells the phone that a phone number is dialed after the secondary dial tone is audible.

You can enter the Secondary Dial Tone string in the Dial Plan using the configuration files or the Aastra Web UI.

You use the following parameter in the configuration files to configure a secondary dial tone:

- **sip dial plan**

Example

sip dial plan: "9;5551313"

Configuring the SIP Local Dial Plan, Dial Plan Terminator, and Digit Timeout

Use the following procedures to configure the SIP Local Dial Plan using the configuration files or the Aastra Web UI.



Configuration Files

For specific parameters you can set in the configuration files, see Appendix A, the section, "[SIP Local Dial Plan Settings](#)" on [page A-72](#).

 Aastra Web UI			
1	<p>Click on Basic Settings->Preferences.</p> <div style="border: 1px solid black; padding: 10px; margin: 10px auto; width: 80%; background-color: #f0f0f0;"> <table border="1" style="width: 100%; border-collapse: collapse;"> <tr> <td style="width: 25%; background-color: #e0e0e0; vertical-align: top; padding: 5px;"> <p>Status System Information</p> <p>Operation User Password Phone Lock Softkeys and XML Programmable Keys Directory Reset</p> <p>Basic Settings Preferences Account Configuration</p> <p>Advanced Settings Network Global SIP Line 1 Line 2 Line 3 Line 4 Line 5 Line 6 Line 7 Line 8 Line 9 Action URI Configuration Server Firmware Update TLS Support 802.1x Support Troubleshooting</p> </td> <td style="padding: 5px;"> <p style="text-align: center;">Preferences</p> <p>General</p> <p>Local Dial Plan <input style="width: 100%;" type="text" value="x+# xx+*"/></p> <p>Send Dial Plan Terminator <input type="checkbox"/> Enabled</p> <p>Digit Timeout (seconds) <input style="width: 50%;" type="text" value="4"/></p> <p>Park Call: <input style="width: 100%;" type="text"/></p> <p>Pick Up Parked Call: <input style="width: 100%;" type="text"/></p> <p>Suppress DTMF Playback <input checked="" type="checkbox"/> Enabled</p> <p>Display DTMF Digits <input type="checkbox"/> Enabled</p> <p>Call Waiting <input checked="" type="checkbox"/> Enabled</p> <p>Play Call Waiting Tone <input checked="" type="checkbox"/> Enabled</p> <p>Stuttered Dial Tone <input checked="" type="checkbox"/> Enabled</p> <p>XML Beep Support <input checked="" type="checkbox"/> Enabled</p> <p>Status Scroll Delay (seconds) <input style="width: 50%;" type="text" value="5"/></p> <p>Incoming Call Interrupts Dialing <input type="checkbox"/> Enabled</p> <p>Switch UI Focus To Ringing Line <input checked="" type="checkbox"/> Enabled</p> <p>Goodbye Key Cancels Incoming Call <input checked="" type="checkbox"/> Enabled</p> <p>UPnP Mapping Lines <input type="text" value="0"/> ▾</p> <p>Message Waiting Indicator Line <input type="text" value="All"/> ▾</p> <p>DND Key Mode <input type="text" value="Phone"/> ▾</p> <p>Call Forward Key Mode <input type="text" value="Account"/> ▾</p> </td> </tr> </table> </div>	<p>Status System Information</p> <p>Operation User Password Phone Lock Softkeys and XML Programmable Keys Directory Reset</p> <p>Basic Settings Preferences Account Configuration</p> <p>Advanced Settings Network Global SIP Line 1 Line 2 Line 3 Line 4 Line 5 Line 6 Line 7 Line 8 Line 9 Action URI Configuration Server Firmware Update TLS Support 802.1x Support Troubleshooting</p>	<p style="text-align: center;">Preferences</p> <p>General</p> <p>Local Dial Plan <input style="width: 100%;" type="text" value="x+# xx+*"/></p> <p>Send Dial Plan Terminator <input type="checkbox"/> Enabled</p> <p>Digit Timeout (seconds) <input style="width: 50%;" type="text" value="4"/></p> <p>Park Call: <input style="width: 100%;" type="text"/></p> <p>Pick Up Parked Call: <input style="width: 100%;" type="text"/></p> <p>Suppress DTMF Playback <input checked="" type="checkbox"/> Enabled</p> <p>Display DTMF Digits <input type="checkbox"/> Enabled</p> <p>Call Waiting <input checked="" type="checkbox"/> Enabled</p> <p>Play Call Waiting Tone <input checked="" type="checkbox"/> Enabled</p> <p>Stuttered Dial Tone <input checked="" type="checkbox"/> Enabled</p> <p>XML Beep Support <input checked="" type="checkbox"/> Enabled</p> <p>Status Scroll Delay (seconds) <input style="width: 50%;" type="text" value="5"/></p> <p>Incoming Call Interrupts Dialing <input type="checkbox"/> Enabled</p> <p>Switch UI Focus To Ringing Line <input checked="" type="checkbox"/> Enabled</p> <p>Goodbye Key Cancels Incoming Call <input checked="" type="checkbox"/> Enabled</p> <p>UPnP Mapping Lines <input type="text" value="0"/> ▾</p> <p>Message Waiting Indicator Line <input type="text" value="All"/> ▾</p> <p>DND Key Mode <input type="text" value="Phone"/> ▾</p> <p>Call Forward Key Mode <input type="text" value="Account"/> ▾</p>
<p>Status System Information</p> <p>Operation User Password Phone Lock Softkeys and XML Programmable Keys Directory Reset</p> <p>Basic Settings Preferences Account Configuration</p> <p>Advanced Settings Network Global SIP Line 1 Line 2 Line 3 Line 4 Line 5 Line 6 Line 7 Line 8 Line 9 Action URI Configuration Server Firmware Update TLS Support 802.1x Support Troubleshooting</p>	<p style="text-align: center;">Preferences</p> <p>General</p> <p>Local Dial Plan <input style="width: 100%;" type="text" value="x+# xx+*"/></p> <p>Send Dial Plan Terminator <input type="checkbox"/> Enabled</p> <p>Digit Timeout (seconds) <input style="width: 50%;" type="text" value="4"/></p> <p>Park Call: <input style="width: 100%;" type="text"/></p> <p>Pick Up Parked Call: <input style="width: 100%;" type="text"/></p> <p>Suppress DTMF Playback <input checked="" type="checkbox"/> Enabled</p> <p>Display DTMF Digits <input type="checkbox"/> Enabled</p> <p>Call Waiting <input checked="" type="checkbox"/> Enabled</p> <p>Play Call Waiting Tone <input checked="" type="checkbox"/> Enabled</p> <p>Stuttered Dial Tone <input checked="" type="checkbox"/> Enabled</p> <p>XML Beep Support <input checked="" type="checkbox"/> Enabled</p> <p>Status Scroll Delay (seconds) <input style="width: 50%;" type="text" value="5"/></p> <p>Incoming Call Interrupts Dialing <input type="checkbox"/> Enabled</p> <p>Switch UI Focus To Ringing Line <input checked="" type="checkbox"/> Enabled</p> <p>Goodbye Key Cancels Incoming Call <input checked="" type="checkbox"/> Enabled</p> <p>UPnP Mapping Lines <input type="text" value="0"/> ▾</p> <p>Message Waiting Indicator Line <input type="text" value="All"/> ▾</p> <p>DND Key Mode <input type="text" value="Phone"/> ▾</p> <p>Call Forward Key Mode <input type="text" value="Account"/> ▾</p>		
2	<p>In the "Local Dial Plan" field, enter a valid local dial plan (up to 512 alphanumeric characters) for the IP phone. Default is X+# XX+*. Enter prepended digits or a “;” to present a secondary dial tone if required.</p> <p>Note: If a User enters a dial plan longer than 512 characters, or a parsing error occurs, the phone uses the default dial plan of “x+# xx+*”.</p>		
3	<p>Enable the "Send Dial Plan Terminator" field by checking "the check box. (Disable this field by unchecking the box). Default is disabled.</p>		
4	<p>In the "Digit Timeout (in seconds)" field, enter a timeout value. This is the length of time, in seconds, the phone waits before dialing. Default is 4 seconds.</p>		
5	<p>Click <input type="button" value="Save Settings"/> to save your changes.</p>		

Park Calls/Pick Up Parked Calls

The IP phones (including the 6757i CT handset) have a park and pickup call feature that allows you to park a call and pickup a call when required. There are two ways a user or administrator can configure this feature:

- Using a static configuration (globally configures park and pickup)
- Using a programmable configuration



Note: The IP phones accept both methods of configuration. However, to avoid redundancy, Aastra Telecom recommends you configure either a static configuration or a programmable configuration.

The IP phones support the Park/Pickup feature on the Asterisk, BroadWorks, Sylantra, and ININ PBX servers.

The following paragraph describes the park and pickup static configuration on the IP phones.

Reference

For information on configuring the park and pickup programmable configuration (using a key), see [“Park/Pick Up Key \(not applicable to the 6751i\)”](#) on [page 5-234](#).

Park/Pickup Static Configuration (8 and 11-Line LCD phones only)

Using the static method of configuring park and pickup configures these features on a global basis for all IP phones connected in the network. You can use the configuration files or the Aastra Web UI to configure a park/pickup static configuration.

In the configuration files, you use the following parameters to statically configure park/pickup:

- **sprecode:**
- **pickupsprecode:**

In the Aastra Web UI, you use the following fields at **Basic Settings-> Preferences** to configure park/pickup statically:

- **Park Call**
- **Pickup Call**

How It displays on the Phone

On the IP phone UI, the static configuration method displays the following:

- When a call comes in, and you pickup the handset, the default label of "**Park**" displays on the first screen of the Phone UI.
- After pressing the "**Park**" softkey to park the call, the default label of "**Pickup**" displays on the first screen of the phone UI.



Note: On the 6757i CT handset, pressing **¶** displays the "Park" and "Pickup" labels.

The values you enter for the Park/Pickup feature are dependant on your type of server. The following table provides the values you enter for the "**sprecode**" and "**pickupsprecode**" parameters (configuration files), or "**Park Call**" and "**Pickup Parked Call**" fields (Aastra Web UI).

Park/Pickup Call Server Configuration Values

Server	Park Values*	Pickup Values*
Asterisk	70	70
Sylantro	*98	*99
BroadWorks	*68	*88
ININ PBX	callpark	pickup

*Leave "value" fields blank to disable the park and pickup feature.

Configuring Park /Pickup using Static Configuration
(8 and 11-Line LCD phones only)

Use the following procedures to configure the Park/Pickup call feature using the static configuration method.



Note: Aastra recommends you configure either the static or the programmable configuration, but not both.



Configuration Files

For specific parameters you can set in the configuration files, see Appendix A, the section, [“Park and Pickup Global Settings \(not applicable to 6751i\)”](#) on [page A-211](#).

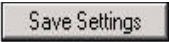
 Aastra Web UI	
1	<p>Click on Basic Settings->Preferences->General.</p> <div style="border: 1px solid black; padding: 10px; margin: 10px 0;"> </div>
2	<p>Enter a server value in the Park Call field to which incoming live calls will be parked.</p> <p>Note: For values to enter in this field, see the table “Park/Pickup Call Server Configuration Values” on page 5-60.</p>
3	<p>Enter a server value in the "Pickup Parked Call" field.</p> <p>Note: For values to enter in this field, see the table “Park/Pickup Call Server Configuration Values” on page 5-60.</p>
4	<p>Click  to save your changes.</p>

Suppressing DTMF Playback

A feature on the IP phones allows users and administrators to enable or disable the suppression of DTMF playback when a number is dialed from the softkeys and programmable keys.

When suppression of DTMF playback is disabled, and you press a softkey or programmable key, the IP phone dials the stored number and displays each digit as dialed in the LCD window.

When the suppression of DTMF playback is enabled, the IP phone dials the stored number and displays the entire number immediately in the LCD window, allowing the call to be dialed much faster.

DTMF playback suppression is enabled by default. Suppressing DTMF playback can be configured using the Aastra Web UI and the configuration files.



Configuring Suppression of DTMF Playback

Use the following procedures to configure the suppression of DTMF playback on the IP phone.

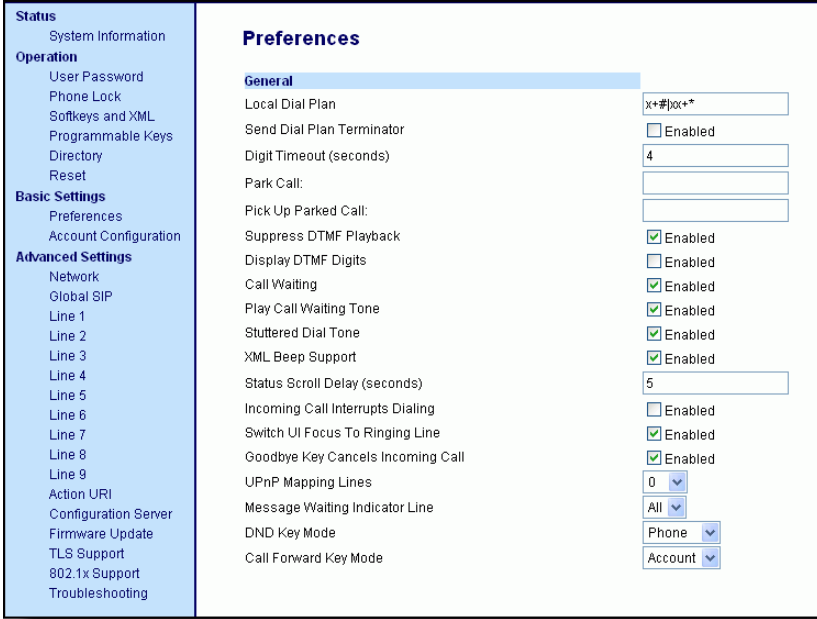
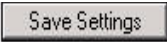

Configuration Files

For specific parameters you can set in the configuration files, see Appendix A, the section, [“Suppress DTMF Playback Setting”](#) on [page A-197](#).

 Aastra Web UI	
1	<p>Click on Basic Settings->Preferences->General.</p> <div style="border: 1px solid black; padding: 10px; margin: 10px 0;">  </div>
2	<p>Enable the "Suppress DTMF Playback" field by checking the check box. (Disable this field by unchecking the box). Default is enabled.</p>
3	<p>Click  to save your settings.</p> <p>You must restart your IP phone for the changes to take affect.</p>
4	<p>Click on Operation->Reset.</p>
5	<p>In the "Restart Phone" field click  to restart the IP phone and apply the changes.</p>

Display DTMF Digits

A feature on the IP phones allows users and administrators to enable or disable DTMF (dual-tone multi-frequency) digits to display to the IP phone when using the keypad to dial, or when dialing from a softkey or programmable key.

DTMF is the signal sent from the phone to the network that you generate when you press the phone's touch keys. This is also known as "touchtone" dialing. Each key you press on your phone generates two tones of specific frequencies. One tone is generated from a high-frequency group of tones and the other from a low frequency group.

If you enable the Display DTMF Digits parameter, the digits you are dialing from the keypad or from a softkey or programmable key display to the IP phone's LCD display. This parameter is disabled by default (no digits display when dialing).

You can enable the "Display DTMF Digits" parameter using the configuration files or the Aastra Web UI.



Configuring Display DTMF Digits

Use the following procedures to configure the suppression of DTMF playback on the IP phone.



Configuration Files

For specific parameters you can set in the configuration files, see Appendix A, the section, "[Display DTMF Digits Setting](#)" on [page A-198](#).

 Aastra Web UI	
1	<p>Click on Basic Settings->Preferences->General.</p> <div style="border: 1px solid black; padding: 10px; margin: 10px 0;"> </div>
2	<p>Enable the "Display DTMF Digits" field by checking the check box. (Disable this field by unchecking the box). Default is disabled.</p>
3	<p>Click  to save your settings.</p> <p>You must restart your IP phone for the changes to take affect.</p>
4	<p>Click on Operation->Reset.</p>
5	<p>In the "Restart Phone" field click  to restart the IP phone and apply the changes.</p>

Call Waiting/Call Waiting Tone

A call waiting feature notifies the user currently on the phone, of a new incoming call. You can disable this call waiting feature, so that the new incoming call is automatically rejected by the phone with a busy message. A User or Administrator can configure this feature.

If you disable call waiting on the phone, and the user is on a call, any further incoming calls will receive busy unless “Call Forward Busy” or “Call Forward No Answer and Busy” is configured on the phone. It will then forward the call according to the rule configured. The phone can only:

- transfer the currently active call
- or
- accept transferred calls if there is no active calls.

If call waiting is disabled:

- on the 6757i CT bases, and the handset is currently on a call, all additional incoming calls are rejected on the handset.
- intercom calls are treated as regular incoming calls and are rejected.
- pre-dialing with live dial pad disabled still accepts incoming calls.
- the “Incoming Call Cancels Dialing” parameter is ignored because the incoming call is automatically rejected.
- the Missed Calls List does not get updated with details of calls.
- the Blind Transfer feature on the phone may not work if two calls are made to the phone at one time.

You can enable/disable call waiting using the configuration files or the Aastra Web UI.

Call Waiting Tone

You can also enable or disable the playing of a short “Call Waiting Tone” when there is an incoming call on your phone. This feature is enabled by default. If you have Call Waiting enabled, and a call comes into the line for which you are on an active call, a tone is audible to notify you of that incoming call. The tone is also audible to the caller to indicate to that caller you are currently on another call.



Note: The Call Waiting Tone feature works only if Call Waiting is enabled.

A User or Administrator can configure this feature. An Administrator can configure this feature using the configuration files or the Aastra Web UI.

Configuring Call Waiting/Call Waiting Tone

Use the following procedures to configure the Call Waiting/Call Waiting Tone features on the IP phone.



Configuration Files

For specific parameters you can set in the configuration files, see Appendix A, the section, “[Call Waiting Settings](#)” on [page A-173](#).

 Aastra Web UI			
1	<p>Click on Basic Settings-> Preferences->General.</p> <div style="border: 1px solid black; padding: 10px; margin: 10px 0;"> <table border="0" style="width: 100%; border-collapse: collapse;"> <tr> <td style="width: 25%; vertical-align: top; padding: 5px;"> <div style="background-color: #e6f2ff; padding: 5px; border: 1px solid #000;"> <p>Status</p> <ul style="list-style-type: none"> System Information <p>Operation</p> <ul style="list-style-type: none"> User Password Phone Lock Softkeys and XML Programmable Keys Directory Reset <p>Basic Settings</p> <ul style="list-style-type: none"> Preferences Account Configuration <p>Advanced Settings</p> <ul style="list-style-type: none"> Network Global SIP Line 1 Line 2 Line 3 Line 4 Line 5 Line 6 Line 7 Line 8 Line 9 Action URI Configuration Server Firmware Update TLS Support 802.1x Support Troubleshooting </div> </td> <td style="padding: 5px;"> <div style="border: 1px solid #ccc; padding: 5px;"> <p>Preferences</p> <p>General</p> <p>Local Dial Plan <input style="width: 100%;" type="text" value="x*# xx+*"/></p> <p>Send Dial Plan Terminator <input type="checkbox"/> Enabled</p> <p>Digit Timeout (seconds) <input style="width: 50%;" type="text" value="4"/></p> <p>Park Call: <input style="width: 100%;" type="text"/></p> <p>Pick Up Parked Call: <input style="width: 100%;" type="text"/></p> <p>Suppress DTMF Playback <input checked="" type="checkbox"/> Enabled</p> <p>Display DTMF Digits <input type="checkbox"/> Enabled</p> <p>Call Waiting <input checked="" type="checkbox"/> Enabled</p> <p>Play Call Waiting Tone <input checked="" type="checkbox"/> Enabled</p> <p>Stuttered Dial Tone <input checked="" type="checkbox"/> Enabled</p> <p>XML Beep Support <input checked="" type="checkbox"/> Enabled</p> <p>Status Scroll Delay (seconds) <input style="width: 50%;" type="text" value="5"/></p> <p>Incoming Call Interrupts Dialing <input type="checkbox"/> Enabled</p> <p>Switch UI Focus To Ringing Line <input checked="" type="checkbox"/> Enabled</p> <p>Goodbye Key Cancels Incoming Call <input checked="" type="checkbox"/> Enabled</p> <p>UPnP Mapping Lines <input type="text" value="0"/> <input type="button" value="v"/></p> <p>Message Waiting Indicator Line <input type="text" value="All"/> <input type="button" value="v"/></p> <p>DND Key Mode <input type="text" value="Phone"/> <input type="button" value="v"/></p> <p>Call Forward Key Mode <input type="text" value="Account"/> <input type="button" value="v"/></p> </div> </td> </tr> </table> </div>	<div style="background-color: #e6f2ff; padding: 5px; border: 1px solid #000;"> <p>Status</p> <ul style="list-style-type: none"> System Information <p>Operation</p> <ul style="list-style-type: none"> User Password Phone Lock Softkeys and XML Programmable Keys Directory Reset <p>Basic Settings</p> <ul style="list-style-type: none"> Preferences Account Configuration <p>Advanced Settings</p> <ul style="list-style-type: none"> Network Global SIP Line 1 Line 2 Line 3 Line 4 Line 5 Line 6 Line 7 Line 8 Line 9 Action URI Configuration Server Firmware Update TLS Support 802.1x Support Troubleshooting </div>	<div style="border: 1px solid #ccc; padding: 5px;"> <p>Preferences</p> <p>General</p> <p>Local Dial Plan <input style="width: 100%;" type="text" value="x*# xx+*"/></p> <p>Send Dial Plan Terminator <input type="checkbox"/> Enabled</p> <p>Digit Timeout (seconds) <input style="width: 50%;" type="text" value="4"/></p> <p>Park Call: <input style="width: 100%;" type="text"/></p> <p>Pick Up Parked Call: <input style="width: 100%;" type="text"/></p> <p>Suppress DTMF Playback <input checked="" type="checkbox"/> Enabled</p> <p>Display DTMF Digits <input type="checkbox"/> Enabled</p> <p>Call Waiting <input checked="" type="checkbox"/> Enabled</p> <p>Play Call Waiting Tone <input checked="" type="checkbox"/> Enabled</p> <p>Stuttered Dial Tone <input checked="" type="checkbox"/> Enabled</p> <p>XML Beep Support <input checked="" type="checkbox"/> Enabled</p> <p>Status Scroll Delay (seconds) <input style="width: 50%;" type="text" value="5"/></p> <p>Incoming Call Interrupts Dialing <input type="checkbox"/> Enabled</p> <p>Switch UI Focus To Ringing Line <input checked="" type="checkbox"/> Enabled</p> <p>Goodbye Key Cancels Incoming Call <input checked="" type="checkbox"/> Enabled</p> <p>UPnP Mapping Lines <input type="text" value="0"/> <input type="button" value="v"/></p> <p>Message Waiting Indicator Line <input type="text" value="All"/> <input type="button" value="v"/></p> <p>DND Key Mode <input type="text" value="Phone"/> <input type="button" value="v"/></p> <p>Call Forward Key Mode <input type="text" value="Account"/> <input type="button" value="v"/></p> </div>
<div style="background-color: #e6f2ff; padding: 5px; border: 1px solid #000;"> <p>Status</p> <ul style="list-style-type: none"> System Information <p>Operation</p> <ul style="list-style-type: none"> User Password Phone Lock Softkeys and XML Programmable Keys Directory Reset <p>Basic Settings</p> <ul style="list-style-type: none"> Preferences Account Configuration <p>Advanced Settings</p> <ul style="list-style-type: none"> Network Global SIP Line 1 Line 2 Line 3 Line 4 Line 5 Line 6 Line 7 Line 8 Line 9 Action URI Configuration Server Firmware Update TLS Support 802.1x Support Troubleshooting </div>	<div style="border: 1px solid #ccc; padding: 5px;"> <p>Preferences</p> <p>General</p> <p>Local Dial Plan <input style="width: 100%;" type="text" value="x*# xx+*"/></p> <p>Send Dial Plan Terminator <input type="checkbox"/> Enabled</p> <p>Digit Timeout (seconds) <input style="width: 50%;" type="text" value="4"/></p> <p>Park Call: <input style="width: 100%;" type="text"/></p> <p>Pick Up Parked Call: <input style="width: 100%;" type="text"/></p> <p>Suppress DTMF Playback <input checked="" type="checkbox"/> Enabled</p> <p>Display DTMF Digits <input type="checkbox"/> Enabled</p> <p>Call Waiting <input checked="" type="checkbox"/> Enabled</p> <p>Play Call Waiting Tone <input checked="" type="checkbox"/> Enabled</p> <p>Stuttered Dial Tone <input checked="" type="checkbox"/> Enabled</p> <p>XML Beep Support <input checked="" type="checkbox"/> Enabled</p> <p>Status Scroll Delay (seconds) <input style="width: 50%;" type="text" value="5"/></p> <p>Incoming Call Interrupts Dialing <input type="checkbox"/> Enabled</p> <p>Switch UI Focus To Ringing Line <input checked="" type="checkbox"/> Enabled</p> <p>Goodbye Key Cancels Incoming Call <input checked="" type="checkbox"/> Enabled</p> <p>UPnP Mapping Lines <input type="text" value="0"/> <input type="button" value="v"/></p> <p>Message Waiting Indicator Line <input type="text" value="All"/> <input type="button" value="v"/></p> <p>DND Key Mode <input type="text" value="Phone"/> <input type="button" value="v"/></p> <p>Call Forward Key Mode <input type="text" value="Account"/> <input type="button" value="v"/></p> </div>		
2	<p>The "Call Waiting" field is enabled by default. To disable this field, uncheck the box. This feature allows you to enable or disable the call waiting feature on the IP phone.</p>		
3	<p>The "Play Call Waiting Tone" field is enabled by default. To disable this field, uncheck the box. This feature allows you to enable or disable the call waiting tone on the IP phone.</p> <p>Note: The Call Waiting Tone feature works only if the "Call Waiting" tone field is enabled.</p>		
4	<p>Click <input style="border: 1px solid #ccc; padding: 2px 10px;" type="button" value="Save Settings"/> to save your changes.</p>		

Stuttered Dial Tone

You can enable or disable the playing of a stuttered dial tone when there is a message waiting on the IP phone.

You can configure this feature using the configuration files and the Aastra Web UI.



Configuring Stuttered Dial Tone

Use the following procedures to configure stuttered dial tone on the IP phones.

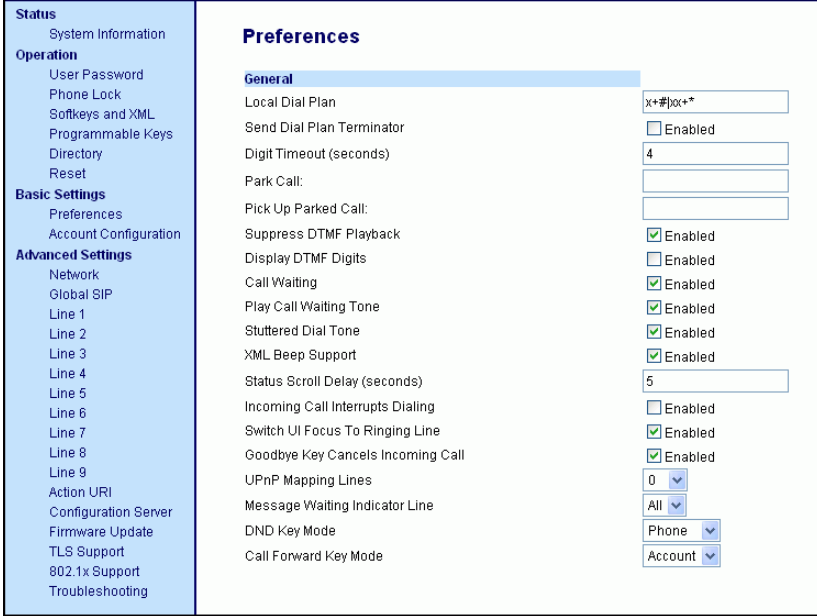

Configuration Files

For specific parameters you can set in the configuration files for enabling/disabling stuttered dial tone, see Appendix A, the section, [“Stuttered Dial Tone Setting”](#) on [page A-172](#).

 Aastra Web UI	
1	<p>Click on Basic Settings->Preferences->General.</p> <div style="border: 1px solid black; padding: 10px; margin: 10px 0;">  </div>
2	<p>The "Stuttered Dial Tone" field is enabled by default. To disable this field, uncheck the box.</p>
3	<p>Click  to save your changes.</p>

XML Beep Support

The IP phones have a feature that allows you to enable or disable a beep on the phone with it receives a status message from an XML application. This beep can be turned ON or OFF using the Aastra Web UI, the configuration files, or in an XML script.

Reference

For more information about enabling/disabling the XML Beep Support in an XML script, see [“XML Customized Services”](#) on [page 5-316](#).



Configuring XML Beep Support

Use the following procedures to enable/disable XML Beep Support.

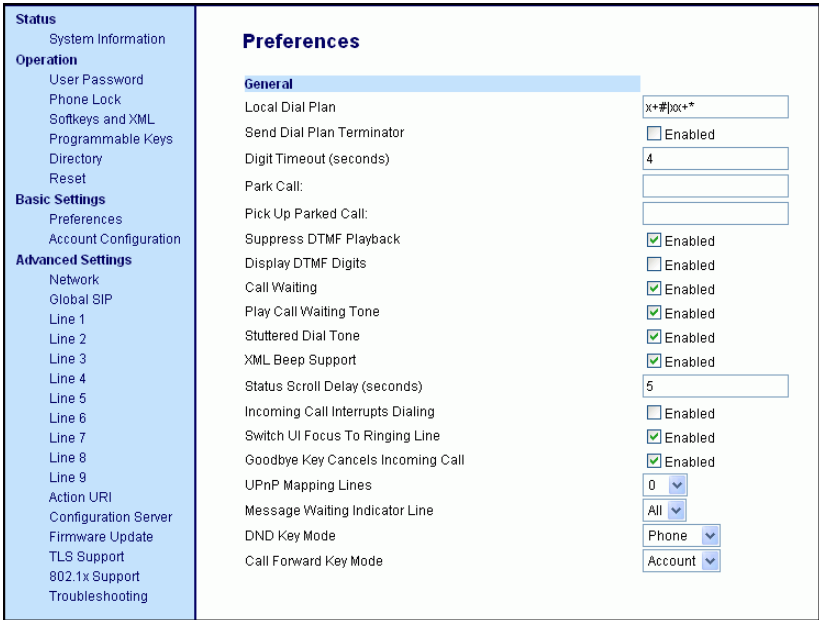

Configuration Files

For specific parameters you can set in the configuration files, see Appendix A, the section, [“XML Settings”](#) on [page A-153](#).

 Aastra Web UI	
1	<p>Click on Basic Settings->Preferences->General.</p> <div style="border: 1px solid black; padding: 10px; margin: 10px 0;">  </div>
2	<p>The “XML Beep Support” field is enabled by default. To disable this field, uncheck the box.</p>
3	<p>Click  to save your changes.</p>

Status Scroll Delay

The IP phones have a feature that allows you to specify the time delay, in seconds, between the scrolling of each status message (including XML status messages) on the phone. The default time is 5 seconds for each message to display before scrolling to the next message. You can configure this option via the configuration files or the Aastra Web UI.

Reference

For more information about configuring the status scroll delay for XML status messages, see [“XML Customized Services”](#) on [page 5-316](#).



Configuring Status Scroll Delay

Use the following procedures to configure Status Scroll Delay.

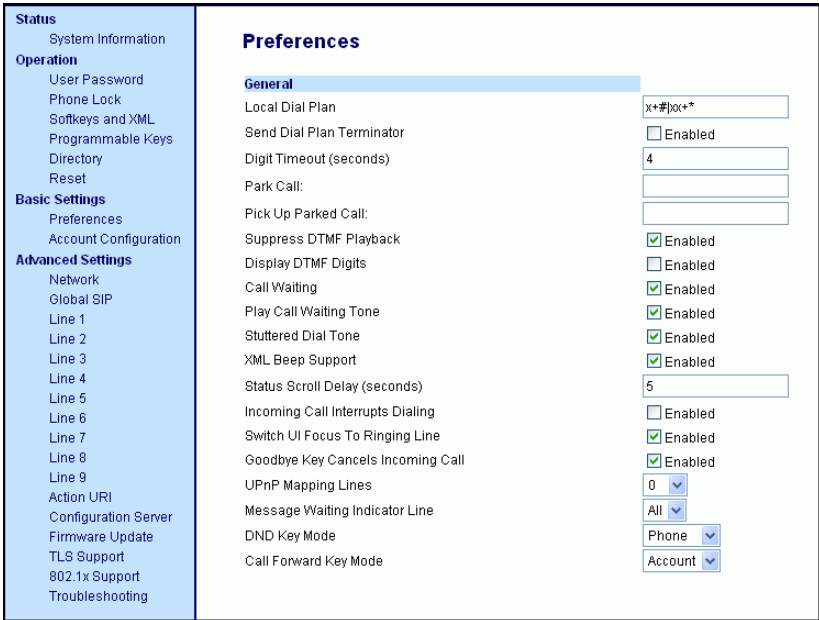

Configuration Files

For specific parameters you can set in the configuration files, see Appendix A, the section, [“XML Settings”](#) on [page A-153](#).

 Aastra Web UI	
1	<p>Click on Basic Settings->Preferences->General.</p> <div style="border: 1px solid black; padding: 10px; margin: 10px 0;">  </div>
2	<p>In the “Status Scroll Delay (seconds)” field, enter a value, in seconds, that each XML status message displays on the phone. Default is 5 seconds. Valid values are 1 to 25.</p>
3	<p>Click  to save your changes.</p>

Incoming Call Interrupts Dialing

You can configure whether or not an incoming call interrupts an outgoing call that is dialing. The “**Incoming Call Interrupts Dialing**” (Web UI) parameter or “**incoming call cancels dialing**” (in config file) parameter controls this feature.

How it Works

When you enable this parameter (1 = enable), an incoming call interrupts the outgoing call during dialing and allows the phone to ring for the user to answer the incoming call.

When you disable this parameter (0 = disable), which is the default, the phone does not interrupt the outgoing call during dialing and the number you were dialing continues to display in the LCD. The phone sends the incoming call to a free line on the phone (or sends busy signal if all remaining lines are busy) and the LED for that line blinks. You have a choice to ignore the incoming call, or answer the incoming call on another line, via the **Ignore** and **Answer** softkeys that display. If you choose to answer the incoming call, you can answer the call, finish the call, and then hang up. You can still go back to the original outgoing call and finish dialing out.



Notes:

1. On the 3-Line LCD display phones, you must use the down arrow key to ignore the call. To answer the call you must press the line key where the call is coming in.
 2. For all models, if you disable this parameter (0=disable), and the phone receives an incoming call while you are dialing an outgoing call, you can pick up the call and perform transfer or conference as required.
 3. This feature works only if the User selects a line for which to dial out. It is recommended that the Administrator always keeps Live Dialpad ON in order for the User to have to select a line before dialing out.
-

Transfer/Conference Call Behavior

If you are dialing the phone to transfer or conference a call, and your phone receives an incoming call, your dialing is never interrupted (regardless of whether the “Incoming Call Interrupts Dialing” is enabled or disabled). For Transfer and Conference, the incoming calls always go to an available line (other than the one you are using for dialing) and the incoming call’s line LED blinks. The LCD still displays your dialing screen.

Intercom Behavior

If “**Incoming Call Interrupts Dialing**” (Web UI) or “**incoming call cancels dialing**” (config file) is enabled and you are dialing an outgoing Intercom call, the enabled interrupt setting takes precedence over an enabled “**Allow Barge In**” setting. The incoming call interrupts your dialing on an outgoing intercom call. On an incoming intercom call, the enabled “**Allow Barge In**” and “**Auto-Answer**” occurs while you are dialing to transfer or conference the call. However, the incoming call goes to an available idle line, and the LED blinks while you are dialing the second half of the conference or transfer.

If “**Incoming Call Interrupts Dialing**” (Web UI) or “**incoming call cancels dialing**” (config file) is disabled, an incoming intercom goes to an available idle line and the LED blinks for that line. The phone answers the call under all conditions.



Configuring Incoming Call Interrupts Dialing

Use the following procedures to configure how the IP phone handles incoming calls that interrupt outgoing dialing.

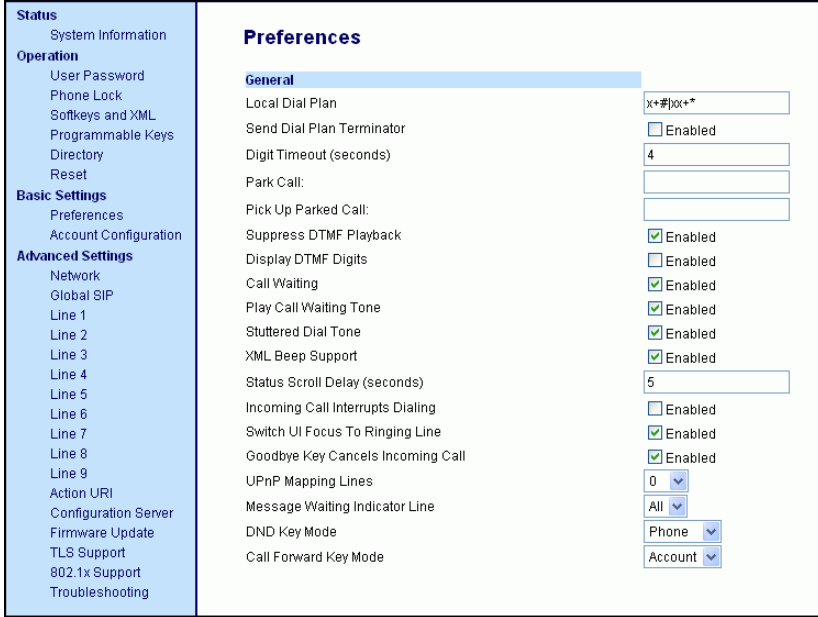

Configuration Files

For specific parameters you can set in the configuration files for enabling/disabling how the IP phones handle incoming calls that interrupt outgoing dialing, see Appendix A, the section, “[Incoming Call Interrupts Dialing Setting](#)” on [page A-167](#).

 Aastra Web UI	
1	<p>Click on Basic Settings->Preferences->General.</p> <div style="border: 1px solid black; padding: 10px; margin: 10px 0;">  </div>
2	<p>Incoming Call Interrupts Dialing is disabled by default. If required, enable the "Incoming Call Interrupts Dialing" field by checking the check box.</p>
3	<p>Click  to save your changes.</p>

Switch Focus to Ringing Line

An Administrator or User can control the behavior of the phone when it receives an incoming call when it is already in a connected call. By default, the phone switches focus to the ringing line to enable the user to see who is calling them.

You can turn off this functionality so that the phone now stays focused on the connected call. You can do this using the “**switch focus to ringing line**” parameter in the configuration files or the Aastra Web UI.



Note: If you configure the BLF/Xfer key(s) and/or Speeddial/Xfer key(s) on the phone, you can enable or disable the switching of the user interface focus to ringing line while the phone is in the connected state.

Configuring “Switch Focus to Ringing Line”

You use the following procedures to enable or disable “Switch Focus to Ringing Line”.



Configuration Files

For specific parameters you can set in the configuration files for enabling disabling “Switch Focus to Ringing Line”, see Appendix A, the section, “[Switch Focus to Ringing Line](#)” on [page A-169](#).

 **Aastra Web UI**

1	<p>Click on Basic Settings->Preferences->General.</p> <div style="border: 1px solid black; padding: 10px; margin: 10px 0;"><div style="display: flex;"><div style="width: 25%; border-right: 1px solid black; padding-right: 5px;"><p>Status</p><p>System Information</p><p>Operation</p><p>User Password</p><p>Phone Lock</p><p>Softkeys and XML</p><p>Directory</p><p>Reset</p><p>Basic Settings</p><p>Preferences</p><p>Account Configuration</p><p>Advanced Settings</p><p>Network</p><p>Global SIP</p><p>Line 1</p><p>Line 2</p><p>Line 3</p><p>Line 4</p><p>Line 5</p><p>Line 6</p><p>Line 7</p><p>Line 8</p><p>Line 9</p><p>Action URI</p><p>Configuration Server</p><p>Firmware Update</p><p>TLS Support</p><p>802.1x Support</p><p>Troubleshooting</p></div><div style="width: 75%; padding-left: 5px;"><p>Preferences</p><p>General</p><p>Local Dial Plan <input type="text" value="x+# xx+*"/></p><p>Send Dial Plan Terminator <input type="checkbox"/> Enabled</p><p>Digit Timeout (seconds) <input type="text" value="4"/></p><p>Park Call: <input type="text"/></p><p>Pick Up Parked Call: <input type="text"/></p><p>Suppress DTMF Playback <input checked="" type="checkbox"/> Enabled</p><p>Display DTMF Digits <input type="checkbox"/> Enabled</p><p>Call Waiting <input checked="" type="checkbox"/> Enabled</p><p>Play Call Waiting Tone <input checked="" type="checkbox"/> Enabled</p><p>Stuttered Dial Tone <input checked="" type="checkbox"/> Enabled</p><p>XML Beep Support <input checked="" type="checkbox"/> Enabled</p><p>Status Scroll Delay (seconds) <input type="text" value="5"/></p><p>Incoming Call Interrupts Dialing <input type="checkbox"/> Enabled</p><p>Switch Focus To Ringing Line <input checked="" type="checkbox"/> Enabled</p><p>Goodbye Key Cancels Incoming Call <input checked="" type="checkbox"/> Enabled</p><p>UPnP Mapping Lines <input type="text" value="0"/> <input type="button" value="v"/></p><p>Message Waiting Indicator Line <input type="text" value="All"/> <input type="button" value="v"/></p><p>DND Key Mode <input type="text" value="Phone"/> <input type="button" value="v"/></p><p>Call Forward Key Mode <input type="text" value="Account"/> <input type="button" value="v"/></p></div></div></div> <p style="text-align: center; margin-top: 10px;">“Switch Focus to Ringing Line” Parameter</p>
2	<p>The “Switch Focus to Ringing Line” field is enabled by default. To disable this field, uncheck the box.</p>
3	<p>Click <input type="button" value="Save Settings"/> to save your changes.</p>

5-80

41-001160-03 Rev 00, Release 2.5

Preferred Line and Preferred Line Timeout

An Administrator or User can define a **preferred line** as well as a **preferred timeout**. If a preferred line is selected, after a call ends (incoming or outgoing), the display switches back to the preferred line. Next time you go off-hook, you pickup on the preferred line. You can specify the number of seconds it takes for the phone to switch back to the preferred line using the “**preferred timeout**” parameter.

An Administrator can configure the “**preferred line**” and the “**preferred timeout**” parameters using the configuration files or the Aastra Web UI. A User can configure these parameters using the Aastra Web UI only.

The following table provides the behavior of the preferred line focus feature with other features on the phone.

Phone Feature	Preferred Line Behavior
call return	The phone switches back to the focused line immediately after the call ends.
speeddial	The line is already specified when the speeddial is created. The phone switches back immediately after the call ends.
conference	For incoming calls, the phone switches back immediately after the call ends.
transfer	For incoming or outgoing calls, the current behavior is that the same line used to transfer the call does not change. For incoming calls, the phone switches back immediately after the call transfers.
blf	The phone switches back immediately after the call ends.
park	The phone switches back immediately after the call ends.
voicemail	The phone switches back immediately after the call ends.
redial	The phone switches back immediately after the call ends.
dialing	For incomplete dialing on a non-preferred line, the focus does not change if some digits are entered. If no digits are entered or digits were cleared, the focus changes to preferred line after the time out has passed without activities.

Phone Feature	Preferred Line Behavior
caller id	If the "Switch UI Focus To Ringing Line" parameter is disabled, the User is able to see the Caller ID when the phone switches the focus to the ringing line.
factory default	Factory default and recovery mode clears the "preferred line" and "preferred line timeout" parameters, and the phone operates in a non-preferred line mode.



Notes:

1. If you specify a value of "0" for the **preferred line** parameter, it disables the preferred line focus feature.
 2. If you specify a value of "0" for the **preferred line timeout** parameter, the phone returns the line to the preferred line immediately.
-

Configuring the Preferred Line and Preferred Line Timeout

You use the following procedures to configure the Preferred Line and the Preferred Line Timeout on the IP Phones.



Configuration Files

For specific parameters you can set in the configuration files for configuring the Preferred Line and Preferred Line Timeout, see Appendix A, the section, "[Preferred Line and Preferred Line Timeout](#)" on [page A-170](#).

Use the following parameters to configure preferred line focus using the Aastra Web UI.

 Aastra Web UI																																													
1	<p>Click on Basic Settings->Preferences->General.</p> <div style="border: 1px solid black; padding: 10px; margin: 10px auto; width: 80%;"> <p>Preferences</p> <p>General</p> <table style="width: 100%; border-collapse: collapse;"> <tr><td>Local Dial Plan</td><td style="border: 1px solid #ccc; padding: 2px;">x+#[xx+*</td></tr> <tr><td>Send Dial Plan Terminator</td><td><input type="checkbox"/> Enabled</td></tr> <tr><td>Digit Timeout (seconds)</td><td style="border: 1px solid #ccc; padding: 2px;">4</td></tr> <tr><td>Park Call:</td><td style="border: 1px solid #ccc; height: 20px;"></td></tr> <tr><td>Pick Up Parked Call:</td><td style="border: 1px solid #ccc; height: 20px;"></td></tr> <tr><td>Suppress DTMF Playback</td><td><input checked="" type="checkbox"/> Enabled</td></tr> <tr><td>Display DTMF Digits</td><td><input type="checkbox"/> Enabled</td></tr> <tr><td>Call Waiting</td><td><input checked="" type="checkbox"/> Enabled</td></tr> <tr><td>Play Call Waiting Tone</td><td><input checked="" type="checkbox"/> Enabled</td></tr> <tr><td>Stuttered Dial Tone</td><td><input checked="" type="checkbox"/> Enabled</td></tr> <tr><td>XML Beep Support</td><td><input checked="" type="checkbox"/> Enabled</td></tr> <tr><td>Status Scroll Delay (seconds)</td><td style="border: 1px solid #ccc; padding: 2px;">5</td></tr> <tr><td>Incoming Call Interrupts Dialing</td><td><input type="checkbox"/> Enabled</td></tr> <tr><td>Switch UI Focus To Ringing Line</td><td><input checked="" type="checkbox"/> Enabled</td></tr> <tr><td>Preferred line</td><td style="border: 1px solid #ccc; padding: 2px;">1</td></tr> <tr><td>Preferred line Timeout (seconds)</td><td style="border: 1px solid #ccc; padding: 2px;">0</td></tr> <tr><td>Goodbye Key Cancels Incoming Call</td><td><input checked="" type="checkbox"/> Enabled</td></tr> <tr><td>UPnP Mapping Lines</td><td style="border: 1px solid #ccc; padding: 2px;">0</td></tr> <tr><td>Message Waiting Indicator Line</td><td style="border: 1px solid #ccc; padding: 2px;">All</td></tr> <tr><td>DND Key Mode</td><td style="border: 1px solid #ccc; padding: 2px;">Phone</td></tr> <tr><td>Call Forward Key Mode</td><td style="border: 1px solid #ccc; padding: 2px;">Account</td></tr> <tr><td>Use LLDP ELIN</td><td><input checked="" type="checkbox"/> Enabled</td></tr> </table> </div> <div style="margin-top: 10px;"> <p>Preferred Line →</p> <p>Preferred Line Timeout →</p> </div>	Local Dial Plan	x+#[xx+*	Send Dial Plan Terminator	<input type="checkbox"/> Enabled	Digit Timeout (seconds)	4	Park Call:		Pick Up Parked Call:		Suppress DTMF Playback	<input checked="" type="checkbox"/> Enabled	Display DTMF Digits	<input type="checkbox"/> Enabled	Call Waiting	<input checked="" type="checkbox"/> Enabled	Play Call Waiting Tone	<input checked="" type="checkbox"/> Enabled	Stuttered Dial Tone	<input checked="" type="checkbox"/> Enabled	XML Beep Support	<input checked="" type="checkbox"/> Enabled	Status Scroll Delay (seconds)	5	Incoming Call Interrupts Dialing	<input type="checkbox"/> Enabled	Switch UI Focus To Ringing Line	<input checked="" type="checkbox"/> Enabled	Preferred line	1	Preferred line Timeout (seconds)	0	Goodbye Key Cancels Incoming Call	<input checked="" type="checkbox"/> Enabled	UPnP Mapping Lines	0	Message Waiting Indicator Line	All	DND Key Mode	Phone	Call Forward Key Mode	Account	Use LLDP ELIN	<input checked="" type="checkbox"/> Enabled
Local Dial Plan	x+#[xx+*																																												
Send Dial Plan Terminator	<input type="checkbox"/> Enabled																																												
Digit Timeout (seconds)	4																																												
Park Call:																																													
Pick Up Parked Call:																																													
Suppress DTMF Playback	<input checked="" type="checkbox"/> Enabled																																												
Display DTMF Digits	<input type="checkbox"/> Enabled																																												
Call Waiting	<input checked="" type="checkbox"/> Enabled																																												
Play Call Waiting Tone	<input checked="" type="checkbox"/> Enabled																																												
Stuttered Dial Tone	<input checked="" type="checkbox"/> Enabled																																												
XML Beep Support	<input checked="" type="checkbox"/> Enabled																																												
Status Scroll Delay (seconds)	5																																												
Incoming Call Interrupts Dialing	<input type="checkbox"/> Enabled																																												
Switch UI Focus To Ringing Line	<input checked="" type="checkbox"/> Enabled																																												
Preferred line	1																																												
Preferred line Timeout (seconds)	0																																												
Goodbye Key Cancels Incoming Call	<input checked="" type="checkbox"/> Enabled																																												
UPnP Mapping Lines	0																																												
Message Waiting Indicator Line	All																																												
DND Key Mode	Phone																																												
Call Forward Key Mode	Account																																												
Use LLDP ELIN	<input checked="" type="checkbox"/> Enabled																																												
2	<p>In the “Preferred Line” field, select a preferred line to switch focus to after incoming or outgoing calls end on the phone. Valid values are:</p> <ul style="list-style-type: none"> • None (disables the preferred line focus feature) • 1 to 9 <p>Default is 1.</p> <p>For example, if you set the preferred line to “1”, when a call (incoming or outgoing) ends on the phone (on any line), the phone switches focus back to Line 1.</p>																																												

**Aastra Web UI**

3	In the " Preferred Line Timeout " field, enter the amount of time, in seconds, that the phone switches back to the preferred line after a call (incoming or outgoing) ends on the phone, or after a duration of inactivity on an active line. Default is 0 . Valid values are: <ul style="list-style-type: none">• 0 to 999
4	Click  to save your changes.

Goodbye Key Cancels Incoming Call

You can configure the Goodbye key to drop active calls or ignore incoming calls using the “**goodbye cancels incoming call**” parameter. This parameter controls the behavior of the goodbye key when the phone is on an active call and a second call is presented to the phone.

How it Works

When you enable this parameter (1 = enable in the configuration files), which is the default, the Goodbye key rejects the incoming call. When you disable this parameter (0 = disable in the configuration files), the Goodbye key hangs up the active call.

For 8 and 11-line LCD phones:

If you enable this parameter, and the phone receives another call when an active call is already present, the phone displays softkey 1 as “**answer**” and softkey 2 as “**ignore**”. You can press the required softkey as applicable.

For 3-line LCD phones:

If you enable this parameter, and the phone receives another call when an active call is already present, the “**ignore**” option *only* displays in the LCD window. The phone ignores the incoming call. If you press the **DOWN** arrow key, the phone answers the incoming call.

You can set this parameter using the configuration files or the Aastra Web UI.



Configuring the Goodbye Key to Cancel Incoming Calls

Use the following procedures to configure the behavior of the Goodbye Key on the IP phone.

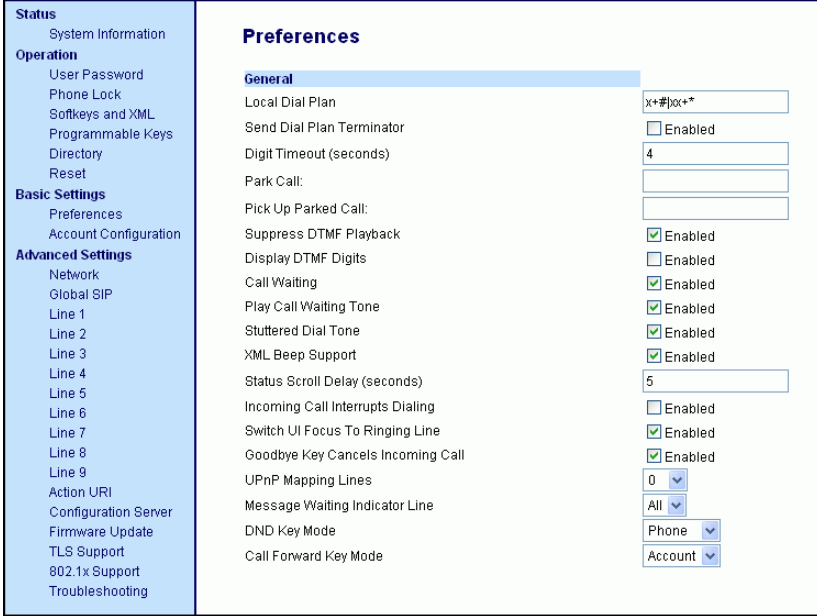

Configuration Files

For specific parameters you can set in the configuration files for enabling/disabling the behavior of the Goodbye Key, see Appendix A, the section, “[Incoming Call Interrupts Dialing Setting](#)” on [page A-167](#).

 Aastra Web UI	
1	<p>Click on Basic Settings->Preferences->General.</p> <div style="border: 1px solid black; padding: 10px; margin: 10px 0;">  </div>
2	<p>Incoming Call Interrupts Dialing is disabled by default. If required, enable the "Incoming Call Interrupts Dialing" field by checking the check box.</p>
3	<p>Click  to save your changes.</p>

Configurable Status Code on Ignoring Incoming Calls

When a user presses the “**Ignore**” key on the phones during an incoming call, the phone rejects the incoming call with a status code of “486 Busy Here”. The IP phones allow an administrator to configure this status code. You can configure the status code using the configuration files only.



Note: Valid status codes are based on RFC3261.

Use the following parameter to configure a status code when ignoring incoming calls:

- **sip ignore status code**

Configuring Status Codes on Ignoring Incoming Calls

You can use the following procedure to set the status code sent in the response when a user presses the “Ignore” key.



Configuration Files

For the specific parameter you can set in the configuration files, see Appendix A, the section, “[Status Code on Ignoring Incoming Calls](#)” on [page A-168](#).

UPnP Mapping Lines (for remote phones)

Universal Plug and Play (UPnP) is a standard that uses Internet protocols to enable devices to be plugged into a network and automatically know about each other. With UPnP, when a user plugs a device into the network, the device configures itself, acquires a TCP IP address, and uses a discovery protocol based on the Internet's HTTP or HTTPS URL to announce its presence on the network to other devices.

This method of device discovery on a network is called “Universal Plug and Play” or UPnP. If you enable UPnP, and the phone is discovered on the network, port mappings are set up between the phone and the Internet Gateway Device (IGD) in your network. The phone controls the opening, closing, and polling of ports on the IGD. HTTP and SIP use a single port each. RTP/RTCP uses a range of ports.

You can enable the UPnP mappings to specific lines on your phone. You set this configuration using the Aastra Web UI at **Basic Settings->Preferences->UPnP Mapping Lines**.



Note: UPnP must be enabled on your remote phone before you can configure the UPnP mapping lines. For information on enabling/disabling UPnP see Chapter 4, the section, “[Universal Plug and Play \(UPnP\) \(for remote phones\)](#)” on [page 4-50](#).



Configuring UPnP Mapping Lines

Use the following procedures to configure UPnP mapping on specific lines on the IP phone.

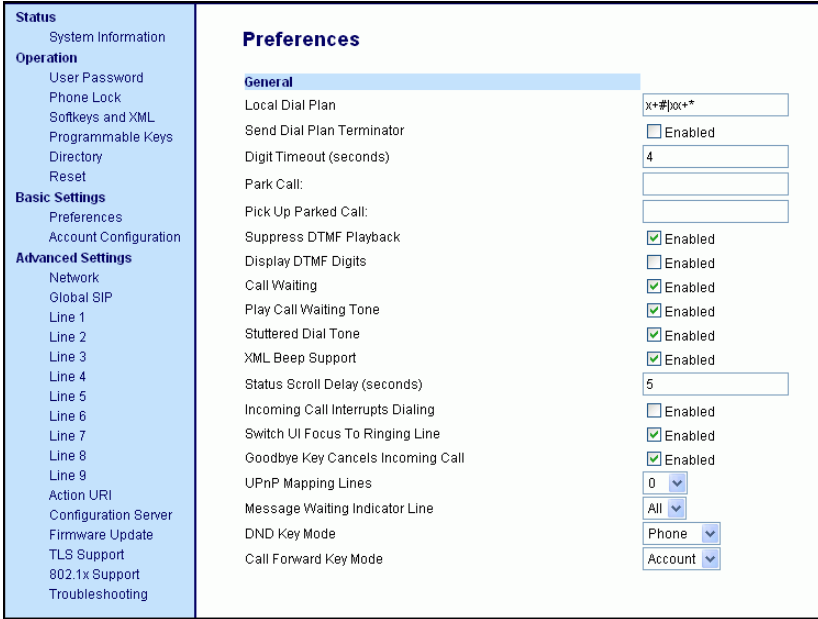

Configuration Files

For specific parameters you can set in the configuration files, see Appendix A, the section, “[UPnP Settings](#)” on [page A-41](#).

 Aastra Web UI	
1	<p>Click on Basic Settings->Preferences->General.</p> <div style="border: 1px solid black; padding: 10px; margin: 10px 0;">  </div>
2	<p>The "UPnP Mapping Lines" field is set to 0 by default. If required, change the setting to a specific line by selecting a line from the list. Valid values are 0 through 10. The line you select is the line that your remote phone uses to perform Universal Plug and Play on the network you are connecting to.</p>
3	<p>Click  to save your changes.</p>

Message Waiting Indicator Line

A User or Administrator can configure the Message Waiting Indicator (MWI) to illuminate for a specific line or for all lines. For example, if you configure the MWI LED on line 3 only, the LED illuminates if a voice mail is pending on line 3. If you configure the MWI LED for all lines, the LED illuminates if a voice mail is pending on any line on the phone (lines 1 through 9).

A User can configure the MWI using the Aastra Web UI only. An Administrator can configure the MWI on single or all lines using the configuration files or the Aastra Web UI.



Configuring Message Waiting Indicator (MWI)

Use the following procedures to configure MWI on the IP phone.

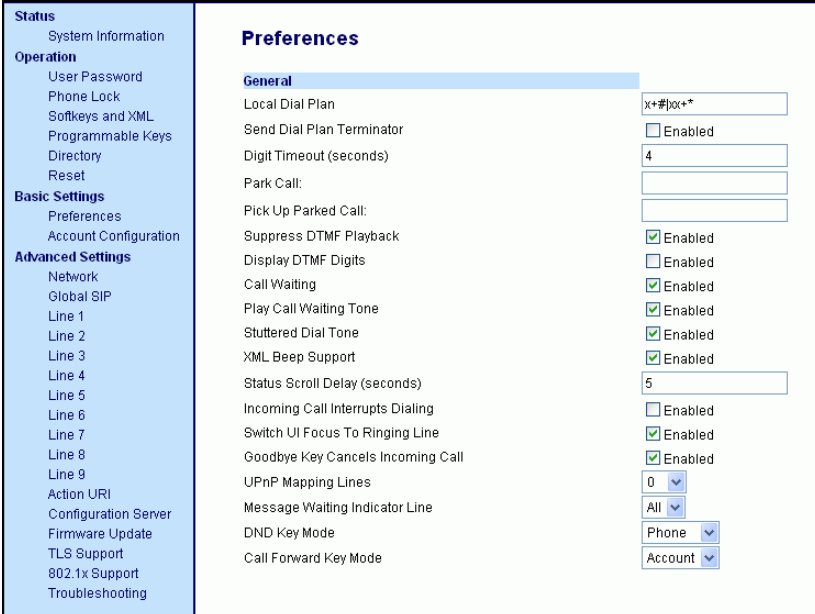

Configuration Files

For specific parameters you can set in the configuration files, see Appendix A, the section, "[Message Waiting Indicator Settings](#)" on [page A-174](#).

 Aastra Web UI	
1	<p>Click on Basic Settings-> Preferences->General.</p> <div style="border: 1px solid black; padding: 10px; margin: 10px 0;">  </div>
2	<p>In the “Message Waiting Indicator Line” field, select a single line from 1 to 9, or select “All” for all lines. If you select a single line, the MWI illuminates when a voice mail message is pending on that line. If you select all lines, the MWI illuminates when a voice mail message is pending on any line from 1 to 9.</p>
3	<p>Click  to save your changes.</p>

DND Key Mode

The IP phones have a feature you can enable called "Do not Disturb (DND). An Administrator or User can set "do not disturb" based on the accounts on the phone (all accounts or a specific account). You can set specific modes for the way you want the phone to handle DND. The three modes you can set on the phone for DND are:

- **Account**
- **Phone**
- **Custom**

An Administrator or User can set the DND mode using the Aastra Web UI at the path *Basic Settings->Preferences->General->DND Key Mode*. An Administrator can also set the DND Key Mode using the configuration files.



Note: You must configure a DND key on the phone to use this feature.

Reference

For more information about how DND works and how you can use it on the phones, see the section, "[Do Not Disturb \(DND\)](#)" on [page 5-207](#).

Configuring the DND Key Mode

Use the following procedures to set the DND Key Mode on the phone.



Configuration Files

For specific parameters you can set in the configuration files, see Appendix A, the section, "[DND Key Mode Settings](#)" on [page A-175](#).

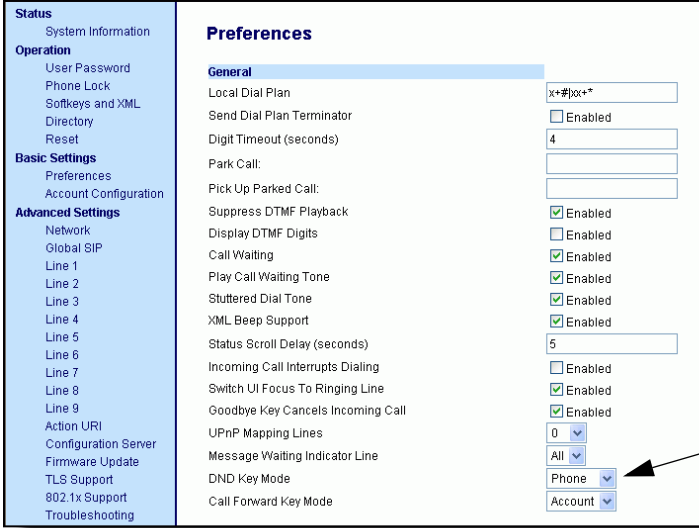
 Aastra Web UI	
1	<p>Click on Basic Settings->Preferences->General.</p> <div style="border: 1px solid black; padding: 10px; margin: 10px 0;">  </div>
2	<p>In the “DND Key Mode” field, select a “do not disturb” (DND) mode to use on the phone. Valid values are: Account, Phone, Custom. Default is Phone.</p> <ul style="list-style-type: none"> • account Sets DND for a specific account. DND key toggles the account in focus on the IP Phone UI, to ON or OFF. • phone Sets DND ON for all accounts on the phone. DND key toggles all accounts on the phone to ON or OFF. • custom Sets the phone to display custom screens after pressing the DND key, that list the account(s) on the phone. The user can select a specific account for DND, turn DND ON for all accounts, or turn DND OFF for all accounts. <p>Notes:</p> <ol style="list-style-type: none"> 1. If there is only one account configured on the phone, then the mode setting is ignored and the phone behaves as if the mode was set to “Phone”. 2. Using the Aastra Web UI, if you change the DND Key Mode to “phone”, all accounts synchronize to the current setting of Account 1.

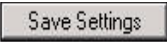
 Aastra Web UI	
3	Configure a DND key on the phone using the procedures in the section, “Do Not Disturb (DND)” on page 5-207 .
4	Click  to save your changes. The change takes effect immediately without a reboot.

Reference

For more information, see the section, [“Do Not Disturb \(DND\)”](#) on [page 5-207](#).

Call Forward Mode

Call Forward (CFWD) on the IP phone allows incoming calls to be forwarded to another destination. The phone sends the SIP message to the SIP proxy, which then forwards the call to the assigned destination.

An Administrator or User can configure CFWD on the phone-side by setting a mode for the phone to use (**Account**, **Phone**, or **Custom**). Once the mode is set, you can use the IP Phone UI to use the CFWD feature at *Options->Call Forward* or by pressing a configured Call Forward softkey/programmable key/extension module key.

The following describes the behavior for each CFWD mode.

- **Account mode** - The account mode allows you to configure CFWD on a per account basis. Pressing a configured CFWD key applies to the account in focus.
- **Phone mode** - The Phone mode allows you to set the same CFWD configuration for all accounts (**All**, **Busy**, and/or **No Answer**). When you configure the initial account, the phone applies the configuration to all other accounts. (In the Aastra Web UI, only the account you configured is enabled. All other accounts are grayed out but set to the same configuration.) Using the Aastra Web UI, if you make changes to that initial account, the changes apply to all accounts on the phone.

- **Custom mode** - The Custom mode allows you to configure CFWD for a specific account or all accounts. You can configure a specific mode (**All**, **Busy**, and/or **No Answer**) for each account independently or all accounts. On the 3-line LCD phones, you can set all accounts to **ALL On** or **ALL Off**. On the 8 and 11-Line LCD phones, you can set all accounts to **All On**, **All Off**, or copy the configuration for the account in focus to all other accounts using a **CopytoAll** softkey.



Note: If there is only one account configured on the phone, then the mode setting is ignored and the phone behaves as if the mode was set to “Phone”.

The states you can set for Call Forward are **All**, **Busy**, **No Answer**. You can enable different call forwarding rules/modes independently (for example, you can set different phone numbers for Busy, All, and NoAns modes and then turn them on/off individually. The behavior of these states is dependent on the mode (account, phone, or custom) you configure on the phone.

Reference

For more information about how Call Forwarding works and how you can use it on the IP Phones, see [“Call Forwarding”](#) on [page 5-249](#).

Configuring Call Forward Key Mode

Use the following procedures to set the Call Forward key mode on the IP phones.



Configuration Files

For specific parameters you can set in the configuration files, see Appendix A, the section, [“Call Forward Key Mode Settings”](#) on [page A-148](#).

Aastra Web UI

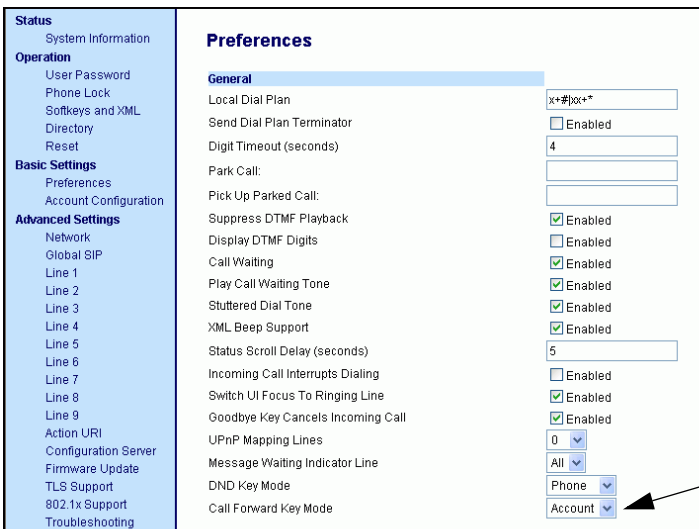

1 Click on **Basic Settings->Preferences->General**.



Status	Preferences
System Information	
Operation	General
User Password	Local Dial Plan <input type="text" value="x*# pc*"/>
Phone Lock	Send Dial Plan Terminator <input type="checkbox"/> Enabled
Softkeys and XML	Digit Timeout (seconds) <input type="text" value="4"/>
Directory	Park Call: <input type="text"/>
Reset	Park Call: <input type="text"/>
Basic Settings	Park Call: <input type="text"/>
Preferences	Pick Up Parked Call: <input type="checkbox"/> Enabled
Account Configuration	Suppress DTMF Playback <input checked="" type="checkbox"/> Enabled
Advanced Settings	Display DTMF Digits <input type="checkbox"/> Enabled
Network	Call Waiting <input checked="" type="checkbox"/> Enabled
Global SIP	Play Call Waiting Tone <input checked="" type="checkbox"/> Enabled
Line 1	Stuttered Dial Tone <input checked="" type="checkbox"/> Enabled
Line 2	XML Beep Support <input checked="" type="checkbox"/> Enabled
Line 3	Status Scroll Delay (seconds) <input type="text" value="5"/>
Line 4	Incoming Call Interrupts Dialing <input type="checkbox"/> Enabled
Line 5	Switch UI Focus To Ringing Line <input checked="" type="checkbox"/> Enabled
Line 6	Goodbye Key Cancels Incoming Call <input checked="" type="checkbox"/> Enabled
Line 7	UPnP Mapping Lines <input type="text" value="0"/>
Line 8	Message Waiting Indicator Line <input type="text" value="All"/>
Line 9	DND Key Mode <input type="text" value="Phone"/>
Action URI	Call Forward Key Mode <input type="text" value="Account"/>
Configuration Server	
Firmware Update	
TLS Support	
802.1x Support	
Troubleshooting	

Call Forward Key Mode Parameter

Note: If there is no CFWD key configured on the phone or it is removed, you can still configure Call Forwarding via the IP Phone UI at the path *Options->Call Forward*.

 Aastra Web UI	
2	<p>In the “Call Forward Key Mode” field, select a call forward mode to use on the phone. Valid values are: Account, Phone, Custom. Default is Account.</p> <ul style="list-style-type: none"> • account The account mode allows you to configure CFWD on a per account basis. Pressing a configured CFWD key applies to the account in focus. • phone The Phone mode allows you to set the same CFWD configuration for all accounts (All, Busy, and/or No Answer). When you configure the initial account, the phone applies the configuration to all other accounts. (In the Aastra Web UI, only the account you configured is enabled. All other accounts are grayed out but set to the same configuration.) Using the Aastra Web UI, if you make changes to that initial account, the changes apply to all accounts on the phone. • custom The Custom mode allows you to configure CFWD for a specific account or all accounts. You can configure a specific state (All, Busy, and/or No Answer) for each account independently or all accounts. On the 3-Line LCD phones, you can set all accounts to ALL On or ALL Off. On the 8 and 11-Line LCD phones, you can set all accounts to All On, All Off, or copy the configuration for the account in focus to all other accounts using a CopytoAll softkey. <p>Notes:</p> <ol style="list-style-type: none"> 1. If there is no CFWD key configured on the phone or it is removed, you can still set the CFWD modes via the IP Phone UI at the path <i>Options->Call Forward</i>. 2. If there is only one account configured on the phone, then the mode setting is ignored and the phone behaves as if the mode was set to “Phone”. 3. When configuring a CFWD state (All, Busy, No Answer) for an account, you must configure a CFWD number for that state in order for the state to be enabled.
3	<p>Click  to save your changes.</p> <p>The change takes effect immediately without a reboot.</p>

Reference

For more information, see the section, “[Call Forwarding](#)” on [page 5-249](#).

Link Layer Discovery Protocol for Media Endpoint Devices (LLDP-MED) and Emergency Location Identification Number (ELIN)

The IP Phones support Link Layer Discovery Protocol for Media Endpoint Devices (LLDP-MED). LLDP-MED is designed to allow for things such as:

- Auto-discovery of LAN policies (such as VLAN, Layer 2 Priority and Diffserv settings) leading to "plug and play" networking.
- Extended and automated power management of Power over Ethernet endpoints.
- Inventory management, allowing network administrators to track their network devices, and determine their characteristics (manufacturer, software and hardware versions, serial / asset number).

On the IP Phones, LLDP-MED performs the following:

- Supports the MAC/PHY configuration (e.g. speed rate/duplex mode).
- Supports VLAN info from the network policy; this takes precedence over manual settings.
- Allows you to enable/disable LLDP-MED if required.
- Allows you to configure time interval between successive LLDP Data Unit (LLDPDU) frames.
- Allows LLDP packets to be received from the LAN port.
- Allows the phone to use the location information, Explicit Congestion Notification (ECN) Emergency Location Identification Number (ELIN), sent by the switch, as a caller ID for making emergency calls.



Note: If the phone receives location information in ECN ELIN format (10 to 25 numeric string), the phone replaces the caller ID SIP header with the ECN ELIN value and the SIP URI does not change. The phone determines if this is an emergency number by checking the emergency dial plan configured on the phone.

The following table identifies the configuration parameters for LLDP and ELIN and which method you can use to configure each parameter. This table also indicates whether the parameters can be configured by an Administrator, a User, or both.

Parameter	Method of Configuration	Who Can Configure
lldp	Configuration Files	Administrator
lldp interval	Configuration Files	Administrator
use lldp elin	Configuration Files	Administrator
LLDP Support	IP Phone UI	Administrator
LLDP	Aastra Web UI	Administrator
LLDP Packet Interval	Aastra Web UI	Administrator
LLDP ELIN	Aastra Web UI	Administrator and User

Configuring LLDP-MED and ELIN

Use the following procedures to configure LLDP-MED and ELIN on the IP phones.



Configuration Files

For specific parameters you can set in the configuration files, see Appendix A, the section, “[LLDP-MED and ELIN Settings](#)” on [page A-150](#).

Use the following procedure to enable/disable LLDP-MED using the IP Phone UI.





Note: You cannot configure the “LLDP Interval” or the “Use LLDP ELIN” parameters via the IP Phone UI.



Aastra IP Phone UI

Step	Action
1	Press Options , and then select Administrator Menu . <i>On the 6751i:</i> Press Services , and then select Options->Administrator Menu .
2	Select Network Settings .
3	Select Ethernet & VLAN .
4	Select LLDP Support .
5	Press CHANGE to toggle the LLDP setting to Enabled or Disabled . This field enables or disables Link Layer Discovery Protocol for Media Endpoint Devices (LLDP-MED) on the IP Phone.
6	Press DONE to save the change.

Use the following procedure to configure LLDP-MED using the Aastra Web UI:

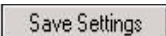
 Aastra Web UI																																											
1	<p>Click on Advanced Settings->Network->Advanced Network Settings.</p> <div style="border: 1px solid black; padding: 10px; margin: 10px 0;"> <p style="margin: 0;">Advanced Network Settings</p> <table style="width: 100%; border-collapse: collapse;"> <tr><td style="width: 60%;">DHCP User Class</td><td style="width: 40%;"><input type="text"/></td></tr> <tr><td>DHCP Option Override</td><td>None <input type="button" value="v"/></td></tr> <tr><td>LLDP</td><td><input checked="" type="checkbox"/> Enabled</td></tr> <tr><td>LLDP packet interval</td><td><input type="text" value="30"/></td></tr> <tr><td>UPnP</td><td><input type="checkbox"/> Enabled</td></tr> <tr><td>NAT IP</td><td><input type="text" value="0.0.0.0"/></td></tr> <tr><td>NAT SIP Port</td><td><input type="text" value="0"/></td></tr> <tr><td>NAT RTP Port</td><td><input type="text" value="0"/></td></tr> <tr><td>Nortel NAT Traversal Enabled</td><td><input type="checkbox"/> Enabled</td></tr> <tr><td>Nortel NAT Timer (seconds)</td><td><input type="text" value="30"/></td></tr> <tr><td>STUN Server</td><td><input type="text" value="0.0.0.0"/></td></tr> <tr><td>STUN Port</td><td><input type="text" value="3478"/></td></tr> <tr><td>TURN Server</td><td><input type="text" value="0.0.0.0"/></td></tr> <tr><td>TURN Port</td><td><input type="text" value="3479"/></td></tr> <tr><td>TURN User ID</td><td><input type="text"/></td></tr> <tr><td>TURN Password</td><td><input type="text"/></td></tr> <tr><td>Rport (RFC 3581)</td><td><input type="checkbox"/> Enabled</td></tr> <tr><td>NTP Time Servers</td><td><input type="checkbox"/> Enabled</td></tr> <tr><td>Time Server 1</td><td><input type="text" value="10.50.10.55"/></td></tr> <tr><td>Time Server 2</td><td><input type="text" value="0.0.0.0"/></td></tr> <tr><td>Time Server 3</td><td><input type="text" value="0.0.0.0"/></td></tr> </table> </div> <p style="margin-top: 10px;"> LLDP → </p> <p> LLDP Packet Interval → </p>	DHCP User Class	<input type="text"/>	DHCP Option Override	None <input type="button" value="v"/>	LLDP	<input checked="" type="checkbox"/> Enabled	LLDP packet interval	<input type="text" value="30"/>	UPnP	<input type="checkbox"/> Enabled	NAT IP	<input type="text" value="0.0.0.0"/>	NAT SIP Port	<input type="text" value="0"/>	NAT RTP Port	<input type="text" value="0"/>	Nortel NAT Traversal Enabled	<input type="checkbox"/> Enabled	Nortel NAT Timer (seconds)	<input type="text" value="30"/>	STUN Server	<input type="text" value="0.0.0.0"/>	STUN Port	<input type="text" value="3478"/>	TURN Server	<input type="text" value="0.0.0.0"/>	TURN Port	<input type="text" value="3479"/>	TURN User ID	<input type="text"/>	TURN Password	<input type="text"/>	Rport (RFC 3581)	<input type="checkbox"/> Enabled	NTP Time Servers	<input type="checkbox"/> Enabled	Time Server 1	<input type="text" value="10.50.10.55"/>	Time Server 2	<input type="text" value="0.0.0.0"/>	Time Server 3	<input type="text" value="0.0.0.0"/>
DHCP User Class	<input type="text"/>																																										
DHCP Option Override	None <input type="button" value="v"/>																																										
LLDP	<input checked="" type="checkbox"/> Enabled																																										
LLDP packet interval	<input type="text" value="30"/>																																										
UPnP	<input type="checkbox"/> Enabled																																										
NAT IP	<input type="text" value="0.0.0.0"/>																																										
NAT SIP Port	<input type="text" value="0"/>																																										
NAT RTP Port	<input type="text" value="0"/>																																										
Nortel NAT Traversal Enabled	<input type="checkbox"/> Enabled																																										
Nortel NAT Timer (seconds)	<input type="text" value="30"/>																																										
STUN Server	<input type="text" value="0.0.0.0"/>																																										
STUN Port	<input type="text" value="3478"/>																																										
TURN Server	<input type="text" value="0.0.0.0"/>																																										
TURN Port	<input type="text" value="3479"/>																																										
TURN User ID	<input type="text"/>																																										
TURN Password	<input type="text"/>																																										
Rport (RFC 3581)	<input type="checkbox"/> Enabled																																										
NTP Time Servers	<input type="checkbox"/> Enabled																																										
Time Server 1	<input type="text" value="10.50.10.55"/>																																										
Time Server 2	<input type="text" value="0.0.0.0"/>																																										
Time Server 3	<input type="text" value="0.0.0.0"/>																																										
2	<p>The “LLDP” field is enabled by default. To disable LLDP, click the check mark in the box to clear the check mark.</p>																																										
3	<p>In the “LLDP Packet Interval” field, enter the time, in seconds, between the transmission of LLDP Data Unit (LLDPDU) packets.</p> <p>The value of zero (0) disables this parameter. Valid values are 0 to 2147483647. Default is 30.</p>																																										
4	<p>Click  to save your changes.</p>																																										

Aastra Web UI																													
5	<p>Select Basic Settings->Preferences->General.</p> <div style="border: 1px solid black; padding: 10px;"><p>Preferences</p><p>General</p><table><tr><td>Local Dial Plan</td><td><input type="text" value="x+##}x+*"/></td></tr><tr><td>Send Dial Plan Terminator</td><td><input type="checkbox"/> Enabled</td></tr><tr><td>Digit Timeout (seconds)</td><td><input type="text" value="4"/></td></tr><tr><td>Suppress DTMF Playback</td><td><input checked="" type="checkbox"/> Enabled</td></tr><tr><td>Display DTMF Digits</td><td><input type="checkbox"/> Enabled</td></tr><tr><td>Call Waiting</td><td><input checked="" type="checkbox"/> Enabled</td></tr><tr><td>Play Call Waiting Tone</td><td><input checked="" type="checkbox"/> Enabled</td></tr><tr><td>Stuttered Dial Tone</td><td><input checked="" type="checkbox"/> Enabled</td></tr><tr><td>XML Beep Support</td><td><input checked="" type="checkbox"/> Enabled</td></tr><tr><td>Status Scroll Delay (seconds)</td><td><input type="text" value="5"/></td></tr><tr><td>Incoming Call Interrupts Dialing</td><td><input type="checkbox"/> Enabled</td></tr><tr><td>Switch UI Focus To Ringing Line</td><td><input checked="" type="checkbox"/> Enabled</td></tr><tr><td>Goodbye Key Cancels Incoming Call</td><td><input checked="" type="checkbox"/> Enabled</td></tr><tr><td>Use LLDP ELIN</td><td><input checked="" type="checkbox"/> Enabled</td></tr></table></div> <p>Use LLDP ELIN →</p>	Local Dial Plan	<input type="text" value="x+##}x+*"/>	Send Dial Plan Terminator	<input type="checkbox"/> Enabled	Digit Timeout (seconds)	<input type="text" value="4"/>	Suppress DTMF Playback	<input checked="" type="checkbox"/> Enabled	Display DTMF Digits	<input type="checkbox"/> Enabled	Call Waiting	<input checked="" type="checkbox"/> Enabled	Play Call Waiting Tone	<input checked="" type="checkbox"/> Enabled	Stuttered Dial Tone	<input checked="" type="checkbox"/> Enabled	XML Beep Support	<input checked="" type="checkbox"/> Enabled	Status Scroll Delay (seconds)	<input type="text" value="5"/>	Incoming Call Interrupts Dialing	<input type="checkbox"/> Enabled	Switch UI Focus To Ringing Line	<input checked="" type="checkbox"/> Enabled	Goodbye Key Cancels Incoming Call	<input checked="" type="checkbox"/> Enabled	Use LLDP ELIN	<input checked="" type="checkbox"/> Enabled
Local Dial Plan	<input type="text" value="x+##}x+*"/>																												
Send Dial Plan Terminator	<input type="checkbox"/> Enabled																												
Digit Timeout (seconds)	<input type="text" value="4"/>																												
Suppress DTMF Playback	<input checked="" type="checkbox"/> Enabled																												
Display DTMF Digits	<input type="checkbox"/> Enabled																												
Call Waiting	<input checked="" type="checkbox"/> Enabled																												
Play Call Waiting Tone	<input checked="" type="checkbox"/> Enabled																												
Stuttered Dial Tone	<input checked="" type="checkbox"/> Enabled																												
XML Beep Support	<input checked="" type="checkbox"/> Enabled																												
Status Scroll Delay (seconds)	<input type="text" value="5"/>																												
Incoming Call Interrupts Dialing	<input type="checkbox"/> Enabled																												
Switch UI Focus To Ringing Line	<input checked="" type="checkbox"/> Enabled																												
Goodbye Key Cancels Incoming Call	<input checked="" type="checkbox"/> Enabled																												
Use LLDP ELIN	<input checked="" type="checkbox"/> Enabled																												
6	<p>The “Use LLDP ELIN” field is enabled by default. To disable LLDP ELIN, click the check mark in the box to clear the check mark.</p> <p>This field enables or disables the use of an Emergency Location Identification Number (ELIN) received from LLDP as a caller ID for emergency numbers.</p>																												
7	<p>Click  to save your changes.</p>																												

Incoming/Outgoing Intercom with Auto-Answer and Barge In

The Intercom feature allows you to press the configured Intercom button on the IP phone and then enter the number you want to call to initiate an intercom call. Intercom calls can be controlled either locally (phone-side) or by the SIP server (server-side).

You can configure incoming and outgoing intercom calls on all phone models. A User can configure incoming intercom calls only.

Outgoing Intercom Calls

On outgoing intercom calls, an available unused line is found when the Icom button is pressed. Since this line has no configuration, the phone applies an existing configuration ("Outgoing Intercom Settings", Line, default is Line 1) to this line in preparation for placing the intercom call. For example, an outgoing intercom call can use the configuration of line 1 but places the actual intercom call using line 9. Only an Administrator can configure outgoing intercom calls.

A **phone-side** Intercom call indicates the phone is responsible for telling the recipient that an intercom call is being placed, while a **server-side** intercom call means the SIP server is responsible for informing the recipient. Server-side calls require additional configuration of a **prefix code**. After pressing the Icom button and entering the number to call, the phone automatically adds the prefix to the called number and sends the outgoing call via the server.

For outgoing intercom calls, an administrator can configure the following parameters:

Configuration File Parameters	Web UI Parameters
• sip intercom type	• Type)
• sip intercom prefix code	• Prefix Code
• sip intercom line	• Line



Note: To configure outgoing intercom calls using these parameters, see [“Configuring Intercom Calls Settings”](#) on [page 5-105](#).

Incoming Intercom Calls

You can configure how the phone handles incoming intercom calls. You can receive incoming intercom calls whether or not there are active calls on the phone. The way the phone handles the call depends on the incoming intercom call configuration. The following paragraphs describe the configuration parameters for incoming intercom calls.

Microphone Mute

You can mute or unmute the microphone on the IP phone for intercom calls made by the originating caller. If you want to mute the intercom call, you enable this feature. If you want to unmute (or hear the intercom call), you disable this feature.

Auto-Answer/Play Warning Tone

The auto-answer feature on the IP phone allows you to enable or disable automatic answering for an Intercom call. If “Auto-Answer” is enabled, the phone automatically answers an incoming intercom call. If “Play Warning Tone” is also enabled, the phone plays a tone to alert the user before answering the intercom call. If “Auto-Answer” is disabled, the phone rejects the incoming intercom call and sends a busy signal to the caller.

“Delay” before Auto-Answer

The IP Phones include support for the "delay" parameter (in the Alert-Info header, used in conjunction with info=alert-autoanswer) in order to facilitate auto-answer functionality. When present, the value of the "delay" parameter specifies the length of time in seconds an IP phone rings before a call is auto-answered. If this value of the "delay" parameter set to 0 (delay=0), then an incoming call is immediately auto-answered. The absence of the parameter is considered as ring forever.

In order for the delay functionality to operate, you must first enable Auto-Answer on the IP Phone.

Allow Barge In

You can configure whether or not the IP phone allows an incoming intercom call to interrupt an active call. The “**sip intercom allow barge in**” parameter controls this feature. When you enable the **sip intercom allow barge in** parameter (1 = enable in the configuration files), which is the default value, an incoming intercom call takes precedence over any active call, by placing the active call on hold and automatically answering the intercom call. When you disable this parameter (0 = disable in the configuration files), and there is an active call, the phone treats an incoming intercom call like a normal call and plays the call warning tone. You can set this parameter using the configuration files or the Aastra Web UI.

For incoming intercom calls, an administrator or user can configure the following parameters:

Configuration File Parameters	Web UI Parameters
• sip allow auto answer	• Auto-Answer
• sip intercom mute mic	• Microphone Mute
• sip intercom warning tone	• Play Warning Tone
• sip intercom allow barge in	• Barge In



Note: To configure incoming intercom calls using these parameters, see “[Configuring Intercom Calls Settings](#)” on page 5-105.

Configuring Intercom Calls Settings

You can configure the Intercom feature using the configuration files or the Aastra Web UI.



Note: An administrator can configure the incoming and outgoing Intercom feature. A user can configure the incoming Intercom feature only.

Use the following procedures to configure Intercom calls on the IP phone.

Configuration Files

For specific parameters you can set in the configuration files for outgoing Intercom, see Appendix A, the section, "[Outgoing Intercom Settings](#)" on [page A-199](#).

For specific parameters you can set in the configuration files for incoming Intercom, see Appendix A, the section, "[Incoming Intercom Settings](#)" on [page A-201](#).



Aastra Web UI

Outgoing intercom settings

1 Click on **Basic Settings->Preferences->Outgoing Intercom Settings**.

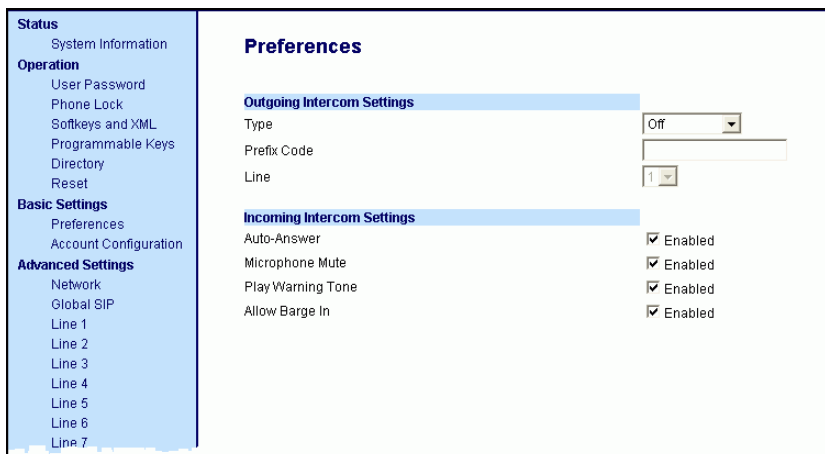

2 Select an Intercom type for outgoing Intercom calls from the **Type** list box.
Valid values are **Phone-Side**, **Server-Side**, **Off**. Default is **Off**.

3 If Server-Side is selected, enter a prefix to add to the phone number in the "**Prefix Code**" field.

Note: For Sylanro servers, enter *96.

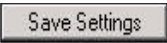
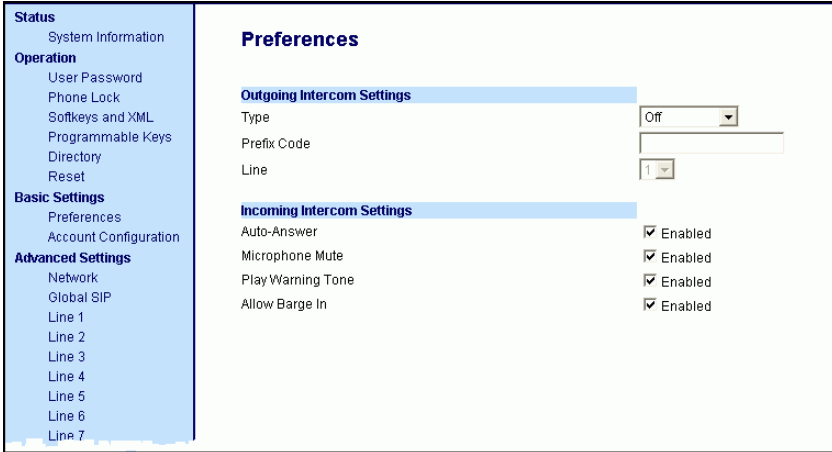
 Aastra Web UI	
4	<p>If Phone-Side or Server-Side is selected, select a line from the Line list box for which you want the IP phone to use as its configuration on the Intercom call.</p> <p>Note: The IP phone uses the configuration from the line you select from this list box. The call itself is made using the first available line at the time of the call.</p>
5	<p>Click  to save your changes.</p>
Incoming intercom settings:	
1	<p>Click on Basic Settings->Preferences->Incoming Intercom Settings.</p> <div style="border: 1px solid black; padding: 10px; margin: 10px 0;">  </div>
2	<p>The "Auto-Answer" field is enabled by default. The automatic answering feature is turned on for the IP phone for answering Intercom calls. To disable this field, uncheck the box.\</p> <p>Note: If the Auto-Answer field is not checked (disabled), the phone rejects the incoming intercom call and sends a busy signal to the caller.</p>
3	<p>The "Microphone Mute" field is enabled by default. The microphone is muted on the IP phone for Intercom calls made by the originating caller. To disable this field, uncheck the box.</p>
4	<p>The "Play Warning Tone" field is enabled by default. If "Auto-Answer" is enabled, the phone plays a warning tone when it receives in incoming intercom call. To disable this field, uncheck the box.</p>

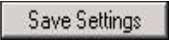
 Aastra Web UI	
5	The " Allow Barge In " field is enabled by default. If an active line on the phone receives an incoming intercom call, the active call is put on hold and the phone automatically answers the incoming intercom call. To disable this field, uncheck the box.
6	Click  to save your changes.

Group Paging RTP Settings

An Administrator or User can configure a specific key (softkey, programmable key, or expansion module key) on the phone that allows you to send/receive a Real Time Transport Protocol (RTP) stream to/from pre-configured multicast address(es) without involving SIP signaling. This is called Group Paging on the IP phones. You can specify up to 5 listening multicast addresses.

An Administrator can use the following parameters in the configuration files to set Group Paging RTP Settings:

- **paging group listening**
- **softkeyN type, topsoftkeyN type, prgkeyN type, or expmodX keyN type**
- **softkeyN label**
- **softkeyN value, topsoftkeyN value, prgkeyN value, or expmodX keyN value**

An Administrator or User can use the following parameters in the Aastra Web UI to set Group Paging RTP Settings:

- **Paging Listen Addresses** (Path: *Basic Settings->Preferences->Group Paging RTP Settings*)
- **<Paging> Key** (*Operation->Softkeys and XML, Programmable Keys, or Expansion Module Keys*)



Note: The Group Paging RTP Settings are dependant upon the setting for the "**Allow Barge In**" parameter.

How it works

After pressing a configured “Paging” key on the phone, the Phone sends RTP to a preconfigured multicast address(es) (IP port). Any phone in the local network then listens for RTP on the preconfigured multicast address(es) (IP port). For both sending and receiving of the multicast RTP there is no sip signaling involved. The Phone displays the multicast RTP sent/received address(es) to the user.



Note: Multicast RTP is one way only - from sender to the receiver (i.e. from sender to the multicast address(es) (receiver)).

The phone uses a preconfigured G711 uLaw CODEC for multicast RTP.

For Paging Systems, the phone only plays RTP traffic; users have the ability to drop a rogue page. The recipient can drop the incoming page if required. The recipient can also set Do Not Disturb (DND) to ignore any incoming pages.



Note: For outgoing RTP multicasts, all other existing calls on the phone are put on hold.

For incoming RTP multicasts, the ringing display is dependant on the “**Allow Barge-In**” parameter. If this parameter is **disabled**, and there is not other call on the phone, then the paging is automatically played via the preferred audio device (see the model-specific *IP Phone User Guide* for setting Audio Mode on the phone).

If there is an existing call on the phone, the call initially displays in the ringing state. The user has the option to accept/ignore the call. If the “**Allow Barge-In**” parameter is **enabled**, the RTP multicast call barges in, and any existing calls are put on hold.

If an RTP multicast session already exists on the phone, and the phone receives another incoming RTP multicast session, the priority is given to the first multicast session and the second multicast session is ignored. The behavior for the incoming calls in this case is also based on the setting for the “**Allow Barge-in**” parameter. The incoming call is handled as if there were an existing call already on the phone.

Configuring Group Paging RTP Settings

Use the following procedure to configure Group Paging RTP Settings using the configuration files.



Configuration Files

For specific parameters you can set in the configuration files, see Appendix A, the section, “[Group Paging RTP Settings](#)” on [page A-203](#).

Use the following procedure to configure RTP streaming for Paging applications using the Aastra Web UI.



Aastra Web UI

1 Click on **Basic Settings->Preferences->Group Paging RTP Settings**.

The screenshot displays the Aastra Web UI interface. On the left is a vertical navigation menu with the following categories and items:

- Status**
 - System Information
- Operation**
 - User Password
 - Phone Lock
 - Softkeys and XML
 - Directory
 - Reset
- Basic Settings**
 - Preferences
 - Account Configuration
- Advanced Settings**
 - Network
 - Global SIP
 - Line 1
 - Line 2
 - Line 3
 - Line 4
 - Line 5
 - Line 6
 - Line 7
 - Line 8
 - Line 9
 - Action URI
 - Configuration Server
 - Firmware Update
 - TLS Support
 - 802.1x Support
 - Troubleshooting

The main content area on the right is titled **Preferences**. Under this heading, the **Group Paging RTP Settings** option is highlighted with a blue bar. Below it, the **Paging Listen Addresses** field is visible, containing a text input box.



Aastra Web UI

2 In the **“Paging Listen Addresses”** text box, enter the multicast IP address(es) and port number on which the phone listens for incoming multicast RTP packets.

Note: Enter the IP address in dotted decimal format (for example, **224.0.0.2:10000,239.0.1.20:15000**) If this field is blank, Paging listening capability is disabled on the phone.

3 Click on **Softkeys and XML**.
 or
 Click on **Programmable Keys**.
 or
 Click on **Expansion Module Keys**.

Softkeys Configuration

Bottom Keys | **Top Keys**

Key	Type	Label	Value	Line	Idle	Connected	Incoming	Outgoing	Busy
1	Paging	Group 1	224.0.0.2:10000	1	<input checked="" type="checkbox"/>	<input checked="" type="checkbox"/>	<input checked="" type="checkbox"/>	<input checked="" type="checkbox"/>	<input checked="" type="checkbox"/>
2	None			1	<input checked="" type="checkbox"/>	<input checked="" type="checkbox"/>	<input checked="" type="checkbox"/>	<input checked="" type="checkbox"/>	<input checked="" type="checkbox"/>
3	None			1	<input checked="" type="checkbox"/>	<input checked="" type="checkbox"/>	<input checked="" type="checkbox"/>	<input checked="" type="checkbox"/>	<input checked="" type="checkbox"/>
4	None			1	<input checked="" type="checkbox"/>	<input checked="" type="checkbox"/>	<input checked="" type="checkbox"/>	<input checked="" type="checkbox"/>	<input checked="" type="checkbox"/>
5	None			1	<input checked="" type="checkbox"/>	<input checked="" type="checkbox"/>	<input checked="" type="checkbox"/>	<input checked="" type="checkbox"/>	<input checked="" type="checkbox"/>
6	None			1	<input checked="" type="checkbox"/>	<input checked="" type="checkbox"/>	<input checked="" type="checkbox"/>	<input checked="" type="checkbox"/>	<input checked="" type="checkbox"/>
7	None			1	<input checked="" type="checkbox"/>	<input checked="" type="checkbox"/>	<input checked="" type="checkbox"/>	<input checked="" type="checkbox"/>	<input checked="" type="checkbox"/>
8	None			1	<input checked="" type="checkbox"/>	<input checked="" type="checkbox"/>	<input checked="" type="checkbox"/>	<input checked="" type="checkbox"/>	<input checked="" type="checkbox"/>
9	None			1	<input checked="" type="checkbox"/>	<input checked="" type="checkbox"/>	<input checked="" type="checkbox"/>	<input checked="" type="checkbox"/>	<input checked="" type="checkbox"/>
10	None			1	<input checked="" type="checkbox"/>	<input checked="" type="checkbox"/>	<input checked="" type="checkbox"/>	<input checked="" type="checkbox"/>	<input checked="" type="checkbox"/>
11	None			1	<input checked="" type="checkbox"/>	<input checked="" type="checkbox"/>	<input checked="" type="checkbox"/>	<input checked="" type="checkbox"/>	<input checked="" type="checkbox"/>
12	None			1	<input checked="" type="checkbox"/>	<input checked="" type="checkbox"/>	<input checked="" type="checkbox"/>	<input checked="" type="checkbox"/>	<input checked="" type="checkbox"/>
13	None			1	<input checked="" type="checkbox"/>	<input checked="" type="checkbox"/>	<input checked="" type="checkbox"/>	<input checked="" type="checkbox"/>	<input checked="" type="checkbox"/>
14	None			1	<input checked="" type="checkbox"/>	<input checked="" type="checkbox"/>	<input checked="" type="checkbox"/>	<input checked="" type="checkbox"/>	<input checked="" type="checkbox"/>
15	None			1	<input checked="" type="checkbox"/>	<input checked="" type="checkbox"/>	<input checked="" type="checkbox"/>	<input checked="" type="checkbox"/>	<input checked="" type="checkbox"/>
16	None			1	<input checked="" type="checkbox"/>	<input checked="" type="checkbox"/>	<input checked="" type="checkbox"/>	<input checked="" type="checkbox"/>	<input checked="" type="checkbox"/>
17	None			1	<input checked="" type="checkbox"/>	<input checked="" type="checkbox"/>	<input checked="" type="checkbox"/>	<input checked="" type="checkbox"/>	<input checked="" type="checkbox"/>
18	None			1	<input checked="" type="checkbox"/>	<input checked="" type="checkbox"/>	<input checked="" type="checkbox"/>	<input checked="" type="checkbox"/>	<input checked="" type="checkbox"/>
19	None			1	<input checked="" type="checkbox"/>	<input checked="" type="checkbox"/>	<input checked="" type="checkbox"/>	<input checked="" type="checkbox"/>	<input checked="" type="checkbox"/>
20	None			1	<input checked="" type="checkbox"/>	<input checked="" type="checkbox"/>	<input checked="" type="checkbox"/>	<input checked="" type="checkbox"/>	<input checked="" type="checkbox"/>

4 Choose a key that you want to assign as the Paging Key and select **Paging** from the **“Type”** field.

5 In the **“Label”** field, enter a key label to assign to the Paging key (for example, **“Group 1”**).

**Aastra Web UI**

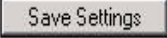
6	<p>In the “Value” field, enter a multicast IP address(es) and a port number for the Paging key. When you press this key, the phone initiates an outgoing multicast RTP session to the specified address(es) using the specified port. (For example, 224.0.0.2:10000).</p> <p>Note: When you select Paging for the “Type” field, the “Line” field and state fields are disabled.</p>
7	<p>Click  to save your changes.</p>

Using the Configured Paging Key on the IP Phone

The following procedure describes the use of the Paging key. The procedure assumes you have already configured the Paging key using the configuration files or the Aastra Web UI.



Notes:

1. Recipient of a Paging call can set a global “Do Not Disturb” (DND) to ignore any incoming pages.
2. For incoming Paging, the phones use the Intercom configuration settings. The incoming Page is dependant on the “Allow Barge-In” parameter setting and the “*Idling/On Call*” state.

 Aastra IP Phone UI	
Step	Action
	<p>On the IP Phone, press the key you configured for Paging (labeled as “Group 1” in the following illustration).</p> <div style="text-align: center; border: 1px solid gray; padding: 5px; width: fit-content; margin: 10px auto;"> <p>Services Icom Dir Callers Tues Jan1 10:00am Group 1 LAB ACD</p> </div> <p>The phone opens a multicast RTP session and an outgoing OR incoming phone screen displays as follows:</p> <div style="text-align: center; border: 1px solid gray; padding: 5px; width: fit-content; margin: 10px auto;"> <p>Paging 00:01 Drop</p> </div> <p>Press the Drop key to end the multicast RTP session and return to the idle screen.</p> <p>Note: If you enable global DND on the phone, the incoming multicast RTP session is dropped.</p>

Key Mapping

There are hard keys on your phone, such as **Hold**, **Redial**, **Xfer**, and **Conf** that are configured by default for specific call-handling features. (See the product-specific User Guide for more information about these key functions.)



Notes:

1. On 8 and 11-Line LCD phones, the Xfer and Conf keys are hard-coded by default on keys 5 and 6 to the left of the LCD display and cannot be reassigned. The Xfer and Conf labels display when you lift the handset. To disable these keys, see [“Enabling/Disabling Redial, Xfer, and Conf Keys”](#) on [page 5-114](#).
 2. On the 3-Line LCD phones, the Xfer and Conf keys are assigned by default to available keys, respectively. These keys are programmable keys and can be reassigned if applicable. To disable these keys, see [“Enabling/Disabling Redial, Xfer, and Conf Keys”](#) on [page 5-114](#).
-

Enabling/Disabling Redial, Xfer, and Conf Keys

You can enable or disable the **Redial**, **Xfer**, and **Conf** keys as required using the following parameters in the configuration files:

- **redial disabled**
- **conference disabled**
- **call transfer disabled**

Valid values for this parameter are **0** (enabled) and **1** (disabled).

If this parameter is set to **1**, the key is not active and is ignored if pressed by the user. For **"redial disabled"** the value of 1 does not save the dialed number to the "Redial List".

If this parameter is set to **0**, the key is active and can be pressed by the user.

This feature is configurable via the configuration files only.

Use the following procedure to enable/disable the **Redial**, **Xfer**, and **Conf** keys.



Configuration Files

For specific parameters you can set in the configuration files, see Appendix A, the section, “[Mapping Key Settings](#)” on [page A-213](#).

Mapping Redial and Conf Keys as Speeddials

You can map the **Redial** and **Conference** keys on the IP phone to use as speeddial keys. When the **Redial** or **Conference** key is pressed, the number configured for the key automatically speed dials. If no number is configured, the **Redial** and **Conference** keys return to their original functionality.

You can configure this feature using the configuration files or the Aastra Web UI.





Note: If you configure the **Redial** and **Conference** keys for speeddialing on the 6757i CT Base Station, the **Redial** and **Conference** keys on the 6757i CT handset retain their original functionality. The **Redial** and **Conference** keys on the handset are not configured for speeddial.

Use the following procedures to set the Redial and Conf keys as speeddial keys.

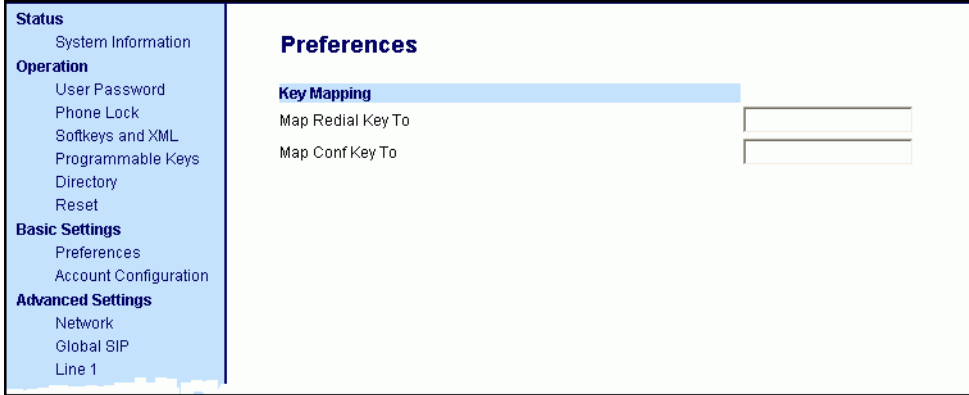

Configuration Files

For specific parameters you can set in the configuration files, see Appendix A, the section, “[Mapping Key Settings](#)” on [page A-213](#).

Aastra Web UI	
1	<p>Click on Basic Settings->Preferences.</p> 
2	<p>In the Key Mapping section, enter a number in the "Map Redial Key To" field, that the IP phone will use to speeddial when the Redial key is pressed.</p>
3	<p>Enter a number in the "Map Conf Key To" field, that the IP phone will use to speeddial when the Conf Key is pressed.</p>
4	<p>Click  to save your changes.</p>

Using Redial Key for “Last Number Redial”

The IP phones have an enhanced redial user interface that allows a user to quickly redial the last number that was dialed out from the phone. You can:

- Press the REDIAL key twice to redial the last number dialed.
- Press the REDIAL key once, scroll the list of numbers, then press the REDIAL button again to dial the number that displays on the screen.

The “last number redial” feature for the Redial key is static and is not configurable.



Note: You can use the Redial key during active calls.

Ring Tones and Tone Sets

You can configure ring tones and ring tone sets on the IP phones.

Ring Tones

There are several distinct ring tones a user or administrator can select from to set on the IP phones. You can enable/disable these ring tones on a global basis or on a per-line basis.

The following table identifies the valid settings and default values for each type of configuration method.

Ring Tone Settings Table

Configuration Method	Valid Values	Default Value
Configuration Files	<u>Global:</u> 0 (Tone1) 1 (Tone 2) 2 (Tone 3) 3 (Tone 4) 4 (Tone 5) 5 (Silent) <u>Per-Line:</u> -1 (global) 0 (Tone1) 1 (Tone 2) 2 (Tone 3) 3 (Tone 4) 4 (Tone 5) 5 (Silent)	<u>Global:</u> 0 (tone 1) <u>Per-Line:</u> -1 (global)
IP Phone UI	<u>Global:</u> Tone 1 Tone 2 Tone 3 Tone 4 Tone 5	<u>Global:</u> Tone 1

Configuration Method	Valid Values	Default Value
Aastra Web UI	<u>Global:</u> Tone 1 Tone 2 Tone 3 Tone 4 Tone 5 Silent <u>Per-Line:</u> Global Tone 1 Tone 2 Tone 3 Tone 4 Tone 5 Silent	<u>Global:</u> Tone 1 <u>Per-Line:</u> Global

Ring Tone Sets

In addition to ring tones, you can configure ring tone sets on a global-basis on the IP phones. Ring tone sets consist of tones customized for a specific country. The ring tone sets you can configure on the IP phones are:

- **US** (Default - also used in Canada)
- **Australia**
- **Europe (generic tones)**
- **France**
- **Germany**
- **Italy**
- **Mexico**
- **Brazil**
- **United Kingdom (UK)**

When you configure the country's tone set, the country-specific tone is heard on the phone for the following:

- dial tone
- secondary dial tone
- ring tone
- busy tone
- congestion tones
- call waiting tone
- ring cadence pattern

Important: You configure ring tones and tone sets using the Aastra Web UI, IP Phone UI, or configuration files. However, when using the IP phone UI, you can set global configuration only.

Configuring Ring Tones and Tone Sets

Use the following procedures to configure ring tones and tone sets on the IP phones.



Configuration Files

For specific parameters you can set in the configuration files for ring tones, see Appendix A, the section, “Ring Tone and Tone Set Global Settings” on page A-164 or “Ring Tone Per-Line Settings” on page A-166.



IP Phone UI

Step	Action
<i>For global configuration only:</i>	
1	Press  on the phone to enter the Options List.
2	Select Preferences .
3	Select Tones .
4	Select Set Ring Tone .
5	Select the type of ring tone (Tone 1 through Tone 5 , or Silent).
6	Press Done to save the change.
7	Select Tone Set .
8	Select the country for which you want to apply the tone set. Valid values are Australia, Europe, France, Germany, Italy, Mexico, Brazil, UK , and US . Default is US .
9	Press Done to save the change. The ring tone and tone set you select is immediately applied to the IP phone.

 **Aastra Web UI**

1 Click on **Basic Settings->Preferences**.



For global configuration:

2 In the "**Ring Tones**" section, select a country from the "**Tone Set**" field. Valid values are **Australia, Europe, France, Germany, Italy, Mexico, Brazil, UK, and US**. Default is **US**.

3 Select a value from the "**Global Ring Tone**" field.
Note: See the "[Ring Tone Settings Table](#)" on [page 5-118](#) for valid values.

For per-line configuration:

4 In the "**Ring Tone**" section, select a line for which you want to set ring tone.

5 Select a value from the "**LineN**" field.
Note: See the "[Ring Tone Settings Table](#)" on [page 5-118](#) for valid values.

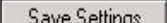
6 Click  to save your changes.

Priority Alerting

Priority alerting on the IP phones is a feature that allows incoming calls to trigger pre-defined ringing or call waiting alert tones.

You can enable or disable priority alerting on the IP phone for the Asterisk, Broadworks, and Sylanro servers using the configuration files and the Aastra Web UI. Configuration of priority alerting is on a global-basis only.

How Priority Alerting Works

When the IP phone detects an incoming call, the phone firmware inspects the INVITE request in the IP packet for an "Alert-Info" header.

If it contains an "Alert-Info" header, the firmware strips out the URL and keyword parameter and maps it to the appropriate Bellcore tone.

If there is no keyword parameter in the "Alert-Info" header, or the INVITE message contains no "Alert-Info" header, then the IP phone firmware uses the Bellcore standard ring tone.

Asterisk/Broadworks Servers

The ring tone keywords that can display in the "Alert-Info" header for an Asterisk and Broadworks server are:

Asterisk/Broadworks Server Ring Tone Keywords
Bellcore-dr2
Bellcore-dr3
Bellcore-dr4
Bellcore-dr5

When the ring tone keywords appear in an "Alert-Info" header from an Asterisk or Broadworks server, the IP phone maps the keywords to the default ring tone patterns.

Sylantro Servers

The ring tone keywords that can display in the "Alert-Info" header for a Sylantro server are:

Sylantro Server Ring Tone Keywords
alert-acd (auto call distribution) alert-community-1 alert-community-2 alert-community-3 alert-community-4 alert-emergency alert-external alert-group alert-internal alert-priority

When the ring tone keywords appear in an "Alert-Info" header from a Sylantro server, the keyword is mapped to the ring tone pattern based on the configuration you set in the Aastra Web UI or the configuration files.

Ring Tone Patterns

In IP Telephony, different ringing patterns have different frequencies and cadences. Ring cadence is the ringing pattern heard by the called party, before they pick up the call.

On the IP phones, if you enable priority alerting when using an Asterisk or Broadworks server, the IP phone uses the following Bellcore-specified tones by default:

Ring Tone Pattern (Asterisk/Broadworks Servers)

Call Criteria	Bellcore Tones
internal calls	Bellcore-dr2
external calls	Bellcore-dr3
calls with contact list	Bellcore-dr4
calls with specific time frames	Bellcore-dr5

If you enable priority alerting when using a Sylanro server, you can specify the Bellcore tone to be used for the following configurable criteria:

Ring Tone Pattern (Sylanro Servers)

Call criteria	Bellcore tones for each call criteria
alert-acd (auto call distribution)	Normal ringing (default)
alert-community-1	Bellcore-dr2
alert-community-2	Bellcore-dr3
alert-community-3	Bellcore-dr4
alert-community-4	Bellcore-dr5
alert-emergency	Silent
alert-external	
alert-group	
alert-internal	
alert-priority	

A System Administrator can configure the ring tone cadences if required, using the configuration files. The following table identifies the different Bellcore ring tone patterns and cadences.

Bellcore Tone	Pattern ID	Pattern	Cadence	Minimum Duration (ms)	Nominal Duration (ms)	Maximum Duration (ms)
(Standard)	1	Ringing Silent	2s On 4s Off	1800 3600	2000 4000	2200 4400
Bellcore-dr2	2	Ringing Silent	Long	630 315	800 400	1025 525
		Ringing Silent	Long Long	630 3475	800 4000	1025 4400
Bellcore-dr3	3	Ringing Silent	Short	315 145	400 200	525 525
		Ringing Silent	Short	315 145	400 200	525 525
		Ringing Silent	Long	630 2975	800 4000	1025 4400
Bellcore-dr4	4	Ringing Silent	Short	200 145	300 200	525 525
		Ringing Silent	Long	800 145	1000 200	1100 525
		Ringing Silent	Short	200 2975	300 4000	525 4400
Bellcore-dr5	5	Ringing		450	500	550



Note: If the "Do Not Disturb" (DND) or the "Call Forward" (CFWD) feature is enabled on the server-side, and the user is still waiting for a call, the "Bellcore-dr5" is a ring splash tone that reminds the user that these are enabled.

Mexican and Brazilian Tone Set Cadences

The following are Mexican tone set cadences.

Tone	Frequency (Hz)	Cadence (on/off)
Dial	425	Continuous
Secondary Dial	425	300/100/300/1300
Ringing	425	1000/4000
Busy	425	500/500
Congestion	425	250/250
Call Waiting	425	100/100/100/10000
Ring Cadence		1000/4000

Brazilian Tone Set Cadences

The following are Brazilian tone set cadences.

Tone	Frequency (Hz)	Cadence (on/off)
Dial	425	Continuous
Secondary Dial	425	300/100/300/1300
Ringing	425	1000/4000
Busy	425	250/250
Congestion	425	500/500
Call Waiting	425	100/100/100/10000
Ring Cadence		1000/4000

Configuring Priority Alerting and Ring Tone Cadences using the Configuration Files

Use the following procedures to configure priority alerting and ring tone cadences on the IP phones.



Configuration Files

For specific parameters you can set in the configuration files, see Appendix A, the sections,



- “[Priority Alert Settings](#)” on [page A-176](#).
- “[Bellcore Cadence Settings](#)” on [page A-181](#).



Note: You can configure Bellcore cadences using the configuration files only.

Configuring Priority Alerting using the Aastra Web UI.

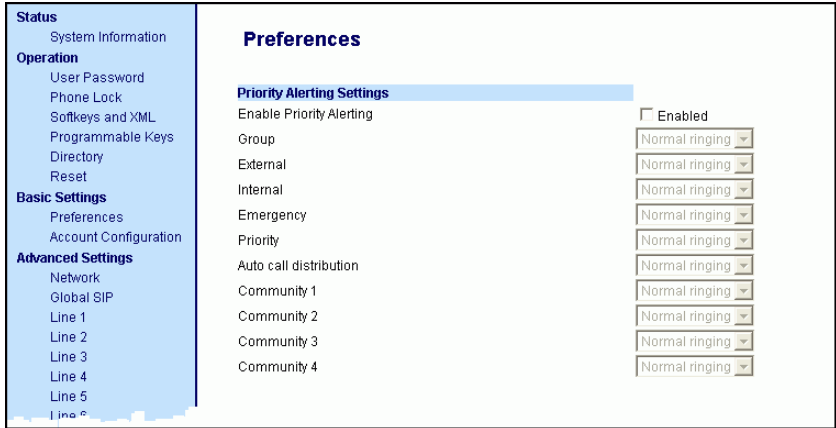
Use the following procedure to configure Priority Alerting using the Aastra Web UI.

Aastra Web UI	
1	<p>Click on Basic Settings->Preferences.</p>  <p>The screenshot shows the Aastra Web UI interface. On the left is a navigation menu with categories: Status (System Information), Operation (User Password, Phone Lock, Softkeys and XML, Programmable Keys, Directory, Reset), Basic Settings (Preferences, Account Configuration), and Advanced Settings (Network, Global SIP, Line 1-6). The 'Preferences' section is selected. Under 'Priority Alerting Settings', there is a checkbox labeled 'Enable Priority Alerting' which is checked. Below it are several settings, each with a dropdown menu set to 'Normal ringing': Group, External, Internal, Emergency, Priority, Auto call distribution, Community 1, Community 2, Community 3, and Community 4.</p>
2	<p>In the "Priority Alerting Settings" section, enable the "Enable Priority Alerting" field by checking the check box. (Disable this field by unchecking the box).</p>
For Sylantrо Servers:	
3	<p>Select a ring tone pattern for each of the following fields:</p> <ul style="list-style-type: none">• Group• Internal• External• Emergency• Priority• auto call distribution• community-1• community-2• community-3• community-4
4	<p>Click  to save your changes.</p>

Call Waiting Tones

Call Waiting is a feature that tells you if a new caller is trying to contact you when you are already on the phone. A discreet tone alerts you to the new caller, so you can answer your second incoming call by putting your first caller on hold.

The IP phones use the following Bellcore-specified call waiting tones.

Bellcore Call-Waiting Tone	Pattern ID	Pattern	Minimum Duration (ms)	Nominal Duration (ms)	Maximum Duration (ms)
CallWaitingTone 1	1	Tone On	270	300	330
Bellcore-dr2 CallWaitingTone2	2	Tone On Tone Off	90 90	100 100	110 110
Bellcore-dr3 CallWaitingTone3	3	Tone On Tone Off Tone On Tone Off	90 90 90 90	100 100 100 100	110 110 110 110
Bellcore-dr4 CallWaitingTone4	4	Tone On Tone Off Tone On Tone Off	90 90 270 90	100 100 300 100	110 110 330 110

For Asterisk and Broadworks servers, call waiting tones are specified by the default Bellcore tones indicated in the table [Ring Tone Pattern \(Asterisk/ Broadworks Servers\)](#) on page -124.

For Sylanro servers, call waiting tones are specified by the Bellcore tones you configure in the Aastra Web UI or the configuration files. See the table [Ring Tone Pattern \(Sylanro Servers\)](#) on page -125.

Reference

For more information about enable/disabling call waiting on the IP Phone, see the section, [“Call Waiting/Call Waiting Tone”](#) on page 5-67.

Directed Call Pickup (BLF or XML Call Interception)

Directed call pickup is a feature on the phones that allows a user to intercept a call on a ringing phone which is part of the same interception group. You can use the Directed call pickup feature on the phone in two ways:

- With the existing BLF feature on Asterisk, a user can dial “*76” followed by the extension to pick up a ringing call on another phone. (For more information about BLF, see “[Busy Lamp Field \(BLF\)](#)” on [page -168](#))
- Using XML, a user can intercept a call by selecting an extension from a list and then pressing a “Pickup” softkey/programmable key. To use the Directed call pickup feature from an XML application, you must list all ringing extensions using the **AastraIPPhoneTextMenu** XML object in an XML script. This allows the user to select the ringing extension from a text menu without having to dial. The following illustration shows an example of how this feature displays to the LCD from an XML application.:

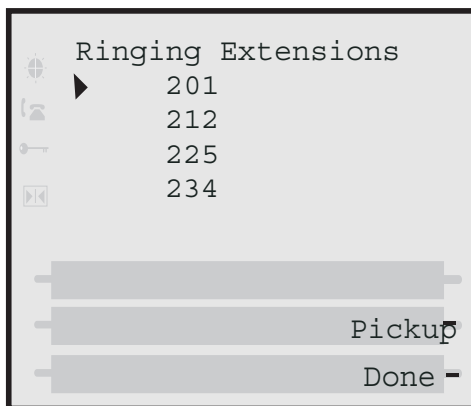

Reference

For more information about using the **AastraIPPhoneTextMenu** object, contact Aastra Customer Support regarding the “[Aastra XML Development Guide](#).”

BLF and XML softkeys/programmable keys monitor the states of an extension. The extension states can be one of three states: "busy", "ringing" and "idle". If the monitored extension is in the "ringing" state with an incoming call, and "Directed call pickup" is enabled, pressing the BLF or XML key can pick up the incoming call on the monitored extension.



Note: The Asterisk and Epygi Quadro 4x/16x IP PBX servers support this feature. For details about Asterisk support, contact Aastra Technical Support.

Directed Call Pickup Prefix (optional)

The optional “directed call pickup prefix” allows you to enter a specific prefix string (depending on what is available on your server), that the phone automatically dials when dialing the Directed Call Pickup number. For example, for Broadsoft servers, you can enter a value of *98 for the “directed call pickup prefix”. When the phone performs the Directed Call Pickup after pressing a BLF or BLF/List softkey, the phone prepends the *98 value to the designated extension of the BLF or BLF/List softkey when dialing out.

How this feature works when Directed Call Pickup is enabled with BLF or BLF/List

1. Phone A monitors Phone B via BLF/List.
2. Phone C calls Phone B; Phone B rings.
3. If you press the BLF/List softkey on Phone A, it picks up the ringing line on Phone B.
4. Phone C connects to Phone A.

How this feature works when Directed Call Pickup is disabled with BLF or BLF/List

1. Phone A monitors Phone B via BLF/List.
2. Phone C calls Phone B; Phone B rings.
3. If you press the BLF/List softkey on Phone A, it performs a speedial to Phone B.
4. Phone C and Phone A are ringing Phone B on separate lines (if available).



Notes:

1. The default method for the phone to use is Directed Call Pickup over BLF if the server provides applicable information. If the Directed Call Pickup over BLF information is missing in the messages to the server, the Directed Call Pickup by Prefix method is used if a value for the prefix code exists in the configuration.
2. You can define only one prefix at a time for the entire BLF/List.
3. The phone that picks up displays the prefix code + the extension number (for example, *981234 where prefix key = *98, extension = 1234).

You can enable/disable “Directed Call Pickup” using the configuration files or the Aastra Web UI.



Note: The “Directed Call Pickup” feature is disabled by default.

Enabling/Disabling Directed Call Pickup

Use the following procedure to enable or disable the Directed Call Pickup feature on the IP phone.



Configuration Files

To enable/disable Directed Call Pickup on the IP phone using the configuration files, see Appendix A, the section, "[Directed Call Pickup \(BLF or XML Call Interception\) Settings](#)" on [page A-208](#).



Aastra Web UI

1 Click on **Basic Settings->Preferences->Directed Call Pickup Settings**.

Status System Information	Preferences
Operation User Password Phone Lock Softkeys and XML Programmable Keys Directory Reset	
Basic Settings Preferences Account Configuration	Directed Call Pickup Settings
Advanced Settings Network Global SIP	Directed Call Pickup <input type="checkbox"/> Enabled
	Directed Call Pickup by Prefix <input type="text"/>
	Play a Ring Splash <input type="checkbox"/> Enabled

2 Enable the "**Directed Call Pickup**" field by checking the check box.
(Disable this field by unchecking the box). Default is disabled.)

3 (optional) Enter a prefix in the "**Directed Call Pickup Prefix**" field. For example, *98.
This prefix is appended to the beginning of the Directed Call Pickup number when dialed from the BLF or BLF/List softkey.

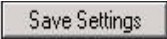

Aastra Web UI

4	Enable the " Play a Ring Splash " field by checking the check box. (Disable this field by unchecking the box). Default is disabled.) The IP phone plays a short "ring splash" when there is an incoming call on the BLF monitored extension. If the " Play a Ring Splash " parameter is enabled, and the host tone is idle, the tone plays a "ring splash".
5	Click  to save your changes.

Configuring BLF/BLF List for Directed Call Pickup

Use the following procedure to configure BLF/BLF List for Directed Call Pickup in the configuration files.



Note: You must enable Directed Call Pickup before performing these procedures. See "[Enabling/Disabling Directed Call Pickup](#)" on [page 5-133](#).



Configuration Files

- To set BLF or BLFList in the configuration files for Directed Call Pickup, see Appendix A, the sections:
- "[Softkey/Programmable Key/Feature Key/Expansion Module Key Parameters](#)" on [page A-216](#).
 - "[BLF List URI Settings](#)" on [page A-255](#).

Use the following procedure to configure BLF or BLF/List for Directed Call Pickup in the Aastra Web UI.

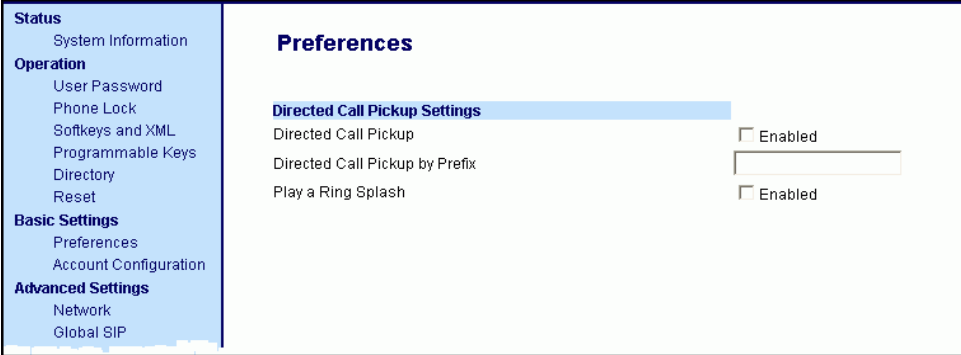
 Aastra Web UI	
1	<p>Click on Basic Settings->Preferences->Directed Call Pickup Settings.</p> <div style="border: 1px solid black; padding: 10px; margin: 10px 0;">  </div>
2	<p>Enable the "Directed Call Pickup" field by checking the check box.</p>
3	<p>(optional) Enter a prefix in the "Directed Call Pickup Prefix" field. For example, *98. This prefix is appended to the beginning of the Directed Call Pickup number when dialed from the BLF or BLF/List softkey.</p>
4	<p>Enable the "Play a Ring Splash" field by checking the check box.</p> <p>The IP phone plays a short "ring splash" when there is an incoming call on the BLF monitored extension. If the "Play a Ring Splash" parameter is enabled, and the host tone is idle, the tone plays a "ring splash".</p>



Aastra Web UI

- 5 Click on **Operation->Softkeys and XML**
or
 Click on **Operation->Programmable Keys**
or
 Click on **Operation->Expansion Module <N>**.

Note: Depending on your phone-model, the key configuration screen displays. The 6757i Key Screen is shown as an example.

Status

System Information

Operation

User Password

Phone Lock

Softkeys and XML

Programmable Keys

Directory

Reset

Basic Settings

Preferences

Account Configuration

Advanced Settings

Network

Global SIP

Line 1

Line 2

Line 3

Line 4

Line 5

Line 6

Line 7

Line 8

Line 9

Action URI

Configuration Server

Firmware Update

TLS Support

802.1x Support

Troubleshooting

Softkeys Configuration

Key	Type	Label	Value	Line	Idle	Connected	Incoming	Outgoing	Busy
1	Directory		94444	5	<input checked="" type="checkbox"/>	<input checked="" type="checkbox"/>	<input checked="" type="checkbox"/>	<input checked="" type="checkbox"/>	<input checked="" type="checkbox"/>
2	None			6	<input checked="" type="checkbox"/>	<input checked="" type="checkbox"/>	<input checked="" type="checkbox"/>	<input checked="" type="checkbox"/>	<input checked="" type="checkbox"/>
3	Speeddial	Lab	222222	7	<input checked="" type="checkbox"/>	<input checked="" type="checkbox"/>	<input checked="" type="checkbox"/>	<input checked="" type="checkbox"/>	<input checked="" type="checkbox"/>
4	None			1	<input checked="" type="checkbox"/>	<input checked="" type="checkbox"/>	<input checked="" type="checkbox"/>	<input checked="" type="checkbox"/>	<input checked="" type="checkbox"/>
5	None			1	<input checked="" type="checkbox"/>	<input checked="" type="checkbox"/>	<input checked="" type="checkbox"/>	<input checked="" type="checkbox"/>	<input checked="" type="checkbox"/>
6	None			1	<input checked="" type="checkbox"/>	<input checked="" type="checkbox"/>	<input checked="" type="checkbox"/>	<input checked="" type="checkbox"/>	<input checked="" type="checkbox"/>
7	None			1	<input checked="" type="checkbox"/>	<input checked="" type="checkbox"/>	<input checked="" type="checkbox"/>	<input checked="" type="checkbox"/>	<input checked="" type="checkbox"/>
8	None			1	<input checked="" type="checkbox"/>	<input checked="" type="checkbox"/>	<input checked="" type="checkbox"/>	<input checked="" type="checkbox"/>	<input checked="" type="checkbox"/>
9	None			1	<input checked="" type="checkbox"/>	<input checked="" type="checkbox"/>	<input checked="" type="checkbox"/>	<input checked="" type="checkbox"/>	<input checked="" type="checkbox"/>
10	None			1	<input checked="" type="checkbox"/>	<input checked="" type="checkbox"/>	<input checked="" type="checkbox"/>	<input checked="" type="checkbox"/>	<input checked="" type="checkbox"/>
11	None			1	<input checked="" type="checkbox"/>	<input checked="" type="checkbox"/>	<input checked="" type="checkbox"/>	<input checked="" type="checkbox"/>	<input checked="" type="checkbox"/>
12	None			1	<input checked="" type="checkbox"/>	<input checked="" type="checkbox"/>	<input checked="" type="checkbox"/>	<input checked="" type="checkbox"/>	<input checked="" type="checkbox"/>
13	None			1	<input checked="" type="checkbox"/>	<input checked="" type="checkbox"/>	<input checked="" type="checkbox"/>	<input checked="" type="checkbox"/>	<input checked="" type="checkbox"/>
14	None			1	<input checked="" type="checkbox"/>	<input checked="" type="checkbox"/>	<input checked="" type="checkbox"/>	<input checked="" type="checkbox"/>	<input checked="" type="checkbox"/>
15	None			1	<input checked="" type="checkbox"/>	<input checked="" type="checkbox"/>	<input checked="" type="checkbox"/>	<input checked="" type="checkbox"/>	<input checked="" type="checkbox"/>
16	None			1	<input checked="" type="checkbox"/>	<input checked="" type="checkbox"/>	<input checked="" type="checkbox"/>	<input checked="" type="checkbox"/>	<input checked="" type="checkbox"/>
17	None			1	<input checked="" type="checkbox"/>	<input checked="" type="checkbox"/>	<input checked="" type="checkbox"/>	<input checked="" type="checkbox"/>	<input checked="" type="checkbox"/>
18	None			1	<input checked="" type="checkbox"/>	<input checked="" type="checkbox"/>	<input checked="" type="checkbox"/>	<input checked="" type="checkbox"/>	<input checked="" type="checkbox"/>
19	None			1	<input checked="" type="checkbox"/>	<input checked="" type="checkbox"/>	<input checked="" type="checkbox"/>	<input checked="" type="checkbox"/>	<input checked="" type="checkbox"/>
20	None			1	<input checked="" type="checkbox"/>	<input checked="" type="checkbox"/>	<input checked="" type="checkbox"/>	<input checked="" type="checkbox"/>	<input checked="" type="checkbox"/>

Services



XML Application URI:

XML Application Title:

BLF List URI:

- 6 Select a softkey or programmable key to configure.

- 7 In the "**Type**" field, select "**BLF**" (Asterisk), "**BLF/List**" (BroadSoft BroadWorks).

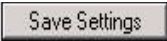
 Aastra Web UI	
8	<p>For 8 and 11-Line LCD softkeys:</p> <p>In the "Label" field, enter the name of the person who's extension you are monitoring (if "Type" is BLF).</p> <p>Note: If BLF\List type is selected, no label value is required. The BroadWorks BLF List name is configured in the "BLF List URI" field instead.</p>
9	<p>In the "Value" field, enter a value to associate with the softkey or programmable key. For example, for BLF, the value is the extension you want to monitor. For BLF\List, the value is an identifier for the list of numbers you are monitoring.</p>
10	<p>Click  to save your changes.</p>
11	<p>In the "Line" field, select a line number that is actively registered to the appropriate SIP proxy you are using.</p>
12	<p>In the "BLF List URI" field, enter the name of the BLF list defined on the BroadSoft BroadWorks Busy Lamp field page for your particular user. For example, my6757i-blf-list@as.broadworks.com.</p> <p>Note: The value of the BLF\List URI parameter must match the list name configured. Otherwise, no values display on the 6757i screen and the feature is disabled.</p>
13	<p>Select the line state (idle, connected, incoming, outgoing, busy) that you want to apply to the BLF softkey or programmable key.</p>
14	<p>Click  to save your changes.</p>

Configuring XML for Directed Call Pickup

Use the following procedure to configure XML for Directed Call Pickup in the configuration files.



Notes:

1. Before implementing this procedure, you must create an XML application that the phone uses when the XML softkey or programmable key is pressed. This XML application must be entered as a URI in the “Value” field of the XML key. For information about creating an XML script, see [Appendix F](#), the section, “Text Menu Object (Menu Screens)” on [page F-6](#).
2. You must enable Directed Call Pickup before performing these procedures. See “[Enabling/Disabling Directed Call Pickup](#)” on [page 5-133](#).



Configuration Files

To set XML in the configuration files for Directed Call Pickup, see [Appendix A](#), the section, “[Softkey/Programmable Key/Feature Key/Expansion Module Key Parameters](#)” on [page A-216](#).

Use the following procedure to configure XML for Directed Call Pickup in the Aastra Web UI.

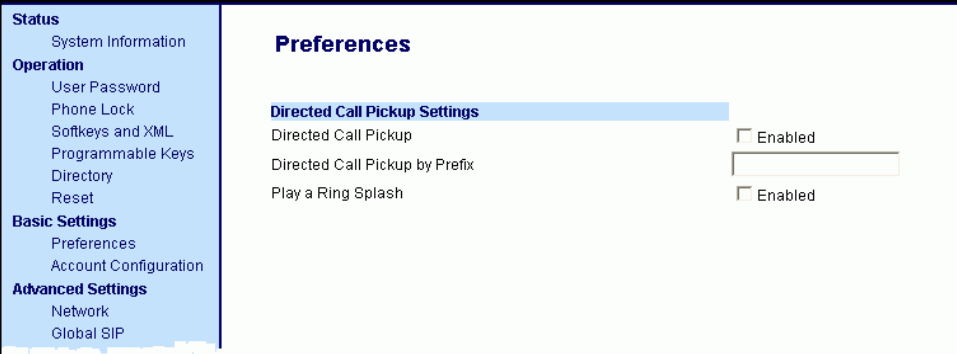
 Aastra Web UI	
1	<p>Click on Basic Settings->Preferences->Directed Call Pickup Settings.</p> <div style="border: 1px solid black; padding: 10px; margin: 10px 0;">  </div>
2	<p>Enable the "Directed Call Pickup" field by checking the check box.</p>
3	<p>(optional) Enter a prefix in the "Directed Call Pickup Prefix" field. For example, *98. This prefix is appended to the beginning of the Directed Call Pickup number when dialed from the BLF or BLF/List softkey.</p>
4	<p>Enable the "Play a Ring Splash" field by checking the check box.</p> <p>The IP phone plays a short "call waiting tone" when there is an incoming call on the BLF monitored extension. If the "Play a Ring Splash" parameter is enabled, and the host tone is idle, the tone plays a "ring splash".</p>



Aastra Web UI

- 5 Click on **Operation->Softkeys and XML**
or
 Click on **Operation->Programmable Keys**
or
 Click on **Operation->Expansion Module <N>**.

Note: Depending on your phone-model, the key configuration screen displays. The 6757i Key Screen is shown as an example.

Status

System Information

Operation

User Password

Phone Lock

Softkeys and XML

Programmable Keys

Directory

Reset

Basic Settings

Preferences

Account Configuration

Advanced Settings

Network

Global SIP

Line 1

Line 2

Line 3

Line 4

Line 5

Line 6

Line 7

Line 8

Line 9

Action URI

Configuration Server

Firmware Update

TLS Support

802.1x Support

Troubleshooting

Softkeys Configuration

Key	Type	Label	Value	Line	Idle	Connected	Incoming	Outgoing	Busy
1	Directory		99999	5	<input checked="" type="checkbox"/>	<input checked="" type="checkbox"/>	<input checked="" type="checkbox"/>	<input checked="" type="checkbox"/>	<input checked="" type="checkbox"/>
2	None			6	<input checked="" type="checkbox"/>	<input checked="" type="checkbox"/>	<input checked="" type="checkbox"/>	<input checked="" type="checkbox"/>	<input checked="" type="checkbox"/>
3	Speeddial	Lab	222222	7	<input checked="" type="checkbox"/>	<input checked="" type="checkbox"/>	<input checked="" type="checkbox"/>	<input checked="" type="checkbox"/>	<input checked="" type="checkbox"/>
4	None			1	<input checked="" type="checkbox"/>	<input checked="" type="checkbox"/>	<input checked="" type="checkbox"/>	<input checked="" type="checkbox"/>	<input checked="" type="checkbox"/>
5	None			1	<input checked="" type="checkbox"/>	<input checked="" type="checkbox"/>	<input checked="" type="checkbox"/>	<input checked="" type="checkbox"/>	<input checked="" type="checkbox"/>
6	None			1	<input checked="" type="checkbox"/>	<input checked="" type="checkbox"/>	<input checked="" type="checkbox"/>	<input checked="" type="checkbox"/>	<input checked="" type="checkbox"/>
7	None			1	<input checked="" type="checkbox"/>	<input checked="" type="checkbox"/>	<input checked="" type="checkbox"/>	<input checked="" type="checkbox"/>	<input checked="" type="checkbox"/>
8	None			1	<input checked="" type="checkbox"/>	<input checked="" type="checkbox"/>	<input checked="" type="checkbox"/>	<input checked="" type="checkbox"/>	<input checked="" type="checkbox"/>
9	None			1	<input checked="" type="checkbox"/>	<input checked="" type="checkbox"/>	<input checked="" type="checkbox"/>	<input checked="" type="checkbox"/>	<input checked="" type="checkbox"/>
10	None			1	<input checked="" type="checkbox"/>	<input checked="" type="checkbox"/>	<input checked="" type="checkbox"/>	<input checked="" type="checkbox"/>	<input checked="" type="checkbox"/>
11	None			1	<input checked="" type="checkbox"/>	<input checked="" type="checkbox"/>	<input checked="" type="checkbox"/>	<input checked="" type="checkbox"/>	<input checked="" type="checkbox"/>
12	None			1	<input checked="" type="checkbox"/>	<input checked="" type="checkbox"/>	<input checked="" type="checkbox"/>	<input checked="" type="checkbox"/>	<input checked="" type="checkbox"/>
13	None			1	<input checked="" type="checkbox"/>	<input checked="" type="checkbox"/>	<input checked="" type="checkbox"/>	<input checked="" type="checkbox"/>	<input checked="" type="checkbox"/>
14	None			1	<input checked="" type="checkbox"/>	<input checked="" type="checkbox"/>	<input checked="" type="checkbox"/>	<input checked="" type="checkbox"/>	<input checked="" type="checkbox"/>
15	None			1	<input checked="" type="checkbox"/>	<input checked="" type="checkbox"/>	<input checked="" type="checkbox"/>	<input checked="" type="checkbox"/>	<input checked="" type="checkbox"/>
16	None			1	<input checked="" type="checkbox"/>	<input checked="" type="checkbox"/>	<input checked="" type="checkbox"/>	<input checked="" type="checkbox"/>	<input checked="" type="checkbox"/>
17	None			1	<input checked="" type="checkbox"/>	<input checked="" type="checkbox"/>	<input checked="" type="checkbox"/>	<input checked="" type="checkbox"/>	<input checked="" type="checkbox"/>
18	None			1	<input checked="" type="checkbox"/>	<input checked="" type="checkbox"/>	<input checked="" type="checkbox"/>	<input checked="" type="checkbox"/>	<input checked="" type="checkbox"/>
19	None			1	<input checked="" type="checkbox"/>	<input checked="" type="checkbox"/>	<input checked="" type="checkbox"/>	<input checked="" type="checkbox"/>	<input checked="" type="checkbox"/>
20	None			1	<input checked="" type="checkbox"/>	<input checked="" type="checkbox"/>	<input checked="" type="checkbox"/>	<input checked="" type="checkbox"/>	<input checked="" type="checkbox"/>

Services

XML Application URI:

XML Application Title:

BLF List URI:

- 6 Select a softkey or programmable key to configure.

- 7 In the "**Type**" field, select "**XML**".

- 8 **For 8 and 11-Line LCD softkeys:**

In the "**Label**" field, enter the name of the person who's extension you are monitoring.

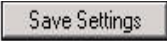

Aastra Web UI

9	<p>In the "Value" field, enter the URI that the phone uses to display the XML application to the LCD. For example, <code>http://65.205.71.13/xml/startup/key.php?user=\$\$SIPREMOVEDNUMBER\$\$</code>.</p> <p>Note: For more information about creating an XML script to use with Directed Call Pickup, see Appendix F, the section, "Text Menu Object (Menu Screens)" on page F-6.</p>
10	<p>Select the line state (idle, connected, incoming, outgoing, busy) that you want to apply to the XML softkey or programmable key.</p>
11	<p>Click  to save your changes.</p>

Softkeys/Programmable Keys/Feature Keys/Expansion Module Keys

You can configure the softkeys, programmable keys, feature keys, and expansion module keys that are applicable to a specific phone model, to perform specific functions on the IP phones.



Note: When entering definitions for softkeys in the configuration files, the “#” sign must be enclosed in quotes.

Softkeys (8 and 11-Line LCD phones)

The 9480i, 9480i CT, and 6755i IP phone have 6 softkeys you can configure to perform specific functions, The 6757i and 6757i CT IP phones have 12 softkeys you can configure. With up to 3 expansion modules attached to a 67xi model phone, you can get an additional 108 softkeys (M670i) or an additional 180 softkeys (M675i) to configure. The following table provides the number of softkeys you can configure, and the number of lines available for each type of phone.

IP Phone Model	Softkeys	Expansion Module Keys	Programmable Keys	Lines Available	Handset Keys Available
9480i	6	Not Applicable	-	9	-
9480i CT	6	Not Applicable	-	9	15
6755i	6	36 to 108* (Model M670i) 60 to 180** (Model M675i)	6	9	-
6757i	12	36 to 108* (Model M670i) 60 to 180** (Model M675i)	-	9	-
6757i CT	12	36 to 108* on Base Station (Model M670i) 60 to 180** on Base Station (Model M675i)	-	9	15

*The M670i expansion module consists of 36 softkeys. You can have up to 3 expansion modules on an IP phone totaling 108 softkeys. Valid for all 67xi model phones EXCEPT the 6751i.

**The M675i expansion module consists of 60 softkeys. You can have up to 3 expansion modules on an IP phone totaling 180 softkeys. Valid for 6755i, 6757i, and 6757i CT phones.

State-Based Softkeys (8 and 11-Line LCD phones only)

Users and administrators can configure a specific state to display when a softkey is being used. Available states you can configure for each softkey include:

- **idle** - The phone is not being used.
- **connected** - The current line is in an active call (or the call is on hold)
- **incoming** - The phone is ringing.
- **outgoing** - The user is dialing a number, or the far-end is ringing.
- **busy** - The current line is busy because the line is in use or the line is set as “Do Not Disturb”.

The following table identifies the applicable default states for each type of softkey you can configure on the IP phone.

Softkey Type	Default States
None	All states disabled.
Line	idle, connected, incoming, outgoing, busy
Speeddial	idle, connected, incoming, outgoing, busy
DND	idle, connected, incoming, outgoing, busy
BLF	idle, connected, incoming, outgoing, busy
BLF List	idle, connected, incoming, outgoing, busy
Auto Call Distribution (ACD)	idle
Directed Call Pickup (DCP)	idle, connected, incoming, outgoing, busy
Group Call Pickup (GCP)	
XML	idle, connected, incoming, outgoing, busy
Flash	All states disabled.
Sprecode	connected
Park	connected
Pickup	idle, outgoing
Last Call Return	idle, connected, incoming, outgoing, busy

Softkey Type	Default States
Call Forward	idle, connected, incoming, outgoing, busy
BLF/Xfer	idle, connected, incoming, outgoing, busy
Speeddial/Xfer	idle, connected, incoming, outgoing, busy
Directory	idle, connected, incoming, outgoing, busy
Callers List	idle, connected, incoming, outgoing, busy
Intercom	idle, connected, incoming, outgoing, busy
Services	idle, connected, incoming, outgoing, busy
Phone Lock	All states disabled.
Paging	All states disabled.
Empty	idle, connected, incoming, outgoing, busy

You can enable or disable the softkey states using the configuration files or the Aastra Web UI. In the Aastra Web UI, you disable a state by unchecking the box for that operational state.

In the configuration files, you use the following parameters to enable and disable operational states:

- **softkeyN states**

You can enter multiple values (**idle, connected, incoming, outgoing, busy**) for the "softkeyN state" parameter. For example:

```
softkeyN states: idle connected
```

You must associate the softkeyN state parameter with a specific softkey. In the following example, the softkeyN states parameter is associated with softkey 12:

```
softkey12 type: speeddial  
softkey12 label: voicemail  
softkey12 value *89  
softkey12 states: outgoing
```



Note: The IP phone idle screen condenses the softkeys. So in the previous example, softkey 12 will appear in position 1 if no other softkeys are set. A softkey type of "empty" does not display on the idle screen at all. For more information about the softkey type of "empty" see Appendix A, the section, [“Softkey Settings for 8 and 11-Line LCD phones”](#) on page A-218.

Configuration Example

The following example illustrates the use of the "softkeyN states" parameter, and the "softkeyN type" parameter with a value of **empty**. For clarity purposes, only the "softkeyN type" and "softkeyNstates" parameters are shown.

```
softkey1 type: line
softkey1 states: idle connected
softkey3 type: dnd
softkey3 states: idle
softkey4 type: line
softkey5 type: empty
softkey5 states: connected
softkey6 type: speeddial
softkey6 states: connected
```

The following table shows how the keys in the example above would display on the IP Phone UI.



Note: The "empty" key type allows a softkey to be removed quickly by deleting the softkey information from the configuration file.

Softkey	Idle	Connected	Notes
softkey1	Key 1	Key 2	Line displays for softkey1. Key 1 in connected state is the Drop key. Idle and connected display as applicable.
softkey2	(not used)	(not used)	Softkey2 is not displayed.
softkey3	Key 2	(not used)	DND displays for softkey3. Idle displays as applicable.
softkey4	Key 3	Key 3	Line displays for softkey4. Default state values (idle, connected, incoming, outgoing) display as applicable.
softkey5	(not used)	Key 4 (blank)	A blank displays for softkey5. Connected displays as applicable.
softkey6	(not used)	Key 5	Speeddial displays for softkey6. Connected displays as applicable.

Softkeys and programmable keys are configurable using the Aastra Web UI or the configuration files.

Programmable Keys (9143i, 6730i, 6731i, 6753i, 6755i)

The following table provides the number of softkeys and programmable keys you can configure, and the number of lines available for each type of phone.

IP Phone Model	Softkeys	Expansion Module Keys	Programmable Keys	Lines Available	Handset Keys Available
9143i	-	Not Applicable	7	9	-
6730i	-	Not Applicable	8	6	-
6730i	-	Not Applicable	8	6	-
6753i	-	36 to 108* (Model M670i)	6**	9	-
6755i	6	36 to 108* (Model M670i) 60 to 180** (Model M675i)	6	9	-

*The M670i expansion module consists of 36 softkeys. You can have up to 3 expansion modules on an IP phone totaling 108 softkeys.

**On the 6753i, two of the 6 programmable keys are the DELETE and SAVE keys and can be programmed only if Administrator allows.

Softkey/Programmable Key/Expansion Module Key Functions

You can configure the softkeys and programmable keys on the phones and any attached expansion module keys to perform specific functions using the configuration files or the Aastra Web UI. The following table identifies the available functions of the softkeys, programmable keys, and expansion module keys on the IP phones. Available functions may vary on each model phone.

The following **Key Functions Table** lists the available functions for the keys on the IP Phones and Expansion Modules.



Note: These functions apply to all model phones unless specifically indicated that the function does not apply. The 6751i IP Phone does not have programmable keys or softkeys.

Key Functions Table

Softkey/ Programmable Key Function	Configuration File Parameter	Aastra Web UI Parameter	Description
None	none	None	Indicates not setting for the key.
Line	line	Line	Indicates the key is configured for line use.
Speeddial	speeddial	Speeddial	<p>Indicates the key is configured for speeddial use.</p> <p>You can configure a softkey to speeddial a specific number. Optionally, you can also configure a speeddial key to dial prefix numbers. With this option, the prefix numbers automatically dial when you press the softkey, and the phone waits for you to enter the remaining numbers to dial out.</p> <p>For more information about speeddial prefixes, see “Speeddial Prefixes” on page 5-166.</p> <p>You can also create speeddial keys and edit the keys using the IP Phone keypad. For more information about speeddial keys and editing speeddial keys, see your Model-specific <i>User Guide</i> for more information.</p>
Busy Lamp Field (BLF)	blf	BLF	<p>Indicates the key is configured for Busy Lamp Field (BLF) use. A user can dial out on a BLF configured key. You can also set a BLF subscription period.</p> <p>For more information about BLF, see the section “Busy Lamp Field (BLF)” on page 5-168.</p> <p>For more information about BLF Subscription Period, see “BLF Subscription Period” on page 5-174.</p>

Operational Features

Softkey/ Programmable Key Function	Configuration File Parameter	Aastra Web UI Parameter	Description
Busy Lamp Field List	list	BLF/List	<p>Indicates the key is configured for BLF list use. A user can dial out on a BLF/List configured key.</p> <p>For more information on BLF, see the section "Busy Lamp Field (BLF)" on page 5-168.</p>
Auto Call Distribution (ACD)	acd	Auto Call Distribution	<p>(For Sylanro Servers) Indicates the key is configured for automatic call distribution (ACD). ACD allows the Sylanro Server to distribute calls from a queue to registered IP Phones (agents). You can also set an ACD subscription period.</p> <p>For more information about ACD, see the section "Automatic Call Distribution (ACD) (for Sylanro Servers)" on page 5-186.</p> <p>For more information about ACD subscription period, see "ACD Subscription Period" on page 5-196.</p>
Directed Call Pickup (DCP)/ Group Call Pickup (GCP)	dcp	Directed Call Pickup	<p>(For Sylanro Servers) Indicates the key is configured for either Directed Call Pickup or Group Call Pickup. The DCP/GCP feature allows you to intercept - or pickup - a call on a monitored extension(s).</p> <p>For more information about DCP/GCP, see the section "Directed Call Pickup/Group Call Pickup (for Sylanro Servers)" on page 5-200.</p>
Do Not Disturb (DND)	dnd	Do Not Disturb	<p>Indicates key is configured for "do not disturb" use.</p> <p>For more information on DND, see the section "Do Not Disturb (DND)" on page 5-207.</p>

Softkey/ Programmable Key Function	Configuration File Parameter	Aastra Web UI Parameter	Description
Extensible Markup Language (XML)	xml	XML	<p>Indicates the key is configured to accept an XML application for accessing customized XML services. You can also specify a URL for an XML key.</p> <p>For more information on XML, see the section "XML Customized Services" on page 5-316.</p>
Flash	flash	Flash	<p>Indicates the key is set to generate a flash event when it is pressed, or when a feature key is pressed on the 6757i CT handset. The IP phone generates flash events only when a call is connected and there is an active RTP stream (for example, when the call is not on hold).</p> <p>For more information about the Flash key, see your Model-specific <i>User Guide</i>.</p>
Sprecode	sprecode	Sprecode	<p>Indicates the key is set to automatically activate specific services offered by the server. For example, if the sprecode value of *82 is configured, then by pressing the key, *82 automatically activates a service provided by the server. The value you enter for this field is dependent on the services provided by the server.</p> <p>For more information about the Flash key, see your Model-specific <i>User Guide</i>.</p>
Park	park	Park	<p>Indicates the key is set to be used as a park key to park an incoming call.</p> <p>For more information on park, see the section "Park/Pick Up Key (not applicable to the 6751i)" on page 5-234.</p>
Pickup	pickup	Pickup	<p>Indicates the key is set to be used as a pickup key to pick up a parked call.</p> <p>For more information on pickup, see the section "Park/Pick Up Key (not applicable to the 6751i)" on page 5-234.</p>

Softkey/ Programmable Key Function	Configuration File Parameter	Aastra Web UI Parameter	Description
Last Call Return (LCR)	lcr	Last Call Return	(For Sylanro Servers) Indicates the key is set to be used to dial the last call that came in on that line. For more information on lcr, see the section "Last Call Return (lcr) (Sylanro Servers)" on page 5-245 .
Call Forward	callforward	Call Forward	Indicates the key is set to be used to access the Call Forward menus on the phone. For more information about call forwarding, see the section "Call Forwarding" on page 5-249 .
BLF/Xfer	blf/xfer	Call Forward	Indicates the key is set to be used as a BLF key AND as a Transfer key. For more information about the BLF/Xfer feature, see the section "BLF/Xfer and Speeddial/Xfer Keys" on page 5-176 .
Speeddial/Xfer	speeddial/xfer	Speeddial/Xfer	Indicates the key is set to be used as a speeddial key AND as a Transfer key. For more information about the Speeddial/Xfer feature, see the section "BLF/Xfer and Speeddial/Xfer Keys" on page 5-176 .
Speeddial/Conf	speeddial/conf	Speeddial/Conf	Indicates the key is set to be used as a speeddial key AND as a conference key. For more information about the Speeddial/Conf feature, see the section "Speeddial/Conference Key (not applicable to the 6751i)" on page 5-182 .
Callers List	callers	Callers List	Indicates the key is set for accessing the Callers List. For more information on the Callers List, see the section "Callers List" on page 5-293 .

Softkey/ Programmable Key Function	Configuration File Parameter	Aastra Web UI Parameter	Description
Directory	directory	Directory	<p>Indicates the key is set for accessing the Directory List.</p> <p>For more information about the Directory List, see the section “Directory List” on page 5-302.</p>
Icom	icom	Intercom	<p>Indicates the key is set to be used as the Intercom key. For more information about using the Intercom key, see your model-specific Aastra IP Phone User’s Guide.</p> <p>For information about other Intercom features, see “Incoming/Outgoing Intercom with Auto-Answer and Barge In” on page 5-103.</p>
Conference (Applicable to the 6753i only)	conf	Conference	<p>Indicates the key is configured as a conference key (for local conferencing).</p> <p>(For Sylantrö and Broadsoft Servers) An Administrator can also enable centralized conferencing on the IP Phones.</p> <p>For more information about using the Conference key, see your Model-specific <i>User’s Guide</i>.</p> <p>For information about enabling centralizing conferencing, see “Centralized Conferencing (for Sylantrö and Broadsoft Servers)” on page 5-363.</p>
Transfer (Applicable to the 6753i only)	xfer	Transfer	<p>Indicates the key is configured as a transfer key for transferring calls.</p> <p>For more information about using the Xfer key, see your Model-specific <i>User’s Guide</i>.</p>
Services	services	Services	<p>Indicates the key is set to access Services, such as, Directory List, Callers List, Voicemail, and any other XML applications configured on the phone.</p> <p>For more information about using the Services key, see your Model-specific <i>User’s Guide</i>.</p>

Operational Features

Softkey/ Programmable Key Function	Configuration File Parameter	Aastra Web UI Parameter	Description
Phone Lock (Not applicable to the cordless handsets on CT models)	phone lock	Phone Lock	Indicates the key is configured as a phone lock key, allowing you to press this key to lock/unlock the phone. For more information about the lock/unlock key, see "Locking IP Phone Keys" on page 5-49 .
Paging	paging	Paging	Indicates the softkey is set for Group Paging on the phone. Pressing this key automatically sends a Real Time Transport Protocol (RTP) stream to pre-configured multicast address(es) without involving SIP signaling. For more information about the Paging key, see "Group Paging RTP Settings" on page 5-108 .
Empty (Not applicable to programmable keys or expansion module keys)	empty	Empty	Indicates the key is configured to force a blank entry on the IP phone display for a specific key. If a particular key is not defined, it is ignored. For more information about empty keys, see your Model-specific <i>User's Guide</i> .

Reference

For more information about key functions for your model phone, see your Model-specific *User's Guide*.

Configuring Softkeys and Programmable Keys

Use the following procedures to configure the softkeys and programmable keys on the IP phone.



Configuration Files

For specific parameters you can set in the configuration files, see Appendix A, the sections, [“Softkey/Programmable Key/Feature Key/Expansion Module Key Parameters”](#) on [page A-216](#).

 **Aastra Web UI**

- 1 Click on **Operation->Softkeys and XML**
or
 Click on **Operation->Programmable Keys**
or
 Click on **Operation->Expansion Module <N>**.

Depending on your phone-model, the key configuration screen displays. The 6757i Key Screen is shown as an example.

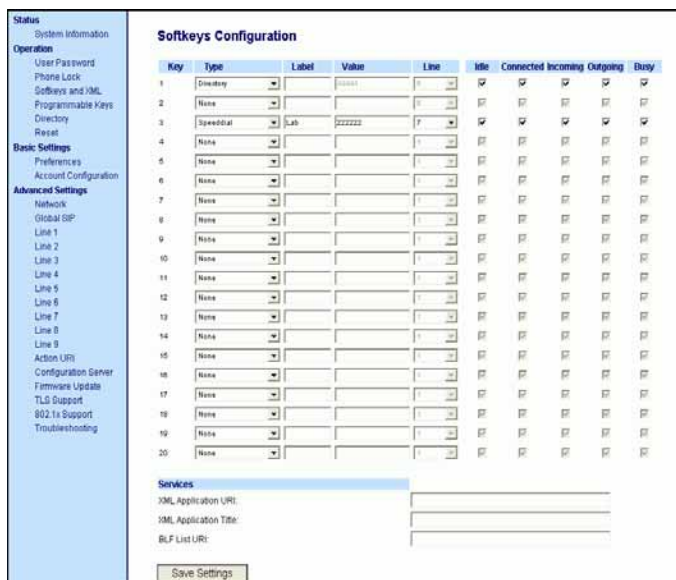

Key	Type	Label	Value	Line	Idle	Connected	Incoming	Outgoing	Busy
1	Speedial		00000	1	<input type="checkbox"/>	<input type="checkbox"/>	<input type="checkbox"/>	<input type="checkbox"/>	<input type="checkbox"/>
2	None			1	<input type="checkbox"/>	<input type="checkbox"/>	<input type="checkbox"/>	<input type="checkbox"/>	<input type="checkbox"/>
3	Speedial	Lab	000000	1	<input type="checkbox"/>	<input type="checkbox"/>	<input type="checkbox"/>	<input type="checkbox"/>	<input type="checkbox"/>
4	None			1	<input type="checkbox"/>	<input type="checkbox"/>	<input type="checkbox"/>	<input type="checkbox"/>	<input type="checkbox"/>
5	None			1	<input type="checkbox"/>	<input type="checkbox"/>	<input type="checkbox"/>	<input type="checkbox"/>	<input type="checkbox"/>
6	None			1	<input type="checkbox"/>	<input type="checkbox"/>	<input type="checkbox"/>	<input type="checkbox"/>	<input type="checkbox"/>
7	None			1	<input type="checkbox"/>	<input type="checkbox"/>	<input type="checkbox"/>	<input type="checkbox"/>	<input type="checkbox"/>
8	None			1	<input type="checkbox"/>	<input type="checkbox"/>	<input type="checkbox"/>	<input type="checkbox"/>	<input type="checkbox"/>
9	None			1	<input type="checkbox"/>	<input type="checkbox"/>	<input type="checkbox"/>	<input type="checkbox"/>	<input type="checkbox"/>
10	None			1	<input type="checkbox"/>	<input type="checkbox"/>	<input type="checkbox"/>	<input type="checkbox"/>	<input type="checkbox"/>
11	None			1	<input type="checkbox"/>	<input type="checkbox"/>	<input type="checkbox"/>	<input type="checkbox"/>	<input type="checkbox"/>
12	None			1	<input type="checkbox"/>	<input type="checkbox"/>	<input type="checkbox"/>	<input type="checkbox"/>	<input type="checkbox"/>
13	None			1	<input type="checkbox"/>	<input type="checkbox"/>	<input type="checkbox"/>	<input type="checkbox"/>	<input type="checkbox"/>
14	None			1	<input type="checkbox"/>	<input type="checkbox"/>	<input type="checkbox"/>	<input type="checkbox"/>	<input type="checkbox"/>
15	None			1	<input type="checkbox"/>	<input type="checkbox"/>	<input type="checkbox"/>	<input type="checkbox"/>	<input type="checkbox"/>
16	None			1	<input type="checkbox"/>	<input type="checkbox"/>	<input type="checkbox"/>	<input type="checkbox"/>	<input type="checkbox"/>
17	None			1	<input type="checkbox"/>	<input type="checkbox"/>	<input type="checkbox"/>	<input type="checkbox"/>	<input type="checkbox"/>
18	None			1	<input type="checkbox"/>	<input type="checkbox"/>	<input type="checkbox"/>	<input type="checkbox"/>	<input type="checkbox"/>
19	None			1	<input type="checkbox"/>	<input type="checkbox"/>	<input type="checkbox"/>	<input type="checkbox"/>	<input type="checkbox"/>
20	None			1	<input type="checkbox"/>	<input type="checkbox"/>	<input type="checkbox"/>	<input type="checkbox"/>	<input type="checkbox"/>

Services

XML Application URI:

XML Application Title:

BLF List URI:



- 2 Select a key to configure.

For Softkeys and Expansion Module Keys:

- 3 In the **"Type"** field, select the type of softkey you want to configure.

Reference: For available type values on each IP phone model, see Appendix A, the section, [“Softkey/Programmable Key/Feature Key/Expansion Module Key Parameters”](#) on [page A-216](#).

- 4 If applicable, enter a label in the **“Label”** field.

 Aastra Web UI	
5	If applicable, in the " Value " field, enter a value to associate with the softkey. For example, for a speeddial value, you can enter a number you want to use for the speeddial key, or 12345+ as a speeddial prefix.
6	If applicable, in the " Line " field, select the line for which you want to associate the softkey.
7	Some softkey types allow you to configure specific operational states. Operational states display to the IP phone when a softkey is used. To enable/disable an operational state, click the " Idle ", " Connected ", " Incoming ", or " Outgoing " fields to check or uncheck the box. Note: Operational states are not applicable to expansion modules.
8	Click  to save your changes.
For programmable keys:	
9	In the " Hard Key " field, select the programmable key type you want to configure. Reference: For available type values on each IP phone model, see Appendix A, the section, " Softkey/Programmable Key/Feature Key/Expansion Module Key Parameters " on page A-216 .
10	In the " Value " field, enter a value to associate with the programmable key. For example, for a speeddial value, you can enter a number you want to use for the speeddial key, or 12345+ as a speeddial prefix.
11	In the " Line " field, select the line for which you want to associate the programmable key.
12	Click  to save your changes.

6757i Cordless (CT) Feature Keys

In addition to the softkeys on the 6757i CT, this phone also has handset keys you can configure with specific features. You can use the Aastra Web UI to configure the handset keys.



Note: You configure the handset keys using the Aastra Web UI (**Operation->Handset Keys**) or by pressing the "F" button on the handset.

You can program up to 15 feature keys on the 6757i CT handset with specific functions using the Aastra Web UI.

The following table identifies the functions available for all 15 handset keys and the default functions for each key.

Handset Key	Key Function	Description
1	Line 1	Line 1 key - Selects line one
2	Line 2	Line 2 key - Selects line two
3	Line 3	Line 3 key - Selects line three
4	Line 4	Line 4 key - Selects line four
5	Icom	Icom key – Enter handset list to select handset to call
6	Dir	Directory key – Activate directory feature
7	Callers	Callers key – Activate callers feature
8	Xfer	Transfer key - Activate transfer feature
9	Conf	Conference key - Activate conference feature
10	Public	Public key – Toggle between public & private call mode
11	None	No function selected. Line 5 key (if available) - Selects line five.
12	None	No function selected. Line 6 key (if available) - Selects line six.
13	None	No function selected. Line 7 key (if available) - Selects line seven.
14	None	No function selected. Line 8 key (if available) - Selects line eight.
15	None	No function selected. Line 9 key (if available) - Selects line nine.

Feature Key Programming Guidelines

The following are guidelines to use when programming the feature keys on the handset:

- All handsets paired with the same Base Station have the same programmed functions since the web interface applies the functions to all the handsets paired with that base.
- A newly registered handset or handset that was out-of-range during the programming needs to perform an "off-hook and on-hook" sequence in order for the newly programmed function to be broadcasted to the affected handsets. Simply press the \vee key from the idle state to go off-hook. Then, press the γ key to go back on-hook.
- Duplicate functions can exist in the feature key as there is no filtering or duplicate checking done on the handset or the base.
- If no line keys are programmed for the feature key, the handset is restricted to intercom calls only.
- If all 12 programmable functions have been programmed to "None", the user is presented with a List empty message when the feature key is pressed.



- For security reasons, the user has 180 seconds (3 minutes) to complete the programming. Otherwise, the phone displays the following error:
** Error **: Session expired, Please reload page.
- For security reasons, the user must submit the page from the same browser that was used to load the page. If the user tries to submit the page from any other IP address, the following error displays:
** Error ** Session invalid. Different Client IP Addresses. —
Please reload page

Handset Feature Key Functions

You can configure the features keys on the 6757i CT handset to perform specific functions using the configuration files or the Aastra Web UI. The following table identifies the available functions for the feature keys on the 6757i CT handset.

The following **Handset Key Functions Table** lists the available functions for the keys on the 6757i CT IP Phone.

Handset Key Functions Table

Feature Key Function	Configuration File Parameter	Aastra Web UI Parameter	Description
None	none	None	Indicates the key is disabled. This option is available from Web UI only.
Line (Lines 1 through 9 are available for selection)	line	Line	Indicates the key is configured for line use.
Icom	icom	Icom	Indicates the key is set to be used as the Intercom key. For more information about the Icom key, see your <i>Aastra IP Phone 6757i CT User's Guide</i> . For information about other Intercom features, see "Incoming/Outgoing Intercom with Auto-Answer and Barge In" on page 5-103 .
Directory	dir	Dir	Indicates the key is set for accessing the Directory List. For more information about the Directory List, see the section "Directory List" on page -302 .
Callers	callers	Callers	Indicates the key is set for accessing the Callers List. For more information on the Callers List, see the section "Callers List" on page -293 .

Feature Key Function	Configuration File Parameter	Aastra Web UI Parameter	Description
Transfer	xfer	Xfer	<p>Indicates the key is configured as a transfer key for transferring calls.</p> <p>For more information about the Xfer key, see your <i>Aastra IP Phone 6757i CT User's Guide</i>.</p>
Park	park	Park	<p>Indicates the key is set to be used as a park key to park an incoming call.</p> <p>For more information on park, see the section "Park/Pick Up Key (not applicable to the 6751i)" on page 5-234.</p>
Pickup	pickup	PickUp	<p>Indicates the key is set to be used as a pickup key to pick up a parked call.</p> <p>For more information on pickup, see the section "Park/Pick Up Key (not applicable to the 6751i)" on page 5-234.</p>
Conference	conf	Conf	<p>Indicates the key is configured as a conference key (for local conferencing).</p> <p>(For Sylanro and Broadsoft Servers) An Administrator can also enable centralized conferencing on the IP Phones.</p> <p>For more information about using the Conference key, see your <i>Aastra IP Phone 6757i CT User's Guide</i>.</p> <p>For information about enabling centralizing conferencing, see "Centralized Conferencing (for Sylanro and Broadsoft Servers)" on page 5-363.</p>

Operational Features

Feature Key Function	Configuration File Parameter	Aastra Web UI Parameter	Description
Public	public	Public	<p>Indicates the key is configured to toggle from public to private mode. A public and private key can be used when at a line item in the Directory List. The Private key toggles a number in the Directory List to private. The Public key allows a number in the Directory List to be sent to the handsets. A 6757i CT accepts a maximum of 50 entries with the public attribute.</p> <p>For more information about the public/private keys, see your <i>Aastra IP Phone 6757i CT User's Guide</i>.</p>
Flash	flash	Flash	<p>Indicates the key is set to generate a flash event when it is pressed, or when a feature key is pressed on the 6757i CT cordless handset. The IP phone generates flash events only when a call is connected and there is an active RTP stream (for example, when the call is not on hold).</p> <p>For more information about the Flash key, see your <i>Aastra IP Phone 6757i CT User's Guide</i>.</p>

Reference

For more information about features key functions for your 6757i CT, see your *Aastra IP Phone 6757i CT User's Guide*.

Configuring Handset Feature Keys

You can program up to 15 feature keys on the 6757i CT IP phone using the configuration files or the Aastra Web UI. Use the following procedure to program the feature keys on your 6757i CT Base Station and all paired handsets.

Use the following procedures to configure the IP phone handset feature keys.



Configuration Files

For specific parameters you can set in the configuration files, see Appendix A, the section, [“Handset Feature Key Settings \(9480i CT and 6757i CT\)”](#) on [page A-239](#).

 **Aastra Web UI**

1 Click on **Operation->Handset Keys**.

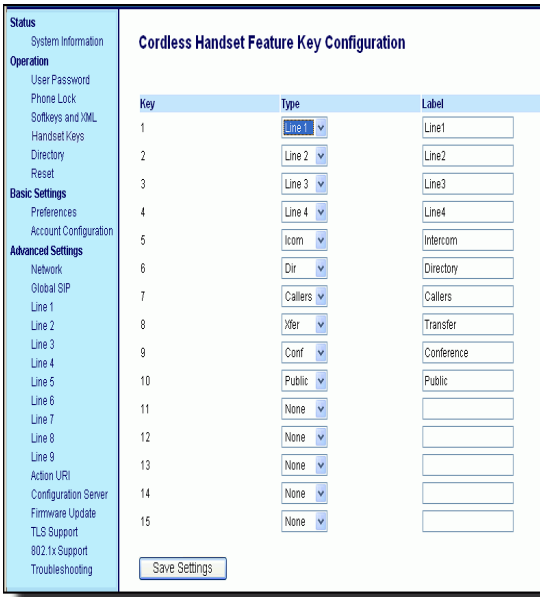

Key	Type	Label
1	Line 1	Line1
2	Line 2	Line2
3	Line 3	Line3
4	Line 4	Line4
5	Icom	Intercom
6	Dir	Directory
7	Callers	Callers
8	Xfer	Transfer
9	Conf	Conference
10	Public	Public
11	None	
12	None	
13	None	
14	None	
15	None	

2 Select the handset key you want to program.

3 Select the function for that handset key from the **"Key Function"** field.

4 Click  to save the function you selected to the handset key.

The key programming information is sent to the 6757i Base Station and to all the cordless handsets associated with that Base Station. Any key programmed to "None" does not appear in the handset's list.

Customizing the Key Type List in the Aastra Web UI

An Administrator can configure which key types display in the Aastra Web UI list for a Softkey, Programmable Key, Expansion Module Key, and/or Feature Key (CT Models). Currently, in the Aastra Web UI for a phone, you can select a type of key from a list of approximately 26 key types to assign to a softkey, programmable key, expansion module key, and/or feature key.

Using the configuration files, you can specify key types to display in the key type list that apply to a User's environment.

List of Available Keys Types

Key	Type	Label	Value	Line
1	WebApps			global
2	None			1
4	Speedial			1
5	BLF			1
6	Auto call distribution			1
7	XML			1
8	Flash			1
9	Park			1
10	Pickup			1
11	BLF/Xfer			1
12	Speedial/Conf			1
13	Directory			1
14	Callers List			1
15	Interroom			1
16	Services			1
17	Phone Lock			1
18	Paging			1
19	Empty			1
20	None			1

Example of a
List of Configured Keys Types
(None, Line, XML, Empty)

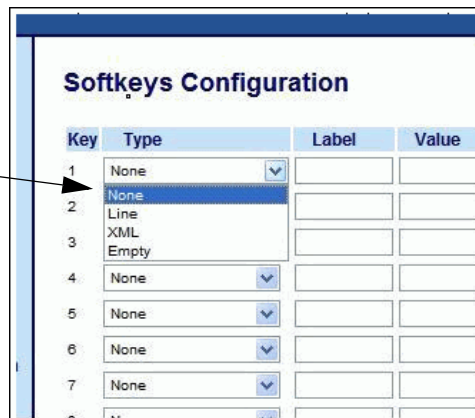

In addition to being able to specify which key types display in the list, the Administrator can also determine in which order the key types display.

You can use the following configuration file parameters to control which key types to display and specify in which order to display them in:

- **softkey selection list**
- **feature key selection list**

If no value is specified for the “softkey selection list” and/or “feature key selection list” parameters, the key “Type” list displays all of the key types by default.

If an Administrator configures specific key types for a phone in the configuration file, and the phone for which he downloads the configuration to already has key types configured on it, those key types display in the key list for those keys, in addition to the key types specified by the Administrator. For example, a phone has a Park key and a Pickup key already configured on the phone, and the Administrator downloads a configuration file to the phone that has specific key types of None, Line, Speeddial, and XML. After the configuration file is downloaded, the Park key list will show None, Line, Speeddial, XML, and Park; the Pickup key list will show None, Line, Speeddial, XML, and Pickup; all other keys that were configured as None before the download will show only None, Line, Speeddial, and XML.



Notes:

1. Any key types configured that do not apply to the phone are ignored.
2. The SAVE and DELETE keys appear by default as Keys 1 and 2 on the 6753i and 9143i, and as Keys 5 and 6 on the 6730i and 6731i, unless your Administrator configured these keys as other functions.
3. An Administrator must use the English value when configuring the key types in the configuration files.
5. After configuring specific key types for a phone, the key types in the Aastra Web UI display the same for both the User and Administrator Web interfaces for that phone.

Customizing the Key Type List Using the Configuration Files

Use the following procedure to configure the Key Type List that displays in the Aastra Web UI.



Configuration Files

For specific parameters you can set in the configuration files, see Appendix A, the section, [“Customizing the Key Type List”](#) on [page A-248](#).

Speeddial Prefixes

The normal function of the **speeddial** option allows you to configure a specific key on the phone to dial a number quickly by pressing the configured key. For example, if you had the following speeddial configuration in the configuration files:

```
softkey1 type: speeddial
softkey1 label: Office
softkey1 value: 5552345
softkey1 line: 1
```

after you press softkey1 on the phone, it dials the Office number at 555-2345 on line 1.

A new feature for the speeddial option allows you to configure a preset string of numbers followed by a “+”. This feature allows the phone to speeddial a prefix number and then pause to let you enter the remaining phone number. You can use this feature for numbers that contain long prefixes. For example, if you had the following speeddial configuration in the configuration files:

```
softkey2 type: speeddial
softkey2 label: Europe Office
softkey2 value: 1234567+
softkey2 line: 2
```

after you press softkey2 on the phone, it dials the prefix number automatically and pauses for you to enter the remaining number using the keypad on the phone.

You can configure the speeddial prefix using the configuration files or the Aastra Web UI.

Enabling/Disabling Ability to Add or Edit a Speeddial Key

The IP Phones allow you to set a parameter, “**speeddial edit**” using the configuration files that allows you to enable or disable the ability to add a speeddial key or edit a speeddial key from the IP Phone UI. Disabling this parameter prevents a user from adding or editing a speeddial key.

The default for this parameter is enabled, allowing you to create and edit speeddial keys on the phone using the Press-and-hold feature, softkeys, programmable keys, expansion module keys and key pad, speeddial menu in the IP Phone UI, and the SAVE TO key.

If this parameter is set to disabled, it blocks the user from using any of the features on the phone to create or edit a speeddial key.

Enabling/Disabling the Ability to Add or Edit a Speeddial Key Using the Configuration Files

Use the following procedure to enable/disable the ability to add and edit a speeddial key.



Configuration Files

For specific parameters you can set in the configuration files, see Appendix A, the section, “[Enabling/Disabling Ability to Add/Edit Speeddial Keys](#)” on [page A-255](#).

Busy Lamp Field (BLF)

The BLF feature on the IP phones allows a specific extension to be monitored for state changes. BLF monitors the status (busy or idle) of extensions on the IP phone.



Note: The BLF setting is applicable to the Asterisk server only.

Example

A Supervisor configures BLFs on his phone for monitoring the status of a worker's phone use (busy or idle). When the worker picks up his phone to make a call, a busy indicator on the Supervisor's phone shows that the worker's phone is in use and busy.

BLF Setting (For use with Asterisk)

On 8 and 11-Line LCD phones, the busy and idle indicators show on the IP phone screen display next to the softkey or programmable key configured for BLF functionality. When the monitored user is idle, an icon with the handset on-hook shows next to the BLF softkey or programmable key. When the monitored user is on an active call, a small telephone icon is shown with the handset off-hook.

On 3-Line LCD phones, the LED lights next to each BLF programmable key illuminate steady to indicate the monitored line is off-hook or unregistered. The LED goes off when the line is idle.



Note: You can configure a maximum of 50 BLFs on the M670i and M675i Expansion Modules.

You can configure a BLF key on the IP Phones using the configuration files or the Aastra Web UI.

BLF/List Setting

(For use with the BroadSoft Broadworks Rel 13 or higher platform only)

The BLF/List feature on the IP phones is specifically designed to support the BroadSoft Broadworks Rel 13 Busy Lamp Field feature. This feature allows the IP phone to subscribe to a list of monitored users defined through the BroadWorks web portal.

In addition to monitoring the idle and busy state, the BLF/List feature also supports the ringing state. When the monitored user is idle, there is a small telephone icon shown with the handset on-hook. When the monitored user is in ringing state, there is a small bell icon shown. When the monitored user is on an active call then a small telephone icon is shown with the handset off-hook.

On 3-Line LCD phones (not applicable to 6751i), the LED lights next to each BLF programmable key illuminate steady to indicate the monitored line is off-hook or unregistered. The LED goes off when the is idle. When the monitored extension is ringing, the LED flashes.



Note: The Broadworks BLF feature is not the same as the Broadworks Shared Call Appearance (SCA) feature and does not permit call control over the monitored extension.

You can configure a BLF/List key on the IP Phones using the configuration files or the Aastra Web UI. You can also specify a BLF list URI that the phone uses to access the required BLF list. You can specify a BLF List URI using the “**list uri**” parameter in the configuration files or the BLF List URI field in the Aastra Web UI at the path *Operation->Softkeys/Programmable Keys/Expansion Module Keys->Services->BLF List URI*. For more information about the “list uri” parameter, see Appendix A, the section, “[BLF List URI Settings](#)” on [page A-255](#).

Example

A receptionist has a 6757i running Broadsoft firmware that subscribes to a list of extensions from the BroadWorks Application Server. Each monitored extension in the list shows up individually on the 6757i screen next to a softkey button. The softkey icons on the screen change depending on the state of the extensions.

On 3-Line LCD phones running Broadsoft firmware, the programmable key LEDs illuminate either flashing, solid, or turn off depending on the state of those extensions.

Asterisk BLF Configuration

You can enable the BLF feature on Asterisk to enable monitoring for specific extensions. BLF on Asterisk is possible through the “hint” extension parameter.

Add the following in the Asterisk *extensions.conf* file for each target extension being monitored.

For example:

```
exten -> 9995551212,hint,SIP/9995551212
```

Add the following in the Asterisk *sip.conf* file for each subscriber if it is not defined already.

For example:

```
[9995551212]  
Subscribecontext=sip
```

BroadSoft BLF Configuration

You can enable the BLF feature on BroadSoft BroadWorks Rel 13 or higher through the BroadWorks Web Portal. Each user must have the Busy Lamp Field service enabled for their user. The user must add each desired extension to the “Monitored Users List” on the Busy Lamp Field service page and also enter in a list name for the monitored users BLF list on the same page.

Changes to the “Monitored Users List” are dynamic and the Aastra IP phones are automatically updated without requiring a restart.

Reference

For sample BLF configurations, see [Appendix D, “Sample BLF Softkey Settings.”](#)

Configuring BLFs

Use the following procedures to configure BLF and BLF\List on the IP phone.



Configuration Files

To set BLF or BLF\List in the configuration files, see Appendix A, the sections,

- [“Softkey/Programmable Key/Feature Key/Expansion Module Key Parameters”](#) on [page A-216](#).
- [“BLF List URI Settings”](#) on [page A-255](#).

Aastra Web UI

1 Click on **Operation->Softkeys and XML**
or
 Click on **Operation->Programmable Keys**
or
 Click on **Operation->Expansion Module <N>**.

Depending on your phone-model, the key configuration screen displays. The 6757i Key Screen is shown as an example.

Status

System Information

Operation

User Password

Phone Lock

Softkeys and XML

Programmable Keys

Directory

Reset

Basic Settings

Preferences

Account Configuration

Advanced Settings

Network

Global SIP

Line 1

Line 2

Line 3

Line 4

Line 5

Line 6

Line 7

Line 8

Line 9

Action URI

Configuration Server

Firmware Update

TLS Support

802.1x Support

Troubleshooting

Softkeys Configuration

Key	Type	Label	Value	Line	Idle	Connected	Incoming	Outgoing	Busy
1	Directory		34444	5	<input checked="" type="checkbox"/>	<input checked="" type="checkbox"/>	<input checked="" type="checkbox"/>	<input checked="" type="checkbox"/>	<input checked="" type="checkbox"/>
2	None			6	<input checked="" type="checkbox"/>	<input checked="" type="checkbox"/>	<input checked="" type="checkbox"/>	<input checked="" type="checkbox"/>	<input checked="" type="checkbox"/>
3	Speeddial	Lab	222222	7	<input checked="" type="checkbox"/>	<input checked="" type="checkbox"/>	<input checked="" type="checkbox"/>	<input checked="" type="checkbox"/>	<input checked="" type="checkbox"/>
4	None			1	<input checked="" type="checkbox"/>	<input checked="" type="checkbox"/>	<input checked="" type="checkbox"/>	<input checked="" type="checkbox"/>	<input checked="" type="checkbox"/>
5	None			1	<input checked="" type="checkbox"/>	<input checked="" type="checkbox"/>	<input checked="" type="checkbox"/>	<input checked="" type="checkbox"/>	<input checked="" type="checkbox"/>
6	None			1	<input checked="" type="checkbox"/>	<input checked="" type="checkbox"/>	<input checked="" type="checkbox"/>	<input checked="" type="checkbox"/>	<input checked="" type="checkbox"/>
7	None			1	<input checked="" type="checkbox"/>	<input checked="" type="checkbox"/>	<input checked="" type="checkbox"/>	<input checked="" type="checkbox"/>	<input checked="" type="checkbox"/>
8	None			1	<input checked="" type="checkbox"/>	<input checked="" type="checkbox"/>	<input checked="" type="checkbox"/>	<input checked="" type="checkbox"/>	<input checked="" type="checkbox"/>
9	None			1	<input checked="" type="checkbox"/>	<input checked="" type="checkbox"/>	<input checked="" type="checkbox"/>	<input checked="" type="checkbox"/>	<input checked="" type="checkbox"/>
10	None			1	<input checked="" type="checkbox"/>	<input checked="" type="checkbox"/>	<input checked="" type="checkbox"/>	<input checked="" type="checkbox"/>	<input checked="" type="checkbox"/>
11	None			1	<input checked="" type="checkbox"/>	<input checked="" type="checkbox"/>	<input checked="" type="checkbox"/>	<input checked="" type="checkbox"/>	<input checked="" type="checkbox"/>
12	None			1	<input checked="" type="checkbox"/>	<input checked="" type="checkbox"/>	<input checked="" type="checkbox"/>	<input checked="" type="checkbox"/>	<input checked="" type="checkbox"/>
13	None			1	<input checked="" type="checkbox"/>	<input checked="" type="checkbox"/>	<input checked="" type="checkbox"/>	<input checked="" type="checkbox"/>	<input checked="" type="checkbox"/>
14	None			1	<input checked="" type="checkbox"/>	<input checked="" type="checkbox"/>	<input checked="" type="checkbox"/>	<input checked="" type="checkbox"/>	<input checked="" type="checkbox"/>
15	None			1	<input checked="" type="checkbox"/>	<input checked="" type="checkbox"/>	<input checked="" type="checkbox"/>	<input checked="" type="checkbox"/>	<input checked="" type="checkbox"/>
16	None			1	<input checked="" type="checkbox"/>	<input checked="" type="checkbox"/>	<input checked="" type="checkbox"/>	<input checked="" type="checkbox"/>	<input checked="" type="checkbox"/>
17	None			1	<input checked="" type="checkbox"/>	<input checked="" type="checkbox"/>	<input checked="" type="checkbox"/>	<input checked="" type="checkbox"/>	<input checked="" type="checkbox"/>
18	None			1	<input checked="" type="checkbox"/>	<input checked="" type="checkbox"/>	<input checked="" type="checkbox"/>	<input checked="" type="checkbox"/>	<input checked="" type="checkbox"/>
19	None			1	<input checked="" type="checkbox"/>	<input checked="" type="checkbox"/>	<input checked="" type="checkbox"/>	<input checked="" type="checkbox"/>	<input checked="" type="checkbox"/>
20	None			1	<input checked="" type="checkbox"/>	<input checked="" type="checkbox"/>	<input checked="" type="checkbox"/>	<input checked="" type="checkbox"/>	<input checked="" type="checkbox"/>

Services

XML Application URI:

XML Application Title:



BLF List URI:

2 Select a softkey, programmable, or expansion module key to configure.

3 In the **"Type"** field, select "BLF" (Asterisk), "BLFList" (BroadSoft BroadWorks).

5-172

41-001160-03 Rev 00, Release 2.5

 Aastra Web UI	
4	<p>For 8 and 11-Line LCD softkeys:</p> <p>In the "Label" field, enter the name of the person who's extension you are monitoring (if "Type" is BLF).</p> <p>Note: If BLF\List type is selected, no label value is required. The BroadWorks BLF List name is configured in the "BLF List URI" field instead.</p>
5	<p>In the "Value" field, enter a value to associate with the softkey or programmable key. For example, for BLF, the value is the extension you want to monitor. For BLF\List, the value is an identifier for the list of numbers you are monitoring.</p>
6	<p>Click  to save your changes.</p>
7	<p>In the "Line" field, select a line number that is actively registered to the appropriate SIP proxy you are using.</p>
8	<p>In the "BLF List URI" field, enter the name of the BLF list defined on the BroadSoft BroadWorks Busy Lamp field page for your particular user. For example, my6757i-blf-list@as.broadworks.com.</p> <p>Note: The value of the BLF\List URI parameter must match the list name configured. Otherwise, no values display on the 6757i screen and the feature is disabled.</p>
9	<p>Click  to save your changes.</p>

BLF Subscription Period

On the IP phones, you can set the time period, in seconds, that the IP phone resubscribes the BLF subscription service after a software/firmware upgrade or after a reboot of the IP phone.

In the configuration files, you enter the following parameter with a valid value to set the BLF subscription period:

```
sip blf subscription period: <value in seconds>
```

The minimum value for this is 120 seconds (2 minutes). The default is 3600 (1 hour).

Setting this parameter to a value lower than 3600 allows the configured BLF feature to become active more quickly after a software/firmware upgrade or after a reboot of the IP phone. If you enter a value lower than 120 for this parameter, the default value (3600) will be used by the IP phone.

You can configure this feature using the configuration files or the Aastra Web UI.

Configuring BLF Subscription Period

Use the following procedures to configure the BLF subscription period on the IP phone.



Configuration Files

To configure the BLF subscription period on the IP phones using the configuration files, see Appendix A, the section, [“Advanced SIP Settings”](#) on [page A-103](#).

 Aastra Web UI			
1	<p>Click on Advanced Settings->Global SIP->Advanced SIP Settings.</p> <div style="border: 1px solid black; padding: 10px; margin: 10px 0;"> <table border="1" style="width: 100%; border-collapse: collapse;"> <tr> <td style="background-color: #D9E1F2; width: 25%; vertical-align: top; padding: 5px;"> <ul style="list-style-type: none"> Status System Information Operation User Password Phone Lock Softkeys and XML Keypad Speed Dial Directory Reset Basic Settings Preferences Account Configuration Advanced Settings Network Global SIP Line 1 Line 2 Line 3 Line 4 Line 5 Line 6 Line 7 Line 8 Line 9 Action URI Configuration Server Firmware Update TLS Support 802.1x Support Troubleshooting </td> <td style="padding: 5px;"> <h3 style="margin: 0;">Global SIP Settings</h3> <p>Advanced SIP Settings</p> <ul style="list-style-type: none"> Explicit MWI Subscription <input type="checkbox"/> Enabled Explicit MWI Subscription Period <input style="width: 100px;" type="text" value="86400"/> MWI for BLA account <input type="checkbox"/> Enabled Missed Call Summary Subscription <input type="checkbox"/> Enabled Missed Call Summary Subscription Period <input style="width: 100px;" type="text" value="86400"/> AS-Feature-Event Subscription <input type="checkbox"/> Enabled AS-Feature-Event Subscription Period <input style="width: 100px;" type="text" value="3600"/> Send MAC Address in REGISTER Message <input type="checkbox"/> Enabled Send Line Number in REGISTER Message <input type="checkbox"/> Enabled Session Timer <input style="width: 100px;" type="text" value="0"/> T1 Timer <input style="width: 100px;" type="text" value="0"/> T2 Timer <input style="width: 100px;" type="text" value="0"/> Transaction Timer <input style="width: 100px;" type="text" value="4000"/> Transport Protocol <input style="border: none; border-bottom: 1px solid gray; background-color: #D9E1F2; text-align: right; padding-right: 5px; font-size: small; color: #4F81BD; cursor: pointer; margin-bottom: 2px;" type="text" value="UDP"/> <div style="border: 1px solid gray; width: 100%; height: 15px; background-color: #D9E1F2; margin-bottom: 2px;"></div> Local SIP UDP/TCP Port <input style="width: 100px;" type="text" value="5060"/> Local SIP TLS Port <input style="width: 100px;" type="text" value="5061"/> Registration Failed Retry Timer <input style="width: 100px;" type="text" value="1800"/> Registration Timeout Retry Timer <input style="width: 100px;" type="text" value="120"/> Registration Renewal Timer <input style="width: 100px;" type="text" value="15"/> BLF Subscription Period <input style="width: 100px;" type="text" value="3600"/> ACD Subscription Period <input style="width: 100px;" type="text" value="3600"/> BLA Subscription Period <input style="width: 100px;" type="text" value="300"/> Blacklist Duration <input style="width: 100px;" type="text" value="300"/> Whitelist Proxy <input type="checkbox"/> Enabled XML SIP Notify <input type="checkbox"/> Enabled </td> </tr> </table> </div>	<ul style="list-style-type: none"> Status System Information Operation User Password Phone Lock Softkeys and XML Keypad Speed Dial Directory Reset Basic Settings Preferences Account Configuration Advanced Settings Network Global SIP Line 1 Line 2 Line 3 Line 4 Line 5 Line 6 Line 7 Line 8 Line 9 Action URI Configuration Server Firmware Update TLS Support 802.1x Support Troubleshooting 	<h3 style="margin: 0;">Global SIP Settings</h3> <p>Advanced SIP Settings</p> <ul style="list-style-type: none"> Explicit MWI Subscription <input type="checkbox"/> Enabled Explicit MWI Subscription Period <input style="width: 100px;" type="text" value="86400"/> MWI for BLA account <input type="checkbox"/> Enabled Missed Call Summary Subscription <input type="checkbox"/> Enabled Missed Call Summary Subscription Period <input style="width: 100px;" type="text" value="86400"/> AS-Feature-Event Subscription <input type="checkbox"/> Enabled AS-Feature-Event Subscription Period <input style="width: 100px;" type="text" value="3600"/> Send MAC Address in REGISTER Message <input type="checkbox"/> Enabled Send Line Number in REGISTER Message <input type="checkbox"/> Enabled Session Timer <input style="width: 100px;" type="text" value="0"/> T1 Timer <input style="width: 100px;" type="text" value="0"/> T2 Timer <input style="width: 100px;" type="text" value="0"/> Transaction Timer <input style="width: 100px;" type="text" value="4000"/> Transport Protocol <input style="border: none; border-bottom: 1px solid gray; background-color: #D9E1F2; text-align: right; padding-right: 5px; font-size: small; color: #4F81BD; cursor: pointer; margin-bottom: 2px;" type="text" value="UDP"/> <div style="border: 1px solid gray; width: 100%; height: 15px; background-color: #D9E1F2; margin-bottom: 2px;"></div> Local SIP UDP/TCP Port <input style="width: 100px;" type="text" value="5060"/> Local SIP TLS Port <input style="width: 100px;" type="text" value="5061"/> Registration Failed Retry Timer <input style="width: 100px;" type="text" value="1800"/> Registration Timeout Retry Timer <input style="width: 100px;" type="text" value="120"/> Registration Renewal Timer <input style="width: 100px;" type="text" value="15"/> BLF Subscription Period <input style="width: 100px;" type="text" value="3600"/> ACD Subscription Period <input style="width: 100px;" type="text" value="3600"/> BLA Subscription Period <input style="width: 100px;" type="text" value="300"/> Blacklist Duration <input style="width: 100px;" type="text" value="300"/> Whitelist Proxy <input type="checkbox"/> Enabled XML SIP Notify <input type="checkbox"/> Enabled
<ul style="list-style-type: none"> Status System Information Operation User Password Phone Lock Softkeys and XML Keypad Speed Dial Directory Reset Basic Settings Preferences Account Configuration Advanced Settings Network Global SIP Line 1 Line 2 Line 3 Line 4 Line 5 Line 6 Line 7 Line 8 Line 9 Action URI Configuration Server Firmware Update TLS Support 802.1x Support Troubleshooting 	<h3 style="margin: 0;">Global SIP Settings</h3> <p>Advanced SIP Settings</p> <ul style="list-style-type: none"> Explicit MWI Subscription <input type="checkbox"/> Enabled Explicit MWI Subscription Period <input style="width: 100px;" type="text" value="86400"/> MWI for BLA account <input type="checkbox"/> Enabled Missed Call Summary Subscription <input type="checkbox"/> Enabled Missed Call Summary Subscription Period <input style="width: 100px;" type="text" value="86400"/> AS-Feature-Event Subscription <input type="checkbox"/> Enabled AS-Feature-Event Subscription Period <input style="width: 100px;" type="text" value="3600"/> Send MAC Address in REGISTER Message <input type="checkbox"/> Enabled Send Line Number in REGISTER Message <input type="checkbox"/> Enabled Session Timer <input style="width: 100px;" type="text" value="0"/> T1 Timer <input style="width: 100px;" type="text" value="0"/> T2 Timer <input style="width: 100px;" type="text" value="0"/> Transaction Timer <input style="width: 100px;" type="text" value="4000"/> Transport Protocol <input style="border: none; border-bottom: 1px solid gray; background-color: #D9E1F2; text-align: right; padding-right: 5px; font-size: small; color: #4F81BD; cursor: pointer; margin-bottom: 2px;" type="text" value="UDP"/> <div style="border: 1px solid gray; width: 100%; height: 15px; background-color: #D9E1F2; margin-bottom: 2px;"></div> Local SIP UDP/TCP Port <input style="width: 100px;" type="text" value="5060"/> Local SIP TLS Port <input style="width: 100px;" type="text" value="5061"/> Registration Failed Retry Timer <input style="width: 100px;" type="text" value="1800"/> Registration Timeout Retry Timer <input style="width: 100px;" type="text" value="120"/> Registration Renewal Timer <input style="width: 100px;" type="text" value="15"/> BLF Subscription Period <input style="width: 100px;" type="text" value="3600"/> ACD Subscription Period <input style="width: 100px;" type="text" value="3600"/> BLA Subscription Period <input style="width: 100px;" type="text" value="300"/> Blacklist Duration <input style="width: 100px;" type="text" value="300"/> Whitelist Proxy <input type="checkbox"/> Enabled XML SIP Notify <input type="checkbox"/> Enabled 		
2	<p>Enter a value, in seconds, from 120 (2 min) to 3600 (1 hour) in the "BLF Subscription Period" field.</p>		
3	<p>Click <input type="button" value="Save Settings"/> to save your changes.</p>		

BLF/Xfer and Speeddial/Xfer Keys

The IP Phones have a transfer (Xfer) enhancement feature you can use with the BLF and Speeddial keys - **BLF/Xfer** and **Speeddial/Xfer**.

The BLF key allows one or more extensions to be monitored, and once there is any state change with those extensions, the key shows the status of the monitored lines. The Xfer key allows a call to be transferred to other recipients blindly or consultatively.

The Speeddial key allows a number to be dialed quickly by pressing one key configured for speeddialing. After answering a call, the recipient can transfer the call to an extension by:

1. Pressing Xfer key
2. Entering the number of the extension or pressing speeddial or BLF key.
3. Pressing Xfer key again

The BLF and Speeddial transfer enhancement feature provides a simpler way of transferring calls using the keys called **BLF/Xfer** and **Speeddial/Xfer**. The **BLF/Xfer** key combines the BLF and Xfer key's functionality together allowing the user to transfer calls or use BLF with one key. Similarly, the **Speeddial/Xfer** key combines the Speeddial key and Xfer key's functionality together allowing the user to press one key to speeddial and transfer calls.



Note: It is recommended that you enable the “**switch focus to ringing**” parameter when using the BLF and Speeddial transfer key feature. For more information about this parameter, see “[Switch Focus to Ringing Line](#)” on [page 5-79](#).”

BLF/Xfer Key Requirements and Functionality

- **BLF/Xfer and BLF**

A BLF/Xfer key can be configured for subscribing to an extension and monitor the status of the extension, similar to the BLF key functionality. Changes of the state of the monitored extension are indicated by a LED / Icon.

- **BLF/Xfer and Blind Transfer Calls**

When the focused line is in the “**Connected**” state, pressing the BLF/Xfer key transfers the call to the extension unconditionally, disregarding the status of the monitored extension.

If transferring a call to an extension fails, a message “*Transfer Failed*” displays on the phone, and you can reconnect the call (get the call back) by pressing the line key again.

- **BLF/Xfer and Call forward**

When the focused line is in the “**Ring**ing” state, pressing the BLF/Xfer key forwards the call to the extension unconditionally, disregarding the status of the monitored extension.

- **BLF/Xfer and Speeddial**

When the focused line and the monitored extension are idle, pressing the BLF/Xfer key causes the phone to go offhook and dial the number of the extension.

Speeddial/Xfer Key Requirements and Functionality

The Speeddial/Xfer key has the following capabilities:

- **Speeddial/Xfer and Speeddial**

When the phone is in the “**Idle**” state, pressing the Speeddial/Xfer key causes the phone to go offhook and dial the predefined extension.

- **Speeddial/Xfer and Blind Transfer**

When the phone is connected to a call, pressing the Speeddial/Xfer key blind transfers the call to the predefined target.

If transferring a call fails, a message “*Transfer Failed*” displays, and you can reconnect the call (get the call back) by pressing the line key again.

- **Speeddial/Xfer and Call Forward**

When the phone is in the “**Ring**ing” state, pressing the Speeddial/Xfer key forwards the call to the predefined extension.

Configuring the BLF/Xfer Key and the Speeddial/Xfer Key Using the Configuration Files

You use the following parameters in the configuration files to configure the BLF/Xfer key and/or Speeddial/Xfer key on the IP Phone.

Softkey Parameters	Programmable Key Parameters	Expansion Module Parameters
softkeyN type softkeyN label softkeyN value softkeyN line softkeyN states	prgkeyN type prgkeyN value prgkeyN line	expmodN keyN type expmodN keyN label expmodN keyN value expmodN keyN line
Top Softkey Parameters		
topsoftkeyN type topsoftkeyN label topsoftkeyN value topsoftkeyN line		

Examples:

```
softkey1 type: speeddialxfer
softkey1 label: BX7801
softkey1 value: 7801
softkey1 line: 1
softkey1 states: idle connected incoming outgoing busy
```

```
prgkey1 type: blfxfer
prgkey1 value: 35
prgkey1 line: 1
```

Refer to the following in Appendix A to configure a BLF/Xfer and Speeddial/Xfer key on the IP phone using the configuration files.



Configuration Files

To set a BLF/Xfer and Speeddial/Xfer key using the configuration files, see Appendix A, "[Softkey/Programmable Key/Feature Key/Expansion Module Key Parameters](#)" on [page A-216](#).

Configuring the BLF/Xfer Key and the Speeddial/Xfer Key Using the Aastra Web UI

You configure the BLF/Xfer key and/or the Speeddial/Xfer Key on the IP phone similar to configuring a BLF key or speeddial key using the Aastra Web UI. Use the following procedure to configure BLF/Xfer and/or Speeddial/Xfer.

Aastra Web UI

1 Click on **Operation->Softkeys and XML.**
or
Click on **Operation->Programmable Keys.**
or
Click on **Operation->Expansion Keys.**

Bottom Keys Tab (6757i example).

Status
System Information

Operation
User Password
Phone Lock
Softkeys and XML
Directory
Reset

Basic Settings
Preferences
Account Configuration

Advanced Settings
Network
Global SIP
Line 1
Line 2
Line 3
Line 4
Line 5
Line 6
Line 7
Line 8
Line 9
Action URI
Configuration Server
Firmware Update
TLS Support
802.1x Support
Troubleshooting

Softkeys Configuration

Bottom Keys
Top Keys

Key	Type	Label	Value	Line	Idle	Connected	Incoming	Outgoing	Busy
1	BLF/Xfer	BX35	35	global	<input checked="" type="checkbox"/>	<input checked="" type="checkbox"/>	<input checked="" type="checkbox"/>	<input checked="" type="checkbox"/>	<input checked="" type="checkbox"/>
2	BLF/Xfer	BX7801	7801	global	<input checked="" type="checkbox"/>	<input checked="" type="checkbox"/>	<input checked="" type="checkbox"/>	<input checked="" type="checkbox"/>	<input checked="" type="checkbox"/>
3	None			1	<input checked="" type="checkbox"/>	<input checked="" type="checkbox"/>	<input checked="" type="checkbox"/>	<input checked="" type="checkbox"/>	<input checked="" type="checkbox"/>
4	None			1	<input checked="" type="checkbox"/>	<input checked="" type="checkbox"/>	<input checked="" type="checkbox"/>	<input checked="" type="checkbox"/>	<input checked="" type="checkbox"/>
5	None			1	<input checked="" type="checkbox"/>	<input checked="" type="checkbox"/>	<input checked="" type="checkbox"/>	<input checked="" type="checkbox"/>	<input checked="" type="checkbox"/>
6	None			1	<input checked="" type="checkbox"/>	<input checked="" type="checkbox"/>	<input checked="" type="checkbox"/>	<input checked="" type="checkbox"/>	<input checked="" type="checkbox"/>
7	None			1	<input checked="" type="checkbox"/>	<input checked="" type="checkbox"/>	<input checked="" type="checkbox"/>	<input checked="" type="checkbox"/>	<input checked="" type="checkbox"/>
8	None			1	<input checked="" type="checkbox"/>	<input checked="" type="checkbox"/>	<input checked="" type="checkbox"/>	<input checked="" type="checkbox"/>	<input checked="" type="checkbox"/>
9	None			1	<input checked="" type="checkbox"/>	<input checked="" type="checkbox"/>	<input checked="" type="checkbox"/>	<input checked="" type="checkbox"/>	<input checked="" type="checkbox"/>
10	None			1	<input checked="" type="checkbox"/>	<input checked="" type="checkbox"/>	<input checked="" type="checkbox"/>	<input checked="" type="checkbox"/>	<input checked="" type="checkbox"/>
11	None			1	<input checked="" type="checkbox"/>	<input checked="" type="checkbox"/>	<input checked="" type="checkbox"/>	<input checked="" type="checkbox"/>	<input checked="" type="checkbox"/>
12	None			1	<input checked="" type="checkbox"/>	<input checked="" type="checkbox"/>	<input checked="" type="checkbox"/>	<input checked="" type="checkbox"/>	<input checked="" type="checkbox"/>
13	None			1	<input checked="" type="checkbox"/>	<input checked="" type="checkbox"/>	<input checked="" type="checkbox"/>	<input checked="" type="checkbox"/>	<input checked="" type="checkbox"/>
14	None			1	<input checked="" type="checkbox"/>	<input checked="" type="checkbox"/>	<input checked="" type="checkbox"/>	<input checked="" type="checkbox"/>	<input checked="" type="checkbox"/>
15	None			1	<input checked="" type="checkbox"/>	<input checked="" type="checkbox"/>	<input checked="" type="checkbox"/>	<input checked="" type="checkbox"/>	<input checked="" type="checkbox"/>
16	None			1	<input checked="" type="checkbox"/>	<input checked="" type="checkbox"/>	<input checked="" type="checkbox"/>	<input checked="" type="checkbox"/>	<input checked="" type="checkbox"/>
17	None			1	<input checked="" type="checkbox"/>	<input checked="" type="checkbox"/>	<input checked="" type="checkbox"/>	<input checked="" type="checkbox"/>	<input checked="" type="checkbox"/>
18	None			1	<input checked="" type="checkbox"/>	<input checked="" type="checkbox"/>	<input checked="" type="checkbox"/>	<input checked="" type="checkbox"/>	<input checked="" type="checkbox"/>
19	None			1	<input checked="" type="checkbox"/>	<input checked="" type="checkbox"/>	<input checked="" type="checkbox"/>	<input checked="" type="checkbox"/>	<input checked="" type="checkbox"/>
20	None			1	<input checked="" type="checkbox"/>	<input checked="" type="checkbox"/>	<input checked="" type="checkbox"/>	<input checked="" type="checkbox"/>	<input checked="" type="checkbox"/>

 **Aastra Web UI**

Top Keys Tab (6757i example)

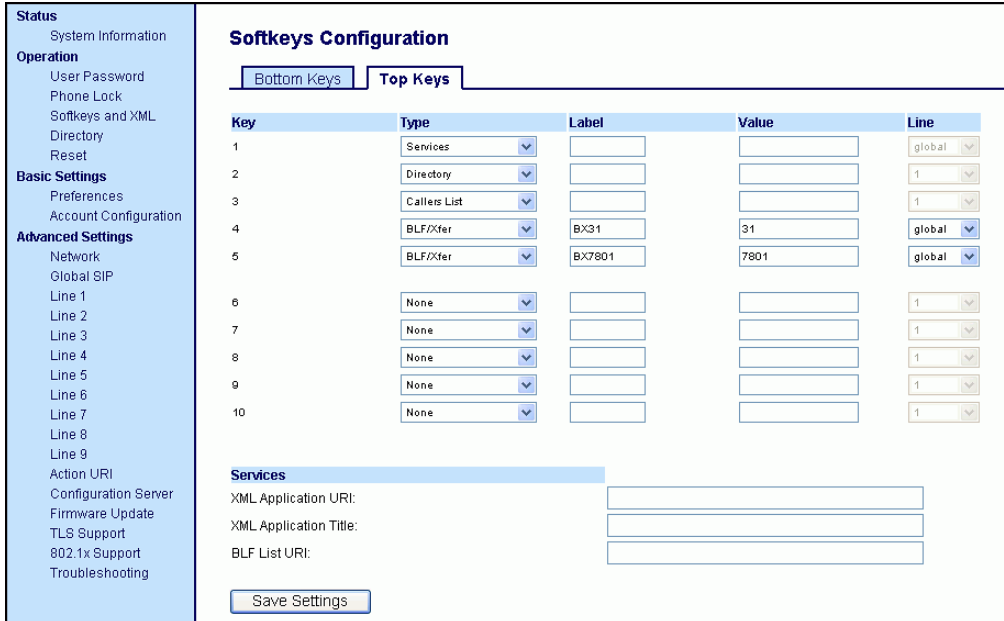

Softkeys Configuration

Bottom Keys | **Top Keys**

Key	Type	Label	Value	Line
1	Services			global
2	Directory			1
3	Callers List			1
4	BLF/Xfer	BX31	31	global
5	BLF/Xfer	BX7801	7801	global
6	None			1
7	None			1
8	None			1
9	None			1
10	None			1

Services

XML Application URI:

XML Application Title:

BLF List URI:

2 Choose a key that you want to assign the BLF/Xfer key or a Speeddial/Xfer key to, and select **BLF/Xfer** or **Speeddial/Xfer** from the “**Type**” field.

3 In the “**Label**” field, enter a key label to assign to the BLF/Xfer key (for example, “**BX35**”).

4 In the “**Value**” field, enter the monitored extension (for example, “**35**”).

5 In the “**Line**” field, select the line for which you want to use the key functionality.

6 On the Bottom Key tab, in the States field, select the state(s) (idle, connected, incoming, outgoing, busy) for which you want to use on the key.

Note: States are not applicable to programmable keys.

7 Click to save your changes.

Speeddial/Conference Key (not applicable to the 6751i)

The IP Phones allow you to configure a softkey/programmable key/expansion module key to be used as a speeddial conference key (**Speeddial/Conf** key) while remaining in the current call. This key allows a user on a call, to conference another party at a pre-defined number while remaining in the conference call.

For example, while on an active call, a user can use the Speeddial/Conf key to dial a recording service and have the resulting conference recorded.



Note: If currently in a conference, the Speeddial/Conf key is disabled on the active call.

How it Works

If you configure a softkey/programmable key/expansion module as a **Speeddial/Conf** key, and you press this key while on an active call, the focused line changes to the dialing line. A **Cancel** softkey displays on the phone (only those phones that have LCDs larger than 3 lines), allowing you to abort the conference speeddial if required. The message "*Ringin...*" displays below the number when the far end is ringing. The message "*Conf. Unavailable*" briefly displays when a conference is already in progress or when the CT handset is in use. The active call is not put on hold when the speeddial number is dialed.

Limitations for Speeddial/Conference Key

The following are limitations for the Speeddial/Conference key:

- The CT handsets are not supported.
- The feature is not compatible with centralized conferencing.

The softkey/programmable key is called "**Speeddial/Conf**" in the Web UI drop down list. In the configuration file, use "**speeddialconf**" as the softkey type.

Configuring the Speeddial/Conf Key Using the Configuration Files

To configure the Speeddial/Conf key using the configuration files, you enter “**speeddialconf**” for the key type. The following parameters are examples you can use to configure the Speeddial/Conf key:

softkey1 type: **speeddialconf**
softkey1 label: **Sales**
softkey1 value: **5645**
softkey1 line: **3**

topsoftkey1 type: **speeddialconf**
topsoftkey1 label: **Sales**
topsoftkey1 value: **5645**
topsoftkey1 line: **3**

prgkey1 type: **speeddialconf**
prgkey1 value: **5645**
prgkey1 line: **1**

expmod1 key1 type: **speeddialconf**
expmod1 key1 label: **Sales**
expmod1 key1 value: **5645**
expmod1 key1 line: **3**

Refer to the following in Appendix A to configure a Speeddial/Conf key on the IP phone using the configuration files.



Configuration Files

To set a Speeddial/Conf key using the configuration files, see Appendix A, “[Softkey/Programmable Key/Feature Key/Expansion Module Key Parameters](#)” on [page A-216](#).

Configuring the Speeddial/Conf Key Using the Aastra Web UI

Use the following procedure to configure the Speeddial/Conf Key using the Aastra Web UI.

Aastra Web UI

1	<p>Click on Operation->Sottkeys and XML. or Click on Operation->Programmable Keys. or Click on Operation->Expansion Module Keys.</p>
<p>Speeddial/Conf Option</p>	
2	In the "Type" field, select Speeddial/Conf from the list of options.
3	In the "Label" field, enter a key label to assign to the Speeddial/Conf key (for example, "Sales").
4	In the "Value" field, enter the number that the phone dials when the Speeddial/Conf key is pressed (for example, "4556").
5	In the "Line" field, select the line for which you want to use the key functionality.

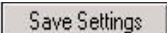

Aastra Web UI

6	<p><i>For phones with softkeys:</i></p> <p>In the States field, select the state(s) (idle, connected, incoming, outgoing, busy) for which you want to use on the key.</p> <p>Note: States are not applicable to programmable keys (9143i, 6730i, 6731i, 6753i, 6755i).</p>
7	<p>Click  to save your changes.</p>

Automatic Call Distribution (ACD) (for Sylanro Servers)

The IP phones support an Automatic Call Distribution (ACD) feature for Sylanro servers. The ACD feature allows the Sylanro server to distribute calls from a queue to registered IP phone users (agents).

To use the ACD feature on an IP phone, the administrator must first configure an ACD softkey or programmable key. When an IP phone user wants to subscribe to a queue (in order to receive incoming calls), the user presses the ACD key. The IP phone UI prompts the user to specify the following information:

- **User ID:** the phone number(s) used to login into the queue.
- **Password:** the password used to login to the queue.
- **Available/unavailable:** Shows the current status of the IP phone. Specifies if the IP phone user is available/unavailable to receive a call from the queue. This parameter is set to “unavailable” by default.

When the IP phone user is ready to receive calls from the server, the user logs into a queue. Depending on the server configuration, the IP phone is either in an “unavailable” or “available” state. If the phone is set to “available” then the server begins to distribute calls to this phone immediately. If the phone is set to unavailable, then server waits until the IP phone user manually changes the phone status to “available” (using the IP phone UI) before distributing calls.

Whenever the IP phone user answers a call, or misses a call, the server automatically changes the phone’s status to unavailable. The server updates its database with this new information and no longer distributes calls to this phone. The IP phone will remain in this state until:

- the IP phone user makes himself “available” again.
- the ACD auto-availability timer expires. This occurs only if the administrator has configured an ACD auto-availability timer as described in [“ACD Auto-Available Timer”](#) on [page 5-187](#).

The IP phone user can also choose to manually change the phone status to unavailable, using the IP Phone UI.



Note: It is recommended you configure no more than a single ACD softkey or programmable key per IP phone.

ACD Auto-Available Timer

Whenever the IP phone user answers a call, or misses a call, the server automatically changes the phone's status to unavailable. The administrator can control how long the IP phone remains in the unavailable state by configuring an auto-available timer. When the timer expires, the IP phone status is automatically changed to available. The default setting for the timer is 60 seconds.

You use the following parameters to configure an ACD Auto-Available Timer in the configuration files:

- `acd auto available`
- `acd auto available timer`

Configuring an Automatic Call Distribution (ACD) Key

You can configure an ACD key on softkeys, programmable keys, and extension module keys. The following table illustrates examples of configuring an ACD key on the phone.

Softkey Examples	Top Softkey Examples	Programmable Key Examples	Extension Module Examples
softkey1 type: acd softkey1 label: sales softkey1 line: 1 softkey1 states: idle	topsoftkey1 type: acd topsoftkey1 label: sales topsoftkey1 line: 1 topsoftkey1 states: idle	prgkey1 type: acd prgkey1 line: 1:	expmod1 key1 type: acd expmod1 key1 label: sales expmod1 key 1 line: 1

Use the following procedures to configure an ACD key n the IP phone.



Configuration Files

To configure an ACD key using the configuration files, see Appendix A, the section, "[Softkey/Programmable Key/Feature Key/Expansion Module Key Parameters](#)" on [page A-216](#).

Configuring the ACD Auto-Available Timer.



Configuration Files

To configure the ACD Auto-Available Timer using the configuration files, see Appendix A, the section, "[ACD Auto-Available Timer Settings](#)" on [page A-210](#).

Configuring an ACD Key Using the Aastra Web UI

Use the following procedure to configure an ACD softkey, programmable key, or expansion module key using the Aastra Web UI. This procedure uses the 6755i IP phone as an example.

Aastra Web UI

1 Click on **Operation->Softkeys and XML**
or
 Click on **Operation->Programmable Keys**
or
 Click on **Operation->Expansion Module <N>**.

Depending on your phone-model, the key configuration screen displays. The 6757i Key Screen is shown as an example.

Key	Type	Label	Value	Line	Idle	Connected	Incoming	Outgoing	Busy
1	Auto call distribution	Sales		1	<input checked="" type="checkbox"/>	<input checked="" type="checkbox"/>	<input checked="" type="checkbox"/>	<input checked="" type="checkbox"/>	<input checked="" type="checkbox"/>
2	None			6	<input checked="" type="checkbox"/>	<input checked="" type="checkbox"/>	<input checked="" type="checkbox"/>	<input checked="" type="checkbox"/>	<input checked="" type="checkbox"/>
3	Line			7	<input checked="" type="checkbox"/>	<input checked="" type="checkbox"/>	<input checked="" type="checkbox"/>	<input checked="" type="checkbox"/>	<input checked="" type="checkbox"/>
4	None			1	<input checked="" type="checkbox"/>	<input checked="" type="checkbox"/>	<input checked="" type="checkbox"/>	<input checked="" type="checkbox"/>	<input checked="" type="checkbox"/>
5	None			1	<input checked="" type="checkbox"/>	<input checked="" type="checkbox"/>	<input checked="" type="checkbox"/>	<input checked="" type="checkbox"/>	<input checked="" type="checkbox"/>
6	None			1	<input checked="" type="checkbox"/>	<input checked="" type="checkbox"/>	<input checked="" type="checkbox"/>	<input checked="" type="checkbox"/>	<input checked="" type="checkbox"/>
7	None			1	<input checked="" type="checkbox"/>	<input checked="" type="checkbox"/>	<input checked="" type="checkbox"/>	<input checked="" type="checkbox"/>	<input checked="" type="checkbox"/>
8	None			1	<input checked="" type="checkbox"/>	<input checked="" type="checkbox"/>	<input checked="" type="checkbox"/>	<input checked="" type="checkbox"/>	<input checked="" type="checkbox"/>
9	None			1	<input checked="" type="checkbox"/>	<input checked="" type="checkbox"/>	<input checked="" type="checkbox"/>	<input checked="" type="checkbox"/>	<input checked="" type="checkbox"/>
10	None			1	<input checked="" type="checkbox"/>	<input checked="" type="checkbox"/>	<input checked="" type="checkbox"/>	<input checked="" type="checkbox"/>	<input checked="" type="checkbox"/>
11	None			1	<input checked="" type="checkbox"/>	<input checked="" type="checkbox"/>	<input checked="" type="checkbox"/>	<input checked="" type="checkbox"/>	<input checked="" type="checkbox"/>
12	None			1	<input checked="" type="checkbox"/>	<input checked="" type="checkbox"/>	<input checked="" type="checkbox"/>	<input checked="" type="checkbox"/>	<input checked="" type="checkbox"/>
13	None			1	<input checked="" type="checkbox"/>	<input checked="" type="checkbox"/>	<input checked="" type="checkbox"/>	<input checked="" type="checkbox"/>	<input checked="" type="checkbox"/>
14	None			1	<input checked="" type="checkbox"/>	<input checked="" type="checkbox"/>	<input checked="" type="checkbox"/>	<input checked="" type="checkbox"/>	<input checked="" type="checkbox"/>
15	None			1	<input checked="" type="checkbox"/>	<input checked="" type="checkbox"/>	<input checked="" type="checkbox"/>	<input checked="" type="checkbox"/>	<input checked="" type="checkbox"/>
16	None			1	<input checked="" type="checkbox"/>	<input checked="" type="checkbox"/>	<input checked="" type="checkbox"/>	<input checked="" type="checkbox"/>	<input checked="" type="checkbox"/>
17	None			1	<input checked="" type="checkbox"/>	<input checked="" type="checkbox"/>	<input checked="" type="checkbox"/>	<input checked="" type="checkbox"/>	<input checked="" type="checkbox"/>
18	None			1	<input checked="" type="checkbox"/>	<input checked="" type="checkbox"/>	<input checked="" type="checkbox"/>	<input checked="" type="checkbox"/>	<input checked="" type="checkbox"/>
19	None			1	<input checked="" type="checkbox"/>	<input checked="" type="checkbox"/>	<input checked="" type="checkbox"/>	<input checked="" type="checkbox"/>	<input checked="" type="checkbox"/>
20	None			1	<input checked="" type="checkbox"/>	<input checked="" type="checkbox"/>	<input checked="" type="checkbox"/>	<input checked="" type="checkbox"/>	<input checked="" type="checkbox"/>

2 In the **"Type"** field, select **Auto Call Distribution**.

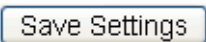
Aastra Web UI	
3	In the “ Label ” field, specify a name for this ACD softkey. The Label helps identify which queue you are subscribing to when you login. (This field does not apply to the programmable keys on the 6730i, 6731i, 6753i, 6755i and 9143i.) For example: Sales
4	In the “ Line ” field, select the line which the IP phone uses to subscribe to the queue. For example: Line 1
5	Click  to save your changes.

Configuring the ACD Auto-Available Timer Using the Aastra Web UI

Use the following procedure to configure an ACD auto-available timer using the Aastra Web UI.

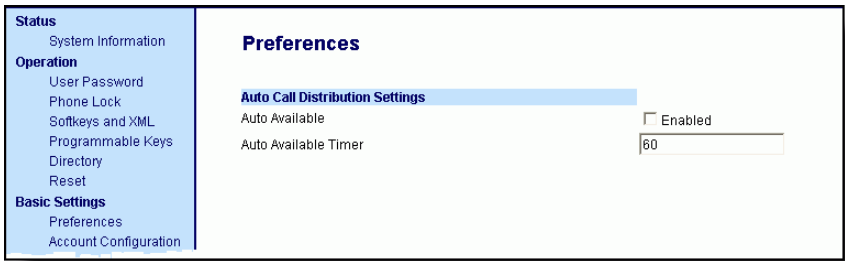
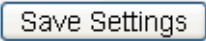
Aastra Web UI	
1	Click on Basic Settings->Preferences->Auto Call Distribution Settings . 
2	In the “ Auto Available ” check-box, click Enabled .
3	In the “ Auto Available Timer ” field, specify the length of time (in seconds) before the IP phone state is automatically reset to “available.” Valid values are 0 to 120 seconds. Default is 60. For example: 60
4	Click  to save your changes.

Using the ACD Feature on your IP Phone

The ACD feature allows you to login to a phone queue in order to receive distributed calls on your IP phone. To login to a phone queue, your system administrator must preconfigure an ACD softkey or programmable key on your Aastra IP phone.

For models 8 and 11-Line LCD phones, the ACD softkey is labeled according to your network requirements. Check with your administrator to verify the label assigned to the ACD softkey on your IP phone. The label usually describes which phone queue you are accessing when you press the ACD softkey.

For example, suppose the administrator wants to configure an ACD softkey to allow an IP phone user to log into the Customer Support phone queue. The administrator assigns the label “Support” to the softkey, so it is easily recognizable to the IP phone user. When the IP phone user wants to subscribe to the Customer Support queue, the user presses the Support key and can log in.





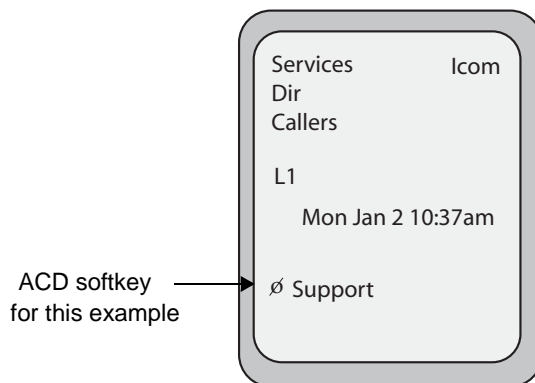

Once logged in to the queue, you can make himself “available” or “unavailable” to take calls by pressing the Available/Unavailable key on the phone UI. The server monitors your IP phone status. When you set the IP phone to “available,” the server begins distributing calls to your phone. When you set the IP phone to “unavailable,” the server temporarily stops distributing calls to your phone.

The icon that appears next to the ACD softkey or programmable key on the IP Phone UI reflects your current status. In the example shown below, the  icon shows the current status of this IP phone user as “logged off.”



Operational Features

This icon changes when you log on to the phone queue and are available to take calls. The icon changes again when you are busy with an active call. The table below describes the meaning of the LED, and each icon, as they may appear on your IP phone:

Phone Model	Status: Logged In and Available	Status: Unavailable	Logged Out
9143i	Solid Red LED	Blinking red LED	No LED
9480i, 9480i CT	Solid Red LED  icon	Blinking Red LED Blinking  icon	No LED  icon
6730i, 6731i, 6753i	Solid Red LED	Blinking red LED	No LED
6755i, 6757i, 6757i CT	Solid Red LED  icon	Blinking Red LED Blinking  icon	No LED  icon

Logging In to a Phone Queue (8 and 11-Line LCD phones)

Use the following procedure to log into a phone queue from your Aastra IP phone.

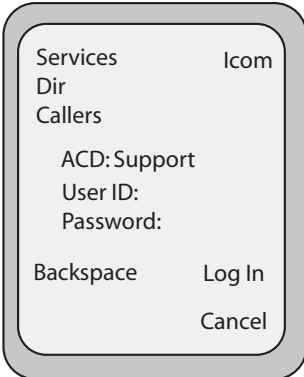
 Aastra IP Phone UI	
Step	Action
1	<p>Press the ACD softkey on your IP phone.</p> <p>Note: Check with your administrator to verify the label assigned to the ACD softkey on your IP phone.</p> <p>The login screen (see below) appears. In this example, the ACD softkey accesses the Customer Support phone queue and is labelled "Support."</p> <div style="text-align: center; border: 1px solid gray; border-radius: 15px; padding: 10px; width: fit-content; margin: 20px auto;">  </div>
2	<p>To log into the phone queue, use your IP phone keypad to enter the following information:</p> <p>User ID: The phone number you use to access the queue.</p> <p>Password: The password you use to access this queue.</p>

**Aastra IP Phone UI**

Step	Action
3	<p>Press the Log In softkey.</p> <p>You are logged into the phone queue. Once you log in, examine the IP Phone UI, and note the following information:</p> <ul style="list-style-type: none">• If your IP phone status is set to “available” then the server will begin to distribute phone calls from this queue to your IP phone.• If your IP phone status remains “unavailable” after you log in, then you must manually change the state to “available” in order to start receiving calls.• To temporarily stop receiving calls, you can switch the IP phone status to “unavailable.” <p>While you are on a call (or miss a call that has been distributed to your IP phone), your IP phone status automatically switches to “unavailable.” Your IP phone remains in the unavailable state until one of the following things occur:</p> <ul style="list-style-type: none">• You use the IP Phone UI to manually switch the IP phone state back to available, or• The availability “timer” for your IP phone expires. This only occurs if your administrator has configured an auto-availability timer on your IP phone.
4	<p>To Log out of the queue, press the Log Out softkey. The server no longer distributes phone calls to your IP phone.</p>

Logging In To a Phone Queue (3-Line LCD phones - not applicable to the 6751i))

Use the following procedure to log into a phone queue from your Aastra IP phone.

 Aastra IP Phone UI	
Step	Action
1	Press the ACD programmable key on your IP phone.
2	To login to the phone queue, use your IP phone keypad to enter the following information: User ID: The phone number you use to access the queue. Password: The password you use to access this queue.
3	<p>Select Login.</p> <p>You are logged into the phone queue. Once you log in, examine the IP Phone UI, and note the following information:</p> <ul style="list-style-type: none"> • If your IP phone status is set to “available” then the server will begin to distribute phone calls from this queue to your IP phone. • If your IP phone status remains “unavailable” after you log in, then you must manually change the state to “available” in order to start receiving calls. • To temporarily stop receiving calls, you can switch the IP phone status to “unavailable.” <p>While you are on a call (or miss a call that has been distributed to your IP phone), your IP phone status automatically switches to “unavailable.” Your IP phone remains in the unavailable state until one of the following things occur:</p> <ul style="list-style-type: none"> • You use the IP Phone UI to manually switch the IP phone state back to available, or • The availability “timer” for your IP phone expires. This only occurs if your administrator has configured an auto-availability timer on your IP phone.
4	<p>To Log out of the queue, select Logout.</p> <p>The server no longer distributes phone calls to your IP phone.</p>

ACD Subscription Period

On the IP phones, you can set the time period, in seconds, that the IP phone resubscribes the ACD subscription service after a software/firmware upgrade or after a reboot of the IP phone.

In the configuration files, you enter the following parameter with a valid value to set the ACD subscription period:

```
sip acd subscription period: <value in seconds>
```

The minimum value for this is 120 seconds (2 minutes).
The default is 3600 (1 hour).

Setting this parameter to a value lower than 3600 allows the configured ACD feature to become active more quickly after a software/firmware upgrade or after a reboot of the IP phone. If you enter a value lower than 120 for this parameter, the default value (3600) will be used by the IP phone.

You can configure this feature using the configuration files or the Aastra Web UI.

Configuring ACD Subscription Period

Use the following procedures to configure the ACD subscription period on the IP phone.



Configuration Files

To configure the ACD subscription period on the IP phones using the configuration files, see Appendix A, the section, [“Advanced SIP Settings”](#) on [page A-103](#).

 Aastra Web UI			
1	<p>Click on Advanced Settings->Global SIP->Advanced SIP Settings.</p> <div style="border: 1px solid black; padding: 10px; margin: 10px 0;"> <table border="1" style="width: 100%; border-collapse: collapse;"> <tr> <td style="background-color: #D9E1F2; width: 25%; padding: 5px; vertical-align: top;"> <p>Status System Information</p> <p>Operation User Password Phone Lock Softkeys and XML Keypad Speed Dial Directory Reset</p> <p>Basic Settings Preferences Account Configuration</p> <p>Advanced Settings Network Global SIP Line 1 Line 2 Line 3 Line 4 Line 5 Line 6 Line 7 Line 8 Line 9 Action URI Configuration Server Firmware Update TLS Support 802.1x Support Troubleshooting</p> </td> <td style="padding: 5px;"> <p>Global SIP Settings</p> <p>Advanced SIP Settings</p> <p>Explicit MWI Subscription <input type="checkbox"/> Enabled</p> <p>Explicit MWI Subscription Period <input type="text" value="86400"/></p> <p>MWI for BLA account <input type="checkbox"/> Enabled</p> <p>Missed Call Summary Subscription <input type="checkbox"/> Enabled</p> <p>Missed Call Summary Subscription Period <input type="text" value="86400"/></p> <p>AS-Feature-Event Subscription <input type="checkbox"/> Enabled</p> <p>AS-Feature-Event Subscription Period <input type="text" value="3600"/></p> <p>Send MAC Address in REGISTER Message <input type="checkbox"/> Enabled</p> <p>Send Line Number in REGISTER Message <input type="checkbox"/> Enabled</p> <p>Session Timer <input type="text" value="0"/></p> <p>T1 Timer <input type="text" value="0"/></p> <p>T2 Timer <input type="text" value="0"/></p> <p>Transaction Timer <input type="text" value="4000"/></p> <p>Transport Protocol <input style="border: none; background-color: #D9E1F2; padding: 2px 5px; font-size: small; text-decoration: none; color: #4F81BD; cursor: pointer; display: inline-block; width: 100%;" type="text" value="UDP"/> ▾</p> <p>Local SIP UDP/TCP Port <input type="text" value="5060"/></p> <p>Local SIP TLS Port <input type="text" value="5061"/></p> <p>Registration Failed Retry Timer <input type="text" value="1800"/></p> <p>Registration Timeout Retry Timer <input type="text" value="120"/></p> <p>Registration Renewal Timer <input type="text" value="15"/></p> <p>BLF Subscription Period <input type="text" value="3600"/></p> <p>ACD Subscription Period <input type="text" value="3600"/></p> <p>BLA Subscription Period <input type="text" value="300"/></p> <p>Blacklist Duration <input type="text" value="300"/></p> <p>Whitelist Proxy <input type="checkbox"/> Enabled</p> <p>XML SIP Notify <input type="checkbox"/> Enabled</p> </td> </tr> </table> </div>	<p>Status System Information</p> <p>Operation User Password Phone Lock Softkeys and XML Keypad Speed Dial Directory Reset</p> <p>Basic Settings Preferences Account Configuration</p> <p>Advanced Settings Network Global SIP Line 1 Line 2 Line 3 Line 4 Line 5 Line 6 Line 7 Line 8 Line 9 Action URI Configuration Server Firmware Update TLS Support 802.1x Support Troubleshooting</p>	<p>Global SIP Settings</p> <p>Advanced SIP Settings</p> <p>Explicit MWI Subscription <input type="checkbox"/> Enabled</p> <p>Explicit MWI Subscription Period <input type="text" value="86400"/></p> <p>MWI for BLA account <input type="checkbox"/> Enabled</p> <p>Missed Call Summary Subscription <input type="checkbox"/> Enabled</p> <p>Missed Call Summary Subscription Period <input type="text" value="86400"/></p> <p>AS-Feature-Event Subscription <input type="checkbox"/> Enabled</p> <p>AS-Feature-Event Subscription Period <input type="text" value="3600"/></p> <p>Send MAC Address in REGISTER Message <input type="checkbox"/> Enabled</p> <p>Send Line Number in REGISTER Message <input type="checkbox"/> Enabled</p> <p>Session Timer <input type="text" value="0"/></p> <p>T1 Timer <input type="text" value="0"/></p> <p>T2 Timer <input type="text" value="0"/></p> <p>Transaction Timer <input type="text" value="4000"/></p> <p>Transport Protocol <input style="border: none; background-color: #D9E1F2; padding: 2px 5px; font-size: small; text-decoration: none; color: #4F81BD; cursor: pointer; display: inline-block; width: 100%;" type="text" value="UDP"/> ▾</p> <p>Local SIP UDP/TCP Port <input type="text" value="5060"/></p> <p>Local SIP TLS Port <input type="text" value="5061"/></p> <p>Registration Failed Retry Timer <input type="text" value="1800"/></p> <p>Registration Timeout Retry Timer <input type="text" value="120"/></p> <p>Registration Renewal Timer <input type="text" value="15"/></p> <p>BLF Subscription Period <input type="text" value="3600"/></p> <p>ACD Subscription Period <input type="text" value="3600"/></p> <p>BLA Subscription Period <input type="text" value="300"/></p> <p>Blacklist Duration <input type="text" value="300"/></p> <p>Whitelist Proxy <input type="checkbox"/> Enabled</p> <p>XML SIP Notify <input type="checkbox"/> Enabled</p>
<p>Status System Information</p> <p>Operation User Password Phone Lock Softkeys and XML Keypad Speed Dial Directory Reset</p> <p>Basic Settings Preferences Account Configuration</p> <p>Advanced Settings Network Global SIP Line 1 Line 2 Line 3 Line 4 Line 5 Line 6 Line 7 Line 8 Line 9 Action URI Configuration Server Firmware Update TLS Support 802.1x Support Troubleshooting</p>	<p>Global SIP Settings</p> <p>Advanced SIP Settings</p> <p>Explicit MWI Subscription <input type="checkbox"/> Enabled</p> <p>Explicit MWI Subscription Period <input type="text" value="86400"/></p> <p>MWI for BLA account <input type="checkbox"/> Enabled</p> <p>Missed Call Summary Subscription <input type="checkbox"/> Enabled</p> <p>Missed Call Summary Subscription Period <input type="text" value="86400"/></p> <p>AS-Feature-Event Subscription <input type="checkbox"/> Enabled</p> <p>AS-Feature-Event Subscription Period <input type="text" value="3600"/></p> <p>Send MAC Address in REGISTER Message <input type="checkbox"/> Enabled</p> <p>Send Line Number in REGISTER Message <input type="checkbox"/> Enabled</p> <p>Session Timer <input type="text" value="0"/></p> <p>T1 Timer <input type="text" value="0"/></p> <p>T2 Timer <input type="text" value="0"/></p> <p>Transaction Timer <input type="text" value="4000"/></p> <p>Transport Protocol <input style="border: none; background-color: #D9E1F2; padding: 2px 5px; font-size: small; text-decoration: none; color: #4F81BD; cursor: pointer; display: inline-block; width: 100%;" type="text" value="UDP"/> ▾</p> <p>Local SIP UDP/TCP Port <input type="text" value="5060"/></p> <p>Local SIP TLS Port <input type="text" value="5061"/></p> <p>Registration Failed Retry Timer <input type="text" value="1800"/></p> <p>Registration Timeout Retry Timer <input type="text" value="120"/></p> <p>Registration Renewal Timer <input type="text" value="15"/></p> <p>BLF Subscription Period <input type="text" value="3600"/></p> <p>ACD Subscription Period <input type="text" value="3600"/></p> <p>BLA Subscription Period <input type="text" value="300"/></p> <p>Blacklist Duration <input type="text" value="300"/></p> <p>Whitelist Proxy <input type="checkbox"/> Enabled</p> <p>XML SIP Notify <input type="checkbox"/> Enabled</p>		
2	<p>Enter a value, in seconds, from 120 (2 min) to 3600 (1 hour) in the "ACD Subscription Period" field.</p>		
3	<p>Click <input type="button" value="Save Settings"/> to save your changes.</p>		

BLA Subscription Period

The IP Phones include a SIP BLA subscription period parameter that allows an Administrator to set the amount of time, in seconds, of the BLA subscription period.

If this parameter is set to zero (0), the phone uses the value specified for the BLA expiration in the subscribe message received from the server. If no value is specified in the Subscribe message received from the server, the phone uses the default value of 300 seconds.

You can configure this parameter using the configuration files or the Aastra Web UI.





Configuring the BLA Subscription Period

Use the following procedures to configure the BLA Subscription Period.



Configuration Files

To configure the BLA subscription period on the IP phones using the configuration files, see Appendix A, the section, “[Advanced SIP Settings](#)” on [page A-103](#).

 Aastra Web UI																																																													
1	<p>Click on Advanced Settings->Global SIP->Advanced SIP Settings.</p> <div style="border: 1px solid black; padding: 5px; margin: 10px 0;"> <table style="width: 100%; border-collapse: collapse;"> <tr> <td style="width: 25%; background-color: #D9E1F2; vertical-align: top; padding: 5px;"> <ul style="list-style-type: none"> Status System Information Operation User Password Phone Lock Softkeys and XML Keypad Speed Dial Directory Reset Basic Settings Preferences Account Configuration Advanced Settings Network Global SIP Line 1 Line 2 Line 3 Line 4 Line 5 Line 6 Line 7 Line 8 Line 9 Action URI Configuration Server Firmware Update TLS Support 802.1x Support Troubleshooting </td> <td style="padding: 5px;"> <table style="width: 100%; border-collapse: collapse;"> <tr> <td colspan="2">Global SIP Settings</td> </tr> <tr> <td colspan="2">Advanced SIP Settings</td> </tr> <tr> <td>Explicit MWI Subscription</td> <td style="text-align: right;"><input type="checkbox"/> Enabled</td> </tr> <tr> <td>Explicit MWI Subscription Period</td> <td style="text-align: right;"><input type="text" value="86400"/></td> </tr> <tr> <td>MWI for BLA account</td> <td style="text-align: right;"><input type="checkbox"/> Enabled</td> </tr> <tr> <td>Missed Call Summary Subscription</td> <td style="text-align: right;"><input type="checkbox"/> Enabled</td> </tr> <tr> <td>Missed Call Summary Subscription Period</td> <td style="text-align: right;"><input type="text" value="86400"/></td> </tr> <tr> <td>AS-Feature-Event Subscription</td> <td style="text-align: right;"><input type="checkbox"/> Enabled</td> </tr> <tr> <td>AS-Feature-Event Subscription Period</td> <td style="text-align: right;"><input type="text" value="3600"/></td> </tr> <tr> <td>Send MAC Address in REGISTER Message</td> <td style="text-align: right;"><input type="checkbox"/> Enabled</td> </tr> <tr> <td>Send Line Number in REGISTER Message</td> <td style="text-align: right;"><input type="checkbox"/> Enabled</td> </tr> <tr> <td>Session Timer</td> <td style="text-align: right;"><input type="text" value="0"/></td> </tr> <tr> <td>T1 Timer</td> <td style="text-align: right;"><input type="text" value="0"/></td> </tr> <tr> <td>T2 Timer</td> <td style="text-align: right;"><input type="text" value="0"/></td> </tr> <tr> <td>Transaction Timer</td> <td style="text-align: right;"><input type="text" value="4000"/></td> </tr> <tr> <td>Transport Protocol</td> <td style="text-align: right;"><input type="text" value="UDP"/></td> </tr> <tr> <td>Local SIP UDP/TCP Port</td> <td style="text-align: right;"><input type="text" value="5060"/></td> </tr> <tr> <td>Local SIP TLS Port</td> <td style="text-align: right;"><input type="text" value="5061"/></td> </tr> <tr> <td>Registration Failed Retry Timer</td> <td style="text-align: right;"><input type="text" value="1800"/></td> </tr> <tr> <td>Registration Timeout Retry Timer</td> <td style="text-align: right;"><input type="text" value="120"/></td> </tr> <tr> <td>Registration Renewal Timer</td> <td style="text-align: right;"><input type="text" value="15"/></td> </tr> <tr> <td>BLF Subscription Period</td> <td style="text-align: right;"><input type="text" value="3600"/></td> </tr> <tr> <td>ACD Subscription Period</td> <td style="text-align: right;"><input type="text" value="3600"/></td> </tr> <tr> <td>BLA Subscription Period</td> <td style="text-align: right;"><input type="text" value="300"/></td> </tr> <tr> <td>Blacklist Duration</td> <td style="text-align: right;"><input type="text" value="300"/></td> </tr> <tr> <td>Whitelist Proxy</td> <td style="text-align: right;"><input type="checkbox"/> Enabled</td> </tr> <tr> <td>XML SIP Notify</td> <td style="text-align: right;"><input type="checkbox"/> Enabled</td> </tr> </table> </td> </tr> </table> </div> <tr> <td style="width: 5%; text-align: center; vertical-align: top; padding: 5px;">2</td> <td style="padding: 5px;"> <p>In the “BLA Subscription Period” field, enter a value, in seconds, that the phone waits to receive a BLA subscribe message from the server. If you specify zero (0), the phone uses the value specified for the BLA expiration in the subscribe message received from the server. If no value is specified, the phone uses the default value of 300 seconds. Valid values are 0 to 3700. Default is 300 seconds.</p> </td> </tr> <tr> <td style="width: 5%; text-align: center; vertical-align: top; padding: 5px;">3</td> <td style="padding: 5px;"> <p>Click  to save your changes.</p> </td> </tr>	<ul style="list-style-type: none"> Status System Information Operation User Password Phone Lock Softkeys and XML Keypad Speed Dial Directory Reset Basic Settings Preferences Account Configuration Advanced Settings Network Global SIP Line 1 Line 2 Line 3 Line 4 Line 5 Line 6 Line 7 Line 8 Line 9 Action URI Configuration Server Firmware Update TLS Support 802.1x Support Troubleshooting 	<table style="width: 100%; border-collapse: collapse;"> <tr> <td colspan="2">Global SIP Settings</td> </tr> <tr> <td colspan="2">Advanced SIP Settings</td> </tr> <tr> <td>Explicit MWI Subscription</td> <td style="text-align: right;"><input type="checkbox"/> Enabled</td> </tr> <tr> <td>Explicit MWI Subscription Period</td> <td style="text-align: right;"><input type="text" value="86400"/></td> </tr> <tr> <td>MWI for BLA account</td> <td style="text-align: right;"><input type="checkbox"/> Enabled</td> </tr> <tr> <td>Missed Call Summary Subscription</td> <td style="text-align: right;"><input type="checkbox"/> Enabled</td> </tr> <tr> <td>Missed Call Summary Subscription Period</td> <td style="text-align: right;"><input type="text" value="86400"/></td> </tr> <tr> <td>AS-Feature-Event Subscription</td> <td style="text-align: right;"><input type="checkbox"/> Enabled</td> </tr> <tr> <td>AS-Feature-Event Subscription Period</td> <td style="text-align: right;"><input type="text" value="3600"/></td> </tr> <tr> <td>Send MAC Address in REGISTER Message</td> <td style="text-align: right;"><input type="checkbox"/> Enabled</td> </tr> <tr> <td>Send Line Number in REGISTER Message</td> <td style="text-align: right;"><input type="checkbox"/> Enabled</td> </tr> <tr> <td>Session Timer</td> <td style="text-align: right;"><input type="text" value="0"/></td> </tr> <tr> <td>T1 Timer</td> <td style="text-align: right;"><input type="text" value="0"/></td> </tr> <tr> <td>T2 Timer</td> <td style="text-align: right;"><input type="text" value="0"/></td> </tr> <tr> <td>Transaction Timer</td> <td style="text-align: right;"><input type="text" value="4000"/></td> </tr> <tr> <td>Transport Protocol</td> <td style="text-align: right;"><input type="text" value="UDP"/></td> </tr> <tr> <td>Local SIP UDP/TCP Port</td> <td style="text-align: right;"><input type="text" value="5060"/></td> </tr> <tr> <td>Local SIP TLS Port</td> <td style="text-align: right;"><input type="text" value="5061"/></td> </tr> <tr> <td>Registration Failed Retry Timer</td> <td style="text-align: right;"><input type="text" value="1800"/></td> </tr> <tr> <td>Registration Timeout Retry Timer</td> <td style="text-align: right;"><input type="text" value="120"/></td> </tr> <tr> <td>Registration Renewal Timer</td> <td style="text-align: right;"><input type="text" value="15"/></td> </tr> <tr> <td>BLF Subscription Period</td> <td style="text-align: right;"><input type="text" value="3600"/></td> </tr> <tr> <td>ACD Subscription Period</td> <td style="text-align: right;"><input type="text" value="3600"/></td> </tr> <tr> <td>BLA Subscription Period</td> <td style="text-align: right;"><input type="text" value="300"/></td> </tr> <tr> <td>Blacklist Duration</td> <td style="text-align: right;"><input type="text" value="300"/></td> </tr> <tr> <td>Whitelist Proxy</td> <td style="text-align: right;"><input type="checkbox"/> Enabled</td> </tr> <tr> <td>XML SIP Notify</td> <td style="text-align: right;"><input type="checkbox"/> Enabled</td> </tr> </table>	Global SIP Settings		Advanced SIP Settings		Explicit MWI Subscription	<input type="checkbox"/> Enabled	Explicit MWI Subscription Period	<input type="text" value="86400"/>	MWI for BLA account	<input type="checkbox"/> Enabled	Missed Call Summary Subscription	<input type="checkbox"/> Enabled	Missed Call Summary Subscription Period	<input type="text" value="86400"/>	AS-Feature-Event Subscription	<input type="checkbox"/> Enabled	AS-Feature-Event Subscription Period	<input type="text" value="3600"/>	Send MAC Address in REGISTER Message	<input type="checkbox"/> Enabled	Send Line Number in REGISTER Message	<input type="checkbox"/> Enabled	Session Timer	<input type="text" value="0"/>	T1 Timer	<input type="text" value="0"/>	T2 Timer	<input type="text" value="0"/>	Transaction Timer	<input type="text" value="4000"/>	Transport Protocol	<input type="text" value="UDP"/>	Local SIP UDP/TCP Port	<input type="text" value="5060"/>	Local SIP TLS Port	<input type="text" value="5061"/>	Registration Failed Retry Timer	<input type="text" value="1800"/>	Registration Timeout Retry Timer	<input type="text" value="120"/>	Registration Renewal Timer	<input type="text" value="15"/>	BLF Subscription Period	<input type="text" value="3600"/>	ACD Subscription Period	<input type="text" value="3600"/>	BLA Subscription Period	<input type="text" value="300"/>	Blacklist Duration	<input type="text" value="300"/>	Whitelist Proxy	<input type="checkbox"/> Enabled	XML SIP Notify	<input type="checkbox"/> Enabled	2	<p>In the “BLA Subscription Period” field, enter a value, in seconds, that the phone waits to receive a BLA subscribe message from the server. If you specify zero (0), the phone uses the value specified for the BLA expiration in the subscribe message received from the server. If no value is specified, the phone uses the default value of 300 seconds. Valid values are 0 to 3700. Default is 300 seconds.</p>	3	<p>Click  to save your changes.</p>
<ul style="list-style-type: none"> Status System Information Operation User Password Phone Lock Softkeys and XML Keypad Speed Dial Directory Reset Basic Settings Preferences Account Configuration Advanced Settings Network Global SIP Line 1 Line 2 Line 3 Line 4 Line 5 Line 6 Line 7 Line 8 Line 9 Action URI Configuration Server Firmware Update TLS Support 802.1x Support Troubleshooting 	<table style="width: 100%; border-collapse: collapse;"> <tr> <td colspan="2">Global SIP Settings</td> </tr> <tr> <td colspan="2">Advanced SIP Settings</td> </tr> <tr> <td>Explicit MWI Subscription</td> <td style="text-align: right;"><input type="checkbox"/> Enabled</td> </tr> <tr> <td>Explicit MWI Subscription Period</td> <td style="text-align: right;"><input type="text" value="86400"/></td> </tr> <tr> <td>MWI for BLA account</td> <td style="text-align: right;"><input type="checkbox"/> Enabled</td> </tr> <tr> <td>Missed Call Summary Subscription</td> <td style="text-align: right;"><input type="checkbox"/> Enabled</td> </tr> <tr> <td>Missed Call Summary Subscription Period</td> <td style="text-align: right;"><input type="text" value="86400"/></td> </tr> <tr> <td>AS-Feature-Event Subscription</td> <td style="text-align: right;"><input type="checkbox"/> Enabled</td> </tr> <tr> <td>AS-Feature-Event Subscription Period</td> <td style="text-align: right;"><input type="text" value="3600"/></td> </tr> <tr> <td>Send MAC Address in REGISTER Message</td> <td style="text-align: right;"><input type="checkbox"/> Enabled</td> </tr> <tr> <td>Send Line Number in REGISTER Message</td> <td style="text-align: right;"><input type="checkbox"/> Enabled</td> </tr> <tr> <td>Session Timer</td> <td style="text-align: right;"><input type="text" value="0"/></td> </tr> <tr> <td>T1 Timer</td> <td style="text-align: right;"><input type="text" value="0"/></td> </tr> <tr> <td>T2 Timer</td> <td style="text-align: right;"><input type="text" value="0"/></td> </tr> <tr> <td>Transaction Timer</td> <td style="text-align: right;"><input type="text" value="4000"/></td> </tr> <tr> <td>Transport Protocol</td> <td style="text-align: right;"><input type="text" value="UDP"/></td> </tr> <tr> <td>Local SIP UDP/TCP Port</td> <td style="text-align: right;"><input type="text" value="5060"/></td> </tr> <tr> <td>Local SIP TLS Port</td> <td style="text-align: right;"><input type="text" value="5061"/></td> </tr> <tr> <td>Registration Failed Retry Timer</td> <td style="text-align: right;"><input type="text" value="1800"/></td> </tr> <tr> <td>Registration Timeout Retry Timer</td> <td style="text-align: right;"><input type="text" value="120"/></td> </tr> <tr> <td>Registration Renewal Timer</td> <td style="text-align: right;"><input type="text" value="15"/></td> </tr> <tr> <td>BLF Subscription Period</td> <td style="text-align: right;"><input type="text" value="3600"/></td> </tr> <tr> <td>ACD Subscription Period</td> <td style="text-align: right;"><input type="text" value="3600"/></td> </tr> <tr> <td>BLA Subscription Period</td> <td style="text-align: right;"><input type="text" value="300"/></td> </tr> <tr> <td>Blacklist Duration</td> <td style="text-align: right;"><input type="text" value="300"/></td> </tr> <tr> <td>Whitelist Proxy</td> <td style="text-align: right;"><input type="checkbox"/> Enabled</td> </tr> <tr> <td>XML SIP Notify</td> <td style="text-align: right;"><input type="checkbox"/> Enabled</td> </tr> </table>	Global SIP Settings		Advanced SIP Settings		Explicit MWI Subscription	<input type="checkbox"/> Enabled	Explicit MWI Subscription Period	<input type="text" value="86400"/>	MWI for BLA account	<input type="checkbox"/> Enabled	Missed Call Summary Subscription	<input type="checkbox"/> Enabled	Missed Call Summary Subscription Period	<input type="text" value="86400"/>	AS-Feature-Event Subscription	<input type="checkbox"/> Enabled	AS-Feature-Event Subscription Period	<input type="text" value="3600"/>	Send MAC Address in REGISTER Message	<input type="checkbox"/> Enabled	Send Line Number in REGISTER Message	<input type="checkbox"/> Enabled	Session Timer	<input type="text" value="0"/>	T1 Timer	<input type="text" value="0"/>	T2 Timer	<input type="text" value="0"/>	Transaction Timer	<input type="text" value="4000"/>	Transport Protocol	<input type="text" value="UDP"/>	Local SIP UDP/TCP Port	<input type="text" value="5060"/>	Local SIP TLS Port	<input type="text" value="5061"/>	Registration Failed Retry Timer	<input type="text" value="1800"/>	Registration Timeout Retry Timer	<input type="text" value="120"/>	Registration Renewal Timer	<input type="text" value="15"/>	BLF Subscription Period	<input type="text" value="3600"/>	ACD Subscription Period	<input type="text" value="3600"/>	BLA Subscription Period	<input type="text" value="300"/>	Blacklist Duration	<input type="text" value="300"/>	Whitelist Proxy	<input type="checkbox"/> Enabled	XML SIP Notify	<input type="checkbox"/> Enabled						
Global SIP Settings																																																													
Advanced SIP Settings																																																													
Explicit MWI Subscription	<input type="checkbox"/> Enabled																																																												
Explicit MWI Subscription Period	<input type="text" value="86400"/>																																																												
MWI for BLA account	<input type="checkbox"/> Enabled																																																												
Missed Call Summary Subscription	<input type="checkbox"/> Enabled																																																												
Missed Call Summary Subscription Period	<input type="text" value="86400"/>																																																												
AS-Feature-Event Subscription	<input type="checkbox"/> Enabled																																																												
AS-Feature-Event Subscription Period	<input type="text" value="3600"/>																																																												
Send MAC Address in REGISTER Message	<input type="checkbox"/> Enabled																																																												
Send Line Number in REGISTER Message	<input type="checkbox"/> Enabled																																																												
Session Timer	<input type="text" value="0"/>																																																												
T1 Timer	<input type="text" value="0"/>																																																												
T2 Timer	<input type="text" value="0"/>																																																												
Transaction Timer	<input type="text" value="4000"/>																																																												
Transport Protocol	<input type="text" value="UDP"/>																																																												
Local SIP UDP/TCP Port	<input type="text" value="5060"/>																																																												
Local SIP TLS Port	<input type="text" value="5061"/>																																																												
Registration Failed Retry Timer	<input type="text" value="1800"/>																																																												
Registration Timeout Retry Timer	<input type="text" value="120"/>																																																												
Registration Renewal Timer	<input type="text" value="15"/>																																																												
BLF Subscription Period	<input type="text" value="3600"/>																																																												
ACD Subscription Period	<input type="text" value="3600"/>																																																												
BLA Subscription Period	<input type="text" value="300"/>																																																												
Blacklist Duration	<input type="text" value="300"/>																																																												
Whitelist Proxy	<input type="checkbox"/> Enabled																																																												
XML SIP Notify	<input type="checkbox"/> Enabled																																																												
2	<p>In the “BLA Subscription Period” field, enter a value, in seconds, that the phone waits to receive a BLA subscribe message from the server. If you specify zero (0), the phone uses the value specified for the BLA expiration in the subscribe message received from the server. If no value is specified, the phone uses the default value of 300 seconds. Valid values are 0 to 3700. Default is 300 seconds.</p>																																																												
3	<p>Click  to save your changes.</p>																																																												

Directed Call Pickup/Group Call Pickup (for Sylanro Servers)

Aastra IP phones and any attached Expansion Modules support the Directed Call Pickup (DCP) and Group Call Pickup (GCP) features.

The Directed Call Pickup/Group Call Pickup feature allows you to intercept - or pickup - a call on a monitored extension. An Administrator or User can configure this feature using the Aastra Web UI to create a DCP or GCP softkey on the IP phone. When you configure a DCP softkey, you specify the extension that you want to monitor. Then, when the monitored extension receives a call, you press the DCP softkey to “pickup” (intercept) it. If the monitored extension receives multiple incoming calls simultaneously, the IP Phone UI displays a list of incoming calls. You select a call from this list, and are connected to the call.

When you configure a GCP softkey, you specify the ring group that you want to monitor for incoming calls. For example, suppose an Operator configures a GCP softkey to monitor incoming calls for a specific ring group (extensions 2200-2210). When an incoming call is received on any of these extensions, the Operator presses the GCP softkey and is connected to the call. If multiple incoming calls are received simultaneously, the Operator does the following actions:

- Presses the GCP softkey. The Operator Phone UI displays the current list of incoming calls (see below).
- Selects an extension to “pickup” first.
- Presses the Pickup softkey. The Operator is connected to the incoming call.

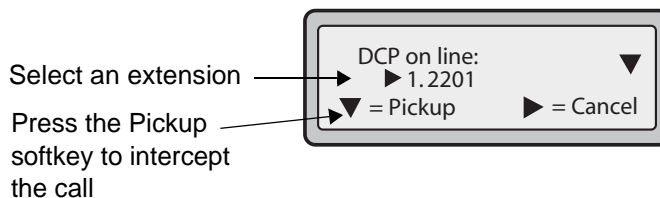

Configuring DCP/GCP Using the Configuration Files (for Sylanro Servers)

Use the following procedures to configure DCP/GCP using the configuration files.



Configuration Files

To set DCP/GCP in the configuration files, see Appendix A, the section, "[Softkey/Programmable Key/Feature Key/Expansion Module Key Parameters](#)" on [page A-216](#).

Configuring Directed Call Pickup (DCP) Using the Aastra Web UI (for Sylanro Servers)

Use the following procedure to configure Directed Call Pickup using the Aastra Web UI. This procedure uses the 6757i IP Phone as an example.

Aastra Web UI

1 Click on **Operation->Softkeys and XML**
or
Click on **Operation->Programmable Keys**
or
Click on **Operation->Expansion Module <N>**.

Depending on your phone-model, the key configuration screen displays. The 6757i Key Screen is shown as an example.

Status

System Information

Operation

User Password

Phone Lock

Softkeys and XML

Programmable Keys

Directory

Reset

Basic Settings

Preferences

Account Configuration

Advanced Settings

Network

Global SIP

Line 1

Line 2

Line 3

Line 4

Line 5

Line 6

Line 7

Line 8

Line 9

Action URI

Configuration Server

Firmware Update

TLS Support

802.1x Support

Troubleshooting

Softkeys Configuration

Key	Type	Label	Value	Line	Idle	Connected	Incoming	Outgoing	Busy
1	Directory		44444	5	<input checked="" type="checkbox"/>	<input checked="" type="checkbox"/>	<input checked="" type="checkbox"/>	<input checked="" type="checkbox"/>	<input checked="" type="checkbox"/>
2	None			6	<input checked="" type="checkbox"/>	<input checked="" type="checkbox"/>	<input checked="" type="checkbox"/>	<input checked="" type="checkbox"/>	<input checked="" type="checkbox"/>
3	Speeddial	Lab	222222	7	<input checked="" type="checkbox"/>	<input checked="" type="checkbox"/>	<input checked="" type="checkbox"/>	<input checked="" type="checkbox"/>	<input checked="" type="checkbox"/>
4	None			1	<input checked="" type="checkbox"/>	<input checked="" type="checkbox"/>	<input checked="" type="checkbox"/>	<input checked="" type="checkbox"/>	<input checked="" type="checkbox"/>
5	None			1	<input checked="" type="checkbox"/>	<input checked="" type="checkbox"/>	<input checked="" type="checkbox"/>	<input checked="" type="checkbox"/>	<input checked="" type="checkbox"/>
6	None			1	<input checked="" type="checkbox"/>	<input checked="" type="checkbox"/>	<input checked="" type="checkbox"/>	<input checked="" type="checkbox"/>	<input checked="" type="checkbox"/>
7	None			1	<input checked="" type="checkbox"/>	<input checked="" type="checkbox"/>	<input checked="" type="checkbox"/>	<input checked="" type="checkbox"/>	<input checked="" type="checkbox"/>
8	None			1	<input checked="" type="checkbox"/>	<input checked="" type="checkbox"/>	<input checked="" type="checkbox"/>	<input checked="" type="checkbox"/>	<input checked="" type="checkbox"/>
9	None			1	<input checked="" type="checkbox"/>	<input checked="" type="checkbox"/>	<input checked="" type="checkbox"/>	<input checked="" type="checkbox"/>	<input checked="" type="checkbox"/>
10	None			1	<input checked="" type="checkbox"/>	<input checked="" type="checkbox"/>	<input checked="" type="checkbox"/>	<input checked="" type="checkbox"/>	<input checked="" type="checkbox"/>
11	None			1	<input checked="" type="checkbox"/>	<input checked="" type="checkbox"/>	<input checked="" type="checkbox"/>	<input checked="" type="checkbox"/>	<input checked="" type="checkbox"/>
12	None			1	<input checked="" type="checkbox"/>	<input checked="" type="checkbox"/>	<input checked="" type="checkbox"/>	<input checked="" type="checkbox"/>	<input checked="" type="checkbox"/>
13	None			1	<input checked="" type="checkbox"/>	<input checked="" type="checkbox"/>	<input checked="" type="checkbox"/>	<input checked="" type="checkbox"/>	<input checked="" type="checkbox"/>
14	None			1	<input checked="" type="checkbox"/>	<input checked="" type="checkbox"/>	<input checked="" type="checkbox"/>	<input checked="" type="checkbox"/>	<input checked="" type="checkbox"/>
15	None			1	<input checked="" type="checkbox"/>	<input checked="" type="checkbox"/>	<input checked="" type="checkbox"/>	<input checked="" type="checkbox"/>	<input checked="" type="checkbox"/>
16	None			1	<input checked="" type="checkbox"/>	<input checked="" type="checkbox"/>	<input checked="" type="checkbox"/>	<input checked="" type="checkbox"/>	<input checked="" type="checkbox"/>
17	None			1	<input checked="" type="checkbox"/>	<input checked="" type="checkbox"/>	<input checked="" type="checkbox"/>	<input checked="" type="checkbox"/>	<input checked="" type="checkbox"/>
18	None			1	<input checked="" type="checkbox"/>	<input checked="" type="checkbox"/>	<input checked="" type="checkbox"/>	<input checked="" type="checkbox"/>	<input checked="" type="checkbox"/>
19	None			1	<input checked="" type="checkbox"/>	<input checked="" type="checkbox"/>	<input checked="" type="checkbox"/>	<input checked="" type="checkbox"/>	<input checked="" type="checkbox"/>
20	None			1	<input checked="" type="checkbox"/>	<input checked="" type="checkbox"/>	<input checked="" type="checkbox"/>	<input checked="" type="checkbox"/>	<input checked="" type="checkbox"/>

Services

XML Application URI:

XML Application Title:

BLF List URI:

2 Select a key for which to configure Directed Call Pickup.

3 In the **"Type"** field, select **Directed Call Pickup**.

5-202

41-001160-03 Rev 00, Release 2.5

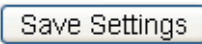

Aastra Web UI

4	In the “ Label ” field, specify a name for this Directed Call Pickup softkey. For example: DCP2200
5	In the “ Value ” field, specify the extension you want to intercept when you press this softkey. For example: 2200
6	Click  to save your changes.

Configuring Group Call Pickup (GCP) Using the Aastra Web UI (for Sylanro Servers)

Use the following procedure to configure Group Call Pickup using the Aastra Web UI.



Note: A ring group must be configured on the Sylanro Server in order for a GCP softkey to function.

Aastra Web UI

1 Click on **Operation->Softkeys and XML**
or
 Click on **Operation->Programmable Keys**
or
 Click on **Operation->Expansion Module <N>**.

Depending on your phone-model, the key configuration screen displays. The 6755i Key Screen is shown as an example.

Status:

- System Information
- Operation**
- User Password
- Phone Lock
- Softkeys and XML
- Programmable Keys
- Directory
- Reset
- Basic Settings**
- Preferences
- Account Configuration
- Advanced Settings**
- Network
- Global SIP
- Line 1
- Line 2
- Line 3
- Line 4
- Line 5
- Line 6
- Line 7
- Line 8
- Line 9
- Action URI
- Configuration Server
- Firmware Update
- TLS Support
- 802.1x Support
- Troubleshooting

Softkeys Configuration

Key	Type	Label	Value	Line	Idle	Connected	Incoming	Outgoing	Busy
1	Directory		99999	5	<input checked="" type="checkbox"/>	<input checked="" type="checkbox"/>	<input checked="" type="checkbox"/>	<input checked="" type="checkbox"/>	<input checked="" type="checkbox"/>
2	None			5	<input type="checkbox"/>	<input type="checkbox"/>	<input type="checkbox"/>	<input type="checkbox"/>	<input type="checkbox"/>
3	Speeddial	Luk	222222	7	<input type="checkbox"/>	<input checked="" type="checkbox"/>	<input checked="" type="checkbox"/>	<input checked="" type="checkbox"/>	<input checked="" type="checkbox"/>
4	None			1	<input type="checkbox"/>	<input type="checkbox"/>	<input type="checkbox"/>	<input type="checkbox"/>	<input type="checkbox"/>
5	None			1	<input type="checkbox"/>	<input type="checkbox"/>	<input type="checkbox"/>	<input type="checkbox"/>	<input type="checkbox"/>
6	None			1	<input type="checkbox"/>	<input type="checkbox"/>	<input type="checkbox"/>	<input type="checkbox"/>	<input type="checkbox"/>
7	None			1	<input type="checkbox"/>	<input type="checkbox"/>	<input type="checkbox"/>	<input type="checkbox"/>	<input type="checkbox"/>
8	None			1	<input type="checkbox"/>	<input type="checkbox"/>	<input type="checkbox"/>	<input type="checkbox"/>	<input type="checkbox"/>
9	None			1	<input type="checkbox"/>	<input type="checkbox"/>	<input type="checkbox"/>	<input type="checkbox"/>	<input type="checkbox"/>
10	None			1	<input type="checkbox"/>	<input type="checkbox"/>	<input type="checkbox"/>	<input type="checkbox"/>	<input type="checkbox"/>
11	None			1	<input type="checkbox"/>	<input type="checkbox"/>	<input type="checkbox"/>	<input type="checkbox"/>	<input type="checkbox"/>
12	None			1	<input type="checkbox"/>	<input type="checkbox"/>	<input type="checkbox"/>	<input type="checkbox"/>	<input type="checkbox"/>
13	None			1	<input type="checkbox"/>	<input type="checkbox"/>	<input type="checkbox"/>	<input type="checkbox"/>	<input type="checkbox"/>
14	None			1	<input type="checkbox"/>	<input type="checkbox"/>	<input type="checkbox"/>	<input type="checkbox"/>	<input type="checkbox"/>
15	None			1	<input type="checkbox"/>	<input type="checkbox"/>	<input type="checkbox"/>	<input type="checkbox"/>	<input type="checkbox"/>
16	None			1	<input type="checkbox"/>	<input type="checkbox"/>	<input type="checkbox"/>	<input type="checkbox"/>	<input type="checkbox"/>
17	None			1	<input type="checkbox"/>	<input type="checkbox"/>	<input type="checkbox"/>	<input type="checkbox"/>	<input type="checkbox"/>
18	None			1	<input type="checkbox"/>	<input type="checkbox"/>	<input type="checkbox"/>	<input type="checkbox"/>	<input type="checkbox"/>
19	None			1	<input type="checkbox"/>	<input type="checkbox"/>	<input type="checkbox"/>	<input type="checkbox"/>	<input type="checkbox"/>
20	None			1	<input type="checkbox"/>	<input type="checkbox"/>	<input type="checkbox"/>	<input type="checkbox"/>	<input type="checkbox"/>

Services

XML Application URI:

XML Application Title:

DLF List URI:

2 Select a key for which to configure Group Call Pickup.

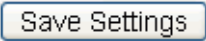
 Aastra Web UI	
3	In the “ Type ” field, select Directed Call Pickup .
4	In the “ Label ” field, specify a name for this Directed Call Pickup softkey. For example: GCP_A
5	In the “ Value ” field, enter groupcallpickup .
6	Click  to save your changes.

Using Directed Call Pickup/Group Call Pickup

Use the following procedure for the DCP/GCP on your phone.



Note: Before using the DCP/GCP feature on your phone, you must first configure the DCP or GCP key. You must identify the extension(s) or phone number(s) you want to monitor when configuring the key.

 IP Phone UI	
Step	Action
Using Directed Call Pickup (DCP)	
1	When the monitored extension receives a call, press the DCP softkey to pick up the call.
2	If the monitored extension receives multiple incoming calls simultaneously, the phone displays a list of incoming calls.
3	Select a call from this list using the UP and DOWN arrow keys. The call is answered.
Using Group Call Pickup (GCP)	
1	When any of the monitored group of extensions receives a call, press the GCP softkey to pick up the call. The call is answered.



IP Phone UI

Step	Action
2	If the monitored extension receives multiple incoming calls simultaneously, the phone displays a list of incoming calls.
3	<p>Select a call from this list using the UP and DOWN arrow keys. Press the "Pickup" softkey to answer the call you selected.</p> <div data-bbox="371 590 1013 789"><p>The screenshot shows a rectangular UI box with a light gray background. At the top, it says 'DCP on line:'. Below that, there is a list of calls, with '1.2201' being the selected one. To the right of the list is a downward-pointing arrow. Below the list, there are two options: '= Pickup' and '= Cancel', each with a right-pointing arrow. Two lines with arrows point from the text 'Select an extension' to the '1.2201' entry, and from 'Press the Pickup key to answer the call' to the '= Pickup' option.</p></div>

Do Not Disturb (DND)

The IP phones have a feature you can enable called "Do not Disturb (DND)". An Administrator or User can set "do not disturb" based on the accounts on the phone (all accounts or a specific account). You can set specific modes for the way you want the phone to handle DND. The three modes you can set on the phone for DND are:

- **Account**
- **Phone**
- **Custom**

DND Account-Based Configuration

An Administrator or User can configure DND on the phone-side by setting a mode for the phone to use (**account**, **phone**, or **custom**). Once the mode is set, you can use the IP Phone UI to use the DND feature.



Notes:

1. If there is only one account configured on the phone, then the mode setting is ignored and the phone behaves as if the mode was set to "Phone".
 2. You must configure a DND key on the phone to be able to use this feature via the phone's keypad.
-

The following describes the DND key behavior for each DND mode.

- **Account** - DND key toggles the account in focus on the IP Phone UI, to ON or OFF if DND enabled for that account.
- **Phone** - DND key toggles all accounts on the phone to ON or OFF.
- **Custom** - DND key displays custom screens on the IP Phone UI. User can select whether to enable/disable DND per account, enable DND on all accounts, or disable DND on all accounts.

The following table describes the DND key and Message Waiting Indicator (MWI) LEDs when you enable DND on the IP Phone.

Softkey LED Behavior for All Modes	MWI LED Behavior for All Modes
DND key LED RED if current account in focus has DND ON. DND key LED OFF when current account in focus has DND disabled.	MWI LED ON if current account in focus has DND ON. MWI LED OFF if current account in focus has DND OFF.

You can configure the DND softkey and the DND mode (**Account**, **Phone**, **Custom**) using the configuration files or the Aastra Web UI. Once you configure DND, you can access the DND screen on the IP Phone UI.

Important Notes

- In the Aastra Web UI, the “Account Configuration” page replaces the previous “Call Forward Settings” page.
- In the IP Phone UI, the new DND key feature now has new menu screens.
- **If you make changes to the configuration for DND via the IP Phone UI, you must refresh the Aastra Web UI screen to see the changes.**

Configuring DND Using the Configuration Files

You use the following parameters to configure DND on the IP Phone:

- **dnd key mode**
- **softkeyN type, topsoftkeyN type, prgkeyN type, or expmodX keyN type**
- **softkeyN states** (optional)



Note: If there is no DND key configured or if it is removed, DND is disabled on the IP Phone.

Example

The following is an example of configuring the mode for DND in the configuration files:

```
dnd key mode: 2
softkey1 type: dnd
softkey1 states: idle connected incoming outgoing busy
```

In the above example, softkey 1 is configured for DND for line 1 only, with a “**custom**” configuration. Pressing softkey 1 displays DND screens for which you can customize on the phone. For specific screens that display in the IP Phone UI, see the section, “[Using DND Modes via the IP Phone UI](#)” on [page 5-213](#).



Configuration Files

To set DND in the configuration files, see Appendix A, the sections:

- “[DND Key Mode Settings](#)” on [page A-175](#).
- “[Softkey/Programmable Key/Feature Key/Expansion Module Key Parameters](#)” on [page A-216](#).

Configuring DND Using the Aastra Web UI

Use the following procedure to configure DND mode using the Aastra Web UI:

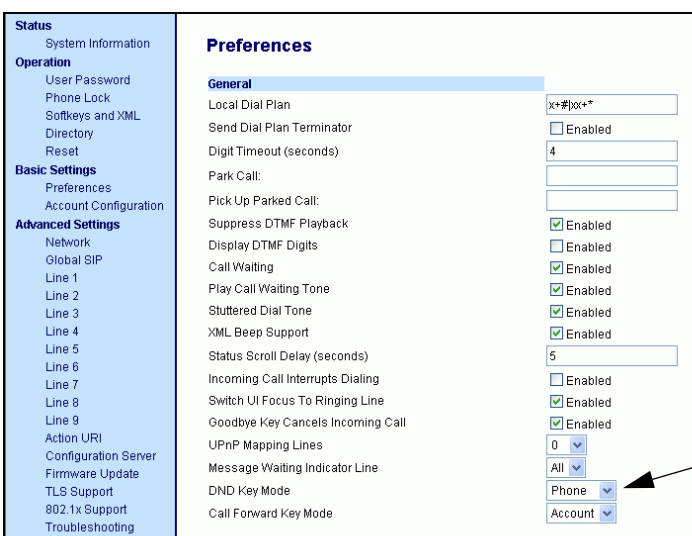
Aastra Web UI	
1	<p>Click on Basic Settings->Preferences->General.</p>  <p>The screenshot shows the 'Preferences' section with the 'General' tab selected. The 'DND Key Mode' dropdown menu is set to 'Phone'. An arrow points to this dropdown with the label 'DND Key Mode Parameter'.</p>
2	<p>In the “DND Key Mode” field, select a “do not disturb” (DND) mode to use on the phone. Valid values are: Account, Phone, Custom. Default is Phone.</p> <ul style="list-style-type: none">• account Sets DND for a specific account. DND key toggles the account in focus on the IP Phone UI, to ON or OFF.• phone Sets DND ON for all accounts on the phone. DND key toggles all accounts on the phone to ON or OFF.• custom Sets the phone to display custom screens after pressing the DND key, that list the account(s) on the phone. The user can select a specific account for DND, turn DND ON for all accounts, or turn DND OFF for all accounts. <p>Notes:</p> <ol style="list-style-type: none">1. If there is only one account configured on the phone, then the mode setting is ignored and the phone behaves as if the mode was set to “Phone”.2. Using the Aastra Web UI, if you change the DND Key Mode to “phone”, all accounts synchronize to the current setting of Account 1.

 **Aastra Web UI**

3 Click  to save your changes.
 The change takes effect immediately without a reboot.

4 Click on **Basic Settings->Account Configuration**.

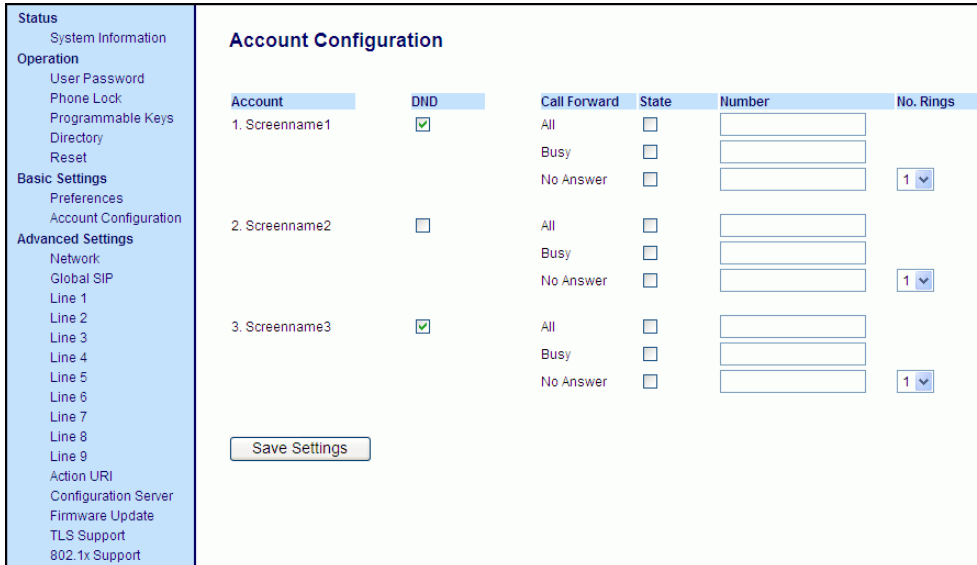

Account	DND	Call Forward	State	Number	No. Rings
1. Screenname1	<input checked="" type="checkbox"/>	All	<input type="checkbox"/>	<input type="text"/>	<input type="text"/>
		Busy	<input type="checkbox"/>	<input type="text"/>	<input type="text"/>
		No Answer	<input type="checkbox"/>	<input type="text"/>	1 <input type="button" value="v"/>
2. Screenname2	<input type="checkbox"/>	All	<input type="checkbox"/>	<input type="text"/>	<input type="text"/>
		Busy	<input type="checkbox"/>	<input type="text"/>	<input type="text"/>
		No Answer	<input type="checkbox"/>	<input type="text"/>	1 <input type="button" value="v"/>
3. Screenname3	<input checked="" type="checkbox"/>	All	<input type="checkbox"/>	<input type="text"/>	<input type="text"/>
		Busy	<input type="checkbox"/>	<input type="text"/>	<input type="text"/>
		No Answer	<input type="checkbox"/>	<input type="text"/>	1 <input type="button" value="v"/>

5 For each account, enable DND by placing a check mark in the box. Disable DND by unchecking the box.

Notes:

1. If you selected **“Account”** or **“Custom”** mode in step 2, you can enable/disable each account or all accounts as applicable.
 If you selected **“Phone”** mode, the first account allows you to change the DND status for all accounts.

2. Number and name of accounts that display to this screen are dependant on the number and name of accounts configured on the phone. In the screen in step 4, Screenname1 is configured on Line 1, Screenname2 is configured on Line 2, and Screenname3 is configured on Line 3. The name for the account is dependant on the name specified for the **“Screen Name”** parameter at the path **Advanced Settings->LineN**. If you do not specify a value for the “Screen Name” parameter, the account name is based on the **“Phone Number”** parameter at the path **Advanced Settings->LineN**. If neither the “Screen Name” nor the “Phone Number” parameters are specified, the account name shows “1”, “2”, “3”, etc. only.

Aastra Web UI

6 Click to save your changes.

The change takes effect immediately without a reboot.

7 Click on **Operation->Softkeys and XML**;
or
Click on **Operation->Programmable Keys**;
or
Click on **Operation->Expansion Module**.

Status

System Information

Operation

User Password

Phone Lock

Softkeys and XML

Directory

Reset

Basic Settings

Preferences

Account Configuration

Advanced Settings

Network

Global SIP

Line 1

Line 2

Line 3

Line 4

Line 5

Line 6

Line 7

Line 8

Line 9

Action URI

Configuration Server

Firmware Update

TLS Support

802.1x Support

Troubleshooting

Softkeys Configuration

Key	Type	Label	Value	Line	Idle	Connected	Incoming	Outgoing	Busy
1	Do Not Disturb			1	<input checked="" type="checkbox"/>	<input checked="" type="checkbox"/>	<input checked="" type="checkbox"/>	<input checked="" type="checkbox"/>	<input checked="" type="checkbox"/>
2	Do Not Disturb			1	<input checked="" type="checkbox"/>	<input checked="" type="checkbox"/>	<input checked="" type="checkbox"/>	<input checked="" type="checkbox"/>	<input checked="" type="checkbox"/>
3	None			1	<input type="checkbox"/>	<input type="checkbox"/>	<input type="checkbox"/>	<input type="checkbox"/>	<input type="checkbox"/>
4	None			1	<input type="checkbox"/>	<input type="checkbox"/>	<input type="checkbox"/>	<input type="checkbox"/>	<input type="checkbox"/>
5	None			1	<input type="checkbox"/>	<input type="checkbox"/>	<input type="checkbox"/>	<input type="checkbox"/>	<input type="checkbox"/>
6	None			1	<input type="checkbox"/>	<input type="checkbox"/>	<input type="checkbox"/>	<input type="checkbox"/>	<input type="checkbox"/>
7	None			1	<input type="checkbox"/>	<input type="checkbox"/>	<input type="checkbox"/>	<input type="checkbox"/>	<input type="checkbox"/>
8	None			1	<input type="checkbox"/>	<input type="checkbox"/>	<input type="checkbox"/>	<input type="checkbox"/>	<input type="checkbox"/>
9	None			1	<input type="checkbox"/>	<input type="checkbox"/>	<input type="checkbox"/>	<input type="checkbox"/>	<input type="checkbox"/>
10	None			1	<input type="checkbox"/>	<input type="checkbox"/>	<input type="checkbox"/>	<input type="checkbox"/>	<input type="checkbox"/>
11	None			1	<input type="checkbox"/>	<input type="checkbox"/>	<input type="checkbox"/>	<input type="checkbox"/>	<input type="checkbox"/>
12	None			1	<input type="checkbox"/>	<input type="checkbox"/>	<input type="checkbox"/>	<input type="checkbox"/>	<input type="checkbox"/>
13	None			1	<input type="checkbox"/>	<input type="checkbox"/>	<input type="checkbox"/>	<input type="checkbox"/>	<input type="checkbox"/>
14	None			1	<input type="checkbox"/>	<input type="checkbox"/>	<input type="checkbox"/>	<input type="checkbox"/>	<input type="checkbox"/>
15	None			1	<input type="checkbox"/>	<input type="checkbox"/>	<input type="checkbox"/>	<input type="checkbox"/>	<input type="checkbox"/>
16	None			1	<input type="checkbox"/>	<input type="checkbox"/>	<input type="checkbox"/>	<input type="checkbox"/>	<input type="checkbox"/>
17	None			1	<input type="checkbox"/>	<input type="checkbox"/>	<input type="checkbox"/>	<input type="checkbox"/>	<input type="checkbox"/>
18	None			1	<input type="checkbox"/>	<input type="checkbox"/>	<input type="checkbox"/>	<input type="checkbox"/>	<input type="checkbox"/>
19	None			1	<input type="checkbox"/>	<input type="checkbox"/>	<input type="checkbox"/>	<input type="checkbox"/>	<input type="checkbox"/>
20	None			1	<input type="checkbox"/>	<input type="checkbox"/>	<input type="checkbox"/>	<input type="checkbox"/>	<input type="checkbox"/>

Softkeys 1 and 2 configured for DND

Note: If there is no DND key configured or if it is removed, DND is disabled on the IP Phone.

8 Click to save your changes.

5-212

41-001160-03 Rev 00, Release 2.5

Using DND Modes via the IP Phone UI

If you add a DND key using the configuration files or the Aastra Web UI, you can toggle the DND state using the IP Phone UI. Use the following procedure to enable/disable DND on the IP Phone.

The following procedure assumes you have already configured a DND key AND assumes there are three accounts configured on the phone.



Notes:

1. If there is no DND key configured or if it is removed, DND is disabled on the IP Phone.
 2. If there is only one account configured on the phone, then the mode setting is ignored and the phone behaves as if the mode was set to “Phone”.
 3. Using the Aastra Web UI, if you change the DND key mode to “phone”, all accounts synchronize to the current setting of Account 1.
-



Aastra IP Phone UI

Step	Action
------	--------

DND in Account Mode

On 3-Line LCD phones (not applicable to 6751i):

With the account in focus on the IP Phone UI, press the **DND** key to toggle DND ON or OFF for the account. Use the RIGHT and LEFT arrow keys to scroll through each account.

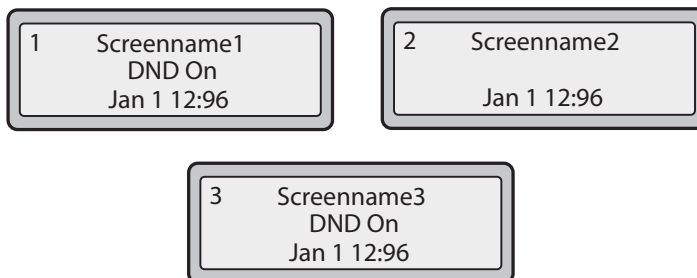

In the above example, Screenname1, Screenname2, and Screenname3, are three accounts configured on the phone. Only Screenname1 and 3 have DND ON. Screenname 2 has DND OFF.

On the 8 and 11-Line LCD phones:

With the account in focus on the IP Phone UI, press the **DND** key to toggle DND ON or OFF for the account. Use the RIGHT and LEFT arrow keys to scroll through each account.

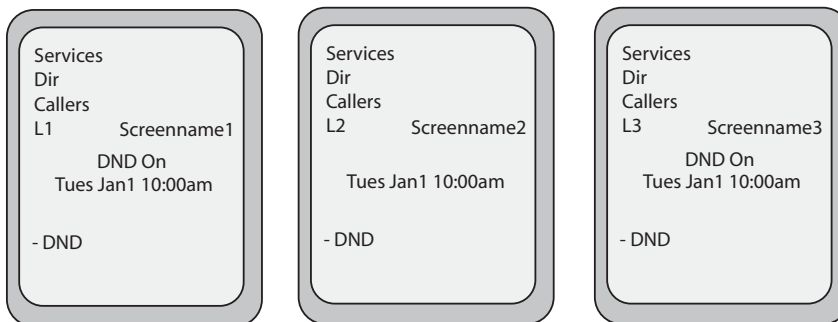

In the above example, Screenname1, Screenname2, and Screenname3, are three accounts configured on the phone. Only Screenname1 and 3 have DND ON. Screenname 2 has DND OFF.



Aastra IP Phone UI

Step	Action
------	--------

DND in Phone Mode

On 3-Line LCD phones (not applicable to 6751i):

Press the **DND** key to toggle DND ON or OFF for all accounts on the phone. Toggling to ON enables DND on all accounts on the phone. Toggling to OFF disables DND on all accounts on the phone. Use the RIGHT and LEFT arrow keys to scroll through each account.

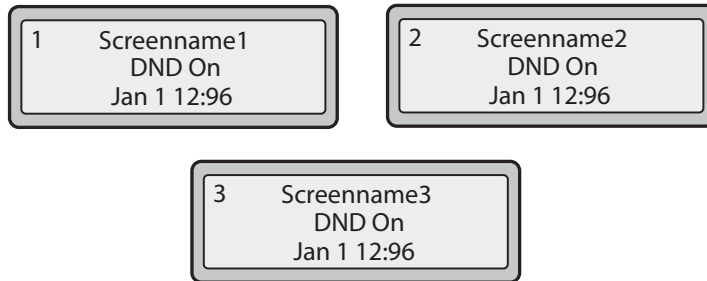

In the above example, toggling Screenname1 to DND ON, enabled DND for Screenname2 and 3 also.

On the 8 and 11-Line LCD phones:

Press the **DND** key to toggle DND ON or OFF for all accounts on the phone. Toggling to ON enables DND on all accounts on the phone. Toggling to OFF disables DND on all accounts on the phone. Use the RIGHT and LEFT arrow keys to scroll through each account.

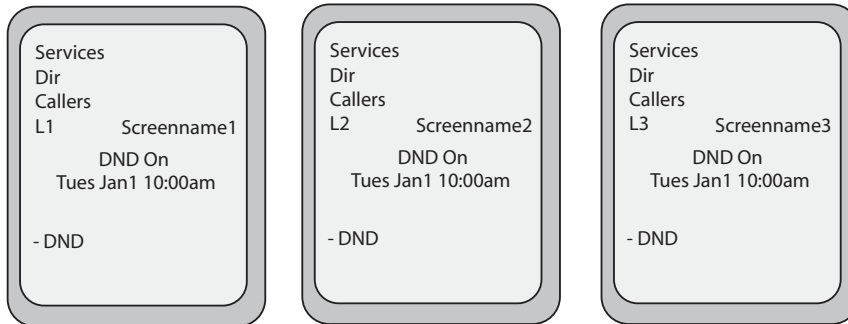

In the above example, toggling Screenname1 to DND ON, enabled DND for Screenname2 and 3 also.

Note: Enabling DND in **“Phone”** mode toggles all accounts on the phone to DND ON.



Aastra IP Phone UI

Step	Action
------	--------

DND in Custom Mode

On 3-Line LCD phones (not applicable to 6751i):

Press the **DND** key on the phone. The screen displays a list of the accounts on the phone and allows you to enable/disable a specific account or all accounts. Use the UP and DOWN arrow keys to scroll through the accounts.

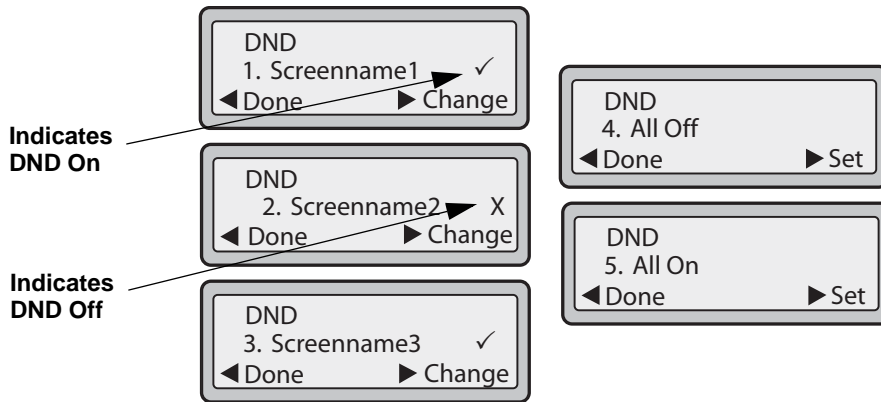

In the above example, Screenname1 and 3 have **DND ON** as indicated by a checkmark (✓). Screenname2 has DND off as indicated by an **X**. Items 4 and 5 allow you to disable or enable DND on all accounts, respectively.

You use the **CHANGE** key to enable or disable DND for a specific account. You use the **SET** key to enable/disable DND for all accounts. After making the change, you must press **DONE** and then **Confirm (#)** to save the change. Pressing **Cancel (0)** cancels the attempted change. The following screen displays after pressing a **DONE** key:

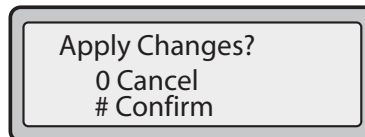



Aastra IP Phone UI

Step	Action
------	--------

DND in Custom Mode (continued)

On the 8 and 11-Line LCD phones:

Press the **DND** key on the phone. The screen displays a list of the accounts on the phone and allows you to enable/disable a specific account or all accounts. Use the UP and DOWN arrow keys to scroll through the accounts.

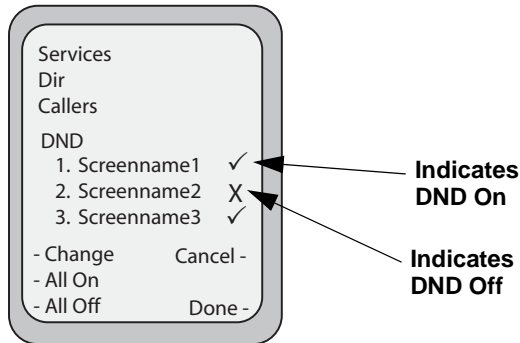

In the above example, Screenname1 and 3 have **DND ON** as indicated by a checkmark (✓). Screenname2 has DND off as indicated by an X. The **ALL ON** and **ALL OFF** softkeys allow you to enable or disable DND on all accounts, respectively.

You use the **CHANGE** key to enable or disable DND for a specific account selected. After making the change, you must press **DONE** to save the change.

If DND is configured on the phone, the softkey or programmable key switches DND ON and OFF. If the phone shares a line with other phones, only the phone that has DND configured is affected.

The second line on the screen of the IP phone shows when DND is configured. When a call comes in on the line, the caller hears a busy signal or recorded message, depending on the server configuration.

Bridged Line Appearance (BLA)

A SIP bridge line appearance (BLA) on the IP phones allows multiple devices to share a single directory address (DA).

For example, people working at a technical support department could be located in different places. If their desktop phones are configured for BLA DA, when customer calls come in, all the phones with the BLA DA would ring but the call can only be answered by one of them.

Once the call is answered, the rest of the phones reflect the status of the call. If the call was put on "hold" by the original recipient, any one from the group can pick up the call.



Note: This feature is dependent on the IP telephony system to which the IP phone is registered and according to [draft-anil-sipping-bla-02.txt](#).

You can apply BLA on the IP phones as follows:

- **As a single BLA group** - One BLA DA is shared among multiple phones. Only one phone at a time can pick up an incoming call or initiate an outgoing call on the BLA DA. All phones reflect the usage of the BLA DA. If the call is put on "hold", any one from the group can pick up the "held" call.
- **As a multiple BLA group** - On one single phone, multiple BLA DA can be associated with different line appearances. Every BLA DA is independent from each other and follows the same rules as "a single BLA group".
- **As multiple instances of a BLA DA** - A "x-line-id" parameter was defined in [draft-anil-sipping-bla-02.txt](#) to present the incoming call to or place an outgoing call on the specified line appearance instance. The parameter is carried in "Alert-Info" header field over the request-URI (INVITE e.g.) or in the NOTIFY messages to report the status of a dialog.

BLA DA can be configured on a global basis or on a per-line basis on the IP phones using the Aastra Web UI or the configuration files.

The following table shows the number of lines that can be set to BLA for each model phone.

IP Phone Model	Possible # of BLA Lines
9143i	9
9480i	9
9480i CT	9
6730i	6
6731i	6
6751i	N/A
6753i	9
6755i	9
6757i	9
6757i CT	9

Configuring BLA

You can configure BLA on a global or per-line basis using the configuration files or the Aastra Web UI.

Global BLA

You configure BLA on a global basis in the configuration files using the following parameters:

```

sip mode
sip user name
sip bla number

```

You configure BLA on a global basis in the Aastra Web UI using the following fields at **Advanced Settings->Global SIP->Basic SIP Settings**:

- **Line Mode**
- **Phone Number**
- **BLA Number**

Per-Line BLA

You configure BLA on a per-line basis in the configuration files using the following parameters:

```
sip lineN mode  
sip lineN username  
sip lineN bla number
```

You configure BLA on a per-line basis in the Aastra Web UI using the following fields at **Advanced Settings->Line 1 thru Line 9**:

- **Line Mode**
- **Phone Number**
- **BLA Number**

Sylantro servers and ININ servers require specific configuration methods for per-line configurations.

For Sylantro Server

When configuring the BLA feature on a per-line basis for a Sylantro server, the value set for the "sip lineN bla number" parameter shall be the same value set for the "sip lineN user name" parameter for all the phones in the group. For example, if sip lineN user name is 1010, you would configure BLA on a per-line basis for the Sylantro server as follows:

```
sip line 1 mode: 3  
sip line1 user name: 1010 (# for all the phones)  
sip line1 bla number: 1010
```

For ININ Server

When configuring the BLA feature on an ININ server, the value set for the sip lineN bla number parameter shall be the same value set for the sip lineN user name parameter without the incremented digit added to the phone #. For example, if the sip lineN user name for the first phone is 10101, and the sip lineN user name for the second phone is 10102, etc., you would configure BLA on a per-line basis for the ININ server as follows:

(# for phone 1 with appearance of phone 3)

```
sip line1 mode: 3
sip line1 user name: 10101 sip line1 bla number: 1010
(# for phone 2 with appearance of phone 3)
sip line1 mode: 3
sip line1 user name: 10102
sip line1 bla number: 1010
(# for phone 3)
sip line1 mode: 3
sip line1 user name: 1010
sip line1 bla number: 1010
```



Note: The original phone number which has the bridged line appearance on other phones, will have the "sip lineN user name" parameter the same as the "sip lineN bla number" (1010 in the above example on Phone 3).

Use the following procedures to configure BLA on the IP phone.

Configuring Global BLA



Configuration Files

For specific **global** parameters you can set in the configuration files, see Appendix A, the section, "SIP Basic, Global Settings" on [page A-77](#).

Configuring Per-Line BLA



Configuration Files

For specific **per-line** parameters you can set in the configuration files, see Appendix A, the section, "SIP Basic, Per-Line Settings" on [page A-86](#).



Aastra Web UI

1

For global configuration of BLA:

Click on **Advanced Settings->Global SIP->Basic SIP Authentication Settings.**

Status System Information	Global SIP Settings
Operation User Password Phone Lock Softkeys and XML Directory Reset	Basic SIP Authentication Settings
Basic Settings Preferences Call Forward	Screen Name <input type="text"/>
Advanced Settings Network Global SIP Line 1 Line 2 Line 3 Line 4 Line 5 Line 6 Line 7 Line 8 Line 9 Action URI Configuration Server Firmware Update Troubleshooting	Screen Name 2 <input type="text"/>
	Phone Number <input type="text"/>
	Caller ID <input type="text"/>
	Authentication Name <input type="text"/>
	Password <input type="text"/>
	BLA Number <input type="text"/>
	Line Mode <input type="text" value="Generic"/>



Aastra Web UI

For per-line configuration of BLA:

Click on **Advanced Settings->Line N (1-9).**

<p>Status</p> <ul style="list-style-type: none"> System Information <p>Operation</p> <ul style="list-style-type: none"> User Password Phone Lock Softkeys and XML Directory Reset <p>Basic Settings</p> <ul style="list-style-type: none"> Preferences Call Forward <p>Advanced Settings</p> <ul style="list-style-type: none"> Network Global SIP Line 1 Line 2 Line 3 Line 4 Line 5 Line 6 Line 7 Line 8 Line 9 Action URI Configuration Server Firmware Update Troubleshooting 	<p>Configuration Line 1</p> <p>Basic SIP Authentication Settings</p> <p>Screen Name <input type="text" value="16107b ser 5555"/></p> <p>Phone Number <input type="text" value="5555"/></p> <p>Caller ID <input type="text" value="5555"/></p> <p>Authentication Name <input type="text" value="4148"/></p> <p>Password <input type="password" value="..."/></p> <p>BLA Number <input type="text"/></p> <p>Line Mode <input style="border: none; background-color: #e0f0ff; padding: 2px; width: 100px;" type="text" value="Generic"/> ▼</p> <p>Basic SIP Network Settings</p> <p>Proxy Server <input type="text" value="0.0.0.0"/></p> <p>Proxy Port <input type="text" value="0"/></p> <p>Backup Proxy Server <input type="text" value="0.0.0.0"/></p> <p>Backup Proxy Port <input type="text" value="0"/></p> <p>Outbound Proxy Server <input type="text" value="0.0.0.0"/></p> <p>Outbound Proxy Port <input type="text" value="0"/></p> <p>Registrar Server <input type="text" value="0.0.0.0"/></p> <p>Registrar Port <input type="text" value="0"/></p> <p>Backup Registrar Server <input type="text" value="0.0.0.0"/></p> <p>Backup Registrar Port <input type="text" value="0"/></p> <p>Registration Period <input type="text" value="0"/></p> <p>RTP Settings</p> <p>DTMF Method <input style="border: none; background-color: #e0f0ff; padding: 2px; width: 100px;" type="text" value="RTP"/> ▼</p>
--	--

In the "Line Mode" field, select the **BLA** option.

2 In the "Phone Number" field, enter the phone number of the IP phone.

3 **For global configuration of BLA:**
In the "BLA Number" field, enter the Bridge Line Appearance (BLA) number to be shared across all IP phones.

For per-line configuration of BLA:
In the "BLA Number" field, enter the Bridge Line Appearance (BLA) number to be shared on a specific line.

4 Click to save your changes.

BLA Subscription Period

The phones include a SIP BLA subscription period parameter that allows an Administrator to set the amount of time, in seconds, of the BLA subscription period.

Reference

For more information about setting the BLA Subscription Period, see the section, [“BLA Subscription Period”](#) on [page 5-198](#).

Using a BLA Line on the IP Phone

If you have either a global or per-line BLA configuration, and you want to share a call on the line with a BLA group, you need to press the Hold button before sharing the call with the group.

For example, if line 1 is configured for BLA, and you pick up a call on line 1, you must press the Hold button to share the call with the BLA group.

If you pick up a call on line 1 configured for BLA, and another call comes in on line 2, you can pick up line 2 without putting line 1 on hold. The line 1 call will be on hold automatically; however it is on hold locally only. The line 1 call cannot be shared with the BLA group.



Note: The Hold button must be pressed for a call on a BLA line to be shared with the BLA group.

BLA Support for Third Party Registration

BLA allows an Address Of Record (AOR) to be assigned onto different line appearances for a group of SIP user agents (IP phones). When a call is made to this BLA number, the call is offered to all user agents that have mapping to this BLA. To support this, the IP phones need to support third party registration for the BLA along with the registration for its own primary appearance number. If the IP phone has the primary appearance as a BLA, then there is no need for third party registration.

When configuring the BLA feature on a per-line basis for third party registration and subscription, the third party name must be configured using the “*sip lineN bla number*” parameter. For third party registration to work effectively, one of the lines should register as generic with its own username.

For example, Bob has Alice’s appearance on his phone. Bob’s configuration is as follows:

#line 1 Bob

```
sip line1 auth name:4082272203
sip line1 password:
sip line1 mode: 0
sip line1 user name:4082272203
sip line1 display name:Bob
sip line1 screen name:Bob
```

#line 2 Alice

```
sip line2 auth name:4082272203
sip line2 password:
```

#BLA mode 3

```
sip line2 mode: 3
sip line2 user name:4082272203
```

```
#Alice phone number
```

```
sip line2 bla number:4085582868  
sip line2 display name:Alice  
sip line2 screen name:Alice
```

Alice's configuration is as follows:

```
#line 1
```

```
sip line1 auth name:4085582868  
sip line1 password:  
sip line1 mode: 3  
sip line1 user name:4085582868  
sip line1 display name: Alice  
sip line1 screen name: Alice
```

P-Preferred Identity Header for BLA Accounts

The IP Phones support the BLA specification, draft-anil-sipping-bla-02, which states that the P-Preferred-Identity header (RFC3325) gets added to the INVITE message to indicate the Caller-ID that is used for the call.



Note: The P-Preferred-Identity for BLA accounts is also sent for hold/unhold messages.

BLA Support for Message Waiting Indicator (MWI)

The IP Phones have an option for a Busy Line Appearance (BLA) configured line to send a SUBSCRIBE SIP message for a Message Waiting Indicator (MWI).



Notes:

1. If you change the setting on this parameter, you must reboot the phone for it to take affect.
 2. Both the “**sip explicit mwi subscription**” and “**sip mwi for bla account**” parameters must be enabled in order for the MWI subscription for BLA to occur.
 3. The MWI re-subscription for the BLA account uses the value set for the “**sip explicit mwi subscription period**” parameter to re-subscribe.
 4. Whether or not the “**sip mwi for bla account**” parameter is enabled, the priority for displaying MWI does not change.
-

You can configure this feature using the configuration files or the Aastra Web UI.

Limitations

The following are limitations of the BLA Support for MWI feature:

- The phone shows MWI for the first matching identity if more than one line with different user names has the same BLA account.
- If a normal line has the same user name as the BLA user of another line, the phone shows MWI only for the normal line.

Use the following procedure to configure BLA support for MWI.

Configuring BLA Support for MWI Using the Configuration Files



Configuration Files

For specific parameters you can set in the configuration files, see Appendix A, the section, “BLA Support for MWI” on page A-97.

Configuring BLA Support for MWI using the Aastra Web UI

Use the following procedure to configure BLA support for MWI.



Aastra Web UI

1

Click on **Advanced Settings->Global SIP->Advanced SIP Settings**.

MWI for BLA Account Parameter

Status System Information	Global SIP Settings
Operation User Password Phone Lock Softkeys and XML Keypad Speed Dial Directory Reset	Advanced SIP Settings <input type="checkbox"/> Explicit MWI Subscription Enabled Explicit MWI Subscription Period 86400 <input type="checkbox"/> MWI for BLA account Enabled Missed Call Summary Subscription <input type="checkbox"/> Enabled Missed Call Summary Subscription Period 86400 AS-Feature-Event Subscription <input type="checkbox"/> Enabled AS-Feature-Event Subscription Period 3600 Send MAC Address in REGISTER Message <input type="checkbox"/> Enabled Send Line Number in REGISTER Message <input type="checkbox"/> Enabled Session Timer 0 T1 Timer 0 T2 Timer 0 Transaction Timer 4000 Transport Protocol UDP Local SIP UDP/TCP Port 5060 Local SIP TLS Port 5061 Registration Failed Retry Timer 1800 Registration Timeout Retry Timer 120 Registration Renewal Timer 15 BLF Subscription Period 3600 ACD Subscription Period 3600 BLA Subscription Period 300 Blacklist Duration 300 Whitelist Proxy <input type="checkbox"/> Enabled
Basic Settings Preferences Account Configuration	
Advanced Settings Network Global SIP Line 1 Line 2 Line 3 Line 4 Line 5 Line 6 Line 7 Line 8 Line 9 Action URI Configuration Server Firmware Update TLS Support 802.1x Support Troubleshooting	

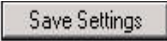
 Aastra Web UI	
2	<p>The "MWI for BLA Account" field is disabled by default. To enable this feature, place a checkmark in the "Enabled" box.</p> <p>Notes:</p> <ol style="list-style-type: none">1. If you change the setting on this parameter, you must reboot the phone for it to take affect.2. Both the "sip explicit mwi subscription" and "sip mwi for bla account" parameters must be enabled in order for the MWI subscription for BLA to occur.3. The MWI re-subscription for the BLA account uses the value set for the "sip explicit mwi subscription period" parameter to re-subscribe.4. Whether or not the "sip mwi for bla account" parameter is enabled, the priority for displaying MWI does not change.
3	<p>Click  to save your changes and reboot the phone for the change to take affect.</p>

Shared Call Appearance (SCA) Call Bridging

Shared Call Appearance (SCA) is when incoming calls are presented to multiple phones simultaneously. For example, it is the ability to assign the boss' extension to a button on the secretary's phone. Calls can be transferred between two phones with the same extension button by simply putting the call on hold at one phone and picking it up on the other. Status LEDs light and flash in unison, allowing all people sharing the extension to see the status at a glance.

The IP Phones include an enhanced SCA for the servers that support call bridging and allows two or more SCA users to be connected in a call with a third party.

Refer to the following example.

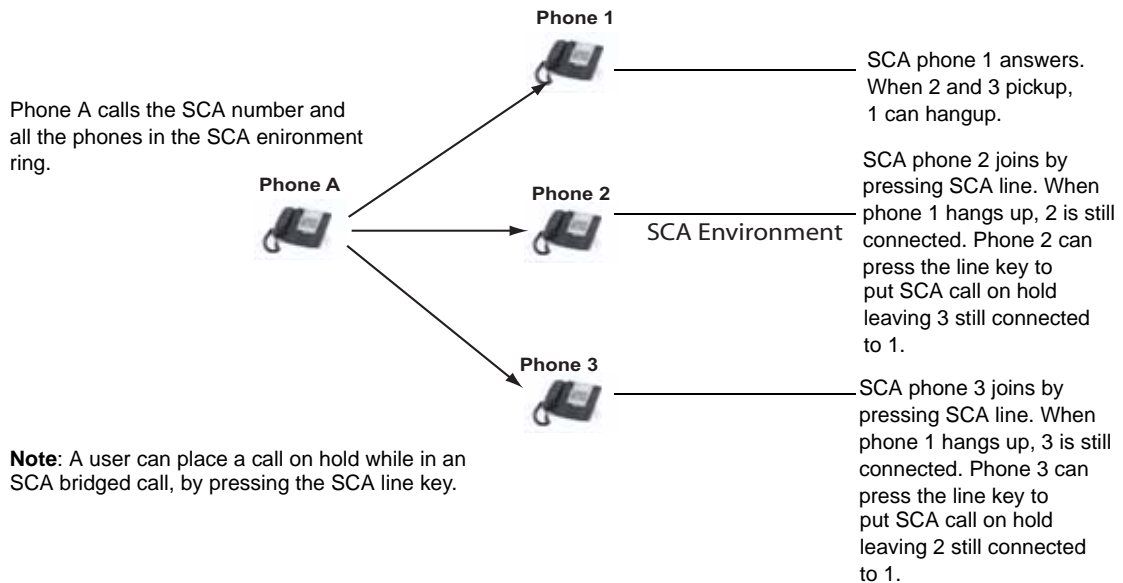

Using the example above, when a call comes into Phone 1, Phone 2 and Phone 3 can pickup the same call by pressing the SCA line key. Phone 2 and 3 display the call they are bridging into on the LCD of the phones. Existing SCA parties in a bridge or one-to-one call hear an audible beep when another party has joined the call.



Note: Enabling/disabling the beep is configurable on the server-side.

If a phone is configured for SCA bridging and it attempts to join a call, but the account on the server does not have this functionality enabled, an error message displays to the LCD on the phone.

The SCA call bridging feature is disabled by default on all phones. You can enable this feature on a global or per-line basis using the configuration files only.

Keys States and LED Behavior

There are two new call states on the phones that support SCA bridging:

- **Bridge-active** - A bridged call is in progress
- **Bridge-held** - The 3rd-party (i.e., non-SCA party) in the bridge is on hold.

The following tables provide the key states and LED behavior in an SCA bridge call for users involved in an SCA call and users not involved in the SCA call.

Line Keys and Idle Screens

State	Call LED	Call Caller ID	Non-Call LED	Non-Call Caller ID
Idle	N/A	N/A	Off	N/A
Seized	Solid Green	None	Solid Red	None
Progressing (outgoing call)	Green	Called Part7	Solid Red	None
Alerting (incoming call)	Blinking Unselected Red	N/A		
Active	Solid Green	Far-end	Solid Red	Far-end
Held	Slow Flashing Green	Far-end	Slow Flashing Red	Far-end
Hold private	Slow Flashing Green	Far-end	Solid Red	Far-end
Bridge-active	Solid Green	Far-end	Solid Red	Far-end
Bridge-held	Slow Flashing Green	Far-end	Solid Red	Far-end

Softkey Line Keys

State	Call Icon	Call LED	Non-Call Icon	Non-Call LED
Idle	Small circle	None	Small circle	None
Seized	N/A	N/A	Sold Circle	Solid Red
Progressing (outgoing call)	Empty circle	Solid Red	Sold Circle	Solid Red
Alerting (incoming call)	Empty blinking circle	Flashing Red	N/A	N/A
Active	Empty circle	Solid Red	Sold Circle	Solid Red
Held	Reverse empty blinking circle	Slow Flashing Red	Sold Reverse Circle	Slow Flashing Red
Hold private	Reverse empty blinking circle	Slow Flashing Red	Sold Circle	Solid Red
Bridge-active	Empty circle	Solid Red	Sold Circle	Solid Red
Bridge-held	Reverse empty blinking circle	Slow Flashing Red	Sold Circle	Solid Red

9143i Phone LED States

State	Call LED	Non-Call LED
Idle	N/A	N/A
Seized	Solid Red	Solid Red
Progressing (outgoing call)	Solid Red	Solid Red
Alerting (incoming call)	Flashing Red	Flashing Red
Active	Solid Red	Solid Red
Held	Slow Flashing Red	Slow Flashing Red
<i>Hold private</i>	<i>Slow Flashing Red</i>	<i>Solid Red</i>
<i>Bridge-active</i>	<i>Solid Red</i>	<i>Solid Red</i>
<i>Bridge-held</i>	<i>Slow Flashing Red</i>	<i>Solid Red</i>

Line key Phone Behavior

State	Call Line Key Pressed	Non-Call Line Key Pressed
Idle	N/A	Attempt to seize the line
Seized	<i>Hang up</i>	Ignore
Progressing	Hang up	Ignore
Alerting	answer	N/A
Active	<i>Hold</i>	<i>Bridge</i>
Held	<i>Retrieve</i>	<i>Bridge</i>
<i>Hold private</i>	<i>Retrieve</i>	<i>Ignore</i>
<i>Bridge-active</i>	<i>Hold</i>	<i>Bridge</i>
<i>Bridge-held</i>	<i>Retrieve</i>	<i>Bridge</i>

Enabling/Disabling SCA Call Bridging Feature

Use the following procedure to enable/disable SCA call bridging on the IP Phones.



Configuration Files

For specific parameters you can set in the configuration files, see Appendix A, the section, [“Shared Call Appearance \(SCA\) Call Bridging”](#) on [page A-98](#).

Park/Pick Up Key (not applicable to the 6751i)

The IP phones (including the CT handsets) have a park and pickup call feature that allows you to park a call and pickup a call when required. There are two ways a user or administrator can configure this feature:

- Using a static configuration (globally configures park and pickup)
- Using a programmable configuration (using a key)



Note: The IP phones accept both methods of configuration. However, to avoid redundancy, Aastra Telecom recommends you configure either a static configuration or a programmable configuration.

The IP phones support the Park/Pickup feature on the Asterisk, BroadWorks, Sylantrio, and ININ PBX servers.

The following paragraph describes the configuration of a park and pickup key on the IP phone. For information about configuring the park and pickup static configuration method see [“Park Calls/Pick Up Parked Calls”](#) on [page 5-59](#).

Park/Pickup Programmable Configuration (using a key)

The programmable method of configuration creates park and pickup keys (softkeys, programmable keys, expansion module keys) that you can configure on the IP phones.

For all phones (EXCEPT the 6751i) you can set a key as "Park" or "Pickup" and then:

- specify a customized label to display on the Phone UI
- specify a value
- specify which line to use
- specify the state of the park and/or pickup keys

For 3-Line LCD display phones (not applicable to 6751i) , you can set a programmable key as "Park" or "Pickup" and then:

- specify a value
- specify a line to use

On 8 and 11-Line LCD Phone UIs

- When a call comes in, and you pickup the handset, the custom label that you configured for the Park softkey displays on the Phone UI.
- After the call is parked, the label that you configured for the Pickup softkey displays on other phones in the network. You can then press the "Pickup" softkey, followed by the applicable value to pickup the call on another phone in your network.
- On the Model CTs, the customized labels apply to the base unit only. On the Model CT handsets, pressing **¶** displays the default labels of "Park" and "Pickup".



Note: On the 9480i/9480i CT and 6757i/6757i CT, the old softkey labeled "Pickup" has been renamed to "Answer". This softkey uses the old functionality - when you pickup the handset, you see a softkey labeled "Answer". You can then press this key to pick up an incoming call. Do not confuse this feature with the new Park/Pickup configuration feature.

On 3-Line LCD Phone UIs (not applicable to 6751i)

- When a call comes in, and you pickup the handset, you can press the applicable "Park" programmable key to park the call.
- After the call is parked, you can press the "Pickup" programmable key, followed by the applicable value to pickup the call.

You can configure a Park and Pickup key configuration using the configuration files or the Aastra Web UI.

Configuring Park/Pickup Key Using Configuration Files

In the configuration files, you configure Park/Pickup using the key parameters. You must specify the "softkeyN value", "prgkeyN value", "topsoftkeyN value", or "expmoX keyN value". The following examples show Park/Pickup configurations using specific servers.

Examples for Models with 8 and 11-Line LCDs

Server	Park Configuration	Pickup Configuration
Asterisk	softkeyN type: park softkeyN label: parkCall softkeyN value: asterisk;70 softkeyN line: 1 softkeyN states: connected*	softkeyN type: pickup softkeyN label: pickupCall softkeyN value: asterisk;70 softkeyN line: 1 softkeyN states: idle, outgoing**
Sylantro	softkeyN type: park softkeyN label: parkCall softkeyN value: sylantro;*98 softkeyN line: 1 softkeyN states: connected*	softkeyN type: pickup softkeyN label: pickupCall softkeyN value: sylantro;*99 softkeyN line: 1 softkeyN states: idle, outgoing**
BroadWorks	softkeyN type: park softkeyN label: parkCall softkeyN value: broadworks;*68 softkeyN line: 1 softkeyN states: connected*	softkeyN type: pickup softkeyN label: pickupCall softkeyN value: broadworks;*88 softkeyN line: 1 softkeyN states: idle, outgoing**
ININ PBX	softkeyN type: park softkeyN label: parkCall softkeyN value: inin;callpark softkeyN line: 1 softkeyN states: connected*	softkeyN type: pickup softkeyN label: pickupCall softkeyN value: inin;pickup softkeyN line: 1 softkeyN states: idle, outgoing**

*When you configure a softkey as "Park", you must configure the state of the softkey as "connected".

**When you configure a softkey as "Pickup", you can configure the state of the softkey as "idle, outgoing", or just "idle", or just "outgoing".

Examples for Models with 3-Line LCDs (not applicable to 6751i)

Server	Park Configuration	Pickup Configuration
Asterisk	prgkeyN type: park prgkeyN value: asterisk;70 prgkeyN line: 1	prgkeyN type: pickup prgkeyN value: asterisk;70 prgkeyN line: 1
Sylantro	prgkeyN type: park prgkeyN value: sylantro;*98 prgkeyN line: 1	prgkeyN type: pickup prgkeyN value: sylantro;*99 prgkeyN line: 1
BroadWorks	prgkeyN type: park prgkeyN value: broadworks;*68 prgkeyN line: 1	prgkeyN type: pickup prgkeyN value: broadworks;*88 prgkeyN line: 1
ININ PBX	prgkeyN type: park prgkeyN value: inin;callpark prgkeyN line: 1	prgkeyN type: pickup prgkeyN value: inin;pickup prgkeyN line: 1



Note: The 6730i, 6731i, 6753i, 6755i and 9143i do not allow for the configuration of labels and states for programmable keys.

Use the following procedure to configure a Park/Pickup key using the configuration files.



Configuration Files

For specific parameters you can set in the configuration files, see Appendix A, the section, "Softkey Settings for 8 and 11-Line LCD phones" on page A-218 and "Programmable Key Settings for 9143i, 6730i, 6731i, 6753i, and 6755i" on page A-227.

Configuring a Park/Pickup Key Using Aastra Web UI

For 8 and 11-Line LCD phones, you configure a Park and/or Pickup key at **Operation->Softkeys and XML**. You enter a key label, and value for a specific line on the phone. The default state of the Park configuration is "**connected**". The default state of the Pickup configuration is "**idle, outgoing**".

The CT handsets use the park/pickup configuration enabled at **Operation->Handset Keys** in the Aastra Web UI. If Park or Pickup are enabled on more than one line on the base unit, the CT handsets use the first programmable configuration.

For example, if line 1 and line 6 are configured for park, the CT handsets use the configuration set for line 1 to park a call.

On 3-Line LCD phones (not applicable to 6751i), you configure a Park and/or Pickup key at **Operation->Programmable Keys**, and then enter the appropriate value and line.



Note: Applicable values depend on the server in your network (Asterisk, BroadWorks, Sylanro, ININ PBX. See the table below for applicable values.

Park/Pickup Call Server Configuration Values

Server	Park Values*	Pickup Values*
Aasterisk	70	70
Sylanro	*98	*99
BroadWorks	*68	*88
ININ PBX	callpark	pickup

*Leave "value" fields blank to disable the park and pickup feature.

Use the following procedure to configure the Park/Pickup call feature using the programmable configuration method and the Aastra Web UI.

 **Aastra Web UI**

For 8 and 11-Line LCD Phones

1 Click on **Operation->Softkeys and XML.**

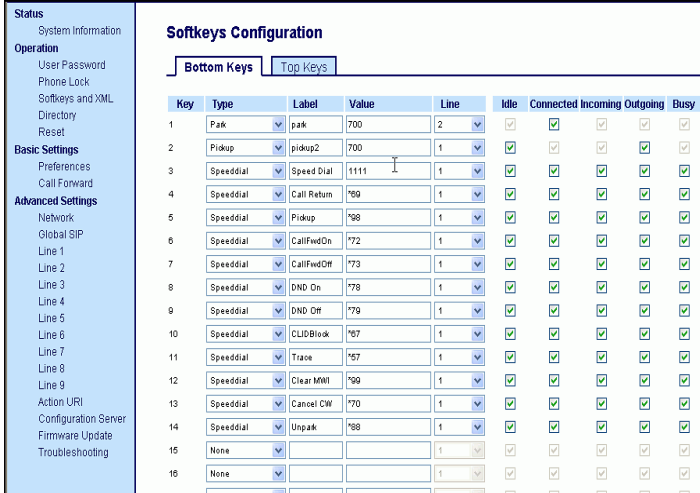

Key	Type	Label	Value	Line	Idle	Connected	Incoming	Outgoing	Busy
1	Park	park	700	2	<input checked="" type="checkbox"/>	<input checked="" type="checkbox"/>	<input checked="" type="checkbox"/>	<input checked="" type="checkbox"/>	<input checked="" type="checkbox"/>
2	Pickup	pickup2	700	1	<input checked="" type="checkbox"/>	<input checked="" type="checkbox"/>	<input checked="" type="checkbox"/>	<input checked="" type="checkbox"/>	<input checked="" type="checkbox"/>
3	Speeddial	Speed Dial	1111	1	<input checked="" type="checkbox"/>	<input checked="" type="checkbox"/>	<input checked="" type="checkbox"/>	<input checked="" type="checkbox"/>	<input checked="" type="checkbox"/>
4	Speeddial	Call Return	*99	1	<input checked="" type="checkbox"/>	<input checked="" type="checkbox"/>	<input checked="" type="checkbox"/>	<input checked="" type="checkbox"/>	<input checked="" type="checkbox"/>
5	Speeddial	Pickup	*98	1	<input checked="" type="checkbox"/>	<input checked="" type="checkbox"/>	<input checked="" type="checkbox"/>	<input checked="" type="checkbox"/>	<input checked="" type="checkbox"/>
6	Speeddial	CallFwdOn	*72	1	<input checked="" type="checkbox"/>	<input checked="" type="checkbox"/>	<input checked="" type="checkbox"/>	<input checked="" type="checkbox"/>	<input checked="" type="checkbox"/>
7	Speeddial	CallFwdOff	*73	1	<input checked="" type="checkbox"/>	<input checked="" type="checkbox"/>	<input checked="" type="checkbox"/>	<input checked="" type="checkbox"/>	<input checked="" type="checkbox"/>
8	Speeddial	DND On	*78	1	<input checked="" type="checkbox"/>	<input checked="" type="checkbox"/>	<input checked="" type="checkbox"/>	<input checked="" type="checkbox"/>	<input checked="" type="checkbox"/>
9	Speeddial	DND Off	*79	1	<input checked="" type="checkbox"/>	<input checked="" type="checkbox"/>	<input checked="" type="checkbox"/>	<input checked="" type="checkbox"/>	<input checked="" type="checkbox"/>
10	Speeddial	CLIRBlock	*67	1	<input checked="" type="checkbox"/>	<input checked="" type="checkbox"/>	<input checked="" type="checkbox"/>	<input checked="" type="checkbox"/>	<input checked="" type="checkbox"/>
11	Speeddial	Trace	*57	1	<input checked="" type="checkbox"/>	<input checked="" type="checkbox"/>	<input checked="" type="checkbox"/>	<input checked="" type="checkbox"/>	<input checked="" type="checkbox"/>
12	Speeddial	Clear MWI	*90	1	<input checked="" type="checkbox"/>	<input checked="" type="checkbox"/>	<input checked="" type="checkbox"/>	<input checked="" type="checkbox"/>	<input checked="" type="checkbox"/>
13	Speeddial	Cancel CW	*70	1	<input checked="" type="checkbox"/>	<input checked="" type="checkbox"/>	<input checked="" type="checkbox"/>	<input checked="" type="checkbox"/>	<input checked="" type="checkbox"/>
14	Speeddial	Unpak	*88	1	<input checked="" type="checkbox"/>	<input checked="" type="checkbox"/>	<input checked="" type="checkbox"/>	<input checked="" type="checkbox"/>	<input checked="" type="checkbox"/>
15	None			1	<input checked="" type="checkbox"/>	<input checked="" type="checkbox"/>	<input checked="" type="checkbox"/>	<input checked="" type="checkbox"/>	<input checked="" type="checkbox"/>
16	None			1	<input checked="" type="checkbox"/>	<input checked="" type="checkbox"/>	<input checked="" type="checkbox"/>	<input checked="" type="checkbox"/>	<input checked="" type="checkbox"/>

2 Pick a softkey to configure for Parking a call.

3 In the "**Type**" field, select **Park**.

4 In the "**Label**" field, enter a label for the Park softkey.

5 In the "**Value**" field, enter the appropriate value based on the server in your network.

Note: For values to enter in this field, see the table "[Park/Pickup Call Server Configuration Values](#)" on [page 5-238](#).

6 In the "**Line**" field, select a line for which to apply the Park configuration.

7 The park softkey has a default state of "**Connected**".
Leave this state enabled or to disable, uncheck the check box.

8 Pick a softkey to configure for Picking up a call.

9 In the "**Type**" field, select **Pickup**.

10 In the "**Label**" field, enter a label for the Pickup softkey.



Aastra Web UI

- 11 In the "**Value**" field, enter the appropriate value based on the server in your network.

Note: For values to enter in this field, see the table "[Park/Pickup Call Server Configuration Values](#)" on [page 5-238](#).
- 12 In the "**Line**" field, select a line for which to apply the Pickup configuration.
- 13 The pickup softkey has a default state of "**Idle**" and "**Outgoing**".
Leave these states enabled or to disable, uncheck the check boxes.
- 14 Click to save your changes.

For CT Handset:s

- 1 Click on **Operation->Handset Keys**.

Key	Type	Label
1	Park	Park
2	PickUp	Pickup
3	Line 3	Line3
4	Line 4	Line4
5	Icom	Intercom
6	Dir	Directory
7	Callers	Callers
8	Xfer	Transfer
9	Conf	Conference
10	Public	Public
11	None	
12	None	
13	None	
14	None	
15	None	

- 2 Pick a handset key to configure for parking a call.
- 3 In the "**Key Function**" field, select **Park**.
- 4 Pick another handset key to configure for picking up a call.
- 5 In the "**Key Function**" field, select **Pickup**.
- 6 Click to save your changes.



Aastra Web UI

For 3-Line LCD phones (not applicable to 6751i):

1 Click on **Operation->Programmable Keys**.

6753i Screen

Key	Hard Key	Value	Line
1	Save		global
2	Delete		global
3	Park	sylantro,*98	1
4	Pickup	sylantro,*99	2
5	Transfer		global
6	Conference		global

Services:
BLF List URI:

Save Settings

2 Pick a key to configure for Parking a call.

3 In the "**Hard Key**" field, select **Park**.

4 In the "**Value**" field, enter the appropriate value based on the server in your network.

Note: For values to enter in this field, see the table "[Park/Pickup Call Server Configuration Values](#)" on [page 5-238](#).

5 **For 3-Line LCD phones (not applicable to 6751i):**

In the "**Line**" field, select a line for which to apply the Park configuration.

6 Pick a key to configure for Picking up a call.

7 In the "**Hard Key**" field, select **Pickup**.



8 In the "**Value**" field, enter the appropriate value based on the server in your network.

Note: For values to enter in this field, see the table "[Park/Pickup Call Server Configuration Values](#)" on [page 5-238](#).

9 **For 3-Line LCD phones (not applicable to 6751i):**

In the "**Line**" field, select a line for which to apply the Pickup configuration.

**Aastra Web UI**

10	Click  to save your changes. You must restart your IP phone for the changes to take affect.
11	Click on Operation->Reset .
12	In the " Restart Phone " field click  to restart the IP phone and apply the changes.

Using the Park Call/Pickup Parked Call Feature

Use the following procedures on the IP phones to park a call and pick up a parked call.

 IP Phone UI					
Step	Action				
Parking a Call					
1	While on a live call, press the "Park" softkey.				
2	<p>Perform the following for your specific server:</p> <table border="1" style="margin-left: 40px;"> <tr> <td> <p>For Asterisk Server:</p> <p>- Server announces the extension number where the call has been parked. Once the call is parked, press the y key to complete parking.</p> </td> </tr> <tr> <td> <p>For BroadWorks Server:</p> <p>- After you hear the greeting from the CallPark server, enter the extension where you want to park the call.</p> </td> </tr> <tr> <td> <p>For Sylanro Server:</p> <p>- Enter the extension number where you want to park the call, followed by "#" key.</p> </td> </tr> <tr> <td> <p>For ININ Server:</p> <p>- Enter the extension number where you want to park the call, followed by "#" key.</p> </td> </tr> </table> <p>If the call is parked successfully, the response is either a greeting voice confirming that the call was parked, or a hang up occurs. The parked call party will get music on hold.</p>	<p>For Asterisk Server:</p> <p>- Server announces the extension number where the call has been parked. Once the call is parked, press the y key to complete parking.</p>	<p>For BroadWorks Server:</p> <p>- After you hear the greeting from the CallPark server, enter the extension where you want to park the call.</p>	<p>For Sylanro Server:</p> <p>- Enter the extension number where you want to park the call, followed by "#" key.</p>	<p>For ININ Server:</p> <p>- Enter the extension number where you want to park the call, followed by "#" key.</p>
<p>For Asterisk Server:</p> <p>- Server announces the extension number where the call has been parked. Once the call is parked, press the y key to complete parking.</p>					
<p>For BroadWorks Server:</p> <p>- After you hear the greeting from the CallPark server, enter the extension where you want to park the call.</p>					
<p>For Sylanro Server:</p> <p>- Enter the extension number where you want to park the call, followed by "#" key.</p>					
<p>For ININ Server:</p> <p>- Enter the extension number where you want to park the call, followed by "#" key.</p>					
3	If the call fails, you can pick up the call (using the next procedure) and press the "Park" softkey again to retry step 2.				
Picking up a Parked Call					
4	Pick up the handset on the phone.				



IP Phone UI

Step	Action
5	Enter the extension number where the call was parked.
6	Press the " Pickup " softkey. If the call pick up is successful, you are connected with the parked call.

Last Call Return (lcr) (Sylantro Servers)

Last call return (lcr) allows an administrator or user to configure a "last call return" function on a softkey or programmable key. This feature is for Sylantro servers only.

You can configure the "lcr" softkey feature via the configuration files or the Aastra Web UI.

How it works

If you configure "lcr" on a softkey or programmable key, and a call comes into your phone, after you are finished with the call and hangup, you can press the key configured for "lcr" and the phone dials the last call you received. When you configure an "lcr" softkey, the label "LCR" displays next to that softkey on the IP phone. When the Sylantro server detects an "lcr" request, it translates this request and routes the call to the last caller.

Configuring Last Call Return

Use the following procedures to configure LCR on the IP phones.



Configuration Files

For specific last call return (lcr) parameters you can set in the configuration files, see Appendix A, the section, "[Softkey/Programmable Key/Feature Key/Expansion Module Key Parameters](#)" on [page A-216](#).

Aastra Web UI

For the 6757i/6757i CT:

1 Click on **Operation->Softkeys and XML.**

Status

System Information

Operation

User Password

Phone Lock

Softkeys and XML

Directory

Reset

Basic Settings

Preferences

Call Forward

Advanced Settings

Network

Global SIP

Line 1

Line 2

Line 3

Line 4

Line 5

Line 6

Line 7

Line 8

Line 9

Action URI

Configuration Server

Firmware Update

Troubleshooting

Softkeys Configuration

Bottom Keys Top Keys

Key	Type	Label	Value	Line	Idle	Connected	Incoming	Outgoing	Busy
1	Park	park	700	2	<input checked="" type="checkbox"/>	<input checked="" type="checkbox"/>	<input checked="" type="checkbox"/>	<input checked="" type="checkbox"/>	<input checked="" type="checkbox"/>
2	Pickup	pickup2	700	1	<input checked="" type="checkbox"/>	<input checked="" type="checkbox"/>	<input checked="" type="checkbox"/>	<input checked="" type="checkbox"/>	<input checked="" type="checkbox"/>
3	Speeddial	Speed Dial	1111	1	<input checked="" type="checkbox"/>	<input checked="" type="checkbox"/>	<input checked="" type="checkbox"/>	<input checked="" type="checkbox"/>	<input checked="" type="checkbox"/>
4	Speeddial	Call Return	99	1	<input checked="" type="checkbox"/>	<input checked="" type="checkbox"/>	<input checked="" type="checkbox"/>	<input checked="" type="checkbox"/>	<input checked="" type="checkbox"/>
5	Speeddial	Pickup	98	1	<input checked="" type="checkbox"/>	<input checked="" type="checkbox"/>	<input checked="" type="checkbox"/>	<input checked="" type="checkbox"/>	<input checked="" type="checkbox"/>
6	Speeddial	CallFwdOn	72	1	<input checked="" type="checkbox"/>	<input checked="" type="checkbox"/>	<input checked="" type="checkbox"/>	<input checked="" type="checkbox"/>	<input checked="" type="checkbox"/>
7	Speeddial	CallFwdOff	73	1	<input checked="" type="checkbox"/>	<input checked="" type="checkbox"/>	<input checked="" type="checkbox"/>	<input checked="" type="checkbox"/>	<input checked="" type="checkbox"/>
8	Speeddial	DND On	78	1	<input checked="" type="checkbox"/>	<input checked="" type="checkbox"/>	<input checked="" type="checkbox"/>	<input checked="" type="checkbox"/>	<input checked="" type="checkbox"/>
9	Speeddial	DND Off	79	1	<input checked="" type="checkbox"/>	<input checked="" type="checkbox"/>	<input checked="" type="checkbox"/>	<input checked="" type="checkbox"/>	<input checked="" type="checkbox"/>
10	Speeddial	CLIRBlock	67	1	<input checked="" type="checkbox"/>	<input checked="" type="checkbox"/>	<input checked="" type="checkbox"/>	<input checked="" type="checkbox"/>	<input checked="" type="checkbox"/>
11	Speeddial	Trace	67	1	<input checked="" type="checkbox"/>	<input checked="" type="checkbox"/>	<input checked="" type="checkbox"/>	<input checked="" type="checkbox"/>	<input checked="" type="checkbox"/>
12	Speeddial	Clear MWI	99	1	<input checked="" type="checkbox"/>	<input checked="" type="checkbox"/>	<input checked="" type="checkbox"/>	<input checked="" type="checkbox"/>	<input checked="" type="checkbox"/>
13	Speeddial	Cancel CW	70	1	<input checked="" type="checkbox"/>	<input checked="" type="checkbox"/>	<input checked="" type="checkbox"/>	<input checked="" type="checkbox"/>	<input checked="" type="checkbox"/>
14	Speeddial	Unpark	88	1	<input checked="" type="checkbox"/>	<input checked="" type="checkbox"/>	<input checked="" type="checkbox"/>	<input checked="" type="checkbox"/>	<input checked="" type="checkbox"/>
15	None			1	<input checked="" type="checkbox"/>	<input checked="" type="checkbox"/>	<input checked="" type="checkbox"/>	<input checked="" type="checkbox"/>	<input checked="" type="checkbox"/>
16	None			1	<input checked="" type="checkbox"/>	<input checked="" type="checkbox"/>	<input checked="" type="checkbox"/>	<input checked="" type="checkbox"/>	<input checked="" type="checkbox"/>

2 Pick a softkey to configure for Last Call Return.

3 In the "**Type**" field, select **lcr**.

4 In the "**Line**" field, select a line for which to apply the last call return configuration.

5 The lcr softkey has a default state of "**Idle**", "**Connected**", "**Incoming**", "**Outgoing**". Leave these states enabled or to disable, uncheck the check boxes as required.

6 Click Save Settings to save your changes.

5-246

41-001160-03 Rev 00, Release 2.5



Aastra Web UI

For the 6757i CT Handset:

1 Click on **Operation->Handset Keys**.

Key	Type	Label
1	Park	Park
2	PickUp	Pickup
3	Line 3	Line3
4	Line 4	Line4
5	Icom	Intercom
6	Dir	Directory
7	Callers	Callers
8	Xfer	Transfer
9	Conf	Conference
10	Public	Public
11	None	
12	None	
13	None	
14	None	
15	None	

Save Settings

2 Pick a handset key to configure for Last Call Return.

3 In the "**Key Function**" field, select **Icr**.

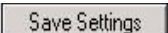
4 Click  to save your changes.



Aastra Web UI

For 3-Line LCD phones (not applicable to 6751i):

1 Click on **Operation->Programmable Keys**.

6753i Screen

Key	Hard Key	Value	Line
1	Save		global
2	Delete		global
3	Park	sylantro;90	1
4	Pickup	sylantro;90	2
5	Transfer		global
6	Conference		global

Services
 BLF List URI:

2 Pick a key to configure for Last Call Return.

3 In the "**Type**" field, select **Icr**.

4 **For 3-Line LCD phones (not applicable to 6751i):**

In the "**Line**" field, select a line for which to apply the Icr configuration.

5 Click to save your changes.

Call Forwarding

Call Forward (CFWD) on the IP phone allows incoming calls to be forwarded to another destination. The phone sends the SIP message to the SIP proxy, which then forwards the call to the assigned destination.

An Administrator or User can configure CFWD on the phone-side by setting a mode for the phone to use (**Account**, **Phone**, or **Custom**). Once the mode is set, you can use the IP Phone UI to use the CFWD feature at *Options->Call Forward* or by pressing a configured Call Forward softkey/programmable key/extension module key.

The following describes the behavior for each CFWD mode.

- **Account mode** - The account mode allows you to configure CFWD on a per account basis. Pressing a configured CFWD key applies to the account in focus.
- **Phone mode** - The Phone mode allows you to set the same CFWD configuration for all accounts (**All**, **Busy**, and/or **No Answer**). When you configure the initial account, the phone applies the configuration to all other accounts. (In the Aastra Web UI, only the account you configured is enabled. All other accounts are grayed out but set to the same configuration.) Using the Aastra Web UI, if you make changes to that initial account, the changes apply to all accounts on the phone.
- **Custom mode** - The Custom mode allows you to configure CFWD for a specific account or all accounts. You can configure a specific mode (**All**, **Busy**, and/or **No Answer**) for each account independently or all accounts. On 3-Line LCD phones (not applicable to 6751i), you can set all accounts to **ALL On** or **ALL Off**. On the 8 and 11-Line LCD phones, you can set all accounts to **All On**, **All Off**, or copy the configuration for the account in focus to all other accounts using a **CopytoAll** softkey.



Note: If there is only one account configured on the phone, then the mode setting is ignored and the phone behaves as if the mode was set to “Phone”.

You can enable different call forwarding rules/modes independently (for example, you can set different phone numbers for Busy, All, and NoAns modes and then turn them on/off individually).

The following table describes the key and Message Waiting Indicator (MWI) LEDs when you enable CFWD on the IP Phone.

Key LED Behavior for All Modes	MWI LED Behavior for All Modes
CFWD key LED RED if CFWD All, CFWD Busy, or CFWD No Answer is enabled for the account in focus. CFWD key LED OFF if any CFWD mode is disabled.	MWI LED ON if current account in focus has CFWD ALL enabled. MWI LED OFF if CFWD All is disabled.

You can enable/disable CFWD and set a CFWD key using the configuration files or the Aastra Web UI. You can set CFWD mode (**Account, Phone, Custom**) using the configuration files, Aastra Web UI or IP Phone UI.

Important Notes

- In the configuration files, the “**call forward key mode**” parameter in the section, “[Configuring Call Forwarding](#)” on [page 5-251](#) is in addition to the previous call forward parameter (**call forward disabled**). You can still use the previous call forwarding parameter if desired in the configuration files.
- In the IP Phone UI, you can access the Call Forwarding features at the path *Options->Call Forward* or by pressing a configured CFWD key.
- **If you make changes to the configuration for CFWD via the IP Phone UI, you must refresh the Aastra Web UI screen to see the changes.**

Configuring Call Forwarding

You use the following parameters to set CFWD on the IP Phone using the configuration files:

- **call forward key mode**
- **softkeyN type, topsoftkeyN type, prgkeyN type, or expmodX keyN type**
- **softkeyN states** (optional)



Notes:

1. If there is no CFWD key configured on the phone or it is removed, you can still set the CFWD modes via the IP Phone UI at the path *Options->Call Forward*.
2. If there is only one account configured on the phone, then the mode setting is ignored and the phone behaves as if the mode was set to “Phone”.
3. When configuring a CFWD mode (**All, Busy, No Answer**) for an account, you must configure a CFWD number for that mode in order for the mode to be enabled.

Use the following procedures to configure Call Forwarding on the IP phones.



Configuration Files

For specific last call forwarding parameters you can set in the configuration files, see Appendix A, the sections,

- [“Priority Alert Settings”](#) on page A-176.
- [“Softkey/Programmable Key/Feature Key/Expansion Module Key Parameters”](#) on page A-216.

:

Aastra Web UI

1 Click on **Operation->Softkeys and XML**;
 or
 Click on **Operation->Programmable Keys**;
 or
 Click on **Operation->Expansion Module**.

Status

System Information

Operation

User Password

Phone Lock

Softkeys and XML

Directory

Reset

Basic Settings

Preferences

Account Configuration

Advanced Settings

Network

Global SIP

Line 1

Line 2

Line 3

Line 4

Line 5

Line 6

Line 7

Line 8

Line 9

Action URI

Configuration Server

Firmware Update

TLS Support

802.1x Support

Troubleshooting

Softkeys Configuration

Bottom Keys
Top Keys

Key	Type	Label	Value	Line	Idle	Connected	Incoming	Outgoing	Busy
1	None	BX35	35	1	<input checked="" type="checkbox"/>	<input checked="" type="checkbox"/>	<input checked="" type="checkbox"/>	<input checked="" type="checkbox"/>	<input checked="" type="checkbox"/>
2	Call Forward	BX7801	7801	1	<input checked="" type="checkbox"/>	<input checked="" type="checkbox"/>	<input checked="" type="checkbox"/>	<input checked="" type="checkbox"/>	<input checked="" type="checkbox"/>
3	None			1	<input checked="" type="checkbox"/>	<input checked="" type="checkbox"/>	<input checked="" type="checkbox"/>	<input checked="" type="checkbox"/>	<input checked="" type="checkbox"/>
4	None			1	<input checked="" type="checkbox"/>	<input checked="" type="checkbox"/>	<input checked="" type="checkbox"/>	<input checked="" type="checkbox"/>	<input checked="" type="checkbox"/>
5	None			1	<input checked="" type="checkbox"/>	<input checked="" type="checkbox"/>	<input checked="" type="checkbox"/>	<input checked="" type="checkbox"/>	<input checked="" type="checkbox"/>
6	None			1	<input checked="" type="checkbox"/>	<input checked="" type="checkbox"/>	<input checked="" type="checkbox"/>	<input checked="" type="checkbox"/>	<input checked="" type="checkbox"/>
7	None			1	<input checked="" type="checkbox"/>	<input checked="" type="checkbox"/>	<input checked="" type="checkbox"/>	<input checked="" type="checkbox"/>	<input checked="" type="checkbox"/>
8	None			1	<input checked="" type="checkbox"/>	<input checked="" type="checkbox"/>	<input checked="" type="checkbox"/>	<input checked="" type="checkbox"/>	<input checked="" type="checkbox"/>
9	None			1	<input checked="" type="checkbox"/>	<input checked="" type="checkbox"/>	<input checked="" type="checkbox"/>	<input checked="" type="checkbox"/>	<input checked="" type="checkbox"/>
10	None			1	<input checked="" type="checkbox"/>	<input checked="" type="checkbox"/>	<input checked="" type="checkbox"/>	<input checked="" type="checkbox"/>	<input checked="" type="checkbox"/>
11	None			1	<input checked="" type="checkbox"/>	<input checked="" type="checkbox"/>	<input checked="" type="checkbox"/>	<input checked="" type="checkbox"/>	<input checked="" type="checkbox"/>
12	None			1	<input checked="" type="checkbox"/>	<input checked="" type="checkbox"/>	<input checked="" type="checkbox"/>	<input checked="" type="checkbox"/>	<input checked="" type="checkbox"/>
13	None			1	<input checked="" type="checkbox"/>	<input checked="" type="checkbox"/>	<input checked="" type="checkbox"/>	<input checked="" type="checkbox"/>	<input checked="" type="checkbox"/>
14	None			1	<input checked="" type="checkbox"/>	<input checked="" type="checkbox"/>	<input checked="" type="checkbox"/>	<input checked="" type="checkbox"/>	<input checked="" type="checkbox"/>
15	None			1	<input checked="" type="checkbox"/>	<input checked="" type="checkbox"/>	<input checked="" type="checkbox"/>	<input checked="" type="checkbox"/>	<input checked="" type="checkbox"/>
16	None			1	<input checked="" type="checkbox"/>	<input checked="" type="checkbox"/>	<input checked="" type="checkbox"/>	<input checked="" type="checkbox"/>	<input checked="" type="checkbox"/>
17	None			1	<input checked="" type="checkbox"/>	<input checked="" type="checkbox"/>	<input checked="" type="checkbox"/>	<input checked="" type="checkbox"/>	<input checked="" type="checkbox"/>
18	None			1	<input checked="" type="checkbox"/>	<input checked="" type="checkbox"/>	<input checked="" type="checkbox"/>	<input checked="" type="checkbox"/>	<input checked="" type="checkbox"/>
19	None			1	<input checked="" type="checkbox"/>	<input checked="" type="checkbox"/>	<input checked="" type="checkbox"/>	<input checked="" type="checkbox"/>	<input checked="" type="checkbox"/>
20	None			1	<input checked="" type="checkbox"/>	<input checked="" type="checkbox"/>	<input checked="" type="checkbox"/>	<input checked="" type="checkbox"/>	<input checked="" type="checkbox"/>

Softkey 2 configured for CFWD

2 Click Save Settings to save your changes.





Aastra Web UI

3 Click on **Basic Settings->Preferences->General.**

Status System Information	Preferences
Operation User Password Phone Lock Softkeys and XML Directory Reset	General
Basic Settings Preferences Account Configuration	Local Dial Plan <input type="text" value="x++# x++*"/>
Advanced Settings Network Global SIP Line 1 Line 2 Line 3 Line 4 Line 5 Line 6 Line 7 Line 8 Line 9 Action URI Configuration Server Firmware Update TLS Support 802.1x Support Troubleshooting	Send Dial Plan Terminator <input type="checkbox"/> Enabled
	Digit Timeout (seconds) <input type="text" value="4"/>
	Park Call: <input type="text"/>
	Pick Up Parked Call: <input type="text"/>
	Suppress DTMF Playback <input checked="" type="checkbox"/> Enabled
	Display DTMF Digits <input type="checkbox"/> Enabled
	Call Waiting <input checked="" type="checkbox"/> Enabled
	Play Call Waiting Tone <input checked="" type="checkbox"/> Enabled
	Stuttered Dial Tone <input checked="" type="checkbox"/> Enabled
	XML Beep Support <input checked="" type="checkbox"/> Enabled
	Status Scroll Delay (seconds) <input type="text" value="5"/>
	Incoming Call Interrupts Dialing <input type="checkbox"/> Enabled
	Switch UI Focus To Ringing Line <input checked="" type="checkbox"/> Enabled
	Goodbye Key Cancels Incoming Call <input checked="" type="checkbox"/> Enabled
	UPnP Mapping Lines <input type="text" value="0"/>
	Message Waiting Indicator Line <input type="text" value="All"/>
	DND Key Mode <input type="text" value="Phone"/>
	Call Forward Key Mode <input type="text" value="Account"/>

**Call Forward
Key Mode
Parameter**

Note: If there is no CFWD key configured on the phone or it is removed, you can still set the CFWD modes via the IP Phone UI at the path *Options->Call Forward*.

 Aastra Web UI	
4	<p>In the “Call Forward Key Mode” field, select a call forward mode to use on the phone. Valid values are: Account, Phone, Custom. Default is Account.</p> <ul style="list-style-type: none"> • account The account mode allows you to configure CFWD on a per account basis. Pressing a configured CFWD key applies to the account in focus. • phone The Phone mode allows you to set the same CFWD configuration for all accounts (All, Busy, and/or No Answer). When you configure the initial account, the phone applies the configuration to all other accounts. (In the Aastra Web UI, only the account you configured is enabled. All other accounts are grayed out but set to the same configuration.) Using the Aastra Web UI, if you make changes to that initial account, the changes apply to all accounts on the phone. • custom The Custom mode allows you to configure CFWD for a specific account or all accounts. You can configure a specific state (All, Busy, and/or No Answer) for each account independently or all accounts. On 3-Line LCD phones, you can set all accounts to ALL On or ALL Off. On the 8 and 11-Line LCD phones, you can set all accounts to All On, All Off, or copy the configuration for the account in focus to all other accounts using a CopytoAll softkey. <p>Notes:</p> <ol style="list-style-type: none"> 1. If there is no CFWD key configured on the phone or it is removed, you can still set the CFWD modes via the IP Phone UI at the path <i>Options->Call Forward</i>. 2. If there is only one account configured on the phone, then the mode setting is ignored and the phone behaves as if the mode was set to “Phone”. 3. When configuring a CFWD state (All, Busy, No Answer) for an account, you must configure a CFWD number for that state in order for the state to be enabled.
5	<p>Click  to save your changes.</p> <p>The change takes effect immediately without a reboot.</p>



Aastra Web UI

6 Click on **Basic Settings->Account Configuration.**

Account	DND	Call Forward	State	Number	No. Rings
1. Screenname1	<input checked="" type="checkbox"/>	All	<input type="checkbox"/>	<input type="text"/>	
		Busy	<input type="checkbox"/>	<input type="text"/>	
		No Answer	<input type="checkbox"/>	<input type="text"/>	1 ▾
2. Screenname2	<input type="checkbox"/>	All	<input type="checkbox"/>	<input type="text"/>	
		Busy	<input type="checkbox"/>	<input type="text"/>	
		No Answer	<input type="checkbox"/>	<input type="text"/>	1 ▾
3. Screenname3	<input checked="" type="checkbox"/>	All	<input type="checkbox"/>	<input type="text"/>	
		Busy	<input type="checkbox"/>	<input type="text"/>	
		No Answer	<input type="checkbox"/>	<input type="text"/>	1 ▾

7 For each account, enable CFWD state by placing a check mark in one or more of the following **“State”** fields:



- **All**
- **Busy**
- **No Answer**

The **“All”** option forwards all incoming calls for this account to the specified phone number regardless of the state of the phone. The phone can be in the Busy or No Answer states, or can be in the idle state. The phone still forwards all calls to the specified number.

The **“Busy”** option call forwards incoming calls only if the account is in the busy state. The calls are forwarded to the specified phone number.

The **“No Answer”** option call forwards incoming calls only if the account rings but is not answered in the defined number of rings. The call gets forwarded to the specified number.

Note: You can use the **“Busy”** and **“No Answer”** states together using different forwarding phone numbers. If these states are enabled for an account (the **“All”** state is disabled), and the phone is in the busy state when a call comes in, the phone can forward the call to the specified phone number (for example, voicemail). If there is no answer on the phone after the specified number of rings, the phone can forward the call to a different specified number, such as a cell phone number.

 Aastra Web UI	
8	<p>For each account, in the “Number” field, enter the phone number for which you want the incoming calls to forward to if the phone is in the specified state.</p> <p>If using the “Account” mode or “Custom” mode, you can enter different phone numbers for each account.</p> <p>Notes:</p> <p>1. If you selected “Account” mode in step 4, you can enable/disable each account or all accounts as applicable. You can enter different phone number for each enabled state. If you selected “Custom” mode, you can enable/disable each account or all accounts as applicable. You can enter different phone numbers for each enabled state. If you selected “Phone” mode, all accounts are set to the same CFWD configuration (All, Busy, and/or No Answer) as Account 1 on the phone. (In the Aastra Web UI, only Account 1 is enabled. All other accounts are grayed out but use the same configuration as Account 1.)</p> <p>Using the Aastra Web UI, if you make changes to Account 1, the changes apply to all accounts on the phone. Using the IP Phone UI, if you make changes to any other account other than Account 1, the changes also apply to all accounts on the phone. When enabling a CFWD state, you must specify a phone number for the phone to CFWD to. The number you specify applies to all accounts of the same mode.</p> <p>2. Number and name of accounts that display to this screen are dependant on the number and name of accounts configured on the phone. In the screen in step 6, Screenname1 is configured on Line 1, Screenname2 is configured on Line 2, and Screenname3 is configured on Line 3. The name for the account is dependant on the name specified for the “Screen Name” parameter at the path Advanced Settings->LineN. If you do not specify a value for the “Screen Name” parameter, the account name is based on the “Phone Number” parameter at the path Advanced Settings->LineN. If neither the “Screen Name” nor the “Phone Number” parameters are specified, the account name shows “1”, “2”, “3”, etc. only.</p>
9	<p>For the No Answer state, in the “No. Rings” field, enter the number of times that the account rings before forwarding the call to the specified number. Valid values are 1 through 20. Default is 1.</p> <p>Note: When using the “Account” mode or “Custom” mode, you can enter a different number of rings for each account. If you use the Aastra Web UI to change the Call Forward Key Mode to “Phone”, all accounts synchronize to Account 1.</p>
10	<p>Click  to save your changes.</p> <p>The change takes effect immediately without a reboot.</p>

Using CFWD Modes via the IP Phone UI

If you enable/disable CFWD using the configuration files or the Aastra Web UI, you can use the CFWD screens that display to the IP Phone UI. You can access the CFWD parameters by pressing a configured CFWD key (if previously configured) OR by pressing *Options->Call Forward* on the phone's front panel.

The following procedure assumes you have already configured a CFWD key AND assumes there are three accounts configured on the phone.



Notes:

1. If there is no CFWD key configured on the phone or it is removed, you can still enable CFWD via the IP Phone UI at the path *Options->Call Forward*.
 2. If there is only one account configured on the phone, then the mode setting is ignored and the phone behaves as if the mode was set to "Phone".
 3. Using the Aastra Web UI, if you change the CFWD key mode to "**Phone**", all accounts synchronize to the current setting of Account 1.
-

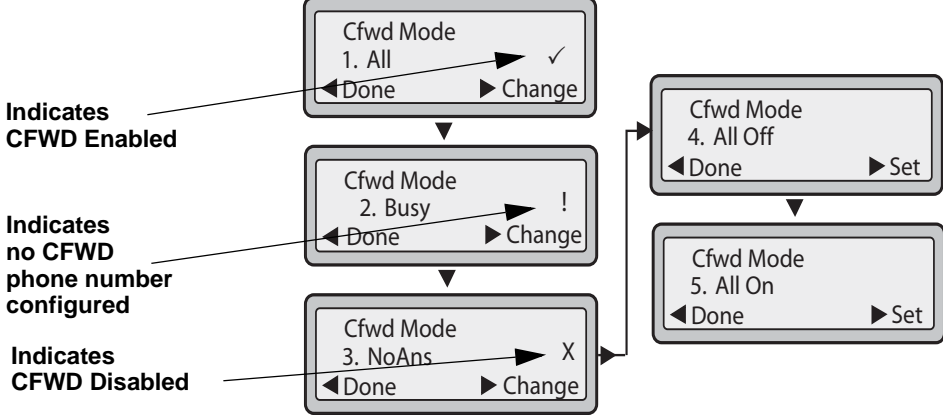
 Aastra IP Phone UI	
Step	Action
CFWD in Account Mode (3-Line LCD Phones - not applicable to 6751i)	
1	<p>Use the RIGHT and LEFT arrow keys to scroll through each account.</p> <div style="display: flex; justify-content: space-around; align-items: center; margin: 10px 0;"> <div style="border: 1px solid gray; padding: 5px; width: 20%;"> 1 Screenname1 CFWD All Jan 1 12:96 </div> <div style="font-size: 2em;">▶</div> <div style="border: 1px solid gray; padding: 5px; width: 20%;"> 2 Screenname2 Jan 1 12:96 </div> <div style="font-size: 2em;">▶</div> <div style="border: 1px solid gray; padding: 5px; width: 20%;"> 3 Screenname3 CFWD Busy Jan 1 12:96 </div> </div> <p>In the above example, Screenname1, Screenname2, and Screenname3, are three accounts configured on the phone. Screenname1 has “CFWD All” enabled, Screenname 2 has CFWD disabled as indicated by no message displayed, and Screenname3 has “CFWD Busy” enabled.</p>
2	<p>Press the Call Forward key. The Call Forward Mode screen displays. Use the UP and DOWN arrow keys to scroll through each state type.</p> <div style="margin: 10px 0;">  <div style="margin-left: 20px;"> <p>Indicates CFWD Enabled →</p> <p>Indicates no CFWD phone number configured →</p> <p>Indicates CFWD Disabled →</p> </div> </div> <p>In the above example, CFWD All is enabled as indicated by a checkmark (✓), CFWD Busy is enabled but no call forward phone number configured as indicated by a !, and CFWD NoAns is disabled, as indicated by an X.</p>

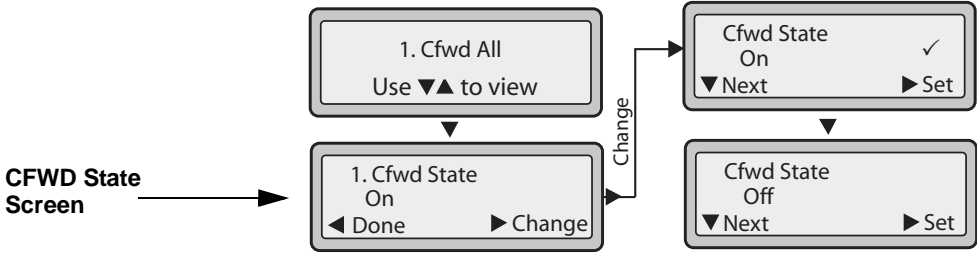

Aastra IP Phone UI

Step	Action
3	<p>Select a state for the account(s) in focus using the UP and DOWN arrow keys.</p> <p>You can enable/disable any or all of the following states for an account:</p> <ul style="list-style-type: none"> • All - Enables CFWD All for an account and forwards all incoming calls for that account, to the specified number. • Busy - Enables CFWD Busy for an account and forwards incoming calls to a specified number if DND has been enabled for that account OR if the account is currently engaged in another call. • No Answer - Enables CFWD NoAns for an account and forwards incoming calls to a specified number if the call has not been answered for the specified number of rings. <p>Note: If CFWD All AND CFWD Busy AND CFWD NoAns are all enabled (and/or if the account has DND enabled), the CFWD All settings take precedence over CFWD Busy and CFWD NoAns.</p> <p>You can also use the following keys if required:</p> <p>All Off - Disables all CFWD states for the current account in focus.</p> <p>All On - Enables all CFWD states for the current account in focus.</p>
4	<p>Press the CHANGE key for the state you selected in step 3. Scroll to the CFWD State screen. This displays the current state of the mode you selected. In the following example, the CFWD All state is ON.</p> 
5	<p>Press the CHANGE key in the CFWD State screen. Press NEXT to toggle the state of the CFWD mode ON or OFF. In the example in Step 4, you press NEXT to change the option to OFF.</p>
6	<p>Press the SET key to save the change.</p>

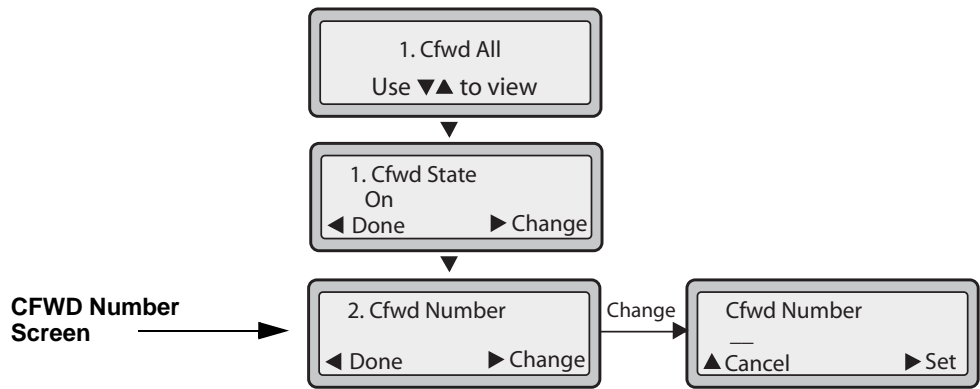
 Aastra IP Phone UI	
Step	Action
7	<p>In the CFWD State screen, press the DOWN arrow key to scroll to the CFWD Number screen and press CHANGE.</p> <div style="text-align: center; margin: 20px 0;">  <pre> graph TD A["1. Cfdw All Use ▼▲ to view"] --> B["1. Cfdw State On ◀ Done ▶ Change"] B --> C["2. Cfdw Number ◀ Done ▶ Change"] C -- Change --> D["Cfdw Number — ▲ Cancel ▶ Set"] E["CFWD Number Screen"] --> C </pre> </div>
8	Enter a phone number to apply to the current state in focus. When the phone is in the state you specified, and a call comes into the phone, it forwards the call to the number you specify.
9	Press SET to save the change.

 **Aastra IP Phone UI**

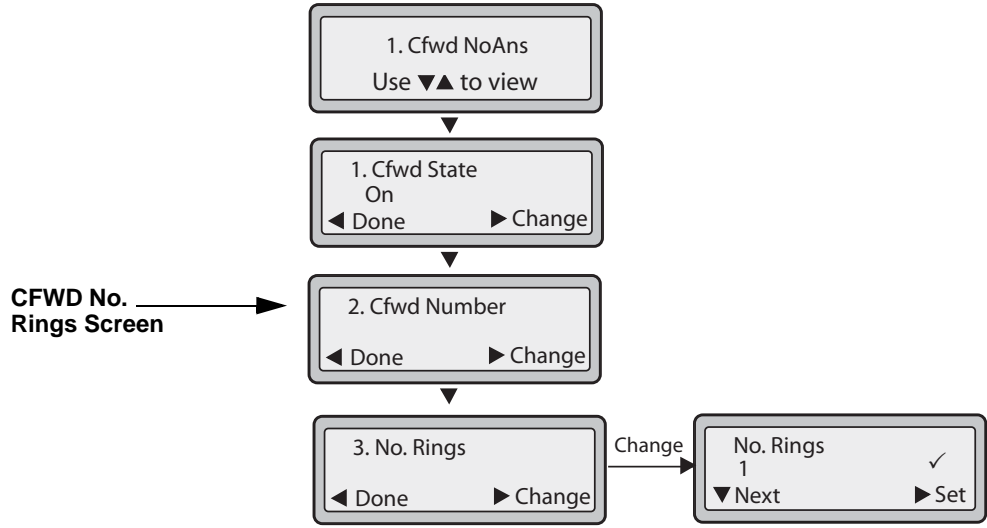
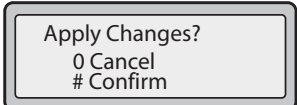
Step	Action
10	<p>For the CFWD No Answer state, In the CFWD Number screen, press the DOWN arrow key to scroll to the CFWD No. Rings screen and press CHANGE.</p>  <pre> graph TD A["1. Cfw NoAns Use ▼▲ to view"] --> B["1. Cfw State On ◀ Done ▶ Change"] B --> C["2. Cfw Number ◀ Done ▶ Change"] C --> D["3. No. Rings ◀ Done ▶ Change"] D -- Change --> E["No. Rings 1 ▼ Next ▶ Set"] </pre> <p>CFWD No. Rings Screen →</p>
11	<p>Press the NEXT key to select the number of rings to apply to the phone for call forwarding incoming calls. Valid values are 1 to 20. Default is 1.</p> <p>When the phone receives an incoming call, and call forward is configured on the phone, the phone rings the number of times you specify in the No. Rings screen, and then forwards the call if there is no answer.</p>
12	<p>Press SET to save the change.</p>
13	<p>Press DONE to save CFWD All Number, CFWD All State, CFWD Busy Number, CFWD Busy State, CFWD No Answer Number, CFWD No Answer State, CFWD No Answer Rings.</p> <p>Each time you press DONE, the following “Apply Changes” screen displays.</p>  <pre> graph TD A["Apply Changes? 0 Cancel # Confirm"] </pre>



Aastra IP Phone UI

Step	Action
14	Press # to confirm the change(s) each time the “Apply Changes” screen displays. All changes are saved to the phone.



Aastra IP Phone UI

Step	Action
------	--------

CFWD in Phone Mode (3-Line LCD Phones - not applicable to 6751i)

1 Use the **RIGHT** and **LEFT** arrow keys to scroll through each account.

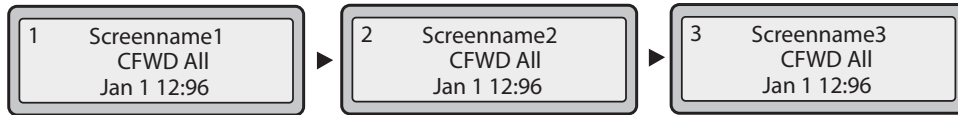

In the above example, Screenname1, Screenname2, and Screenname3, are three accounts configured on the phone. All three accounts have CFWD enabled as indicated by the “**CFWD All**” message.

Note: In “Phone” mode, when you change the call forward configuration for an account, the change applies to all accounts.

Step	Action
2	<p>Press the Call Forward key. The Call Forward Mode screen displays. Use the UP and DOWN arrow keys to scroll through each state type.</p> <div data-bbox="257 416 828 1076"><p>Indicates CFWD ALL enabled</p><p>Indicates no CFWD phone number configured for Busy</p><p>Indicates CFWD NoAns enabled</p></div> <p>In the above example, the account has CFWD All and CFWD NoAns enabled as indicated by a checkmark (✓). The CFWD Busy setting is enabled but no call forward phone number is configured as indicated by a !</p>



Aastra IP Phone UI

Step	Action
3	<p>Select a state using the UP and DOWN arrow keys.</p> <p>You can enable/disable a specific account on the phone with any or all of the following states. However, the configuration you set will apply to all accounts on the phone.</p> <ul style="list-style-type: none"> • All - Enables CFWD All on the phone and forwards all incoming calls to the specified number. • Busy - Enables CFWD Busy on the phone and forwards incoming calls to a specified number if DND has been enabled OR if the phone is currently engaged in another call. • No Answer - Enables CFWD NoAns on the phone and forwards incoming calls to a specified number if the call has not been answered for the specified number of rings. <p>Note: If CFWD All AND CFWD Busy AND CFWD NoAns are all enabled (and/or if the account has DND enabled), the CFWD All settings take precedence over CFWD Busy and CFWD NoAns.</p> <p>You can also use the following keys if required:</p> <p>All Off - Disables all CFWD states for the phone.</p> <p>All On - Enables all CFWD states for the phone.</p> <p>Note: In “Phone” mode, the initial configuration you set for an account applies to all the accounts on the phone.</p>
4	<p>Press the CHANGE key for the mode you selected in step 2. Scroll to the CFWD State screen. This displays the current state of the mode you selected. In the following example, the CFWD All state is ON.</p> <pre> graph TD Start[CFWD State Screen] --> S1["1. Cfwd All On Use ▼▲ to view ▼"] S1 -- Change --> S2["Cfwd State On ✓ ▼ Next ▶ Set"] S2 -- Set --> S3["Cfwd State Off ▼ Next ▶ Set"] S3 -- Change --> S1 </pre>

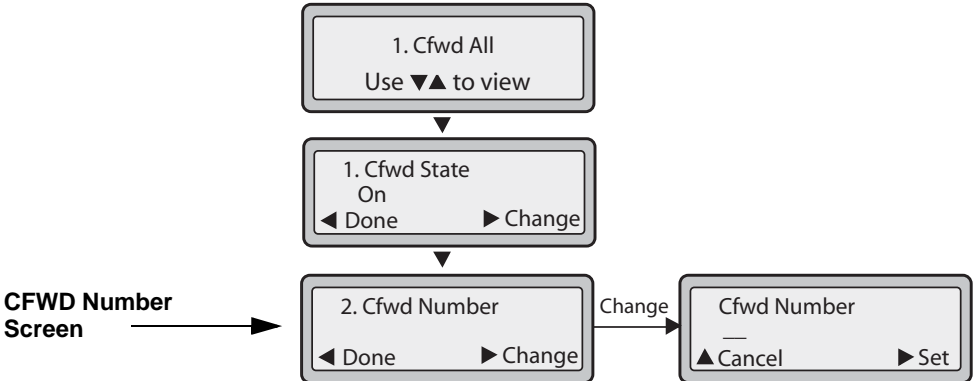
 Aastra IP Phone UI	
Step	Action
5	Press the CHANGE key in the CFWD State screen. Press NEXT to toggle the state of the CFWD state ON or OFF. In the example in Step 4, you press NEXT to change the option to OFF .
6	Press the SET key to save the change.
7	<p>In the CFWD State screen, press the DOWN arrow key to scroll to the CFWD Number screen and press CHANGE.</p> <div style="text-align: center;">  <pre> graph TD A["1. Cfwd All Use ▼▲ to view"] --> B["1. Cfwd State On ◀ Done ▶ Change"] B --> C["2. Cfwd Number ◀ Done ▶ Change"] C -- Change --> D["Cfwd Number — ▲ Cancel ▶ Set"] E["CFWD Number Screen"] --> C </pre> </div>
8	Enter a phone number to apply to the current state in focus. When the phone is in the state you specified, and a call comes into the phone, it forwards the call to the number you specify.
9	Press SET to save the change.

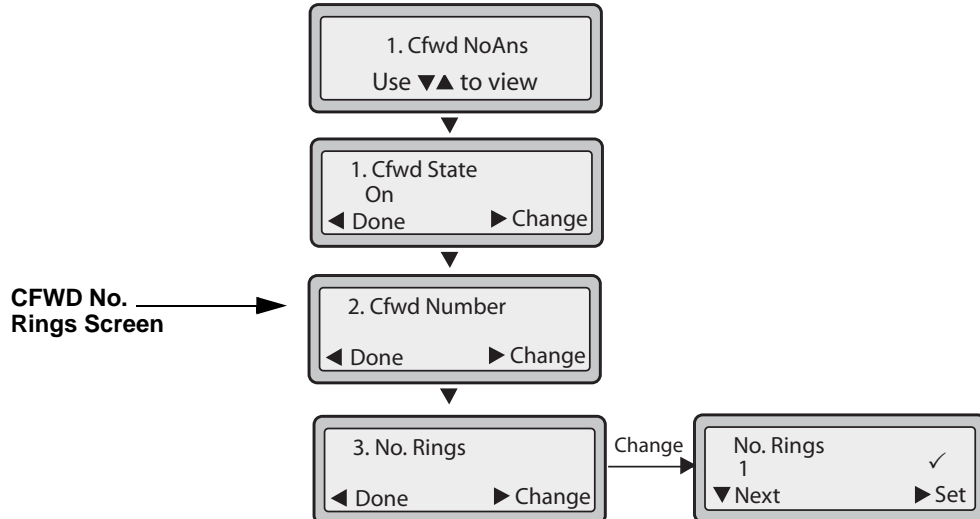
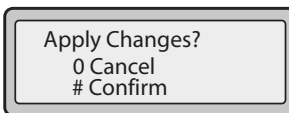
 Aastra IP Phone UI	
Step	Action
10	<p>For the CFWD No Answer state, in the CFWD Number screen, press the DOWN arrow key to scroll to the CFWD No. Rings screen and press CHANGE.</p> <div style="text-align: center;">  <pre> graph TD A["1. Cfd NoAns Use ▼▲ to view"] --> B["1. Cfd State On ◀ Done ▶ Change"] B --> C["2. Cfd Number ◀ Done ▶ Change"] C --> D["3. No. Rings ◀ Done ▶ Change"] D -- Change --> E["No. Rings 1 ▼ Next ▶ Set"] </pre> </div>
11	<p>Press the NEXT key to select the number of rings to apply to the phone for call forwarding incoming calls. Valid values are 1 to 20. Default is 1.</p> <p>When the phone receives an incoming call, and call forward is configured on the phone, the phone rings the number of times you specify in the No. Rings screen, and then forwards the call.</p>
12	Press SET to save the change.
13	<p>Press DONE to save CFWD All Number, CFWD All State, CFWD Busy Number, CFWD Busy State, CFWD No Answer Number, CFWD No Answer State, CFWD No Answer Rings.</p> <p>Each time you press DONE, the following “Apply Changes” screen displays.</p> <div style="text-align: center;">  <pre> graph TD A["Apply Changes? 0 Cancel # Confirm"] </pre> </div>



Aastra IP Phone UI

Step	Action
14	Press # to confirm the change(s) each time the “Apply Changes” screen displays. All the same changes are saved to all accounts on the phone.



Aastra IP Phone UI

Step	Action
------	--------

CFWD in Custom Mode (3-Line LCD Phones - not applicable to 6751i)

1 Use the **RIGHT** and **LEFT** arrow keys to scroll through each account.

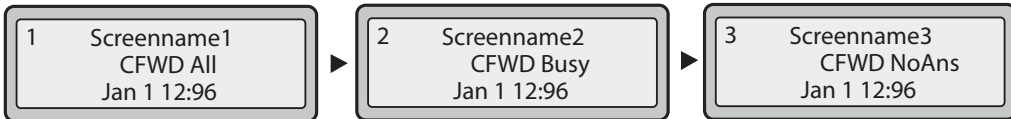

In the above example, Screenname1, Screenname2, and Screenname3, are three accounts configured on the phone. All three accounts have CFWD enabled as indicated by the “**CFWD All**”, “**CFWD Busy**”, and “**CFWD NoAns**” messages.

Press the **Call Forward** key. The CFWD Account screens display. Use the **UP** and **DOWN** arrow keys to scroll through each account.

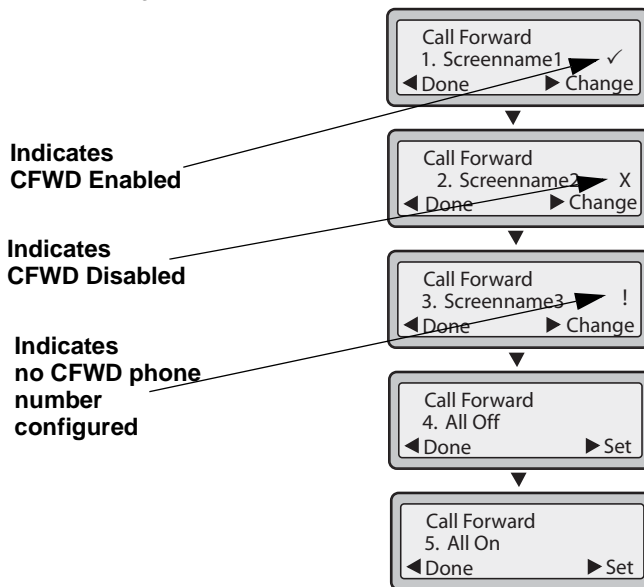

In the above example, Screenname1 has one or more CFWD states enabled as indicated by a checkmark (✓). Screenname2 has one or more CFWD states disabled as indicated by an X. Screenname3 has one or more CFWD states configured but a specific state has no call forward phone number configured as indicated by a !. Items 4 and 5 allow you to disable or enable CFWD on all accounts, respectively.

Step	Action
2	<p>Select an account to configure. Press the CHANGE key. The CFWD Mode screen displays. Use the UP and DOWN arrow keys to scroll through each state screen.</p> <div style="text-align: center;"> </div> <p>Indicates CFWD All enabled</p> <p>Indicates no CFWD phone number configured for Busy</p> <p>Indicates CFWD NoAns enabled</p> <p>In the above example, the account has CFWD All and CFWD NoAns enabled as indicated by a checkmark (✓). The CFWD Busy setting is enabled for the account but has no call forward phone number configured as indicated by a !.</p>



Aastra IP Phone UI

Step	Action
3	<p>Select a state for the account(s) in focus using the UP and DOWN arrow keys.</p> <p>You can enable/disable any or all of the following states for a specific account or for all accounts (with individual configurations):</p> <ul style="list-style-type: none"> • All - Enables CFWD All for an account and forwards all incoming calls for that account, to the specified number. The phone number can be different between accounts. • Busy - Enables CFWD Busy for an account and forwards incoming calls to a specified number if DND has been enabled for that account OR if that account is currently engaged in another call. The phone number can be different between accounts. • No Answer - Enables CFWD NoAns for an account and forwards incoming calls to a specified number if the call has not been answered for a specified number of rings. The phone number can be different between accounts. <p>Note: If CFWD All AND CFWD Busy AND CFWD NoAns are all enabled (and/or if the account has DND enabled), the CFWD All settings take precedence over CFWD Busy and CFWD NoAns.</p> <p>You can also use the following keys if required:</p> <p>All Off - Disables all CFWD states for the current account in focus or all accounts.</p> <p>All On - Enables all CFWD states for the current account in focus or all accounts.</p>
4	<p>Press the CHANGE key for the mode you selected in step 2. Scroll to the CFWD State screen. This displays the current state of the mode you selected. In the following example, the CFWD All state is ON.</p> <pre> graph TD A["1. Cfwd All Use ▼▲ to view"] -- "▼" --> B["1. Cfwd State On ◀ Done ▶ Change"] B -- "Change" --> C["Cfwd State On ✓ ▼ Next ▶ Set"] C -- "▼" --> D["Cfwd State Off ▼ Next ▶ Set"] </pre> <p>CFWD State Screen →</p>

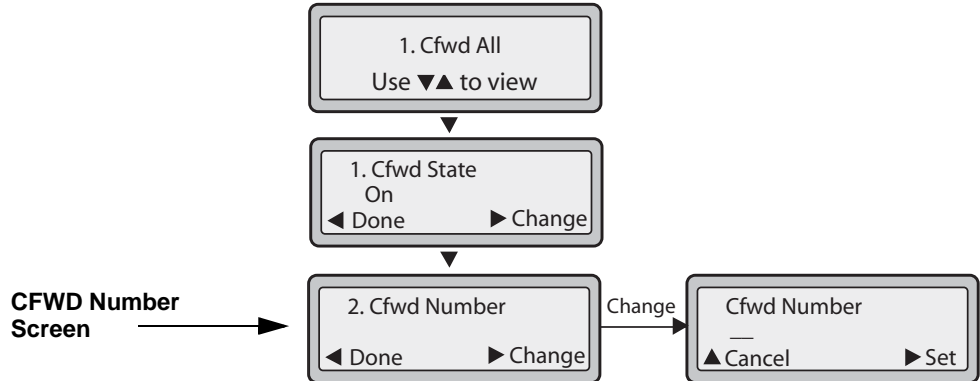
 Aastra IP Phone UI	
Step	Action
5	Press the CHANGE key in the CFWD State screen. Press NEXT to toggle the state of the CFWD state ON or OFF. In the example in Step 4, you press NEXT to change the option to OFF .
6	Press the SET key to save the change.
7	<p>In the CFWD State screen, press the DOWN arrow key to scroll to the CFWD Number screen and press CHANGE.</p> <div style="text-align: center;">  <pre> graph TD A["1. Cfw All Use ▼▲ to view"] --> B["1. Cfw State On ◀ Done ▶ Change"] B --> C["2. Cfw Number ◀ Done ▶ Change"] C -- Change --> D["Cfw Number — ▲ Cancel ▶ Set"] </pre> </div>
8	Enter a phone number to apply to the current state in focus. When the phone is in the state you specified, and a call comes into the phone, it forwards the call to the number you specify.
9	Press SET to save the change.

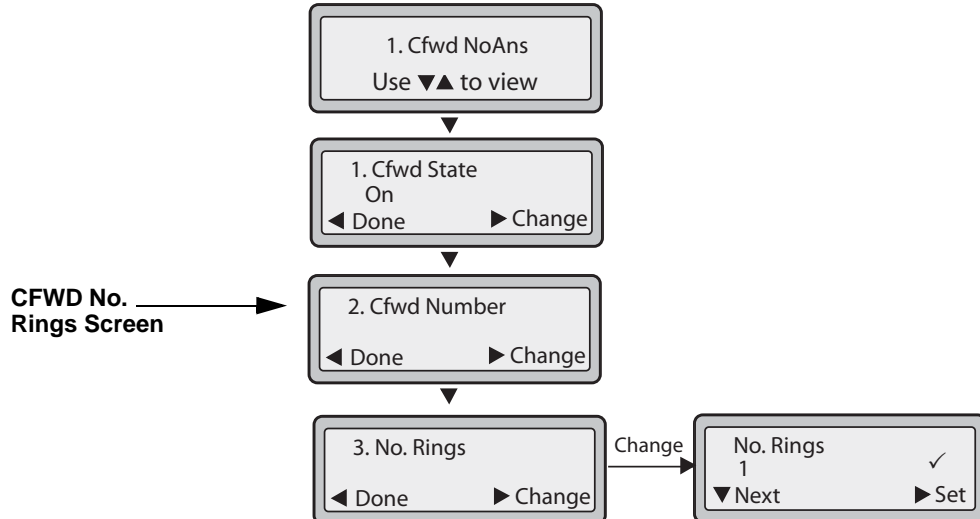
 Aastra IP Phone UI	
Step	Action
10	<p>For the CFWD No Answer state, in the CFWD Number screen, press the DOWN arrow key to scroll to the CFWD No. Rings screen and press CHANGE.</p> <div style="text-align: center; margin: 20px 0;">  <pre> graph TD A["1. Cfdw NoAns Use ▼▲ to view"] --> B["1. Cfdw State On ◀ Done ▶ Change"] B --> C["2. Cfdw Number ◀ Done ▶ Change"] C --> D["3. No. Rings ◀ Done ▶ Change"] D -- Change --> E["No. Rings 1 ✓ ▼ Next ▶ Set"] </pre> </div>
11	<p>Press the NEXT key to select the number of rings to apply to the phone for call forwarding incoming calls. Valid values are 1 to 20. Default is 1.</p> <p>When the phone receives an incoming call, and call forward is configured on the phone, the phone rings the number of times you specify in the No. Rings screen, and then forwards the call.</p>
12	<p>Press SET to save the change.</p>



Aastra IP Phone UI

Step	Action
13	<p>Press DONE to save CFWD All Number, CFWD All State, CFWD Busy Number, CFWD Busy State, CFWD No Answer Number, CFWD No Answer State, CFWD No Answer Rings.</p> <p>Each time you press DONE, the following “Apply Changes” screen displays.</p> <div data-bbox="608 506 898 614" style="border: 1px solid gray; padding: 5px; text-align: center; margin: 10px auto; width: fit-content;"><p>Apply Changes? 0 Cancel # Confirm</p></div>
14	<p>Press # to confirm the change(s) each time the “Apply Changes” screen displays.</p> <p>All changes are saved to the phone for all accounts.</p>



Aastra IP Phone UI

Step	Action
------	--------

CFWD in Account Mode (8 and 11-Line LCD Phones)

1 Use the **RIGHT** and **LEFT** arrow keys to scroll through each account.

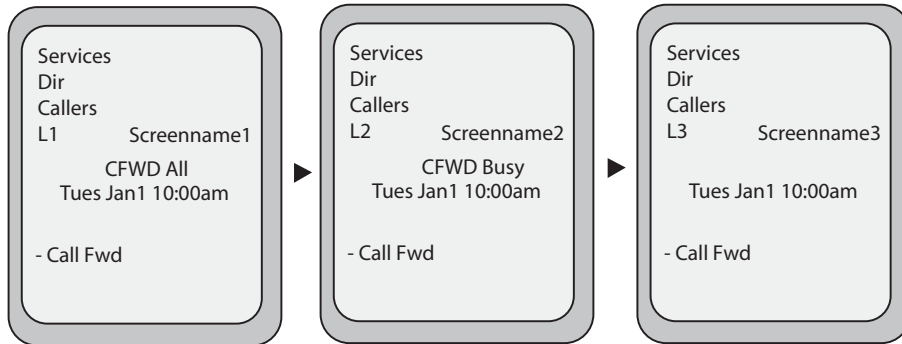

In the above example, Screenname1, Screenname2, and Screenname3, are three accounts configured on the phone. Screenname1 has “**CFWD All**” enabled, Screenname2 has “**CFWD Busy**” enabled, and Screenname3 has CFWD disabled as indicated by no message displayed.

2 Press the **Call Forward** key. The Call Forward Mode screen displays for the account you selected. Use the **UP** and **DOWN** arrow keys to scroll through each state type.

**Call Forward
Mode Screen**

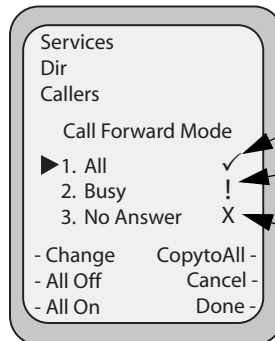

Indicates
CFWD Enabled

Indicates
**no CFWD phone
number configured**

Indicates
CFWD Disabled

In the above example, **CFWD All** is enabled as indicated by a checkmark (✓), **CFWD Busy** is enabled but no call forward phone number is configured as indicated by a !, and **CFWD NoAns** is disabled as indicated by an X.



Aastra IP Phone UI

Step	Action
3	<p>Select a state for the account(s) in focus using the UP and DOWN arrow keys.</p> <p>You can enable/disable any or all of the following states for an account:</p> <ul style="list-style-type: none">• All - Enables CFWD All for an account and forwards all incoming calls for that account, to the specified number.• Busy - Enables CFWD Busy for an account and forwards incoming calls to a specified number if DND has been enabled for that account OR if the account is currently engaged in another call.• No Answer - Enables CFWD NoAns for an account and forwards incoming calls to a specified number if the call has not been answered for the specified number of rings. <p>Note: If CFWD All AND CFWD Busy AND CFWD NoAns are all enabled (and/or if the account has DND enabled), the CFWD All settings take precedence over CFWD Busy and CFWD NoAns.</p> <p>You can also use the following keys if required:</p> <p>All Off Key- Disables all CFWD states for the current account in focus.</p> <p>All On Key - Enables all CFWD states for the current account in focus.</p> <p>CopytoAll Key - Copies the call forward phone number and state of the Call Forward mode (All, Busy, No Answer) in focus to every Call Forward mode of that account. For example, if you have the cursor pointing at the “All” state and it is enabled and has a call forward phone number configured, pressing the CopytoAll Key enables the Busy state and the NoAns state and assigns the same phone number to both states.</p> <p>Cancel Key - Cancels any configuration you may have made without saving. To cancel a configuration, you must press this CANCEL key before pressing the DONE key.</p>



Aastra IP Phone UI

Step

Action

4

For the **CFWD No Answer** state, press the **CHANGE** key for the mode you selected in step 2. This displays the Call Forward State screen. In the following example, the CFWD All state is ON.

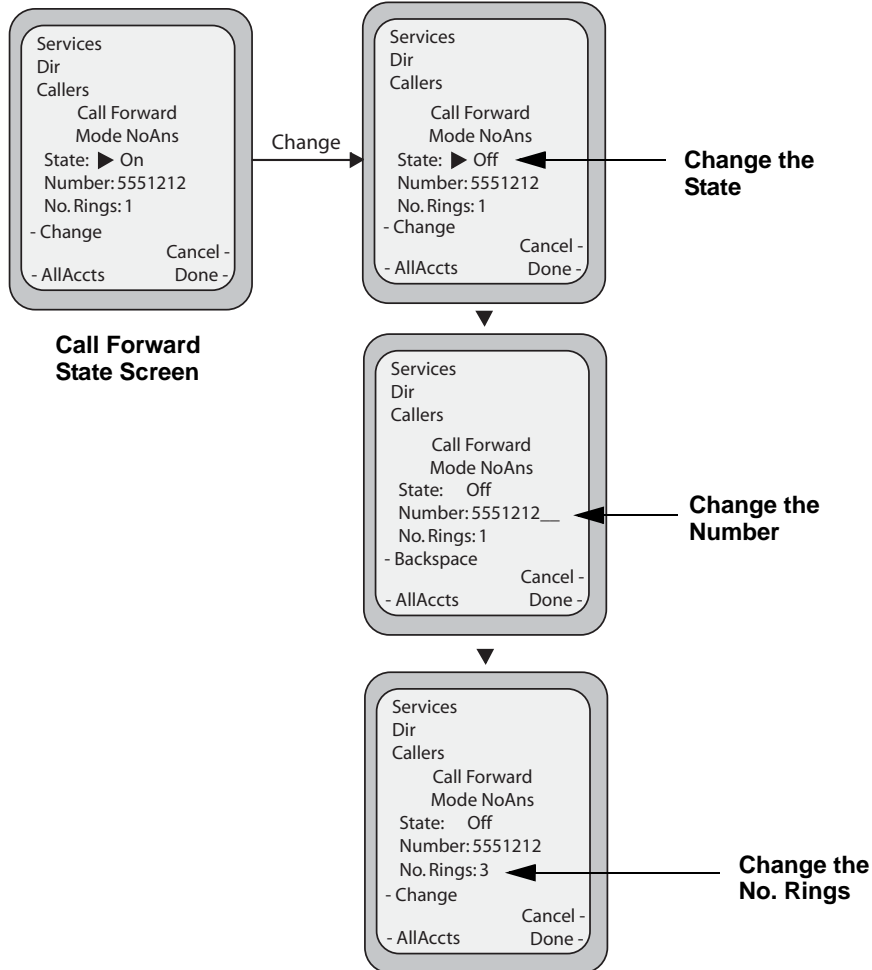

Note: You can press the **AllAccts** key to copy the settings in the current Call Forward Settings screen for a specific call forward mode, to every account on the phone. Every account will have the same settings for that call forward mode.

 Aastra IP Phone UI	
Step	Action
5	<p>Press the CHANGE key in the CFWD State screen. With the cursor in the “State” field, toggle the state ON and OFF by pressing the CHANGE key.</p> <p>Note: You can press the AllAccts key to copy the settings in the current Call Forward Settings screen for a specific call forward mode, to every account on the phone. Every account will have the same settings for that call forward mode.</p>
6	<p>Use the DOWN arrow key to scroll to the “Number” field. Enter a phone number to apply to the current state in focus. When the phone is in the state you specified, and a call comes into the phone, it forwards the call to the number you specify.</p> <p>Use the BACKSPACE key if required to delete characters.</p> <p>Note: You can press the AllAccts key to copy the settings in the current Call Forward Settings screen for a specific call forward mode, to every account on the phone. Every account will have the same settings for that call forward mode.</p>
7	<p>Use the DOWN arrow key to scroll to the “No. Rings” field. Press the CHANGE key to select the number of rings to apply to the phone for call forwarding incoming calls. Valid values are 1 to 20. Default is 1.</p> <p>When the phone receives an incoming call, and call forward is configured on the phone, the phone rings the number of times you specify in the No. Rings screen, and then forwards the call.</p> <p>Note: You can press the AllAccts key to copy the settings in the current Call Forward Settings screen for a specific call forward mode, to every account on the phone. Every account will have the same settings for that call forward mode.</p>
8	<p>Press DONE in the CFWD State Screen to save all changes. Press DONE in the CFWD Mode Screen to save all changes.</p>



Aastra IP Phone UI

Step	Action
------	--------

CFWD in Phone Mode (8 and 11-Line LCD Phones)

1 Use the **RIGHT** and **LEFT** arrow keys to scroll through each account.

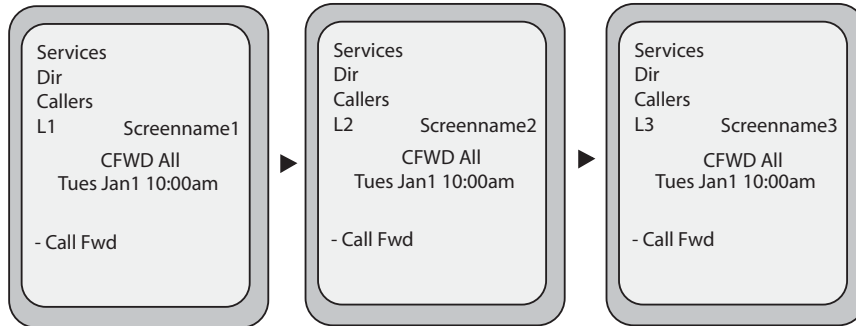

In the above example, Screenname1, Screenname2, and Screenname3, are three accounts configured on the phone. Screenname1, 2 and 3 have “**CFWD All**” enabled.

Note: In “Phone” mode, the initial configuration you set for an account applies to all the accounts on the phone.

2 Press the **Call Forward** key. The Call Forward Mode screen displays. Use the **UP** and **DOWN** arrow keys to scroll through each state type.

Call Forward Mode Screen

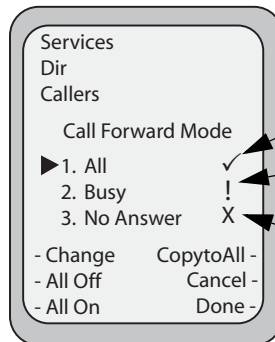

Indicates **CFWD Enabled**

Indicates **no CFWD phone number configured**

Indicates **CFWD Disabled**

In the above example, **CFWD All** is enabled as indicated by a checkmark (✓), **CFWD Busy** is enabled but no call forward phone number is configured as indicated by a !, and **CFWD No Answer** is disabled, as indicated by an X.



Aastra IP Phone UI

Step	Action
3	<p>Select a state for the phone using the UP and DOWN arrow keys.</p> <p>You can enable/disable a specific account on the phone with any or all of the following states. However, the configuration you set will apply to all accounts on the phone.</p> <ul style="list-style-type: none">• All - Enables CFWD All on the phone and forwards all incoming calls to the specified number.• Busy - Enables CFWD Busy on the phone and forwards incoming calls to a specified number if DND has been enabled OR if the phone is currently engaged in another call.• No Answer - Enables CFWD NoAns on the phone and forwards incoming calls to a specified number if the call has not been answered for the specified number of rings. <p>Note: If CFWD All AND CFWD Busy AND CFWD NoAns are all enabled (and/or if the account has DND enabled), the CFWD All settings take precedence over CFWD Busy and CFWD NoAns.</p> <p>You can also use the following keys if required:</p> <p>All Off Key - Disables all CFWD modes.</p> <p>All On Key - Disables all CFWD modes.</p> <p>CopytoAll Key - Copies the call forward phone number and state of the Call Forward mode (All, Busy, No Answer) in focus to every Call Forward mode. For example, if you have the cursor pointing at the “All” state and it is enabled and has a call forward phone number configured, pressing the CopytoAll Key enables the Busy state and the NoAns state and assigns the same phone number to both states.</p> <p>Cancel Key - Cancels any configuration you may have made without saving. To cancel a configuration, you must press this CANCEL key before pressing the DONE key.</p>



Aastra IP Phone UI

Step	Action
4	<p>In the CFWD No Answer state, press the CHANGE key for the mode you selected in step 2. This displays the Call Forward State screen. In the following example, the CFWD All state is ON.</p> <p>Call Forward State Screen</p> <p>Change the State</p> <p>Change the Number</p> <p>Change the No. Rings</p>
5	<p>Press the CHANGE key in the CFWD State screen. With the cursor in the “State” field, toggle the state ON and OFF by pressing the CHANGE key.</p>

**Aastra IP Phone UI**

Step	Action
6	<p>Use the DOWN arrow key to scroll to the “Number” field. Enter a phone number to apply to the current state in focus. When the phone is in the state you specified, and a call comes into the phone, it forwards the call to the number you specify.</p> <p>Use the BACKSPACE key if required to delete characters.</p>
7	<p>Use the DOWN arrow key to scroll to the “No. Rings” field. Press the CHANGE key to select the number of rings to apply to the phone for call forwarding incoming calls. Valid values are 1 to 20. Default is 1.</p> <p>When the phone receives an incoming call, and call forward is configured on the phone, the phone rings the number of times you specify in the No. Rings screen, and then forwards the call.</p>
8	<p>Press DONE in the CFWD State Screen to save all changes. Press DONE in the CFWD Mode Screen to save all changes.</p> <p>Note: In “Phone” mode, the configuration applies to all the accounts on the phone.</p>



Aastra IP Phone UI

Step	Action
------	--------

CFWD in Custom Mode (8 and 11-Line LCD Phones)

1 Use the **RIGHT** and **LEFT** arrow keys to scroll through each account.

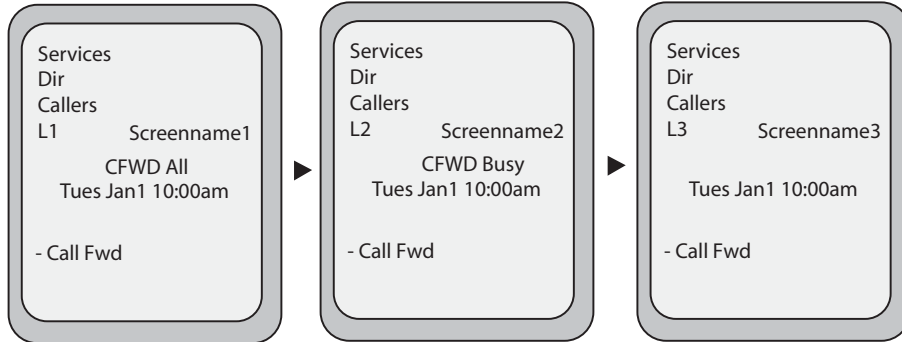

In the above example, Screenname1, Screenname2, and Screenname3, are three accounts configured on the phone. Screenname1 has “**CFWD All**” enabled, Screenname2 has “**CFWD Busy**” enabled, and Screenname3 has CFWD disabled as indicated by no message displayed.

2 With the account in focus on the IP Phone UI, press the **Call Forward** key. The Call Forward Account screen displays which lists all the accounts on the phone. Use the **UP** and **DOWN** arrow keys to scroll through each account.

Call Forward Account Screen

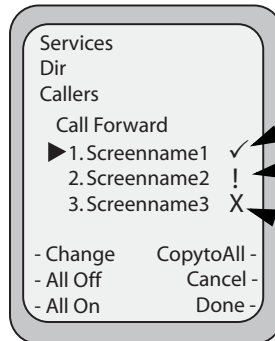

Indicates
CFWD Enabled

Indicates
no CFWD phone number configured

Indicates
CFWD Disabled

In the above example, Screenname1 has one or more CFWD states enabled as indicated by a checkmark (✓), Screenname 2 has one or more CFWD states enabled but a specific state has no call forward phone number configured as indicated by a !, and Screenname3 has one or more CFWD states disabled as indicated by an X.

 **Aastra IP Phone UI**

Step	Action
3	<p>Select an account using the UP and DOWN arrow keys.</p> <p>You can also use the following keys if required:</p> <p>All Off Key- Disables CFWD for all accounts on the phone.</p> <p>All On Key - Enables CFWD for all accounts on the phone.</p> <p>CopytoAll Key - Copies all settings for the account you select, to all other accounts on the Call Forward Account screen. For example, if you have the cursor pointing at Screenname1, and you press the CopytoAll key, all of the CFWD settings for Screenname1 are copied to Screenname2 and Screenname3.</p> <p>Cancel Key - Cancels any configuration you may have made without saving. To cancel a configuration, you must press this CANCEL key before pressing the DONE key.</p>
4	<p>After selecting an account, press CHANGE.</p> <p>The Call Forward Mode screen displays for the account you selected. Use the UP and DOWN arrow keys to scroll through each state type.</p> <div style="display: flex; align-items: center; justify-content: center;"> <div style="margin-right: 20px;"> <p>Call Forward Mode Screen</p> </div> <div style="border: 1px solid gray; padding: 10px; border-radius: 10px; background-color: #f0f0f0;"> <p>Services Dir Callers</p> <p>Call Forward Mode</p> <p>▶ 1. All ✓</p> <p>2. Busy !</p> <p>3. No Answer X</p> <p>- Change CopytoAll - - All Off Cancel - - All On Done -</p> </div> <div style="margin-left: 20px;"> <p>Indicates CFWD Enabled</p> <p>Indicates no CFWD phone number configured</p> <p>Indicates CFWD Disabled</p> </div> </div> <p>In the above example, CFWD All is enabled as indicated by a checkmark (✓), CFWD Busy is enabled but no call forward phone number is configured as indicated by a !, and CFWD No Answer is disabled, as indicated by an X.</p>



Aastra IP Phone UI

Step	Action
5	<p>Select a state for the selected account(s) using the UP and DOWN arrow keys.</p> <p>You can enable/disable any or all of the following states for a specific account or for all accounts (with individual configurations):</p> <ul style="list-style-type: none"> • All - Enables CFWD All for an account and forwards all incoming calls for that account, to the specified number. The phone number can be different between accounts. • Busy - Enables CFWD Busy for an account and forwards incoming calls to a specified number if DND has been enabled for that account OR if that account is currently engaged in another call. The phone number can be different between accounts. • No Answer - Enables CFWD NoAns for an account and forwards incoming calls to a specified number if the call has not been answered for a specified number of rings. The phone number can be different between accounts. <p>Note: If CFWD All AND CFWD Busy AND CFWD NoAns are all enabled (and/or if the account has DND enabled), the CFWD All settings take precedence over CFWD Busy and CFWD NoAns.</p> <p>You can also use the following keys if required:</p> <p>All Off Key - Disables all CFWD states for the selected account.</p> <p>All On Key - Enables all CFWD states for the selected account.</p> <p>CopytoAll Key - Copies the call forward phone number and state of the selected Call Forward mode (All, Busy, No Answer) to every Call Forward mode of that account. For example, if you have the cursor pointing at the "All" state and it is enabled and has a call forward phone number configured, pressing the CopytoAll Key enables the Busy state and the NoAns state and assigns the same phone number to both states.</p> <p>Cancel Key - Cancels any configuration you may have made without saving. To cancel a configuration, you must press this CANCEL key before pressing the DONE key.</p>

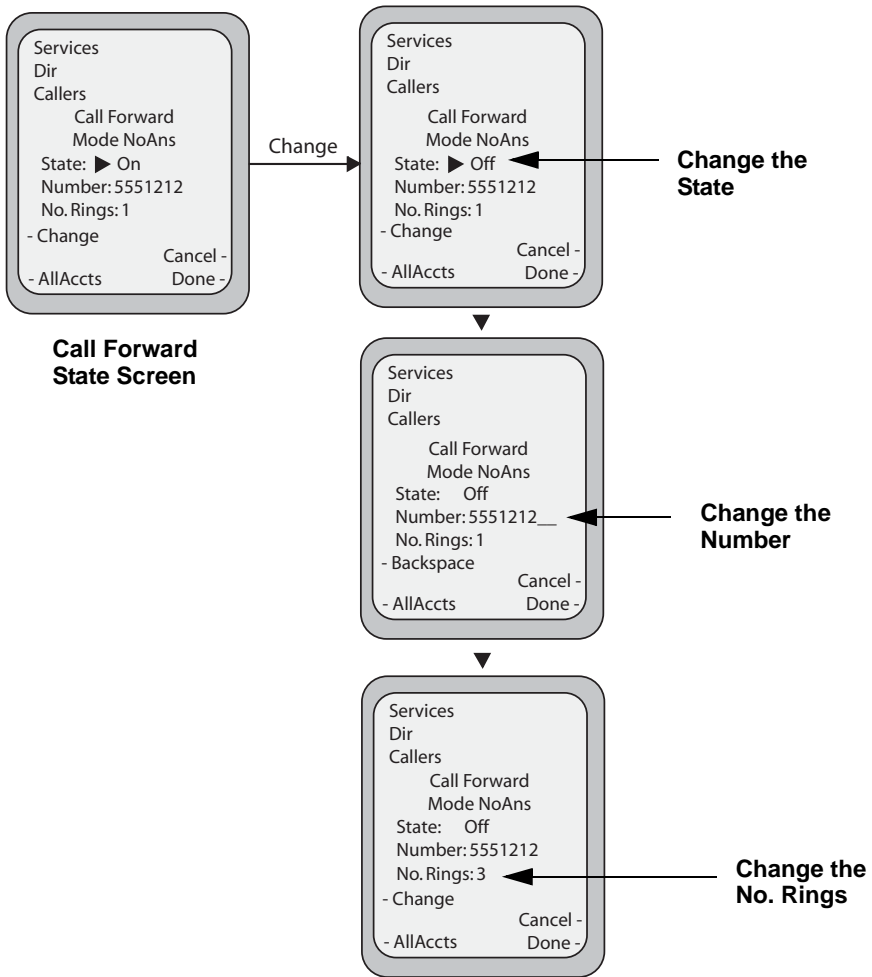
 Aastra IP Phone UI	
Step	Action
6	<p>Press the CHANGE key for the mode you selected in step 4. This displays the Call Forward State screen. In the following example, the CFWD All state is ON.</p> <div style="text-align: center; margin: 20px 0;">  </div> <p>Call Forward State Screen</p>
<p>Note: You can press the AllAccts key to copy the settings in the current Call Forward Settings screen for a specific call forward mode, to every account on the phone. Every account will have the same settings for that call forward mode.</p>	



Aastra IP Phone UI

Step	Action
7	<p>Press the CHANGE key in the CFWD State screen. With the cursor in the “State” field, toggle the state ON and OFF by pressing the CHANGE key.</p> <p>Note: You can press the AllAccts key to copy the settings in the current Call Forward Settings screen for a specific call forward mode, to every account on the phone. Every account will have the same settings for that call forward mode.</p>
8	<p>Use the DOWN arrow key to scroll to the “Number” field. Enter a phone number to apply to the current state in focus. When the phone is in the state you specified, and a call comes into the phone, it forwards the call to the number you specify.</p> <p>Use the BACKSPACE key if required to delete characters.</p> <p>Note: You can press the AllAccts key to copy the settings in the current Call Forward Settings screen for a specific call forward mode, to every account on the phone. Every account will have the same settings for that call forward mode.</p>
9	<p>Use the DOWN arrow key to scroll to the “No. Rings” field. Press the CHANGE key to select the number of rings to apply to the phone for call forwarding incoming calls. Valid values are 1 to 20. Default is 1.</p> <p>When the phone receives an incoming call, and call forward is configured on the phone, the phone rings the number of times you specify in the No. Rings screen, and then forwards the call.</p> <p>Note: You can press the AllAccts key to copy the settings in the current Call Forward Settings screen for a specific call forward mode, to every account on the phone. Every account will have the same settings for that call forward mode.</p>
10	<p>Press DONE in the CFWD State screen to save all changes. Press DONE in the CFWD Mode screen to save all changes. Press DONE in the CFWD Account screen to save all changes.</p>

SIP Phone Diversion Display

When an outgoing call from the phone is being diverted to another destination (i.e., via call forward), the phone displays the Caller ID (phone number and/or caller name) of the new destination and the reason for the call diversion. Similarly, at the new destination, the Caller ID of the original call destination now displays.

Call Diversion Example	
1	Tim calls Mark at x400.
2	Mark's phone is busy.
3	Mark's phone diverts the incoming call to another destination (Roger @ x 464).
4	Tim's phone displays name and extension of where the call is being diverted to and reason for diverting the call. The screen scrolls between Screen 1 and Screen 2.
5	Roger's phone accepts the call and displays the name and number of the phone the incoming call (Tim) and the name (or number) of the original destination (Mark). The screens scroll between Screen 1 and Screen 2..

See examples of the phones' LCD below.

The diversion LCD screens scroll every 3 seconds.

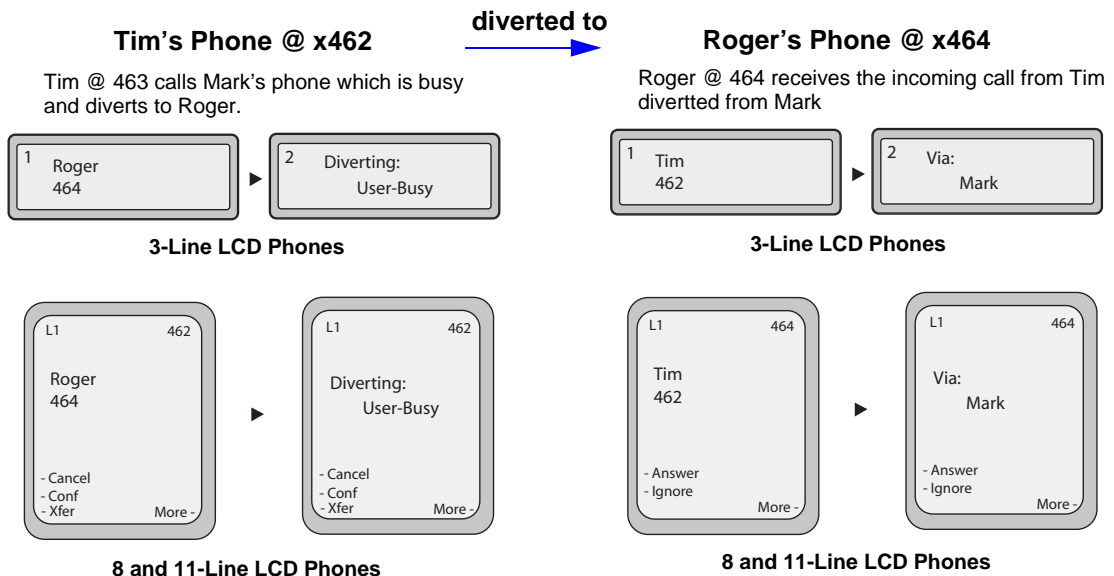



Note: If proxy servers exist in the network, it is possible that multiple diversions can take place on the phones. When multiple diversion headers are returned in a single 302 response back to the originating phone, the phone that originated the call (i.e., Tim's phone in above example) displays the URI of the newest (first encountered) Diversion header, but displays the REASON of the oldest (last encountered) Diversion Header. The phone that receives the diverted call (i.e., Roger's phone in example above) displays the information of the oldest diverted call (last encountered).

You can enable or disable this feature on a global or per-line basis using the configuration files only.

Configuring SIP Diversion Display on the Phone

Use the following procedures to configure SIP diversion display on the IP phones.



Configuration Files

For specific parameters you can set in the configuration files, see Appendix A, the section, "[SIP Diversion Display](#)" on [page A-183](#).

Limitations

- The diversion header assumes that the the ID of the 'diverted' caller is passed in a URI style manner.
- This feature relies on the server supporting and generating the Diversion header; the phone does not generate the header itself.
- Diversion header parameters such as counter, limit, privacy, screen, and extension are not recognized or supported by the phone. However, they are still passed along during the diversion process.

Displaying Call Destination for Incoming Calls

The IP Phones allow an Administrator to enable and disable the call destination name in the “TO” header of the INVITE message for incoming calls. When this feature is enabled, the call destination name displays on the LCD of the phone. This allows the user to easily determine the intended destination of an incoming call.

Behavior of the Phone

When this feature is enabled, the phone behaves as follows:

IF	THEN
A value exists for the Display Name field in the “TO” header of the INVITE message for incoming calls...	the phone displays the call destination name.
Display Name field is empty...	the phone uses the name specified for the “Screen name 1” parameter.
“Screen name 1” parameter is empty...	the phone uses the name specified for the “Display Name” parameter.
“Display Name” parameter is empty...	the phone uses the name specified for the “SIP User Name” parameter.
“SIP User Name” parameter is empty...	the phone uses the name specified for the “Call Destination Number” parameter.

The call destination information displays on multiple screens that scroll every 3 seconds. The following example shows call destination information on the phones.

Call Destination Enabled on the Phone

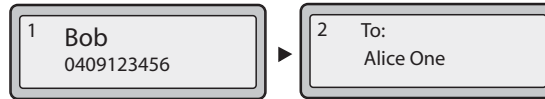

Incoming Phone UI on 3-Line LCD Phones

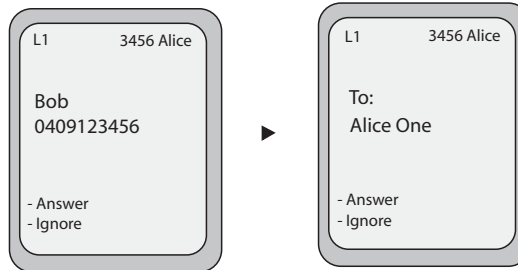

Incoming Phone UI on 8 and 11-Line LCD Phones

Since Call Diversion is enabled on the phone by default, the following example shows the behavior when call destination is also enabled.

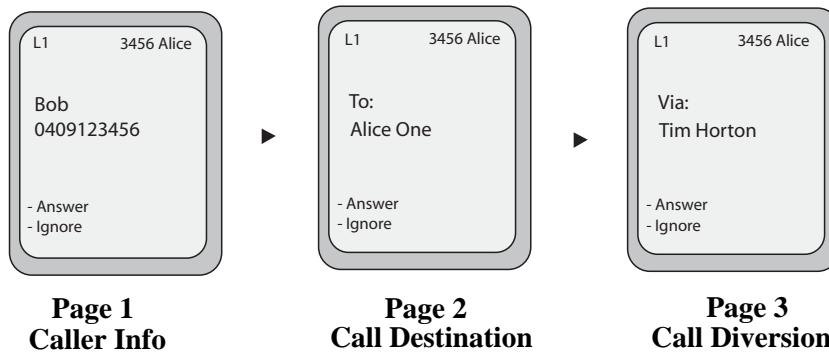



Note: As shown above, when both call diversion and call destination are enabled, the formation displays to the phone's screens in the following order:

- | | |
|-----------------|------------------|
| Screen 1 | Caller info |
| Screen 2 | Call destination |
| Screen 3 | Call diversion |

Configuring the Display of Call Destination for Incoming Calls

Use the following procedures to configure the display of call destination for incoming calls on the IP Phones.



Configuration Files

For the specific parameter you can set in the configuration files, see Appendix A, the section, "[Display of Call Destination for Incoming Calls](#)" on [page A-184](#).

Limitations

The following are limitations of this feature:

- Any call destination name exceeding the screen length is truncated by the phone.
- The CT cordless handsets do not support this feature.
- Page scrolling every 3 seconds is hard-coded and not configurable.

Callers List

The IP phones have a "Callers List" feature that store the name, phone number, and incremental calls, for each call received by the phone.

The following illustrations show the default location of the Callers List Key on each type of phone model.

Callers List Key

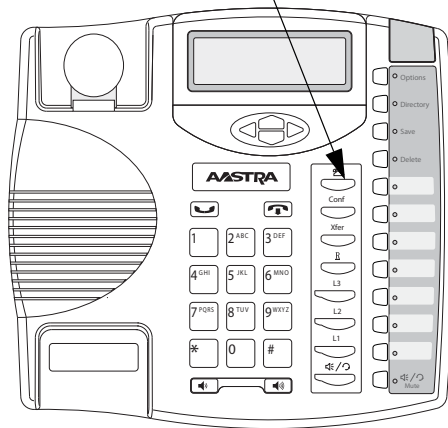

9143i

Callers List Key under Services Menu

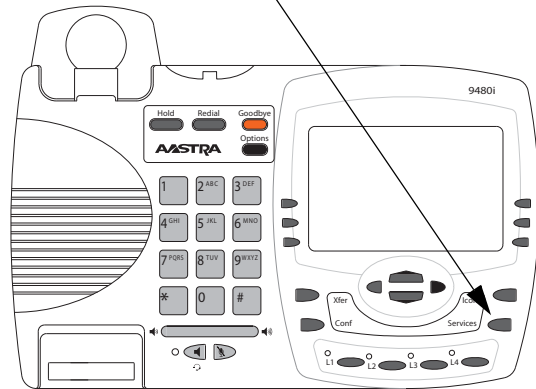

9480i/9480i CT

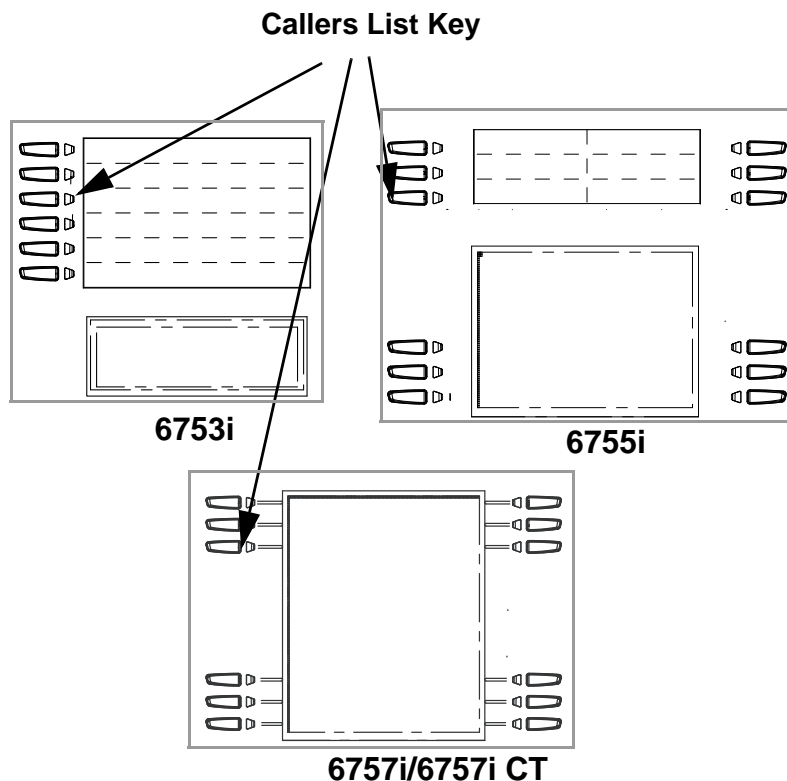

You can enable and disable the Callers List feature using the configuration files. When disabled, the Callers List does not display on the IP phone UI and the Caller List key is ignored when pressed.

When enabled, you can view, scroll, and delete line items in the Callers List from the IP phone UI. You can also directly dial from a displayed line item in the Callers List. You can download the Callers List to your PC for viewing using the Aastra Web UI.

When you download the Callers List, the phone stores the *callerlist.csv* file to your computer in comma-separated value (CSV) format.

You can use any spreadsheet application to open the file for viewing. The following is an example of a Callers List in a spreadsheet application.

	A	B	C	D	E	F
1	John	41373	2			
2	Tim	41376	1			
3	Carol	4443245	1			
4	Tom	41356	3			
5						
6						
7						
8						
9						
10						
11						
12						

The file displays the name, phone number, and the line that the call came in on.

Enabling/Disabling Callers List

You can enable and disable user access to the Callers List on the IP phones using the following parameter in the configuration files:

- **callers list disabled**

Valid values for this parameter are **0** (enabled) and **1** (disabled). If this parameter is set to **0**, the Callers List can be accessed by all users. If this parameter is set to **1**, the IP phone does not save any caller information to the Caller List. For 6757i and 6757i CT phones, the "Caller List" option on the IP phone is removed from the Services menu, and the Caller List key is ignored if pressed by the user.

Use the following procedures to enable/disable the Callers List on the IP phones.



Configuration Files

For specific parameters you can set in the configuration files for enabling/disabling the Callers List, see Appendix A, the section, "Callers List Settings" on [page A-145](#).

Using the Callers List

Use the following procedure to access and use the Callers List.



IP Phone UI

Step	Action
1	<p>On all phones (except the 6751i):</p> <p>Press the "Callers List" key on the phone to enter the Callers List.</p> <p>On the 9480i, 9480i CT:</p> <p>Press the "Services" key on the phone, and then select "Callers List" from the list of options.</p>
2	<p>Use the r and s to scroll through the line items in the Callers List.</p> <p>To the left of a line item, a  icon displays with the handset ON or OFF the receiver. The ON receiver indicates the call came in as a missed call. The OFF receiver indicates the call came in and was answered.</p>







IP Phone UI

Step	Action
3	<p>To delete all entries in the Callers list, press the 3 Delete key at the "Callers List" header.</p> <p>To delete a line item from the Callers List, select the line item you want to delete and press the 3 Delete key.</p>
4	<p>To cancel a delete function, press the r or the s Scroll keys.</p>
5	<p>To save a line item to a programmable key for speeddialing, press the 3 Save key and enter the line number at the "Save to?" prompt that is already configured for speeddialing at a programmable key.</p>
6	<p>To dial a displayed entry from the Callers List, pick up the handset, press the d /f handsfree key, or press a line key.</p>
7	<p>To exit the Callers List, press the "Callers List" key again or the "Goodbye" key.</p>

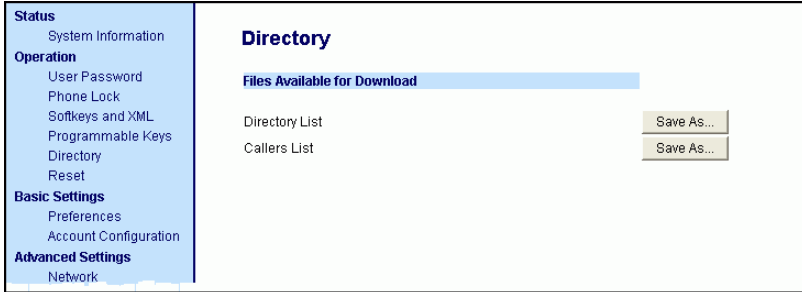
Downloading the Callers List

Use the following procedure to download the Callers List using the Aastra Web UI.

Aastra Web UI	
1	<p>Click on Operation->Directory.</p> 
2	<p>In the Callers List field, click on  .</p> <p>A "<i>File Download</i>" message displays.</p>
3	<p>Click  .</p>
4	<p>Enter the location on your computer where you want to download the Callers List and click  .</p> <p>The <i>callerslist.csv</i> file downloads to your computer.</p>
5	<p>Use a spreadsheet application to open and view the Callers List.</p>

Customizable Callers List and Services Keys

The IP phones may have a Callers List key and a Services key (as a hard key or softkey/programmable key) depending on your model phone. An Administrator can specify URI overrides for these keys using the following parameters in the configuration files:

- **services script**
- **callers list script**

Specifying URIs for these parameters cause the creation of an XML custom application instead of the standard function of the Callers List and Services keys.

An Administrator can configure these parameters using the configuration files only.

Creating Customizable Callers List and Services Keys

Use the following procedure to create customized Callers List and Services keys on the IP Phone using the configuration files.



Configuration Files

For specific parameters you can set in the configuration files, see Appendix A, the section, "[Customize Callers List and Services Key](#)" on [page A-146](#).

Missed Calls Indicator

The IP phone has a "missed calls" indicator that increments the number of missed calls to the phone. This feature is accessible from the IP phone UI only.

You can enable and disable the Missed Calls Indicator feature using the configuration files. When disabled, the Missed Calls Indicator does not increment as calls come into the IP phone.

When enabled, the number of calls that have not been answered increment on the phone's idle screen as "**<number> New Calls**". As the number of unanswered calls increment, the phone numbers associated with the calls are stored in the Callers List. The user can access the Callers List and clear the call from the list. Once the user accesses the Callers List, the "**<number> New Calls**" on the idle screen is cleared.



Note: The phones also include a "Missed-Calls-Message" field in a "message summary" event of a SIP NOTIFY message.

Enabling/Disabling Missed Calls Indicator

You can enable (turn on) and disable (turn off) the Missed Calls Indicator on the IP phones using the following parameter in the configuration files:

- **missed calls indicator disabled**

Valid values for this parameter are **0** (enabled) and **1** (disabled). If this parameter is set to **0**, the indicator increments as unanswered calls come into the IP phone. If set to **1**, the indicator does not increment the unanswered calls.

Use the following procedures to enable/disable the Missed Calls Indicator on the IP phones.



Configuration Files

For specific parameters you can set in the configuration files for enabling/disabling the Missed Calls Indicator, see Appendix A, the section, "[Missed Calls Indicator Settings](#)" on [page A-152](#).

Accessing and Clearing Missed Calls

Use the following procedure to access and clear missed calls from the Callers List. Once you display the Callers List, the "<number> New Calls" indicator clears.

 IP Phone UI	
Step	Action
1	Press the “Callers List” key on the phone to enter the Callers List.
2	Use the r and s to scroll through the line items in the Callers List to find the line items that have the ⓪ icon with the receiver ON. These are the missed calls to the phone.
3	<p>To clear the line item from the Callers List, select the line item you want to clear and press the 3, Clear, or Delete key (depending on your phone model).</p> <p>Note: To cancel a delete function, press the r or the s Scroll keys.</p> <p>The line item deletes from the Callers List.</p>

Directory List

The IP phones have a "**Directory List**" feature that allows you to store frequently used names and numbers on the phone. You can also dial directly from the directory entry.

The following illustrations show the default location of the Directory Key on each type of phone model.

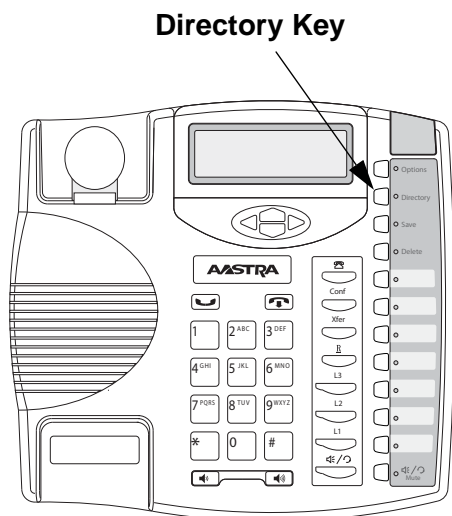

9143i

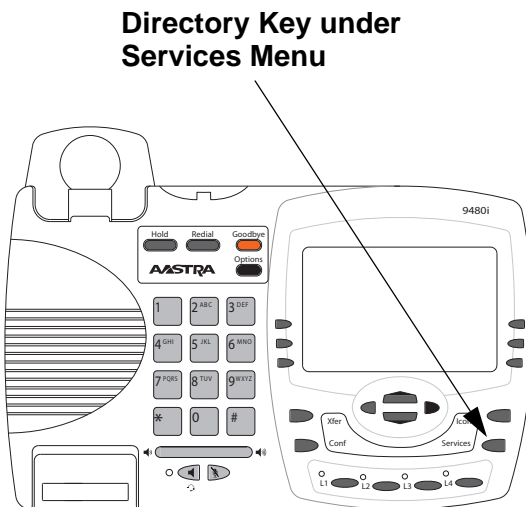

9480i/9480i CT

Options Key
(Directory is
an option under
Services Menu)

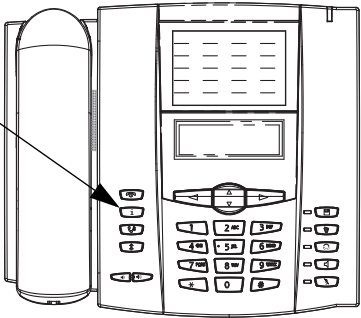

6751i

Directory Key

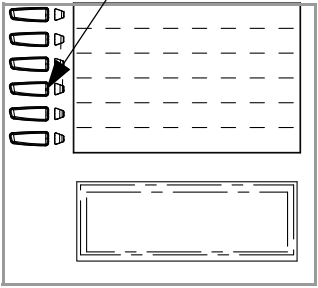

6753i

Directory Key

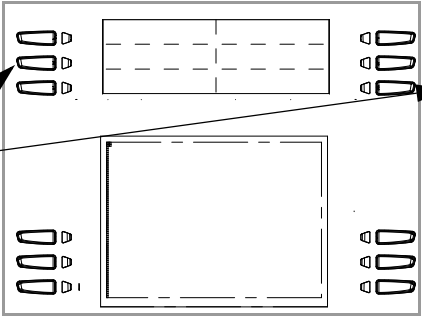

6755i

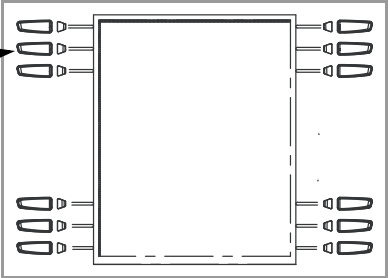

6757i/6757i CT

Directory List Capabilities

In the Directory List a user or administrator can store a maximum of 7 numbers associated with a unique name. You can apply pre-defined labels to the entry which include, **Office**, **Home**, **Cell**, and **Pager**, or create your own labels. Labels can be up to 14 characters in length.

You can also sort multiple numbers according to preference and perform a quick-search feature that allows you to enter the first letter that corresponds to a name in the Directory to find specific line items. The phone displays the first name with this letter. The quick-search feature in the Directory List works only when the Directory is first accessed.

Reference

For more detailed information about the Directory Key on your IP phone, and the Directory List, see your model-specific *User Guide*.

Administrator/User Functions for Directory List

You can perform the following pertaining to the Directory List:

- You can enable and disable access to the Directory List using the configuration files. When disabled, the Directory List does not display on the IP phone UI and the Directory List softkey is ignored when pressed. This is an administrator function only.
- If the Directory List is enabled, you can view, add, change, and delete entries to/from the Directory List using the IP phone UI. You can also directly dial a number from the Directory List. This is an administrator and user function.
- A public and private softkey can be used when at a line item in the Directory List. The **Private** key toggles a number in the Directory List to private. The **Public** key allows a number in the Directory List to be sent to the handsets. A 6757i CT accepts a maximum of 50 entries with the public attribute. This is an administrator and user function.
- You can download the Directory List to your PC via the Aastra Web UI. The phone stores the *directorylist.csv* file to your PC in comma-separated value (CSV) format. This is an administrator and user function.

- You can use any spreadsheet application to open the file for viewing. The following is an example of a Directory List in a spreadsheet application. This is an administrator and user function.

	A	B	C	D	E	F
1	John	41373	2			
2	Tim	41376	1			
3	Carol	4443245	1			
4	Tom	41356	3			
5						
6						
7						
8						
9						
10						
11						
12						

The file displays the name, phone number(s), and line number(s) for each Directory entry.

Enabling/Disabling Directory List

You can enable and disable user access to the Directory List on the IP phones using the following parameter in the configuration files:

- directory disabled**

Valid values for this parameter are **0** (enabled) and **1** (disabled). If this parameter is set to **0**, the Directory List can be accessed by all users. If this parameter is set to **1**, the Directory List does not display on the IP phone and the Directory key is disabled. On 3-Line LCD phones, the "Directory" option is also removed from the "Services" menu.

Use the following procedures to enable/disable the Directory List on the IP phones.



Configuration Files

For specific parameters you can set in the configuration files for enabling/disabling the Directory List, see Appendix A, the section, "[Directory Settings](#)" on [page A-143](#).

Server to IP Phone Download

You can populate your IP phone Directory List with server directory files. To activate this feature, you need to add the following parameters to the configuration files:

- **directory 1: company_directory**
- **directory 2: my_personal_directory'**

The IP phone recognizes the following characters in a Directory List:

Character	Description
'#'	Pound character; any characters appearing after the # on a line are treated as a comment
','	Comma character; used to separate the name, URI number, line, and mode fields within each directory entry.
''''	Quotation mark; when pound and comma characters are found between quotes in a name field or URI number field, they are treated as regular characters.

A valid directory entry has a name, a URI number, and optional line number, and an optional mode attribute, all separated by commas. If a line number is not present, the entry is assigned to line 1. If a mode attribute (public or private) is not present, the entry is assigned to "**Private**".

The following directory entries are considered valid:

```
# our company's directory
# updated 1 jan 2012

# mode = private, by default
#
joe foo bar, 123456789, 6

# line = 1, by default
# mode = private, by default
#
snidley whiplash, 000111222

# the parser ignores the COMMA # in the name
# mode = private, by default
#
"manny, jr", 093666888, 9

# the parser ignores the POUND # chars in the URI number
# mode = private, by default
#
hello dolly, "12#34#7", 2
```

Server to IP Phone Download Behavior

The software that reads directory files from the server, loads the file's contents into the phone's NVRAM when the phone is booting. Directory entries in the NVRAM that originate from a server directory file are 'owned' by the server.

During the boot process both directory files are read, combined into a single list, and any duplicate entries are deleted from the list. Any entries in this list that are not already in the phone's NVRAM are added to the NVRAM and flagged as being owned by the server.

Likewise, any entries in the NVRAM that are owned by the server, but are no longer in one of the server's directory files, are removed from the NVRAM. Entries made from the IP phone UI are never touched.

Directory List Limitations

The following table indicates the maximum characters for each line and field in the Directory List.

Directory List Limitations	
Maximum length of a line	255 characters
Maximum length of a name	15 characters
Maximum length of a URI	45 characters
Maximum number directory entries in the NVRAM	200 entries
Maximum number directory entries in the NVRAM with the "public" attribute (6757i CT only)	50 entries

Using the Directory List

Use the following procedures to access and use the Directory List.



Note: In the following procedure, the location of keys (hard keys, softkeys, and programmable keys) on the phone are dependant on your specific phone model. See Chapter 1, Overview, for the keys that are specific to your phone model.

 IP Phone UI	
Step	Action
1	<p>On the 9143i and all 67xxi phones (except the 6751i):</p> <p>Press the DIRECTORY key to enter the Directory List.</p> <p>On the 9480i, 9480i CT:</p> <p>Press the Services key, and then select “Directory” from the list of options.</p> <p>Note: After entering the Directory List, if no key is pressed within 3 seconds, the phone prompts you to press the first letter in the name of the required directory entry. The phone finds and displays the first name with this letter.</p>
2	Use the r and s to scroll through the line items in the Directory List.
To dial from an entry in the Directory List:	
3	<p>At a line item in the Directory List, pick up the handset, press the d /f key, or press a line key.</p> <p>The phone automatically dials the Directory List number for you.</p>
To add a new entry to the Directory List:	
4	<p>a Press the SAVE key or ADD NEW softkey (depending on your model phone) at the Directory List header screen and perform step 4.</p> <p>or</p> <p>Press the SAVE key or ADD NEW softkey at a line item and press the DIRECTORY key again.</p> <p>b Enter a phone number, name, and line number and press the SAVE key after each field entry.</p>



IP Phone UI

Step	Action
To edit an entry in the Directory List:	
5	<p>a At a line item in the Directory List, press the 3 key.</p> <p>Note: Use the SAVE key to scroll between the number, name and line entries.</p> <p>b Edit the phone number if required and press SAVE.</p> <p>c Edit the name if required and press SAVE.</p> <p>d Edit the line if required and press SAVE.</p> <p>e Press SAVE to save the changes and exit the editing function.</p>
To delete an entry from the Directory List:	
6	<p>a At a line item in the Directory List, press DELETE. The following prompt displays:</p> <p><i>“DELETE again to erase this item”.</i></p> <p>b Press DELETE again to delete the entry from the Directory List.</p> <p>Note: To cancel a delete function, press the r or the s scroll keys.</p>
To delete all entries from the Directory List:	
7	<p>a At the Directory List header, press DELETE or DELETE LIST (depending on your phone model). The following prompt displays:</p> <p><i>“DELETE again to erase all items”.</i></p> <p>b Press DELETE again to delete all entries from the Directory List.</p> <p>Note: To cancel a delete function, press the r or the s scroll keys.</p>

 IP Phone UI	
Step	Action
To copy an entry from the Directory List to a speeddial key (for 3-Line LCD phones - not applicable to 6751i):	
8	<p>At a line item in the Directory List, press the SAVE key. The "Save to?" prompt displays. Enter a number from 1 to 9 (associated with the keypad) where you want to save the item as a speeddial.</p> <p>Note: You must have a speeddial key previously configured on your phone to use this feature. To configure a speeddial key, see your Model-specific <i>User's Guide</i>.</p>
9	<p>To exit the Directory List, press the DIRECTORY key again, the GOODBYE key, or the QUIT key (depending on your specific phone model).</p>
From the CT handsets:	
10	<p>a Press the Public/Private softkeys to toggle between making the new entry public or private.</p> <p>Note: The entry is set to Private by default. If the entry is made Public, the entry is sent to the handsets. A 6757i CT accepts a maximum of 50 entries with the public attribute.</p> <p>b To edit an entry, use the Change softkey. A screen displays allowing you to edit the name, phone number, and line number, as well as the public/private setting.</p> <p>c To dial a displayed entry from the Directory List, pick up the handset, press the d /f handsfree key, or press the Dial softkey.</p>

Downloading from the Server to the IP Phone

You can use the configuration files to download the Directory List from the configuration server to the IP phone..



Note: You must use TFTP to download the Directory List.

Use the following procedure to configure the download.



Configuration Files

For specific parameters you can set in the configuration files for downloading the Directory List, see Appendix A, the section, “[Directory Settings](#)” on [page A-143](#).

Downloading from the IP Phone to the Server

You can use the Aastra Web UI to download the Directory List from the IP phone to the configuration server.



Note: You must use TFTP to download the Directory List.

Use the following procedure to configure the download.

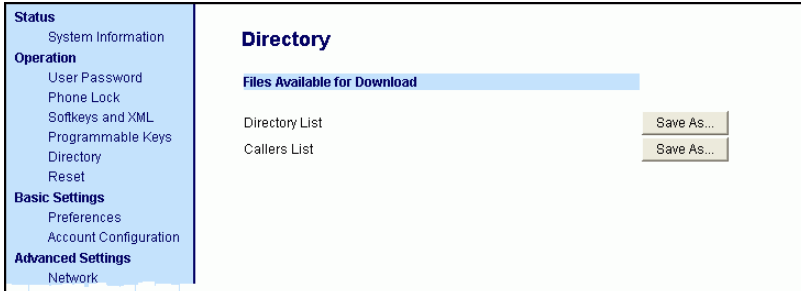
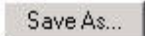
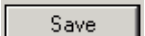
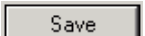
Aastra Web UI	
1	<p>Click on Operation->Directory.</p> 
2	<p>In the Directory List field, click on  .</p> <p>A "File Download" message displays.</p>
3	<p>Click  .</p>
4	<p>Enter the location on your computer where you want to download the Directory List and click  .</p> <p>The <i>directorylist.csv</i> file downloads to your computer.</p>
5	<p>Use a spreadsheet application to open and view the Directory List.</p>

Voicemail (not applicable to 6751i)

The Voicemail feature on the IP phones allow you to configure lines with phone numbers so the phone can dial out to connect to a voicemail server. You associate the Voicemail numbers with the phone numbers configured on each line (1 - 9 lines or 1-6 lines depending on your model phone).

For each assigned Voicemail number, there can be a minimum of 0 or a maximum of 1 Voicemail access phone number.

The Voicemail list displays a list of phone numbers assigned to the IP phone that has registered voicemail accounts associated with them.



Note: The Voicemail list does not display the voicemail access number.

The phone displays up to 99 voicemails for an account even if the number of voicemails exceeds the limit.

Registered account numbers/URIs that exceed the length of the screen, either with or without the voicemail icon and the message count, are truncated with an ellipse character at the end of the number/URI string.

The end of the Voicemail list displays the number of new voicemail messages (if any exist).

Configuring Voicemail (not applicable to the 6751i)

You configure Voicemail in the configuration files to dial a specific number to access an existing voicemail account. The user then follows the voicemail instructions for listening to voicemails.



Note: The phone must have a registered voicemail account from a server for this feature to be enabled. When no registered voicemail accounts are registered to the phone, the display shows "List Empty".

To configure the Voicemail feature on the IP phone (not applicable to 6751i), you must enter the following parameter in the configuration files:

- **sip lineN vmal:**

You can enter up to 9 Voicemail numbers associated with each of the 9 lines on the phone.

For example:

```
sip line1 vmal: *97  
sip line2 vmal: *95
```



Note: In the above example, the user would dial *97 to access the voicemail account for line 1, and *95 to access the voicemail account for line 2.

Use the following procedure to configure voicemail using the configuration files.



Configuration Files

For specific parameters you can set in the configuration files, see Appendix A, the section, [“Voicemail Settings”](#) on [page A-141](#).

Using Voicemail (not applicable to 6751i)

Use the following procedure to access and use voicemail.

 IP Phone UI	
Step	Action
<i>For all phones (not applicable to 6751i):</i>	
1	Press Services on the phone to display the Services menu.
2	From the Services menu, select " Voicemail ".
3	Use the r and s to scroll through the line items in the Voicemail List.
4	When you have selected a line item, press the d /f handsfree key, 4 Scroll Right key, or press a line softkey to make an outgoing call using the voicemail access phone number associated with the line for which the voicemail account is registered. From a selected item in the Voicemail list, you can also lift the handset (go offhook) to make an outgoing call using the voicemail access phone number.

XML Customized Services

Extensible Markup Language (XML) is a markup language much like HTML. HTML was designed to display data and to focus on how data looks. XML was designed to describe data and to focus on what data is.

The following are characteristics of XML:

- XML tags are not predefined. You must define your own tags.
- XML uses a Document Type Definition (DTD) or an XML Schema to describe the data.
- XML with a DTD or XML Schema is designed to be self-descriptive
- XML is a W3C Standard Recommendation

Creating Customized XML Services on the IP Phones

The XML application for the IP phones allows users to create custom services they can use via the phone's keyboard and display. These services include things like weather and traffic reports, contact information, company info, stock quotes, or custom call scripts.

The IP phone XML application supports the following proprietary objects that allow for the customization of the IP phone's display.

XML Object	Description
AstralIPPhoneTextMenu (for Menu screens)	Creates a numerical list of menu items on the IP phones.
AstralIPPhoneTextScreen (for Text screens)	Creates a screen of text that wraps appropriately.
AstralIPPhoneFormattedTextScreen (for Text screens)	Creates a formatted screen of text (specifies text alignment, text size, text static or scrolling)
AstralIPPhoneInputScreen (for User Input screens)	Creates screens for which the user can input text where applicable.
AstralIPPhoneInputScreen Time and Date Attributes (for User Input screens)	Allows you to specify US (HH:MM:SS am/pm and MM/DD/YYYY) or International (HH:MM:SS and DD/MM/YYYY) time/date formats for an XML user input screen.

XML Object	Description
AastrapPhoneDirectory (for Directory List screen)	Creates an online Directory List that a user can browse in real-time.
AastrapPhoneStatus (for Idle screen)	Creates a screen that displays status messages when applicable.
AastrapPhoneExecute (for executing XML commands)	Allows the phone to execute commands (i.e., "reset", "NoOp", etc.) using XML.
AastrapPhoneConfiguration (for pushing a configuration to the phone)	Allows the server to push a configuration to the phone. (See page 5-321 for more information).
AastrapPhoneImageScreen (Standard Bitmap Image)	Creates a display with a single bitmap image according to alignment, height, and width specifications.
AastrapPhoneImageMenu (Menu Image)	Creates a display with a bitmap image as a menu. Menu selections are linked to keypad keys (0-9, *, #).
AastrapPhoneTextMenu (Icon Menu) (Icon Menu Image)	Creates a display that has a small icon before each item in the menu.

Reference

For more information about creating customized XML applications, contact Aastra Customer Support regarding the "Aastra XML Development Guide."

You can also use the following attributes/options with the XML objects to further customize your XML applications:

Attribute/Option	Description/Usage	Valid Values
Beep	<p>Enables or disables a BEEP option to indicate a status on the phone.</p> <p>Use with: XML object (See Appendix F) Configuration files (See page 5-320) Aastra Web UI (See page 5-320)</p>	<p>yes no Default = no</p> <p>Note: This value is case sensitive.</p>
xml status scroll delay (config files) Status Scroll Delay (seconds) (Web UI)	<p>Allows you to set the time delay, in seconds, between the scrolling of each status message on the phone.</p> <p>Use with: Configuration files (See page 5-321) Aastra Web UI (See page 5-321)</p>	<p>1 to 25 Default = 5</p>
Timeout	<p>Specifies a timeout value for the LCD screen display.</p> <p>Use with: XML object (See Appendix F)</p>	<p>0, 30, 45, 60 Default =45</p>
XML Get Timeout	<p>Specifies a timeout value, in seconds, that the phone waits for the far side to return a response after accepting the HTTP GET connection.</p> <p>Use with: Configuration Files (See page 5-322)</p>	<p>0 to 214748364 seconds Default =0 (never timeout)</p>

Attribute/Option	Description/Usage	Valid Values
LockIn	Specifies whether or not the information on the LCD screen stays displayed when other events occur (such as pressing buttons on the keypad). Use with: XML object (See Appendix F)	yes no Default = no
CancelAction	Specifies a URI that the phone executes a GET on when the user presses the default CANCEL key. Use with: XML object (See Appendix F)	Fully qualified URI For example: cancelAction= http:// 10.50.10.117/ ft.xml

Enabling/Disabling a Beep for Status Message Displays

You can enable or disable a BEEP option using the Status Message object (AastraIPPhoneStatus), the configuration files, or the Aastra Web UI.



Note: For enabling/disabling a status message beep using the Status Message object, see [Appendix F, “Creating and Managing XML Applications.”](#)

When the phone receives a status message, the BEEP notifies the user that the message is displaying.

You can use the following to enable/disable a status message beep:

- **AastraIPPhoneStatus** object (via XML object; see [Appendix F](#))
- **xml beep notification** (via configuration files)
- **XML Beep Support** (via the Aastra Web UI)

Enabling the beep is an indication to the phone to sound a beep when it receives an AastraIPPhoneStatus object. If you disable the beep, or no AastraIPPhoneStatus object appears in the status message, then the default behavior is no beep is heard when the object arrives to the phone.

The value set in the configuration files and Aastra Web UI override the attribute you specify for the AastraIPPhoneStatus object.

For example, if the AastraIPPhoneStatus object has the attribute of **Beep=“yes”**, and you uncheck (disable) the “**XML Beep Support**” in the Aastra Web UI, the phone does not beep when it receives an AastraIPPhoneStatus object.

Setting the BEEP option in the configuration files and the Aastra Web UI applies to the phone immediately.

Reference

For information about enabling/disabling the XML beep in the Aastra Web UI, see “[XML Beep Support](#)” on [page 5-72](#).

Scroll Delay Option for Status Messages

The IP phones support a scroll delay option that allows you to set the time delay, in seconds, between the scrolling of each status message on the phone. The default time is 5 seconds for each message to display before scrolling to the next message. You can configure this option via the configuration files or the Aastra Web UI.

You can use the following to set the scroll delay for status messages:

- **xml status scroll delay** (via the configuration files)
- **Status Scroll Delay (seconds)** (via the Aastra Web UI)

Changes apply to the phone immediately.

Reference

For more information about configuring status scroll delay, see [“Status Scroll Delay”](#) on [page 5-74](#).

XML Configuration Push from the Server

The IP phones provide an XML feature that allows you to make configuration changes to the phone that take affect immediately, without having to reboot the phone. This feature involves creating XML scripts that push the changed configuration parameter(s) from the server to the IP phones.

You can use the **AastraIPPhoneConfiguration** object in the XML scripts to change configuration parameters or configure new parameters. However, since the IP phone does not save **new** parameters created in XML scripts to the *local.cfg* file, when the phone reboots, it does not save the new parameters on the phone. In order for the phone to apply **new** configuration parameters, you have to enter the parameters via the user interfaces (Telephone User Interface, Web User Interface, or configuration files), or reapply the new parameters using the XML scripts after every boot.

Specific configuration parameters are dynamic on the phone when pushed from XML scripts on the server. See [Appendix F, “Creating and Managing XML Applications”](#) for more information about XML configuration scripts and dynamic configuration parameters.

For more information about creating XML configuration scripts and for XML script examples, see [Appendix F, “Creating and Managing XML Applications”](#).

Configuring the Phone to use XML

You can configure the phone to request the XML objects you create by configuring specific parameters via the configuration files or the Aastra Web UI.

Users can access XML applications via softkeys configured on the IP phones. The phone performs an HTTP GET on the URI configured in the Aastra Web UI or configuration files.

You configure the following parameters for object requests:

- **xml application URI**
- **xml application title**

The xml application URI is the application you are loading into the IP phone.

The xml application title is the name of the XML application that displays on the Services menu in the IP Phone UI (as option #4).

XML Get Timeout

The IP phone has a parameter called, “**xml get timeout**” that allows you to specify a timeout value, in seconds, that the phone waits for the far side to return a response after accepting the HTTP GET connection. If the far side accepts the GET connection but never returns a response, it blocks the phone until it is rebooted. If you enter a value greater than 0 for this parameter, the phone times out and will not be blocked.

For more information about configuring this parameter, see Appendix A, the section, “[XML Settings](#)” on [page A-153](#).

XML Push Requests

In addition to initiating a request to an XML application from a softkey, an HTTP server can push an XML object to the phone via HTTP Post. When the phone sees a PUSH request containing an XML object, it tries to authenticate the request. It does so by checking the IP address or host name of the requesting host against a list of trusted hosts (or domain names) configured via the Aastra Web UI (parameter called **XML Push Server List**) or the configuration files (parameter called **xml application post list**). If the request is authenticated, the XML object is handled by the IP phone accordingly, and displays the information to the screen.



Note: The HTTP Post must contain HTTP packets that have an "xml" line in the message body. For more information about adding "xml" lines in HTTP packets, see [Appendix F, “Creating and Managing XML Applications”](#).

Example Configuration of XML Application

The following example shows the parameters you enter in the configuration files to configure an XML application:

```
xml application URI: http://172.16.96.63/aastra/internet.php
```

```
xml application title: Aastra Telecom
```

```
xml application post list: 10.50.10.53, dhcp10-53.ana.aastra.com
```

Configuring for XML on the IP Phone

After creating an XML application, an administrator can configure the IP phone to use the application using the configuration files or the Aastra Web UI.



Configuration Files

For specific parameters you can set in the configuration files, see Appendix A, the section, “XML Settings” on [page A-153](#).

Aastra Web UI

For 8 and 11-Line LCD phones:

1 Click on **Operation->Softkeys and XML**.

Status

System Information

Operation

User Password

Phone Lock

Softkeys and XML

Programmable Keys

Directory

Reset

Basic Settings

Preferences

Account Configuration

Advanced Settings

Network

Global SIP

Line 1

Line 2

Line 3

Line 4

Line 5

Line 6

Line 7

Line 8

Line 9

Action URI

Configuration Server

Firmware Update

TLS Support

802.1x Support

Troubleshooting

Softkeys Configuration

Key	Type	Label	Value	Line	Idle	Connected	Incoming	Outgoing	Busy
1	Directory		44444	5	<input checked="" type="checkbox"/>	<input checked="" type="checkbox"/>	<input checked="" type="checkbox"/>	<input checked="" type="checkbox"/>	<input checked="" type="checkbox"/>
2	None			0	<input checked="" type="checkbox"/>	<input checked="" type="checkbox"/>	<input checked="" type="checkbox"/>	<input checked="" type="checkbox"/>	<input checked="" type="checkbox"/>
3	Speedial	Lab	222222	7	<input checked="" type="checkbox"/>	<input checked="" type="checkbox"/>	<input checked="" type="checkbox"/>	<input checked="" type="checkbox"/>	<input checked="" type="checkbox"/>
4	None			1	<input checked="" type="checkbox"/>	<input checked="" type="checkbox"/>	<input checked="" type="checkbox"/>	<input checked="" type="checkbox"/>	<input checked="" type="checkbox"/>
5	None			1	<input checked="" type="checkbox"/>	<input checked="" type="checkbox"/>	<input checked="" type="checkbox"/>	<input checked="" type="checkbox"/>	<input checked="" type="checkbox"/>
6	None			1	<input checked="" type="checkbox"/>	<input checked="" type="checkbox"/>	<input checked="" type="checkbox"/>	<input checked="" type="checkbox"/>	<input checked="" type="checkbox"/>
7	None			1	<input checked="" type="checkbox"/>	<input checked="" type="checkbox"/>	<input checked="" type="checkbox"/>	<input checked="" type="checkbox"/>	<input checked="" type="checkbox"/>
8	None			1	<input checked="" type="checkbox"/>	<input checked="" type="checkbox"/>	<input checked="" type="checkbox"/>	<input checked="" type="checkbox"/>	<input checked="" type="checkbox"/>
9	None			1	<input checked="" type="checkbox"/>	<input checked="" type="checkbox"/>	<input checked="" type="checkbox"/>	<input checked="" type="checkbox"/>	<input checked="" type="checkbox"/>
10	None			1	<input checked="" type="checkbox"/>	<input checked="" type="checkbox"/>	<input checked="" type="checkbox"/>	<input checked="" type="checkbox"/>	<input checked="" type="checkbox"/>
11	None			1	<input checked="" type="checkbox"/>	<input checked="" type="checkbox"/>	<input checked="" type="checkbox"/>	<input checked="" type="checkbox"/>	<input checked="" type="checkbox"/>
12	None			1	<input checked="" type="checkbox"/>	<input checked="" type="checkbox"/>	<input checked="" type="checkbox"/>	<input checked="" type="checkbox"/>	<input checked="" type="checkbox"/>
13	None			1	<input checked="" type="checkbox"/>	<input checked="" type="checkbox"/>	<input checked="" type="checkbox"/>	<input checked="" type="checkbox"/>	<input checked="" type="checkbox"/>
14	None			1	<input checked="" type="checkbox"/>	<input checked="" type="checkbox"/>	<input checked="" type="checkbox"/>	<input checked="" type="checkbox"/>	<input checked="" type="checkbox"/>
15	None			1	<input checked="" type="checkbox"/>	<input checked="" type="checkbox"/>	<input checked="" type="checkbox"/>	<input checked="" type="checkbox"/>	<input checked="" type="checkbox"/>
16	None			1	<input checked="" type="checkbox"/>	<input checked="" type="checkbox"/>	<input checked="" type="checkbox"/>	<input checked="" type="checkbox"/>	<input checked="" type="checkbox"/>
17	None			1	<input checked="" type="checkbox"/>	<input checked="" type="checkbox"/>	<input checked="" type="checkbox"/>	<input checked="" type="checkbox"/>	<input checked="" type="checkbox"/>
18	None			1	<input checked="" type="checkbox"/>	<input checked="" type="checkbox"/>	<input checked="" type="checkbox"/>	<input checked="" type="checkbox"/>	<input checked="" type="checkbox"/>
19	None			1	<input checked="" type="checkbox"/>	<input checked="" type="checkbox"/>	<input checked="" type="checkbox"/>	<input checked="" type="checkbox"/>	<input checked="" type="checkbox"/>
20	None			1	<input checked="" type="checkbox"/>	<input checked="" type="checkbox"/>	<input checked="" type="checkbox"/>	<input checked="" type="checkbox"/>	<input checked="" type="checkbox"/>

Services

XML Application URI:

XML Application Title:

BLF List URI:

2 Select a key from keys 1 through 20.

3 In the "**Type**" field, select **XML** from the list box.



4 In the "**Label**" field, enter a label that displays on the IP phone for the softkey. For example, "**XML**".

5 In the "**Value**" field, enter the IP address or qualified domain name of the XML application.

6 In the "**XML Application URI**" field, enter the HTTP server path or qualified domain name of the XML application you want to load to the IP phone. For example, you could enter an XML application called "http://172.16.96.63/aastra/internet.php" in the applicable field.

5-324

41-001160-03 Rev 00, Release 2.5

 Aastra Web UI																																											
7	<p>In the "XML Application Title" field, enter the name of the XML application that you want to display on the IP phone Services Menu. In the illustration above, the XML Application Title is "Aastra Telecom".</p>																																										
8	<p>Click  to save your changes.</p> <p>The XML application is applied to the IP phone immediately.</p> <p>When the XML application is pushed to the phone via an HTTP POST, a host IP address or domain name server is required.</p>																																										
9	<p>Click on Advanced Settings->Configuration Server.</p> <div style="border: 1px solid black; padding: 10px; margin: 10px 0;"> <table border="0" style="width: 100%; border-collapse: collapse;"> <tr> <td style="width: 30%; vertical-align: top; padding-right: 10px;"> <div style="background-color: #e6f2ff; padding: 5px; border: 1px solid #add8e6;"> <p>Status</p> <ul style="list-style-type: none"> System Information <p>Operation</p> <ul style="list-style-type: none"> User Password Phone Lock Softkeys and XML Programmable Keys Keypad Speed Dial Directory Reset Expansion Module 1 <p>Basic Settings</p> <ul style="list-style-type: none"> Preferences Account Configuration <p>Advanced Settings</p> <ul style="list-style-type: none"> Network Global SIP Line 1 Line 2 Line 3 Line 4 Line 5 Line 6 Line 7 Line 8 Line 9 Action URI Configuration Server Firmware Update TLS Support 802.1x Support Troubleshooting </div> </td> <td style="vertical-align: top; padding-left: 10px;"> <p>Configuration Server Settings</p> <p>Settings</p> <table border="0" style="width: 100%; border-collapse: collapse;"> <tr> <td style="width: 70%;">Download Protocol</td> <td style="border: 1px solid #add8e6;">TFTP</td> </tr> <tr> <td>TFTP Server</td> <td style="border: 1px solid #add8e6;">10.50.10.68</td> </tr> <tr> <td>TFTP Path</td> <td style="border: 1px solid #add8e6;">C:\Documents and Sett</td> </tr> <tr> <td>Alternate Server</td> <td style="border: 1px solid #add8e6;">0.0.0.0</td> </tr> <tr> <td>Alternate TFTP Path</td> <td style="border: 1px solid #add8e6;"></td> </tr> <tr> <td>Use Alternate TFTP</td> <td style="border: 1px solid #add8e6;"><input type="checkbox"/> Enabled</td> </tr> <tr> <td>FTP Server</td> <td style="border: 1px solid #add8e6;"></td> </tr> <tr> <td>FTP Path</td> <td style="border: 1px solid #add8e6;"></td> </tr> <tr> <td>FTP Username</td> <td style="border: 1px solid #add8e6;"></td> </tr> <tr> <td>FTP Password</td> <td style="border: 1px solid #add8e6;"></td> </tr> <tr> <td>HTTP Server</td> <td style="border: 1px solid #add8e6;"></td> </tr> <tr> <td>HTTP Path</td> <td style="border: 1px solid #add8e6;"></td> </tr> <tr> <td>HTTP Port</td> <td style="border: 1px solid #add8e6;">80</td> </tr> <tr> <td>HTTPS Server</td> <td style="border: 1px solid #add8e6;"></td> </tr> <tr> <td>HTTPS Path</td> <td style="border: 1px solid #add8e6;"></td> </tr> <tr> <td>HTTPS Port</td> <td style="border: 1px solid #add8e6;">443</td> </tr> </table> <p>Auto-Resync</p> <table border="0" style="width: 100%; border-collapse: collapse;"> <tr> <td style="width: 70%;">Mode</td> <td style="border: 1px solid #add8e6;">None</td> </tr> <tr> <td>Time (24-hour)</td> <td style="border: 1px solid #add8e6;">00:00</td> </tr> <tr> <td>Maximum Delay</td> <td style="border: 1px solid #add8e6;">15</td> </tr> <tr> <td>Days</td> <td style="border: 1px solid #add8e6;">0</td> </tr> </table> </td> </tr> </table> </div>	<div style="background-color: #e6f2ff; padding: 5px; border: 1px solid #add8e6;"> <p>Status</p> <ul style="list-style-type: none"> System Information <p>Operation</p> <ul style="list-style-type: none"> User Password Phone Lock Softkeys and XML Programmable Keys Keypad Speed Dial Directory Reset Expansion Module 1 <p>Basic Settings</p> <ul style="list-style-type: none"> Preferences Account Configuration <p>Advanced Settings</p> <ul style="list-style-type: none"> Network Global SIP Line 1 Line 2 Line 3 Line 4 Line 5 Line 6 Line 7 Line 8 Line 9 Action URI Configuration Server Firmware Update TLS Support 802.1x Support Troubleshooting </div>	<p>Configuration Server Settings</p> <p>Settings</p> <table border="0" style="width: 100%; border-collapse: collapse;"> <tr> <td style="width: 70%;">Download Protocol</td> <td style="border: 1px solid #add8e6;">TFTP</td> </tr> <tr> <td>TFTP Server</td> <td style="border: 1px solid #add8e6;">10.50.10.68</td> </tr> <tr> <td>TFTP Path</td> <td style="border: 1px solid #add8e6;">C:\Documents and Sett</td> </tr> <tr> <td>Alternate Server</td> <td style="border: 1px solid #add8e6;">0.0.0.0</td> </tr> <tr> <td>Alternate TFTP Path</td> <td style="border: 1px solid #add8e6;"></td> </tr> <tr> <td>Use Alternate TFTP</td> <td style="border: 1px solid #add8e6;"><input type="checkbox"/> Enabled</td> </tr> <tr> <td>FTP Server</td> <td style="border: 1px solid #add8e6;"></td> </tr> <tr> <td>FTP Path</td> <td style="border: 1px solid #add8e6;"></td> </tr> <tr> <td>FTP Username</td> <td style="border: 1px solid #add8e6;"></td> </tr> <tr> <td>FTP Password</td> <td style="border: 1px solid #add8e6;"></td> </tr> <tr> <td>HTTP Server</td> <td style="border: 1px solid #add8e6;"></td> </tr> <tr> <td>HTTP Path</td> <td style="border: 1px solid #add8e6;"></td> </tr> <tr> <td>HTTP Port</td> <td style="border: 1px solid #add8e6;">80</td> </tr> <tr> <td>HTTPS Server</td> <td style="border: 1px solid #add8e6;"></td> </tr> <tr> <td>HTTPS Path</td> <td style="border: 1px solid #add8e6;"></td> </tr> <tr> <td>HTTPS Port</td> <td style="border: 1px solid #add8e6;">443</td> </tr> </table> <p>Auto-Resync</p> <table border="0" style="width: 100%; border-collapse: collapse;"> <tr> <td style="width: 70%;">Mode</td> <td style="border: 1px solid #add8e6;">None</td> </tr> <tr> <td>Time (24-hour)</td> <td style="border: 1px solid #add8e6;">00:00</td> </tr> <tr> <td>Maximum Delay</td> <td style="border: 1px solid #add8e6;">15</td> </tr> <tr> <td>Days</td> <td style="border: 1px solid #add8e6;">0</td> </tr> </table>	Download Protocol	TFTP	TFTP Server	10.50.10.68	TFTP Path	C:\Documents and Sett	Alternate Server	0.0.0.0	Alternate TFTP Path		Use Alternate TFTP	<input type="checkbox"/> Enabled	FTP Server		FTP Path		FTP Username		FTP Password		HTTP Server		HTTP Path		HTTP Port	80	HTTPS Server		HTTPS Path		HTTPS Port	443	Mode	None	Time (24-hour)	00:00	Maximum Delay	15	Days	0
<div style="background-color: #e6f2ff; padding: 5px; border: 1px solid #add8e6;"> <p>Status</p> <ul style="list-style-type: none"> System Information <p>Operation</p> <ul style="list-style-type: none"> User Password Phone Lock Softkeys and XML Programmable Keys Keypad Speed Dial Directory Reset Expansion Module 1 <p>Basic Settings</p> <ul style="list-style-type: none"> Preferences Account Configuration <p>Advanced Settings</p> <ul style="list-style-type: none"> Network Global SIP Line 1 Line 2 Line 3 Line 4 Line 5 Line 6 Line 7 Line 8 Line 9 Action URI Configuration Server Firmware Update TLS Support 802.1x Support Troubleshooting </div>	<p>Configuration Server Settings</p> <p>Settings</p> <table border="0" style="width: 100%; border-collapse: collapse;"> <tr> <td style="width: 70%;">Download Protocol</td> <td style="border: 1px solid #add8e6;">TFTP</td> </tr> <tr> <td>TFTP Server</td> <td style="border: 1px solid #add8e6;">10.50.10.68</td> </tr> <tr> <td>TFTP Path</td> <td style="border: 1px solid #add8e6;">C:\Documents and Sett</td> </tr> <tr> <td>Alternate Server</td> <td style="border: 1px solid #add8e6;">0.0.0.0</td> </tr> <tr> <td>Alternate TFTP Path</td> <td style="border: 1px solid #add8e6;"></td> </tr> <tr> <td>Use Alternate TFTP</td> <td style="border: 1px solid #add8e6;"><input type="checkbox"/> Enabled</td> </tr> <tr> <td>FTP Server</td> <td style="border: 1px solid #add8e6;"></td> </tr> <tr> <td>FTP Path</td> <td style="border: 1px solid #add8e6;"></td> </tr> <tr> <td>FTP Username</td> <td style="border: 1px solid #add8e6;"></td> </tr> <tr> <td>FTP Password</td> <td style="border: 1px solid #add8e6;"></td> </tr> <tr> <td>HTTP Server</td> <td style="border: 1px solid #add8e6;"></td> </tr> <tr> <td>HTTP Path</td> <td style="border: 1px solid #add8e6;"></td> </tr> <tr> <td>HTTP Port</td> <td style="border: 1px solid #add8e6;">80</td> </tr> <tr> <td>HTTPS Server</td> <td style="border: 1px solid #add8e6;"></td> </tr> <tr> <td>HTTPS Path</td> <td style="border: 1px solid #add8e6;"></td> </tr> <tr> <td>HTTPS Port</td> <td style="border: 1px solid #add8e6;">443</td> </tr> </table> <p>Auto-Resync</p> <table border="0" style="width: 100%; border-collapse: collapse;"> <tr> <td style="width: 70%;">Mode</td> <td style="border: 1px solid #add8e6;">None</td> </tr> <tr> <td>Time (24-hour)</td> <td style="border: 1px solid #add8e6;">00:00</td> </tr> <tr> <td>Maximum Delay</td> <td style="border: 1px solid #add8e6;">15</td> </tr> <tr> <td>Days</td> <td style="border: 1px solid #add8e6;">0</td> </tr> </table>	Download Protocol	TFTP	TFTP Server	10.50.10.68	TFTP Path	C:\Documents and Sett	Alternate Server	0.0.0.0	Alternate TFTP Path		Use Alternate TFTP	<input type="checkbox"/> Enabled	FTP Server		FTP Path		FTP Username		FTP Password		HTTP Server		HTTP Path		HTTP Port	80	HTTPS Server		HTTPS Path		HTTPS Port	443	Mode	None	Time (24-hour)	00:00	Maximum Delay	15	Days	0		
Download Protocol	TFTP																																										
TFTP Server	10.50.10.68																																										
TFTP Path	C:\Documents and Sett																																										
Alternate Server	0.0.0.0																																										
Alternate TFTP Path																																											
Use Alternate TFTP	<input type="checkbox"/> Enabled																																										
FTP Server																																											
FTP Path																																											
FTP Username																																											
FTP Password																																											
HTTP Server																																											
HTTP Path																																											
HTTP Port	80																																										
HTTPS Server																																											
HTTPS Path																																											
HTTPS Port	443																																										
Mode	None																																										
Time (24-hour)	00:00																																										
Maximum Delay	15																																										
Days	0																																										
10	<p>In the "XML Push Server List (Approved IP Addresses)" field, enter the host IP address and/or domain name server. You can enter multiple IP address and/or domain name servers (separated by commas). In the example in Step 8, the illustration shows a host IP address of "10.50.10.53, 10.50.10.54" in the applicable field.</p>																																										
11	<p>Click  to save your changes.</p> <p>Note: No posting is performed if a session times out.</p>																																										

Aastra Web UI

For 3-Line LCD phones (not applicable to the 6751i):

1	<p>Click on Operation->Programmable Keys.</p> <p>6753i Screen</p> <div style="border: 1px solid black; padding: 5px; margin: 10px 0;"> <div style="display: flex;"> <div style="width: 25%; background-color: #D9E1F2; padding: 5px; border-right: 1px solid black;"> <p>Status</p> <p>System Information</p> <p>Operation</p> <p>User Password</p> <p>Phone Lock</p> <p>Programmable Keys</p> <p>Directory</p> <p>Reset</p> <p>Basic Settings</p> <p>Preferences</p> <p>Account Configuration</p> <p>Advanced Settings</p> <p>Network</p> <p>Global SIP</p> <p>Line 1</p> <p>Line 2</p> <p>Line 3</p> <p>Line 4</p> <p>Line 5</p> </div> <div style="width: 75%; padding: 5px;"> <p style="text-align: center;">Programmable Keys Configuration</p> <table border="1" style="width: 100%; border-collapse: collapse;"> <thead> <tr style="background-color: #D9E1F2;"> <th style="width: 10%;">Key</th> <th style="width: 15%;">Hard Key</th> <th style="width: 50%;">Value</th> <th style="width: 25%;">Line</th> </tr> </thead> <tbody> <tr> <td style="text-align: center;">1</td> <td style="text-align: center;">Save</td> <td><input type="text"/></td> <td style="text-align: center;">global</td> </tr> <tr> <td style="text-align: center;">2</td> <td style="text-align: center;">Delete</td> <td><input type="text"/></td> <td style="text-align: center;">global</td> </tr> <tr> <td style="text-align: center;">3</td> <td style="text-align: center;">Directory</td> <td><input type="text"/></td> <td style="text-align: center;">1</td> </tr> <tr> <td style="text-align: center;">4</td> <td style="text-align: center;">Callers List</td> <td><input type="text"/></td> <td style="text-align: center;">1</td> </tr> <tr> <td style="text-align: center;">5</td> <td style="text-align: center;">Transfer</td> <td><input type="text"/></td> <td style="text-align: center;">global</td> </tr> <tr> <td style="text-align: center;">6</td> <td style="text-align: center;">Conference</td> <td><input type="text"/></td> <td style="text-align: center;">global</td> </tr> </tbody> </table> <p>Services</p> <p>BLF List URI: <input style="width: 100%;" type="text"/></p> <p style="text-align: center;"><input type="button" value="Save Settings"/></p> </div> </div> </div>	Key	Hard Key	Value	Line	1	Save	<input type="text"/>	global	2	Delete	<input type="text"/>	global	3	Directory	<input type="text"/>	1	4	Callers List	<input type="text"/>	1	5	Transfer	<input type="text"/>	global	6	Conference	<input type="text"/>	global
Key	Hard Key	Value	Line																										
1	Save	<input type="text"/>	global																										
2	Delete	<input type="text"/>	global																										
3	Directory	<input type="text"/>	1																										
4	Callers List	<input type="text"/>	1																										
5	Transfer	<input type="text"/>	global																										
6	Conference	<input type="text"/>	global																										
2	For 3-Line LCD phones (not applicable to 6751i), select an available key.																												
3	In the " Hard Key " field, select XML from the list box.																												
4	In the " Value " field, enter the IP address or qualified domain name of the XML application.																												
5	<p>Click <input style="border: 1px solid gray; padding: 2px 5px;" type="button" value="Save Settings"/> to save your changes.</p> <p>The XML application is applied to the IP phone immediately.</p> <p>When the XML application is pushed to the phone via an HTTP POST, a host IP address or domain name server is required.</p>																												



Aastra Web UI

6 Click on **Advanced Settings->Configuration Server.**

<p>Status</p> <ul style="list-style-type: none"> System Information <p>Operation</p> <ul style="list-style-type: none"> User Password Phone Lock Softkeys and XML Programmable Keys Keypad Speed Dial Directory Reset Expansion Module 1 <p>Basic Settings</p> <ul style="list-style-type: none"> Preferences Account Configuration <p>Advanced Settings</p> <ul style="list-style-type: none"> Network Global SIP Line 1 Line 2 Line 3 Line 4 Line 5 Line 6 Line 7 Line 8 Line 9 Action URI Configuration Server Firmware Update TLS Support 802.1x Support Troubleshooting 	<p>Configuration Server Settings</p> <p>Settings</p> <table border="0"> <tr> <td>Download Protocol</td> <td>TFTP</td> </tr> <tr> <td>TFTP Server</td> <td>10.50.10.68</td> </tr> <tr> <td>TFTP Path</td> <td>C:\Documents and Sett</td> </tr> <tr> <td>Alternate Server</td> <td>0.0.0.0</td> </tr> <tr> <td>Alternate TFTP Path</td> <td></td> </tr> <tr> <td>Use Alternate TFTP</td> <td><input type="checkbox"/> Enabled</td> </tr> <tr> <td>FTP Server</td> <td></td> </tr> <tr> <td>FTP Path</td> <td></td> </tr> <tr> <td>FTP Username</td> <td></td> </tr> <tr> <td>FTP Password</td> <td></td> </tr> <tr> <td>HTTP Server</td> <td></td> </tr> <tr> <td>HTTP Path</td> <td></td> </tr> <tr> <td>HTTP Port</td> <td>80</td> </tr> <tr> <td>HTTPS Server</td> <td></td> </tr> <tr> <td>HTTPS Path</td> <td></td> </tr> <tr> <td>HTTPS Port</td> <td>443</td> </tr> </table> <p>Auto-Resync</p> <table border="0"> <tr> <td>Mode</td> <td>None</td> </tr> <tr> <td>Time (24-hour)</td> <td>00:00</td> </tr> <tr> <td>Maximum Delay</td> <td>15</td> </tr> <tr> <td>Days</td> <td>0</td> </tr> </table>	Download Protocol	TFTP	TFTP Server	10.50.10.68	TFTP Path	C:\Documents and Sett	Alternate Server	0.0.0.0	Alternate TFTP Path		Use Alternate TFTP	<input type="checkbox"/> Enabled	FTP Server		FTP Path		FTP Username		FTP Password		HTTP Server		HTTP Path		HTTP Port	80	HTTPS Server		HTTPS Path		HTTPS Port	443	Mode	None	Time (24-hour)	00:00	Maximum Delay	15	Days	0
Download Protocol	TFTP																																								
TFTP Server	10.50.10.68																																								
TFTP Path	C:\Documents and Sett																																								
Alternate Server	0.0.0.0																																								
Alternate TFTP Path																																									
Use Alternate TFTP	<input type="checkbox"/> Enabled																																								
FTP Server																																									
FTP Path																																									
FTP Username																																									
FTP Password																																									
HTTP Server																																									
HTTP Path																																									
HTTP Port	80																																								
HTTPS Server																																									
HTTPS Path																																									
HTTPS Port	443																																								
Mode	None																																								
Time (24-hour)	00:00																																								
Maximum Delay	15																																								
Days	0																																								

7 In the **"XML Push Server List (Approved IP Addresses)"** field, enter the host IP address and/or domain name server. You can enter multiple IP address and/or domain name servers (separated by commas). In the example in Step 6, the illustration shows a host IP address of "10.50.10.53, 10.50.10.54" in the applicable field.

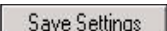
8 Click  to save your changes.

Note: No posting is performed if a session times out.

Using the XML Customized Service

After you create, save, and configure the IP phone with an XML application, the customized service is ready for you to use.

Reference

For more information about customizing the phones using XML objects, contact Aastra Customer Support regarding the “Aastra XML Development Guide.”

Use the following procedure to use the XML feature on the IP phone.

 IP Phone UI	
Step	Action
<i>For 8 and 11-Line LCD phones:</i>	
1	Press the Services key on the phone to display the Services menu.
2	Select " Custom Features ".
3	Use the r and s to scroll through the line items in a menu-driven and directory " Custom Features " screen. Message services display to the screen after selecting the " Custom Features " option. For user input services, follow the prompts as appropriate.
4	To exit from the " Custom Features " screen, press Exit .



IP Phone UI

Step	Action
<i>For 3-Line LCD phones (not applicable to 6751i):</i>	
1	Press the programmable key configured on the phone for XML services. A " Custom Features " screen displays.
2	Use the r and s to scroll through the customized features.
3	Select a service to display the information for that customized service. Message services display to the screen after pressing the programmable key. For user input services, follow the prompts as appropriate.
4	To exit from the " Custom Features " screen, press the XML programmable key again.

XML Action URIs

The IP phones have a feature that allows an administrator to specify a uniform resource identifier (URI) that triggers a GET when certain events occur. The IP phone events that support this feature are:

The IP phones have a feature that allows an administrator to specify a uniform resource identifier (URI) that triggers a GET when certain XML events occur. The Action URI feature prevents the phones from hanging if the Action URIs should fail. The phones also support transparent, non-blocking, XML post execute item URIs.

The IP phone XML events that support this feature are defined in the following table.

Action URI	Description
Startup	Specifies the URI for which the phone executes a GET on when a startup event occurs.
Successful Registration	Specifies the URI for which the phone executes a GET on when a successful registration event occurs.
Registration Event	Specifies the URI for when registration events occur or when there are registration state changes. Note: This action URI is not called when the same event is repeated (for example, a timeout occurs again when registration is already in a timeout state.)
Incoming Call	Specifies the URI for which the phone executes a GET on when an incoming call event occurs.
Outgoing Call	Specifies the URI for which the phone executes a GET on when an outgoing call event occurs.
Offhook	Specifies the URI for which the phone executes a GET on when an offhook event occurs.
Onhook	Specifies the URI for which the phone executes a GET on when an onhook event occurs.
Disconnected	Specifies the URI that the phone executes a GET on, when it transitions from the incoming, outgoing, calling, or connected state into the idle state. For more information, see "Action URI Disconnected" on page 5-341 .

Action URI	Description
XML SIP Notify	Specifies the URI to be called when an empty XML SIP NOTIFY is received by the phone. For more information, see “XML SIP Notify Events” on page 5-344 .
Poll	Specifies the URI to be called every "action uri poll interval" seconds. For more information, see “Polling Action URIs” on page 5-339 .
Poll Interval	Specifies the interval, in seconds, between calls from the phone to the "action uri poll". For more information, see “Polling Action URIs” on page 5-339 .



Note: For more information about the XML execute items, see [Appendix F, “Creating and Managing XML Applications”](#).

The following table identifies the configurable action URI parameters in the configuration files and the Aastra Web UI. This table also identifies the variables that apply to specific parameters.

Action URIs and Associated Variables

Configuration File Parameters	Aastra Web UI Parameters at Advanced Settings->Action URI	Applicable Variables
action uri startup	Startup	\$\$RE MOTENUMBER\$\$ \$\$DISP LAYNAME\$\$ \$\$SIPUSERNAME\$\$ \$\$SIPAUTHNAME\$\$ \$\$INCOMINGNAME\$\$ \$\$PROXYURL\$\$ \$\$LINESTATE\$\$ \$\$LOCALIP\$\$ \$\$DISP LAYNAME\$\$ \$\$CALLDURATION\$\$ \$\$CALLDIRECTION\$\$
action uri registered	Successful Registration	\$\$SIPUSERNAME\$\$ \$\$SIPAUTHNAME\$\$ \$\$PROXYURL\$\$ \$\$LINESTATE\$\$ \$\$LOCALIP\$\$

Operational Features

Configuration File Parameters	Aastra Web UI Parameters at Advanced Settings->Action URI	Applicable Variables
action uri registration event	Registration Event	\$\$REGISTRATIONSTATE\$\$ \$\$REGISTRATIONCODE\$\$
action uri incoming	Incoming Call	\$\$REMOTENUMBER\$\$ \$\$DISPLAYNAME\$\$ \$\$SIPUSERNAME\$\$ \$\$INCOMINGNAME\$\$ \$\$LINESTATE\$\$ \$\$CALLDURATION\$\$ \$\$CALLDIRECTION\$\$ \$\$LOCALIP\$\$
action uri outgoing	Outgoing Call	\$\$REMOTENUMBER\$\$ \$\$SIPUSERNAME\$\$ \$\$LINESTATE\$\$ \$\$LOCALIP\$\$
action uri offhook	Offhook	\$\$LINESTATE\$\$ \$\$LOCALIP\$\$
action uri onhook	Onhook	\$\$LOCALIP\$\$ \$\$CALLDURATION\$\$ \$\$CALLDIRECTION\$\$ \$\$LINESTATE\$\$
action uri disconnected	Disconnected	\$\$LINESTATE\$\$ \$\$LOCALIP\$\$ For more information, see “Action URI Disconnected” on page -341 .
action uri xml sip notify	XML SIP Notify	\$\$LOCALIP\$\$ For more information, see “XML SIP Notify Events” on page 5-344 .
action uri poll	Poll	For more information, see “Polling Action URIs” on page 5-339 .
action uri poll interval	Interval	For more information, see “Polling Action URIs” on page 5-339 .

Variable Descriptions

The following table provides a description of each variable.

Variable	Description
\$\$\$SIPUSERNAME\$\$	Username associated with: <ul style="list-style-type: none"> • registered phone • incoming caller • outgoing caller
\$\$\$SIPAUTHNAME\$\$	Authentication name associated with: <ul style="list-style-type: none"> • registered phone
\$\$PROXYURL\$\$	Proxy URL associated with: <ul style="list-style-type: none"> • registered phone
\$\$LINESTATE\$\$	Current line state associated with: <ul style="list-style-type: none"> • registered phone • incoming caller • outgoing caller • offhook • onhook • disconnected
\$\$LOCALIP\$\$ Note: This variable allows for enhanced information in call records and billing applications.	IP Address associated with: <ul style="list-style-type: none"> • registered phone • onhook
\$\$REMOTENUMBER\$\$	Remote number associated with: <ul style="list-style-type: none"> • incoming caller • outgoing caller
\$\$DISPLAYNAME\$\$	Display name associated with: <ul style="list-style-type: none"> • incoming caller
\$\$\$SIPUSERNAME\$\$	Username associated with: <ul style="list-style-type: none"> • registered phone • incoming caller • outgoing caller
\$\$INCOMINGNAME\$\$	Name associated with: <ul style="list-style-type: none"> • incoming caller
\$\$CALLDURATION\$\$ Note: This variable allows for enhanced information in call records and billing applications.	Duration of last call. This variable is associated with: <ul style="list-style-type: none"> • onhook

Variable	Description
\$\$CALLDIRECTION\$\$ Note: This variable allows for enhanced information in call records and billing applications.	Specifies whether the current/last call was incoming or outgoing. This variable is associated with: <ul style="list-style-type: none">• onhook
\$\$REGISTRATIONSTATE\$\$	Specifies the state of the phone's registration. Registration states can be: <ul style="list-style-type: none">• registered• unregistered• expired• refused• timeout
\$\$REGISTRATIONCODE\$\$	Specifies the code generated during the registration process. Registration code can be: "xxx" where xxx is the 3 digit code; for example, "403". Possible codes are: <ul style="list-style-type: none">• 001 (registration successful)• 403 (registration failed)

How it works

When a startup, successful registration, incoming call, outgoing call, offhook, or onhook call event occurs on the phone, the phone checks to see if the event has an action URI configured. If the phone finds a URI configured, any variables configured (in the form \$\$VARIABLENAME\$\$) are replaced with the value of the appropriate variable. After all of the variables are bound, the phone executes a GET on the URI. The Action URI binds all variables and is not dependant on the state of the phone.

For example, if you enter the following string for the **action uri outgoing** parameter:

```
action uri outgoing: http://10.50.10.140/  
outgoing.pl?number=$$REMOTENUMBER$$
```

and you dial out the number 5551212, the phone executes a GET on:

```
http://10.50.10.140/outgoing.pl?number=5551212
```



Note: If the phone can't find the Action URI you specify, it returns a "NULL" response. For example,

`http://10.50.10.140/outgoing.pl?number=`

You can configure this feature via the configuration files or the Aastra Web UI.

Configuring XML Action URIs

Use the following procedures to configure XML Action URIs using the configuration files or the Aastra Web UI.



Configuration Files

For specific parameters you can set in the configuration files, see Appendix A, the section, "[Action URI Settings](#)" on [page A-156](#).

Aastra Web UI

1	<p>Click on Advanced Settings->Action URI.</p> <div style="border: 1px solid black; padding: 5px; margin: 5px 0;"> <table style="width: 100%; border-collapse: collapse;"> <tr> <td style="width: 25%; background-color: #D9E1F2; padding: 5px; vertical-align: top;"> <ul style="list-style-type: none"> Status <ul style="list-style-type: none"> System Information Operation <ul style="list-style-type: none"> User Password Phone Lock Softkeys and XML Programmable Keys Keypad Speed Dial Directory Reset Expansion Module 1 Basic Settings <ul style="list-style-type: none"> Preferences Account Configuration Advanced Settings <ul style="list-style-type: none"> Network Global SIP Line 1 Line 2 Line 3 Line 4 Line 5 Line 6 Line 7 </td> <td style="padding: 5px;"> <h3 style="margin: 0;">Action URI Configuration</h3> <table style="width: 100%; border-collapse: collapse;"> <thead> <tr style="background-color: #D9E1F2;"> <th style="text-align: left; padding: 2px;">Event</th> <th style="width: 50%;"></th> </tr> </thead> <tbody> <tr><td>StartUp</td><td><input style="width: 95%;" type="text"/></td></tr> <tr><td>Successful Registration</td><td><input style="width: 95%;" type="text"/></td></tr> <tr><td>Registration Event</td><td><input style="width: 95%;" type="text"/></td></tr> <tr><td>Incoming Call</td><td><input style="width: 95%;" type="text"/></td></tr> <tr><td>Outgoing Call</td><td><input style="width: 95%;" type="text"/></td></tr> <tr><td>Offhook</td><td><input style="width: 95%;" type="text"/></td></tr> <tr><td>Onhook</td><td><input style="width: 95%;" type="text"/></td></tr> <tr><td>Disconnected</td><td><input style="width: 95%;" type="text"/></td></tr> <tr><td>XML SIP Notify</td><td><input style="width: 95%;" type="text"/></td></tr> </tbody> </table> <table style="width: 100%; border-collapse: collapse; margin-top: 5px;"> <thead> <tr style="background-color: #D9E1F2;"> <th style="text-align: left; padding: 2px;">Event</th> <th style="width: 30%;"></th> <th style="text-align: left; padding: 2px;">Settings</th> <th style="width: 30%;"></th> </tr> </thead> <tbody> <tr> <td style="padding: 2px;">Poll</td> <td><input style="width: 95%;" type="text"/></td> <td style="padding: 2px;">Interval</td> <td><input style="width: 95%;" type="text" value="0"/></td> </tr> </tbody> </table> <div style="text-align: center; margin-top: 5px;"> <input type="button" value="Save Settings"/> </div> </td> </tr> </table> </div>	<ul style="list-style-type: none"> Status <ul style="list-style-type: none"> System Information Operation <ul style="list-style-type: none"> User Password Phone Lock Softkeys and XML Programmable Keys Keypad Speed Dial Directory Reset Expansion Module 1 Basic Settings <ul style="list-style-type: none"> Preferences Account Configuration Advanced Settings <ul style="list-style-type: none"> Network Global SIP Line 1 Line 2 Line 3 Line 4 Line 5 Line 6 Line 7 	<h3 style="margin: 0;">Action URI Configuration</h3> <table style="width: 100%; border-collapse: collapse;"> <thead> <tr style="background-color: #D9E1F2;"> <th style="text-align: left; padding: 2px;">Event</th> <th style="width: 50%;"></th> </tr> </thead> <tbody> <tr><td>StartUp</td><td><input style="width: 95%;" type="text"/></td></tr> <tr><td>Successful Registration</td><td><input style="width: 95%;" type="text"/></td></tr> <tr><td>Registration Event</td><td><input style="width: 95%;" type="text"/></td></tr> <tr><td>Incoming Call</td><td><input style="width: 95%;" type="text"/></td></tr> <tr><td>Outgoing Call</td><td><input style="width: 95%;" type="text"/></td></tr> <tr><td>Offhook</td><td><input style="width: 95%;" type="text"/></td></tr> <tr><td>Onhook</td><td><input style="width: 95%;" type="text"/></td></tr> <tr><td>Disconnected</td><td><input style="width: 95%;" type="text"/></td></tr> <tr><td>XML SIP Notify</td><td><input style="width: 95%;" type="text"/></td></tr> </tbody> </table> <table style="width: 100%; border-collapse: collapse; margin-top: 5px;"> <thead> <tr style="background-color: #D9E1F2;"> <th style="text-align: left; padding: 2px;">Event</th> <th style="width: 30%;"></th> <th style="text-align: left; padding: 2px;">Settings</th> <th style="width: 30%;"></th> </tr> </thead> <tbody> <tr> <td style="padding: 2px;">Poll</td> <td><input style="width: 95%;" type="text"/></td> <td style="padding: 2px;">Interval</td> <td><input style="width: 95%;" type="text" value="0"/></td> </tr> </tbody> </table> <div style="text-align: center; margin-top: 5px;"> <input type="button" value="Save Settings"/> </div>	Event		StartUp	<input style="width: 95%;" type="text"/>	Successful Registration	<input style="width: 95%;" type="text"/>	Registration Event	<input style="width: 95%;" type="text"/>	Incoming Call	<input style="width: 95%;" type="text"/>	Outgoing Call	<input style="width: 95%;" type="text"/>	Offhook	<input style="width: 95%;" type="text"/>	Onhook	<input style="width: 95%;" type="text"/>	Disconnected	<input style="width: 95%;" type="text"/>	XML SIP Notify	<input style="width: 95%;" type="text"/>	Event		Settings		Poll	<input style="width: 95%;" type="text"/>	Interval	<input style="width: 95%;" type="text" value="0"/>
<ul style="list-style-type: none"> Status <ul style="list-style-type: none"> System Information Operation <ul style="list-style-type: none"> User Password Phone Lock Softkeys and XML Programmable Keys Keypad Speed Dial Directory Reset Expansion Module 1 Basic Settings <ul style="list-style-type: none"> Preferences Account Configuration Advanced Settings <ul style="list-style-type: none"> Network Global SIP Line 1 Line 2 Line 3 Line 4 Line 5 Line 6 Line 7 	<h3 style="margin: 0;">Action URI Configuration</h3> <table style="width: 100%; border-collapse: collapse;"> <thead> <tr style="background-color: #D9E1F2;"> <th style="text-align: left; padding: 2px;">Event</th> <th style="width: 50%;"></th> </tr> </thead> <tbody> <tr><td>StartUp</td><td><input style="width: 95%;" type="text"/></td></tr> <tr><td>Successful Registration</td><td><input style="width: 95%;" type="text"/></td></tr> <tr><td>Registration Event</td><td><input style="width: 95%;" type="text"/></td></tr> <tr><td>Incoming Call</td><td><input style="width: 95%;" type="text"/></td></tr> <tr><td>Outgoing Call</td><td><input style="width: 95%;" type="text"/></td></tr> <tr><td>Offhook</td><td><input style="width: 95%;" type="text"/></td></tr> <tr><td>Onhook</td><td><input style="width: 95%;" type="text"/></td></tr> <tr><td>Disconnected</td><td><input style="width: 95%;" type="text"/></td></tr> <tr><td>XML SIP Notify</td><td><input style="width: 95%;" type="text"/></td></tr> </tbody> </table> <table style="width: 100%; border-collapse: collapse; margin-top: 5px;"> <thead> <tr style="background-color: #D9E1F2;"> <th style="text-align: left; padding: 2px;">Event</th> <th style="width: 30%;"></th> <th style="text-align: left; padding: 2px;">Settings</th> <th style="width: 30%;"></th> </tr> </thead> <tbody> <tr> <td style="padding: 2px;">Poll</td> <td><input style="width: 95%;" type="text"/></td> <td style="padding: 2px;">Interval</td> <td><input style="width: 95%;" type="text" value="0"/></td> </tr> </tbody> </table> <div style="text-align: center; margin-top: 5px;"> <input type="button" value="Save Settings"/> </div>	Event		StartUp	<input style="width: 95%;" type="text"/>	Successful Registration	<input style="width: 95%;" type="text"/>	Registration Event	<input style="width: 95%;" type="text"/>	Incoming Call	<input style="width: 95%;" type="text"/>	Outgoing Call	<input style="width: 95%;" type="text"/>	Offhook	<input style="width: 95%;" type="text"/>	Onhook	<input style="width: 95%;" type="text"/>	Disconnected	<input style="width: 95%;" type="text"/>	XML SIP Notify	<input style="width: 95%;" type="text"/>	Event		Settings		Poll	<input style="width: 95%;" type="text"/>	Interval	<input style="width: 95%;" type="text" value="0"/>		
Event																															
StartUp	<input style="width: 95%;" type="text"/>																														
Successful Registration	<input style="width: 95%;" type="text"/>																														
Registration Event	<input style="width: 95%;" type="text"/>																														
Incoming Call	<input style="width: 95%;" type="text"/>																														
Outgoing Call	<input style="width: 95%;" type="text"/>																														
Offhook	<input style="width: 95%;" type="text"/>																														
Onhook	<input style="width: 95%;" type="text"/>																														
Disconnected	<input style="width: 95%;" type="text"/>																														
XML SIP Notify	<input style="width: 95%;" type="text"/>																														
Event		Settings																													
Poll	<input style="width: 95%;" type="text"/>	Interval	<input style="width: 95%;" type="text" value="0"/>																												
2	<p>Enter an XML URI for a startup event in the “Startup” field. For example:</p> <pre>http://10.50.10.140/startup</pre> <p>This parameter specifies the URI for which the phone executes a GET on when a startup event occurs.</p>																														
3	<p>Enter an XML URI for a successful registration in the “Successful Registration” field. For example:</p> <pre>http://10.50.10.14/registered.php?auth name=\$\$SIPAUTHNAME\$\$</pre> <p>This parameter specifies the URI for which the phone executes a GET on when a successful registration event occurs.</p> <p>Note: For a successful registration event, use the associated variables indicated in the table “Action URIs and Associated Variables” on page 5-331.</p> <p>The “Successful Registration” parameter executes on the first successful registration of each unique line configured on the phone.</p>																														

 Aastra Web UI	
4	<p>Enter an XML URI in the “Registration Event” field, for when the phone performs registration. For example:</p> <pre>http://10.30.100.39/PHPtests/ actionuri.php?action=RegEvt&regstate=\$\$REGISTRATIONSTATE\$\$&regcode=\$\$REGISTRATIONCODE\$\$</pre> <p>This parameter specifies the URI that the phone executes a GET on, when a registration event change occurs.</p> <p>Note: For a registration event, use the associated variables indicated in the table “Action URIs and Associated Variables” on page 5-331.</p>
5	<p>Enter an XML URI for an incoming call event in the “Incoming Call” field. For example:</p> <pre>http://10.50.10.140/incoming.php?number=\$\$REMOTENUMBER\$\$</pre> <p>This parameter specifies the URI for which the phone executes a GET on when an incoming call event occurs.</p> <p>Note: For an incoming call event, use the associated variables indicated in the table “Action URIs and Associated Variables” on page 5-331.</p>
6	<p>Enter an XML URI for an outgoing call event in the “Outgoing Call” field. For example:</p> <pre>http://10.50.10.140/outgoing.php?number=\$\$REMOTENUMBER\$\$</pre> <p>This parameter specifies the URI for which the phone executes a GET on when an outgoing call event occurs.</p> <p>Note: For an outgoing call event, use the associated variables indicated in the table “Action URIs and Associated Variables” on page 5-331.</p>
7	<p>Enter an XML URI for an offhook event in the “Offhook” field. For example:</p> <pre>http://10.50.10.140/offhook.php?state=\$\$LINESTATE\$\$</pre> <p>This parameter specifies the URI for which the phone executes a GET on when an offhook event occurs.</p> <p>Note: For an offhook event, use the associated variables indicated in the table “Action URIs and Associated Variables” on page 5-331.</p>

**Aastra Web UI**

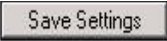
8	<p>Enter an XML URI for an onhook event in the “Onhook” field. For example:</p> <pre>http://10.50.10.140/onhook.php?state=\${LINESTATE\$}</pre> <p>This parameter specifies the URI for which the phone executes a GET on when an onhook event occurs.</p> <p>Note: For an onhook event, use the associated variables indicated in the table “Action URIs and Associated Variables” on page 5-331.</p>
9	To configure a Disconnected event, see the section, “ Action URI Disconnected ” on page 5-341 .
10	To configure an XML SIP Notify event, see the section, “ XML SIP Notify Events ” on page 5-344 .
11	(Optional) You can poll a URI at specific intervals on the phones. For more information about polling Action URIs, see “ Polling Action URIs ” on page 5-339 .
12	Click  to save your changes.

Polling Action URIs

Another way to reach a phone behind a NAT/firewall is to have the phone make an XML call at periodic intervals. An Administrator can use the **action uri poll** parameter that commands the phone to perform an XML call at configurable intervals.

An Administrator can specify the URI to be called and specify the interval between polls using the configuration files or the Aastra Web UI. Configuration of this feature is dynamic (no reboot required).

Configuring Polling Action URI via the Configuration Files

Use the following parameters to configure the polling Action URI on the IP Phones.

- **action uri poll**
- **action uri poll interval**



Configuration Files

For the specific parameter you can set in the configuration files, see Appendix A, the section, "[Polling Action URI Settings](#)" on [page A-163](#).

Configuring Polling Action URI via the Aastra Web UI

Use the following procedure to configure polling Action URI using the Aastra Web UI.

 Aastra Web UI																															
1	<p>Click on Advanced Settings->Action URI.</p> <div style="border: 1px solid black; padding: 10px; margin: 10px 0;"> <table border="1" style="width: 100%; border-collapse: collapse;"> <tr> <td style="background-color: #4F81BD; color: white; width: 25%; vertical-align: top;"> <p>Status System Information</p> <p>Operation User Password Phone Lock Softkeys and XML Programmable Keys Keypad Speed Dial Directory Reset Expansion Module 1</p> <p>Basic Settings Preferences Account Configuration</p> <p>Advanced Settings Network Global SIP Line 1 Line 2 Line 3 Line 4 Line 5 Line 6 Line 7</p> </td> <td style="padding: 10px;"> <p style="text-align: center;">Action URI Configuration</p> <table border="1" style="width: 100%; border-collapse: collapse;"> <thead> <tr style="background-color: #4F81BD; color: white;"> <th style="width: 60%;">Event</th> <th style="width: 40%;"></th> </tr> </thead> <tbody> <tr><td>StartUp</td><td><input type="text"/></td></tr> <tr><td>Successful Registration</td><td><input type="text"/></td></tr> <tr><td>Registration Event</td><td><input type="text"/></td></tr> <tr><td>Incoming Call</td><td><input type="text"/></td></tr> <tr><td>Outgoing Call</td><td><input type="text"/></td></tr> <tr><td>Offhook</td><td><input type="text"/></td></tr> <tr><td>Onhook</td><td><input type="text"/></td></tr> <tr><td>Disconnected</td><td><input type="text"/></td></tr> <tr><td>XML SIP Notify</td><td><input type="text"/></td></tr> </tbody> </table> <table border="1" style="width: 100%; border-collapse: collapse; margin-top: 10px;"> <thead> <tr style="background-color: #4F81BD; color: white;"> <th style="width: 30%;">Event</th> <th style="width: 30%;"></th> <th style="width: 30%;">Settings</th> <th style="width: 10%;"></th> </tr> </thead> <tbody> <tr> <td>Poll</td> <td><input type="text"/></td> <td>Interval</td> <td><input type="text" value="0"/></td> </tr> </tbody> </table> <p style="text-align: center; margin-top: 10px;"><input type="button" value="Save Settings"/></p> </td> </tr> </table> </div>	<p>Status System Information</p> <p>Operation User Password Phone Lock Softkeys and XML Programmable Keys Keypad Speed Dial Directory Reset Expansion Module 1</p> <p>Basic Settings Preferences Account Configuration</p> <p>Advanced Settings Network Global SIP Line 1 Line 2 Line 3 Line 4 Line 5 Line 6 Line 7</p>	<p style="text-align: center;">Action URI Configuration</p> <table border="1" style="width: 100%; border-collapse: collapse;"> <thead> <tr style="background-color: #4F81BD; color: white;"> <th style="width: 60%;">Event</th> <th style="width: 40%;"></th> </tr> </thead> <tbody> <tr><td>StartUp</td><td><input type="text"/></td></tr> <tr><td>Successful Registration</td><td><input type="text"/></td></tr> <tr><td>Registration Event</td><td><input type="text"/></td></tr> <tr><td>Incoming Call</td><td><input type="text"/></td></tr> <tr><td>Outgoing Call</td><td><input type="text"/></td></tr> <tr><td>Offhook</td><td><input type="text"/></td></tr> <tr><td>Onhook</td><td><input type="text"/></td></tr> <tr><td>Disconnected</td><td><input type="text"/></td></tr> <tr><td>XML SIP Notify</td><td><input type="text"/></td></tr> </tbody> </table> <table border="1" style="width: 100%; border-collapse: collapse; margin-top: 10px;"> <thead> <tr style="background-color: #4F81BD; color: white;"> <th style="width: 30%;">Event</th> <th style="width: 30%;"></th> <th style="width: 30%;">Settings</th> <th style="width: 10%;"></th> </tr> </thead> <tbody> <tr> <td>Poll</td> <td><input type="text"/></td> <td>Interval</td> <td><input type="text" value="0"/></td> </tr> </tbody> </table> <p style="text-align: center; margin-top: 10px;"><input type="button" value="Save Settings"/></p>	Event		StartUp	<input type="text"/>	Successful Registration	<input type="text"/>	Registration Event	<input type="text"/>	Incoming Call	<input type="text"/>	Outgoing Call	<input type="text"/>	Offhook	<input type="text"/>	Onhook	<input type="text"/>	Disconnected	<input type="text"/>	XML SIP Notify	<input type="text"/>	Event		Settings		Poll	<input type="text"/>	Interval	<input type="text" value="0"/>
<p>Status System Information</p> <p>Operation User Password Phone Lock Softkeys and XML Programmable Keys Keypad Speed Dial Directory Reset Expansion Module 1</p> <p>Basic Settings Preferences Account Configuration</p> <p>Advanced Settings Network Global SIP Line 1 Line 2 Line 3 Line 4 Line 5 Line 6 Line 7</p>	<p style="text-align: center;">Action URI Configuration</p> <table border="1" style="width: 100%; border-collapse: collapse;"> <thead> <tr style="background-color: #4F81BD; color: white;"> <th style="width: 60%;">Event</th> <th style="width: 40%;"></th> </tr> </thead> <tbody> <tr><td>StartUp</td><td><input type="text"/></td></tr> <tr><td>Successful Registration</td><td><input type="text"/></td></tr> <tr><td>Registration Event</td><td><input type="text"/></td></tr> <tr><td>Incoming Call</td><td><input type="text"/></td></tr> <tr><td>Outgoing Call</td><td><input type="text"/></td></tr> <tr><td>Offhook</td><td><input type="text"/></td></tr> <tr><td>Onhook</td><td><input type="text"/></td></tr> <tr><td>Disconnected</td><td><input type="text"/></td></tr> <tr><td>XML SIP Notify</td><td><input type="text"/></td></tr> </tbody> </table> <table border="1" style="width: 100%; border-collapse: collapse; margin-top: 10px;"> <thead> <tr style="background-color: #4F81BD; color: white;"> <th style="width: 30%;">Event</th> <th style="width: 30%;"></th> <th style="width: 30%;">Settings</th> <th style="width: 10%;"></th> </tr> </thead> <tbody> <tr> <td>Poll</td> <td><input type="text"/></td> <td>Interval</td> <td><input type="text" value="0"/></td> </tr> </tbody> </table> <p style="text-align: center; margin-top: 10px;"><input type="button" value="Save Settings"/></p>	Event		StartUp	<input type="text"/>	Successful Registration	<input type="text"/>	Registration Event	<input type="text"/>	Incoming Call	<input type="text"/>	Outgoing Call	<input type="text"/>	Offhook	<input type="text"/>	Onhook	<input type="text"/>	Disconnected	<input type="text"/>	XML SIP Notify	<input type="text"/>	Event		Settings		Poll	<input type="text"/>	Interval	<input type="text" value="0"/>		
Event																															
StartUp	<input type="text"/>																														
Successful Registration	<input type="text"/>																														
Registration Event	<input type="text"/>																														
Incoming Call	<input type="text"/>																														
Outgoing Call	<input type="text"/>																														
Offhook	<input type="text"/>																														
Onhook	<input type="text"/>																														
Disconnected	<input type="text"/>																														
XML SIP Notify	<input type="text"/>																														
Event		Settings																													
Poll	<input type="text"/>	Interval	<input type="text" value="0"/>																												
2	In the "Poll" field, enter a URI to be called every "action uri pool interval" seconds. Enter the value in a URI format. For example, http://myserver.com/myappli.xml .																														
3	In the "Interval" field, enter the interval, in seconds, between calls from the phone to the "action uri poll". The value of "0" is disabled.																														
4	Click <input type="button" value="Save Settings"/> to save your changes.																														

Action URI Disconnected

The phones have a parameter, “**action uri disconnected**” that allow a disconnect event to occur when the phone transitions from any active state (outgoing, incoming, connected, or calling) to an idle state. This parameter can use the variable “**\$\$LINESTATE\$\$**”.



Note: The **\$\$LINESTATE\$\$** variable is optional and not required when enabling the “**action uri disconnected**” parameter.

If the Administrator enables this feature (by specifying a disconnect URI), when a call is disconnected, the phone checks to see if the event has a Disconnect URI configured. If the phones finds a configured URI with a **\$\$LINESTATE\$\$** variable, it replaces the **\$\$LINESTATE\$\$** variable with the appropriate line state of the current active line. After all of the variables are bound, the phone executes a GET on the URI. The following table lists the applicable values for the **\$\$LINESTATE\$\$** variable.

\$\$LINESTATE\$\$ Value	Description	Meaning in a Disconnected URI
IDLE	Phone is idle.	N/A
DIALING	Phone is offhook and ready to dial.	N/A
CALLING	A SIP INVITE was sent but no response was received.	Error occurred during the call.
OUTGOING	Remote party is ringing.	Call was cancelled.
INCOMING	Local phone is ringing.	Call was missed or cancelled.
CONNECTED	Parties are talking.	Call was successful.
CLEARING	Call was released but not acknowledged.	N/A

The Action URI Disconnect feature allows an Administrator to determine the reason for the disconnect if required.



Note: If you enable the Action URI Disconnect feature by specifying a URI, the URI is called when any disconnect event occurs including an intercom call or a conference setup.

Example

If you enter the following string on Phone A for the “**action uri disconnected**” parameter:

```
action uri disconnected: http://fargo.ana.aastra.com/  
disconnected.xml?state=$$LINESTATE$$
```

and then Phone A calls Phone B, Phone B answers and then hangs up, Phone A executes a GET on:

```
http://fargo.ana.aastra.com/disconnected.xml?state=CONNECTED
```

which is what the remote server receives.



Note: If the phone can't find the Action URI you specify, it returns a “NULL” response. For example,

```
http://fargo.ana.aastra.com/disconnected.xml?state=
```

An Administrator can enable the disconnect feature using the configuration files or the Aastra Web UI.

Configuring the Action URI Disconnected Feature

Use the following procedure to configure the Action URI Disconnected feature on the phone.



Configuration Files

For specific parameters you can set in the configuration files, see Appendix A, the section, “[Action URI Settings](#)” on [page A-156](#).

Aastra Web UI

1

Click on **Advanced Settings->Action URI->Event.**

Status

System Information

Operation

User Password

Phone Lock

Keypad Speed Dial

Directory

Reset

Basic Settings

Preferences

Account Configuration

Advanced Settings

Network

Global SIP

Action URI

Configuration Server

Firmware Update

TLS Support

802.1x Support

Troubleshooting

Action URI Configuration

Event	Settings
StartUp	<input type="text"/>
Successful Registration	<input type="text"/>
Incoming Call	<input type="text"/>
Outgoing Call	<input type="text"/>
Offhook	<input type="text"/>
Onhook	<input type="text"/>
Disconnected	<input "="" type="text" value="http://fargo.ana.aastra.com/disconnected.xml?state="/>
XML SIP Notify	<input type="text"/>

Event	Settings	Interval
Poll	<input type="text"/>	<input type="text"/>

2

In the **“Disconnected”** field, enter a valid URI for which the phone executes a GET on, when it transitions from the incoming, outgoing, calling, or connected state into the idle state. Leaving this field empty disables the Action URI Disconnected feature. For example,

[http://fargo.ana.aastra.com/disconnected.xml?state=\\$\\$LINESTATE\\$\\$](http://fargo.ana.aastra.com/disconnected.xml?state=$$LINESTATE$$)

The following table lists the applicable values and descriptions for the \$\$LINESTATE\$\$.

\$\$LINESTATE\$\$ Value	Description	Meaning in a Disconnected URI
IDLE	Phone is idle.	N/A
DIALING	Phone is offhook and ready to dial.	N/A
CALLING	A SIP INVITE was sent but no response was received.	Error occurred during the call.
OUTGOING	Remote party is ringing.	Call was cancelled.
INCOMING	Local phone is ringing.	Call was missed or cancelled.
CONNECTED	Parties are talking.	Call was successful.
CLEARING	Call was released but not acknowledged.	N/A

3

Click to save your settings.

41-001160-03 Rev 00, Release 2.5

5-343

XML SIP Notify Events

In order for an XML push to bypass the NAT/firewall, the phone supports a proprietary SIP NOTIFY event (aastra-xml) with or without XML content. An Administrator can enable/disable the SIP NOTIFY event using a specific parameter in the configuration files (**sip xml notify event**) or the Aastra Web UI (**XML SIP Notify**).

If XML content is provided in the SIP NOTIFY, it is processed directly by the phone as it is done for an XML PUSH.

If the content is empty in the SIP NOTIFY, the phone automatically triggers a new pre-configured action uri (**action uri xml sip notify**).

Example of a SIP NOTIFY with XML Content

```
NOTIFY sip:200@10.30.100.103:5060 SIP/2.0
Via: SIP/2.0/UDP 10.30.100.103:5060;branch=z9hG4bK7bbc1fac;rport
From: <sip:201@10.30.100.103:5060>;tag=81be2861f3
To: Jacky200 <sip:200@10.30.100.103:5060>
Contact: <sip:201@10.30.100.103>
Call-ID: 59638f5d95c9d301
CSeq: 4 NOTIFY
Max-Forwards: 70
Event: aastra-xml
Content-Type: application/xml
Content-Length: 115
<AastraIPPhoneExecute><ExecuteItem URI="http://10.30.100.39/XMLtests/
SampleTextScreen.xml" /></AastraIPPhoneExecute>
```

When the phone receives the SIP NOTIFY, the XML content is processed as any XML object. In the above example, the phone calls <http://10.30.100.39/XMLtests/SampleTextScreen.xml> after reception of the SIP NOTIFY.



Note: The phone supports all the current XML objects with all the existing limitations. For example if an AastraIPPhoneExecute is used, the embedded URI(s) can not be HTTPS based.

Example of a SIP NOTIFY without XML Content

```
NOTIFY sip:200@10.30.100.103:5060 SIP/2.0
Via: SIP/2.0/UDP 10.30.100.103:5060;branch=z9hG4bK7bbc1fac;rport
From: <sip:201@10.30.100.103:5060>;tag=81be2861f3
To: Jacky200 <sip:200@10.30.100.103:5060>
Contact: <sip:201@10.30.100.103>
Call-ID: 59638f5d95c9d301
CSeq: 4 NOTIFY
Max-Forwards: 70
Event: aastra-xml
Content-Type: application/xml
Content-Length: 0
```

When the phone receives the SIP NOTIFY, it will trigger the **action uri xml sip notify** parameter, if it has been previously configured using the configuration files or the Aastra Web UI. If the **action uri xml sip notify** parameter is not configured, the phone does not do anything.

On the phone side, a System Administrator can enable or disable this SIP NOTIFY feature using the configuration files or the phone Web UI.

Also to ensure that the SIP NOTIFY is coming from a trusted source, it is recommended that you enable the Whitelist feature (Whitelist Proxy parameter) on the IP phone. If enabled, and the phone receives a SIP NOTIFY from a server that is NOT on the whitelist, the phone rejects the message.

Enabling/Disabling XML SIP NOTIFY using the Configuration Files

To enable/disable the SIP NOTIFY event, you can set the following parameter in the configuration files:

- **sip xml notify event**

If the content is missing in the SIP NOTIFY message received by the phone, the phone automatically uses the value you specify for the following parameter:

- **action uri xml sip notify**



Configuration Files

For the specific parameter you can set in the configuration files, see Appendix A, the section, "[Polling Action URI Settings](#)" on [page A-163](#).

Enabling/Disabling XML SIP NOTIFY Using the Aastra Web UI

Use the following procedure to enable/disable the XML SIP NOTIFY feature in the Aastra Web UI.

Aastra Web UI

Enabling/Disabling the XML SIP NOTIFY Feature

1 Click on **Advanced Settings->Global SIP->Advanced SIP Settings**.

Status

System Information

Operation

User Password

Phone Lock

Softkeys and XML

Directory

Reset

Basic Settings

Preferences

Account Configuration

Advanced Settings

Network

Global SIP

Line 1

Line 2

Line 3

Line 4

Line 5

Line 6

Line 7

Line 8

Line 9

Action URI

Configuration Server

Firmware Update

TLS Support

002 fx Support

Troubleshooting

Global SIP Settings

Advanced SIP Settings

Explicit MWI Subscription Enabled

Explicit MWI Subscription Period

Missed Call Summary Subscription Enabled

Missed Call Summary Subscription Period

AS-Feature-Event Subscription Period

Send MAC Address in REGISTER Message Enabled

Send Line Number in REGISTER Message Enabled

Session Timer

T1 Timer

T2 Timer

Transaction Timer

Transport Protocol

Local SIP UDP/TCP Port

Local SIP TLS Port

Registration Failed Retry Timer

Registration Timeout Retry Timer

Registration Renewal Timer

BLF Subscription Period

ACD Subscription Period

Blacklist Duration

Whitelist Proxy Enabled

XML SIP Notify Enabled

XML SIP Notify Parameter

Enabling Whitelist Proxy is recommended

**Aastra Web UI**

2	<p>The “XML SIP Notify” field is disabled by default. To enable this field, check the box.</p> <p>This field enables or disables the phone to accept or reject an aastra-xml SIP NOTIFY message.</p> <p>Note: To ensure the SIP NOTIFY is coming from a trusted source, it is recommended that you enable the Whitelist feature (Whitelist Proxy parameter) on the IP phone. If enabled, and the phone receives a SIP NOTIFY from a server that is NOT on the whitelist (i.e. untrusted server), the phone rejects the message.</p>
3	<p>Click  to save your changes.</p>

Configuring XML SIP NOTIFY using the Aastra Web UI if an Empty SIP NOTIFY Message Received by the Phone

Use the following procedure in the Aastra Web UI to configure the XML SIP NOTIFY parameter when the phone receives an empty SIP NOTIFY message.

Aastra Web UI

1 If the content is missing in the SIP NOTIFY message received by the phone, the phone automatically uses the value you specify for the Action URI **XML SIP Notify** parameter at the path *Advanced Settings->Action URI*.

Click on **Advanced Settings->Action URI**.

<p>Status</p> <p>System Information</p> <p>Operation</p> <p>User Password</p> <p>Phone Lock</p> <p>Softkeys and XML</p> <p>Programmable Keys</p> <p>Keypad Speed Dial</p> <p>Directory</p> <p>Reset</p> <p>Expansion Module 1</p> <p>Basic Settings</p> <p>Preferences</p> <p>Account Configuration</p> <p>Advanced Settings</p> <p>Network</p> <p>Global SIP</p> <p>Line 1</p> <p>Line 2</p> <p>Line 3</p> <p>Line 4</p> <p>Line 5</p> <p>Line 6</p> <p>Line 7</p> <p>Line 8</p>	<p>Action URI Configuration</p> <table style="width: 100%; border-collapse: collapse;"> <thead> <tr style="background-color: #D9E1F2;"> <th style="text-align: left;">Event</th> <th style="width: 50%;"></th> </tr> </thead> <tbody> <tr><td>StartUp</td><td><input type="text"/></td></tr> <tr><td>Successful Registration</td><td><input type="text"/></td></tr> <tr><td>Registration Event</td><td><input type="text"/></td></tr> <tr><td>Incoming Call</td><td><input type="text"/></td></tr> <tr><td>Outgoing Call</td><td><input type="text"/></td></tr> <tr><td>Offhook</td><td><input type="text"/></td></tr> <tr><td>Onhook</td><td><input type="text"/></td></tr> <tr><td>Disconnected</td><td><input type="text"/></td></tr> <tr><td>XML SIP Notify</td><td><input type="text"/></td></tr> </tbody> </table> <table style="width: 100%; border-collapse: collapse; margin-top: 5px;"> <thead> <tr style="background-color: #D9E1F2;"> <th style="text-align: left;">Event</th> <th style="width: 30%;"></th> <th style="text-align: left;">Settings</th> <th style="width: 10%;"></th> </tr> </thead> <tbody> <tr> <td>Poll</td> <td><input type="text"/></td> <td>Interval</td> <td><input type="text" value="0"/></td> </tr> </tbody> </table> <p style="text-align: center; margin-top: 5px;"><input type="button" value="Save Settings"/></p>	Event		StartUp	<input type="text"/>	Successful Registration	<input type="text"/>	Registration Event	<input type="text"/>	Incoming Call	<input type="text"/>	Outgoing Call	<input type="text"/>	Offhook	<input type="text"/>	Onhook	<input type="text"/>	Disconnected	<input type="text"/>	XML SIP Notify	<input type="text"/>	Event		Settings		Poll	<input type="text"/>	Interval	<input type="text" value="0"/>
Event																													
StartUp	<input type="text"/>																												
Successful Registration	<input type="text"/>																												
Registration Event	<input type="text"/>																												
Incoming Call	<input type="text"/>																												
Outgoing Call	<input type="text"/>																												
Offhook	<input type="text"/>																												
Onhook	<input type="text"/>																												
Disconnected	<input type="text"/>																												
XML SIP Notify	<input type="text"/>																												
Event		Settings																											
Poll	<input type="text"/>	Interval	<input type="text" value="0"/>																										

XML SIP Notify Parameter

2 Specify a URI to be called when an empty XML SIP NOTIFY is received by the phone.

For example:
http://myserver.com/myappli.xml

Note: The **sip xml notify event** parameter at the path *Advanced Settings->Global SIP->Advanced SIP Settings* must be enabled.

3 Click to save your changes.

XML Softkey URI

In addition to specifying variables for the Action URIs, you can also specify variables in the XML softkey URIs that are bound when the key is pressed. These variables are the same as those used in the Action URIs.

When an administrator enters an XML softkey URI either via the Aastra Web UI or the configuration files, they can specify the following variables:

- \$\$SIPUSERNAME\$\$
- \$\$SIPAUTHNAME\$\$
- \$\$PROXYURL\$\$
- \$\$LINESTATE\$\$
- \$\$LOCALIP\$\$
- \$\$REMOTENUMBER\$\$
- \$\$DISPLAYNAME\$\$
- \$\$SIPUSERNAME\$\$
- \$\$INCOMINGNAME\$\$
- \$\$CALLDURATION\$\$
- \$\$CALLDIRECTION\$\$



Note: For a description of each variable in the above list, see [“Variable Descriptions”](#) on [page 5-332](#).

When the softkey is pressed, if the phone finds a URI configured with variables (in the form \$\$VARIABLENAME\$\$), they are replaced with the value of the appropriate variable. After all of the variables are bound, the softkey executes a GET on the URI.

Example

For example, if the administrator specifies an XML softkey with the value:

```
http://10.50.10.140/script.pl?name=$$SIPUSERNAME$$
```

This softkey executes a GET on:

```
http://10.50.10.140/script.pl?name=42512
```

assuming that the sip username of the specific line is 42512.

You can configure the XML softkey URI variables via the configuration files or the Aastra Web UI.

Configuring XML Softkey URIs

Use the following procedures to configure XML Softkey URIs using the configuration files or the Aastra Web UI.



Configuration Files

For specific parameters you can set in the configuration files, see Appendix A, the section, [“Softkey/Programmable Key/Feature Key/Expansion Module Key Parameters”](#) on [page A-216](#).

Aastra Web UI

For 8 and 11-Line LCD phones:

1 Click on **Operation->Softkeys and XML.**

Status

- System Information

Operation

- User Password
- Phone Lock
- Softkeys and XML
- Programmable Keys
- Directory
- Reset

Basic Settings

- Preferences
- Account Configuration

Advanced Settings

- Network
- Global SIP
- Line 1
- Line 2
- Line 3
- Line 4
- Line 5
- Line 6
- Line 7
- Line 8
- Line 9
- Action URI
- Configuration Server
- Firmware Update
- TLS Support
- 802.1x Support
- Troubleshooting

Softkeys Configuration

Key	Type	Label	Value	Line	Idle	Connected	Incoming	Outgoing	Busy
1	Directory		44455	5	<input checked="" type="checkbox"/>	<input checked="" type="checkbox"/>	<input checked="" type="checkbox"/>	<input checked="" type="checkbox"/>	<input checked="" type="checkbox"/>
2	None			5	<input checked="" type="checkbox"/>	<input checked="" type="checkbox"/>	<input checked="" type="checkbox"/>	<input checked="" type="checkbox"/>	<input checked="" type="checkbox"/>
3	Speeddial	Lab	222222	7	<input checked="" type="checkbox"/>	<input checked="" type="checkbox"/>	<input checked="" type="checkbox"/>	<input checked="" type="checkbox"/>	<input checked="" type="checkbox"/>
4	None			1	<input checked="" type="checkbox"/>	<input checked="" type="checkbox"/>	<input checked="" type="checkbox"/>	<input checked="" type="checkbox"/>	<input checked="" type="checkbox"/>
5	None			1	<input checked="" type="checkbox"/>	<input checked="" type="checkbox"/>	<input checked="" type="checkbox"/>	<input checked="" type="checkbox"/>	<input checked="" type="checkbox"/>
6	None			1	<input checked="" type="checkbox"/>	<input checked="" type="checkbox"/>	<input checked="" type="checkbox"/>	<input checked="" type="checkbox"/>	<input checked="" type="checkbox"/>
7	None			1	<input checked="" type="checkbox"/>	<input checked="" type="checkbox"/>	<input checked="" type="checkbox"/>	<input checked="" type="checkbox"/>	<input checked="" type="checkbox"/>
8	None			1	<input checked="" type="checkbox"/>	<input checked="" type="checkbox"/>	<input checked="" type="checkbox"/>	<input checked="" type="checkbox"/>	<input checked="" type="checkbox"/>
9	None			1	<input checked="" type="checkbox"/>	<input checked="" type="checkbox"/>	<input checked="" type="checkbox"/>	<input checked="" type="checkbox"/>	<input checked="" type="checkbox"/>
10	None			1	<input checked="" type="checkbox"/>	<input checked="" type="checkbox"/>	<input checked="" type="checkbox"/>	<input checked="" type="checkbox"/>	<input checked="" type="checkbox"/>
11	None			1	<input checked="" type="checkbox"/>	<input checked="" type="checkbox"/>	<input checked="" type="checkbox"/>	<input checked="" type="checkbox"/>	<input checked="" type="checkbox"/>
12	None			1	<input checked="" type="checkbox"/>	<input checked="" type="checkbox"/>	<input checked="" type="checkbox"/>	<input checked="" type="checkbox"/>	<input checked="" type="checkbox"/>
13	None			1	<input checked="" type="checkbox"/>	<input checked="" type="checkbox"/>	<input checked="" type="checkbox"/>	<input checked="" type="checkbox"/>	<input checked="" type="checkbox"/>
14	None			1	<input checked="" type="checkbox"/>	<input checked="" type="checkbox"/>	<input checked="" type="checkbox"/>	<input checked="" type="checkbox"/>	<input checked="" type="checkbox"/>
15	None			1	<input checked="" type="checkbox"/>	<input checked="" type="checkbox"/>	<input checked="" type="checkbox"/>	<input checked="" type="checkbox"/>	<input checked="" type="checkbox"/>
16	None			1	<input checked="" type="checkbox"/>	<input checked="" type="checkbox"/>	<input checked="" type="checkbox"/>	<input checked="" type="checkbox"/>	<input checked="" type="checkbox"/>
17	None			1	<input checked="" type="checkbox"/>	<input checked="" type="checkbox"/>	<input checked="" type="checkbox"/>	<input checked="" type="checkbox"/>	<input checked="" type="checkbox"/>
18	None			1	<input checked="" type="checkbox"/>	<input checked="" type="checkbox"/>	<input checked="" type="checkbox"/>	<input checked="" type="checkbox"/>	<input checked="" type="checkbox"/>
19	None			1	<input checked="" type="checkbox"/>	<input checked="" type="checkbox"/>	<input checked="" type="checkbox"/>	<input checked="" type="checkbox"/>	<input checked="" type="checkbox"/>
20	None			1	<input checked="" type="checkbox"/>	<input checked="" type="checkbox"/>	<input checked="" type="checkbox"/>	<input checked="" type="checkbox"/>	<input checked="" type="checkbox"/>

Services

XML Application URI:

XML Application Title:

BLF List URI:

2 Select a key from keys 1 through 20.

3 In the "**Type**" field, select **XML** from the list box.

4 In the "**Label**" field, enter a label that displays on the IP phone for the XML softkey. For example, "**aastra**".

5-352

41-001160-03 Rev 00, Release 2.5

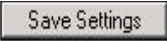

Aastra Web UI

5	<p>In the "Value" field, enter the URI that the phone performs a GET on when the key is pressed. For example:</p> <pre>http://10.50.10.140/script.pl?name=\$\$SIPUSERNAME\$\$</pre> <p>Note: You can use the following variables in the URI:</p> <ul style="list-style-type: none">• \$\$SIPUSERNAME\$\$• \$\$SIPAUTHNAME\$\$• \$\$PROXYURL\$\$• \$\$LINESTATE\$\$• \$\$LOCALIP\$\$• \$\$REMOTENUMBER\$\$• \$\$DISPLAYNAME\$\$• \$\$SIPUSERNAME\$\$• \$\$INCOMINGNAME\$\$• \$\$CALLDURATION\$\$• \$\$CALLDIRECTION\$\$
6	<p>Click  to save your changes.</p>

Aastra Web UI

For 3-Line LCD phones (not applicable to 6751i):

1	<p>Click on Operation->Programmable Keys.</p> <p>6753i Screen</p> <div style="border: 1px solid black; padding: 5px; margin: 10px 0;"> <table style="width: 100%; border-collapse: collapse;"> <tr> <td style="width: 25%; background-color: #D9E1F2; vertical-align: top; padding: 2px;"> <ul style="list-style-type: none"> Status System Information Operation User Password Phone Lock Programmable Keys Directory Reset Basic Settings Preferences Account Configuration Advanced Settings Network Global SIP Line 1 Line 2 Line 3 Line 4 Line 6 </td> <td style="padding: 2px;"> <p style="text-align: center;">Programmable Keys Configuration</p> <table border="1" style="width: 100%; border-collapse: collapse;"> <thead> <tr style="background-color: #D9E1F2;"> <th style="width: 10%;">Key</th> <th style="width: 15%;">Hard Key</th> <th style="width: 55%;">Value</th> <th style="width: 20%;">Line</th> </tr> </thead> <tbody> <tr> <td style="text-align: center;">1</td> <td style="text-align: center;">Save</td> <td><input type="text"/></td> <td style="text-align: center;">global</td> </tr> <tr> <td style="text-align: center;">2</td> <td style="text-align: center;">Delete</td> <td><input type="text"/></td> <td style="text-align: center;">global</td> </tr> <tr> <td style="text-align: center;">3</td> <td style="text-align: center;">Directory</td> <td><input type="text"/></td> <td style="text-align: center;">1</td> </tr> <tr> <td style="text-align: center;">4</td> <td style="text-align: center;">Callers List</td> <td><input type="text"/></td> <td style="text-align: center;">1</td> </tr> <tr> <td style="text-align: center;">5</td> <td style="text-align: center;">Transfer</td> <td><input type="text"/></td> <td style="text-align: center;">global</td> </tr> <tr> <td style="text-align: center;">6</td> <td style="text-align: center;">Conference</td> <td><input type="text"/></td> <td style="text-align: center;">global</td> </tr> </tbody> </table> <p style="margin-top: 5px;">Services</p> <p>BLF List URI: <input style="width: 150px;" type="text"/></p> <p style="text-align: center; margin-top: 5px;"><input type="button" value="Save Settings"/></p> </td> </tr> </table> </div>	<ul style="list-style-type: none"> Status System Information Operation User Password Phone Lock Programmable Keys Directory Reset Basic Settings Preferences Account Configuration Advanced Settings Network Global SIP Line 1 Line 2 Line 3 Line 4 Line 6 	<p style="text-align: center;">Programmable Keys Configuration</p> <table border="1" style="width: 100%; border-collapse: collapse;"> <thead> <tr style="background-color: #D9E1F2;"> <th style="width: 10%;">Key</th> <th style="width: 15%;">Hard Key</th> <th style="width: 55%;">Value</th> <th style="width: 20%;">Line</th> </tr> </thead> <tbody> <tr> <td style="text-align: center;">1</td> <td style="text-align: center;">Save</td> <td><input type="text"/></td> <td style="text-align: center;">global</td> </tr> <tr> <td style="text-align: center;">2</td> <td style="text-align: center;">Delete</td> <td><input type="text"/></td> <td style="text-align: center;">global</td> </tr> <tr> <td style="text-align: center;">3</td> <td style="text-align: center;">Directory</td> <td><input type="text"/></td> <td style="text-align: center;">1</td> </tr> <tr> <td style="text-align: center;">4</td> <td style="text-align: center;">Callers List</td> <td><input type="text"/></td> <td style="text-align: center;">1</td> </tr> <tr> <td style="text-align: center;">5</td> <td style="text-align: center;">Transfer</td> <td><input type="text"/></td> <td style="text-align: center;">global</td> </tr> <tr> <td style="text-align: center;">6</td> <td style="text-align: center;">Conference</td> <td><input type="text"/></td> <td style="text-align: center;">global</td> </tr> </tbody> </table> <p style="margin-top: 5px;">Services</p> <p>BLF List URI: <input style="width: 150px;" type="text"/></p> <p style="text-align: center; margin-top: 5px;"><input type="button" value="Save Settings"/></p>	Key	Hard Key	Value	Line	1	Save	<input type="text"/>	global	2	Delete	<input type="text"/>	global	3	Directory	<input type="text"/>	1	4	Callers List	<input type="text"/>	1	5	Transfer	<input type="text"/>	global	6	Conference	<input type="text"/>	global
<ul style="list-style-type: none"> Status System Information Operation User Password Phone Lock Programmable Keys Directory Reset Basic Settings Preferences Account Configuration Advanced Settings Network Global SIP Line 1 Line 2 Line 3 Line 4 Line 6 	<p style="text-align: center;">Programmable Keys Configuration</p> <table border="1" style="width: 100%; border-collapse: collapse;"> <thead> <tr style="background-color: #D9E1F2;"> <th style="width: 10%;">Key</th> <th style="width: 15%;">Hard Key</th> <th style="width: 55%;">Value</th> <th style="width: 20%;">Line</th> </tr> </thead> <tbody> <tr> <td style="text-align: center;">1</td> <td style="text-align: center;">Save</td> <td><input type="text"/></td> <td style="text-align: center;">global</td> </tr> <tr> <td style="text-align: center;">2</td> <td style="text-align: center;">Delete</td> <td><input type="text"/></td> <td style="text-align: center;">global</td> </tr> <tr> <td style="text-align: center;">3</td> <td style="text-align: center;">Directory</td> <td><input type="text"/></td> <td style="text-align: center;">1</td> </tr> <tr> <td style="text-align: center;">4</td> <td style="text-align: center;">Callers List</td> <td><input type="text"/></td> <td style="text-align: center;">1</td> </tr> <tr> <td style="text-align: center;">5</td> <td style="text-align: center;">Transfer</td> <td><input type="text"/></td> <td style="text-align: center;">global</td> </tr> <tr> <td style="text-align: center;">6</td> <td style="text-align: center;">Conference</td> <td><input type="text"/></td> <td style="text-align: center;">global</td> </tr> </tbody> </table> <p style="margin-top: 5px;">Services</p> <p>BLF List URI: <input style="width: 150px;" type="text"/></p> <p style="text-align: center; margin-top: 5px;"><input type="button" value="Save Settings"/></p>	Key	Hard Key	Value	Line	1	Save	<input type="text"/>	global	2	Delete	<input type="text"/>	global	3	Directory	<input type="text"/>	1	4	Callers List	<input type="text"/>	1	5	Transfer	<input type="text"/>	global	6	Conference	<input type="text"/>	global		
Key	Hard Key	Value	Line																												
1	Save	<input type="text"/>	global																												
2	Delete	<input type="text"/>	global																												
3	Directory	<input type="text"/>	1																												
4	Callers List	<input type="text"/>	1																												
5	Transfer	<input type="text"/>	global																												
6	Conference	<input type="text"/>	global																												
2	On 3-Line LCD phones (not applicable to 6751i), select an available key.																														
3	In the " Type " field, select XML from the list box.																														
4	On 3-Line LCD phones (not applicable to 6751i), in the " Label " field, enter a label that displays on the IP phone for the XML softkey. For example, " aastra ".																														

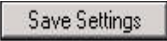

Aastra Web UI

5	<p>In the "Value" field, enter the URI that the phone performs a GET on when the key is pressed. For example:</p> <pre>http://10.50.10.140/script.pl?name=\$\$SIPUSERNAME\$\$</pre> <p>Note: You can use the following variables in the URI:</p> <ul style="list-style-type: none">• \$\$SIPUSERNAME\$\$• \$\$SIPAUTHNAME\$\$• \$\$PROXYURL\$\$• \$\$LINESTATE\$\$• \$\$LOCALIP\$\$• \$\$REMOTENUMBER\$\$• \$\$DISPLAYNAME\$\$• \$\$SIPUSERNAME\$\$• \$\$INCOMINGNAME\$\$• \$\$CALLDURATION\$\$• \$\$CALLDIRECTION\$\$
6	<p>Click  to save your changes.</p>

XML Key Redirection

The IP phones allow the redirecting of phone-based hard keys to XML scripts. This allows the server to provide the phone with Redial, Transfer (Xfer), Conference (Conf), and Intercom (Icom) key features, and the Voicemail option feature, rather than accessing them from the phone-side. This feature allows you to access the redirected keys and voicemail option from the server using the IP Phone's Services Menu. By default, the server-side keys function the same as the phone-side key features.

The following table identifies the phone states that apply to each key redirection.

Hard Keys/Options	Redirects in
Conference (Conf)	the connected state
Transfer (Xfer)	the connected and dialing states
Redial	all states
Intercom (Icom)	all states
Voicemail	all states



Notes:

1. If XML key redirection is enabled on the 6751i., the **Xfer** and **Conf** menu items perform redirection.
 2. Key remapping takes precedence over redirecting.
 3. Disabling the redial, conference, or transfer features on the phone also disables the redirection of these keys.
-

The following URI configuration parameters control the redirection of the keys and the voicemail option:

- **redial script**
- **xfer script**
- **conf script**
- **icom script**
- **voicemail script**

An Administrator can configure the XML key, redirection URI parameters using the configuration files only.

Configuring XML Redirection of the Redial, Xfer, Conf, and Icom Keys, and the Voicemail Option

Use the following procedure to configure XML redirection of the Redial, Xfer, Conf, and Icom keys, and the Voicemail option.



Configuration Files

For the specific parameters you can set in the configuration files, see Appendix A, the section, “[XML Key Redirection Settings \(for Redial, Xfer, Conf, Icom, Voicemail\)](#)” on [page A-262](#).

Options Key Redirection

(for Options Menu on all phones and Services Menu on 6751i)

The IP phones allow the redirecting of the Options Key (Options Menu on all phones and Services Menu on the 6751i) to an XML script. This allows the server to provide the phone with available options, rather than accessing them from the phone-side. You access the Options Key XML script by pressing the Options Key. You can still access the Options Menu from the phone-side by pressing and holding the Options key to display the phone-side Options Menu.

The following URI configuration parameter controls the redirection of the Options Key:

- **options script**

IMPORTANT NOTES

- If no Options URI script is configured, the local Options Menu on the phone displays as normal.
- If you configure password access to the Options Menu, this password is required when accessing the local Option Menu, but is not required for the Options Key redirection feature.
- Pressing the Options Menu for redirection from the server does not interfere with normal operations of the phone (for example, pressing the options menu when on a call does not affect the call).
- If the phone is locked, you must unlock the phone before accessing the Options Menu redirect feature. After pressing the Options Key, the phone displays a screen that allows you to unlock the phone before continuing.

- On the 6751i, the redirection feature works after selecting “Options” from the Services Menu. To display the original Options Menu, press and hold the Services key.

An Administrator can configure the XML Options Key (or Services Key on the 6751i), redirection URI parameter using the configuration files only.

Configuring XML Redirection of the Options Key (Services Key on the 6751i)

Use the following procedure to configure XML redirection of the Options key (Services key on 6751i).



Configuration Files

For the specific parameter you can set in the configuration files, see Appendix A, the section, “[Options Key Redirection Setting \(Services key on 6751i\)](#)” on [page A-264](#).

XML Applications and Off-Hook Interaction

A feature on the IP phone allows you to specify whether the phone is prevented from going into the off-hook/dialing state when the handset is off-hook and the call ends.

By default, the phone behaves as follows:

You are in a call using the handset and the phone displays an XML application. The far-end terminates the call, and a new XML application gets pushed/pulled onto the display. Since the handset is off-hook and in idle mode, the "offhook idle timer" starts. When this timer expires, the phone applies dial tone and moves to the off-hook/dialing state, which then destroys the XML application that was being displayed.

With the "off-hook interaction" feature you can set an "**auto offhook**" parameter that determines whether or not the phone is prevented from entering the off-hook/dialing state, if the handset is off-hook and the call ends.

An Administrator can enable (allow phone to enter the off-hook dialing state) or disable (prevent the phone from entering the off-hook dialing state) using the "**auto offhook**" parameter in the configuration files only.

Configuring the Off-Hook Interaction Feature

Use the following procedure to configure the XML application and off-hook interaction feature.



Configuration Files

For the specific parameter you can set in the configuration files, see Appendix A, the section, "[Off-Hook and XML Application Interaction Setting](#)" on [page A-264](#).

XML URI for Key Press Simulation

The Phones provide a feature that allow an XML Developer or Administrator to define XML Key URIs that can send key press events to the phone, just as if the physical hard key, softkey, or programmable key were pressed on the phone.

For more information about this feature, see [Appendix F](#), the section, "[XML URI for Key Press Simulation](#)" on [page F-60](#).

XML Override for a Locked Phone

The IP phones have a feature that allows a locked phone to be overridden when an XML application is sent to the phone. This feature also allows you to still use any softkeys/programmable key/Extension Module Keys applicable to the XML application even though the phone is locked. However, any keys NOT associated with the XML application cannot be used when the phone is locked.

Also, XML Get Requests override the locked feature on the phone so that any softkey pressed by the user that initiates a Get Request continues to get sent.

To allow the overriding of the locked phone for XML applications, the System Administrator must enter the following parameter in the configuration files:

- **xml lock override**

Configuring XML Override for a Locked Phone using the Configuration Files



Configuration Files

For the specific parameter you can set in the configuration files, see Appendix A, the section, “[XML Override for a Locked Phone Setting](#)” on [page A-265](#).



Note: A System Administrator can also lock and unlock a remote phone using the “**lock**” and “**unlock**” commands with the **AastraIPPhoneExecute** object in an XML application. For more information about this feature, contact Aastra Customer Support regarding the “Aastra XML Development Guide.”

Audio Transmit and Receive Gain Adjustments

The audio gain properties for the IP phone handset, headset, and speakerphone is adjusted to reduce side-tone and echo on the local and far-end equipment. You can adjust these settings from -10 db to +10 db to best suit your comfort level and deployment environment by using the following parameters in the configuration files:

- **headset tx gain**
- **headset sidetone gain**
- **handset tx gain**
- **handset sidetone gain**
- **handsfree tx gain**
- **audio mode**

The default setting for these parameters is 0 (zero).



Note: Aastra Telecom recommends you leave the default of 0 (zero) as the settings for these parameters.

The following table describes each parameter.

Parameter	Description
Headset tx gain	The increased (+db) or decreased (-db) amount of signal transmitted from the headset microphone to the far-end party.
Headset sidetone gain	The increased (+db) or decreased (-db) amount of sidetone signal from the headset microphone to the headset speaker.
Handset tx gain	The increased (+db) or decreased (-db) amount of signal transmitted from the handset microphone to the far-end party.
Handset sidetone gain	The increased (+db) or decreased (-db) amount of sidetone signal from the handset microphone to the handset speaker.

(continued)

Parameter	Description
Handsfree tx gain	The increased (+db) or decreased (-db) amount of signal transmitted from the base microphone to the far-end party.
Audio mode	Allows you to configure how the d/f key (handsfree key) works. Audio mode has 4 options: 0 (Speaker) - Calls can be made or received using the handset or handsfree speakerphone and can be switched between the two modes by pressing the d /fkey. When on speaker, you can return to using the handset by placing the handset on the cradle and picking it up again. 1 (Headset) - Calls can be made or received using the headset. Calls can be switched between the headset and handset by pressing the d /fkey. 2 (Speaker/Headset) - Incoming calls are sent to the speakerphone. By pressing the d /fkey, you can switch between the handsfree speakerphone, the headset, and the handset. 3 (Headset/Speaker) - Incoming calls are sent to the headset. By pressing the d /fkey, you can switch between the headset, the handsfree speakerphone, and the handset.

Configuring Audio Transmit and Receive Gain Adjustments

You can configure the audio transmit and gain adjustments using the configuration files only.

Use the following procedure to configure this feature.



Configuration Files

For specific parameters you can set in the configuration files, see Appendix A, the section, "[Audio Transmit and Receive Gain Adjustment Settings](#)" on [page A-204](#).

Centralized Conferencing (for Sylanro and Broadsoft Servers)

The IP phones include support for centralized conferencing (Ad-Hoc conferencing) for Sylanro and Broadsoft servers. This feature provides centralized conferencing on the SIP server (versus localized, on the phone) and allows IP phone users to do these tasks:

- Conference two active calls together into a conference call.
- When on an active conference call, invite another party into the call.
- Create simultaneous conference calls on the same IP phone (Sylanro servers only). For example, the IP phone user at extension 2005 could create these two conferences, and put one conference on hold while conversing with the other party:
 - Line 1: conference together extensions 2005, 2010, and 2020.
 - Line 2: conference together extensions 2005, 2011 and 2021.

When an IP phone user is connected to multiple conference calls, some outbound proxies have maximum call “hold” time set from 30-90 seconds. After this time, the call that is on hold is disconnected.

- Disconnect from an active conference call while allowing the other callers to remain connected.
- Ability to create N-way conference.
- Join two active calls together into a conference call.
- Incoming or outgoing active call can join any of the existing conferences.

If the administrator does not configure centralized conferencing, then the IP phone uses localized conferencing by default.



Note: When you configure centralized conferencing globally for an IP Phone, the global settings apply to all lines. Although, for the global setting to work on soft lines, the user must configure the lines with the applicable phone number.

An Administrator can configure centralized conferencing on a global or per-line basis using the configuration files or the Aastra Web UI.

To use the centralized conferencing after it is enabled, see your Model-specific IP Phone *User Guide*.

Configuring Centralized Conferencing Using the Configuration Files

You use the following parameters to configure centralized conferencing in the configuration files:

Global Parameter

- `sip centralized conf`

Per-Line Parameter

`sip lineN centralized conf`





Configuration Files

For specific parameters you can set in the configuration files, see Appendix A, the section, "[Centralized Conferencing Settings](#)" on [page A-99](#).

Configuring Centralized Conferencing Using the Aastra Web UI

Use the following procedure to configure centralized conferencing using the Aastra Web UI.

 Aastra Web UI																											
Global Configuration																											
1	<p>Click on Advanced Settings->Global SIP Settings->Basic SIP Network Settings.</p> <div style="border: 1px solid black; padding: 5px; margin: 10px 0;"> <table border="1" style="width: 100%; border-collapse: collapse;"> <tr> <td style="width: 25%; vertical-align: top;"> <p>Status</p> <ul style="list-style-type: none"> System Information <p>Operation</p> <ul style="list-style-type: none"> User Password Phone Lock Softkeys and XML Programmable Keys Directory Reset <p>Basic Settings</p> <ul style="list-style-type: none"> Preferences Account Configuration <p>Advanced Settings</p> <ul style="list-style-type: none"> Network Global SIP Line 1 Line 2 Line 3 Line 4 Line 5 Line 6 Line 7 </td> <td style="vertical-align: top;"> <p style="text-align: center;">Global SIP Settings</p> <p>Basic SIP Network Settings</p> <table style="width: 100%; border-collapse: collapse;"> <tr><td>Proxy Server</td><td style="text-align: right;">0.0.0.0</td></tr> <tr><td>Proxy Port</td><td style="text-align: right;">0</td></tr> <tr><td>Backup Proxy Server</td><td style="text-align: right;">0.0.0.0</td></tr> <tr><td>Backup Proxy Port</td><td style="text-align: right;">0</td></tr> <tr><td>Outbound Proxy Server</td><td style="text-align: right;">0.0.0.0</td></tr> <tr><td>Outbound Proxy Port</td><td style="text-align: right;">0</td></tr> <tr><td>Registrar Server</td><td style="text-align: right;">0.0.0.0</td></tr> <tr><td>Registrar Port</td><td style="text-align: right;">0</td></tr> <tr><td>Backup Registrar Server</td><td style="text-align: right;">0.0.0.0</td></tr> <tr><td>Backup Registrar Port</td><td style="text-align: right;">0</td></tr> <tr><td>Registration Period</td><td style="text-align: right;">0</td></tr> <tr><td>Conference Server URI</td><td></td></tr> </table> </td> </tr> </table> </div>	<p>Status</p> <ul style="list-style-type: none"> System Information <p>Operation</p> <ul style="list-style-type: none"> User Password Phone Lock Softkeys and XML Programmable Keys Directory Reset <p>Basic Settings</p> <ul style="list-style-type: none"> Preferences Account Configuration <p>Advanced Settings</p> <ul style="list-style-type: none"> Network Global SIP Line 1 Line 2 Line 3 Line 4 Line 5 Line 6 Line 7 	<p style="text-align: center;">Global SIP Settings</p> <p>Basic SIP Network Settings</p> <table style="width: 100%; border-collapse: collapse;"> <tr><td>Proxy Server</td><td style="text-align: right;">0.0.0.0</td></tr> <tr><td>Proxy Port</td><td style="text-align: right;">0</td></tr> <tr><td>Backup Proxy Server</td><td style="text-align: right;">0.0.0.0</td></tr> <tr><td>Backup Proxy Port</td><td style="text-align: right;">0</td></tr> <tr><td>Outbound Proxy Server</td><td style="text-align: right;">0.0.0.0</td></tr> <tr><td>Outbound Proxy Port</td><td style="text-align: right;">0</td></tr> <tr><td>Registrar Server</td><td style="text-align: right;">0.0.0.0</td></tr> <tr><td>Registrar Port</td><td style="text-align: right;">0</td></tr> <tr><td>Backup Registrar Server</td><td style="text-align: right;">0.0.0.0</td></tr> <tr><td>Backup Registrar Port</td><td style="text-align: right;">0</td></tr> <tr><td>Registration Period</td><td style="text-align: right;">0</td></tr> <tr><td>Conference Server URI</td><td></td></tr> </table>	Proxy Server	0.0.0.0	Proxy Port	0	Backup Proxy Server	0.0.0.0	Backup Proxy Port	0	Outbound Proxy Server	0.0.0.0	Outbound Proxy Port	0	Registrar Server	0.0.0.0	Registrar Port	0	Backup Registrar Server	0.0.0.0	Backup Registrar Port	0	Registration Period	0	Conference Server URI	
<p>Status</p> <ul style="list-style-type: none"> System Information <p>Operation</p> <ul style="list-style-type: none"> User Password Phone Lock Softkeys and XML Programmable Keys Directory Reset <p>Basic Settings</p> <ul style="list-style-type: none"> Preferences Account Configuration <p>Advanced Settings</p> <ul style="list-style-type: none"> Network Global SIP Line 1 Line 2 Line 3 Line 4 Line 5 Line 6 Line 7 	<p style="text-align: center;">Global SIP Settings</p> <p>Basic SIP Network Settings</p> <table style="width: 100%; border-collapse: collapse;"> <tr><td>Proxy Server</td><td style="text-align: right;">0.0.0.0</td></tr> <tr><td>Proxy Port</td><td style="text-align: right;">0</td></tr> <tr><td>Backup Proxy Server</td><td style="text-align: right;">0.0.0.0</td></tr> <tr><td>Backup Proxy Port</td><td style="text-align: right;">0</td></tr> <tr><td>Outbound Proxy Server</td><td style="text-align: right;">0.0.0.0</td></tr> <tr><td>Outbound Proxy Port</td><td style="text-align: right;">0</td></tr> <tr><td>Registrar Server</td><td style="text-align: right;">0.0.0.0</td></tr> <tr><td>Registrar Port</td><td style="text-align: right;">0</td></tr> <tr><td>Backup Registrar Server</td><td style="text-align: right;">0.0.0.0</td></tr> <tr><td>Backup Registrar Port</td><td style="text-align: right;">0</td></tr> <tr><td>Registration Period</td><td style="text-align: right;">0</td></tr> <tr><td>Conference Server URI</td><td></td></tr> </table>	Proxy Server	0.0.0.0	Proxy Port	0	Backup Proxy Server	0.0.0.0	Backup Proxy Port	0	Outbound Proxy Server	0.0.0.0	Outbound Proxy Port	0	Registrar Server	0.0.0.0	Registrar Port	0	Backup Registrar Server	0.0.0.0	Backup Registrar Port	0	Registration Period	0	Conference Server URI			
Proxy Server	0.0.0.0																										
Proxy Port	0																										
Backup Proxy Server	0.0.0.0																										
Backup Proxy Port	0																										
Outbound Proxy Server	0.0.0.0																										
Outbound Proxy Port	0																										
Registrar Server	0.0.0.0																										
Registrar Port	0																										
Backup Registrar Server	0.0.0.0																										
Backup Registrar Port	0																										
Registration Period	0																										
Conference Server URI																											
2	<p>In the “Conference Server URI” field, do one of the following actions:</p> <ul style="list-style-type: none"> • To disable centralized conferencing on the IP phone, leave this field empty (blank). • To enable SIP centralized conferencing on the IP phone, do one of the following actions: <ul style="list-style-type: none"> — If you have specified a proxy server/registrar server, then to reach the media server via the proxy server, set this field to one of the following: <p style="margin-left: 40px;">conf (Sylantro server), or</p> <p style="margin-left: 40px;">Conference (Broadsoft server)</p> <p>By setting this field to conf or Conference, you specify <code>conf@<proxy_server_address>:<proxy_port></code>. For example, if the proxy server address is 206.229.26.60 and the port used is 10060, then by setting this parameter to conf, you are specifying the following: <code>conf@206.229.26.60:10060</code>.</p> <ul style="list-style-type: none"> — To reach the media server using a different address/port than that specified by the proxy, set this field to the following: conf@<media_server_address>: <media_port> 																										

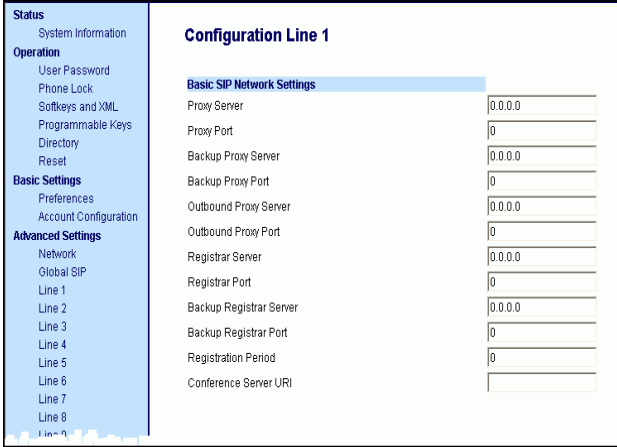
 Aastra Web UI	
3	Click <input type="button" value="Save Settings"/> to save your changes.
Per-Line Configuration	
1	Click on Advanced Settings->Line <#>->Basic SIP Network Settings 
2	In the “ Conference Server URI ” field, do one of the following actions: <ul style="list-style-type: none"> • To disable centralized conferencing on this line, leave this field empty (blank). • To enable SIP centralized conferencing on this line, do one of the following actions: <ul style="list-style-type: none"> — If you have specified a proxy server/registrar server, then to reach the media server via the proxy server, set this field to one of the following: <p style="margin-left: 40px;">conf (Sylantro server), or</p> <p style="margin-left: 40px;">Conference (Broadsoft server)</p> — To reach the media server using a different address/port than that specified by the proxy, set this field to the following: <p style="margin-left: 40px;">conf@<media_server_address>: <media_port></p> <p style="margin-left: 20px;">By setting this field to conf or Conference, you specify conf@<proxy_server_address>: <proxy_port>.</p>
3	Click <input type="button" value="Save Settings"/> to save your changes.

“SIP Join” Feature for 3-Way Conference (not applicable to the 6751i)

The IP Phones support RFC 3911 which allows an additional caller to join an active call between two parties if the caller knows the dialog information. This feature begins a conference using a join header as described in RFC 3911.

The “SIP Join“ feature provides the following:

- Security via the whitelist (which is a feature that already exists on the phone).
- Initiates an offhook action uri when it is answered.
- Initiates an onhook action uri at call termination.
- Creates a caller list entry.

This feature is disabled by default. You can enable the “SIP Join” feature by setting the “sip join support” parameter in the configuration files.

Limitations of the “SIP Join” Feature

The following are limitations of the “SIP Join” feature:

- Not applicable to a conference call already in progress.
- Not applicable to a CT handset that has two active calls.
- Not applicable to a phone mixing RTP.
- Allows secondary parties to join calls if they can determine the dialog parameters. In order to provide security, it is recommended that the Administrator configure the SIP whitelist.
- Not applicable while the active call between two parties is in the early dialog state.

Configuring the “SIP Join” Feature Using the Configuration Files

You use the following parameters to configure the “SIP Join feature in the configuration files:

`sip join support`



Configuration Files

For specific parameters you can set in the configuration files, see Appendix A, the section, [“SIP Join Feature for 3-Way Conference”](#) on [page A-101](#).

Conference Ends and Transfers Remaining Parties

On the IP Phones, a Host can drop from a 3-way conference and let the other two parties remain connected by pressing a **Xfer** key.



Notes:

1. The 3-line LCD display phones (6730i, 6731i, 6751i, 6753i, 9143i) and cordless handsets (CT handsets) do not support scrolling between lines.
2. The phones **MUST** have a **Xfer** key (hardkey, or configured programmable or softkey) on the phone.

Reference

For more information about using the 3-way conference and the Xfer key, see the IP Phone Model-specific User Guide.

Limitations

The following are limitations of this feature:

- The phone **MUST** have a Xfer key configured on the phone (programmable key or softkey)
- Asterisk SLA does not support this feature.
- A “xfer script” can override this feature if a custom application is created and control is given to the server-side.
- The Caller ID of the dropped Host still displays on the remaining parties’ phones.

Transferring Two Existing Calls

The IP Phones allow Users to perform a transfer of a call when there are currently two active calls on the phone. For example, on the User's phone, there are two active calls - Call A and Call B. Call B is on hold. The User can perform the following to transfer Call A to Call B:

1. Press **Xfer** key. A new line opens.
2. Press or scroll to the **Line** where Call B is on hold.
3. Press **Xfer** key.

Call A is transferred to Call B.

Reference

For more information about using the Xfer key to transfer two existing calls, see the IP Phone Model-specific User Guide.

Limitations

The following are limitations of this feature:

- If a user presses the **Xfer** key but doesn't continue to transfer the call by pressing a **Line** key, there is no indication on the phone that the transfer didn't take place.
- Once the transfer takes place, the phone which has been transferred to, still displays the original call.
- For this feature, 3-line LCD display phones (6730i, 6731i, 6751i, 6753i, 9143i) do not support scrolling between lines.

Authentication Support for HTTP/HTTPS Download Methods, used with Broadsoft Client Management System (CMS)

The IP phones support HTTP/HTTPS digest authentication as defined in RFC 2617. (The HTTP client supports digest authentication; the HTTP server does not; the HTTP server supports basic authentication). This feature allows the phones to interoperate with Broadsoft's CMS phone configuration tool.

Using the configuration files, you can enable/disable the following parameter to display a LOG IN softkey which allows the HTTP/HTTPS server to perform digest authentication:

- **http digest force login** - specifies whether or not to display the LOG IN softkey on the IP Phone UI screen. Valid values are **0** (disabled) or **1** (enabled). Default is **0** (disabled).

If the “**http digest force login**” parameter is set to **1** (enabled), after the phone boots, the LOG IN softkey displays on the phone's LCD. If the user presses this softkey, a username/password screen displays, allowing the user to enter the configured username and password that is sent to the HTTP/HTTPS server for digest authentication by the server. By default, username is “**aastra**” and password is “**aastra**”. You can enter the username and password in two ways:

- Using the configuration files, you can change the default values for the following parameters:
 - **http digest username** - specifies the username to use for HTTP/HTTPS digest authentication.
 - **http digest password** - specifies the password to use for HTTP/HTTPS digest authentication.
- By enabling the “**http digest force login**” parameter (setting to 1) - the phone displays the LOG IN key so the user can enter the default username/password via the IP Phone UI.

Configuring Broadsoft CMS Support via the Configuration Files

Configure Broadsoft CMS support on the IP Phone using the following parameters in the configuration files:

- **http digest force login**
- **http digest username**
- **http digest password**



Configuration Files

For specific parameters you can set in the configuration files, see Appendix A, the section, [“HTTP/HTTPS Authentication Support for Broadsoft CMS”](#) on [page A-102](#).

Using the IP Phone when Broadsoft CMS is Enabled

If you enable the HTTP/HTTPS digest authentication feature, the phone behaves as follows with the BroadSoft CMS tool:

1. Factory default the phone.
2. Configure the HTTP or HTTPS server (specify the HTTP or HTTPS server, path, and port).
3. Restart the phone.

The first time the phone reboots, the phone is challenged by the server. The phone sends the default username of **“aastra”** and the default password of **“aastra”** to the server.

The server sends the default profile to the phone. This profile includes the information **“http digest force login: 1”**. When the phone receives the profile, it displays the **“Log In”** key on the IP Phone UI’s idle screen.

4. Press the “**Log In**” key to displays the username/password screen.



Note: On the 8 and 11-Line LCD phones, you use the **Log In** softkey to log in. On 3-Line LCD phones, you press the **right arrow** key to log in.

3-Line LCD Phones Login Screens

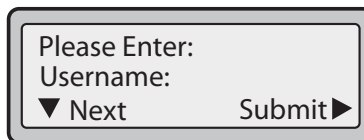
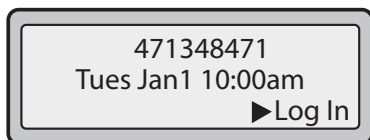

8 and 11-Line LCD Phones Login Screens

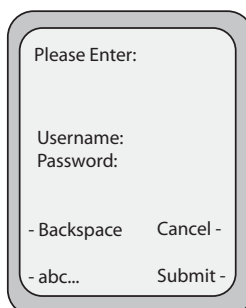
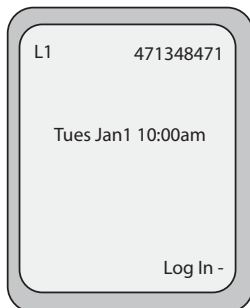

5. Enter a username in the “**Username**” field (up to 40 characters) and a password in the “**Password**” field (up to 20 characters).



Note: The “**Username**” and “**Password**” fields accept special characters, such as, @, #, %, =, _, etc. You can also specify domain names in the **Username** field (i.e., user@domain).

6. After entering the username and password, press **Submit**.
The phone attempts to authenticate with the server. If successful, the phone reboots and loads the user configuration. If unsuccessful, the phone displays “*Authentication Failed*”.

Customizing the Display Columns on the M675i Expansion Module

The M675i Expansion Module screen displays softkeys in column format. The function keys on the bottom left of the Module allow you to display 3 full screens of softkeys. Each screen consists of 2 columns with the following default headings on each page:

Page 1 "List 1" and "List 2"

Page 2 "List 3" and "List 4"

Page 3 "List 5" and "List 6"

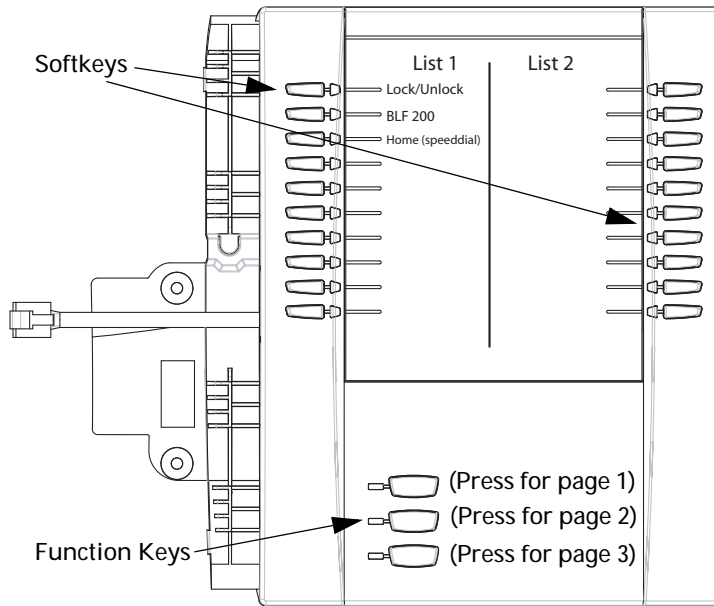

Page 1 Screen

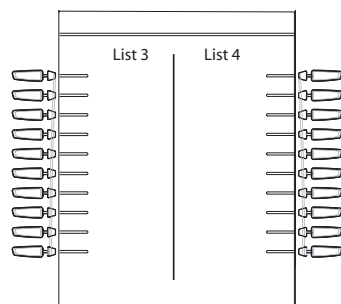
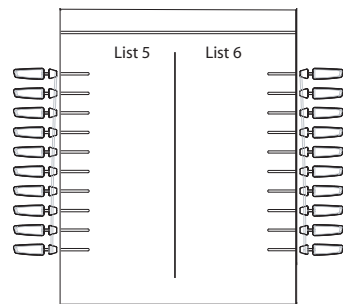
**Page 2 Screen****Page 3 Screen**

To use the M675i, press the function key for the page you want to display to the LCD (page 1, page2, or page 3), and press the applicable softkey.

You can customize the headings on each M675i Expansion Module screen using the configuration files. You use the following parameters to customize the column headings:

Expansion Module 1 (3 pages)

- expmod1page1left
- expmod1page1right
- expmod1page2left
- expmod1page2right
- expmod1page3left
- expmod1page3right

Expansion Module 2 (3 pages)

- expmod2page1left
- expmod2page1right
- expmod2page2left
- expmod2page2right
- expmod2page3left
- expmod2page3right

Expansion Module 3 (3 pages)

- expmod3page1left
- expmod3page1right
- expmod3page2left
- expmod3page2right
- expmod3page3left
- expmod3page3right

Example

The following is an example of configuring Expansion Module 1 column headings.

```
expmod1page1left: Personnel Ext  
expmod1page1right: Operations Ext  
expmod1page2left: Marketing Ext  
expmod1page2right: Logistics Ext  
expmod1page3left: Engineering Ext  
expmod1page3right: Shipping Ext
```

These settings display to the Expansion Module as shown in the following illustrations.

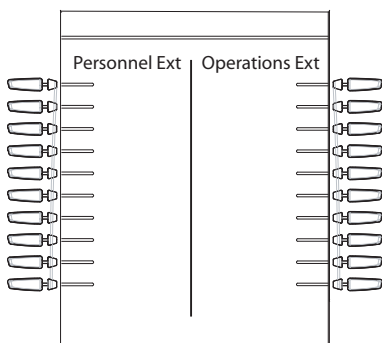

Page 1 Screen

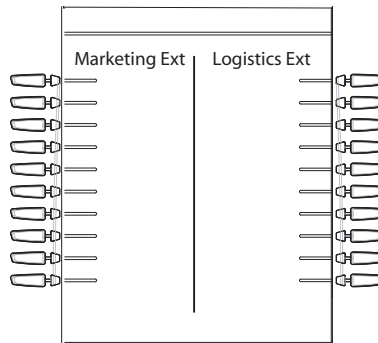

Page 2 Screen

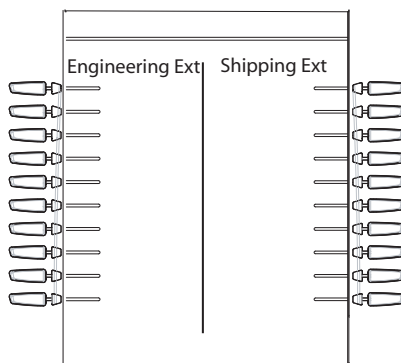

Page 3 Screen

Customizing the M675i Expansion Module Column Display.



Configuration Files

For specific parameters you can set in the configuration files, see Appendix A, the section, [“Customizing M675i Expansion Module Column Display”](#) on [page A-256](#).

Chapter 6

Configuring Advanced Operational Features

About this chapter

Introduction

The IP phones have advanced operational features you can configure using the configuration files and/or the Aastra Web UI.

This chapter describes each of these features and provides procedures for configuring each feature.

Topics

This chapter covers the following topics:

Topic	Page
Advanced Operational Features	page 6-3
MAC Address/Line Number in REGISTER Messages	page 6-5
SIP Message Sequence for Blind Transfer	page 6-7
Update Caller ID During a Call	page 6-8
Boot Sequence Recovery Mode	page 6-9
Auto-discovery Using mDNS	page 6-10
Single Call Restriction (6757i CT and 9480i CT only)	page 6-11
Missed Call Summary Subscription	page 6-13
As-Feature-Event Subscription	page 6-17

About this chapter

Topic	Page
Blacklist Duration	page 6-22
Whitelist Proxy	page 6-24
Transport Layer Security (TLS)	page 6-26
802.1x Support	page 6-31
Symmetric UDP Signaling	page 6-41
Removing UserAgent and Server SIP Headers	page 6-42
GRUU and sip.instance Support	page 6-43
Multi-Stage Digit Collection (Billing Codes) Support (for Sylantro Servers)	page 6-44
Configurable DNS Queries	page 6-47
Ignore Out of Sequence Errors	page 6-49
“Early-Only” Parameter in Replaces Header RFC3891	page 6-50
Reason Header Field in SIP Message	page 6-50
Configurable “Allow” and “Allow-Event” Optional Headers	page 6-50

Advanced Operational Features

Description

This section provides the following information about advanced features of the IP phones:

Feature	Description
MAC Address/Line Number in REGISTER Messages	Allows you to enable or disable the sending of the MAC address and line number from the IP phone to the call server, in a REGISTER message.
SIP Message Sequence for Blind Transfer	Allows you to enable or disable the phone to use the Blind Transfer method available in software prior to release 1.4.
Update Caller ID During a Call	Allows you to enable or disable the updating of the Caller ID information during a call.
Boot Sequence Recovery Mode	Allows you to enable or disable Web recovery mode and set the maximum boot count on the IP phone.
Auto-discovery Using mDNS	The IP phones automatically perform an auto-discovery of all servers on a network using mDNS. When the IP phone discovers a TFTP server, it is automatically configured by that TFTP server.
Single Call Restriction (6757i CT and 9480i CT only)	Allows you to enable or disable a single call restriction between the 6757i CT base unit and a call server.
Missed Call Summary Subscription	Allows missed calls that have been redirected by the server, to be incremented in the missed calls indicator on the phone it was initially directed to.
As-Feature-Event Subscription	Allows you to enable or disable a specific line on the phone with the BroadSoft's server-side DND, CFWD, or ACD features.
Blacklist Duration	Allows you to specifies the length of time, in seconds, that a failed server remains on the server blacklist. The IP phone avoids sending a SIP message to a failed server (if another server is available) for this amount of time.
Whitelist Proxy	Allows you to configure the phone to either accept or reject call requests from a trusted proxy server.

Feature	Description
Transport Layer Security (TLS)	<p>Allows you to enable or disable the use of Persistent Transport Layer Security (TLS).</p> <p>Persistent TLS sets up the connection to the server once and re-uses that connection for all calls from the phone. The setup connection for Persistent TLS is established during the registration of the phone. If the phones are set to use Persistent TLS, and a call is made from the phone, this call and all subsequent calls use the same authenticated connection. This significantly reduces the delay time when placing a call.</p>
802.1x Support	<p>Allows you to enable or disable the 802.1x Protocol support on the IP Phones.</p>
Symmetric UDP Signaling	<p>Allows you to enable or disable the phone to use port 5060 to send SIP UDP messages.</p>
Removing UserAgent and Server SIP Headers	<p>Allows you to enable or disable the addition of the User-Agent and Server SIP headers in the SIP stack.</p>
Multi-Stage Digit Collection (Billing Codes) Support (for Sylanro Servers)	<p>IP Phones support Sylanro Server features, like mandatory and optional billing codes that require the application server to notify the phone to collect more digits before completing the call. The IP phone is able to collect digits in two stages to support the billing code feature.</p>
Configurable DNS Queries	<p>Allows you to specify the Domain Name Service (DNS) query method to use when the phone performs a DNS lookup.</p>
Ignore Out of Sequence Errors	<p>Allows you to configure the phone to ignore CSeq number errors on all SIP dialogs on the phone.</p>
“Early-Only” Parameter in Replaces Header RFC3891	<p>The phones support the “early-only” parameter in the “Replaces” header according to RFC3891.</p>
Reason Header Field in SIP Message	<p>The IP Phones support the receiving of the Reason Header Field in a SIP CANCEL message, as described in RFC3326.</p>
Configurable “Allow” and “Allow-Event” Optional Headers	<p>On the IP Phones, an Administrator can enable or disable whether or not the optional “Allow” and “Allow-Events” headers are included in the NOTIFY message from the phone.</p>

MAC Address/Line Number in REGISTER Messages

The IP phones can send the MAC address and line number in the REGISTER packets making it easier for the call server when a user configures the phones via the Aastra Web UI or the IP Phone UI. The following two configurable headers send this information to the call server:

```
Aastra-Mac: <mac address>  
Aastra-Line: <line number>
```

The MAC address is sent in uppercase hex numbers, for example, 00085D03C792. The line number is a number between 1 and 9.

The following parameters allow you to enable/disable the sending of MAC address and line number to the call server:

- **sip send mac**
- **sip send line**



These parameters are disabled by default. The parameters are configurable via the configuration files or the Aastra Web UI.

Configuring the MAC address/Line Number in REGISTER Message

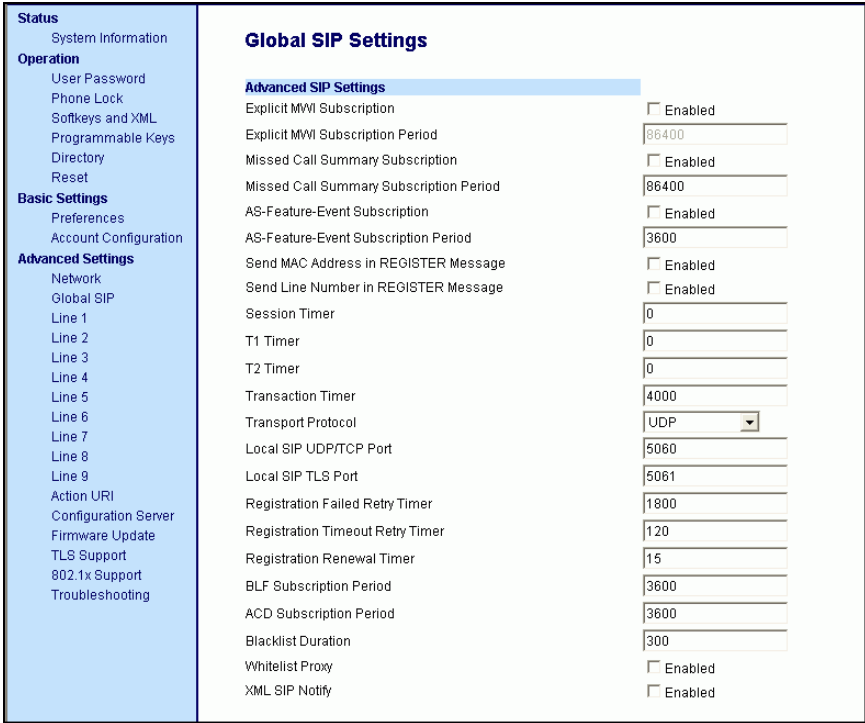

Configuration Files

For specific parameters you can set in the configuration files for enabling/disabling MAC address and line number, see Appendix A, the section, “[Advanced Operational Parameters](#)” on [page A-258](#).

 Aastra Web UI	
Step	Action
1	<p>Click on Advanced Settings->Global SIP->Advanced SIP Setting.</p> 
2	<p>Enable the "Send MAC Address in REGISTER Message" field by checking the check box. (Disable this field by unchecking the box).</p>
3	<p>Enable the "Send Line Number in REGISTER Message" field by checking the check box. (Disable this field by unchecking the box).</p>
4	<p>Click  to save your settings.</p> <p>Note: The session prompts you to restart the IP phone to apply the configuration settings.</p>
5	<p>Select Operation->Reset and click .</p>

SIP Message Sequence for Blind Transfer

The SIP message sequence for Blind Transfer avoids the transfer target having two simultaneous calls. Prior to release 1.4, a CANCEL message was sent to the transfer target (if it was in a ringing state) after sending a REFER to the transferee to complete the transfer. In the 1.4 and later releases, the CANCEL is now sent before the REFER message.

The following parameter allows the system administrator to force the phone to use the Blind Transfer method available in software versions prior to 1.4:

sip cancel after blind transfer

This parameter is configurable via the configuration files only.

Configuring SIP Message Sequence for Blind Transfer



Configuration Files

For the specific parameter you can set in the configuration files for enabling/disabling the blind transfer method, see Appendix A, the section, [“Blind Transfer Setting”](#) on [page A-258](#).

Update Caller ID During a Call

It is possible for a proxy or call server to update the Caller ID information that displays on the phone during a call, by modifying the SIP Contact header in the re-INVITE message. The phone displays the updated name and number information contained within the Contact header.

The following parameter allows the system administrator to enable or disable this feature:

sip update callerid:

This parameter is configurable via the configuration files only.

Configuring Update Caller ID During a Call



Configuration Files

For the specific parameter you can set in the configuration files for enabling/disabling the update of caller ID during a call, see Appendix A, the section, [“Update Caller ID Setting.”](#) on [page A-258](#).

Boot Sequence Recovery Mode

You can force the IP phone into recovery mode by pressing the **1** and **#** keys during boot up when the logo displays. This feature is enabled by default on the IP phone.

You can disable this feature using the following parameter in the configuration files:

- **force web recovery mode disabled**

Valid values for this parameter are 0 (false) and 1 (true). Default is 0 (false).

A boot counter increments after each faulty boot. When the counter reaches a predetermined value, it forces Web recovery mode. The counter is reset to zero upon a successful boot.

The predetermined value is set using the following parameter in the configuration files:

- **max boot count**

A zero (0) value disables this feature. The default value is 10.

You can configure the boot sequence recovery mode parameters using the configuration files only.

Configuring Boot Sequence Recovery Mode



Configuration Files

For the specific parameters you can set in the configuration files for boot sequence recovery mode, see Appendix A, the section, "[Boot Sequence Recovery Mode Settings.](#)" on [page A-259.](#)

Auto-discovery Using mDNS

The IP phones can perform an auto-discovery of all servers on a network using mDNS. When the IP phone discovers a TFTP server, it is automatically configured by that TFTP server.

An unconfigured phone (phone right out of the box) added to a network, attempts to auto-discover a configuration server on the network without any end-user intervention. When it receives DHCP option 66 (TFTP server), it automatically gets configured by the TFTP server.

An already configured phone (either previously configured by auto-discovery or manually configured) added to a network, uses its predefined configuration to boot up.



Notes:

1. Configuration parameters received via DHCP do not constitute configuration information, with the exception of a TFTP server. Therefore, you can plug a phone into a DHCP environment, still use the auto-discovery process, and still allow the use of the TFTP server parameter to set the configuration server.
 2. DHCP option 66 (TFTP server details) overrides the mDNS phase of the auto-discovery. Therefore, the DHCP option takes priority and the remaining process of auto-discovery continues.
 3. As the phone performs auto-discovery, all servers in the network (including the TFTP server), display in the phone window. However, only the server configured for TFTP automatically configures the phone.
-

Single Call Restriction (6757i CT and 9480i CT only)

On the 6757i CT and 9480i CT, an administrator can enable or disable a single call restriction between the 6757i CT and 9480i CT base unit and a call server.

When this feature is enabled (set to 1), you can make separate active calls from the 6757i CT and 9480i CT base unit and from the cordless handset. If this feature is disabled (set to 0), only one call can be active at a time either from the base unit or from the handset. When this feature is disabled, and you make an active call on either the base unit or the handset, any other attempt to make an active call is put on hold. Also, when this feature is disabled, more than one call can negotiate complex audio codecs since only a single call is decoding audio at a time.

You can configure this feature via the configuration files or the Aastra Web UI.

Configuring Single Call Restriction.



Configuration Files

For the specific parameters you can set in the configuration files for single call restriction on the 6757i CT and 9480i CT, see Appendix A, the section, “[Single Call Restriction Setting](#)” on [page A-260](#).

 Aastra Web UI			
Step	Action		
1	<p>Click on Advanced Settings->Global SIP->RTP Settings.</p> <div style="border: 1px solid black; padding: 10px; margin: 10px 0;"> <table border="0" style="width: 100%; border-collapse: collapse;"> <tr> <td style="width: 30%; vertical-align: top; padding: 5px;"> <p>Status System Information</p> <p>Operation User Password Softkeys and XML Handset Keys Directory Reset</p> <p>Basic Settings Preferences Account Configuration</p> <p>Advanced Settings Network Global SIP Line 1 Line 2 Line 3 Line 4 Line 5 Line 6 Line 7 Line 8 Line 9 Action URI Configuration Server Firmware Update Troubleshooting</p> </td> <td style="padding: 5px;"> <p>Global SIP Settings</p> <p>RTP Settings</p> <p>RTP Port <input style="width: 100px;" type="text" value="3000"/></p> <p>Basic Codecs (G.711 u-Law, G.711 a-Law, G.729) <input type="checkbox"/> Enabled</p> <p>Force RFC2833 Out-of-Band DTMF <input checked="" type="checkbox"/> Enabled</p> <p>Customized Codec Preference List <input style="width: 100px;" type="text"/></p> <p>DTMF Method <input type="text" value="RTP"/></p> <p>Silence Suppression <input checked="" type="checkbox"/> Enabled</p> <p>Two Call Support <input checked="" type="checkbox"/> Enabled</p> </td> </tr> </table> </div>	<p>Status System Information</p> <p>Operation User Password Softkeys and XML Handset Keys Directory Reset</p> <p>Basic Settings Preferences Account Configuration</p> <p>Advanced Settings Network Global SIP Line 1 Line 2 Line 3 Line 4 Line 5 Line 6 Line 7 Line 8 Line 9 Action URI Configuration Server Firmware Update Troubleshooting</p>	<p>Global SIP Settings</p> <p>RTP Settings</p> <p>RTP Port <input style="width: 100px;" type="text" value="3000"/></p> <p>Basic Codecs (G.711 u-Law, G.711 a-Law, G.729) <input type="checkbox"/> Enabled</p> <p>Force RFC2833 Out-of-Band DTMF <input checked="" type="checkbox"/> Enabled</p> <p>Customized Codec Preference List <input style="width: 100px;" type="text"/></p> <p>DTMF Method <input type="text" value="RTP"/></p> <p>Silence Suppression <input checked="" type="checkbox"/> Enabled</p> <p>Two Call Support <input checked="" type="checkbox"/> Enabled</p>
<p>Status System Information</p> <p>Operation User Password Softkeys and XML Handset Keys Directory Reset</p> <p>Basic Settings Preferences Account Configuration</p> <p>Advanced Settings Network Global SIP Line 1 Line 2 Line 3 Line 4 Line 5 Line 6 Line 7 Line 8 Line 9 Action URI Configuration Server Firmware Update Troubleshooting</p>	<p>Global SIP Settings</p> <p>RTP Settings</p> <p>RTP Port <input style="width: 100px;" type="text" value="3000"/></p> <p>Basic Codecs (G.711 u-Law, G.711 a-Law, G.729) <input type="checkbox"/> Enabled</p> <p>Force RFC2833 Out-of-Band DTMF <input checked="" type="checkbox"/> Enabled</p> <p>Customized Codec Preference List <input style="width: 100px;" type="text"/></p> <p>DTMF Method <input type="text" value="RTP"/></p> <p>Silence Suppression <input checked="" type="checkbox"/> Enabled</p> <p>Two Call Support <input checked="" type="checkbox"/> Enabled</p>		
2	<p>Enable the "Two Call Support" field by checking the check box. (Disable this field by unchecking the box).</p>		
3	<p>Click <input type="button" value="Save Settings"/> to save your settings.</p> <p>Note: The session prompts you to restart the IP phone to apply the configuration settings.</p>		
4	<p>Select Operation->Reset and click <input type="button" value="Restart"/>.</p>		

Missed Call Summary Subscription

The “**Missed Call Summary Subscription**” feature allows missed calls that have been redirected by the server, to be incremented in the missed calls indicator on the phone it was initially directed to. This feature is called the Missed Call Summary Subscription and can be set with a timer that allows the phone to use the feature for a period of time before the timer expires. For this feature to work, you must configure voicemail on the phone that the call was initially directed to.

For example, phones A, B, and C are connected to the server. You configure the server to direct calls coming into phone B (which has voicemail configured) to be forwarded to phone C. When phone A calls phone B, the server forwards the call to phone C. With this feature, phone B receives notification from the server that the call was forwarded and the missed calls indicator is incremented on phone B.

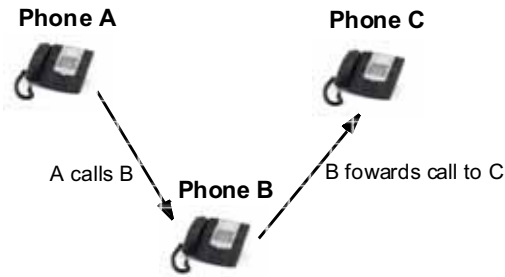

Missed calls indicator increments on phone B.

Note: Voicemail must be configured on phone B.

An Administrator can configure this feature on a global or per-line basis, using the configuration files or the Aastra Web UI.

Configuring Missed Call Summary Subscription using the Configuration Files

In addition to enabling/disabling the Misses Call Summary Subscription, You can also configure the amount of time, in seconds, that the phone uses this feature. The timer is configurable on a global basis only.

You use the following parameters to configure Missed Call Summary Subscription feature on a global basis:

Global Parameters

- **sip missed call summary subscription**
- **sip missed call summary subscription period**

Use the following parameters to configure Missed Call Summary Subscription feature on a per-line basis:

Per-Line Parameter

- **sip lineN missed call summary subscription**



Configuration Files

For the specific parameters you can set in the configuration files for Missed Call Summary Subscription, see Appendix A, the section, "[Missed Call Summary Subscription Settings](#)" on [page A-112](#).

Configuring Missed Call Summary Subscription using the Aastra Web UI

Use the following procedure to configure the Missed Call Summary Subscription feature using the Aastra Web UI.

Aastra Web UI

Global Configuration

1

Click on **Advanced Settings->Global SIP->Advanced SIP Settings.**

<div style="background-color: #d9e1f2; padding: 5px; border: 1px solid #ccc;"> <p>Status</p> <ul style="list-style-type: none"> System Information <p>Operation</p> <ul style="list-style-type: none"> User Password Phone Lock Softkeys and XML Programmable Keys Directory Reset <p>Basic Settings</p> <ul style="list-style-type: none"> Preferences Account Configuration <p>Advanced Settings</p> <ul style="list-style-type: none"> Network Global SIP Line 1 Line 2 Line 3 Line 4 Line 5 Line 6 Line 7 Line 8 Line 9 Action URI Configuration Server Firmware Update TLS Support 802.1x Support Troubleshooting </div>	<div style="border: 1px solid #ccc; padding: 10px;"> <p style="font-weight: bold; margin: 0;">Global SIP Settings</p> <p style="margin: 5px 0 0 0;">Advanced SIP Settings</p> <table style="width: 100%; border-collapse: collapse;"> <tr> <td style="padding: 2px 5px;">Explicit MWI Subscription</td> <td style="text-align: right; padding: 2px 5px;"><input type="checkbox"/> Enabled</td> </tr> <tr> <td style="padding: 2px 5px;">Explicit MWI Subscription Period</td> <td style="text-align: right; padding: 2px 5px;"><input style="width: 80px;" type="text" value="86400"/></td> </tr> <tr> <td style="padding: 2px 5px;">Missed Call Summary Subscription</td> <td style="text-align: right; padding: 2px 5px;"><input type="checkbox"/> Enabled</td> </tr> <tr> <td style="padding: 2px 5px;">Missed Call Summary Subscription Period</td> <td style="text-align: right; padding: 2px 5px;"><input style="width: 80px;" type="text" value="86400"/></td> </tr> <tr> <td style="padding: 2px 5px;">AS-Feature-Event Subscription</td> <td style="text-align: right; padding: 2px 5px;"><input type="checkbox"/> Enabled</td> </tr> <tr> <td style="padding: 2px 5px;">AS-Feature-Event Subscription Period</td> <td style="text-align: right; padding: 2px 5px;"><input style="width: 80px;" type="text" value="3600"/></td> </tr> <tr> <td style="padding: 2px 5px;">Send MAC Address in REGISTER Message</td> <td style="text-align: right; padding: 2px 5px;"><input type="checkbox"/> Enabled</td> </tr> <tr> <td style="padding: 2px 5px;">Send Line Number in REGISTER Message</td> <td style="text-align: right; padding: 2px 5px;"><input type="checkbox"/> Enabled</td> </tr> <tr> <td style="padding: 2px 5px;">Session Timer</td> <td style="text-align: right; padding: 2px 5px;"><input style="width: 80px;" type="text" value="0"/></td> </tr> <tr> <td style="padding: 2px 5px;">T1 Timer</td> <td style="text-align: right; padding: 2px 5px;"><input style="width: 80px;" type="text" value="0"/></td> </tr> <tr> <td style="padding: 2px 5px;">T2 Timer</td> <td style="text-align: right; padding: 2px 5px;"><input style="width: 80px;" type="text" value="0"/></td> </tr> <tr> <td style="padding: 2px 5px;">Transaction Timer</td> <td style="text-align: right; padding: 2px 5px;"><input style="width: 80px;" type="text" value="4000"/></td> </tr> <tr> <td style="padding: 2px 5px;">Transport Protocol</td> <td style="text-align: right; padding: 2px 5px;"><input style="width: 80px;" type="text" value="UDP"/></td> </tr> <tr> <td style="padding: 2px 5px;">Local SIP UDP/TCP Port</td> <td style="text-align: right; padding: 2px 5px;"><input style="width: 80px;" type="text" value="5060"/></td> </tr> <tr> <td style="padding: 2px 5px;">Local SIP TLS Port</td> <td style="text-align: right; padding: 2px 5px;"><input style="width: 80px;" type="text" value="5061"/></td> </tr> <tr> <td style="padding: 2px 5px;">Registration Failed Retry Timer</td> <td style="text-align: right; padding: 2px 5px;"><input style="width: 80px;" type="text" value="1800"/></td> </tr> <tr> <td style="padding: 2px 5px;">Registration Timeout Retry Timer</td> <td style="text-align: right; padding: 2px 5px;"><input style="width: 80px;" type="text" value="120"/></td> </tr> <tr> <td style="padding: 2px 5px;">Registration Renewal Timer</td> <td style="text-align: right; padding: 2px 5px;"><input style="width: 80px;" type="text" value="15"/></td> </tr> <tr> <td style="padding: 2px 5px;">BLF Subscription Period</td> <td style="text-align: right; padding: 2px 5px;"><input style="width: 80px;" type="text" value="3600"/></td> </tr> <tr> <td style="padding: 2px 5px;">ACD Subscription Period</td> <td style="text-align: right; padding: 2px 5px;"><input style="width: 80px;" type="text" value="3600"/></td> </tr> <tr> <td style="padding: 2px 5px;">Blacklist Duration</td> <td style="text-align: right; padding: 2px 5px;"><input style="width: 80px;" type="text" value="300"/></td> </tr> <tr> <td style="padding: 2px 5px;">Whitelist Proxy</td> <td style="text-align: right; padding: 2px 5px;"><input type="checkbox"/> Enabled</td> </tr> <tr> <td style="padding: 2px 5px;">XML SIP Notify</td> <td style="text-align: right; padding: 2px 5px;"><input type="checkbox"/> Enabled</td> </tr> </table> </div>	Explicit MWI Subscription	<input type="checkbox"/> Enabled	Explicit MWI Subscription Period	<input style="width: 80px;" type="text" value="86400"/>	Missed Call Summary Subscription	<input type="checkbox"/> Enabled	Missed Call Summary Subscription Period	<input style="width: 80px;" type="text" value="86400"/>	AS-Feature-Event Subscription	<input type="checkbox"/> Enabled	AS-Feature-Event Subscription Period	<input style="width: 80px;" type="text" value="3600"/>	Send MAC Address in REGISTER Message	<input type="checkbox"/> Enabled	Send Line Number in REGISTER Message	<input type="checkbox"/> Enabled	Session Timer	<input style="width: 80px;" type="text" value="0"/>	T1 Timer	<input style="width: 80px;" type="text" value="0"/>	T2 Timer	<input style="width: 80px;" type="text" value="0"/>	Transaction Timer	<input style="width: 80px;" type="text" value="4000"/>	Transport Protocol	<input style="width: 80px;" type="text" value="UDP"/>	Local SIP UDP/TCP Port	<input style="width: 80px;" type="text" value="5060"/>	Local SIP TLS Port	<input style="width: 80px;" type="text" value="5061"/>	Registration Failed Retry Timer	<input style="width: 80px;" type="text" value="1800"/>	Registration Timeout Retry Timer	<input style="width: 80px;" type="text" value="120"/>	Registration Renewal Timer	<input style="width: 80px;" type="text" value="15"/>	BLF Subscription Period	<input style="width: 80px;" type="text" value="3600"/>	ACD Subscription Period	<input style="width: 80px;" type="text" value="3600"/>	Blacklist Duration	<input style="width: 80px;" type="text" value="300"/>	Whitelist Proxy	<input type="checkbox"/> Enabled	XML SIP Notify	<input type="checkbox"/> Enabled
Explicit MWI Subscription	<input type="checkbox"/> Enabled																																														
Explicit MWI Subscription Period	<input style="width: 80px;" type="text" value="86400"/>																																														
Missed Call Summary Subscription	<input type="checkbox"/> Enabled																																														
Missed Call Summary Subscription Period	<input style="width: 80px;" type="text" value="86400"/>																																														
AS-Feature-Event Subscription	<input type="checkbox"/> Enabled																																														
AS-Feature-Event Subscription Period	<input style="width: 80px;" type="text" value="3600"/>																																														
Send MAC Address in REGISTER Message	<input type="checkbox"/> Enabled																																														
Send Line Number in REGISTER Message	<input type="checkbox"/> Enabled																																														
Session Timer	<input style="width: 80px;" type="text" value="0"/>																																														
T1 Timer	<input style="width: 80px;" type="text" value="0"/>																																														
T2 Timer	<input style="width: 80px;" type="text" value="0"/>																																														
Transaction Timer	<input style="width: 80px;" type="text" value="4000"/>																																														
Transport Protocol	<input style="width: 80px;" type="text" value="UDP"/>																																														
Local SIP UDP/TCP Port	<input style="width: 80px;" type="text" value="5060"/>																																														
Local SIP TLS Port	<input style="width: 80px;" type="text" value="5061"/>																																														
Registration Failed Retry Timer	<input style="width: 80px;" type="text" value="1800"/>																																														
Registration Timeout Retry Timer	<input style="width: 80px;" type="text" value="120"/>																																														
Registration Renewal Timer	<input style="width: 80px;" type="text" value="15"/>																																														
BLF Subscription Period	<input style="width: 80px;" type="text" value="3600"/>																																														
ACD Subscription Period	<input style="width: 80px;" type="text" value="3600"/>																																														
Blacklist Duration	<input style="width: 80px;" type="text" value="300"/>																																														
Whitelist Proxy	<input type="checkbox"/> Enabled																																														
XML SIP Notify	<input type="checkbox"/> Enabled																																														

 **Aastra Web UI**

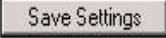
- | | |
|---|--|
| 2 | <p>The "Missed Call Summary Subscription" field is disabled by default. To enable this field, check the box.</p> <p>This feature allows missed calls that have been redirected by the server, to be incremented in the missed calls indicator on the phone it was initially directed to. For example, phones A, B, and C are connected to the server. You configure the server to direct calls coming into phone B (which has voicemail configured) to be forwarded to phone C. When phone A calls sip missed call summary subscription parameter, phone B receives notification from the server that the call was forwarded and the missed calls indicator is incremented on phone B.</p> <p>Note: You must configure voicemail on the phone that the call was initially directed to (phone B in the above example).</p> |
| 3 | <p>The "Missed Call Summary Subscription Period" field is enabled with a default value of 86400. To disable this field, enter zero (0), or leave the field blank.</p> |
| 4 | <p>Click  to save your changes.</p> |

Per-Line Configuration

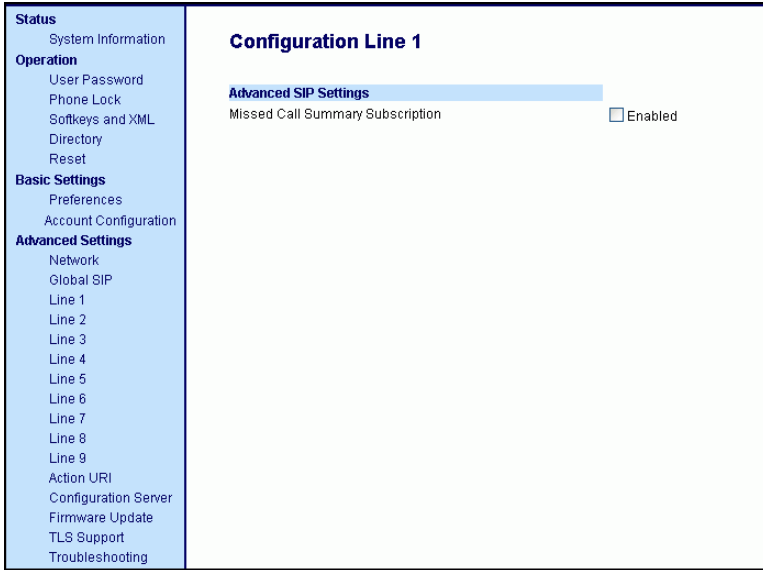
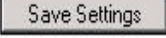
- | | |
|---|--|
| 1 | <p>Click on Advanced Settings->Line <N>->Advanced SIP Settings.</p>  |
| 2 | <p>Click  to save your changes.</p> |

As-Feature-Event Subscription

The IP phones support server-side Do Not Disturb (DND), Call Forward (CFWD), and Automatic Call Distribution (ACD) feature events. This feature is called “as-feature-event” and works with the DND, CFWD, and ACD keys.



Notes:

1. The 6751i supports server-side DND and CFWD only.
 2. The DND, CFWD, and ACD server-side feature is not applicable to the CT handset.
-

This feature is configurable using the configuration files or the Aastra Web UI.

How it Works on the Phone UI

When you enable the “as-feature-event” on the phone, AND you activate a DND, CFWD, and/or ACD key, pressing the key performs as follows:

- If the key is configured for an account on the phone, the server applies DND, CFWD or ACD to that account. (For information about CFWD and DND account configuration, see Chapter 3, the section, “[Account Configuration](#)” on [page 3-35](#)).
- If the key is “custom” configured, a screen displays on the phone allowing the user to choose the account to apply DND or CFWD. (For information about CFWD and DND custom configuration, see Chapter 3, the section, “[Account Configuration](#)” on [page 3-35](#)).
- A solid “Message Waiting Indicator” (MWI) indicates if one line/account has DND or CFWD enabled, and the LED next to the DND/CFWD key is ON. A status displays on the LCD that indicates the status of the line in focus (for example, the status of CFWD could be “Call Forward Busy” (CFWDB) or “Call Forward No Answer” (CFWDNA)).



Note: If the ACD key is configured on the phone, and the “as-feature-event” is not enabled, the phones uses the ACD icons and LED behavior from a Sylantro server instead.

When you press the DND, CFWD, or ACD key, only one attempt is made to enable/disable the “as-feature-event” feature on the server. The message “*Trying*” displays on the phone’s LCD after pressing the key. If the attempt is successful, the idle screen displays. If the attempt is unsuccessful, the message “*Failed*” displays. The user can press the softkey again to re-attempt the feature if required.

The following screen displays on the IP Phone UI for server-side call forwarding:

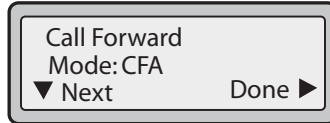

For server-side ACD, when you press the ACD softkey, the screen that displays is dependant on the state of the ACD subscription. Possible state for ACD are::

- **Logged Out** - User has the option of logging in.
- **Logged In** - User has the option of logging out or making the phone unavailable.
- **Unavailable** - User has the option of logging out or making the phone available.

ACD Screen For 3-Line LCD Displays:

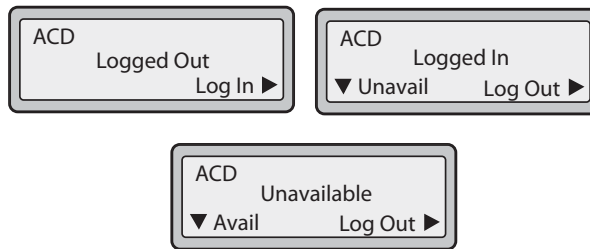

ACD Screen for 8 and 11-Line LCD Phones

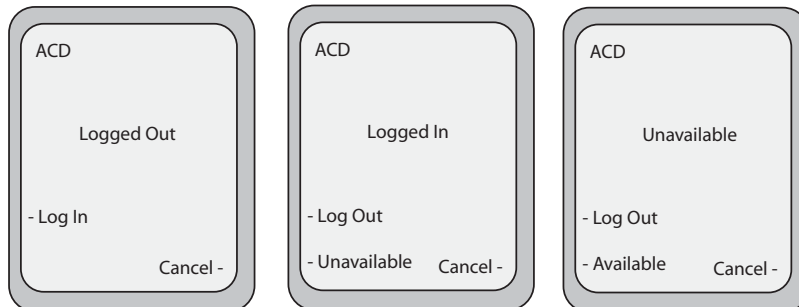



Note: IMPORTANT!

If DND and CFWD are configured to use “**Account**” mode on the IP Phone, pressing the DND and CFWD keys apply to the account in focus as described in Chapter 3, the section, “[Account Configuration](#)” on [page 3-35](#).

If ACD is configured on the phone, the ACD softkey applies to the line for which the key is configured. The ACD softkey must be configured for the first line of an account. For example, if account 2 has line 3 and line 4 you must configure the ACD softkey for line 3.

Configuring As-Feature-Event Subscription Using the Configuration Files

If the phone-side features of the DND, CFWD, and ACD keys are enabled, the phone uses the existing parameter values for these keys. If the server-side features are enabled, the phone saves the state of the features from the server on the phone.

Use the following parameters to enable/disable the server-side “as-feature-event” on the IP Phone:

- **sip lineN as-feature-event subscription**
- **sip as-feature-event subscription period**





Configuration Files

For the specific parameters you can set in the configuration files, see Appendix A, the section, “[As-Feature-Event Subscription Settings](#)” on [page A-115](#).

Configuring As-Feature-Event Subscription Using the Aastra Web UI

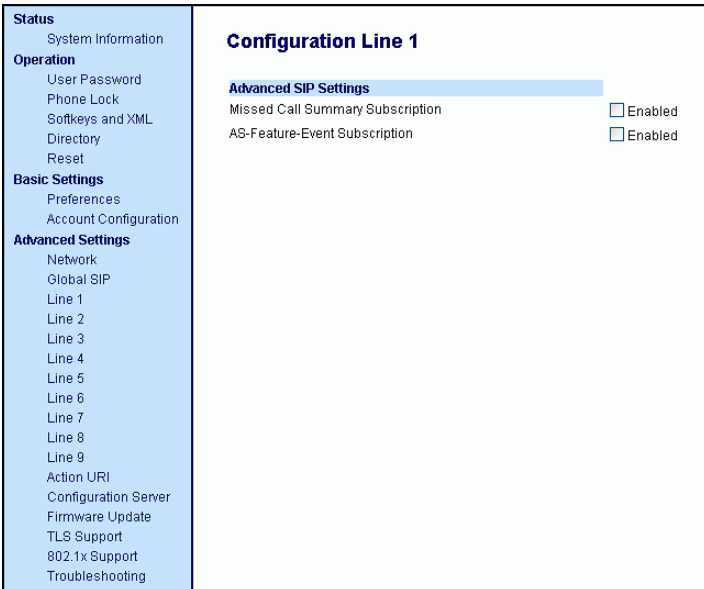
Use the following procedure to enable/disable the server-side “as-feature-event” on the IP Phone using the Aastra Web UI.

Aastra Web UI	
1	<p>Click on Advanced Settings->LineN->Advanced SIP Settings.</p> 
2	<p>In the “Advanced SIP Settings” section, enable the "As--Feature-Event Subscription” field, by checking the check box. (Disable this field by unchecking the box).</p>
3	<p>Click  to save your changes.</p>

**Aastra Web UI**

4 Click on **Advanced Settings->Global SIP->Advanced SIP Settings.**

Status System Information	Global SIP Settings
Operation User Password Phone Lock Softkeys and XML Directory Reset	Advanced SIP Settings Explicit MWI Subscription <input type="checkbox"/> Enabled Explicit MWI Subscription Period <input type="text" value="86400"/> Missed Call Summary Subscription <input type="checkbox"/> Enabled Missed Call Summary Subscription Period <input type="text" value="86400"/> AS-Feature-Event Subscription Period <input type="text" value="3600"/> Send MAC Address in REGISTER Message <input type="checkbox"/> Enabled Send Line Number in REGISTER Message <input type="checkbox"/> Enabled Session Timer <input type="text" value="0"/> T1 Timer <input type="text" value="0"/> T2 Timer <input type="text" value="0"/> Transaction Timer <input type="text" value="4000"/> Transport Protocol <input type="text" value="UDP"/> Local SIP UDP/TCP Port <input type="text" value="5060"/> Local SIP TLS Port <input type="text" value="5061"/> Registration Failed Retry Timer <input type="text" value="1800"/> Registration Timeout Retry Timer <input type="text" value="120"/> Registration Renewal Timer <input type="text" value="15"/> BLF Subscription Period <input type="text" value="3600"/> ACD Subscription Period <input type="text" value="3600"/> Blacklist Duration <input type="text" value="300"/> Whitelist Proxy <input type="checkbox"/> Enabled XML SIP Notify <input type="checkbox"/> Enabled
Basic Settings Preferences Account Configuration	
Advanced Settings Network Global SIP Line 1 Line 2 Line 3 Line 4 Line 5 Line 6 Line 7 Line 8 Line 9 Action URI Configuration Server Firmware Update TLS Support 802.1x Support Troubleshooting	

As-Feature-Event Subscription Period

5 In the “Advanced SIP Settings” section, in the “**As-Feature-Event Subscription Period**” field, enter the amount of time, in seconds, that the phone waits after sending a SUBSCRIBE, to receive a NOTIFY response from the server side. Default is 3600. Valid values are

6 Click  to save your changes.

Blacklist Duration

The Blacklist Duration feature helps to reduce unnecessary delays during proxy/registrar server failures, caused by the IP phone repeatedly sending SIP messages to a failed server. If you enable this feature, then whenever the IP phone sends a SIP message to a server, and does not get a response, the phone automatically adds the server to the blacklist. The IP phone avoids sending messages to any servers on the blacklist. If all servers are on the blacklist, then the IP phone attempts to send the message to the first server on the list.

You can specify how long failed servers remain on the blacklist in the IP phone's configuration file or in the Aastra Web UI. The default setting is 300 seconds. If you set the duration to 0 seconds, then you disable the blacklist feature.

Configuring Blacklist Duration Using the Configuration Files

Use the following parameter to configure the Blacklist Duration in the configuration files:

- `sip blacklist duration`



Configuration Files

For the specific parameters you can set in the configuration files for setting Blacklist Duration, see Appendix A, the section, [“Blacklist Duration Setting”](#) on [page A-261](#).

Configuring a Server Blacklist Using the Aastra Web UI

You use the following procedure to configure Blacklist Duration using the Aastra Web UI.

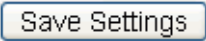
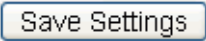
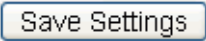
 Aastra Web UI																																																									
1	<p>Click on Advanced Settings->Global SIP->Advanced SIP Settings</p> <div style="border: 1px solid black; padding: 10px; margin: 10px 0;"> <table border="1" style="width: 100%; border-collapse: collapse;"> <tr> <td style="background-color: #D9E1F2; vertical-align: top; padding: 5px;"> <ul style="list-style-type: none"> Status System Information Operation User Password Phone Lock Softkeys and XML Keypad Speed Dial Directory Reset Basic Settings Preferences Account Configuration Advanced Settings Network Global SIP Line 1 Line 2 Line 3 Line 4 Line 5 Line 6 Line 7 Line 8 Line 9 Action URI Configuration Server Firmware Update TLS Support 802.1x Support Troubleshooting </td> <td style="padding: 5px;"> <p style="text-align: center;">Global SIP Settings</p> <p>Advanced SIP Settings</p> <table style="width: 100%; border-collapse: collapse;"> <tr> <td>Explicit MWI Subscription</td> <td style="text-align: right;"><input type="checkbox"/> Enabled</td> </tr> <tr> <td>Explicit MWI Subscription Period</td> <td style="text-align: right;"><input type="text" value="86400"/></td> </tr> <tr> <td>MWI for BLA account</td> <td style="text-align: right;"><input type="checkbox"/> Enabled</td> </tr> <tr> <td>Missed Call Summary Subscription</td> <td style="text-align: right;"><input type="checkbox"/> Enabled</td> </tr> <tr> <td>Missed Call Summary Subscription Period</td> <td style="text-align: right;"><input type="text" value="86400"/></td> </tr> <tr> <td>AS-Feature-Event Subscription</td> <td style="text-align: right;"><input type="checkbox"/> Enabled</td> </tr> <tr> <td>AS-Feature-Event Subscription Period</td> <td style="text-align: right;"><input type="text" value="3600"/></td> </tr> <tr> <td>Send MAC Address in REGISTER Message</td> <td style="text-align: right;"><input type="checkbox"/> Enabled</td> </tr> <tr> <td>Send Line Number in REGISTER Message</td> <td style="text-align: right;"><input type="checkbox"/> Enabled</td> </tr> <tr> <td>Session Timer</td> <td style="text-align: right;"><input type="text" value="0"/></td> </tr> <tr> <td>T1 Timer</td> <td style="text-align: right;"><input type="text" value="0"/></td> </tr> <tr> <td>T2 Timer</td> <td style="text-align: right;"><input type="text" value="0"/></td> </tr> <tr> <td>Transaction Timer</td> <td style="text-align: right;"><input type="text" value="4000"/></td> </tr> <tr> <td>Transport Protocol</td> <td style="text-align: right;"><input type="text" value="UDP"/></td> </tr> <tr> <td>Local SIP UDP/TCP Port</td> <td style="text-align: right;"><input type="text" value="5060"/></td> </tr> <tr> <td>Local SIP TLS Port</td> <td style="text-align: right;"><input type="text" value="5061"/></td> </tr> <tr> <td>Registration Failed Retry Timer</td> <td style="text-align: right;"><input type="text" value="1800"/></td> </tr> <tr> <td>Registration Timeout Retry Timer</td> <td style="text-align: right;"><input type="text" value="120"/></td> </tr> <tr> <td>Registration Renewal Timer</td> <td style="text-align: right;"><input type="text" value="15"/></td> </tr> <tr> <td>BLF Subscription Period</td> <td style="text-align: right;"><input type="text" value="3600"/></td> </tr> <tr> <td>ACD Subscription Period</td> <td style="text-align: right;"><input type="text" value="3600"/></td> </tr> <tr> <td>BLA Subscription Period</td> <td style="text-align: right;"><input type="text" value="300"/></td> </tr> <tr> <td>Blacklist Duration</td> <td style="text-align: right;"><input type="text" value="300"/></td> </tr> <tr> <td>Whitelist Proxy</td> <td style="text-align: right;"><input type="checkbox"/> Enabled</td> </tr> <tr> <td>XML SIP Notify</td> <td style="text-align: right;"><input type="checkbox"/> Enabled</td> </tr> </table> </td> </tr> </table> </div> <tr> <td style="vertical-align: top; padding: 5px;">2</td> <td style="padding: 5px;"> <p>In the “Blacklist Duration” field, specify the length of time, in seconds, that a failed server remains on the server blacklist. The IP phone avoids sending a SIP message to a failed server (if another server is available) for this amount of time. Valid values are 0 to 9999999. Default is 300 seconds (5 minutes).</p> <p>For example: 600</p> <p>Note: The value of “0” disables the blacklist feature.</p> </td> </tr> <tr> <td style="vertical-align: top; padding: 5px;">3</td> <td style="padding: 5px;"> <p>Click  to save your changes.</p> </td> </tr>	<ul style="list-style-type: none"> Status System Information Operation User Password Phone Lock Softkeys and XML Keypad Speed Dial Directory Reset Basic Settings Preferences Account Configuration Advanced Settings Network Global SIP Line 1 Line 2 Line 3 Line 4 Line 5 Line 6 Line 7 Line 8 Line 9 Action URI Configuration Server Firmware Update TLS Support 802.1x Support Troubleshooting 	<p style="text-align: center;">Global SIP Settings</p> <p>Advanced SIP Settings</p> <table style="width: 100%; border-collapse: collapse;"> <tr> <td>Explicit MWI Subscription</td> <td style="text-align: right;"><input type="checkbox"/> Enabled</td> </tr> <tr> <td>Explicit MWI Subscription Period</td> <td style="text-align: right;"><input type="text" value="86400"/></td> </tr> <tr> <td>MWI for BLA account</td> <td style="text-align: right;"><input type="checkbox"/> Enabled</td> </tr> <tr> <td>Missed Call Summary Subscription</td> <td style="text-align: right;"><input type="checkbox"/> Enabled</td> </tr> <tr> <td>Missed Call Summary Subscription Period</td> <td style="text-align: right;"><input type="text" value="86400"/></td> </tr> <tr> <td>AS-Feature-Event Subscription</td> <td style="text-align: right;"><input type="checkbox"/> Enabled</td> </tr> <tr> <td>AS-Feature-Event Subscription Period</td> <td style="text-align: right;"><input type="text" value="3600"/></td> </tr> <tr> <td>Send MAC Address in REGISTER Message</td> <td style="text-align: right;"><input type="checkbox"/> Enabled</td> </tr> <tr> <td>Send Line Number in REGISTER Message</td> <td style="text-align: right;"><input type="checkbox"/> Enabled</td> </tr> <tr> <td>Session Timer</td> <td style="text-align: right;"><input type="text" value="0"/></td> </tr> <tr> <td>T1 Timer</td> <td style="text-align: right;"><input type="text" value="0"/></td> </tr> <tr> <td>T2 Timer</td> <td style="text-align: right;"><input type="text" value="0"/></td> </tr> <tr> <td>Transaction Timer</td> <td style="text-align: right;"><input type="text" value="4000"/></td> </tr> <tr> <td>Transport Protocol</td> <td style="text-align: right;"><input type="text" value="UDP"/></td> </tr> <tr> <td>Local SIP UDP/TCP Port</td> <td style="text-align: right;"><input type="text" value="5060"/></td> </tr> <tr> <td>Local SIP TLS Port</td> <td style="text-align: right;"><input type="text" value="5061"/></td> </tr> <tr> <td>Registration Failed Retry Timer</td> <td style="text-align: right;"><input type="text" value="1800"/></td> </tr> <tr> <td>Registration Timeout Retry Timer</td> <td style="text-align: right;"><input type="text" value="120"/></td> </tr> <tr> <td>Registration Renewal Timer</td> <td style="text-align: right;"><input type="text" value="15"/></td> </tr> <tr> <td>BLF Subscription Period</td> <td style="text-align: right;"><input type="text" value="3600"/></td> </tr> <tr> <td>ACD Subscription Period</td> <td style="text-align: right;"><input type="text" value="3600"/></td> </tr> <tr> <td>BLA Subscription Period</td> <td style="text-align: right;"><input type="text" value="300"/></td> </tr> <tr> <td>Blacklist Duration</td> <td style="text-align: right;"><input type="text" value="300"/></td> </tr> <tr> <td>Whitelist Proxy</td> <td style="text-align: right;"><input type="checkbox"/> Enabled</td> </tr> <tr> <td>XML SIP Notify</td> <td style="text-align: right;"><input type="checkbox"/> Enabled</td> </tr> </table>	Explicit MWI Subscription	<input type="checkbox"/> Enabled	Explicit MWI Subscription Period	<input type="text" value="86400"/>	MWI for BLA account	<input type="checkbox"/> Enabled	Missed Call Summary Subscription	<input type="checkbox"/> Enabled	Missed Call Summary Subscription Period	<input type="text" value="86400"/>	AS-Feature-Event Subscription	<input type="checkbox"/> Enabled	AS-Feature-Event Subscription Period	<input type="text" value="3600"/>	Send MAC Address in REGISTER Message	<input type="checkbox"/> Enabled	Send Line Number in REGISTER Message	<input type="checkbox"/> Enabled	Session Timer	<input type="text" value="0"/>	T1 Timer	<input type="text" value="0"/>	T2 Timer	<input type="text" value="0"/>	Transaction Timer	<input type="text" value="4000"/>	Transport Protocol	<input type="text" value="UDP"/>	Local SIP UDP/TCP Port	<input type="text" value="5060"/>	Local SIP TLS Port	<input type="text" value="5061"/>	Registration Failed Retry Timer	<input type="text" value="1800"/>	Registration Timeout Retry Timer	<input type="text" value="120"/>	Registration Renewal Timer	<input type="text" value="15"/>	BLF Subscription Period	<input type="text" value="3600"/>	ACD Subscription Period	<input type="text" value="3600"/>	BLA Subscription Period	<input type="text" value="300"/>	Blacklist Duration	<input type="text" value="300"/>	Whitelist Proxy	<input type="checkbox"/> Enabled	XML SIP Notify	<input type="checkbox"/> Enabled	2	<p>In the “Blacklist Duration” field, specify the length of time, in seconds, that a failed server remains on the server blacklist. The IP phone avoids sending a SIP message to a failed server (if another server is available) for this amount of time. Valid values are 0 to 9999999. Default is 300 seconds (5 minutes).</p> <p>For example: 600</p> <p>Note: The value of “0” disables the blacklist feature.</p>	3	<p>Click  to save your changes.</p>
<ul style="list-style-type: none"> Status System Information Operation User Password Phone Lock Softkeys and XML Keypad Speed Dial Directory Reset Basic Settings Preferences Account Configuration Advanced Settings Network Global SIP Line 1 Line 2 Line 3 Line 4 Line 5 Line 6 Line 7 Line 8 Line 9 Action URI Configuration Server Firmware Update TLS Support 802.1x Support Troubleshooting 	<p style="text-align: center;">Global SIP Settings</p> <p>Advanced SIP Settings</p> <table style="width: 100%; border-collapse: collapse;"> <tr> <td>Explicit MWI Subscription</td> <td style="text-align: right;"><input type="checkbox"/> Enabled</td> </tr> <tr> <td>Explicit MWI Subscription Period</td> <td style="text-align: right;"><input type="text" value="86400"/></td> </tr> <tr> <td>MWI for BLA account</td> <td style="text-align: right;"><input type="checkbox"/> Enabled</td> </tr> <tr> <td>Missed Call Summary Subscription</td> <td style="text-align: right;"><input type="checkbox"/> Enabled</td> </tr> <tr> <td>Missed Call Summary Subscription Period</td> <td style="text-align: right;"><input type="text" value="86400"/></td> </tr> <tr> <td>AS-Feature-Event Subscription</td> <td style="text-align: right;"><input type="checkbox"/> Enabled</td> </tr> <tr> <td>AS-Feature-Event Subscription Period</td> <td style="text-align: right;"><input type="text" value="3600"/></td> </tr> <tr> <td>Send MAC Address in REGISTER Message</td> <td style="text-align: right;"><input type="checkbox"/> Enabled</td> </tr> <tr> <td>Send Line Number in REGISTER Message</td> <td style="text-align: right;"><input type="checkbox"/> Enabled</td> </tr> <tr> <td>Session Timer</td> <td style="text-align: right;"><input type="text" value="0"/></td> </tr> <tr> <td>T1 Timer</td> <td style="text-align: right;"><input type="text" value="0"/></td> </tr> <tr> <td>T2 Timer</td> <td style="text-align: right;"><input type="text" value="0"/></td> </tr> <tr> <td>Transaction Timer</td> <td style="text-align: right;"><input type="text" value="4000"/></td> </tr> <tr> <td>Transport Protocol</td> <td style="text-align: right;"><input type="text" value="UDP"/></td> </tr> <tr> <td>Local SIP UDP/TCP Port</td> <td style="text-align: right;"><input type="text" value="5060"/></td> </tr> <tr> <td>Local SIP TLS Port</td> <td style="text-align: right;"><input type="text" value="5061"/></td> </tr> <tr> <td>Registration Failed Retry Timer</td> <td style="text-align: right;"><input type="text" value="1800"/></td> </tr> <tr> <td>Registration Timeout Retry Timer</td> <td style="text-align: right;"><input type="text" value="120"/></td> </tr> <tr> <td>Registration Renewal Timer</td> <td style="text-align: right;"><input type="text" value="15"/></td> </tr> <tr> <td>BLF Subscription Period</td> <td style="text-align: right;"><input type="text" value="3600"/></td> </tr> <tr> <td>ACD Subscription Period</td> <td style="text-align: right;"><input type="text" value="3600"/></td> </tr> <tr> <td>BLA Subscription Period</td> <td style="text-align: right;"><input type="text" value="300"/></td> </tr> <tr> <td>Blacklist Duration</td> <td style="text-align: right;"><input type="text" value="300"/></td> </tr> <tr> <td>Whitelist Proxy</td> <td style="text-align: right;"><input type="checkbox"/> Enabled</td> </tr> <tr> <td>XML SIP Notify</td> <td style="text-align: right;"><input type="checkbox"/> Enabled</td> </tr> </table>	Explicit MWI Subscription	<input type="checkbox"/> Enabled	Explicit MWI Subscription Period	<input type="text" value="86400"/>	MWI for BLA account	<input type="checkbox"/> Enabled	Missed Call Summary Subscription	<input type="checkbox"/> Enabled	Missed Call Summary Subscription Period	<input type="text" value="86400"/>	AS-Feature-Event Subscription	<input type="checkbox"/> Enabled	AS-Feature-Event Subscription Period	<input type="text" value="3600"/>	Send MAC Address in REGISTER Message	<input type="checkbox"/> Enabled	Send Line Number in REGISTER Message	<input type="checkbox"/> Enabled	Session Timer	<input type="text" value="0"/>	T1 Timer	<input type="text" value="0"/>	T2 Timer	<input type="text" value="0"/>	Transaction Timer	<input type="text" value="4000"/>	Transport Protocol	<input type="text" value="UDP"/>	Local SIP UDP/TCP Port	<input type="text" value="5060"/>	Local SIP TLS Port	<input type="text" value="5061"/>	Registration Failed Retry Timer	<input type="text" value="1800"/>	Registration Timeout Retry Timer	<input type="text" value="120"/>	Registration Renewal Timer	<input type="text" value="15"/>	BLF Subscription Period	<input type="text" value="3600"/>	ACD Subscription Period	<input type="text" value="3600"/>	BLA Subscription Period	<input type="text" value="300"/>	Blacklist Duration	<input type="text" value="300"/>	Whitelist Proxy	<input type="checkbox"/> Enabled	XML SIP Notify	<input type="checkbox"/> Enabled						
Explicit MWI Subscription	<input type="checkbox"/> Enabled																																																								
Explicit MWI Subscription Period	<input type="text" value="86400"/>																																																								
MWI for BLA account	<input type="checkbox"/> Enabled																																																								
Missed Call Summary Subscription	<input type="checkbox"/> Enabled																																																								
Missed Call Summary Subscription Period	<input type="text" value="86400"/>																																																								
AS-Feature-Event Subscription	<input type="checkbox"/> Enabled																																																								
AS-Feature-Event Subscription Period	<input type="text" value="3600"/>																																																								
Send MAC Address in REGISTER Message	<input type="checkbox"/> Enabled																																																								
Send Line Number in REGISTER Message	<input type="checkbox"/> Enabled																																																								
Session Timer	<input type="text" value="0"/>																																																								
T1 Timer	<input type="text" value="0"/>																																																								
T2 Timer	<input type="text" value="0"/>																																																								
Transaction Timer	<input type="text" value="4000"/>																																																								
Transport Protocol	<input type="text" value="UDP"/>																																																								
Local SIP UDP/TCP Port	<input type="text" value="5060"/>																																																								
Local SIP TLS Port	<input type="text" value="5061"/>																																																								
Registration Failed Retry Timer	<input type="text" value="1800"/>																																																								
Registration Timeout Retry Timer	<input type="text" value="120"/>																																																								
Registration Renewal Timer	<input type="text" value="15"/>																																																								
BLF Subscription Period	<input type="text" value="3600"/>																																																								
ACD Subscription Period	<input type="text" value="3600"/>																																																								
BLA Subscription Period	<input type="text" value="300"/>																																																								
Blacklist Duration	<input type="text" value="300"/>																																																								
Whitelist Proxy	<input type="checkbox"/> Enabled																																																								
XML SIP Notify	<input type="checkbox"/> Enabled																																																								
2	<p>In the “Blacklist Duration” field, specify the length of time, in seconds, that a failed server remains on the server blacklist. The IP phone avoids sending a SIP message to a failed server (if another server is available) for this amount of time. Valid values are 0 to 9999999. Default is 300 seconds (5 minutes).</p> <p>For example: 600</p> <p>Note: The value of “0” disables the blacklist feature.</p>																																																								
3	<p>Click  to save your changes.</p>																																																								

Whitelist Proxy

To protect your IP phone network, you can configure a “**Whitelist Proxy**” feature that screens incoming call requests received by the IP phones. When this feature is enabled, an IP phone accepts call requests from a trusted proxy server *only*. The IP phone rejects any call requests from an untrusted proxy server

Configuring Whitelist Proxy Using the Configuration Files

You use the following parameter to configure the whitelist proxy feature using the configuration files:

- `sip whitelist`



Configuration Files

For the specific parameters you can set in the configuration files for setting Whitelist Proxy, see Appendix A, the section, “[Whitelist Proxy Setting](#)” on [page A-261](#).

Configuring Whitelist Proxy Using the Aastra Web UI

Use the following procedure to configure the Whitelist Proxy feature using the Aastra Web UI.

 Aastra Web UI			
1	<p>Click on Advanced Settings->Global SIP->Advanced SIP Settings</p> <div style="border: 1px solid black; padding: 5px; margin: 10px 0;"> <table border="1" style="width: 100%; border-collapse: collapse;"> <tr> <td style="width: 25%; vertical-align: top;"> <p>Status</p> <ul style="list-style-type: none"> System Information <p>Operation</p> <ul style="list-style-type: none"> User Password Phone Lock Softkeys and XML Keypad Speed Dial Directory Reset <p>Basic Settings</p> <ul style="list-style-type: none"> Preferences Account Configuration <p>Advanced Settings</p> <ul style="list-style-type: none"> Network Global SIP Line 1 Line 2 Line 3 Line 4 Line 5 Line 6 Line 7 Line 8 Line 9 Action URI Configuration Server Firmware Update TLS Support 802.1x Support Troubleshooting </td> <td style="width: 75%; vertical-align: top;"> <p>Global SIP Settings</p> <p>Advanced SIP Settings</p> <ul style="list-style-type: none"> Explicit MWI Subscription <input type="checkbox"/> Enabled Explicit MWI Subscription Period <input type="text" value="86400"/> MWI for BLA account <input type="checkbox"/> Enabled Missed Call Summary Subscription <input type="checkbox"/> Enabled Missed Call Summary Subscription Period <input type="text" value="86400"/> AS-Feature-Event Subscription <input type="checkbox"/> Enabled AS-Feature-Event Subscription Period <input type="text" value="3600"/> Send MAC Address in REGISTER Message <input type="checkbox"/> Enabled Send Line Number in REGISTER Message <input type="checkbox"/> Enabled Session Timer <input type="text" value="0"/> T1 Timer <input type="text" value="0"/> T2 Timer <input type="text" value="0"/> Transaction Timer <input type="text" value="4000"/> Transport Protocol <input style="border: none; border-bottom: 1px solid black; background-color: #f0f0f0; text-decoration: none; color: #000080; font-weight: bold; font-size: 0.9em; padding: 2px 5px; margin: 0 5px; width: 100%;" type="text" value="UDP"/> Local SIP UDP/TCP Port <input type="text" value="5060"/> Local SIP TLS Port <input type="text" value="5061"/> Registration Failed Retry Timer <input type="text" value="1800"/> Registration Timeout Retry Timer <input type="text" value="120"/> Registration Renewal Timer <input type="text" value="15"/> BLF Subscription Period <input type="text" value="3600"/> ACD Subscription Period <input type="text" value="3600"/> BLA Subscription Period <input type="text" value="300"/> Blacklist Duration <input type="text" value="300"/> Whitelist Proxy <input type="checkbox"/> Enabled XML SIP Notify <input type="checkbox"/> Enabled </td> </tr> </table> </div>	<p>Status</p> <ul style="list-style-type: none"> System Information <p>Operation</p> <ul style="list-style-type: none"> User Password Phone Lock Softkeys and XML Keypad Speed Dial Directory Reset <p>Basic Settings</p> <ul style="list-style-type: none"> Preferences Account Configuration <p>Advanced Settings</p> <ul style="list-style-type: none"> Network Global SIP Line 1 Line 2 Line 3 Line 4 Line 5 Line 6 Line 7 Line 8 Line 9 Action URI Configuration Server Firmware Update TLS Support 802.1x Support Troubleshooting 	<p>Global SIP Settings</p> <p>Advanced SIP Settings</p> <ul style="list-style-type: none"> Explicit MWI Subscription <input type="checkbox"/> Enabled Explicit MWI Subscription Period <input type="text" value="86400"/> MWI for BLA account <input type="checkbox"/> Enabled Missed Call Summary Subscription <input type="checkbox"/> Enabled Missed Call Summary Subscription Period <input type="text" value="86400"/> AS-Feature-Event Subscription <input type="checkbox"/> Enabled AS-Feature-Event Subscription Period <input type="text" value="3600"/> Send MAC Address in REGISTER Message <input type="checkbox"/> Enabled Send Line Number in REGISTER Message <input type="checkbox"/> Enabled Session Timer <input type="text" value="0"/> T1 Timer <input type="text" value="0"/> T2 Timer <input type="text" value="0"/> Transaction Timer <input type="text" value="4000"/> Transport Protocol <input style="border: none; border-bottom: 1px solid black; background-color: #f0f0f0; text-decoration: none; color: #000080; font-weight: bold; font-size: 0.9em; padding: 2px 5px; margin: 0 5px; width: 100%;" type="text" value="UDP"/> Local SIP UDP/TCP Port <input type="text" value="5060"/> Local SIP TLS Port <input type="text" value="5061"/> Registration Failed Retry Timer <input type="text" value="1800"/> Registration Timeout Retry Timer <input type="text" value="120"/> Registration Renewal Timer <input type="text" value="15"/> BLF Subscription Period <input type="text" value="3600"/> ACD Subscription Period <input type="text" value="3600"/> BLA Subscription Period <input type="text" value="300"/> Blacklist Duration <input type="text" value="300"/> Whitelist Proxy <input type="checkbox"/> Enabled XML SIP Notify <input type="checkbox"/> Enabled
<p>Status</p> <ul style="list-style-type: none"> System Information <p>Operation</p> <ul style="list-style-type: none"> User Password Phone Lock Softkeys and XML Keypad Speed Dial Directory Reset <p>Basic Settings</p> <ul style="list-style-type: none"> Preferences Account Configuration <p>Advanced Settings</p> <ul style="list-style-type: none"> Network Global SIP Line 1 Line 2 Line 3 Line 4 Line 5 Line 6 Line 7 Line 8 Line 9 Action URI Configuration Server Firmware Update TLS Support 802.1x Support Troubleshooting 	<p>Global SIP Settings</p> <p>Advanced SIP Settings</p> <ul style="list-style-type: none"> Explicit MWI Subscription <input type="checkbox"/> Enabled Explicit MWI Subscription Period <input type="text" value="86400"/> MWI for BLA account <input type="checkbox"/> Enabled Missed Call Summary Subscription <input type="checkbox"/> Enabled Missed Call Summary Subscription Period <input type="text" value="86400"/> AS-Feature-Event Subscription <input type="checkbox"/> Enabled AS-Feature-Event Subscription Period <input type="text" value="3600"/> Send MAC Address in REGISTER Message <input type="checkbox"/> Enabled Send Line Number in REGISTER Message <input type="checkbox"/> Enabled Session Timer <input type="text" value="0"/> T1 Timer <input type="text" value="0"/> T2 Timer <input type="text" value="0"/> Transaction Timer <input type="text" value="4000"/> Transport Protocol <input style="border: none; border-bottom: 1px solid black; background-color: #f0f0f0; text-decoration: none; color: #000080; font-weight: bold; font-size: 0.9em; padding: 2px 5px; margin: 0 5px; width: 100%;" type="text" value="UDP"/> Local SIP UDP/TCP Port <input type="text" value="5060"/> Local SIP TLS Port <input type="text" value="5061"/> Registration Failed Retry Timer <input type="text" value="1800"/> Registration Timeout Retry Timer <input type="text" value="120"/> Registration Renewal Timer <input type="text" value="15"/> BLF Subscription Period <input type="text" value="3600"/> ACD Subscription Period <input type="text" value="3600"/> BLA Subscription Period <input type="text" value="300"/> Blacklist Duration <input type="text" value="300"/> Whitelist Proxy <input type="checkbox"/> Enabled XML SIP Notify <input type="checkbox"/> Enabled 		
2	<p>The "Whitelist Proxy" field is disabled by default. To enable this field, check the box.</p> <p>When this feature is enabled, an IP phone accepts call requests from a trusted proxy server <i>only</i>. The IP phone rejects any call requests from an untrusted proxy server.</p>		
3	<p>Click <input type="button" value="Save Settings"/> to save your changes.</p>		

Transport Layer Security (TLS)

The IP Phones support a transport protocol called **Transport Layer Security (TLS)** and **Persistent TLS**. TLS is a protocol that ensures communication privacy between the SIP phones and the Internet. TLS ensures that no third party may eavesdrop or tamper with any message.

TLS is composed of two layers: the TLS Record Protocol and the TLS handshake protocol. The TLS Record Protocol provides connection security with some encryption method such as the Data Encryption Standard (DES). The TLS Handshake Protocol allows the server and client to authenticate each other and to negotiate an encryption algorithm and cryptographic keys before data is exchanged. TLS requires the use of the following security certificate files to perform TLS handshake:

- Root and Intermediate Certificates
- Local Certificate
- Private Key
- Trusted Certificate

When the phones use **TLS** to authenticate with the server, each individual call must setup a new TLS connection. This can take more time when placing each call. Thus, the IP phones also have a feature that allows you to setup the connection to the server once and re-use that one connection for all calls from the phone. It is called **Persistent TLS**. The setup connection for Persistent TLS is established during the registration of the phone. If the phones are set to use Persistent TLS, and a call is made from the phone, this call and all subsequent calls use the same authenticated connection. This significantly reduces the delay time when placing a call.

**Notes:**

1. Persistent TLS requires the **outbound proxy server** and **outbound proxy port** parameters be configured in either the configuration files or the Aastra Web UI (*Advanced Settings->Global SIP->Basic SIP Network Settings*). There can be only one persistent TLS connection created per phone. The phone establishes the TLS connection to the configured outbound proxy.
2. If you configure the phone to use Persistent TLS, you must also specify the Trusted Certificate file to use. The Root and Intermediate Certificates, Local Certificate, and Private Key files are optional.

On the IP phones, an Administrator can configure TLS and Persistent TLS on a global-basis only, using the configuration files or the Aastra Web UI.

SIP Asserted Identity (for Sylantrio Servers)

The IP Phones support a private extension to SIP for Asserted Identity within trusted networks (as defined in RFC 3325).



Note: The phones support PAI header in the UPDATE message, according to draft-ietf-sipping-update-pai-00. This feature is always enabled.

If an UPDATE is received with a PAI header from a trusted source, the phone updates the display with this information. The phone ignores any PAI received from untrusted entities

This feature allows a network of trusted SIP servers to assert the identity of authenticated users, and verify that phone messages originate from a Trusted Identity. Upon receiving a message from a caller in the Trust Network, the IP phone reads the contents of the P-Asserted-Identity (PAI) header field and displays it on the phone UI. This field contains a more accurate description of the caller identity (extension/phone number) than is contained in the SIP message.

When an IP phone receives an incoming call, the IP phone does the following actions:

- Checks to see if the incoming call is from a registered proxy server.
- If the call is forwarded via a registered proxy server, then the message has already been verified and authenticated by the server. The caller is part of the Trust Network. The IP phone UI displays the caller information contained in the PAI header.
- If the call is not forwarded via a registered proxy server - and therefore is not a “Trusted Entity” - the IP phone UI does not display any trust information contained in the PAI header.

Configuring TLS Using the Configuration Files

You use the following parameters to configure TLS in the configuration files:

- `sip transport protocol`
- `sips persistent tls`
- `sips root and intermediate certificates`
- `sips local certificate`
- `sips private key`
- `sips trusted certificates`







Configuration Files

For the specific parameters you can set in the configuration files for setting TLS, see Appendix A, the section, “[Transport Layer Security \(TLS\) Settings](#)” on [page A-116](#).

Configuring TLS Using the Aastra Web UI

To configure TLS using the Aastra Web UI, you must enable TLS or Persistent TLS first. Then you must define the TLS certificate file names that you want the phone to use. Use the following procedure to configure TLS using the Aastra Web UI.

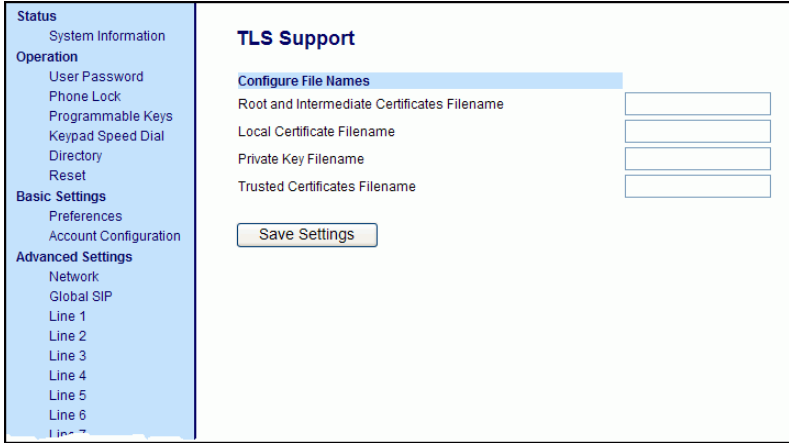
 Aastra Web UI																																							
1	<p>Click on Advanced Settings->Global SIP->Advanced SIP Settings.</p> <div style="border: 1px solid black; padding: 10px; margin: 10px auto; width: 80%;"> <table border="1" style="width: 100%; border-collapse: collapse;"> <tr> <td style="background-color: #4F81BD; color: white; vertical-align: top; padding: 5px;"> Status System Information Operation User Password Phone Lock Softkeys and XML Directory Reset Basic Settings Preferences Account Configuration Advanced Settings Network Global SIP Line 1 Line 2 Line 3 Line 4 Line 5 Line 6 Line 7 Line 8 Line 9 Action URI Configuration Server Firmware Update TLS Support Troubleshooting </td> <td style="padding: 5px;"> <h3 style="text-align: center; margin: 0;">Global SIP Settings</h3> <p>Advanced SIP Settings</p> <table style="width: 100%; border-collapse: collapse;"> <tr> <td style="width: 70%;">Explicit MWI Subscription</td> <td style="text-align: right;"><input type="checkbox"/> Enabled</td> </tr> <tr> <td>Explicit MWI Subscription Period</td> <td style="text-align: right;"><input type="text" value="86400"/></td> </tr> <tr> <td>Missed Call Summary Subscription</td> <td style="text-align: right;"><input type="checkbox"/> Enabled</td> </tr> <tr> <td>Missed Call Summary Subscription Period</td> <td style="text-align: right;"><input type="text" value="86400"/></td> </tr> <tr> <td>Send MAC Address in REGISTER Message</td> <td style="text-align: right;"><input type="checkbox"/> Enabled</td> </tr> <tr> <td>Send Line Number in REGISTER Message</td> <td style="text-align: right;"><input type="checkbox"/> Enabled</td> </tr> <tr> <td>Session Timer</td> <td style="text-align: right;"><input type="text" value="0"/></td> </tr> <tr> <td>T1 Timer</td> <td style="text-align: right;"><input type="text" value="0"/></td> </tr> <tr> <td>T2 Timer</td> <td style="text-align: right;"><input type="text" value="0"/></td> </tr> <tr> <td>Transaction Timer</td> <td style="text-align: right;"><input type="text" value="4000"/></td> </tr> <tr> <td>Transport Protocol</td> <td style="text-align: right;"><input style="border: 1px solid #ccc;" type="text" value="Persistent TLS"/></td> </tr> <tr> <td>Registration Failed Retry Timer</td> <td style="text-align: right;"><input type="text" value="1800"/></td> </tr> <tr> <td>Registration Timeout Retry Timer</td> <td style="text-align: right;"><input type="text" value="120"/></td> </tr> <tr> <td>Registration Renewal Timer</td> <td style="text-align: right;"><input type="text" value="15"/></td> </tr> <tr> <td>BLF Subscription Period</td> <td style="text-align: right;"><input type="text" value="3600"/></td> </tr> <tr> <td>ACD Subscription Period</td> <td style="text-align: right;"><input type="text" value="3600"/></td> </tr> <tr> <td>Blacklist Duration</td> <td style="text-align: right;"><input type="text" value="300"/></td> </tr> <tr> <td>Whitelist Proxy</td> <td style="text-align: right;"><input type="checkbox"/> Enabled</td> </tr> </table> </td> </tr> </table> </div>	Status System Information Operation User Password Phone Lock Softkeys and XML Directory Reset Basic Settings Preferences Account Configuration Advanced Settings Network Global SIP Line 1 Line 2 Line 3 Line 4 Line 5 Line 6 Line 7 Line 8 Line 9 Action URI Configuration Server Firmware Update TLS Support Troubleshooting	<h3 style="text-align: center; margin: 0;">Global SIP Settings</h3> <p>Advanced SIP Settings</p> <table style="width: 100%; border-collapse: collapse;"> <tr> <td style="width: 70%;">Explicit MWI Subscription</td> <td style="text-align: right;"><input type="checkbox"/> Enabled</td> </tr> <tr> <td>Explicit MWI Subscription Period</td> <td style="text-align: right;"><input type="text" value="86400"/></td> </tr> <tr> <td>Missed Call Summary Subscription</td> <td style="text-align: right;"><input type="checkbox"/> Enabled</td> </tr> <tr> <td>Missed Call Summary Subscription Period</td> <td style="text-align: right;"><input type="text" value="86400"/></td> </tr> <tr> <td>Send MAC Address in REGISTER Message</td> <td style="text-align: right;"><input type="checkbox"/> Enabled</td> </tr> <tr> <td>Send Line Number in REGISTER Message</td> <td style="text-align: right;"><input type="checkbox"/> Enabled</td> </tr> <tr> <td>Session Timer</td> <td style="text-align: right;"><input type="text" value="0"/></td> </tr> <tr> <td>T1 Timer</td> <td style="text-align: right;"><input type="text" value="0"/></td> </tr> <tr> <td>T2 Timer</td> <td style="text-align: right;"><input type="text" value="0"/></td> </tr> <tr> <td>Transaction Timer</td> <td style="text-align: right;"><input type="text" value="4000"/></td> </tr> <tr> <td>Transport Protocol</td> <td style="text-align: right;"><input style="border: 1px solid #ccc;" type="text" value="Persistent TLS"/></td> </tr> <tr> <td>Registration Failed Retry Timer</td> <td style="text-align: right;"><input type="text" value="1800"/></td> </tr> <tr> <td>Registration Timeout Retry Timer</td> <td style="text-align: right;"><input type="text" value="120"/></td> </tr> <tr> <td>Registration Renewal Timer</td> <td style="text-align: right;"><input type="text" value="15"/></td> </tr> <tr> <td>BLF Subscription Period</td> <td style="text-align: right;"><input type="text" value="3600"/></td> </tr> <tr> <td>ACD Subscription Period</td> <td style="text-align: right;"><input type="text" value="3600"/></td> </tr> <tr> <td>Blacklist Duration</td> <td style="text-align: right;"><input type="text" value="300"/></td> </tr> <tr> <td>Whitelist Proxy</td> <td style="text-align: right;"><input type="checkbox"/> Enabled</td> </tr> </table>	Explicit MWI Subscription	<input type="checkbox"/> Enabled	Explicit MWI Subscription Period	<input type="text" value="86400"/>	Missed Call Summary Subscription	<input type="checkbox"/> Enabled	Missed Call Summary Subscription Period	<input type="text" value="86400"/>	Send MAC Address in REGISTER Message	<input type="checkbox"/> Enabled	Send Line Number in REGISTER Message	<input type="checkbox"/> Enabled	Session Timer	<input type="text" value="0"/>	T1 Timer	<input type="text" value="0"/>	T2 Timer	<input type="text" value="0"/>	Transaction Timer	<input type="text" value="4000"/>	Transport Protocol	<input style="border: 1px solid #ccc;" type="text" value="Persistent TLS"/>	Registration Failed Retry Timer	<input type="text" value="1800"/>	Registration Timeout Retry Timer	<input type="text" value="120"/>	Registration Renewal Timer	<input type="text" value="15"/>	BLF Subscription Period	<input type="text" value="3600"/>	ACD Subscription Period	<input type="text" value="3600"/>	Blacklist Duration	<input type="text" value="300"/>	Whitelist Proxy	<input type="checkbox"/> Enabled
Status System Information Operation User Password Phone Lock Softkeys and XML Directory Reset Basic Settings Preferences Account Configuration Advanced Settings Network Global SIP Line 1 Line 2 Line 3 Line 4 Line 5 Line 6 Line 7 Line 8 Line 9 Action URI Configuration Server Firmware Update TLS Support Troubleshooting	<h3 style="text-align: center; margin: 0;">Global SIP Settings</h3> <p>Advanced SIP Settings</p> <table style="width: 100%; border-collapse: collapse;"> <tr> <td style="width: 70%;">Explicit MWI Subscription</td> <td style="text-align: right;"><input type="checkbox"/> Enabled</td> </tr> <tr> <td>Explicit MWI Subscription Period</td> <td style="text-align: right;"><input type="text" value="86400"/></td> </tr> <tr> <td>Missed Call Summary Subscription</td> <td style="text-align: right;"><input type="checkbox"/> Enabled</td> </tr> <tr> <td>Missed Call Summary Subscription Period</td> <td style="text-align: right;"><input type="text" value="86400"/></td> </tr> <tr> <td>Send MAC Address in REGISTER Message</td> <td style="text-align: right;"><input type="checkbox"/> Enabled</td> </tr> <tr> <td>Send Line Number in REGISTER Message</td> <td style="text-align: right;"><input type="checkbox"/> Enabled</td> </tr> <tr> <td>Session Timer</td> <td style="text-align: right;"><input type="text" value="0"/></td> </tr> <tr> <td>T1 Timer</td> <td style="text-align: right;"><input type="text" value="0"/></td> </tr> <tr> <td>T2 Timer</td> <td style="text-align: right;"><input type="text" value="0"/></td> </tr> <tr> <td>Transaction Timer</td> <td style="text-align: right;"><input type="text" value="4000"/></td> </tr> <tr> <td>Transport Protocol</td> <td style="text-align: right;"><input style="border: 1px solid #ccc;" type="text" value="Persistent TLS"/></td> </tr> <tr> <td>Registration Failed Retry Timer</td> <td style="text-align: right;"><input type="text" value="1800"/></td> </tr> <tr> <td>Registration Timeout Retry Timer</td> <td style="text-align: right;"><input type="text" value="120"/></td> </tr> <tr> <td>Registration Renewal Timer</td> <td style="text-align: right;"><input type="text" value="15"/></td> </tr> <tr> <td>BLF Subscription Period</td> <td style="text-align: right;"><input type="text" value="3600"/></td> </tr> <tr> <td>ACD Subscription Period</td> <td style="text-align: right;"><input type="text" value="3600"/></td> </tr> <tr> <td>Blacklist Duration</td> <td style="text-align: right;"><input type="text" value="300"/></td> </tr> <tr> <td>Whitelist Proxy</td> <td style="text-align: right;"><input type="checkbox"/> Enabled</td> </tr> </table>	Explicit MWI Subscription	<input type="checkbox"/> Enabled	Explicit MWI Subscription Period	<input type="text" value="86400"/>	Missed Call Summary Subscription	<input type="checkbox"/> Enabled	Missed Call Summary Subscription Period	<input type="text" value="86400"/>	Send MAC Address in REGISTER Message	<input type="checkbox"/> Enabled	Send Line Number in REGISTER Message	<input type="checkbox"/> Enabled	Session Timer	<input type="text" value="0"/>	T1 Timer	<input type="text" value="0"/>	T2 Timer	<input type="text" value="0"/>	Transaction Timer	<input type="text" value="4000"/>	Transport Protocol	<input style="border: 1px solid #ccc;" type="text" value="Persistent TLS"/>	Registration Failed Retry Timer	<input type="text" value="1800"/>	Registration Timeout Retry Timer	<input type="text" value="120"/>	Registration Renewal Timer	<input type="text" value="15"/>	BLF Subscription Period	<input type="text" value="3600"/>	ACD Subscription Period	<input type="text" value="3600"/>	Blacklist Duration	<input type="text" value="300"/>	Whitelist Proxy	<input type="checkbox"/> Enabled		
Explicit MWI Subscription	<input type="checkbox"/> Enabled																																						
Explicit MWI Subscription Period	<input type="text" value="86400"/>																																						
Missed Call Summary Subscription	<input type="checkbox"/> Enabled																																						
Missed Call Summary Subscription Period	<input type="text" value="86400"/>																																						
Send MAC Address in REGISTER Message	<input type="checkbox"/> Enabled																																						
Send Line Number in REGISTER Message	<input type="checkbox"/> Enabled																																						
Session Timer	<input type="text" value="0"/>																																						
T1 Timer	<input type="text" value="0"/>																																						
T2 Timer	<input type="text" value="0"/>																																						
Transaction Timer	<input type="text" value="4000"/>																																						
Transport Protocol	<input style="border: 1px solid #ccc;" type="text" value="Persistent TLS"/>																																						
Registration Failed Retry Timer	<input type="text" value="1800"/>																																						
Registration Timeout Retry Timer	<input type="text" value="120"/>																																						
Registration Renewal Timer	<input type="text" value="15"/>																																						
BLF Subscription Period	<input type="text" value="3600"/>																																						
ACD Subscription Period	<input type="text" value="3600"/>																																						
Blacklist Duration	<input type="text" value="300"/>																																						
Whitelist Proxy	<input type="checkbox"/> Enabled																																						
2	<p>In the "Transport Protocol" field, select TLS or Persistent TLS.</p> <p>Note: If configuring Persistent TLS, you must go to <i>Advanced Settings->Global SIP->Basic Network Settings</i> and configure the "Outbound Proxy Server" and "Outbound Proxy Port" parameters.</p>																																						
3	<p>Click  to save your changes.</p>																																						

 Aastra Web UI	
4	<p>Click on Advanced Settings->TLS Support.</p> <div style="border: 1px solid black; padding: 10px; margin: 10px 0;">  </div>
5	<p>Enter the certificate file names and the private key file name in the appropriate fields.</p> <p>The Root and Intermediate Certificate files contain one root certificate and zero or more intermediate certificates which must be placed in order of certificate signing with root certificate being the first in the file. If the local certificate is signed by some well known certificate authority, then that authority provides the user with the Root and Intermediate Certificate files (most likely just CA root certificate).</p> <p>The Trusted Certificate files define a list of trusted certificates. The phone's trusted list must contain the CA root certificates for all the servers it is connecting to. For example, if the phone is connecting to server A which has a certificate signed by CA1, and server B which has a certificate signed by CA2, the phone must have CA1 root certificate and CS2 root certificate in its Trusted Certificate file.</p> <p>Notes:</p> <ol style="list-style-type: none"> 1. If configuring TLS, you must specify the files for Root and Intermediate Certificates, the Local Certificate, the Private Key, and the Trusted Certificates in order for the phone to receive calls. 2. If configuring Persistent TLS, you must specify the Trusted Certificates (which contains the trusted certificate list). All other certificates and the Private Key are optional. 3. The certificate files and Private Key file names must use the format “.pem”. 4. To create custom certificate files and private key files to use on your IP phone, contact Aastra Technical Support.
6	<p>Click  to save your changes.</p>

802.1x Support

The IP phones support the IEEE 802.1x protocol. The 802.1x protocol is a standard for passing Extensible Authentication Protocol (EAP) over a wired or wireless Local Area Network (LAN).

The 802.1x protocol on the IP phone facilitates media-level access control, and offers the capability to permit or deny network connectivity, control LAN access, and apply traffic policy, based on user or endpoint identity. This feature supports both the EAP-MD5 and EAP-TLS protocols.

If 802.1x on the phone is enabled, the following screen displays during startup of the phone.

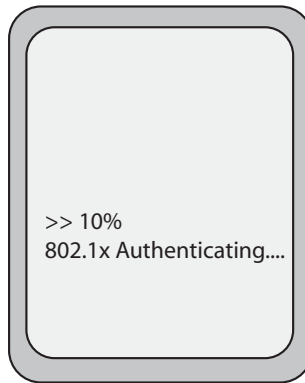

If the 802.1x failed to authenticate with the server, the phone continues its normal startup process using DHCP. However, the network port on the phone may or may not be disabled, depending on the switch configuration.

Certificates and Private Key Information

- If the certificates and private key are NOT stored in the phone:
 - the phone connects to an open unauthenticated VLAN and the certificates are downloaded.
 - or
 - the phone connects using EAP-MD5 to a restricted VLAN and the certificates are downloaded.

- If the certificates and private key **ARE** stored in the phone, the phone uses them during the authentication process.
- If the phone uses EAP-TLS for successful authentication, after the phone reboots, it downloads the latest certificates and private key files to the phone.
- The private key uses AES-128 to encrypt the private key file.
- Switch Supplicant Mode - The switch supports the following 2 modes:
 - **Single supplicant** - This mode enables the port once any machine connected to this port is authenticated. For security reasons, the IP phone has the option to disable the pass-through port.
 - **Multiple supplicants** - Using this mode, the switch can support multiple clients connected to same port. The switch distinguishes between the clients based on their MAC address.
- Factory default and recovery mode deletes all certificates and private keys, and sets the EAP type to **disabled**.

You can configure the 802.1x feature on the IP phone using the configuration files, the IP Phone UI, or the Aastra Web UI.



Note: If configuring 802.1x using the IP Phone UI, the certificates and private keys must already be configured and stored on the phone. Use the configuration files or the Aastra Web UI to load certificates and private keys.

Configuring the 802.1x Protocol Using the Configuration Files

You use the following parameters to configure the 802.1x Protocol on your phone using the configuration files.

For EAP-MD5 use:

- **eap type**
- **identity**
- **md5 password**
- **pc port passthrough enabled**

For EAP-TLS use:

- **eap type**
- **identity**
- **802.1x root and intermediate certificates**
(use 1 root and 0 or 1 intermediate certificates)
- **802.1x local certificate**
(use 1 local certificate)
- **802.1x private key**
(1 private key that corresponds to local certificate)
- **802.1x trusted certificates**
(0 or more trusted certificates (a maximum of 2))



Configuration Files

For the specific parameters you can set in the configuration files for setting 802.1x support, see Appendix A, the section, “[802.1x Support Settings](#)” on [page A-125](#).

Configuring the 802.1x Protocol Using the IP Phone UI

Use the following procedure to configure the 802.1x Protocol on your phone using the IP Phone UI.





Note: If configuring 802.1x using the IP Phone UI, the certificates and private keys must already be configured and stored on the phone. Use the configuration files or the Aastra Web UI to load certificates and private keys.





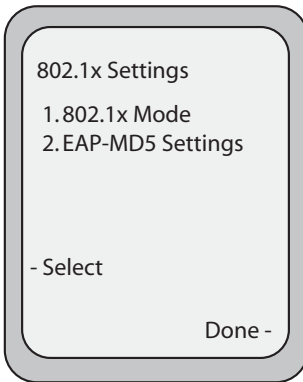
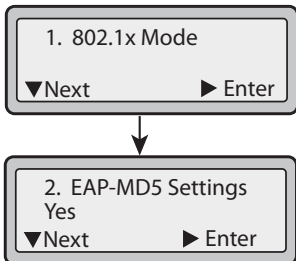
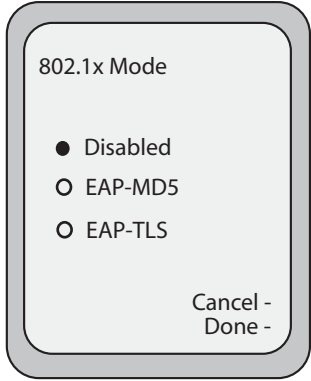
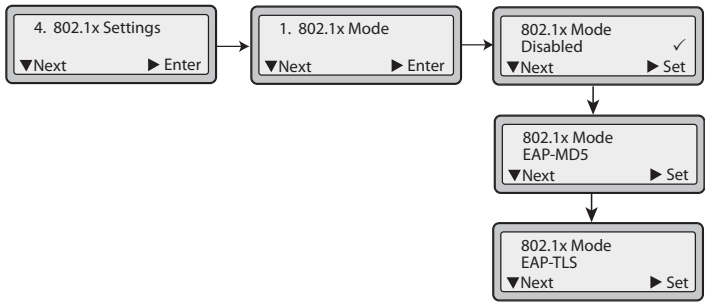

Aastra IP Phone UI

Step	Action
1	Press  to enter the Options List.
2	Select Administrator Menu and enter your Administrator password.

 Aastra IP Phone UI	
Step	Action
3	<p>On 11-Line LCDs:</p> <p>Select Network Settings->Ethernet & VLAN->802.1x Settings.</p> <p>On 3-Line LCDs:</p> <p>Select Network Settings->Ethernet & VLAN->802.1x Settings.</p> <div style="display: flex; justify-content: space-around; align-items: center; margin: 20px 0;"> <div style="border: 1px solid gray; border-radius: 15px; padding: 10px; width: 25%;"> <p style="text-align: center;">Ethernet & VLAN Settings</p> <ol style="list-style-type: none"> 1. LAN Port Link 2. PC Port Link 3. VLAN Settings 4. 802.1x Settings <p style="text-align: center;">- Select</p> <p style="text-align: right;">Done -</p> </div> <div style="text-align: center;"> <div style="border: 1px solid gray; border-radius: 10px; padding: 5px; display: inline-block;"> 10. Ethernet & VLAN ▼Next ▶ Enter </div> → <div style="border: 1px solid gray; border-radius: 10px; padding: 5px; display: inline-block;"> 4. 802.1x Settings ▼Next ▶ Enter </div> </div> </div> <p style="text-align: center; margin: 10px 0;">3-Line LCDs</p> <p style="text-align: center; margin: 10px 0;">11-Line LCDs</p>
4	Select 802.1x Settings.



 Aastra IP Phone UI	
Step	Action
5	<p>Select 802.1x Mode.</p>  
6	<p>Select EAP-MD5 to configure the phone to use MD5 authentication; or Select EAP-TLS to configure the phone to use TLS authentication.</p>   <p>Note: The 802.1x Protocol is disabled by default. If you select EAP-TLS authentication, you must use the configuration files or the Aastra Web UI to configure the certificates and private key for the phone.</p>
7	<p>Press Done (on 8 and 11-Line LCD phones) or Press Set (on 3-Line LCD phones - not applicable to the 6751i).</p>
8	<p>To configure MD5, select EAP-MD5 Settings.</p>



 Aastra IP Phone UI	
Step	Action
9	<p>Select Identity.</p> <div style="display: flex; align-items: flex-start;"> <div style="border: 1px solid gray; border-radius: 10px; padding: 10px; width: 25%; margin-right: 10px;"> <p>EAP-MD5 Setting</p> <p>1. Identity</p> <p>2. MD5 Password</p> <p>- Select</p> <p style="text-align: right;">Done -</p> </div> <div style="display: flex; flex-direction: column; align-items: center;"> <div style="border: 1px solid gray; border-radius: 5px; padding: 5px; margin-bottom: 5px;"> <p>1. EAP-MD5 Settings</p> <p>▼Next ►Enter</p> </div> <div style="border: 1px solid gray; border-radius: 5px; padding: 5px; margin-bottom: 5px;"> <p>1. Identity</p> <p>▼Next ►Enter</p> </div> <div style="border: 1px solid gray; border-radius: 5px; padding: 5px; margin-bottom: 5px;"> <p>User Name</p> <p> </p> <p>▲Cancel ►Set</p> </div> <div style="margin-bottom: 5px;">↓</div> <div style="border: 1px solid gray; border-radius: 5px; padding: 5px; margin-bottom: 5px;"> <p>2. MD5 Password</p> <p>▼Next ►Enter</p> </div> <div style="border: 1px solid gray; border-radius: 5px; padding: 5px;"> <p>Password</p> <p> </p> <p>▲Cancel ►Set</p> </div> </div> </div>
10	<p>Enter the identity or username used for authenticating the phone.</p> <div style="display: flex; align-items: flex-start;"> <div style="border: 1px solid gray; border-radius: 10px; padding: 10px; width: 25%; margin-right: 10px;"> <p>Username</p> <p>Username:</p> <p> </p> <p>- Backspace Nextspace -</p> <p style="text-align: right;">Cancel -</p> <p>- ABC ► Done -</p> </div> <div style="display: flex; flex-direction: column; align-items: center;"> <div style="border: 1px solid gray; border-radius: 5px; padding: 5px; margin-bottom: 5px;"> <p>1. EAP-MD5 Settings</p> <p>▼Next ►Enter</p> </div> <div style="border: 1px solid gray; border-radius: 5px; padding: 5px; margin-bottom: 5px;"> <p>1. Identity</p> <p>▼Next ►Enter</p> </div> <div style="border: 1px solid gray; border-radius: 5px; padding: 5px; margin-bottom: 5px;"> <p>User Name</p> <p> </p> <p>▲Cancel ►Set</p> </div> <div style="margin-bottom: 5px;">↓</div> <div style="border: 1px solid gray; border-radius: 5px; padding: 5px; margin-bottom: 5px;"> <p>2. MD5 Password</p> <p>▼Next ►Enter</p> </div> <div style="border: 1px solid gray; border-radius: 5px; padding: 5px;"> <p>Password</p> <p> </p> <p>▲Cancel ►Set</p> </div> </div> </div>
11	<p>Use the keys as applicable while entering the username; then press Done (8 and 11-Line LCD phones). or Press Set (3-Line LCD phones (not applicable to 6751i)).</p>

 Aastra IP Phone UI	
Step	Action
12	<p>Enter the password used for authenticating the phone.</p> <div style="display: flex; align-items: flex-start;"> <div style="border: 1px solid gray; border-radius: 15px; padding: 10px; margin-right: 20px; width: 200px;"> <p>Password</p> <p>Password: </p> <p>- Backspace Nextspace - Cancel - - ABC  Done -</p> </div> <div style="display: flex; flex-direction: column; align-items: center;"> <div style="display: flex; justify-content: space-between; width: 100px;"> ▼Next ►Enter </div> <div style="border: 1px solid gray; padding: 5px; margin: 5px;">1. EAP-MD5 Settings</div> <div style="margin: 5px;">→</div> <div style="display: flex; justify-content: space-between; width: 100px;"> ▼Next ►Enter </div> <div style="border: 1px solid gray; padding: 5px; margin: 5px;">1. Identity</div> <div style="margin: 5px;">↓</div> <div style="display: flex; justify-content: space-between; width: 100px;"> ▼Next ►Enter </div> <div style="border: 1px solid gray; padding: 5px; margin: 5px;">2. MD5 Password</div> <div style="margin: 5px;">→</div> <div style="display: flex; justify-content: space-between; width: 100px;"> ▲Cancel ►Set </div> <div style="border: 1px solid gray; padding: 5px; margin: 5px;">User Name</div> <div style="margin: 5px;"> </div> <div style="display: flex; justify-content: space-between; width: 100px;"> ▲Cancel ►Set </div> </div> </div>
13	<p>Use the keys as applicable while entering the password; then press Done (8 and 11-Line LCD phones). or Press Set (3-Line LCD phones (not applicable to 6751i)).</p>
14	<p>Press the  key to save your settings and exit from the IP Phone UI.</p>

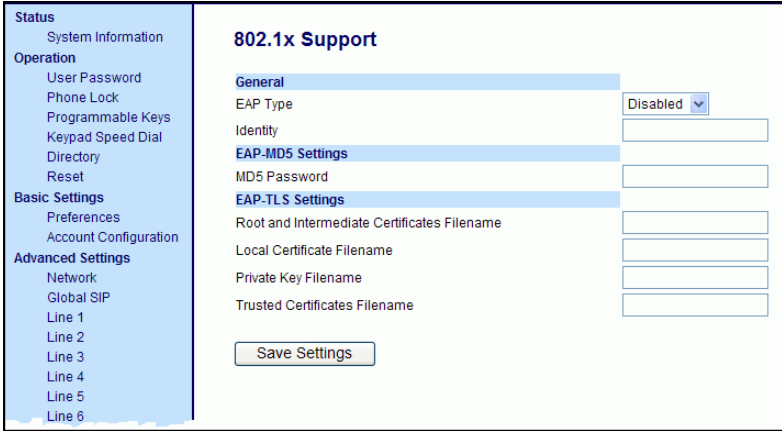
Configuring the 802.1x Protocol Using the Aastra Web UI

Use the following procedure to configure the 802.1x Protocol on your phone using the Aastra Web UI.

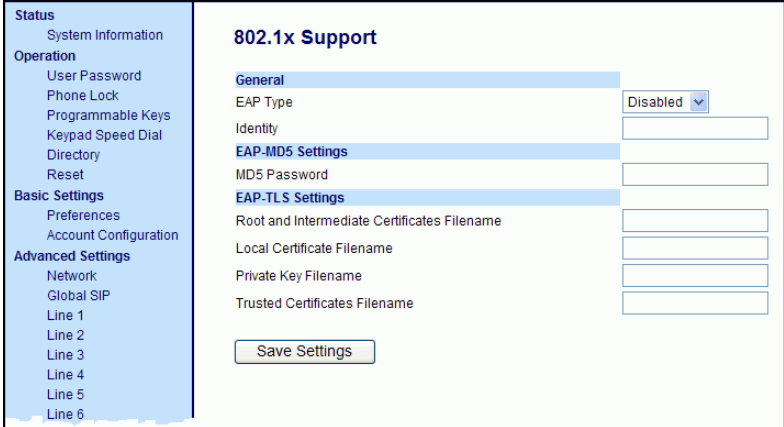
 Aastra Web UI	
1	<p>Click on Advanced Settings->802.1x Support.</p> <div style="border: 1px solid black; padding: 10px; margin: 10px 0;">  </div>
To configure EAP-MD5:	
2	<p>In the “EAP Type” field, select EAP-MD5. Valid values are: Disabled (Default), EAP-MD5, and EAP-TLS.</p>
3	<p>In the “Identity” field, enter an Identity for the IP phone for which you are configuring 802.1x. For example, phone1.</p>
4	<p>In the “MD5 Password” field, enter a password used for the MD5 authentication of the phone. For example, password1.</p>
5	<p>Click  to save your changes.</p>

 Aastra Web UI	
To configure EAP-TLS:	
1	<p>Click on Advanced Settings->802.1x Support.</p> <div style="border: 1px solid black; padding: 10px; margin: 10px 0;">  </div>
1	<p>In the “EAP Type” field, select EAP-TLS. Valid values are: Disabled (Default), EAP-MD5, and EAP-TLS.</p>
2	<p>In the “Identity” field, enter an Identity for the IP phone for which you are configuring 802.1x. For example, phone1.</p>
3	<p>In the “Root and Intermediate Certificates Filename” field, enter the filename that contains the root and intermediate certificates related to the local certificate. For example: root_Intermed_certifi.pem.</p>
4	<p>In the “Local Certificate Filename” field, enter the filename that contains the local certificate. For example: localcertificate.pem.</p>
5	<p>In the “Private Key Filename” field, enter the filename that contains the private key. For example: privatekey.pem.</p>
6	<p>In the “Trusted Certificates Filename” field, enter the filename that contains the trusted certificates. For example: trusted_certificates.pem.</p>
7	<p>Click  to save your changes.</p>

Symmetric UDP Signaling

By default, the IP phones use symmetric UDP signaling for outgoing UDP SIP messages. When symmetric UDP is enabled, the IP phone generates and listens for UDP messages using port 5060.

You can manually disable symmetric UDP signaling using the IP phone's configuration file. When you disable symmetric UDP signaling, then the IP phone chooses a random source port for UDP messages.

The IP phone also chooses a random source port for UDP messages if you configure a backup proxy server, registrar server, or outbound proxy server.

An Administrator can configure symmetric UDP signaling using the configuration files only.

Configuring Symmetric UDP Signaling Using the Configuration Files

You use the following parameter to enable or disable Symmetric UDP Signaling in the configuration files:

- `sip symmetric udp signaling`



Configuration Files

For the specific parameter you can set in the configuration files, see Appendix A, the section, "[RTP, Codec, DTMF Global Settings](#)" on [page A-133](#).

Removing UserAgent and Server SIP Headers

Currently, the phone always configures the SIP UserAgent/Server headers to contain:

Aastra <PhoneModel>/<FirmwareVersion>

You can suppress the addition of these headers by using the following parameter in the configuration files:

- **sip user-agent**

Setting this parameter allows you to enable or disable the addition of the User-Agent and Server SIP headers from the SIP stack.

You can configure this feature using the configuration files only.

Configuring UserAgent/Server SIP Headers

You use the following parameter to specify whether the UserAgent and Server SIP header is added to the SIP stack.

- **sip user-agent**



Configuration Files

For the specific parameter you can set in the configuration files, see Appendix A, the section, “[User-Agent Setting](#)” on [page A-266](#).

GRUU and sip.instance Support

Globally Routable User-Agent URIs (GRUUs) provide a way for anyone on the Internet to route a call to a specific instance of a User-Agent.

The IP phones provide GRUU support using draft-ietf-sip-gruu-15. A sip.instance is added to all non-GRUU contacts. By default, this feature is enabled. You can enable or disable this support using the configuration files.

Limitations of the GRUU Feature

The following are limitations of the GRUU feature on the phones:

- GRUU-Draft-15 is not compatible with versions prior to GRUU-Draft-10.
- Phones do not support temporary or phone-created GRUUs.

Enabling/Disabling GRUU and sip.instance Support

Use the following procedure to enable/disable GRUU and sip.instance support.



Configuration Files

For the specific parameter you can set in the configuration files, see Appendix A, the section, "[GRUU and sip.instance Support](#)" on [page A-266](#).

Multi-Stage Digit Collection (Billing Codes) Support (for Sylanro Servers)

The IP Phones support Multi-Stage Digit Collection (billing codes) for Sylanro Servers. Sylanro Server features, like mandatory and optional billing codes, requires that the application server notify the phone to collect more digits before completing the call. The IP phone is able to collect digits in two stages to support the billing code feature.

Aastra IP Phone users are prompted to enter the correct billing code when they dial these numbers:

- External numbers.
- Eternal numbers dialed using a Speeddial key.

Billing Codes Implementation Notes

Note the following implementation information:

- IP phone users may enter a 2-9 digit billing code. Billing codes may not start with either 0 (Operator) or 9 (external calls).
- When using Sylanro Click-to-Call, IP phone users select a billing code from a pull-down menu.
- When placing a call, a secondary dial tone alerts IP phone users to enter the billing code. The IP phone UI also displays a “Enter Billing Code” message.
- If an IP phone user redials a number, they do not have to re-enter the billing code. The billing code information is maintained and processed accordingly.
- If an IP phone user enters an invalid billing code, the call fails.

Mandatory versus Optional Billing Codes

This release of the Aastra IP phones supports two types of billing codes: Mandatory and Optional. The Sylanro server configuration determines which type of billing code is used on the IP phones.

- **Mandatory billing codes:** Calls are not connected until the user enters a valid billing code. The user dials the phone number. When prompted for billing codes, user dials the billing code.

For example, suppose the IP phone user is using billing code 300, and dialing the external number 617-238-5500. The IP user then enters the number using the following format:

6172385000#300

Using mandatory billing codes, if the user is configuring a Speeddial number, then they enter the number using the following format:

<phonenumber>%23<billingcode>

To use this format with the default dial plan terminator (#), the # sign required by Sylanro as a delimiter should be represented as an escaped character by using the sequence %23. The speed dial format for an external number that includes a mandatory billing code becomes:

<phonenumber>%23<billing code>

- **Optional billing codes:** The user dials an optional billing code by dialing *50, followed by the billing code digits. When prompted for additional digits, user enters the phone number.

For example, suppose the IP phone user is using billing code 500, and dialing the external number 617-238-5000. The IP user then enters the number using the following format:

***50500#6172385000**

If the user is dialing configuring a Speeddial number, then they enter the number using the following format:

***50<billingcode>#<phonenumber>**

To use this format with the default dial plan terminator (#), the # sign required by Sylanro as a delimiter should be represented as an escaped character by using the sequence %23. The speed dial format for an external number that includes an optional billing code becomes:

***50<billing code>%23<phone number>**

Numbers Not Requiring Billing Codes

Billing codes are not required for the following two types of calls:

- Emergency calls (E911)
- Calls between extensions

Configurable DNS Queries

The domain name system (DNS) is the way that Internet domain names are located and translated into Internet Protocol addresses. A domain name is a meaningful and easy-to-remember identifier for an Internet address.

The lists of domain names and IP addresses are distributed throughout the Internet in a hierarchy of authority within a database of records. There is usually a DNS server within close proximity to your geographic location that maps the domain names in your Internet requests or forwards them to other servers in the Internet.

The IP Phones support three methods of DNS lookups allowing it to adapt to various deployment environments: **eNone**, **eSRV**, and **eNAPTR&SRV**. (See the following table for a description of each method). When the IP Phone accesses the Internet, it sends out a DNS query to the proxy to lookup the IP address and the port, and then waits for a response from the proxy.

You can configure the phone to use any one of these methods by entering the applicable value in the configuration files:.

Configuration File Value	DNS Server Method Used	Description
0	A only	The phone sends "A" (Host IP Address) lookup for the IP address and uses the default port number of 5060.
1	SRV & A	The phone sends "SRV" (Service Location Record) lookup to get the port number. Most often, the IP address is included in the response from the DNS server to avoid extra queries. If there is no IP address returned in the response, the phone sends out the "A" DNS lookup to find the IP address.
2	NAPTR & SRV & A	First, the phone sends "NAPTR" (Naming Authority Pointer) lookup to get the "SRV" pointer and service type (such as "aastra.com SIP+2DT _sip.tcp.aastra.net", which means the service prefers to use TCP and "_sip.tcp.aastra.net" for the SRV query instead of the default "_sip._tcp.aastra.com"). If the NAPTR record is returned empty then the default value is used, so in the same case, the phone will use "_sip._udp.aastra.com" for the next step lookup. Next, the phone does SRV lookup to get the IP address and port number. If there is no IP address in the SRV response then it sends out and "A" lookup to get it.



Note: On the phone side, if you configure the phone with a Fully-Qualified Domain Name (FQDN) proxy and specified port, the phone always sends “**A only**” lookups to find the Host IP Address of the proxy.

Configuring the DNS Query Method

You can configure the DNS query method for the phone to use for performing DNS lookups using the following parameter in the configuration files:

- `sip dns query type`



Configuration Files

For the specific parameter you can set in the configuration files, see Appendix A, the section, “[DNS Query Setting](#)” on [page A-267](#).

Ignore Out of Sequence Errors

An Administrator can configure the phone via the “**sip accept out of order requests**” parameter to ignore CSeq number errors on all SIP dialogs on the phone. When this parameter is enabled, the phone no longer verifies that the sequence numbers increase for each message within a dialog, and does not report a "CSeq Out of Order" error if they do not increase.



Note: As the default Asterisk configuration does not fully track dialogs through a reboot, it is recommended that this parameter be enabled when using the BLF feature with an Asterisk server. If you do not enable this feature, then rebooting the Asterisk server may cause BLF to stop working. With this parameter enabled, the BLF key starts working again when the phone re-subscribes, which by default, are one hour apart.

An Administrator can enable/disable this feature using the configuration files only.

Enabling/Disabling “Out of Order SIP Requests”

Use the following procedure to enable/disable “out of order SIP requests”.



Configuration Files

For the specific parameter you can set in the configuration files, see Appendix A, the section, “[Ignore Out of Order SIP Requests](#)” on [page A-268](#).

“Early-Only” Parameter in Replaces Header RFC3891

The phones support the “early-only” parameter in the “Replaces” header according to RFC3891. When the phone receives a Replaces header with the early-only parameter, it replaces the existing dialog if the call is still in the early state. If the call has been answered, then the Replaces request is rejected.



Note: This feature is not supported in outgoing requests.

Reason Header Field in SIP Message

The IP Phones support the receiving of the Reason Header Field in a SIP CANCEL message, as described in RFC3326. This allows a call that is answered from somewhere else to still display in the Callers List. Also, the missed calls indicator and counter do not change.

Limitation

If the call is answered somewhere else, the duration of the call does not display in the Callers List.

Configurable “Allow” and “Allow-Event” Optional Headers

On the IP Phones, an Administrator can enable or disable whether or not the optional “Allow” and “Allow-Events” headers are included in the NOTIFY message from the phone.

SIP NOTIFY messages from the phone may contain optional headers called “Allow” and “Allow-events”. If the NOTIFY message contains these headers, the UDP packet returned by the server may be too large and may fragment the packet. To prevent the fragmenting of the UDP packet, the “Allow” and “Allow-events” headers may be removed using the parameter, “**sip notify opt headers**”. If this parameter is set to “0” (disabled), the optional headers are not included in the SIP NOTIFY message which reduces the size of the packet returned by the server, and prevents fragmentation of the packet.

The value set for this parameter specifies whether or not to include the optional headers in the SIP NOTIFY message from the phone.

An Administrator can enable/disable the optional “Allow” and “Allow-Event” headers using the following parameter in the configuration files:

- **sip notify opt headers**

Enabling/Disabling Optional “Allow” and “Allow-Event” Headers

Use the following procedure to enable/disable “Allow” and “Allow-Event” headers.



Configuration Files

For the specific parameter you can set in the configuration files, see Appendix A, the section, “[Optional “Allow” and “Allow-Event” Headers](#)” on [page A-268](#).

Configurable SIP P-Asserted Identity (PAI)

The IP Phones support a private extension to SIP for Asserted Identity within trusted networks (as defined in RFC 3325). This feature allows a network of trusted SIP servers to assert the identity of authenticated users, and verify that phone messages originate from a Trusted Identity. Upon receiving a message from a caller in the Trusted Network, the IP phone reads the contents of the P-Asserted-Identity (PAI) header field and displays it on the phone UI.

The phones provide the ability for the Administrator to enable or disable the display of P-Asserted Identity (PAI) information on the phone using the following parameter in the configuration files:

- **sip pai**

Enabling/Disabling P-Asserted Identity (PAI)

Use the following procedure to enable/disable PAI.



Configuration Files

For the specific parameter you can set in the configuration files, see Appendix A, the section, “[P-Asserted Identity \(PAI\)](#)” on [page A-269](#).

Chapter 7

Encrypted Files on the IP Phone

About this chapter

Introduction

This chapter provides information about encryption on the IP phones and provides methods an administrator can use to store encrypted files to a server.

Topics

This chapter covers the following topics:

Topic	Page
Encrypted Files on the IP Phone	page 7-2
Configuration File Encryption Method	page 7-2
Procedure to Encrypt Configuration Files	page 7-4
Vendor Configuration File Encryption	page 7-6

Encrypted Files on the IP Phone

An encryption feature for the IP phone allows Service Providers the capability of storing encrypted files on their server to protect against unauthorized access and tampering of sensitive information (i.e., user accounts, login passwords, registration information). Service Providers also have the capability of locking a phone to use a specific server-provided configuration only.

Configuration File Encryption Method

Only a System Administrator can encrypt the configurations files for an IP Phone. System Administrators use a password distribution scheme to manually pre-configure or automatically configure the phones to use the encrypted configuration with a unique key.

From a Microsoft Windows command line, the System Administrator uses an Aastra-supplied encryption tool called "*anacrypt.exe*" to encrypt the *<MAC>.tuz* file.



Note: Aastra also supplies encryption tools to support Linux platforms (*anacrypt.linux*) and Solaris platforms (*anacrypt.sunos*) if required.

This tool processes the plain text *<mac>.cfg* and *aastra.cfg* files and creates triple-DES encrypted versions called *<mac>.tuz* and *aastra.tuz*. Encryption is performed using a secret password that is chosen by the administrator.

The encryption tool is also used to create an additional encrypted tag file called *security.tuz*, which controls the decryption process on the IP phones. If *security.tuz* is present on the TFTP/FTP/HTTP server, the IP phones download it and use it locally to decrypt the configuration information from the *aastra.tuz* and *<mac>.tuz* files. Because only the encrypted versions of the configuration files need to be stored on the server, no plain-text configuration or passwords are sent across the network, thereby ensuring security of the configuration data.

To make changes to the configuration files, the System Administrator must save the original files.



Note: If the use of encrypted configuration files is enabled (via *security.tuz* or pre-provisioned on the IP phone) the *aastra.cfg* and *<mac>.cfg* files are ignored, and only the encrypted equivalent files *aastra.tuz* and *<mac>.tuz* are read.

The security feature described above prevents unauthorized parties from **reading** or **writing** the contents of the *<MAC>.tuz* file. It also provides the following:

- Prevents users from using the *<MAC>.tuz* file that does not match the user's phone MAC address.
- Renders the *<MAC>.tuz* file invalid if the user renames the file.
- Works with IP phone releases prior to Release 2.2.
- Provides compatibility between the previous encryption routine and the new decryption routine.

Procedure to Encrypt Configuration Files

To encrypt the IP phone configuration files:

1. Open a command line window application (i.e., DOS window).
2. At the prompt, enter *anacrypt.exe* and press <Return>.

```
C:\> anacrypt.exe -h
```

Provides encryption of the configuration files used for the family of Aastra IP phones, using 56bit triple-DES and site-specific keys.

Copyright (c) 2008, Aastra Technologies, Ltd.

Copyright (c) 1999, Philip J. Erdelsky

Usage:

```
anacrypt {infile.cfg|-d <dir>} [-p password] [-m] [-i] [-v] [-h]
```

Anacrypt Switch	Description
{infile.cfg -d <dir>}	Specifies that all .cfg files in <dir> should be encrypted
[-p password]	Specifies password used to generate keys
-m	Generate MAC.tuz files that are phone specific. This switch generates files that are only usable for phones with firmware version 2.2.0 and above.
-i	Generate security.tuz file
-v	Specifies the version of encryption that the anacrypt tool uses. Use version 1 encryption (i.e., -v1) to generate firmware that is readable by all model phones. Without the -v1 switch, the anacrypt tool generates files that are only readable by phones with firmware 2.2.0 and above.
-h	Display program help text

Note: Incorrect password produces garbage. For site-specific keyfile security.cfg the plaintext must match password.

Examples

The following examples illustrate the use of the anacrypt.exe file.

Example 1

Generating a security.tuz file with password 1234abcd

For firmware version 2.2.0 and up:

```
C:\>anacrypt -i -p 1234abcd
```

For any firmware version:

```
C:\>anacrypt -i -p 1234abcd -v1
```

Example 2

Encrypting a single aastra.cfg file with password 1234abcd

```
C:\>anacrypt aastra.cfg -p 1234abcd
```

Example 3

Encrypting a <mac>.cfg file with password 1234abcd

```
C:\>anacrypt 00085d000000.cfg -p 1234abcd
```

Example 4

Encrypting a <mac>.cfg file with password 1234abcd using the new MAC encryption (-m is only supported for firmware version 2.2.0 and up)

```
C:\>anacrypt 00085d000000.cfg -m -p 1234abcd
```

Example 5

Encrypting all cfg files in C:\data with password 1234abcd using the new MAC encryption and generating a security.tuz file at the same time.(2.2.0 and up)

```
C:\>anacrypt -d C:\data -p 1234abcd -m -i
```

Example 6

Encrypting all cfg files in C:\data with password 1234abcd using the and generating a security.tuz file at the same time for all firmware versions.(any version)

```
C:\>anacrypt -d C:\data -p 1234abcd -i -v1
```

Vendor Configuration File Encryption

Some vendors can have specific methods to encrypt files on their configuration servers. For each phone, the configuration server can generate a random hex string (encryption key) that is used to encrypt the phone's MAC-specific configuration file.

The encryption key is placed in a plain text MAC-specific configuration file that the server downloads to the phone. After the phone receives the file, it updates the encryption key.

This method of encryption does not affect the implementation of the Aastra method of file encryption.



Note: The *aastra.cfg* file is not encrypted with this feature.

You can set the phone-specific encryption key using the configuration files only.

For more information about configuration file encryption, contact Aastra Technical Support.

Configuring Vendor Configuration File Encryption

Use the following procedure to configure vendor configuration file encryption on the IP Phones.



Configuration Files

For specific parameters you can set in the configuration files for automatic update, see Appendix A, the section, [“Configuration Encryption Setting”](#) on [page A-270](#).

Chapter 8

Upgrading the Firmware

About this chapter

Introduction

This chapter provides information about upgrading the IP phone firmware.

Topics

This chapter covers the following topics:

Topic	Page
Upgrading the Firmware	page 8-2
Using the "Firmware Update" Page in the Aastra Web UI	page 8-2
Using the Restart Feature	page 8-5
Using the Auto-Resync Feature	page 8-7

Upgrading the Firmware

The IP phones support the protocols, TFTP, FTP, HTTP or HTTPS to download configuration files and upgrade firmware to the phones from a configuration server.

The configuration server should be ready and able to accept connections. For information on configuration server requirements, see Chapter 1, the section, [“Configuration Server Requirement”](#) on page 1-40.

You can download the firmware stored on the configuration server in one of three ways:

- Using the **“Firmware Update”** page in the Aastra Web UI at the location *Advanced Settings->Firmware Update*.
- Using the IP Phone UI or the Aastra Web UI to **restart** the phone. The phone automatically looks for firmware updates and configuration files during the boot process.
- Setting an **Auto-Resync** feature to automatically update the firmware, configuration files, or both at a specific time in a 24-hour period). (Feature can be enabled using the configuration files or the Aastra Web UI).

Using the “Firmware Update” Page in the Aastra Web UI

You can use the Aastra Web UI to manually force a firmware update from the configuration server to a phone in your network by selecting *Advanced Settings->Firmware Update*. You can configure the phone to perform the update using any of the protocols that the phone supports: TFTP, FTP, HTTP, or HTTPS.



Warning: Do not reset or turn off the phone until the download is complete.



Note: This procedure downloads an updated *<phone model.st>* file as well as any other firmware files that were updated, to your phone.



Use the following procedure to manually update the firmware on your phone from the specified configuration server.

Aastra Web UI	
Step	Action
1	<p>Click on Advanced Settings->Firmware Update.</p> <div data-bbox="385 477 1113 1058"><p>Status System Information</p><p>Operation User Password Phone Lock Softkeys and XML Keypad Speed Dial Directory Reset</p><p>Basic Settings Preferences Account Configuration</p><p>Advanced Settings Network Global SIP Line 1 Line 2 Line 3 Line 4 Line 5 Line 6 Line 7 Line 8 Line 9 Action URI Configuration Server Firmware Update TLS Support 802.1x Support Troubleshooting</p><h3>Manual Firmware Update</h3><p>To update the firmware on the phone, the new firmware must be placed on the server defined under the Configuration Server section. Enter the server's IP address and the name of the firmware below to initiate a firmware update.</p><p>File Name <input type="text" value="57i.st"/></p><p>Download Protocol <input type="text" value="TFTP"/></p><p>Server <input type="text"/></p><p>Path <input type="text"/></p><p>Port <input type="text"/></p><p>Username <input type="text"/></p><p>Password <input type="text"/></p><p><input type="button" value="Download Firmware"/></p></div>



Aastra Web UI

Step	Action																						
2	<p>In the “File Name” field, enter the firmware file name (<i><phone model>.st</i>) that you want to download to your IP phone. For example, <i>53i.st</i> (for a 6753i phone).</p> <p>Note: This file name must match the actual name of the firmware file residing on your configuration server.</p> <p>IMPORTANT: The renamed 675xi phones still use the old naming convention for the .st files. See the following table.</p> <table border="1"> <thead> <tr> <th>IP Phone Model</th> <th>Associated Firmware</th> </tr> </thead> <tbody> <tr> <td>9143i</td> <td>9143i.st</td> </tr> <tr> <td>9480i</td> <td>9480i.st</td> </tr> <tr> <td>9480i CT</td> <td>9480iCT.st</td> </tr> <tr> <td>6730i</td> <td>6730i.st</td> </tr> <tr> <td>6731i</td> <td>6731i.st</td> </tr> <tr> <td>6751i</td> <td>51i.st</td> </tr> <tr> <td>6753i</td> <td>53i.st</td> </tr> <tr> <td>6755i</td> <td>55i.st</td> </tr> <tr> <td>6757i</td> <td>57i.st</td> </tr> <tr> <td>6757i CT</td> <td>57iCT.st</td> </tr> </tbody> </table>	IP Phone Model	Associated Firmware	9143i	9143i.st	9480i	9480i.st	9480i CT	9480iCT.st	6730i	6730i.st	6731i	6731i.st	6751i	51i.st	6753i	53i.st	6755i	55i.st	6757i	57i.st	6757i CT	57iCT.st
IP Phone Model	Associated Firmware																						
9143i	9143i.st																						
9480i	9480i.st																						
9480i CT	9480iCT.st																						
6730i	6730i.st																						
6731i	6731i.st																						
6751i	51i.st																						
6753i	53i.st																						
6755i	55i.st																						
6757i	57i.st																						
6757i CT	57iCT.st																						
3	<p>In the “Download Protocol” field, select the protocol from the list to use for downloading the new firmware. Valid values are:</p> <ul style="list-style-type: none"> • TFTP • FTP • HTTP • HTTPS 																						
4	<p>In the “Server” field, enter the IP address in dotted decimal format, of the TFTP configuration server, or the domain name of the FTP, HTTP, or HTTPS configuration servers (dependant on the protocol you selected in step 3.) For example: 432.221.45.6.</p>																						
5	<p>In the “Path” field, enter the path location on the protocol server for where the new firmware resides. For example, C:\aastra\configserver\firmwareupgrade.</p>																						

 Aastra Web UI	
Step	Action
6	In the "Port" field, enter the port number of the protocol server. For example, 80 (for HTTP) or 443 (for HTTPS). Note: This field is not applicable to the TFTP and FTP protocols.
7	(FTP only) In the "Username" field, enter the username that is used for authentication when the FTP server is accessed.
8	(FTP only) In the "Password" field, enter the password that is used for authentication when the FTP server is accessed.
9	Click  . This starts the upgrade process. If the upgrade is successful the following message displays on the screen: "Firmware Upgrade Successful".

Using the Restart Feature

Restarting the phone forces the phone to check for both firmware and configuration files stored on the configuration server.





Warning: Do not reset or turn off the phone until the download is complete.

Restarting the Phone Using the IP Phone UI

 IP Phone UI	
Step	Action
1	Press  on the phone to enter the Options List.

 IP Phone UI	
Step	Action
2	Select Restart Phone .
3	<p>For 3-Line LCD Displays:: Press # to confirm.</p> <p>Note: To cancel the Restart, press the 3 key.</p> <p>For 8 and 11-Line LCD Displays:: Press Restart.</p> <p>Note: To cancel the Restart, press Cancel.</p>

Restarting the Phone Using the Aastra Web UI

 Aastra Web UI	
1	<p>Click on Operation->Reset->Phone.</p> <div data-bbox="374 916 1110 1263" data-label="Image"> </div>
2	<p>Click  to restart the phone.</p>

Using the Auto-Resync Feature

The auto-resync feature on the IP phones allows an administrator to enable the phone to be updated automatically once a day at a specific time in a 24-hour period if the files on the server have changed. This feature works with TFTP, FTP, HTTP, and HTTPS servers. An administrator can enable this feature using the Aastra Web UI or using the configuration files (aastra.cfg and <mac>.cfg).



Note: The automatic update feature works with both encrypted and plain text configuration files.

An Administrator can enable Auto-Resync using the configuration files or the Aastra Web UI. In the configuration files you set the following parameters:

- **auto resync mode** - Determines whether the configuration server automatically updates the phone's configuration files only, the firmware only, both the firmware and configuration files, or disables automatic updates. This parameter works with TFTP, FTP, HTTP, and HTTPS servers.
- **auto resync time** - Sets the time of day in a 24-hour period for the IP phone to be automatically updated. This parameter works with TFTP, FTP, HTTP and HTTPS servers.
- **auto resync max delay** - Specifies the maximum time, in minutes, the phone waits past the scheduled time before starting a checksync.
- **auto resync days** - Specifies the amount of days that the phone waits between checksync operations.

In the Aastra Web UI, you can set the following parameters at the path *Advanced Settings->Configuration Server->Auto-Resync*:

- **Mode**
- **Time (24 hours)**
- **Maximum Delay**
- **Days**

Setting the “**auto resync max delay**” (Maximum Delay) and “auto resync days” (Days) parameters can greatly reduce the load placed on the configuration server when downloading configurations.

Enabling Auto-Resync Using the Configuration Files

Use the following procedure to configure automatic updates of the IP phone firmware, configuration files, or both.



Configuration Files

For specific parameters you can set in the configuration files for automatic update, see Appendix A, the section, "[Configuration Server Settings](#)" on [page A-18](#).





Notes:

1. If a user is accessing the Aastra Web UI, they are not informed of an auto-reboot.
 2. Any changes made using the Aastra Web UI or the IP phone UI are not overwritten by an auto-resync update. Auto-resync affects the configuration files only. However, the settings in the Aastra Web UI take precedence over the IP phone UI and the configuration files.
 3. If the IP phone is in use (not idle) at the time of the resync check, the reboot occurs when the phone becomes idle.
 4. The resync time is based on the local time of the IP phone.
 5. The automatic update feature works with both encrypted and plain text configuration files.
-

Enabling Auto-Resync Using the Aastra Web UI

Use the following procedure to enable auto-resync for the phones in your network.

Aastra Web UI	
Step	Action
1	<p>Click on Advanced Settings->Configuration Server->Auto-Resync.</p> <div style="border: 1px solid black; padding: 10px;"> <p>Auto-Sync Parameters</p> <p>Configuration Server Settings</p> <p>Settings</p> <p>Download Protocol: TFTP</p> <p>TFTP Server: 10.50.10.68</p> <p>TFTP Path: C:\Documents and Sett</p> <p>Alternate Server: 0.0.0.0</p> <p>Alternate TFTP Path: </p> <p>Use Alternate TFTP: <input type="checkbox"/> Enabled</p> <p>FTP Server: </p> <p>FTP Path: </p> <p>FTP Username: </p> <p>FTP Password: </p> <p>HTTP Server: </p> <p>HTTP Path: </p> <p>HTTP Port: 80</p> <p>HTTPS Server: </p> <p>HTTPS Path: </p> <p>HTTPS Port: 443</p> <p>Auto-Resync</p> <p>Mode: None</p> <p>Time (24-hour): 00:00</p> <p>Maximum Delay: 15</p> <p>Days: 0</p> </div>

 Aastra Web UI	
Step	Action
2	<p>In the “Mode” field, select the auto-resync mode you want to use to automatically update the phone.</p> <p>Valid values are:</p> <p>None Disable auto-resync</p> <p>Configuration Files Updates the configuration files on the IP phone automatically at the specified time if the files on the server have changed.</p> <p>Firmware Updates the firmware on the IP phone automatically at the specified time if the files on the server have changed.</p> <p>Both Updates the configuration files and firmware automatically at the specified time if the files on the server have changed.</p> <p>Notes:</p> <ol style="list-style-type: none"> 1. If a user is accessing the Aastra Web UI, they are not informed of an auto-reboot. 2. Any changes made using the Aastra Web UI or the IP phone UI are not overwritten by an auto-resync update. Auto-resync affects the configuration files only. However, the settings in the Aastra Web UI take precedence over the IP phone UI and the configuration files. 3. The resync time is based on the local time of the IP phone. 4. If the IP phone is in use (not idle) at the time of the resync check, the reboot occurs when the phone becomes idle.
3	<p>In the “Time (24-hour)” field, select the time that you want the update to take place.</p> <p>Valid values are 00:00 to 23:30 (in 30 minute increments).</p> <p>Notes:</p> <ol style="list-style-type: none"> 1. The resync time is based on the local time of the IP phone. 2. The value of 00:00 is 12:00 A.M. 3. When selecting a value for this parameter in the Aastra Web UI, the values are in 30-minute increments only.
4	<p>In the “Maximum Delay” field, specify the maximum time, in minutes, the phone waits past the scheduled time before starting a checksync. The range is 0 to 1439. Default is 15.</p>
5	<p>In the “Days” field, specify the amount of days that the phone waits between checksync operations. The range is 0 to 364. Default is 0.</p> <p>Note: A value of 0 causes the phone to checksync every time the clock reads the proper time. A value of 1 forces the phone to wait 24 hours prior to doing the first checksync.</p>
6	<p>Click  to save your settings.</p> <p>These changes are not dynamic. You must restart your IP phone for the changes to take affect.</p>



Aastra Web UI

Step	Action
7	Click on Operation->Reset .
8	In the " Restart Phone " field click  to restart the IP phone and apply the update. The update performs automatically at the time you designated.

Chapter 9

Troubleshooting

About this chapter

Introduction

This chapter describes tasks that a system administrator can perform on the IP phones for troubleshooting purposes. It also includes answers to questions you may have while using the IP phones.

Topics

This chapter covers the following topics:

Topic	Page
Troubleshooting	page 9-3
Log Settings	page 9-3
Module/Debug Level Settings	page 9-4
Support Information	page 9-7
WatchDog Task Feature	page 9-12
Error Messages Display	page 9-15
Troubleshooting Solutions	page 9-19
Why does my phone display "Application missing"?	page 9-19
Why does my phone display the "No Service" message?	page 9-20
Why does my phone display "Bad Encrypted Config"?	page 9-20
Why is my phone not receiving the TFTP IP address from the DHCP Server?	page 9-21
How do I restart the IP phone?	page 9-22

About this chapter

Topic	Page
How do I set the IP phone to factory default?	page 9-23
How do I erase the phone's local configuration?	page 9-24
How to reset a user's password?	page 9-25
How do I lock and unlock the phone?	page 9-27

Troubleshooting

This section describes tasks that a system administrator can perform on the IP phones for troubleshooting purposes. Using the Aastra Web UI, a system administrator can:

- Assign an IP address and IP port in which to save log files
- Filter the logs according to severity that get reported to log files
- Save the current local configuration file to a specified location
- Save the current server configuration file to a specified location
- Show task and stack status (including “Free Memory” and “Maximum Memory Block Size”)

Aastra Technical Support can then use the information gathered to perform troubleshooting tasks.

Log Settings

Using the configuration files or the Aastra Web UI, you can specify the location for which to save files for troubleshooting purposes.

In the configuration files, you use the following parameters to configure log settings:

- **log server ip** - The IP address for which to save log files for troubleshooting purposes.
- **log server port** - The IP port to use to save log files for troubleshooting purposes.
- **log level** - The severity level of the logs to be reported to a log file. Log Level default is Error (3). (Changes to this parameter via the Aastra Web UI require a reboot).

In the Aastra Web UI, you use the following parameters to configure log settings:

- **Log IP** - The IP address for which to save log files for troubleshooting purposes.
- **Log Port** - The IP port to use to save log files for troubleshooting purposes.

Reference

For more information about the log setting configuration parameters, see [Appendix A](#), the section, “[Troubleshooting Parameters](#)” on [page A-271](#).

For information about configuring the log settings using the Aastra Web UI, see “[Performing Troubleshooting Tasks](#)” on [page 9-8](#).

Module/Debug Level Settings

The Aastra IP phones provide blog module support that allows enhanced severity filtering of log calls sent as blog output.

The blog, as used on the IP phones, is an online debugging tool that can be frequently updated and intended for technical support analysis. Blogs are defined by their format: a series of entries posted to a single page in reverse-chronological order. The IP Phone blogs are separated into modules which allow you to log specific information for analyzing.

The following table identifies the blog modules you can set.

Aastra Web UI Parameters	Configuration File Parameters
LINMGR (Line Manager information)	log module linemgr
UI (User Interface (UI) related)	log module user interface
MISC (Miscellaneous)	log module misc
SIP (Call control SIP stack)	log module sip
DIS (Display drivers)	log module dis
DSTORE (Delayed storage)	log module dstore
EPT (Endpoint module)	log module ept
IND (Indicator module)	log module ind

Aastra Web UI Parameters	Configuration File Parameters
KBD (Keyboard module)	log module kbd
NET (Network module)	log module net
PROVIS (Provisioning module)	log module provis
RTPT (Realtime Transport module)	log module rtpt
SND (Sound module)	log module snd
PROF (Profiler module)	log module prof
XML (Extension Markup Lanaguage)	log module xml
STUN (Simple Traversal of User Datagram Protocol (UDP) through Network Address Translation (NAT))	log module stun

Setting Values for the Module/Debug Levels

There are 6 debug levels for the modules. Each debug level has a value you can use to turn individual levels ON and OFF. The following table identifies these debug levels and their values. The value of “1” (fatal errors) is the default setting for all modules.

Debug Level	Value
Fatal Errors	1 (default)
Errors	2
Warnings	4
Init	8
Functions	16
Info	32
All debug levels OFF	0
All Debug Levels ON	65535

Example 1

To turn two or more debug levels on at the same time, you add the value associated with each level. For example,

Fatal Errors + Errors + Warnings = 1 + 2 + 4 = 7

```
log module linemgr: 7
log module user interface: 7
log module sip: 7
```

In the above example, fatal errors, general errors, and warnings are logged for the line manager, user interface, and SIP call control modules.

Example 2

Functions and Info = 16 + 32 = 48

```
log module dis: 48
log module net: 48
log module snd: 48
```

In the above example, functions and general information are logged for the display drivers, network, and sound modules.

Example 3

```
log module rtpt: 0
log module ind: 65535
```

In the above example, all debug levels are OFF for the Real Time Transport module. All debug levels are ON for the indicator module.

You can set the Module/Debug Levels using the configuration files or the Aastra Web UI.

Reference

For more information about the debug level configuration parameters, see [Appendix A](#), the section, “[Troubleshooting Parameters](#)” on [page A-271](#).

For information about configuring the log settings using the Aastra Web UI, see “[Performing Troubleshooting Tasks](#)” on [page 9-8](#).

Support Information

You can save the local and/or server configuration files of the IP phone to the location specified in the "Log Settings" section.

Performing this task allows Aastra Technical Support to view the current configuration of the IP phone and troubleshoot as necessary.

In the **“Support Information”** section, you can:

- **Get local.cfg**
- **Get server.cfg**
- **Show Task and Stack Status**

Aastra Technical Support uses this support information for troubleshooting the IP phone when required.

Using the Aastra Web UI and selecting **“Show Task and Stack Status”** displays the tasks and stack status on the IP phone. This screen also displays the **Free Memory** and the **Max Block Free Memory** currently on the phone as shown in the following illustration. This information is for troubleshooting purposes only.

Line 7	CDRCL	8003a80c	PEND	80d7ac28	276	4080	3804	0	0
Line 8	SIGT	80033c38	DELAY	80d79980	396	4080	3684	0	1
Line 9	HAPIGET	80040dc4	DELAY	80d78728	468	4080	3612	3d0002	18
Action URI	RTPT	803ddfb0	PEND	80d74a90	2320	10224	7904	3d0002	0
Configuration Server	SipEngine	804dd8ec	PEND+T	80d70de8	2340	16368	14028	3d0002	7
Firmware Update	Transport	804dd8ec	PEND+T	80d0dc28	1708	16368	14860	3d0002	429106314
TLS Support	Resolver	804dd8ec	PEND+T	80d09678	796	16368	15572	3006b	2147093217
Troubleshooting	SENG	8049af2c	PEND	80cbcc08	556	12272	11716	0	0
	AUTOKEY	801658e4	PEND	80cb2678	344	5104	4760	0	0
	SIPINFO	801c8dc0	PEND	80cb0f88	344	5104	4760	0	0
	TimeServer	803dca20	PEND+T	80caaf88	908	6128	5220	3d0004	5650
	AutoResyncTask	803d72f0	PEND+T	80ca5d18	1276	16368	15092	3d0004	5629
	HTS3	8040c728	PEND	80c862f8	3744	8176	4432	0	0
	HTS0	8040c728	PEND	80c910d8	4972	8176	3204	0	0
	HTS1	8040c728	READY	80c8e728	3744	8176	4432	0	0
	Total number of tasks		51						
	Total stack usage		60244						
	Total stack allocated		424720						
	Free memory		2346208						
	Max memory block size		2317840						
	Back								

Free Memory

Max Memory Block Size

Performing Troubleshooting Tasks

Use the following procedures to perform troubleshooting on the IP phone via the configuration files or the Aastra Web UI.



Configuration Files

For specific parameters you can set in the configuration files, see [Appendix A](#), the section, "Log Settings" on [page A-271](#).



 **Aastra Web UI**



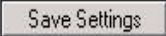

Step	Action
------	--------

1	<p>Click on Advanced Settings->Troubleshooting.</p> <div style="border: 1px solid black; padding: 10px; margin: 10px 0;"> <table border="1" style="width: 100%; border-collapse: collapse;"> <tr> <td style="width: 30%; background-color: #e0f0ff; vertical-align: top;"> <p>Status System Information</p> <p>Operation User Password Phone Lock Softkeys and XML Programmable Keys Directory Reset</p> <p>Basic Settings Preferences Account Configuration</p> <p>Advanced Settings Network Global SIP Line 1 Line 2 Line 3 Line 4 Line 5 Line 6 Line 7 Line 8 Line 9 Action URI Configuration Server Firmware Update TLS Support 802.1x Support Troubleshooting</p> </td> <td style="padding: 10px;"> <p style="text-align: center;">Troubleshooting</p> <p>Log Settings</p> <p>Log IP <input style="width: 100px;" type="text" value="0.0.0.0"/></p> <p>Log Port <input style="width: 100px;" type="text" value="0"/></p> <table border="1" style="width: 100%; border-collapse: collapse;"> <thead> <tr> <th style="text-align: left;">Module</th> <th style="text-align: left;">Debug Level</th> </tr> </thead> <tbody> <tr><td>LINEMGR</td><td><input style="width: 50px;" type="text" value="1"/></td></tr> <tr><td>UI</td><td><input style="width: 50px;" type="text" value="1"/></td></tr> <tr><td>MISC</td><td><input style="width: 50px;" type="text" value="1"/></td></tr> <tr><td>SIP</td><td><input style="width: 50px;" type="text" value="1"/></td></tr> <tr><td>DIS</td><td><input style="width: 50px;" type="text" value="1"/></td></tr> <tr><td>DSTORE</td><td><input style="width: 50px;" type="text" value="1"/></td></tr> <tr><td>EPT</td><td><input style="width: 50px;" type="text" value="1"/></td></tr> <tr><td>IND</td><td><input style="width: 50px;" type="text" value="1"/></td></tr> <tr><td>KBD</td><td><input style="width: 50px;" type="text" value="1"/></td></tr> <tr><td>NET</td><td><input style="width: 50px;" type="text" value="1"/></td></tr> <tr><td>PROVIS</td><td><input style="width: 50px;" type="text" value="1"/></td></tr> <tr><td>RTPT</td><td><input style="width: 50px;" type="text" value="1"/></td></tr> <tr><td>SND</td><td><input style="width: 50px;" type="text" value="1"/></td></tr> <tr><td>PROF</td><td><input style="width: 50px;" type="text" value="1"/></td></tr> <tr><td>XML</td><td><input style="width: 50px;" type="text" value="1"/></td></tr> <tr><td>STUN</td><td><input style="width: 50px;" type="text" value="1"/></td></tr> </tbody> </table> <p style="text-align: center;"><input type="button" value="Save Settings"/></p> <p>Support Information</p> <p>Get local.cfg <input style="float: right;" type="button" value="Save As..."/></p> <p>Get server.cfg <input style="float: right;" type="button" value="Save As..."/></p> <p>Show Task and Stack Status <input style="float: right;" type="button" value="Show"/></p> </td> </tr> </table> </div>	<p>Status System Information</p> <p>Operation User Password Phone Lock Softkeys and XML Programmable Keys Directory Reset</p> <p>Basic Settings Preferences Account Configuration</p> <p>Advanced Settings Network Global SIP Line 1 Line 2 Line 3 Line 4 Line 5 Line 6 Line 7 Line 8 Line 9 Action URI Configuration Server Firmware Update TLS Support 802.1x Support Troubleshooting</p>	<p style="text-align: center;">Troubleshooting</p> <p>Log Settings</p> <p>Log IP <input style="width: 100px;" type="text" value="0.0.0.0"/></p> <p>Log Port <input style="width: 100px;" type="text" value="0"/></p> <table border="1" style="width: 100%; border-collapse: collapse;"> <thead> <tr> <th style="text-align: left;">Module</th> <th style="text-align: left;">Debug Level</th> </tr> </thead> <tbody> <tr><td>LINEMGR</td><td><input style="width: 50px;" type="text" value="1"/></td></tr> <tr><td>UI</td><td><input style="width: 50px;" type="text" value="1"/></td></tr> <tr><td>MISC</td><td><input style="width: 50px;" type="text" value="1"/></td></tr> <tr><td>SIP</td><td><input style="width: 50px;" type="text" value="1"/></td></tr> <tr><td>DIS</td><td><input style="width: 50px;" type="text" value="1"/></td></tr> <tr><td>DSTORE</td><td><input style="width: 50px;" type="text" value="1"/></td></tr> <tr><td>EPT</td><td><input style="width: 50px;" type="text" value="1"/></td></tr> <tr><td>IND</td><td><input style="width: 50px;" type="text" value="1"/></td></tr> <tr><td>KBD</td><td><input style="width: 50px;" type="text" value="1"/></td></tr> <tr><td>NET</td><td><input style="width: 50px;" type="text" value="1"/></td></tr> <tr><td>PROVIS</td><td><input style="width: 50px;" type="text" value="1"/></td></tr> <tr><td>RTPT</td><td><input style="width: 50px;" type="text" value="1"/></td></tr> <tr><td>SND</td><td><input style="width: 50px;" type="text" value="1"/></td></tr> <tr><td>PROF</td><td><input style="width: 50px;" type="text" value="1"/></td></tr> <tr><td>XML</td><td><input style="width: 50px;" type="text" value="1"/></td></tr> <tr><td>STUN</td><td><input style="width: 50px;" type="text" value="1"/></td></tr> </tbody> </table> <p style="text-align: center;"><input type="button" value="Save Settings"/></p> <p>Support Information</p> <p>Get local.cfg <input style="float: right;" type="button" value="Save As..."/></p> <p>Get server.cfg <input style="float: right;" type="button" value="Save As..."/></p> <p>Show Task and Stack Status <input style="float: right;" type="button" value="Show"/></p>	Module	Debug Level	LINEMGR	<input style="width: 50px;" type="text" value="1"/>	UI	<input style="width: 50px;" type="text" value="1"/>	MISC	<input style="width: 50px;" type="text" value="1"/>	SIP	<input style="width: 50px;" type="text" value="1"/>	DIS	<input style="width: 50px;" type="text" value="1"/>	DSTORE	<input style="width: 50px;" type="text" value="1"/>	EPT	<input style="width: 50px;" type="text" value="1"/>	IND	<input style="width: 50px;" type="text" value="1"/>	KBD	<input style="width: 50px;" type="text" value="1"/>	NET	<input style="width: 50px;" type="text" value="1"/>	PROVIS	<input style="width: 50px;" type="text" value="1"/>	RTPT	<input style="width: 50px;" type="text" value="1"/>	SND	<input style="width: 50px;" type="text" value="1"/>	PROF	<input style="width: 50px;" type="text" value="1"/>	XML	<input style="width: 50px;" type="text" value="1"/>	STUN	<input style="width: 50px;" type="text" value="1"/>
<p>Status System Information</p> <p>Operation User Password Phone Lock Softkeys and XML Programmable Keys Directory Reset</p> <p>Basic Settings Preferences Account Configuration</p> <p>Advanced Settings Network Global SIP Line 1 Line 2 Line 3 Line 4 Line 5 Line 6 Line 7 Line 8 Line 9 Action URI Configuration Server Firmware Update TLS Support 802.1x Support Troubleshooting</p>	<p style="text-align: center;">Troubleshooting</p> <p>Log Settings</p> <p>Log IP <input style="width: 100px;" type="text" value="0.0.0.0"/></p> <p>Log Port <input style="width: 100px;" type="text" value="0"/></p> <table border="1" style="width: 100%; border-collapse: collapse;"> <thead> <tr> <th style="text-align: left;">Module</th> <th style="text-align: left;">Debug Level</th> </tr> </thead> <tbody> <tr><td>LINEMGR</td><td><input style="width: 50px;" type="text" value="1"/></td></tr> <tr><td>UI</td><td><input style="width: 50px;" type="text" value="1"/></td></tr> <tr><td>MISC</td><td><input style="width: 50px;" type="text" value="1"/></td></tr> <tr><td>SIP</td><td><input style="width: 50px;" type="text" value="1"/></td></tr> <tr><td>DIS</td><td><input style="width: 50px;" type="text" value="1"/></td></tr> <tr><td>DSTORE</td><td><input style="width: 50px;" type="text" value="1"/></td></tr> <tr><td>EPT</td><td><input style="width: 50px;" type="text" value="1"/></td></tr> <tr><td>IND</td><td><input style="width: 50px;" type="text" value="1"/></td></tr> <tr><td>KBD</td><td><input style="width: 50px;" type="text" value="1"/></td></tr> <tr><td>NET</td><td><input style="width: 50px;" type="text" value="1"/></td></tr> <tr><td>PROVIS</td><td><input style="width: 50px;" type="text" value="1"/></td></tr> <tr><td>RTPT</td><td><input style="width: 50px;" type="text" value="1"/></td></tr> <tr><td>SND</td><td><input style="width: 50px;" type="text" value="1"/></td></tr> <tr><td>PROF</td><td><input style="width: 50px;" type="text" value="1"/></td></tr> <tr><td>XML</td><td><input style="width: 50px;" type="text" value="1"/></td></tr> <tr><td>STUN</td><td><input style="width: 50px;" type="text" value="1"/></td></tr> </tbody> </table> <p style="text-align: center;"><input type="button" value="Save Settings"/></p> <p>Support Information</p> <p>Get local.cfg <input style="float: right;" type="button" value="Save As..."/></p> <p>Get server.cfg <input style="float: right;" type="button" value="Save As..."/></p> <p>Show Task and Stack Status <input style="float: right;" type="button" value="Show"/></p>	Module	Debug Level	LINEMGR	<input style="width: 50px;" type="text" value="1"/>	UI	<input style="width: 50px;" type="text" value="1"/>	MISC	<input style="width: 50px;" type="text" value="1"/>	SIP	<input style="width: 50px;" type="text" value="1"/>	DIS	<input style="width: 50px;" type="text" value="1"/>	DSTORE	<input style="width: 50px;" type="text" value="1"/>	EPT	<input style="width: 50px;" type="text" value="1"/>	IND	<input style="width: 50px;" type="text" value="1"/>	KBD	<input style="width: 50px;" type="text" value="1"/>	NET	<input style="width: 50px;" type="text" value="1"/>	PROVIS	<input style="width: 50px;" type="text" value="1"/>	RTPT	<input style="width: 50px;" type="text" value="1"/>	SND	<input style="width: 50px;" type="text" value="1"/>	PROF	<input style="width: 50px;" type="text" value="1"/>	XML	<input style="width: 50px;" type="text" value="1"/>	STUN	<input style="width: 50px;" type="text" value="1"/>		
Module	Debug Level																																				
LINEMGR	<input style="width: 50px;" type="text" value="1"/>																																				
UI	<input style="width: 50px;" type="text" value="1"/>																																				
MISC	<input style="width: 50px;" type="text" value="1"/>																																				
SIP	<input style="width: 50px;" type="text" value="1"/>																																				
DIS	<input style="width: 50px;" type="text" value="1"/>																																				
DSTORE	<input style="width: 50px;" type="text" value="1"/>																																				
EPT	<input style="width: 50px;" type="text" value="1"/>																																				
IND	<input style="width: 50px;" type="text" value="1"/>																																				
KBD	<input style="width: 50px;" type="text" value="1"/>																																				
NET	<input style="width: 50px;" type="text" value="1"/>																																				
PROVIS	<input style="width: 50px;" type="text" value="1"/>																																				
RTPT	<input style="width: 50px;" type="text" value="1"/>																																				
SND	<input style="width: 50px;" type="text" value="1"/>																																				
PROF	<input style="width: 50px;" type="text" value="1"/>																																				
XML	<input style="width: 50px;" type="text" value="1"/>																																				
STUN	<input style="width: 50px;" type="text" value="1"/>																																				

To set log settings:

2	In the " Log IP " field, enter the IP address of where you want log files to be stored.
3	In the " Log Port " field, enter the port number associated with the IP address specified in the "Log IP" field. This port passes the information from the IP phone to the IP address location.

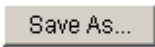
 Aastra Web UI																			
Step	Action																		
4	Click  to save your settings.																		
5	Click on Operation->Reset .																		
6	In the " Restart Phone " field click  to restart the IP phone.																		
To set blog modules:																			
7	Select a module for which you want to have log files created, and sent to a blog.																		
8	<p>Enter a debug level value in the "Debug Level" field for a module. Valid values are:</p> <table border="1" data-bbox="559 647 918 1102" style="margin-left: auto; margin-right: auto;"> <thead> <tr> <th style="background-color: #D9E1F2;">Debug Level</th> <th style="background-color: #D9E1F2;">Value</th> </tr> </thead> <tbody> <tr> <td>Fatal Errors</td> <td>1 (default)</td> </tr> <tr> <td>Errors</td> <td>2</td> </tr> <tr> <td>Warnings</td> <td>4</td> </tr> <tr> <td>Init</td> <td>8</td> </tr> <tr> <td>Functions</td> <td>16</td> </tr> <tr> <td>Info</td> <td>32</td> </tr> <tr> <td>All debug levels OFF</td> <td>0</td> </tr> <tr> <td>All Debug Levels ON</td> <td>65535</td> </tr> </tbody> </table> <p>The value of "0" turns all debug levels OFF for a module. The value of "65535" turns all debug levels ON for a module.</p> <p>To turn two or more debug levels on at the same time, you add the value associated with each level. For example, Fatal Errors + Errors + Warnings = 1 + 2 + 4 = 7</p> <pre style="margin-left: 40px;">log module linemgr: 7 log module user interface: 7 log module sip: 7</pre> <p>In the above example, fatal errors, general errors, and warnings are logged for the line manager, user interface, and SIP call control modules.</p>	Debug Level	Value	Fatal Errors	1 (default)	Errors	2	Warnings	4	Init	8	Functions	16	Info	32	All debug levels OFF	0	All Debug Levels ON	65535
Debug Level	Value																		
Fatal Errors	1 (default)																		
Errors	2																		
Warnings	4																		
Init	8																		
Functions	16																		
Info	32																		
All debug levels OFF	0																		
All Debug Levels ON	65535																		
9	Click  to save your settings.																		

 Aastra Web UI	
Step	Action
10	Click on Operation->Reset .
11	In the " Restart Phone " field click  to restart the IP phone.
To perform support tasks:	
12	To store the local configuration file to the specified location, click on  in the " Get local.cfg " field.
13	To store the server configuration file to the specified location, click on  in the " Get server.cfg " field.
14	To display task and stack status information, as well as Free Memory and Maximum Block Free Memory on the phone, click on  in the " Show Task and Stack Status " field. Note: The local and server configuration file information and the task and stack status information is for use by Aastra Technical Support for troubleshooting purposes.

Reference

For information that describes solutions to most common problems using the IP phones, see the next section, "[Troubleshooting Solutions](#)" on [page 9-19](#).

WatchDog Task Feature

The IP Phones include a troubleshooting feature called the “**WatchDog**” task that monitors the status of the phones and provides the ability to get stack traces from the last time the phone failed. When the phone detects a failure (i.e., a crash), it automatically reboots. You can view a WatchDog crash file using the Aastra Web UI at the path, *Advanced Settings->Troubleshooting*. You can enable/disable the WatchDog task using the configuration files or the Aastra Web UI.

Enabling/Disabling WatchDog

Use the following procedure to enable/disable the WatchDog.



Configuration Files

For specific parameters you can set in the configuration files, see [Appendix A](#), the section, “[WatchDog Settings](#)” on [page A-274](#).

Use the following procedure to enable/disable the WatchDog task for the IP Phones using the Aastra Web UI. You can also view the “Crash Log” generated by the WatchDog task using the Aastra Web UI.

Aastra Web UI

1 Click on **Advanced Settings->Troubleshooting.**

Status

System Information

Operation

User Password

Phone Lock

Programmable Keys

Keypad Speed Dial

Directory

Reset

Basic Settings

Preferences

Account Configuration

Advanced Settings

Network

Global SIP

Line 1

Line 2

Line 3

Line 4

Line 5

Line 6

Line 7

Line 8

Line 9

Action URI

Configuration Server

Firmware Update

TLS Support

802.1x Support

Troubleshooting

Troubleshooting

Log Settings

Log IP

Log Port

Module	Debug Level
LINEMGR	<input type="text" value="1"/>
UI	<input type="text" value="1"/>
MISC	<input type="text" value="1"/>
SIP	<input type="text" value="1"/>
DIS	<input type="text" value="1"/>
DSTORE	<input type="text" value="1"/>
EPT	<input type="text" value="1"/>
IND	<input type="text" value="1"/>
KBD	<input type="text" value="1"/>
NET	<input type="text" value="1"/>
PROVIS	<input type="text" value="1"/>
RTPT	<input type="text" value="1"/>
SND	<input type="text" value="1"/>
PROF	<input type="text" value="1"/>
XML	<input type="text" value="1"/>
STUN	<input type="text" value="1"/>
LLDP	<input type="text" value="1"/>
Watchdog	<input checked="" type="checkbox"/> Enabled

Support Information

Get local.cfg

Get server.cfg

Get Crash Log

Show Task and Stack Status

Enable/Disable WatchDog

View Crash Log

Enable/Disable WatchDog Task

2 The **“WatchDog”** field is enabled by default. To disable the WatchDog task, click in the “Enabled” box to clear the check mark.

3 Click to save your changes.

41-001160-03 Rev 00, Release 2.5

9-13



Aastra Web UI

View the Crash Log

4

To view a crash log, in the **"Get a Crash Log"** field, click the **SAVE AS** button. You can open the file immediately, or you can save the Crash Log to your PC.

Error Messages Display

An Administrator can view generated error messages that may have occurred during startup or reboot of the IP Phones. The IP Phone UI has a selection on the Phone Status page called, “**Error Messages**” at the location, *Options->Phone Status->Error Messages*. The Aastra Web UI also allows you to view these error messages at the location *Advanced Settings->Troubleshooting->Error Messages*. These options allow you to view error messages generated by modules during startup only (not after registration has completed). You can use this information for troubleshooting purposes or for reporting the errors to the Administrator.



The IP Phone stores and displays up to 10 error messages (any extra error messages beyond 10 are discarded). The time and date of each error message also displays. After a reboot, the previous error messages are discarded and, if applicable, new error messages display. If there are no error messages during startup or after a reboot, the message, “*No Error Messages*” displays on the screen. Error messages display in the language currently set on the phone.

The following table identifies the possible error messages that may display.

Possible Error Message	Description
Bad Certificate	A Transport Layer Security (TLS) certificate is not valid. The invalid certificate can be any of the following: <ul style="list-style-type: none"> • root and intermediate certificate • local certificate • private key filename • trusted certificate
802.1x Startup Failed	The Extensible Authentication Protocol TLS (EAP-TLS) certificates and/or the EAP-MD5 information has failed on the phone.
LLDP Startup Failed	Link Layer Discovery Protocol (LLDP) failed during startup of the phone.
HTTP Connection Manager Init Failed	The Hypertext Transfer Protocol (HTTP) connection manager initialization failed while updating the configuration on the phone.
Failed to config Line Manager	The configuration of the Line Manager module on the phone has failed.

Viewing the Error Messages Using the IP Phone UI

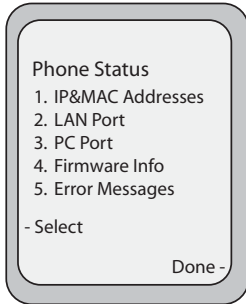
Use the following procedure to view the error messages, if any, that generated during startup.

 IP Phone UI	
1	Press the Options key on the phone to enter the Options List.
2	Select Phone Status .
3	Select Error Messages .  <p>8 and 11-Line LCD Phones</p> <p>Phone Status 1. IP&MAC Addresses 2. LAN Port 3. PC Port 4. Firmware Info 5. Error Messages - Select Done -</p>  <p>3-Line LCD Phones</p> <p>5. Error Messages ▲ ▶ Enter</p>



IP Phone UI

4

If error messages display, use the UP and DOWN navigation keys to view the messages. If no error message exist, the message, “*No Error Messages*” displays on the screen.

8 and 11-Line LCD Phones

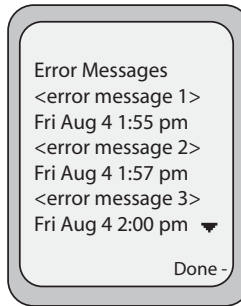

Error Messages

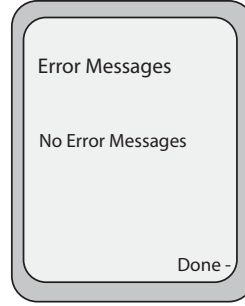

No Error Messages

3-Line LCD Phones

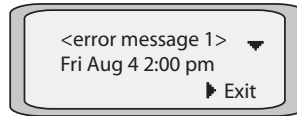

Error Messages

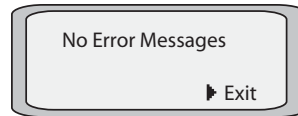

No Error Messages

5

When done viewing, press **Done** or **Exit** to exit the Error Messages screen.

Viewing the Error Messages Using the Aastra Web UI

Use the following procedure to view the error messages, if any, that generated during startup.

 **Aastra Web UI**

1 Click on **Advanced Settings->Troubleshooting->Error Messages**.

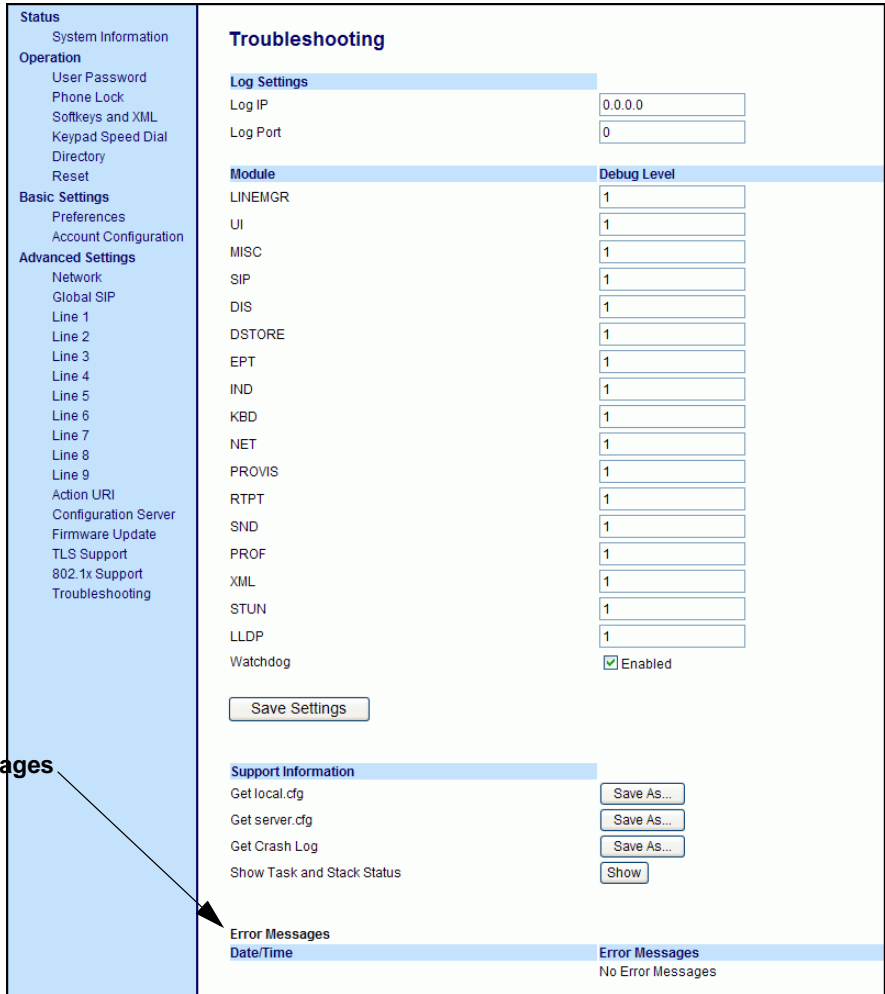

Module	Debug Level
LINEMGR	1
UI	1
MISC	1
SIP	1
DIS	1
DSTORE	1
EPT	1
IND	1
KBD	1
NET	1
PROVIS	1
RTPT	1
SND	1
PROF	1
XML	1
STUN	1
LLDP	1
Watchdog	<input checked="" type="checkbox"/> Enabled

Error Messages

Date/Time	Error Messages
	No Error Messages

2 Scroll down to the **“Error Messages”** section to view the error messages that may have generated during startup or reboot of the IP Phone.

Troubleshooting Solutions

Description

This section describes solutions to some most common problems that can occur while using the IP phones.

Why does my phone display “Application missing”?

If you have experienced networking issues while the phone was downloading the application from the TFTP server, it is possible that the phone can no longer retrieve the required firmware file. In the event that the phone is no longer able to communicate with the TFTP server in its attempt to re-download the firmware and the phone cannot locate the application locally, the message "Application missing" displays.

The phone also displays the following: “Recovery web-client at: <IP Address>”. The IP Address displayed is the IP address of the phone. If the phone is unable to receive an IP from the DHCP server or has lost its record of its static IP, the phone auto-assigns itself the default IP 192.168.0.50.

To recover the firmware for your phone in this circumstance, please perform the following:

1. Launch your web browser on your computer.
Note: Your computer needs to be on the same network as your IP Phone.
2. In the URL, type: “**http://<IP Address>**” (where IP Address is the IP Address displayed on the phone). Your browser launches the **Aastra IP Phone Firmware Recovery** page.
3. Call Customer Support and request a <phone model>.st file.
4. Copy the file to your TFTP server.
5. Enter the <phone model>.st file that is ready for download.
6. Enter the IP address or qualified domain name of the TFTP server.
7. Press the Download Firmware button.

Please ensure that the TFTP server is running and accessible on the network. If the firmware file is correctly located on the running TFTP server, the phone will locate the file and reload the application onto the phone.

Why does my phone display the “No Service” message?

The phone displays the “No Service” message if the SIP settings have not been set up correctly.

The Registrar server could be set to 0.0.0.0. A global value of 0.0.0.0 disables registration. However, the phone is still active and you can dial using `username@ip` address of the phone. The phone displays "No Service".

If the Registrar IP address is set to 0.0.0.0 for a per-line basis (i.e, line 1, line 2, etc.), then the register request is not sent, the "No Service" message does not display, and the message waiting indicator (MWI) does not come on.

Check that the "Registrar Server" IP address in the Aastra Web UI at **Advanced Settings->Global SIP** is correct. Check the "**sip registrar ip**" parameter in the configuration files is correct.

Why does my phone display "Bad Encrypted Config"?

The IP phone displays "Bad Encrypted Config" because encrypted configuration files are enabled but the decryption process has failed. Specific cases where decryption fails are:

Reason:

The site-specific password in `security.tuz` does not match the password used to encrypt the `<mac>.tuz` or `aastra.tuz` files.

Fix:

Encrypt the `.cfg` files to `.tuz` using the correct password, or replace the `security.tuz` with the correct encrypted file.

Reason:

Neither of the <mac>.tuz and aastra.tuz files are present on the configuration server (TFTP/FTP/HTTP).

Fix:

Create the encrypted files using *anacrypt.exe* and copy them to the configuration server.

Reason:

The encrypted <mac>.tuz or aastra.tuz file is encrypted using a different version of *anacrypt.exe* than the phone firmware.

Fix:

Run "*anacrypt.exe -v*" and confirm that the correct version is reported, compared to the phone firmware version.



Why is my phone not receiving the TFTP IP address from the DHCP Server?



For DHCP to automatically populate the IP address or qualified domain name for the TFTP server, your DHCP server must support Option 66. Option 66 is responsible for forwarding the TFTP server IP address or domain name to the phone automatically. If your DHCP server does not support Option 66, you must manually enter the IP address or qualified domain name for the TFTP server into your IP phone configuration.

For procedures on configuring the TFTP server using the IP phone UI and the Aastra Web UI, see Chapter 4, the section, [“Configuring the Configuration Server Protocol”](#) on [page 4-112](#).



For specific protocol parameters you can set in the configuration files, see Appendix A, the section, [“Configuration Server Settings”](#) on [page A-18](#).

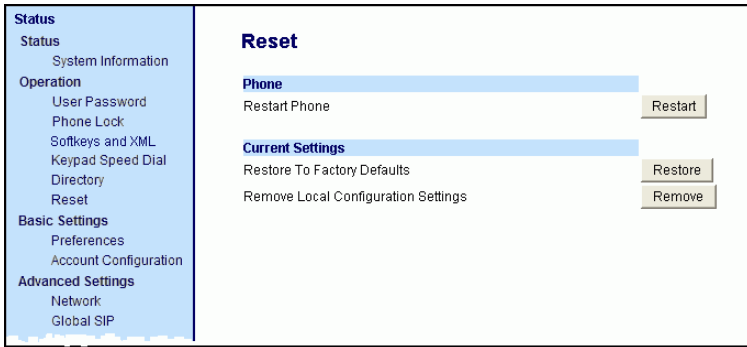

How do I restart the IP phone?

 IP Phone UI	
Step	Action
1	Press  on the phone to enter the Options List.
2	Select Restart Phone .
3	<p>For 3-Line LCD Displays:: Press # to confirm.</p> <p>Note: To cancel the Restart, press the 3 key.</p> <p>For 8 and 11-Line LCD Displays:: Press Restart.</p> <p>Note: To cancel the Restart, press Cancel.</p>



 Aastra Web UI	
1	<p>Click on Operation->Reset->Phone.</p> <div data-bbox="375 1046 1115 1394" style="border: 1px solid black; padding: 10px; margin: 10px 0;">  <p>The screenshot shows a web interface with a left-hand navigation menu and a main content area. The navigation menu includes sections for Status, Operation, Basic Settings, and Advanced Settings. The 'Operation' section is expanded, showing options like User Password, Phone Lock, Softkeys and XML, Keypad Speed Dial, Directory, and Reset. The 'Reset' option is selected, leading to a 'Reset' page with three main sections: 'Phone' (with a 'Restart' button), 'Current Settings' (with 'Restore' and 'Remove' buttons), and 'Remove Local Configuration Settings' (with a 'Remove' button).</p> </div>
2	Click  to restart the phone.



How do I set the IP phone to factory default?

 IP Phone UI	
Step	Action
1	Press  on the phone to enter the Options List.
2	Select Administrator Menu and enter your Administrator Password (default is 22222).
3	Select Factory Default .
4	<p>For 3-Line LCD Displays:: The "Restore Defaults?" prompt displays. Press # to confirm.</p> <p>For 8 and 11-Line LCD Phones: The "Reset phone to factory defaults?" prompt displays. Press Default to confirm.</p>



 Aastra Web UI	
Step	Action
1	<p>Click on Operation->Reset->Current Settings.</p> 
2	<p>In the "Restore to Factory Defaults" field, click  .</p> <p>This restores all factory defaults, and removes any saved configuration and directory list files.</p>

How do I erase the phone's local configuration?

 IP Phone UI	
Step	Action
1	Press  on the phone to enter the Options List.
2	Select Administrator Menu and enter your Administrator Password (default is 22222).
3	Select Erase Local Config .
4	<p>For 3-Line LCD Displays:: The "Erase local config?" prompt displays. Press # to confirm.</p> <p>For 8 and 11-Line LCD Displays:: The "Erase local config?" prompt displays. Press Erase to confirm.</p>

 Aastra Web UI	
Step	Action
1	<p>Click on Operation->Reset->Current Settings.</p> 
2	<p>In the "Remove Local Configuration Settings" field, click  .</p> <p>This removes the last customized configuration settings made on the phone.</p>

How to reset a user's password?

IP Phone UI 	
1	Press  on the phone to enter the Options List.
2	Select User Password .
3	Enter the current user password.
4	Press Enter .
5	Enter the new user password. Note: The IP phones support numeric characters only in passwords. If you enter a password with alpha characters, the phone uses the default password instead.
6	Press Enter .
7	Re-enter the new user password.
8	Press Enter . A message, "Password Changed" displays on the screen.

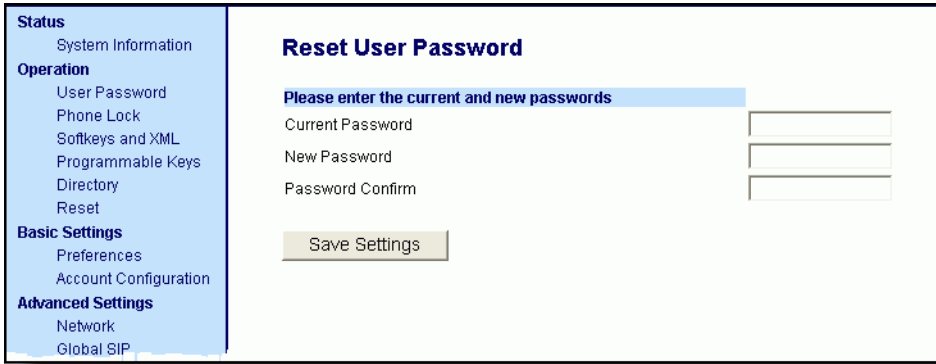

 Aastra Web UI	
Step	Action
1	Click on Operation->User Password . 
2	In the " Current Password " field, enter the current user password.
3	In the " New Password " field, enter the new user password.



Aastra Web UI

Step	Action
4	In the " Confirm Password " field, enter the new user password again.
5	Click  to save your changes.

How do I lock and unlock the phone?

 IP Phone UI	
Step	Action
Lock the phone:	
1	Press  on the phone to enter the Options List.
2	Select Phone Lock . The prompt, " <i>Lock the phone?</i> " displays.
3	Press Lock to lock the phone.
Unlock the phone:	
1	Press  on the phone to enter the Options List. The prompt, " <i>To unlock the phone...Password?</i> "
2	Enter the user or administrator password and press Enter . The phone unlocks.

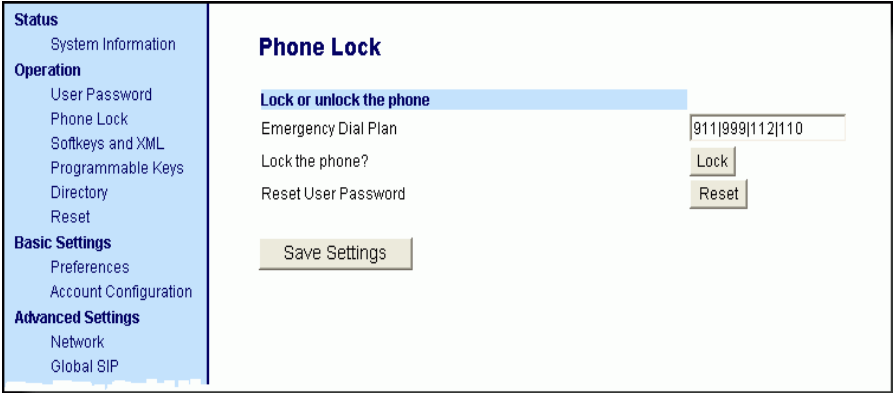
Aastra Web UI	
1	<p>Click on Operation->Phone Lock.</p> 
Lock the phone:	
2	<p>In the “Lock the Phone?” field, click <input type="button" value="Lock"/> .</p> <p>The phone locks dynamically and displays the following message: <i>“Phone is locked”</i>.</p>
Unlock the phone:	
3	<p>Click on Operation->Phone Lock.</p>
4	<p>In the “Unlock the Phone?” field, click <input type="button" value="Unlock"/> .</p> <p>The phone unlocks dynamically and displays the following message: <i>“Phone is unlocked”</i>.</p>

Appendix A

Configuration Parameters

About this appendix

Introduction

This appendix describes the parameters you can set in the configuration files for the IP phones. The configuration files include <mac.cfg> and config.cfg.

Topics

This appendix covers the following topics:

Topic	Page
Setting Parameters in Configuration Files	page A-6
Operational, Basic, and Advanced Parameters	page A-7
Simplified IP Phone UI Options Menu	page A-7
Network Settings	page A-8
DHCP Option Settings	page A-13
Password Settings	page A-15
Emergency Dial Plan Settings	page A-16
Aastra Web UI Settings	page A-17
Configuration Server Settings	page A-18
Multiple Configuration Server Settings	page A-29
Network Address Translation (NAT) Settings	page A-31

About this appendix

Topic	Page
Rport Setting	page A-33
Local SIP UDP/TCP Port Setting	page A-34
Local SIP TLS Port	page A-34
HTTPS Client and Server Settings	page A-35
HTTPS Server Certificate Validation Settings	page A-37
UPnP Settings	page A-41
Virtual Local Area Network (VLAN) Settings	page A-42
RTCP Summary Reports	page A-47
Type of Service (ToS)/DSCP Settings	page A-51
Time and Date Settings	page A-52
Time Server Settings	page A-59
Custom Time Zone and DST Settings	page A-61
Backlight Mode Settings (6755i, 6757i, 6757i CT)	page A-70
Live Dialpad Settings	page A-71
SIP Local Dial Plan Settings	page A-72
SIP Outbound Support	page A-75
Dynamic SIP for Registration and Subscription	page A-76
SIP Basic, Global Settings	page A-77
SIP Basic, Per-Line Settings	page A-86
BLA Support for MWI	page A-97
Shared Call Appearance (SCA) Call Bridging	page A-98
Centralized Conferencing Settings	page A-99
SIP Join Feature for 3-Way Conference	page A-101
HTTP/HTTPS Authentication Support for Broadsoft CMS	page A-102
Advanced SIP Settings	page A-103
Missed Call Summary Subscription Settings	page A-112
As-Feature-Event Subscription Settings	page A-115
Transport Layer Security (TLS) Settings	page A-116
802.1x Support Settings	page A-125
RTP, Codec, DTMF Global Settings	page A-133
Autodial Settings	page A-138

Topic	Page
Voicemail Settings	page A-141
Directory Settings	page A-143
Callers List Settings	page A-145
Customize Callers List and Services Key	page A-146
Call Forward Settings	page A-147
Call Forward Key Mode Settings	page A-148
LLDP-MED and ELIN Settings	page A-150
Missed Calls Indicator Settings	page A-152
XML Settings	page A-153
Action URI Settings	page A-156
XML SIP Notify Settings	page A-162
Polling Action URI Settings	page A-163
Ring Tone and Tone Set Global Settings	page A-164
Ring Tone Per-Line Settings	page A-166
Incoming Call Interrupts Dialing Setting	page A-167
Status Code on Ignoring Incoming Calls	page A-168
Switch Focus to Ringing Line	page A-169
Preferred Line and Preferred Line Timeout	page A-170
Goodbye Key Cancels Incoming Call	page A-171
Stuttered Dial Tone Setting	page A-172
Call Waiting Settings	page A-173
Message Waiting Indicator Settings	page A-174
DND Key Mode Settings	page A-175
Priority Alert Settings	page A-176
Bellcore Cadence Settings	page A-181
SIP Diversion Display	page A-183
Display of Call Destination for Incoming Calls	page A-184
Language Settings	page A-185
Language Pack Settings	page A-187
Suppress DTMF Playback Setting	page A-197
Display DTMF Digits Setting	page A-198

About this appendix

Topic	Page
Intercom, Auto-Answer, and Barge In Settings	page A-199
Group Paging RTP Settings	page A-203
Audio Transmit and Receive Gain Adjustment Settings	page A-204
Directed Call Pickup (BLF or XML Call Interception) Settings	page A-208
ACD Auto-Available Timer Settings	page A-210
Park and Pickup Global Settings (not applicable to 6751i))	page A-211
Mapping Key Settings	page A-213
Softkey/Programmable Key/Feature Key/Expansion Module Key Parameters	page A-216
Softkey Settings for 8 and 11-Line LCD phones	page A-218
Programmable Key Settings for 9143i, 6730i, 6731i, 6753i, and 6755i	page A-227
Top Softkey Settings for 6757i and 6757i CT	page A-232
Handset Feature Key Settings (9480i CT and 6757i CT)	page A-239
Expansion Module Key Settings for M670i (6753i, 6755i, 6757i, 6757i CT) and M675i (for 6755i, 6757i, 6757i CT)	page A-241
Customizing the Key Type List	page A-248
Locking Softkeys and Programmable Keys	page A-251
Locking the SAVE and DELETE Keys (6753i)	page A-254
Enabling/Disabling Ability to Add/Edit Speedial Keys	page A-255
BLF List URI Settings	page A-255
Customizing M675i Expansion Module Column Display	page A-256
Expansion Module 1 through 3	page A-256
Advanced Operational Parameters	page A-258
Blind Transfer Setting	page A-258
Update Caller ID Setting.	page A-258
Boot Sequence Recovery Mode Settings.	page A-259
Single Call Restriction Setting	page A-260
Blacklist Duration Setting	page A-261
Whitelist Proxy Setting	page A-261
XML Key Redirection Settings (for Redial, Xfer, Conf, Icom, Voicemail)	page A-262
Options Key Redirection Setting (Services key on 6751i)	page A-264
Off-Hook and XML Application Interaction Setting	page A-264

Topic	Page
XML Override for a Locked Phone Setting	page A-265
Symmetric UDP Signaling Setting	page A-265
User-Agent Setting	page A-266
GRUU and sip.instance Support	page A-266
DNS Query Setting	page A-267
Ignore Out of Order SIP Requests	page A-268
Optional "Allow" and "Allow-Event" Headers	page A-268
P-Asserted Identity (PAI)	page A-269
Configuration Encryption Setting	page A-270
Troubleshooting Parameters	page A-271
Log Settings	page A-271
WatchDog Settings	page A-274

Setting Parameters in Configuration Files

You can set specific configuration parameters in the configuration files for configuring your IP phone. The *aastra.cfg* and *<mac>.cfg* files are stored on the server. The *aastra.cfg* file stores global IP phone configuration settings. The *<mac>.cfg* file stores configuration settings specific to the IP phone with that MAC address. When you restart the IP phone, these files are downloaded to the phone.

If you make changes to the phone configuration, the changes are stored in a local configuration on the phone (not on the server).

Configuration changes made to the *<mac>.cfg* file override the configuration settings in the *aastra.cfg* file.



Note: Configuration parameters that you enter in the configuration files are NOT case sensitive.

Reference

For information about configuration file precedence, see Chapter 1, the section, “[Configuration File Precedence](#)” on [page -43](#).

This section includes the following types of configurable parameters:

- [Operational, Basic, and Advanced Parameters](#) on [page A-7](#)
- [Mapping Key Settings](#) on [page A-213](#)
- [Softkey/Programmable Key/Feature Key/Expansion Module Key Parameters](#) on [page A-216](#)
- [Advanced Operational Parameters](#) on [page A-258](#)
- [Troubleshooting Parameters](#) on [page A-271](#)

Operational, Basic, and Advanced Parameters

The following sections provide the configuration parameters you can configure on the IP phone. Each parameter table includes the name of the parameter, a description, the format, default value, range, and example. The table also provides the method for which the parameters can be configured (IP phone UI, Aastra Web UI, or configuration files).

Simplified IP Phone UI Options Menu

Parameter – <i>options simple menu</i>	Configuration Files aastra.cfg, <mac>.cfg																
Description	<p>Allows you to enable a simplified options menu or enable the full menu on the IP Phone UI.</p> <table border="1"> <thead> <tr> <th>Full Options Menu</th> <th>Simplified Options Menu</th> </tr> </thead> <tbody> <tr> <td>Call Forward</td> <td>Call Forward</td> </tr> <tr> <td>Preferences</td> <td> Preferences Only the following display: Services (3-Line LCD phones) Tones Contrast Level Live Dialpad Set Audio (8 and 11-Line LCD phones only) Handset Pairing (9480i CT and 6757i CT) </td> </tr> <tr> <td>Phone Status</td> <td>Phone Status</td> </tr> <tr> <td>User Password</td> <td>Removed</td> </tr> <tr> <td>Administrator Menu</td> <td>Removed</td> </tr> <tr> <td>Restart Phone</td> <td>Removed</td> </tr> <tr> <td>Phone Lock</td> <td>Phone Lock</td> </tr> </tbody> </table> <p>Warning: When using the simplified menu, you cannot change the Network settings from the IP Phone UI. If the network settings become misconfigured, you must “factory default” the phone and use the full menu to recover the network settings from the Phone UI OR use the Aastra Web UI to configure the network settings.</p>	Full Options Menu	Simplified Options Menu	Call Forward	Call Forward	Preferences	Preferences Only the following display: Services (3-Line LCD phones) Tones Contrast Level Live Dialpad Set Audio (8 and 11-Line LCD phones only) Handset Pairing (9480i CT and 6757i CT)	Phone Status	Phone Status	User Password	Removed	Administrator Menu	Removed	Restart Phone	Removed	Phone Lock	Phone Lock
Full Options Menu	Simplified Options Menu																
Call Forward	Call Forward																
Preferences	Preferences Only the following display: Services (3-Line LCD phones) Tones Contrast Level Live Dialpad Set Audio (8 and 11-Line LCD phones only) Handset Pairing (9480i CT and 6757i CT)																
Phone Status	Phone Status																
User Password	Removed																
Administrator Menu	Removed																
Restart Phone	Removed																
Phone Lock	Phone Lock																
Format	Boolean																
Default Value	0 (full options menu)																
Range	0 (full options menu) 1 (simplified options menu)																
Example	options simple menu: 1																

Network Settings

Parameter – <i>dhcp</i> <i>DHCP</i> (in Web UI)	IP phone UI Options->Administrator Menu->Network Settings Aastra Web UI Advanced Settings->Network->Basic Network Settings Configuration Files aastra.cfg, <mac>.cfg
Description	<p>Enables or disables DHCP. Enabling DHCP populates the required network information. The DHCP server serves the network information that the IP phone requires. If the IP phone is unable to get any required information, then you must enter it manually. DHCP populates the following network information:</p> <p>IP Address, Subnet Mask, Gateway,, Domain Name Servers (DNS), TFTP, HTTP, HTTP Port, HTTPS, HTTPS Port, and FTP servers, and Timer Servers.</p> <p>Note: For DHCP to automatically populate the IP address or qualified domain name for the TFTP server, your DHCP server must support Option 66.</p>
Format	Integer
Default Value	1 (enabled)
Range	0 (disabled) 1 (enabled)
Example	dhcp: 1

Parameter – <i>ip</i> <i>Ip Address</i> (in Web UI)	IP phone UI Options->Administrator Menu->Network Settings Aastra Web UI Advanced Settings->Network->Basic Network Settings Configuration Files aastra.cfg, <mac>.cfg
Description	<p>This parameter assigns a static IP address to the IP phone device.</p> <p>Note: For DHCP to automatically populate this parameter, your DHCP server must support Option 66.</p>
Format	IP address
Default Value	0.0.0.0
Range	Not Applicable
Example	ip: 192.168.0.25

Parameter – <i>subnet mask</i> <i>Subnet Mask</i> (in Web UI)	IP phone UI Options->Administrator Menu-> Network Settings Aastra Web UI Advanced Settings->Network-> Basic Network Settings Configuration Files aastra.cfg, <mac>.cfg
Description	Subnet mask defines the IP address range local to the IP phone. Note: For DHCP to automatically populate this parameter, your DHCP server must support Option 66.
Format	IP address
Default Value	255.255.255.0
Range	Not Applicable
Example	subnet mask: 255.255.255.224

Parameter – <i>default gateway</i> <i>Gateway</i> (in Web UI)	IP phone UI Options->Administrator Menu-> Network Settings Aastra Web UI Advanced Settings->Network-> Basic Network Settings Configuration Files aastra.cfg, <mac>.cfg
Description	The IP address of the network's gateway or default router IP address. Note: For DHCP to automatically populate this parameter, your DHCP server must support Option 66.
Format	IP address
Default Value	1.0.0.1
Range	Not Applicable
Example	default gateway: 192.168.0.1

Operational, Basic, and Advanced Parameters

Parameter – <i>dns1</i> <i>Primary DNS</i> (in Web UI)	IP phone UI Options->Administrator Menu-> Network Settings Aastra Web UI Advanced Settings->Network-> Basic Network Settings Configuration Files aastra.cfg, <mac>.cfg
Description	Primary domain name server IP address. For any of the IP address settings on the IP phone a domain name value can be entered instead of an IP address. With the help of the domain name servers the domain names for such parameters can then be resolved to their corresponding IP addresses. Note: For DHCP to automatically populate this parameter, your DHCP server must support Option 66.
Format	IP address
Default Value	0.0.0.0
Range	Not Applicable
Example	dns1: 192.168.0.5

Parameter – <i>dns2</i> <i>Secondary DNS</i> (in Web UI)	IP phone UI Options->Administrator Menu-> Network Settings Aastra Web UI Advanced Settings->Network-> Basic Network Settings Configuration Files aastra.cfg, <mac>.cfg
Description	A service that translates domain names into IP addresses. To assign static DNS addresses, disable DHCP. Note: For DHCP to automatically populate this parameter, your DHCP server must support Option 66.
Format	IP address
Default Value	0.0.0.0
Range	Not Applicable
Example	dns2: 192.168.0.6

Parameter – <i>ethernet port 0</i> <i>LAN Port</i> (in Web UI)	IP phone UI Options->Administrator Menu-> Network Settings Aastra Web UI Advanced Settings->Network-> Basic Network Settings Configuration Files aastra.cfg, <mac>.cfg
Description	The send (TX) and receive (RX) method to use on Ethernet port 0 to transmit and receive data over the LAN.
Format	Integer
Default Value	0
Range	0 - auto-negotiate 1 - full-duplex, 10Mbps 2 - full-duplex, 100Mbps 3 - half-duplex, 10Mbps 4 - half-duplex, 100Mbps
Example	ethernet port 0: 3

Parameter – <i>ethernet port 1</i> <i>PC Port</i> (in Web UI)	IP phone UI Options->Administrator Menu-> Network Settings Aastra Web UI Advanced Settings->Network-> Basic Network Settings Configuration Files aastra.cfg, <mac>.cfg
Description	The send (TX) and receive (RX) method to use on Ethernet port 1 to transmit and receive data over the LAN. Note: PC Port parameters are not applicable to the 6730i IP Phone.
Format	Integer
Default Value	0
Range	0 - auto-negotiate 1 - full-duplex, 10Mbps 2 - full-duplex, 100Mbps 3 - half-duplex, 10Mbps 4 - half-duplex, 100Mbps
Example	ethernet port 1: 2

Parameter – <i>pc port passthru enabled</i>	IP phone UI Options->Administrator Menu-> Network Settings->Ethernet Link Aastra Web UI Advanced Settings->Network-> Basic Network Settings Configuration Files aastra.cfg, <mac>.cfg
Description	Enables or disables the PC port. Note: PC Port parameters are not applicable to the 6730i IP Phone.
Format	Integer
Default Value	1 (enable)
Range	0 (disable) 1 (enable)
Example	pc port passthru enabled: 1

DHCP Option Settings

Option 12

Parameter– <i>hostname</i> <i>Hostname</i> (in Web UI)	Configuration Files aastra.cfg, <mac>.cfg IP Phone UI Options->Administrator Menu-> Network Settings->Hostname Aastra Web UI Advanced Settings->Network-> Basic Network Settings
Description	Specifies the hostname DHCP Option 12 that the phone sends with the DHCP Request packet. Note: If you change this parameter, you must restart your phone for the change to take affect.
Format	String
Default Value	[<model><MAC IP Address>]
Range	Up to 64 alpha-numeric characters Note: The value for this parameter can also be a fully qualified domain name.
Example	hostname: aastra4

Option 77

Parameter– <i>dhcp userclass</i> <i>DHCP User Class</i> (in Web UI)	Configuration Files aastra.cfg, <mac>.cfg IP Phone UI Options->Administrator Menu-> Network Settings->DHCP Settings-> DHCP User Class Aastra Web UI Advanced Settings->Network-> Advanced Network Settings
Description	Specifies the User Class DHCP Option 77 that the phone sends to the configuration server with the DHCP Request packet. Note: If you specify a value for this parameter, you must restart your phone for the change to take affect. Any change in its value during start-up results in an automatic reboot.
Format	String
Default Value	""
Range	Up to 64 alpha-numeric characters
Example	dhcp userclass: admin

Options 159 and 160 - DHCP Option Override

Parameter – <i>dhcp config option override</i> <i>DHCP Download Options</i> (in Web UI)	Configuration Files aastra.cfg, <mac>.cfg IP Phone UI Options->Administrator Menu-> Network Settings->DHCP Settings-> Download Options Aastra Web UI Advanced Settings->Network-> Advanced Network Settings
Description	The value specified for this parameter overrides the precedence order for determining a configuration server. Note: You must restart the IP Phone for this parameter to take affect.
Format	Integer
Default Value	0 (Any - no override - uses normal precedence order of 43, 160, 159, 66)
Range	-1 (Disabled - ignores all DHCP configuration options (43, 66, 159, 160) 0 (Any) 43 66 159 160
Example	dhcp config option override: 66

Password Settings

Parameter – <i>admin password</i>	Configuration Files aastra.cfg, <mac>.cfg
Description	Allows you to set a new administrator password for the IP phone. Note: The IP phones support numeric characters only in passwords. If you enter a password with alpha characters, the phone uses the default password instead.
Format	Integer
Default Value	22222
Range	0 to 4294967295
Example	admin password: 1234567890

Parameter – <i>user password</i> <i>Current Password</i> (in Web UI)	IP phone UI Options->User Password Aastra Web UI Operation->User Password Configuration Files aastra.cfg, <mac>.cfg
Description	Allows you to set a new user password for the IP phone. Note: The IP phones support numeric characters only in passwords. If you enter a password with alpha characters, the phone uses the default password instead.
Format	Integer
Default Value	Default value is an empty string "" (left blank)
Range	0 to 4294967295
Example	user password: 123

Emergency Dial Plan Settings

Parameter – <i>emergency dial plan</i>	Configuration Files aastra.cfg, <mac>.cfg Aastra Web UI Operation->Phone Lock												
Description	<p>Allows you to specify an emergency number to use on your IP phone so a caller can contact emergency services in the local area when required.</p> <p>The default emergency numbers on the IP phones is 911, 999, 112, and 110.</p> <p>911 - A United States emergency number. 999 - A United Kingdom emergency number. 112 - An international emergency telephone number for GSM mobile phone networks. In all European Union countries it is also the emergency telephone number for both mobile and fixed-line telephones. 110 - A police and/or fire emergency number in Asia, Europe, Middle East, and South America.</p> <table> <thead> <tr> <th>Dial plan(characters)</th> <th>Length (bytes)</th> </tr> </thead> <tbody> <tr> <td>911</td> <td>14</td> </tr> <tr> <td>4xx</td> <td>18</td> </tr> <tr> <td>x+## xx+*</td> <td>35</td> </tr> <tr> <td>911 999 112 110 450</td> <td>54</td> </tr> <tr> <td>911 112 011XX+## 101XX+## 1[2-3]XXXXXXXXXX [4-5]XXXXXXXXXX [6-7]XXXXXXXXXX,3 [8-9]XXXXXXXXXX,2 XX+* XX+## *XXX+## #XX+## 4xx,2</td> <td>325</td> </tr> </tbody> </table> <p>Note: Contact your local phone service provider for available emergency numbers in your area.</p>	Dial plan(characters)	Length (bytes)	911	14	4xx	18	x+## xx+*	35	911 999 112 110 450	54	911 112 011XX+## 101XX+## 1[2-3]XXXXXXXXXX [4-5]XXXXXXXXXX [6-7]XXXXXXXXXX,3 [8-9]XXXXXXXXXX,2 XX+* XX+## *XXX+## #XX+## 4xx,2	325
Dial plan(characters)	Length (bytes)												
911	14												
4xx	18												
x+## xx+*	35												
911 999 112 110 450	54												
911 112 011XX+## 101XX+## 1[2-3]XXXXXXXXXX [4-5]XXXXXXXXXX [6-7]XXXXXXXXXX,3 [8-9]XXXXXXXXXX,2 XX+* XX+## *XXX+## #XX+## 4xx,2	325												
Format	Integer												
Default Value	x+## xx+*												
Range	Up to 512 characters												
Example	emergency dial plan: 911 999												

Parameter – <i>options password enabled</i>	Configuration Files aastra.cfg, <mac>.cfg
Description	<p>Enables or disables password protection of the Options key on the IP phone. If enabled, upon pressing the Options key, a user has to enter a password at the IP phone UI. If the password is entered correctly, the user is allowed to gain access to the Options Menu and no more password prompts display for other password protected screens. If the user fails to enter the correct password in three attempts, access to the Options Menu is denied and the IP phone returns to the idle screen.</p> <p>Note: The password to enter is the administrator password configured for that phone.</p>
Format	Boolean
Default Value	0
Range	0 (false; not password protected) 1 (true; password protected)
Example	options password enabled: 1

Aastra Web UI Settings

Parameter – <i>web interface enabled</i>	Configuration Files aastra.cfg, <mac>.cfg
Description	<p>Enables or disables the Aastra Web UI for a single IP phone when this parameter is entered in the <mac>.cfg file.</p> <p>Enables or disables the Aastra Web UI for all phones when this parameter is placed in the <i>aastra.cfg</i> file.</p>
Format	Boolean
Default Value	Not Applicable
Range	0 = Disable 1 = Enable
Example	web interface enabled: 1

Configuration Server Settings

Parameter – <i>download protocol</i> <i>Download Protocol</i> (in Web UI)	IP phone UI Aastra Web UI Configuration Files	Options->Administrator Menu-> Network Settings Advanced Settings->Configuration Server aastra.cfg, <mac>.cfg
Description	Protocol to use for downloading new versions of software to the IP phone.	
Format	Text	
Default Value	TFTP	
Range	TFTP FTP HTTP HTTPS	
Example	download protocol: HTTPS	

Parameter – <i>tftp server</i> <i>TFTP Server</i> (in Web UI)	IP phone UI Aastra Web UI Configuration Files	Options->Administrator Menu-> Network Settings->TFTP Server->Primary TFTP Advanced Settings->Configuration Server aastra.cfg, <mac>.cfg
Description	<p>The TFTP server's IP address. If DHCP is enabled and the DHCP server provides the information, this field is automatically populated. Use this parameter to change the IP address or domain name of the TFTP server. This will become effective after this configuration file has been downloaded into the phone.</p> <p>Note: For DHCP to automatically populate this parameter, your DHCP server must support Option 66.</p>	
Format	IP address or qualified domain name	
Default Value	0.0.0.0	
Range	Not Applicable	
Example	tftp server: 192.168.0.130	

Parameter – <i>tftp path</i>	Aastra Web UI Advanced Settings-> Configuration Server->Settings IP Phone UI Options->Administrator Menu-> Configuration Server->TFTP Settings Configuration Files aastra.cfg, <mac>.cfg
Description	Specifies the path name for which the configuration files reside on the TFTP server for downloading to the IP Phone. Note: Enter the path name in the form <i>folderX\folderX\folderX</i> . For example, <i>ipphone\6757\configfiles</i> .
Format	String
Default Value	N/A
Range	Up to 64 alphanumeric characters
Example	tftp path: configs\tftp

Parameter – <i>alternate tftp server</i> <i>Alternate TFTP</i> (in Web UI)	IP phone UI Options->Administrator Menu-> Network Settings->TFTP Server-> Alternate TFTP Aastra Web UI Advanced Settings->Configuration Server Configuration Files aastra.cfg, <mac>.cfg
Description	The alternate TFTP server's IP address or qualified domain name. This will become effective after this configuration file has been downloaded into the phone.
Format	IP address or qualified domain name
Default Value	0.0.0.0
Range	Not Applicable
Example	alternate tftp server: 192.168.0.132

Operational, Basic, and Advanced Parameters

Parameter – <i>alternate tftp path</i>	Aastra Web UI Advanced Settings-> Configuration Server->Settings	IP Phone UI Options->Administrator Menu-> Configuration Server->TFTP Settings
Description	Specifies a path name for which the configuration files reside on an alternate TFTP server for downloading to the IP Phone. Note: Enter the path name in the form <i>folderX\folderX\folderX</i> . For example, <i>ipphone\6757\configfiles</i> .	
Format	String	
Default Value	N/A	
Range	Up to 64 alphanumeric characters	
Example	alternate tftp path: configs\alternate	

Parameter – <i>use alternate tftp</i> <i>Use Alternate TFTP</i> (in Web UI)	IP phone UI Options->Administrator Menu-> Network Settings->TFTP Server->Select TFTP	Aastra Web UI Advanced Settings->Configuration Server
Description	Configuration Files aastra.cfg, <mac>.cfg	
Description	Enables or disables the alternate TFTP server. Valid values are "0" disabled and "1" enabled.	
Format	Not Applicable	
Default Value	0	
Range	0 or 1	
Example	use alternate tftp: 1	

<p>Parameter – <i>ftp server</i></p> <p><i>FTP Server</i> (in Web UI)</p>	<p>IP phone UI Options->Administrator Menu-> Network Settings->FTP Server</p> <p>Aastra Web UI Advanced Settings->Configuration Server</p> <p>Configuration Files aastra.cfg, <mac>.cfg</p>
<p>Description</p>	<p>The FTP server's IP address or network host name. This will become effective after this configuration file has been downloaded into the phone.</p> <p>Optional: You can also assign a username and password for access to the FTP server. See the following parameters for setting username and password.</p> <p>Note: For DHCP to automatically populate this parameter, your DHCP server must support Option 66.</p>
<p>Format</p>	<p>IP address or fully qualified Domain Name</p>
<p>Default Value</p>	<p>0.0.0.0</p>
<p>Range</p>	<p>Not Applicable</p>
<p>Example</p>	<p>ftp server: 192.168.0.131</p>

<p>Parameter – <i>ftp path</i></p>	<p>Aastra Web UI Advanced Settings-> Configuration Server->Settings</p> <p>IP Phone UI Options->Administrator Menu-> Configuration Server->FTP Settings</p> <p>Configuration Files aastra.cfg, <mac>.cfg</p>
<p>Description</p>	<p>Specifies a path name for which the configuration files reside on an FTP server for downloading to the IP Phone.</p> <p>Note: Enter the path name in the form <i>folderX\folderX\folderX</i>. For example, <i>ipphone67571\configfiles</i>.</p>
<p>Format</p>	<p>String</p>
<p>Default Value</p>	<p>N/A</p>
<p>Range</p>	<p>Up to 64 alphanumeric characters</p>
<p>Example</p>	<p>ftp path: configs\ftp</p>

Operational, Basic, and Advanced Parameters

Parameter – <i>ftp username</i> <i>FTP User Name</i> (in Web UI)	IP phone UI Aastra Web UI Configuration Files	Options->Administrator Menu-> Network Settings->FTP Server Advanced Settings->Configuration Server aastra.cfg, <mac>.cfg
Description	The username to enter for accessing the FTP server. This will become effective after this configuration file has been downloaded into the phone. Note: The IP Phones support usernames containing dots (“.”).	
Format	Text	
Default Value	Not Applicable	
Range	Up to 63 alphanumeric characters	
Example	ftp username: 6757iaastra	
Parameter – <i>ftp password</i> <i>FTP Password</i> (in Web UI)	IP phone UI Aastra Web UI Configuration Files	Options->Administrator Menu-> Network Settings->FTP Server Advanced Settings->Configuration Server aastra.cfg, <mac>.cfg
Description	The password to enter for accessing the FTP server. This will become effective after this configuration file has been downloaded into the phone.	
Format	Text	
Default Value	Not Applicable	
Range	Up to 63 alphanumeric characters	
Example	ftp password: 1234	

Parameter – <i>http server</i> <i>HTTP Server</i> (in Web UI)	IP phone UI Aastra Web UI Configuration Files	Options->Administrator Menu-> Network Settings->HTTP Server Advanced Settings->Configuration Server aastra.cfg, <mac>.cfg
Description	The HTTP server's IP address. This will become effective after this configuration file has been downloaded into the phone. Optional: You can also assign an HTTP relative path to the HTTP server. See the next parameter (http path). Note: For DHCP to automatically populate this parameter, your DHCP server must support Option 66.	
Format	IP address or fully qualified Domain Name	
Default Value	0.0.0.0	
Range	Not Applicable	
Example	http server: 192.168.0.132	

Parameter – <i>http path</i> <i>HTTP Path</i> (in Web UI)	IP phone UI Aastra Web UI Configuration Files	Options->Administrator Menu-> Network Settings->HTTP Server Advanced Settings->Configuration Server aastra.cfg, <mac>.cfg
Description	The HTTP path name to enter. If the IP phone's configuration and firmware files are located in a sub-directory beneath the server's HTTP root directory, the relative path to that sub-directory should be entered in this field.	
Format	dir/dir/dir	
Default Value	Not Applicable	
Range	Up to 63 alphanumeric characters	
Example	http path: ipphones/67571	

Operational, Basic, and Advanced Parameters

Parameter – <i>http port</i>	IP Phone UI: Options->Administrator Menu-> Configuration Server->HTTP Settings
<i>HTTP Port</i> (in Web UI)	Aastra Web UI: Advanced Settings->Configuration Server-> Settings
	Configuration Files aastra.cfg, <mac>.cfg
Description	Specifies the HTTP port that the server uses to load the configuration to the phone over HTTP. Note: For DHCP to automatically populate this parameter, your DHCP server must support Option 66.
Format	Integer
Default Value	80
Range	1 through 65535
Example	http port: 1025

Parameter – <i>https server</i>	IP phone UI Options->Administrator Menu-> Network Settings->HTTPS-> HTTPS Client->Download Server
<i>HTTPS Server</i> (in Web UI)	Aastra Web UI Advanced Settings->Configuration Server
	Configuration Files aastra.cfg, <mac>.cfg
Description	The HTTPS server's IP address. This will become effective after this configuration file has been downloaded into the phone. Optional: You can also assign an HTTPS relative path to the HTTPS server. See the next parameter (https path). Note: For DHCP to automatically populate this parameter, your DHCP server must support Option 66.
Format	IP address or fully qualified Domain Name
Default Value	0.0.0.0
Range	Not Applicable
Example	https server: 192.168.0.143

Parameter – <i>https path</i> <i>HTTPS Path</i> (in Web UI)	IP phone UI Options->Administrator Menu->Network Settings->HTTPS->HTTPS Client->Download Path Aastra Web UI Advanced Settings->Configuration Server Configuration Files aastra.cfg, <mac>.cfg
Description	The HTTPS path name to enter. If the IP phone's configuration and firmware files are located in a sub-directory beneath the server's HTTPS root directory, the relative path to that sub-directory should be entered in this field.
Format	dir/dir/dir
Default Value	Not Applicable
Range	Up to 63 alphanumeric characters
Example	https path: ipphones/6755i

Parameter – <i>https port</i> <i>HTTPS Port</i> (in Web UI)	IP Phone UI: Options->Administrator Menu->Configuration Server->HTTPS Settings Aastra Web UI: Advanced Settings->Configuration Server->Settings Configuration Files aastra.cfg, <mac>.cfg
Description	Specifies the HTTPS port that the server uses to load the configuration to the phone over HTTPS. Note: For DHCP to automatically populate this parameter, your DHCP server must support Option 66.
Format	Integer
Default Value	443
Range	1 through 65535
Example	https port: 1025

Parameter – <i>auto resync mode</i> <i>Mode</i> (in Web UI)	Aastra Web UI Advanced Settings->Configuration Server-> Auto-Resync Configuration Files aastra.cfg, <mac>.cfg
Description	Determines whether the configuration server automatically updates the configuration files only, the firmware only, both the firmware and configuration files, or disables automatic updates. This parameter works with TFTP, FTP, HTTP and HTTPS servers. Valid values are: None (0) - Disable auto-resync Configuration Files (1) - Updates the configuration files on the IP phone automatically at the specified time if the files on the server have changed. Firmware (2) - Updates the firmware on the IP phone automatically at the specified time if the files on the server have changed. Both (3) - Updates the configuration files and firmware automatically at the specified time if the files on the server have changed. Notes: <ol style="list-style-type: none"> 1. If a user is accessing the Aastra Web UI, they are not informed of an auto-reboot. 2. Any changes made using the Aastra Web UI or the IP phone UI are not overwritten by an auto-resync update. Auto-resync affects the configuration files only. However, the settings in the Aastra Web UI take precedence over the IP phone UI and the configuration files. 3. The resync time is based on the local time of the IP phone. 4. If the IP phone is in use (not idle) at the time of the resync check, the reboot occurs when the phone becomes idle. 5. The automatic update feature works with both encrypted and plain text configuration files.
Format	Integer
Default Value	Aastra Web UI None Configuration Files 0
Range	Aastra Web UI None Configuration Files Firmware Both Configuration Files 0 (none) 1 (configuration files only) 2 (firmware only) 3 (configuration files and firmware)
Example	auto resync mode: 1

<p>Parameter – <i>auto resync time</i></p> <p><i>Time (24-hour)</i> (in Web UI)</p>	<p>Aastra Web UI Advanced Settings->Configuration Server-> Auto-Resync</p> <p>Configuration Files aastra.cfg, <mac>.cfg</p>
<p>Description</p>	<p>Sets the time of day in a 24-hour period for the IP phone to be automatically updated. This parameter works with TFTP, FTP, HTTP and HTTPS servers.</p> <p>Notes:</p> <ol style="list-style-type: none"> 1. The resync time is based on the local time of the IP phone. 2. The value of 00:00 is 12:00 A.M. 3. When selecting a value for this parameter in the Aastra Web UI, the values are in 30-minute increments only. 4. When entering a value for this parameter using the configuration files, the value can be entered using minute values from 00 to 59 (for example, the auto resync time can be entered as 02:56). 5. Auto-Resync adds up to 15 minutes random time to the configured time. For example, if the auto resync time parameter is set to 02:00, the event takes place any time between 02:00 and 02:15. 6. When the language on the phone is set to French or Spanish, you must enter the time in the format "00h00" (configuration files only).
<p>Format</p>	<p>hh:mm 00h00 (for French and Spanish configuration files)</p>
<p>Default Value</p>	<p>Aastra Web UI 00:00</p> <p>Configuration Files 00:00</p>
<p>Range</p>	<p>Aastra Web UI 00:00 to 23:30 (in 30 minute increments)</p> <p>Configuration Files hh = 00 to 23 mm = 00 to 59</p>
<p>Example</p>	<p>auto resync time: 03:24</p>

Operational, Basic, and Advanced Parameters

Parameter – <i>auto resync max delay</i> <i>Maximum Delay</i> (in Web UI)	Configuration Files Aastra Web UI	aastra.cfg, <mac>.cfg Advanced Settings->Configuration Server-> Auto-Resync
Description	Specifies the maximum time, in minutes, the phone waits past the scheduled time before starting a checksync.	
Format	Integer	
Default Value	15	
Range	0 to 1439	
Example	auto resync max delay: 20	

Parameter – <i>auto resync days</i> <i>Days</i> (in Web UI)	Configuration Files Aastra Web UI	aastra.cfg, <mac>.cfg Advanced Settings->Configuration Server-> Auto-Resync
Description	Specifies the amount of days that the phone waits between checksync operations. Note: A value of 0 causes the phone to checksync every time the clock reads the proper time. A value of 1 forces the phone to wait 24 hours prior to doing the first checksync.	
Format	Integer	
Default Value	0	
Range	0 to 364	
Example	auto resync days: 1	

Multiple Configuration Server Settings

Parameter – <i>firmware server</i>	Configuration Files aastra.cfg, <mac>.cfg
Description	<p>Specifies the URL of a server (other than the original configuration server) from which the phones in the network get their firmware.</p> <p>Note: The default method for the update of firmware to the phones is from the original configuration server. The Administrator must specify a correct server URL for the phones to get their firmware information from that server. If the URL is incorrect, no firmware download occurs to the phones from the specified server.</p>
Format	<p>String (up to 256 characters)</p> <p>FTP "ftp://username:password@0.0.0.0:port/path"</p> <p>TFTP "tftp://0.0.0.0:port/path"</p> <p>HTTP "http://0.0.0.0:port/path"</p> <p>HTTPS "https://0.0.0.0:port/path"</p>
Default Value	Blank
Range	Not Applicable
Example	<p>firmware server:</p> <p>Leaving this parameter blank downloads all configuration and firmware files from the original configuration server.</p> <p>firmware server: tftp://10.30.102.158/test1</p> <p>The above example uses TFTP to download all firmware files that exist in the "test1" directory on the specified server, to the phones.</p>

Additional Information

The directory files, language packs, TLS certificate files, 802.1x certificate files, and HTTPS files can also be downloaded to the phone from a server other than the configuration server. For each of these types of files, you can specify a URL

(server IP address) from which the phone gets these files. You can use existing parameters on the phone to specify the URL. For more information about this feature, refer to [Chapter 1](#), the section, “[Directory Files, Language Packs, TLS Certificates, 802.1x Certificates, HTTPS Files and Multiple Configuration Servers](#)” on page 1-47.

For information on configuring the directory, language pack, TLS certificates, 802.1x certificates, and HTTPS parameters, see the applicable parameters in this Appendix.

Network Address Translation (NAT) Settings

Parameter – <i>sip nat ip</i> <i>NAT IP</i> (in Web UI)	IP phone UI Aastra Web UI Configuration Files	Options->Administrator Menu->SIP Settings Advanced Settings->Network aastra.cfg, <mac>.cfg
Description	IP address of the network device that enforces NAT.	
Format	IP Address	
Default Value	0.0.0.0	
Range	Not Applicable	
Example	sip nat ip: 192.245.2.1	

Parameter – <i>sip nat port</i> <i>NAT SIP Port</i> (in Web UI)	IP phone UI Aastra Web UI Configuration Files	Options->Administrator Menu->SIP Settings Advanced Settings->Network aastra.cfg, <mac>.cfg
Description	Port number of the network device that enforces NAT.	
Format	Integer	
Default Value	0	
Range	Not Applicable	
Example	sip nat port: 51620	

Operational, Basic, and Advanced Parameters

Parameter – <i>sip nat rtp port</i> <i>NAT RTP Port</i> (in Phone UI and Web UI)	IP Phone UI Options->Administrator Menu-> SIP Settings->RTP Port Base Aastra Web UI Advanced Settings->Network-> Advanced Network Settings Configuration Files aastra.cfg, <mac>.cfg
Description	Indicates the port through which the RTP packets are sent. This value must specify the beginning of the RTP port range on the gateway or router. The RTP port is used for sending DTMF tones and for the audio stream. Your network administrator may close some ports for security reasons. You may want to use this parameter to send RTP data using a different port. Note: The phones support decoding and playing out DTMF tones sent in SIP INFO requests. The following DTMF tones are supported: <ul style="list-style-type: none"> • Support signals 0-9, #, * • Support durations up to 5 seconds
Format	Integer
Default Value	51720
Range	Not Applicable
Example	sip nat rtp port: 51730

Parameter – <i>sip nortel nat support</i> <i>Nortel NAT Traversal</i> <i>Enabled</i> (in Web UI)	IP phone UI Options->Administrator Menu->SIP Settings Aastra Web UI Advanced Settings->Network Configuration Files aastra.cfg, <mac>.cfg
Description	Enables or disables the phone to operate while connected to a network device that enforces NAT.
Format	Integer
Default Value	0 (disabled)
Range	0 (disabled) 1 (enabled)
Example	sip nortel nat support: 1

Parameter – <i>sip nortel nat timer</i> <i>Nortel NAT Timer</i> (in Web UI)	Aastra Web UI Advanced Settings->Network Configuration Files aastra.cfg, <mac>.cfg
Description	The interval, in seconds, that the phone sends SIP ping requests to the Nortel proxy.
Format	Integer
Default Value	30
Range	0 to 2147483647
Example	sip nortel nat timer: 60

Rport Setting

Parameter – <i>sip rport</i>	Aastra Web UI: Advanced Settings->Network-> Advanced Network Settings Configuration Files aastra.cfg, <mac>.cfg
Description	Allows you to enable (1) or disable (0) the use of Rport on the IP phone. “Rport” in RFC 3581, allows a client to request that the server send the response back to the source IP address and the port from which the request came. Note: Configuring the Rport parameter is recommended for clients behind a Network Address Translation (NAT) or firewall.
Format	Boolean
Default Value	0
Range	0 (disable) 1 (enable)
Example	sip rport: 1

Local SIP UDP/TCP Port Setting

Parameter – <i>sip local port</i>	Aastra Web UI: Advanced Settings->Global SIP-> Advanced SIP Settings Configuration Files aastra.cfg, <mac>.cfg
Description	Specifies the local source port (UDP/TCP) from which the phone sends SIP messages.
Format	Numeric
Default Value	5060
Range	Greater than 1024 and less than 65535 Notes: 1. It is recommended that you avoid the conflict RTP port range in case of a UDP transport. 2. By default, the IP phones use symmetric UDP signaling for outgoing UDP SIP messages. When symmetric UDP is enabled, the IP phone generates and listens for UDP messages using port 5060. If symmetric UDP signaling is disabled, the phone sends from random ports but it listens on the configured SIP local port.
Example	sip local port: 5060

Local SIP TLS Port

Parameter – <i>sip local tls port</i>	Aastra Web UI: Advanced Settings->Global SIP-> Advanced SIP Settings Configuration Files aastra.cfg, <mac>.cfg
Description	Specifies the local source port (SIPS/TLS) from which the phone sends SIP messages.
Format	Numeric
Default Value	5061
Range	Greater than 1024 and less than 65535 Note: It is recommended that you avoid the conflict with any TCP ports being used. For example: WebUI HTTP server on 80/tcp and HTTPS on 443/tcp.
Example	sip local tls port: 5061

HTTPS Client and Server Settings

Parameter – <i>https client method</i> <i>HTTPS Client Method</i> (in Web UI)	IP Phone UI Options->Administrator Menu->Network Settings->HTTPS->HTTPS Client Aastra Web UI Advanced Settings->Network->Advanced Network Settings Configuration Files aastra.cfg, <mac>.cfg
Description	Defines the security method that the client advertises to the server during the Secure Socket Layer (SSL) handshake. Available options are: TLS 1.0 - Transport Layer Security version 1 (TLS 1.0) is a protocol that ensures privacy between communicating applications and their users on the Internet. TLS is the successor to SSL. SSL 3.0 - Secure Socket Layer version 3 (SSL 3.0) is a commonly-used protocol for managing the security of a message transmission on the Internet.
Format	Alphanumeric characters
Default Value	SSL 3.0
Range	TLS 1.0 SSL 3.0 (default)
Example	https client method: TLS 1.0

Parameter – <i>https redirect http get</i> <i>HTTPS Server - Redirect HTTP to HTTPS</i> (in Web UI)	IP Phone UI Options->Administrator Menu->Network Settings->HTTPS->HTTPS Server->Redirect Aastra Web UI Advanced Settings->Network->Advanced Network Settings Configuration Files aastra.cfg, <mac>.cfg
Description	Allows or disallows redirection from the HTTP server to the HTTPS server.
Format	Boolean
Default Value	1 (enables redirection)
Range	0 (disables redirection) 1 (enables redirection)
Example	https redirect http get: 0

Parameter – <i>https block http post xml</i> <i>HTTPS Server - Block XML</i> <i>HTTP POSTs</i> <i>(in Web UI)</i>	IP Phone UI Options->Administrator Menu->Network Settings->HTTPS->HTTPS Server->XML Aastra Web UI Advanced Settings->Network->Advanced Network Settings Configuration Files aastra.cfg, <mac>.cfg
Description	<p>Enables or disables the blocking of XML scripts from HTTP POSTs.</p> <p>Some client applications use HTTP POSTs to transfer XML scripts. The phones's HTTP server accepts these POSTs even if server redirection is enabled, effectively bypassing the secure connection. When this parameter is enabled (blocking is enabled), receipt of an HTTP POST containing an XML parameter header results in the following response: "403 Forbidden". This forces the client to direct the POSTs to the HTTPS server through use of the "https://" URL.</p>
Format	Boolean
Default Value	0 (disables blocking of XML HTTP POSTs)
Range	0 (disables blocking of XML HTTP POSTs) 1 (enables blocking of XML HTTP POSTs)
Example	https block http post xml: 1

HTTPS Server Certificate Validation Settings

Parameter– <i>https validate certificates</i> <i>Validate Certificates</i> (in Web UI)	Configuration Files IP Phone UI Aastra Web UI	aastra.cfg, <mac>.cfg Options->Administrator Menu-> Configuration Server->HTTPS Settings-> Cert Validation Advanced Settings->Network->HTTPS Settings
Description	Enables or disables the HTTPS validation of certificates on the phone. When this parameter is set to 1, the HTTPS client performs validation on SSL certificates before accepting them. Note: If you are using HTTPS as a configuration method, and use a self signed certificate, you must set this parameter to “0” (disabled) before upgrading to Release 2.3 of the IP Phones.	
Format	Boolean	
Default Value	1 (enabled)	
Range	0 (disabled) 1 (enabled)	
Example	https validate certificates: 0	

Parameter– <i>https validate expires</i> <i>Check Certificate Expiration</i> (in Web UI)	Configuration Files IP Phone UI Aastra Web UI	aastra.cfg, <mac>.cfg Options->Administrator Menu-> Configuration Server->HTTPS Settings-> Cert Validation->Check Expires Advanced Settings->Network->HTTPS Settings
Description	Enables or disables the HTTPS validation of the expiration of the certificates. When this parameter is set to 1, the HTTPS client verifies whether or not a certificate has expired prior to accepting the certificate. Note: If the “https validate expires” parameter is set to enable, the clock on the phone must be set for the phone to accept the certificates.	
Format	Boolean	
Default Value	1 (enabled)	
Range	0 (disabled) 1 (enabled)	
Example	https validate expires: 0	

Parameter– <i>https validate hostnames</i> <i>Check Certificate Hostnames</i> (in Web UI)	Configuration Files IP Phone UI Aastra Web UI	aastra.cfg, <mac>.cfg Options->Administrator Menu-> Configuration Server->HTTPS Settings-> Cert Validation->Check Hostnames Advanced Settings->Network->HTTPS Settings
Description	Enables or disables the HTTPS validation of hostnames on the phone.	
Format	Boolean	
Default Value	1 (enabled)	
Range	0 (disabled) 1 (enabled)	
Example	https validate hostnames: 0	

<p>Parameter– <i>https user certificates</i></p> <p><i>Trusted Certificates Filename (in Web UI)</i></p>	<p>Configuration Files aastra.cfg, <mac>.cfg</p> <p>Aastra Web UI Advanced Settings->Network->HTTPS Settings</p>
<p>Description</p>	<p>Specifies a file name for a .PEM file located on the configuration server. This file contains the User-provided certificates in PEM format. These certificates are used to validate peer certificates.</p> <p>Note: You must disable the “https validate certificates” parameter in order for the phone to accept the User-provided certificates.</p> <p>You can use this parameter in three ways:</p> <ul style="list-style-type: none"> • To download no certificates • To download a certificate from the original configuration server • To download a certificate from another specified server <p>To download a specific file, the string value MUST HAVE A FILENAME at the end of the string. For example:</p> <p>https user certificates: ftp://admin:admin!@1.2.3.4:50/path/phonesHTTPSUserCert.pem</p> <p>where “path” is the directory and “phonesHTTPSUserCert.pem” is the filename. If you do not specify a filename, the download fails.</p> <p>See examples for each below.</p>
<p>Format</p>	<p>Alphanumeric string in the format <filename.pem></p>
<p>Default Value</p>	<p>Not applicable</p>
<p>Range</p>	<p>Not applicable</p>

Example

The following example downloads no HTTPS user certificate file:

```
https user certificates:
```

The following example downloads the HTTPS user certificate file from the original configuration server.

```
https user certificates: phonesHTTPSUserCert.pem
```

The following example uses FTP to download the firmware file "phonesHTTPSUserCert.pem" (HTTPS user certificate file) from the "path" directory on server 1.2.3.4 using port 50:

```
https user certificates:ftp://admin:admin!@1.2.3.4:50/path/  
phonesHTTPSUserCert.pem
```

UPnP Settings

Parameter – <i>upnp manager</i>	IP phone UI Aastra Web UI Configuration Files	Options->Administrator Menu-> Network Settings->UPnP Advanced Settings->Network-> Advanced Network Settings aastra.cfg, <mac>.cfg
<i>UPnP</i> (in Web UI)		
Description	Enables or disables Universal Plug and Play (UPnP) on the IP phone. If you set this parameter to “0”, you can manually configure NAT on the IP phone and the UPnP manager will not start.	
Format	Boolean	
Default Value	0 (false)	
Range	0 (false) 1 (true)	
Example	upnp manager: 1	

Parameter – <i>upnp gateway</i>	Configuration Files	aastra.cfg, <mac>.cfg
Description	IP address or fully qualified Domain Name of the Internet gateway or router. This parameter stores the IP address of the gateway or router in the event that only non-default UPnP gateways get discovered on the network. The UPnP port mappings are saved to this IP address so even if the phone reboots, it will still have the correct port mappings.	
Format	IP address or fully qualified Domain Name	
Default Value	0.0.0.0	
Range	Not Applicable	
Example	upnp gateway: 120.400.003.2	

Parameter – <i>upnp mapping lines</i> <i>UPnP Mapping Lines</i> (in Web UI)	Aastra Web UI Configuration Files	Basic Settings->Preferences->General aastra.cfg, <mac>.cfg
Description	Enables or disables the use of Universal Plug and Play (UPnP) on a specific line on the IP phone. Note: For this feature to work, UPnP must be enabled on the phone (upnp manager and upnp gateway must be set).	
Format	Integer	
Default Value	0 (UPnP is not mapped to a specific line)	
Range	0 to 10	
Example	upnp mapping lines: 5 This example indicates that line 5 allows UPnP mapping.	

Virtual Local Area Network (VLAN) Settings

Global Parameters

Parameter – <i>tagging enabled</i> <i>VLAN Enable</i> (in Web UI)	IP phone UI Aastra Web UI Configuration Files	Options->Administrator Menu-> Network Settings->VLAN->VLAN Enable Advanced Settings->Network->VLAN->Global aastra.cfg, <mac>.cfg
Description	Enables or disables VLAN on the IP phones. This is a global setting.	
Format	Boolean	
Default Value	0 (false)	
Range	0 (false) 1 (true)	
Example	tagging enabled: 1	

Parameter – <i>priority non-ip</i>	IP phone UI	Options->Administrator Menu->Network Settings->VLAN->Phone->Priority ->Other
<i>Priority, Non-IP Packet</i> (in Web UI)	Aastra Web UI Configuration Files	Advanced Settings->Network->VLAN->Global aastra.cfg, <mac>.cfg
Description	Specifies the priority value for non-IP packets. This is a global setting.	
Format	Integer	
Default Value	5	
Range	0 to 7	
Example	priority non-ip: 7	

LAN Port (Ethernet Port 0) Parameters

Parameter – <i>vlan id</i>	IP phone UI	Options->Administrator Menu->Network Settings->VLAN->Phone->VLAN ID
<i>VLAN ID</i> (for LAN Port in Web UI)	Aastra Web UI Configuration Files	Advanced Settings->Network->VLAN->Port 0 aastra.cfg, <mac>.cfg
Description	VLAN is a feature on the IP phone that allows for multiple logical Ethernet interfaces to send outgoing RTP packets over a single physical Ethernet as described in IEEE Std 802.3. On the IP phone, you configure a VLAN ID that associates with the physical Ethernet Port 0.	
Format	Integer	
Default Value	1	
Range	1 to 4094	
Example	VLAN id: 300	

The following table identifies the default DSCP-to-priority mapping structure.

DSCP Range	DSCP Priority
0-7	0
8-15	1
16-23	2
24-31	3
32-39	4
40-47	5
48-55	6
56-63	7

PC Port (Ethernet Port 1) Parameters

Parameter – <i>vlan id port 1</i> VLAN ID (for PC Port in Web UI)	IP phone UI Options->Administrator Menu-> Network Settings->VLAN-> Passthrough->VLAN ID Aastra Web UI Configuration Files Advanced Settings->Network->VLAN->Port 1 aastra.cfg, <mac>.cfg
Description	<p>Specifies the VLAN ID used to pass packets through to a PC via Port 1.</p> <p>Note: If you set the VLAN id port 1 (passthrough port) to 4095, all untagged packets are sent to this port. The following is an example of configuring the phone on a VLAN where all untagged packets are sent to the passthrough port.</p> <p style="text-align: center;">Example</p> <p>You enable tagging on the phone port as normal but set the passthrough port (VLAN id port 1) to 4095. The following example sets the phone to be on VLAN 3 but the passthrough port is configured as untagged.</p> <pre style="margin-left: 40px;">tagging enabled: 1 VLAN id: 3 VLAN id port 1: 4095</pre> <p>Note: PC Port parameters are not applicable to the 6730i IP Phone.</p>
Format	Integer
Default Value	1
Range	1 to 4095
Example	VLAN id port 1: 3

Parameter – <i>QoS eth port 1 priority</i>	IP phone UI	Options->Administrator Menu-> Network Settings->VLAN->Passthrough ->Priority
<i>Priority</i> (for PC Port in Web UI)	Aastra Web UI Configuration Files	Advanced Settings->Network->VLAN->Port 1 aastra.cfg, <mac>.cfg
Description	Specifies the priority value used for passing VLAN packets through to a PC via Port 1.	
Format	Integer	
Default Value	0	
Range	0 to 7	
Example	QoS eth port 1 priority: 3	

RTCP Summary Reports

Global Parameters

Parameter – <i>sip rtcp summary reports</i>	Configuration Files	aastra.cfg, <mac>.cfg
Description	Specifies whether or not to send of RTCP summary reports. Note: You must restart the phone after setting a value for this parameter.	
Format	Boolean	
Default Value	0	
Range	0 (disabled - OFF) 1 (enabled - ON)	
Example	sip rtcp summary reports: 1	

Parameter – <i>sip rtcp summary report collector</i>	Configuration Files aastra.cfg, <mac>.cfg
Description	Specifies the hostname server for which to send (collect) the RTCP summary reports. Note: You must restart the phone after setting a value for this parameter.
Format	<username>@<server> Note: Hostname/server string must not exceed 128 characters in length.
Default Value	Not Applicable
Range	Not Applicable
Example	sip rtcp summary report collector: collector@example.org

Parameter – <i>sip rtcp summary report collector port</i>	Configuration Files aastra.cfg, <mac>.cfg
Description	Specifies the port address of the hostname server receiving the RTCP summary reports. Note: You must restart the phone after setting a value for this parameter.
Format	Integer
Default Value	0
Range	0 to 65536
Example	sip rtcp summary report collector port: 5060

Line Parameters

Parameter – <i>sip lineN rtcp summary reports</i> (N is a line number from 1 to 9)	Configuration Files aastra.cfg, <mac>.cfg
Description	Enables/disables the specified line number on the phone for which to send the RTCP summary reports. Note: You must restart the phone after setting a value for this parameter.
Format	Boolean
Default Value	0 (disabled)
Range	0 (disabled) 1 (enabled)
Example	sip line1 rtcp summary reports: 1

Parameter – <i>sip lineN rtcp summary report collector</i> (N is a line number from 1 to 9)	Configuration Files aastra.cfg, <mac>.cfg
Description	Per-line parameter specifying the hostname of the server receiving the RTCP summary reports. Note: You must restart the phone after setting a value for this parameter.
Format	<username>@<server> Note: Hostname/server string must not exceed 128 characters in length.
Default Value	Not Applicable
Range	Not Applicable
Example	sip line1 rtcp summary report collector: collector@example.org

Parameter – <i>sip lineN rtcp summary report collector port</i> (N is a line number from 1 to 9)	Configuration Files aastra.cfg, <mac>.cfg
Description	Per-line parameter specifying the port address of the server receiving the RTCP summary reports. Note: You must restart the phone after setting a value for this parameter.
Format	Integer
Default Value	0
Range	0 to 65536
Example	sip line1 rtcp summary report collector port: 5060

Type of Service (ToS)/DSCP Settings

Parameter – <i>tos sip</i> <i>SIP</i> (in Web UI)	IP phone UI Aastra Web UI Configuration Files	Options->Administrator Menu-> Network Settings->Type of Service->SIP Advanced Settings->Network-> Type of Service,DSCP aastra.cfg, <mac>.cfg
Description	The Differentiated Services Code Point (DSCP) for SIP packets.	
Format	Integer	
Default Value	26	
Range	0 to 63	
Example	tos sip: 3	

Parameter – <i>tos rtp</i> <i>RTP</i> (in Web UI)	IP phone UI Aastra Web UI Configuration Files	Options->Administrator Menu-> Network Settings->Type of Service->RTP Advanced Settings->Network-> Type of Service,DSCP aastra.cfg, <mac>.cfg
Description	The Differentiated Services Code Point (DSCP) for RTP packets.	
Format	Integer	
Default Value	46	
Range	0 to 63	
Example	tos rtp: 2	

Parameter – <i>tos rtcp</i> <i>RTCP</i> (in Web UI)	IP phone UI Aastra Web UI Configuration Files	Options->Administrator Menu-> Network Settings->Type of Service->RTCP Advanced Settings->Network-> Type of Service,DSCP aastra.cfg, <mac>.cfg
Description	The Differentiated Services Code Point (DSCP) for RTCP packets.	
Format	Integer	
Default Value	46	
Range	0 to 63	
Example	tos rtcp: 3	

Time and Date Settings

Parameter – <i>time format</i> <i>Time Format</i> (in Phone UI)	IP phone UI Configuration Files	Options->Time and Date->Time Format aastra.cfg, <mac>.cfg
Description	This parameter changes the time to 12 hour or 24 hour format. Use “0” for the 12 hour format and “1” for the 24 hour format.	
Format	Integer	
Default Value	0	
Range	0 (12 hr format) 1 (24 hr format)	
Example	time format: 0	

Parameter – <i>date format</i> <i>Date Format</i> (in Phone UI)	IP phone UI Configuration Files	Options->Time and Date->Date Format aastra.cfg, <mac>.cfg
Description	This parameter allows the user to change the date to various formats.	
Format	Integer	
Default Value	0	
Range	0 (WWW MMM DD) (default) 1 (DD-MMM-YY) 2 (YYYY-MM-DD) 3 (DD/MM/YYYY) 4 (DD/MM/YY) 5 (DD-MM-YY) 6 (MM/DD/YY) 7 (MMM DD) 8 (DD MMM YYYY) 9 (WWW DD MMM) 10 (DD MMM) 11 (DD.MM.YYYY)	
Example	date format: 7	

Parameter – <i>dst config</i>	IP phone UI Configuration Files	Options->Time and Date->Daylight Savings aastra.cfg, <mac>.cfg
<i>Daylight Savings</i> (in Phone UI)		
Description	Enables/disables the use of daylight savings time.	
Format	Integer	
Default Value	3	
Range	0 - OFF 1 - 30 min summertime 2 - 1 hr summertime 3 - automatic	
Example	dst config: 0	

Parameter – <i>time zone name</i>	IP phone UI Configuration Files	Options->Time and Date->Time Zone aastra.cfg, <mac>.cfg
<i>Time Zone</i> (in Phone UI)		
Description	Assigns a time zone name to the time server.	
Format	Text	
Default Value	US-Eastern	
Range	See “Time Zone Name/Time Zone Code Table” below.	
Example	time zone name: US-Central	

Time Zone Name/Time Zone Code Table

Time Zone Name	Time Zone Code
AD-Andorra	CET
AE - Dubai	GST
AG-Antigua	AST
AI-Anguilla	AST
AL-Tirane	CET
AN-Curacao	AST
AR-Buenos Aires	ART
AS-Pago Pago	BST
AT-Vienna	CET
AU-Lord Howe	LHS
AU-Tasmania	EST
AU-Melbourne	EST
AU-Sydney	EST
AU-Broken Hill	CST
AU-Brisbane	EST
AU-Lindeman	EST
AU-Adelaide	CST
AU-Darwin	CST
AU-Perth	WST
AW-Aruba	AST
AZ - Baku	AZT
BA-Sarajevo	EET
BB-Barbados	AST
BE-Brussels	CET
BG-Sofia	EET
BM-Bermuda	AST
BO-La Paz	BOT
BR-Noronha	FNT
BR-Belem	BRT
BR-Fortaleza	BRT
BR-Recife	BRT
BR-Araguaina	BRS
BR-Maceio	BRT
BR-Sao Paulo	BRS
BR-Cuiaba	AMS
BR-Porto Velho	AMT
BR-Boa Vista	AMT
BR-Manaus	AMT
BR-Eirunepe	ACT
BR-Rio Branco	ACT
BS-Nassau	EST
BY-Minsk	EET
BZ-Belize	CST

Time Zone Name	Time Zone Code
CA-Newfoundland	NST
CA-Atlantic	AST
CA-Eastern	EST
CA-Saskatchewan	EST
CA-Central	CST
CA-Mountain	MST
CA-Pacific	PST
CA-Yukon	PST
CH-Zurich	CET
CK-Rarotonga	CKS
CL-Santiago	CLS
CL-Easter	EAS
CN-China	CST
CO-Bogota	COS
CR-Costa Rica	CST
CU-Havana	CST
CY-Nicosia	EES
CZ-Prague	CET
DE-Berlin	CET
DK-Copenhagen	CET
DM-Dominica	AST
DO-Santo Domingo	AST
EE-Tallinn	EET
ES-Madrid	CET
ES-Canary	WET
FI-Helsinki	EET
FJ-Fiji	NZT
FK-Stanley	FKS
FO-Faeroe	WET
FR-Paris	CET
GB-London	GMT
GB-Belfast	GMT
GD-Grenada	AST
GE-Tbilisi	GET
GF-Cayenne	GFT
GI-Gibraltar	CET
GP-Guadeloupe	AST
GR-Athens	EET
GS-South Georgia	GST
GT-Guatemala	CST
GU-Guam	CST
GY-Guyana	GYT

Operational, Basic, and Advanced Parameters

Time Zone Name	Time Zone Code
HK-Hong Kong	HKS
HN-Tegucigalpa	CST
HR-Zagreb	CET
HT-Port-au-Prince	EST
HU-Budapest	CET
IE-Dublin	GMT
IS-Reykjavik	GMT
IT-Rome	CET
JM-Jamaica	EST
JP-Tokyo	JST
KY-Cayman	EST
LC-St Lucia	AST
LI-Vaduz	CET
LT-Vilnius	EET
LU-Luxembourg	CET
LV-Riga	EET
MC-Monaco	CET
MD-Chisinau	EET
MK-Skopje	CET
MQ-Martinique	AST
MS-Montserrat	AST
MT-Malta	CET
MU - Mauritius	MUT
MX-Mexico City	CST
MX-Cancun	CST
MX-Merida	CST
MX-Monterrey	CST
MX-Mazatlan	MST
MX-Chihuahua	MST
MX-Hermosillo	MST
MX-Tijuana	PST
NI-Managua	CST
NL-Amsterdam	CET
NO-Oslo	CET
NR-Nauru	NRT
NU-Niue	NUT
NZ-Auckland	NZS
NZ-Chatham	CHA
OM-'Muscat	GST

Time Zone Name	Time Zone Code
PA-Panama	EST
PE-Lima	PES
PL-Warsaw	CET
PR-Puerto Rico	AST
PT-Lisbon	WET
PT-Madeira	WET
PT-Azores	AZO
PY-Asuncion	PYS
RO-Bucharest	EET
RU-Kaliningrad	EET
RU-Moscow	MSK
RU-Samara	SAM
RU-Yekaterinburg	YEK
RU-Omsk	OMS
RU-Novosibirsk	NOV
RU-Krasnoyarsk	KRA
RU-Irkutsk	IRK
RU-Yakutsk	YAK
RU-Vladivostok	VLA
RU-Sakhalin	SAK
RU-Magadan	MAG
RU-Kamchatka	PET
RU-Anadyr	ANA
SE-Stockholm	CET
SG-Singapore	SGT
SI-Ljubljana	CET
SK-Bratislava	CET
SM-San Marino	CET
SR-Paramaribo	SRT
SV-El Salvador	CST
TR-Istanbul	EET
TT-Port of Spain	AST
TW-Taipei	CST
UA-Kiev	EET
US-Eastern	EST
US-Central	CST
US-Mountain	MST
US-Pacific	PST
US-Alaska	AKS
US-Aleutian	HAS
US-Hawaii	HST
UY-Montevideo	UYS

Time Zone Name	Time Zone Code
VA-Vatican	CET
YU-Belgrade	CET

Time Server Settings

Parameter – <i>time server disabled</i> <i>NTP Time Servers</i> (in Web UI)	Aastra Web UI IP Phone UI* Configuration Files	Basic Settings->Preferences-> Time and Date Settings Options->Preferences-> Time and Date->Time Servers aastra.cfg, <mac>.cfg
Description	Enables or disables the time server. This parameter affects the time server1 , time server2 , and time server3 parameters. Setting this parameter to 0 allows the use of the configured Time Server(s). Setting this parameter to 1 prevents the use of the configured Time Server(s). Note: For DHCP to automatically populate this parameter, your DHCP server must support Option 66.	
Format	Integer	
Default Value	0 (disabled)	
Range	0 (disabled) 1 (enabled)	
Example	time server disabled: 0	

Parameter – <i>time server1</i> <i>Time Server 1</i> (in Web UI)	Aastra Web UI IP Phone UI* Configuration Files	Basic Settings->Preferences-> Time and Date Settings Options->Preferences-> Time and Date->Time Servers aastra.cfg, <mac>.cfg
Description	The primary time server's IP address or qualified domain name. If the time server is enabled, the value for time server1 will be used to request the time from. Note: For DHCP to automatically populate this parameter, your DHCP server must support Option 66.	
Format	IP address or qualified domain name	
Default Value	0.0.0.0	
Range	Not Applicable	
Example	time server1: 192.168.0.5	

Operational, Basic, and Advanced Parameters

Parameter – <i>time server2</i>	Aastra Web UI	Basic Settings->Preferences-> Time and Date Settings
<i>Time Server 2</i> (in Web UI)	IP Phone UI'	Options->Preferences-> Time and Date->Time Servers
	Configuration Files	aastra.cfg, <mac>.cfg
Description	The secondary time server's IP address or qualified domain name. If the time server is enabled, and the primary time server is not configured or cannot be accessed the value for time server2 will be used to request the time from.	
Format	IP address or qualified domain name	
Default Value	0.0.0.0	
Range	Not Applicable	
Example	time server2: 192.168.0.5	

Parameter – <i>time server3</i>	Aastra Web UI	Basic Settings->Preferences-> Time and Date Settings
<i>Time Server 3</i> (in Web UI)	IP Phone UI'	Options->Preferences-> Time and Date->Time Servers
	Configuration Files	aastra.cfg, <mac>.cfg
Description	The tertiary time server's IP address or qualified domain name. If the time server is enabled, and the primary and secondary time servers are not configured or cannot be accessed the value for time server3 will be used to request the time from.	
Format	IP address or qualified domain name	
Default Value	0.0.0.0	
Range	Not Applicable	
Example	time server3: 192.168.0.5	

Custom Time Zone and DST Settings

Parameter – <i>time zone minutes</i>	Configuration Files aastra.cfg, <mac>.cfg
Description	The number of minutes the timezone is offset from UTC (Coordinated Universal Time). This can be positive (West of the Prime Meridian) or negative (East of the Prim Meridian). Eastern Standard Time (EST) has a value of 300.
Format	Integer
Default Value	N/A
Range	Any positive or negative Integer
Example	time zone minutes: 300

Parameter – <i>dst minutes</i>	Configuration Files aastra.cfg, <mac>.cfg
Description	The number of minutes to add during Daylight Saving Time. Valid values are a positive integer between 0 to 60.
Format	Integer
Default Value	N/A
Range	0 to 60
Example	dst minutes: 60

Parameter – <i>dst [start end] relative date</i>	Configuration Files aastra.cfg, <mac>.cfg
Description	Specifies how to interpret the start and end day, month, and week parameters - absolute (0) or relative (1).
Format	Boolean
Default Value	N/A
Range	0 (absolute) 1 (relative)
Example	dst [start end] relative date: 1

Absolute Time

Parameter – <i>dst start month</i>	Configuration Files aastra.cfg, <mac>.cfg
Description	The month that DST starts. Valid values are 1 to 12 (January to December).
Format	Integer
Default Value	N/A
Range	1 (January) 2 (February) 3 (March) 4 (April) 5 (May) 6 (June) 7 (July) 8 (August) 9 (September) 10 (October) 11 (November) 12 (December)
Example	dst start month: 7

Parameter – <i>dst end month</i>	Configuration Files aastra.cfg, <mac>.cfg
Description	The month that DST ends. Valid values are 1 to 12 (January to December).
Format	Integer
Default Value	N/A
Range	1 (January) 2 (February) 3 (March) 4 (April) 5 (May) 6 (June) 7 (July) 8 (August) 9 (September) 10 (October) 11 (November) 12 (December)
Example	dst end month: 6

Parameter – <i>dst start day</i>	Configuration Files aastra.cfg, <mac>.cfg
Description	The day of the month that DST starts. Valid values are 1 to 31.
Format	Integer
Default Value	N/A
Range	1 to 31
Example	dst start day: 1

Operational, Basic, and Advanced Parameters

Parameter – <i>dst end day</i>	Configuration Files aastra.cfg, <mac>.cfg
Description	The day of the month that DST ends. Valid values are 1 to 31.
Format	Integer
Default Value	N/A
Range	1 to 31
Example	dst end day: 31

Parameter – <i>dst start hour</i>	Configuration Files aastra.cfg, <mac>.cfg
Description	The hour that DST starts. Valid values are an integer from 0 (midnight) to 23.
Format	Integer
Default Value	N/A
Range	0 (midnight) to 23
Example	dst start hour: 0

Parameter – <i>dst end hour</i>	Configuration Files aastra.cfg, <mac>.cfg
Description	The hour that DST ends. Valid values are an integer from 0 (midnight) to 23.
Format	Integer
Default Value	N/A
Range	0 (midnight) to 23
Example	dst end hour: 23

Relative Time

Parameter – <i>dst start month</i>	Configuration Files aastra.cfg, <mac>.cfg
Description	The month that DST starts. Valid values are 1 to 12 (January to December).
Format	Integer
Default Value	N/A
Range	1 (January) 2 (February) 3 (March) 4 (April) 5 (May) 6 (June) 7 (July) 8 (August) 9 (September) 10 (October) 11 (November) 12 (December)
Example	dst start month: 6

Operational, Basic, and Advanced Parameters

Parameter – <i>dst end month</i>	Configuration Files aastra.cfg, <mac>.cfg
Description	The month that DST ends. Valid values are 1 to 12 (January to December).
Format	Integer
Default Value	N/A
Range	1 (January) 2 (February) 3 (March) 4 (April) 5 (May) 6 (June) 7 (July) 8 (August) 9 (September) 10 (October) 11 (November) 12 (December)
Example	dst end month: 12

Parameter – <i>dst start week</i>	Configuration Files aastra.cfg, <mac>.cfg
Description	The week in the specified month in which DST starts. Valid value is a positive or negative integer from 1 to 5.
Format	Integer
Default Value	N/A
Range	1 = first full week of month -1 = last occurrence "dst start day" in the month 2 = second full week of month -2 =second last occurrence "dst start day" in the month 3 = third full week of month -3 =third last occurrence "dst start day" in the month 4 = fourth full week of month -4 = fourth last occurrence ""dst start day" in the month 5 = fifth full week of month -5 = fifth last occurrence "dst start day" in the month
Example	dst start week: 1

Parameter – <i>dst end week</i>	Configuration Files aastra.cfg, <mac>.cfg
Description	The week in the specified month in which DST ends. Valid value is a positive or negative integer from 1 to 5.
Format	Integer
Default Value	N/A
Range	1 = first full week of month -1 = last occurrence "dst start day" in the month 2 = second full week of month -2 =second last occurrence "dst start day" in the month 3 = third full week of month -3 =third last occurrence "dst start day" in the month 4 = fourth full week of month -4 = fourth last occurrence ""dst start day" in the month 5 = fifth full week of month -5 = fifth last occurrence "dst start day" in the month
Example	dst end week: 5

Operational, Basic, and Advanced Parameters

Parameter – <i>dst start day</i>	Configuration Files aastra.cfg, <mac>.cfg
Description	The day of the specified week in the specified month that DST starts on. Valid values are an integer from 1 to 7.
Format	Integer
Default Value	N/A
Range	1 (Sunday) 2 (Monday) 3 (Tuesday) 4 (Wednesday) 5 (Thursday) 6 (Friday) 7 (Saturday)
Example	dst start day: 1

Parameter – <i>dst end day</i>	Configuration Files aastra.cfg, <mac>.cfg
Description	The day of the specified week in the specified month that DST ends on. Valid values are an integer from 1 to 7.
Format	Integer
Default Value	N/A
Range	1 (Sunday) 2 (Monday) 3 (Tuesday) 4 (Wednesday) 5 (Thursday) 6 (Friday) 7 (Saturday)
Example	dst end day: 7

Parameter – <i>dst start hour</i>	Configuration Files aastra.cfg, <mac>.cfg
Description	The hour that DST starts. Valid values are an integer from 0 (midnight) to 23.
Format	Integer
Default Value	N/A
Range	0 (midnight) to 23
Example	dst start hour: 0

Parameter – <i>dst end hour</i>	Configuration Files aastra.cfg, <mac>.cfg
Description	The hour that DST ends. Valid values are an integer from 0 (midnight) to 23.
Format	Integer
Default Value	N/A
Range	0 (midnight) to 23
Example	dst end hour: 23

Backlight Mode Settings (6755i, 6757i, 6757i CT)

Parameter – <i>backlight mode</i> <i>Backlight</i> (in Phone UI)	IP phone UI Options->Preferences->Display->Backlight Configuration Files aastra.cfg, <mac>.cfg
Description	Allows you to turn the backlight on the LCD, Off (always off) or Auto. The “Auto” setting sets the phone to turn off the backlight after a period of inactivity. You can set the amount of time before the backlight goes off using the “ Backlight On Time ” parameter.
Format	Integer
Default Value	1 (Auto)
Range	0 (Off - Turns the backlight off constant) 1 (Auto - Turns the backlight off after a period of inactivity.) Note: In the IP Phone UI, the options for this parameter are “Off” and “Auto” only.
Example	backlight mode: 0

Parameter – <i>bl on time</i> <i>Backlight On Time</i> (in Phone UI)	IP phone UI Options->Preferences->Display->Backlight Configuration Files aastra.cfg, <mac>.cfg
Description	Allows you to set the amount of time, in seconds, that the backlight stays ON before turning OFF because of inactivity. This settings is applicable to the “ Auto ” mode only.
Format	Integer
Default Value	600 seconds (equals 10 minutes)
Range	1 to 7200 seconds
Example	bl on time: 15

Live Dialpad Settings

Parameter – <i>live dialpad</i> <i>Live Dialpad</i> (in Phone UI)	IP phone UI Options->Preferences->Live Dialpad Configuration Files aastra.cfg, <mac>.cfg
Description	Turns the “Live Dialpad” feature ON or OFF. With live dial pad ON, the IP phone automatically dials out and turns ON Handsfree mode as soon as a dial pad key or softkey is pressed. With live dial pad OFF, if you dial a number while the phone is on-hook, lifting the receiver or pressing the  initiates a call to that number.
Format	Boolean
Default Value	0 (Off)
Range	0 (Off) 1 (On)
Example	live dialpad: 1

SIP Local Dial Plan Settings

Parameter – <i>sip dial plan</i> <i>Local Dial Plan</i> (in Web UI)	Aastra Web UI Configuration Files Basic Settings->Preferences aastra.cfg, <mac>.cfg
Description	<p>Reference: A dial plan describes the number and pattern of digits that a user dials to reach a particular telephone number. The SIP local dial plan is as follows:</p> <p>Reference: SymbolDescription</p> <p>Reference: 0, 1, 2, 3, 4, 5, 6, 7, 8, 9Digit symbol</p> <p>Reference: XMatch any digit symbol (wildcard)</p> <p>Reference: *, #, .Other keypad symbol; # can terminate a dial string</p> <p>Reference: Expression inclusive OR</p> <p>Reference: +0 or more of the preceding digit symbol or [] expression</p> <p>Reference: []Symbol inclusive OR</p> <p>Reference: -Used only with [], represent a range of acceptable symbols; For example, [2-8]</p> <p>Reference: “,” (open/close quotes)In the configuration files, enter the sip dial plan value using quotes.</p> <p>Reference: .;.Used when a secondary dial tone is required on the phone. (For example, “9;xxxxx”, when a user has to dial “9” to get and outside line and needs a secondary dial tone presented.</p> <p>Reference:</p> <p>Reference: You can configure prefix dialing by adding a prepend digit to the dial string. For example, if you add a prepend map of “[2-9]XXXXXXXX,91”, the IP phone adds the digits “91” to any 10-digit number beginning with any digit from 2 to 9 that is dialed out. Other examples of prepend mappings are:</p> <p>Reference:</p> <p>Reference: 1X+#,9 (Prepends 9 to any digit string beginning with “1” and terminating with “#”.)</p> <p>Reference: 6XXX,579 (Prepends “579” to any 4-digit string starting with “6”.)</p> <p>Reference: [4-6]XXXXXX,78 (Prepends “78” to any 7-digit string starting with “4”, “5”, or “6”.)</p>
Format	Reference: Alphanumeric characters
Default Value	Reference: X+# XX+*

Range	<p>Reference: Up to 512 alphanumeric characters.</p> <p>Reference:</p> <p>Reference: If a User enters a dial plan longer than 512 characters, or a parsing error occurs, the phone uses the default dial plan of "x+# xx+*". If this is the case, the Administrator cannot change the dial plan from the configuration files. The dial plan must be changed from the Aastra Web UI.</p>
Example	<p>sip dial plan: "X+# XXX+*"</p>

<p>Parameter – <i>sip dial plan terminator</i></p> <p><i>Send Dial Plan Terminator</i> (in Web UI)</p>	<p>Aastra Web UI Basic Settings->Preferences</p> <p>Configuration Files aastra.cfg, <mac>.cfg</p>
Description	<p>Allows you to enable or disable a dial plan terminator. If you enable the use of this parameter, when you configure the IP phone's dial plan with a dial plan terminator or timeout (such as the pound symbol (#)), the phone waits 4 or 5 seconds after you pick up the handset or after to finish dialing the number on the keypad before making the call.</p>
Format	<p>Boolean</p>
Default Value	<p>0</p>
Range	<p>0 (Disable) 1 (Enable)</p>
Example	<p>sip dial plan terminator: 1</p>

Parameter – <i>sip digit timeout</i> <i>Digit Timeout</i> (in Web UI)	Aastra Web UI Basic Settings->Preferences Configuration Files aastra.cfg, <mac>.cfg
Description	Represents the time, in seconds, between consecutive key presses on the IP phone. The default for this parameter is 4 seconds. If you press a key on the phone and wait 4 seconds before pressing the next key, the key times out and cancels the digit selection. You must press consecutive keys before the timeout occurs.
Format	Integer
Default Value	4
Range	Not Applicable
Example	sip digit timeout: 6

SIP Outbound Support

Parameter – <i>sip outbound support</i>	Configuration Files aastra.cfg, <mac>.cfg
Description	<p>Enables and disables whether or not the phone uses Draft 15 (draft-ietf-sip-outbound-15) support for SIP outbound packets.</p> <p>A SIP User Agent (UA) behind a firewall, reuses an existing connection (usually the REGISTER outbound connection) for the inbound request if the proxy supports it. The UA uses keep-alive packets to monitor the connection status.</p> <p>Notes:</p> <ol style="list-style-type: none"> 1. You must restart the phone after setting a value for this parameter. 2. TLS and TCP both support this feature. 3. If the Global SIP parameter “Persistent TLS” is set on the phone, then only one TLS persistent connection can be established since the phone uses the local port 5061 for connection. If the Global SIP parameter “TLS” is set on the phone, more than one connection can be setup since the phone uses a random local port for connection.
Format	Boolean
Default Value	0
Range	0 (disabled) 1 (enabled)
Example	sip outbound support: 1

Dynamic SIP for Registration and Subscription

Parameter – <i>dynamic sip</i>	Configuration Files aastra.cfg, <mac>.cfg
Description	<p>Enables or disables the dynamic SIP functionality on the phone.</p> <p>If enabled, this parameter allows an Administrator to change the account information on a phone (i.e., registrar, username, registrar port, password, proxy, outbound proxy, proxy port, backup proxy, authentication name, backup registrar) and have it dynamically update to the phone when the phone is inactive (phone not being used) without having to reboot the phone. During the re-registration process, the phone unsubscribes and dynamically re-subscribes as required.</p> <p>If disabled, the phone updates its account information and the phone reboots upon the user saving an LCD page or leaving a menu.</p> <p>Notes:</p> <ol style="list-style-type: none"> 1. This parameter does not make previous changes dynamic. Changes apply dynamically only AFTER setting this parameter to enable. 2. ONLY BLF and MWI events support dynamic subscription on the phones. 3. This feature does not effect the DND and CFWD state of a line. 4. This feature does not support the addition and deletion of accounts.
Format	Boolean
Default Value	0
Range	0 (disabled) 1 (enabled)
Example	dynamic sip: 1

SIP Basic, Global Settings

SIP Global Authentication Settings

Parameter – <i>sip screen name</i> <i>Screen Name</i> (in Web UI)	IP Phone UI Aastra Web UI Configuration Files	Options->Administrator Menu->SIP Settings Advanced Settings->Global SIP-> Basic SIP Settings aastra.cfg, <mac>.cfg
Description	Used to display text on the screen of the phone. You may want to set this parameter to display the user's name of the phone.	
Format	Text	
Default Value	Not Applicable	
Range	Up to 20 alphanumeric characters	
Example	sip screen name: Joe Smith	

Parameter – <i>sip screen name 2</i> <i>Screen Name 2</i> (in Web UI)	IP Phone UI Aastra Web UI Configuration Files	Options->Administrator Menu->SIP Settings Advanced Settings->Global SIP-> Basic SIP Settings aastra.cfg, <mac>.cfg
Description	Used to display text on a second line on the screen of the phone. Notes: <ol style="list-style-type: none"> 1. If other status messages display on the phone, such as "Network Disconnected", the Screen Name 2 value does not display. 2. Symbol characters are allowed (such as "#"). 3. If the text is longer than the display width, than the display truncates the text to fit the display. 	
Format	Alphanumeric characters.	
Default Value	Not Applicable	
Range	Up to 20 alphanumeric characters.	
Example	sip screen name 2: Lab Phone	

Operational, Basic, and Advanced Parameters

Parameter – <i>sip user name</i> <i>Phone Number</i> (in Web UI)	IP Phone UI Aastra Web UI Configuration Files	Options->Administrator Menu->SIP Settings Advanced Settings->Global SIP-> Basic SIP Settings aastra.cfg, <mac>.cfg
Description	Used in the name field of the <i>SIP URI</i> for the IP phone and for registering the IP phone at the registrar. Note: The IP Phones support Usernames containing dots (“.”).	
Format	Text	
Default Value	Not Applicable	
Range	Up to 20 alphanumeric characters	
Example	sip user name: 1010	

Parameter – <i>sip display name</i> <i>Caller ID</i> (in Web UI)	IP Phone UI Aastra Web UI Configuration Files	Options->Administrator Menu->SIP Settings Advanced Settings->Global SIP-> Basic SIP Settings aastra.cfg, <mac>.cfg
Description	Used in the display name field of the <i>From</i> SIP header field. Some IP PBX systems use this as the caller’s ID and some may overwrite this with the string that is set at the PBX system.	
Format	Text	
Default Value	Not Applicable	
Range	Up to 20 alphanumeric characters	
Example	sip display name: Joe Smith	

Parameter – <i>sip auth name</i> <i>Authentication Name</i> (in Web UI)	IP Phone UI Aastra Web UI Configuration Files	Options->Administrator Menu->>SIP Settings Advanced Settings->Global SIP-> Basic SIP Settings aastra.cfg, <mac>.cfg
Description	Used in the username field of the Authorization header field of the <i>SIP REGISTER</i> request.	
Format	Text	
Default Value	Not Applicable	
Range	Up to 20 alphanumeric characters	
Example	sip auth name: 5553456	

Parameter – <i>sip password</i> <i>Password</i> (in Web UI)	IP Phone UI Aastra Web UI Configuration Files	Options->Administrator Menu->SIP Settings Advanced Settings->Global SIP-> Basic SIP Settings aastra.cfg, <mac>.cfg
Description	The password that will be used to register at the registrar.	
Format	Text	
Default Value	Not Applicable	
Range	Up to 20 alphanumeric characters	
Example	sip password: 12345	

Operational, Basic, and Advanced Parameters

Parameter – <i>sip bla number</i>	Aastra Web UI	Advanced Settings->Global SIP-> Basic SIP Settings
<i>BLA Number</i> (in Web UI)	Configuration Files	aastra.cfg, <mac>.cfg
Description	Allows you to assign a phone number that is shared across all IP phones.	
Format	Integer	
Default Value	Not Applicable	
Range	Not Applicable	
Example	sip bla number: 1010	

Parameter – <i>sip mode</i>	Aastra Web UI	Advanced Settings->Global SIP-> Basic SIP Settings
<i>Line mode</i> (in Web UI)	Configuration Files	aastra.cfg, <mac>.cfg
Description	Allows you to configure the mode of the line. Applicable values are: <ul style="list-style-type: none"> • Generic - Normal line • BroadSoft SCA - Shared Call/Line Appearances (SCA) line for BroadWorks network (call activity can go to more than one phone) • Nortel - Conference line for Nortel Networks (private - all call activity goes to one phone) • BLA - Bridged Line Appearance (BLA) line. 	
Format	Integer	
Default Value	0	
Range	Valid values are: 0 - Generic 1 - BroadSoft SCA 2 - Nortel 3 - BLA	
Example	sip mode: 2	

SIP Global Network Settings.

Parameter – <i>sip proxy ip</i>	IP Phone UI Aastra Web UI	Options->Administrator Menu->SIP Settings Advanced Settings->Global SIP-> Basic SIP Settings
<i>Proxy Server</i> (in Web UI)	Configuration Files	aastra.cfg, <mac>.cfg
Description	The IP address of the SIP proxy server for which the IP phone uses to send all SIP requests. A SIP proxy is a server that initiates and forwards requests generated by the IP phone to the targeted user.	
Format	IP address or fully qualified Domain Name	
Default Value	0.0.0.0	
Range	Not applicable	
Example	sip proxy ip: 192.168.0.101	

Parameter – <i>sip proxy port</i>	IP Phone UI Aastra Web UI	Options->Administrator Menu->SIP Settings Advanced Settings->Global SIP-> Basic SIP Settings
<i>Proxy Port</i> (in Web UI)	Configuration Files	aastra.cfg, <mac>.cfg
Description	The proxy server's port number.	
Format	Integer	
Default Value	0	
Range	Not Applicable	
Example	sip proxy port: 5060	

Operational, Basic, and Advanced Parameters

Parameter – <i>sip backup proxy ip</i> <i>Backup Proxy Server</i> (in Web UI)	Aastra Web UI Configuration Files	Advanced Settings->Global SIP-> Basic SIP Network Settings aastra.cfg, <mac>.cfg
Description	The IP address of the backup SIP proxy server for which the IP phone uses when the primary SIP proxy is unavailable.	
Format	IP address or fully qualified Domain Name	
Default Value	0.0.0.0	
Range	Not Applicable	
Example	sip backup proxy ip: 192.168.0.102	

Parameter – <i>sip backup proxy port</i> <i>Backup Proxy Port</i> (in Web UI)	Aastra Web UI Configuration Files	Advanced Settings->Global SIP-> Basic SIP Network Settings aastra.cfg, <mac>.cfg
Description	The backup proxy's port number.	
Format	Integer	
Default Value	0	
Range	Not Applicable	
Example	sip backup proxy port: 5060	

Parameter – <i>sip outbound proxy</i> <i>outbound proxy server</i> (in Web UI)	Aastra Web UI Configuration Files	Advanced Settings->Global SIP-> Advanced SIP Settings aastra.cfg, <mac>.cfg
Description	This is the address of the outbound proxy server. All SIP messages originating from the phone are sent to this server. For example, if you have a Session Border Controller in your network, then you would normally set its address here.	
Format	IP Address or fully qualified Domain Name	
Default Value	0.0.0.0	
Range	Not Applicable	
Example	sip outbound proxy: 10.42.23.13	

Parameter – <i>sip outbound proxy port</i> <i>outbound proxy port</i> (in Web UI)	Aastra Web UI Advanced Settings->Global SIP-> Advanced SIP Settings Configuration Files aastra.cfg, <mac>.cfg
Description	The proxy port on the proxy server to which the IP phone sends all SIP messages.
Format	Integer
Default Value	0
Range	Not Applicable
Example	sip outbound proxy port: 5060

Parameter – <i>sip registrar ip</i> <i>Registrar Server</i> (in Web UI)	IP Phone UI Options->Administrator Menu->SIP Settings Aastra Web UI Advanced Settings->Global SIP-> Basic SIP Settings Configuration Files aastra.cfg, <mac>.cfg
Description	The address of the registrar for which the IP phone uses to send <i>REGISTER</i> requests. A SIP registrar is a server that maintains the location information of the IP phone. A global value of 0.0.0.0 disables registration. However, the phone is still active and you can dial using username@ip address of the phone. If the Registrar IP address is set to 0.0.0.0 for a per-line basis (i.e, line 1, line 2, etc.), then the register request is not sent, the "No Service" message does not display, and the message waiting indicator (MWI) does not come on.
Format	IP address or fully qualified Domain Name
Default Value	0.0.0.0
Range	Not Applicable
Example	sip registrar ip: 192.168.0.101

Operational, Basic, and Advanced Parameters

Parameter – <i>sip registrar port</i> <i>Registrar Port</i> (in Web UI)	IP Phone UI Aastra Web UI Configuration Files	Options->Administrator Menu->SIP Settings Advanced Settings->Global SIP-> Basic SIP Settings aastra.cfg, <mac>.cfg
Description	The registrar's port number.	
Format	Integer	
Default Value	0	
Range	Not Applicable	
Example	sip registrar port: 5060	

Parameter – <i>sip backup registrar ip</i> <i>Backup Registrar Server</i> (in Web UI)	Aastra Web UI Configuration Files	Advanced Settings->Global SIP-> Basic SIP Network Settings aastra.cfg, <mac>.cfg
Description	<p>The address of the backup registrar (typically, the backup SIP proxy) for which the IP phone uses to send <i>REGISTER</i> requests if the primary registrar is unavailable.</p> <p>A global value of 0.0.0.0 disables backup registration. However, the phone is still active and you can dial using username@ip address of the phone.</p> <p>If the backup registrar IP address is set to 0.0.0.0 for a per-line basis (i.e., line 1, line 2, etc.), then the backup register request is not sent, the "No Service" message does not display, and the message waiting indicator (MWI) does not come on.</p>	
Format	IP address or fully qualified Domain Name	
Default Value	0.0.0.0	
Range	Not Applicable	
Example	sip backup registrar ip: 192.168.0.102	

Parameter – <i>sip backup registrar port</i> <i>Backup Registrar Port</i> (in Web UI)	Aastra Web UI Advanced Settings->Global SIP-> Basic SIP Network Settings Configuration Files aastra.cfg, <mac>.cfg
Description	The backup registrar's (typically the backup SIP proxy) port number.
Format	Integer
Default Value	0
Range	Not Applicable
Example	sip backup registrar port: 5060

Parameter – <i>sip registration period</i> <i>Registration Period</i> (in Web UI)	Aastra Web UI Advanced Settings->Global SIP-> Basic SIP Network Settings Configuration Files aastra.cfg, <mac>.cfg
Description	The requested registration period, in seconds, from the registrar.
Format	Integer
Default Value	0
Range	0 to 2147483647
Example	sip registration period: 3600

SIP Basic, Per-Line Settings

The following parameters are SIP per-line settings. The value of "N" is 1 - 9 or 1-6 depending on your model phone. Line settings are not applicable to the 6751i.

SIP Per-Line Authentication Settings

Parameter – <i>sip lineN screen name</i> Screen Name (in Web UI)	Aastra Web UI Advanced Settings->Line 1 thru 9 Configuration Files aastra.cfg, <mac>.cfg
Description	Used to display text on the screen of the phone. You may want to set this parameter to display the phone user's name.
Format	Text
Default Value	Not Applicable
Range	Up to 20 alphanumeric characters
Example	sip line1 screen name: Joe Smith

Parameter – <i>sip lineN screen name 2</i> Screen Name 2 (in Web UI)	Aastra Web UI Advanced Settings->Line 1 thru 9 Configuration Files aastra.cfg, <mac>.cfg
Description	Used to display text on a second line on the screen of the phone. Notes: 1. If other status messages display on the phone, such as "Network Disconnected", the Screen Name 2 value does not display. 2. Characters are allowed (such as "#"). 3. If the text is longer than the display width, than the display truncates the text to fit the display.
Format	Alphanumeric characters
Default Value	Not Applicable
Range	Up to 20 alphanumeric characters
Example	sip line1 screen name 2: Lab Phone

Parameter – <i>sip lineN user name</i> <i>Phone Number</i> (in Web UI)	Aastra Web UI Advanced Settings->Line 1 thru 9 Configuration Files aastra.cfg, <mac>.cfg
Description	Used in the name field of the <i>SIP URI</i> for the IP phone and for registering the IP phone at the registrar. When configuring per-line BLA on an ININ server, the username must be incremented as shown in the example for the "sip lineN bla number" parameter on page A-89 . Note: The IP Phones support Usernames containing dots (".").
Format	Text
Default Value	Not Applicable
Range	Up to 20 alphanumeric characters
Example	sip line1 user name: 1010

Parameter – <i>sip lineN display name</i> <i>Caller ID</i> (in Web UI)	Aastra Web UI Advanced Settings->Line 1 thru 9 Configuration Files aastra.cfg, <mac>.cfg
Description	Used in the display name field of the <i>From</i> SIP header field. Some IP PBX systems use this as the caller's ID and some may overwrite this with the string that is set at the PBX system.
Format	Text
Default Value	Not Applicable
Range	Up to 20 alphanumeric characters
Example	sip line1 display name: Joe Smith

Operational, Basic, and Advanced Parameters

Parameter – <i>sip lineN auth name</i> <i>Authentication Name</i> (in Web UI)	Aastra Web UI Configuration Files Advanced Settings->Line 1 thru 9 aastra.cfg, <mac>.cfg
Description	Used in the username field of the Authorization header field of the <i>SIP REGISTER</i> request.
Format	Text
Default Value	Not Applicable
Range	Up to 20 alphanumeric characters
Example	sip line1 auth name: 5553456

Parameter – <i>sip lineN password</i> <i>Password</i> (in Web UI)	Aastra Web UI Configuration Files Advanced Settings->Line 1 thru 9 aastra.cfg, <mac>.cfg
Description	The password that will be used to register at the registrar.
Format	Text
Default Value	Not Applicable
Range	Up to 20 alphanumeric characters
Example	sip line1 password: 12345

<p>Parameter – <i>sip lineN bla number</i></p> <p><i>BLA Number</i> (in Web UI)</p>	<p>Aastra Web UI Advanced Settings->Line 1 thru 9 Configuration Files aastra.cfg, <mac>.cfg</p>
<p>Description</p>	<p>Allows you to assign a phone number that is shared on specific lines on the IP phone.</p> <p>For Sylanro Server: When configuring the BLA feature on a Sylanro server, the value set for the sip lineN bla number parameter shall be the same value set for the sip lineN user name parameter for all the phones in the group. For example, if sip lineN user name is 1010, you would configure BLA on a per-line basis for the Sylanro server as follows: sip line1 user name: 1010(# for all the phones) sip line1 bla number: 1010</p> <p>For ININ Server: When configuring the BLA feature on an ININ server, the value set for the sip lineN bla number parameter shall be the same value set for the sip lineN user name parameter without the incremented digit added to the phone #. For example, if the sip lineN user name for the first phone is 10101, and the sip lineN user name for the second phone is 10102, etc. you would configure BLA on a per-line basis for the ININ server as follows: sip line1 user name: 10101(# for phone 1 with) sip line1 bla number: 1010appearance of phone 3)</p> <p>sip line1 user name: 10102(# for phone 2 with) sip line1 bla number: 1010appearance of phone 3)</p> <p>sip line1 user name: 1010(# for phone 3) sip line1 bla number: 1010</p> <p>Note: The original phone number which has the bridged line appearance on other phones, will have the "sip lineN user name" parameter the same as the "sip lineN bla number" (1010 in the above example on Phone 3).</p>
<p>Format</p>	<p>Integer</p>
<p>Default Value</p>	<p>Not Applicable</p>
<p>Range</p>	<p>Not Applicable</p>
<p>Example</p>	<p>Sylanro Server: sip line1 bla number: 1010</p> <p>ININ Server: sip line 1 bla number: 1010</p>

Parameter – <i>sip lineN mode</i> <i>Line Mode</i> (in Web UI)	Aastra Web UI Advanced Settings->Line 1 thru 9 Configuration Files aastra.cfg, <mac>.cfg
Description	Allows you to configure the mode of the line. Applicable values are: <ul style="list-style-type: none"> • Generic - Normal line • BroadSoft SCA - Shared Call/Line Appearances (SCA) line for BroadWorks network (call activity can go to more than one phone) • Nortel - Conference line for Nortel Networks (private - all call activity goes to one phone) • BLA - Bridged Line Appearance (BLA) line. • If the softkeys on the 6757i/6757i CT or the programmable keys on the 6753i are set as line keys, and you configure that line key for BLA, the key is configured to use BLA.
Format	Integer
Default Value	0
Range	Valid values are: 0 - Generic 1 - BroadSoft SCA 2 - Nortel 3 - BLA
Example	sip line1 mode: 2

SIP Per-Line Network Settings.

Parameter – <i>sip lineN proxy ip</i>	Aastra Web UI Configuration Files	Advanced Settings->Line 1 thru 9 aastra.cfg, <mac>.cfg
<i>Proxy Server</i> (in Web UI)		
Description	The IP address of the SIP proxy server for which the IP phone uses to send all SIP requests. A SIP proxy is a server that initiates and forwards requests generated by the IP phone to the targeted user.	
Format	IP address or fully qualified Domain Name	
Default Value	0.0.0.0	
Range	Not applicable	
Example	sip line1 proxy ip: 192.168.0.101	
Parameter – <i>sip lineN proxy port</i>	Aastra Web UI Configuration Files	Advanced Settings->Line 1 thru 9 aastra.cfg, <mac>.cfg
<i>Proxy Port</i> (in Web UI)		
Description	The proxy server's port number	
Format	Integer	
Default Value	0	
Range	Not Applicable	
Example	sip line1 proxy port: 5060	

Operational, Basic, and Advanced Parameters

Parameter – <i>sip lineN backup proxy ip</i>	Aastra Web UI	Advanced Settings->Line 1 thru 9
<i>Backup Proxy Server</i> (in Web UI)	Configuration Files	aastra.cfg, <mac>.cfg
Description	The IP address of the backup SIP proxy server for which the IP phone uses when the primary SIP proxy is unavailable.	
Format	IP address or fully qualified Domain Name	
Default Value	0.0.0.0	
Range	Not Applicable	
Example	sip line1 backup proxy ip: 192.168.0.102	

Parameter – <i>sip lineN backup proxy port</i>	Aastra Web UI	Advanced Settings->Line 1 thru 9
<i>Backup Proxy Port</i> (in Web UI)	Configuration Files	aastra.cfg, <mac>.cfg
Description	The backup proxy's port number.	
Format	Integer	
Default Value	0	
Range	Not Applicable	
Example	sip line1 backup proxy port: 5060	

<p>Parameter – <i>sip lineN outbound proxy</i></p> <p><i>Outbound Proxy Server</i> (in Web UI)</p>	<p>Aastra Web UI Configuration Files Advanced Settings->Line 1 thru 9 aastra.cfg, <mac>.cfg</p>
<p>Description</p>	<p>This is the address of the outbound proxy server. All SIP messages originating from the phone are sent to this server. For example, if you have a Session Border Controller in your network, then you would normally set its address here.</p>
<p>Format</p>	<p>IP Address or fully qualified Domain Name</p>
<p>Default Value</p>	<p>0.0.0.0</p>
<p>Range</p>	<p>Not Applicable</p>
<p>Example</p>	<p>sip outbound proxy: 10.42.23.13</p>
<p>Parameter – <i>sip lineN outbound proxy port</i></p> <p><i>Outbound Proxy Port</i> (in Web UI)</p>	<p>Aastra Web UI Configuration Files Advanced Settings->Line 1 thru 9 aastra.cfg, <mac>.cfg</p>
<p>Description</p>	<p>The proxy port on the proxy server to which the IP phone sends all SIP messages.</p>
<p>Format</p>	<p>Integer</p>
<p>Default Value</p>	<p>0</p>
<p>Range</p>	<p>Not Applicable</p>
<p>Example</p>	<p>sip outbound proxy port: 5060</p>

Parameter – <i>sip lineN registrar ip</i> <i>Registrar Server</i> (in Web UI)	Aastra Web UI Configuration Files Advanced Settings->Line 1 thru 9 aastra.cfg, <mac>.cfg
Description	The address of the registrar for which the IP phone uses to send <i>REGISTER</i> requests. A SIP registrar is a server that maintains the location information of the IP phone. A global value of 0.0.0.0 disables registration. However, the phone is still active and you can dial using username@ip address of the phone. If the Registrar IP address is set to 0.0.0.0 for a per-line basis (i.e, line 1, line 2, etc.), then the register request is not sent, the "No Service" message does not display, and the message waiting indicator (MWI) does not come on.
Format	IP address or fully qualified Domain Name
Default Value	0.0.0.0
Range	Not Applicable
Example	sip line1 registrar ip: 192.168.0.101

Parameter – <i>sip lineN registrar port</i> <i>Registrar Port</i> (in Web UI)	Aastra Web UI Configuration Files	Advanced Settings->Line 1 thru 9 aastra.cfg, <mac>.cfg
Description	The registrar's port number	
Format	Integer	
Default Value	0	
Range	Not Applicable	
Example	sip line1 registrar port: 5060	

Parameter – <i>sip lineN backup registrar ip</i> <i>Backup Registrar Server</i> (in Web UI)	Aastra Web UI Configuration Files	Advanced Settings->LineN-> Basic SIP Network Settings aastra.cfg, <mac>.cfg
Description	The address of the backup registrar (typically, the backup SIP proxy) for which the IP phone uses to send <i>REGISTER</i> requests if the primary registrar is unavailable. A global value of 0.0.0.0 disables backup registration. However, the phone is still active and you can dial using username@ip address of the phone. If the backup registrar IP address is set to 0.0.0.0 for a per-line basis (i.e., line 1, line 2, etc.), then the backup register request is not sent, the "No Service" message does not display, and the message waiting indicator (MWI) does not come on.	
Format	IP address or fully qualified Domain Name	
Default Value	0.0.0.0	
Range	Not Applicable	
Example	sip line1 backup registrar ip: 192.168.0.102	

Operational, Basic, and Advanced Parameters

Parameter – <i>sip lineN backup registrar port</i> <i>Backup Registrar Port</i> (in Web UI)	Aastra Web UI Configuration Files	Advanced Settings->LineN-> Basic SIP Network Settings aastra.cfg, <mac>.cfg
Description	The backup registrar's (typically the backup SIP proxy) port number.	
Format	Integer	
Default Value	0	
Range	Not Applicable	
Example	sip line1 backup registrar port: 5060	

Parameter – <i>sip lineN registration period</i> <i>Registration Period</i> (in Web UI)	Aastra Web UI Configuration Files	Advanced Settings->Line 1 thru 9 aastra.cfg, <mac>.cfg
Description	The requested registration period, in seconds, from the registrar.	
Format	Integer	
Default Value	0	
Range	0 to 2147483647	
Example	sip line1 registration period: 3600	

BLA Support for MWI

Parameter – <i>sip mwi for bla account</i> <i>MWI for BLA Account</i> (in Web UI)	Configuration Files aastra.cfg, <mac>.cfg Aastra Web UI Advanced Settings->Global SIP-> Advanced SIP Settings
Description	Enables or disables a BLA configured line to send an MWI SUBSCRIBE message for the BLA account. Notes: <ol style="list-style-type: none"> 1. If you change the setting on this parameter, you must reboot the phone for it to take affect. 2. Both the “sip explicit mwi subscription” and “sip mwi for bla account” parameters must be enabled in order for the MWI subscription for BLA to occur. 3. The MWI re-subscription for the BLA account uses the value set for the “sip explicit mwi subscription period” parameter to re-subscribe. 4. Whether or not the “sip mwi for bla account” parameter is enabled, the priority for displaying MWI does not change.
Format	Boolean
Default Value	0 (disabled)
Range	0 (disabled) 1 (enabled)
Example	sip mwi for bla account: 1

Shared Call Appearance (SCA) Call Bridging

Global Setting

Parameter – <i>sip sca bridging</i>	Configuration Files aastra.cfg, <mac>.cfg
Description	Enables/disables SCA bridging on the phone-side on a global basis. Note: You must restart the phone after setting a value for this parameter.
Format	Boolean
Default Value	0
Range	0 (disabled) 1 (enabled)
Example	sip sca bridging: 1

Per-Line Setting

Parameter – <i>sip lineN sca bridging</i> (N is a line number from 1 to 9)	Configuration Files aastra.cfg, <mac>.cfg
Description	Enables/disables SCA bridging on the phone-side on a per-account basis using a specific SCA-configured line. Note: You must restart the phone after setting a value for this parameter.
Format	Boolean
Default Value	0
Range	0 (disabled) 1 (enabled)
Example	sip line1 sca bridging: 1

Centralized Conferencing Settings

Global Setting

Parameter – <i>sip centralized conf</i> <i>Conference Server URI</i> (in Web UI)	Aastra Web UI Advanced->Global SIP Settings-> Basic SIP Network Settings Configuration Files aastra.cfg, <mac>.cfg
Description	<p>Globally enables or disables SIP centralized conferencing for an IP phone as follows:</p> <ul style="list-style-type: none"> • To disable centralized conferencing, leave this field empty (blank). • To enable SIP centralized conferencing, then do one of the following actions: <ul style="list-style-type: none"> — If you have specified a proxy server/registrar server, then to reach the media server via the proxy server, set this field to one of the following: <p style="margin-left: 40px;">conf (Sylantro server), or</p> <p style="margin-left: 40px;">Conference (Broadsoft server)</p> <p>By setting this field to conf, you specify <code>conf@<proxy_server_address>: <proxy_port></code>. For example, if the proxy server address is 206.229.26.60 and the proxy port used is 10060, then by setting this parameter to conf, you are specifying the following: <code>conf@206.229.26.60:10060</code></p> <ul style="list-style-type: none"> — To reach the media server using a different address/port than that specified by the proxy, set this field to the following: <p style="margin-left: 40px;">conf@<media_server_address>: <media_port></p>
Format	String
Default Value	Blank
Example	<code>sip centralized conf: conf</code>

Per-Line Setting

Parameter – <i>sip lineN centralized conf</i> <i>Conference Server URI</i> (in Web UI)	Aastra Web UI Advanced->Line <1 thru 9>-> Basic SIP Network Settings Configuration Files aastra.cfg, <mac>.cfg
Description	<p>Enable or disable per-line SIP centralized conferencing for an IP phone as follows:</p> <ul style="list-style-type: none"> • To disable centralized conferencing, leave this field empty (blank). • To enable SIP centralized conferencing on a specific line, do one of the following actions: <ul style="list-style-type: none"> — If you have specified a proxy server/registrars server, then to reach the media server via the proxy server, set this field to one of the following: <p style="margin-left: 40px;">conf (Sylantro server), or</p> <p style="margin-left: 40px;">Conference (Broadsoft server)</p> <p>By setting this field to conf, you specify <code>conf@<proxy_server_address>: <proxy_port></code>. For example, if the proxy server address is 206.229.26.60 and the proxy port used is 10060, then by setting this parameter to conf, you are specifying the following: <code>conf@206.229.26.60:10060</code>.</p> <ul style="list-style-type: none"> — To reach the media server using a different address/port than that specified by the proxy, set this field to the following: <p style="margin-left: 40px;">conf@<media_server_address>: <media_port></p>
Format	String
Default Value	Blank
Examples	sip line3 centralized conf: conf

SIP Join Feature for 3-Way Conference

Parameter – <i>sip join support</i>	Configuration Files aastra.cfg, <mac>.cfg
Description	Enables or disables the phone to allow a conference to be set up with a join header as described in RFC 3911.
Format	Boolean
Default Value	0 (disabled)
Range	0 (disabled) 1 (enabled)
Example	sip join support: 1

HTTP/HTTPS Authentication Support for Broadsoft CMS

Parameter – <i>http digest username</i>	Configuration Files aastra.cfg, <mac>.cfg
Description	Specifies the username to use for HTTP/HTTPS digest authentication. The server uses this username for authentication purposes when loading configuration to the phone over HTTP/HTTPS. This parameter initiates a “Username/Password” screen after pressing the Log In softkey. Notes: <ol style="list-style-type: none"> 1. The Username field accepts special characters, such as, @, #, %, =, _, etc. You can also specify domain names (i.e., user@domain). 2. You must reboot the phone after setting the HTTP/HTTPS digest authentication parameters.
Format	String
Default Value	N/A
Range	Up to 40 alphanumeric characters
Example	http digest username: mysuername

Parameter – <i>http digest password</i>	Configuration Files aastra.cfg, <mac>.cfg
Description	Specifies the password to use for HTTP/HTTPS digest authentication. The server uses this password for authentication purposes when loading configuration to the phone over HTTP/HTTPS. This parameter initiates a “Username/Password” screen after pressing the Log In softkey. Notes: <ol style="list-style-type: none"> 1. The Password field accepts special characters, such as, @, #, %, =, _, etc. 2. You must reboot the phone after setting the HTTP/HTTPS digest authentication parameters.
Format	String
Default Value	N/A
Range	Up to 20 alphanumeric characters
Example	http digest password: mypassword

Parameter – <i>http digest force login</i>	Configuration Files aastra.cfg, <mac>.cfg
Description	Enables and disables the display of a LOGIN key on the phone's idle screen. Note: After the server has authenticated the phone, this parameter must be set to "0" in order for the server to send the default profile to the phone.
Format	Boolean
Default Value	0 (disable)
Range	0 (disable) 1 (enable)
Example	http digest force login: 1

Advanced SIP Settings

Parameter – <i>sip explicit mwi subscription</i> <i>Explicit MWI Subscription</i> (in Web UI)	Aastra Web UI Advanced Settings->Global SIP-> Advanced SIP Settings Configuration Files aastra.cfg, <mac>.cfg
Description	If the IP phone has a message waiting subscription with the Service Provider, a Message Waiting Indicator (MWI) (LED or display icon) tells the user there is a message on the IP Phone. You can enable and disable MWI by setting this parameter to the following: "0" to disable "1" to enable
Format	Boolean
Default Value	0
Range	0 (disable) 1 (enable)
Example	sip explicit mwi subscription: 1

Operational, Basic, and Advanced Parameters

Parameter – <i>sip explicit mwi subscription period</i> <i>Explicit MWI Timeout</i> (in Web UI)	Aastra Web UI Advanced Settings->Global SIP-> Advanced SIP Settings Configuration Files aastra.cfg, <mac>.cfg
Description	The requested duration, in seconds, before the MWI subscription times out. The phone re-subscribes to MWI before the subscription period ends.
Format	Integer
Default Value	86400
Range	30 - 214748364
Example	sip explicit mwi subscription period: 30

Parameter – <i>sip send mac</i> <i>Send MAC Address in REGISTER Message</i> (in Web UI)	Aastra Web UI: Advanced Settings->Global SIP-> Advanced SIP Settings Configuration Files aastra.cfg, <mac>.cfg
Description	Adds an "Aastra-Mac:" header to the SIP REGISTER messages sent from the phone to the call server, where the value is the MAC address of the phone.
Format	Boolean
Default Value	0 (disabled)
Range	0 (disabled) 1 (enabled)
Example	sip send mac: 1

<p>Parameter – <i>sip send line</i></p> <p><i>Send Line Number in REGISTER Message (in Web UI)</i></p>	<p>Aastra Web UI: Advanced Settings->Global SIP-> Advanced SIP Settings</p> <p>Configuration Files aastra.cfg, <mac>.cfg</p>
<p>Description</p>	<p>Adds an "Aastra-Line:" header to the SIP REGISTER messages sent from the phone to the call server, where the value is the MAC address of the phone.</p>
<p>Format</p>	<p>Boolean</p>
<p>Default Value</p>	<p>0 (disabled)</p>
<p>Range</p>	<p>0 (disabled) 1 (enabled)</p>
<p>Example</p>	<p>sip send line: 1</p>

<p>Parameter – <i>sip session timer</i></p> <p><i>Session Timer (in Web UI)</i></p>	<p>Aastra Web UI Advanced Settings->Global SIP-> Advanced SIP Settings</p> <p>Configuration Files aastra.cfg, <mac>.cfg</p>
<p>Description</p>	<p>The time, in seconds, that the IP phone uses to send periodic re-<i>INVITE</i> requests to keep a session alive. The proxy uses these re-<i>INVITE</i> requests to maintain the status' of the connected sessions. See RFC4028 for details.</p>
<p>Format</p>	<p>Integer</p>
<p>Default Value</p>	<p>0</p>
<p>Range</p>	<p>Not Applicable</p>
<p>Example</p>	<p>sip session timer: 30</p>

Operational, Basic, and Advanced Parameters

Parameter – <i>sip T1 timer</i>	Aastra Web UI Advanced Settings->Global SIP-> Advanced SIP Settings Configuration Files aastra.cfg, <mac>.cfg
<i>T1 Timer</i> (in Web UI)	
Description	This timer is a SIP transaction layer timer defined in RFC 3261. Timer 1 is an estimate, in milliseconds, of the round-trip time (RTT).
Format	Integer
Default Value	500
Range	Not Applicable
Example	sip T1 timer: 600

Parameter – <i>sip T2 timer</i>	Aastra Web UI Advanced Settings->Global SIP-> Advanced SIP Settings Configuration Files aastra.cfg, <mac>.cfg
<i>T2 Timer</i> (in Web UI)	
Description	This timer is a SIP transaction layer timer defined in RFC 3261. Timer 2 represents the amount of time, in milliseconds, a non-INVITE server transaction takes to respond to a request.
Format	Integer
Default Value	0
Range	Not Applicable
Example	sip T2 timer: 8

<p>Parameter – <i>sip transaction timer</i></p> <p><i>Transaction Timer</i> (in Web UI)</p>	<p>Aastra Web UI Advanced Settings->Global SIP-> Advanced SIP Settings</p> <p>Configuration Files aastra.cfg, <mac>.cfg</p>
<p>Description</p>	<p>The amount of time, in milliseconds that the phone allows the callserver (registrar/proxy) to respond to SIP messages that it sends. If the phone does not receive a response in the amount of time designated for this parameter, the phone assumes the message has timed out.</p>
<p>Format</p>	<p>Integer</p>
<p>Default Value</p>	<p>4000</p>
<p>Range</p>	<p>4000 to 64000</p>
<p>Example</p>	<p>sip transaction timer: 6000</p>

Parameter – <i>sip transport protocol</i> <i>Transport Protocol</i> (in Web UI)	Aastra Web UI Advanced Settings->Global SIP-> Advanced SIP Settings Configuration Files aastra.cfg, <mac>.cfg
Description	<p>The protocol that the Real-Time Transport Protocol (RTP) port on the IP phone uses to send out SIP signaling packets.</p> <p>Notes:</p> <ol style="list-style-type: none"> 1. If you set the value of this parameter to 4 (TLS), the phone checks to see if the “sips persistent tls” is enabled. If it is enabled, the phone uses Persistent TLS on the connection. If “sips persistent tls” is disabled, then the phone uses TLS on the connection. If TLS is used, you must specify the Root and Intermediate Certificates, the Local Certificate, the Private Key, and the Trusted Certificates. 2. If the phone uses Persistent TLS, you MUST specify the Trusted Certificates; the Root and Intermediate Certificates, the Local Certificate, and the Private Key are optional. <p>For more information about Persistent TLS, see “Transport Layer Security (TLS) Settings” on page A-116.</p>
Format	Integer
Default Value	1 - UDP
Range	Valid values are: 0 - User Datagram Protocol (UDP) and Transmission Control Protocol (TCP) 1 - UDP 2 - TCP 4 - Transport Layer Security (TLS)
Example	sip transport protocol: 4

<p>Parameter – <i>sip registration retry timer</i></p> <p><i>Registration Failed Retry Timer</i> (in Web UI)</p>	<p>Aastra Web UI Advanced Settings->Global SIP-> Advanced SIP Settings</p> <p>Configuration Files aastra.cfg, <mac>.cfg</p>
<p>Description</p>	<p>Specifies the time, in seconds, that the phone waits between registration attempts when a registration is rejected by the registrar.</p>
<p>Format</p>	<p>Integer</p>
<p>Default Value</p>	<p>1800 (30 minutes)</p>
<p>Range</p>	<p>30 to 1800</p>
<p>Example</p>	<p>sip registration retry timer: 30</p>

<p>Parameter – <i>sip registration timeout retry timer</i></p> <p><i>Registration Timeout Retry Timer</i> (in Web UI)</p>	<p>Aastra Web UI Advanced Settings->Global SIP-> Advanced SIP Settings</p> <p>Configuration Files aastra.cfg, <mac>.cfg</p>
<p>Description</p>	<p>Specifies the length of time, in seconds, that the phone waits until it re-attempts to register after a REGISTER message times out.</p> <p>If this parameter is set lower than 30 seconds, the phone uses a minimum timer of 30 seconds.</p>
<p>Format</p>	<p>Integer</p>
<p>Default Value</p>	<p>120</p>
<p>Range</p>	<p>30 to 214748364</p>
<p>Example</p>	<p>sip registration timeout retry timer: 150</p>

Operational, Basic, and Advanced Parameters

Parameter – <i>sip registration renewal timer</i> Registration Renewal Timer (in Web UI)	Aastra Web UI Advanced Settings->Global SIP-> Advanced SIP Settings Configuration Files aastra.cfg, <mac>.cfg
Description	<p>The length of time, in seconds, prior to expiration, that the phone renews registrations.</p> <p>For example, if the value is set to 20, then 20 seconds before the registration is due to expire, a new REGISTER message is sent to the registrar to renew the registration.</p>
Format	Integer
Default Value	15
Range	0 to 214748364 The value set for this parameter should be between 0 and the value set for the registration period.
Example	sip registration renewal timer: 10

Parameter – <i>sip blf subscription period</i> BLF Subscription Period (in Web UI)	Aastra Web UI Advanced Settings->Global SIP ->Advanced SIP Settings Configuration Files aastra.cfg, <mac>.cfg
Description	Specifies the time period, in seconds, that the IP phone resubscribes the BLF subscription service after a software/firmware upgrade or after a reboot of the IP phone.
Format	Integer
Default Value	3600
Range	120 (2 minutes is the minimum value)
Example	sip blf subscription period: 2000

Parameter – <i>sip acd subscription period</i> <i>ACD Subscription Period</i> (in Web UI)	Aastra Web UI Advanced Settings->Global SIP ->Advanced SIP Settings Configuration Files aastra.cfg, <mac>.cfg
Description	Specifies the time period, in seconds, that the IP phone resubscribes the Automatic Call Distribution (ACD) subscription service after a software/ firmware upgrade or after a reboot of the IP phone.
Format	Integer
Default Value	3600
Range	120 (2 minutes is the minimum value)
Example	sip acd subscription period: 2000

Parameter– <i>sip bla subscription period</i> <i>BLA Subscription Period</i> (in Web UI)	Configuration Files aastra.cfg, <mac>.cfg Aastra Web UI Advanced Settings->Global SIP-> Advanced SIP Settings
Description	Specifies the amount of time, in seconds, that the phone waits to receive a BLA subscribe message from the server. If you specify zero (0), the phone uses the value specified for the BLA expiration in the subscribe message received from the server. If no value is specified, the phone uses the default value of 300 seconds.
Format	Integer
Default Value	300
Range	0 to 3700 Note: When set to zero (0), the phone uses BLA expiry value specified in subscribe message.
Example	sip bla subscription period: 0

Missed Call Summary Subscription Settings

Global Parameters

<p>Parameter – <i>sip missed call summary subscription</i></p> <p><i>Missed Call Summary Subscription</i> (in Web UI)</p>	<p>Aastra Web UI Advanced Settings->Global SIP-> Advanced SIP Settings</p> <p>Configuration Files aastra.cfg, <mac>.cfg</p>
<p>Description</p>	<p>Enables or disables the Missed Call Summary Subscription feature. This feature allows missed calls that have been redirected by the server, to be incremented in the missed calls indicator on the phone it was initially directed to.</p> <p>For example, phones A, B, and C are connected to the server. You configure the server to direct calls coming into phone B (which has voicemail configured) to be forwarded to phone C. When phone A calls sip missed call summary subscription parameter, phone B receives notification from the server that the call was forwarded and the missed calls indicator is incremented on phone B.</p> <p>Note: You must configure voicemail on the phone that the call was initially directed to (phone B in the above example).</p>
<p>Format</p>	<p>Boolean</p>
<p>Default Value</p>	<p>0 (disabled)</p>
<p>Range</p>	<p>0 (disabled) 1 (enabled)</p>
<p>Example</p>	<p>sip missed call summary subscription: 1</p>

<p>Parameter – <i>sip missed call summary subscription period</i></p> <p><i>Missed Call Summary Subscription Period (in Web UI)</i></p>	<p>Aastra Web UI Advanced Settings->Global SIP-> Advanced SIP Settings</p> <p>Configuration Files aastra.cfg, <mac>.cfg</p>
<p>Description</p>	<p>Specifies the amount of time, in seconds, that the phone uses the Missed Calls Summary Subscription feature. This parameter is always enabled with a default value of 86400 seconds. When the phone reaches the limit set for this parameter, it sends the subscription again.</p> <p>To disable this parameter, leave the field blank or set the field to zero (0).</p>
<p>Format</p>	<p>Integer</p>
<p>Default Value</p>	<p>86400</p>
<p>Range</p>	<p>0 to 99999999</p>
<p>Example</p>	<p>sip missed call summary subscription period: 70000</p>

Per-Line Parameter

Parameter – <i>sip lineN missed call summary subscription</i> <i>Missed Call Summary Subscription (in Web UI)</i>	Aastra Web UI Advanced Settings->Global SIP-> Advanced SIP Settings Configuration Files aastra.cfg, <mac>.cfg
Description	<p>Enables or disables the Missed Call Summary Subscription feature. This feature allows missed calls that have been redirected by the server, to be incremented in the missed calls indicator on the phone it was initially directed to.</p> <p>For example, phones A, B, and C are connected to the server. You configure the server to direct calls coming into phone B (which has voicemail configured) to be forwarded to phone C. When phone A calls phone B, the server forwards the call to phone C. If you enable the sip missed call summary subscription parameter, phone B receives notification from the server that the call was forwarded and the missed calls indicator is incremented on phone B.</p> <p>Note: You must configure voicemail on the phone that the call was initially directed to (phone B in the above example).</p>
Format	Boolean
Default Value	0 (disabled)
Range	0 (disabled) 1 (enabled)
Example	sip line1 missed call summary subscription: 1

As-Feature-Event Subscription Settings

Parameter – <i>sip lineN as-feature-event subscription</i>	Aastra Web UI: Advanced Settings->LineN->Advanced SIP Settings Configuration Files aastra.cfg, <mac>.cfg
Description	Enables or disables the specified line with the BroadSoft's server-side DND, CFWD, or ACD features.
Format	Boolean
Default Value	0 (disable)
Range	0 (disable) 1 (enable)
Example	sip line1 as-feature-event subscription: 1

Parameter – <i>sip as-feature-event subscription period</i>	Aastra Web UI: Basic Settings->Global SIP->Advanced SIP Settings Configuration Files aastra.cfg, <mac>.cfg
Description	Specifies the amount of time, in seconds, between resubscribing. If the phone does not resubscribe in the time specified for this parameter, it loses subscription.
Format	Integer
Default Value	3600
Range	5 to 2147483648
Example	sip as-feature-event subscription period: 600

Transport Layer Security (TLS) Settings

To configure TLS, you must enter the “**sip transport protocol**” parameter with a value of “**4**” (TLS). See the “sip transport protocol” description on [page A-108](#).

Also enter the following parameters in the configuration files to configure TLS:

Parameter – <i>sips persistent tls</i>	Configuration Files aastra.cfg, <mac>.cfg
Description	<p>Enables or disables the use of Persistent Transport Layer Security (TLS).</p> <p>Persistent TLS sets up the connection to the server once and re-uses that connection for all calls from the phone. The setup connection for Persistent TLS is established during the registration of the phone. If the phones are set to use Persistent TLS, and a call is made from the phone, this call and all subsequent calls use the same authenticated connection. This significantly reduces the delay time when placing a call.</p> <p>Notes:</p> <ol style="list-style-type: none"> 1. Persistent TLS requires the outbound proxy server and outbound proxy port parameters be configured in either the configuration files or the Aastra Web UI (<i>Advanced Settings->Global SIP->Basic SIP Network Settings</i>). There can be only one persistent TLS connection created per phone. The phone establishes the TLS connection to the configured outbound proxy. 2. If you configure the phone to use Persistent TLS, you must also specify the Trusted Certificate file to use. The Root and Intermediate Certificates, Local Certificate, and Private Key files are optional.
Format	Boolean
Default Value	0 (disabled)
Range	0 (disabled) 1 (enabled)
Example	sips persistent tls: 1

<p>Parameter – <i>sips root and intermediate certificates</i></p> <p><i>Root and Intermediate Certificates Filename</i> (in Web UI)</p>	<p>Aastra Web UI Advanced Settings->TLS Support Configuration Files aastra.cfg, <mac>.cfg</p>
<p>Description</p>	<p>Allows you to specify the SIP Root and Intermediate Certificate files to use when the phone uses the TLS transport protocol to setup a call.</p> <p>The Root and Intermediate Certificate files contain one root certificate and zero or more intermediate certificates which must be placed in order of certificate signing with root certificate being the first in the file. If the local certificate is signed by some well known certificate authority, then that authority provides the user with the Root and Intermediate Certificate files (most likely just CA root certificate).</p> <p>This parameter is required when configuring TLS (optional for Persistent TLS.)</p> <p>You can use this parameter in three ways:</p> <ul style="list-style-type: none"> • To download no certificates • To download a certificate from the original configuration server • To download a certificate from another specified server <p>To download a specific file, the string value MUST HAVE A FILENAME at the end of the string. For example:</p> <p>sips root and intermediate certificates:ftp://admin:admin!@1.2.3.4:50/path/phonesRootCert.pem</p> <p>where “path” is the directory and “phonesRootCert.pem” is the filename. If you do not specify a filename, the download fails.</p> <p>See examples for each below.</p> <p>Note: The certificate files must use the format “.pem”. To create custom certificate files to use on your IP phone, contact Aastra Technical Support.</p>
<p>Format</p>	<p><file name>.pem</p>
<p>Default Value</p>	<p>N/A</p>
<p>Range</p>	<p>N/A</p>

Example

The following example downloads no root and intermediate certificate file:

sips root and intermediate certificates:

The following example downloads the root and intermediate certificate file from the original configuration server.

sips root and intermediate certificates: phonesRootCert.pem

The following example uses FTP to download the firmware file "phonesRootCert.pem" (root and intermediate certificate file) from the "path" directory on server 1.2.3.4 using port 50:

sips root and intermediate certificates:ftp://admin:admin!@1.2.3.4:50/path/phonesRootCert.pem

<p>Parameter – <i>sips local certificate</i></p> <p><i>Local Certificate Filename</i> (in Web UI)</p>	<p>Aastra Web UI Advanced Settings->TLS Support Configuration Files aastra.cfg, <mac>.cfg</p>
<p>Description</p>	<p>Allows you to specify the Local Certificate file to use when the phone uses the TLS transport protocol to setup a call.</p> <p>This parameter is required when configuring TLS (optional for Persistent TLS.)</p> <p>You can use this parameter in three ways:</p> <ul style="list-style-type: none"> • To download no certificates • To download a certificate from the original configuration server • To download a certificate from another specified server <p>To download a specific file, the string value MUST HAVE A FILENAME at the end of the string. For example:</p> <p>sips local certificate:ftp://admin:admin!@1.2.3.4:50/path/phonesLocalCert.pem</p> <p>where “path” is the directory and “phonesLocalCert.pem” is the filename. If you do not specify a filename, the download fails.</p> <p>See examples for each below.</p> <p>Note: The certificate file must use the format “.pem”. To create specific certificate files to use on your IP phone, contact Aastra Technical Support.</p>
<p>Format</p>	<p><file name>.pem</p>
<p>Default Value</p>	<p>N/A</p>
<p>Range</p>	<p>N/A</p>

Example

The following example downloads no local certificate file:

sips local certificate:

The following example downloads the local certificate file from the original configuration server.

sips local certificate: phonesLocalCert.pem

The following example uses FTP to download the firmware file "phonesLocalCert.pem" (local certificate file) from the "path" directory on server 1.2.3.4 using port 50:

sips local certificate:ftp://admin:admin!@1.2.3.4:50/path/
phonesLocalCert.pem

<p>Parameter – <i>sips private key</i></p> <p><i>Private Key Filename</i> (in Web UI)</p>	<p>Aastra Web UI Advanced Settings->TLS Support Configuration Files aastra.cfg, <mac>.cfg</p>
<p>Description</p>	<p>Allows you to specify a Private Key file to use when the phone uses the TLS transport protocol to setup a call.</p> <p>This parameter is required when configuring TLS (optional for Persistent TLS.)</p> <p>You can use this parameter in three ways:</p> <ul style="list-style-type: none"> • To download no private key • To download a private key from the original configuration server • To download a private key from another specified server <p>To download a specific file, the string value MUST HAVE A FILENAME at the end of the string. For example:</p> <p>sips trusted certificates:ftp://admin:admin!@1.2.3.4:50/path/phonesPrivatekey.pem</p> <p>where “path” is the directory and “phonesPrivateKey.pem” is the filename. If you do not specify a filename, the download fails.</p> <p>See examples for each below.</p> <p>Note: The key file must use the format “.pem”. To create specific private key files to use on your IP phone, contact Aastra Technical Support.</p>
<p>Format</p>	<p><file name>.pem</p>
<p>Default Value</p>	<p>N/A</p>
<p>Range</p>	<p>N/A</p>

Example

The following example downloads no private key file:

sips private key:

The following example downloads the private key file from the original configuration server.

sips private key: phonesPrivateKey.pem

The following example uses FTP to download the firmware file "phonesPrivateKey.pem" (private key file) from the "path" directory on server 1.2.3.4 using port 50:

sips private key: ftp://admin:admin!@1.2.3.4:50/path/
phonesPrivateKey.pem

<p>Parameter – <i>sips trusted certificates</i></p> <p><i>Trusted Certificates Filename (in Web UI)</i></p>	<p>Aastra Web UI Advanced Settings->TLS Support Configuration Files aastra.cfg, <mac>.cfg</p>
<p>Description</p>	<p>Allows you to specify the Trusted Certificate files to use when the phone uses the TLS transport protocol to setup a call.</p> <p>The Trusted Certificate files define a list of trusted certificates. The phone's trusted list must contain the CA root certificates for all the servers it is connecting to. For example, if the phone is connecting to server A which has a certificate signed by CA1, and server B which has a certificate signed by CA2, the phone must have CA1 root certificate and CA2 root certificate in its Trusted Certificate file.</p> <p>This parameter is required when configuring TLS or Persistent TLS.</p> <p>You can use this parameter in three ways:</p> <ul style="list-style-type: none"> • To download no certificates • To download a certificate from the original configuration server • To download a certificate from another specified server <p>To download a specific file, the string value MUST HAVE A FILENAME at the end of the string. For example:</p> <p>sips trusted certificates:ftp://admin:admin!@1.2.3.4:50/path/ phonesTrustedCert.pem</p> <p>where "path" is the directory and "phonesTrustedCert.pem" is the filename. If you do not specify a filename, the download fails.</p> <p>See examples for each below.</p> <p>Note: The certificate files must use the format ".pem". To create custom certificate files to use on your IP phone, contact Aastra Technical Support.</p>
<p>Format</p>	<p><file name>.pem</p>
<p>Default Value</p>	<p>N/A</p>
<p>Range</p>	<p>N/A</p>

Example

The following example downloads no trusted certificate file:

sips trusted certificates:

The following example downloads the trusted certificate file from the original configuration server.

sips trusted certificates: phonesTrustedCert.pem

The following example uses FTP to download the firmware file "phonesTrustedCert.pem" (trusted certificate file) from the "path" directory on server 1.2.3.4 using port 50:

sips trusted certificates:ftp://admin:admin!@1.2.3.4:50/path/
phonesTrustedCert.pem

802.1x Support Settings

Use the following parameters to configure the 802.1x Protocol on your phone using the configuration files.

For EAP-MD5 use:

- **eap type**
- **identity**
- **md5 password**
- **pc port passthrough enabled**

For EAP-TLS use:

- **eap type**
- **identity**
- **802.1x root and intermediate certificates**
(use 1 root and 0 or 1 intermediate certificates)
- **802.1x local certificate**
(use 1 local certificate)
- **802.1x private key**
(1 private key that corresponds to local certificate)
- **802.1x trusted certificates**
(0 or more trusted certificates (a maximum of 2))
- **pc port passthrough enabled**

Operational, Basic, and Advanced Parameters

Parameter – <i>pc port passthru enabled</i> <i>PC Port PassThru Enable/ Disable</i> (in Web UI)	IP phone UI Aastra Web UI Configuration Files	Options->Administrator Menu-> Network Settings->Ethernet Link Advanced Settings->Network-> Basic Network Settings aastra.cfg, <mac>.cfg
Description	Enables or disables the PC port.	
Format	Integer	
Default Value	1 (enable)	
Range	0 (disable) 1 (enable)	
Example	pc port passthru enabled: 1	

Parameter – <i>eap type</i> <i>EAP Type</i> (in Web UI)	IP Phone UI: Aastra Web UI: Configuration Files	Options->Administrator Menu-> Network Settings->Ethernet Link-> 802.1x Settings->802.1x Mode Advanced Settings->802.1x Support->General aastra.cfg, <mac>.cfg
Description	Specifies the type of authentication to use on the IP Phone.	
Format	Integer	
Default Value	0 (disable)	
Range	0 (disable) 1 (MD5) 2 (TLS)	
Example	eap type: 1	

<p>Parameter – <i>identity</i></p> <p><i>Identity</i> (in Web UI)</p>	<p>IP Phone UI: Options->Administrator Menu->Network Settings->Ethernet Link->802.1x Settings->EAP-MD5 Settings</p> <p>Aastra Web UI: Advanced Settings->802.1x Support->General</p> <p>Configuration Files aastra.cfg, <mac>.cfg</p>
<p>Description</p>	<p>Specifies the identity or username used for authenticating the phone.</p> <p>Note: The value you enter for this parameter also displays in the Aastra Web UI at the path Advanced Settings->802.1x Support->General->Identity.</p>
<p>Format</p>	<p>String</p>
<p>Default Value</p>	<p>N/A</p>
<p>Range</p>	<p>N/A</p>
<p>Example</p>	<p>identity: phone1</p>

<p>Parameter – <i>md5 password</i></p> <p><i>MD5 Password</i> (in Web UI)</p>	<p>IP Phone UI: Options->Administrator Menu->Network Settings->Ethernet Link->802.1x Settings->EAP-MD5 Settings</p> <p>Aastra Web UI: Advanced Settings->802.1x Support->EAP-MD5 Settings</p> <p>Configuration Files aastra.cfg, <mac>.cfg</p>
<p>Description</p>	<p>Specifies the password used for the MD5 authentication of the phone.</p> <p>Note: The value you enter for this parameter also displays in the Aastra Web UI at the path Advanced Settings->802.1x Support->EAP-MD5 Settings->MD5 Password. The password displays as "*****".</p>
<p>Format</p>	<p>String</p>
<p>Default Value</p>	<p>N/A</p>
<p>Range</p>	<p>N/A</p>
<p>Example</p>	<p>md5 password: password1</p>

<p>Parameter – <i>802.1x root and intermediate certificates</i></p> <p><i>Root and Intermediate Certificates</i> (in Web UI)</p>	<p>Aastra Web UI: Advanced Settings->802.1x Support-> EAP-TLS Settings</p> <p>Configuration Files aastra.cfg, <mac>.cfg</p>
<p>Description</p>	<p>Specifies the file name that contains the root and intermediate certificates related to the local certificate.</p> <p>You can use this parameter in three ways:</p> <ul style="list-style-type: none"> • To download no certificates • To download a certificate from the original configuration server • To download a certificate from another specified server <p>To download a specific file, the string value MUST HAVE A FILENAME at the end of the string. For example:</p> <p>802.1x root and intermediate certificates:ftp:// admin:admin!@1.2.3.4:50/path/phones802RootCert.pem</p> <p>where “path” is the directory and “phones802RootCert.pem” is the filename. If you do not specify a filename, the download fails.</p> <p>See examples for each below.</p>
<p>Format</p>	<p>String</p>
<p>Default Value</p>	<p>N/A</p>
<p>Range</p>	<p>N/A</p>

Example

The following example downloads no 802.1x root and intermediate certificate file:

802.1x root and intermediate certificates:

The following example downloads the 802.1x root and intermediate certificate file from the original configuration server.

802.1x root and intermediate certificates: phones802RootCert.pem

The following example uses FTP to download the firmware file "phones802RootCert.pem" (802.1x root and intermediate certificate file) from the "path" directory on server 1.2.3.4 using port 50:

802.1x root and intermediate certificates:ftp://
admin:admin!@1.2.3.4:50/path/phones802RootCert.pem

<p>Parameter – <i>802.1x local certificate</i></p> <p><i>Local Certificate</i> (in Web UI)</p>	<p>Aastra Web UI: Advanced Settings->802.1x Support-> EAP-TLS Settings</p> <p>Configuration Files aastra.cfg, <mac>.cfg</p>
<p>Description</p>	<p>Specifies the file name that contains the local certificate.</p> <p>You can use this parameter in three ways:</p> <ul style="list-style-type: none"> • To download no certificates • To download a certificate from the original configuration server • To download a certificate from another specified server <p>To download a specific file, the string value MUST HAVE A FILENAME at the end of the string. For example:</p> <p>802.1x local certificate:ftp://admin:admin!@1.2.3.4:50/path/ phones802LocalCert.pem</p> <p>where “path” is the directory and “phones802LocalCert.pem” is the filename. If you do not specify a filename, the download fails.</p> <p>See examples for each below.</p>
<p>Format</p>	<p>String</p>
<p>Default Value</p>	<p>N/A</p>
<p>Range</p>	<p>N/A</p>
<p>Example</p>	<p>The following example downloads no local certificate file:</p> <p>802.1x local certificate:</p> <p>The following example downloads the local certificate file from the original configuration server.</p> <p>802.1x local certificate: phones802LocalCert.pem</p> <p>The following example uses FTP to download the firmware file “phones802LocalCert.pem” (802.1x local certificate file) from the “path” directory on server 1.2.3.4 using port 50:</p> <p>802.1x local certificate:ftp://admin:admin!@1.2.3.4:50/path/ phones802LocalCert.pem</p>

<p>Parameter – 802.1x private key</p> <p><i>Private Key</i> (in Web UI)</p>	<p>Aastra Web UI: Advanced Settings->802.1x Support-> EAP-TLS Settings</p> <p>Configuration Files aastra.cfg, <mac>.cfg</p>
<p>Description</p>	<p>Specifies the file name that contains the private key.</p>
<p>Format</p>	<p>String</p>
<p>Default Value</p>	<p>ANDN/A</p>
<p>Range</p>	<p>N/A</p>
<p>Example</p>	<p>802.1x private key: filename.pem</p>

<p>Parameter – <i>802.1x trusted certificates</i></p> <p><i>Trusted Certificates</i> (in Web UI)</p>	<p>Aastra Web UI: Advanced Settings->802.1x Support-> EAP-TLS Settings</p> <p>Configuration Files aastra.cfg, <mac>.cfg</p>
<p>Description</p>	<p>Specifies the file name that contains the trusted certificates.</p> <p>You can use this parameter in three ways:</p> <ul style="list-style-type: none"> • To download no certificates • To download a certificate from the original configuration server • To download a certificate from another specified server <p>To download a specific file, the string value MUST HAVE A FILENAME at the end of the string. For example:</p> <p>802.1x trusted certificates:ftp://admin:admin!@1.2.3.4:50/path/ phones802TrustedCert.pem</p> <p>where “path” is the directory and “phones802TrustedCert.pem” is the filename. If you do not specify a filename, the download fails.</p> <p>See examples for each below.</p>
<p>Format</p>	<p>String</p>
<p>Default Value</p>	<p>N/A</p>
<p>Range</p>	<p>N/A</p>
<p>Example</p>	<p>The following example downloads no 802.1x trusted certificate file:</p> <p>802.1x trusted certificates:</p> <p>The following example downloads the 802.1x trusted certificate file from the original configuration server.</p> <p>802.1x trusted certificates: phones802TrustedCert.pem</p> <p>The following example uses FTP to download the firmware file “phones802TrustedCert.pem” (802.1x trusted certificate file) from the “path” directory on server 1.2.3.4 using port 50:</p> <p>802.1x trusted certificates:ftp://admin:admin!@1.2.3.4:50/path/ phones802TrustedCert.pem</p>

RTP, Codec, DTMF Global Settings

Global Settings

<p>Parameter – <i>sip rtp port</i></p> <p><i>RTP Port Base</i> (in IP Phone UI)</p> <p><i>RTP Port</i> (in Web UI)</p>	<p>IP Phone UI Options->Administrator Menu-> SIP Settings->RTP Port Base</p> <p>Aastra Web UI Advanced Settings->Global SIP->RTP Settings</p> <p>Configuration Files aastra.cfg, <mac>.cfg</p>
<p>Description</p>	<p>Indicates the port through which the RTP packets are sent. This value must specify the beginning of the RTP port range on the gateway or router.</p> <p>The RTP port is used for sending DTMF tones and for the audio stream. Your network administrator may close some ports for security reasons. You may want to use this parameter to send RTP data using a different port.</p> <p>Note: The phones support decoding and playing out DTMF tones sent in SIP INFO requests. The following DTMF tones are supported:</p> <ul style="list-style-type: none"> • Support signals 0-9, #, * • Support durations up to 5 seconds
<p>Format</p>	<p>Integer</p>
<p>Default Value</p>	<p>3000</p>
<p>Range</p>	<p>Not Applicable</p>
<p>Example</p>	<p>sip rtp port: 3000</p>

Operational, Basic, and Advanced Parameters

Parameter – <i>sip use basic codecs</i> <i>Basic Codecs</i> (in Web UI)	Aastra Web UI Configuration Files	Advanced Settings->Global SIP->RTP Settings aastra.cfg, <mac>.cfg
Description	Enables or disables basic codecs. Enabling this parameter allows the IP phone to use the basic Codecs when sending/receiving RTP packets.	
Format	Boolean	
Default Value	0	
Range	0 - Disable 1 - Enable	
Example	sip use basic codecs: 1	

Parameter – <i>sip out-of-band dtmf</i> <i>Force RFC2833 Out-of-Band DTMF</i> (in Web UI)	Aastra Web UI Configuration Files	Advanced Settings->Global SIP->RTP Settings aastra.cfg, <mac>.cfg
Description	Enables or disables out-of-band DTMF. Enabling this parameter forces the IP phone to use out-of-band DTMF according to RFC2833.	
Format	Boolean	
Default Value	1	
Range	0 - Disable 1 - Enable	
Example	sip out-of-band dtmf: 0	

Parameter – <i>sip srtp mode</i>	Aastra Web UI Advanced Settings->Global SIP-> RTP Settings Configuration Files aastra.cfg, <mac>.cfg
<i>RTP Encryption</i> (in Web UI)	
Description	This parameter determines if SRTP is enabled on this IP phone, as follows: <ul style="list-style-type: none"> • If set to 0, then disable SRTP. • If set to 1 then SRTP calls are preferred. • If set to 2, then SRTP calls only are generated/accepted.
Format	Integer
Default Value	0 (SRTP Disabled)
Range	0 (SRTP Disabled) 1 (SRTP Preferred) 2 (SRTP Only)
Example	sip srtp mode: 1

Parameter – <i>sip silence suppression</i>	Aastra Web UI Advanced Settings->Global SIP->RTP Settings Configuration Files aastra.cfg, <mac>.cfg
<i>Silence Suppression</i> (in Web UI)	
Description	Silence suppression is enabled by default on the IP phones. The phone negotiates whether or not to use silence suppression. Disabling this feature forces the phone to ignore any negotiated value.
Format	Boolean
Default Value	1 (enabled)
Range	0 (disabled) 1 (enabled)
Example	sip silence suppression: 0

Per-Line Settings

Parameter – <i>sip lineN dtmf method</i>	Aastra Web UI Advanced Settings->Global SIP->RTP Settings Configuration Files aastra.cfg, <mac>.cfg
<i>DTMF Method</i> (in Web UI)	
Description	Sets the Dual-tone multifrequency (DTMF) method to use on the IP phone for a specific line.
Format	Integer
Default Value	0 (RTP)
Range	0 (RTP) 1 (SIP INFO) 2 (BOTH)
Example	sip line1 dtmf method: 1

Parameter – <i>sip lineN srtp mode</i>	Aastra Web UI Advanced Settings->Line <1-9>->RTP Settings Configuration Files aastra.cfg, <mac>.cfg
Description	This parameter determines if SRTP is enabled on this line, as follows: <ul style="list-style-type: none"> • If set to -1, then use the global setting for this line. (This is the default setting.) • If set to 0, then disable SRTP. • If set to 1 then SRTP calls are preferred. • If set to 2, then SRTP calls only are generated/accepted.
Format	Integer
Default Value	0 (disabled)
Range	-1 0 1 2
Example	sip line1 mode: 1

Autodial Settings

Global Settings

Parameter – <i>sip autodial number</i> <i>Autodial Number</i> (in Web UI)	Aastra Web UI Advanced Settings->Global SIP-> Autodial Settings Configuration Files aastra.cfg, <mac>.cfg
Description	Globally specifies the SIP phone number that the IP phone autodial when the handset is lifted from the phone cradle. An empty (blank) value disables autodial on the phone.
Format	Integer
Default Value	Blank
Range	Any valid SIP number
Examples	sip autodial number: 8500

Parameter – <i>sip autodial timeout</i> <i>Autodial Timeout</i> (in Web UI)	Aastra Web UI Advanced Settings->Global SIP-> Autodial Settings Configuration Files aastra.cfg, <mac>.cfg
Description	Globally specifies the time, in seconds, that the phone waits to dial a preconfigured number after the handset is lifted from the IP phone cradle. If this parameter is set to 0 (hotline), the phone immediately dials a preconfigured number when you lift the handset. If this parameter is set to a value greater than 0, the phone waits the specified number of seconds before dialing the preconfigured number (warmline) when you lift the handset. Default is 0 (hotline).
Format	Integer
Default Value	0
Range	0 to 120
Examples	sip autodial timeout: 30

Per-Line Settings

Parameter – <i>sip lineN autodial number</i> <i>Autodial Number</i> (in Web UI)	Aastra Web UI Advanced Settings->LineN->Autodial Settings Configuration Files aastra.cfg, <mac>.cfg
Description	On a per-line basis, this parameter specifies the SIP phone number that the IP phone autodial when the handset is lifted from the phone cradle. Valid values can be: -1 (Default) The phone uses the global autodial setting for this line. Blank (Empty field) Disables autodial on this line. Valid SIP Number Dials the SIP number specified for this line.
Format	Integer
Default Value	-1
Range	Any valid SIP number.
Examples	sip line1 autodial number: 8500

Parameter – <i>sip lineN autodial timeout</i> <i>AutoDial Timeout</i> (in Web UI)	Aastra Web UI Advanced Settings->LineN->Autodial Settings Configuration Files aastra.cfg, <mac>.cfg
Description	<p>On a per-line basis, this parameter specifies the time, in seconds, that the phone waits to dial a preconfigured number after the handset is lifted from the IP phone cradle.</p> <p>If this parameter is set to 0 (hotline), the phone immediately dials a preconfigured number when you lift the handset. If this parameter is set to a value greater than 0, the phone waits the specified number of seconds before dialing the preconfigured number (warmline) when you lift the handset.</p> <p>Default is 0 (hotline).</p>
Format	Integer
Default Value	0
Range	0 to 120
Examples	sip line1 autodial timeout: 30

Voicemail Settings

<p>Parameter – <i>sip lineN vmail</i></p> <p>Note: The value of "N" is 1 - 9 or 1-6 depending your your model phone. Line settings are not applicable to the 6751i.</p>	<p>Configuration Files aastra.cfg, <mac>.cfg</p>
<p>Description</p>	<p>Use this parameter in the <mac>.cfg file to configure the phone to dial a specific number to access an existing voicemail account on a Service Provider's server. The user then follows the voicemail instructions for listening to voicemails.</p> <p>Note: The phone must have a registered voicemail account from a server for this feature to be enabled.</p> <p>When no registered voicemail accounts are registered to the phone, the display shows "List Empty".</p> <p>The phone displays up to 99 voicemails for an account even if the number of voicemails exceeds the limit.</p> <p>Registered account numbers/URIs that exceed the length of the screen, either with or without the voicemail icon and the message count, are truncated with an ellipse character at the end of the number/URI string.</p>
<p>Format</p>	<p>String</p>
<p>Default Value</p>	<p>Not Applicable</p>
<p>Range</p>	<p>0 to 99</p>
<p>Example</p>	<p>sip line1 vmail: *97</p> <p>Note: In the above example, the user would dial *97 to access the voicemail account.</p>

Parameter – <i>sip vmail</i>	Configuration Files aastra.cfg, <mac>.cfg
Description	<p>Specifies the phone number of the voicemail system connected to the sip account. This parameter specifies the phone number you dial from your phone to retrieve your voicemail.</p> <p>Configuring this parameter allows you to call the voice mail system directly from the "voicemail" application via the IP Phone UI under the "Services" menu of the IP Phone.</p>
Format	Integer
Default Value	Not Applicable
Range	Not Applicable
Example	sip vmail: 5553435

Directory Settings

Parameter – <i>directory 1</i> <i>Directory List</i> (in Web UI)	Aastra Web UI Configuration Files Operation->Directory aastra.cfg, <mac>.cfg
Description	<p>The name of a directory list that you can download from the configuration server.</p> <p>Note: You can use this parameter in three ways:</p> <ul style="list-style-type: none"> • To download no directory • To download a directory from the original configuration server • To download a directory from another specified server <p>To download a specific file, the string value MUST HAVE A FILENAME at the end of the string. For example:</p> <p>directory 1: ftp://10.30.102.158/path/companylist.csv</p> <p>where “path” is the directory and “companylist.csv” is the filename. If you do not specify a filename, the download fails.</p> <p>See examples for each below.</p>
Format	Alphanumeric characters
Default Value	Not Applicable
Range	Not Applicable
Example	<p>The following example downloads no directory:</p> <p>directory 1:</p> <p>The following example downloads a company directory from the original configuration server:</p> <p>directory 1:companylist.csv</p> <p>The following example downloads a company directory file from the specified server in the “path” directory:</p> <p>directory 1: ftp://10.30.102.158/path/companylist.csv</p>

Parameter – <i>directory 2</i> <i>Directory List</i> (in Web UI)	Aastra Web UI Operation->Directory Configuration Files aastra.cfg, <mac>.cfg
Description	<p>The name of a directory list that you can download from the configuration server.</p> <p>Note: You can use this parameter in three ways:</p> <ul style="list-style-type: none"> • To download no directory • To download a directory from the original configuration server • To download a directory from another specified server <p>To download a specific file, the string value MUST HAVE A FILENAME at the end of the string. For example:</p> <p>directory 1: ftp://10.30.102.158/path/companylist.csv</p> <p>where “path” is the directory and “companylist.csv” is the filename. If you do not specify a filename, the download fails.</p> <p>See examples for each below.</p>
Format	Alphanumeric characters
Default Value	Not Applicable
Range	Not Applicable
Example	<p>The following example downloads no directory:</p> <p>directory 2:</p> <p>The following example downloads a company directory from the original configuration server:</p> <p>directory 2:companylist.csv</p> <p>The following example downloads a company directory file from the specified server in the “path” directory:</p> <p>directory 2: ftp://10.30.102.158/path/companylist.csv</p>

Parameter – <i>directory disabled</i>	Configuration Files aastra.cfg, <mac>.cfg
Description	Enables or disables the Directory on the IP phone. If this parameter is set to 0, users can access the Directory List via the IP phone UI. If this parameter is set to 1, the Directory List does not display on the IP phone and the Directory key is disabled. On the 6757i and 6757i CT the "Directory" option is also removed from the "Services" menu.
Format	Boolean
Default Value	0 (false)
Range	0 (false), 1 (true)
Example	directory disabled: 1

Callers List Settings

Parameter – <i>callers list disabled</i>	Configuration Files aastra.cfg, <mac>.cfg
Description	Enables or disables the Callers List. If this parameter is set to 0, the Callers List can be accessed by all users. If this parameter is set to 1, the IP phone does not save any caller information to the Caller List. For 6757i and 6757i CT phones, the "Caller List" option on the IP phone is removed from the Services menu, and the Caller List key is ignored if pressed by the user.
Format	Boolean
Default Value	0 (false)
Range	0 (false), 1 (true)
Example	callers list disabled: 1

Customize Callers List and Services Key

Parameter – <i>services script</i>	Configuration Files aastra.cfg, <mac>.cfg
Description	Allows you to specify a specific URI for accessing services after pressing the Services key. When this parameter is set, it overrides the standard function of the Services key.
Format	Alphanumeric characters
Default Value	N/A
Range	N/A
Example	services script: http://10.50.100.234/test.xml

Parameter – <i>callers list script</i>	Configuration Files aastra.cfg, <mac>.cfg
Description	Allows you to specify a specific URI for accessing the Callers List after pressing the Callers List key. When this parameter is set, it overrides the standard function of the Callers List key.
Format	Alphanumeric characters
Default Value	N/A
Range	N/A
Example	callers list script: http://10.50.100.234/test.xml

Call Forward Settings

Parameter – <i>call forward disabled</i>	IP Phone UI Aastra Web UI Configuration Files	Options->Call Forward Basic Settings->Account Configuration aastra.cfg, <mac>.cfg
Description	Enables or disables the ability to configure Call Forwarding. If this parameter is set to 0, a user and administrator can configure Call Forwarding via the Aastra Web UI and the IP Phone UI using the "Call Forward" options. If this parameter is set to 1, all "Call Forward" options are removed from the Aastra Web UI and the IP Phone UI, preventing the ability to configure Call Forwarding.	
Format	Boolean	
Default Value	0 (false)	
Range	0 (false), 1 (true)	
Example	call forward disabled: 1	

Call Forward Key Mode Settings

Parameter – <i>call forward key mode</i>	Aastra Web UI: Basic Settings->Preferences->General Configuration Files aastra.cfg, <mac>.cfg
Description	<p>Sets the mode for how the phone uses “call forwarding” (CFWD)</p> <ul style="list-style-type: none"> • account The account mode allows you to configure CFWD on a per account basis. Pressing a configured CFWD key applies to the account in focus. • phone The Phone mode allows you to set the same CFWD configuration for all accounts (All, Busy, and/or No Answer). When you configure the initial account, the phone applies the configuration to all other accounts. (In the Aastra Web UI, only the account you configured is enabled. All other accounts are grayed out but set to the same configuration.) Using the Aastra Web UI, if you make changes to that initial account, the changes apply to all accounts on the phone. • custom The Custom mode allows you to configure CFWD for a specific account or all accounts. You can configure a specific mode (All, Busy, and/or No Answer) for each account independently or all accounts. On 3-Line LCD phones, you can set all accounts to ALL On or ALL Off. On 8 and 11-Line LCD phones, you can set all accounts to All On, All Off, or copy the configuration for the account in focus to all other accounts using a CopytoAll softkey. <p>Notes:</p> <ol style="list-style-type: none"> 1. If there is no CFWD key configured on the phone or it is removed, you can still set the CFWD modes via the IP Phone UI at the path <i>Options->Call Forward</i>. 2. If there is only one account configured on the phone, then the mode setting is ignored and the phone behaves as if the mode was set to “Phone”. 3. When configuring a CFWD mode (All, Busy, No Answer) for an account, you must configure a CFWD number for that mode in order for the mode to be enabled.
Format	Integer
Default Value	0 (account)
Range	0 (account) 1 (phone) 2 (custom)
Example	call forward key mode: 2

Example

The following is an example of configuring the CFWD key mode in the configuration files:

```
call forward key mode: 2
softkey1 type: callforward
softkey1 states: idle connected incoming outgoing busy
```

In the above example, softkey 1 is configured for CFWD on line 1 (account 1) with a “**custom**” configuration. Pressing softkey 1 displays CFWD screens for which you can customize on the phone.

LLDP-MED and ELIN Settings

Parameter– <i>lldp</i> <i>LLDP Support</i> (IP Phone UI) <i>LLDP</i> (in Web UI)	Configuration Files IP Phone UI Aastra Web UI	aastra.cfg, <mac>.cfg Options->Administrator Menu-> Network Settings->Ethernet&VLAN-> LLDP Support Advanced Settings->Network-> Advanced Network Settings
Description	Enables or disables Link Layer Discovery Protocol for Media Endpoint Devices (LLDP-MED) on the IP Phone.	
Format	Boolean	
Default Value	1 (enabled)	
Range	0 (disabled) 1 (enabled)	
Example	lldp: 0	

Parameter– <i>lldp interval</i> <i>LLDP Packet Interval</i> (in Web UI)	Configuration Files Aastra Web UI	aastra.cfg, <mac>.cfg Advanced Settings->Network-> Advanced Network Settings
Description	The amount of time, in seconds, between the transmission of LLDP Data Unit (LLDPDU) packets. The value of zero (0) disables this parameter.	
Format	Integer	
Default Value	30	
Range	0 to 2147483647	
Example	lldp interval: 60	

Parameter – <i>use lldp elin</i> <i>Use LLDP ELIN</i> (in Web UI)	Configuration Files aastra.cfg, <mac>.cfg Aastra Web UI Basic Settings->Preferences->General
Description	Enables or disables the use of an Emergency Location Identification Number (ELIN) received from LLDP as a caller ID for emergency numbers.
Format	Boolean
Default Value	1 (enabled)
Range	0 (disabled) 1 (enabled)
Example	use lldp elin: 0

Missed Calls Indicator Settings

Parameter – <i>missed calls indicator disabled</i>	Configuration Files aastra.cfg, <mac>.cfg
Description	Enables or disables the Missed Calls Indicator. If the "missed calls indicator disabled" parameter is set to 0, the indicator increments as unanswered calls come into the IP phone. If the "missed calls indicator disabled" parameter is set to 1, the indicator is disabled and will NOT increment as unanswered calls come into the IP phone.
Format	Boolean
Default Value	0 (false)
Range	0 (false), 1 (true)
Example	missed calls indicator disabled: 1

XML Settings

Parameter – <i>xml get timeout</i>	Configuration Files aastra.cfg, <mac>.cfg
Description	Allows you to specify a timeout value, in seconds, that the phone waits for the far side to return a response after accepting the HTTP GET connection. If the far side accepts the GET connection but never returns a response, it blocks the phone until it is rebooted. If you enter a value greater than 0 for this parameter, the phone times out and will not be blocked.
Format	Integer
Default Value	0 (never timeout)
Range	0 to 214748364 seconds
Example	xml get timeout: 20

Parameter – <i>xml application URI</i> <i>XML Application URI</i> (in Web UI)	Aastra Web UI Operation->Softkeys and XML->Services Configuration Files aastra.cfg, <mac>.cfg
Description	This is the XML application you are loading into the IP phone configuration.
Format	HTTP server path or fully qualified Domain Name
Default Value	Not Applicable
Range	Not Applicable
Example	xml application URI: http://172.16.96.63/aastra/internet.php

Operational, Basic, and Advanced Parameters

Parameter – <i>xml application title</i> <i>XML Application Title</i> (in Web UI)	Aastra Web UI Configuration Files	Operation->Softkeys and XML->Services aastra.cfg, <mac>.cfg
Description	This parameter allows you to rename the XML application in the IP phone UI (Services->4. Custom Feature). By default, when you load an XML application to the IP phone, the XML application title is called "Custom Feature". The "xml application title" parameter allows you to change that title. For example, if you are loading a traffic report XML application, you could change this parameter title to "Traffic Reports", and that title will display in the IP phone UI as Services->4. Traffic Reports.	
Format	Alphanumeric characters	
Default Value	Not Applicable	
Range	Not Applicable	
Example	xml application title: Traffic Reports	

Parameter – <i>xml application post list</i> <i>XML Push Server List</i> <i>(Approved IP Addresses)</i> (in Web UI)	Aastra Web UI Configuration Files	Advanced Settings->Configuration Server aastra.cfg, <mac>.cfg
Description	The HTTP server that is pushing XML applications to the IP phone.	
Format	IP address in dotted decimal format and/or Domain name address	
Default Value	Not Applicable	
Range	Not Applicable	
Example	xml application post list: 10.50.10.53, dhcp10-53.ana.aastra.com	

<p>Parameter – <i>xml beep notification</i></p> <p><i>XML Beep Support</i> (in Web UI)</p>	<p>Aastra Web UI Basic Settings->Preferences Configuration Files aastra.cfg, <mac>.cfg</p>
Description	<p>Enables or disables a BEEP notification on the phone when a status message object (AastralPPhoneStatus) containing a “beep” attribute arrives to the phone.</p> <p>Changes to this parameter are applied immediately.</p>
Format	Boolean
Default Value	1 (ON)
Range	<p>0 (OFF)No beep is audible even if the beep attribute is present in the XML object.</p> <p>1 (ON)The phone beeps when an XML object with the “beep” attribute arrives to the phone.</p>
Example	xml beep notification: 0

<p>Parameter – <i>xml status scroll delay</i></p> <p><i>Status Scroll Delay (seconds)</i> (in Web UI)</p>	<p>Aastra Web UI Basic Settings->Preferences Configuration Files aastra.cfg, <mac>.cfg</p>
Description	<p>Specifies the length of time, in seconds, that each XML status message displays on the phone.</p> <p>Note: Changes to this parameter are applied immediately.</p>
Format	Integer
Default Value	5
Range	1 to 25
Example	xml status scroll delay: 3

Action URI Settings

Parameter – <i>action uri startup</i> <i>Startup</i> (in Web UI)	Aastra Web UI Advanced Settings->Action URI Configuration Files aastra.cfg, <mac>.cfg
Description	Specifies the URI for which the phone executes a GET on when a startup event occurs. This parameter can use any of the following variables: \$\$RE MOTENUMBER\$\$ \$\$DISP LAYNAME\$\$ \$\$SIPUSERNAME\$\$ \$\$SIPAUTHNAME\$\$ \$\$INCOMINGNAME\$ \$\$PROXYURL\$\$ \$\$LINESTATE\$\$ \$\$LOCALIP\$\$ \$\$DISP LAYNAME\$\$ \$\$CALLDURATION\$\$ \$\$CALLDIRECTION\$\$
Format	Fully qualified URI
Default Value	Not Applicable
Range	Up to 128 ASCII characters
Example	action uri startup: http://10.50.10.140/startup

<p>Parameter – <i>action uri registered</i></p> <p><i>Successful Registration</i> (in Web UI)</p>	<p>Aastra Web UI Advanced Settings->Action URI Configuration Files aastra.cfg, <mac>.cfg</p>
<p>Description</p>	<p>Specifies the URI for which the phone executes a GET on when a successful registration event occurs. This parameter can use the following variables: \$\$SIPUSERNAME\$\$ \$\$SIPAUTHNAME\$\$ \$\$PROXYURL\$\$ \$\$LINESTATE\$\$ \$\$LOCALIP\$\$ Note: The “action uri registered” parameter executes on the first successful registration of each unique line configured on the phone.</p>
<p>Format</p>	<p>Fully qualified URI</p>
<p>Default Value</p>	<p>Not Applicable</p>
<p>Range</p>	<p>Up to 128 ASCII characters</p>
<p>Example</p>	<p>action uri registered: http://10.50.10.14/registered.php?auth name=\$\$SIPAUTHNAME\$\$</p>

Operational, Basic, and Advanced Parameters

Parameter – <i>action uri registration event</i> <i>Registration Event</i> (in Web UI)	Configuration Files aastra.cfg, <mac>.cfg Aastra Web UI Advanced Settings->Action URI
Description	Specifies the URI that the phone executes a GET on, when a registration event change occurs. This parameter uses the following variables to determine the state of the event: \$\$REGISTRATIONSTATE\$\$ \$\$REGISTRATIONCODE\$\$ Note: This action URI is not called when the same event is repeated (for example, a timeout occurs again when registration is already in a timeout state.)
Format	String
Default Value	Not Applicable
Range	Any valid URI
Example	action uri registration event: http://10.30.100.39/PHPtests/ actionuri.php?action=RegEvt®state=\$\$REGISTRATIONSTATE\$\$®code=\$\$REGISTRATIONCODE\$\$

Parameter – <i>action uri incoming</i> <i>Incoming Call</i> (in Web UI)	Aastra Web UI Configuration Files	Advanced Settings->Action URI aastra.cfg, <mac>.cfg
Description	Specifies the URI for which the phone executes a GET on when an incoming call event occurs. This parameter can use the following variables: \$\$REMOTENUMBER\$\$ \$\$DISPLAYNAME\$\$ \$\$SIPUSERNAME\$\$ \$\$INCOMINGNAME\$\$ \$\$LINESTATE\$\$ \$\$CALLDURATION\$\$ \$\$CALLDIRECTION\$\$ \$\$LOCALIP\$\$	
Format	Fully qualified URI	
Default Value	Not Applicable	
Range	Up to 128 ASCII characters	
Example	action uri incoming: http://10.50.10.140/ incoming.php?number=\$\$REMOTENUMBER\$\$	

Parameter – <i>action uri outgoing</i> <i>Outgoing Call</i> (in Web UI)	Aastra Web UI Configuration Files	Advanced Settings->Action URI aastra.cfg, <mac>.cfg
Description	Specifies the URI for which the phone executes a GET on when an outgoing call event occurs. This parameter can use the following variables: \$\$REMOTENUMBER\$\$ \$\$SIPUSERNAME\$\$ \$\$LINESTATE\$\$ \$\$LOCALIP\$\$	
Format	Fully qualified URI	
Default Value	Not Applicable	
Range	Up to 128 ASCII characters	
Example	action uri outgoing: http://10.50.10.140/ outgoing.php?number=\$\$REMOTENUMBER\$\$	

Operational, Basic, and Advanced Parameters

Parameter – <i>action uri offhook</i>	Aastra Web UI Configuration Files	Advanced Settings->Action URI aastra.cfg, <mac>.cfg
<i>Offhook</i> (in Web UI)		
Description	Specifies the URI for which the phone executes a GET on when an offhook event occurs. This parameter can use the following variables: \$\$LINESTATE\$\$ \$\$LOCALIP\$\$	
Format	Fully qualified URI	
Default Value	Not Applicable	
Range	Up to 128 ASCII characters	
Example	action uri offhook: http://10.50.10.140/offhook	

Parameter – <i>action uri onhook</i>	Aastra Web UI Configuration Files	Advanced Settings->Action URI aastra.cfg, <mac>.cfg
<i>Onhook</i> (in Web UI)		
Description	Specifies the URI for which the phone executes a GET on when an onhook event occurs. This parameter can use the following variables: \$\$LOCALIP\$\$ \$\$CALLDURATION\$\$ \$\$CALLDIRECTION\$\$ \$\$LINESTATE\$\$ Note: The “LocalIP”, “CallDuration”, and “CallDirection” variables allow for enhanced information in call records and billing applications.	
Format	Fully qualified URI	
Default Value	Not Applicable	
Range	Up to 128 ASCII characters	
Example	action uri onhook: http://10.50.10.140/onhook	

Parameter – <i>action uri disconnected</i>	Aastra Web UI Advanced Settings->Action URI->Event Configuration Files aastra.cfg, <mac>.cfg
Description	Specifies the URI that the phone executes a GET on, when it transitions from the incoming, outgoing, calling, or connected state into the idle state. This parameter uses the following variables to determine the state of the line: \$\$LINESTATE\$\$ \$\$LOCALIP\$\$
Format	String
Default Value	Not Applicable
Range	Any valid URI
Example	action uri disconnected: http://fargo.ana.aastra.com/ disconnected.xml?state=\$\$LINESTATE\$\$

XML SIP Notify Settings

Parameter – <i>sip xml notify event</i>	Aastra Web UI: Advanced Settings->Global SIP-> Advanced SIP Settings Configuration Files aastra.cfg, <mac>.cfg
Description	Enables or disables the phone to accept or reject an aastra-xml SIP NOTIFY message. Note: To ensure the SIP NOTIFY is coming from a trusted source, it is recommended that you enable the Whitelist feature (Whitelist Proxy parameter) on the IP phone. If enabled, and the phone receives a SIP NOTIFY from a server that is NOT on the whitelist (i.e. untrusted server), the phone rejects the message.
Format	Boolean
Default Value	0
Range	0 - disabled 1 - enabled
Example	sip xml notify event: 1

Parameter – <i>action uri xml sip notify</i>	Aastra Web UI: Advanced Settings->Action URI Configuration Files aastra.cfg, <mac>.cfg
Description	Specifies the URI to be called when an empty XML SIP NOTIFY is received by the phone. This parameter can use the following variable: \$\$LOCALIP\$\$ Note: The sip xml notify event parameter must be enabled.
Format	HTTP(s) server path or Fully Qualified Domain Name
Default Value	N/A
Range	N/A
Example	action uri xml sip notify: http://myserver.com/myappli.xml

Polling Action URI Settings

Parameter – <i>action uri poll</i>	Aastra Web UI Advanced Settings->Action URI Configuration Files aastra.cfg, <mac>.cfg
Description	Specifies the URI to be called every "action uri poll interval" seconds.
Format	HTTP(s) server path or Fully Qualified Domain Name
Default Value	N/A
Range	N/A
Example	action uri poll: http://myserver.com/myappli.xml

Parameter – <i>action uri poll interval</i>	Aastra Web UI Advanced Settings->Action URI Configuration Files aastra.cfg, <mac>.cfg
Description	Specifies the interval, in seconds, between calls from the phone to the "action uri poll".
Format	Integer
Default Value	0 (disabled)
Range	N/A
Example	action uri poll interval: 60

Ring Tone and Tone Set Global Settings

Parameter – <i>ring tone</i> <i>Global Ring Tone</i> (in Web UI)	IP Phone UI Aastra Web UI: Configuration Files	Options->Tones->Set Ring Tone Basic Settings->Preferences->Ring Tones aastra.cfg, <mac>.cfg
Description	Globally sets the type of ring tone on the IP phone. Ring tone can be set to one of six distinct rings.	
Format	Integer	
Default Value	Aastra Web UI: Tone 1 IP Phone UI: Tone 1 Configuration Files: 0 (Tone 1)	
Range	Aastra Web UI & IP Phone UI Tone 1 Tone 2 Tone 3 Tone 4 Tone 5 Silent Configuration Files 0 (Tone 1) 1 (Tone 2) 2 (Tone 3) 3 (Tone 4) 4 (Tone 5) 5 (Silent)	
Example	ring tone: 3	

<p>Parameter – <i>tone set</i></p> <p><i>Tone Set</i> (in Web UI)</p>	<p>IP Phone UI Aastra Web UI: Configuration Files</p> <p>Options->Tones->Tone Set Basic Settings->Preferences->Ring Tones aastra.cfg, <mac>.cfg</p>
<p>Description</p>	<p>Globally sets a tone set for a specific country.</p>
<p>Format</p>	<p>Text</p>
<p>Default Value</p>	<p>US</p>
<p>Range</p>	<p>Australia Europe (generic tones) France Germany Italy Mexico Brazil United Kingdom (UK) US (also used in Canada)</p>
<p>Example</p>	<p>tone set: Germany</p>

Ring Tone Per-Line Settings

Parameter – <i>lineN ring tone</i> <i>N=1 through 9</i> <i>Line N</i> (in Web UI)	Aastra Web UI: Basic Settings->Preferences->Ring Tones Configuration Files aastra.cfg, <mac>.cfg
Description	Sets the type of ring tone on the IP phone on a per-line basis. Ring tone can be set to one of six distinct rings. Note: LineN is applicable to lines 1 through 9. Not applicable to the 6751i.
Format	Integer
Default Value	Aastra Web UI: Global Configuration Files: -1 (Global)
Range	Aastra Web UI Global Tone 1 Tone 2 Tone 3 Tone 4 Tone 5 Silent Configuration Files -1 (Global) 0 (Tone 1) 1 (Tone 2) 2 (Tone 3) 3 (Tone 4) 4 (Tone 5) 5 (Silent)
Example	line1 ring tone: 3

Incoming Call Interrupts Dialing Setting

<p>Parameter – <i>incoming call cancels dialing</i></p> <p><i>Incoming Call Interrupts Dialing</i> (in Web UI)</p>	<p>Aastra Web UI: Basic Settings->Preferences->General Configuration Files aastra.cfg, <mac>.cfg</p>
<p>Description</p>	<p>Enables or disables how the phone handles incoming calls while the phone is dialing out.</p> <p>When you enable this parameter (1 = true), an incoming call interrupts the outgoing call during dialing and allows the phone to ring for the user to answer the incoming call.</p> <p>When you disable this parameter (0 = disable), which is the default, the phone does not interrupt the outgoing call during dialing and the number you were dialing continues to display in the LCD. The phone sends the incoming call to a free line on the phone (or sends busy signal if all remaining lines are busy) and the LED for that line blinks. You have a choice to ignore the incoming call, or answer the incoming call on another line, via the Ignore and Answer softkeys that display. If you choose to answer the incoming call, you can answer the call, finish the call, and then hang up. You can still go back to the original outgoing call and finish dialing out.</p> <p>Notes:</p> <ol style="list-style-type: none"> 1. On 3-Line LCD phones (not applicable to the 6751i), you must use the up and down arrow keys to ignore or answer the call. 2. On all phone models, if you disable this parameter (0=disable), and the phone receives an incoming call while you are dialing an outgoing call, you can pick up the call and perform transfer or conference as required. <p>After enabling or disabling this feature, it takes affect on the phone immediately.</p>

Description (Cont'd)	<p>Transfer/Conference Call Behavior If you are dialing the phone to transfer or conference a call, and your phone receives an incoming call, your dialing is never interrupted (regardless of whether the “Incoming Call Interrupts Dialing” is enabled or disabled). For Transfer and Conference, the incoming calls always go to an available line (other than the one you are using for dialing) and the incoming call’s line LED blinks. The LCD still displays your dialing screen.</p> <p>Intercom Behavior If “Incoming Call Interrupts Dialing” (or incoming call cancels dialing in config files) is enabled and you are dialing an outgoing Intercom call, the enabled interrupt setting takes precedence over an enabled “Allow Barge In” setting. The incoming call interrupts your dialing on an outgoing intercom call. On an incoming intercom call, the enabled “Allow Barge In” and “Auto-Answer” occurs while you are dialing to transfer or conference the call. However, the incoming call goes to an available idle line, and the LED blinks while you are dialing the second half of the conference or transfer.</p> <p>If “Incoming Call Interrupts Dialing” (or incoming call cancels dialing in config files) is disabled, an incoming intercom goes to an available idle line and the LED blinks for that line. The phone answers the call under all conditions.</p>
Format	Boolean
Default Value	0 (disable)
Range	0 (disable) 1 (enable)
Example	incoming call cancels dialing: 1

Status Code on Ignoring Incoming Calls

Parameter – <i>sip ignore status code</i>	Configuration Files aastra.cfg, <mac>.cfg
Description	Specifies the status code that is sent in the response to the server when a user ignores an incoming call.
Format	Integer
Default Value	486
Range	Valid SIP final negative response code (Refer to RFC3261)
Example	sip ignore status code: 486

Switch Focus to Ringing Line

Parameter – <i>switch focus to ringing line</i>	Aastra Web UI: Basic Settings->Preferences->General Configuration Files aastra.cfg, <mac>.cfg
Description	Specifies whether or not the UI focus is switched to a ringing line while the phone is in the connected state.
Format	Boolean
Default Value	1 (enable)
Range	0 (disable) 1 (enable)
Example	switch focus to ringing line: 1

Preferred Line and Preferred Line Timeout

Parameter– <i>preferred line</i>	Configuration Files Aastra Web UI	aastra.cfg, <mac>.cfg Basic Settings->Preferences->General
<i>Preferred Line (in Web UI)</i>		
Description	Specifies the preferred line to switch focus to when incoming or outgoing calls end on the phone.	
Format	Integer	
Default Value	1	
Range	0 (none - disables the preferred line focus feature) 1 to 9	
Example	preferred line: 2	

Parameter– <i>preferred line timeout</i>	Configuration Files Aastra Web UI	aastra.cfg, <mac>.cfg Basic Settings->Preferences->General
<i>Preferred Line Timeout (seconds) (in Web UI)</i>		
Description	Specifies the time, in seconds, that the phone switches back to the preferred line after a call (incoming or outgoing) ends on the phone, or after a duration of inactivity on an active line.	
Format	Integer	
Default Value	0 (the phone returns the line to the preferred line immediately)	
Range	0 to 999	
Example	preferred line timeout: 30	

Goodbye Key Cancels Incoming Call

<p>Parameter – <i>goodbye cancels incoming call</i></p> <p><i>Goodbye Key Cancels Incoming Call</i> (in Web UI)</p>	<p>Aastra Web UI: Basic Settings->Preferences->General Configuration Files aastra.cfg, <mac>.cfg</p>
<p>Description</p>	<p>Enable or disables the behavior of the Goodbye Key on the IP phone.</p> <p>When you enable this parameter (1 = enable), the Goodbye key rejects the incoming call. When you disable this parameter (0 = disable), the Goodbye key hangs up the active call.</p> <p>For 8 and 11-Line LCD phones: If you enable this parameter, and the phone receives another call when an active call is already present, the phone displays softkey 1 as “answer” and softkey 2 as “ignore”. You can press the required softkey as applicable.</p> <p>For 3-Line LCD phones: If you enable this parameter, and the phone receives another call when an active call is already present, the “ignore” option <i>only</i> displays in the LCD window. The phone ignores the incoming call. If you press the DOWN arrow key, the phone answers the incoming call.</p> <p>Note: After enabling or disabling this feature, it takes affect on the phone immediately.</p>
<p>Format</p>	<p>Boolean</p>
<p>Default Value</p>	<p>1 (true)</p>
<p>Range</p>	<p>0 (false) 1 (true)</p>
<p>Example</p>	<p>goodbye cancels incoming call: 0</p>

Stuttered Dial Tone Setting

Parameter – <i>stutter disabled</i>	Aastra Web UI: Basic Settings->Preferences->General Configuration Files aastra.cfg, <mac>.cfg
<i>Stuttered Dial Tone</i> (in Web UI)	
Description	Enable or disables the playing of a stuttered dial tone when there is a message waiting on the IP phone.
Format	Boolean
Default Value	0 (false)
Range	0 (false) 1 (true)
Example	stuttered disabled: 1

Call Waiting Settings

Parameter – <i>call waiting</i> <i>Call Waiting</i> (in Web UI)	Aastra Web UI Basic Settings->Preferences->General Configuration Files aastra.cfg, <mac>.cfg
Description	<p>Allows you to enable or disable Call Waiting on the IP phone.</p> <p>If you enable call waiting (default), the user has the option of accepting a second call while currently on the first call. If you disable call waiting, and a user is currently on a call, a second incoming call is automatically rejected by the phone with a busy message.</p> <p>If you disable call waiting on the phone, and the user is on a call, any further incoming calls will receive busy unless “Call Forward Busy” or “Call Forward No Answer and Busy” is configured on the phone. It will then forward the call according to the rule configured. The phone can only:</p> <ul style="list-style-type: none"> • -transfer the currently active call or • accept transferred calls if there is no active calls. <p>If call waiting is disabled:</p> <ul style="list-style-type: none"> • on the 6757i CT base, and the handset is currently on a call, all additional incoming calls are rejected on the handset. • intercom calls are treated as regular incoming calls and are rejected. • pre-dialing with live dial pad disabled still accepts incoming calls. • the “Incoming Call Cancels Dialing” parameter is ignored because the incoming call is automatically rejected. • the Missed Calls List does not get updated with details of calls. • the Blind Transfer feature on the phone may not work if two calls are made to the phone at one time.
Format	Boolean
Default Value	1 (enabled)
Range	0 (disabled) 1 (enabled)
Example	call waiting: 0

Operational, Basic, and Advanced Parameters

Parameter – <i>call waiting tone</i>	Aastra Web UI: Basic Settings->Preferences->General Configuration Files aastra.cfg, <mac>.cfg
<i>Play Call Waiting Tone</i> (in Web UI)	
Description	Enable or disables the playing of a call waiting tone when a caller is on an active call and a new call comes into the phone. Note: The Call Waiting Tone feature works only if the Call Waiting parameter is enabled.
Format	Boolean
Default Value	1 (enabled)
Range	0 (disable) 1 (enabled)
Example	call waiting tone: 0

Message Waiting Indicator Settings

Parameter – <i>mwi led line</i>	Aastra Web UI Basic Settings->Preferences->General Configuration Files aastra.cfg, <mac>.cfg
<i>Message Waiting Indicator Line</i> (in Web UI)	
Description	Allows you to enable the Message Waiting Indicator (MWI) on a single line or on all lines on the phone. For example, if you set this parameter to 3, the LED illuminates if a voice mail is pending on line 3. If you set this parameter to 0, the LED illuminates if a voice mail is pending on any line on the phone (lines 1 through 9). Note: To enable MWI for all lines in the configuration files, set this parameter to zero (0). The enable MWI for all lines in the Aastra Web UI, select "All" in the "Message Waiting Indicator Line" field.
Format	Integer
Default Value	0 (all lines)
Range	0 to 9
Example	mwi led line: 3

DND Key Mode Settings

Parameter – <i>dnd key mode</i>	Aastra Web UI: Basic Settings->Preferences->General Configuration Files aastra.cfg, <mac>.cfg
Description	<p>Sets the mode for how the phone uses “do not disturb” (DND):</p> <ul style="list-style-type: none"> • account Sets DND for a specific account. DND key toggles the account in focus on the IP Phone UI, to ON or OFF. • phone Sets DND ON for all accounts on the phone. DND key toggles all accounts on the phone to ON or OFF. • custom Sets the phone to display custom screens after pressing the DND key, that list the account(s) on the phone. The user can select a specific account for DND, turn DND ON for all accounts, or turn DND OFF for all accounts. <p>Notes:</p> <ol style="list-style-type: none"> 1. If there is only one account configured on the phone, then the mode setting is ignored and the phone behaves as if the mode was set to “Phone”. 2. You must configure a DND key on the phone to use this feature. To configure a DND key, see “Softkey/Programmable Key/Feature Key/Expansion Module Key Parameters” on page A-216.
Format	Integer
Default Value	1 (phone)
Range	0 (account) 1 (phone) 2 (custom)
Example	dnd key mode: 2

Example

The following is an example of configuring the mode for DND in the configuration files:

```
dnd key mode: 2
softkey1 type: dnd
softkey1 states: idle connected incoming outgoing busy
```

In the above example, softkey 1 is configured for DND for line 1 only, with a “**custom**” configuration. Pressing softkey 1 displays DND screens for which you can customize on the phone.

Priority Alert Settings

Parameter – <i>priority alerting enabled</i> <i>Enable Priority Alerting</i> (in Web UI)	Aastra Web UI: Basic Settings->Preferences-> Priority Alerting Settings Configuration Files aastra.cfg, <mac>.cfg
Description	Enables and disables distinctive ringing on the IP phone for incoming calls and call-waiting calls.
Format	Boolean
Default Value	1 (true)
Range	0 (false) 1 (true)
Example	priority alerting enabled: 0

For Sylanro Server only

Parameter – <i>alert auto call distribution</i> <i>auto call distribution</i> (in Web UI)	Aastra Web UI: Basic Settings->Preferences-> Priority Alerting Settings Configuration Files aastra.cfg, <mac>.cfg
Description	When an "alert-acd" keyword appears in the header of the INVITE request, the configured Bellcore ring tone is applied to the IP phone.
Format	Integer
Default Value	0 Normal ringing
Range	0 Normal ringing (default) 1 Bellcore-dr2 2 Bellcore-dr3 3 Bellcore-dr4 4 Bellcore-dr5 5 Silent
Example	alert auto call distribution: 2

Parameter – <i>alert community 1</i> <i>community-1</i> (in Web UI)	Aastra Web UI: Basic Settings->Preferences-> Priority Alerting Settings Configuration Files aastra.cfg, <mac>.cfg
Description	When an "alert community-1" keyword appears in the header of the INVITE request, the configured Bellcore ring tone is applied to the IP phone.
Format	Integer
Default Value	0 Normal ringing
Range	0 Normal ringing (default) 1 Bellcore-dr2 2 Bellcore-dr3 3 Bellcore-dr4 4 Bellcore-dr5 5 Silent
Example	alert community 1: 3

Parameter – <i>alert community 2</i> <i>community-2</i> (in Web UI)	Aastra Web UI: Basic Settings->Preferences-> Priority Alerting Settings Configuration Files aastra.cfg, <mac>.cfg
Description	When an "alert community-2" keyword appears in the header of the INVITE request, the configured Bellcore ring tone is applied to the IP phone.
Format	Integer
Default Value	0 Normal ringing
Range	0 Normal ringing (default) 1 Bellcore-dr2 2 Bellcore-dr3 3 Bellcore-dr4 4 Bellcore-dr5 5 Silent
Example	alert community 2: 4

Operational, Basic, and Advanced Parameters

Parameter – <i>alert community 3</i> <i>community-3</i> (in Web UI)	Aastra Web UI: Basic Settings->Preferences-> Priority Alerting Settings Configuration Files aastra.cfg, <mac>.cfg
Description	When an "alert community-3" keyword appears in the header of the INVITE request, the configured Bellcore ring tone is applied to the IP phone.
Format	Integer
Default Value	0 Normal ringing
Range	0 Normal ringing (default) 1 Bellcore-dr2 2 Bellcore-dr3 3 Bellcore-dr4 4 Bellcore-dr5 5 Silent
Example	alert community 3: 1

Parameter – <i>alert community 4</i> <i>community-4</i> (in Web UI)	Aastra Web UI: Basic Settings->Preferences-> Priority Alerting Settings Configuration Files aastra.cfg, <mac>.cfg
Description	When an "alert community-4" keyword appears in the header of the INVITE request, the configured Bellcore ring tone is applied to the IP phone.
Format	Integer
Default Value	0 Normal ringing
Range	0 Normal ringing (default) 1 Bellcore-dr2 2 Bellcore-dr3 3 Bellcore-dr4 4 Bellcore-dr5 5 Silent
Example	alert community 4: 2

Parameter – <i>alert external</i> <i>alert external</i> (in Web UI)	Aastra Web UI: Basic Settings->Preferences-> Priority Alerting Settings Configuration Files aastra.cfg, <mac>.cfg
Description	When an "alert external" keyword appears in the header of the INVITE request, the configured Bellcore ring tone is applied to the IP phone.
Format	Integer
Default Value	0 Normal ringing
Range	0 Normal ringing (default) 1 Bellcore-dr2 2 Bellcore-dr3 3 Bellcore-dr4 4 Bellcore-dr5 5 Silent
Example	alert external: 4

Parameter – <i>alert emergency</i> <i>alert emergency</i> (in Web UI)	Aastra Web UI: Basic Settings->Preferences-> Priority Alerting Settings Configuration Files aastra.cfg, <mac>.cfg
Description	When an "alert emergency" keyword appears in the header of the INVITE request, the configured Bellcore ring tone is applied to the IP phone.
Format	Integer
Default Value	0 Normal ringing
Range	0 Normal ringing (default) 1 Bellcore-dr2 2 Bellcore-dr3 3 Bellcore-dr4 4 Bellcore-dr5 5 Silent
Example	alert emergency: 4

Operational, Basic, and Advanced Parameters

Parameter – <i>alert group</i> <i>Group</i> (in Web UI)	Aastra Web UI: Basic Settings->Preferences-> Priority Alerting Settings Configuration Files aastra.cfg, <mac>.cfg
Description	When an "alert group" keyword appears in the header of the INVITE request, the configured Bellcore ring tone is applied to the IP phone.
Format	Integer
Default Value	0 Normal ringing
Range	0 Normal ringing (default) 1 Bellcore-dr2 2 Bellcore-dr3 3 Bellcore-dr4 4 Bellcore-dr5 5 Silent
Example	alert group: 4

Parameter – <i>alert internal</i> <i>alert internal</i> (in Web UI)	Aastra Web UI: Basic Settings->Preferences-> Priority Alerting Settings Configuration Files aastra.cfg, <mac>.cfg
Description	When an "alert-internal" keyword appears in the header of the INVITE request, the configured Bellcore ring tone is applied to the IP phone.
Format	Integer
Default Value	0 Normal ringing
Range	0 Normal ringing (default) 1 Bellcore-dr2 2 Bellcore-dr3 3 Bellcore-dr4 4 Bellcore-dr5 5 Silent
Example	alert internal: 4

Parameter – <i>alert priority</i>	Aastra Web UI: Basic Settings->Preferences-> Priority Alerting Settings
<i>alert priority</i> (in Web UI)	Configuration Files aastra.cfg, <mac>.cfg
Description	When an "alert priority" keyword appears in the header of the INVITE request, the configured Bellcore ring tone is applied to the IP phone.
Format	Integer
Default Value	0 Normal ringing
Range	0 Normal ringing (default) 1 Bellcore-dr2 2 Bellcore-dr3 3 Bellcore-dr4 4 Bellcore-dr5 5 Silent
Example	alert priority: 4

Bellcore Cadence Settings

Parameter– <i>bellcore cadence dr2</i>	Configuration Files aastra.cfg, <mac>.cfg
Description	Sets the cadence for Bellcore-dr2. Note: You can define up to 8 cadence rings. The value of -1 indicates "do not repeat".
Format	Integer
Default Value	800,400, 800,4000
Range	N/A
Example	bellcore cadence dr2: 800, 400, 800, 4000

Operational, Basic, and Advanced Parameters

Parameter – <i>bellcore cadence dr3</i>	Configuration Files aastra.cfg, <mac>.cfg
Description	Sets the cadence for Bellcore-dr3. Note: You can define up to 8 cadence rings. The value of -1 indicates “do not repeat”.
Format	Integer
Default Value	400,200,400,200,800,4000
Range	N/A
Example	bellcore cadence dr3: 400,200,400,200,800,4000

Parameter – <i>bellcore cadence dr4</i>	Configuration Files aastra.cfg, <mac>.cfg
Description	Sets the cadence for Bellcore-dr4. Note: You can define up to 8 cadence rings. The value of -1 indicates “do not repeat”.
Format	Integer
Default Value	300,200,1000,200,300,4000
Range	N/A
Example	bellcore cadence dr4: 300,200,1000,200,300,300,200,4000

Parameter – <i>bellcore cadence dr5</i>	Configuration Files aastra.cfg, <mac>.cfg
Description	Sets the cadence for Bellcore-dr5. Note: You can define up to 8 cadence rings. The value of -1 indicates “do not repeat”.
Format	Integer
Default Value	500,-1
Range	N/A
Example	bellcore cadence dr5: 500,-1

SIP Diversion Display

Global Setting

Parameter – <i>sip diversion display</i>	Configuration Files aastra.cfg, <mac>.cfg
Description	Global parameter that enables/disables the display of the Caller ID and/or caller name, and reason for diversion on the phones LCD for an outgoing call that is being diverted to another destination. The phone that receives the diverted call displays the Caller ID of the original call destination. Note: You must restart the phone after setting a value for this parameter.
Format	Boolean
Default Value	1
Range	0 (disabled - do not display diversion information to the phone's LCD) 1 (enabled - display diversion information to the phone's LCD)
Example	sip diversion display: 0

Per-Line Setting

Parameter – <i>sip lineN diversion display</i> (N is a line number from 1 to 9)	Configuration Files aastra.cfg, <mac>.cfg
Description	For a specific line on the phone, this parameter enables/disables the display of the Caller ID and/or caller name, and reason for diversion on the phones LCD for an outgoing call that is being diverted to another destination. The phone that receives the diverted call displays the Caller ID of the original call destination. Note: You must restart the phone after setting a value for this parameter.
Format	Boolean
Default Value	1
Range	0 (disabled - do not display diversion information to the phone's LCD) 1 (enabled - display diversion information to the phone's LCD)
Example	sip line1 diversion display: 0

Display of Call Destination for Incoming Calls

Parameter – <i>show call destination name</i>	Configuration Files aastra.cfg, <mac>.cfg
Description	Enable/disables the display of the call destination name to the LCD on the phone during incoming calls.
Format	Boolean
Default Value	0
Range	0 (disabled) 1 (enabled)
Example	show call destination name: 1

Language Settings

Parameter – <i>language</i> <i>Webpage Language</i> (in Web UI)	IP Phone UI Options->Language Aastra Web UI Basic Settings->Preferences-> Language Settings->Webpage Language Configuration File aastra.cfg, <mac>.cfg
Description	<p>The language you want to display in the IP Phone UI and the Aastra Web UI.</p> <p>Valid values for all phones are:</p> <ul style="list-style-type: none"> 0 (English) 1 (French) 2 (Spanish) 3 (German) 4 (Italian) 5 (Portuguese) <p>Valid values for CT cordless handsets are:</p> <ul style="list-style-type: none"> 0 (English) 1 (French) 2 (Spanish) <p>Note: All languages may not be available for selection. The available languages are dependant on the language packs currently loaded to the IP phone. For more information about loading language packs, see “Loading Language Packs” on page -34.</p>
Format	Integer
Default Value	0
Range	0 to 4 (all phones) 0 to 2 (for CT handsets)
Example	language: 2 language: 3 language: 4

Parameter– <i>input language</i> <i>Input Language</i> (in Web UI)	IP Phone UI: Language->Input Language Aastra Web UI: Basic Settings->Preferences->Language Settings Configuration Files aastra.cfg, <mac>.cfg
Description	Allows you to specify the language to use for inputs on the IP Phone. Entering a language value for this parameter allows users to enter text and characters in the IP Phone UI, Aastra Web UI, and in XML applications via the keypad on the phone, in the language(s) specified.
Format	Text
Default Value	English
Range	Valid values are: <ul style="list-style-type: none"> • English • French • Français • German • Deutsch • Italian • Italiano • Spanish • Español • Português
Example	input language: French input language: Español

Language Pack Settings

<p>Parameter – <i>language N</i></p> <p><i>Language N</i> (in Web UI)</p> <p>Where “N” can be 1, 2, 3, or 4</p>	<p>Aastra Web UI Basic Settings->Preferences-> Language Settings</p> <p>Configuration File <mac>.cfg</p>
<p>Description</p>	<p>The language pack you want to load to the IP phone.</p> <p>Valid values are:</p> <p>lang_de.txt (German)* lang_es.txt (Spanish) lang_es_mx.txt (Mexican Spanish) lang_fr.txt (French) lang_fr_ca.txt (Canadian French) lang_it.txt (Italian) lang_pt.txt (Portuguese) lang_pt_br.txt (Brazilian Portuguese)</p> <p>You can use this parameter in three ways:</p> <ul style="list-style-type: none"> • To download no language packs • To download a language pack(s) from the original configuration server • To download a language pack(s) from another specified server <p>Notes:</p> <ol style="list-style-type: none"> 1. The languages packs you load are dependant on available language packs from the configuration server. For more information about loading language packs, see “Loading Language Packs” on page -34. 2. You must reboot the phone to load a language pack. 3. To download a specific file, the string value MUST HAVE A FILENAME at the end of the string. For example: <p>language 1:ftp://admin:admin!@1.2.3.4:50/path/lang_de.txt</p> <p>where “path” is the directory and “lang_de.txt” is the filename. If you do not specify a filename, the download fails.</p> <p>See examples for each below.</p>

Format	lang_<ISO 639>_<ISO 3166>.txt or lang_<ISO 639>.txt Note: For valid values for <ISO 639> and <ISO 3166>, see “Language Codes (from Standard ISO 639)” on page A-189 and “Country Codes (from Standard ISO 3166)” on page A-189.
Default Value	N/A
Range	N/A
Example	<p>The following example downloads no language pack file:</p> <pre>language 1:</pre> <p>The following example downloads the German language pack to the phones from the original configuration server:</p> <pre>language 1: lang_de.txt</pre> <p>The following example uses FTP to download the firmware file “lang_de.txt” (German language pack) from the “path” directory on server 1.2.3.4 using port 50:</p> <pre>language 1:ftp://admin:admin!@1.2.3.4:50/path/lang_de.txt</pre>

The following table identifies the language code to use for the IP phone language packs.

Language Codes (from Standard ISO 639)

Language	Language Code
English	en
European French	fr
French Canadian	fr_ca
European Spanish	es
Mexican Spanish	es_mx
German	de
Italian	it
Portuguese	pt
Brazilian Portuguese	br_pt

The following table identifies the country codes to use for the IP phone language packs.

Country Codes (from Standard ISO 3166)

Country	Country Code
AFGHANISTAN	AF
ÅLAND ISLANDS	AX
ALBANIA	AL
ALGERIA	DZ
AMERICAN SAMOA	AS
ANDORRA	AD
ANGOLA	AO
ANGUILLA	AI
ANTARCTICA	AQ
ANTIGUA AND BARBUDA	AG
ARGENTINA	AR
ARMENIA	AM
ARUBA	AW
AUSTRALIA	AU
AUSTRIA	AT
AZERBAIJAN	AZ

Operational, Basic, and Advanced Parameters

Country	Country Code
BAHAMAS	BS
BAHRAIN	BH
BANGLADESH	BD
BARBADOS	BB
BELARUS	BY
BELGIUM	BE
BELIZE	BZ
BENIN	BJ
BERMUDA	BM
BHUTAN	BT
BOLIVIA	BO
BOSNIA AND HERZEGOVINA	BA
BOTSWANA	BW
BOUVET ISLAND	BV
BRAZIL	BR
BRITISH INDIAN OCEAN TERRITORY	IO
BRUNEI DARUSSALAM	BN
BULGARIA	BG
BURKINA FASO	BF
BURUNDI	BI
CAMBODIA	KH
CAMEROON	CM
CANADA	CA
CAPE VERDE	CV
CAYMAN ISLANDS	KY
CENTRAL AFRICAN REPUBLIC	CF
CHAD	TD
CHILE	CL
CHINA	CN
CHRISTMAS ISLAND	CX
COCOS (KEELING) ISLANDS	CC
COLOMBIA	CO
COMOROS	KM
CONGO	CG
CONGO, THE DEMOCRATIC REPUBLIC OF THE	CD
COOK ISLANDS	CK
COSTA RICA	CR
CÔTE D'IVOIRE	CI
CROATIA	HR
CUBA	CU
CYPRUS	CY
CZECH REPUBLIC	CZ

Operational, Basic, and Advanced Parameters

Country	Country Code
DENMARK	DK
DJIBOUTI	DJ
DOMINICA	DM
DOMINICAN REPUBLIC	DO
ECUADOR	EC
EGYPT	EG
EL SALVADOR	SV
EQUATORIAL GUINEA	GQ
ERITREA	ER
ESTONIA	EE
ETHIOPIA	ET
FALKLAND ISLANDS (MALVINAS)	FK
FAROE ISLANDS	FO
FIJI	FJ
FINLAND	FI
FRANCE	FR
FRENCH GUIANA	GF
FRENCH POLYNESIA	PF
FRENCH SOUTHERN TERRITORIES	TF
GABON	GA
GAMBIA	GM
GEORGIA	GE
GERMANY	DE
GHANA	GH
GIBRALTAR	GI
GREECE	GR
GREENLAND	GL
GRENADA	GD
GUADELOUPE	GP
GUAM	GU
GUATEMALA	GT
GUERNSEY	GG
GUINEA	GN
GUINEA-BISSAU	GW
GUYANA	GY
HAITI	HT
HEARD ISLAND AND MCDONALD ISLANDS	HM
HOLY SEE (VATICAN CITY STATE)	VA
HONDURAS	HN
HONG KONG	HK
HUNGARY	HU

Operational, Basic, and Advanced Parameters

Country	Country Code
ICELAND	IS
INDIA	IN
INDONESIA	ID
IRAN, ISLAMIC REPUBLIC OF	IR
IRAQ	IQ
IRELAND	IE
ISLE OF MAN	IM
ISRAEL	IL
ITALY	IT
JAMAICA	JM
JAPAN	JP
JERSEY	JE
JORDAN	JO
KAZAKHSTAN	KZ
KENYA	KE
KIRIBATI	KI
KOREA, DEMOCRATIC PEOPLE'S REPUBLIC OF	KP
KOREA, REPUBLIC OF	KR
KUWAIT	KW
KYRGYZSTAN	KG
LAO PEOPLE'S DEMOCRATIC REPUBLIC	LA
LATVIA	LV
LEBANON	LB
LESOTHO	LS
LIBERIA	LR
LIBYAN ARAB JAMAHIRIYA	LY
LIECHTENSTEIN	LI
LITHUANIA	LT
LUXEMBOURG	LU

Operational, Basic, and Advanced Parameters

Country	Country Code
MACAO	MO
MACEDONIA, THE FORMER YUGOSLAV REPUBLIC OF	MK
MADAGASCAR	MG
MALAWI	MW
MALAYSIA	MY
MALDIVES	MV
MALI	ML
MALTA	MT
MARSHALL ISLANDS	MH
MARTINIQUE	MQ
MAURITANIA	MR
MAURITIUS	MU
MAYOTTE	YT
MEXICO	MX
MICRONESIA, FEDERATED STATES OF	FM
MOLDOVA, REPUBLIC OF	MD
MONACO	MC
MONGOLIA	MN
MONTENEGRO	ME
MONTSERRAT	MS
MOROCCO	MA
MOZAMBIQUE	MZ
MYANMAR	MM
NAMIBIA	NA
NAURU	NR
NEPAL	NP
NETHERLANDS	NL
NETHERLANDS ANTILLES	AN
NEW CALEDONIA	NC
NEW ZEALAND	NZ
NICARAGUA	NI
NIGER	NE
NIGERIA	NG
NIUE	NU
NORFOLK ISLAND	NF
NORTHERN MARIANA ISLANDS	MP
NORWAY	NO
OMAN	OM

Operational, Basic, and Advanced Parameters

Country	Country Code
PAKISTAN	PK
PALAU	PW
PALESTINIAN TERRITORY, OCCUPIED	PS
PANAMA	PA
PAPUA NEW GUINEA	PG
PARAGUAY	PY
PERU	PE
PHILIPPINES	PH
PITCAIRN	PN
POLAND	PL
PORTUGAL	PT
PUERTO RICO	PR
QATAR	QA
RÉUNION	RE
ROMANIA	RO
RUSSIAN FEDERATION	RU
RWANDA	RW

Operational, Basic, and Advanced Parameters

Country	Country Code
SAINT HELENA	SH
SAINT KITTS AND NEVIS	KN
SAINT LUCIA	LC
SAINT PIERRE AND MIQUELON	PM
SAINT VINCENT AND THE GRENADINES	VC
SAMOA	WS
SAN MARINO	SM
SAO TOME AND PRINCIPE	ST
SAUDI ARABIA	SA
SENEGAL	SN
SERBIA	RS
SEYCHELLES	SC
SIERRA LEONE	SL
SINGAPORE	SG
SLOVAKIA	SK
SLOVENIA	SI
SOLOMON ISLANDS	SB
SOMALIA	SO
SOUTH AFRICA	ZA
SOUTH GEORGIA AND THE SOUTH SANDWICH ISLANDS	GS
SPAIN	ES
SRI LANKA	LK
SUDAN	SD
SURINAME	SR
SVALBARD AND JAN MAYEN	SJ
SWAZILAND	SZ
SWEDEN	SE
SWITZERLAND	CH
SYRIAN ARAB REPUBLIC	SY
TAIWAN, PROVINCE OF CHINA	TW
TAJIKISTAN	TJ
TANZANIA, UNITED REPUBLIC OF	TZ
THAILAND	TH
TIMOR-LESTE	TL
TOGO	TG
TOKELAU	TK
TONGA	TO
TRINIDAD AND TOBAGO	TT
TUNISIA	TN
TURKEY	TR
TURKMENISTAN	TM
TURKS AND CAICOS ISLANDS	TC
TUVALU	TV

Operational, Basic, and Advanced Parameters

Country	Country Code
UGANDA UKRAINE UNITED ARAB EMIRATES UNITED KINGDOM UNITED STATES UNITED STATES MINOR OUTLYING ISLANDS URUGUAY UZBEKISTAN	UG TA AE GB US TM UY UZ
VANUATU Vatican City State VENEZUELA VIET NAM VIRGIN ISLANDS, BRITISH VIRGIN ISLANDS, U.S.	VU see HOLY SEE VE VN VG VI
WALLIS AND FUTUNA WESTERN SAHARA	WF EH
YEMEN	YE
Zaire ZAMBIA ZIMBABWE	see CONGO, THE DEMOCRATIC REPUBLIC OF THE ZM ZW

Suppress DTMF Playback Setting

Parameter – <i>suppress dtmf playback</i> <i>Suppress DTMF Playback</i> (in Web UI)	Aastra Web UI Configuration Files	Basic Settings->Preferences aastra.cfg, <mac>.cfg
Description	<p>Enables and disables suppression of DTMF playback when a number is dialed from the softkeys or programmable keys.</p> <p>When you disable the suppression of DTMF playback and you press a softkey or programmable key, the IP phone dials the stored number and displays each digit as dialed in the LCD window. When you enable the suppression of DTMF playback, the IP phone dials the stored number and displays the entire number immediately in the LCD window, allowing the call to be dialed faster.</p>	
Format	Boolean	
Default Value	1 (enabled)	
Range	0 (disabled) 1 (enabled)	
Example	suppress dtmf playback: 0	

Display DTMF Digits Setting

Parameter – <i>display dtmf digits</i> <i>Display DTMF Digits</i> (in Web UI)	Aastra Web UI Basic Settings->Preferences->General Configuration Files aastra.cfg, <mac>.cfg
Description	<p>Enables and disables the display of DTMF digits when dialing on the IP phone.</p> <p>DTMF is the signal sent from the phone to the network that you generate when you press the phone's touch keys. This is also known as "touchtone" dialing. Each key you press on your phone generates two tones of specific frequencies. One tone is generated from a high-frequency group of tones and the other from a low frequency group.</p> <p>If enabled, this parameter displays the digits on the IP phone display if you are dialing from the keypad, or from a softkey or programmable key. This parameter is disabled by default (no digits display when dialing).</p>
Format	Boolean
Default Value	0 (disabled)
Range	0 (disabled) 1 (enabled)
Example	display dtmf digits: 1

Intercom, Auto-Answer, and Barge In Settings

Outgoing Intercom Settings

Parameter – <i>sip intercom type</i> <i>Type</i> (in Web UI)	Aastra Web UI Basic Settings->Preferences-> Outgoing Intercom Settings Configuration Files aastra.cfg, <mac>.cfg
Description	Determines whether the IP phone or the server is responsible for notifying the recipient that an Intercom call is being placed.
Format	Integer
Default Value	For Aastra Web UI: Off For Configuration Files: 3 - Off
Range	For Aastra Web UI: Phone-Side Server-Side Off For Configuration Files: 1 - Phone-Side 2 - Server-Side 3 - Off
Example	sip intercom type: 1

Operational, Basic, and Advanced Parameters

Parameter – <i>sip intercom prefix code</i> <i>Prefix Code</i> (in Web UI)	Aastra Web UI Configuration Files	Basic Settings->Preferences-> Outgoing Intercom Settings aastra.cfg, <mac>.cfg
Description	The prefix to add to the phone number for server-side outgoing Intercom calls. This parameter is required for all server-side Intercom calls. Note: The example below shows *96 for the prefix code which is used for Sylanro servers.	
Format	String	
Default Value	N/A	
Range	N/A	
Example	sip intercom prefix code: *96	

Parameter – <i>sip intercom line</i> <i>Line</i> (in Web UI)	Aastra Web UI Configuration Files	Basic Settings->Preferences-> Outgoing Intercom Settings aastra.cfg, <mac>.cfg
Description	Specifies the line for which the IP phone uses the configuration from, when making the Intercom call. The IP phone uses the first available line for physically making the call but uses the configuration from the line you set for this parameter. Note: The " <i>sip intercom type</i> " parameter must be set with the Server-Side option to enable the " <i>sip intercom line</i> " parameter.	
Format	Integer	
Default Value	1	
Range	Line 1 through 9	
Example	sip intercom line: 1	

Incoming Intercom Settings

Parameter – <i>sip allow auto answer</i> <i>Auto-Answer</i> (in Web UI)	Aastra Web UI Configuration Files	Basic Settings->Preferences-> Incoming Intercom Settings aastra.cfg, <mac>.cfg
Description	Enables or disables the IP phone to allow automatic answering for an Intercom call. If auto-answer is enabled on the IP phone, the phone plays a tone to alert the user before answering the intercom call. If auto-answer is disabled, the phone rejects the incoming intercom call and sends a busy signal to the caller.	
Format	Boolean	
Default Value	1 (true)	
Range	0 (false - do not allow auto-answer) 1 (true - allow auto-answer)	
Example	sip allow auto answer: 0	

Parameter – <i>sip intercom mute mic</i> <i>Microphone Mute</i> (in Web UI)	Aastra Web UI Configuration Files	Basic Settings->Preferences-> Incoming Intercom Settings aastra.cfg, <mac>.cfg
Description	Enables or disables the microphone on the IP phone for Intercom calls made by the originating caller.	
Format	Integer	
Default Value	1 (true)	
Range	0 (false - microphone is not muted) 1 (true - microphone is muted)	
Example	sip intercom mute mic: 1	

Operational, Basic, and Advanced Parameters

Parameter – <i>sip intercom warning tone</i> <i>Play Warning Tone</i> (in Web UI)	Aastra Web UI Basic Settings->Preferences-> Incoming Intercom Settings Configuration Files aastra.cfg, <mac>.cfg
Description	Enables or disables a warning tone to play when the phone receives an incoming intercom call on an active line.
Format	Integer
Default Value	1 (true)
Range	0 (false - warning tone will not play) 1 (true - warning tone will play)
Example	sip intercom warning tone: 0

Parameter – <i>sip intercom allow barge in</i> <i>Allow Barge In</i> (in Web UI)	Aastra Web UI: Basic Settings->Preferences-> Incoming Intercom Settings Configuration Files aastra.cfg, <mac>.cfg
Description	<p>Enable or disables how the phone handles incoming intercom calls while the phone is on an active call.</p> <p>When you enable this parameter (1 = enable), which is the default value, an incoming intercom call takes precedence over any active call, by placing the active call on hold and automatically answering the intercom call.</p> <p>When you disable this parameter (0 = disable), and there is an active call, the phone treats an incoming intercom call like a normal call and plays the call warning tone.</p> <p>Note: After enabling or disabling this feature, it takes affect on the phone immediately.</p>
Format	Boolean
Default Value	1 (true)
Range	0 (false) 1 (true)
Example	sip intercom allow barge in: 0

Group Paging RTP Settings

Parameter – <i>paging group listening</i>	Aastra Web UI: Basic Settings->Preferences-> Group Paging RTP Settings Configuration Files aastra.cfg, <mac>.cfg
Description	Specifies the multicast address(es) and the port on which the phone listens for incoming multicast RTP packets. Note: If this field is blank, Paging listening capability is disabled on the phone.
Format	IP Address in dotted decimal format/Port #
Default Value	N/A
Range	N/A
Example	paging group listening: 224.0.0.2:10000,239.0.1.20:15000 0

Example

The following is an example of configuring RTP streaming for Paging applications using the configuration files:

```
paging group listening: 224.0.0.2:10000,239.0.1.20:15000
softkey1 type: multicast
softkey1 label: Group 1
softkey1 value: 224.0.0.2:10000,239.0.1.20:15000
```

Audio Transmit and Receive Gain Adjustment Settings

Parameter – <i>headset tx gain</i>	Configuration Files aastra.cfg, <mac>.cfg
Description	This is the increased (+db) or decreased (-db) amount of signal transmitted from the headset microphone to the far-end party. The amount of Tx gain in the IP phone firmware has been reduced to avoid side-tone and echo on the local and far-end equipment. This parameter allows you to adjust the Tx gain settings to best suit your comfort level and deployment environment.
Format	Integer
Default Value	0
Range	-10 db to +10 db
Example	headset tx gain: -5

Parameter – <i>headset sidetone gain</i>	Configuration Files aastra.cfg, <mac>.cfg
Description	This is the is the increased (+db) or decreased (-db) amount of sidetone signal from the headset microphone to the headset speaker. The amount of sidetone gain in the IP phone firmware has been reduced to avoid side-tone and echo on the local and far-end equipment. This parameter allows you to adjust the sidetone gain settings to best suit your comfort level and deployment environment.
Format	Integer
Default Value	0
Range	-10 db to +10 db
Example	headset sidetone gain: -1

Parameter – <i>handset tx gain</i>	Configuration Files aastra.cfg, <mac>.cfg
Description	This is the increased (+db) or decreased (-db) amount of signal transmitted from the handset microphone to the far-end party. The amount of Tx gain in the IP phone firmware has been reduced to avoid side-tone and echo on the local and far-end equipment. This parameter allows you to adjust the Tx gain settings to best suit your comfort level and deployment environment.
Format	Integer
Default Value	0
Range	-10 db to +10 db
Example	handset tx gain: -5

Parameter – <i>handset sidetone gain</i>	Configuration Files aastra.cfg, <mac>.cfg
Description	This is the increased (+db) or decreased (-db) amount of sidetone signal from the handset microphone to the handset speaker. The amount of sidetone gain in the IP phone firmware has been reduced to avoid side-tone and echo on the local and far-end equipment. This parameter allows you to adjust the sidetone gain settings to best suit your comfort level and deployment environment.
Format	Integer
Default Value	0
Range	-10 db to +10 db
Example	handset sidetone gain: -1

Parameter – <i>handsfree tx gain</i>	Configuration Files aastra.cfg, <mac>.cfg
Description	<p>This is the increased (+db) or decreased (-db) amount of signal transmitted from the base microphone to the far-end party. The amount of Tx gain in the IP phone firmware has been reduced to avoid side-tone and echo on the local and far-end equipment. This parameter allows you to adjust the Tx gain settings to best suit your comfort level and deployment environment.</p> <p>Note: The example below increases the speakerphone mic transmit gain by 10 db.</p>
Format	Integer
Default Value	0
Range	-10 db to +10 db
Example	handsfree tx gain: 10

Parameter – <i>audio mode</i>	IP Phone UI Configuration Files	Options->Set Audio aastra.cfg, <mac>.cfg
Description	Allows you to configure how the "handsfree" key on the IP phone operates.	
Format	Integer	
Default Value	0	
Range	<p>0 Speaker - Calls can be made or received using the handset or handsfree speakerphone and can be switched between the two modes by pressing the d /fkey. When on speaker, you can return to using the handset by placing the handset on the cradle and picking it up again.</p> <p>1 Headset - Calls can be made or received using the headset. Calls can be switched between the headset and handset by pressing the d /fkey.</p> <p>2 Speaker/headset - Incoming calls are sent to the speakerphone. By pressing the d /f key, you can switch between the handsfree speakerphone, the headset, and the handset.</p> <p>3 Headset/speaker - Incoming calls are sent to the headset. By pressing the d /fkey, you can switch between the headset, the handsfree speakerphone, and the handset.</p>	
Example	audio mode: 2	

Directed Call Pickup (BLF or XML Call Interception) Settings

Parameter – <i>directed call pickup</i> <i>Directed Call Pickup</i> (in Web UI)	Aastra Web UI Basic Settings->Preferences ->Directed Call Pickup Settings Configuration Files aastra.cfg, <mac>.cfg
Description	Enables or disables the use of "directed call pickup" feature.
Format	Boolean
Default Value	0 (disabled)
Range	0 (disabled) 1 (enabled)
Example	directed call pickup: 1

Parameter – <i>directed call pickup prefix</i> <i>Directed Call Pickup by Prefix</i> (in Web UI)	Aastra Web UI Basic Settings->Preferences-> Directed Call Pickup Settings Configuration Files aastra.cfg, <mac>.cfg
Description	<p>Allows you to enter a specific prefix string (depending on what is available on your server), that the phone automatically dials when dialing the Directed Call Pickup number.</p> <p>For example, for Broadsoft servers, you can enter a value of *98 for the "directed call pickup prefix". When the phone performs the Directed Call Pickup after pressing a BLF or BLF/List softkey, the phone prepends the *98 value to the designated extension of the BLF or BLF/List softkey when dialing out.</p> <p>Notes:</p> <ol style="list-style-type: none"> 1. The default method for the phone to use is Directed Call Pickup over BLF if the server provides applicable information. If the Directed Call Pickup over BLF information is missing in the messages to the server, the Directed Call Pickup by Prefix method is used if a value for the prefix code exists in the configuration. 2. You can define only one prefix at a time for the entire BLF/List. 3. The phone that picks up displays the prefix code + the extension number (for example, *981234 where prefix key = *98, extension = 1234). 4. Symbol characters are allowed (for example "**").

Format	Integer
Default Value	Not Applicable
Range	Not Applicable
Example	directed call pickup prefix: *98

Parameter – <i>play a ring splash</i> <i>Play a Ring Splash</i> (in Web UI)	Aastra Web UI Basic Settings->Preferences ->Directed Call Pickup Settings Configuration Files aastra.cfg, <mac>.cfg
Description	Enables or disables the playing of a short "call waiting tone" when there is an incoming call on the BLF monitored extension. If the host tone is idle, the tone plays a "ring splash".
Format	Boolean
Default Value	0 (disabled)
Range	0 (disabled) 1 (enabled)
Example	play a ring splash: 1

ACD Auto-Available Timer Settings

Parameter – <i>acd auto available</i> <i>Auto Available</i> (in Web UI)	Aastra Web UI Configuration Files	Basic Settings->Preferences ->Auto Call Distribution Settings aastra.cfg, <mac>.cfg
Description	Enables or disables the use of the ACD Auto-Available Timer.	
Format	Boolean	
Default Value	0 (disabled)	
Range	0 (disabled) 1 (enabled)	
Example	acd auto available: 1	

Parameter – <i>acd auto available timer</i> <i>Auto Available Timer</i> (in Web UI)	Aastra Web UI Configuration Files	Basic Settings->Preferences ->Auto Call Distribution Settings aastra.cfg, <mac>.cfg
Description	Specifies the length of time, in seconds, before the IP phone status switches back to “available.”	
Format	Integer	
Default Value	60 (seconds)	
Range	0 to 120 (seconds)	
Example	acd auto available timer: 60	

Park and Pickup Global Settings (not applicable to 6751i)

<p>Parameter – <i>sprecode</i></p> <p><i>Park Call</i> (in Web UI)</p>	<p>Aastra Web UI Basic Settings->Preferences Configuration Files aastra.cfg, <mac>.cfg</p>										
<p>Description</p>	<p>Specifies the code to enter before entering the extension for where you want to park an incoming call. The applicable value is dependant on the type of server in the network:</p> <table border="0" data-bbox="489 510 828 638"> <thead> <tr> <th><u>Server</u></th> <th><u>Park Values*</u></th> </tr> </thead> <tbody> <tr> <td>Asterisk</td> <td>70</td> </tr> <tr> <td>Sylantro</td> <td>*98</td> </tr> <tr> <td>BroadWorks</td> <td>*68</td> </tr> <tr> <td>ININ PBX</td> <td>callpark</td> </tr> </tbody> </table> <p>*Leave "value" fields blank to disable the park and pickup feature.</p>	<u>Server</u>	<u>Park Values*</u>	Asterisk	70	Sylantro	*98	BroadWorks	*68	ININ PBX	callpark
<u>Server</u>	<u>Park Values*</u>										
Asterisk	70										
Sylantro	*98										
BroadWorks	*68										
ININ PBX	callpark										
<p>Format</p>	<p>Alphanumeric characters</p>										
<p>Default Value</p>	<p><Blank></p>										
<p>Range</p>	<p>See applicable values in the table above.</p>										
<p>Example</p>	<p>sprecode: *68</p>										

Parameter – <i>pickupsprecode</i> <i>Pick Up Parked Call</i> (in Web UI)	Aastra Web UI Configuration Files Basic Settings->Preferences aastra.cfg, <mac>.cfg										
Description	Specifies the code to enter before entering the extension for where you want to pickup a parked call. The applicable value is dependant on the type of server in the network: <table border="0"> <thead> <tr> <th><u>Server</u></th> <th><u>Pickup Values*</u></th> </tr> </thead> <tbody> <tr> <td>Asterisk</td> <td>70</td> </tr> <tr> <td>Sylantro</td> <td>*99</td> </tr> <tr> <td>BroadWorks</td> <td>*88</td> </tr> <tr> <td>ININ PBX</td> <td>pickup</td> </tr> </tbody> </table> *Leave "value" fields blank to disable the park and pickup feature.	<u>Server</u>	<u>Pickup Values*</u>	Asterisk	70	Sylantro	*99	BroadWorks	*88	ININ PBX	pickup
<u>Server</u>	<u>Pickup Values*</u>										
Asterisk	70										
Sylantro	*99										
BroadWorks	*88										
ININ PBX	pickup										
Format	Alphanumeric characters										
Default Value	<Blank>										
Range	See applicable values in the table above.										
Example	pickupsprecode: *88										

Mapping Key Settings

This section provides the hard key settings you can use to enable and disable the Redial, Conf, and Xfer keys on the IP phone.

Parameter – <i>redial disabled</i>	Configuration Files aastra.cfg, <mac>.cfg
Description	Enables or disables the Redial key on the IP phone. If this parameter is set to 0, the key is active and can be pressed by the user. If this parameter is set to 1, pressing the Redial key is ignored, and the dialed number is not saved to the "Redial List".
Format	Boolean
Default Value	0 (false)
Range	0 (false), 1 (true)
Example	redial disabled: 1

Parameter – <i>conference disabled</i>	Configuration Files aastra.cfg, <mac>.cfg
Description	Enables or disables the Conf key on the IP phone. If this parameter is set to 0, the key is active and can be pressed by the user. If this parameter is set to 1, pressing the Conf key is ignored.
Format	Boolean
Default Value	0 (false)
Range	0 (false), 1 (true)
Example	conference disabled: 1

Operational, Basic, and Advanced Parameters

Parameter – <i>call transfer disabled</i>	Configuration Files aastra.cfg, <mac>.cfg
Description	Enables or disables the Xfer key on the IP phone. If this parameter is set to 0, the key is active and can be pressed by the user. If this parameter is set to 1, pressing the Xfer key is ignored.
Format	Boolean
Default Value	0 (false)
Range	0 (false), 1 (true)
Example	call transfer disabled: 1

Parameter – <i>map redial key to</i>	Aastra Web UI Basic Settings->Preferences->Key Mapping Configuration Files aastra.cfg, <mac>.cfg
<i>Map Redial Key To</i> (in Web UI)	
Description	Sets the Redial key as a speeddial key if a value is entered for this parameter. If you leave this parameter blank, the Redial key returns to its original functionality. Note: If you configure the Redial key for speeddialing on the 6757i CT Base Station, the Redial key on the 6757i CT handset retains its original functionality. The Redial key on the handset is not configured for speeddial.
Format	Integer
Default Value	N/A
Range	N/A
Example	map redial key to: 5551234

<p>Parameter – <i>map conf key to</i></p> <p><i>Map Conf Key To</i> (in Web UI)</p>	<p>Aastra Web UI Basic Settings->Preferences->Key Mapping Configuration Files aastra.cfg, <mac>.cfg</p>
<p>Description</p>	<p>Sets the Conf key as a speeddial key if a value is entered for this parameter. If you leave this parameter blank, the Conf key returns to its original functionality.</p> <p>Note: If you configure the Conf key for speeddialing on the 6757i CT Base Station, the Conf key on the 6757i CT handset retains its original functionality. The Conf key on the handset is not configured for speeddial.</p>
<p>Format</p>	<p>Integer</p>
<p>Default Value</p>	<p>N/A</p>
<p>Range</p>	<p>N/A</p>
<p>Example</p>	<p>map conf key to: 5551267</p>

Softkey/Programmable Key/Feature Key/ Expansion Module Key Parameters

This section provides the softkey, programmable key, feature key, and expansion module key parameters you can configure on the IP phones. The following table provides the number of keys you can configure for each model phone and expansion module, and the number of lines available for each type of phone.

IP Phone Model	Softkeys	Expansion Module Keys	Programmable Keys	Lines Available	Handset Keys Available
9143i	-	Not Applicable	7	9	-
9480i	6	Not Applicable	-	9	-
9480i CT	6	Not Applicable	-	9	15
6730i	-	Not Applicable	8	6	-
6731i	-	Not Applicable	8	6	-
6753i	-	36 to 108* (Model M670i)	6***	9	-
6755i	6 Bottom Keys	36 to 108* (Model M670i) 60 to 180** (Model M675i)	6 Top Keys	9	-
6757i	12 Top and Bottom Softkeys	36 to 108* (Model M670i) 60 to 180** (Model M675i)	-	9	-
6757i CT	12 Top and Bottom Softkeys	36 to 108* on Base Station 60 to 180** on Base Station (Model M675i)	-	9	15

*The M670i expansion module consists of 36 softkeys. You can have up to 3 expansion modules on an IP phone totaling 108 softkeys. Valid for 6753i, 6755i, 6757i, and 6757i CT phones.

**The M675i expansion module consists of 60 softkeys. You can have up to 3 expansion modules on an IP phone totaling 180 softkeys. Valid for 6755i, 6757i, and 6757i CT phones.

Softkey/Programmable Key/Feature Key/Expansion Module Key Parameters

***On the 6753i, two of the 6 programmable keys are the DELETE and SAVE keys and can be programmed only if Administrator allows.



Note: When entering definitions for softkeys, the “#” sign must be enclosed in quotes.

Softkey Settings for 8 and 11-Line LCD phones

The value of "N" for the following parameters is dependent on the number of softkeys available on the 9480i, 9480i CT, 6755i, 6757i, and 6757i CT models. See the table above for applicable values.

Parameter – <i>softkeyN type</i> <i>Type</i> (in Web UI)	Aastra Web UI Operation->Softkeys and XML Configuration Files aastra.cfg, <mac>.cfg
Description	<p>The type of softkey to configure. Valid types are:</p> <ul style="list-style-type: none"> • none - Indicates softkey key is disabled. • line - Indicates softkey is configured for line use. • speeddial - Indicates softkey is configured for speeddial use. Speeddial is applicable to the M670i and M675i also. You can configure a softkey to speeddial a specific number by pressing that softkey. Optionally, you can also configure a speeddial key to dial prefix numbers. With this option, the prefix numbers automatically dial when you press the softkey, and the phone waits for you to enter the remaining numbers to dial out. Note: When there is an active call, the speeddial keys send DTMF digits through the active voice path. To dial out, you have to first put the active call on hold and then press the speeddial key. • dnd - Indicates softkey is configured for do not disturb on the phone. This option is "Do Not Disturb" in the Aastra Web UI). You must also set the DND key mode. See • blf - Indicates softkey is configured for Busy Lamp Field (BLF) use. User can dial out on a BLF configured key. Maximum of 50 BLFs are applicable to the M670i and M675i also. • list - Indicates softkey is configured for BLF list use. (This option is BLF/List in the Aastra Web UI). User can dial out on a BLF List configured key. You can also use the "BLF List URI" parameter to specify a URI for the phone to access for the BLF List. • acd - (for Sylanro Servers only) Indicates the programmable key is configured for auto call distribution (called "Auto call distribution" in the Aastra Web UI). The ACD feature allows the Sylanro server to distribute calls from a queue to registered IP phone users (agents). • dcp - (for Sylanro Servers only) Indicates the programmable key is configured for either directed call pickup or group call pickup (called "Directed Call Pickup" in the Aastra Web UI). The Directed Call Pickup/Group Call Pickup feature allows you to intercept or pickup a call on a monitored extension or a group of monitored extensions. • xml - Indicates the softkey is configured to accept an XML application for accessing customized XML services. You can also specify an XML softkey URL for this option.

	<ul style="list-style-type: none"> • flash - Indicates the softkey is set to generate a flash event when it is pressed, or a feature key is pressed on the CT handsets. The IP phone generates flash events only when a call is connected and there is an active RTP stream (for example, when the call is not on hold). • sprecode - Indicates the softkey is configured to automatically activate specific services offered by the server. For example, if the sprecode value of *82 is configured, then by pressing the softkey, *82 automatically activates a service provided by the server. • park - Indicates the softkey is configured to park incoming calls when pressed. • pickup - Indicates the softkey is configured to pick up parked calls when pressed. • lcr - Indicates the softkey is configured for “last call return” when pressed. • callforward - Indicates the softkey is configured for accessing the Call Forward features on the phone. A Call Forwarding Mode must be enabled to use this softkey. “Account” mode is the default. • blf/xfer - Indicates the softkey is configured to transfer calls AND configured for BLF on a single key. • speeddial/xfer - Indicates the softkey is configured to transfer calls AND configured for speeddialing to a specific number. • speeddial/conf - Indicates the softkey is configured to be used as a speeddial key AND as a conference key. • dir - Indicates the softkey is set for accessing the Directory List. • callers - Indicates the softkey is set for accessing the Callers List. • icom - Indicates the softkey is set to be used as the Intercom key. • services - Indicates the softkey is set to be used as the Services key. • phonerlock - Indicates the softkey is set to be used to lock/unlock the phone. • paging - Indicates the softkey is set for Group Paging on the phone. Pressing this key automatically sends a Real Time Transport Protocol (RTP) stream to pre-configured multicast address(es) without involving SIP signaling. • empty - Indicates the softkey is configured to force a blank entry on the IP phone display for a specific softkey. <p>The softkeys are added in order (from softkey1 to softkey20) after any hard-coded keys have been added. If a particular soft key is not defined, it is ignored.</p>
Format	Text
Default Value	none

Range	<p> none line speeddial dnd ("do not disturb" in the Aastra Web UI) blf list ("BLFList" in the Aastra Web UI) acd ("Auto call distribution" in the Aastra Web UI) dcp ("Directed Call Pickup" in the Aastra Web UI) xml flash sprecode park pickup lcr callforward blf/xfer speeddial/xfer speeddial/conf callers ("Callers List" in Aastra Web UI) dir icom services phonelock paging empty </p>
Example	<p> softkey1 type: line softkey2 type: speeddial softkey3 type: lcr softkey4 type: xml </p> <p> Directed Call Pickup on Extension 2200 softkey2 type: dcp softkey2 label: dcp2200 softkey2 value: 2200 softkey2 states: incoming outgoing idle connected </p> <p> Group Call Pickup on group_A softkey3 type: dcp softkey3 label: gcp_A softkey3 value: groupcallpickup softkey3 states: incoming outgoing idle connected </p>

Softkey/Programmable Key/Feature Key/Expansion Module Key Parameters

<p>Parameter – <i>softkeyN label</i></p> <p><i>Label</i> (in Web UI)</p>	<p>Aastra Web UI Configuration Files Operation->Softkeys and XML aastra.cfg, <mac>.cfg</p>
Description	<p>The text label that displays on the IP phone for the softkey.</p> <p>The “softkeyN label” parameter can be set for the following softkey types only:</p> <ul style="list-style-type: none"> • speeddial • blf • acd • dcp • xml • flash • sprecode • park • pickup • blf/xfer • speeddial/xfer • speeddial/conf • dir • callers • icom • services • paging <p>Notes:</p> <ol style="list-style-type: none"> 1. For 8 and 11-Line LCD phones, an icon appears beside the soft key label that indicates the status of the line. 2. If the <i>softkeyN type</i> parameter is set to “flash”, and no label value is entered for the <i>softkeyN label</i> parameter, the label of “Flash” is used.
Format	Text
Default Value	Not Applicable
Range	<p>For line, blf types - Up to 9 characters.</p> <p>For speeddial type - Up to 11 characters.</p>
Example	<p>softkey1 label: “Line 9” softkey2 label: “info” softkey3 label: flash softkey4 label: “johnsmith”</p>

<p>Parameter – <i>softkeyN value</i></p> <p><i>Value</i> (In Web UI)</p>	<p>Aastra Web UI Configuration Files Operation->Softkeys and XML aastra.cfg, <mac>.cfg</p>
<p>Description</p>	<p>This is the value you assign to the softkey.</p> <p>The “softkeyN value” parameter can be set for the following softkey types only:</p> <ul style="list-style-type: none"> • speeddial (you can enter a speeddial number for this field; optionally, you can also enter a prefix for the speeddial value to allow the phone to dial the prefix after you press the speeddial softkey; you then enter the rest of the number from the keypad on the phone.) • blf • sprecode • park • pickup • dcp • xml • blf/xfer • speeddial/xfer • speeddial/conf • paging <p>Notes:</p> <ol style="list-style-type: none"> 1. For speeddial - Value is the phone number, extension, or prefix number to enter for the softkey. 2. For blf - Value is the extension you want to monitor. 3. For sprecode - Value is dependent on services offered by server. 4. For Park, Pickup - For valid values, see Chapter 5, the section, “Park/Pickup Call Server Configuration Values” on page -238. For Park/Pickup examples, see Chapter 5, the section, “Examples for Models with 8 and 11-Line LCDs” on page -236. 5. For xml - You can specify a URI to use for this XML softkey. The variables you can use with the XML softkey URI are: <ul style="list-style-type: none"> • \$\$\$SIPUSERNAME\$\$ • \$\$\$SIPAUTHNAME\$\$ • \$\$\$PROXYURL\$\$ • \$\$\$LINESTATE\$\$ • \$\$\$LOCALIP\$\$ • \$\$\$REMOTENUMBER\$\$ • \$\$\$DISPLAYNAME\$\$ • \$\$\$SIPUSERNAME\$\$ • \$\$\$INCOMINGNAME\$\$ • \$\$\$CALLDURATION\$\$ • \$\$\$CALLDIRECTION\$\$

Softkey/Programmable Key/Feature Key/Expansion Module Key Parameters

Format	String
Default Value	Not Applicable
Range	N/A
Example	softkey1 value: 9 softkey2 value: 411 softkey4 value: http://10.50.10.140 script.pl?name=\$\$SIPUSERNAME\$\$ softkey5 value: 123456+ (example of a speeddial prefix)

Softkey/Programmable Key/Feature Key/Expansion Module Key Parameters

Parameter – <i>softkeyN line</i> <i>Line</i> (in Web UI)	Aastra Web UI Operation->Softkeys and XML Configuration Files aastra.cfg, <mac>.cfg
Description	This is the line associated with the softkey you are configuring. The number of applicable lines available is dependent on the specific IP phone model. The “ softkeyN line ” parameter can be set for the following softkey types only: <ul style="list-style-type: none"> • speeddial • blf • blf/list • acd • dcp • park • pickup • lcr • blf/xfer • speeddial/xfer • speeddial/conf
Format	Integer
Default Value	1
Range	1 through 9
Example	softkey1 line: 1 softkey2 line: 5

Softkey/Programmable Key/Feature Key/Expansion Module Key Parameters

<p>Parameter – <i>softkeyN states</i></p> <p><i>Idle, Connected, Incoming, Outgoing, Busy</i> (in Web UI)</p>	<p>Aastra Web UI Operation->Softkeys and XML Configuration Files aastra.cfg, <mac>.cfg</p>
<p>Description</p>	<p>Displays the status of the phone when a softkey is pressed. You can enter multiple values (idle, connected, incoming, outgoing, busy) for the "softkeyN state" parameter.</p> <p>You must associate the softkeyN state parameter with a specific softkey. In the following example, the softkeyN states parameter is associated with softkey 12:</p> <p>softkey12 type: speeddial softkey12 label: voicemail softkey12 value *89 softkey12 states: outgoing</p> <p>Note: The IP phone idle screen condenses the softkeys. So in the previous example, softkey 12 will appear in position 1 if no other softkeys are set. A softkey type of "empty" does not display on the idle screen at all.</p>
<p>Format</p>	<p>Text</p>
<p>Default Value</p>	<p>For softkey type - None: All states disabled</p> <p>For softkey types - Line, DND, speeddial, BLF, BLF List, dcp, XML, Icr, CallForward, BLF/Xfer, Speeddial/Xfer, Speeddial/Conf, Directory, Callers List, Icom, Services, empty: idle, connected, incoming, outgoing</p> <p>For softkey type - Flash: All states disabled</p> <p>For softkey type - Sprecode, Park: connected</p> <p>For softkey type - Pickup: idle, outgoing</p> <p>For softkey type - acd: idle</p>

Softkey/Programmable Key/Feature Key/Expansion Module Key Parameters

Range	Valid values are: idle The phone is not being used. connected The line currently being displayed is in an active call (or the call is on hold) incoming The phone is ringing. outgoing The user is dialing a number, or the far-end is ringing. busy The current line is busy because the line is in use or the line is set as "Do Not Disturb" Note: For softkey type, Pickup, values can be: just idle, just outgoing, or idle outgoing.
Example	softkey1 states: idle incoming outgoing softkey2 states: connected

Programmable Key Settings for 9143i, 6730i, 6731i, 6753i, and 6755i

The value of "N" for the following parameters is dependent on the number of programmable keys available on the phone models. See the table on [page 216](#) for the applicable values.

Parameter – <i>prgkeyN type</i> <i>Type</i> (in Web UI)	Aastra Web UI Operation->Programmable Keys Configuration Files aastra.cfg, <mac>.cfg
Description	<p>The type of programmable key to configure. Valid types are:</p> <ul style="list-style-type: none"> • none - Indicates no setting for programmable key. • line - Indicates programmable key is configured for line use. • speeddial - Indicates programmable key is configured for speeddial use. You can configure a programmable key to speeddial a specific number by pressing that key. Optionally, you can also configure a speeddial key to dial prefix numbers. With this option, the prefix numbers automatically dial when you press the programmable key, and the phone waits for you to enter the remaining numbers to dial. Note: When there is an active call, the speeddial keys send DTMF digits through the active voice path. To dial out, you have to first put the active call on hold and then press the speeddial key. • dnd - Indicates programmable key is configured for do not disturb on the phone. This option is "Do Not Disturb" in the Aastra Web UI). • blf - Indicates programmable key is configured for Busy Lamp Field (BLF) use. User can dial out on a BLF configured key. • list - Indicates programmable key is configured for BLF list use. User can dial out on a BLF List configured key. You can also use the "BLF List URI" parameter to specify a URI for the phone to access for the BLF List. • acd - (for Sylanro Servers only) Indicates the programmable key is configured for auto call distribution (called "Auto Call Distribution" in the Aastra Web UI). The ACD feature allows the Sylanro server to distribute calls from a queue to registered IP phone users (agents). • dcp - (for Sylanro Servers only) Indicates the programmable key is configured for either directed call pickup or group call pickup (called "Directed Call Pickup" in the Aastra Web UI). The Directed Call Pickup/Group Call Pickup feature allows you to intercept or pickup a call on a monitored extension or a group of monitored extensions. • xml - Indicates programmable key is configured to accept an XML application for accessing customized XML services. You can also specify an XML softkey URL for this option.

	<ul style="list-style-type: none"> • flash - Indicates programmable key is set to generate a flash event when it is pressed. The IP phone generates flash events only when a call is connected and there is an active RTP stream (for example, when the call is not on hold). • sprecode - Indicates programmable key is configured to automatically activate specific services offered by the server. For example, if the sprecode value of *82 is configured, then by pressing the softkey, *82 automatically activates a service provided by the server. • park - Indicates programmable key is configured to park incoming calls when pressed. • pickup - Indicates programmable key is configured to pick up parked calls when pressed. • lcr - Indicates programmable key is configured for "last call return" when pressed. • callforward - Indicates the programmable key is configured for accessing the Call Forward features on the phone. A Call Forwarding Mode must be enabled to use this softkey. "Account" mode is the default. • blf/xfer - Indicates the programmable key is configured to transfer calls AND configured for BLF on a single key. • speeddial/xfer - Indicates the programmable key is configured to transfer calls AND configured for speeddialing to a specific number. • speeddial/conf - Indicates the programmable key is configured to be used as a speeddial key AND as a conference key. • dir - Indicates programmable key is configured to access the Directory List. • callers - Indicates programmable key is configured to access the Callers List. • conf - Indicates programmable key is configured as a conference key. Enter as "conf" in configuration files. • xfer - Indicates programmable key is configured as a Transfer key for transferring calls. Enter as "xfer" in configuration files. • services - Indicates the programmable key is set to be used as the Services key. • phonelock - Indicates the programmable key is set to be used to lock/unlock the phone. • paging - Indicates the softkey is set for Group Paging on the phone. Pressing this key automatically sends a Real Time Transport Protocol (RTP) stream to pre-configured multicast address(es) without involving SIP signaling. • empty - Indicates programmable key is configured to force a blank entry on the IP phone display for a specific programmable key.
Format	Text
Default Value	Not Applicable

Softkey/Programmable Key/Feature Key/Expansion Module Key Parameters

Range	none line speeddial dnd ("do not disturb" in the Aastra Web UI) blf list ("BLF/List" in the Aastra Web UI) acd ("Auto call distribution" in the Aastra Web UI) dcp ("Directed Call Pickup" in the Aastra Web UI) xml flash sprecode park pickup lcr callforward directory callers("Callers List" in Aastra Web UI) conf xfer blf/xfer speeddial/xfer speeddial/conf phonelock services paging empty
Example	prgkey3 type: speeddial

<p>Parameter – <i>prgkeyN value</i></p> <p><i>Value</i> (in Web UI)</p>	<p>Aastra Web UI Operation->Programmable Keys Configuration Files aastra.cfg, <mac>.cfg</p>
<p>Description</p>	<p>This is the value you assign to the programmable key.</p> <p>The “prgkeyN value” parameter can be set for the following softkey types only:</p> <ul style="list-style-type: none"> • speedial (you can enter a speedial number for this field; optionally, you can also enter a prefix for the speedial value to allow the phone to dial the prefix after you press the speedial programmable key; you then enter the rest of the number from the keypad on the phone.) • line • blf • sprecode • dcp • xml • park • pickup • blf/xfer • speedial/xfer • speedial/conf • paging <p>Notes:</p> <ol style="list-style-type: none"> 1. For speedial - Value is the phone number, extension, or prefix number to enter for the programmable key. 2. For line - Value is optional; for example L4. 3. For blf - Value is the extension you want to monitor. 4. For sprecode - Value is dependent on services offered by server. 5. For xml - You can specify a URI to use for this XML softkey. The variables you can use with the XML softkey URI are: <ul style="list-style-type: none"> • \$\$SIPUSERNAME\$\$ • \$\$SIPAUTHNAME\$\$ • \$\$PROXYURL\$\$ • \$\$LINESTATE\$\$ • \$\$LOCALIP\$\$ • \$\$REMOTENUMBER\$\$ • \$\$DISPLAYNAME\$\$ • \$\$SIPUSERNAME\$\$ • \$\$INCOMINGNAME\$\$ • \$\$CALLDURATION\$\$ • \$\$CALLDIRECTION\$ 6. For Park, Pickup - For valid values, see Chapter 5, the section, “Park/Pickup Call Server Configuration Values” on page -238. For Park/Pickup examples, see Chapter 5, the section “Examples for Models with 3-Line LCDs (not applicable to 6751i)” on page -237.
<p>Format</p>	<p>String</p>

Softkey/Programmable Key/Feature Key/Expansion Module Key Parameters

Default Value	N/A
Range	N/A
Example	prgkey3 value: 411 prgkey4 value: 123456+ (example of a speeddial prefix)
Parameter– <i>prgkeyN line</i> <i>Line</i> (in Web UI)	Aastra Web UI Operation->Programmable Keys Configuration Files aastra.cfg, <mac>.cfg
Description	This is the line associated with the programmable key you are configuring. The “ prgkeyN line ” parameter can be set for the following softkey types only: <ul style="list-style-type: none"> • speeddial • blf • blf/List • acd • dcp • park • pickup • lcr • blf/xfer • speeddial/xfer • speeddial/conf
Format	Integer
Default Value	1
Range	1 through 9
Example	prgkey3 line: 1 prgkey4 line: 5

Top Softkey Settings for 6757i and 6757i CT

<p>Parameter – <i>topsoftkeyN type</i></p> <p><i>Top Softkeys->Type</i> (in Web UI)</p>	<p>Aastra Web UI Operation->Softkeys and XML Configuration Files aastra.cfg, <mac>.cfg</p>
<p>Description</p>	<p>The type of softkey to configure. Valid types are:</p> <ul style="list-style-type: none"> • none - Indicates softkey is disabled. • line - Indicates softkey is configured for line use. • speeddial - Indicates softkey is configured for speeddial use. You can configure a softkey to speeddial a specific number by pressing that softkey. Optionally, you can also configure a speeddial key to dial prefix numbers. With this option, the prefix numbers automatically dial when you press the softkey, and the phone waits for you to enter the remaining numbers to dial out. Note: When there is an active call, the speeddial keys send DTMF digits through the active voice path. To dial out, you have to first put the active call on hold and then press the speeddial key. • dnd - Indicates softkey is configured for do not disturb on the phone. This option is "Do Not Disturb" in the Aastra Web UI). • blf - Indicates softkey is configured for Busy Lamp Field (BLF) use. User can dial out on a BLF configured key. • list - Indicates softkey is configured for BLF list use. (This option is BLF/List in the Aastra Web UI). User can dial out on a BLF List configured key. You can also use the "BLF List URI" parameter to specify a URI for the phone to access for the BLF List. • acd - (for Sylanro Servers only) Indicates the programmable key is configured for auto call distribution (called "Auto call distribution" in the Aastra Web UI). The ACD feature allows the Sylanro server to distribute calls from a queue to registered IP phone users (agents). • dcp - (for Sylanro Servers only) Indicates the programmable key is configured for either directed call pickup or group call pickup (called "Directed Call Pickup" in the Aastra Web UI). The Directed Call Pickup/Group Call Pickup feature allows you to intercept or pickup a call on a monitored extension or a group of monitored extensions. • xml - Indicates the softkey is configured to accept an XML application for accessing customized XML services. You can also specify an XML softkey URL for this option.

Softkey/Programmable Key/Feature Key/Expansion Module Key Parameters

	<ul style="list-style-type: none"> • flash - Indicates the softkey is set to generate a flash event when it is pressed, or a feature key is pressed on the CT handsets. The IP phone generates flash events only when a call is connected and there is an active RTP stream (for example, when the call is not on hold). • sprecode - Indicates the softkey is configured to automatically activate specific services offered by the server. For example, if the sprecode value of *82 is configured, then by pressing the softkey, *82 automatically activates a service provided by the server. • park - Indicates the softkey is configured to park incoming calls when pressed. • pickup - Indicates the softkey is configured to pick up parked calls when pressed. • lcr - Indicates the softkey is configured for “last call return” when pressed. • callforward - Indicates the softkey is configured for accessing the Call Forward features on the phone. A Call Forwarding Mode must be enabled to use this softkey. “Account” mode is the default. • blf/xfer - Indicates the softkey is configured to transfer calls AND configured for BLF on a single key. • speeddial/xfer - Indicates the softkey is configured to transfer calls AND configured for speeddialing to a specific number. • speeddial/conf - Indicates the softkey is configured to be used as a speeddial key AND as a conference key. • callers - Indicates the softkey is set for accessing the Callers List. • directory - Indicates the softkey is set for accessing the Directory List. • icom - Indicates the softkey is set to be used as the Intercom key. • services - Indicates the softkey is set to be used as the Services key. • phonelock - Indicates the softkey is set to be used to lock/unlock the phone. • paging - Indicates the softkey is set for Group Paging on the phone. Pressing this key automatically sends a Real Time Transport Protocol (RTP) stream to pre-configured multicast address(es) without involving SIP signaling. • empty - Indicates the softkey is configured to force a blank entry on the IP phone display for a specific softkey. The soft keys are added in order (from softkey1 to softkey20) after any hard-coded keys have been added. If a particular soft key is not defined, it is ignored.
Format	Text
Default Value	none

Softkey/Programmable Key/Feature Key/Expansion Module Key Parameters

Range	none line speeddial dnd blf list ("BLFList" in the Aastra Web UI) acd ("Auto call distribution" in the Aastra Web UI) dcp ("Directed Call Pickup" in the Aastra Web UI) xml flash sprecode callforward park pickup blf/xfer speeddial/xfer speeddial/conf lcr callers ("Callers List" in Aastra Web UI) directory icom services phonelock paging empty
Example	topsoftkey1 type: line topsoftkey2 type: speeddial topsoftkey3 type: lcr topsoftkey4 type: xml

Softkey/Programmable Key/Feature Key/Expansion Module Key Parameters

<p>Parameter – <i>topsoftkeyN label</i></p> <p><i>Top Softkeys->Label</i> (in Web UI)</p>	<p>Aastra Web UI Operation->Softkeys and XML Configuration Files aastra.cfg, <mac>.cfg</p>
Description	<p>The text label that displays on the IP phone for the softkey.</p> <p>The “topsoftkeyN label” parameter can be set for the following softkey types only:</p> <ul style="list-style-type: none"> • speeddial • blf • acd • dcp • xml • flash • sprecode • park • pickup • blf/xfer • speeddial/xfer • speeddial/conf • paging • directory • callers list • icom • services <p>Notes:</p> <ol style="list-style-type: none"> 1. For the 6757i and 6757i CT phones, an icon appears beside the soft key label that indicates the status of the line. 2. If the <i>topsoftkeyN type</i> parameter is set to “flash”, and no label value is entered for the <i>topsoftkeyN label</i> parameter, the label of “Flash” is used.
Format	Text
Default Value	Not Applicable
Range	For line, blf types - Up to 9 characters. For speeddial type - Up to 11 characters.
Example	topsoftkey1 label: “Line 9” topsoftkey2 label: “info” topsoftkey4 label: “johnsmith”

<p>Parameter – <i>topsoftkeyN value</i></p> <p><i>Top Softkeys->Value</i> (In WEb UI)</p>	<p>Aastra Web UI Configuration Files Operation->Softkeys and XML aastra.cfg, <mac>.cfg</p>
<p>Description</p>	<p>This is the value you assign to the softkey.</p> <p>The “topsoftkeyN value” parameter can be set for the following softkey types only:</p> <ul style="list-style-type: none"> • speeddial (you can enter a speeddial number for this field; optionally, you can also enter a prefix for the speeddial value to allow the phone to dial the prefix after you press the speeddial programmable key; you then enter the rest of the number from the keypad on the phone.) • blf • sprecode • park • pickup • dcp • xml • blf/xfer • speeddial/xfer • speeddial/conf • paging <p>Notes:</p> <ol style="list-style-type: none"> 1. For speeddial - Value is the phone number, extension, or prefix number to enter for the softkey. 2. For blf - Value is the extension you want to monitor. 3. For sprecode - Value is dependent on services offered by server. 4. For Park, Pickup - For valid values, see Chapter 5, the section, “Park/Pickup Call Server Configuration Values” on page -238. For Park/Pickup examples, see Chapter 5, the section, “Examples for Models with 8 and 11-Line LCDs” on page -236. 5. For xml - You can specify a URI to use for this XML softkey. The variables you can use with the XML softkey URI are: <ul style="list-style-type: none"> • \$\$\$SIPUSERNAME\$\$ • \$\$\$SIPAUTHNAME\$\$ • \$\$\$PROXYURL\$\$ • \$\$\$LINESTATE\$\$ • \$\$\$LOCALIP\$\$ • \$\$\$REMOTENUMBER\$\$ • \$\$\$DISPLAYNAME\$\$ • \$\$\$SIPUSERNAME\$\$ • \$\$\$INCOMINGNAME\$\$ • \$\$\$CALLDURATION\$\$ • \$\$\$CALLDIRECTION\$\$

Softkey/Programmable Key/Feature Key/Expansion Module Key Parameters

Format	String
Default Value	Not Applicable
Range	N/A
Example	topsoftkey1 value: 9 topsoftkey2 value: 411 topsoftkey4 value: http://10.50.10.140 script.pl?name=\$\$SIPUSERNAME\$\$ topsoftkey5 value: 12345+ (example of a speeddial prefix)

Parameter – <i>topsoftkeyN line</i> <i>Top Softkeys->Line</i> (in Web UI)	Aastra Web UI Operation->Softkeys and XML Configuration Files aastra.cfg, <mac>.cfg
Description	This is the line associated with the softkey you are configuring. The number of applicable lines available is dependent on the specific IP phone model. The “ topsoftkeyN line ” parameter can be set for the following softkey types only: <ul style="list-style-type: none"> • speeddial • blf • blf/list • acd • dcp • park • pickup • lcr • blf/xfer • speeddial/xfer • speeddial/conf
Format	Integer
Default Value	1
Range	1 through 9
Example	topsoftkey1 line: 1 topsoftkey2 line: 5

Handset Feature Key Settings (9480i CT and 6757i CT)

Parameter – <i>featurekeyN type</i> <i>Type</i> (in Web UI)	Aastra Web UI Operation->Handset Keys Configuration Files aastra.cfg, <mac>.cfg
Description	The type of feature key to configure. Valid types are: <ul style="list-style-type: none"> • none - Indicates feature key is disabled. • line - Indicates the feature key is configured for line use. • xfer- Indicates feature key is configured for transferring a call. • conf - Indicates feature key is configured for conference calling. • public - Indicates feature key is configured to toggle from public to private mode. A public and private softkey can be used when at a line item in the Directory List. The Private key toggles a number in the Directory List to private. The Public key allows a number in the Directory List to be sent to the handsets. A 6757i CT accepts a maximum of 50 entries with the public attribute. • icom - Indicates the feature key is set to be used to make an intercom call. • dir - Indicates the feature key is set for accessing the Directory List. • callers - Indicates the feature key is set for accessing the Callers List. • park- Indicates the feature key is configured to park incoming calls when pressed. • pickup- Indicates the feature key is configured to pick up parked calls when pressed. • flash - Indicates the feature key is set to generate a flash event when it is pressed CT handsets. The IP phone generates flash events only when a call is connected and there is an active RTP stream (for example, when the call is not on hold).
Format	Text
Default Value	None
Range	none line transfer conference public icom directory callers (“Callers List” in Aastra Web UI) park pickup flash

Softkey/Programmable Key/Feature Key/Expansion Module Key Parameters

Example	featurekey1 type: line featurekey2 type: public featurekey3 type: park featurekey4 type: pickup	
Parameter – <i>featurekeyN label</i>	Aastra Web UI	Operation->Handset Keys
<i>Label</i> (in Web UI)	Configuration Files	aastra.cfg, <mac>.cfg
Description	The text label that displays on the IP phone for the feature key.	
	Notes: <ol style="list-style-type: none"> 1. For the 6757i CT phones, an icon appears beside the feature key label that indicates the status of the line. 2. If a feature key is configured but no label is set, the IP phone sets the label to the English, French, or Spanish translation of the chosen action. The language used is based on the current language of the cordless handset. 	
Format	Text	
Default Value	Not Applicable	
Range	Not Applicable	
Example	featurekey1 label: Line 9 featurekey2 label: Public featurekey4 label: John Smith	

Expansion Module Key Settings for M670i (6753i, 6755i, 6757i, 6757i CT) and M675i (for 6755i, 6757i, 6757i CT)

Parameter – <i>expmodX keyN type</i> <i>Type</i> (in Web UI)	Aastra Web UI Configuration Files Operation->Expansion Module N aastra.cfg, <mac>.cfg
Description	<p>The type of softkey to configure. Valid types are:</p> <ul style="list-style-type: none"> • none - Indicates softkey is disabled. • line - Indicates softkey is configured for line use. • speeddial - Indicates softkey is configured for speeddial use. You can configure a softkey to speeddial a specific number by pressing that softkey. Optionally, you can also configure a speeddial key to dial prefix numbers. With this option, the prefix numbers automatically dial when you press the softkey, and the phone waits for you to enter the remaining numbers to dial out. Note: When there is an active call, the speeddial keys send DTMF digits through the active voice path. To dial out, you have to first put the active call on hold and then press the speeddial key. • dnd - Indicates softkey is configured for do not disturb on the phone. This option is "Do Not Disturb" in the Aastra Web UI). • blf - Indicates softkey is configured for Busy Lamp Field (BLF) use. User can dial out on a BLF configured key. • list - Indicates softkey is configured for BLF list use. (This option is BLF/List in the Aastra Web UI). User can dial out on a BLF List configured key. You can also use the "BLF List URI" parameter to specify a URI for the phone to access for the BLF List. • acd - (for Sylanro Servers only) Indicates the programmable key is configured for auto call distribution (called "Auto call distribution" in the Aastra Web UI). The ACD feature allows the Sylanro server to distribute calls from a queue to registered IP phone users (agents). • dcp - (for Sylanro Servers only) Indicates the programmable key is configured for either directed call pickup or group call pickup (called "Directed Call Pickup" in the Aastra Web UI). The Directed Call Pickup/Group Call Pickup feature allows you to intercept or pickup a call on a monitored extension or a group of monitored extensions. • xml - Indicates the softkey is configured to accept an XML application for accessing customized XML services. You can also specify an XML softkey URL for this option. • flash - Indicates the softkey is set to generate a flash event when it is pressed, or a feature key is pressed on the CT handsets. The IP phone generates flash events only when a call is connected and there is an active RTP stream (for example, when the call is not on hold).

Format	<ul style="list-style-type: none"> • sprecode - Indicates the softkey is configured to automatically activate specific services offered by the server. For example, if the sprecode value of *82 is configured, then by pressing the softkey, *82 automatically activates a service provided by the server. • park - Indicates the softkey is configured to park incoming calls when pressed. • pickup - Indicates the softkey is configured to pick up parked calls when pressed. • lcr - Indicates the softkey is configured for "last call return" when pressed. • callforward - Indicates the softkey is configured for accessing the Call Forward features on the phone. A Call Forwarding Mode must be enabled to use this softkey. "Account" mode is the default. • blf/xfer - Indicates the softkey is configured to transfer calls AND configured for BLF on a single key. • speeddial/xfer - Indicates the softkey is configured to transfer calls AND configured for speeddialing to a specific number. • speeddial/conf - Indicates the softkey is configured to be used as a speeddial key AND as a conference key. • callers - Indicates the softkey is set for accessing the Callers List. • directory - Indicates the softkey is set for accessing the Directory List. • icom - Indicates the softkey is set to be used as the Intercom key. • services - (not available on the 6753i) Indicates the softkey is set to be used as the Services key. • phonelock - Indicates the softkey is set to be used to lock/unlock the phone. • paging - Indicates the softkey is set for Group Paging on the phone. Pressing this key automatically sends a Real Time Transport Protocol (RTP) stream to pre-configured multicast address(es) without involving SIP signaling. • empty - Indicates the softkey is configured to force a blank entry on the IP phone display for a specific softkey. The soft keys are added in order (from softkey1 to softkey20) after any hard-coded keys have been added. If a particular soft key is not defined, it is ignored.
Default Value	none

Softkey/Programmable Key/Feature Key/Expansion Module Key Parameters

Range	<ul style="list-style-type: none">• none• line• speeddial• dnd• blf• list ("BLF\List" in the Aastra Web UI)• acd ("Auto call distribution" in the Aastra Web UI)• dcp ("Directed Call Pickup" in the Aastra Web UI)• xml• flash• sprecode• park• pickup• lcr• callforward• blf/xfer• speeddial/xfer• speeddial/conf• callers ("Callers List" in Aastra Web UI)• directory• icom• services (not available on the 6753i)• phonelock• paging• empty
Example	expmod1 key1 type: line expmod1 key2 type: speeddial expmod1 key3 type: blf expmod1 key4 type: list

Softkey/Programmable Key/Feature Key/Expansion Module Key Parameters

Parameter – <i>expmodX keyN label</i> <i>Label</i> (in Web UI)	Aastra Web UI Operation->Expansion Module N Configuration Files aastra.cfg, <mac>.cfg
Description	<p>The text label that displays on the softkey for the Expansion Module.</p> <p>The “expmodX keyN label” parameter can be set for the following softkey types only:</p> <ul style="list-style-type: none"> • speeddial • blf • acd • dcp • xml • flash • sprecode • park • pickup • directory • callers list • icom • services • blf/xfer • speeddial/xfer • speeddial/conf • paging <p>Notes:</p> <ol style="list-style-type: none"> 1. For 8 and 11-Line LCD phones, an icon appears beside the soft key label that indicates the status of the line.
Format	Text
Default Value	Not Applicable
Range	For line, blf types - Up to 9 characters. For speeddial type - Up to 11 characters.
Example	expmod1 key1 label: “Line 9” expmod2 key1 label: “info” expmod3 key1 label: “johnsmith”

Softkey/Programmable Key/Feature Key/Expansion Module Key Parameters

<p>Parameter – <i>expmodX keyN value</i></p> <p><i>Value</i> (In WEb UI)</p>	<p>Aastra Web UI Configuration Files Operation->Expansion Module N aastra.cfg, <mac>.cfg</p>
<p>Description</p>	<p>The text label that displays on the IP phone for the softkey on the Expansion Module.</p> <p>The “expmodX keyN value” parameter can be set for the following softkey types only:</p> <ul style="list-style-type: none"> • speeddial • blf • dcp • xml • sprecode • park • pickup • directory • callers (“Callers List” in Aastra Web UI) • icom • services (not available on 6753i) • blf/xfer • speeddial/xfer • speeddial/conf • paging <p>Notes:</p> <ol style="list-style-type: none"> 1. For the 6757i and 6757i CT phones, an icon appears beside the soft key label that indicates the status of the line. 2. For blf - Value is the extension you want to monitor. 3. For xml - You can specify a URI to use for this XML softkey. The variables you can use with the XML softkey URI are: <ul style="list-style-type: none"> • \$\$SIPUSERNAME\$\$ • \$\$SIPAUTHNAME\$\$ • \$\$PROXYURL\$\$ • \$\$LINESTATE\$\$ • \$\$LOCALIP\$\$ • \$\$REMOTENUMBER\$\$ • \$\$DISPLAYNAME\$\$ • \$\$SIPUSERNAME\$\$ • \$\$INCOMINGNAME\$\$ • \$\$CALLDURATION\$\$ • \$\$CALLDIRECTION\$\$
<p>Format</p>	<p>String</p>
<p>Default Value</p>	<p>Not Applicable</p>
<p>Range</p>	<p>N/A</p>

Softkey/Programmable Key/Feature Key/Expansion Module Key Parameters

Example	expmod1 key1 value: 9 expmod1 key2 value: 411 expmod1 key3 value: 123456+ (example of a speeddial prefix)
----------------	---

Softkey/Programmable Key/Feature Key/Expansion Module Key Parameters

<p>Parameter – <i>expmodX keyN line</i></p> <p><i>Line</i> (in Web UI)</p>	<p>Aastra Web UI Operation->Expansion Module N Configuration Files aastra.cfg, <mac>.cfg</p>
<p>Description</p>	<p>This is the line associated with the softkey you are configuring on the Expansion Module. The number of applicable lines available is dependent on the specific IP phone model.</p> <p>The “expmodX keyN line” parameter can be set for the following softkey types only:</p> <ul style="list-style-type: none"> • speeddial • blf • blf/list • acd • dcp • lcr • park • pickup • blf/xfer • speeddial/xfer • speeddial/conf
<p>Format</p>	<p>Integer</p>
<p>Default Value</p>	<p>1</p>
<p>Range</p>	<p>1 through 9</p>
<p>Example</p>	<p>expmod1 key1 line: 1 expmod1 key2 line: 5</p>

Customizing the Key Type List

Softkeys, Programmable Keys, Expansion Module Keys

Parameter – <i>softkey selection list</i>	Configuration Files aastra.cfg, <mac>.cfg
Description	<p>Allows you to specify which key types to display and the order in which to display them in the “Type” list for softkeys, programmable keys, and/or expansion module keys when configuring the keys in the Aastra Web UI.</p> <p>If no value is specified for this “softkey selection list” parameter, the key “Type” list displays ALL of the key types by default in the Aastra Web UI.</p> <p>:</p> <ol style="list-style-type: none"> 1. Any key types configured that do not apply to the phone’s environment are ignored. 2. The SAVE and DELETE keys appear by default as Keys 1 and 2 on the 6753i and 9143i, and as 5 and 6 on the 6730i and 6731i unless specifically changed by your Administrator. 3. An Administrator must use the English value when configuring the key types in the configuration files. 4. Any key type already configured on a phone displays in that key’s “Type” list, in addition to the values specified for this parameter. 5. After configuring specific key types for a phone, the key types in the Aastra Web UI display the same for both the User and Administrator Web interfaces for that phone.
Format	Alpha Characters in a comma separated list

Softkey/Programmable Key/Feature Key/Expansion Module Key Parameters

Default Value	<table border="1" style="width: 100%; border-collapse: collapse;"> <tr> <td style="width: 50%; vertical-align: top;"> <ul style="list-style-type: none"> • none • line • speeddial • dnd • blf • list • acd • dcp • xml • flash • sprecode • park • pickup • lcr </td> <td style="width: 50%; vertical-align: top;"> <ul style="list-style-type: none"> • callforward • blf/xfer • speeddial/xfer • speeddial/conf • directory • callers • conf (6730i, 6731i, 6753i, 9143i) • xfer (6730i, 6731i, 6753i, 9143i) • icom • services • phonelock • paging • empty (6755i, 6757i, 6757 CT, 9480i, 9480i CT) </td> </tr> </table>	<ul style="list-style-type: none"> • none • line • speeddial • dnd • blf • list • acd • dcp • xml • flash • sprecode • park • pickup • lcr 	<ul style="list-style-type: none"> • callforward • blf/xfer • speeddial/xfer • speeddial/conf • directory • callers • conf (6730i, 6731i, 6753i, 9143i) • xfer (6730i, 6731i, 6753i, 9143i) • icom • services • phonelock • paging • empty (6755i, 6757i, 6757 CT, 9480i, 9480i CT)
<ul style="list-style-type: none"> • none • line • speeddial • dnd • blf • list • acd • dcp • xml • flash • sprecode • park • pickup • lcr 	<ul style="list-style-type: none"> • callforward • blf/xfer • speeddial/xfer • speeddial/conf • directory • callers • conf (6730i, 6731i, 6753i, 9143i) • xfer (6730i, 6731i, 6753i, 9143i) • icom • services • phonelock • paging • empty (6755i, 6757i, 6757 CT, 9480i, 9480i CT) 		
Range	Any of the key types in the "Default Value" field above.		
Example	softkey selection list: blf, speeddial, line, xml		

Handset Feature Keys (for CT Models ONLY)

Parameter – <i>feature key selection list</i>	Configuration Files aastra.cfg, <mac>.cfg												
Description	<p>Allows you to specify which key types to display and the order in which to display them in the “Type” list for the feature keys (CT models only) when configuring the keys in the Aastra Web UI.</p> <p>If no value is specified for this “feature key selection list” parameter, the key “Type” list displays ALL of the key types by default in the Aastra Web UI.</p> <p>:</p> <ol style="list-style-type: none"> 1. Any key types configured that do not apply to the phone's environment are ignored. 2. An Administrator must use the English value when configuring the key types in the configuration files. 3. Any key type already configured on a phone displays in that key's “Type” list, in addition to the values specified for this parameter. 4. After configuring specific key types for a phone, the key types in the Aastra Web UI display the same for both the User and Administrator Web interfaces for that phone. 												
Format	Alpha Characters in a comma separated list												
Default Value	<table border="1"> <tbody> <tr> <td>• none</td> <td>• park</td> </tr> <tr> <td>• line</td> <td>• pickup</td> </tr> <tr> <td>• icom</td> <td>• conf</td> </tr> <tr> <td>• dir</td> <td>• private</td> </tr> <tr> <td>• callers</td> <td>• public</td> </tr> <tr> <td>• xfer</td> <td>• flash</td> </tr> </tbody> </table>	• none	• park	• line	• pickup	• icom	• conf	• dir	• private	• callers	• public	• xfer	• flash
• none	• park												
• line	• pickup												
• icom	• conf												
• dir	• private												
• callers	• public												
• xfer	• flash												
Range	Any of the key types in the “Default Value” field above.												
Example	feature key selection list: line, dir, callers												

Locking Softkeys and Programmable Keys

Parameter — <i>softkeyN locked</i>	Configuration Files aastra.cfg, <mac>.cfg
Description	<p>Locks the specified softkey on the 9480i, 9480i CT, 6755i, 6757i, or 6757i CT IP phone. Locking the key prevents a user from changing or configuring the softkey. When a key is locked, the phone uses the server settings and ignores any previous local configuration.</p> <p>Affects the following parameters:</p> <ul style="list-style-type: none"> • softkeyN type • softkeyN label • softkeyN value • softkeyN line • softkeyN states
Format	Boolean
Default Value	0 (disable)
Range	0 (disable) 1 (enable)
Example	softkey1 locked: 1

Parameter — <i>topsoftkeyN locked</i>	Configuration Files aastra.cfg, <mac>.cfg
Description	<p>Locks the specified top softkey on the 6757i or 6757i CT IP phone. Locking the key prevents a user from changing or configuring the softkey. When a key is locked, the phone uses the server settings and ignores any previous local configuration.</p> <p>Affects the following parameters:</p> <ul style="list-style-type: none"> • topsoftkeyN type • topsoftkeyN label • topsoftkeyN value • topsoftkeyN line
Format	Boolean
Default Value	0 (disable)
Range	0 (disable) 1 (enable)
Example	topsoftkey1 locked: 1

Softkey/Programmable Key/Feature Key/Expansion Module Key Parameters

Parameter — <i>prgkeyN locked</i>	Configuration Files aastra.cfg, <mac>.cfg
Description	Locks the specified programmable key on the 9143i, 6730i, 6731i, 6753i, or 6755i IP phone. Locking the key prevents a user from changing or configuring the programmable key. When a key is locked, the phone uses the server settings and ignores any previous local configuration. Affects the following parameters: <ul style="list-style-type: none"> • prgkeyN type • prgkeyN value • prgkeyN line
Format	Boolean
Default Value	0 (disable)
Range	0 (disable) 1 (enable)
Example	prgkey1 locked: 1

Parameter — <i>featurekeyN locked</i>	Configuration Files aastra.cfg, <mac>.cfg
Description	Locks the specified feature key on the CT handset. Locking the key prevents a user from changing or configuring the feature key. When a key is locked, the phone uses the server settings and ignores any previous local configuration. Affects the following parameters: <ul style="list-style-type: none"> • featurekeyN type • featurekeyN label
Format	Boolean
Default Value	0 (disable)
Range	0 (disable) 1 (enable)
Example	featurekey1 locked: 1

Softkey/Programmable Key/Feature Key/Expansion Module Key Parameters

Parameter — <i>expmodX keyN locked</i>	Configuration Files aastra.cfg, <mac>.cfg
Description	<p>Locks the specified top softkey on the 5-Series Expansion Module attached to the IP phone. Locking the key prevents a user from changing or configuring the softkey on the expansion module. When a key is locked, the phone uses the server settings and ignores any previous local configuration.</p> <p>Affects the following parameters:</p> <ul style="list-style-type: none">• expmodX keyN type• expmodX keyN value• expmodX keyN line
Format	Boolean
Default Value	0 (disable)
Range	0 (disable) 1 (enable)
Example	expmod1 key4 locked: 1

Locking the SAVE and DELETE Keys (6753i)

Parameter — <i>prgkey1 locked</i>	Configuration Files aastra.cfg, <mac>.cfg
Description	<p>Allows you to lock or unlock the Save key on the 6753i IP Phone. When the Save key is unlocked, a User can change the function of the key using the Aastra Web UI. An Administrator can change the function of the key using the Aastra Web UI or the configuration files.</p> <p>Note:</p> <ol style="list-style-type: none"> 1. The save function on the 6753i IP Phone is limited to Key 1 only. 2. Changing the function from the Save key to another function, removes the ability to save items on the IP phone.
Format	Boolean
Default Value	1 (lock)
Range	0 (unlock) 1 (lock)
Example	prgkey1 locked: 0

Parameter — <i>prgkey2 locked</i>	Configuration Files aastra.cfg, <mac>.cfg
Description	<p>Allows you to lock or unlock the Delete key on the 6753i IP Phone. When the Delete key is unlocked, a User can change the function of the key using the Aastra Web UI. An Administrator can change the function of the key using the Aastra Web UI or the configuration files.</p> <p>Note:</p> <ol style="list-style-type: none"> 1. The delete function on the 6753i IP Phone is limited to Key 2 only. 2. Changing the function from the Delete key to another function, removes the ability to delete items on the IP phone.
Format	Boolean
Default Value	1 (lock)
Range	0 (unlock) 1 (lock)
Example	prgkey2 locked: 0

Enabling/Disabling Ability to Add/Edit Speeddial Keys

Parameter – <i>speeddial edit</i>	Configuration Files aastra.cfg, <mac>.cfg
Description	<p>Allows you to enable or disable the ability to add a speeddial key or edit a speeddial key.</p> <p>The default is enabled (Yes) allowing you to create and edit speeddial keys on the phone using the Press-and-hold feature, softkeys, programmable keys, expansion module keys and key pad, speeddial menu in the IP Phone UI, and the SAVE TO key.</p> <p>If this parameter is set to disabled (No), it blocks the user from using any of the features on the phone to create or edit a speeddial key.</p>
Format	Boolean
Default Value	1 (Enabled)
Range	0 (Disabled) 1 (Enabled)
Example	speeddial edit: 0

BLF List URI Settings

Parameter– <i>list uri</i>	Aastra Web UI	Operation->Softkeys and XML->Services Operation->Programmable Keys->Services Operation->Expansion Module Keys->Services
<i>BLF List URI</i> (in Web UI)	Configuration Files	aastra.cfg, <mac>.cfg
Description	Specifies the URI that the phone uses to access the BLF list on the Broadsoft server when the BLF list key is pressed. When you specify a URI for this parameter, the phone uses the Internet to access the BLF list on the Broadsoft server.	
Format	HTTP server path or Fully Qualified Domain Name	
Default Value	Not Applicable	
Range	Not Applicable	
Example	list uri: my6757i-blf-list@as.broadworks.com	

Customizing M675i Expansion Module Column Display

Expansion Module 1 through 3

Parameter — <i>expmodXpageNleft</i>	Configuration Files aastra.cfg, <mac>.cfg
Description	<p>Allows you to specify a customized heading for the M675i expansion module, in the left column of a specific page. You can specify the following options for this parameter:</p> <p>Expansion Module 1 expmod1page1left (Expansion Module 1, Page 1, left column) expmod1page2left (Expansion Module 1, Page 2, left column) expmod1page3left (Expansion Module 1, Page 3, left column)</p> <p>Expansion Module 2 expmod2page1left (Expansion Module 2, Page 1, left column) expmod2page2left (Expansion Module 2, Page 2, left column) expmod2page3left (Expansion Module 2, Page 3, left column)</p> <p>Expansion Module 3 expmod3page1left (Expansion Module 3, Page 1, left column) expmod3page2left (Expansion Module 3, Page 2, left column) expmod3page3left (Expansion Module 3, Page 3, left column)</p>
Format	Text String
Default Value	N/A
Range	N/A
Example	expmod1page1left: Personnel Ext

Parameter — <i>expmodXpageNright</i>	Configuration Files aastra.cfg, <mac>.cfg
Description	<p>Allows you to specify a customized heading for the M675i expansion module, in the right column of a specific page. You can specify the following options for this parameter:</p> <p>Expansion Module 1 expmod1page1right (Expansion Module 1, Page 1, right column) expmod1page2right (Expansion Module 1, Page 2, right column) expmod1page3right (Expansion Module 1, Page 3, right column)</p> <p>Expansion Module 2 expmod2page1right (Expansion Module 2, Page 1, right column) expmod2page2right (Expansion Module 2, Page 2, right column) expmod2page3right (Expansion Module 2, Page 3, right column)</p> <p>Expansion Module 3 expmod3page1right (Expansion Module 3, Page 1, right column) expmod3page2right (Expansion Module 3, Page 2, right column) expmod3page3right (Expansion Module 3, Page 3, right column)</p>
Format	Text String
Default Value	N/A
Range	N/A
Example	expmod1page1right: Operations Ext

Advanced Operational Parameters

The following parameters in this section allow the system administrator to set advanced operational features on the IP phones.

Blind Transfer Setting

Parameter – <i>sip cancel after blind transfer</i>	Configuration Files aastra.cfg, <mac>.cfg
Description	Forces the phone to use the Blind Transfer method available in software prior to release 1.4. This method sends the CANCEL message after the REFER message when blind transferring a call.
Format	Boolean
Default Value	0 (disabled)
Range	0 (disabled) 1 (enabled)
Example	sip cancel after blind transfer: 1

Update Caller ID Setting.

Parameter – <i>sip update callerid</i>	Configuration Files aastra.cfg, <mac>.cfg
Description	Enables or disables the updating of the Caller ID information during a call.
Format	Boolean
Default Value	0 (disabled)
Range	0 (disabled) 1 (enabled)
Example	sip update callerid: 1

Boot Sequence Recovery Mode Settings.

Parameter – <i>force web recovery mode disabled</i>	Configuration Files aastra.cfg, <mac>.cfg
Description	Enables or disables the forcing web recovery mode feature. If this parameter is set to "1", you cannot force web recovery. If this parameter is set to "0", press 1 and # keys during boot up when the logo displays to force the web recovery mode.
Format	Boolean
Default Value	0 (false)
Range	0 (false) 1 (true)
Example	force web recovery mode disabled: 1

Parameter – <i>max boot count</i>	Configuration Files aastra.cfg, <mac>.cfg
Description	Specifies the number of faulty boots that occur before the phone is forced into Web recovery mode.
Format	Integer
Default Value	10
Range	0 to 32767 Zero (0) disables the max boot count feature.
Example	max boot count: 0

Single Call Restriction Setting

Parameter – <i>two call support</i> <i>Two Call Support</i> (in Web UI)	Aastra Web UI Configuration Files	Advanced Settings->Global SIP->RTP Settings aastra.cfg, <mac>.cfg
Description	<p>Enables or disables the single media path restriction between the 6757i CT and 9480i CT base unit and the handset.</p> <p>When this feature is enabled (set to 1), you can make separate active calls from the 6757i CT and 9480i CT base unit and from the cordless handset. If this feature is disabled (set to 0), only one call can be active at a time either from the base unit or from the handset.</p> <p>When this feature is disabled, and you make an active call on either the base unit or the handset, any other attempt to make an active call is put on hold. Also, when this feature is disabled, more than one call can negotiate complex audio codecs since only a single call is decoding audio at a time.</p>	
Format	Boolean	
Default Value	1	
Range	0 - Disable 1 - Enable	
Example	two call support: 0	

XML Key Redirection Settings (for Redial, Xfer, Conf, Icom, Voicemail)

Parameter– <i>redial script</i>	Configuration Files aastra.cfg, <mac>.cfg
Description	Specifies a redial script for the phone to use. When this parameter is set, pressing the Redial key GETs the specified URI from the server to use in performing the redial action.
Format	String
Default Value	empty
Range	Any valid URI
Example	redial script: http://bluevelvet.ana.aastra.com/redial.php

Parameter– <i>xfer script</i>	Configuration Files aastra.cfg, <mac>.cfg
Description	Specifies an Xfer script for the phone to use. When this parameter is set, pressing the Xfer key GETs the specified URI from the server instead of starting the transfer action.
Format	String
Default Value	empty
Range	Any valid URI
Example	xfer script: http://bluevelvet.ana.aastra.com/xfer.php

Parameter– <i>conf script</i>	Configuration Files aastra.cfg, <mac>.cfg
Description	Specifies an Conf script for the phone to use. When this parameter is set, pressing the Conf key GETs the specified URI from the server to use in performing the conference action.
Format	String
Default Value	empty
Range	Any valid URI
Example	conf script: http://bluevelvet.ana.aastra.com/conf.php

Parameter– <i>icom script</i>	Configuration Files aastra.cfg, <mac>.cfg
Description	Specifies an Icom script for the phone to use. When this parameter is set, pressing the Icom key GETs the specified URI from the server to use in performing the Intercom action.
Format	String
Default Value	empty
Range	Any valid URI
Example	icom script: http://bluevelvet.ana.aastra.com/icom.php

Parameter– <i>voicemail script</i>	Configuration Files aastra.cfg, <mac>.cfg
Description	Specifies an Voicemail script for the phone to use. When this parameter is set, selecting the voicemail option from the Services Menu GETs the specified URI from the server instead of starting the Voicemail application.
Format	String
Default Value	empty
Range	Any valid URI
Example	voicemail script: http://bluevelvet.ana.aastra.com/voicemail.php

Options Key Redirection Setting (Services key on 6751i)

Parameter– options script	Configuration Files aastra.cfg, <mac>.cfg
Description	Specifies an Options script for the phone to use. When this parameter is set, pressing the Options Key (or Services Key on the 6751i) GETs the specified URI from the server. Note: Pressing and holding the Options key (or the Services Key on the 6751i) displays the local Options Menu on the phone.
Format	String
Default Value	empty
Range	Any valid URI
Example	options script: http://fargo.ana.aastra.com/options.xml

Off-Hook and XML Application Interaction Setting

Parameter– auto offhook	Configuration Files aastra.cfg, <mac>.cfg
Description	Specifies whether or not the phone is prevented from entering the off-hook/dialing state, if the handset is off-hook for more than 2 seconds, and the call ends.
Format	Boolean
Default Value	0 (disabled)
Range	0 (disabled - phone is prevented from entering the off-hook dialing state) 1 (enabled - allows phone to enter the off-hook dialing state)
Example	auto offhook: 1

XML Override for a Locked Phone Setting

Parameter – <i>xml lock override</i>	Configuration Files aastra.cfg, <mac>.cfg
Description	Specifies the method to use for overriding a locked phone when XML applications are sent to the phone. There are three settings for this parameter: 0 Phone prevents XML POSTs and XML GETs from being received or sent. 1 Phone allows XML POSTs; however, XML GETs by pressing the XML keys (softkeys/programmable keys/extension module keys) are not allowed. 2 Phone allows XML POSTs to the phone as well as XML GETs to/from the phone by pressing the XML keys (softkeys/programmable keys/extension module keys).
Format	Integer
Default Value	0
Range	0 to 2
Example	xml lock override: 1

Symmetric UDP Signaling Setting

Parameter – <i>sip symmetric udp signaling</i>	Configuration Files aastra.cfg, <mac>.cfg
Description	Allows you to enable or disable the phone to use port 5060 to send SIP UDP messages. The value “1” (which is the default) enables the phone to use port 5060. The value “0” (zero) disables the phone from using port 5060 and allows the phone to choose a random port to send SIP UDP messages.
Format	Boolean
Default Value	1 (enabled)
Range	0 (disabled) 1 (enabled)
Example	sip symmetric udp signaling: 0

User-Agent Setting

Parameter – <i>sip user-agent</i>	Configuration Files aastra.cfg, <mac>.cfg
Description	Allows you to enable or disable the addition of the User-Agent and Server SIP headers in the SIP stack. The value of “0” prevents the UserAgent and Server SIP header from being added to the SIP stack. The value of “1” allows these headers to be added.
Format	Boolean
Default Value	1 (true)
Range	0 (false) 1 (true)
Example	sip user-agent: 0

GRUU and sip.instance Support

Parameter – <i>sip gruu</i>	Configuration Files aastra.cfg, <mac>.cfg
Description	Enables or disables Globally Routable User-Agent URI (GRUU) support on the IP Phone according to draft-ietf-sip-gruu-15. If this parameter is disabled, parsing of inbound GRUU's for transfer are still enabled.
Format	Boolean
Default Value	1 (enabled)
Range	0 (disabled) 1 (enabled)
Example	sip gruu: 0

DNS Query Setting

Parameter – <i>sip dns query type</i>	Configuration Files aastra.cfg, <mac>.cfg
Description	Specifies the Domain Name Service (DNS) query method to use when the phone performs a DNS lookup.
Format	Integer
Default Value	1
Range	<p>0 A only - The phone sends “A” (Host IP Address) lookup for the IP address and uses the default port number of 5060.</p> <p>1 SRV & A - The phone sends “SRV” (Service Location Record) lookup to get the port number. Most often, the IP address is included in the response from the DNS server to avoid extra queries. If there is no IP address returned in the response, the phone sends out the “A” DNS lookup to find the IP address.</p> <p>2 NAPTR & SRV & A - First, the phone sends “NAPTR” (Naming Authority Pointer) lookup to get the “SRV” pointer and service type (such as “aastra.com SIP+2DT _sip.tcp.aastra.net”, which means the service prefers to use TCP and “_sip.tcp.aastra.net” for the SRV query instead of the default “_sip._tcp.aastra.com”). If the NAPTR record is returned empty then the default value is used, so in the same case, the phone will use “_sip._udp.aastra.com” for the next step lookup. Next, the phone does SRV lookup to get the IP address and port number. If there is no IP address in the SRV response then it sends out and “A” lookup to get it.</p> <p>Note: On the phone side, if you configure the phone with a Fully- Qualified Domain Name (FQDN) proxy and specified port, the phone always sends “A only” lookups to find the Host IP Address of the proxy.</p>
Example	sip dns query type: 2

Ignore Out of Order SIP Requests

Parameter – <i>sip accept out of order requests</i>	Configuration Files aastra.cfg, <mac>.cfg
Description	Enables a workaround for non-compliant SIP devices (for example, Asterisk) which do not increment the CSeq numbers in SIP requests sent to the phone.
Format	Boolean
Default Value	0 (disabled)
Range	0 (disabled) 1 (enabled)
Example	sip accept out of order requests: 1

Optional “Allow” and “Allow-Event” Headers

Parameter – <i>sip notify opt headers</i>	Configuration Files aastra.cfg, <mac>.cfg
Description	Enables and disables whether or not the “Allow” and Allow-Events” optional headers are included in the SIP NOTIFY messages sent from the phone to the server.
Format	Boolean
Default Value	1
Range	0 (disabled - optional headers are removed from the SIP NOTIFY message) 1 (enabled - no change; optional headers are included in SIP NOTIFY message)
Example	sip notify opt headers: 0

P-Asserted Identity (PAI)

Parameter – <i>sip pai</i>	Configuration Files aastra.cfg, <mac>.cfg
Description	Enables or disables whether the SIP PAI displays to the IP phone.
Format	Boolean
Default Value	1
Range	0 (disabled) 1 (enabled)
Example	sip pai: 0

Configuration Encryption Setting

Parameter– <i>config encryption key</i>	Configuration Files aastra.cfg, <mac>.cfg
Description	Specifies the phone-specific encryption key that the configuration server uses to encrypt in a MAC-specific configuration file.
Format	String
Default Value	Not applicable
Range	String length of 4 to 32 alphanumeric characters
Example	config encryption key: 123abcd

Troubleshooting Parameters

The following parameters in this section allow the system administrator to set logging and support settings for troubleshooting purposes.

Log Settings

Parameter – <i>log server ip</i>	Aastra Web UI	Advanced Settings->Troubleshooting-> Log Settings
<i>Log IP</i> (in Web UI)	Configuration Files	aastra.cfg, <mac>.cfg
Description	Specifies the IP address for which to save log files for troubleshooting purposes.	
Format	IP address	
Default Value	0.0.0.0	
Range	Not Applicable	
Example	log server ip: 192.168.3.2	

Parameter – <i>log server port</i>	Aastra Web UI	Advanced Settings->Troubleshooting-> Log Settings
<i>Log Port</i> (in Web UI)	Configuration Files	aastra.cfg, <mac>.cfg
Description	Specifies the IP port to use to save log files for troubleshooting purposes. This is the IP port that transmits information from the IP phone to the IP address location.	
Format	Integer	
Default Value	0	
Range	Any valid IP port	
Example	log server port: 2	

<p>Parameters – <i>log module <module name></i></p> <p><i>Module/Debug Level</i> (in Web UI)</p>	<p>Aastra Web UI Advanced Settings->Troubleshooting-> Module/Debug Level</p> <p>Configuration Files aastra.cfg, <mac>.cfg</p>
<p>Description</p>	<p>Allows enhanced severity filtering of log calls sent as blog output.</p> <p>The blog, as used on the IP phones, is an online debugging tool that can be frequently updated and intended for technical support analysis. Blogs are defined by their format: a series of entries posted to a single page in reverse-chronological order. The IP Phone blogs are separated into modules which allow you to log specific information for analyzing:</p> <p><u>Module Name (configuration files)</u></p> <ul style="list-style-type: none"> • linemgr (line manager information) • user interface • misc (miscellaneous) • sip (call control SIP stack) • dis (display driver) • dstore (delayed storage) • ept (endpoint) • ind (indicator) • kbd (keyboard) • net (network) • provis (provisioning) • rtpt (Real Time Transport) • snd (sound) • prof (profiler) • xml (Extension Markup Language) • stun (Simple Traversal of User Datagram Protocol (UDP) through Network Address Translation (NAT))
<p>Format</p>	<p>Integer</p>
<p>Default Value</p>	<p>1 (fatal errors)</p>

Range

Debug Level	Value
Fatal Errors	1 (default)
Errors	2
Warnings	4
Init	8
Functions	16
Info	32
All debug levels OFF	0
All Debug Levels ON	65535

Examples

Enter a debug level value in the “**Debug Level**” field for a module.

Example 1

To turn two or more debug levels on at the same time, you add the value associated with each level. For example,

$$\text{Fatal Errors} + \text{Errors} + \text{Warnings} = 1 + 2 + 4 = 7$$

```
log module linemgr: 7
log module user interface: 7
log module sip: 7
```

In the above example, fatal errors, general errors, and warnings are logged for the line manager, user interface, and SIP call control modules.

Example 2

$$\text{Functions and Info} = 16 + 32 = 48$$

```
log module dis: 48
log module net: 48
log module snd: 48
```

In the above example, functions and general information are logged for the display drivers, network, and sound modules.

Example 3

```
log module rpt: 0
log module ind: 65535
```

In the above example, all debug levels are OFF for the Real Time Transport module. All debug levels are ON for the indicator module. You can set the Module/Debug Levels using the configuration files or the Astra Web UI.

WatchDog Settings

Parameter– <i>watchdog enable</i>	Configuration Files Aastra Web UI	aastra.cfg, <mac>.cfg Advanced Settings->Troubleshooting
<i>WatchDog</i> (in Web UI)		
Description	Enables/disables the use of the WatchDog task for the IP Phones.	
Format	Boolean	
Default Value	1 (enabled)	
Range	0 (disabled) 1 (enabled)	
Example	watchdog enable: 0	

Appendix B

Configuring the IP Phone at the Asterisk IP PBX

About this appendix

Introduction

This appendix describes how to setup a user's phone with an extension to make and receive calls using the Asterisk as the PBX.

Topics

This appendix covers the following topics:

Topic	Page
IP Phone at the Asterisk IP PBX	page B-2

IP Phone at the Asterisk IP PBX

The following configuration illustrates how to create a user with an extension to make and receive calls using the Asterisk as the PBX. This configuration is defined in the *sip.conf* file present along with the other configuration files that are created when Asterisk is installed. Usually, the configuration files can be found at the */etc/asterisk* directory.

*;This is used in the “extensions.conf” file to identify this
;physical phone when issuing Dial commands.
[phone1]*

*;The type to use for the 6757i is “friend”.
;”Peer” is used when the Asterisk is contacting a proxy,
;”user” is used for phones that can only make calls
;and “friend” acts as both a peer and a user.
type=friend*

*;If your host has an entry in your DNS then you just enter the
;machines name in the host= field.
host=dynamic
defaultip=192.168.1.1 ;default IP address that the phone is
;configured to*

*;The password that phone1 will use to register with this PBX
secret=1234*

*dtmfmode=rfc2833;Choices are inband, rfc2833, or info
mailbox=1000 ;Mailbox for message waiting indicator*

;If a phone is not in a valid context you will not be

```

;able to use it. In this example 'sip' is used. You can use
;whatever you like, but make sure they are the same, you will
;need to make an entry in your extensions.conf file (which we
;will get to later)
context=sip
callerid="Phone 1" <1234>

```

After this is defined in the “sip.conf” file, some information has to be entered in the “extensions.conf” file present in the same directory as the “sip.conf” file. The following definition in the file under the [sip]section/context completes defining the extension for the 6757i phone.

Table 1:

```

exten -> 1234,1,Dial(SIP/phone1,20)

```

This definition completes configuring the 6757i phone at the IP PBX system.

To verify whether the extension has been successfully registered at the IP PBX system, enter the Asterisk console and reload Asterisk. Use the command “sip show peers” at the console. This will display the extensions that are registered at the IP PBX system.

Table 2:

<i>Name/username</i>	<i>Host</i>	<i>Mask</i>	<i>Port</i>	<i>Status</i>
phone1/phone1	192.168.1.1	(D) 255.255.255.255	5060	Unmonitored

This completes the basic set-up for the 6757i phone with 1234 extension at the Asterisk IP PBX system. Refer to Asterisk documentation for set-up on extended or advanced features such as voice mail and call forwarding, etc.

Appendix C

Sample Configuration Files

About this appendix

Introduction

This appendix provides sample configuration files for the 6757i, 6757i CT, and 6753i.

Topics

This appendix covers the following topics:

Topic	Page
Sample Configuration Files	page C-2
6757i Sample Configuration File	page C-2
6757i CT Sample Configuration File	page C-12
6753i Sample Configuration File	page C-29

Sample Configuration Files

This section consists of the sample configuration files necessary to configure the IP phones. The general format is similar to configuration files used by several Unix-based programs. Any text following a number sign (#) on a line is considered to be a comment, unless the # is contained within double-quotes. Currently, Boolean fields use 0 for false and 1 for true.

6757i Sample Configuration File

```
# Sample Configuration File
# =====

# Date: October 20th, 2005

# Phone Model: 6757i

# Notes:
#
# The general format used here is similar to configuration files
# used by several UNIX-based programs. Any text following a number
# sign (#) is considered to be a comment, unless the number sign is
# contained within double-quotes ("#") where it is considered to be
# a pound. For Boolean fields, 0 = false, 1 = true.

# Comments:
#
# This file contains sample configurations for the "aastra.cfg" or
# "<mac>.cfg" file. The settings included here are examples only.
# You should change/comment the values to suit your requirements.
#
# Not all possible paramters are shown, refer to the admin guide for
# the full list of supported parameters, their defaults and valid
# ranges.
#
```



```
# The Aastra 6757i, 6757iCT, and 6753i phones will download 2
# configuration files from the TFTP server while restarting, the
# "aastra.cfg" file and the "<mac>.cfg" file. These two configuration
# files can be used to configure all of the settings of the phone with
# the exception of assigning a static IP address to a phone and line
# settings, which should only be set in the "<mac>.cfg" file.
#
# The "aastra.cfg" file configures the settings server wide, while
# the "<mac>.cfg" file configures only the phone with the MAC address
# for which the file is named (for example, "00085d0304f4.cfg"). The
# settings in the "aastra.cfg" file will be overridden by settings
# which also appear in the "<mac>.cfg" file.
#-----
```

```
# DHCP Setting
# =====
```

```
#dhcp: 1 # DHCP enabled.
```

```
# DHCP:
# 0 = false, means DHCP is disabled.
# 1 = true, means DHCP is enabled.
#
# Notes:
#
# DHCP is normally set from the Options list on the phone or
# the web interface
#
# If DHCP is disabled, the following network settings will
# have to be configured manually either through the configuration
# files, the Options List in the phone, or the Web Client: IP
# Address (of the phone), Subnet Mask, Gateway, DNS, and TFTP
# Server.
#-----
```

Network Settings

= = = = =

Notes: If DHCP is enabled, you do not need to set these network
settings. Although depending on you DHCP server configuration you
may still have to set the dns address.

#ip: # This value is unique to each phone on a server
and should be set in the "<mac>.cfg" file if
setting this manually.

#subnet mask:
#default gateway:
#dns1:
#dns2:

Time Server Settings

=====

#time server disabled: 1 # Time server disabled.
#time server1: # Enable time server and enter at
#time server2: # least one time server IP address or
#time server3: # qualified domain name

Time Server Disabled:
0 = false, means the time server is not disabled.
1 = true, means the time server is disabled.

NAT Settings

=====

Option 1:

If you are connecting to a Nortel MCS call server and there is a

NAT device between the server and the phone, then you must set the
following two parameters for the phone to function correctly.

```
#sip nortel nat support: 1      # 1 = enabled
#sip nortel nat timer: 60     # seconds between keep alive messages
```

Option 2:

#

If you are using a session border controller, you should set the
outbound proxy to the session border controller address

```
#sip outbound proxy: sbc.aastra.com
#sip outbound proxy port: 0      # a value of 0 enables SRV
                                # lookups for the address of
                                # the proxy.
```

Option 3:

#

If you know the public IP address of your NAT device and have
opened up a port for the SIP messages then you can statically
assign this information.

```
#sip nat ip: 67.123.122.90
#sip nat port: 5890
```

Additional Network Settings

=====

```
#sip rtp port: 3000      # Eg. RTP packets are sent to port 3000.
```

#-----

Configuration Server Settings

= = = = =

Notes: This section defines which server the phone retrieves new
firmware images and configuration files from. Three protocols are
supported TFTP, FTP and HTTP

download protocol: TFTP # valid values are TFTP, FTP and HTTP

TFTP server settings

tftp server: 192.168.0.130

#alternate tftp server:

#use alternate tftp server: 1 # If your DHCP server assigns
a TFTP server address which
you do not use, you can use
the alternate tftp server.

FTP server settings

#ftp server: 192.168.0.131 # can be IP or FQDN

#ftp username: aastra

#ftp password: 6757iaastra

HTTP server settings (for http://bogus.aastra.com/firmware/)

#http server: bogus.aastra.com # can be IP or FQDN

#http path: firmware

#-----

Dial Plan Settings

=====

#

Notes:

#

As you dial a number on the phone, the phone will initiate a call

when one of the following conditions are met:

```
#
# (1) The entered number is an exact match in the dial plan
# (2) The "#" symbol has been pressed
# (3) A timeout occurs
#
# The dial plan is a regular expression that supports the following
# syntax:
#
# 0,1,2,3,4,5,6,7,8,9,*,# : matches the keypad symbols
# x                       : matches any digit (0..9)
# +                       : matches 0 or more repetitions of the
#                           : previous expression
# [ ]                     : matches any number inside the brackets
#                           : can be used with a "-" to represent a
#                           : range
# ( )                     : expression grouping
# |                       : either or
#
#
# If the dialled number doesn't match the dial plan then the call
# is rejected.

sip digit timeout: 3      # set the inter-digit timeout in seconds

# Example dial plans
sip dial plan: "x+#|xx+*" # this is the default dial string, note
                           # that is must be quoted since it contains
                           # a '#' character

#sip dial plan: [01]xxx|[2-8]xxxx|9lxxxxxxxxxxx
                           # accept any 4 digit number beginning
                           # with a 0 or 1, any 5 digit number
                           # beginning with a number between 2 and 8
                           # (inclusive) or a 12 digit number
                           # beginning with 9l
```

```
#sip dial plan terminator: 1 # enable sending of the "#" symbol to
                             # to the proxy in the dial string
```

```
#-----
```

General SIP Settings

= = = = =

```
#sip session timer: 30 # enable support of RFC4028, the default
                       # value of 0 disables this functionality
```

```
#sip transport protocol: 0 # use UDP (1), TCP (2) or both (0) for sip
                            # messaging
```

```
#sip use basic codecs: 1 # limit codecs to G711 and G729
```

```
#sip out-of-band dtmf: 0 # turn off support for RFC2833 (on by
                          # default)
```

Global SIP User Settings

=====

#

Notes:

```
# These settings are used as the default configuration for the hard
# key lines on the phone. That is:
```

#

```
# L1 to L4 on the 6757i and 6757iCT
```

```
# L1 to L3 on the 6753i
```

#

```
# These can be over-ridden on a per-line basis using the per-line
# settings.
```

#

```
# See the Admin Guide for a detailed explanation of how this works
```

```
sip screen name: Joe Smith      # the name display on the phone's screen
sip user name: 4256             # the phone number
sip display name: Joseph Smith # the caller name sent out when making
                               # a call.
sip vmail: *78                 # the number to reach voicemail on

sip auth name: jsmith          # account used to authenticate user
sip password: 12345           # password for authentication account

sip mode: 0                    # line type:
                               # 0 - generic,
                               # 1 - BroadSoft SCA line
                               # 2 - Nortel line

sip proxy ip: proxy.aastra.com # IP address or FQDN of proxy
sip proxy port: 5060           # port used for SIP messages on the
                               # proxy. Set to 0 to enable SRV
                               # lookups

sip registrar ip: aastra.com   # IP address or FQDN of registrar
sip registrar port: 0          # as proxy port, but for the registrar
sip registration period: 3600 # registration period in seconds
```

Per-line SIP Settings

```
# =====
```

```
# configure line 3 as the support Broadsoft SCA line
# - the proxy and registrar settings are taken from the global
# settings above
```

```
sip line3 screen name: Support
sip line3 user name: 4000
sip line3 display name: Aastra Support
sip line3 auth name: support
sip line3 password: 54321
sip line3 mode: 1
```

```
sip line3 vmail: *78
```

```
# configure line 5 (a soft key line) as an ordinary line  
# of a test server
```

```
sip line5 screen name: Test 1  
sip line5 user name: 5551001  
sip line5 display name: Test 1  
sip line5 auth name: 5551001  
sip line5 password: 5551001  
sip line5 mode: 0  
sip line5 proxy ip: 10.50.10.102  
sip line5 proxy port: 5060  
sip line5 registrar ip: 10.50.10.102  
sip line5 registrar port: 5060  
sip line5 registration period: 60
```

```
#-----
```

```
# Softkey Settings  
#
```

```
# Softkeys can be set either server wide or unique to each phone.  
# Setting softkeys as line/call appearances should be done in the  
# "<mac>.cfg" file, since these are unique to each phone.
```

```
# Notes:
```

```
#  
# There are a maximum of 18 softkeys that can be configured on the  
# 6757i or 6757iCT phone. These can be set up through either of the 2  
# configuration files, depending on whether this is to be server wide  
# ("astra.cfg") or phone specific ("<mac>.cfg"). Each softkey needs  
# to be numbered from 1 - 18, for example "softkey12 type:  
# speeddial". Softkeys can be set up as speeddials or as additional  
# call/line appearances and have a type, label and value associated
```



```
# with it as seen here in the default softkey settings.

# SOFTKEY TYPES: "line", "speeddial", "blf", "list", "dnd"
# SOFTKEY LABEL: Alpha numeric name for the softkey. The maximum
#                 number of characters for this value is 10 for
#                 speeddials and dnd, 9 chars for lines, blf
# SOFTKEY VALUE: If softkey type is a speeddial, any DTMF's (from
#                 0 - 9, *, "#") or a comma (,) for 500ms pause and
#                 'E' for On-hook can be set for the value.
#                 If softkey type is blf it is the extension you want
#                 to monitor.
# SOFTKEY LINE: This is line associated with the softkey. For line
#                 softkeys the value must be between 5 and 9 (1 - 4
#                 are already hardcoded as the L1, L2, L3 and L4 hard
#                 key line/call appearances)
```

Speed Dials

```
softkey1 type: speeddial
softkey1 label: "Ext Pickup"
softkey1 value: *8
softkey2 type: speeddial
softkey2 label: "Call Return"
softkey2 value: *69
```

DND Key

```
softkey4 type: dnd
softkey4 label: DND
```

Line appearance

```
softkey6 type: line
softkey6 label: Test 1
softkey6 line: 5
```

blf

```
softkey8 type: blf
softkey8 label: Jane Doe
softkey8 value: 4559
```

softkey8 line: 1

```
# list
softkey11 type: list
softkey12 type: list
```

6757i CT Sample Configuration File

Sample Configuration File

=====

Date: October 26th, 2005

Phone Model: 6757iCT

Notes:

#

The general format used here is similar to configuration files
used by several UNIX-based programs. Any text following a number
sign (#) is considered to be a comment, unless the number sign is
contained within double-quotes ("#") where it is considered to be
a pound. For Boolean fields, 0 = false, 1 = true.

Comments:

#

This file contains sample configurations for the "aastra.cfg" or
"<mac>.cfg" file. The settings included here are examples only.
You should change/comment the values to suit your requirements.

Not all possible paramters are shown, refer to the admin guide for
the full list of supported parameters, their defaults and valid
ranges.

#

The Aastra 6757i, 6757iCT, and 6753i phones will download 2
configuration files from the TFTP server while restarting, the

```
# "astra.cfg" file and the "<mac>.cfg" file. These two configuration
# files can be used to configure all of the settings of the phone with
# the exception of assigning a static IP address to a phone and line
# settings, which should only be set in the "<mac>.cfg" file.
#
# The "astra.cfg" file configures the settings server wide, while the
# "<mac>.cfg" file configures only the phone with the MAC address for
# which the file is named (for example, "00085d0304f4.cfg"). The
# settings in the "astra.cfg" file will be overridden by settings
# which also appear in the "<mac>.cfg" file.
#-----
```

DHCP Setting

```
# =====
```

```
#dhcp: 1 # DHCP enabled.
```

```
# DHCP:
```

```
# 0 = false, means DHCP is disabled.
```

```
# 1 = true, means DHCP is enabled.
```

```
#
```

```
# Notes:
```

```
#
```

```
# DHCP is normally set from the Options list on the phone or
```

```
# the web interface
```

```
#
```

```
# If DHCP is disabled, the following network settings will
```

```
# have to be configured manually either through the configuration
```

```
# files, the Options List in the phone, or the Web Client: IP
```

```
# Address (of the phone), Subnet Mask, Gateway, DNS, and TFTP
```

```
# Server.
```

```
#-----
```

Network Settings

=====

Notes: If DHCP is enabled, you do not need to set these network
settings. Although depending on you DHCP server configuration you
may still have to set the dns address.

```
#ip:      # This value is unique to each phone on a server
          # and should be set in the "<mac>.cfg" file if
          # setting this manually.

#subnet mask:
#default gateway:
#dns1:
#dns2:

# Time Server Settings
# =====

#time server disabled: 1 # Time server disabled.
#time server1:          # Enable time server and enter at
#time server2:          # least one time server IP address or
#time server3:          # qualified domain name

# Time Server Disabled:
# 0 = false, means the time server is not disabled.
# 1 = true, means the time server is disabled.

# NAT Settings
#=====

# Option 1:
#
# If you are connecting to a Nortel MCS call server and there is a
# NAT device between the server and the phone, then you must set the
# following two parameters for the phone to function correctly.

#sip nortel nat support: 1      # 1 = enabled
```

```
#sip nortel nat timer: 60      # seconds between keep alive messages
```

```
# Option 2:
```

```
#
```

```
# If you are using a session border controller, you should set the  
# outbound proxy to the session border controller address
```

```
#sip outbound proxy: sbc.aastra.com
```

```
#sip outbound proxy port: 0      # a value of 0 enables SRV  
                                # lookups for the address of  
                                # the proxy.
```

```
# Option 3:
```

```
#
```

```
# If you know the public IP address of your NAT device and have  
# opened up a port for the SIP messages then you can statically  
# assign this information.
```

```
#sip nat ip: 67.123.122.90
```

```
#sip nat port: 5890
```

```
# Additional Network Settings
```

```
#=====
```

```
#sip rtp port: 3000      # Eg. RTP packets are sent to port 3000.
```

```
#-----
```

```
# Configuration Server Settings
```

```
#=====
```

```
# Notes: This section defines which server the phone retrieves new
# firmware images and configuration files from. Three protocols are
# supported TFTP, FTP and HTTP
```

```
download protocol: TFTP # valid values are TFTP, FTP and HTTP
```

```
## TFTP server settings
```

```
tftp server: 192.168.0.130
```

```
#alternate tftp server:
```

```
#use alternate tftp server: 1 # If your DHCP server assigns
# a TFTP server address which
# you do not use, you can use
# the alternate tftp server.
```

```
## FTP server settings
```

```
#ftp server: 192.168.0.131 # can be IP or FQDN
```

```
#ftp username: aastra
```

```
#ftp password: 6757iaastra
```

```
## HTTP server settings (for http://bogus.aastra.com/firmware/)
```

```
#http server: bogus.aastra.com # can be IP or FQDN
```

```
#http path: firmware
```

```
#-----
```

```
# Dial Plan Settings
```

```
# =====
```

```
#
```

```
# Notes:
```

```
#
```

```
# As you dial a number on the phone, the phone will initiate a call
# when one of the following conditions are meet:
#
# (1) The entered number is an exact match in the dial plan
# (2) The "#" symbol has been pressed
# (3) A timeout occurs
#
# The dial plan is a regular expression that supports the following
# syntax:
#
# 0,1,2,3,4,5,6,7,8,9,*,# : matches the keypad symbols
# x                       : matches any digit (0..9)
# +                       : matches 0 or more repetitions of the
#                          : previous expression
# []                      : matches any number inside the brackets
#                          : can be used with a "-" to represent a
#                          : range
# ()                      : expression grouping
# |                       : either or
#
#
# If the dialled number doesn't match the dial plan then the call
# is rejected.

sip digit timeout: 3      # set the inter-digit timeout in seconds

# Example dial plans
sip dial plan: "x+#[xx+*" # this is the default dial string, note
                          # that is must be quoted since it contains
                          # a '#' character

#sip dial plan: [01]xxx|[2-8]xxxx|9lxxxxxxxxxxx
                          # accept any 4 digit number beginning
```



```

# with a 0 or 1, any 5 digit number
# beginning with a number between 2 and 8
# (inclusive) or a 12 digit number
# beginning with 91

#sip dial plan terminator: 1 # enable sending of the "#" symbol to
# to the proxy in the dial string

#-----

# General SIP Settings
# =====

#sip session timer: 30 # enable support of RFC4028, the default
# value of 0 disables this functionality

#sip transport protocol: 0 # use UDP (1), TCP (2) or both (0) for sip
# messaging

#sip use basic codecs: 1 # limit codecs to G711 and G729
#sip out-of-band dtmf: 0 # turn off support for RFC2833 (on by
# default)

# Global SIP User Settings
# =====
#
# Notes:
# These settings are used as the default configuration for the hard
# key lines on the phone. That is:
#
```

IP Phone Administrator Guide

Sample Configuration Files

```
# L1 to L4 on the 6757i and 6757iCT
# L1 to L3 on the 6753i
#
# These can be over-ridden on a per-line basis using the per-line
# settings.
#
# See the Admin Guide for a detailed explanation of how this works

sip screen name: Joe Smith      # the name display on the phone's screen
sip user name: 4256             # the phone number
sip display name: Joseph Smith # the caller name sent out when making
                               # a call.
sip vmail: *78                 # the number to reach voicemail on

sip auth name: jsmith          # account used to authenticate user
sip password: 12345           # password for authentication account

sip mode: 0                    # line type:
                               # 0 - generic,
                               # 1 - BroadSoft SCA line
                               # 2 - Nortel line

sip proxy ip: proxy.aastra.com # IP address or FQDN of proxy
sip proxy port: 5060           # port used for SIP messages on the
                               # proxy. Set to 0 to enable SRV
                               # lookups

sip registrar ip: aastra.com   # IP address or FQDN of registrar
sip registrar port: 0           # as proxy port, but for the registrar
sip registration period: 3600  # registration period in seconds

# Per-line SIP Settings
# =====
```

```
# configure line 3 as the support Broadsoft SCA line
# - the proxy and registrar settings are taken from the global
#   settings above
```

```
sip line3 screen name: Support
sip line3 user name: 4000
sip line3 display name: Aastra Support
sip line3 auth name: support
sip line3 password: 54321
sip line3 mode: 1
sip line3 vmail: *78
```

```
# configure line 5 (a soft key line) as an ordinary line
# of a test server
```

```
sip line5 screen name: Test 1
sip line5 user name: 5551001
sip line5 display name: Test 1
sip line5 auth name: 5551001
sip line5 password: 5551001
sip line5 mode: 0
sip line5 proxy ip: 10.50.10.102
sip line5 proxy port: 5060
sip line5 registrar ip: 10.50.10.102
sip line5 registrar port: 5060
sip line5 registration period: 60
```

```
#-----
```

```
# Softkey Settings
```

```
# =====
```

```
# Softkeys can be set either server wide or unique to each phone.
# Setting softkeys as line/call appearances should be done in the
# "<mac>.cfg" file, since these are unique to each phone.

# Notes:
#
# There are a maximum of 18 softkeys that can be configured on the
# 6757i or 6757iCT phone. These can be set up through either of the 2
# configuration files, depending on whether this is to be server wide
# ("astra.cfg") or phone specific ("<mac>.cfg"). Each softkey needs
# to be numbered from 1 - 18, for example "softkey12 type:
# speeddial". Softkeys can be set up as speeddials or as additional
# call/line appearances and have a type, label and value associated
# with it as seen here in the default softkey settings.

# SOFTKEY TYPES: "line", "speeddial", "blf", "list", "dnd"
# SOFTKEY LABEL: Alpha numeric name for the softkey. The maximum
#                 number of characters for this value is 10 for
#                 speeddials and dnd, 9 chars for lines, blf
# SOFTKEY VALUE: If softkey type is a speeddial, any DTMFs (from
#                 0 - 9, *, "#") or a comma (,) for 500ms pause and
#                 'E' for On-hook can be set for the value.
#                 If softkey type is blf it is the extension you want
#                 to monitor.
# SOFTKEY LINE: This is line associated with the softkey. For line
#                 softkeys the value must be between 5 and 9 (1 - 4
#                 are already hardcoded as the L1, L2, L3 and L4 hard
#                 key line/call appearances)

# Speed Dials
softkey1 type: speeddial
softkey1 label: "Ext Pickup"
softkey1 value: *8
```

```
softkey2 type: speeddial
softkey2 label: "Call Return"
softkey2 value: *69
```

```
# DND Key
softkey4 type: dnd
softkey4 label: DND
```

```
# Line appearance
softkey6 type: line
softkey6 label: Test 1
softkey6 line: 5
```

```
# blf
softkey8 type: blf
softkey8 label: Jane Doe
softkey8 value: 4559
softkey8 line: 1
```

```
# list
softkey11 type: list
softkey12 type: list
```

```
#-----
```

```
# Cordless Handset Feature Keys
```

```
# =====
```

```
# Notes:
```

```
#
```

```
# In addition to the configuration parameters that exist on the 6757i
# phone, following are the parameters specific to the 6757i Cordless
# phones' handset. These parameters can be defined either int the
```

```
# aastra.cfg or the <mac>.cfg files.
#
# The feature keys are displayed when the user presses the F button
# on the cordless phone's hand set. If any changes to the features
# keys are made using these parameters the feature keys that exist on
# the hand set have to be refreshed. To refresh the feature keys
# simply open a new line or press one of the feature keys that are
# available from the hand set. After a couple of seconds the cordless
# should get the new list from the base set. There are 15 feature
# keys that can be configured for the cordless hand set. Each feature
# key has the following settings. N corresponds to the feature key
# that is being configured for and ranges from 0-14. Feature key N
# En label: "String" Feature key N Fr label: "Fr-String" Feature key
# N Sp label: "Sp-String" Feature key N control: 1 #Takes an
# integer value Feature key N hs event: 1 #Takes an integer value
# Feature key N base event: 1 #Takes an integer value
```

```
#key list version: 1
# The parameter value has to be incremented by one whenever the
# parameters that carry the feature keys change. The range is from
# 1-254. After reaching 254 start over from 1.
```

```
#Feature key 0 En label: "Line 1"
# English label for the key. Displayed when the phone's language is
# set to use English
```

```
#Feature key 0 Fr label: "Fr-Line 1"
# French label for the key. Displayed when the phone's language
# is set to use French
```

```
#Feature key 0 Sp label: "Sp-Line 1"
# Spanish label for the key. Displayed when the phone's language
# is set to use Spanish
```

```
Feature key 0 Gr label: "Gr-Line 1"
# German label for the key. Displayed when the phone's language
# is set to use German

Feature key 0 It label: "It-Line 1"
# Italian label for the key. Displayed when the phone's language
# is set to use Italian

#Feature key 0 control: 1
# 1 - Make the key configurable by the user through the phone and
#     the phone's web client
# 2 - Locks the key from user modifications. User cannot modify
#     this key from the handset or the phone's web client.
# 4 - Hide this key. Do not show it in the Feature keys list in the
#     cordless handset
# 6 - Lock and hide this key. Do not show it in the Feature keys
#     list in the cordless handset and do not let the user modify
#     this key using the phone or the web client.

#Feature key 0 hs event: 7
# These events are for handset specific events. Events can be local
# to the handset like directory/caller's list, intercom etc. or may
# be an event that is sent to the base set for further processing.
# When this key is configured as a base event then the base set
# will process the value of this key in conjunction with the value
# configured for the "Feature key N base event". Where N is the
# feature key is being configured for.
# In addition to the values listed below the valid values are
# [7-23]. The values [7-23] indicate generic handset events. If
# you are using values within this range make sure to use the value
# only once.
# The events local to the handset are as follows:
#
```

IP Phone Administrator Guide

Sample Configuration Files

```
# 58 - Menu (Options)
# 59 - Feature Key
# 60 - Redial
# 61 - Directory
# 62 - Callers' list
# 63 - Services
# 86 - Icom

#Feature key 0 base event: 1
# Indicates a corresponding action to perform on the base set when
# the "Feature key N hs event" is set to any value between 7-23.
#
# 1 - Seize base set's line1
# 2 - Seize base set's line2
# 3 - Seize base set's line3
# 4 - Seize base set's line4
# 5 - Seize base set's line5
# 6 - Seize base set's line6
# 7 - Seize base set's line7
# 8 - Seize base set's line8
# 9 - Seize base set's line9
# 10 - Seize base set's line0
# 11 - Send the base set's transfer event
# 12 - Send the base set's conference event
# 13 - Make feature list public

# Example configuration
key list version: 1

Feature key 0 En label: "Line 1"
Feature key 0 Fr label: "Fr-Line 1"
Feature key 0 Sp label: "Sp-Line 1"
Feature key 0 control: 0
```

Feature key 0 hs event: 7
Feature key 0 base event: 1

Feature key 1 En label: "Conf."
Feature key 1 Fr label: "Fr-Conf."
Feature key 1 Sp label: "Sp-Conf."
Feature key 1 control: 1
Feature key 1 hs event: 8
Feature key 1 base event: 12

Feature key 2 En label: "Xfer"
Feature key 2 Fr label: "Fr-Xfer."
Feature key 2 Sp label: "Sp-Xfer."
Feature key 2 control: 2
Feature key 2 hs event: 9
Feature key 2 base event: 11

Feature key 3 En label: "Icom"
Feature key 3 Fr label: "Fr-Icom"
Feature key 3 Sp label: "Sp-Icom"
Feature key 3 control: 1
Feature key 3 hs event: 86
Feature key 3 base event: 13

Feature key 4 En label: "Opt"
Feature key 4 Fr label: "Fr-Opt"
Feature key 4 Sp label: "Sp-Opt"
Feature key 4 hs event: 58
Feature key 4 control: 1
Feature key 4 base event: 13

Feature key 5 En label: "Callers"
Feature key 5 Fr label: "Fr-Callers"
Feature key 5 Sp label: "Sp-Callers"

Feature key 5 hs event: 62
Feature key 5 control: 1
Feature key 5 base event: 13

Feature key 6 En label: "Top"
Feature key 6 Fr label: "Fr-Top"
Feature key 6 Sp label: "Sp-Top"
Feature key 6 hs event: 17
Feature key 6 control: 1
Feature key 6 base event: 13

Feature key 7 En label: "Redial"
Feature key 7 Fr label: "Fr-Redial"
Feature key 7 Sp label: "Sp-Redial"
Feature key 7 hs event: 60
Feature key 7 control: 4
Feature key 7 base event: 13

Feature key 8 En label: "Dir."
Feature key 8 Fr label: "Fr-Dir."
Feature key 8 Sp label: "Sp-Dir."
Feature key 8 hs event: 61
Feature key 8 control: 2
Feature key 8 base event: 13

Feature key 9 En label: "Services"
Feature key 9 Fr label: "Fr-Services"
Feature key 9 Sp label: "Sp-Services"
Feature key 9 hs event: 63
Feature key 9 control: 1
Feature key 9 base event: 13

6753i Sample Configuration File

Sample Configuration File

#= = = = =

Date: October 26th, 2005

Phone Model: 6753i

Notes:

#

The general format used here is similar to configuration files used by several UNIX-based programs. Any text following a number sign (#) is considered to be a comment, unless the number sign is contained within double-quotes ("#") where it is considered to be a pound. For Boolean fields, 0 = false, 1 = true.

Comments:

#

This file contains sample configurations for the "astra.cfg" or "<mac>.cfg" file. The settings included here are examples only. You should change/comment the values to suit your requirements.

#

Not all possible parameters are shown, refer to the admin guide for the full list of supported parameters, their defaults and valid ranges.

#

The Aastra 6757i, 6757iCT, and 6753i phones will download 2 configuration files from the TFTP server while restarting, the "astra.cfg" file and the "<mac>.cfg" file. These two configuration files can be used to configure all of the settings of the phone with the exception of assigning a static IP address to a phone and line settings, which should only be set in the "<mac>.cfg" file.

#

```
# The "aastra.cfg" file configures the settings server wide, while
# the "<mac>.cfg" file configures only the phone with the MAC
# address for which the file is named (for example,
# "00085d0304f4.cfg"). The settings in the "aastra.cfg" file will
# be overridden by settings which also appear in the "<mac>.cfg" file.
#-----
```

```
# DHCP Setting
# =====
```

```
#dhcp: 1 # DHCP enabled.
```

```
# DHCP:
```

```
# 0 = false, means DHCP is disabled.
```

```
# 1 = true, means DHCP is enabled.
```

```
#
```

```
# Notes:
```

```
#
```

```
# DHCP is normally set from the Options list on the phone or
# the web interface
```

```
#
```

```
# If DHCP is disabled, the following network settings will
# have to be configured manually either through the configuration
# files, the Options List in the phone, or the Web Client: IP
# Address (of the phone), Subnet Mask, Gateway, DNS, and TFTP
# Server.
```

```
#-----
```

```
# Network Settings
# = = = = = = = =
```

```
# Notes: If DHCP is enabled, you do not need to set these network
# settings. Although depending on you DHCP server configuration
# you may still have to set the dns address.
```

```
#ip:      # This value is unique to each phone on a server
          # and should be set in the "<mac>.cfg" file if
          # setting this manually.

#subnet mask:
#default gateway:
#dns1:
#dns2:

# Time Server Settings
# =====

#time server disabled: 1 # Time server disabled.
#time server1:          # Enable time server and enter at
#time server2:          # least one time server IP address or
#time server3:          # qualified domain name.

# Time Server Disabled:
# 0 = false, means the time server is not disabled.
# 1 = true, means the time server is disabled.

# NAT Settings
# = = = = =

# Option 1:
#
# If you are connecting to a Nortel MCS call server and there is a
# NAT device between the server and the phone, then you must set
# the following two parameters for the phone to function
# correctly.

#sip nortel nat support: 1      # 1 = enabled
```

```
#sip nortel nat timer: 60      # seconds between keep alive messages
```

```
# Option 2:
#
# If you are using a session border controller, you should set the
# outbound proxy to the session border controller address

#sip outbound proxy: sbc.aastra.com
#sip outbound proxy port: 0          # a value of 0 enables SRV
                                   # lookups for the address of
                                   # the proxy.
```

```
# Option 3:
#
# If you know the public IP address of your NAT device and and have
# opened up a port for the SIP messages then you can statically
# assign this information.
```

```
#sip nat ip: 67.123.122.90
#sip nat port: 5890
```

Additional Network Settings
=====

```
#sip rtp port: 3000    # Eg. RTP packets are sent to port 3000.
```

```
#-----
```

Configuration Server Settings
= = = = =

```
# Notes: This section defines which server the phone retrieves new
# firmware images and configuration files from. Three protocols
# are supported TFTP, FTP and HTTP
```

```
download protocol: TFTP  # valid values are TFTP, FTP and HTTP
```



```
## TFTP server settings
tftp server: 192.168.0.130
#alternate tftp server:
#use alternate tftp server: 1    # If your DHCP server assigns
                                # a TFTP server address which
                                # you do not use, you can use
                                # the alternate tftp server.
```

```
## FTP server settings
#ftp server: 192.168.0.131    # can be IP or FQDN
#ftp username: aastra
#ftp password: 6757iaastra
```

```
## HTTP server settings (for http://bogus.aastra.com/firmware/)
#http server: bogus.aastra.com    # can be IP or FQDN
#http path: firmware
```

```
#-----
```

Dial Plan Settings

```
# =====
```

```
#
```

```
# Notes:
```

```
#
```

```
# As you dial a number on the phone, the phone will initiate a call
```

```
# when one of the following conditions are met:
```

```
#
```

```
# (1) The entered number is an exact match in the dial plan
```

```
# (2) The "#" symbol has been pressed
```

```
# (3) A timeout occurs
```

```
#
```

```
# The dial plan is a regular expression that supports the
```

```
# following:
```

```
# syntax:
```

#

```
# 0,1,2,3,4,5,6,7,8,9,*,# : matches the keypad symbols
# x : matches any digit (0..9)
# + : matches 0 or more repetitions of the
# : previous expression
# [] : matches any number inside the brackets
# : can be used with a "-" to represent a
# : range
# () : expression grouping
# | : either or
#
#
# If the dialled number doesn't match the dial plan then the call
# is rejected.
```

```
sip digit timeout: 3 # set the inter-digit timeout in seconds
```

```
# Example dial plans
```

```
sip dial plan: "x+#|xx+*" # this is the default dial string, note
# that is must be quoted since it contains
# a '#' character
```

```
#sip dial plan: [01]xxx|[2-8]xxxx|9lxxxxxxxxxxx
# accept any 4 digit number beginning
# with a 0 or 1, any 5 digit number
# beginning with a number between 2 and 8
# (inclusive) or a 12 digit number
# beginning with 9l
```

```
#sip dial plan terminator: 1 # enable sending of the "#" symbol to
# to the proxy in the dial string
```

```
#-----
```

General SIP Settings

=====

#sip session timer: 30 # enable support of RFC4028, the default
value of 0 disables this functionality

#sip transport protocol: 0 # use UDP (1), TCP (2) or both (0) for
sip messaging

#sip use basic codecs: 1 # limit codecs to G711 and G729

#sip out-of-band dtmf: 0 # turn off support for RFC2833 (on by
default)

Global SIP User Settings

=====

#

Notes:

These settings are used as the default configuration for the
hard key lines on the phone. That is:

#

L1 to L4 on the 6757i and 6757iCT

L1 to L3 on the 6753i

#

These can be over-ridden on a per-line basis using the per-line
settings.

#

See the Admin Guide for a detailed explanation of how this
works

sip screen name: Joe Smith # the name display on the phone's screen

sip user name: 4256 # the phone number

sip display name: Joseph Smith # the caller name sent out when making
a call.

sip vmail: *78 # the number to reach voicemail on

```
sip auth name: jsmith      # account used to authenticate user
sip password: 12345        # password for authentication account

sip mode: 0                # line type:
                           # 0 - generic,
                           # 1 - BroadSoft SCA line
                           # 2 - Nortel line

sip proxy ip: proxy.aastra.com # IP address or FQDN of proxy
sip proxy port: 5060        # port used for SIP messages on the
                           # proxy. Set to 0 to enable SRV
                           # lookups

sip registrar ip: aastra.com # IP address or FQDN of registrar
sip registrar port: 0       # as proxy port, but for the registrar
sip registration period: 3600 # registration period in seconds
```

Per-line SIP Settings

```
# =====
```

```
# configure line 3 as the support Broadsoft SCA line
# - the proxy and registrar settings are taken from the global
# settings above
```

```
sip line3 screen name: Support
sip line3 user name: 4000
sip line3 display name: Aastra Support
sip line3 auth name: support
sip line3 password: 54321
sip line3 mode: 1
sip line3 vmail: *78
```

```
# configure line 5 (a soft key line) as an ordinary line
# of a test server
```

```
sip line5 screen name: Test 1
sip line5 user name: 5551001
sip line5 display name: Test 1
sip line5 auth name: 5551001
sip line5 password: 5551001
sip line5 mode: 0
sip line5 proxy ip: 10.50.10.102
sip line5 proxy port: 5060
sip line5 registrar ip: 10.50.10.102
sip line5 registrar port: 5060
sip line5 registration period: 60
```

```
#-----
```

Programmable Key Settings

```
# =====
```

```
# Programmable keys can be set either server wide or unique to each
# phone.
```

```
# Setting programmable keys as line/call appearances should be done
# in the "<mac>.cfg" file, since these are unique to each phone.
```

```
# Notes:
```

```
#
```

```
# There are a maximum of 7 programmable keys that can be configured
# on the 6753i phone, and only 2 on the phone. These can be
# set up through either of the 2 configuration files, depending on
# whether this is to be server wide ("aastra.cfg") or phone
# specific ("<mac>.cfg"). Each prgkey needs to be numbered from
# 1 - 7, for example "prgkey2 type:
# speeddial". Programmable keys can be set up as speeddials or as
# additional call/line appearances or as feature keys and have a
# type, value and line associated with it as seen here in the
# default programmable settings.
```

```
# PRGKEY TYPES: "line", "speeddial", "blf", "list", "dnd"
```

```
# PRGKEY VALUE: If prgkey type is a speeddial, any DTMFs (from
#               0 - 9, *, "#") or a comma (,) for 500ms pause and
#               'E' for On-hook can be set for the value.
#               If prgkey type is blf it is the extension you want
#               to monitor.
# PRGKEY LINE:  This is line associated with the prgkey. For line
#               prgkeys the value must be between 4 and 9 (1 - 3
#               are already hardcoded as the L1, L2 and L3 hard
#               key line/call appearances).
```

Speed Dials

```
prgkey1 type: speeddial
prgkey1 value: *8
prgkey2 type: speeddial
prgkey2 value: *69
```

DND Key

```
prgkey3 type: dnd
```

Line appearance

```
prgkey4 type: line
prgkey4 line: 5
```

blf

```
prgkey5 type: blf
prgkey5 value: 4559
prgkey5 line: 1
```

list

```
prgkey6 type: list
prgkey7 type: list
```

Appendix D

Sample BLF Softkey Settings

About this appendix

Introduction

This appendix provides sample BLF softkey settings for both the Asterisk server and the BroadSoft BroadWorks server.

Topics

This appendix covers the following topics:

Topic	Page
Sample BLF Softkey Settings	page D-2
Asterisk BLF	page D-2
BroadSoft BroadWorks BLF	page D-3

Sample BLF Softkey Settings

Asterisk BLF

The following are sample softkey and programmable key configurations to enable Asterisk BLF support on Aastra IP phones.

6757i and 6757i CT Configuration Parameters for Asterisk BLF

```
softkey1 type: blf  
softkey1 value: 9995551212  
softkey1 label: John  
softkey1 line: 1
```

6753i Configuration Parameters for Asterisk BLF

```
prgkey1 type: blf  
prgkey1 value: 9995551212  
prgkey1 label: John  
prgkey1 line: 1
```

```
prgkey7 type: blf  
prgkey7 value: 9995551313  
prgkey7 label: Jane  
prgkey7 line: 1
```

BroadSoft BroadWorks BLF

The following are sample softkey and programmable key configurations to enable Broadsoft BroadWorks Busy Lamp Field support on Aastra IP phones.

6757i and 6757i CT Configuration Parameters for Broadsoft BroadWorks BLF



Note: One softkey must be defined of type “list” for EACH monitored user. So if there are 2 users being monitored, 2 softkeys must be defined of type list.

```
softkey1 type: list
softkey1 label:
softkey1 value:
softkey1 line: 1
softkey2 type: list
softkey2 label:
softkey2 value:
softkey2 line: 1
list uri: sip:my6757i-blf-list@as.broadsoft.com
```

6753i Configuration Parameters for Broadsoft BroadWorks BLF



Note: One prgkey must be defined of type “list” for each monitored user. So if there are 2 users being monitored, 2 prgkeys must be defined of type list.

```
prgkey6 type: list
prgkey6 label:
prgkey6 value: 1

prgkey7 type: list
prgkey7 label:
prgkey7 value: 1

list uri: sip:my53i-blf-list@as.broadsoft.com
```

Appendix E

Sample Multiple Proxy Server Configuration

About this appendix

Introduction

This appendix provides a sample multiple proxy server configuration.

Topics

This appendix covers the following topics:

Topic	Page
Multiple Proxy Server Configuration	page E-2

Multiple Proxy Server Configuration

Multiple proxy servers can be configured in the *aastra.cfg* file or the *<mac>.cfg* file. In the example below, the default proxy setting is used if no specific setting is specified in the line configuration. Line2 and line3 are used for the global proxy configurations, while line1 and line4 use their own specific settings.



Note: The phones include support for RFC3327, SIP extension header for phones to discover intermediate proxies. This feature is always enabled on the phone.

```
#sip settings
sip proxy ip: #.#.#.#
sip proxy port: 5060
sip registrar ip: #.#.#.#
sip registrar port: 5060
sip registration period:3600
sip nortel nat support:0
sip nortel nat timer:0
sip broadsoft talk:0
sip broadsoft hold:0
sip broadsoft conference:0

sip dial plan: "x+#"

#line info
# Fill in all necessary information below carefully. Populate all
lines even if there is only
# one account
#line 1
sip line1 auth name:
sip line1 password:
sip line1 mode: 0
sip line1 user name:
sip line1 display name:
sip line1 screen name:
sip line1 proxy ip: &.&.&.&
sip line1 proxy port: 5060
sip line1 registrar ip: #.#.#.#
sip line1 registrar port: 5060
sip registration period:600
sip nortel nat support:1
sip nortel nat timer:120
sip broadsoft talk:0
sip broadsoft hold:0
sip broadsoft conference:0
```

Continued.....

```
#line 2
sip line2 auth name:
sip line2 password:
sip line2 mode: 0
sip line2 user name:
sip line2 display name:
sip line2 screen name:

#line 3
sip line3 auth name:
sip line3 password:
sip line3 mode: 0
sip line3 user name:
sip line3 display name:
sip line3 screen name:

#line 4
sip line4 auth name:
sip line4 password:
sip line4 mode: 0
sip line4 user name:
sip line4 display name:
sip line4 screen name:
sip line4 proxy ip: %.%.%.%
sip line4 proxy port: 5060
sip line4 registrar ip: %.%.%.%
sip line4 registrar port: 5060
sip registration period:500
sip nortel nat support:0
sip nortel nat timer:0
sip broadsoft talk:1
sip broadsoft hold:1
sip broadsoft conference:1
```

Limited Warranty

Limited Warranty

Aastra Telecom warrants this product against defects and malfunctions during a one (1) year period from the date of original purchase. If there is a defect or malfunction, Aastra Telecom shall, at its option, and as the exclusive remedy, either repair or replace the telephone set at no charge, if returned within the warranty period.

If replacement parts are used in making repairs, these parts may be refurbished, or may contain refurbished materials. If it is necessary to replace the telephone set, it may be replaced with a refurbished telephone of the same design and color. If it should become necessary to repair or replace a defective or malfunctioning telephone set under this warranty, the provisions of this warranty shall apply to the repaired or replaced telephone set until the expiration of ninety (90) days from the date of pick up, or the date of shipment to you, of the repaired or replacement set, or until the end of the original warranty period, whichever is later. Proof of the original purchase date is to be provided with all telephone sets returned for warranty repairs.

Exclusions

Aastra Telecom does not warrant its telephone sets to be compatible with the equipment of any particular telephone company. This warranty does not extend to damage to products resulting from improper installation or operation, alteration, accident, neglect, abuse, misuse, fire or natural causes such as storms or floods, after the telephone is in your possession.

Aastra Telecom shall not be liable for any incidental or consequential damages, including, but not limited to, loss, damage or expense directly or indirectly arising from the customers use of or inability to use this telephone, either separately or in combination with other equipment. This paragraph, however, shall not apply to consequential damages for injury to the person in the case of telephones used or bought for use primarily for personal, family or household purposes.

This warranty sets forth the entire liability and obligations of Aastra Telecom with respect to breach of warranty, and the warranties set forth or limited herein are the sole warranties and are in lieu of all other warranties, expressed or implied, including warranties or fitness for particular purpose and merchantability.

Warranty Repair Services

Should the set fail during the warranty period:

In North America, please call 1-800-574-1611 for further information.

Outside North America, contact your sales representative for return instructions.

You will be responsible for shipping charges, if any. When you return this telephone for warranty service, you must present proof of purchase.

After Warranty Service

Aastra Telecom offers ongoing repair and support for this product. This service provides repair or replacement of your Aastra Telecom product, at Aastra Telecom's option, for a fixed charge. You are responsible for all shipping charges. For further information and shipping instructions:

In North America, contact our service information number: 1-800-574-1611.

Outside North America, contact your sales representative.

Repairs to this product may be made only by the manufacturer and its authorized agents, or by others who are legally authorized. This restriction applies during and after the warranty period. Unauthorized repair will void the warranty.

"Allow" and "Allow-Event" headers 6-50

802.1x Support 6-31

802.1x local certificate 3-90

802.1x private key 3-91

802.1x root and intermediate certificates 3-90

802.1x trusted certificates 3-91

certificates and private key info 6-31

configuring using the Aastra Web UI 6-39

configuring using the config files 6-33

configuring using the IP Phone UI 6-34

eap-type 3-89

identity 3-89

md5 password 3-90

A

Aastra Web UI

advanced settings description 2-15

basic settings description 2-14

enabling and disabling 2-16

operation description 2-12

status description 2-12

account configuration 3-35

account mode 3-35

custom mode 3-36

phone mode 3-36

ACD

subscription period 5-196

action URIs 3-72, 5-330

action URIs, configuring 5-335

adapter, optional equipment for 6731i and 6751i 1-5

Administration Guide, for IP phone 1-xviii

administrator options 3-1, 4-2

auto call distribution

acd auto available 3-30

acd auto available timer 3-30

subscription period 5-196

Auto Call Distribution (ACD) key 5-148

auto-answer 5-104, A-201

about 5-103

auto-answer, delay before 5-104

B

backlight mode (6755i, 6757i, 6757i CT) A-70

barge in 5-105, A-202

Basic Preferences 3-19

Basic settings

Call Forward Mode 3-23

call waiting 3-21

digit timeout 3-19

display dtmf digits 3-20

DND key mode 3-22

goodbye key cancels incoming call 3-22

incoming call interrupts dialing 3-21

LLDP ELIN 3-23

local dial plan 3-19

MWI Line 3-22

park call (sprecode) (global setting) 3-20

pickup parked call (pickupsprecode global setting) 3-20

play call waiting tone 3-21

preferred line 3-22

preferred line timeout 3-22

send dial plan terminator 3-19

status scroll delay 3-21

stuttered dial tone 3-21

suppress dtmf playback 3-20

switch focus to ringing line 3-21

UPnP mapping lines 3-22

xml beep support 3-21

beep, for xml applicaton 5-318

Bellcore cadences 5-125

- Bellcore ring tones [5-125](#)
 - BLA subscription period [5-224](#)
 - BLA support for MWI [5-227](#)
 - blacklist duration [6-22](#)
 - BLF
 - configuring [5-171](#)
 - directed call pickup [5-130](#)
 - on Asterisk [5-170](#)
 - on BroadSoft [5-170](#)
 - overview [5-168](#)
 - setting [5-168](#)
 - subscription period [5-174](#)
 - subscription period, configuring [5-174, 5-196](#)
 - BLF key [5-147](#)
 - BLF List,setting [5-169](#)
 - BLF subscription period [5-174](#)
 - BLF/List key [5-148](#)
 - BLF/Xfer key [5-150, 5-176](#)
 - Brazilian cadences [5-126](#)
 - Bridged Line Appearance (BLA)
 - about BLA [5-218](#)
 - configuring [5-219](#)
- ## C
- cadence settings, Bellcore [A-181](#)
 - cadences, configuring [5-127](#)
 - call destination for incoming calls [5-290](#)
 - call forward key [5-150](#)
 - call forwarding [5-249](#)
 - call waiting [5-67](#)
 - call waiting tone [5-68](#)
 - call waiting tones [5-129](#)
 - callers list
 - downloading to phone [5-298](#)
 - enabling/disabling [5-296](#)
 - overview [5-293](#)
 - using on phone [5-296](#)
 - Callers List key [1-30, 1-35](#)
 - callers list key [1-8, 1-17, 1-20, 5-150, 5-158](#)
 - CancelAction, for XML applications [5-319](#)
 - Codecs [4-96](#)
 - customized preference list of [4-97](#)
 - conf key [5-151, 5-159](#)
 - conference
 - transfer remaining parties when conference ends [5-368](#)
 - conference key [1-8, 1-18, 1-21](#)
 - enabling/disabling [5-114](#)
 - mapping as speedial [5-115](#)
 - Conference softkey [1-31, 1-35](#)
 - conferencing, SIP Join feature [5-367](#)
 - config server
 - alternate TFTP [3-76](#)
 - auto resync days [3-83](#)
 - auto resync max delay [3-82](#)
 - auto resync mode [3-81](#)
 - auto resync time [3-82](#)
 - download path (HTTPS path) [3-80](#)
 - download port (HTTPS port) [3-80](#)
 - download protocol [3-75](#)
 - download server (HTTPS sserver) [3-80](#)
 - FTP password [3-78](#)
 - FTP path [3-78](#)
 - FTP server [3-77](#)
 - FTP username [3-78](#)
 - HTTP path [3-79](#)
 - HTTP port [3-79](#)
 - HTTP server [3-79](#)
 - primary TFTP [3-76](#)
 - select TFTP [3-77](#)
 - TFTP path [3-76, 3-77](#)
 - XML application post list [3-83](#)
 - configuration
 - file precedence [1-43](#)
 - methods for performing [2-2](#)
 - configuration file, description of [1-41](#)
 - configuration files
 - installing [1-44](#)
 - using [2-17](#)
 - configuration server [4-112](#)
 - configuring [4-112](#)
 - configuration server settings [3-75](#)
- ## D
- default gateway [3-39](#)

-
- delete key 1-9, 1-18, 1-21, 1-27
 - DHCP 3-38, 4-4
 - configuring 3-5, 4-5
 - download preference 4-20
 - not using 1-38
 - Option 12 4-11
 - Option 159 and 160 4-17
 - Option 77 User Class 4-14
 - Options 60, 66, and 43 4-8
 - using 1-38
 - using option 43 to customize the phone 4-9
 - DHCP config option override (configuration files) 3-41
 - dhcp user class 3-41
 - dial plan
 - configuring 5-57
 - dial plan, emergency 5-16
 - dial plan, emergency dial plan and pattern matching 5-17
 - dial plans
 - overview 5-53
 - Dial softkey 1-31, 1-35
 - dial tones, stuttered
 - about 5-70
 - configuring 5-70, 5-77, 5-85, 5-88, 5-90
 - DiffServ QoS 4-54
 - Directed call pickup
 - configuring 5-133
 - description of 5-130
 - directed call pickup
 - enable/disable 3-29
 - play ring splash 3-29
 - prefix setting 3-29
 - Directed Call Pickup (DCP) key 5-148
 - Directory key 1-30, 1-35
 - directory key 1-9, 1-18, 1-21, 5-151, 5-158
 - directory list
 - download behavior 5-307
 - downloading procedures 5-311
 - downloading to server 5-306
 - limitations for 5-307
 - overview 5-302
 - using 5-308
 - DND
 - account-based 5-207
 - configuring 5-201
 - DND key 5-148
 - DNS caching 4-23
 - DNS1 3-39
 - DNS2 3-40
 - DSCP 3-50, 4-56
 - DTMF digits
 - configuring display of 5-65, 5-68
 - displaying 5-65
 - DTMF methods 4-99
 - DTMF playback, configuring suppression for 5-63
 - DTMF, out-of-band 4-98
 - DTMF, suppressing playback 5-63
 - dynamic sip, registration and subscription 4-76
- ## E
- Early-Only parameter in Replaces Header 6-50
 - emergency dial plan, defining 5-16
 - empty key 5-152
 - encryption
 - methods for 7-2
 - overview 7-2
 - procedure for 7-4
 - Ethernet cable 1-4
 - expansion module, customizing columns for 5-376, A-256
 - expansion module, M670i 1-6
 - expansion module, M675i 1-6
- ## F
- feature keys 5-142
 - configuring 5-156, A-239
 - feature keys, configuring 5-161
 - feature keys, guidelines for programming 5-157
 - firmware
 - configuration server requirement for 1-40
 - description of 1-41
 - installation considerations 1-38
-

installation methods 1-38
 installing 1-44
 firmware update
 by restarting the phone 8-5
 using the Aastra Web UI 8-2
 using the auto-resync feature 8-7
 firmware updates 3-84
 flash key 5-149, 5-160

G

General Preferences 3-19
 Goodbye Key
 canceling incoming call using 5-85
 goodbye key 1-8, 1-17, 1-20
 Group Call Pickup (GCP) key 5-148
 GRUU support 6-43

H

handsfree key 1-9
 hold key 1-8, 1-17, 1-20
 hostname 3-40
 HTTP and HTTPS support 2-6
 HTTP/HTTPS and Broadsoft CMS 2-8
 HTTPS
 client functions 2-7
 client/server configuration 4-40
 security method for A-35, A-36
 server functions 2-7
 using via Aastra Web UI 2-9
 HTTPS certificate expiration 3-48
 HTTPS certificate hostname 3-49
 HTTPS client method 3-47
 HTTPS Server block XML HTTP posts 3-46
 HTTPS server redirect 3-46
 HTTPS settings 3-46
 HTTPS trusted certificates filename 3-49
 HTTPS validate certificates 3-48

I

Icom key 5-151
 icom key 5-158
 incoming call interrupts dialing 5-76
 Installation 1-17, 1-23, 1-26
 Installation Guide, for IP phone 1-xviii
 intercom feature
 configuring 5-105
 incoming calls 5-104
 outgoing calls 5-103
 Intercom key 1-35
 intercom settings, incoming
 allow barge in 3-24
 auto-answer 3-24
 microphone mute 3-24
 play warning tone 3-24
 intercom settings, outgoing
 line 3-25
 prefix code 3-25
 type 3-25
 intercom warning tone A-202
 IP phone UI 2-2

K

key descriptions 1-12
 key list in Web UI, customizing 5-163
 key mapping
 map conf key to 3-26
 map redial key to 3-26
 key mapping, enable/disable Redial, Xfer, Conf
 Keys 5-114
 key press simulation, XML URI 5-359
 key redirection (redial, conf, xfer, icom,
 voicemail) 5-356
 keys
 callers list 1-17, 1-20
 conference 1-18, 1-21
 delete 1-18, 1-21
 directory 1-18, 1-21
 goodbye 1-17, 1-20
 hold 1-17, 1-20

- line 1-18, 1-21
- navigation 1-17, 1-20
- options 1-17, 1-20
- programmable 1-18, 1-21
- redial 1-17, 1-20
- save 1-18, 1-21
- services 1-18, 1-21
- speaker 1-17, 1-20
- transfer 1-18, 1-21
- volume control 1-17, 1-20

L

- LAN Port 3-40

- Language

- language 1 thru 4 3-34

- language

- overview 5-34
 - specifying on IP phone 5-37
 - WebPage Language 3-33, 3-34

- language pack settings A-187

- language settings A-185

- language, input 5-41

- keypad alphabet tables 5-41
 - specifying in XML applications 5-47
 - specifying using the Aastra Web UI 5-46
 - specifying using the configuration files 5-44
 - specifying using the IP Phone UI 5-44

- last call return (lcr)

- configuring 5-245
 - how it works 5-245

- lcr key 5-150

- line key 5-147, 5-158

- line keys 1-18, 1-21

- line settings 3-70

- line/call appearance keys 1-9

- LLDP 3-42

- lldp packet interval 3-42

- LLDP-MED and ELIN 5-98

- local dial plan

- dial plan terminator 5-55
 - secondary dial tone 5-56

- lockIn, for xml applications 5-319

- locking keys, on the IP phone 5-49

- locking keys, procedures 5-50

- locking softkeys and programmable keys A-251, A-256

- locking/unlocking the phone 5-10

M

- Mexican cadences 5-126

- microphone mute A-201

- missed calls indicator

- accessing and clearing 5-301
 - enabling/disabling 5-300
 - overview 5-300

- Model 6751i 1-16, 1-19, 1-22

- Model 6753i 1-25

- Model 6755i 1-28

- Model 6757i 1-32

- Model 6757i Cordless Handset 1-36

- Model 6757i CT 1-32

- Model 9143i 1-7

- Model 9480i 1-11

- Model 9480i CT 1-11

- Model 9480i CT Cordless Handset 1-14

N

- NAP SIP port 3-43

- NAT

- configuring 4-32
 - configuring NAT address and port 4-35
 - Nortel Networks 4-32
 - overview 4-30
 - router configuration 4-31

- NAT IP 3-43

- NAT RTP port 3-44

- navigation keys 1-8, 1-17, 1-20

- network configuration 4-4

- network parameters A-8

- network settings, advanced 3-41, 3-46, 4-30

- DHCP download options 3-41
 - DHCP user class 3-41

[HTTPS block XML HTTP Posts](#) 3-46
[HTTPS certificate expiration](#) 3-48
[HTTPS certificate hostname](#) 3-49
[HTTPS Client Method](#) 3-47
[HTTPS redirect](#) 3-46
[HTTPS trusted certificates filename](#) 3-49
[LLDP packet interval](#) 3-42
[LLDP support](#) 3-42
[NAT IP](#) 3-43
[NAT RTP port](#) 3-44
[NAT SIP Port](#) 3-43
[Nortel NAT](#) 3-44
[Nortel NAT timer](#) 3-44
[NTP time servers](#) 3-44, 3-45
[Time Servers 1 thru 3](#) 3-45
[UPnP](#) 3-43
[upnp gateway](#) 3-43
[network settings, basic](#) 3-38, 4-4
 [DHCP](#) 3-38
 [Ethernet \(PC Port and LAN Port\)](#) 3-40
 [gateway](#) 3-39
 [hostname](#) 3-40
 [IP Address](#) 3-38
 [primary DNS](#) 3-39
 [secondary DNS](#) 3-40
 [subnet mask](#) 3-39
[network settings, configuring](#) 4-24
[none key](#) 5-147, 5-158
[Nortel NAT timer](#) 3-44
[Nortel NAT traversal enabled](#) 3-44
[Nortel Proxy](#) 4-31
[NTP time servers](#) 3-45

O

[operational features](#) 5-5
[operational features, advanced](#) 6-3
 [configuring line number](#) 6-5
 [configuring MAC address](#) 6-5
 [configuring message sequence for blind transfer](#) 6-7
[options](#)
 [via Aastra Web UI](#) 3-6
 [via Configuration Files](#) 3-8
 [via IP Phone UI](#) 3-3

[options key](#) 1-9, 1-17, 1-20
[Options key redirection](#) 5-357
[options menu, simplified](#) A-7
[out of sequence errors, ignoring](#) 6-49

P

[paging](#)
 [configuring group RTP settings](#) 5-110
 [group RTP setting description](#) 5-108
[Paging key](#) 5-152
[paging RTP](#)
 [paging listen addresses](#) 3-26
[parameters](#)
 [6755i, 6757i, 6757i CT softkeys](#) A-218
 [802.1x support settings](#) A-125
 [Aastra Web UI](#) A-17
 [acd auto-available timer](#) A-210
 [ACD subscription period](#) A-111
 [Action URIs](#) A-156
 [advanced SIP](#) A-103
 [as-feature-event subscription](#) A-115
 [audio transmit and receive adjustment settings](#) A-204
 [auto-answer settings](#) A-199
 [backlight mode \(6755i, 6757i, 6757i CT\)](#) A-70
 [BLA support for MWI](#) A-97
 [blacklist duration](#) A-261
 [BLF list URI](#) A-255
 [BLF subscription period](#) A-110
 [blind transfer setting](#) A-258
 [boot sequence recover mode](#) A-259
 [call forward key mode](#) A-148
 [call forward settings](#) A-147
 [call waiting settings](#) A-173
 [Callers List settings](#) A-145
 [centralized conferencing](#) A-99
 [configuration encryption setting](#) A-270
 [configuration server](#) A-18
 [custom time zone and dst settings](#) A-61
 [customized callers list and services keys](#) A-146
 [customizing Aastra Web UI Key List](#) A-248
 [DHCP option settings](#) A-13
 [dial plan](#) A-72
 [directed call pickup](#) A-208
 [directory settings](#) A-143

- DND key mode [A-175](#)
- dns query setting [A-267](#)
- DSCP [A-51](#)
- DTMF digits [A-198](#)
- dynamic sip [A-76](#)
- emergency dial plan [A-16](#)
- expansion module keys [A-241](#)
- global ring tone settings [A-164](#)
- global SIP [A-77](#)
- goodbye key cancels incoming call [A-171](#)
- group paging RTP settings [A-203](#)
- GRUU Support [A-266](#)
- handset feature keys [A-239](#)
- HTTP/HTTPS authentication with Broadsoft CMS [A-102](#)
- HTTPS client and server settings [A-35](#)
- HTTPS server certificate validation [A-37](#)
- incoming call interrupts dialing [A-167](#)
- incoming intercom [A-201](#)
- Intercom settings [A-199](#)
- language [A-185](#)
- language pack [A-187](#)
- live dialpad [A-71](#)
- LLDP ELIN [A-150](#)
- local SIP TLS port [A-34](#)
- local SIP UDP/TCP port [A-34](#)
- locking SAVE and DELTE keys (6753i) [A-254](#)
- locking softkeys and programmable keys [A-251](#)
- MAC Address/Line Number [A-104](#)
- mapping key [A-213](#)
- message waiting indicator [A-174](#)
- missed call summary subscription period [A-113](#)
- missed call summary subscription, global [A-112](#)
- missed call summary subscription, per-line [A-114](#)
- Missed Calls Indicator settings [A-152](#)
- NAT [A-31](#)
- out of order SIP requests [A-268](#)
- outgoing intercom [A-199](#)
- park and pickup global settings [A-211](#)
- password [A-15](#)
- per-line ring tone settings [A-166](#)
- per-line SIP [A-86](#)
- polling action URIs [A-163](#)
- preferred line [A-170](#)
- preferred line timeout [A-170](#)
- priority alert settings [A-176](#)
- programmable keys (6753i, 6755i) [A-227](#)
- rport [A-33](#)
- RTCP summary reports [A-47](#)
- RTP, Codec, DTMF global settings [A-133](#)
- show call destination name [A-184](#)
- silence suppression settings [A-136](#)
- single call restriction setting [A-260](#)
- sip diversion display (global setting) [A-183](#)
- SIP join feature [A-101](#)
- sip lineN diversion display (per-line setting) [A-183](#)
- sip notify opt headers [A-268](#)
- sip outbound support [A-75](#)
- sip pai [A-269](#)
- SIP registration retry timer [A-109](#)
- sip sca bridging (global setting) [A-98](#)
- softkeys, programmable keys, feature keys [A-216](#)
- stuttered dial tone setting [A-172](#)
- Suppress DTMF Playback [A-197](#)
- switch focus to ringing line [A-169](#)
- symmetric UDP signaling [A-265](#)
- time and date [A-52](#)
- time server [A-59](#)
- top softkeys [A-232](#)
- ToS [A-51](#)
- Transport Layer Security (TLS) [A-116](#)
- updating caller ID [A-258](#)
- UPnP [A-41](#)
- user-agent setting [A-266](#)
- VLAN [A-42](#)
- voicemail [A-141](#)
- whitelist proxy [A-261](#)
- XML key redirection (redial, xfer, conf, icom, voicemail) [A-262](#)
- XML override for a locked phone [A-265](#)
- XML settings [A-153](#)
- XML SIP notify [A-162](#)
- parameters, list of configurable [A-7](#)
 - time server settings [A-59](#)
- parameters, setting in configuration files [A-6](#)
- park key [5-149](#), [5-159](#)
- park/pickup
 - about parked/pickup calls [5-59](#), [5-234](#)
 - configuring a static configuration [5-61](#)
 - configuring programmable configuration using config files [5-236](#)
 - configuring programmable configuration using Web UI [5-238](#)
 - programmable configuration of [5-234](#)

- static configuration of [5-59](#)
 - using on the IP phone [5-243](#)
 - parrameters
 - sip lineN sca bridging (per-line setting) [A-98](#)
 - P-Asserted Identity (PAI) [6-51](#)
 - pass-thru port [3-40](#)
 - password, resetting user's [5-7](#)
 - passwords
 - for a user [5-5](#)
 - for an administrator [5-9](#)
 - PC Port [3-40](#)
 - phone lock key [5-152](#)
 - Phone Status
 - Firmware Version [3-10](#)
 - IP&MAC Address [3-10](#)
 - LAN Port [3-10](#)
 - PC Port [3-10](#)
 - phone status settings [3-9](#)
 - pickup key [5-149](#), [5-159](#)
 - play warning tone [5-104](#)
 - PoE [1-4](#)
 - preferred line [5-81](#)
 - preferred line timeout [5-81](#)
 - priority alerting
 - about [5-123](#)
 - configuring [5-127](#)
 - priority alerting settings
 - auto call distribution [3-28](#)
 - community 1 thru 4 [3-28](#)
 - emergency [3-28](#)
 - enabling [3-27](#)
 - external [3-28](#)
 - group [3-27](#)
 - internal [3-28](#)
 - priority [3-28](#)
 - programmable keys [5-142](#)
 - about [1-18](#), [1-21](#)
 - configuring [5-153](#)
 - public key [5-160](#)
- Q**
- QoS [4-54](#)
- R**
- Reason Header field in SIP message [6-50](#)
 - redial key [1-8](#), [1-17](#), [1-20](#)
 - enabling/disabling [5-114](#)
 - mapping as speeddial [5-115](#)
 - repair [0-2](#)
 - requirements, IP phone [1-39](#)
 - restarting IP phone [3-13](#)
 - ring tone
 - global ring tone [3-27](#)
 - patterns used for [5-124](#)
 - per-line ring tone [3-27](#)
 - tone set setting [3-27](#)
 - ring tone sets [5-120](#)
 - configuring [5-121](#)
 - ring tones [5-118](#)
 - configuring [5-121](#)
 - ring tone [3-27](#)
 - tone set [3-27](#)
 - Rport [3-44](#)
 - rport, configuring [4-65](#)
 - RTCP summary reports [4-105](#)
 - RTP
 - basic codecs for [4-96](#)
 - configuring [4-95](#), [4-101](#)
 - customized codec preference list [4-97](#)
 - dtmf method [4-99](#)
 - encryption method (SRTP) [4-99](#)
 - out-of-band DTMF [4-98](#)
 - RTP port [4-96](#)
 - silence suppression [4-100](#)
 - rtp encryption [4-99](#)
 - RTP port [4-96](#)
 - RTP settings [3-67](#), [3-69](#)
- S**
- SAVE and DELETE keys, locking (6753i) [A-254](#)
 - save key [1-9](#), [1-18](#), [1-21](#), [1-27](#)
 - SBG and ALG proxy [4-31](#)
 - screen timeout, for XML [5-318](#)
 - scroll delay [5-318](#)

-
- Services key 1-30, 1-35
 - services key 1-18, 1-21, 5-151
 - shared call appearance (SCA call bridging) 5-230
 - silence suppression 4-100
 - SIP
 - advanced settings 4-86
 - configuring 4-78
 - overview of 4-70
 - parameter precedence 4-73
 - SIP diversion display 5-288
 - sip outbound support 4-74
 - SIP settings
 - autodial number 3-69
 - autodial timeout 3-69
 - autodial, use global settings 3-69
 - RTP port 3-67
 - SIP settings, advanced 3-60
 - acd subscription period 3-65
 - as-feature-event subscription 3-61
 - as-feature-event subscription period 3-61
 - bla subscription period 3-65
 - blacklist duration 3-65
 - BLF subscription period 3-65
 - explicit mwi subscription 3-60
 - explicit mwi subscription period 3-60
 - local SIP UDP/TCP Port 3-63, 3-64
 - missed call summary subscription 3-60
 - missed call summary subscription period 3-61
 - registration failed retry timer 3-64
 - registration renewal timer 3-64
 - registration timeout retry timer 3-64
 - send line number in REGISTER message 3-62
 - send MAC address in REGISTER message 3-61
 - session timer 3-62
 - timer 1 and timer 2 3-62
 - transaction timer 3-62
 - transport protocol 3-63
 - whitelist proxy 3-66
 - XML SIP Notify 3-66
 - SIP settings, basic 3-55
 - auth name 3-56
 - BLA number 3-56
 - caller ID 3-55
 - display name 3-55
 - line mode 3-56
 - password 3-56
 - phone number 3-55
 - screen name 3-55
 - screen name 2 3-55
 - user name 3-55
 - SIP settings, network
 - backup proxy port 3-57
 - backup proxy server 3-57
 - backup registrar port 3-59
 - backup registrar server 3-59
 - outbound proxy port 3-58
 - outbound proxy server 3-58
 - proxy port 3-57
 - proxy server 3-57
 - registrar port 3-58
 - registrar server 3-58
 - registration period 3-59
 - SIP Settings, RTP
 - Basic Codecs 3-67
 - customized Codec preference list 3-68
 - DTMF method 3-68
 - Force RFC2833 Out of Band DTMF 3-67
 - RTP encryption 3-68
 - RTP port 3-67
 - silence suppression 3-68
 - Softkey settings A-216
 - softkeys 5-142
 - configuring 5-153
 - Softkeys and Programmable Keys
 - locking 5-50, 5-376
 - softkeys and programmable keys
 - locking A-251
 - softkeys, state-based 5-143
 - speaker key 1-17, 1-20
 - speeddial key 5-147
 - speeddial keys
 - enabling/disabling ability to add and edit 5-167
 - prefixes for 5-166
 - Speeddial/Conf key 5-150, 5-182
 - Speeddial/Xfer key 5-150, 5-176
 - sprecode key 5-149
 - SRV lookup, configuring 4-75
 - status message beep
 - configuring in configuration files and Web UI 5-320

- status message scrolling
 - configuring in configuration files and Web UI 5-321
- subnet mask 3-39
- switch focus to ringing line 5-79

T

- time and date
 - date format 3-31
 - NTP time servers 3-31
 - time format 3-31
 - Time Server 1 3-32
 - Time Server 2 3-32
 - Time Server 3 3-32
- time and date, configuring 5-23
- time servers, configuring 4-67
- time zone and dst settings, custom 5-20, A-61
 - absolute A-62
 - relative time A-65
- TLS (Transport Layer Security) 6-26
 - configuring using the Aastra Web UI 6-29
 - configuring using the config files 6-28
 - SIP asserted identify (Sylantro Servers) 6-27
- TLS support
 - sip persistent tls 3-86
 - sip transport protocol 3-85
 - sips local certificate 3-87
 - sips private key 3-88
 - sips root and intermediate certificates 3-87
 - sips trusted certificates 3-88
- ToS 4-54
- ToS, DSCP 3-50
- transfer key 1-8, 1-18, 1-21
- Transfer softkey 1-31, 1-35
- troubleshooting 9-3
 - error messages 9-15
 - log settings 9-3
 - log settings for A-271
 - module/debug level settings 9-4
 - solutions to common problems 9-19
 - support information 9-7
 - watchdog feature 9-12
 - WatchDog tasks for A-274

- Tx/Rx adjustments
 - about 5-361
 - configuring 5-362
- type of service
 - RTCP 3-50
 - RTP 3-50
 - SIP 3-50

U

- upgrading, firmware 8-2
- UPnP
 - configuring 4-51, A-41
 - description of 4-50
- upnp gateway 3-43
- upnp manager 3-43
- User Guide, for IP phone 1-xviii
- usernames
 - administrator 2-11, 3-6, 4-3
 - configuring for FTP server 4-118
 - configuring for SIP authentication 4-80
 - for FTP A-22
 - for SIP authentication 4-71, 4-72, A-78, A-87
 - global BLA 5-219
 - per-line BLA 5-220
 - user 2-11

V

- VLAN 3-51
 - configuring 4-54
 - DSCP Range 4-56
 - global priority non-IP packet 3-51
 - global VLAN enable 3-51
 - LAN Port SIP, RTP, RTCP Priority 3-52
 - LAN Port VLAN ID 3-51
 - PC Port priority 3-53
 - PC Port VLAN ID 3-53
 - priority mapping 4-56
- voicemail
 - overview 5-313
 - using 5-315
- voicemail, configuring 5-313
- volume
 - control keys 1-17, 1-20

volume key 1-8

W

warranty 0-1

warranty exclusions 0-1

whitelisted proxy 6-24

X

xfer key 5-151, 5-159

Xfer key, enabling/disabling 5-114

XML

- action URIs 5-330

- configuring on IP phone 5-322

- configuring SIP Notify for empty message 5-349

- creating customized services 5-316

- customized services 5-316

- disconnected action URI 5-341

- enabling/disabling SIP Notify 5-346

- key redirection 5-356

- off-hook interaction with XML applications 5-359

- Options key redirection (Services key on 6751i) 5-357

- override for a locked phone 5-360

- polling action URIs 5-339

- procedure for configuring 5-323

- push from the server 5-321

- push requests 5-323

- scroll delay for status messages 5-321

- SIP Notify events 5-344

- softkey URIs 5-350

- status message beep 5-320

- using customized services 5-328

xml beep support 5-72, 5-74

XML Get timeout 5-318

XML key 5-149

Third Party Copyright Compliance

This product contains software provided under license to Aastra Telecom by one or more third parties. In addition to the Aastra SLA shown above, use and distribution of this product is subject to the following license terms:

Expat XML Parser

Copyright (c) 1998, 1999, 2000 Thai Open Source Software Center Ltd and Clark Cooper

Copyright (c) 2001, 2002, 2003, 2004, 2005, 2006 Expat maintainers.

Permission is hereby granted, free of charge, to any person obtaining a copy of this software and associated documentation files (the "Software"), to deal in the Software without restriction, including without limitation the rights to use, copy, modify, merge, publish, distribute, sublicense, and/or sell copies of the Software, and to permit persons to whom the Software is furnished to do so, subject to the following conditions:

The above copyright notice and this permission notice shall be included in all copies or substantial portions of the Software.

THE SOFTWARE IS PROVIDED "AS IS", WITHOUT WARRANTY OF ANY KIND, EXPRESS OR IMPLIED, INCLUDING BUT NOT LIMITED TO THE WARRANTIES OF MERCHANTABILITY, FITNESS FOR A PARTICULAR PURPOSE AND NONINFRINGEMENT.

IN NO EVENT SHALL THE AUTHORS OR COPYRIGHT HOLDERS BE LIABLE FOR ANY CLAIM, DAMAGES OR OTHER LIABILITY, WHETHER IN AN ACTION OF CONTRACT, TORT OR OTHERWISE, ARISING FROM, OUT OF OR IN CONNECTION WITH THE SOFTWARE OR THE USE OR OTHER DEALINGS IN THE SOFTWARE.

M5T SIP Stack - M5T

Portions of this software are © 1997 - 2006 M5T a Division of Media5 Corporation ("M5T(tm)").

All intellectual property rights in such portions of the software and documentation are owned by M5T and are protected by Canadian copyright laws, other applicable copyright laws and international treaty provisions. M5T and its suppliers retain all rights not expressly granted.

MD5 RSA

Copyright (C) 1991-2, RSA Data Security, Inc. Created 1991. All rights reserved.

License to copy and use this software is granted provided that it is identified as the "RSA Data Security, Inc. MD5 Message-Digest Algorithm" in all material mentioning or referencing this software or this function. License is also granted to make and use derivative works provided that such works are identified as "derived from the RSA Data Security, Inc. MD5 Message-Digest Algorithm" in all material mentioning or referencing the derived work.

RSA Data Security, Inc. makes no representations concerning either the merchantability of this software or the suitability of this software for any particular purpose. It is provided "as is" without express or implied warranty of any kind.

These notices must be retained in any copies of any part of this documentation and/or software.

OpenSSL

License Issues

The OpenSSL toolkit stays under a dual license, i.e. both the conditions of the OpenSSL License and the original SSLeay license apply to the toolkit. See below for the actual license texts. Actually both licenses are BSD-style Open Source licenses. In case of any license issues related to OpenSSL please contact openssl-core@openssl.org.

OpenSSL License

```
/* =====  
* Copyright (c) 1998-2007 The OpenSSL Project. All rights reserved.  
*  
* Redistribution and use in source and binary forms, with or without  
* modification, are permitted provided that the following conditions  
* are met:  
*  
* 1. Redistributions of source code must retain the above copyright  
* notice, this list of conditions and the following disclaimer.  
*  
* 2. Redistributions in binary form must reproduce the above copyright  
* notice, this list of conditions and the following disclaimer in  
* the documentation and/or other materials provided with the  
* distribution.  
*  
* 3. All advertising materials mentioning features or use of this  
* software must display the following acknowledgment:  
* "This product includes software developed by the OpenSSL Project  
* for use in the OpenSSL Toolkit. (http://www.openssl.org/)"  
*  
* 4. The names "OpenSSL Toolkit" and "OpenSSL Project" must not be used to  
* endorse or promote products derived from this software without  
* prior written permission. For written permission, please contact  
* openssl-core@openssl.org.  
*  
* 5. Products derived from this software may not be called "OpenSSL"  
* nor may "OpenSSL" appear in their names without prior written  
* permission of the OpenSSL Project.  
*  
* 6. Redistributions of any form whatsoever must retain the following  
* acknowledgment:  
* "This product includes software developed by the OpenSSL Project  
* for use in the OpenSSL Toolkit (http://www.openssl.org/)"
```

* THIS SOFTWARE IS PROVIDED BY THE OpenSSL PROJECT ``AS IS" AND ANY
* EXPRESSED OR IMPLIED WARRANTIES, INCLUDING, BUT NOT LIMITED TO, THE
* IMPLIED WARRANTIES OF MERCHANTABILITY AND FITNESS FOR A PARTICULAR
* PURPOSE ARE DISCLAIMED. IN NO EVENT SHALL THE OpenSSL PROJECT OR
* ITS CONTRIBUTORS BE LIABLE FOR ANY DIRECT, INDIRECT, INCIDENTAL,
* SPECIAL, EXEMPLARY, OR CONSEQUENTIAL DAMAGES (INCLUDING, BUT
* NOT LIMITED TO, PROCUREMENT OF SUBSTITUTE GOODS OR SERVICES;
* LOSS OF USE, DATA, OR PROFITS; OR BUSINESS INTERRUPTION)
* HOWEVER CAUSED AND ON ANY THEORY OF LIABILITY, WHETHER IN CONTRACT,
* STRICT LIABILITY, OR TORT (INCLUDING NEGLIGENCE OR OTHERWISE)
* ARISING IN ANY WAY OUT OF THE USE OF THIS SOFTWARE, EVEN IF ADVISED
* OF THE POSSIBILITY OF SUCH DAMAGE.

* =====
*
* This product includes cryptographic software written by Eric Young
* (eay@cryptsoft.com). This product includes software written by Tim
* Hudson (tjh@cryptsoft.com).
*/

Original SSLeay License

/* Copyright (C) 1995-1998 Eric Young (eay@cryptsoft.com)
* All rights reserved.
*
* This package is an SSL implementation written
* by Eric Young (eay@cryptsoft.com).
* The implementation was written so as to conform with Netscapes SSL.
*
* This library is free for commercial and non-commercial use as long as
* the following conditions are aheared to. The following conditions
* apply to all code found in this distribution, be it the RC4, RSA,
* lhash, DES, etc., code; not just the SSL code. The SSL documentation
* included with this distribution is covered by the same copyright terms
* except that the holder is Tim Hudson (tjh@cryptsoft.com).
*
* Copyright remains Eric Young's, and as such any Copyright notices in
* the code are not to be removed.
* If this package is used in a product, Eric Young should be given attribution
* as the author of the parts of the library used.
* This can be in the form of a textual message at program startup or
* in documentation (online or textual) provided with the package.
* Redistribution and use in source and binary forms, with or without
* modification, are permitted provided that the following conditions
* are met:

-
- * 1. Redistributions of source code must retain the copyright notice, this list of conditions and the following disclaimer.
 - * 2. Redistributions in binary form must reproduce the above copyright notice, this list of conditions and the following disclaimer in the documentation and/or other materials provided with the distribution.
 - * 3. All advertising materials mentioning features or use of this software must display the following acknowledgement:
 - * "This product includes cryptographic software written by Eric Young (eay@cryptsoft.com)"
 - * The word 'cryptographic' can be left out if the routines from the library being used are not cryptographic related :-).
 - * 4. If you include any Windows specific code (or a derivative thereof) from the apps directory (application code) you must include an acknowledgement:
 - * "This product includes software written by Tim Hudson (tjh@cryptsoft.com)"
 - *
 - * THIS SOFTWARE IS PROVIDED BY ERIC YOUNG ``AS IS" AND
 - * ANY EXPRESS OR IMPLIED WARRANTIES, INCLUDING, BUT NOT LIMITED TO, THE
 - * IMPLIED WARRANTIES OF MERCHANTABILITY AND FITNESS FOR A PARTICULAR PURPOSE
 - * ARE DISCLAIMED. IN NO EVENT SHALL THE AUTHOR OR CONTRIBUTORS BE LIABLE
 - * FOR ANY DIRECT, INDIRECT, INCIDENTAL, SPECIAL, EXEMPLARY, OR CONSEQUENTIAL
 - * DAMAGES (INCLUDING, BUT NOT LIMITED TO, PROCUREMENT OF SUBSTITUTE GOODS
 - * OR SERVICES; LOSS OF USE, DATA, OR PROFITS; OR BUSINESS INTERRUPTION)
 - * HOWEVER CAUSED AND ON ANY THEORY OF LIABILITY, WHETHER IN CONTRACT, STRICT
 - * LIABILITY, OR TORT (INCLUDING NEGLIGENCE OR OTHERWISE) ARISING IN ANY WAY
 - * OUT OF THE USE OF THIS SOFTWARE, EVEN IF ADVISED OF THE POSSIBILITY OF
 - * SUCH DAMAGE.
 - *
 - * The licence and distribution terms for any publically available version or
 - * derivative of this code cannot be changed. i.e. this code cannot simply be
 - * copied and put under another distribution licence
 - * [including the GNU Public Licence.]
 - * /

libSRTP (SRTP) - Cisco

Copyright (c) 2001-2005 Cisco Systems, Inc. All rights reserved.

Redistribution and use in source and binary forms, with or without modification, are permitted provided that the following conditions are met:

- Redistributions of source code must retain the above copyright notice, this list of conditions and the following disclaimer.
- Redistributions in binary form must reproduce the above copyright notice, this list of conditions and the following disclaimer in the documentation and/or other materials provided with the distribution.
- Neither the name of the Cisco Systems, Inc. nor the names of its contributors may be used to endorse or promote products derived from this software without specific prior written permission.

THIS SOFTWARE IS PROVIDED BY THE COPYRIGHT HOLDERS AND CONTRIBUTORS "AS IS" AND ANY EXPRESS OR IMPLIED WARRANTIES, INCLUDING, BUT NOT LIMITED TO, THE IMPLIED WARRANTIES OF MERCHANTABILITY AND FITNESS FOR A PARTICULAR PURPOSE ARE DISCLAIMED. IN NO EVENT SHALL THE COPYRIGHT HOLDERS OR CONTRIBUTORS BE LIABLE FOR ANY DIRECT, INDIRECT, INCIDENTAL, SPECIAL, EXEMPLARY, OR CONSEQUENTIAL DAMAGES (INCLUDING, BUT NOT LIMITED TO, PROCUREMENT OF SUBSTITUTE GOODS OR SERVICES; LOSS OF USE, DATA, OR PROFITS; OR BUSINESS INTERRUPTION).

HOWEVER CAUSED AND ON ANY THEORY OF LIABILITY, WHETHER IN CONTRACT, STRICT LIABILITY, OR TORT (INCLUDING NEGLIGENCE OR OTHERWISE) ARISING IN ANY WAY OUT OF THE USE OF THIS SOFTWARE, EVEN IF ADVISED OF THE POSSIBILITY OF SUCH DAMAGE.

Wind River Systems - VxWorks software

The VxWorks Run-Time software module is Copyright (c) WindRiver Systems Inc, all rights reserved. It is licensed for use, not sold. All use of this product and the VxWorks Run-Time module is subject to agreement with the following EULA terms

With respect to the Run-Time Module, Wind River and its licensors are third party beneficiaries of the End User License Agreement and that the provisions related to the Run-Time Module are made expressly for the benefit of, and are enforceable by, Wind River and its licensors.

Activities expressly prohibited: (i) copying the Run-Time Module, except for archive purposes consistent with the End User's archive procedures; (ii) transferring the Run-Time Module to a third party apart from the Target Application; (iii) modifying, decompiling, disassembling, reverse engineering or otherwise attempting to derive the Source Code of the Run-Time Module; (iv) exporting the Run-Time Module or underlying technology in contravention of applicable U.S. and foreign export laws and regulations; and (v) using the Run-Time Module other than in connection with operation of the Target Application.

Aastra Telecom and Wind River Systems: (i) Retain ownership of all copies of the Run-Time Module; (ii) expressly disclaim all implied warranties, including without limitation the implied warranties of merchantability, fitness for a particular purpose, title and non-infringement; (iii) exclude liability for any special, indirect, punitive, incidental and consequential damages; and (iv) require that any further distribution of the Run-Time Module be subject to the same restrictions set forth herein.

UPnP - Intel

INTEL SOFTWARE LICENSE AGREEMENT (Final, Site License)

IMPORTANT - READ BEFORE COPYING, INSTALLING OR USING.

Do not use or load this software and any associated materials (collectively, the "Software") until you have carefully read the following terms and conditions. By loading or using the Software, you agree to the terms of this Agreement. If you do not wish to so agree, do not install or use the Software.

LICENSE. You may copy the Software onto your organization's computers for your organization's use, and you may make a reasonable number of back-up copies of the Software, subject to these conditions:

1. You may not copy, modify, rent, sell, distribute or transfer any part of the Software except as provided in this Agreement, and you agree to prevent unauthorized copying of the Software.
2. You may not reverse engineer, decompile, or disassemble the Software.
3. You may not sublicense the Software.
4. The Software may include portions offered on terms in addition to those set out here, as set out in a license accompanying those portions.

OWNERSHIP OF SOFTWARE AND COPYRIGHTS. Title to all copies of the Software remains with Intel or its suppliers. The Software is copyrighted and protected by the laws of the United States and other countries, and international treaty provisions. You may not remove any copyright notices from the Software. Intel may make changes to the Software, or to items referenced therein, at any time without notice, but is not obligated to support or update the Software. Except as otherwise expressly provided, Intel grants no express or implied right under Intel patents, copyrights, trademarks, or other intellectual property rights. You may transfer the Software only if the recipient agrees to be fully bound by these terms and if you retain no copies of the Software.

LIMITED MEDIA WARRANTY. If the Software has been delivered by Intel on physical media, Intel warrants the media to be free from material physical defects for a period of ninety days after delivery by Intel. If such a defect is found, return the media to Intel for replacement or alternate delivery of the Software as Intel may select.

EXCLUSION OF OTHER WARRANTIES. EXCEPT AS PROVIDED ABOVE, THE SOFTWARE IS PROVIDED "AS IS" WITHOUT ANY EXPRESS OR IMPLIED WARRANTY OF ANY KIND INCLUDING WARRANTIES OF MERCHANTABILITY, NONINFRINGEMENT, OR FITNESS FOR A PARTICULAR PURPOSE.

Intel does not warrant or assume responsibility for the accuracy or completeness of any information, text, graphics, links or other items contained within the Software.

LIMITATION OF LIABILITY. IN NO EVENT SHALL INTEL OR ITS SUPPLIERS BE LIABLE FOR ANY DAMAGES WHATSOEVER (INCLUDING, WITHOUT LIMITATION, LOST PROFITS, BUSINESS INTERRUPTION, OR LOST INFORMATION) ARISING OUT OF THE USE OF OR INABILITY TO USE THE SOFTWARE, EVEN IF INTEL HAS BEEN ADVISED OF THE POSSIBILITY OF SUCH DAMAGES. SOME JURISDICTIONS PROHIBIT EXCLUSION OR LIMITATION OF LIABILITY FOR IMPLIED WARRANTIES OR CONSEQUENTIAL OR INCIDENTAL DAMAGES, SO THE ABOVE LIMITATION MAY NOT APPLY TO YOU. YOU MAY ALSO HAVE OTHER LEGAL RIGHTS THAT VARY FROM JURISDICTION TO JURISDICTION. TERMINATION OF THIS AGREEMENT.

Intel may terminate this Agreement at any time if you violate its terms. Upon termination, you will immediately destroy the Software or return all copies of the Software to Intel.

APPLICABLE LAWS. Claims arising under this Agreement shall be governed by the laws of California, excluding its principles of conflict of laws and the United Nations Convention on Contracts for the Sale of Goods. You may not export the Software in violation of applicable export laws and regulations. Intel is not obligated under any other agreements unless they are in writing and signed by an authorized representative of Intel.

GOVERNMENT RESTRICTED RIGHTS. The Software is provided with "RESTRICTED RIGHTS." Use, duplication, or disclosure by the Government is subject to restrictions as set forth in FAR52.227-14 and DFAR252.227-7013 et seq. or its successor. Use of the Software by the Government constitutes acknowledgment of Intel's proprietary rights therein. Contractor or Manufacturer is Intel Corporation, 2200 Mission College Blvd., Santa Clara, CA 95052.

SIP IP Phone Administrator Guide

Models 9143i, 9480i, 9480i CT, and 67xxi Series

© 2009 Aastra Telecom Inc.

If you've read this owner's manual and consulted the Troubleshooting section and still have problems, please visit our website at www.aastratelecom.com or call 1-800-574-1611 for technical assistance.

41-001160-03, Rev 00

Release 2.5
March 2009

