



Automation Technologies

Electromechanical Products and System Solutions

aerospace
climate control
electromechanical
filtration
fluid & gas handling
hydraulics
pneumatics
process control
sealing & shielding



ENGINEERING YOUR SUCCESS.

Parker Hannifin Corporation

Parker Hannifin is the leading global manufacturer of components and systems designed to control motion, flow and pressure in all types of machinery.

Parker offers more than 1,400 product lines that control motion in 1,000 industrial, mobile and aerospace markets. We are the only manufacturer to offer our customers a choice of hydraulic, pneumatic, electromechanical and computer motion control solutions.

Additionally, we have the largest global distribution network in our field, with more than 7,500 distributors serving more than 422,000 customers.

Parker Hannifin is a Fortune 300 corporation listed on the New York Stock Exchange as PH.



Engineering Expertise



Premier Customer Service



Worldwide Support Network

Innovative Automation Products and System Solutions

The Parker Electromechanical Automation Division brings together leading brands in industrial automation, including ***Acroloop, Bayside, Compumotor, CTC, Custom Servo Motor, Daedal, Hauser, IPS, SSD and Trilogy.***

When it comes to electromechanical components and solutions, no company offers more than Parker.

We hope this shortform catalog provides you with a brief overview and understanding of our primary electromechanical product technologies.

For complete information on these products or to discuss your next solution contact Parker today.

- **Use the web address listed by each product in this shortform to access complete information on our website**
- **For literature: 800-CPARKER (272-7537) e-mail: c-parker@parker.com or visit us on-line at: www.parkermotion.com**
- **For information on software and training programs, visit www.parkermotion.com/support_training.html**

Content

Automation Technologies 4 - 5
Selectable Levels of Integration™ 6 - 7
Product and Technologies Overview 8 - 9



Visualization – HMI

HMI Powerstations and software . . . 10 - 11
Monitors and factory displays 12
PAC integrated machine control 13



Motion and Machine Control

ACR controllers 14 - 15
ETHERNET Powerlink controllers . . . 16 - 17



Drives and Drive/Controllers

Servo drives and drive/controllers . . 18 - 19
Stepper drives and drive/controllers . 20 - 21



Rotary and Linear Motors

Servo motors 22 - 23
Stepper motors 24 - 25
Specialty motors 26 - 27
Linear motors 27



Gearheads & Gearmotors

Planetary, NEMA and
MultiDrive gearheads 28 - 29
Integral gearmotor solutions 29



Linear and Rotary Positioners

Linear positioners 30 - 39
Rotary positioners 40 - 41
Manual linear and rotary positioners . 42 - 43



Electric Cylinders 44 - 45



Modular Structural Solutions 46 - 47



Engineered Solutions 48 - 50

On-line Resources 51

International Sales Locations 52

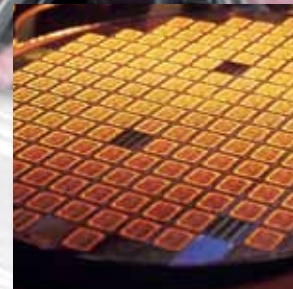

Parker electromechanical automation products are found just about everywhere — from laboratories, cleanrooms and factory floors, to mines, foundries and satellites in space — our products are used anywhere machines, processes and people depend on reliable high-performance motion control.

The products described in this catalog represent our most popular products and capabilities. If you don't find exactly what you are looking for, please contact us for information on other suitable Parker products and to discuss your specific application requirements.

The Best Automation Solutions

Parker is about motion control engineering, manufacturing, application expertise and unparalleled customer service. Our electromechanical systems and solutions are available wherever needed—around the corner or around the world.

Today's industrial automation applications demand the best in quality and productivity. Likewise, high-technology automation applications demand performance in quality throughput and precision.

Industrial solutions from Parker's Electromechanical Automation Division combine speed, accuracy and high-load capability to give machine builders and OEMs a competitive edge in industrial markets that include:

- **Packaging**
- **Automotive manufacturing and assembly**
- **Printing**
- **Material handling**
- **Military applications**



In high-precision fields, miniaturization of semiconductor, electronics and life science applications have created the need to partner with companies that have the experience and products to meet stringent specifications for smaller, more precise motion control solutions.

Parker's dedicated electromechanical business is rapidly becoming an industry leader in providing precision connectivity to PC-based controls for target industries including:

- **Semiconductor**
- **Electronics**
- **Computer peripherals**
- **Life science**
- **Medical equipment**



It's Our Business to Help Your Business

Many of the systems shown in this catalog are built specifically to customer requests and needs. Parker system customers can receive many optional services such as:

- **3-D custom assembly drawings**
- **Electronics integration**
- **Finite element analysis**
- **Life load testing**
- **End effector integration**
- **High-flex cabling systems**

Unlike many other motion technologies, electromechanical applications often require custom solutions. Parker has a Custom Systems Group staffed by experienced engineers and technicians who utilize systematic processes for handling component modifications or complete one-of-a-kind systems.

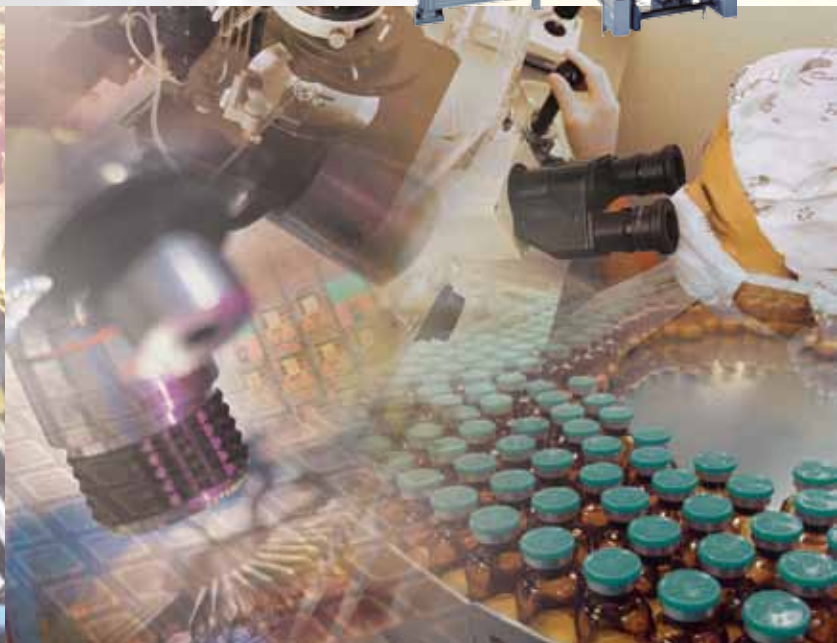
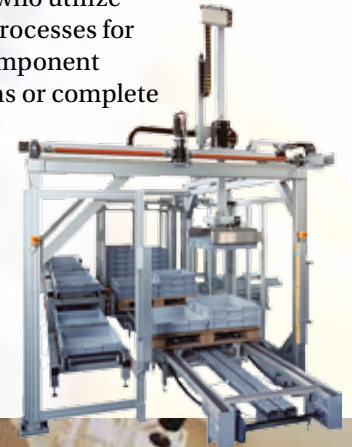

Unrivalled Support from Design Concept to After-Sale Service

Our advanced manufacturing and assembly processes allow us to build quality and consistency into every element of your motion system. Each mechanical system is fully assembled prior to shipment and each component is properly handled to protect finish and appearance.

Performance and specifications are verified with state-of-the-art testing, including:

Cleanroom testing – Parker is equipped with particulate testing to certify materials for cleanroom ratings.

EMI testing – Parker has an EMI test chamber, which allows us to test equipment to verify levels of electromagnetic interference.

Precision metrology labs – Parker certifies all precision-grade positioners using state-of-the-art laser interferometers, and provides reports to validate accuracy and bidirectional repeatability.

Engineering Support Tools to Make Your Job Easier

Years of experience have culminated in a vast assortment of engineering support tools including

- **Comprehensive engineering references available on CD or on-line**
- **Motor sizing and selection software**
- **Application programming software**
- **Product installation videos**
- **CAD files available for most products**
- **System design assistance for custom application requirements**

Application Assistance

When you have urgent questions, expert answers are only a phone call away. Our team of experienced engineers is ready to take your call. These engineers have practical field experience and can provide you with application and product assistance throughout the stages of your project and for the life of the product. For presale support, including sizing and system selection, call 800-245-6903 (724-861-8200 outside the US). For post-sale support with technical questions on programming and troubleshooting, call 800-358-9070 (707-584-7558 outside the US). Our staffing and support tools allow us to resolve most issues and get your project rolling in less than one hour.

Parker Automation Technology Centers

Parker Automation Technology Centers are a network of premier product and service providers who can serve you locally for your automation needs. Each Automation Technology Center is certified to have completed significant product training and has the ability to provide subsystem solutions with local support.

24/7 Emergency Breakdown Referrals

The Parker product information center at 800-C-PARKER offers live operators 24/7 to help identify replacement parts or services. The operators at 800-C-PARKER can connect you with on-call representatives for all motion control technologies.

The Best Lead Times in the Industry

We have the #1 rated, industry-leading, on-time delivery to customer-requested ship dates.

Electromechanical Extranet

Parker's Extranet allows the customer to maintain a direct relationship with the factory. Available 24/7, the site allows customers to go on-line to track order status and perform other transactions, including ordering and scheduling. And of course, Parker's hallmark field service organization is always available to meet with the customer as desired.

www.parkermotion.com

The Parker Electromechanical Automation site offers the most extensive on-line support tools in the industry, including:

- **Complete on-line catalog**
- **FAQ database with more than 500 answers to common questions**
- **Interactive product sizing and selection tool**
- **Comprehensive CAD drawings and 3-D models for electronic and mechanical products**
- **User guides and detailed product specifications**
- **Latest software and firmware revisions**
- **Application case studies**
- **Custom solutions photo library**
- **Innovative technology white papers**

Selectable Levels of Integration™

Selectable Levels of Integration™ is a philosophy of product development and management that allows the machine builder to select an appropriate system, subsystem, or component to meet a specific need.

Parker has solutions for machine builders of all types, from those who want a complete, integrated system to those who want to build their own system with tailored components to match their performance and price requirements.

Systems

Machine builders and OEMs often choose to integrate a complete electromechanical system into their machine. They have confidence in knowing that our knowledge, experience, and support will ensure that their goals are met. Minimal design engineering ensures component compatibility from a single source.



Subsystems and Bundled Products

For a cost-effective and efficient solution, Parker offers bundled or kitted systems. We can combine motors, gearheads, and positioning systems to deliver a configured subsystem ready for installation. Parker configuration and setup software accommodates the rest of the product line, making start-up a snap. Combining this with our custom product modification capabilities gives the machine builder an economical custom-fit solution. Result: reduced engineering effort, straightforward integration, and modular compatibility.

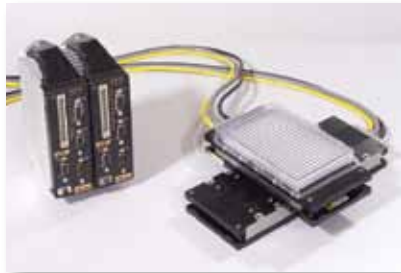

Component Products

We offer the broadest range of linear and rotary motion products available for automation systems. If you have the capability and experience to develop your own systems, our innovative, easy-to-use products will help you get the job done. Parker provides short lead times, large selection, and proven reliability.



Products and Technologies

Whether using one component or an entire integrated system, Parker has the right solution. Parker Electromechanical Automation Division offers a vast array of motion and control products including:

To request a catalog or for complete on-line information, go to www.parkermotion.com



Visualization – Human-Machine Interfaces (HMI)

Parker offers HMI solutions for any application, from

simple push-button replacement to sophisticated networking, multimedia and data logging requirements. Parker pre-loads Interact or InteractX HMI software on PowerStation industrial computers to provide a ready-to-go HMI solution. This bundled approach reduces development and integration time for your HMI project.



Motion & Machine Controllers

Parker motion controllers are powerful designs that have the

processing power to coordinate multiple axes of motion. Parker controllers have advanced features built in, such as kinematics transformation for the control of robots and other non-linear functions. Each Parker controller comes with free libraries for Visual Basic® and Visual C++®.





Drives & Drive/Controllers

Parker drives are designed to deliver a maximum amount of power output and performance in minimal package size. These drives have industry-leading power density and smart digital designs with features to ease integration and start-up.



Rotary & Linear Motors

Using advanced technologies, Parker rotary motors provide maximum performance and value. Our exposed-lamination designs provide maximum torque per package size, and the motor designs provide cog-free rotary motion for the best low-speed smoothness. Patented linear motor designs provide the greatest winding uniformity and accuracy in the industry, and our product line-up includes the smallest linear motor components on the market to the largest force capacity.



Gearheads & Gearmotors

With high-precision designs, Parker gearheads have less than three arc-min of backlash. They have an industry-leading two-year warranty.



Linear & Rotary Positioners

Parker offers best-in-class positioner designs with screw-, belt-, or linear motor-drive technologies. Our award-winning designs lead the way with unmatched flexibility and precision capabilities. Parker's complete breadth of positioning product solutions include robust, low-maintenance industrial-focused positioners, miniatures, OEM-friendly linear motors, precision and high-payload industrial rotary positioners, and manual and micrometer-driven linear and rotary products.



Electric Cylinders

Parker produced one of the first servo-driven, high-quality electric cylinders more than 20 years ago. Today, Parker has one of the most complete electric cylinder lines available, including high-force ball screw cylinders, extreme-force roller screw cylinders, and low- to medium-capacity lead screw/ball screw versions. With products from ISO32 up to 160 mm frame sizes, and capable of up to 40,000 lbs of thrust, traditionally hydraulic and pneumatic applications can now benefit from the cost savings and cleanliness of servo positioning.



Structural Framing

Parker structural framing utilizes aircraft-grade aluminum for robust, high-strength assemblies. Whatever your design requirement, Parker has the product versatility and engineering expertise to match. Choose from individual components, bundled inventory, kits and turnkey systems. Plus, we offer full engineering, fabrication and assembly services. We are your single source/complete resource for all your structural design needs.



I/O

The Parker I/O system is a modular and flexible remote I/O system designed to work with today's common fieldbuses. The modular design of the Parker I/O allows the user to choose the number and type of I/O points that best suit each application.



Systems

Parker offers multi-axis cartesian and gantry-style robots as standard pre-configured, ready-to-run solutions. If the application needs something more custom, we offer best-fit custom automation solutions ranging from precision cleanroom/laboratory to heavy-duty industrial automation. When you partner with Parker, you leverage the full extent of our global motion and control leadership for unrivalled application solutions.

Visualization – HMI

Interact **Xpress** HMI Software and XPR PowerStations

Call 800-358-9070 or [click here for more information...](#)



Interact Xpress™ is designed specifically to simplify and cost-reduce HMI applications.

By far, the most cost-effective way to support machinery installations or remote stations across geographical distances is via the internet or other IP connections. Interact Xpress takes full advantage of the internet and the wide availability of web browsers to design, publish, run and support your HMI applications without sophisticated Windows-based software and hardware. Interact Xpress can be accessed from either the HMI panel or any PC running Internet Explorer®.

Interact Xpress software is pre-installed and bundled with the new XPR PowerStation hardware, which is designed to optimize the performance, storage and connectivity features of Xpress HMI. This NEMA4/4X-rated family of CE-based workstations is available in either an embedded no display unit or with a 6", 8", 10" and 15" TFT touchscreen display models.

- **Hardware/software integration optimizes performance, storage and connectivity**
- **Rich, graphical runtime interface that is scalable to various screen sizes**
- **Runs sophisticated graphics, animations and video to enhance the operator experience**
- **Built-in networking, web publishing and browsing from any operator station**
- **Advanced security tools support single and multi-user applications, as well as integrated development from operator interface**
- **Optimized runtime client performance using Adobe Flash technology**
- **Unlimited tags included**
- **35+ device communication drivers included**
- **Affordable HMI for multi-site, multi-station and standalone machines, particularly when remote control, monitoring and support are desirable**
- **Supervisory stations created by simply publishing the local HMI screens to supervisory software or a simple web browser**



InteractX™ Supervisory HMI

Call 800-358-9070 or [click here for more information...](#)



InteractX™ has always led the industry with breakthrough HMI graphics and built-in connectivity. Now with version 3.X, InteractX leads the way into supervisory HMI by dramatically reducing application development time and integration cost for your manufacturing operations.

InteractX now provides powerful trending and analysis tools that aggregate data from multiple machines or workcells. InteractX also makes it easy to push Interact Xpress™ machine level HMI screens and data directly into its interface - without having to recreate applications or input tags!

- **Full featured historical trending software**
- **Supervisory-level HMI aggregates data from multiple sources, including 3rd-party PLCs and HMI panels**
- **Time-saving “distributed HMI” integration with Interact Xpress**
- **Scalable, lifelike graphics**
- **No preset limits on pens or logs**
- **Unlimited tags - no hidden costs**
- **Over 60 standard communication drivers included**
- **Sophisticated recipe management tools included**
- **Preconfigured and custom Panel tool library for quick screen development**
- **Supports ActiveX controls for easy integration of 3rd-party tools**
- **Includes VB for applications (VBA) for easy customization**
- **Vast 3rd-party OPC client/server support**
- **Easy multi-language support**
- **Includes easy E-Sigs tools to simplify 21CFR11 compliance**

IPX/IPC PowerStations

Call 800-358-9070 or [click here for more information...](#)



Parker’s industrial PC products include 10”, 15”, and 17” panel-mount color touchscreen systems and a machine-mount, PC-only system. The IPX PowerStations come with InteractX runtime preloaded and enabled, reducing the time it takes to get a project running. The IPC PowerStations are configured to run third-party or custom Windows applications and do not include an InteractX runtime licence.

- **Celeron M 550 at 2.0 GHz or Core2Duo T7500 at 2.2 GHz**
- **2 GB memory standard, 4 GB optional**
- **Intel Express graphics**
- **80 GB SSD standard on IPX (optional on IPC)**
- **160 GB HDD standard on IPC (optional on IPX)**
- **8 USB 2.0 ports (2) RS-232, (1) RS-232/422/485**
- **2 1000 BaseT Ethernet ports**
- **HD audio**

Visualization – HMI

PHM Industrial Monitors

Call 800-358-9070 or [click here for more information...](#)



This family of industrially hardened monitors is perfect for harsh environments. They feature a chemical-resistive NEMA 4/4X front bezel and convenient clip mounting.

Display Sizes

- 15" XGA (1024 x 768)
- 17" SXGA (1280 x 1024)
- Analog resistive touchscreen
- On-screen display controls

- Auto power sensing and sleep mode
- Stainless steel bezel available on 15" models
- USB and serial interfaces for touchscreen
- VGA and DVI interfaces for video
- 24 VDC power
- CE, UL and cUL agency approvals standard
- Class 1 Div. 2 available

PFD Factory Display

Call 800-358-9070 or [click here for more information...](#)



The new Parker Factory Display offers unparalleled visual impact that enhances the message, while its distributed architecture easily integrates into your existing manufacturing and IS infrastructure. Whether remotely publishing displays from anywhere via the web or visualizing non-conforming parts on a production line, the Parker Factory Display does so much more than other production board displays and systems... and at a lower cost.

Parker Factory Display comes with pre-installed software that fully leverages the wide availability of web-browsing software for remote support and application sharing on the Internet and IP Networks. PFD applications can be developed, edited and published using its built-in web server.

One of the best ways to cut the high cost of downtime and scrap is to empower workers with real-time, situational awareness for faster response to downs and non-conforming conditions on the factory floor. That's why the new Parker Factory Display (PFD) visualization system pays for itself so quickly.

PFD offers unprecedented flexibility and impact for delivering critical messages to associates on the factory floor. Whether presenting Andon displays, lean metrics, production status, OEE data, safety policies or employee announcements, the Parker Factory Display is much more than a "scoreboard" that simply displays text.

- Move information around or even off the plant floor
- Intuitive development tools and templates
- HD image quality
- Templates allow corporate-wide, standard metrics to be deployed faster and easier
- Direct PLC connectivity automates data collection – over 40 drivers included at no charge
- Continuous improvement database can be distributed to multiple locations
- Sophisticated security allows 6 different access levels including "view only" for remote users
- Offered in 32", 40" and 46" widescreen sizes with 16.7 million colors (contact factory for larger display requirements)
- Thermal sensors and fans provide cooling in industrial environments
- Power can be scheduled to match downtime - saving energy
- VESA 200 mm mounting

Xpress PAC Integrated Machine Control Solutions

Call 800-358-9070 or [click here for more information...](#)



Xpress PAC is the first truly integrated family of machine control solutions available from one vendor. From HMI to mechanics and everything in between, Parker's Xpress PAC family of programmable automation control products offer unique advantages unavailable from any other source:

- **World-class visualization and motion platform products**
- **Fast, cost-effective motionbus**
- **Open Ethernet protocols**
- **Industry-leading mechanical solutions**
- **Industry's largest, strongest sales application support & service network**

The Xpress PAC family is specifically designed to offer unprecedented interoperability:

- **Expedite project implementation**
- **Reduce time to market**
- **Increase ROI**

Xpress PAC is a multi-faceted integrated automation solution offering:

- **Visualization**
- **IEC control**
- **Network/fieldbus**
- **Motion control**
- **Drive**
- **Motor**
- **Mechanics**

The Xpress PAC family centers around our new ACR-96xx Programmable Automation Controller (see page 14). A truly converged platform, the ACR-96xx includes logic, motion and HMI in a single scalable product.

Interact Xpress HMI (see page 10), is the machine-level member of the Xpress PAC family. Interact Xpress provides your system with a connection to the other side of the plant, or your plant on the other side of the world.

The Xpress PAC family supports standards-based development environments, open communications protocols and integrated remote support and data collection capabilities.

These features guarantee a migration path as your needs evolve and provide the industry's easiest tools for moving information off the plant floor to wherever it's needed.



Motion & Machine Control

ACR Series Programmable Automation Controllers

Call 800-358-9070 or [click here for more information...](#)



ACR Series Controllers offer a powerful combination of motion and machine control in multiple hardware configurations.

Many industry standards, such as IEC61131-3 for programming and EtherNet/IP for communications, make the controller suitable for a wide array of users and applications.

Options for ETHERNET Powerlink and CANopen present flexibility to create numerous machine architectures.

Motion and Programming Capabilities

- IEC61131-3 programming: structured text, ladder logic and CFC
- Up to 16 PLC tasks: timer, cyclic or interrupt configurable task priority
- Additional 16 AcroBasic tasks available

PLCopen Function Blocks

- Absolute, incremental and continuous moves
- Power, reset and status
- Home, stop and halt
- Axis parameter read and write

Parker Function Blocks

- Electronic gearing
- Electronic cam
- Touchprobe
- Controller parameter read and write
- Linear interpolation
- Circular interpolation

Hardware Features

- ETHERNET Powerlink digital motion bus
- EPL versions support up to 16 axes of coordinated motion
- Available support for traditional analog drives
- Analog versions are available in 2-, 4-, 6- or 8-axis models
- Equipped with 2MB of user memory standard
- Robust connectors hold up in harsh environments
- EtherNet/IP, CANopen, USB2.0, RS232 and RS485 communications are supported, with multiple channels available simultaneously
- Industry-standard Ethernet/IP communications
- CANopen I/O support for over 1000 points of I/O



ETHERNET 
POWERLINK
 Standardization Group

Model	ACR9600	ACR9630	ACR9640
Input Power	120 – 240 VAC	120 – 240 VAC	24 VDC
ETHERNET Powerlink	No	Up to 16 axes	Up to 16 axes
Servo/Stepper	2, 4,6, or 8 axes	2, 4,6, or 8 axes	No
On-board I/O	Up to 40 in/8 out	Up to 40 in/8 out	No
Expanded I/O	CANopen	CANopen	CANopen

ACR-View Software Development Kit

Call 800-358-9070 or [click here for more information...](#)

ACR-View is a powerful project development suite that assists the ACR user with programming, debugging and commissioning their application. Many features are incorporated to assist both the novice and expert user in developing code. Project set-up is streamlined through the use of the Configuration Wizard.

The ACR-9xxx can be configured in a matter of minutes as the user is guided through a series of simple steps. ACR-View will set the necessary parameters to have the controller ready for motion and code development.

ACR-View's configurable environment allows you to create a development system that works the way you do. Elements of the environment can be docked, floated or moved to where they work best for you. Additional information is available from tool tips and a context sensitive help system. ACR-View automatically generates a suite of common tags for each project you define. These tags can be automatically used in your Xpress HMI application.

All the tools needed to build and maintain a motion project are included.

- Ethernet, USB, CANopen and serial connection support
- Project Configuration Wizard
- Servo tuning tools
- Built-in oscilloscope, strip chart and XY plot
- IEC 61131-3 editor (structured text, ladder diagram and continuous function chart)
- On-line PLC program monitoring and editing
- User-created watch window
- Real-time terminal interface
- Servo loop diagnostic tool
- Comprehensive status panels
- Integrated help files
- Libraries for PC application development in .NET, C++ and Labview

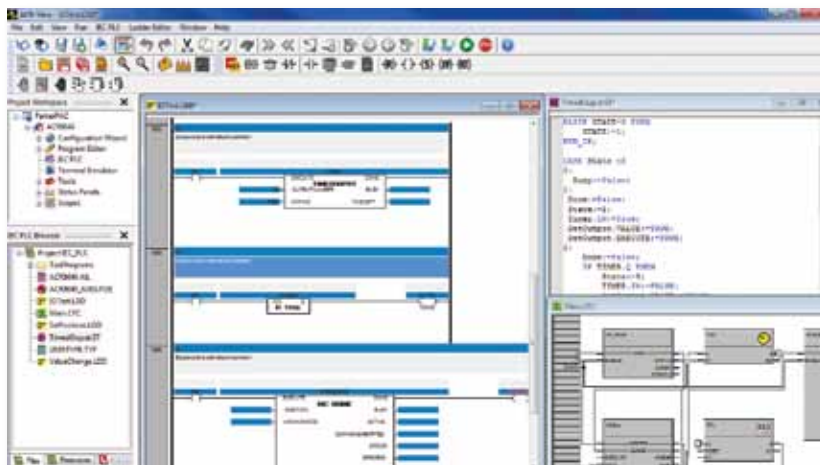

Motion & Machine Control

ETHERNET Powerlink (EPL)

Call 800-358-9070 or [click here for more information...](#)

ETHERNET Powerlink (EPL) expands the ACR family by enabling real-time motion control via Ethernet. The high-bandwidth digital communications network enhances machine performance and configuration possibilities while reducing set-up time and installation complexity.

ETHERNET Powerlink is a deterministic, real-time Ethernet motion bus solution connecting motion controller to servo drives and I/O points using standard Ethernet hardware. EPL is an open standard communication protocol, developed to achieve the timing and synchronization required in high-performance automation and motion control applications.

Parker's EPL solution includes all the motion and communication features of the ACR family for complete motion and machine control solutions. A full range of servo drives is available with Aries and Compax3 Series drives, supporting a wide variety of motors and feedback devices. All drive and motor configuration, programming and system troubleshooting can be accomplished through the ACR controllers.

EPL Highlights

- **Open industry standard communication protocol**
- **Standard Ethernet hardware**
- **No proprietary ASICs required**
- **Based on CANopen device profiles**
- **Simplified system design**
- **Reduced installation time**
- **Enhanced diagnostics**

Parker EPL Solutions

- **Up to 16 axes with ACR controllers**
- **Aries and Compax3 servo drives**
- **Built-in repeating hubs for flexible connection options**
- **Drive and controller on-board I/O**
- **Single point of communication for entire motion system**
- **Auto-tuning and motor configuration via ACR-View**



Aries EPL Servo Drive

Call 800-358-9070 or [click here for more information...](#)



Aries EPL servo drives combine Parker's high-performance digital servo control technology with the real-time performance benefits of ETHERNET Powerlink motionbus technology.

The Aries EPL servo drives deliver all the performance benefits that digital drive technology has to offer, including fast update rates and ease of installation. The Aries EPL can run rotary or linear servomotors with a wide range of feedback devices, making it the ideal drive choice to solve a variety of machine applications.

- **ETHERNET Powerlink-enabled servo drive**
- **Integrated 2-port Ethernet hub**
- **Rotary or linear servo motor control**
- **3, 4.5 and 6.3 A RMS continuous current**
- **120/240 VAC power input**
- **Multiple feedback options – Smart encoder, quadrature encoder, Heidenhain EnDat absolute encoder**
- **Auto-tuning**
- **CE (EMC & LVD), UL recognized**

Compax3 EPL Servo Drive

Call 800-358-9070 or [click here for more information...](#)



The Compax3 servo drives combine a high-performance, digital design with industrial ruggedness and expansive power capabilities. Compax3 servo drives are designed for industrial applications with heavy duty features such as built-in regeneration capabilities and AC input line filtering. The wide variety of power levels, up to 155 A RMS, ensures that no application is too large for the Compax3 servo drive.

- **ETHERNET Powerlink-enabled servo drive**
- **Integrated 2-port Ethernet hub**
- **Rotary or linear servo motor control**
- **From 2.5 to 155 A RMS continuous current**
- **Built-in regeneration and line filtering**
- **120/240/480 VAC single- and three-phase power input**
- **Quadrature encoder, absolute encoder and resolver feedback**
- **CE (EMC & LVD), UL and cUL recognized**

Drives & Drive/Controllers

Servo Product Families

Series	Aries	Compax3	ViX
Input Power	120/240 VAC	120/240/480 VAC	24 to 80 VDC
Shaft Power	Up to 3 kW	Up to 100 kW	Up to 400 W
Feedback	Encoder, Sincos, Endat, Resolver	Encoder, Sincos, Endat, Hiperface, SSI, Resolver	Encoder, Resolver
Command Input	±10V Analog, 5V Step and Direction, CW, CCW	±10V Analog, 5V Step and Direction, Encoder Input	±10 V Analog, 5V Step and Direction, CW, CCW, Encoder Input
Controller Version	Yes	T11, T30, T40*	Yes
Fieldbus Communications	ETHERNET Powerlink	Profibus, DeviceNet, CANopen, ETHERNET Powerlink, EtherCAT	RS232/RS485
Inputs/Outputs	Enable/Reset/Fault	8 Inputs, 4 Outputs; Expandable	5 Inputs, 3 Outputs
Compatible Motor	PM Brushless Servo	PM Brushless Servo	PM Brushless Servo
Parker Motor Series	MPP, SM, BE, Linear Motors	MPP, SM, BE, Linear Motors	MPP, SM, BE, MX80, LX80

* T11 - Basic indexer; T30 - Fully programmable IEC 61131-3; T40 - T30 plus electronic camming, gearing, PLS, etc.

Aries Servo Drives & Drive/Controllers

[Call 800-358-9070 or click here for more information on drives...](#)

[Call 800-358-9070 or click here for more information on drive/controllers...](#)



The Aries Series are compact, easy-to-use servo motor drives and drive/controllers. Aries is a cost-effective and flexible digital servo solution where users are required to pay for only the performance they need. All models are CE (EMC & LVD), UL compliant.

Aries Drive

The Aries Drive is standard as a torque-only amplifier, but is software selectable to run in velocity mode. An optional step-and-direction version is also available.

- **120/240 VAC input**
- **100 to 3000 W power levels**
- **Plug in and spin – no set up required; auto-configures when used with Parker’s “smart encoder” motor**
- **Drive Talk – ACR9000 controller can access all drive parameters**
- **Supported feedback devices include Smart encoder, quadrature encoder, Heidenhain EnDat absolute encoder and resolver**

Aries Drive/Controller

The Aries Controller combines the versatile and cost-effective Aries digital servo drive platform with the advanced control capabilities of the ACR servo controller into a single-axis drive/controller.

- **Ethernet TCP/IP communications**
- **400 to 1300 W power levels**
- **1 1/2 axis encoder input for camming, following, and gearing**
- **Up to 16 multi-tasking programs**
- **Set-up and auto-tuning via ACR-View SDK**
- **Supports EtherNet/IP**

Compax3 Servo Drives & Drive/Controllers

[Call 800-358-9070 or click here for more drive information...](#)

[Call 800-358-9070 or click here for more information on drive/controllers...](#)



With its high performance and modular design, the Compax3 family of industrial servo drives and drive/controllers offers a new level of servo performance and flexibility.

Enhanced by the IEC 61131-3 programming environment, the modular structure of the Compax3

family allows options such as intelligent motion controllers, fieldbus interfaces and industry standard motor feedback.

Available in single- or multi-axis configurations, with numerous expansion options, all models are rated for 120 – 480 VAC input, continuous current output from 2.5 A (rms) to 155 A (rms), and are CE (EMC & LVD) and UL compliant.

Compax3 Drive

- **5V/24V step/direction and $\pm 10V$ analog command**
- **Resolver, encoder or high-resolution SinCos[®] Hiperface[™] and Endat 2.1**
- **Torque, velocity or position control modes**
- **Encoder tracking capability**

Compax3 Drive/Controller

- **Available as:**
 - **servo positioning**
 - **programmable positioning with function modules according to PLCopen**
 - **advanced programmable positioning with electronic camming, gearing, etc.**
- **Certified safety technology integrated into drive (EN954-1 Category 3)**
- **Fieldbus options: DeviceNet, Profibus, CANopen, ETHERNET Powerlink and RS232**
- **Supports all five IEC 61131-3 programming languages and continuous flow chart**
- **Resolver, encoder or high-resolution Sin/Cos[®], Hiperface[™], Endat 2.1 and SSI feedback devices**

ViX Servo Drives & Drive/Controllers

[Call 800-358-9070 or click here for more information on drives...](#)

[Call 800-358-9070 or click here for more information on drive/controllers...](#)



The ViX Series is flexible, powerful and compact, giving users a robust and cost-effective DC product, particularly in multi-axis applications. Designed for easy set-up and tuning, the ViX can be fully configured and running within minutes of unpacking the unit.

ViX Drive

- **24 to 80 VDC input**
- **2.5 and 5 A RMS continuous versions available**
- **Torque, velocity, or position control**
- **Resolver or encoder feedback (software selectable)**
- **High-resolution encoder feedback option**
- **Five digital inputs and three digital outputs**
- **CE (EMC and LVD) and UL compliant**
- **RS232 or RS485 fieldbus**

ViX Drive/Controller

- **Storage of up to 16 sequences**
- **Encoder following, registration, feed-rate override**
- **5 digital inputs, 3 digital outputs, 1 analog input**
- **Conditional statements**
- **Optional RS485/CANbus interface**
- **Resolver or encoder feedback**

Drives & Drive/Controllers

Microstepping Product Families

Series	E-AC	E-DC	Ion	OEMZL	ViX
Input Power	95 to 132 VAC	24 to 48 VDC	12 to 24 VDC	95 to 132 VAC	24 to 80 VDC
Peak Current Output (Amps)	0.02 to 3.5	0.2 to 4.8	0.4 to 2.0	0.14 to 6.00	0.2 to 8
Overall Dimensions mm (in)	109.22 x 57.15 x 48.26 (4.3 x 2.25 x 1.9)	127 x 91.44 x 40.64 (5.0 x 3.6 x 1.6)	80.0 x 25.0 x 25.0 (3.14 x 0.98 x 0.98)	224.0 x 180.0 x 70.0 (8.80 x 7.14 x 2.75)	124.46 x 86.36 x 43.18 (4.9 x 3.4 x 1.7)
Control Version	—	—	—	OEMZL6104	ViX250IM ViX500IM
Control Version Features	—	—	—	Motion profiles, conditionals, registration position maintenance stall detection, following, 16 inputs/8 outputs	Motion profiles, conditionals, registration position maintenance stall detection, following, 5 inputs/3 outputs

E-AC and E-DC Microstepping Drives

Call 800-358-9070 or [click here for more information on E-AC...](#)

Call 800-358-9070 or [click here for more information on E-DC...](#)



The E Series is a high-performing, low-cost family of packaged AC-input and DC-input microstepping drives.

- **Anti-resonance circuitry suppresses mid-range instability**
- **Recommended motor inductance range of 0.5 mH to 80 mH**

- **Selectable resolution up to 50,800 steps/rev**
- **Auto standby reduces motor current (and heating)**
- **Current waveforms to optimize smoothness**
- **Optically isolated step and direction inputs**
- **Short-circuit and over-temperature protection**

Ion Microstepping Drives

Call 800-358-9070 or [click here for more information...](#)



The Ion Series stepper drive is an OEM-friendly miniature motion drive capable of up to 2 Amps in a 1" x 1" x 3.3" square package.

- **Adjustable run current via potentiometer**
- **Auto standby adjustable current to reduce heat generation and power consumption**

- **Stepper resolution to 3200 steps per rev**
- **RoHS compliant**
- **DIN rail mountable or mounts directly to LCR Series linear positioners**
- **Accepts single or differential step and direction inputs**

OEMZL Microstepping Drives & Drive/Controllers

Call 800-358-9070 or [click here for more information...](#)



OEMZL microstepping drives are standalone, packaged microstepping drives & drive/controllers that incorporate breakthrough techniques known as Active Damping™ and Electronic Viscosity™. The OEMZL family of drives comes in two power versions: OEMZL4 and OEMZL6.

Designed for reliability, the OEMZL drive family offers premier quality and performance while being easy to use and apply. The OEMZL drive family meets the need for global solutions:

- **CE (LVD), CE (LVD and EMC) or low-noise applications**
- **UL recognized**
- **120 VAC input**
- **DIP-switch selectable**
- **Resolution from 200 to 50,800**
- **Controller version provides 16 inputs/8 outputs**

ViX Microstepping Drives & Drive/Controllers

Call 800-358-9070 or [click here for more information on drives...](#)

Call 800-358-9070 or [click here for more information on drive/controllers...](#)



The ViX Series is a digital, compact and high-power family of DC-input microstepping drives.

- **Wizard-based configuration**
- **Anti-resonance circuitry suppresses mid-range instability**
- **Recommended motor inductance range of 0.5 mH to 20 mH**

- **24 to 80 VDC bus input voltage**
- **Integer-selectable resolution from 200 to 51,200 steps/rev**
- **Five digital inputs and three digital outputs**
- **One analog input**
- **Controller version provides basic control functionality**
- **RS232 or RS485 fieldbus**

Rotary & Linear Motors

Rotary Servo Motor Family Attributes

Series	SM	BE	MPP/MPJ
Page	24	24	25
Application Advantages	Smooth motion, high inertia	Rapid moves, high acceleration	Rapid moves, high acceleration
Frame Sizes	NEMA 16, 23	NEMA 16, 23, 34	7 sizes, 92 to 270 mm
Continuous Torque Range Nm (in-lb)	0.19 to 1.2 (1.7 to 10.6)	0.15 to 4.9 (1.3 to 43.4)	1.5 to 158 (13 to 1398)
Speed Range	0 to 7500 rpm	0 to 5000 rpm	0 to 7000 rpm
Feedback	Encoder/Resolver	Encoder/Resolver	Encoder/Resolver/SinCos - Hyperface/Sincos - Endat
Drive Family	Aries, Compax3	Aries, Compax3	Aries, Compax3

Rotary Stepper Motor Family Attributes

Series	LV	HV
Page	25	25
Application Advantages	Low voltage, up to 80 VDC	High voltage, 120 VAC
Frame Sizes	11, 14, 17, 23, 34	17, 23, 34
Static Torque Range Nm (in-oz)	0.05 to 9.07 (6.5 to 1285)	0.4 to 9.07 (56 to 1285)
Speed Range	Up to 3000 rpm	0 to 5000 rpm
Feedback	Encoder optional	Encoder optional
Drive Family	E-DC, ion, ViX	E-AC, OEMZL

Specialty Rotary Servo Motor Family Attributes

Series	K	EX	HW/HKW	TMW/TMA
Page	26	26	26	27
Application Advantages	Direct integration with a mechanical transmission; very high system stiffness	Rapid moves, high acceleration, explosive environments	Direct integration into machine, high speeds, constant power	Direct drive, low speed, high torque
Frame Sizes	10 sizes, 32 to 254 mm	4 sizes, 92 to 145 mm	6 sizes, 85 to 310 mm	3 sizes, 360 to 762 mm
Continuous Torque Range Nm (in-lb)	0.044 to 58.35 (0.39 to 516.4)	1.75 to 35 (15.5 to 311)	4.9 to 1080 (43.4 to 9558.8)	670 to 21,000 (5969 to 187,110)
Speed Range	0 to 50,000 rpm	0 to 4000 rpm	0 to 50,000 rpm	0 to 330 rpm
Feedback	Hall sensors, customer-supplied	Resolver/SinCos - Hyperface/Sincos - Endat	Customer-supplied	Resolver/SinCos - Hyperface/Sincos - Endat
Drive Family	Compax3, Aries	Compax3	Compax3	Compax3H

Linear Motors

Series	I-Force Ironless	RIPPED Ironcore
Page	27	27
Continuous force N (lbf)	24.5 to 878.6 (5.5 to 197.5)	154 to 2230 (35 to 501)
Peak force	108.5 to 3928 (24.4 to 883)	587 to 7433 (132 to 1671)
Cogging force	Zero	Low
Attractive force	Zero	High
Magnet tracks	Dual	Single
Heat dissipation	Good	Better
Applications	Rapid accelerations, extremely smooth motion	High force, lower cost for long travels

Modified and Custom Motor Resources

Call 800-358-9070 or [click here for more information...](#)

Parker's standard shaft, feedback, and connection motor options meet the needs of most customers. However, we also engineer custom designs for customers whose applications require unique connectors, mountings, or windings.

Purchasing a custom motor from Parker is cost-effective, in part because we don't require you to order minimum quantities of your design. Plus, we offer short lead times for custom design services. Whether you buy a standard or custom motor, you can count on Parker to provide the best servo motor solution.

Other Modification Services

- Private labeling
- Special paints/coatings
- Special windings
- Shorter lengths
- High-speed balancing

Connectors

- MS connectors
- Right-angle rotatable
- MS connectors on back cover
- Special cable lengths
- High-flex cables
- Custom cables and connectors
- Cable exiting through rear cover

Flanges

- Tapped mounting holes
- NEMA flanges
- Face mount
- Customer-specified flanges

Gearheads

- Custom ratios
- Customer-specified flanges
- Customer-specified output shaft

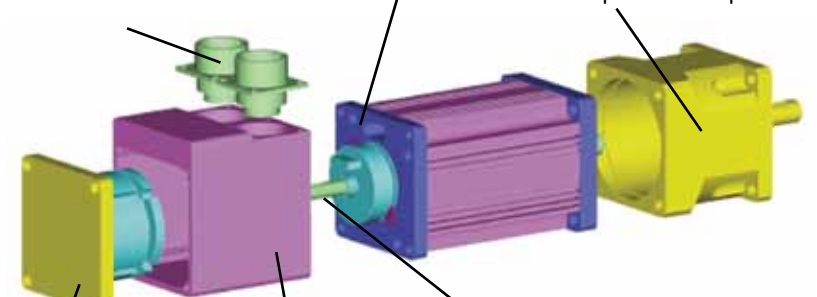

Brakes

- Spring released
- Permanent magnet
- 24 and 90 volt brakes

Feedback

- Incremental and smart encoders
- Absolute encoders — single- and multi-turn
- Resolver
- Custom feedback devices

Shafts

- Special lengths
- Special flats
- Special keyways
- Special shaft diameters
- Hollow shafts
- Rear shaft extension
- Double flats
- Shaft pinning
- Pressed-on gears
- Center tapped
- Special shaft materials

Rotary & Linear Motors

SM Series Servo Motors

Call 800-358-9070 or [click here for more information...](#)



The SM Series brushless servo motors feature a slotless stator design eliminating all detent torque in the motor to provide extremely smooth motion, especially at low speeds.

The slotless design also creates a higher rotor inertia, which is ideal for applications involving high inertial loads (such as lead screws and belt drives). This higher rotor inertia simplifies tuning and increases system stiffness.

The SM Series motors also feature a rugged anodized aluminum body and connector housing. An IP65 rating can be obtained on motors with PS connectors and an optional shaft seal. All SM motors are CE (LVD) compliant.

Parker's wide range of planetary gearheads are well-suited for the SM Series motor. Easy sizing and selection can be done using Parker's MotionSizer.

- NEMA size 16 and 23
- 0.19 to 1.2 Nm (1.7 to 10.6 in-lb) continuous stall torque
- 0.57 to 3.6 Nm (5.0 to 31.9 in-lb) peak torque
- Up to 7500 RPM rated speed
- Brushless construction
- Slotless design
 - Negligible detent torque
 - Reduced torque ripple
 - High inertia
- High-performance neodymium magnets
- Thermostat protected
- TENV housing
- IP65 option
- Feedback options
 - Encoder/Hall effect
 - Smart encoder
 - Resolver
- CE compliant

BE Series Servo Motors

Call 800-358-9070 or [click here for more information...](#)



BE Series brushless servo motors produce high continuous stall torque in a cost-reduced package.

The exceptional torque of the BE Series motors is the result of an increased number of magnetic poles on the rotor.

Traditional motors in these frame sizes have four magnetic poles, while the BE Series motors have eight poles.

The BE motors incorporate Parker's proven bridged stator design. This two-piece lamination design simplifies the winding process, creating cost savings. The bridged stator construction also results in less audible noise generated by the motor.

Parker's wide range of planetary gearheads are well-suited for the BE Series motor. Easy sizing and selection can be done using Parker's MotionSizer.

- NEMA 16, 23, and 34 sizes
- 0.15 to 4.9 Nm (1.3 to 43.4 in-lb) continuous stall torque
- 0.45 to 14.6 Nm (4.0 to 129.2 in-lb) peak torque
- Up to 5000 RPM rated speed
- Brushless construction
- Eight-pole open-lamination design provides increased torque and lower cost
- High torque density packaging
- Bridged stator design – quiet operation
- High-performance neodymium magnets
- Thermostat protection
- Feedback options
 - Encoder/Hall effect
 - Smart encoder
 - Resolver
- CE compliant

MPP/MPJ Series Rotary Servo Motors

Call 800-358-9070 or [click here for more information...](#)



The MaxPlusPlus (MPP) family of brushless servo motors is redefining performance, flexibility, and reliability. The industry's highest-performing servo motor uses eight-pole segmented lamination technology, which produces more torque in a shorter package. Use MaxPlusPlus motors for higher torque applications, customization options, or when high performance is required.

When higher inertia is desired to improve system performance, the MPJ is the perfect choice. It includes all the same features and benefits of the MPP, but increases the rotor inertia by 3 to 8 times over the standard MPP.

- **MPP – 92 to 270 mm frame sizes**
- **MPJ – 92 to 142 mm frame sizes**
- **1.5 to 158 Nm (13 to 1398 in-lb) continuous stall torque**
- **4.3 to 402 Nm (38.1 to 3558 in-lb) peak torque**
- **Very high torque-to-inertia ratio**
- **Right-angle rotatable connectors**
- **Seven different feedback devices including encoder, serial encoder, resolver, Heidenhain and Stegmann single and multi-turn absolute encoders**
- **IP64 standard, IP65 optional**
- **Special shaft, front flange, and feedback devices available**
- **CE and UL**

LV/HV Series Rotary Stepper Motors

Call 800-358-9070 or [click here for more information...](#)



The LV (Low Voltage) and HV (High Voltage) motor series provides outstanding performance at a competitive price. The LV motors are available in five frame sizes, and the HV are available in three frame sizes, so it is easy to choose the optimal speed and torque combination.

The LV motors are rated for use with drives running up to 80 VDC; the HV are rated for use with drives running off of 120 VAC power.

The LV/HV Series is optimized for use with the E-Series microstepping drives.

- **High performance**
- **Cost effective**
- **Optimized motors for both low-voltage and high-voltage applications**
- **Static torques from 6.5 to 1285 in-oz)**
- **LV – 11, 14, 17, 23, and 34 frame sizes**
- **HV – 17, 23, and 34 frame sizes**
- **Single, double, or triple stack lengths available**
- **LV – up to 80 VDC windings**
- **HV – up to 170 VDC windings**
- **Single or double shaft options**
- **Flying leads or 10-foot cable options**
- **Customization available**
- **Encoder options available**
- **CE (LVD)**

Rotary & Linear Motors

K Series Frameless Kit Motors

Call 800-358-9070 or [click here for more information...](#)



Frameless kit motors are the ideal solution for machine designs that require high performance in small spaces. Kit motors are directly integrated with the drive train, resulting in a smaller, more reliable motor package. Direct drive motion construction also gives equipment designers the advantages of lower costs, increased reliability and improved performance.

When to Use

- **A significant cost savings**
- **Reduced mechanical complexity**
- **Greater design flexibility**
- **High performance in a compact package**
- **Improved dynamic response and settling**
- **Minimum motor size per application space**
- **Low cogging for smooth operation**
- **Low inertia for high acceleration**

Features

- **High peak torque up to 93.37 Nm (826.4 in-lb)**
- **High speeds up to 50,000 RPM**
- **Superior performance – high stiffness and better response**
- **High reliability – no mechanical couplings**
- **Compact design – minimizes product size**
- **Low cogging - special orientation of the laminations and odd slot count**
- **Very low torque ripple at low speeds for smooth and precise rotary motion**

EX Series Explosion Proof Servo Motors

Call 800-358-9070 or [click here for more information...](#)



The EX Servo motors are designed to function in Category II, Group II explosive atmospheres in respect to the EN 50014 standard. These servo motors are certified according to directive ATEX 94/9/CE and are available in a Gas or Gas-Dust version. The motors differ in that the Gas-Dust version is equipped with a special lip seal on the customer end shaft.

- **Explosion-proof material “D” according to directive ATEX 94/9/CE**
- **Stall torque from 1.75 to 35 Nm (15.5 to 311 in-lb)**
- **Rated speeds up to 4000 RPM**
- **Extremely compact**
- **High dynamics**
- **Integrated resolver does not require an additional encoder**
- **Maintenance-free, lubricated for life bearings**

HW/HKW Series Synchronous Water Cooled Spindle Motors

Call 800-358-9070 or [click here for more information...](#)



The HW servomotors are water-cooled brushless synchronous motors delivered as individual components (rotor, stator and resolver) to make a complete spindle unit. These motors are driven by Compax3 Series servo drives.

- **Permanent magnet cold rotor**
- **Compact size with low rotor inertia**
- **Stable balancing**
- **Speed range to 50000 RPM**
- **Reduced maintenance**
- **High torque at zero speed**
- **Positioning capability**

TMW/TMA Series Torque Motors

Call 800-358-9070 or [click here for more information...](#)



The torque motor is a permanent magnet brushless motor, optimized to operate at low speeds. It is particularly suitable for direct drive applications requiring high torque capabilities at low speeds.

As a replacement for asynchronous or direct current motors coupled with a gearbox, torque motors are advantageous with their more compact, quieter, maintenance-free design.

- No more gearbox
- No maintenance
- Energy savings
- Silent operation (European directive 2003/20/Ce)
- Better speed regulation
- Compact design
- Stall torque from 391 to 21,000 Nm (289 to 15,540 ft-lb)
- Rated speeds up to 800 RPM
- TMA Series air cooled, without fan; TMW Series water cooled with anticorrosive
- IP55 rating
- Sincos Hiperface, Sincos Endat feedback

I-Force Ironless Linear Motors

Call 800-358-9070 or [click here for more information...](#)



Parker I-Force ironless motors offer high force and rapid accelerations in a compact package. Parker's patented I-beam shape, with its overlapping windings, allows for a higher power density in a smaller motor, improved heat removal, and added structural stiffness. A forgiving air gap and no attractive forces allow for easy installation and zero cogging during motion.

- 5 different cross sections (110, 210, 310, 410, and ML50) with up to 8 poles
- Compact size with high force density and superior heat removal
- Air and water cooling
- Vacuum rated to 10^{-6} torr
- Ultra high-flex cable standard

RIPPED Ironcore Linear Motors

Call 800-358-9070 or [click here for more information...](#)



Parker RIPPED ironcore linear motors, with their patented anti-cog technology, can produce the large forces needed for many industrial applications - without the roughness associated with traditional ironcore linear motors. The RIPPED family is well suited for a broad range of extremely demanding applications.

- Patented anti-cog technology for extremely smooth motion
- 3 different cross sections
- Single magnet row for high performance at an economical price
- Connector module allows for quick installation and easy cable management
- Ultra high-flex cable standard

Gearheads & Gearmotors

Planetary Gearheads

Call 800-358-9070 or [click here for more information...](#)



Our Generation II Stealth® Series provides higher radial load, increased service life and easier mounting than comparably sized planetary gearheads. The Stealth Generation II Helical Planetary Gearheads incorporate design enhancements to provide superior performance for the most demanding high-performance applications. Generation II models are available in 60 to 142 mm and NEMA 23 to 42 frame sizes.

For larger frame sizes, Parker offers Generation I Stealth® Series gearheads in 180 to 220 mm and NEMA 56 frame sizes.

For standard precision applications, the PV Series gearhead combines power and versatility in an economical package which is available in a wide range of options. PV Series gearheads are available in 40 to 115 mm and NEMA 17 to 42 frame sizes.

- **Nominal continuous torque from 3.5 to 1808 Nm (31 to 16,091 in-lb)**
- **In-line or right-angle configurations**
- **Higher radial and axial load capacity – widely spaced angular contact output bearings**
- **Increased service life – full complement planet needle bearings**
- **Universal mounting kits – quicker deliveries and easier mounting**
- **Helical planetary gearing: high torque and low backlash**
- **High stiffness – integral ring gear and rigid sun gear**
- **Plasma nitrited gear treating – higher gear wear resistance**
- **Some models optionally available with flange mounting for easy installation**

NEMA Gearheads

Call 800-358-9070 or [click here for more information...](#)



Parker's NEMA gearheads feature a high-efficiency spur gear in-line design in a light, compact package. Designed to mount directly to the face of NEMA face stepper and servo motors, NEMA gearheads are ideal for applications requiring low weight and low starting torque.

- **NEMA 23, 34 and 42 frame sizes**
- **Continuous torque from 6 to 40 Nm (50 to 350 in-lb)**
- **Ratios from 3:1 to 100:1 are available**
- **Lightweight, aluminum housing and spur gearing**
- **Compact, short overall length and direct mounting to NEMA motors**
- **Low friction, low running torque, ideal for stepper motors**

MultiDrive Gearheads

Call 800-358-9070 or [click here for more information...](#)



Stealth® MultiDrive offers three different output options for true flexibility:

RB Series low ratio
RD Series double shaft
RT Series hollow shaft

All models are configured in a compact, right-angle package. MultiDrive gearheads feature Stealth® helical gearing for high torque, high accuracy and quiet operation. With five frame sizes and multiple ratios to choose from, you are sure to find a Stealth® MultiDrive to fit your servo motor application.

- Frame sizes from 90 to 220 mm
- Continuous torque from 23 to 585 Nm (204 to 5178 in-lb)
- Space saving: compact, right-angle design saves space in many applications
- Low backlash: standard as low as 8 arc-minutes and 4 arc-minutes optional
- Smooth, quiet operation and long life: hardened, precision spiral bevel gears ensure quiet operation
- Quick, error-free mounting to any servo or stepper motor using Parker's ServoMount® design
- Sealed unit: seals and O-rings provide IP65 protection to prevent leaks and to protect against harsh environments

Integral Gearmotor Solutions

Call 800-358-9070 or [click here for more information on gearmotors...](#)

Call 800-358-9070 or [click here for more information on servo wheel drives...](#)



Stealth® Gearmotors represent the first time a brushless servo motor and a helical planetary gearhead have been integrated into a single product. Previously, engineers needing a gear drive with servo motor were forced to purchase the gearhead and motor separately. Parker manufactures servomotors, precision gearheads and gearmotors under one roof.

DX Series Wheel Drive

- Integral 6- and 8-inch wheel drive
- 12, 24, 36 and 48 volt operation
- 1.5 to 4.5 MPH max speed

GM Series Gearmotors

- Helical planetary in-line gearmotors in frame sizes from 60 to 142 mm and NEMA 23 to 56
- Continuous torque from 3 to 60 Nm (27 to 533 in-lb)
- Encoder/resolver feedback

Linear & Rotary Positioners

Screw-Driven Linear Positioners

Series	XR	HD	XE	MX	LCR	OSP-E
Page	32	32	33	33	34	34
Positional Repeatability – μm	± 1.3	± 8	± 5	± 1.5	± 100	± 50
Travel Range – mm	50 – 2000	50 – 2000	25 – 700	25 – 150	5 – 600	3200
Maximum Speed – m/s	1.3	2.2	1.4	0.2	0.2	1.25
Axial Thrust Capacity – N	4500	882	685	123	75	2500
Maximum Normal Load – N	14,400	14,400	1400	80	100	3,000
Profile Width – mm	41, 58, 95, 150, 285	85, 125, 185	50, 60, 95	45, 80	22, 30	41, 52, 87
Overall Height – mm	50, 57, 47, 70, 105	70, 85, 95	36, 45, 47	25, 35	30, 40	53, 67, 93
Seal Design	Stainless Steel Strip	Rigid Polymer Belt	N/A	N/A	Stainless Steel Strip	Stainless Steel Strip

Belt-Driven Linear Positioners

Series	LCR	OSP-E	HPLA/HLE	ERV	ODS-B	HLE-Z*	HZR
Page	34	34	35	35	36	36	37
Positional Repeatability – μm	± 200	± 100	± 200	± 100	± 50	± 50	± 200
Travel Range – mm	Up to 1000	Up to 5000	Up to 9470	Up to 6050	Up to 6000	Unlimited	Up to 2000
Maximum Speed – m/s	5	5	5	5	5	5	5
Axial Thrust Capacity – N	30	425	4170	808	3750	1000	1500
Maximum Normal Load – N	100	850	15,000	3,590	10,000	3,500	N/A
Profile Width – mm	22, 30	41, 52, 87	60, 80, 100, 120, 150, 180	100, 130	145, 175, 225	47, 58, 150, 180	260, 270, 300
Overall Height – mm	30, 40	53, 67, 93	75, 100, 120, 143, 175, 215	85, 110	88, 112, 125	123, 155, 295, 329	Stroke Dependent
Seal Design	Stainless Steel Strip	Stainless Steel Strip	Stainless Steel Strip	N/A	Stainless Steel Strip	HPLA180Z Version Only	Enclosed

* Includes OSP-BV Origa design profiles

Linear Motor-Driven Positioners

Series	LXR	MX	LX	T	TR
Page	37	38	38	39	39
Positional Repeatability – μm	± 1	± 0.4	± 1.5	± 1	± 1
Travel Range – mm	Up to 3000	Up to 200	Up to 750	Up to 2941*	Up to 2745*
Maximum Speed – m/s	3	2	3	7	7
Axial Thrust Capacity – N	355	8	10	879	2230
Maximum Normal Load – N	9500	80	60	1774	4410
Profile Width – mm	98, 150, 285	80	80	133, 170, 165, 190, 203, 234, 234, 272	203, 273, 349
Overall Height – mm	60, 70, 106	25	45	53, 50, 64, 66, 80	59, 80, 93
Seal Design	Stainless Steel Strip	N/A	N/A	Bellows Option	Bellows Option

*Longer travels available with custom splice kit

Modified & Customized Positioner Products & Services

Call 800-245-6903 or [click here for more information...](#)



Please review our Modified and Engineered Systems section on page 48 for more information on Parker capabilities for modified and customized positioner systems and engineered solutions.

Many of today's applications require unique features not offered in a standard positioning design. Parker has long been an industry leader for customizing solutions, and creating tailor-made designs based on customer requests. This ability to provide perfect fit solutions in customer demanded time frames allows Parker to differentiate themselves from the non-user friendly design restrictions of other manufacturers.

Some of the desired custom examples have included environmental conditions, optical needs, aesthetic needs, loading orientation, accuracy demands, space constraints, and more. A partial list of some of the standard modifications we have designed includes:

- **Conformal coating for circuit board protection**
- **Custom color anodize/ paint for optical or aesthetic purposes**
- **Private labelling for OEM brand management**
- **IP65 electric cylinders for washdown environments**
- **Epoxy coating for harsh chemicals**
- **Low ESD coatings for electrically sensitive environments**
- **Cleanroom designs down to Class 1 with test report capabilities**
- **Custom space constraint designs maximizing travel per overall length**
- **High force designs for maximizing thrust force capabilities**
- **Miniaturized motion for lab instruments**

Linear & Rotary Positioners

XR Series Precision Screw-Driven Positioners

Call 800-245-6903 or [click here for more information...](#)



The award-winning XR Series of linear positioners has achieved global recognition for consistent accuracy, reliable performance, high strength, and unmatched versatility. The XRs have excelled in industries such as life sciences, fiber optics and instrumentation, where the highest degree of precision is required. And yet, because of the rugged construction, strength, and sealed

design, these units have been used extensively for industrial automation applications such as packaging and automotive.

The XR family offers an unrivaled array of features and modular options that are easily matched to fit any application, from the very basic to the highly complex. Superior performance, modularity, and quick delivery make these tables the perfect building blocks for multi-axis positioning systems. Options like class 10 cleanroom prep, field installed assemblies (brakes or parallel motor mounts), easy lube options, and much more distinguish the XR family from all others.

- Precision ground ballscrew drive
- High-strength aluminum body
- 100% duty cycle
- Profiles from 41 x 50 mm to 285 x 105 (w x h – mm)
- Travel lengths to 2 m
- Load capacities to 14,400 N
- 2g acceleration
- 1.3 μm repeatability (bidirectional) on most models
- Stiff square rail bearings
- Flexible motor mount
- Laser certified precision
- Proven IP30-rated strip seal
- Dowel holes for precise mounting
- Optional linear feedback, brake, sensor pack, cleanroom prep

HD Series Industrial Screw-Driven Positioners

Call 800-245-6903 or [click here for more information...](#)



The HD Series linear table line is a robust, industrial positioner that is easy to apply, easy to install, and — with the “lubed for life” bearings — easy to maintain.

The robust design begins with a deep-channel extruded body and carriage that provides exceptional beam strength and carriage rigidity. The linear bearings and ballscrew are designed to be maintenance-free and selected for their long life at 100% duty operation. The HD Series also includes IP30-rated belt seals that protect the interior components from debris.

- High-efficiency ballscrew
- Ultra-high-rigidity extrusion design
- Profiles from 85 x 70 mm to 185 x 95 (w x h – mm)
- Travel lengths to 2 m
- Load capacities to 14,400 N
- 2g acceleration
- $\pm 8 \mu\text{m}$ repeatability
- Maintenance-free square rail bearings
- Proven IP30-rated belt seal
- Dowel holes for repeatable mounting
- Flush mount sensors for tight spaces
- Brake option for fail-safe operation
- Parallel and easy-to-use custom motor mount designs

XE Series Economy Screw-Driven Positioners

[Call 800-245-6903 or click here for more information on 402/403XE...](#)
[Call 800-245-6903 or click here for more information on 404XE...](#)



The 402/403XE Series of positioners combines a rugged steel body construction with an integrated precision ballscrew and bearing guide. The result is a highly accurate, cost-effective line of positioners ideal for applications in the hard disk, semiconductor, medical, machine building and many other industries.

- **Significant force-per-dollar value**
- **Easily integrated into multi-axis designs**
- **Small package size**
- **Profiles from 57 x 36 mm or 80 x 45 mm (w x h)**
- **Travel lengths to 655 mm**
- **Load capacities to 160 kg**
- **2g acceleration**
- **±5 µm repeatability**

The 404XE positioner combines versatility and rugged construction into a compact platform ideal for 100% duty cycle automation applications. Like its cousin the 404XR, the 404XE offers a myriad of options and accessories. The XE is also mount compatible with the XR and LXR positioners, allowing a mix and match of technologies to balance system cost and performance.

- **Reliable, cost-effective positioner**
- **Short carriage and parallel motor mounts to minimize length**
- **High-strength design**
- **Multi-axis configurations**
- **Profile of 95 x 48 mm (w x h)**
- **Travel lengths to 700 mm**
- **Load capacities to 1400 N**
- **2g acceleration**
- **±20 µm repeatability**

MX Series Miniature Screw-Driven Positioners

[Call 800-245-6903 or click here for more information...](#)



The MXS miniature positioner is the screw-driven member of Parker's MX family. Like its linear motor-driven counterpart, the MX is designed for applications requiring reliable linear positioning in space-restricted applications.

The MX is equipped with a high-efficiency leadscrew drive capable of reaching 200 mm per second velocity. The leadscrew drive employs a PTFE-coated leadscrew with a preloaded nut to produce extremely smooth and quiet linear translation. A choice of three leads provides improved opportunity for matching desired velocity/resolution requirements.

The MX can also be supplied with a precision ground ballscrew drive. The 2.0 mm lead ballscrew provides high performance 24/7 operation with a thrust load capacity of 123 N (28 lb) and velocity to 100 mm/second at 100% duty cycle.

- **Low-profile miniature size**
- **Cleanroom environment option**
- **Up to 150 mm travels**
- **Multi-axis platform**
- **Ballscrew or leadscrew drive options**
- **Up to 123 N axial thrust**
- **2g acceleration**
- **Cross roller bearing (zero cage creep option)**
- **Stepper or servo motor drive options**
- **Digital limit/home system**
- **Optional linear encoder**
- **Low ESD option for electrically sensitive applications**

Linear & Rotary Positioners

LCR Series Light-Capacity Screw- or Belt-Driven Positioners

Call 800-245-6903 or [click here for more information...](#)



Light Capacity Rodless (LCR) Series positioners are ideal for OEM lab instrument and machine builders looking for significant ROI for an off-the-shelf yet tailor-made solution. The LCR provides unmatched flexibility with a choice of two profile sizes, two bearing options, three drive train options, many motor options, and the option to include the modular ion stepper drive.

The LCR Series will reduce the total design time, the overall cost of development and increase your return on investment.

LCR Series	Screw-Driven	Belt-Driven
Positional Repeatability – μm	± 100	± 200
Travel Range – mm	5 – 600	Up to 1000
Maximum Speed – m/s	0.2	5
Axial Thrust Capacity – N	75	30
Maximum Normal Load – N	100	100

LCR Applications

- Liquid handling – pipetting, aspirating, dispensing
- Laboratory automation – microtiter tray, well plates, slide automation
- Electric gripping
- Laners and diverters for light packaging conveyors
- Point of purchase / kiosk automation

Advantages

- Lower design costs
- Reduced component complexity
- Reduced inventory costs
- Reduced time to market
- Higher ROI
- ISO qualified supplier
- Simplified procurement process with one point of contact for the complete motion system

OSP-E Series Medium-Capacity Screw- or Belt-Driven Positioners

Call 800-245-6903 or [click here for more information...](#)



The OSP-E Series offers a medium-capacity, flexible, value-priced screw-driven or belt-driven actuator. The OSP-E simplifies the crossover to electric actuation from pneumatics, with dimensional similarities to the Parker Origa OSP-P pneumatic line of products.

With options for bushing bearings, square-rail bearings, or the robust roller-wheel design, the OSP-E offers users the ability to balance cost and performance.

OSP-E Series	Screw-Driven	Belt-Driven
Positional Repeatability – μm	± 50	± 200
Travel Range – mm	3200	Up to 5000
Maximum Speed – m/s	1.25	5
Axial Thrust Capacity – N	2500	425
Maximum Normal Load – N	3,000	850

- Simple pneumatic to electromechanical conversion
- Stepper or servo motor compatibility
- Ball or trapezoidal lead screw-drive options
- High-thrust-force designs
- Cleanroom options
- IP54 sealing design
- Bushing, roller-wheel, or square-rail bearing designs

HPLA/HLE Series Industrial Belt-Driven Positioners

Call 800-245-6903 or [click here for more information...](#)



The HLE/HPLA linear modules are ideal as single-axis products or as components for high-speed multi-axis gantries. With thousands of units in operation worldwide, the HPLA/HLE Series are proven performers offering long life and with trouble-free operation.

With flexible design options for bearing selection, profile size, stroke length, and motor/gearbox combination, the HPLA/HLE design has your application covered.

- **Rugged construction for heavy duty applications**
- **Thrust force capacity to 5455 N**
- **Standard travel up to 9 meters**
- **Velocity up to 5 meters/sec.**

- **Positional repeatability of ± 0.2 mm**
- **Timing belt and pulley drive mechanism for fast, accurate positioning**
- **Increased system stiffness due to larger belt width**
- **Low-maintenance sealed bearings**
- **Hollow-shaft input option for higher axial forces**
- **Steel-wheel or square-rail designs for normal load capacities up to 15 kN**
- **Quiet operation**
- **Corrosion-resistant option for harsh environments**
- **IP30 seal design**

ERV Series Value Line Belt-Driven Positioners

Call 800-245-6903 or [click here for more information...](#)



Parker's ERV Series rodless actuator is an affordable package that includes an extruded base and an external carriage containing outboard roller bearings for high load capacity.

Utilizing the HPLA/HLE composite wheels with a wider wheel base, the ERV offers extremely high roll-moment capacity due to a superior bearing separation distance. The result of this separation is a high moment load per package size. All of the added force density is delivered in a value-priced belt-drive package.

- **High-strength extruded body**
- **External bearing carriage for high loads up to 3590 N**
- **Economical design for high-load and high-speed applications**
- **Easy-to-use belt-tension access hole**
- **Parker IPS-compatible T-slots and mounting options (IPS 56 & 80 mm profiles)**

Linear & Rotary Positioners

ODS-B Series High-Rigidity Belt-Driven Positioners

Call 800-245-6903 or [click here for more information...](#)



The ODS-B is a new generation of powerful belt-driven linear drives that are the ideal solution for accurate positioning of medium loads. The ODS-B offers particularly user-friendly flexibility in terms of assembly and disassembly. Optional add-ons such as limit switches, encoder feedback, braking systems and even centralized lubrication and optimized energy chain entrainment offer complete versatility.

Profile Designs

- 145, 175, 225 mm wide profiles
- Basic profile for mounting directly to the machine base
- Reinforced profile for self-supporting assembly

Mounting Systems

- Integrated T-slots for attaching from below
- Standard or customized hole pattern for attaching from above

Bearing System

- Dual square-rail bearing blocks on 2 rails

- IP20 or IP54 protection
- Integrated, adjustable position switch for end of travel and homing
- Integrated shock absorbers for impact protection at both end positions
- Holding brake can be implemented for horizontal and vertical movements
- Directly attachable drag chains for various cabling
- Motor flexibility allowing motor mounting at the 0, 90, 180, 270 degree mounting positions relative to the carriage

HLE-Z Long-Travel Belt-Driven Positioners

Call 800-245-6903 or [click here for more information...](#)



The HLE-Z (and OSP-BV) “endless” linear units are designed for guiding, transporting or positioning payloads over long travel distances with high rigidity and accuracy. This is accomplished by incorporating Parker’s uniquely designed rack-and-pinion-based drive system with an HLE150 or HPLA180 linear module housing. The exceptional dynamic characteristics inherent to these units make them well suited for applications requiring high-speed linear translation and positioning over long travel distances.

- Long travels – selectable up to 50 meters
- Load capacities up to 15,000 N
- Up to 5 meters/sec. velocity
- ± 0.05 mm positional repeatability
- Rack-and-pinion drive mechanism
- Independent multiple carriages on single rail
- Roller wheel bearings for smooth, high-speed linear motion

HZR Vertical-Axis Belt-Driven Positioners

Call 800-245-6903 or [click here for more information...](#)



The HZR is a rugged vertical-axis unit unique to the high-speed automation industry. It is specifically designed to satisfy the mechanical demands placed on the vertical axis of a multi-axis gantry robot - utilized for high throughput lifting and transporting of heavy or bulky loads.

- **Designed as a vertical-axis unit**
- **Load lifting capacities up to 1500 N**
- **Velocity up to 5 meters/sec.**
- **Positional repeatability of ± 0.2 mm**
- **Torsion-resistant housing**
- **Roller wheel bearings for smooth vertical motion**
- **High vertical acceleration**



LXR Series Precision Linear Motor-Driven Positioners

Call 800-245-6903 or [click here for more information...](#)



The 400LXR Series linear servo motor tables offer high acceleration, velocity, and precision with quick settling for superior throughput. Optimum performance is achieved by combining slotless linear motor technology with performance-matched feedback and mechanical elements. Offered in three widths with a myriad of options, the 400LXR Series can solve most high-performance applications.

- **Incremental standard lengths from 50 mm to 3 m**
- **Load capacity to 9310 N**
- **5g acceleration**
- **Velocity up to 3 m/s**
- **Continuous force to 355 N, peak force to 1000 N**
- **± 1 μ m repeatability**
- **100% certification of precision with test reports in every shipment**
- **Cleanroom preparation**
- **Easy multi-axis configuration**
- **Pre-engineered, low-profile, modular cable management**
- **Proven IP30 strip-seal protection**
- **Encoder resolutions to 0.1 μ m**
- **Fast settling**
- **Dowel holes provided for precise payload and multi-axis mounting**



Linear & Rotary Positioners

MX Miniature Linear Motor-Driven Positioners

Call 800-245-6903 or [click here for more information...](#)

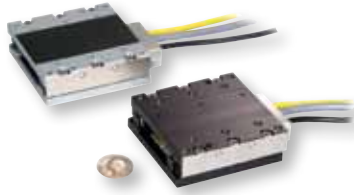

Miniaturization of fiber optics, photonics, electronics and biomedical processes has driven the need for smaller and more efficient positioners.

Parker's MX miniature stage, the smallest linear servo motor-driven positioner in the industry, is loaded with high-performance features for both rapid linear

translation and precise positioning of lighter loads in small work envelopes. Designed for today's 24/7 production demands, the MX has redefined "high-throughput automation" in the world of miniature positioners.

- **5 g acceleration**
- **Fast settling**
- **Submicron precision**
- **High velocity (2 m/sec.)**
- **Multi-axis platform**
- **Low-profile miniature size - (25 mm high X 80 mm wide)**
- **Linear servo motor drive**
- **Linear encoder resolutions (0.01 μm to 5.0 μm)**

- **25 to 200 mm travels**
- **Cross roller bearing (zero cage creep design)**
- **Precision or standard grade**
- **Cleanroom and low-ESD options**
- **Fully adjustable home and limit sensors**
- **Dowel holes for repeatable mounting of payload**
- **Master reference surface to travel path**
- **"Plug-in" factory configured drive/controller**
- **Pneumatic z-axis counterbalance**
- **No moving cables**

LX Compact Width Linear Motor-Driven Positioners

Call 800-245-6903 or [click here for more information...](#)



The LX picks up where the MX Series leaves off, offering longer travels while maintaining a very small profile. Like the MX, the LX is designed to meet the rigors of today's 24/7 production demands.

Although it has a small profile, the LX is large on performance and reliability. All key components are "built-in," residing within the body of the table to provide a clean-looking, reliable, unobstructed package.

At the heart of the LX is an innovative non-contact linear servo motor. This direct drive motor has been optimized for force, speed, and acceleration to deliver outstanding performance and response. A high-precision non-contact linear encoder provides submicron resolution, repeatability and accuracy with selectable resolutions ranging from 0.1 microns to 5 microns. Hall effect limit and home sensors are conveniently designed into the unit for easy adjustment over the positioner's entire length of travel.

Precision square rail bearings provide load support and precise linear translation, while effectively countering the problematic effects of heat, high speeds, and high acceleration.

Cable management is neatly packaged inside the unit so no moving cables are visible. From the end of the unit, "high-flex" cabling is connected directly to the servo drive, alleviating cable flexing concerns associated with second or third axis in a multi-axis system.

- **Velocity to 3 m/sec**
- **Acceleration to 5 g's**
- **Encoder resolution to 0.1 micron**
- **Cleanroom compatible**
- **Easy multi-axis mounting**
- **Internal cable management**
- **Dowel holes for repeatable mounting**

T Series Smooth Motion Ironless Positioners

Call 800-245-6903 or [click here for more information...](#)



The Parker T Series linear positioners utilize our high-performance ironless linear motors in a pre-engineered, easily integrated, ready-to-run package.

The T Series advantages include economical cost and design flexibility to accommodate customization.

- **Incremental standard lengths from 100 mm to 2.9 m, extended lengths optional**
 - **Load capacity to 1774 N**
 - **5g acceleration**
 - **Velocity up to 7 m/s**
 - **Continuous force to 878 N, peak force to 3928 N**
 - **$\pm 1 \mu\text{m}$ repeatability**
- **Ground steel or aluminum bases to meet high-accuracy requirements for straightness and flatness**
 - **Single- or dual-bearing rail positioners match performance and cost requirements**
 - **Includes a magnetic encoder for industrial environments or an optical encoder with resolutions down to $0.1 \mu\text{m}$**
 - **Multiple carriage and cable track configurations available**
 - **Options include a variety of bellows, hard covers and brackets for X-Y and X-Y-Z multi-axis configurations**

TR Series High Force Ironcore Positioners

Call 800-245-6903 or [click here for more information...](#)

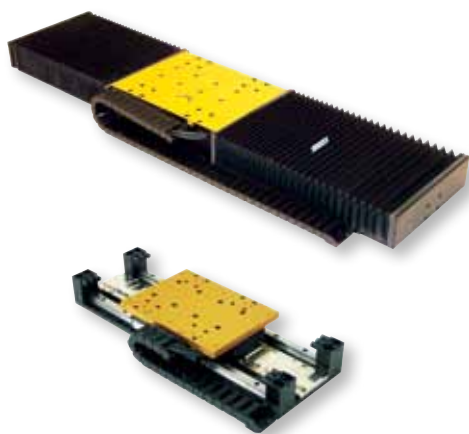

The Parker TR Series linear positioners utilize our high-performance RIPPED ironcore linear motors to produce extremely smooth motion for use in many applications where ironless motors were traditionally needed. TR positioners utilize a dual-rail-bearing design for high normal and moment loads.

- **Incremental standard travel lengths from 100 mm to 2.9 m, extended lengths optional**
 - **Load capacity to 4410 N**
 - **5g acceleration**
 - **Velocity up to 7 m/s**
 - **Continuous force to 2230 N, peak force to 7433 N**
 - **$\pm 1 \mu\text{m}$ repeatability**
- **Ground steel or aluminum bases to meet high-accuracy requirements for straightness and flatness**
 - **Includes a magnetic encoder for industrial environments or an optical encoder with resolutions down to $0.1 \mu\text{m}$ (0.000 04")**
 - **Magnetic home and end-of-travel limits**
 - **Options include a variety of cable management systems, bellows, hard covers and brackets for X-Y and X-Y-Z multi-axis configurations**

Linear & Rotary Positioners

Motorized Rotary Positioners

Series	RD	RM	RT
Positional Repeatability – arc-sec	1.4	12	12
Travel Range – mm	Unlimited	Unlimited	Unlimited
Maximum Table Speed – rpm	700	30	20
Maximum Normal Load – N	250	10,000	900
Drive Type	Servo motor	Worm gear	Worm gear
Duty Cycle – %	100	50	50
Table Diameter – mm (in)	100, 150, 200	100, 150, 200, 300	(5, 6, 8, 10, 12)
Overall Height – mm (in)		55, 75, 90, 108	(1.8, 2, 2.5, 3)

RD Series Direct Drive Servo Rotary Positioners

Call 800-245-6903 or [click here for more information...](#)



Parker direct drive rotary stages feature a robust construction and high performance in a compact package, providing smooth, near frictionless motion with zero backlash.

Featuring an integral brushless DC servo motor, these rotary stages offer several distinct advantages over traditional worm gear-driven stages. The elimination of the worm gearing offers the ability to reduce wear with zero backlash while exhibiting near frictionless motion.

The RD's high positioning accuracy, solely based on the stage's encoder, provides repeatability within 2 encoder counts, with resolutions down to 1.4 arc-seconds. The RD Direct Drive features speeds up to 700 RPM with significant torque capability.

- **Robust bearing design for high load capacity**
- **Integrated brushless motor features high copper slot fill and rare earth magnets for maximum torque efficiency**
- **In-line rotary encoder for direct position feedback. Also includes once per rev index mark**
- **Aluminum or stainless steel precision ground top plate for accurate mounting**
- **Motor rotor and top plate shaft as one-piece construction for high stiffness**
- **Sub “D” connectors for “plug & play” operation and simple connectivity**

RM Series High-Capacity Worm-Drive Rotary Positioners

Call 800-245-6903 or [click here for more information...](#)



The RM Series offers high load capacity in a compact package. These rotary stages utilize a precision worm gear with the worm “flexed” against the gear to ensure a proper mesh. This feature provides an auto anti-backlash calibration with smooth motion. Additionally, the rotary stages incorporate an oversized preloaded cross roller bearing, offering exceptional stiffness and high normal and moment load capacity.

- **Unique self-compensating preload to limit backlash**
- **Solid table tops or through holes for access**
- **Robust bearing design for high-load capacity**
- **Built-in limit switches**
- **Aluminum construction with stainless steel top plate**

RT Series High-Precision Worm-Drive Rotary Positioners

Call 800-245-6903 or [click here for more information...](#)



RT Series rotary tables are designed for precise motor-driven rotary positioning and indexing. These tables are designed to function independently or in conjunction with linear tables used in high-precision automation applications. Their low-profile design minimizes stack height in multi-axis configurations and enables them to fit in many places where other motorized rotary devices cannot.

Models are available in 5-, 6-, 8-, 10-, or 12-inch diameters and are offered with four gear ratios making it convenient to match size, speed, and load requirements to application needs. They can be selected in either imperial or metric mounting. They are found in virtually all industries where intermittent part indexing, part scanning, skew adjustment, or precise angular alignment is required.

At the heart of these tables is a rugged main support bearing, which is comprised of two preloaded angular contact bearing races. It is designed for smooth, flat rotary motion. The drive is a precision worm gear assembly, which is preloaded to remove backlash.

The top and base are constructed of high-quality aluminum with an attractive black anodized finish. The top and bottom mounting surfaces are precision ground to assure flatness.

- **Highly repeatable indexing (12 arc-sec)**
- **Load capacities to 200 lbs**
- **360 degrees continuous travel**
- **Performance-tested worm gear drive**
- **Selectable table sizes and drive ratio**
- **Dual race angular contact support bearing**

Linear & Rotary Positioners

Free-Travel Slides and Bearings

Call 800-245-6903 or [click here for more information...](#)



Parker offers a complete line of ball slide and crossed roller slides that is among the most extensive in the industry.

Ball slides are mechanically simple linear bearings, which are designed and assembled to provide exceptional smoothness and linear straight line accuracy. This is achieved by the ball and rod linear bearing design.

Crossed roller slides are very similar to ball slides, except the ball and rod linear bearing is replaced with a crossed roller slide bearing system. Crossed roller slides have higher load-carrying capability and significantly increased stiffness.

- Imperial and metric mounting available on most models
- Precision machined mounting surfaces ensure flatness
- Widths from 31.8 to 152 mm (1.25 to 6.0")
- Travels to 762 mm (30")
- Loads to 2000 N (448 lb) for ball slides: 12000 N (2738 lb) for crossed roller slides

Micrometer-Driven Slides and Stages

Call 800-245-6903 or [click here for more information...](#)



Parker manual positioners combine a ball slide or a crossed roller slide with a drive mechanism. The slide is spring loaded against the drive mechanism to provide a constant preload between the drive and the carriage.

Ball bearing positioners provide ultra-smooth, extremely low-friction motion by minimizing bearing contact area. Additionally, this design provides extremely good straight-line and flatness accuracy.

Crossed roller positioners have higher load-carrying capability than comparably-sized ball bearing positioners due to the larger (line) contact surface. The crossed roller design also significantly increases stiffness.

Both designs are preloaded to eliminate any side play and to provide a uniform coefficient of friction.

- Imperial and metric mounting available on most models
- Precision machined mounting surfaces ensure flatness
- Widths from 31.8 to 152 mm (1.25 to 6.0") for ball bearing versions; 44.5 to 152 mm (1.75 to 6.0") for cross roller versions
- Travels to 300 mm (12")
- Loads to 133 kg (294 lb) for ball bearing versions: 786 kg (1735 lb) for cross roller versions
- Center or side drive configurations
- Available with a choice of drive mechanisms including:
 - fine adjustment screw
 - differential screw
 - imperial and metric micrometer heads
 - digital micrometer heads

Non-Motorized Rotary Positioners

Call 800-245-6903 or [click here for more information...](#)



Parker rotary stages are designed to produce precision rotary motion. The basic components in these stages are a base, main bearing, drive mechanism and top (load platform). The base of all the units house the main bearing and drive mechanism and is designed to be mounted to a stationary surface. The main bearings provide low-friction contact between the base and top. The drive mechanisms used are either tangent arms or worm gears. The table top provides a mounting surface for mounting payloads.

Tangent Arm Drive

Tangent arm drives produce very fine resolution over a limited rotary travel range. Angular rotation is controlled by three control knobs. The release knob disengages the shaft from the drive, freeing the table to be rotated by hand to a desired location. The release knob is then tightened to re-engage the drive mechanism and transfer control to the adjustment knob, which, when rotated, produces precise angular positioning of the shaft and table top. The locking knob can then be used to positively lock the table at the desired setting.

- **Imperial and metric models**
- **Rotary platform diameters from 47.7 to 66.5 mm (1.88 to 2.62")**
- **Load capacity to 4.5 kg (10 lb)**

Worm Gear Drive

A precision worm gear drive mechanism consists of a worm wheel (gear) and worm drive. Controlled rotation of the worm drive shaft creates precise angular rotation of the worm wheel and table top. The worm gear and shaft are matched sets and are preloaded to remove backlash. This type of drive provides high resolution (180:1) and continuous angular positioning over a full 360° range.

- **Imperial and metric models**
- **Rotary platform diameters from 69.8 to 305.0 mm (2.75 to 12.00")**
- **Load capacity to 90 kg (200 lb)**



Electric Cylinders

Electric Cylinder Product Families

Series	ETH	ETL	XFC
Max Thrust – kN	44.5	1.3	178
Max Speed – mm/s	1500	1000	1000
Max Travel – mm	2000	2000	2000
Drive Type	Metric Ball Screw	Metric Ball Screw	Planetary Roller Screw
Profile Size – mm	47, 67, 95, 115*, 140*	47, 67	75, 90, 115, 140, 165, 190
ISO Size	32, 50, 80, 100*, 125*	32, 50	N/A
Repeatability – mm	0.03	0.05	0.03

*Sizes still offered in ET product only, not ETH Series.

ETH Series High-Force Electric Cylinders

[Call 800-245-6903](tel:800-245-6903) or [click here for more information...](#)



The Parker ETH Series is a next-generation version of the well-known, widely used ET Series. The ETH design offers unrivaled power density based on larger screw and bearing designs in smaller packages. The result is a comparable force output from a smaller size or a longer product life using the same size. The ETH also offers a user-friendly design in a diversified range of configurations to meet specific application requirements.

- **Flush mount sensors and cables (which can be hidden with slot cover)**
- **Easy lubrication port reducing maintenance costs**
- **Reduced noise emission**
- **ISO flange norm (DIN ISO 15552:2005-12) conformity**
- **Greatly increased product lifetime (5 times longer life)**
- **Strokes up to 2000 mm**
- **Speeds up to 1.7 m/s**
- **Increased parallel motor mount torque capacity**
- **Predefined standard motor and gearbox flanges for quick selection available directly from Parker (one-stop shopping)**
- **3 different protection classes available:**
 - IP54 with galvanized fasteners and hardware
 - IP54 with stainless steel fasteners and hardware
 - IP65 (on request)

ETL Series Medium-Capacity Electric Cylinders

Call 800-245-6903 or [click here for more information...](#)



For medium-capacity industrial electric cylinder needs, the ETL is the best-fit solution. With a reduced feature set, the ETL offers an economic alternative to the higher-force, higher-value ETH Series. The ETL is available in ISO32 & ISO50 sizes. The ETL also offers the flexibility customers have come to expect from a high-quality Parker product. All this in a design that provides an economic alternative to pneumatic actuation.

- ISO rod ends typical of pneumatic designs
- Motor mounting flexibility with in-line or parallel mounts
- Custom motor mount designs available
- Value-driven electric cylinder positioning
- Optional brushed DC motor/drive package for simple two-position control
- Complete family of products with mounts similar to ETH design

XFC Series Extreme-Force Electric Cylinders

Call 800-245-6903 or [click here for more information...](#)



For applications requiring extreme force, the XFC offers the highest force capacity of the Parker electric cylinder offering. The steel tie-rod design is ideal for customers converting light-to medium-capacity hydraulic motion to electric actuation. Applications ranging from presses, tube benders, turbine pitch control, lumber handling, and more benefit from the XFC. The XFC's rugged design also incorporates an oil- or grease-filled lubrication system for better heat dissipation and a longer life.

- In-line or parallel gear drive configuration
- Multiple screw leads per frame size
- Replaceable rod seal
- Elastomeric seals throughout
- High-strength tie rods
- Steel heads and caps
- Heavy wall steel tubing cylinder body
- Direct input from Parker gearheads
- Parker MPP Motors as standard selections
- High-speed capabilities of up to 1 m/sec
- Optional electric fail safe holding brake
- Position and force holding capabilities
- High efficiency

Modular Structural Solutions

High-Strength Aluminum Framing and Components

Call 800-333-4932 or [click here for more information...](#)



Parker Industrial Profile Systems (IPS) is a leading value-added manufacturer of high-strength aluminum framing, systems and components. Our focus is on our customer. By offering local inventory, application engineering, fabrication and assembly, and integration of industry leading Parker motion control products, we strive to exceed our customer's expectations in service, quality, delivery, and value.

Typical Applications

- Motion system integration
- Enclosures and guarding
- Machine bases and frames
- Work stations and tables
- Material handling systems
- Lean manufacturing tools
- Cleanroom designs

Benefits

- Extremely short turnaround time from design to completion
- No welding, grinding, cleaning, painting, or distortions
- Eliminates costly traditional manufacturing processes
- Flexibility to re-configure as requirements change

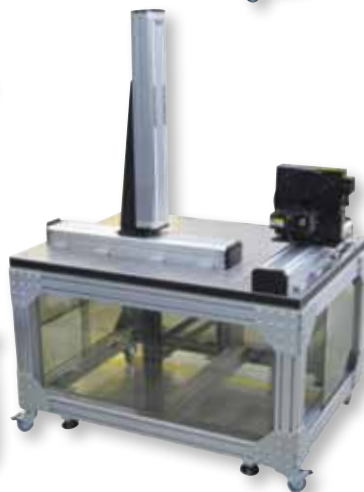

Your Choice to Suit Your Needs

Choose a level of service to suit your needs from a completely assembled structure to a bundle of uncut profiles.



Turnkey Assemblies - Parker IPS offers complete assembled solutions that are designed, custom fabricated, and shipped in as little as seven business days.



Kits - Profiles are cut and machined to order, fasteners and accessories are included based on a parts list, and the entire order is packaged and shipped for final assembly at your location.



Bundles - Our entire product line can be ordered as bundles of uncut or cut-to-length profiles, with packages of fasteners and accessories.

Profiles

Parker Industrial Profile Systems has one of the most comprehensive product offerings in the industry.

- **More than 100+ individual high-strength aluminum profiles**
- **All structural profiles are aircraft grade, high strength, mill-certified with metallurgical properties of 6105-T5**
- **Aesthetically appealing extrusions offer best-in-class rigidity, durability, and hardness**
- **Unique T-slot design for reliable connection and easy modification**
- **Metric sizes range from 20 mm to 160 mm; inch sizes range from 1" to 6"**
- **Extensive range of smooth, grooveless profiles**

Linear Motion Components

- **Roller bearing components**
- **Delrin and UHMW slide bearings**
- **Easy-to-design, do-it-yourself, belt-driven solutions**

Tools and Support

Parker IPS offers the tools needed to design and develop your assembly solution. Download the tools you need at:

www.parkermotion.com/ips

- **Complete selection and specification information on all IPS products available on-line in pdf format**
- **3D CAD files for all available IPS products**

Avoid paying too much for an over-engineered solution, contact our applications team today at 800-333-4932 for quick response and help with designing the best solution.

Fasteners and Accessories

The design of our structural framing fasteners and accessories takes a number of criteria into consideration, including functionality, aesthetics, strength, ease of assembly, and modular, flexible adaptation.



Parker offers a complete line of accessories to provide the right part for your application including:

- **T-slots, end caps, fasteners, and covers**
- **Gussets, plates and brackets**
- **Handles and hinges**
- **Panels, sliding doors and gate hardware**
- **Feet and casters**
- **Work station accessories**
- **Slide blocks and bushings**



Panels & Wire Mesh

Panels and wire mesh are available in full sheets or to specified cut-to-size dimensions. Standard panel choices include:

- **Lexan®**
- **Trespa®**
- **Expanded PVC**
- **PVC coated wire mesh**
- **Aluminum composite**

Specialty panels of any material can be ordered for any project.

Machining Services

Standard machining options include cutting, tapping, drilling, and counter boring. Additional custom machining by our expert machinists ensure that your design is complete and to your exact requirements.

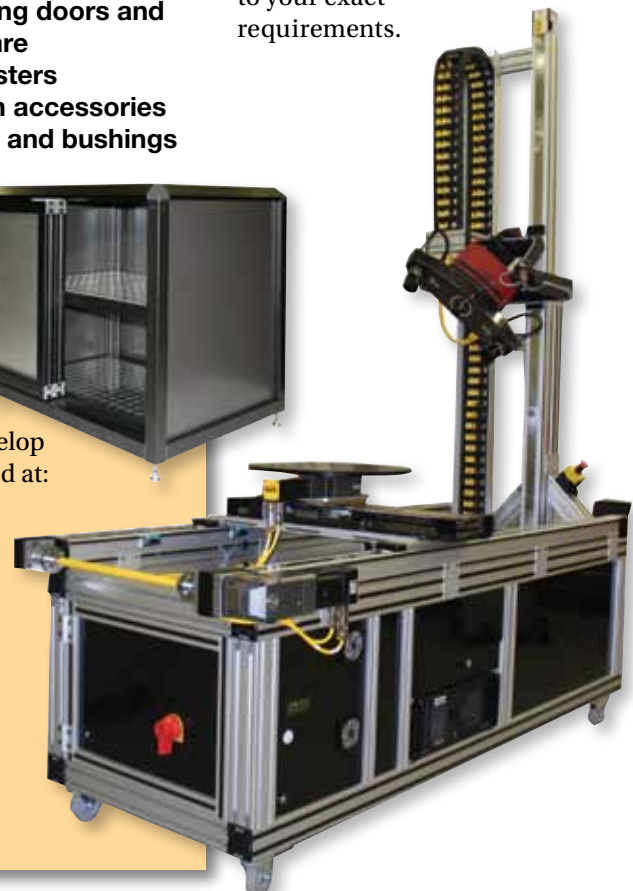

Automation Systems



Parker's extensive portfolio of automation products enables machine builders and OEMs to configure cost-effective, easy-to-integrate system solutions. From standard Cartesian or gantry systems to custom engineered solutions, Parker has the breadth of product and expertise to solve even the most challenging automation applications.

Partnering with Parker gives machine builders and OEMs the benefit of a vast array of motion and control knowledge, experience, and support without added in-house resources. The power of Parker also provides multi-technology component compatibility and minimized design time resulting in faster time to market and reduced total cost of ownership.

Standard System Solutions

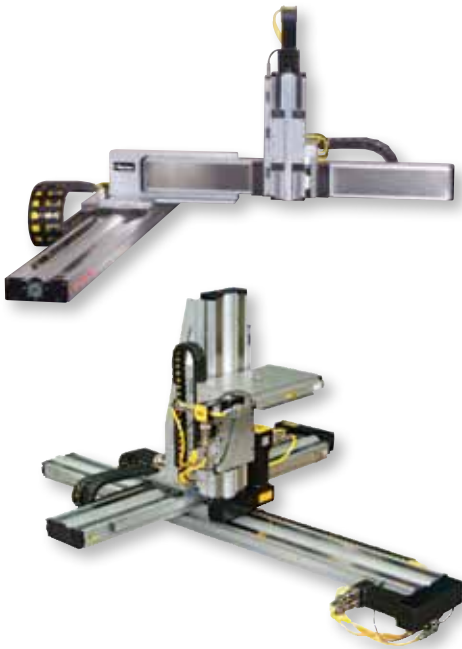

For the engineer looking for a cost-effective, high-performance system with quick delivery, the XRS Series of "standard" Cartesian robot modules is an ideal solution.

Available in small, medium and large platform sizes, XRS systems are a combination of 124 pre-engineered XY and XYZ configurations. These standard systems consist of a mix of ballscrew and linear motor technologies that match the system's performance to the application's requirements, and are fully equipped with mounting brackets, motors and cable management.

When paired with Parker's industry-leading drives and motion controllers, XRS systems offer the end user a high-performance, "off-the-shelf" complete system solution with a lead time similar to that of a single-axis stage.

- **XY and XYZ configurations**
- **Unique mix of linear motor and ballscrew technologies**
- **Right- and left-hand versions**
- **Work areas to 1 m x 1 m**
- **Payloads: 5, 12, and 25 kg**
- **Pass-through, high-flex cabling for power, signals, and air**
- **Dowel holes for repeatable system and payload installation**
- **3-D CAD drawings available**
- **Easily customized for specialized travel, load and environmental considerations**

XRS "Standard" Cartesian Systems

Call 800-245-6903 or [click here for more information...](#)

Modified System Solutions



Gantry-Style Robot Systems
[Call 800-245-6903 or click here for more information...](#)

When a standard system won't meet an application's requirements, Parker excels at combining any number of standard products and engineered components into an unlimited number of system configurations.

From small 2-axis systems suited for the life-science industry to large gantry style robots utilized in pick-and-place or packaging applications, Parker has the product portfolio to solve a vast majority of system needs. System design time can be minimized by using one of Parker's six basic XY, XZ and XYZ configurations.



Cartesian Work Cell Systems
[Call 800-245-6903 or click here for more information...](#)

Beyond the base electromechanical components Parker supplies additional products to help complete these system solutions. Structural aluminum components such as custom framing and guarding are available alongside pneumatic products such as cylinders, grippers, vacuum cups, air valves, air filters, regulators, and lubricators. If your system requires it, chances are Parker can supply it.

- Six basic styles available in XY, XZ and XYZ standard configurations
- Unlimited custom configurations available
- Payloads up to 250 kg
- Velocity up to 4 m/s
- Economical robotic solution
- Sizing and selection available for standard systems
- Easy to customize
- Automated storage and retrieval systems
- Cleanroom compatible

Optional Hardware

- Cable management
- Machine base platforms
- Machine safeguarding
- Pneumatic actuators
- Vacuum cups and generators

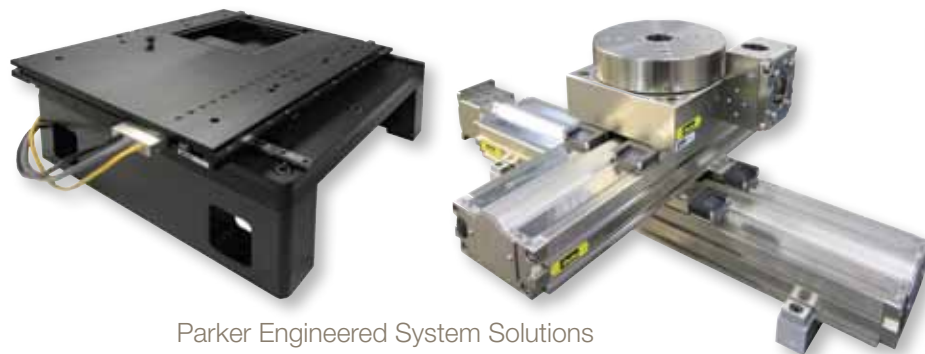

Parker Engineered System Solutions
[Call 800-245-6903 or click here for more information...](#)



Engineered Solutions Capabilities

Motion System Development

Call 800-245-6903 or [click here for more information...](#)

When an application requires high volumes and/or highly complex and demanding system operation, Parker has an engineering team dedicated to ground-up development of complete engineered solutions.

Parker's engineered solutions can include air-bearings, custom linear motors, custom controls, granite bases, pneumatic technology, special testing and more with composite or conventional materials to create a total solution.

Due to the nature of these solutions, we maintain strict confidentiality on each application, resulting in long term partnerships and customer growth.



To bridge the gap to becoming a Parker partner, an industry leading six-step process is used to manage the development cycle and to track the project management of these engineered solutions.

We welcome the opportunity to assist in engineering your success.

Parker's Six-Step Project Management Process



1. Understand Your Needs

Based on a review of your goals, we help develop a rigorous definition of system requirements.



4. Project Management

A project manager assigned to your project uses a secure, web-based tool to manage progress and keep everyone in the loop.



2. System Analysis

Proprietary software analyzes the proposed system value and optimal component sizing.



5. Accept Test Procedure

This mutually agreed upon document outlines the procedures, tools and methods used to verify that all project performances meet desired specifications.



3. Solution Proposal

We document the system requirements, cost effectiveness of options, proposed system design and analysis, price quotation and delivery schedule.



6. After-Sales Support

Includes: an engineer on site during delivery, machine inspection, training, maintenance and 24/7 support.

Find More On-line...

For complete information on all our Parker Electromechanical products including products not covered in this overview, please visit our website at:

www.parkermotion.com

In addition to comprehensive product information, the site also offers a host of other resources including:

- Application stories
- Engineering reference corner
- Sample markets
- Product manuals
- 3-D CAD files
- FAQ
- RSS news feeds
- Locate your local ATC
- Buy on-line
- And much more!

In addition to our electromechanical motion products, Parker Hannifin offers thousands of product lines ranging from viton seals and brass fittings to hydraulic cylinders with kilo-newtons of force.

To find out more about the complete Parker Hannifin family of products, please visit our corporate home page at:

www.parker.com



WARNING - USER RESPONSIBILITY

FAILURE OR IMPROPER SELECTION OR IMPROPER USE OF THE PRODUCTS DESCRIBED HEREIN OR RELATED ITEMS CAN CAUSE DEATH, PERSONAL INJURY AND PROPERTY DAMAGE.

This document and other information from Parker-Hannifin Corporation, its subsidiaries and authorized distributors provide product or system options for further investigation by users having technical expertise.

The user, through its own analysis and testing, is solely responsible for making the final selection of the system and components and assuring that all performance, endurance, maintenance, safety and warning requirements of the application are met. The user must analyze all aspects of the application, follow applicable industry standards, and follow the information concerning the product in the current product catalog and in any other materials provided from Parker or its subsidiaries or authorized distributors.

To the extent that Parker or its subsidiaries or authorized distributors provide component or system options based upon data or specifications provided by the user, the user is responsible for determining that such data and specifications are suitable and sufficient for all applications and reasonably foreseeable uses of the components or systems.

OFFER OF SALE

The items described in this document are hereby offered for sale by Parker-Hannifin Corporation, its subsidiaries or its authorized distributor. This offer and its acceptance are governed by the provisions stated in the detailed Parker Hannifin "Offer of Sale".

EM Sales Offices

Australia

Parker Hannifin (Australia) Pty Ltd.
9 Carrington Road
Castle Hill NSW 2154
Australia
Tel: +61 (0) 2 9634-7777
Fax: +61 (0) 2 9634 3749

Brazil

Parker Hannifin Ind. Com Ltda.
Av. Lucas Nogueira Garcez 2181
Esperança
12325-900 Jacareí, SP
Tel: 12 3954 5100
Fax: 12 3954 5262
Email: automation.brazil@parker.com

Canada

Parker Hannifin (Canada) Inc.
160 Chisholm Dr
Milton, Ontario L9T 3G9
Tel: 905-693-3000
Fax: 905-876-1958
Email: miltoncustservice@parker.com

China

Parker Hannifin Motion & Control
(Shanghai) Co., Ltd
280 Yunqiao Rd. Jin Qiao Export
Processing Zone
Shanghai 201206, China
Tel: (86-21) 50312525
Fax: (86-21) 64459717

France

Parker SSD Parvex
8 avenue du Lac
B.P. 249
F-21007 Dijon Cedex
Tel: +33 (0) 3 80 42 41 40
Fax: +33 (0) 3 80 42 41 23

Germany

Electromechanical Europe
Parker Hannifin GmbH & Co KG
Robert-Bosch-Strasse 22
D-77656 Offenburg
Germany
Tel: +49 (0) 781 509 0
Fax: +49 (0) 781 509 98176

India

Parker Hannifin India Pvt. Ltd
Automation Group-SSD Drives Div.
133 & 151 Developed Plots Estate
Perungudi, Chennai 600 096
Tel: 044-4391-0799
Fax: 044-4391-0700

Italy

Parker Hannifin SpA
Via Gounod 1
20092 Cinsello Balsamo
Milano, Italy
Tel: +39 02 361081
Fax: +39 02 36108400

Korea

Parker Hannifin Korea
9th Floor KAMCO Yangjae Tower
949-3 Dogok 1-dong Gangnam-gu
Seoul 135-860, Korea
Tel: 82-2-559-0454
Fax: 82-2-556-8187

Mexico

Parker Hannifin de Mexico
Eje uno Norte No.100
Parque Industrial Toluca 2000
Toluca, CP 50100 México
Tel: 52-722-275-4200
Fax: 52-722-279-0316

Singapore

Parker Hannifin Singapore Pte Ltd
11, Fourth Chin Bee Road
Singapore 619702
Tel: (65) 6887 6300
Fax: (65) 6265 5125/6261 4929

Taiwan

Parker Hannifin Taiwan Co., Ltd
No. 40, Wuchiuan 3rd Road
Wuku Industrial Park
Taipei County, Taiwan 248
ROC
Tel: 886 2 2298 8987
Fax: 886 2 2298 8982

Thailand

Parker Hannifin (Thailand) Co., Ltd.
1023, 3rd Floor, TPS Building,
Pattanakarn Road,
Suanluang, Bangkok 10250
Thailand
Tel: (66) 02717 8140
Fax: (66) 02717 8148

UK

Parker Hannifin Ltd.
Tachbrook Park Drive
Tachbrook Park
Warwick CV34 6TU
Tel: +44 (0) 1926 317970
Fax: +44 (0) 1926 317980

USA

Parker Hannifin Electromechanical
Automation Division Main Office/
Compumotor/CTC
5500 Business Park Drive
Rohnert Park, CA 94928 USA
Tel: 707-584-7558
800-358-9070
Fax: 707-584-8015
Email: emn_support@parker.com

Parker Hannifin Electromechanical
Automation Division/Daedal
1140 Sandy Hill Road
Irwin, PA 15642
Tel: 724-861-8200
800-245-6903
Fax: 724-861-3330
Email: ddllcat@parker.com

