

Interactive System Productivity Facility (ISPF)



Dialog Developer's Guide and Reference

z/OS Version 1 Release 7.0

Interactive System Productivity Facility (ISPF)



Dialog Developer's Guide and Reference

z/OS Version 1 Release 7.0

Note

Before using this document, read the general information under "Notices" on page 399.

Fifth Edition (September 2005)

This edition applies to ISPF for Version 1 Release 7.0 of the licensed program z/OS (program number 5694-A01) and to all subsequent releases and modifications until otherwise indicated in new editions.

IBM welcomes your comments. A form for comments appears at the back of this publication. If the form has been removed and you have ISPF-specific comments, address your comments to:

IBM Corporation
Department J87/D325
555 Bailey Avenue
San Jose, CA 95141-1003
U.S.A.

Internet: comments@us.ibm.com

If you would like a reply, be sure to include your name and your address, telephone number, e-mail address, or FAX number.

Make sure to include the following in your comment or note:

- Title and order number of this document
- Page number or topic related to your comment

When you send information to IBM, you grant IBM a nonexclusive right to use or distribute the information in any way it believes appropriate without incurring any obligation to you.

The ISPF development team maintains a site on the World Wide Web. The URL for the site is:
<http://www.ibm.com/software/awdtools/ispf/>

© Copyright International Business Machines Corporation 1980, 2005. All rights reserved.

US Government Users Restricted Rights – Use, duplication or disclosure restricted by GSA ADP Schedule Contract with IBM Corp.

Contents

Figures	vii
--------------------------	------------

Preface	ix
--------------------------	-----------

About this document	ix
Who should use this document	ix
What is in this document?	ix
Notation conventions	x
Using LookAt to look up message explanations	xi
Using IBM Health Checker for z/OS	xi

What's in the z/OS V1R7.0 ISPF library?	xiii
--	-------------

The ISPF User Interface	xv
--	-----------

Some Terms You Should Know	xv
How to Navigate in ISPF Using the Action Bar Interface	xvi
Action Bars	xvi
Command Nesting	xviii
Action Bar Choices	xix
Point-and-Shoot Text Fields	xx
Function Keys	xxi
Selection Fields.	xxii
How to Navigate in ISPF without Using Action Bars	xxii

Chapter 1. Introduction to ISPF.	1
---	----------

What Is ISPF?	1
What Is a Dialog?.	1
Functions	2
Variables.	2
Command Tables	2
Panel Definitions	3
Message Definitions	3
File-tailoring Skeletons	3
Tables	3
What Does a Dialog Do?	4
Developing a Dialog.	4
How Dialog Elements Interact	5
Dialog Variables	7

Chapter 2. Controlling ISPF Sessions	9
---	----------

Dialog Control and Data Flow	9
Processing a Dialog.	10
Starting a Dialog	10
Syntax for Issuing the ISPSTART Command	10
Using the ISPSTART Command	17
Invoking a Dialog from a Selection Panel	18
Invoking a Dialog from a Master Application Menu	18
What the SELECT Service Does.	19
Invoking the SELECT Service	21
Terminating a Dialog	21
Return Codes from Terminating Dialogs.	21

An Example Using the ZISPFRC Return Code.	23
ISPF Test and Trace Modes	24
Test Modes	25
ISPF Trace Modes	26
Invoking Authorized Programs	26
Invoking TSO Commands	26
Compiled REXX Requirements	27
CLIST Requirements	27
Attention exits	27
Using APL2	29
Invoking APL2	29
Executing APL2 Functions	31
Invoking ISPF Dialog Services in the APL2 Environment	31
APL2 Workspace as the ISPF Function Pool	32
Interface between ISPF and APL2	32
Subtasking Support.	33
ESTAE Restrictions	33
ISPF Services in Batch Mode.	33
Command Processors in the TSO Batch Environment	33
Batch Display Facility for Background Panel Processing	35
ISPF Graphical User Interface in Batch Mode	38

Chapter 3. Introduction to Writing Dialogs	41
---	-----------

Using the Display Services	41
Example: Creating a Display with TBDISPL	42
Processing Selected Rows.	44
Adding Table Rows Dynamically during Table Display Scrolling	45
Example: Dynamic Table Expansion	49
Using the Variable Services	59
Searching Variable Pools	60
SELECT Service and Variable Access	60
Function Pools and Dialog Functions.	61
Command Procedures, Program Functions, and Function Pools	61
Use a Variable Service to Create or Delete Defined Variables	63
Creating Implicit Variables	63
Naming Defined and Implicit Variables	63
Sharing Variables among Dialogs	64
Saving Variables across ISPF Sessions.	64
Removing Variables from the Shared or Profile Pool	65
Read-Only Profile Pool Extension Variables.	65
Variables Owned by ISPF.	66
Variable Formats	67
System Variables Communicate between Dialogs and ISPF	67
Using VDEFINE, VDELETE, VRESET, VCOPY, VMASK, and VREPLACE	68
Using the VGET, VPUT, and VERASE Services	68

Summary of Variable Services	69
Using the Table Services	69
Where Tables Reside	69
Accessing Data	70
Services That Affect an Entire Table	70
Services That Affect Table Rows	71
Protecting Table Resources	71
Example: Create and Update a Simple Table	72
Determining Table Size	72
Example: Function Using the DISPLAY, TBGET, and TBADD Services	73
Specifying DBCS Search Argument Format for Table Services	81
Using the File-Tailoring Services	81
Skeleton Files.	82
Example of Using File-Tailoring Services.	83
Using the PDF Services	84
BROWSE, EDIT, and EDREC	84
BRIF, EDIF, and EDIREC	85
Library Access Services	85
Using the Miscellaneous Services	86
CONTROL Service	86
GDDM Services (GRINIT, GRTERM, and GRERROR)	86
GETMSG Service	87
LIBDEF Service	87
LIST Service	87
LOG Service	87
PQUERY Service.	87

**Chapter 4. Common User Access
(CUA) Guidelines 89**

Using the Dialog Tag Language to Define Dialog Elements	89
Keylists.	89
Action Bars and Pull-Downs.	90
Pop-Up Windows	90
Movable Pop-Ups	91
WINDOW Command	91
Manual Movement	92
Pop-Up Movement Considerations	93
Field-Level Help.	93
Extended Help	93
Keys Help.	93
Reference Phrase Help.	94
START Service	95

**Chapter 5. Graphical User Interface
(GUI) Guidelines 97**

How to Display an Application in GUI Mode	97
Other Considerations	99
Some General GUI Restrictions	101

**Chapter 6. Panel Definition Statement
Guide. 103**

Introduction to Panel Definition Sections	104
Guidelines for Formatting Panels.	105
Requirements for Specifying Message and Command Line Placement	106
Factors That Affect a Panel's Size.	110

Syntax Rules and Restrictions for Panel Definition	111
Using Blanks and Comments	112
Formatting Items in Lists	112
Using Variables and Literal Expressions in Text Fields	113
Validating DBCS Strings.	114
Special Requirements for Defining Certain Panels	114
Defining Menus	115
Defining Table Display Panels.	131
Formatting Panels That Contain Dynamic Areas	143
Formatting Panels That Contain a Graphic Area	148
Using DBCS-Related Variables in Panels	150
Using Preprocessed Panels	150
Restrictions for Using ISPPREP	152
Using ISPPREP with the SELECT Service	152
Handling Error Conditions and Return Codes	155

**Chapter 7. Panel Definition Statement
Reference 157**

Defining Panel Sections	157
Defining the Action Bar Choice Section.	157
Defining the Action Bar Choice Initialization Section	163
Defining the Action Bar Choice Processing Section	164
Defining the Area Section	164
Defining the Attribute Section.	170
Defining the Body Section	207
Defining the CCSID Section	213
Defining the END Section	213
Defining the FIELD Section.	214
Defining the HELP Section.	220
Defining the Initialization Section	221
Defining the LIST Section	222
Defining the Model Section.	223
Defining the Panel Section	223
Defining the Point-and-Shoot Section	227
Defining the Processing Section	231
Defining the Reinitialization Section.	231
Formatting Panel Definition Statements	234
The Assignment Statement	235
The ELSE Statement	241
EXIT and GOTO Statements	242
The IF Statement	244
The PANEXIT Statement	248
The REFRESH Statement	255
The *REXX Statement	256
The TOG Statement	264
The VEDIT Statement	265
The VER Statement	266
The VGET Statement.	277
The VPUT Statement	279
Using ISPF Control Variables	279
.ALARM	281
.ATTR and .ATTRCHAR.	282
.AUTOSEL	285
.CSRPOS	285
.CSRROW	286
.CURSOR.	286
.HELP.	287
.HHELP	288

.MSG	288
.NRET	289
.PFKEY	290
.RESP	290
.TRAIL	291
.ZVARS	291

Chapter 8. ISPF Help and Tutorial Panels 293

Processing Help	294
Help Requests from an Application Panel	294
Help Available from a Help Panel	296
Ending Help	296
ISPF Default Keylist for Help Panels	296
The ISPF Tutorial Panels.	297

Chapter 9. Defining Messages 303

How to Define a Message	304
Message Display Variations.	308
Messages Tagged with CCSID.	309
Modeless Message Pop-Ups	310
Message Pop-Up Text Formatting.	310
English Rules for Message Text Formatting	311
Asian Rules for Message Text Formatting	311
Substitutable Parameters in Messages	312
Syntax Rules for Consistent Message Definition	312
DBCS-Related Variables in Messages	313

Chapter 10. Defining File-Tailoring Skeletons 315

Control characters	315
Considerations for data records	317
Control characters for data records	317
Considerations for control statements	318
Control statements	318
Sample skeleton file	327
DBCS-related variables in file skeletons.	328

Chapter 11. Extended Code Page Support 329

Translating Common Characters	329
Z Variables	329
Panels Tagged with CCSID.	330
Messages Tagged with CCSID.	330
GETMSG Service	330
TRANS Service.	330
ISPccsid Translate Load Modules.	330
ISPccsid Translate Load Module Generation	
Macro	331
ISPCCSID Macro	331
Description of Parameters	331
ISPccsid Translate Load Module Definition	
Examples.	332
KANA and NOKANA Keywords.	332
Character Translation.	333
Supported CCSIDs	333
Base Code Pages for Terminals	336
Adding Translate Tables for Extended Code Page Support	336

Base CCSIDs	338
Extended Code Page Translate Tables Provided by ISPF	338
Example of User-Modifiable ISPF Translate Table	339

Appendix A. Character Translations for APL, TEXT, and Katakana. 343

Appendix B. ISPTTDEF Specify Translate Table Set 347

Appendix C. Diagnostic Tools and Information 349

ISPF debug tools	349
Panel trace command (ISPDPTRC)	349
Trace format.	352
File tailoring trace command (ISPFTRC)	355
Trace format.	358
Diagnostic information	360
Using the ENVIRON system command.	360
ENVIRON command syntax and parameter descriptions	361
Abend panels provide diagnostic information	366
ISPF statistics entry in a PDS directory	369
Common problems using ISPF	369
Messages.	369
Unexpected output	371
Abend codes and information.	371
Terminal I/O error codes	374
Register linkage conventions	375
Obtaining message IDs	375
Installation, maintenance, and migration diagnostics	376

Appendix D. Dialog Variables 379

PDF Non-Modifiable Variables	384
--	-----

Appendix E. System Variables 385

Configuration Utility	386
Time and Date	386
General	387
ZSCRNAME Examples	390
Terminal and Function Keys	391
Scrolling	393
PRINTG Command	393
Table Display Service.	393
LIST Service.	394
LOG and LIST Data Sets	394
Dialog Error.	394
Tutorial Panels	394
Selection Panels	395
DTL Panels or Panels Containing a)PANEL Section	395

Appendix F. Accessibility 397

Using assistive technologies	397
Keyboard navigation of the user interface	397
z/OS information	397

Notices 399
Programming Interface Information 400
Trademarks 401

Index 403

Figures

1. Panel with an Action Bar Pull-Down Menu	xvii	44. ISPF Primary Option Menu Definition	126
2. Pop-Up Selected from an Action Bar Pull-Down	xviii	45. ISPF Primary Option Menu DTL Source	127
3. Panel with an Action Bar and Point-and-Shoot Fields	xviii	46. Parts of a TBDISPL display	132
4. An Unavailable Choice on a Pull-Down	xx	47. Table Display Panel Definition	141
5. Using ISPF	5	48. Table as Displayed	142
6. Typical Dialog Organization Starting with a Menu	6	49. Table Display Panel Definition with Several Model Lines	142
7. Typical Dialog Starting with a Function	7	50. Table as Displayed with Several Model Lines	143
8. Control and Data Flow	9	51. Panel Definition Illustrating SCROLL and EXTEND	145
9. Application Dialog Running under ISPF	10	52. Dynamic Area with Character Attributes	148
10. Sample Selection Panel	18	53. Panel for Specifying Preprocessed Panel Data Sets (ISPPREPA)	151
11. ISPF Master Application Menu (ISP@MSTR)	19	54. Action Bar Section Example	163
12. SELECT Service Used to Invoke and Process a Dialog	20	55. Invalid Scrollable Area Definition	168
13. Sample Background ISPF Job	24	56. Valid Scrollable Area Definition	168
14. Sample Dialog Using System Variable ZISPFRC	24	57. Scrollable Area Screen Display (Part 1 of 2)	170
15. MVS Batch Job	35	58. Scrollable Area Screen Display (Part 2 of 2)	170
16. Invoking Client/Server in Batch Mode	39	59. Panel Definition Illustrating a Graphic Area	177
17. TBDISPL Panel Definition	43	60. Panel Definition with Graphic Area	177
18. TBDISPL Display	43	61. Definition of Panel Graphic Area with Overlapping Text Field	178
19. Panel Definition Dynamic Table Expansion	50	62. Example of CKBOX keyword	180
20. PL/I Dialog Function Example Program	51	63. Attribute Section in a Panel Definition	200
21. Initial Display for Dynamic Table Expansion Example	56	64. Group Box Definition	205
22. Second Display for Dynamic Table Expansion Example	57	65. Sample Panel Definition	212
23. Third Display for Dynamic Table Expansion Example	58	66. Sample Panel—When Displayed	212
24. Fourth Display for Dynamic Table Expansion Example	59	67. Sample Point-and-Shoot Definition	231
25. Control and Data Flow in a Dialog	61	68. Panel Processing	233
26. CLIST to Create a Read-Only Extension Table	66	69. Sample Panel Definition with TRANS and TRUNC	238
27. Panel Definition SER	74	70. Sample Panel Definition with IF and ELSE Statement	242
28. Panel Display SER	75	71. Standard Parameter List Format	251
29. Panel Display SER with an ISPF-provided Message Superimposed on Line 1	76	72. Panel REXX example	259
30. Message EMPX21	77	73. Sample member VALUSER to invoke panel REXX	263
31. Panel Display SER—Short Form of Message EMPX210 Superimpose Line 1	77	74. TOG Statement Example	265
32. Panel Display SER—Long Form of Message EMPX210 Superimposed on Line 3	78	75. VEDIT Example	266
33. Panel Definition DATA	79	76. Sample Panel Definition with Verification	277
34. Panel Display DATA	79	77. Sample Panel Definition with Control Variables	281
35. Sample Skeleton File	83	78. Example of Z Variable Place-Holders	292
36. Example Panel Displaying Three Pop-Up Windows	91	79. Help Panel Flow	295
37. Reference Phrase Help Example	95	80. Sample Tutorial Hierarchy	300
38. Sample Panel Definition Format	105	81. Sample Tutorial Panel Definition (Panel B)	300
39. CUA Panel Definition	108	82. Sample Tutorial Panel Definition (Panel F2)	301
40. Sample CUA Panel (SAMPAN on ISPKLUP)	110	83. Sample Messages	304
41. Example of a Menu (ISP@MSTR)	115	84. Example Syntax for Defining Messages	304
42. Master Application Menu Definition	120	85. Sample Skeleton File	328
43. Master Application Menu DTL Source	121	86. Basic ISP00111 Translate Module	332
		87. ISP00222 Translate Module with Two Direct CCSID Entries	332
		88. Translation to CCSID 00500 from CCSID XXXXX	336

89.	Translation to CCSID XXXXX from CCSID 00500	337		94.	Sample PROCESS trace	355
90.	Internal Character Representations for APL Keyboards	344		95.	Sample file tailoring trace header	358
91.	Internal Character Representations for Text Keyboards	345		96.	Sample file tailoring process trace.	360
	92.	Sample Panel Trace header		97.	ENVIRON Settings Panel (ISPENVA)	361
	93.	Sample DISPLAY trace		98.	Error Recovery Panel (ISPPRS1)	367
				99.	Additional Diagnostic Information panel (ISPPRS3).	368

Preface

This document describes how to use the ISPF Dialog Manager elements from programs or command procedures.

About this document

The *z/OS ISPF Dialog Developer's Guide and Reference* is a guide for learning and using the Dialog Manager component of the ISPF product. It provides:

- An introduction to ISPF basics
- Information on running ISPF sessions
- Guidelines for:
 - Writing panel definitions
 - Defining messages
 - Defining file-tailoring skeletons
- Tables of dialog variables and system variables.

Who should use this document

This document is for programmers who develop ISPF application dialogs, and for system analysts and system programmers.

Users should be familiar with the MVS operating system and are expected to know at least one of the ISPF-supported programming or command procedure languages: Assembler, PL/I, COBOL, VS FORTRAN, C, APL2[®], Pascal, CLIST, and REXX.

What is in this document?

Chapter 1, "Introduction to ISPF," describes what ISPF is and what it does for you.

Chapter 2, "Controlling ISPF Sessions," describes how to start and stop an ISPF session and how to use many of the ISPF facilities.

Chapter 3, "Introduction to Writing Dialogs," describes how to write dialogs using the ISPF services for display, variable, table, file tailoring, and PDF.

Chapter 4, "Common User Access (CUA) Guidelines," describes how ISPF supports the Common User Access[®] (CUA[®]) guidelines.

Chapter 5, "Graphical User Interface (GUI) Guidelines," provides information for dialog developers who need to write or adapt dialogs to run in GUI mode on a workstation.

Chapter 6, "Panel Definition Statement Guide," provides guide-type information for sections, panel definition statements, and control variables. It explains how to create panels using the panel definition statements.

Chapter 7, "Panel Definition Statement Reference," provides reference information on how to create ISPF panels using Dialog Tag Language (DTL) and the ISPF DTL conversion utility, DTL and panel definition statements, or panel definition statements.

Chapter 8, “ISPF Help and Tutorial Panels,” describes online help and tutorial panels that a developer can include to provide online information for an application user.

Chapter 9, “Defining Messages,” describes how to create and change ISPF messages using an existing message definition or the DTL tags MSG and MSGMBR.

Chapter 10, “Defining File-Tailoring Skeletons,” describes ISPF skeleton definitions and how to create or change skeletons.

Chapter 11, “Extended Code Page Support,” describes how extended code page support allows panels, messages, and variable application data to be displayed correctly on terminals using any of the supported code pages.

Appendix A, “Character Translations for APL, TEXT, and Katakana,” contains the character translation tables for APL, TEXT, and Katakana.

Appendix B, “ISPTTDEF Specify Translate Table Set,” describes a program, ISPTTDEF, that can be used to specify the set of terminal translation tables.

Appendix C, “Diagnostic Tools and Information,” contains information to help you diagnose ISPF problems.

Appendix D, “Dialog Variables,” describes the ISPF dialog function pool variables that are both read from and written to by ISPF library access services.

Appendix E, “System Variables,” describes system variables with type and pool information.

Notation conventions

This document uses the following notation conventions:

- Uppercase commands and their uppercase parameters to show required entry
- Lowercase characters to show parameters that can be specified by the user
- Brackets [] to show optional parameters (required parameters do not have brackets)
- An OR (!) symbol to show two or more parameters you *must* select from
- Stacked parameters to show two or more parameters you *can* select from

Note: You can choose one or none. If you choose none, ISPF uses the underscored parameter.

- Braces {} with stacked parameters to show that you *must* select one. For example:

```
{KEYWORD1(variable) [OPTPAR1(variable)]}  
{KEYWORD2(variable)}  
{KEYWORD3(variable) [OPTPAR2(variable)]}  
{KEYWORD4(variable) [OPTPAR3(variable)]}
```

indicates that you must select either KEYWORD1, KEYWORD2, KEYWORD3, or KEYWORD4.

- Underscores to show defaults
- An ellipsis (...) to show that the parameter can be repeated, specifying additional items of the same category.

Using LookAt to look up message explanations

LookAt is an online facility that lets you look up explanations for most of the IBM® messages you encounter, as well as for some system abends and codes. Using LookAt to find information is faster than a conventional search because in most cases LookAt goes directly to the message explanation.

You can use LookAt from these locations to find IBM message explanations for z/OS® elements and features, z/VM®, VSE/ESA™, and Clusters for AIX® and Linux™:

- The Internet. You can access IBM message explanations directly from the LookAt Web site at <http://www.ibm.com/servers/eserver/zseries/zos/bkserv/lookat/>.
- Your z/OS TSO/E host system. You can install code on your z/OS or z/OS.e systems to access IBM message explanations using LookAt from a TSO/E command line (for example: TSO/E prompt, ISPF, or z/OS UNIX® System Services).
- Your Microsoft® Windows® workstation. You can install LookAt directly from the z/OS Collection (SK3T-4269) or the z/OS and Software Products DVD Collection (SK3T4271) and use it from the resulting Windows graphical user interface (GUI). The command prompt (also known as the DOS > command line) version can still be used from the directory in which you install the Windows version of LookAt.
- Your wireless handheld device. You can use the LookAt Mobile Edition from <http://www.ibm.com/servers/eserver/zseries/zos/bkserv/lookat/lookatm.html> with a handheld device that has wireless access and an Internet browser (for example: Internet Explorer for Pocket PCs, Blazer or Eudora for Palm OS, or Opera for Linux handheld devices).

You can obtain code to install LookAt on your host system or Microsoft Windows workstation from:

- A CD-ROM in the z/OS Collection (SK3T-4269).
- The z/OS and Software Products DVD Collection (SK3T4271).
- The LookAt Web site (click **Download** and then select the platform, release, collection, and location that suit your needs). More information is available in the LOOKAT.ME files available during the download process.

Using IBM Health Checker for z/OS

IBM Health Checker for z/OS is a z/OS component that installations can use to gather information about their system environment and system parameters to help identify potential configuration problems before they impact availability or cause outages. Individual products, z/OS components, or ISV software can provide checks that take advantage of the IBM Health Checker for z/OS framework. This book refers to checks or messages associated with this component.

For additional information about checks and about IBM Health Checker for z/OS, see *IBM Health Checker for z/OS and Sysplex: User's Guide*. z/OS V1R4, V1R5, and V1R6 users can obtain the IBM Health Checker for z/OS from the z/OS Downloads page at <http://www.ibm.com/servers/eserver/zseries/zos/downloads/>.

SDSF also provides functions to simplify the management of checks. See z/OS *SDSF Operation and Customization* for additional information.

What's in the z/OS V1R7.0 ISPF library?

You can order the ISPF books using the numbers provided below.

Title	Order Number
<i>z/OS ISPF Dialog Developer's Guide and Reference</i>	SC34-4821-04
<i>z/OS ISPF Dialog Tag Language Guide and Reference</i>	SC34-4824-04
<i>z/OS ISPF Edit and Edit Macros</i>	SC34-4820-04
<i>z/OS ISPF Messages and Codes</i>	SC34-4815-04
<i>z/OS ISPF Planning and Customizing</i>	GC34-4814-04
<i>z/OS ISPF Reference Summary</i>	SC34-4816-04
<i>z/OS ISPF Software Configuration and Library Manager Project Manager's and Developer's Guide</i>	SC34-4817-04
<i>z/OS ISPF Software Configuration and Library Manager Reference</i>	SC34-4818-04
<i>z/OS ISPF Services Guide</i>	SC34-4819-04
<i>z/OS ISPF User's Guide Vol I</i>	SC34-4822-04
<i>z/OS ISPF User's Guide Vol II</i>	SC34-4823-04

The ISPF User Interface

ISPF provides an action bar-driven interface that exploits many of the usability features of Common User Access (CUA) interfaces. Refer to *Object-Oriented Interface Design: IBM Common User Access Guidelines* for additional information.

These action bars give you another way to move around in ISPF, as well as the ability to nest commands. Command nesting allows you to *suspend* an activity while you perform a new one rather than having to end a function to perform another function.

This chapter primarily explains the action bar-driven interface and the use of ISPF's graphical user interface (GUI).

Some Terms You Should Know

The following terms are used in this document:

action bar

The area at the top of an ISPF panel that contains choices that give you access to actions available on that panel. When you select an action bar choice, ISPF displays a *pull-down menu*.

command procedure

A CLIST or REXX EXEC

data set

A sequential or partitioned data set

function key

In previous releases of ISPF, a programmed function (PF) key. *This is a change in terminology only.*

library

A partitioned data set

menu A selection panel

mnemonics

Action bar choices can be defined with a underscored letter in the action bar choice text. In host mode you can access the action bar choice with the ACTIONS command and parameter *x*, where *x* is the underscored letter in the action bar choice text. In GUI mode you can use a *hot key* to access a choice on the action bar; that is, you can press the ALT key in combination with the letter that is underscored in the action bar choice text.

modal pop-up window

A type of window that requires you to interact with the panel in the pop-up before continuing. This includes canceling the window or supplying information requested.

modeless pop-up window

A type of window that allows you to interact with the dialog that produced the pop-up before interacting with the pop-up itself.

point-and-shoot text

Text on a screen that is cursor-sensitive. See "Point-and-Shoot Text Fields" on page xx for more information.

The ISPF User Interface

pop-up window

A bordered temporary window that displays over another panel.

pull-down menu

A list of numbered choices extending from the selection you made on the action bar. The action bar selection is highlighted; for example, Utilities in Figure 1 on page xvii appears highlighted on your screen. You can select an action either by typing in its number and pressing Enter or by selecting the action with your cursor. ISPF displays the requested panel. If your choice contains an ellipsis (...), ISPF displays a *pop-up window*. When you exit this panel or pop-up, ISPF closes the pull-down and returns you to the panel from which you made the initial action bar selection.

push button

A rectangle with text inside. Push buttons are used in windows for actions that occur immediately when the push button is selected (available only when you are running ISPF in GUI mode).

select In conjunction with point-and-shoot text fields and action bar choices, this means moving the cursor to a field and simulating Enter.

terminal

Any of the supported display devices

How to Navigate in ISPF Using the Action Bar Interface

Most ISPF panels have action bars at the top; the choices appear on the screen in white by default. Many panels also have point-and-shoot text fields, which appear in turquoise by default. The panel shown in Figure 3 on page xviii has both.

Action Bars

Action bars give you another way to move through ISPF. If the cursor is located somewhere on the panel, there are several ways to move it to the action bar:

- Use the cursor movement keys to manually place the cursor on an action bar choice.
- Type ACTIONS on the command line and press Enter to move the cursor to the first action bar choice.
- Press F10 (Actions) or the Home key to move the cursor to the first action bar choice.

If mnemonics are defined for action bar choices, you can:

- In 3270 mode, on the command line, type ACTIONS and the mnemonic letter that corresponds to an underscored letter in the action bar choice text. This results in the display of the pull-down menu for that action bar choice.
- In 3270 mode, on the command line enter the mnemonic letter that corresponds to an underscored letter in the action bar choice text, and press the function key assigned to the ACTIONS command. This results in the display of the pull-down menu for that action bar choice.
- In GUI mode, you can use a *hot key* to access a choice on an action bar or on a pull-down menu; that is, you can press the ALT key in combination with the mnemonic letter that is underscored in the choice text to activate the text.

Use the tab key to move the cursor among the action bar choices. If you are running in GUI mode, use the right and left cursor keys.

Notes:

1. ISPF does not provide a mouse emulator program. This document uses *select* in conjunction with point-and-shoot text fields and action bar choices to mean moving the cursor to a field and simulating Enter.
2. Some users program their mouse emulators as follows:
 - Mouse button 1 – position the cursor to the pointer and simulate Enter
 - Mouse button 2 – simulate F12 (Cancel).
3. If you want the Home key to position the cursor at the first input field on an ISPF panel, type SETTINGS on any command line and press Enter to display the ISPF Settings panel. Deselect the “Tab to action bar choices” option.
4. If you are running in GUI mode, the Home key takes you to the beginning of the current field.

When you select one of the choices on the action bar, ISPF displays a pull-down menu. Figure 1 shows the pull-down menu displayed when you select Options on the ISPF Primary Option Menu action bar.

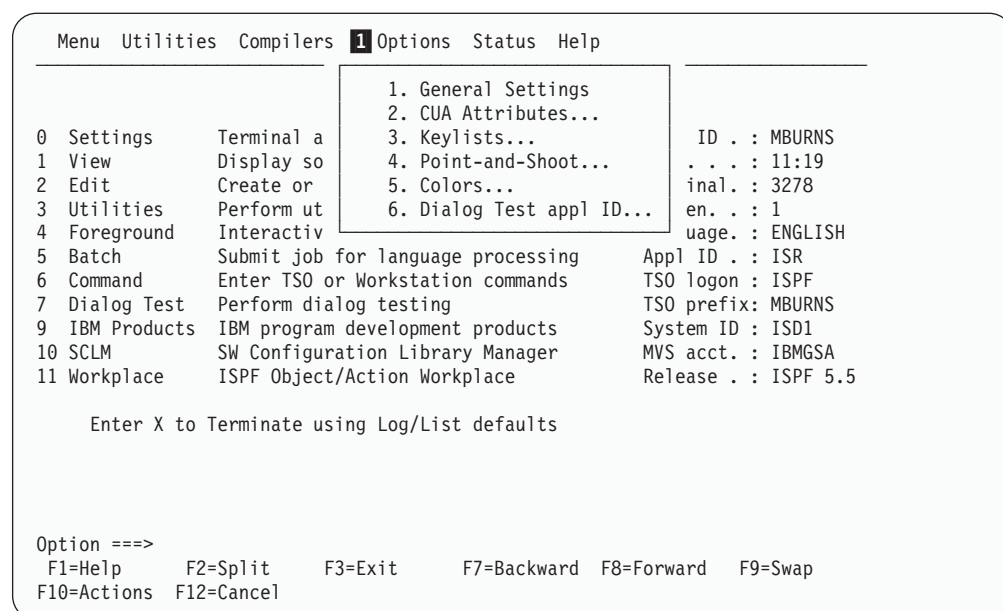

1 The selected action bar choice is highlighted.

Figure 1. Panel with an Action Bar Pull-Down Menu

To select a choice from the Options pull-down menu, type its number in the entry field (underlined) and press Enter or select the choice. To cancel a pull-down menu without making a selection, press F12 (Cancel). For example, if you select choice 6, ISPF displays the Dialog Test Application ID pop-up, as shown in Figure 2 on page xviii.

Note: If you entered a command on the command line prior to selecting an action bar choice, the command is processed, and the pull-down menu is never displayed. The CANCEL, END, and RETURN commands are exceptions. These three commands are not processed and the cursor is repositioned to the first input field in the panel body. If there is no input field, the cursor is repositioned under the action bar area. If you are running in GUI mode and

The ISPF User Interface

select an action bar choice, any existing command on the command line is ignored.

```

Menu Utilities Compilers Options Status Help
-----
Dialog Test Application ID
0 Change the application ID for Dialog Test.
1
2 Application ID . . . ISR
3
4 Command ==>
5 F1=Help F2=Split F3=Exit
6 F9=Swap F12=Cancel
7
8
9
10
11 Workplace ISPF Object/Action Workplace

Enter X to Terminate using Log/List defaults

Option ==>
F1=Help F2=Split F3=Exit F7=Backward F8=Forward F9=Swap
F10=Actions F12=Cancel

ption Menu
ters User ID . . : MBURNS
listings Time. . . : 11:19
data Terminal. . : 3278
s Screen. . . : 1
cessing Language. . : ENGLISH
processing Appl ID . . : ISR
commands TSO logon : ISPF
TSO prefix: MBURNS
products System ID : ISD1
Manager MVS acct. : IBMGSA
Release . . : ISPF 5.5

```

Figure 2. Pop-Up Selected from an Action Bar Pull-Down

```

1 Menu Utilities Compilers Options Status Help
-----
ISPF Primary Option Menu
2
3
0 Settings Terminal and user parameters User ID . . : MBURNS
1 View Display source data or listings Time. . . : 12:29
2 Edit Create or change source data Terminal. . : 3278
3 Utilities Perform utility functions Screen. . . : 1
4 Foreground Interactive language processing Language. . : ENGLISH
5 Batch Submit job for language processing Appl ID . . : ISR
6 Command Enter TSO or Workstation commands TSO logon : ISPF
7 Dialog Test Perform dialog testing TSO prefix: MBURNS
9 IBM Products IBM program development products System ID : ISD1
10 SCLM SW Configuration Library Manager MVS acct. : IBMGSA
11 Workplace ISPF Object/Action Workplace Release . . : ISPF 5.5

Enter X to Terminate using Log/List defaults

Option ==>
F1=Help F2=Split F3=Exit F7=Backward F8=Forward F9=Swap
F10=Actions F12=Cancel

```

- 1** Action bar. You can select any of the action bar choices and display a pull-down.
- 2** Options. The fields in this column are point-and-shoot text fields.
- 3** Dynamic status area. You can specify what you want to be displayed in this area.

Figure 3. Panel with an Action Bar and Point-and-Shoot Fields

Command Nesting

You can use the action bars to *suspend* an activity while you perform a new one.

For example, if you are editing a data set and want to allocate another data set, select the Data set choice from the Utilities pull-down on the Edit panel action bar. ISPF suspends your edit session and displays the Data Set Utility panel. When you have allocated the new data set and ended the function, ISPF returns you directly to your edit session.

By contrast, if you used the jump function (=3.2), ISPF would end your edit session before displaying the Data Set Utility.

Action Bar Choices

The action bar choices available vary from panel to panel, as do the choices available from their pull-downs. However, Menu and Utilities are basic action bar choices, and the choices on their pull-down menus are always the same.

Menu Action Bar Choice

The following choices are available from the Menu pull-down:

Settings	Displays the ISPF Settings panel
View	Displays the View Entry panel
Edit	Displays the Edit Entry panel
ISPF Command Shell	Displays the ISPF Command Shell panel
Dialog Test...	Displays the Dialog Test Primary Option panel
Other IBM Products...	Displays the Additional IBM Program Development Products panel
SCLM	Displays the SCLM Main Menu
ISPF Workplace	Displays the Workplace entry panel
Status Area...	Displays the ISPF Status panel
Exit	Exits ISPF.

Note: If a choice displays in blue (the default) with an asterisk as the first digit of the selection number (if you are running in GUI mode, the choice will be *grayed*), the choice is unavailable for one of the following reasons:

- Recursive entry is not permitted here
- The choice is the current state; for example, RefMode is currently set to Retrieve in Figure 4 on page xx.

The ISPF User Interface

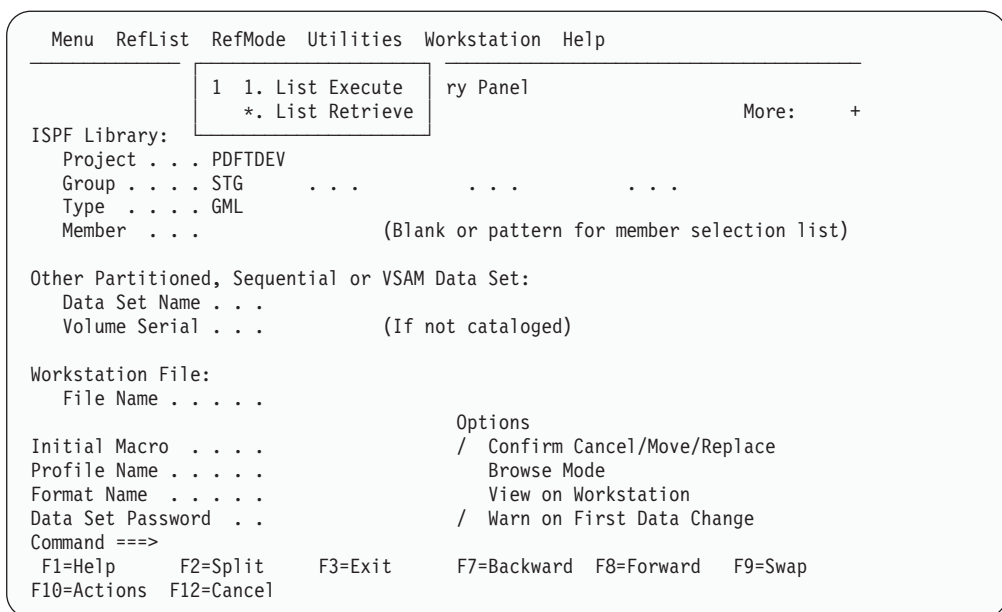

Figure 4. An Unavailable Choice on a Pull-Down

Utilities Action Bar Choice

The following choices are available from the Utilities pull-down:

Library	Displays the Library Utility panel
Data Set	Displays the Data Set Utility panel
Move/Copy	Displays the Move/Copy Utility panel
Data Set List	Displays the Data Set List Options panel
Reset Statistics	Displays the Reset ISPF Statistics panel
Hardcopy	Displays the Hardcopy Utility panel
Download...	Displays the panel that enables you to download workstation clients and other files from the host.
Outlist	Displays the Outlist Utility panel
Commands...	Displays the Command Table Utility panel
Reserved	Reserved for future use by ISPF; an unavailable choice
Format	Displays the Format Specification panel
SuperC	Displays the SuperC Utility panel
SuperCE	Displays the SuperCE Utility panel
Search-for	Displays the Search-For Utility panel.
Search-forE	Displays the Search-ForE Utility panel.

Point-and-Shoot Text Fields

Point-and-shoot text fields are cursor-sensitive; if you select a field, the action described in that field is performed. For example, if you select Option 0, Settings, in Figure 3 on page xviii, ISPF displays the ISPF Settings panel.

Note: If you have entered a command on the command line, this command is processed before any point-and-shoot command unless you are running in GUI mode.

The cursor-sensitive portion of a field often extends past the field name. Until you are familiar with this new feature of ISPF, you might want to display these fields in reverse video (use the PSCOLOR command to set Highlight to REVERSE).

Note: You can use the Tab key to position the cursor to point-and-shoot fields by selecting the “Tab to point-and-shoot fields” option on the ISPF Settings panel (Option 0).

Function Keys

ISPF uses CUA-compliant definitions for function keys F1–F12 (except inside the Edit function). F13–F24 are the same as in ISPF Version 3. By default you see the CUA definitions because your “Primary range” field is set to 1 (Lower - 1 to 12).

To use non-CUA-compliant keys, select the “Tailor function key display” choice from the Function keys pull-down on the ISPF Settings (option 0) panel action bar. On the Tailor Function Key Definition Display panel, specify 2 (Upper - 13 to 24) in the “Primary range” field.

The following function keys help you navigate in ISPF:

- F1** **Help.** Displays Help information. If you press F1 (and it is set to Help) after ISPF displays a short message, a long message displays in a pop-up window.
- F2** **Split.** Divides the screen into two logical screens separated by a horizontal line or changes the location of the horizontal line.

Note: If you are running in GUI mode, each logical screen displays in a separate window.
- F3** **Exit** (from a pull-down). Exits the panel underneath a pull-down.
- F3** **End.** Ends the current function.
- F7** **Backward.** Moves the screen up the scroll amount.
- F8** **Forward.** Moves the screen down the scroll amount.
- F9** **Swap.** Moves the cursor to where it was previously positioned on the other logical screen of a split-screen pair.
- F10** **Actions.** Moves the cursor to the action bar. If you press F10 a second time, the cursor moves to the command line.
- F12** **Cancel.** Issues the Cancel command. Use this command to remove a pull-down menu if you do not want to make a selection. F12 also moves the cursor from the action bar to the Option ==> field on the ISPF Primary Option Menu. See *z/OS ISPF Dialog Developer's Guide and Reference* for cursor-positioning rules.
- F16** **Return.** Returns you to the ISPF Primary Option Menu or to the display from which you entered a nested dialog. RETURN is an ISPF system command.

Selection Fields

z/OS V1R7.0 ISPF uses the following CUA-compliant conventions for selection fields:

A single period (.)

Member lists that use a single period in the selection field recognize only a single selection. For example, within the Edit function you see this on your screen:

```
EDIT      USER1.PRIVATE.TEST                ROW 00001 of 00002
Name      VV MM Created   Changed  Size Init  Mod  ID
. MEM1    01.00 94/05/12 94/07/22 40   0   0  USER1
. MEM2    01.00 94/05/12 94/07/22 30   0   0  KEENE
```

You can select only one member to edit.

A single underscore (_)

Selection fields marked by a single underscore prompt you to use a slash (/) to select the choice. You may use any nonblank character. For example, the "Panel display CUA mode" field on the ISPF Settings panel has a single underscore for the selection field:

```
Options
Enter "/" to select option
_ Command line at bottom
_ Panel display CUA mode
_ Long message in pop-up
```

Note: In GUI mode, this type of selection field displays as a check box; that is, a square box with associated text that represents a choice. When you select a choice, the check box is filled to indicate that the choice is in effect. You can clear the check box by selecting the choice again.

An underscored field (___)

Member lists or text fields that use underscores in the selection field recognize multiple selections. For example, from the Display Data Set List Option panel, you may select multiple members for print, rename, delete, edit, browse, or view processing.

How to Navigate in ISPF without Using Action Bars

If you use a non-programmable terminal to access z/OS V1R7.0 ISPF and you do not want to take advantage of the command nesting function, you can make selections the same way you always have: by typing in a selection number and pressing Enter.

Chapter 1. Introduction to ISPF

This chapter describes ISPF at an introductory level. It explains what ISPF is and what it does for you.

What Is ISPF?

Consider the Interactive System Productivity Facility (ISPF) program product an extension of the MVS Time Sharing Option (TSO) host system on which it runs. ISPF services complement those of the host system to provide interactive processing. ISPF is similar to a control program or access method in that it provides services to dialogs (applications) during their execution. The types of services provided by ISPF are:

- Display services
- File-tailoring services
- Variable services
- Table services
- Miscellaneous services
- Dialog test facility, including:
 - Setting breakpoints
 - Tracing usage of dialog services and dialog variables
 - Browsing trace output in the ISPF log data set
 - Examining and updating ISPF tables
 - Interactively invoking most dialog services.

A dialog receives requests and data from a user at a terminal. The dialog responds by using ISPF services to obtain information from, or enter information into, a computer system.

What Is a Dialog?

To understand the dialog interface, you must first understand what a dialog is. A dialog is the interaction between a person and a computer. It helps a person who is using an interactive display terminal to exchange information with a computer.

The user starts an interactive application through an interface that the system provides. The dialog with the user begins with the computer displaying a panel and asking for user interaction. It ends when the task for which the interactions were initiated is completed.

A dialog developer creates the parts of a dialog, called dialog elements. Each dialog application is made up of a command procedure or program, together with dialog elements that allow an orderly interaction between the computer and the application user.

The elements that make up a dialog application are:

- Functions
- Variables
- Command tables
- Panel definitions
- Message definitions
- File-tailoring skeletons
- Tables

A dialog does not necessarily include all types of elements. For example, certain kinds of applications do not use tables and skeletons.

Functions

A function is a command procedure or a program that performs processing requested by the user. It can invoke ISPF dialog services to display panels and messages, build and maintain tables, generate output data sets, and control operational modes.

A function can be coded in a command procedure language using CLIST or REXX or in a programming language, such as PL/I, COBOL, FORTRAN, APL2, Pascal, or C.

You can use more than one language in a dialog application. For example, within a single application containing three functions, each function could be written using a different language, such as PL/I, COBOL, or FORTRAN. One or more of the functions can be written using a command procedure language instead of a programming language.

Notes:

1. ISPF functions written in PL/I should not be linked with the PL/I multitasking libraries.
2. ISPF functions written in FORTRAN should be linked in FORTRAN link mode. That is, include the VLNKMLIB library ahead of the VFORTLIB library in the SYSLIB concatenation. Refer to the *VS FORTRAN Programming Guide* for additional information.
3. ISPF functions written in the C language should be linked with the C\$START load module. For more information, refer to the *C Compiler User's Guide*.
4. A function coded in a programming language can be designed for cross-system use, to be processed by equivalent levels of ISPF running under VM and z/OS. Such a function would need to use equivalent ISPF services available on both VM and z/OS.

Variables

ISPF services use variables to communicate information among the various elements of a dialog application. ISPF provides a group of services for variable management. Variables can vary in length from zero to 32K bytes and are stored in variable pools according to how they are to be used. A set of variables whose names begin with the character Z are system variables. Z variables are reserved for ISPF system-related uses.

Command Tables

A system command table (ISPCMD5) is distributed with ISPF in the table input library. An application can provide an application command table by including a table named *xxxx*CMDS in its table input library, where *xxxx* is a 1- to 4-character application ID. In addition, you can specify up to three User command tables and up to three Site command tables. The application IDs for the User and Site command tables are specified in the ISPF Configuration table. You can also specify if the Site command tables are to be searched before or after the system command table.

You can define an application command table either by using the Dialog Tag Language (DTL) and ISPF conversion utility, or by using ISPF option 3.9.

When a user enters a command, the dialog manager searches the application command table, if any, and then the system command table. If it finds the command, action is taken immediately. If it does not find the command in the application or system tables, the command is passed to the dialog, unaltered, in the command field. The dialog then takes appropriate action.

Note: You can use the TSO ISPCMDTB command to convert existing command tables to DTL. To use ISPCMDTB, ensure the command table is in your table concatenation (ISPTLIB), then type TSO ISPCMDTB *applid* (where *applid* is the application id of the command table). This will begin an edit session containing the DTL version of the command table. Use the editor CREATE or REPLACE command to save the table to your DTL source data set.

Panel Definitions

A panel definition is a programmed description of the panel. It defines both the content and format of a panel.

Most panels prompt the user for input. The user's response can identify which path is to be taken through the dialog, as on a selection panel. The response can be interpreted as data, as on a data-entry panel.

Panels can invoke REXX statements, enabling the dialog developer to use the powers of the REXX language to perform operations such as arithmetic, formatting of dialog variables, and verification, transformation, and translation of data.

Message Definitions

Message definitions specify the format and text of messages to users. A message can confirm that a user-requested action is in progress or completed, or it can report an error in the user's input. Messages can be superimposed on the display to which they apply, directed to a hardcopy log, or both.

File-tailoring Skeletons

A file-tailoring skeleton, or simply a skeleton, is a generalized representation of sequential data. It can be customized during dialog execution to produce an output data set. After a skeleton is processed, the output data set can be used to drive other processes. File skeletons are frequently used to produce job data sets for batch execution.

Tables

Tables are two-dimensional arrays that contain data and are created by dialog processing. They can be created as a temporary data repository, or they can be retained across sessions. A retained table can also be shared among several applications. The type and amount of data stored in a table depends on the nature of the application.

Tables are generated and updated during dialog execution. The organization of each table is specified to ISPF using ISPF table services.

What Does a Dialog Do?

You can use ISPF to simplify the programming that provides interactive application operations. Operations performed during dialog execution include:

- Identifying to the user choices of available processing routines
- Invoking a requested routine, based on the user's choice
- Prompting the user to enter data
- Reading the data into a work area
- Checking the data to verify that it is appropriate for the application

If the data is not appropriate for the application:

- Identifying the error to the user
- Prompting the user to enter new data and verifying that data

If the entered data is in the proper form:

- Displaying any information requested by the user
- Processing or storing the user's data, then advising the user of its disposition

- Creating sequential output data sets or reports
- Providing online messages, help, and tutorial displays to help users understand application processing.

Developing a Dialog

A developer, using an editor such as the PDF editor in Option 2 of ISPF, develops a dialog by creating its various elements at a terminal and storing them in libraries. You can use any available editor when creating dialog elements.

However, in addition to an editor, ISPF provides special facilities to aid dialog development. Examples of these facilities are:

- A VIEW facility for displaying source data or output listings
- Utilities to simplify data handling
- Programming-language processing facilities
- Edit models for messages, file-tailoring skeletons, panels, and DTL source
- Library access services for accessing both ISPF libraries and other data sets.

Figure 5 on page 5 shows a developer using ISPF to create and test dialog elements. As shown in the figure, panel definitions, message definitions, and file-tailoring skeletons are created before running the dialog. These dialog elements are saved in libraries. The developer stores the program (after compilation) or command procedure in an appropriate system program library. During dialog testing, tables of data, log entries, and file-tailoring output data sets can be created by dialog processing. ISPF creates the log data set the first time the user performs some action that results in a log message, such as saving edited data or submitting a job to the batch machine. ISPF creates the list data set the first time a user requests a print function or executes a dialog that issues a LIST service request.

When the developer completes the functions, panel definitions, and any other dialog elements required by the application being developed, the dialog is ready to be processed under ISPF.

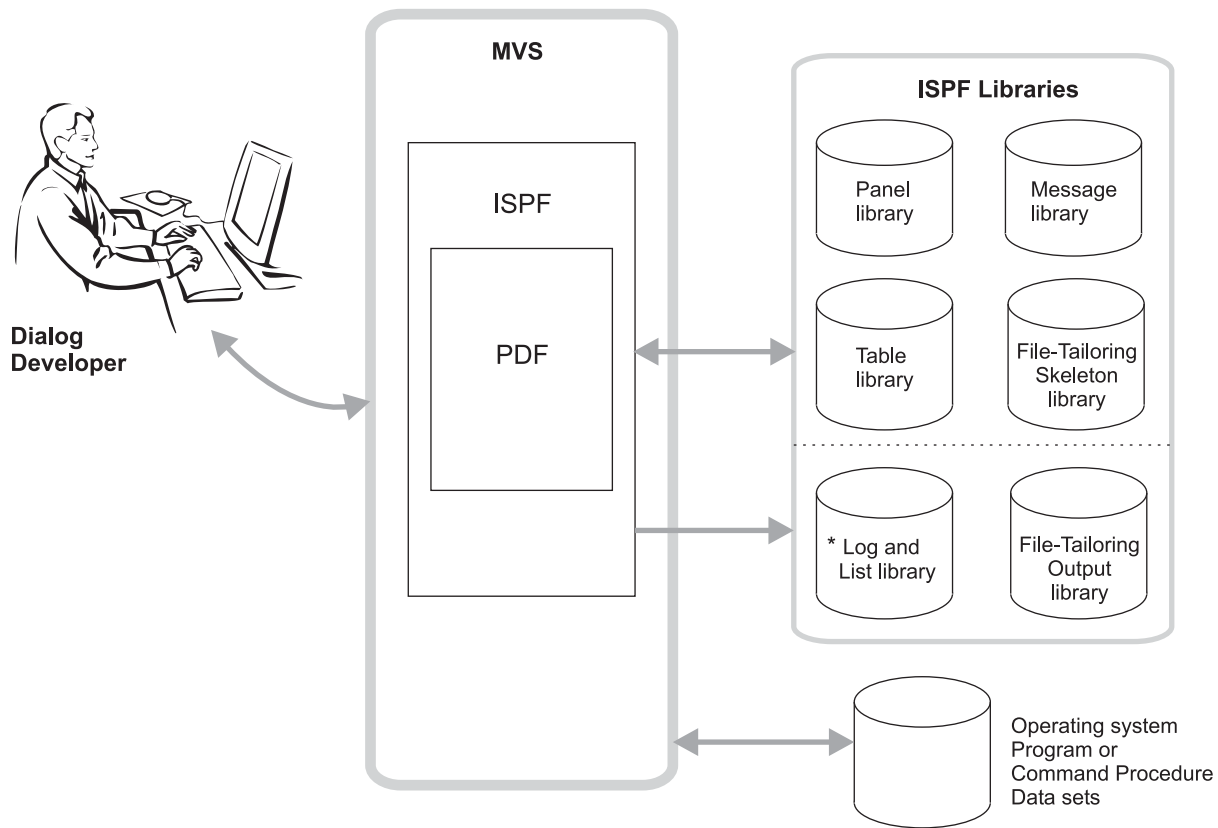

* As well as being an output data set, the log data set can be browsed and is an input data set when Dialog Test option 7.5 is in effect.

Figure 5. Using ISPF

How Dialog Elements Interact

A dialog can be organized in a variety of ways to suit the requirements of the application and the needs of the application user.

A typical dialog organization, shown in Figure 6 on page 6, starts with display of the highest menu, called the primary option menu. User options selected from the primary option menu can result in the call of a function or the display of a lower-level menu. Each lower-level menu can also cause functions to receive control or still other menus to be displayed.

Eventually, a function receives control. The function can use any of the dialog services provided by ISPF. Typically, the function can continue the interaction with the user by means of the DISPLAY service. The function might also display data-entry panels to prompt the user for information. When the function ends, the menu from which it was invoked is redisplayed.

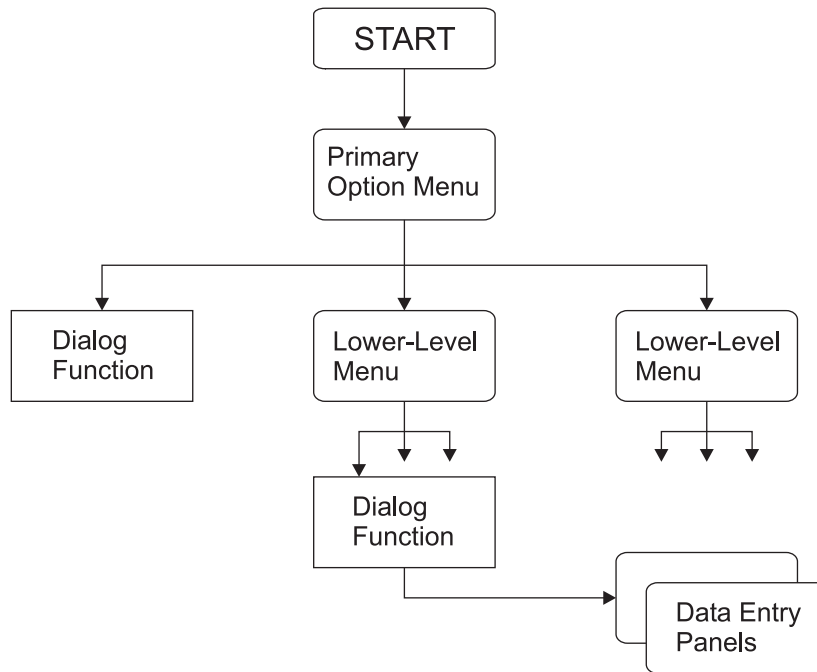

Figure 6. Typical Dialog Organization Starting with a Menu

Figure 7 on page 7 shows another type of dialog organization in which a dialog function receives control first, before the display of a menu. The function performs application-dependent initialization and displays data-entry panels to prompt the user for basic information. It then starts the selection process by using the SELECT service to display the primary option menu for the application.

Figure 7 also shows how a dialog function can invoke another function without displaying a menu. It uses the SELECT service to do this, which provides a convenient way to pass control from a program-coded function to a command-coded function, or vice versa. The invoked function then starts a lower-level menu process, again by using the SELECT service.

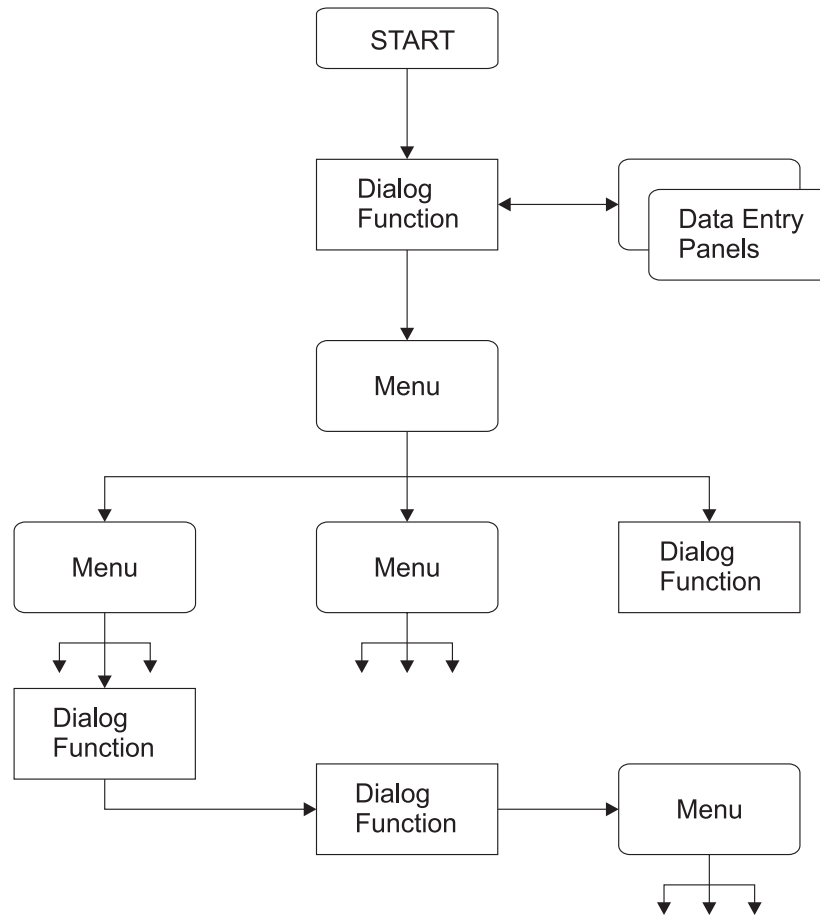

Figure 7. Typical Dialog Starting with a Function

To relate your application design to CUA design models and principles, refer to the *IBM Common User Access Guidelines*. It is recommended that you use DTL to design CUA-based panels. Refer to the *z/OS ISPF Dialog Tag Language Guide and Reference* for more information.

Dialog Variables

ISPF uses dialog variables to communicate data between the dialog management services and the dialog elements. A dialog variable's value is a character string that can vary in length from 0 to 32K bytes. Some services restrict the length of dialog variable data.

Dialog variables are referred to symbolically. The name is composed of 1–8 characters (6 for FORTRAN). Alphanumeric characters A–Z, 0–9, #, \$, or @ can be used in the name, but the first character cannot be numeric. APL variable names cannot contain #, \$, or @.

Dialog variables can be used with panels, messages, and skeleton definitions, as well as within dialog functions. For example, a dialog variable name can be defined in a panel definition, and then referred to in a function of the same dialog. Or, the variable can be defined in a function, then used in a panel definition to initialize information on a display panel, then later used to store data entered by the user on the display panel.

For functions coded in a programming language other than APL2, the internal program variables that are to be used as dialog variables can be identified to ISPF and accessed using the ISPF variable services. The use of STEM or COMPOUND variables within a REXX procedure is not supported by ISPF. For a function coded as CLIST or REXX command procedures or as an APL2 procedure, variables used in the procedure are automatically treated as dialog variables. In this case, no special action is required to define them to ISPF.

Chapter 2. Controlling ISPF Sessions

This chapter is intended to help you understand how to control ISPF sessions. It describes how to start and stop an ISPF session and how to use many of the ISPF facilities.

Dialog Control and Data Flow

Figure 8 illustrates dialog control and data flow. At the start of an ISPF session, you can use the ISPSTART command either to request a selection panel from which to choose the first task or to call a dialog function. The figure also illustrates how the ISPF services interact with the various dialog elements.

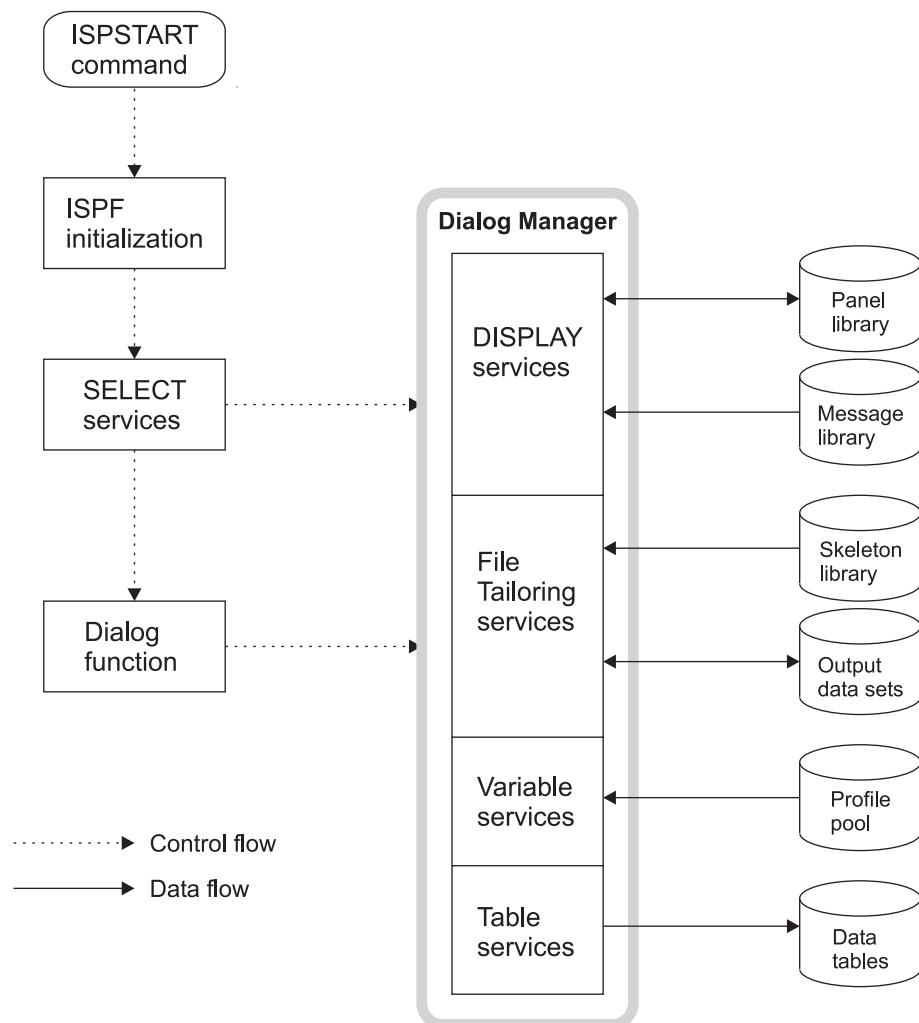

Figure 8. Control and Data Flow

Processing a Dialog

Figure 9 shows a dialog being processed under ISPF. The figure shows that ISPF dialog services are available only to command procedures or programs running under ISPF. During dialog processing, the dialog requests specific ISPF services and identifies the panel and message definitions, skeletons, and tables to use. The figure also shows that entries in the log and list data sets, as well as the file-tailoring output data sets, can be generated during dialog processing.

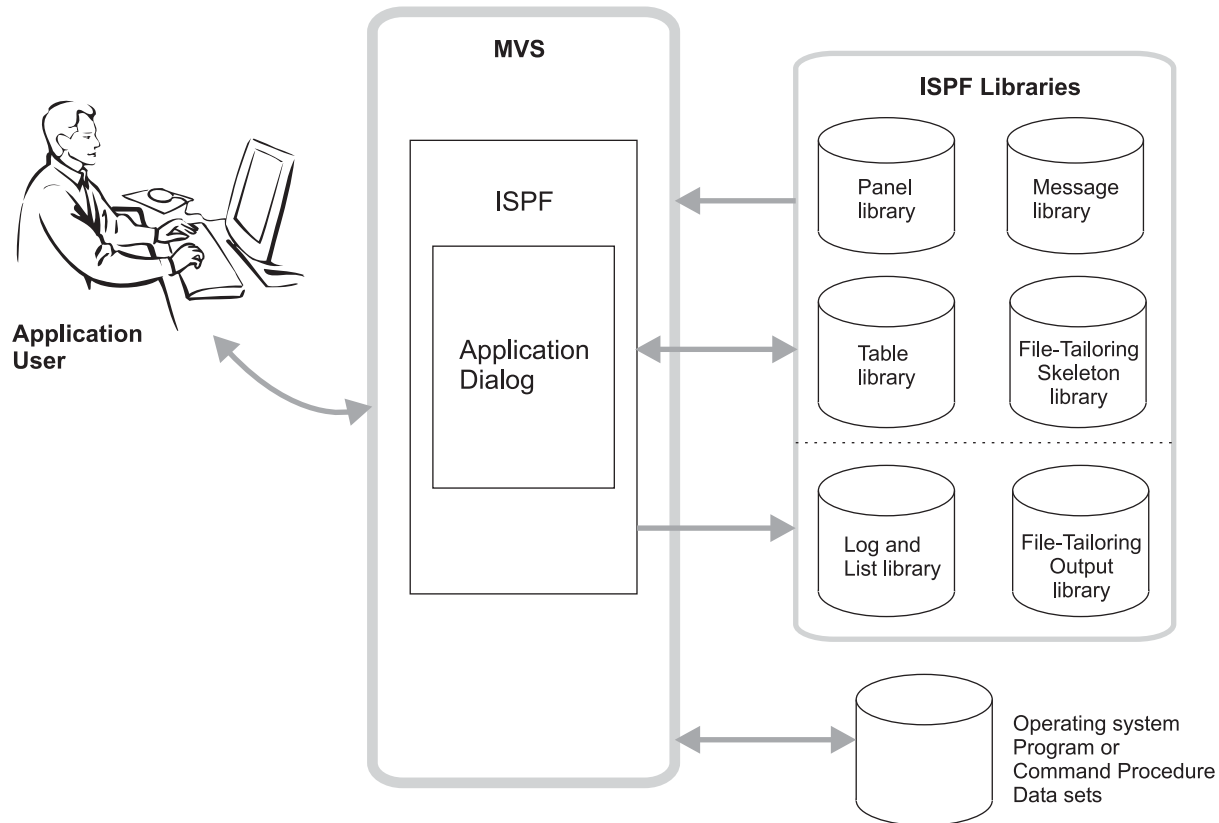

Figure 9. Application Dialog Running under ISPF

Dialog processing begins either with the display of a selection panel or with a function. In either case, you can invoke a dialog from a terminal running under control of TSO.

Starting a Dialog

You can use the ISPF, PDF, or ISPSTART command, with the CMD, PGM, or PANEL keyword, to start ISPF or other dialogs. ISPF is a command procedure that runs under TSO. For example, it can be run from a terminal running under TSO, or from a CLIST or REXX command procedure.

Before a dialog starts, data sets referred to by that dialog must be defined to ISPF.

Syntax for Issuing the ISPSTART Command

You invoke ISPF by using the ISPSTART command. ISPSTART command parameters specify the first menu to be displayed or the first function to receive control before the display of a menu.

If no parameters are specified, the ISPSTART command displays the default primary panel specified in the DEFAULT_PRIMARY_PANEL keyword in the ISPF configuration table. This keyword is typically set to ISP@MSTR.

The PDF and ISPF commands are aliases for ISPSTART that can be used to start ISPF. If you enter ISPF or PDF with no parameters, the command ISPSTART PANEL(*panel*) NEWAPPL(ISR) is run, where *panel* is determined by the following rules:

- If the default primary panel is ISP@MSTR or is not set, *panel*=ISR@PRIM
- If the default primary panel is set to any other panel, *panel*=DEFAULT_PRIMARY_PANEL

Parameters

All the parameters below apply to the PDF and ISPF commands as well as ISPSTART. For more information about the GUI parameters, see Chapter 5, “Graphical User Interface (GUI) Guidelines,” on page 97. For more information about running in GUI mode, refer to the chapter on the ISPF user interface in the *z/OS ISPF User’s Guide Vol I*.

```
ISPSTART
{PANEL(panel-name) [OPT(option)] [ADDDPOP]}
{CMD(command parm1 parm2) [LANG(APL|CREX)]}
{PGM(program-name) [PARM(parameters)]}
{WSCMD(workstation-command)
    [MODAL|MODELESS]
    [WSDIR(dir)]
    [MAX|MIN]
    [VIS|INVIS]}
{WSCMDV(var_name)
    [MODAL|MODELESS]
    [WSDIR(dir)]
    [MAX|MIN]
    [VIS|INVIS]}
[GUI(LU:address:tpname | IP:address:port |,FI:) |,NOGUIDSP)] [TITLE(title)]
[GUISCRW(screen-width)]
[GUISCRD(screen-depth)]
[FRAME(STD|FIX|DLG)]
[CODEPAGE(codepage)] [CHARSET(character_set)]
[BKGRND(STD|DLG)]
[NEWAPPL[(application-id)]]
[SCRNAME(screen-name)]
[TEST|TESTX|TRACE|TRACEX]
[NOLOGO|LOGO(logo-panel-name)]
[BATSCRW(screen-width)]
[BATSCRD(screen-depth)]
[BDISPMAX(max-number-of-displays)]
[BREDIMAX(max-number-of-redisplays)]
[BDBCS]
[DANISH|ENGLISH|GERMAN|JAPANESE|PORTUGUE|SPANISH|KOREAN|
FRENCH|ITALIAN|CHINESET|CHINESES|SGERMAN|UPPERENG]
```

where:

panel-name

Specifies the name of the first menu (that is, the primary option menu) to be displayed.

option

Specifies an initial option, which should be a valid option on the first menu. This causes direct entry to that option without displaying the primary option

menu. (The primary option menu is processed in nondisplay mode, as though the user had entered the option.) If you specify an option that is not valid, the primary option menu displays an appropriate error message.

ADDDPOP

Specifies that the panel displayed from a SELECT service appears in a pop-up window. An explicit REMPOP is performed when the SELECT PANEL has ended.

command

Specifies a command procedure (CLIST or REXX), an APL2 command, or a TSO command processor that is to be invoked as the first dialog function. For more information about invoking APL2 dialogs, refer to the *z/OS ISPF Services Guide*.

CLIST or REXX command parameters can be included within the parentheses. For example, the call format would be:

```
ISPSTART CMD(MYCLIST parm1 parm2 ...)
```

These parameters are passed to the command procedure. For information about specifying CLIST parameters, see *z/OS TSO/E CLISTS*. For information about specifying REXX parameters, see *z/OS TSO/E REXX User's Guide*.

You can type a percent sign (%) preceding the CLIST or REXX procedure name to:

- Improve performance
- Prevent ISPF from entering line-display mode when the procedure is started.

Note: When starting a CLIST or REXX procedure or a program through the SELECT service, a MODE(LINE | FSCR) parameter is available for specifying either line mode or full-screen mode. If you do not specify the mode parameter or do not use the % prefix, ISPF enters line-display mode.

- Ensure that the command procedure is invoked if ISPF has access to a program function that has the same name as the procedure. If you use the percent sign prefix, ISPF searches only for a procedure with the specified name. However, without the percent sign prefix, ISPF searches first for a program, then for a CLIST or REXX procedure.

On extended data stream terminals, using the percent sign causes the keyboard to remain in a locked condition. To avoid this condition, the CLIST or REXX procedure can issue output line I/O before issuing a READ.

LANG(APL | CREX)

Specifies special language invocations. LANG(APL) specifies to start the command specified by the CMD keyword, and to start an APL2 environment. LANG(CREX) specifies that the command specified by the CMD keyword is a REXX EXEC that has been compiled and link-edited into a LOAD module and that a CLIST/REXX function pool is to be used. LANG(CREX) is optional if the compiled REXX has been link-edited to include any of the stubs EAGSTCE, EAGSTCPP, or EAGSTMP.

program-name

Specifies the name of a program that is to be invoked as the first dialog function. In PL/I, it must be a MAIN procedure. This parameter must specify the name of a load module that is accessible by use of the LINK macro.

However, if the program dialog consists of multiple tasks and if any of the subtasks use ISPF services, the CMD keyword, not the PGM keyword, must be

used. Dialog developers should avoid using prefixes ISP and ISR, the ISPF component codes, in naming dialog functions. Special linkage conventions, intended only for internal ISPF use, are used to invoke programs named `ISPxxxx` and `ISRxxxx`.

parameters

Specifies input parameters to be passed to the program. The program should not attempt to modify these parameters.

The parameters within the parentheses are passed as a single character string, preceded by a half-word containing the length of the character string, in binary. (The length value does not include itself.) This convention is the same as that for passing parameters by use of the `PARM=` keyword on a JCL EXEC statement.

Parameters on the `ISPSTART` command to be passed to a PL/I program are coded in the standard way:

```
XXX: PROC (PARM) OPTIONS(MAIN);  
      DCL PARM CHAR (nnn) VAR;
```

If the value of the `PARM` field is to be used as an ISPF dialog variable, it must be assigned to a fixed character string because the `VDEFINE` service cannot handle varying length PL/I strings. In PL/I the first character of the `PARM` field must be a slash (/), as PL/I assumes that any value before the slash is a runtime option.

workstation-command

Specifies a fully qualified workstation program including any parameters. To issue a command that is not a program (.exe, .com, .bat) DOS allows it to be prefaced with `COMMAND`. For example:

```
SELECT WSCMD(COMMAND /C DIR C:)
```

MODAL

The `MODAL` parameter invokes the workstation command modally. It waits until the workstation command has completed and then returns to ISPF.

MODELESS

The `MODELESS` parameter invokes the command modelessly. It is only valid when running in GUI mode. It is the default. It does not wait until the workstation command has completed. It always returns a return code of zero if the command was started, even if the command does not exist at the workstation.

WSDIR(dir)

The `WSDIR` parameter specifies the variable name containing the workstation current working directory. This directory is the directory from which the workstation command should be invoked.

MAX

The `MAX` parameter attempts to start the workstation command in a maximized window. The workstation command may override this request. `MAX` and `MIN` are mutually exclusive.

MIN

The `MIN` parameter attempts to start the workstation command in a minimized window. The workstation command may override this request. `MAX` and `MIN` are mutually exclusive.

VIS

The `VIS` parameter attempts to start the workstation command as a visible

window. The workstation command may override this request. This is the default. VIS and INVIS are mutually exclusive.

INVIS

The INVIS parameter attempts to start the workstation command in an invisible (hidden) window. The workstation command may override this request. VIS and INVIS are mutually exclusive.

var_name

Specifies a variable name that contains the text string of a command and its parameters. Use this when the command path or parameters, or both, contain any of the following: embedded blanks, quotation marks, or special characters that might not parse properly with the WSCMD service.

LU:address:tpname

Specifies the workstation's Advanced Program-to-Program Communication (APPC) network name.

Note: The variable ZGUI will be set to the workstation address (in character format) if ISPSTART is issued with the GUI parameter; ZGUI will be set to blank if ISPSTART is issued without the GUI parameter.

IP:address:port

Specifies the workstation's TCP/IP hardware-level IP address: a fully qualified machine name.

Note: The variable ZGUI will be set to the workstation address (in character format) if ISPSTART is issued with the GUI parameter; ZGUI will be set to blank if ISPSTART is issued without the GUI parameter.

FI: Specifies that you want to search a file allocated to DD ISPDTPRF for the user's network protocol and workstation address to be used when initiating a workstation connection or GUI display. For more information, refer to the section on workstation connections in the Settings chapter of the *z/OS ISPF User's Guide Vol II*.

NOGUIDSP

Specifies that you want to make a connection to the workstation, but DO NOT want ISPF to display in GUI mode.

Note: This parameter is only valid if you have specified an LU, IP, or FI parameter. In other words, you can have any of the following situations:

- you specify LU:address:tpname, IP:address:port, *or* FI: without the NOGUIDSP parameter
- *or* you specify LU:address:tpname, NOGUIDSP
- *or* you specify IP:address:port, NOGUIDSP
- *or* you specify FI:, NOGUIDSP

TITLE(title)

Specifies the text displayed in the title bar unless a dialog has assigned a nonblank value to ZWINTTL or ZAPPTTL. The default value for the title bar is the user ID. This value has a maximum length of 255 characters and will be truncated without notice to the user at display time if it does not fit on the panel.

GUISCRW(screen-width)

Allows you to specify a screen width different than that of the emulator or real device from which you enter the ISPSTART command. If you do not specify GUISCRD, the depth will be that of the emulator or real device.

If GUISCRW is different than the emulator or real device, and GUI initialization fails, ISPF will not initialize. Dialogs started with dimensions other than those of the emulator or real device that use the GRINIT service will not display GDDM[®] screens.

Note: This parameter is usually only used with the GUI parameter. If you do specify a value for this parameter without using the GUI parameter, ISPF ignores it. If you specify a value that is not valid for this parameter, ISPF might return an error condition.

GUISCRD(*screen-depth*)

Allows you to specify a screen depth different than that of the emulator or real device from which you enter the ISPSTART command. If you do not specify GUISCRW, the width will be that of the emulator or real device.

If GUISCRD is different than the emulator or real device and GUI initialization fails, ISPF will not initialize. Dialogs started with dimensions other than those of the emulator or real device that use the GRINIT service will not display GDDM screens.

Note: This parameter is usually only used with the GUI parameter. If you do specify a value for this parameter without using the GUI parameter, ISPF ignores it. If you specify a value that is not valid for this parameter, ISPF might return an error condition.

CODEPAGE(*codepage*) **CHARSET**(*character_set*)

When running in GUI mode or connecting to the workstation, these values are used as the host codepage and character set in translating data from the host to the workstation, regardless of the values returned from the terminal query response.

When running in 3270 mode, if your terminal or emulator does not support codepages, these values are used as the host codepage and character set. Otherwise, these values are ignored.

FRAME(**STD**|**FIX**|**DLG**)

Specifies that the first window frame displayed will be a standard (STD), fixed (FIX), or dialog (DLG) window frame, where:

Standard	A GUI window frame that can be resized and has max/min buttons. This is the default value.
Fixed	A GUI window frame that has max/min buttons but cannot be resized.
Dialog	A GUI window frame that cannot be resized and does not have max/min buttons.

Notes:

1. Pop-up panels are displayed in dialog frames by default.
2. This parameter is usually only used with the GUI parameter. If you do specify a value for this parameter without using the GUI parameter, ISPF ignores it. If you specify a value that is not valid for this parameter, ISPF might return an error condition.

BKGRND(**STD**|**DLG**)

Specifies that the first window frame displayed will be a standard (STD) or dialog (DLG) background color. These colors are defined by the workstation. The default is DLG.

Note: This parameter is usually only used with the GUI parameter. If you do specify a value for this parameter without using the GUI parameter, ISPF ignores it. If you specify a value that is not valid for this parameter, ISPF might return an error condition.

NEWAPPL(application-id)

Specifies a 1- to 4-character code that identifies the application that is being invoked. The code is to be prefixed to the user and edit profile names or to the command table associated with the application, as follows:

```
User Profile   - xxxxPROF
Edit Profile   - xxxxEDIT
Command Table  - xxxxCMDS
```

where *xxxx* is the application-id. If the application-id is omitted, or if the NEWAPPL keyword is omitted, the application-id defaults to ISP.

SCRNAME(screen-name)

Specifies a screen name to be used with the SWAP command and the ISPF task list. The name can be any set of 2 to 8 characters, except LIST, PREV, or NEXT.

TEST

Specifies that ISPF is to be operated in TEST mode, described under “ISPF Test and Trace Modes” on page 24.

TESTX

Specifies that ISPF is to be operated in extended TEST mode, described under “ISPF Test and Trace Modes” on page 24.

TRACE

Specifies that ISPF is to be operated in TRACE mode, described under “ISPF Trace Modes” on page 26.

TRACEX

Specifies that ISPF is to be operated in extended TRACE mode, described under “ISPF Trace Modes” on page 26.

LOGO(logo-panel-name)

Specifies that ISPF displays the named panel before invoking the specified dialog object. Subsequent SELECT service requests that identify a LOGO panel will *not* result in the indicated panel being displayed. This includes a repeat of the first SELECT as a result of a split-screen request or a logical screen restart following a severe dialog error.

Applications can choose to display their own LOGO panel directly. These applications can determine whether the user specified the NOLOGO keyword on ISPSTART by retrieving the ISPF system variable ZLOGO. Applications that choose to display their own LOGO panel are responsible for controlling that display operation during split-screen operations and logical-screen restart situations.

NOLOGO

Specifies that ISPF is to bypass the display of the message pop-up window containing the product title and copyright statement.

screen-width

For batch mode, specifies screen width in character positions. The default value is 80. This parameter is ignored when not running in batch mode.

All screen sizes from 24 x 80 to 62 x 160 are valid.

screen-depth

For batch mode, specifies screen depth in lines. The default value is 32. This parameter is ignored when not running in batch mode.

max-number-of-displays

For batch mode, specifies the maximum number of displays that can occur during a session. This number includes the total of all SELECT PANEL calls, plus all DISPLAY and TBDISPL calls (with or without panel name). This number does not include redisplay calls related to the .MSG control variable. The largest number that can be specified is 999999999. The batch default value is 100. This parameter is ignored when not running in batch mode.

max-number-of-redisplays

For batch mode, specifies the maximum number of redisplay calls allowed for a .MSG-redisplay loop. The largest number that can be specified is 255. The batch default value is 2. This parameter is ignored when not running in batch mode.

BDBCS

For batch mode, specifies that Double-Byte Character Set (DBCS) terminal support is required. This parameter is ignored when not running in batch mode.

DANISH, ENGLISH, GERMAN, JAPANESE, PORTUGUE, SPANISH, KOREAN, FRENCH, ITALIAN, CHINESET, CHINESES, SGERMAN, UPPERENG

Specifies the national language that is to override the default language for this session. The JAPANESE keyword specifies that the KANJI character set is to be used. The CHINESET keyword stands for Traditional Chinese, CHINESES stands for Simplified Chinese, and SGERMAN stands for Swiss-German. The UPPERENG keyword specifies that the uppercase English character set is to be used. For information about establishing the default session language, refer to *z/OS ISPF Planning and Customizing*.

Notes:

1. Attempting to run a dialog under a session language other than that for which it was intended may produce unexpected results.
2. When the Korean, French, Italian, Traditional Chinese, Simplified Chinese, Spanish, Brazilian-Portuguese, or Danish session language is specified, its respective literal module is used. However, the ISPF product panels and messages are displayed in English.

Using the ISPSTART Command

ISPSTART command parameters specify the first menu to be displayed or the first function to receive control. For example, the following command invokes ISPF and specifies that dialog processing is to begin by displaying a selection panel named ABC, which must be stored in the panel library:

```
ISPSTART PANEL(ABC)
```

The next example invokes ISPF and specifies that dialog processing is to begin with a CLIST command procedure function named DEF:

```
ISPSTART CMD(%DEF)
```

The final example invokes ISPF and specifies that dialog processing is to begin with a program function named GHI:

```
ISPSTART PGM(GHI)
```

Note: If you specify the CMD (command) or PANEL (panel) keyword more than once on an ISPSTART command line, ISPF uses the last value specified. For example:

```
ISPSTART PANEL(PANELA) PANEL(PANELX)
```

ISPF interprets this command as:

```
ISPSTART PANEL(PANELX)
```

The ISPSTART command is typically entered during logon or from a command procedure. For example, suppose you begin an application from a terminal by invoking a command procedure named ABC. Procedure ABC allocates the libraries for the application, and then issues an ISPSTART command to begin ISPF processing. The ABC procedure cannot use ISPF dialog services, because it does not run under ISPF.

ISPF is a command processor that can be attached by another command processor as a subtask. You should always specify SZERO=NO in the MVS ATTACH macro, as ISPF does when it attaches a subtask, to assure that at ISPF termination the storage that was acquired by ISPF will be released. For more information on the ATTACH macro, refer to *z/OS MVS Programming: Assembler Services Reference ABE-HSP*. For more information on using MVS macros, refer to *z/OS MVS Programming: Assembler Services Guide*.

Invoking a Dialog from a Selection Panel

Figure 10 shows a selection panel on which the user has selected option 3. When the user presses Enter, option 3, the INVENTORY application, is given control.

```
----- BUILDING 661 -----
SELECT OPTION ==> 3_

  1 PAYROLL   - Add, update, or delete employee records
  2 MAILING   - Add, delete, or change address of employee
  3 INVENTORY - Status of stock
  4 SCHEDULE  - Building maintenance

ENTER END COMMAND TO TERMINATE.
```

Figure 10. Sample Selection Panel

Invoking a Dialog from a Master Application Menu

If your installation provides an ISPF master application menu, you can invoke a dialog from that menu. A master application menu is one from which any of the installation's applications can be invoked. It generally is displayed at the beginning of each ISPF session. Figure 11 on page 19 is an illustration of the sample master application menu shipped with ISPF.

```

                                ISPF Master Application Menu

1 Sample 1   Sample application 1                               Userid . : LSACKV
2 .          (Description for option 2)                       Time . . : 11:12
3 .          (Description for option 3)                       Terminal : 3278
4 .          (Description for option 4)                       Pf keys  : 24
5 .          (Description for option 5)                       Screen . : 1
X Exit      Terminate ISPF using list/log defaults           Language : ENGLISH
                                                    Appl ID  : ISP
                                                    Release  : ISPF 5.6

Enter END command to terminate application

5694-A01 (C) COPYRIGHT IBM CORP 1982, 2003

Licensed Materials - Property of IBM
5637-A01 (C) Copyright IBM Corp. 1980, 2004.
All rights reserved.
US Government Users Restricted Rights -
Use, duplication or disclosure restricted
by GSA ADP Schedule Contract with IBM Corp.

Option ==>
F1=Help      F2=Split    F3=Exit      F9=Swap      F10=Actions  F12=Cancel

```

Figure 11. ISPF Master Application Menu (ISP@MSTR)

You usually invoke the master menu by using the `ISPSTART` command with no operands. `ISPSTART` can be issued automatically as part of a user's logon procedure or from a CLIST or REXX command procedure.

What the SELECT Service Does

The `SELECT` service initiates dialog execution. Selection keywords, passed to the `SELECT` service, specify whether the dialog begins with the display of a menu (`PANEL` keyword) or the execution of a dialog function (`CMD` or `PGM` keyword). The dialog terminates when the selected menu or function terminates. The action at termination depends on how the `SELECT` service was originally invoked.

`SELECT` is both a control facility and a dialog service. ISPF uses `SELECT` during its initialization to invoke the function or selection panel that begins a dialog. During dialog processing, `SELECT` displays selection panels and invokes program functions or command procedure functions.

The principal `SELECT` parameters are:

```

PANEL(panel-name)
CMD(command)
PGM(program-name)

```

See *z/OS ISPF Services Guide* for a full description of the `SELECT` service syntax.

The `panel-name` parameter specifies the name of the next selection panel to be displayed. You must use the ISPF panel definition statements (described in Chapter 6, "Panel Definition Statement Guide," on page 103) to define the panel.

The `command` and `program-name` parameters specify a function, coded as a CLIST command procedure or program, respectively, to receive control. Input parameters can be passed to the function as part of the command specification or, for programs, by the use of the `PARM` parameter.

Figure 12 shows how the SELECT service is used when invoking or processing a dialog. After SELECT starts a dialog, the dialog uses it as a service to invoke a function or to display a selection panel. In turn, that function or menu can use SELECT to invoke another function or to display another menu. This function or menu can, in turn, using SELECT, invoke still another function or menu. This process can continue for many levels and establishes a hierarchy of invoked functions and menus. There is no restriction on the number of levels allowed in this hierarchy.

Subtasks attached by the SELECT service do not share subpools. ISPF specifies SZERO=NO when issuing the ATTACH macro to assure that at SELECT termination the storage that was acquired by ISPF is released.

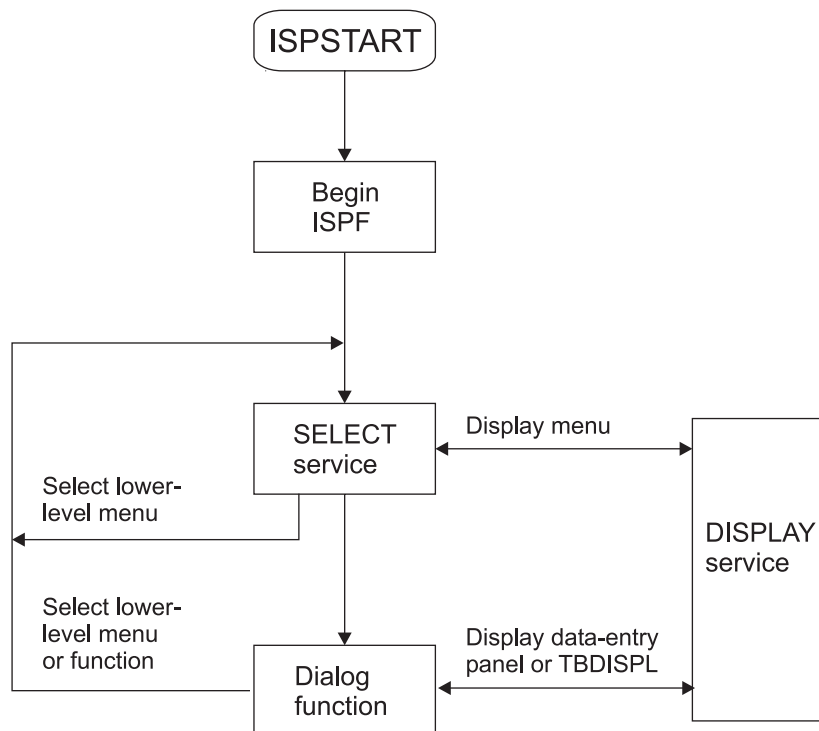

Figure 12. SELECT Service Used to Invoke and Process a Dialog

When a lower-level function or menu in the hierarchy completes its processing, control returns to the higher-level function or menu from which it was invoked. The higher-level function resumes its processing, or the higher-level menu is redisplayed for the user to make another selection. Thus, SELECT is used in a dialog to establish a hierarchy of functions and menus. This hierarchy determines the sequence in which functions and menus are processed, including the sequence in which they are terminated.

Dialog functions written as command procedures can directly invoke other functions written as command procedures without using the SELECT service. They are *not* treated as new functions by ISPF.

Dialog functions written as programs can invoke another function only through using the SELECT service. Thus, when a program-coded function calls another program directly, without using the SELECT service, the called program is treated as part of the function that called it. It is not treated as a new function by ISPF.

Invoking the SELECT Service

The SELECT service can be invoked in the following ways:

- During initialization, the dialog manager automatically invokes the SELECT service to start the first dialog. The selection keywords originally specified on the ISPSTART command are passed to the SELECT service.
For dialogs invoked by ISPSTART, ISPF error processing is not put into effect until ISPF is fully initialized. ISPF is considered to be fully initialized when the Enter key on the primary option menu has been processed without a severe error occurring.
- If you enter split-screen mode, the dialog manager again invokes the SELECT service and again passes the selection keywords from the ISPSTART command. This causes the first dialog, specified in the ISPSTART command, to be initiated on the new logical screen.
- The SELECT service recursively invokes itself when you select an option from a menu displayed by the SELECT service. In this case, the selection keywords are specified in the panel definition for the menu.
- The SELECT service can be invoked from a dialog function. In this case, the selection keywords are passed as calling sequence parameters.

Terminating a Dialog

The action taken at dialog termination is as follows:

- If a dialog function invoked the SELECT service, control returns to that function and the function continues execution.
- If a menu invoked the SELECT service, that menu is redisplayed, including execution of the INIT section in the panel definition.
- If you are terminating split-screen mode, the original dialog ends on that logical screen, and the other logical screen expands to the full size of the viewing area.
- If you are terminating ISPF, which can be done only in single-screen mode, either the ISPF termination panel is displayed or the ISPF SETTINGS defaults for list/log processing are used.

ISPF displays the termination panel if:

- The dialog started with the display of a menu and you entered the END command on that menu.
- The dialog started with the execution of a function, and the function ended with a return code of 0.

The list/log defaults are used if:

- The dialog started with the display of a menu and you entered the RETURN command or selected the EXIT option.
- The dialog started with the execution of a function and the function ended with a return code of 4 or higher. A return code other than 0 or 4 causes an error message to be displayed.

If you have not specified valid list/log defaults, the ISPF termination panel is displayed in all cases.

Return Codes from Terminating Dialogs

The return code from ISPSTART for a successful dialog completion is either 0 or a value returned by the executing dialog in the system variable ZISPFRC. ZISPFRC is a shared-pool input variable of length 8. The dialog can set ZISPFRC to any

value in the range of 0 to 16777215, except the values reserved for ISPF use (900 through 999, and 9000 through 9100). This value must be left-justified and padded with blanks.

At termination, ISPF copies the value from ZISPFRC and passes it to the invoking application (or Terminal Monitor Program) in register 15. If the value in ZISPFRC is not within the valid range or is otherwise not valid, such as a value that is not numeric, ISPF issues an appropriate line message and passes a return code of 908. If the dialog has not set ZISPFRC to a value, ISPF returns a value of 0.

Notes:

1. CLIST procedures that invoke ISPSTART can check the CLIST variable LASTCC for the ISPF return code. In REXX, check the variable *rc* after an ISPF function.
2. Even though ISPF restricts the return code value to the range 0 to 16777215, other products or subsystems, such as JES when processing JCL condition codes, can be more restrictive on return code values. See documentation for the affected product for more information.
3. ZISPFRC should not be confused with the normal dialog return code set by the function; it has no effect on ISPF log/list termination processing.

ZISPFRC is intended to be used by applications that invoke a dialog dedicated to a single task or function. However, it is valid to set ZISPFRC from a selection panel invoked by the ISPSTART command.

ISPF checks for the existence of ZISPFRC only at ISPF termination. If ZISPFRC is set by any dialog other than the one invoked by the ISPSTART command, ISPF ignores the value.

Return Codes from Termination Dialogs

Error codes that ISPF can return in register 15 to an application are:

- | | |
|-----|---|
| 908 | ZISPFRC value not valid. |
| 920 | ISPSTART command syntax not valid. |
| 985 | An attempt was made to start a GUI in batch mode, but no workstation connection was made. |
| 987 | An attempt was made to start GUI with GUISCRW or GUISCRD and the GUI initialization failed. |
| 988 | An error occurred initializing IKJSATTN. |
| 989 | The ISPF C/S component window was closed while still running ISPF in GUI mode. |
| 990 | An error occurred running in batch mode. If ZISPFRC has not been set previously, and ISPF encounters a severe error that terminates the product, then 990 is set. |
| 997 | Uncorrectable TPUT error. |
| 998 | ISPF initialization error. A 998 error code can result from: <ul style="list-style-type: none">• Required ISPF data element library not preallocated• Error opening ISPF data element library• ISPF data element library has invalid data set characteristics• Error loading literals module• Recursive ISPF call |

ISPF issues a line message that indicates which of these errors caused the 998 return code.

999 ISPF environment not valid. A 999 error code can result from:

- TSO/MVS environment not valid
- Unsupported screen size

ISPF issues a line message that indicates which of these errors caused the 999 return code.

| When running in batch, ISPF can also return the following return codes:

| **9008** Abend termination.

| **9012** Attach error.

| **9014** Authorized command invocation error, or TSO CMD START exit routine
| rejected the command.

| **9016** Command not found, or was otherwise unable to execute, or an exit
| routine returned an invalid return code.

| **9018** Invalid command: LOGOFF, ISPF, etc.

| **9020** TSO RTN IKJTBLIS (called from CAU) abended.

An Example Using the ZISPFRC Return Code

Figure 13 on page 24 shows a portion of a background job that invokes ISPF. The final job step executes only if the job step that invoked the ISPF dialog terminates with a return code of 8 or less.

```

:
:
//*****
//*                               *
//* INVOKE ISPF TO EXECUTE DIALOG "DIALOG1". *
//* DIALOG1 PASSES BACK A RETURN CODE OF *
//* 20 IF IT DID NOT PROCESS SUCCESSFULLY. *
//*                               *
//*****
//ISPFSTEP EXEC PGM=IKJEFT01,DYNAMNBR=30,REGION=2048K
//*
//* ALLOCATE DIALOG AND ISPF PRODUCT LIBRARIES, *
//* ISPF LOG DATA SET, AND TSO OUTPUT DATA SET. *
//*                               *
//ISPPROF DD DSN=USER1.ISPF.TABLES,DISP=SHR
:
//* ALLOCATE TSO INPUT DATA SET. *
//*                               *
//SYSTSIN DD *
    PROFILE PREFIX(USER1) /* ESTABLISH PREFIX */
    ISPSTART CMD(%DIALOG1) /* INVOKE DIALOG1 */
/*
//*****
//* EXECUTE NEXT JOB STEP ONLY IF THE ISPF STEP *
//* ENDED WITH A RETURN CODE LESS THAN OR EQUAL *
//* TO 8. THAT IS, BYPASS THE STEP IF 8 IS *
//* LESS THAN THE ISPF RETURN CODE. *
//*                               *
//*****
//NEXTSTEP EXEC PGM=IKJEFT01,DYNAMNBR=30,REGION=2048K,
// COND=(8,LT,ISPFSTEP)
:
:

```

Figure 13. Sample Background ISPF Job

The portion of the invoked dialog, DIALOG1, that establishes the value in system variable ZISPFRC is shown in Figure 14.

```

PROC 0
:
:
IF &MAXCC > 8 THEN +
DO
    SET &ZISPFRC = 20
    VPUT (ZISPFRC) SHARED
END
EXIT CODE(0)

```

Figure 14. Sample Dialog Using System Variable ZISPFRC

ISPF Test and Trace Modes

The testing modes of ISPF provide special processing actions to help debug a dialog. Consider using the Dialog Test (option 7) facility.

You can specify any one of four mutually exclusive keyword parameters on the ISPSTART command to control the operational mode when testing a dialog:

TEST Test mode

TESTX	Extended test mode; logged messages are displayed
TRACE	Trace mode; ISPF service calls are logged
TRACEX	Extended trace mode; ISPF service calls are logged and displayed

Test Modes

In TEST mode, ISPF operates differently from normal mode in the following ways:

- Panel and message definitions are fetched again from the panel and message files when a panel name or message ID is specified in an ISPF service. In normal mode, the most recently accessed panel definitions are retained in virtual storage. If you have modified the panel or message file, use of TEST mode ensures that the latest version of each panel or message is accessed during a test run.

Using an editor to modify a panel, message, or skeleton can result in an additional DASD extent being required for the associated data set. DASD rarely (if ever) gains new extents as the result of the execution of software (with the possible exception of DASD formatting software). It can also be caused by link-editing a module. When a new extent is allocated, you can access the modification only by first terminating and then invoking ISPF again.

- Tutorial panels are displayed with current panel name, previous panel name, and previous message ID on the bottom line of the display screen. This assists you in identifying the position of the panel in the tutorial hierarchy.
- Screen printouts, obtained through use of the PRINT or PRINT-HI commands, include line numbers, current panel name, and message ID.
- In PDF, the index listing (option 3.1) for a partitioned data set includes TTR data for each member of the data set.
- If a dialog function is operating in the CANCEL error mode (the default), the panel that is displayed on an error allows you to force the dialog to continue in spite of the error. Results from that point on, however, are unpredictable and ISPF can abend.

If a dialog function is operating in any other error mode, and a command run from the SELECT service abends, any ISPF-detected error, abend, or program interrupt forces an abend of ISPF. You can also force an abend by entering ABEND or CRASH in the command line of any panel. For more information about the SELECT service, refer to the *z/OS ISPF Services Guide*.

- The PA1 key causes an immediate exit from ISPF.

The ISPF controller task attaches one ISPF subtask for each logical screen. Any additional logical screens are created by the SPLIT command and there can be up to four screens on a 3290 terminal.

If an ISPF subtask abends, pressing Enter after the abend message appears generates a dump, provided that a SYSUDUMP, SYSMDUMP, or SYSABEND data set has been allocated.

Dialogs invoked with the SELECT CMD(XXX) cause an attach of a new subtask under the ISPF subtask. If an abend occurs under the new subtask, an immediate dump is taken.

In TESTX mode, ISPF operates the same as it does in TEST mode, except that all messages written to the ISPF log file are also displayed at the terminal.

ISPF provides the ENVIRON command, which allows you to cause a dump following an abend condition, even if ISPF is not running in TEST mode. See “Using the ENVIRON system command” on page 360 for a description of using the ENVIRON command.

ISPF Trace Modes

In TRACE mode, ISPF operates as it does in TEST mode, except that a message is written to the ISPF log file when any ISPF service is invoked, even if CONTROL ERRORS RETURN has been issued, and when any error is detected by an ISPF service. Note that only CLIST, APL2, and CALL ISPEXEC service requests are recorded. This does not include service requests issued under Dialog Test option 7.6. CALL ISPLINK requests for service are not recorded in the log file.

In TRACEX (extended trace) mode, ISPF operates the same as it does in TRACE mode except that all messages written to the ISPF log file, including the trace messages, are also displayed at the terminal. If the length of the message text exceeds the width of the terminal screen, the message will be truncated.

Invoking Authorized Programs

You can invoke authorized programs by using the SELECT service, a selection panel, a command table, or by using the TSO CALL command under ISPF. ISPF uses the TSO Service Facility IKJEFTSR to invoke authorized commands and programs. Authorized programs are invoked under the TSO TMP (Terminal Monitor Program) and therefore should not reside in the ISPLLIB library. Authorized programs cannot issue dialog service requests. Refer to *z/OS TSO/E Customization* for information about adding authorized programs and commands to the list maintained by your installation.

Invoking TSO Commands

TSO commands can be initiated by use of the SELECT dialog service (with the CMD keyword), from a selection panel, from a command table, by entering the ISPF TSO system command in the command field of any panel, or be contained in a CLIST or REXX command procedure that is invoked under ISPF.

You can invoke authorized TSO commands by using the SELECT service, a selection panel, or a command table. Authorized commands are attached under the TSO TMP (Terminal Monitor Program) and, therefore, should not reside in the ISPLLIB library. Authorized commands cannot issue dialog service requests.

You can execute most TSO commands under ISPF. The following commands are not allowed:

- LOGON
- LOGOFF
- SPF
- ISPF
- PDF
- ISPSTART
- TEST
- Commands that are restricted by TSO or PCF (Program Control Facility)

Note: The LOGON, LOGOFF, and TEST commands can be executed within ISPF if the TSOEXEC interface is used (for example, TSO TSOEXEC LOGOFF). In that case, the LOGON and LOGOFF commands are processed upon ISPF

termination, instead of returning to TSO READY. When the TEST command is being executed, TSO TEST is entered immediately. However, because TSOEXEC executes commands in a parallel TMP structure, ISPF dialogs cannot be run under TSO TEST in this situation.

Compiled REXX Requirements

ISPF supports compiled REXX load modules through ISPSTART and the SELECT service. The REXX program must be compiled with the OBJECT option of the IBM Compiler for REXX/370. This OBJECT output needs to be link-edited with the CPPL stub that is a part of the IBM Library for REXX/370.

The SELECT service and ISPSTART command contain a value, CREX, for the LANG parameter on the CMD keyword. Specifying LANG(CREX) on the CMD keyword indicates that it is a Compiled REXX load module and that a REXX function pool is to be used for variable manipulation. LANG(CREX) is optional if the compiled REXX has been link-edited to include any of the stubs EAGSTCE, EAGSTCPP, or EAGSTMP.

The CPPL stub takes the parameters that are passed by the SELECT CMD service or the ISPSTART invocation, and converts them into arguments for the REXX program. For complete details on how to create a REXX load module, see *IBM Compiler and Library for REXX on zSeries User's Guide and Reference*.

Compiled REXX programs that were compiled with the CEXEC option must be executed using the CMD option of the SELECT service or ISPSTART command, and must NOT use the LANG(CREX) parameter.

CLIST Requirements

A CLIST cannot invoke any of the restricted TSO commands. TERMIN command procedure statements can cause unpredictable results.

Note: If a CLIST contains CONTROL MAIN, the TSO input stack is not flushed after an ISPF severe error.

Attention exits

When a CLIST command procedure is executing under ISPF, the ATTN statement in the procedure defines how attention interrupts are to be handled. You can find information about using attention exits in *z/OS TSO/E CLISTs* and *z/OS TSO/E Programming Services*.

Restrictions on Using Attention Exits from CLISTs

Restrictions that apply to using attention exits from a CLIST dialog are:

- CLIST attention exits are not supported when running in ISPF TEST or TRACE modes. This is because the ISPF attention exit routine is not established in TEST or TRACE modes.
- The CLIST must issue a null command to return from an attention exit. If the dialog issues a TSO command to terminate the exit routine, ISPF discards the command. The ISPF dialog then resumes execution as if CONTROL MAIN NOFLUSH were in effect for this CLIST.
- You can stack CLIST attention exits only within one SELECT CMD level. An exit applies only to the logical screen from which the CLIST owning the attention

exit was invoked. Therefore, when you are operating in split-screen mode, invoking a CLIST attention exit from one logical screen has no effect on the other logical screens.

- You should not invoke an ISPF dialog service from a CLIST attention exit routine. If you do, results are unpredictable.
- Attention interrupts initiated while an exit routine is executing are not honored.

Examples of CLIST Attention Exit Process Flow

Single CLIST with One Attention Exit:

1. From a selection panel, select a CLIST procedure named CLIST1. CLIST1 has one attention exit routine, named ATTN1.
2. CLIST1 displays PANEL1.
3. Press the attention key.
4. Exit routine ATTN1 executes and PANEL1 redisplay.

Nested CLISTs with Two Attention Exits (One SELECT Level):

1. From a selection panel, select a CLIST procedure named CLIST1. CLIST1 has one attention exit routine, named ATTN1.
2. CLIST1 invokes procedure CLIST2 by using the TSO EXEC command. CLIST2 has one attention exit routine, named ATTN2.
3. CLIST2 displays PANEL2.
4. Press the attention key.
5. Exit routine ATTN2 executes and PANEL2 redisplay.
6. Press Enter to return control to CLIST2. CLIST2 then terminates processing and control returns to CLIST1.
7. CLIST1 displays PANEL1.
8. Press the attention key.
9. Exit routine ATTN1 executes and PANEL1 redisplay.

Nested CLISTs with One Attention Exit:

1. From a selection panel, select a CLIST procedure named CLIST1. CLIST1 has one attention exit routine, named ATTN1.
2. CLIST1 invokes procedure CLIST2 by using the TSO EXEC command. CLIST2 has no attention exit routine.
3. CLIST2 displays PANEL2.
4. Press the attention key.
5. Exit routine ATTN1 executes and PANEL2 redisplay.
6. Press Enter to return control to CLIST2. CLIST2 then terminates processing and control returns to CLIST1.
7. CLIST1 displays PANEL1.
8. Press the attention key.
9. Exit routine ATTN1 executes and PANEL1 redisplay.

Nested CLISTs and SELECT Levels with One Attention Exit:

1. From a selection panel, select a CLIST procedure named CLIST1. CLIST1 has one attention exit routine, named ATTN1.
2. CLIST1 invokes procedure CLIST2 by using the ISPEXEC SELECT CMD(CLIST2) command. CLIST2 has no attention exit routine.
3. Press the attention key.

4. Because CLIST2 has no attention exit routine, and ISPF does not propagate attention exits across SELECT levels:
 - An error message indicates that a CLIST was interrupted by an attention condition.
 - The logical screen terminates and restarts, causing the primary option menu to redisplay.

Using APL2

ISPF permits the use of APL2, as follows:

- ISPF dialogs can be written in an APL2 workspace.
- APL2 can be selected as a command, initializing an ISPF-APL2 environment.
- APL2 functions can be selected as options (from a selection panel), as ISPF commands (from an application command table), or from another dialog function, once the ISPF-APL2 environment has been established.
- All dialog manager services available to the command language dialog writer are executable from the APL2 workspace after the ISPF-APL2 environment has been established.
- ISPF views the APL2 workspace variables as the dialog function pool whenever an ISPF dialog service is executing.
- ISPF supports APL on a DBCS device with an APL keyboard.

The ISPF/GDDM interface is not available to an APL2 dialog. However, the APL2 dialog can interface directly with GDDM and interleave the ISPF and GDDM services.

Invoking APL2

You can invoke APL2 by specifying the APL2 command and its appropriate keywords as the value of the CMD keyword of the SELECT service. You must also code the SELECT keyword and the value LANG(APL) on the SELECT statement. The LANG(APL) parameter provides the basis for establishing an ISPF-APL2 environment. It is required if any ISPF dialog services are to be used.

You can code any of the APL2 command keywords. However, the following can be of special interest:

APNAMES

ISPF and APL2 communicate through an APL2 Auxiliary Processor (AP), ISPAP AUX, which is released with the ISPF product. This AP, number 317, must be made available to APL2 when APL2 is invoked, as follows:

- The dialog writer can specify ISPAP AUX in the APNAMES list of auxiliary processors to be dynamically loaded.

When APL2 is invoked, ISPAP AUX must exist as a load module in a system library, or in a private library named by the LOADLIB keyword.

LOADLIB

Keep in mind that if this keyword is used, the dialog must be changed or accept this keyword's value dynamically (for example, through a variable), if the name of the private library containing the AP is changed.

TERMCODE (code)

The user is prompted to enter an appropriate character if this keyword is not coded. This allows APL2 to identify the terminal type that is currently being used.

Typically, a dialog ensures that the user does not have to perform this extra step by identifying the terminal type through the TERMCODE keyword.

ISPF system variable ZTERM contains this information. However, ISPF terminal types are different from those of APL2. For those dialog writers who wish to make use of currently available ISPF information, program dialog ISPAPTT can be selected before the call of APL2. ISPAPTT expects one parameter, which is the ISPF variable name into which the corresponding APL2 terminal type is returned. The variable is created in the shared variable pool.

For a CLIST, the use of ISPAPTT can look as follows:

```

:
ISPEXEC SELECT PGM(ISPAPTT) PARM(APLTT)
ISPEXEC VGET APLTT
ISPEXEC SELECT CMD(APL2.....TERMCODE(&APLTT)) LANG(APL)
:

```

The following ISPF to APL2 mappings are supported:

ISPF (ZTERM)	APL2
3277	3277
3278	3279
3277A	32771
3278A	32791
3278T	32791
3278CF	3279
3277KN	3277
3278KN	3279

If ISPF is executing in the background, then ISPAPTT will return a terminal code of 1.

If ZTERM contains a value other than those listed above, the specified variable is set to a value of 3277 in the shared variable pool.

FREESIZE, WSSIZE

Some combination of these keywords should be coded to accommodate the user's storage requirements; however, remember that ISPF and the ISPF-APL2 AP require storage (beyond that currently allocated) to execute, especially if ISPF split-screen facilities are to be used.

INPUT

A user dialog can specify the INPUT keyword to load a given workspace, start an APL2 dialog function, and terminate APL2. This allows a user to enter APL2, use APL2 dialog capabilities, and leave APL2 without needing special APL2 expertise.

For example, to start a dialog named EMPLOY in workspace MYWS:

```
.....INPUT(')LOAD MYWS' 'EMPLOY' ')OFF HOLD').....
```

Note that a dialog function can also be started through the latent function definition in the workspace. In addition, the Alternate Input Auxiliary Processor, AP101, can be used to stack commands for execution.

If INPUT is coded and QUIET and PROFILE are not coded (see below), the first ISPF panel can be refreshed before the keyboard is unlocked.

QUIET

A dialog can specify the QUIET keyword to suppress the APL2 entry and exit information, so that the user does not see non-dialog APL2 messages.

PROFILE

A dialog can specify the PROFILE keyword with a value of null to suppress any entry and exit APL2 session manager screens, so that the user does not see any non-dialog panels.

Executing APL2 Functions

It is possible to start an APL2 function dialog by using the INPUT keyword, as described in “Invoking APL2” on page 29. However, for many applications it is necessary to invoke additional APL2 functions as options (from a selection panel), as commands (from an application command table), or from other dialog functions.

Such functions are selected by specifying the function request as the value of the SELECT CMD keyword, and once again, specifying LANG(APL). Because APL2 has already been started, and the APL2 environment established, the string is passed back to the APL2 workspace, and an APL2 EXECUTE function is performed on the string. For example, option 5 on a selection panel can be defined to APL2 function AVG (assuming that APL2 has already been started) as follows:

```
⋮  
5, 'CMD(AVG 1 2 3 4 5) LANG(APL)'  
⋮
```

The return code for the selected function is passed back as a fullword of 0 (zero) if no terminating (to a quad-EA) APL2 errors have occurred. Otherwise, a fullword consisting of the quad-ET values in the two halfwords is returned.

APL2 cannot be invoked more than once, either within the same screen or on more than one screen. ISPF does nothing to prevent the second call. If APL2 is invoked a second time while running under ISPF, the results are unpredictable. Note that ISPF’s split-screen capabilities can be used as long as APL2 is not invoked on a second screen.

Invoking ISPF Dialog Services in the APL2 Environment

A dialog service can be invoked by using the *function form* of ISPEXEC:

```
[n] lastrc←ISPEXEC character-vector
```

lastrc

Specifies the name of an APL2 variable in which the return code from the service is to be stored.

character-vector

Specifies a vector of characters that contains parameters to be passed to the dialog service. The format of the vector is the same as that for dialog service statements for command procedures written in CLIST.

A workspace containing the ISPEXEC function is provided with ISPF. All dialog writers must use this ISPEXEC function, as it contains the interface to ISPF and handles the implementation of commands (through the APL2 EXECUTE function); otherwise, results are unpredictable.

For example:

```

[1]      OPEN THE TABLE
[2]      LASTCC←ISPEXEC 'TBOPEN TABLE NOWRITE'
[3]      →(LASTCC = 0)/NORMALCONT
[4]      PROCESS ERRORS HERE

[15]     NORMALCONT:.....

```

APL2 Workspace as the ISPF Function Pool

When an APL2 function invokes an ISPF dialog service, the APL2 workspace is considered to be the ISPF function pool. The dialog writer need not do anything special to make use of this mechanism. However, the following restrictions apply:

- Any variable retrieved or set is the most local to the currently executing APL2 function.
- The dialog writer should not use variables whose names begin with the three characters ISP; these names are reserved for ISPF. All variables used in the ISPEXEC function have names that start with these three characters.
- Only those variables whose names and formats fit both ISPF and APL2 protocols can be used for ISPF entities such as panels or tables:
 - All variable names must be 1 to 8 characters in length, composed of alphanumeric characters (A–Z, 0–9), of which the first must not be numeric. Note that #, \$, and @ are not allowed.
 - All variable values must be simple character strings; APL2 general data types are not allowed. Note that the only acceptable null vector is that for character strings (“”).

If an attempt is made to use a name or format incompatible with ISPF for an ISPF entity, a severe error occurs. Any APL2 name or format can be used within a dialog function, as long as that variable is not used for an ISPF entity.

- Whenever an APL2 function is selected after APL2 is started, the original APL2 function pool (the APL2 workspace) is used. This implies that information can remain in the function pool from previous SELECTs, and the dialog writer must handle any such cases. Moreover, this rule is unaffected by SELECTs where new shared or profile pools are created; it is the responsibility of the dialog writer to ensure that the integrity of the workspace is maintained.
- If the PDF component is installed, and the Dialog Test Variables option is requested, only those variables that have the correct name and format are displayed; if an attempt is made to enter a variable with a name that is not valid (to ISPF or APL2), an error occurs. The variables displayed are the most local to the currently executing function.
- A maximum of 64K bytes can be retrieved from the APL2 workspace during the execution of a DM service.

Interface between ISPF and APL2

The interface between ISPF and APL2 is like a telephone call. If one side of the communication is broken, any attempt to use the interface causes error messages to be generated. The link between the two products can be broken by:

- The APL2 user “hanging up”. For example, if a new workspace is loaded and there are still ISPF service requests that have not completed (for example, options in the selection panel process), the ISPF Auxiliary Processor (ISPAP AUX) issues an error message, informs ISPF and waits for the process to begin again

(by “hanging up” until another ISPF request is made). ISPF issues a severe error message telling the user that the link has been damaged.

If the user is in ISPF TEST mode, then, on user request, ISPF attempts to reshow all panels traversed in an effort to unnest all service requests. When all requests have been unnested, ISPF will again wait for the ISPF Auxiliary Processor to make a request. During the unnesting process, any attempts to invoke APL2 functions are rejected, severe error messages are issued, and any requests for APL2 variables are logged.

- The APL2 user “cutting the line”. For example, if the user terminates APL2 while there are still outstanding APL2 function requests from ISPF (for example, options in the selection panel process), the ISPF Auxiliary Processor (ISPAP AUX) issues an error message, informs ISPF, and terminates. ISPF issues a severe error message telling the user that the link has been damaged, and if in TEST mode, proceeds to unnest as described above. When all requests have been unnested, APL2 will be terminated. During the unnesting process, any attempts to invoke APL2 functions are rejected, severe error messages are issued, and any requests for APL2 variables are logged.
- An APL2 failure. This is handled as if the line were cut, assuming APL2 performs recovery and returns to ISPF.
- An ISPF failure. In this case, ISPF or the logical screen can fail, causing APL2 termination.

Subtasking Support

A dialog attached by ISPF, as described in “Invoking TSO Commands” on page 26, can invoke a dialog service. It does this by a call to either the ISPLINK or ISPEXEC interfaces from any subtask level. For subtasks to issue ISPF services, the program that attaches these subtasks must be invoked with the `SELECT(cmd)` service.

In addition, ISPF allows a task to detach its subtask at any time, even if an ISPF service invoked by that subtask is processing. The SUBTASK keyword of the CONTROL service, described in *z/OS ISPF Services Guide*, provides additional information. Multiple dialog services issued from multiple tasks executing asynchronously are not supported, and results will be unpredictable.

ESTAE Restrictions

Programs that code their own ESTAE routines should not issue ISPF services within the MVS ESTAE routine. Unpredictable results can occur. For more information on ESTAE, refer to *z/OS MVS Programming: Assembler Services Reference ABE-HSP*. For more information on using MVS macros, refer to *z/OS MVS Programming: Assembler Services Guide*.

ISPF Services in Batch Mode

When initiated in a batch environment, ISPF services execute as a background command. Background calls are generally used to invoke ISPF table and file tailoring services. However, access to other dialog services is also available.

Command Processors in the TSO Batch Environment

TSO provides facilities for executing command processors in the batch environment. The JCL stream provides for data sets to be preallocated before the call of any command. Invoke the Terminal Monitor Program (TMP) using the EXEC statement to establish the necessary control blocks for the TSO environment.

The command input stream is accessed from the SYSTSIN DD statement. All terminal line I/O outputs issued by the TSO I/O service routines are directed to the SYSTSPRT DD statement definition. Allocate ISPF libraries by using DD statements. Panel, message, skeleton, table, and profile data sets must be preallocated. While not required, it is recommended that the log data set also be preallocated. If a log data set is dynamically allocated, it is always kept at ISPF termination.

To invoke ISPF, place the ISPSTART command in the SYSTSIN input stream with the PANEL, CMD, or PGM keywords that name the dialog to be invoked.

Note: When running on MVS with TSO/E Version 2 Release 1, ISPF does not read and execute the CLIST statements that follow the ISPSTART command. With ISPF running in batch (background) mode in the MVS environment with TSO/E Version 2 Release 1, you can select a CLIST procedure.

A user ID is selected for the background job as follows:

1. If available, the user ID supplied during RACF[®] authorization checking is used.
2. If a user ID is not available from RACF, the prefix supplied with the TSO PROFILE command is used.
3. If neither of the above is available, the default is BATCH.

Although the user ID defaults to BATCH, the prefix used by ISPF when dynamically allocating a data set has no default. Therefore, a prefix should always be supplied on the TSO PROFILE command. At various times, ISPF attempts dynamic allocation and if no prefix has been supplied, allocation will fail and the job will abend. Multiple jobs executing concurrently must have unique prefixes.

The contents of positions 17–24 in system variable ZENVIR indicate whether ISPF is running interactively (TSO followed by five blanks) or background (BATCH followed by three blanks).

Sample Batch Job

Figure 15 on page 35 shows a sample batch job. This job invokes the MVS/TSO Terminal Monitor Program (TMP) which, in MVS, establishes the environment necessary to attach command processors. The ISPSTART command is specified in the TSO background input stream (SYSTSIN) with the name of a CLIST (TBUPDATE) that contains the ISPF services to be executed.

```

//USERAA JOB (AA04,BIN1,000000),'I. M. USERAA',
// CLASS=L,MSGCLASS=A,NOTIFY=USERAA,MSGLEVEL=(1,1)
//*-----*/
//* EXECUTE ISPF COMMAND IN THE BACKGROUND */
//*-----*/
//*
//ISPFBACK EXEC PGM=IKJEFT01,DYNAMNBR=25,REGION=1024K
//*- - ALLOCATE PROFILE, PANELS, MSGS, PROCS, AND TABLES -*/
//ISPPROF DD DSN=USERAA.ISPF.PROFILE,DISP=OLD
//ISPPLIB DD DSN=ISP.SISPPENU,DISP=SHR
//ISPLIB DD DSN=ISP.SISPMENU,DISP=SHR
//ISPSLIB DD DSN=ISP.SISPSENU,DISP=SHR
// DD DSN=ISP.SISPSLIB,DISP=SHR
//ISPTLIB DD DSN=USERAA.ISPF.TABLES,DISP=SHR
// DD DSN=ISP.SISPTENU,DISP=SHR
// DD DSN=ISP.SISPTLIB,DISP=SHR
//ISPTABL DD DSN=USERAA.ISPF.TABLES,DISP=SHR
//*
//*- - ALLOCATE ISPF LOG DATA SET - - - - -*/
//ISPLOG DD DSN=USERAA.ISPF.LOG,DISP=SHR
//*
//*- - ALLOCATE DIALOG PROGRAM AND TSO COMMAND LIBRARIES -*/
//ISPLLIB DD DSN=USERAA.ISPF.LOAD,DISP=SHR
//SYSEXEC DD DSN=ISP.SISPEXEC,DISP=SHR
//SYSPROC DD DSN=ISP.SISPCLIB,DISP=SHR
//*
//*- - ALLOCATE TSO BACKGROUND OUTPUT AND INPUT DS - - -*/
//SYSTSPRT DD DSN=USERAA.ISPF.ISPFPRNT,DISP=SHR
//SYSTSIN DD *
        PROFILE PREFIX(USERAA) /* ESTABLISH PREFIX */
        ISPSTART CMD(%TBUPDATE) /* INVOKE CLIST DIALOG */
/*

```

Figure 15. MVS Batch Job

Processing Errors

ISPF terminates with an error message if a required library is not available. The ISPSTART command must also be invoked naming either a CLIST, PGM function, or selection panel. If no dialog is specified, a message is issued. These messages are directed to the data set defined by the SYSTSPRT DD statement.

Errors encountered during background dialog execution are handled in the same manner as errors encountered during foreground execution. Messages normally written to the ISPF log data set for severe errors are also written to the SYSTSPRT file. This is useful when executing a CLIST dialog because any error messages are listed immediately after the ISPEXEC service in which the error occurred.

If a function encounters an abend, the entire ISPF batch job stream terminates. A message is issued to the SYSTSPRT file indicating the type of abend.

Batch Display Facility for Background Panel Processing

The Batch Display Facility allows applications to simulate full-screen write operations while ISPF is executing in the background. This requires that dialogs provide the input to ISPF that would normally be supplied by the user or by information associated with the type of terminal being used. Much of this is done by having the dialog assign values to panel input variables, and by supplying screen size information through keywords on the ISPSTART command.

Batch execution has traditionally not allowed the use of services that require user interaction. Any full-screen write operation would result in an error condition.

The Batch Display Facility overcomes these limitations. Although there is no user interaction during execution; the Batch Display Facility does allow background execution of interactive services. These services include:

- DISPLAY
- TBDISPL
- SELECT PANEL
- SETMSG
- PQUERY

These services are issued for batch just as they are issued for dialogs running in interactive mode. ISPF GDDM services do not run in the background, and thus, cannot be requested in a batch environment.

All ISPF commands except SPLIT and SPLITV can be executed in dialogs running in batch mode.

Installations can easily convert current interactive applications that use these services so they run in a batch environment. When you are running in a batch environment, you cannot direct your display to a workstation; that is, the GUI parameter on the ISPSTART command is not supported in a batch environment.

Supplying Input in Lieu of Interactive Users

When an application is running in batch, there is no user to respond to panel input operations. Therefore, the primary requirement for running interactive applications in batch is to supply expected input data by an alternate means. For example, panel variables can be given values by dialog function statements or by the processing specified in the panel's executable sections. This processing is begun in the batch environment as though a user had pressed Enter. In the absence of an alternative action on the dialog's part, ISPF assumes an ENTER condition following a panel display.

A dialog can override the ENTER condition and establish an END condition by doing one of the following:

- Using the .RESP control variable
- Setting the panel command field to END
- Issuing a CONTROL NONDISPL END before the display operation.

Supplying Batch Terminal Characteristics

In a batch environment there is no terminal from which ISPF can get screen width and screen depth values, so you must supply to ISPF data related to terminal type. You can include two optional keywords, BATSCRW and BATSCRD, on the ISPSTART command line to specify, respectively, screen width and screen depth values. The default values, if you do not include these keywords, are a screen width of 80 characters and a screen depth of 32 lines. The width and depth values, whether specified on the ISPSTART command or through the default values, establish the values in system variables ZSCREENW, ZSCREEND, ZSCRMAXW, and ZSCRMAXD.

In addition to the display services, use of the PQUERY service requires that the screen width and depth values be supplied to ISPF, either through default values or as defined on the ISPSTART command.

When running batch, terminal characteristics cannot be changed during a session, although some characteristics can be changed during an interactive session. For

example, when ISPF is running interactively you can specify 3278 Model 5 and 3290 screen formatting. In batch mode, a dialog does not interact with a physical screen. Therefore, screen size, specified by including the BATSCRW and BATSCRD keywords on the ISPSTART command, is fixed for the duration of the batch session.

When running in batch mode, you can include the BDBCS keyword on the ISPSTART command. ISPF then processes the dialog as though it were running on a DBCS terminal.

The value in system variable ZCOLORS defines the number of colors (either 1 or 7) that a terminal can display. In batch mode, ISPF sets ZCOLORS to 1.

The value in system variable ZHILITE (YES or NO) determines if a terminal is to have extended highlighting capability, including underscore, blinking, and reverse video. In batch mode, ISPF sets ZHILITE to NO.

Message Processing in the Batch Environment

In an interactive environment ISPF displays two types of messages:

- Informational messages, normally those resulting from the MSG keyword specified on the SETMSG, DISPLAY, or TBDISPL service
- Error messages, including those resulting from the .MSG control variable in an executable panel section.

When running in a batch environment, ISPF writes any informational or error messages to the ISPF log data set at the processing point that the messages would normally be displayed to a user. The information logged includes the name of the panel associated with the message, followed by the short message and the long message.

A .MSG-initiated error message plus an ENTER condition causes a panel redisplay. In a batch environment, there is no interactive user to correct the error, so it must be handled by statements in the panel's)REINIT or)PROC sections. This leads to the possibility of a .MSG-redisplay loop if the error condition is not corrected. Some panel language functions that can lead to this problem are VER, TRANS, ADDSOSI, DELSOSI, .MSG, and PANEXIT. To prevent this loop, a BREDIMAX keyword on the ISPSTART command is available to specify the maximum number (default 2) of redispays. If this number of redispays is exceeded, a severe error condition (return code 20) results and the related error message is written to SYSTSPRT.

Command Processing in the Batch Environment

ISPF processes most commands when running in the batch environment in the same way it processes them when running interactively, except the following:

- The SPLIT and SPLITV commands are disabled
- The ENVIRON, LOG, LIST, ISPPREP, KEYS, ZKEYS, and PFSHOW TAILOR commands can result in display loops.

Display Error Processing in the Batch Environment

When ISPF is running interactively with CONTROL ERRORS CANCEL in effect, a return code of 12 or higher causes the ISPF error panel to display. These same conditions in the batch environment cause the error panel message to be written to the SYSTSPRT data set, after which ISPF terminates. In the interactive or batch environment with CONTROL ERRORS RETURN in effect, control returns to the dialog for error processing following a return code of 12 or higher.

How ISPF Handles Log and List Data Sets in the Batch Environment

If ISPF allocates a log or list data set in the batch environment, it is always kept at termination, regardless of the disposition specified on SETTINGS Option 0.

Avoiding Panel Loop Conditions in the Batch Environment

When writing new dialogs or altering existing dialogs to run in the batch environment, dialog developers must be very careful not to create functions that result in a processing loop where user input is expected and none is supplied. See “Supplying Input in Lieu of Interactive Users” on page 36 for more information. For example, running the ISPPREP command causes ISPF to call an interactive ISPPREP dialog, which will cause a loop condition in a batch environment. Instead, you should invoke the non-interactive ISPPREP facility directly by using the SELECT PGM(ISPPREP) service request as described for batch mode under Figure 53 on page 151.

The KEYS command can cause a loop condition because its processing termination depends on an END or RETURN command. An ENTER condition, which ISPF assumes in absence of an END or RETURN being forced, results only in another panel display, which leads to a loop condition.

To help deal with possible looping situations, the BDISPMAX keyword on the ISPSTART command is available to specify the maximum number of panel displays that can occur during a session. The default value is 100. You can test the current number of displays in a batch mode session by reading the ZBDMXCNT system variable. The value of BDISPMAX is stored in the ZBDMAX system variable.

If the number specified in BDISPMAX is exceeded, a severe error condition (return code 20) results and an error message, stating that the maximum number of displays has been exceeded, is written to the SYSTSPRT data set.

ISPF Graphical User Interface in Batch Mode

ISPF provides the capability to run the ISPF Client/Server (C/S) component in a batch environment. You can start ISPF using the GUI parameter to enable a C/S session to run on a specific workstation without tying up the invoking session.

This function also enables you to capture REXX trace output (in SYSTSPRT), and to invoke ISPF without a 3270 terminal, such as through an icon on the workstation through APPC or TCP/IP, or through a Telnet linemode session.

Restrictions

When using the batch mode capabilities of the C/S, be sure to consider these restrictions:

- The number of initiators on the batch machine. Because the JCL remains resident for the duration of the session, you should be aware that you have reduced the number of available initiators for other uses.
- The limitation of the C/S Server to 30 sessions.
- Each batch session must have a unique profile (just like each user ID).
- The PA1 key is not available within the GUI environment.
- Full-screen TPUT function is not supported.
- Because you are in batch mode, and therefore you are *not* using a TSO emulator, GDDM is disabled and TSO line-mode output is not available.

- Other TSO batch limitations. Some commands might not be supported in GUI Batch mode because of the inability to provide terminal input to them (such as RECEIVE). Refer to the *z/OS TSO/E User's Guide* for more information about running TSO in batch mode.

Example JCL: Invoking Client/Server in Batch Mode

The JCL job that follows can be run from your MVS session to invoke ISPF running the Client/Server in batch mode. Before submitting this JCL job, you must update it with this information:

- The jobcard information in line 1 must be furnished, and a unique jobname must be used.
- Update "userid.PRIVATE" with your private libraries, if needed. If you do not use private libraries, remove those data sets from the concatenation.
- If your ISPF product data sets are not named "ISP.SISxxxx", update the data set names.
- Update the TSO profile.
- Update the ISPSTART invocation with the session title.
- Update the GUI() keyword for either TCPIP (your_ip_address) or APPC (your_lu_name), and remove the other keyword.

```
//userid0    your jobcard information here
//* JCL TO RUN ISPF IN BATCH
//WSGUI     EXEC PGM=IKJEFT01,REGION=4096K,TIME=1439,DYNAMNBR=200
//STEPLIB  DD DSN=ISP.SISPLPA,DISP=SHR
//          DD DSN=ISP.SISPLOAD,DISP=SHR
//          DD DSN=ISP.SISPSASC,DISP=SHR
//          DD DSN=userid.PRIVATE.LOAD,DISP=SHR
//ISPLLIB  DD DSN=ISP.SISPLPA,DISP=SHR
//          DD DSN=ISP.SISPLOAD,DISP=SHR
//          DD DSN=ISP.SISPSASC,DISP=SHR
//          DD DSN=userid.PRIVATE.LOAD,DISP=SHR
//SYSEXEC  DD DSN=userid.PRIVATE.EXEC,DISP=SHR
//          DD DSN=ISP.SISPEXEC,DISP=SHR
//SYSPROC  DD DSN=userid.PRIVATE.CLIST,DISP=SHR
//          DD DSN=ISP.SISPCLIB,DISP=SHR
//ISPLLIB  DD DSN=userid.PRIVATE.MSGS,DISP=SHR
//          DD DSN=ISP.SISPMENU,DISP=SHR
//ISPPLIB  DD DSN=userid.PRIVATE.PANELS,DISP=SHR
//          DD DSN=ISP.SISPPENU,DISP=SHR
//ISPSLIB  DD DSN=userid.PRIVATE.SKELS,DISP=SHR
//          DD DSN=ISP.SISPSLIB,DISP=SHR
//          DD DSN=ISP.SISPSENU,DISP=SHR
//SYSIN    DD DUMMY,DCB=(LRECL=120,BLKSIZE=2400,DSORG=PS,RECFM=FB)
//SYSUADS  DD DSN=SYS1.UADS,DISP=SHR
//SYSHelp  DD DSN=SYS1.HELP,DISP=SHR
```

Figure 16. Invoking Client/Server in Batch Mode (Part 1 of 2)

```

//ISPCTL0 DD UNIT=SYSDA,
//          SPACE=(TRK,(5,5)),
//          DCB=(RECFM=FB,LRECL=80,BLKSIZE=6160),
//          DISP=(,DELETE,DELETE)
//ISPCTL1 DD UNIT=SYSDA,
//          SPACE=(TRK,(5,5)),
//          DCB=(RECFM=FB,LRECL=80,BLKSIZE=6160),
//          DISP=(,DELETE,DELETE)
//ISPCTL2 DD UNIT=SYSDA,
//          SPACE=(TRK,(5,5)),
//          DCB=(RECFM=FB,LRECL=80,BLKSIZE=6160),
//          DISP=(,DELETE,DELETE)
//ISPWRK0 DD UNIT=SYSDA,
//          SPACE=(TRK,(5,5)),
//          DCB=(RECFM=FB,LRECL=256,BLKSIZE=2560),
//          DISP=(,DELETE,DELETE)
//ISPWRK1 DD UNIT=SYSDA,
//          SPACE=(TRK,(5,5)),
//          DCB=(RECFM=FB,LRECL=256,BLKSIZE=2560),
//          DISP=(,DELETE,DELETE)
//ISPWRK2 DD UNIT=SYSDA,
//          SPACE=(TRK,(5,5)),
//          DCB=(RECFM=FB,LRECL=256,BLKSIZE=2560),
//          DISP=(,DELETE,DELETE)
//ISPLST0 DD UNIT=SYSDA,
//          SPACE=(TRK,(5,5)),
//          DCB=(RECFM=FBA,LRECL=121,BLKSIZE=1210),
//          DISP=(,DELETE,DELETE)
//ISPLST1 DD UNIT=SYSDA,
//          SPACE=(TRK,(5,5)),
//          DCB=(RECFM=FBA,LRECL=121,BLKSIZE=1210),
//          DISP=(,DELETE,DELETE)
//ISPLST2 DD UNIT=SYSDA,
//          SPACE=(TRK,(5,5)),
//          DCB=(RECFM=FBA,LRECL=121,BLKSIZE=1210),
//          DISP=(,DELETE,DELETE)
//ISPTABL DD DSN=userid.PRIVATE.TABLES,DISP=SHR
//ISPTLIB DD DSN=userid.PRIVATE.TABLES,DISP=SHR
//          DD DSN=ISP.SISPTENU,DISP=SHR
//SYSUDUMP DD DUMMY
//ISPLOG DD SYSOUT=T,
//          DCB=(RECFM=VA,LRECL=125,BLKSIZE=129)
//ISPPROF DD DSN=userid.PRIVATE.TABLES,DISP=SHR
//SYSTSPRT DD DSN=userid.PRIVATE.TSOOUT,DISP=SHR
//*SYSTSPRT DD SYSOUT=(*)
//SYSPRINT DD SYSOUT=(*)
//SYSOUT DD SYSOUT=(*)
//SYSTSIN DD *
PROFILE PREFIX(profile)
PROFILE NOPROMPT
ISPSTART PANEL(ISR@PRIM) NEWAPPL(ISR) TITLE(your_session_title) +
          GUI(IP:your_ip_address) or GUI(LU:your_lu_name)

```

Figure 16. Invoking Client/Server in Batch Mode (Part 2 of 2)

Chapter 3. Introduction to Writing Dialogs

This chapter introduces you to how to write dialogs using the ISPF display, variable, table, file-tailoring, PDF, and other miscellaneous services. For more detailed information on using these services, refer to the *z/OS ISPF Services Guide*.

You can use the ISDPTRC command to trace both the execution of panel service calls (DISPLAY, TBDISPL, and TBQUERY) and the processing that occurs within the Dialog Manager panel code. For more information, refer to “Panel trace command (ISDPTRC)” on page 349.

Using the Display Services

The display services allow a dialog to display information and interpret responses from users. The display services are:

- ADDPOP** Start pop-up window mode. The ADDPOP service specifies that the following panel displays are to be in a pop-up window. It also identifies the location of the pop-up window on the screen in relation to the underlying panel or window.
- DISPLAY** Display a panel. The DISPLAY service reads a panel definition from the panel files, initializes variable information in the panel from the corresponding dialog variables in the function, shared, or profile variable pools, and displays the panel on the screen. Optionally, the DISPLAY service might superimpose a message on the display.
- After the user has entered information on the panel, the information is stored in the corresponding dialog variables in the function, shared, or profile variable pools, and the DISPLAY service returns control to the calling function.
- The COMMAND option on the DISPLAY service allows a dialog to pass a chain of commands to ISPF for execution. This option is explained fully in the *z/OS ISPF Services Guide*. Use of the DISPLAY service is illustrated in a function example later in this chapter.
- LIBDEF** Define optional search libraries. The LIBDEF service allows users to define an optional, application-level set of libraries containing, for example, messages or panels, to be searched before the IBM-supplied ISPF libraries. Refer to the *z/OS ISPF Services Guide* for more information.
- REMPop** Remove a pop-up window. The REMPOP service call removes a pop-up window from the screen.
- SELECT** Select a panel or function. The SELECT service is used to display a hierarchy of selection panels or invoke a function.
- SETMSG** Display a message on the next panel. The SETMSG service constructs a specified message from the message file in an ISPF system save area. The message will be superimposed on the next panel displayed by any DM service. The optional COND parameter allows you to specify that the message is to be displayed on the next panel only if there is no SETMSG request pending.

Display Services

TBDISPL Display a table. The TBDISPL service combines information from panel definitions with information stored in ISPF tables. It displays selected rows from a table, and allows the user to identify rows for processing.

Panel definitions used by the TBDISPL service contain nonscrollable text, including column headings, followed by one or more “model lines” that specify how each row from the table is to be formatted in the scrollable area of the display. For more information about TBDISPL, see “Defining Table Display Panels” on page 131 and the description of the TBDISPL service in *z/OS ISPF Services Guide*.

Example: Creating a Display with TBDISPL

The TBDISPL service displays information from an ISPF table on a panel formatted by information on a panel definition. Table 1 illustrates an ISPF table named TAB1.

Table 1. TBDISPL – ISPF Table

RANK	ID	CITY	STATE	POPCH	ROW
1	FLO621	Fort Myers	fl	+95.1	r1
2	NV1235	Las Vegas	nv	+69.0	r2
3	FL1972	Sarasota	fl	+68.0	r3
4	COO649	Fort Collins	co	+66.0	r4
5	FL2337	West Palm Beach	fl	+64.3	r5
6	FLO608	Fort Lauderdale	fl	+63.6	r6
7	TXO231	Bryan	tx	+61.5	r7
8	NV1833	Reno	nv	+60.0	r8
9	UT1656	Provo	ut	+58.4	r9
10	TX1321	McAllen	tx	+56.1	r10

Figure 17 on page 43 illustrates a panel definition named PAN1.

```

*****
* )Attr *
* @ Type(output) Intens(low) Just(asis) Caps(off) *
* )Body *
* ----- Population Change ----- *
* +Command ==>Cmdfld +Scroll ==>_samt+ *
* + *
* This table shows selected metropolitan areas which had a *
* *
* large relative increase in population from 1970 to 1980. *
* *
* +Metro area State Change *
* + (Percent) *
* )Model *
* @City @State @popchg+ *
* *
* )Init *
* &samt=page *
* )Proc *
* )End *
*****

```

---> (A, Figure 18)

-----> (B, Figure 18)

Figure 17. TDISPL Panel Definition

The)BODY section of PAN1 defines the fixed portion of the display, area “A” in Figure 17. The)MODEL section of PAN1 produces the scrollable portion of the display, area “B” in Figure 17.

There can be up to eight model lines. Panel PAN1 has only one. The scrollable portion of the display is formed by replicating the model lines to fill the screen. Each of these replications, as well as the original, is known as a model set. Each model set corresponds to a table row. Table rows are then read to fill in the appropriate fields in the model set replications.

PAN1 displays only three (city, state, and popchg) of the five columns of table TAB1. The model lines can include any number of the KEYS, NAMES, and extension variables of the table. They can also include fields that are not variables in the table. Figure 18 shows the effect of displaying information from TAB1 on panel PAN1.

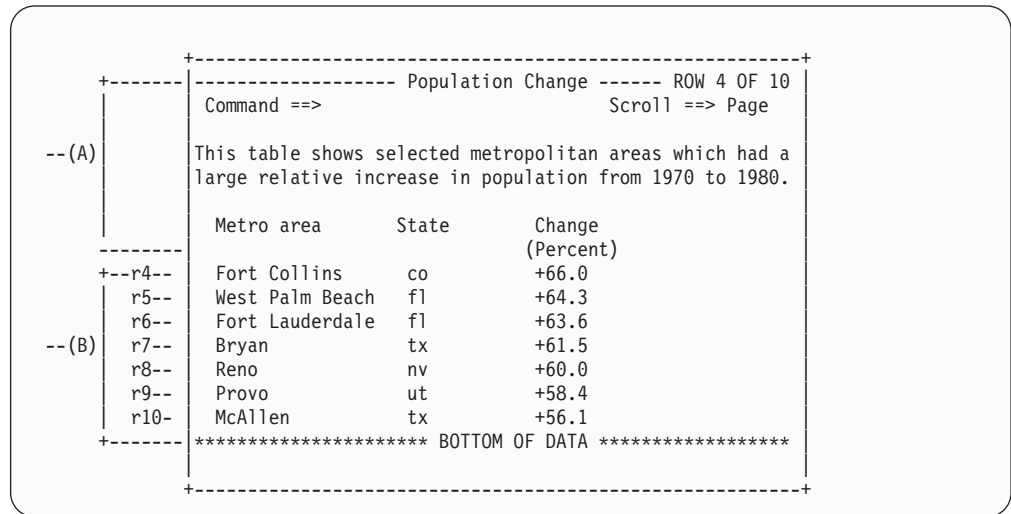

Figure 18. TDISPL Display

Display Services

When the TBDISPL service is invoked with the panel name specified, the scrollable portion begins with the current row. That is, the current row is the top row displayed. In this example, the current row pointer (CRP) for table TAB1 has been set to row 4. Table rows are read starting with row 4 to fill in the appropriate fields in the model set replications. If there were any non-table variables in the model line, they would be filled in with their current values. Because there aren't enough rows in the table to fill the screen, the bottom-of-data marker is placed in the display after the last row. The "empty" model sets beyond this marker are not displayed.

In Table 1 on page 42, the symbols r1 through r10 label the 10 rows in the table TAB1. The highlighted rows, r4 through r10, indicate that these rows provide the information for the scrollable portion of the display (marked as area B in Figure 18 on page 43).

Figure 18 on page 43 is the result of using the TBDISPL service with panel definition PAN1 (Figure 17 on page 43) and ISPF table TAB1 (Table 1 on page 42). Portion A is the fixed portion defined by the)BODY section of PAN1. Portion B is the scrollable portion defined by the)MODEL section of PAN1. The table information in the display is the specified columns from row 4 to row 10.

Processing Selected Rows

When a user changes data in a model set, the corresponding table row is said to be selected for processing. More than one row can be selected in a single interaction. Before the TBDISPL service returns control to the dialog function, the CRP is positioned to the first of the selected rows. *First* means the row closest to the top of the table, not the row that was selected first. The other selected rows are called pending selected rows.

When the CRP is positioned at a selected row, the row is retrieved, meaning the values from that row are stored in the appropriate dialog variables. Then, all input fields in the selected model set on the display are stored in the corresponding dialog variables.

The dialog function can then process the row in any manner it chooses. For example, the function can invoke the TBPUR service to update the row, or it can invoke the BROWSE service to examine a file specified in that row.

A call of the TBDISPL service is required to position the CRP to each pending selected row. For these calls, neither the PANEL nor MSG parameter should be specified.

The system variable ZTDSELS contains the number of selected rows. It can be tested by the dialog function or in the)PROC section of the table display panel to determine if any rows were selected. For example:

```
)PROC
. . .          /* Process fixed portion fields */
  IF (&ZTDSELS = 0000) /* Any selected rows? */
. . .          /* Process scrollable portion flds*/
)END
```

The interpretation of this variable is as follows:

0000 No selected rows
0001 One selected row (now the current row)

- 0002 Two selected rows, consisting of the current row and a pending selected row
- 0003 Three selected rows, consisting of the current row and two pending selected rows
- ⋮
- n “n” selected rows, consisting of the current row and “n-1” pending selected rows.

As TBDISPL is reinvoked without the PANEL and MSG parameters (to process any pending selected rows), ZTDSELS is decremented by one. An example is shown in Table 2.

Table 2. ZTDSELS Decrementation

DM Service	User Action	Value of ZTDSELS
TBDISPL TAB1 PANEL(PAN1)	Selects 3 rows	0003 (current row plus two pending selected rows)
TBDISPL TAB1	None	0002 (current row plus one pending selected row)
TBDISPL TAB1	None	0001 (current row; no pending selected rows)

Adding Table Rows Dynamically during Table Display Scrolling

Assume that you have access to a large amount of related data that might be built into a single table. However, you need to interface with only a subset of that data during an ISPF session, but you are not sure just how extensive that subset is. Normally, you would have to initially construct a table that included all possible data that you might wish to access during a session before you began scrolling and update activity on the table. This could lead to a great deal of unnecessary overhead because you might include a lot of data in your table that you never access.

By interacting with a set of function system variables, an ISPF function can dynamically expand the table as you scroll through it during a session. The function can specify that the table is to be expanded upward when the user has scrolled past the top, expanded downward when the user has scrolled past the bottom, or both. In this way, the function adds only the table rows that satisfy your needs as you need them.

System Variables Are the ISPF-Function Interface

Eight system variables in the function pool are the vehicle for passing, between ISPF and the function, values that control table expansion. These variables and the functions they perform are:

ZTDRET (input; length 8)

The function sets variable ZTDRET in the function pool to a value (UP, DOWN, or VERTICAL) that indicates to ISPF when control is to return to the function so that more rows can be added to the table being processed.

ZTDADD (output; length 3)

ISPF sets this variable to either YES or NO before returning control to the function. A value of YES indicates that the function needs to add more rows to the table being processed. ZTDADD is normally set to NO, indicating that no more rows need to be added to the table.

ZTDSCR (input/output; length 6)

This variable is set to the row pointer (number of the row relative to the top of the table) of the row that is to be at the top of the panel's scrollable area after the scroll request is processed. If ISPF cannot determine this value, this variable is set to zero.

ZTDSRID (output; length 6)

ISPF sets this variable to the row ID of the row pointed to by the value in variable ZTDSCR. During table processing, the row pointer value for a given row can change. However, the row ID of that row does not change.

ZTDAMT (output; length 4)

When ISPF returns control to the function with the value of variable ZTDADD set to YES, the value that ISPF has set in variable ZTDAMT tells the function how many rows, based on the information available, ISPF calculates should be added to the table to satisfy the current scroll request.

ZTDSIZE (output; length 4)

ISPF sets the value of ZTDSIZE to the total number of model sets; that is, the number of table rows that fill the scrollable area of the panel. This is not necessarily the same as the number of lines displayed in the panel's scrollable area.

ZTDLTOP (input; length 6)

The function can optionally set this variable to a value for ISPF to use in calculating the value x (top-row-displayed) in the indicator 'ROW x OF y ', which ISPF displays on a TBDISPL screen.

ZTDLROWS (input; length 6)

The function can optionally set this variable to a value for ISPF to use as the value y (total rows in the logical table) in the indicator 'ROW x OF y '.

You can define variables ZTDAMT, ZTDSCR, ZTDSRID, ZTDSIZE, ZTDLTOP, and ZTDLROWS as fullword fixed binary in a program function. If you do not, the default for each of these variables is character with lengths as specified in the system variable charts in the Appendix E, "System Variables," on page 385.

Dynamic Table Building: To put the dynamic table building concept into practice, a function first builds a basic table structure. The initial size of this table is determined by balancing the minimum amount of table data that would satisfy most anticipated user needs against the overhead of including a large amount of table data to cover more contingencies. As more table rows are needed to satisfy scroll requests, ISPF returns control to the function so that it can add those rows.

When a user issues a scroll request, there might be input fields in a panel that have been typed into (selected for processing). In that case, the dialog first processes all selected rows and then issues a TBDISPL request, without panel name, to cause the panel to redisplay. If no table rows are needed to fill the scroll request, ISPF completes the scroll and redisplay the panel. If more table rows are needed to fill the scroll request, ISPF returns control to the function to add table rows. Keep in mind that each time control returns to the function, the)PROC section of the panel from which the table display was requested is executed. After adding the table rows, the function issues a TBDISPL without a panel name to complete the scroll and redisplay. Remember, specifying a panel name on a TBDISPL request nullifies any pending selected rows or request for scrolling.

The values of a set of system variables in the function pool are the parameters used in the interchange between ISPF and a function when dynamically increasing the table size.

Using Variable ZTDRET

The need for expanding a table occurs when a user scrolls beyond the top or bottom of the table while using the TBDISPL service. The function must set variable ZTDRET to a value that tells ISPF when to return control so the function can expand the table. The function sets ZTDRET to one of three possible values:

- UP** Control returns to the function when the top of the scrollable data is reached. This applies when you are building the table upward from the bottom. The value UP has no effect when the bottom of the scrollable data is reached.
- DOWN** Control returns to the function when the bottom of scrollable data is reached. This applies when you are building the table downward from the top. The value DOWN has no effect when the top of the scrollable data is reached.
- VERTICAL** Control returns to the function when the top or bottom of the scrollable data is reached.

The value in ZTDRET must be left-justified (no leading blanks). ISPF evaluates the value of ZTDRET only when the function issues a TBDISPL request *with a panel name specified*. This is true, even though in the interim, the function might change the value of ZTDRET and issue TBDISPL requests without a panel name specified. A TBDISPL request with a panel name specified also nullifies processing of any pending selected table rows and any pending scroll request.

When a scroll request is pending, a TBDISPL request with a message ID specified (but without a panel name specified) causes the panel to be redisplayed with the message, but the scroll request is nullified.

Using Variable ZTDADD

Before returning control to a function from a TBDISPL request, ISPF sets function variable ZTDADD to YES or NO, indicating to the function whether rows are to be added to the table. The function normally receives a return code of 0 from the TBDISPL service. It can then interrogate variable ZTDADD. If its value is 'YES', then ZTDSCRIP, ZTDSRID, ZTDAMT, and ZTDSIZE contain valid values.

ISPF normally returns control to the function for reasons other than to add table rows. In those cases, ISPF sets the value of ZTDADD to NO. For example, the function might need to interact with table rows that have been selected for processing during a table display.

Using Variable ZTDAMT

When ISPF returns control to a function with variable ZTDADD set to YES, the function must add rows to the table. If rows must be added to the table to satisfy a scroll request, ISPF calculates, when possible, the number of rows that need to be added to the table and returns that value to the function in variable ZTDAMT. The function should use this value for determining the number of rows to add.

For some scroll requests, such as UP MAX or DOWN MAX, ISPF cannot determine the number of rows to be added to the table. In those cases, ISPF returns a value of 0 to the function in ZTDAMT.

Using Variables ZTDSCRIP and ZTDSRID

When ZTDSCRIP contains a value other than 0, that value is the number of the table row that is to be at the top of the panel's scrollable area when the panel is redisplayed. ISPF sets ZTDSCRIP to a nonzero value if a user has requested a

Display Services

downward scroll such that, when ISPF redisplay the panel following the scroll, the top row displayed in the scrollable area existed in the table at the time of the scroll request.

When the user requests an UP MAX or DOWN MAX, ISPF does not require the ZTDSCRIP value to position the table when it is redisplayed following the scroll. It simply positions the table in the scrollable display area relative to the top table row (UP MAX) or the bottom-of-data marker (DOWN MAX).

For other scroll requests that require that rows be added to the table, ISPF may not be able to determine what the value of ZTDSCRIP should be. In other words, one of the table rows to be added by the function will be the new top row displayed. ISPF has no way of knowing what the number of that row will be. In those cases, ISPF returns a value of 0 to the function.

If a function receives a value of 0 in ZTDSCRIP (other than for UP MAX or DOWN MAX), it must set the variable's value to the number of the new table row that should display at the top of the panel's scrollable area. When the function sets the value of ZTDSCRIP, the developer must take into account that the number specified is the number of the top displayed table row relative to the top of the table as the user who issued the scroll requests will see it. The developer must also take into account any processing that takes place from the time the user requests a scroll to the time the scroll is processed. For example, assume that variable ZTDRET is set to UP. A user issues:

```
UP 10
```

but there are only eight table rows above the top one currently displayed. ISPF returns control to the function with variable ZTDAMT having a value of 2, indicating that two lines must be added to the table to satisfy the current scroll request. ISPF has set variable ZTDSCRIP to 0 because the new top displayed row did not exist in the table when the scroll was requested. Assume that, instead of adding only the two required table rows at the top of the table to satisfy this scroll request, the function adds 20 rows as a cushion against additional scrolling. Therefore, the function must set ZTDSCRIP to 19 so that ISPF will redisplay the panel with the table positioned as the user wants it.

In addition to the row pointer in variable ZTDSCRIP, ISPF returns to the function in variable ZTDSRID the identification (rowid) of the row that is to be displayed at the top of the scrollable area. As just described for ZTDSCRIP, if ISPF cannot determine which is to be the top row displayed, it returns a value of 0 in ZTDSRID.

Using Variable ZTDSIZE

When ISPF returns control to the function to add more rows to a table, variable ZTDSIZE contains the *total* number of table rows that can fit into the entire panel scrollable area. Changes made to the panel structure, such as by PFSHOW ON or split-screen mode, do not affect this value. The value is the total number of scrollable area rows.

Using Variables ZDRTOP and ZDRLROWS

ISPF displays in the upper-right corner of a TDISPL panel a default top-row-displayed indicator, 'ROW x OF y', where *x* is the current row pointer of the top row displayed, and *y* is the total number of rows in the physical table being displayed. By assigning a message ID to system variable ZDMSG, a function can specify a message whose short message text is to replace the top-row-displayed indicator. However, keep in mind that in the following text all

references to the top-row-displayed indicator refer to the default supplied by ISPF, not an alternate indicator specified by the application.

Because the dimensions of only the physical table are available, ISPF has no way of assuring what the x and y values for the top-row-displayed indicator should be. Therefore, it is the application's responsibility to pass to ISPF the logical table positioning in variables ZDTLTOP and ZDTLROWS, respectively, any time control returns to the function to add table rows. If the function does not set these variables to a value, ISPF calculates the x and y values according to the size and position of the table being displayed.

For example, assume that, to satisfy scroll requests, an application adds records dynamically to a table from a 1000-record file. The application initially builds the table with records 500 through 520. To pass these values to ISPF for use as the x and y values in the top-row-displayed indicator, the application function sets ZDTLTOP to 500 and sets ZDTLROWS to 1000. This causes the indicator text 'ROW 500 OF 1000' to be displayed initially on the TDBISPL panel. Then assume that the user scrolls down 10 rows. ISPF, using the value in ZDTLTOP plus the 10 rows scrolled, changes the indicator to 'ROW 510 OF 1000'.

In the example just described, assume that the user first scrolled up 10 rows instead of down 10 rows. Because the top row displayed was the top table row, control returns to the application function to add rows to the top of the table so the scroll request can be completed. As mentioned above, it is the application's responsibility to change the values of ZDTLTOP and ZDTLROWS as needed to provide ISPF an accurate base for generating the top-row-displayed indicator. Therefore, after adding rows to the top of the table, the function sets variable ZDTLTOP to 490 before issuing the TDBISPL request to redisplay the table. The text of the top-row-displayed indicator on the displayed panel is now 'ROW 490 OF 1000'.

Example: Dynamic Table Expansion

This example illustrates how you can use dynamic expansion to reduce the initial overhead of creating a large table for display.

Assume that you are given the task of creating an ISPF dialog that allows a user to browse through a list of invoices for a given year. The list is maintained in a sequential file. It contains information (such as invoice number, transaction date, part number, quantity, and customer name) for each transaction made during the year.

The file is fixed-block with a logical record length of 80 and a block size of 6160. The first record in the file contains the year and the number of invoices that follow in the file.

The format of this record is as follows:

Positions	Format
1-4	Year
5-10	Number of invoices
11-80	Reserved

The format of each of the invoice records is as follows:

Positions	Format
1-6	Invoice number

Display Services

7-14	Transaction date (format mm/dd/yy)
15-18	Part number
19-21	Quantity (right justified)
22-46	Customer name (left justified)
47-80	Reserved

For example, the file might look something like this:

```
1986010000
00000101/06/867071100Acme Auto
00000201/06/860015 15Parts City
00000301/07/861023340Cary Auto Center
00000401/08/860231 1Parts Unlimited
00000501/08/863423805Bosworth's Parts
00000601/08/862341165Acme Parts
00000701/08/867653 20Acme Parts
00000801/08/863353100Bosworth's Parts
00000901/08/860003325Bosworth's Parts
00001001/08/863322 1Bosworth's Parts
:
:
00999912/15/860325 43ABC Parts
01000012/18/864234340ACME Parts
```

As you can see, the file is in no form to be browsed as it is. One way to implement the dialog is to transfer the invoice file to a temporary ISPF table, and then display the table with the TBDISPL service. However, since the number of invoices can be relatively high (in this example, there are 10 000 invoices), the initial overhead of reading every record and adding it to the table is unacceptable. As an alternative, the dialog uses dynamic table expansion instead. Using this method, it adds only the first 60 invoices to the table initially. Other invoices are added on an as-needed basis as the user scrolls through the table. The user sees no evidence that only a portion of the invoices are in the table.

Figure 19 shows the definition for panel INV PANEL, which the dialog uses to display table rows.

```
)Attr
 @ Type(Output) Intens(Low)
)Body Expand(//)
+/-/--%&year TRANSACTIONS+/-/-
%Command =====>_cmd %Scroll ===>_amt +
+
+
%Invoice Transaction Part
%Number Date Number Quantity Customer
%-----
)Model
@inv @date @part @qty @cust +
)Init
&amt = PAGE
)End
```

Figure 19. Panel Definition Dynamic Table Expansion

The PL/I dialog function, INVOICE (shown in Figure 20 on page 51), requires that the invoice file be allocated to ddname INVFILE before the dialog is executed. The intent of this example is to illustrate the dynamic expansion function. Normal error checking and error processing is not shown, but should be included in all dialogs.

```

INVOICE: PROC OPTIONS(MAIN);
/*****
/* THIS PROGRAM ILLUSTRATES THE USE OF DYNAMIC EXPANSION WITH */
/* THE TABLE DISPLAY SERVICE. THE PROGRAM READS RECORDS FROM A */
/* SEQUENTIAL FILE CONTAINING A LIST OF INVOICES AND ADDS THE */
/* INVOICE INFORMATION TO A TEMPORARY ISPF TABLE (INVTABLE). */
/* THE TABLE IS THEN DISPLAYED SO THAT THE USER CAN BROWSE */
/* THROUGH THE INVOICES. THE FOLLOWING STEPS ARE PERFORMED BY */
/* THE PROGRAM: */
/*
/* 1. DEFINE THE FUNCTION POOL VARIABLES FOR THE TEMPORARY */
/* TABLE, THE TBCREATE SERVICE CALL FOR TEMPORARY TABLE, AND MISCELLANEOUS */
/* VARIABLES. */
/*
/* 2. ISSUE A TBCREATE SERVICE CALL FOR TEMPORARY TABLE, */
/* INVTABLE. */
/*
/* 3. OPEN FILE INVFILE AND READ THE HEADER RECORD INTO THE */
/* HEADER_RECORD STRUCTURE. */
/*
/* 4. READ EACH OF THE FIRST 60 INVOICE RECORDS FROM INVFILE */
/* INTO THE INVOICE_RECORD STRUCTURE AND ADD THEM TO TABLE */
/* INVTABLE. USE THE TBADD MULT PARAMETER TO OPTIMIZE */
/* TBADD ROW STORAGE MANAGEMENT. */
/*
/* 5. ISSUE A TBTOP SERVICE CALL TO POSITION THE CRP AT THE */
/* TOP OF INVTABLE. */
/*
/* 6. INITIALIZE SYSTEM VARIABLE ZTDRET TO "DOWN" */
/* AND SYSTEM VARIABLE ZTDLROWS TO THE NUMBER OF INVOICES */
/* IN THE FILE. */
/*
/* 7. ISSUE A TBCREATE SERVICE CALL THAT REFERS TO TABLE */
/* INVTABLE AND PANEL INVTABLE. */
/*
/* 8. LOOP WHILE THE TBCREATE SERVICE RETURN CODE IS LESS THAN */
/* 8 (WHILE THE USER HAS NOT ISSUED THE END COMMAND AND */
/* WHILE THERE HAVE BEEN NO SEVERE ERRORS). ON RETURN */
/* FROM THE TBCREATE SERVICE, DO THE FOLLOWING: */
/*
/* - CHECK TO SEE IF ADDITIONAL ROWS ARE NEEDED TO */
/* SATISFY A SCROLL REQUEST. */
/*
/* - IF ADDITIONAL ROWS ARE NEEDED, READ THE APPROPRIATE */
/* NUMBER OF INVOICES FROM INVFILE AND ADD THEM TO */
/* INVTABLE AGAIN USING THE TBADD MULT PARAMETER. */
/*
/* - IF NECESSARY, SET THE SYSTEM VARIABLE ZTDCRCP TO */
/* THE CRP OF THE NEW TOP ROW. */
/*
/* - FINALLY, ISSUE A TBCREATE SERVICE CALL (WITHOUT A */
/* PANEL NAME) TO REDISPLAY INVTABLE. */
/*
/* 9. PERFORM SOME FINAL CLEANUP BEFORE EXITING THE DIALOG: */
/*
/* - ISSUE A TBEND SERVICE CALL TO CLOSE AND DELETE */
/* INVTABLE. */
/*
/* - CLOSE INVFILE. */
/*
/* - ISSUE A VDELETE SERVICE CALL TO DELETE ALL FUNCTION */
/* POOL VARIABLES CREATED BY THE DIALOG. */
*****/

```

Figure 20. PL/I Dialog Function Example Program (Part 1 of 5)

Display Services

```

DECLARE                                     /*                                     */
  1 HEADER_RECORD,                         /* HEADER RECORD FIELDS */
  3 YEAR CHAR(4),                          /* YEAR OF INVOICES    */
  3 NUM_RECS CHAR(6),                       /* NUMBER OF INVOICES  */
  3 FILLER CHAR(70);                       /* ** RESERVED **     */
                                           /*                                     */
DECLARE                                     /*                                     */
  1 INVOICE_RECORD,                        /* INVOICE RECORD FIELDS */
  3 INV CHAR(6),                           /* INVOICE NUMBER      */
  3 DATE CHAR(8),                          /* TRANSACTION DATE    */
  3 PART CHAR(4),                          /* PART NUMBER        */
  3 QTY CHAR(3),                           /* QUANTITY            */
  3 CUST CHAR(25),                         /* CUSTOMER NAME       */
  3 FILLER CHAR(34),                       /* ** RESERVED **     */
  INVOICE_FORMAT (5) CHAR(8)               /* FORMAT ARRAY FOR    */
    INIT((5) (1) 'CHAR '),                /* INVOICE_RECORD VDEF */
  INVOICE_LENGTH (5) FIXED BIN(31,0)      /* LENGTH ARRAY FOR    */
    INIT(6,8,4,3,25);                    /* INVOICE_RECORD VDEF */
                                           /*                                     */
DECLARE                                     /*                                     */
  1 SCROLL_VARS,                          /* TBDISPL SCROLL FIELDS */
  3 ZSCROLLA CHAR(4),                      /* SCROLL AMOUNT      */
  3 ZTDRET CHAR(8),                        /* RETURN ON EOD      */
  3 ZTDSCRIP FIXED BIN(31,0),              /* TOP ROW CRP       */
  3 ZTDAMT FIXED BIN(31,0),               /* #ROWS TO ADD      */
  3 ZTDSIZE FIXED BIN(31,0),              /* SCROLLABLE AREA SIZE*/
  3 ZTDLROWS FIXED BIN(31,0),             /* #ROWS IN LOGICAL TBL*/
  3 ZTDADD CHAR(3),                       /* NEED TO ADD ROWS? */
  SCROLL_FORMAT (7) CHAR(8)               /* FORMAT ARRAY FOR    */
    INIT((2) (1) 'CHAR ',                 /* SCROLL_VARS VDEFINE */
          (4) (1) 'FIXED ',               /*                       */
          'CHAR '),                       /*                       */
  SCROLL_LENGTH (7) FIXED BIN(31,0)       /* LENGTH ARRAY FOR    */
    INIT(4,8,4,4,4,4,3);                 /* SCROLL_VARS VDEFINE */
                                           /*                                     */
DECLARE                                     /*                                     */
  I FIXED BIN(31,0),                       /* WORK INDEX         */
  L4 FIXED BIN(31,0),                      /* VDEFINE LENGTH PARM */
  TBDISPL_RC FIXED BIN(31,0),              /* TBDISPL RETURN CODE */
  BOTTOM FIXED BIN(31,0),                  /* CRP OF BOTTOM ROW  */
  NEW_BOTTOM FIXED BIN(31,0),              /* CRP OF NEW BOTTOM ROW */
  REQUESTED_TOP FIXED BIN(31,0),           /* TOP ROW REQUESTED BY */
                                           /* END USER SCROLL   */
  ADD_NUMBER FIXED BIN(31,0);              /* #ROWS TO ADD      */
                                           /*                                     */
DECLARE                                     /*                                     */
  MIN BUILTIN,                             /* PL/I BUILTIN       */
  PLIRETV BUILTIN,                        /* FUNCTIONS          */
  ISPLINK EXTERNAL ENTRY                   /* ISPF SERVICE       */
    OPTIONS(ASM INTER RETCODE);           /* INTERFACE         */
                                           /*                                     */
DECLARE                                     /*                                     */
  INVFILE FILE INPUT RECORD SEQUENTIAL     /* INVOICE FILE      */
    ENV(FB BLKSIZE(6160) RECSIZE(80));    /*                   */
                                           /*                                     */

```

Figure 20. PL/I Dialog Function Example Program (Part 2 of 5)

```

/*****/
/*
/* ISSUE VDEFINE SERVICE CALLS TO DEFINE THE TABLE VARIABLES,
/* SCROLL SYSTEM VARIABLES, AND OTHER MISCELLANEOUS FIELDS TO
/* ISPF.
/*
/*****/
/*
/* DEFINE TABLE VARS
CALL ISPLINK('VDEFINE ',
             '(INV DATE PART QTY CUST)',
             INVOICE_RECORD,
             INVOICE_FORMAT,
             INVOICE_LENGTH,
             'LIST ');
/*
/* DEFINE SCROLL VARS
CALL ISPLINK('VDEFINE ',
             '(ZSCROLLA ZTDRET ZTDSCRIP ZTDAMT ZTDSIZE ZTDLROWS ZTDADD)',
             SCROLL_VARS,
             SCROLL_FORMAT,
             SCROLL_LENGTH,
             'LIST ');
L4 = 4;
/* DEFINE BOTTOM ROW CRP
CALL ISPLINK('VDEFINE ',
             '(BOTTOM)',
             BOTTOM,
             'FIXED ',
             L4);
/* DEFINE PANEL VAR YEAR
CALL ISPLINK('VDEFINE ',
             '(YEAR)',
             YEAR,
             'CHAR ',
             L4);
/*****/
/*
/* ISSUE TBCREATE SERVICE CALL TO CREATE TEMPORARY TABLE
/* INVTABLE. MAKE EACH OF THE TABLE VARIABLES NAME VARIABLES.
/*
/*****/
/*
/*
CALL ISPLINK('TBCREATE',
             'INVTABLE',
             ' ',
             '(INV DATE PART QTY CUST)');
/*****/
/*
/* OPEN FILE INVFILE AND READ THE HEADER RECORD.
/*
/*****/
/*
/* OPEN INVOICE FILE
OPEN FILE(INVFILE);
/* READ HEADER RECORD
READ FILE(INVFILE)
INTO(HEADER_RECORD);
/*

```

Figure 20. PL/I Dialog Function Example Program (Part 3 of 5)

Display Services

```

/*****
/*
/* READ THE FIRST 60 RECORDS FROM INVFILE, ADDING EACH TO THE
/* TABLE.
/*
/*
/*****
/*
ADD_NUMBER = 60;
DO I = 1 TO ADD_NUMBER;
  READ FILE(INVFILE)
  INTO(INVOICE_RECORD);
  CALL ISPLINK('TBADD ',
              'INVTABLE',
              ' ',
              ' ',
              ADD_NUMBER);
END;

/*****
/*
/* SKIP BACK TO THE TABLE TOP, INITIALIZE THE ZTDRET AND
/* ZTDLROWS SYSTEM VARIABLES, AND ISSUE A TDISPL SERVICE CALL
/* TO DISPLAY THE TABLE.
/*
/*
/*****
/*
CALL ISPLINK('TBTOP ',
            'INVTABLE');
ZTDRET = 'DOWN ';
ZTDLROWS = NUM RECS;
CALL ISPLINK('TBDISPL ',
            'INVTABLE',
            'INVPANEL');
TBDISPL_RC = PLIRETV();

/*****
/*
/* LOOP WHILE USER HAS NOT ISSUED THE END COMMAND, CHECK TO
/* SEE IF ADDITIONAL ROWS ARE NEEDED TO SATISFY SCROLL, ADD ROWS
/* IF APPROPRIATE, AND THEN REDISPLAY TABLE.
/*
/*
/*****
/*
DO WHILE(TBDISPL_RC < 8);
  IF ZTDADD = 'YES' THEN
    DO;
      CALL ISPLINK('VGET ',
                  '(ZSCROLLA)',
                  'SHARED ');
      IF ZSCROLLA = 'MAX' THEN
        ZTDAMT = 999999;
      ELSE;
      CALL ISPLINK('TBBOTTOM',
                  'INVTABLE',
                  ' ',
                  ' ',
                  'BOTTOM ');
    END;
  END;

```

Figure 20. PL/I Dialog Function Example Program (Part 4 of 5)

```

ADD_NUMBER = MIN(ZTDAMT,          /* ADD ZTDAMT ROWS OR */
                 ZTDLROWS-BOTTOM); /* UNTIL INVFILE EOF */
DO I = 1 TO ADD_NUMBER;          /*                      */
                                /*                      */
    READ FILE(INVFILE)           /* READ RECORD        */
      INTO(INVOICE_RECORD);      /*                      */
                                /*                      */
    CALL ISPLINK('TBADD  ',      /* ADD IT TO TABLE   */
                'INVTABLE',     /*                      */
                ' ',            /*                      */
                ' ',            /*                      */
                ADD_NUMBER);     /*                      */
END;                              /*                      */
IF ZSCROLLA ^= 'MAX' THEN        /* IF NOT MAX SCROLL, */
  IF ZTDSCR = 0 THEN             /* MAY NEED TO SET    */
    DO;                          /* ZTDSCR             */
                                /*                      */
        NEW_BOTTOM = BOTTOM +     /* CALCULATE NEW BOTTOM */
          ADD_NUMBER;           /*                      */
        REQUESTED_TOP = BOTTOM +  /* CALCULATE TOP ROW   */
          ZTDAMT - ZTDSIZE + 1;  /* REQUESTED BY SCROLL */
                                /*                      */
        IF NEW_BOTTOM <         /* IF REACH EOF BEFORE */
          REQUESTED_TOP THEN     /* REACHING TOP ROW   */
          ZTDSCR = NEW_BOTTOM +  /* REQUESTED, DISPLAY  */
            1;                  /* ONLY BOTTOM OF     */
                                /* DATA MARKER       */
        ELSE                     /* ELSE               */
          ZTDSCR = REQUESTED_TOP; /* ADDED REQUESTED    */
                                /* TOP, SET ZTDSCR    */
                                /* TO NEW TOP ROW     */
                                /*                      */
    END;                          /*                      */
  ELSE;                          /* NO NEED TO SET     */
  ELSE;                          /* ZTDSCR             */
                                /*                      */
END;                              /*                      */
ELSE;                              /* DON'T NEED TO ADD ROWS*/
                                /*                      */
CALL ISPLINK('TBDISPL ',        /* REDISPLAY TABLE   */
            'INVTABLE');        /*                      */
TBDISPL_RC = PLIRETV();         /*                      */
END;                              /*                      */
                                /*                      */
/*****
/*
/* PERFORM FINAL CLEANUP.
/*
*****/
                                /*                      */
CALL ISPLINK('TBEND  ',        /* CLOSE AND DELETE   */
            'INVTABLE');        /* TABLE             */
CLOSE FILE(INVFILE);           /* CLOSE INVOICE FILE */
CALL ISPLINK('VDELETE ',      /* DELETE FUNCTION POOL */
            '* ');             /* VARIABLES          */
                                /*                      */
RETURN (0);                    /*                      */
END INVOICE;                    /*                      */

```

Figure 20. PL/I Dialog Function Example Program (Part 5 of 5)

Now, assume that a user is running the invoice dialog on a terminal with 24 lines. The initial display of the table is shown in Figure 21 on page 56.

Display Services

```
----- 1986 TRANSACTIONS ----- ROW 1 OF 10000
Command ==>>                               Scroll ==> PAGE
```

Invoice	Transaction	Part	Quantity	Customer
Number	Date	Number		
0000001	01/06/86	7071	100	Acme Parts
0000002	01/06/86	0015	15	Parts City
0000003	01/07/86	1023	340	Cary Auto Center
0000004	01/08/86	0231	1	Parts Unlimited
0000005	01/08/86	3423	805	Bosworth's Parts
0000006	01/08/86	2341	165	Acme Parts
0000007	01/08/86	7653	20	Acme Parts
0000008	01/08/86	3353	100	Bosworth's Parts
0000009	01/08/86	0003	325	Bosworth's Parts
0000010	01/08/86	3322	1	Bosworth's Parts
0000011	01/10/86	2344	23	Parts Unlimited
0000012	01/10/86	4333	55	Cary Auto Center
0000013	01/10/86	3079	65	Parts Company of NC
0000014	01/10/86	4763	340	Cary Auto Center
0000015	01/10/86	0956	70	Cary Auto Center
0000016	01/10/86	4536	52	ABC Parts
0000017	01/10/86	0973	330	ABC Parts

Figure 21. Initial Display for Dynamic Table Expansion Example

Notice that even though the table actually contains only 60 rows, the top row displayed indicator shows “ROW 1 OF 10000”. This was accomplished by setting the ZTDLROWS variable in the function pool to a value of 10 000. TBDISPL will pick up this value and use it when ZTDRET has been properly set.

Assume that the user enters the command “DOWN 50” on the command line. This should result in rows 51–67 being displayed. Remember though that only rows 1–60 are currently in the table. Because there are not enough rows in the table to fill the screen, control will return to function INVOICE. Upon return from TBDISPL, the system variables used by the dialog have the following values:

ZSCROLLA	0050
ZTDADD	YES
ZTDSCRIP	51
ZTDAMT	7
ZTDSIZE	17

ZTDAMT contains the number of rows that must be added to satisfy the scroll request and fill a full screen. ZTDSCRIP has the CRP of the row that will be at the top of the screen after the scroll. Because it is nonzero, function INVOICE does not need to set it. In fact, all that the function has to do is skip to the table bottom, read and add the next 7 invoices to the table, and then issue a TBDISPL service request to redisplay the table. When the table is displayed again, it appears as shown in Figure 22 on page 57.

```

----- 1986 TRANSACTIONS ----- ROW 51 OF 10000
Command ==>>                               Scroll ==> PAGE

Invoice  Transaction  Part   Quantity  Customer
Number   Date          Number -----
0000051  01/15/86     7536   6         Parts Unlimited
0000052  01/15/86     0546   54        ABC Parts
0000053  01/15/86     3349   65        Parts Company of NC
0000054  01/15/86     4234   340       Cary Auto Center
0000055  01/15/86     0342   70        Cary Auto Center
0000056  01/18/86     4544   52        ABC Parts
0000057  01/19/86     0763   330       Cary Auto Parts
0000058  01/19/86     0841   540       Bosworth's Parts
0000059  01/19/86     0445   560       ABC Parts
0000060  01/19/86     4542   450       ACME Parts
0000061  01/25/86     7071   100       Acme Parts
0000062  01/25/86     0015   15        Parts City
0000063  02/27/86     1023   340       Cary Auto Center
0000064  02/04/86     0231   1         Parts Unlimited
0000065  02/04/86     3423   805       Bosworth's Parts
0000066  02/04/86     2341   165       Acme Parts
0000067  02/04/86     7653   20        Acme Parts

```

Figure 22. Second Display for Dynamic Table Expansion Example

Now assume that the user runs the command DOWN 5000:

This should result in rows 5051–5067 being displayed. As before, there are not enough rows in the table to handle the scroll request, so control returns to function INVOICE with the following information in the system variables:

```

ZSCROLLA          5000
ZTDADD            YES
ZTDSCR           0
ZTDAMT           5000
ZTDSIZE          17

```

Notice that this time ZTDSCR has a value of 0. This indicates that the new top row, as requested by the user scroll, is not in the physical table. After adding the 5000 rows indicated by the ZTDAMT system variable, function INVOICE must set ZTDSCR to the CRP of the row that should be displayed at the top after the scroll (row 5051). This is accomplished in the dialog by adding ZTDAMT to the number of rows in the current table, and then subtracting out the size of the scrollable area (ZTDSIZE). When the table is redisplayed, it appears as shown in Figure 23 on page 58.

Display Services

```
----- 1986 TRANSACTIONS ----- ROW 5051 OF 10000
Command =====>                               Scroll ==> PAGE
```

Invoice Number	Transaction Date	Part Number	Quantity	Customer
0005051	07/12/86	7326	436	Parts Unlimited
0005052	07/12/86	0516	54	ABC Parts
0005053	07/21/86	3549	5	Parts Company of NC
0005054	07/24/86	4243	350	Cary Auto Center
0005055	07/25/86	0342	540	Cary Auto Center
0005056	07/31/86	4544	444	ABC Parts
0005057	07/11/86	0653	30	Cary Auto Parts
0005058	08/29/86	0821	450	Bosworth's Parts
0005059	08/01/86	6445	460	ABC Parts
0005060	08/01/86	4942	850	ACME Parts
0005061	08/01/86	7021	180	Acme Parts
0005062	08/01/86	6026	945	Parts City
0005063	08/07/86	1523	30	Cary Auto Center
0005064	08/07/86	0531	451	Parts Unlimited
0000065	08/07/86	3263	455	Bosworth's Parts
0005066	08/07/86	2771	5	Acme Parts
0005067	08/07/86	7453	576	Acme Parts

Figure 23. Third Display for Dynamic Table Expansion Example

Finally, assume that the user runs the command `DOWN 5000`: A scroll of 5000 would display rows 10051–10067, if there were that many invoices in the file. However, because there are only 10 000 invoices, function `INVOICE` can add only rows 5068–10000 to the table and then redisplay the table. On return from `TBDISPL`, the system variables again contain the following information.

```
ZSCROLLA          5000
ZTDADD            YES
ZTDSCR           0
ZTDAMT           5000
ZTDSize          17
```

After adding all of the invoices to the table (end of file is reached), the dialog must set system variable `ZTDSCR`. Because the scroll amount has caused the user to scroll past the end of data, the dialog sets `ZTDSCR` to a value that will cause only the bottom of data marker to be displayed. That is, `ZTDSCR` is set to a value greater than the number of rows in the table. When the table is redisplayed it appears as shown in Figure 24 on page 59.

```

----- 1986 TRANSACTIONS -----
Command ==>>>                               Scroll ==>> PAGE

Invoice   Transaction   Part   Quantity   Customer
Number   Date       Number
-----
***** BOTTOM OF DATA *****

```

Figure 24. Fourth Display for Dynamic Table Expansion Example

One case not illustrated above is that of the user issuing a DOWN MAX scroll request. In this case ZTDAMT and ZTDSCRIP would each have a value of 0 when control returns to the dialog. ZSCROLLA would have a value of MAX. The dialog would add all remaining invoices to the table and then redisplay the table. It is not necessary in a MAX scroll case to set ZTDSCRIP before redisplaying the table because ISPF automatically positions the table so that a full screen plus the bottom of data marker are displayed.

In this example the program has been written so that control continues to return to the dialog after all of the invoice file records have been added to the table. To further improve performance, it may be desirable for the dialog to disable the return after the end of file has been reached. This can be done by setting the ZTDRET function pool variable to some value other than DOWN, UP, or VERTICAL, and then issuing a TBDISPL service request with the panel name specified. Be aware that when a panel name is specified, ISPF clears any pending scroll requests. So it is up to the dialog to position the table CRP to the appropriate row to simulate the scroll. For example, assume that a DOWN MAX scroll request has been issued and the dialog has added all remaining invoices to the table. The dialog then sets ZTDRET to blank and prepares to issue the TBDISPL service request, with a panel name, to display the table. To simulate the user scroll the dialog issues a TBSKIP service request to position the CRP to the row that will cause a full screen plus the bottom of data marker to be displayed. When the TBDISPL request is subsequently issued, ISPF will position the table based on the CRP, thereby simulating the scroll.

Using the Variable Services

Dialog variables are the main communication vehicle between the components of a dialog and ISPF services. Program modules, command procedures, panels, messages, tables, and skeletons can all refer to the same data through the use of dialog variables. Variable services allow you to define and use dialog variables.

Some variable services require that ISPF search through the variable pools to locate requested variables. ISPF searches the pools in the following order:

Variable Services

1. Function pool (defined variables)
2. Function pool (implicit variables)
3. Shared pool
4. Application profile pool (profile pool).

Searching Variable Pools

Dialog variables are organized into groups, or pools, according to the dialog and application with which they are associated. An application is one or more dialogs, each of which has been started using the same application ID.

A pool can be thought of as a list of variable names that enables ISPF to access the associated values. When a DM service encounters a dialog variable name in a panel, message, table, or skeleton, it searches these pools to access the dialog variable's value. The pools and the types of dialog variables that reside in them are listed below:

- Function pool** Contains variables accessible only by that function. A variable that resides in the function pool of the function currently in control is called a function variable.
- Shared pool** Contains variables accessible only by dialogs belonging to the same application. A variable that resides in the shared pool of the current application is called a shared variable.
- Profile pool** Contains variables that are automatically retained for the user from one session to another. A variable that resides in the profile pool is called an application profile variable or profile variable. Profile variables are automatically available when an application begins and are automatically saved when it ends.

The number of shared, function, and profile variables that can exist at any one time depends on the amount of storage available.

SELECT Service and Variable Access

Figure 25 on page 61 shows how the SELECT service can be used to pass control within a dialog and illustrates the resulting pool structures. Menus A and B access variables from the shared and profile pools, because menus are not part of any function. The dialog invokes Function X, which uses the VPUT service to copy one of the variables from its function pool into the shared pool. Next, the dialog invokes Function Y, which uses the VGET service to copy a dialog variable from the shared pool to its function pool. Then it uses the SELECT service for further menu processing.

Figure 25 on page 61 also shows how the SELECT service controls access to dialog variable pools from both functions and menus.

When you define a variable as an input variable on a selection panel, the following actions occur during processing of the menu:

- If the variable does not exist in either the shared pool or the profile pool, it is created in the shared pool.
- If the variable exists in the shared pool, it is accessed from, and is updated in, the shared pool.
- If the variable exists in the profile pool and not in the shared pool, it is accessed from, and is updated in, the profile pool.

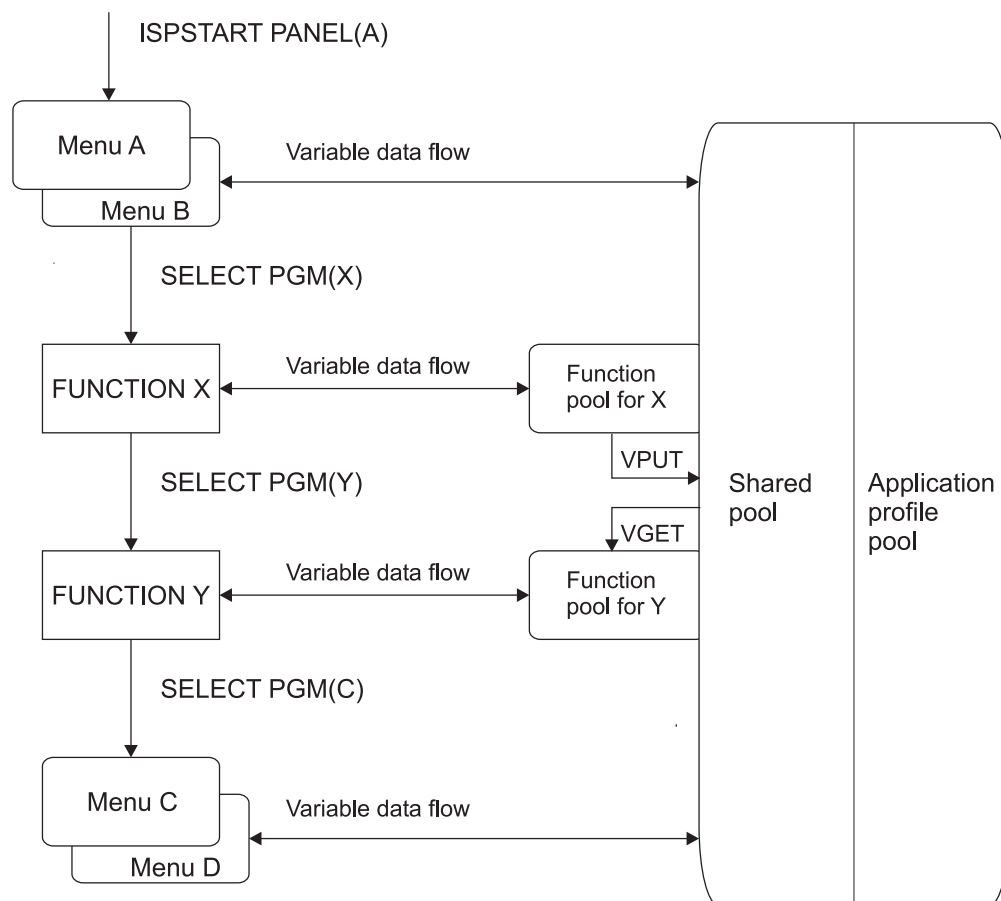

Figure 25. Control and Data Flow in a Dialog

Function Pools and Dialog Functions

Each function has its own unique pool of dialog variables. This is illustrated in Figure 25. These function pools are maintained by ISPF on behalf of each respective function. A function uses these dialog variables to communicate with the various DM services. A function pool's variables can be accessed only by the function for which the pool was created. To make these variables available to other functions, you must use variable services to copy any variables to be shared into the shared pool.

Dialog variables associated with one function can have the same names as dialog variables associated with another function, but they reside in different function pools, and therefore, are not the same variables.

When a new function begins, ISPF creates a function pool for it. Variables can then be created in the function pool and accessed from it. When the function ends, its function pool, along with any variables in it, is deleted.

Command Procedures, Program Functions, and Function Pools

When the function in control is a command procedure, the list of variable names kept by the command language processor and the list of function variables kept by

Variable Services

ISPF is the same list. Thus, a variable created by the command procedure during its execution is automatically a dialog variable. Likewise, the command procedure can automatically access a dialog variable entered in the function pool by ISPF. However, ISPF variable names cannot exceed 8 characters.

Any CLIST or REXX variable such as SYSDATE and SYSTIME, which are dynamically evaluated when referred to, can be used in a CLIST or REXX exec running under ISPF; however, it cannot be used in panels, messages, skeletons, or tables. For SYSDATE and SYSTIME, use ISPF system variables ZDATE and ZTIME, respectively, which contain similar information.

ISPF makes available two other system variables, ZDATEF and ZDATEFD, to support date representation in various national languages. ZDATEF contains the date represented by the characters YY, MM, and DD plus delimiters. These characters are never translated; however, they can be in any order. For example, the date could be expressed MM/DD/YY, YY/MM/DD, and so on, depending on how a date is expressed in a given national language. ZDATEFD contains the same date format, translated into the session national language.

TSO global variables, in effect when ISPF is started, are not available to CLISTS running under ISPF. These global variables are restored when ISPF terminates. Any global variables put into effect from within ISPF are lost when ISPF terminates.

The following CLIST command procedure example illustrates that ISPF treats command procedure variables as dialog variables.

Assume that the definition for panel XYZ contains two dialog variable input fields, AAA and BBB. In the panel definition, they might appear as follows:

```
+ INITIAL VALUE %===>_AAA      +
+ INCREMENT      %===>_BBB      +
```

where the underscore indicates the start of an input field, followed by the name of the variable.

When the procedure:

```
SET &AAA = 1
ISPEXEC DISPLAY PANEL(XYZ)
SET &CCC = &AAA + &BBB
```

is executed, variable AAA is set to the value 1. The procedure then invokes the DISPLAY service to display panel XYZ. The value of AAA is 1 on the displayed panel. ISPF creates the variable BBB in the function pool and displays it as a blank.

Now, in response to the panel display, you type 100 in the first field (AAA) and 20 in the second field (BBB). When you press Enter, the value 100 is automatically stored in AAA and the value of 20 is automatically stored into BBB. The DISPLAY service then returns control to the command procedure. When the next statement executes, it creates variable CCC and sets it to 120, the sum of AAA and BBB.

When the function in control is a program, the associated function pool is not shared with ISPF. This is because a program is compiled, not interpreted as command procedures are. ISPF maintains a list of variables that belong to the function so that DM services can use dialog variables for communication of data.

ISPF makes two types of entries in the program function pool, defined and implicit.

Use a Variable Service to Create or Delete Defined Variables

Use the VDEFINE service to create a defined dialog variable name in the function pool and associate it with the corresponding program variable. This association enables ISPF to directly access and modify that program variable. Otherwise, the program's variables are not available to ISPF. Use the VDELETE service to end this association and remove ISPF's ability to access that program variable.

The following program coded in PL/I specifies that field PA of the program can be accessed by ISPF by using a dialog variable named FA. Then, the DISPLAY service is called to display panel XYZ.

```
DECLARE PA CHAR(8);
DECLARE LENGTHPA FIXED BIN(31) INIT(LENGTH(PA));
PA = 'OLD DATA';
CALL ISPLINK ('VDEFINE ', 'FA ', PA, 'CHAR ', LENGTHPA);
CALL ISPLINK ('DISPLAY ', 'XYZ ');
```

PA is declared as a program variable (character string, length 8). The program calls the VDEFINE service to make PA accessible to ISPF through dialog variable FA. If dialog variable FA is specified as an input field on panel XYZ, then "OLD DATA" displays in field FA, and ISPF stores any data entered in that field into the program variable PA.

Creating Implicit Variables

ISPF places implicit variables in the function pool when an ISPF service:

- Refers to a dialog variable name that is not found in the standard search reference
- Must store data in a dialog variable that does not already exist in the function pool.

Let us illustrate how ISPF creates an implicit variable. Assume that panel XYZ, in the preceding example, allows the user to enter a second value and that this value is to be stored in dialog variable IA. This is the first reference to IA; therefore, it does not yet exist in the function pool. Because variable IA does not exist when it is referred to, ISPF creates it in the function pool. ISPF then stores into IA the value entered on the panel. Thus, IA is an implicit dialog variable.

Any DM service invoked by a program function can access an implicit variable directly by referencing the variable name. However, implicit variables cannot be accessed directly from a program function. Programs access implicit variables only through the use of the VCOPY and VREPLACE services.

When you are using APL2, variables in the current APL2 workspace that follow APL2 and ISPF naming rules become function pool variables. ISPF treats these as implicit variables. The VDEFINE service is not used with APL2 dialogs.

Naming Defined and Implicit Variables

A defined variable and an implicit variable can have the same name. This occurs when, using the VDEFINE service, a defined variable is created that uses the same name as an existing implicit variable. When the same name exists in both the defined and the implicit areas of a function pool, only the defined entry can be accessed. You can make the implicit entry accessible by using the VDELETE service to remove any defined entries for that variable name made through the VDEFINE service. The implicit entries are not affected.

Variable Services

You can define a given dialog variable name many times within a given function. Each definition can associate a different program variable with the dialog variable name. This is referred to as *stacking*. Only the most recent definition of that dialog variable is accessible. A previous definition of that variable can be made accessible by using the VDELETE service to delete the more recent definitions of that name.

For example, the main routine of a program can define a dialog variable to be associated with one program variable. A subroutine is called and can define the same dialog variable name to be associated with a different program variable. Any ISPF services invoked after the second VDEFINE would have access to only the subroutine's program variable. The subroutine would use the VDELETE service to delete that dialog variable before returning, thereby uncovering the earlier definition set up in the main routine. To avoid a possible program error, each VDEFINE processed within a function for a given dialog variable name should have a VDELETE using the same name or an asterisk (*) as the operand. When an asterisk is used as the operand, the VDELETE service removes all dialog variable names previously defined by the program module from the function pool.

The VRESET service allows a program to remove its function pool variables as though VDELETEs had been done. Any implicit variables are also deleted.

Sharing Variables among Dialogs

The shared pool allows dialog functions and selection panels to share access to dialog variables.

The SELECT service creates shared pools when it processes the ISPSTART or ISPF command, and when you specify the NEWAPPL or NEWPOOL keywords with the SELECT service. When SELECT returns, it deletes the shared pool and reinstates any previous shared pool.

A function can copy dialog variables from its function pool to the shared pool by using the VPUT service. In addition, another function can directly copy these variables to its function pool by means of the VGET service. Because a panel displayed by the SELECT service does not belong to any function, any dialog variables used in the panel are read from and stored into the shared or profile pool.

Saving Variables across ISPF Sessions

Like the shared pool, the application profile pool contains variables that are accessible to dialogs within an application. But, unlike the shared pool, the profile variables are saved across sessions.

When a new application is started, it has access to a profile pool. If an application is restarted by split screen, for example, both calls of the application access exactly the same profile pool. The profile pool is maintained as an ISPF table whose name is *xxxxPROF*, where *xxxx* is the application ID. If the application is already active, then the current profile pool is used.

When accessing an application profile pool that is not currently active, ISPF first searches the user's profile files for a profile named *xxxxPROF*. ISPF finds the profile if the user previously ran the application, and thus, had a copy of the profile pool.

If ISPF cannot find the profile, it searches the table input file. The application developer can provide a profile pool with the table files. A profile pool contains variable names and values initialized for the application.

If ISPF cannot find the member in either the user's profile pool or table input library, it initializes the application profile pool with the contents of the default profile pool, ISPPROF, which is read from the table input library. If the dialog manager application ID "ISP" is active, the currently active copy of ISPPROF is used as the default, rather than reading ISPPROF from ISPTLIB. ISPPROF is distributed with ISPF. It contains a set of default Function key values. An installation can modify this table to change these settings or to include other variables that will be copied to initialize new profile pools.

Upon completion of the application, ISPF saves the contents of the application profile pool, under the name *xxxxPROF*, in the user's profile library. ISPF deletes the profile pool from storage when the last call of the application terminates.

You must use the VPUT service to enter variables in the profile pool. Functions can copy variables from the profile pool into function pools by using the VGET variable services. Selection panels automatically update existing profile variables.

Removing Variables from the Shared or Profile Pool

As mentioned in an earlier topic, you can use the VDELETE or VRESET service to remove variables only from the function pool. However, if you wish to do some housekeeping in the other variable pools, you can use the VERASE service. The VERASE service allows you to remove variable names and values from the shared pool, the profile pool, or both. You can specify on the VERASE service request a list of one or more variable names to be removed from the shared pools or both. For example:

```
ISPEXEC VERASE (AGE ADDRESS SOCSEC) PROFILE
```

might be used to remove variable values for age, address, and social security number from the profile pool.

For detailed information about VERASE and other services, refer to the *z/OS ISPF Services Guide*.

Read-Only Profile Pool Extension Variables

ISPF provides for a read-only extension of the application profile variable pool. This allows installations to maintain better control over application default profile variables. It also results in conservation of disk storage because a copy of these variables need not exist in the application profile of every application user.

To use the read-only extension, you do two things:

1. First you must define the read-only extension. The read-only extension is actually a table, which you can create by using the ISPF TBCREATE table service. You add variables to this table as extension variables; that is, variables not specified when the table is created. This is illustrated in the CLIST procedure below, using the SAVE keyword on the TBADD table service. You need to create the extension table only once. After the table is saved, you must define it to ISPF by using an ALLOCATE command or a LIBDEF service request.
2. You then use DM variable services to put the name of the read-only extension table into system variable ZPROFAPP in the profile variable pool.

Variable Services

An example of a CLIST to create a read-only extension table named ROTABLE is shown in Figure 26. The table is to contain variables RONLY1, RONLY2, and RONLY3 set to values of LKHFC, FLIST, and SPOOLFUL, respectively. After the procedure closes the table, it sets system variable ZPROFAPP to the table name, ROTABLE. The procedure then puts ZPROFAPP into the profile variable pool.

```
/* Example of creating a read-only extension table */
SET ROV1 = LKHFC
SET ROV2 = FLIST
SET ROV3 = SPOOLFUL
SET ROVLIST = &STR(ROV1 ROV2 ROV3)
ISPEXEC TBCREATE ROTABLE
ISPEXEC TBADD ROTABLE SAVE(&ROVLIST)
ISPEXEC TBCLOSE ROTABLE
SET &RC = &LASTCC
IF &RC = 0 THEN -
DO
  /* Put extension table name into system variable ZPROFAPP. */
  SET ZPROFAPP = ROTABLE
  ISPEXEC VPUT ZPROFAPP PROFILE
END
```

Figure 26. CLIST to Create a Read-Only Extension Table

When a new application that uses the NEWAPPL keyword on the SELECT service is specified, ISPF interrogates variable ZPROFAPP in the new application's profile pool. If the variable value is not null, it is assumed to be the name of the profile extension table. ISPF searches the table input files for a table with the name specified by ZPROFAPP. The set of variables in this table becomes the read-only extension for the profile pool of the application just selected.

Although variable services are not effective for updating the read-only extension, you can create or update the table used as the extension by using DM table services. Updating the extension may be done only when the application is not active, because the table is open in nowrite mode while the application is active.

If a variable name is referred to and exists in both the profile pool and the read-only extension table, ISPF uses the variable from the user's profile pool. In other words, the search order is: first the profile pool, and then the read-only extension.

If a VPUT PROFILE is issued for a variable in the read-only extension, the update for that variable is made to the user area of the profile pool, not to the read-only extension. Only the profile pool variable update is saved and accessed, not the extension variable value.

Variables Owned by ISPF

A second level of profile pool, the system profile pool (ISPSPROF), is always active. The dialog manager owns the dialog variables within the system profile pool, and the variables cannot be modified by an application. They can be read, however, because the system profile pool is included in the standard search sequence after the profile pool. All system variable names begin with "Z", such as ZTERM, and supply information such as terminal type and list and log defaults.

If a system profile pool variable is used on a selection panel, a corresponding field is created in the profile pool (ISPPROF). Subsequently, when that variable is

referred to by the dialog, the profile pool value is used rather than the system profile pool value. The dialog can use the VERASE service to delete variables from the profile (ISPPROF) pool.

Variable Formats

Information entered on a panel is in character string format. All dialog variables remain in character string format when stored:

- As implicit variables in a function pool
- In the shared pool
- In the profile pool
- In ISPF tables.

Defined variables, however, can be translated to a fixed binary, bit, hexadecimal, float, packed, or binary string, or to a user-defined format when stored internally in a program module. The translation occurs automatically when the variable is stored by an ISPF service. A translation back to character string format occurs automatically when the variable is accessed.

The VMASK service is used to validate input into a VDEFINED dialog variable. Refer to the *z/OS ISPF Services Guide* for more information.

When a defined variable is stored, either of two errors can occur:

- | | |
|--------------------|---|
| Truncation | If the current length of the variable is greater than the defined length within the module, the remaining data is lost. |
| Translation | If the variable is defined as something other than a character string, and the external representation has invalid characters, the contents of the defined variable are lost. |

In either case, the ISPF service issues a return code of 16.

System Variables Communicate between Dialogs and ISPF

System variables are used to communicate special information between the dialog and the dialog manager (ISPF). System variable names are reserved for use by the system. They begin with the letter "Z". Therefore, avoid names that begin with "Z" when choosing dialog variable names.

The types of system variables are input, output, non-modifiable, and input-output. Their type depends on their usage.

To access and update system variables, use variable services according to which pool the variables are in. System variables in the function pool can be accessed and updated directly from a command procedure. Those in the shared or profile pools can be accessed by using the VGET service, and updated by using the VPUT service.

A program function can access and update system variables in the function pool using the VDEFINE service. Dialog variables can be accessed by using the VCOPY service and updated by using the VREPLACE service.

The system variables in the shared or profile pools can be accessed by using the VCOPY service. They can be updated by first updating the variable in the function pool by using the VDEFINE or VREPLACE service and then moving that value to the shared or profile pool by using the VPUT service.

Using VDEFINE, VDELETE, VRESET, VCOPY, VMASK, and VREPLACE

For functions coded in a programming language other than APL2, you can manage the availability to ISPF of the internal program variables that are to be used as dialog variables through the ISPF VDEFINE, VDELETE, and VRESET services.

Variables used in a program function are not automatically put into that function's variable pool. Therefore, those variables are not initially available to ISPF for processing function requests. A function can use the VDEFINE service to make function variable names available to ISPF through the function pool.

The VDELETE and VRESET services are used to cancel the effect of using VDEFINE service requests. VDELETE can be used to delete access by ISPF to selected defined variables by removing them from the function pool. VRESET removes all defined and implicit variables from the function pool.

A program function can obtain a copy of dialog variables by using the VCOPY service. The service request can specify that either the variable data address or the data itself be returned.

The VMASK service is used to validate the data of a variable defined with the VDEFINE service. VMASK associates a specified user or predefined mask with a variable previously defined with VDEFINE. The VEDIT statement must be used to indicate VMASKed variables on a panel.

A program function can update the contents of dialog-defined or implicit variables in the function pool by using the VREPLACE service. The names of the variables to be updated and the new contents are specified with the VREPLACE service request.

The VDEFINE, VDELETE, VRESET, VCOPY, VMASK, and VREPLACE variable services are not used with functions coded as procedures. For a function coded as a CLIST or APL2 procedure, variables used in the procedure are automatically treated as dialog variables. No special action is required to define them to ISPF. Any trailing blanks in CLIST variables are not truncated; they remain as part of the variables.

Using the VGET, VPUT, and VERASE Services

The VGET, VPUT, and VERASE services can be used by both program and procedure functions. Functions use the VGET and VPUT services to control movement of variables between function pools and shared or profile pools.

Each function has its own function variable pool. The variables in a given function's pool are not available to other functions, and vice versa. To overcome this, a function can use the VGET service to copy into its function pool variables from the shared or profile pools. The function can make variables in its function pool available to other functions in the same application by copying them to the shared or profile pool by using the VPUT service.

You can use the VERASE service to remove variable names and values from the shared pool and profile pool. The VDELETE and VRESET services are available for removing function pool variables.

Summary of Variable Services

The variable services are:

All Functions

VERASE	Remove variables from shared pool or profile pool
VGET	Retrieve variables from shared pool or profile pool
VPUT	Update variables in shared pool or profile pool

Program Functions Only

VCOPY	Copy data from a dialog variable to the program
VDEFINE	Define function program variables to ISPF
VDELETE	Remove definition of function variables
VMASK	Associate a mask with a dialog variable
VREPLACE	Update dialog variable with program data specified in the service request
VRESET	Reset function variables

Using the Table Services

Table services let you use and maintain sets of dialog variables. A table is a two-dimensional array of information in which each column corresponds to a dialog variable, and each row contains a set of values for those variables.

Contents for a table are shown in Table 3 on page 74. In that example, the variables that define the columns are as follows:

EMPSER	Employee Serial Number
LNAME	Last Name
FNAME	First Name
I	Middle Initial
PHA	Home Phone: Area Code
PHNUM	Home Phone: Local Number

Where Tables Reside

A table can be either temporary or permanent. A temporary table exists only in virtual storage. It cannot be written to disk storage.

Permanent tables are maintained in one or more table libraries. A permanent table, while created in virtual storage, can be saved on direct access storage. It can be opened for update or for read-only access, at which time the entire table is read into virtual storage. When a table is being updated in virtual storage, the copy of the table on direct access storage cannot be accessed until the update is complete.

For both temporary and permanent tables, rows are accessed and updated from the in-storage copy. A permanent table that has been accessed as read-only can be modified in virtual storage, but cannot be written back to disk storage.

When a permanent table is opened for processing, it is read from a table input library. A table to be saved can be written to a table output library that is different from the input library. The input and output libraries should be the same if the updated version of the table is to be reopened for further processing by the same dialog.

Accessing Data

You specify the variable names that define table columns when the table is created. Specify each variable as either a KEY field or a NAME (non-key) field. You can specify one or more columns (variable names) as keys for accessing the table. For the table shown in Table 3 on page 74, EMPSER might be defined as the key variable. Or EMPSER and LNAME might both be defined as keys, in which case, a row would be found only if EMPSER and LNAME both match the current values of those variables. A table can also be accessed by one or more "argument" variables that need not be key variables. You can define the variables that constitute the search argument dynamically by using the TBSARG and TBSCAN services.

In addition, a table can be accessed by use of the current row pointer (CRP). The table can be scanned by moving the CRP forward or backward. A row can be retrieved each time the CRP is moved. When a table is opened, the CRP is automatically positioned at TOP, ahead of the first row. Table services, such as TBTOP, TBBOTTOM, and TBSKIP are available for positioning the CRP.

When a row is retrieved from a table, the contents of the row are stored in the corresponding dialog variables. When a row is updated or added, the contents of the dialog variables are saved in that row.

When a row is stored, a list of "extension" variables can be specified by name. These extension variables, and their values, are added to the row. Thus, variables that were not specified when the table was created can be stored in the row. A list of extension variable names for a row can be obtained when the row is read. If the list of extension variables is not specified again when the row is rewritten, the extensions are deleted.

ISPF Table Services treat blank data and NULL (zero-length) data as equal. For example, the following VDEFINES are executed:

```
"ISPLINK('VDEFINE ','(V1)',VAL1,'CHAR ',L8,' NOBSCAN ')"
"ISPLINK('VDEFINE ','(V2)',VAL2,'CHAR ',L8)"
```

If L8 = 8, VAL1 = 'ABCD ' and VAL2 = 'ABCD ', V1 will have a length of 8 and a value of 'ABCD ', and V2 will have a length of 4 and a value of 'ABCD'. To ISPF, V1 and V2 will be equal because before ISPF compares two values, it pads the shorter value with blanks so that the lengths are equal.

If the same VDEFINES are done with VAL1 = ' ' and VAL2 = ' ', V1 will have a length of 8 and a value of ' ' (8 blanks), and V2 will have a length of 0 (NULL value). To ISPF, V1 is EQUAL to V2, because ISPF will pad V2 with 8 blanks before doing the comparison to V1.

Services That Affect an Entire Table

The following services operate on an entire table:

TBCLOSE	Closes a table and saves a permanent copy if the table was opened
TBCREATE	Creates a new table and opens it for processing
TBEND	Closes a table without saving
TBERASE	Deletes a permanent table from the table output file
TBOPEN	Opens an existing permanent table for processing
TBQUERY	Obtains information about a table
TBSAVE	Saves a permanent copy of a table without closing
TBSORT	Sorts a table
TBSTATS	Provides access to statistics for a table

Temporary tables are created by the TBCREATE service (NOWRITE mode) and deleted by either the TBEND or TBCLOSE service. A new permanent table is created in virtual storage by the TBCREATE service (write mode). The table does not become permanent until it is stored on direct access storage by either the TBSAVE or TBCLOSE service.

An existing permanent table is opened and read into virtual storage by the TBOPEN service. If the table is to be updated (WRITE mode), the new copy is saved by either the TBSAVE or TBCLOSE service. If it is not to be updated (NOWRITE mode), the virtual storage copy is deleted by either the TBEND or TBCLOSE service.

Services That Affect Table Rows

The following services operate on a row of the table:

TBADD	Adds a new row to the table.
TBBOTTOM	Sets CRP to the last row and retrieves the row.
TBDELETE	Deletes a row from the table.
TBEXIST	Tests for the existence of a row (by key).
TBGET	Retrieves a row from the table.
TBMOD	Updates an existing row in the table. Otherwise, adds a new row to the table.
TBPUT	Updates a row in the table if it exists and if the keys match.
TBSARG	Establishes a search argument for use with TBSCAN. Can also be used in conjunction with TBDISPL.
TBSCAN	Searches a table for a row that matches a list of “argument” variables, and retrieves the row.
TBSKIP	Moves the CRP forward or back by a specified number of rows, and then retrieves the row at which the CRP is positioned.
TBTOP	Sets CRP to TOP, ahead of the first row.
TBVCLEAR	Sets to null dialog variables that correspond to variables in the table.

Protecting Table Resources

Table services provide a resource protection mechanism designed to prevent concurrent updating of the same table by more than one user. This protection mechanism assumes that for all users having update access to a given table, the same library name is used in the first statement defining the table for the table library. This can be ISPTLIB or another specified library. Other libraries can be specified by the use of the LIBRARY keyword or the LIBDEF service.

When a table is opened or created in write mode, an exclusive enqueue is requested for a resource name consisting of the first library name defined in the ISPTLIB, or the first library name defined in the LIBRARY DD or the top file specified in the LIBDEF Service stack, concatenated with the table name. The TBOPEN or TBCREATE service fails with a return code of 12 if this enqueue or lock is unsuccessful. A successful enqueue or lock stays in effect until the completion of a TBEND or TBCLOSE service for the table. If the NAME parameter is specified on the TBSAVE or TBCLOSE service, an additional exclusive enqueue or lock is issued. The resource name consists of the first library name defined in the ISPTLIB, or the first library name defined in the LIBRARY DD or the top file specified in the LIBDEF Service stack, concatenated with the name specified in the NAME parameter. If this enqueue or lock fails, the service terminates with a return code of 12 and the table is not written.

Table Services

The table output library represented by the ISPTABL definition or specified library name is protected from concurrent output operations from any ISPF function through a separate mechanism not specific to table services.

Example: Create and Update a Simple Table

The following series of commands demonstrates the use of table services:

1. Create a permanent table, named DALPHA, to consist of dialog variables AA, BB, and CC. AA is the key field. BB and CC are name fields.

```
ISPEXEC TBCREATE DALPHA KEYS(AA) NAMES(BB CC) WRITE DALPHA
```

AA	BB	CC
Pauly John	W590	Jones Beach
Clark Joan	Y200	Bar Harbour

Table services adds a row to table DALPHA immediately following the row added by the previous TBADD. Following the TBADD, the current row pointer (CRP) is positioned at the newly added row. Before a row is added by the TBADD service, table service scans the table to determine if the KEY field of the new row to be added duplicates the KEY field of an existing row. If it does, the TBADD is not performed.

2. Save table DALPHA for later use by writing it to the table output library.

```
ISPEXEC TBCLOSE DALPHA
```

The table DALPHA is written from virtual storage to the file specified by ISPTABL.

Determining Table Size

The length of any row in a table cannot exceed 65 536 bytes. The length can be computed as follows:

$$\text{Row size} = 22 + 4a + b + 9c$$

where:

- a** = total number of variables in the row, including extensions
- b** = total length of variable data in the row
- c** = total number of extension variables in the row

The maximum number of rows allowed in a table is 16 777 215. However, dialog variables later used in processing can only keep a value of 999 999 as the maximum number of table rows. The total table size is the sum of the row lengths, plus the length of the data table control block (DTCB), plus the sort information record for sorted tables. The length of the DTCB can be computed as follows:

$$\text{DTCB length} = 152 + 16d$$

where:

- d** = total number of columns in the table, not including extension variables

The length of the sort information record can be computed as follows:

$$\text{sort-information length} = 12 + 8e$$

where:

- e** = number of sort fields

The number of tables that can be processed at one time is limited only by the amount of available virtual storage.

Example: Function Using the DISPLAY, TBGET, and TBADD Services

This topic describes the use of the DISPLAY, TBGET, and TBADD services in a dialog function that allows a user to add data to a table. A user can start the function by using the ISPSTART command. If the user has already started ISPF, the function can be started from:

- A menu
- The command field in any display with an application command that is defined in the current command table to have the SELECT action
- Another function by using the SELECT service

During function processing, the DISPLAY service controls displays requesting the user to enter data about new employees. The data consists of:

- Employee serial number, entered on panel SER
- Name and phone number, entered on panel DATA.

Entered information is added to the table, as a row, through the TBADD service.

If the user enters an employee serial number for which an employee record already exists in the table, a DUPLICATE NUMBER short message displays on line 1 of panel SER. If the user enters the HELP command or presses the HELP Function key to get further explanation of this short message, the following long message is displayed on line 3 of the panel:

```
EMPLOYEE RECORD ALREADY EXISTS FOR THIS NUMBER. ENTER ANOTHER
```

When the user successfully enters data for an employee, the short message NEW RECORD INSERTED is displayed on line 1 of panel SER. Then the user can enter the serial number of the next employee for which table data is to be added.

The user ends function processing by entering the END or RETURN command on any displayed panel or by pressing the END Function key or RETURN Function key.

The following section lists the complete function, followed by each statement with supporting text and figures.

Command Procedure Function

1. CONTROL ERRORS CANCEL
2. TBOPEN TAB1 WRITE
3. DISPLAY PANEL(SER)
4. if return code = 0, go to 6
5. if return code = 8, go to 21
6. TBGET TAB1
7. if return code = 0, go to 9
8. if return code = 8, go to 12
9. DISPLAY PANEL(SER) MSG(EMPX210)
10. if return code = 0, go to 6
11. if return code = 8, go to 21
12. Set dialog variables to blanks
13. DISPLAY PANEL(DATA)
14. if return code = 0, go to 16

Table Services

15. if return code = 8, go to 21
16. TBADD TAB1
17. if return code = 0, go to 18
18. DISPLAY PANEL(SER) MSG(EMPX211)
19. if return code = 0, go to 6
20. if return code = 8, go to 21
21. TBCLOSE TAB1
22. End the function

Description of Function Steps

1. CONTROL ERRORS CANCEL

This DM service request specifies that the function is to be terminated for a return code of 12 or higher from a DM service request.

2. TBOpen TAB1 WRITE

Open table TAB1 in update (WRITE) mode. Read table contents, shown in Table 3, into virtual storage. TAB1 is referred to by Steps 2, 6, 16, and 21.

Table 3. Five Rows in Table TAB1

EMPSER	LNAME	FNAME	I	PHA	PHNUM
598304	Robertson	Richard	P	301	840-1224
172397	Smith	Susan	A	301	547-8465
813058	Russell	Richard	L	202	338-9557
395733	Adams	John	Q	202	477-1776
502774	Kelvey	Ann	A	914	555-4156

3. DISPLAY PANEL(SER)

This DISPLAY operation uses the panel definition SER, shown in Figure 27, to control the format and content of the panel display, shown in Figure 28 on page 75.

```
)BODY
%----- EMPLOYEE SERIAL -----%
%COMMAND ==>_ZCMD %
+
%ENTER EMPLOYEE SERIAL BELOW:
+
+
+ EMPLOYEE SERIAL%==>_EMPSER+ (MUST BE 6 NUMERIC DIGITS)
+
+
+PRESS%ENTER+TO DISPLAY NEXT SCREEN FOR ENTRY OF EMPLOYEE DATA.
+
+PRESS%END KEY+(PF3) TO END THIS SESSION.

)PROC
VER (&EMPSER, NONBLANK, PICT, NNNNNN)

)END
```

Figure 27. Panel Definition SER

```

----- EMPLOYEE SERIAL -----
COMMAND ==>

ENTER EMPLOYEE SERIAL BELOW:

    EMPLOYEE SERIAL ==>          (MUST BE 6 NUMERIC DIGITS)

PRESS ENTER TO DISPLAY NEXT SCREEN FOR ENTRY OF EMPLOYEE DATA.
PRESS END KEY (PF3) TO END THIS SESSION.

```

Figure 28. Panel Display SER

Both the panel definition and the display are referred to in Steps 3, 9, and 18. The display requests that a serial number be entered for an employee. The user enters the serial number in the field labeled EMPLOYEE SERIAL NUMBER. The DISPLAY service then stores it in function pool variable EMPSER, and verifies it as specified on the panel definition. The verification is specified in a VER statement in the)PROC section of the panel definition, as shown in Figure 27 on page 74:

```
VER (&EMP SER, NONBLANK, PICT, NNNNNN)
```

This statement specifies that EMPSER must be nonblank and must consist of six digits, each in the range of 0–9.

When the input passes the verification, the DISPLAY service returns control to the function.

If the input fails the verification, the panel is automatically displayed again, but with an appropriate ISPF-supplied message displayed, right-justified, on line 1. For example, if the user fails to enter the required employee serial number, the ENTER REQUIRED FIELD message is displayed, as shown in Figure 29 on page 76, and referred to in Steps 3 and 18.

```

----- EMPLOYEE SERIAL -----ENTER REQUIRED FIELD
COMMAND ==>

ENTER EMPLOYEE SERIAL BELOW:

    EMPLOYEE SERIAL ==>          (MUST BE 6 NUMERIC DIGITS)

PRESS ENTER TO DISPLAY NEXT SCREEN FOR ENTRY OF EMPLOYEE DATA.
PRESS END KEY (PF3) TO END THIS SESSION.

```

Figure 29. Panel Display SER with an ISPF-provided Message Superimposed on Line 1

After the user re-enters the information, it is stored again in function pool variable EMPSER and reverified. The process is repeated until the information passes the verification tests.

4. if return code = 0, go to 6
If the return code is 0, the display operation is successfully completed. Go to step 6 to verify that no record exists for this employee number.
5. if return code = 8, go to 21
If the return code is 8, the END or RETURN command was entered on the display by the user. Go to step 21 to end processing.
6. TBGET TAB1
This TBGET uses the employee serial number, stored in EMPSER in step 3 or 18, to attempt retrieval of an employee record from the TAB1 table. The table is a keyed table and has been created in another dialog by the service request:
TBCREATE TAB1 KEYS(EMPSER) NAMES(LNAME FNAME I PHA PHNUM)
7. if return code = 0, go to 9
A return code of 0 means that the record is found. Therefore, a record already exists for the employee serial number entered by the user. Go to step 9 to display the DUPLICATE NUMBER message.
8. if return code = 8, go to 12
A return code of 8 means that no record is found. Go to step 12 to request the user to enter employee data.
9. DISPLAY PANEL(SER) MSG(EMPX210)
This DISPLAY operation uses panel definition SER (Figure 27 on page 74) and message EMPX210, shown in Figure 30 on page 77 to control the format and content of the display. Figure 30 is referred to by steps 9, 13, and 18.

```

EMPX210 'DUPLICATE NUMBER' .ALARM=YES
'EMPLOYEE RECORD ALREADY EXISTS FOR THIS NUMBER. ENTER ANOTHER.'

EMPX211 'NEW RECORD INSERTED'
'ENTER SERIAL NUMBER FOR NEXT EMPLOYEE RECORD TO BE INSERTED.'

EMPX212 'ENTER PHONE NUMBER'
'IF THE EMPLOYEE HAS NO PHONE, ENTER 000-000'

EMPX213 'ENTER FIRST NAME'
'A FIRST NAME OR FIRST INITIAL IS REQUIRED.'

EMPX214 'ENTER LAST NAME'
'A LAST NAME IS REQUIRED.'

```

Figure 30. Message EMPX21

The following DISPLAY request, omitting the PANEL(SER) parameter, could have been used in this step:

```
DISPLAY MSG(EMPX210)
```

When the PANEL parameter is omitted, the specified message is superimposed on the panel currently being displayed, which, in this case, is the panel SER.

The short form of the message EMPX210, DUPLICATE NUMBER, is superimposed on line 1 of the panel display, shown in Figure 31.

```

----- EMPLOYEE SERIAL -----DUPLICATE NUMBER
COMMAND ==>

ENTER EMPLOYEE SERIAL BELOW:

EMPLOYEE SERIAL ==> 598304 (MUST BE 6 NUMERIC DIGITS)

PRESS ENTER TO DISPLAY NEXT SCREEN FOR ENTRY OF EMPLOYEE DATA.
PRESS END KEY (PF3) TO END THIS SESSION.

```

Figure 31. Panel Display SER—Short Form of Message EMPX210 Superimpose Line 1

While viewing this message, the user can request the long form of the message by pressing the HELP Function key. The long form of the message EMPLOYEE RECORD ALREADY EXISTS FOR THIS NUMBER. ENTER ANOTHER.

is superimposed on line 3 of the display. See Figure 32 on page 78.

```
----- EMPLOYEE SERIAL -----DUPLICATE NUMBER
COMMAND ==>
EMPLOYEE RECORD ALREADY EXISTS FOR THIS NUMBER. ENTER ANOTHER.
ENTER EMPLOYEE SERIAL BELOW:

EMPLOYEE SERIAL ==> 598304      (MUST BE 6 NUMERIC DIGITS)

PRESS ENTER TO DISPLAY NEXT SCREEN FOR ENTRY OF EMPLOYEE DATA.
PRESS END KEY (PF3) TO END THIS SESSION.
```

Figure 32. Panel Display SER—Long Form of Message EMPX210 Superimposed on Line 3

After the user enters the requested serial number, the DISPLAY service stores it in function pool variable EMPSER and verifies it as described for step 3. After the input passes verification, the DISPLAY service returns control to the function.

10. if return code = 0, go to 6
If the return code is 0, the display operation is successfully completed. Go to step 6 to verify that no record already exists for this employee number.
11. if return code = 8, go to 21
If the return code is 8, the END or RETURN command was entered on the display by the user. Go to step 21 to end processing.
12. Set dialog variables to blanks
These function pool variables are set to blank to prepare to receive data for a new employee record.
13. DISPLAY PANEL(DATA)
The DISPLAY operation uses panel definition DATA, shown in Figure 33 on page 79, to control the format and content of the display shown in Figure 34 on page 79.

```

)BODY
%----- EMPLOYEE RECORDS -----%
%COMMAND ==>_ZCMD
+
%   EMPLOYEE SERIAL: &EMP SER
+
+   EMPLOYEE NAME:
+   LAST   %>_LNAME      +
+   FIRST  %>_FNAME      +
+   INITIAL%>_I+
+
+   HOME PHONE:
+   AREA CODE %>_PHA+
+   LOCAL NUMBER%>_PHNUM +
+
+
+PRESS%ENTER+TO STORE EMPLOYEE DATA AS ENTERED ABOVE.
+
+PRESS%END KEY+(PF3) TO END THIS SESSION.

)INIT
.CURSOR = LNAME
IF (&PHA = ' ')
  &PHA = 914

)PROC
VER (&LNAME,ALPHA)
VER (&FNAME,ALPHA)
VER (&I,ALPHA)
VER (&PHA,NONBLANK,PICT,NNN)
VER (&PHNUM,PICT,'NNN-NNNN')
VER (&LNAME,NONBLANK,MSG=EMPX214)
VER (&FNAME,NONBLANK,MSG=EMPX213)
VER (&PHNUM,NONBLANK,MSG=EMPX212)

)END

```

Figure 33. Panel Definition DATA

```

----- EMPLOYEE RECORDS -----
COMMAND ==>

EMPLOYEE SERIAL: 106085

EMPLOYEE NAME:
LAST   ==>  _
FIRST  ==>  _
INITIAL ==>

HOME PHONE:
AREA CODE   ==>
LOCAL NUMBER ==>

PRESS ENTER TO STORE EMPLOYEE DATA AS ENTERED ABOVE.

PRESS END KEY (PF3) TO END THIS SESSION.

```

Figure 34. Panel Display DATA

Table Services

The variables set to blank in step 12 are displayed, along with the new employee serial number entered in step 3 or 18. The user is asked to enter, in the blank fields displayed on the screen, the name and phone number for the employee.

After the user enters these fields, the DISPLAY service stores the input in function pool variables LNAME, FNAME, I, PHA, and PHNUM. Then, verification of the input is performed as specified in VER statements in the)PROC section of the panel definition (Figure 33 on page 79).

If the input fields pass the verification tests, the DISPLAY service returns control to the function.

If the input fields fail the verification tests, a short-form message is displayed on line 1.

The message can be provided by ISPF, or the number of the message displayed may have been specified in the VER statement that defined the verification test. See VER statements containing message IDs EMPX212, EMPX213, and EMPX214 in Figure 33 on page 79. When a message ID is specified, this message is displayed instead of an ISPF-provided message. In either case, if the user enters the HELP command, the long form of the message is displayed on line 3.

The messages request that information be re-entered. When re-entered, this information is stored again in function pool variables and reverified. The process is repeated until the verification tests are passed.

14. if return code = 0, go to 16

If the return code is 0, the display operation is successfully completed. Go to step 16 to add the record to the table.

15. if return code = 8, go to 21

If the return code is 8, the END or RETURN command was entered on the display by the user. Go to step 21 to end processing.

16. TBADD TAB1

This TBADD adds a row to table TAB1 by copying values from function pool variables to the table row. The values copied are employee serial number, stored in the function pool variable EMPSER by step 3 or 18, and employee name and phone number, stored in function pool variables LNAME, FNAME, I, PHA, and PHNUM by step 13. Function pool variables must have the same names as the table variables to which they are to be copied by the TBADD operation. Therefore, the names used in the TBCREATE request are the same as the names used in the definitions for panels on which the DISPLAY service accepts user input.

17. if return code = 0, go to 18

If the return code is 0, the TBADD operation is successfully completed. Go to step 18 to display the NEW RECORD INSERTED message.

18. DISPLAY PANEL(SER) MSG(EMPX211)

This DISPLAY operation uses panel definition SER (Figure 27 on page 74) and message EMPX211 (Figure 30 on page 77) to control the format and content of the display. The short form of message EMPX211, NEW RECORD INSERTED, is displayed on line 1. If the user enters the HELP command while this message is being displayed, the long form of the message (Figure 30 on page 77):

```
ENTER SERIAL NUMBER FOR NEXT EMPLOYEE RECORD TO BE INSERTED
```

is displayed on line 3.

The user enters another serial number. The DISPLAY service verifies it as described in step 3. When the serial number passes the verification tests, the DISPLAY service returns control to the function.

19. if return code = 0, go to 6
If the return code is 0, the display operation is successfully completed. Go to step 6 to verify that no record already exists for this employee number.
20. if return code = 8, go to 21
If the return code is 8, the END or RETURN command was entered on the display by the user. Go to step 21 to end processing.
21. TBCLOSE TAB1
Close the table TAB1. Write it from virtual storage to permanent storage.
22. End the function.

Specifying DBCS Search Argument Format for Table Services

For table services, you can specify either a DBCS or MIX (DBCS and EBCDIC) format string as a search argument. If either is used as a generic search argument, such as xxx* (any argument whose first three characters are 'xxx'), the argument must be specified as follows:

- DBCS format string

DBDBDBDB**

where DBDBDBDB represents a 4-character DBCS string and ** is a single DBCS character representing the asterisk (*).

- MIX (DBCS and EBCDIC) format string

eeee[DBDBDBDBDB]*

where eeee represents a 4-character EBCDIC string, DBDBDBDBDB represents a 5-character DBCS string, [and] represent shift-out and shift-in characters, and * is an asterisk in single-byte EBCDIC format.

Using the File-Tailoring Services

The file-tailoring services, listed in the order they are normally invoked, are:

FTOPEN	Prepares the file-tailoring process and specifies whether the temporary file is to be used for output
FTINCL	Specifies the skeleton to be used and starts the tailoring process
FTCLOSE	Ends the file-tailoring process
FTERASE	Erases an output file created by file tailoring.

File-tailoring services read skeleton files and write tailored output that can be used to drive other functions. Frequently, file tailoring is used to generate job files for batch execution.

The file-tailoring output can be directed to a file specified by the function, or it can be directed to a temporary sequential file provided by ISPF. The file name of the temporary file is available in system variable ZTEMPF. In MVS, ZTEMPF contains a data set name. The ddname of the temporary file is available in system variable ZTEMPN.

You can use the ISPFTRC command to trace both the execution of file tailoring service calls (FTOPEN, FTINCL, FTCLOSE, and FTERASE) and the processing that occurs within the file tailoring code and processing of each statement. For more information, refer to "File tailoring trace command (ISPFTRC)" on page 355.

Skeleton Files

Each skeleton file is read record-by-record. Each record is scanned to find any dialog variable names, which are names preceded by an ampersand. When a variable name is found, its current value is substituted from a variable pool.

Skeleton file records can also contain statements that control processing. These statements provide the ability to:

- Set dialog variables
- Imbed other skeleton files
- Conditionally include records
- Iteratively process records in which variables from each row of a table are substituted.

When iteratively processing records, file-tailoring services read each row from a specified table. If the table was already open before processing the skeleton, it remains open with the CRP positioned at TOP. If the table was not already open, file tailoring opens it automatically and closes it upon completion of processing.

Problems can occur when using file-tailoring services in conjunction with other services (EDIT, COPY, ...) that result in modifying the data set members in the ISPSLIB concatenation. ISPSLIB is the input skeleton library, and it is assumed to be a static library. FTINCL obtains existing DCB/DEB information based on the last OPEN done against ISPSLIB by ISPF. It is recommended that applications that use file tailoring and modify members of ISPSLIB, use the LIBDEF service for ISPSLIB to point to the application's skeleton library.

The application should also check for any changes to the data set information DCB/DEB before invoking file-tailoring services. If there has been a change, then the application should issue a NULL LIBDEF for ISPSLIB and then reissue the original LIBDEF for ISPSLIB. This will force a close and re-open of the ISPSLIB library.

Example of a Skeleton File

A sample skeleton file is shown in Figure 35 on page 83. It contains MVS job control language (JCL) for an assembly and optional load-and-go. The tailored output could be submitted to the background for submission.

```

//ASM EXEC          PGM=IFOX00,REGION=128K
//                PARM=(&ASMPARMS)
//SYSIN DD         DSN=&ASMIN: (&MEMBER) ,DISP=SHR
//SYSLIB DD       DSN=SYS1.MACLIB,DISP=SHR
)SEL  &ASMMAC1   ^=&Z
// DD          DSN=&ASMMAC1,DISP=SHR
)SEL  &ASMMAC2   ^=&Z
// DD          DSN=&ASMMAC2,DISP=SHR
)ENDSEL
)ENDSEL
//SYSUT1 DD      UNIT=SYSDA,SPACE=(CYL,(5,2))
//SYSUT2 DD      UNIT=SYSDA,SPACE=(CYL,(2,1))
//SYSUT3 DD      UNIT=SYSDA,SPACE=(CYL,(2,1))
//SYSPRINT DD    SYSOUT=(&ASMPRT)
)CM  IF USER SPECIFIED "GO", WRITE OUTPUT IN TEMP DATA SET
)CM  THEN IMBED "LINK AND GO" SKELETON
)SEL  &GOSTEP=YES
//SYSGO DD      DSN=&&&&OBJSET,UNIT=SYSDA,SPACE=(CYL,(2,1)),
//              DISP=(MOD,PASS)
)IM  LINKGO
)ENDSEL
)CM  ELSE (NOGO), WRITE OUTPUT TO USER DATA SET
)SEL  &GOSTEP=NO
//SYSGO DD      DSN=&ASMOUT (&MEMBER) ,DISP=OLD
)ENDSEL
//*
```

Figure 35. Sample Skeleton File

The sample skeleton refers to several dialog variables (ASMPARMS, ASMIN, MEMBER, and so on) highlighted in the figure. It also illustrates use of select statements “)SEL” and “)ENDSEL” to conditionally include records. The first part of the example has nested selects to include concatenated macro libraries if the library names have been specified by the user (that is, if variables ASMMAC1 and ASMMAC2 are not equal to the null variable Z).

In the second part of the example, select statements are used to conditionally execute a load-and-go step. An imbed statement, “)IM”, is used to bring in a separate skeleton for the load-and-go step.

Example of Using File-Tailoring Services

The following example illustrates file-tailoring services. For this example, assume that:

- LABLSKEL is a member in the file tailoring library, containing:

```

)DOT DALPHA
  NAME:  &AA
  APARTMENT:  &BB
  CITY:  &CC
  YEAR:  &ZYEAR
)ENDDOT
```

ZYEAR is the name of an ISPF system variable that contains the current year.

- DALPHA is a member of the table library, containing:

DALPHA

AA	BB	CC
Pauly John	W590	Jones Beach
Clark Joan	Y200	Bar Harbour

This example creates a name and address list. The file-tailoring service requests are:

- **ISPEXEC FTOPEN**

- **ISPEXEC FTINCL LABLSKEL**

- Issue ISPF commands to process skeleton LABLSKEL. Obtain values for dialog variables AA, BB, and CC from table DALPHA. The resulting file-tailoring output consists of one address label for each row of information in table DALPHA.

- FTOPEN opens both the file-tailoring skeleton and file-tailoring output files. These files must be defined to ISPF before starting the ISPF session.

- FTINCL performs the file-tailoring process by using the file-tailoring skeleton named LABLSKEL. LABLSKEL contains the file-tailoring controls,)DOT and)ENDDOT, which specify the use of table DALPHA.

- You can issue multiple FTINCL commands to pull in more than one skeleton.

- **ISPEXEC FTCLOSE NAME (LABLOUT)**

- Write the resulting file-tailoring output to a member named LABLOUT SKELETON.

At the conclusion of processing the previous commands, file-tailoring output file LABLOUT SKELETON contains:

```
NAME:   Pauly John
APARTMENT: W590
CITY:   Jones Beach
YEAR:   84
NAME:   Clark Joan
APARTMENT: Y200
CITY:   Bar Harbour
YEAR:   84
```

Using the PDF Services

PDF services consist of the BRIF (Browse Interface), BROWSE, EDIF (Edit Interface), EDIREC (edit recovery for EDIF), EDIT, and EDREC (edit recovery for EDIT) services and a set of library access services.

BROWSE, EDIT, and EDREC

The BROWSE and EDIT services allow you to create, read, or change MVS data sets or members of an ISPF library. An *ISPF library* is a cataloged partitioned data set with a three-level name made up of a project, a group, and type. The ISPF library can be private (available only to you) or can be shared by a group of users. The BROWSE and EDIT *services* provide direct access to the Browse and Edit *options* of PDF, bypassing the Browse mode on the View Entry panel and Edit Entry panels.

The EDREC service, which you usually invoke *before* calling EDIT, helps you recover work that would otherwise be lost if ISPF ended abnormally, such as after a power loss.

Refer to the *z/OS ISPF Services Guide* for complete descriptions, including examples, of the BROWSE, EDIT, and EDREC services.

BRIF, EDIF, and EDIREC

Two services, the Browse Interface (BRIF) service and the Edit Interface (EDIF) service, allow dialogs to provide their own I/O for PDF Browse and Edit. These services provide edit and browse functions for data accessed through dialog-supplied I/O routines. BRIF and EDIF require that the invoking dialog perform all environment-dependent functions (such as allocating, opening, reading, writing, closing, and freeing files).

Use of the BRIF and EDIF services allows the type of data and data access methods being employed by a dialog to be transparent to Browse and Edit. The Edit Interface Recovery (EDIREC) service performs edit recovery for EDIF.

These services make it possible to implement functions such as:

- Edit/browse of data other than partitioned data sets or sequential files
- Edit/browse of in-storage data
- Pre- and post-processing of edited or browsed data.

Refer to *z/OS ISPF Services Guide* for descriptions and examples of BRIF, EDIF, and EDIREC.

Library Access Services

The library access services can interact with the BROWSE and EDIT services and can also give you access to ISPF libraries and to certain system data sets. These services carry out functions such as opening a library, copying a library or library member, and displaying a library's members.

You can use the library access services with four types of libraries or data sets:

- An ISPF library known by project, group, and type
- A concatenated set of up to four ISPF libraries
- A single existing TSO or MVS partitioned or sequential data set
- A concatenated set of up to four MVS partitioned data sets.

The library access services only support data sets with the following attributes:

- the data set is stored on a single DASD volume
- the record format is F, FB, V, VB, or U
- the data set organization is either partitioned or sequential

z/OS ISPF User's Guide Vol I contains an explanation of the ISPF library structure.

Refer to the *z/OS ISPF Services Guide* for complete descriptions, including examples, of the library access services.

Another way you can maintain different levels or versions of a library member is to use the software configuration and library manager (SCLM) utilities. SCLM is a software tool that helps you develop complex software applications. Throughout the development cycle, SCLM automatically controls, maintains, and tracks all of the software components of the application. And, you can lock the version being edited in a private library and then promote it to another group within the library for further development or testing. Refer to *z/OS ISPF Software Configuration and Library Manager Project Manager's and Developer's Guide* for more information about SCLM.

Using the Miscellaneous Services

ISPF provides the CONTROL, GRINIT, GRTERM, GRERROR, GETMSG, LIBDEF, LIST, LOG, and PQUERY services, which are briefly described in the following paragraphs. You can find more information about these services in the *z/OS ISPF Services Guide*.

CONTROL Service

The CONTROL service allows a function to condition ISPF to expect certain kinds of display output, or to control the disposition of errors encountered by DM services. For example, some display conditions are:

LINE	Expect line output to be generated by the dialog or by execution of a TSO command. Optionally, the starting line can be specified.
LOCK	Allow the next display without unlocking the terminal keyboard. LOCK is generally used with the DISPLAY service to overlay a currently displayed panel with an "in-process" message; for example: <pre>DISPLAY PANEL(panel-name) : : CONTROL DISPLAY LOCK DISPLAY MSG(message-id) : :</pre>
NONDISPL	Do not display the next panel. Process the panel without actually displaying it, and simulate the Enter key or END command.
REFRESH	Refresh the entire screen on the next display. Typically used before or after invoking some other full-screen application that is not using DM display services.
SPLIT	Enable or disable split-screen operation by a user as required by the application.

The disposition of errors can be controlled as follows:

CANCEL	Terminate the function on an error with a return code 12 or higher from any service. A message is displayed and logged before termination.
RETURN	Return control to the function on all errors, with appropriate return code. A message ID is stored in system variable ZERRMSG, which can be used by the function to display or log a message.

The default disposition is CANCEL. If a function sets the disposition to RETURN, the change affects only the current function. It does not affect lower-level functions invoked by using the SELECT service, nor a higher-level function when the current function completes.

GDDM Services (GRINIT, GRTERM, and GRERROR)

The graphics initialization (GRINIT) service initializes the ISPF/GDDM interface and optionally requests that ISPF define a panel's graphic area as a GDDM graphics field. The graphics termination (GRTERM) service terminates a previously established GDDM interface. The graphics error block (GRERROR) service provides access to the address of the GDDM error record and the address of the GDDM call format descriptor module.

GETMSG Service

The GETMSG service obtains a message and related information and stores them in variables specified in the service request.

LIBDEF Service

The LIBDEF service provides applications with a method of dynamically defining application data element files while in an active ISPF session.

LIST Service

The LIST service allows a dialog to write data lines directly (without using print commands or utilities) to the ISPF list data set. You specify the name of the dialog variable containing the data to be written on the LIST service request.

LOG Service

The LOG service allows a function to write a message to the ISPF log file. The user can specify whether the log is to be printed, kept, or deleted when ISPF is terminated.

PQUERY Service

The PQUERY service returns information for a specific area on a specific panel. The type, size, and position characteristics associated with the area are returned in variables.

Miscellaneous Services

Chapter 4. Common User Access (CUA) Guidelines

This chapter briefly describes how ISPF supports the Common User Access (CUA) guidelines. The CUA guidelines define a user interface in terms of common elements, such as the way information appears on a screen, and interaction techniques, such as the way users respond to what appears on a screen. Refer to the *SAA CUA Basic Interface Design Guide*.

ISPF supports the CUA guidelines in the following ways. You can:

- Define a list of function keys to be associated with each panel.
- Define an action bar and pull-downs on a panel.
- Define and display pop-up windows.
- Define and display help panels for field-level help, extended help, and keys help. See Chapter 8, “ISPF Help and Tutorial Panels,” on page 293 for more information about CUA help panels.

With ISPF, the panel ID is displayed according to CUA defaults and the PANELID command acts as a toggle.

ISPF also lets you indicate, for an application session, if you want to use CUA defaults. If selected, the Panel display CUA mode option on the ISPF Settings panel controls:

- The location of the function keys on the panel in relation to the command and message lines.
- The appearance and display format of the keys.

Using the Dialog Tag Language to Define Dialog Elements

The Dialog Tag Language (DTL) is a set of markup language tags that you can use to define dialog elements. You can use DTL tags in addition to or instead of ISPF methods for defining panels, messages, and command tables. In addition, when you define a panel using DTL tags, you can assign a specific keylist to be associated with and displayed on that panel, if requested by the user.

The DTL defines the source information for the dialog elements, and the ISPF dialog tag language conversion utility converts the source file to a format ISPF understands. The *z/OS ISPF Dialog Tag Language Guide and Reference* explains in detail how to create the various elements using the DTL and ISPF conversion utility.

Keylists

The key assignments active for an application panel are defined and stored within keylists. These key assignments allow the user to request commands and other actions through the use of function keys. Key assignments for your application are displayed in the function key area of application panels. Keylists can be *shared* across all users by defining them using DTL. This creates an xxxxKEYS table that is placed in the ISPTLIB concatenation. Users can modify keylists using the KEYS and KEYLIST commands. Both commands invoke the Keylist utility. Modifications to keylists are stored in the user’s application profile, thus they are called *private*.

You can view or modify keylists either through the KEYLIST command or the **Keylist settings** choice from the Function keys pull-down on the ISPF Settings panel. You can control whether your application uses keylists or not with the KEYLIST command or the **Keylist settings** choice from the Function keys pull-down on the ISPF Settings panel. You can also control whether you use keylists as shipped with the application or with user modifications. You assign the keylist to a particular panel by using the keylist keyword on the)PANEL statement or by using the keylist attribute on the PANEL tag. For a description of the panel section, see “Defining the Panel Section” on page 223.

Action Bars and Pull-Downs

An action bar is the panel element located at the top of an application panel that contains action bar choices for the panel. Each action bar choice represents a group of related choices that appear in the pull-down associated with the action bar choice. When the user selects an action bar choice, the associated pull-down appears directly below the action bar choice. Pull-downs contain choices that, when selected by the user, perform actions that apply to the contents of the panel.

For complete details on coding action bars and pull-downs, refer to the *z/OS ISPF Dialog Tag Language Guide and Reference* or the “Defining the Action Bar Choice Section” on page 157.

Pop-Up Windows

Pop-up windows display information that extends the user’s interaction with the underlying panel. When a pop-up is displayed, the user must finish interacting with that pop-up window before continuing with the dialog in the underlying panel.

The ADDPOP service allows your application to use pop-up windows. After you issue the ADDPOP service, subsequent DISPLAY, TDISPL, or SELECT service calls display panels in that pop-up window until your application issues a corresponding REMPOP service or issues another ADDPOP service.

You specify the location of the pop-up window using the ADDPOP service call.

Note: When you are running in GUI mode, this pop-up window location specification is ignored. Default positioning is used.

You can specify the size of the window (width and depth) on the panel definition BODY statement or use the WIDTH and DEPTH attributes on the DTL PANEL tag. If you do not specify the size, the Dialog Manager displays the pop-up window in a 76 X 22 window with a border.

Each pop-up window created as a result of a successful ADDPOP service call can also have a window title. The title is embedded in the top of the window frame border and can be only one line in length. If the title is longer than the window frame, the dialog manager truncates it. To define the window title, set system variable ZWINTTL to the desired window title text.

Note: If you are running in GUI mode, the value in ZWINTTL has a maximum length of 255 characters and will be truncated without notice to the user at display time if it does not fit on the panel.

The following example will display three pop-up windows, as shown in Figure 36. The window that panel B is displayed within will have the title *POPUP WINDOW TITLE*.

```

PROC 0
ISPEXEC ADDPOP
ISPEXEC DISPLAY PANEL(A)
ISPEXEC ADDPOP POPLOC(F1)
SET ZWINTTL = POPUP WINDOW TITLE
ISPEXEC DISPLAY PANEL(B)
SET ZWINTTL =
ISPEXEC ADDPOP
ISPEXEC DISPLAY PANEL(C)

```

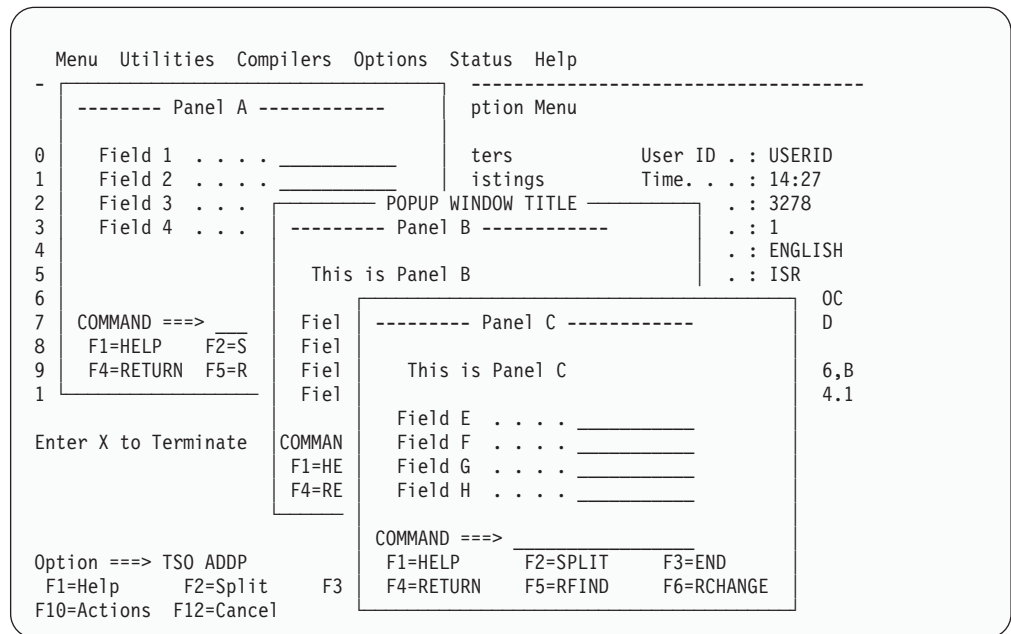

Figure 36. Example Panel Displaying Three Pop-Up Windows

The REMPOP service removes the current pop-up window. After you call the REMPOP service, a subsequent DISPLAY service will either display a panel in the full panel area of the screen or in a lower-level pop-up window, if it is active.

Refer to *z/OS ISPF Services Guide* for a complete description of the ADDPOP and REMPOP services.

Movable Pop-Ups

ISPF provides two ways for you to move the currently active pop-up window: the WINDOW command, and manual movement using two terminal interactions and no specific ISPF command. You can also move the window with any other method you normally use to move windows on your workstation.

Note: The WINDOW command is disabled if you are running in GUI mode.

WINDOW Command

The WINDOW command can be associated with a function key or can be typed on the command line. The cursor placement specifies the new location for the upper-left corner of the pop-up window frame. If the pop-up window does not fit

on the physical screen at the specified location, it is repositioned to fit following the current pop-up window positioning rules. The cursor is placed in the same relative position it occupied before a dialog or help pop-up window was moved.

If the cursor location would be covered as a result of moving a modeless message window, the cursor is repositioned to the first input field on the active panel. If an input field does not exist, the cursor is positioned in the upper-left corner of the active panel. The cursor is returned to its intended location if the modeless message window is moved to a location that no longer conflicts with cursor display. Cursor positioning is not affected by an input field that becomes protected as a result of a modeless message window position unless the cursor itself would be covered. In other words, the cursor can be positioned on a protected input field.

The WINDOW command is an immediate action command. Panel processing is not performed when this command is used.

If the WINDOW command is typed in the command line, the cursor should be moved to the desired window position before pressing Enter.

If the WINDOW command is included in the keylist associated with the currently active application panel, the user can move the cursor to any position on the screen, press the function key assigned to the WINDOW command, and the pop-up is repositioned to the user's cursor position. The WINDOW command can be included in the keylist by the application developer, or the user can use the KEYLIST utility to add it to the keylist.

For panels that do not include the KEYLIST keyword in the)PANEL statement, the application can assign the WINDOW command to a ZPFnn system variable. The user can also associate WINDOW with a function key by using the ZKEYS command to access the function key assignment utility.

If the split screen is used, the pop-up cannot be moved to a different logical screen. The new pop-up window location must be in the same logical screen in which the pop-up was originally located. A pop-up is not displayed over the split line. The split line cuts off the pop-up at the split line location; the pop-up is not automatically repositioned to fit above the split line.

Note: Pull Down Choice (PDC), Action Bar is also a pop-up window, so the split screen line cuts off the Action Bar location, too. The pop-up is not automatically repositioned to fit above the split line.

If the WINDOW command is requested when pop-up windows are not active, a message is displayed to the user. A pop-up window containing an Action Bar panel cannot be moved while a pull-down is actively displayed. A message is displayed to the user if the WINDOW command is requested during this condition.

Manual Movement

The second method for moving pop-up windows involves two terminal interactions but does not require a unique ISPF command. A user can request window movement by placing the cursor anywhere on the active window frame and pressing Enter. ISPF acknowledges the window move request by displaying WINDOW MOVE PENDING message. The alarm will sound if the terminal is so

equipped. The message text will be yellow/high intensity if the Panel display CUA mode option on the ISPF Settings panel has been selected. Otherwise, the message text will be white/low intensity.

Place the cursor where you want the upper-left corner of the window frame to be, and press Enter a second time. The window is moved to the new location as though the WINDOW command had been issued. The rules for cursor placement inside the window, and window placement on the physical display, are the same as those described for the WINDOW command.

Pop-Up Movement Considerations

Modeless and modal message pop-up windows can be moved in the same manner as dialog pop-up windows.

Only the active pop-up window can be moved. If a modal or modeless message pop-up is displayed over a dialog pop-up window, only the message pop-up window can be moved. The underlying dialog pop-up window cannot be moved while a message pop-up window is displayed over it.

Input fields that are partially or totally covered by a pop-up window become protected fields (data cannot be entered into the field). If a field becomes totally uncovered as a result of moving the pop-up window, the field is restored to an unprotected field (data can be entered into the field).

Field-Level Help

Field-level help provides help panels for fields defined on an application panel. When the cursor is on a field and you request HELP, ISPF displays the help panel defined for that field. See “Defining the HELP Section” on page 220.

Extended Help

Extended help provides general information about the contents of a panel. The information in extended help can be an overall explanation of items on the panel, an explanation of the panel’s purpose in the application, or instructions for the user to interact with the panel. The user invokes extended help by issuing the command EXHELP. EXHELP requests ISPF to display help text for the entire panel.

For more information about help, see “.HELP” on page 287 and Chapter 8, “ISPF Help and Tutorial Panels,” on page 293.

Keys Help

Keys help provides the user with a brief description of each key defined for a panel. You define the contents of this help panel. The user invokes keys help by issuing the command KEYSHELP.

KEYSHELP requests ISPF to display the help panel for the current keylist. The help panel name can be provided as part of the keylist definition. If the keys help panel is not identified in the keylist definition, it can be supplied in the ZKEYHELP system variable. Use separate ZKEYHELP variable values for each keys help panel to be displayed.

Reference Phrase Help

Reference phrase (RP) help is available on all panels. Place the cursor on a highlighted reference phrase within a panel, request help, and you receive the help panel defined for that reference phrase.

When a panel with reference phrases is displayed for the first time, the cursor is positioned in the upper-left corner. After a reference phrase is selected and control is returned to the original panel, the panel scrolls automatically to put the cursor on the reference phrase from which the reference phrase help was invoked. The exact scroll position might not be the same as when the reference phrase help was invoked. ISPF positions the reference phrase at the top of the display is scrolling is necessary to display the reference phrase help field. The reference phrase is an input-capable field that allows tabbing. Therefore, the reference phrase text is refreshed whenever the panel is redisplayed.

Reference phrase help panels themselves can also contain reference phrases. When a reference phrase help panel is canceled, the panel from which reference phrase help was requested is redisplayed. All other help facilities are available from a reference phrase help panel.

The TYPE(RP) attribute in the panel attribute section is used to identify a reference phrase in a panel. See “Defining the Attribute Section” on page 170. An entry is then placed in the)HELP section of the panel for each reference phrase attribute coded in the)BODY or optional)AREA panel sections. The following example is a)HELP section reference phrase definition:

```
)HELP  
  FIELD(ZRPxyyy)  PANEL(panel-name)
```

xx 00 for a reference phrase defined in)BODY section and 01 to 99 for the number of the scrollable area in which the reference phrase is defined.

Each scrollable area is assigned a sequential number based on its relative position within the panel body. The scrollable area closest to the upper-left corner of the panel body is assigned number 01 with each additional scrollable area, scanning left to right, top to bottom, assigned the next sequential number. A maximum of 99 scrollable areas in any given panel may contain reference phrases.

yyy 001 to 999 for the relative number of the reference phrase within the panel body or within a particular scrollable area.

panel-name

Name of the help panel to be displayed when HELP for this reference phrase is requested.

A reference phrase can wrap around multiple terminal lines in panels that are not displayed in a window. A reference phrase that logically wraps in a pop-up window requires the beginning of each wrapped line to contain a RP field attribute, and there must be an entry in the)HELP section for each wrapped line. This is also true for panels containing the WINDOW() keyword that are not displayed in a pop-up window. The additional)HELP section entries would normally be pointing to the same panel.

The example in Figure 37 on page 95 illustrates both single and multiple line reference phrases.

```

)PANEL
)ATTR
  # TYPE(RP)
  $ AREA(SCRL) EXTEND(OFF)
)BODY
+This is sample text. This is a #Reference Phrase+.
+This is an example of a #Reference Phrase being
  physically continued to the next line.+
+ *****
+ *$SAREA1          $*          *****
+ *$                $*          *$SAREA2      $*
+ *$                $*          *$            $*
+ *****          *$            $*
+ *****          *$            $*
+ *$SAREA3          $*          *$            $*
+ *$                $*          *****
+ *$                $*
+ *****
+This is an example of a #Reference Phrase being+
#logically continued to the next line.+
+
)AREA SAREA1
+          +
#Area 01 Ref Phrase+
+          +
)AREA SAREA2
+          +
+ #Area 02+ +
+ #Reference++
+ #Phrase+ +
)AREA SAREA3
+          +
#Area 03 Ref Phrase+
+          +
)HELP
FIELD(ZRP00001)  PANEL (BODY0001)
FIELD(ZRP00002)  PANEL (BODY0002)
FIELD(ZRP00003)  PANEL (BODY0003)
FIELD(ZRP00004)  PANEL (BODY0003)
FIELD(ZRP01001)  PANEL (AREA0101)
FIELD(ZRP02001)  PANEL (AREA0201)
FIELD(ZRP02002)  PANEL (AREA0201)
FIELD(ZRP02003)  PANEL (AREA0201)
FIELD(ZRP03001)  PANEL (AREA0301)
)END

```

Figure 37. Reference Phrase Help Example

START Service

You can use the START service to start a dialog in a new logical screen. This function is similar to the function nesting made available with action bars except that the “nesting” occurs in a new logical screen.

You can invoke the START service in any of the following ways:

- From any command line, you can enter a command in this form:

```
START some_dialog
```

some_dialog can be any of the following:

- A command from the command table; for example, MYCMD1

- A command with parameters (must be in quotes); for example,
'MYCMD1 PARM1'
- A dialog invocation; for example, PANEL(MYPAN1), or
'PGM(MYPGM1) PARM(MYPARM1,MYPARM2)'
- You can code a pull-down choice,
ACTION RUN(START) PARM(*some_dialog*)

where *some_dialog* is the same as outlined above.

- You can code a selection panel option,
'PGM(ISPSTRT) PARM(*some_dialog*)'

For example,

```
&ZSEL = TRANS(&XX
          0,'PGM(ISPSTRT) PARM(PGM(MYPGM0))'
          1,'PGM(ISPSTRT) PARM(PGM(MYPGM1) PARM(MYPARM1))'
          2,'PGM(ISPSTRT) PARM(MYCMD1 MYPARM2)'
          3,'PGM(ISPSTRT) PARM(PANEL(MYPANEL1))')
```

- From a dialog, you can invoke,
ISPEXEC SELECT PGM(ISPSTRT) PARM(*some_dialog*)

where *some_dialog* is the same as described above.

Notes:

1. The *some_dialog* must not exceed 249 characters. It will be truncated at 249 without warning.
2. Do not use either WSCMD or WSCMDV in your specification of *some_dialog*.
3. For ISPF functions that have service interfaces, such as EDIT and BROWSE, you should use the service invocations. Using ISPSTRT passing the selection strings from panel ISR@PRIM does not work in all situations and is not supported.

If the maximum number of logical screens do not exist when the START command is invoked and:

- *some_dialog* is a command from the command table, the new screen is invoked with the default initial command (in non-display mode) and the command is run. When the user ends the dialog this new screen still exists.
- if *some_dialog* is specified as PGM(xxx), CMD(xxx), or PANEL(xxx), the new screen is invoked with PGM(xxx), CMD(xxx), or PANEL(xxx) as the initial command, program, or panel. The result is that when you end the xxx dialog, this new screen is terminated.

If the maximum number of logical screens has already been reached when the START command is invoked, the specified *some_dialog* is executed on top of the currently displayed screen. The result is that when you end the dialog, ISPF returns to the previously displayed screen.

On 3270 displays, if ISPF is not in split screen mode the START command and ISPSTRT program split the screen at the top or bottom line of the display. If ISPF is already in split screen mode, ISPF starts the new screen in the opposite screen, using the existing split line location.

Chapter 5. Graphical User Interface (GUI) Guidelines

This section provides information that dialog developers need to write or adapt dialogs to run in GUI mode on a workstation.

How to Display an Application in GUI Mode

Use the GUI parameter on the ISPSTART command to invoke an application in GUI mode. For example, the following command starts ISPF in GUI mode on a workstation at the specified IP address:

```
ISPSTART GUI(IP:9.67.229.115)
```

For more information about ISPSTART, see “Syntax for Issuing the ISPSTART Command” on page 10. For more information about running in GUI mode, refer to the chapter on the ISPF user interface in *z/OS ISPF User's Guide Vol I*.

```
GUI(LU:address:tpname|IP:address:port|FI:|,NOGUIDSP)
TITLE(title) FRAME(STD|FIX|DLG)
GUISCRW(screen-width) GUISCRD(screen-depth)
CODEPAGE(codepage) CHARSET(character_set)
```

where:

LU:address:tpname

The workstation's Advanced Program-to-Program Communication (APPC) network address and tpname.

An APPC address can be in fully-qualified LU name format or in symbolic destination name format. A fully-qualified LU name format consists of a network identifier and an LU name, separated by a period. For example, **USIBMNR.NRI98X00** is a fully-qualified LU name.

An APPC address in symbolic destination name format consists of a 1- to 8-character name such as **JSMITH**. The symbolic destination name must be defined as a *DESTNAME* and the corresponding fully-qualified LU name must be defined as the associated *PARTNER_LU* in the APPC/MVS side information.

If specified, the tpname is used to construct the names of the two transaction programs required to support an ISPF Client/Server connection. The ISPF Client/Server function appends different single alphabetic characters to the supplied name to form the actual names of the two APPC transaction programs.

If the tpname is used, the same tpname must be specified from the Options action bar choice on the WSA.

IP:address:port

The workstation's Internet Protocol (IP) address and TCP/IP port.

A TCP/IP address can be in dotted decimal format or in domain name format. Dotted decimal format is a sequence of decimal numbers separated by periods, for example, **9.87.654.321**.

A TCP/IP address in domain name format consists of one or more domain qualifiers separated by periods. The minimum specification for addresses

within the same domain is a TCP/IP host name, for example, **jsmith**. The fully-qualified domain name for *jsmith* is formed by appending the appropriate subdomain name and root domain name to *jsmith*, such as **jsmith.raleigh.ibm.com**. To use domain naming, a domain name server must be active and providing domain name resolution for domain names within your TCP/IP network. The domain name server address is determined by the value of the **NSINTERADDR** statement in the TCP/IP configuration data set. ISPF must be able to locate the TCP/IP configuration data set as described in the section on configuring TCP/IP connections in the *z/OS ISPF User's Guide Vol I*.

- FI:** Specifies that you want to search a file allocated to DD ISPDTPRF for the user's network protocol and workstation address to be used when initiating a workstation connection or GUI display. For example, the system programmer could maintain a file containing all of the user's workstation addresses so all users would be able to use the same logon procedure or startup CLIST to run ISPF GUI.

The file itself can be sequential or a member of a PDS. It can be fixed block (FB) or variable blocked (VB). Each line of the file should be formatted as follows:

```
userid WORKSTAT protocol_id:network_address
```

Where:

userid user's TSO userid

protocol_id network protocol identifier: **ip** for TCP/IP or **lu** for APPC.

network_address
 workstation address

For example, KRAUSS WORKSTAT ip:7.30.200.94 might be one line of your file.

EXAMPLES OF ISPSTART SYNTAX USING FI: OPTION:

To specify that you want ISPF to search the file allocated to ISPDTPRF DD for your network address when connecting to the workstation from ISPSTART, and to run ISPF in GUI mode, enter `ISPSTART GUI(FI:)`.

To specify that you want to search the file, but to run ISPF in 3270 mode, enter `ISPSTART GUI(FI: ,NOGUIDSP)`.

NOGUIDSP

Specifies that you want to make a connection to the workstation, but DO NOT want ISPF to display in GUI mode. For more information about the NOGUIDSP parameter, refer to page 14.

TITLE(*title*)

The default value for the title bar variable. This value has a maximum length of 255 characters and can be truncated without notice to the user at display time.

FRAME(STD | FIX | DLG)

Specifies that the first window frame displayed be a standard (STD), fixed (FIX), or dialog (DLG) window frame.

Note: Pop-up panels are always displayed in dialog window frames.

GUISCRW(*screen-width*)

Enables you to specify a screen width different than that of the emulator or real device from which you enter the ISPSTART command. If you do not specify GUISCRW, the depth is that of the emulator or real device.

If GUISCRW is different than the emulator or real device and GUI initialization fails, ISPF does not initialize. Dialogs started with dimensions other than those of the emulator or real device that use the GRINIT service cannot display GDDM screens.

GUISCRD(*screen-depth*)

Enables you to specify a screen depth different than that of the emulator or real device from which you enter the ISPSTART command. If you do not specify GUISCRW, the width is that of the emulator or real device.

If GUISCRD is different than the emulator or real device and GUI initialization fails, ISPF does not initialize. Dialogs started with dimensions other than those of the emulator or real device that use the GRINIT service cannot display GDDM screens.

The variable ZGUI is set to the workstation address (in character format) if ISPSTART is issued with the GUI parameter; ZGUI is set to blank if ISPSTART is issued without the GUI parameter.

Note: Users can force the application into GUI mode using the ISPF Settings panel (option 0). The display address specified on this panel is saved across ISPF sessions.

CODEPAGE(*codepage*) **CHARSET**(*character_set*)

When running in GUI mode or connecting to the workstation, these values are used as the host codepage and character set in translating data from the host to the workstation, regardless of the values returned from the terminal query response.

Other Considerations

Action Bars and Pull-Down Menus

Action bars are responsive entities at the workstation and do not require an interrupt to the host to display a pull-down menu. All)ABCINIT sections run before sending the panel to the workstation. The)ABCPROC section runs after the pull-down has been selected at the workstation.

Title Bars

Various types of data can appear in the title bar, depending on the following values. The first of the following values for which ISPF finds data is displayed in the title bar:

- The value defined in the application dialog variable ZWINTTL is used if the panel is displayed in a pop-up
- The value defined in the application dialog variable ZAPPTTL.
- The value specified in the *title* variable on the TITLE parameter of the ISPSTART command.
- The value specified in the GUI Title field on the Initiate GUI Session panel available in option 0.
- The value specified in the *title* variable on the TITLE parameter of the WSCON service.
- Your user ID.

ZWINTTL and the *title* variable on ISPSTART have a maximum length of 255 characters and can be truncated without notice to the user at display time if they do not fit on the panel.

Messages

A short or long message that would appear in a pop-up window in non-GUI mode is displayed in a message box in GUI mode. The message box includes the appropriate icon as defined by CUA guidelines:

- .TYPE=NOTIFY produces a question mark (?).
- .TYPE=WARNING produces an exclamation point (!).
- .TYPE=ACTION or .TYPE=CRITICAL produces a red circle with a diagonal line across it.

Closing a Window

If a user closes a window (that is, selects Close from the system menu), ISPF returns the CANCEL, END, EXIT, or RETURN command to the dialog, as specified on the GUI Settings panel (option 0).

Function Keys

You cannot give a function key the default focus.

Check Boxes

Check boxes are supported at the workstation if CKBOX(ON) is set for a 1-character entry field that is followed by an output field. Refer to the “CKBOX Keyword” on page 179 for more information.

List Boxes

List boxes are supported at the workstation. Refer to the “LISTBOX Keyword” on page 188 for more information.

Drop-down Lists

Drop-down lists are supported at the workstation. Refer to the “DDLIST Keyword” on page 182 for more information.

Group Boxes

Group boxes are supported at the workstation. Refer to “Group Box” on page 203 for more information.

Combination Boxes

Combination boxes are supported at the workstation. Refer to the “COMBO Keyword” on page 181 for more information.

Unavailable Choices

Unavailable choices for check boxes, radio buttons, and push buttons are supported at the workstation. Refer to the “UNAVAIL Keyword” on page 198 for more information.

Mnemonics

Mnemonics are supported at the workstation in action bar and pull-down menu choices using the MNEM keyword on the ABC and PDC statements.

Separator Bars

Separator bars group logically related choices in pull-down menus. Use the PDC keyword PDSEP to display separator bars.

Accelerators

Accelerators are assigned to menu choices so those choices can be initiated quickly, even when the menu that the choice appears on is not currently displayed. Use the PDC keyword ACC to implement accelerators.

Radio Buttons

Radio buttons provide a way to select mutually exclusive choices. Use the)ATTR keyword RADIO to set radio buttons.

Enter Key

An Enter key push button appears, by default, on all panels. You can change the text on the push button using the ZENTKTEXT variable.

Note: If a dialog sets ZENTKTEXT to blanks, the Enter push button is not displayed even if you select the Display Enter Key option on the GUI Settings panel available from option 0.

APL/TEXT Character Sets

The ZGE variable is set to Off when you are running in GUI mode. Any character defined with GE(ON) displays as a blank.

Cursor Placement

.CURSOR can be set only to an input or push button (point-and-shoot) field. If the application attempts to set the cursor to any other field, ISPF ignores the placement and uses the default cursor placement. The up and down cursor keys move vertically through a group of input fields, point-and-shoot fields, and pull-down choices.

Images

ISPF supports image files in the graphic interchange format (GIF) when running in GUI mode.

ISPF ships sample files in the sample library SISPSAMP. The panel ISR@PRIM uses three of the images (ISPFGIFL, ISPFGIFS, and ISPEXIT).

To use images, store the image files on the host in a partitioned data set and allocate this image data set to ddname ISPILIB before starting ISPF. For more information about allocating this image library, refer to the chapter Getting Ready to Run on MVS in the *z/OS ISPF User's Guide Vol I*.

Some General GUI Restrictions

This section describes some restrictions that apply when you run ISPF in GUI mode.

Cursor Placement

.CURSOR can be set only to an input or push button (point-and-shoot) field. If the application attempts to set the cursor to any other field, ISPF ignores the placement and uses the default cursor placement.

Character-Level Color, Intensity, and Highlighting

Character-level color, intensity, and highlighting are not supported when you are running in GUI mode.

Field-Level Intensity and Highlighting

Field-level intensity and highlighting are not supported when you are running in GUI mode.

Graphic Areas

Graphic areas are not supported. When a GRINIT statement is encountered, the user receives a message that panels with graphics cannot be displayed. The user may choose to continue. When a panel with graphics is encountered, a pop-up is displayed that enables you to specify that the panel be displayed on the host emulator session or on the workstation without the graphic.

Notes:

1. If you are in split-screen mode, the graphic area panel cannot be displayed on the host session.
2. If you specified GUISCRD or GUISCRW values on the ISPSTART invocation that are different from the actual host screen size, GDDM cannot be initialized, and the GRINIT service ends with a return code of 20.

Pop-Up Windows and Message Pop-Up Positioning

Dialog-specific pop-up positioning is not supported if you are running in GUI mode; that is, the POPLOC, ROW, and COLUMN parameters on the ADDPOP service are ignored. The MSGLOC parameter on the DISPLAY, SETMSG, and TBDISPL services is ignored.

SKIP Attribute

The panel attribute SKIP(ON) is ignored on the GUI display.

OUTLINE Attribute

The OUTLINE attribute is ignored on the GUI display.

3290 Partition Mode

You cannot invoke ISPF in GUI mode if you are configured to run ISPF in 3290 partition mode.

Chapter 6. Panel Definition Statement Guide

You can create ISPF panels in one of three ways:

1. Use the Dialog Tag Language (DTL) and ISPF DTL conversion utility only. With DTL, you create a source file containing DTL tags that define what information you want for each panel. This source file is then processed through the ISPF conversion utility to produce a preprocessed ISPF panel library member ready for display.
2. Use DTL and panel definition statements. This option allows you to stop the conversion process at the ISPF panel definition source level. You can then edit the resulting panel definition source file using any of the panel definition statements available in this document.
3. Use panel definition statements only. Using panel definition statements, you define panels closely resembling the finished panel. Each character position in the panel definition corresponds to the same relative position on the display screen.

To create panels with DTL or to learn how to capture the panel definition source file, refer to the *z/OS ISPF Dialog Tag Language Guide and Reference*.

This chapter explains how to create panels using the panel definition statements. (This information applies to the second and third options described above.) Both general overview information on panel definition and specific information on each panel section is included. The topics are arranged as follows:

- An introduction to the panel definition sections
- General tips and guidelines for formatting panels
- Syntax rules and restrictions for panel definition
- A discussion of each panel section
- Using Z variables as field name placeholders
- Panel processing considerations
- Support for panel user exit routines
- Special requirements for defining menus, table display panels, and panels with dynamic or graphic areas.

Figure 39 on page 108 shows an example panel definition which uses CUA panel-element attributes. See Figure 65 on page 212 for an example panel definition that does not use CUA panel-element attributes.

Notes:

1. You can use the ISPDPTRC command to trace both the execution of panel service calls (DISPLAY, TBDISPL, and TBQUERY) and the processing that occurs within the Dialog Manager panel code. For more information, refer to “Panel trace command (ISPDPTRC)” on page 349.
2. When not in TEST mode, the most recently accessed panel definitions are retained in virtual storage for performance reasons. If you have modified a panel, use TEST mode to ensure that the updated version of the panel is picked up by ISPF services. See “ISPF Test and Trace Modes” on page 24 for more information.

Introduction to Panel Definition Sections

Each panel definition consists of a combination of the sections described in Table 4. The sections)CCSID to)PROC, if used, must be in the order listed in this table. The sections)FIELD,)HELP,)LIST, and)PNTS, if used, can be in any order as long as they appear after the sections)CCSID to)PROC).)END must be the last section.

Table 4. Panel Definition Sections

Section	Required	Description
)CCSID	No	CCSID section. Specifies the Coded Character Set Identifier (CCSID) used in the panel definition. If used, panel text characters are translated to the terminal code page for display.
)PANEL	No	Panel section. Specifies a keylist to be used during the display of the panel, and identifies where to find the keylist. Specifies that the panel is to be displayed in CUA mode.
)ATTR	No	Attribute section. Defines the special characters in the body of the panel definition that represent attribute (start of field) bytes. You can override the default ISPF attribute characters.
)ABC	No	Action bar choice section. Defines a choice in the action bar, its associated pull-down choices, and the actions to be taken for each pull-down choice.
)ABCINIT	Yes, if)ABC is specified	Action bar choice initialization section. Specifies processing that is to occur for an action bar choice before the panel is displayed.
)ABCPROC	No	Action bar choice processing section. Specifies processing that is to occur for an action bar when the panel is submitted for processing.
)BODY	Yes	Body section. Defines the format of the panel as seen by the user and defines the name of each variable field on the panel.
)MODEL	Yes, for table display	Model section. Defines the format of each row of scrollable data. This section is required for table display panels. Only one)MODEL section is allowed per panel.
)AREA	No	Scrollable area definition section. Defines a scrollable section of the panel.
)INIT	No	Initialization section. Specifies the initial processing that is to occur before the panel is displayed. This section is typically used to define how variables are to be initialized.
)REINIT	No	Reinitialization section. Specifies processing that is to occur before a panel is redisplayed.
)PROC	No	Processing section. Specifies processing that is to occur after the panel has been displayed or redisplayed. This section is typically used to define how variables are to be verified and translated.
)FIELD	No	Scrollable field section. Defines a field as scrollable, giving it the ability to display and input a variable that is larger than the display area that the dialog variable occupies.
)HELP	No	Field help section. Specifies the help panels to display when help is requested for a field, list column, action bar choice, or pull-down choice defined in the panel or reference phrase.
)LIST	No	List section. Specifies a list to build on the panel.
)PNTS	No	Point-and-shoot section. Contains an entry for each field on a panel that has been designated as a point-and-shoot field.
)END	Yes	End section. Specifies the end of the panel definition, and consists only of the)END statement. ISPF ignores any data that appears on lines following the)END statement.

Guidelines for Formatting Panels

Consider using the ISPF edit model facilities to help you create panel definitions.

When using Edit to create a panel definition, specify NUMBER OFF to prevent numbers from appearing in the file. Numbers cause a panel syntax error when you attempt to process the panel definition.

ISPF panel definitions are stored in a panel library and are displayed by means of the SELECT, DISPLAY, or TBDISPL service. Each panel definition is referred to by its name, which is the same as the member name in the library.

You can create or change panel definitions by editing directly into the panel library. No compile or preprocessing step is required. Use the name of this panel library member as the panel-name parameter when requesting dialog services, such as DISPLAY and SELECT.

As shown in Figure 38, the first three displayable lines below the action bar, if present, in a panel definition include:

- Panel ID and title area
- System-defined (default) areas for message display
- A command/option field
- A scroll field, if applicable.

You can override the location of the long message area and command field from the ISPF Settings panel.

Action Bar Line or Lines		
Separator Line		
Panel ID	Title	Short Message
Command/Option		Scroll
Long Message		

Figure 38. Sample Panel Definition Format

Action Bar Line

The action bar line displays the action bar choice-description-text. You can define multiple action bars for a panel. A separator line should follow the last action bar line. ISPF considers the panel line following the last action bar choice as part of the action bar area. See “Defining the Action Bar Choice Section” on page 157.

Title Line

The title line should contain a centered title indicating the function being performed or, where appropriate, information critical to that function. If not running in GUI mode, up to 17 characters at the start of this line can be overlaid by the system commands SYSNAME, USERID, SCRNAME, or PANELID. Do not use the last 26 characters of this line to display critical information if messages are to be shown in the default short message area.

Short Messages

If short messages are used, they should provide a brief indication of either:

- Successful completion of a processing function
- Error conditions, accompanied by audible alarm.

Short messages temporarily overlay information currently displayed at the end of the first line, and are removed from display on the next interaction. The original information is redisplayed when the message is removed.

Use short messages consistently throughout the application, or not at all.

For table display, the short message area contains a top-row-displayed indicator, except when overlaid by a function-requested message. Attribute bytes in the short message The TBDISPL service automatically generates this indicator, and replaces data that was in the panel definition in that area. Attribute bytes in the short message area can cause the top-row displayed indicator to be unreadable.

Command/Option Line

The command/option line generally contains the command field. This same field should be used for option entry on menus. The command field, when the first input field on the panel or when identified by using the keyword CMD on the header of the panel body section, can be named using any valid variable name. However, the name ZCMD is generally used.

Cursor placement for viewing a panel differs, depending on the use of the name ZCMD or other names. When you use ZCMD and cursor placement is not explicitly specified, ISPF skips over a blank command field to place the cursor on a following input field. When you use a name other than ZCMD, ISPF does not skip over a blank command field when placing the cursor during display.

Scroll Amount

For table display, Edit, and Browse panels, as well as panels with scrollable dynamic areas, the scroll amount field should be on the right side of the command line. The scroll amount field must be the first input field following the command field and must be exactly 4 characters in length. A scroll amount field is not meaningful for other types of panels and should be omitted from them.

Long Messages

The long message line should generally be left blank, so that long messages do not overlay any significant information. An exception to this rule might be made in the case of table display panels, to allow as much scrollable data as possible to fit on the screen. An input field, such as the command field, should not be located on the same line on which long messages are displayed. The display of long messages will be superimposed on the input field, and results are unpredictable.

Requirements for Specifying Message and Command Line Placement

The placement of the command line and long message field at the bottom of a logical screen is a user-definable option. Placement is controlled by the system variable ZPLACE. You can select or deselect Command line at bottom on the ISPF Settings panel, and the setting changes the value of ZPLACE. ZPLACE can also be changed in a dialog.

The value of ZPLACE is stored in the application profile pool. To change the value, use the VPUT statement in a panel definition, the VPUT service in a dialog function, or the ISPF Settings panel options. None of these settings takes priority over the others. For example, an ISPF Settings panel selection can change what a dialog set, and vice versa.

If the panel specifies ASIS on the)BODY statement for a panel, the command and message lines are not repositioned, even if you specify placement at the BOTTOM. The command line moves only if all of the following are true.

- **For primary windows:**

1. If the WINDOW(*w,d*) keyword is specified on the header statement where *w* is less than the screen width, then:
 - a. The keyword ASIS must not be specified on the)BODY header statement.
 - b. The first character of the command line must be an attribute character.
2. If the WINDOW(*w,d*) keyword is specified on the header statement where *w* is equal to the screen width or the WINDOW keyword is not specified, then:
 - a. The keyword ASIS must not be specified on the)BODY header statement.
 - b. The first and last character of the command line must be an attribute character, and one of the following is true:
 - 1) There is an attribute byte in the first column of the line following the command line.
 - 2) There is an attribute byte in the last column of the line preceding the command line.
3. **For pop-up windows**, the keyword ASIS is not specified on the)BODY header statement.

Command lines that move in panels designed for primary windows will continue to move if these panels are displayed in pop-up windows. In addition, command lines in panels created using the DTL and converted using the ISPF conversion utility will move in both primary and pop-up windows.

If requirement 2b1 is false, but 2b2 is true, ISPF changes the attribute byte in the last column of the line preceding the command line to match the attribute byte in the last column of the command line. This gives the same result as 2b1.

For the long message line to be moved, the panel must be designed so that the system default is used to position the long message. That is, an alternate long message field cannot be specified by the panel designer using the keyword 'LMSG' on the)BODY header statement.

The long message line is not moved unless the command line is moved, but the command line is moved regardless of whether the long message field is moved.

Additional Suggestions for Designing Panels

- Avoid cluttered panels. Split “busy” panels into two or more simpler panels that have less information and are easier to read. Use scrollable areas where appropriate.
- Do not use the last available line in a panel body. For example, if the dialog can be used on 24-line terminals, limit the body to 23 lines, or less. This is because in split-screen mode the maximum length of a logical screen is one less than the length of the physical screen.

The PFSHOW|FKA command usually requires a minimum of two lines of a panel for displaying function key status. Therefore, you should leave the bottom two panel lines blank.

- Place important input fields near the top of the panel and less important fields, especially optional input fields, further down. In split-screen mode, the bottom of the panel might not be visible unless you reposition the split line.
- Place important input fields near the top of a scrollable area to minimize the need for scrolling.

- Place the command line near the top of the panel. If the command line is near the bottom and you enter split-screen mode, the command line cannot be visible on the screen. Therefore, if you do not have function keys, you might not be able to continue processing the dialog. If, for a particular session, you will not be entering the split-screen mode, you can use the option 0 (Settings) to specify that the command line be placed at the bottom of the screen. However, if you want to place the command line at the bottom, use the ZPLACE system variable.
- Where practical, align fields vertically on a panel, especially input fields. Group related input fields under a common heading. Minimize the use of multiple input fields on the same line, so that the NEW LINE key can be used to skip from one input field to the next.
- Use visual indicators for particular field types, such as arrows to indicate input fields, and colons to indicate variable information that is protected. Examples:
FILE NAME ==> (arrow signals an input field)

EMPLOYEE SERIAL: 123456 (colon signals a protected field)

To conform to the CUA guidelines, use leader dots and an ending colon for all protected fields, use leader dots for all input fields, and use ==> for all command areas. For example:

```
EMPLOYEE NUMBER . . : 015723
ADDRESS . . . . . 6510 Main Street
CITY, STATE . . . . Imperial, PA
```

Command ==>

In any case, be consistent. Arrows, colons, and other visual signals are very confusing if used inconsistently.

- Use highlighting sparingly. Too many intensified fields result in visual confusion. Do highlight the same type of information on all panels.
- Use DTL to design CUA-based panels. The conversion process can be stopped at the ISPF panel definition source level if you need to add additional processing.

Example of a CUA Panel Definition

Figure 39 illustrates many of the panel sections and panel-element attributes that are available to support CUA panel definitions.

```
)PANEL KEYLIST(ISPSAB,ISP)
)ATTR FORMAT(MIX)
! TYPE(AB)
@ TYPE(ABSL)
# TYPE(PT)
$ TYPE(CH)
< TYPE(FP)
~ TYPE(NT)
_ TYPE(NEF) PADC(_)
? TYPE(NEF) PADC(_) CAPS(ON)
| TYPE(LEF) PADC(_)
% TYPE(LI)
~ TYPE(LI) CAPS(ON)
)ABC
DESC('Options')
PDC DESC('Create ')
PDC DESC('Change ')
PDC DESC('Delete ')
PDC DESC('Browse ')
PDC DESC('Exit Keylist Utility ')
```

Figure 39. CUA Panel Definition (Part 1 of 3)

```

)ABCINIT
.ZVARS=ZPDC
&ZPDC=' '
IF (&COPTIONS=CREATE)
&ZPDC=1
IF (&COPTIONS=CHANGE)
&ZPDC=2
IF (&COPTIONS=DELETE)
&ZPDC=3
IF (&COPTIONS=BROWSE)
&ZPDC=4
IF (&COPTIONS=EXIT)
&ZPDC=5
)ABCPROC
VER (&ZPDC,LIST,1,2,3,4,5)
IF (&ZPDC=1)
&COPTIONS=CREATE
IF (&ZPDC=2)
&COPTIONS=CHANGE
IF (&ZPDC=3)
&COPTIONS=DELETE
IF (&ZPDC=4)
&COPTIONS=BROWSE
IF (&ZPDC=5)
&COPTIONS=EXIT
)ABC
DESC('Change Keylists')
PDC DESC('Current panel keylist ')
PDC DESC('Current dialog keylist ')
PDC DESC('Specify keylist ')
)ABCINIT
.ZVARS=ZPDC
&ZPDC=' '
IF (&CCHANGE=PANEL)
&ZPDC=1
IF (&CCHANGE=DIALOG)
&ZPDC=2
IF (&CCHANGE=ANY)
&ZPDC=3
)ABCPROC
VER (&ZPDC,LIST,1,2,3)
IF (&ZPDC=1)
&CCHANGE=PANEL
IF (&ZPDC=2)
&CCHANGE=DIALOG
IF (&ZPDC=3)
&CCHANGE=ANY
)BODY WINDOW(62,22) CMD(ZCMD)
^! Options! Change Keylists^
@-----
# Keylist Utility for &kluapl
^Command ==>_Z
^
<Enter keylist name?Z ^<OR ^
^
^Select one keylist name from the list below: ^
$Select Keylist T -

```

Figure 39. CUA Panel Definition (Part 2 of 3)

```

)MODEL
|Z^ ~Z ^%Z^%Z
)INIT
.ZVARS = '( ZCMD KEYLISTN S KLUKLNFT SOURCET CURKEYL)'
.HELP = ISPO5800
&ZCMD = ' '
.ATTR(S)='JUST(LEFT) '
.ATTR(KLUKLNFT)='JUST(LEFT) '
.ATTR(SOURCET)='JUST(LEFT) '
.ATTR(CURKEYL)='JUST(LEFT) '
.CURSOR = 'KEYLISTN'
)PROC
VER (&KEYLISTN NAME)
)HELP
FIELD(ZABC01) PANEL(ISPKH2)
FIELD(ZPDC0101) PANEL(ISPKH2A)
FIELD(ZPDC0102) PANEL(ISPKH2B)
FIELD(ZPDC0103) PANEL(ISPKH2C)
FIELD(ZPDC0104) PANEL(ISPKH2D)
FIELD(ZABC02) PANEL(ISPKH3)
FIELD(ZPDC0201) PANEL(ISPKH3A)
FIELD(ZPDC0202) PANEL(ISPKH3B)
FIELD(ZPDC0203) PANEL(ISPKH3C)
FIELD(KEYLISTN) PANEL(ISPKH1)
)END

```

Figure 39. CUA Panel Definition (Part 3 of 3)

This panel definition will display the keylist utility panel, SAMPAN, shown in Figure 40.

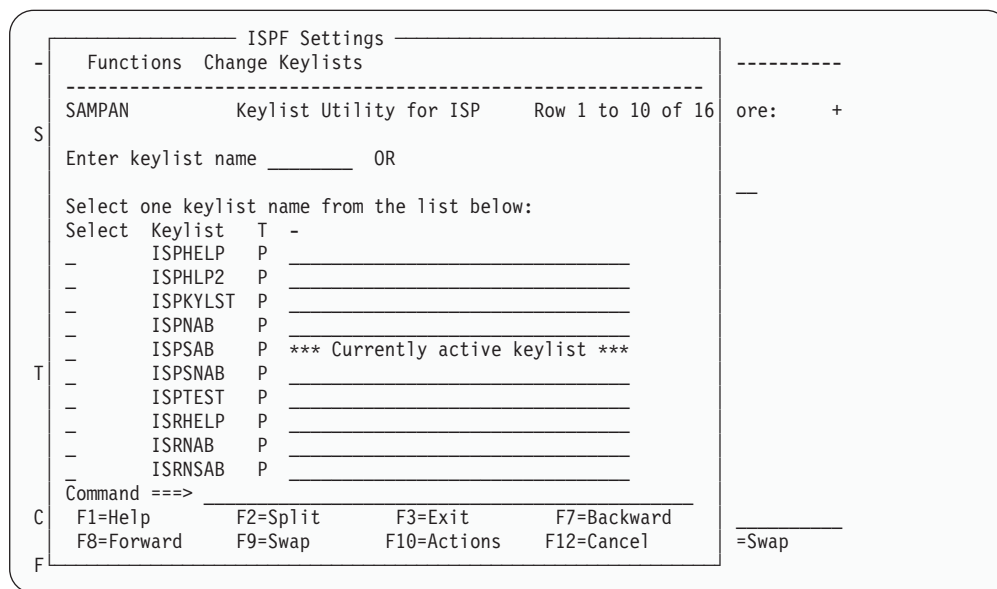

Figure 40. Sample CUA Panel (SAMPAN on ISPKLUP)

Factors That Affect a Panel's Size

The total number of lines allowed in a panel definition depends upon the storage size available. Panel definitions can be 80–160 characters wide. However, the width cannot be greater than that of the physical screen of the terminal used for the display. The WIDTH keyword in the panel definition determines the width of a display. If you are defining a panel to be displayed in a pop-up window, use the WINDOW keyword on the)BODY statement.

Two shared pool system variables, ZSCRMAXD and ZSCRMAXW, contain physical terminal screen depth and width. These variables cannot be modified. When using terminals for which an alternate size is available, these variables reflect the configuration that produces the largest screen buffer.

For example, in the case of a 3278-5 (or 3290 set up as a 3278-5), the available screen sizes are 24 x 80 and 27 x 132. Therefore, the values in ZSCRMAXD and ZSCRMAXW are 27 and 132, respectively. For the 3290, these variables contain the sizes of the hardware partition in which ISPF is operating.

When running in GUI mode, if the panel exceeds the width or depth of the physical display, scroll bars are automatically added to allow viewing of the hidden portion of the screen.

Vertically Scrollable Panels

You can also define more information than can fit on the panel display by defining an AREA(SCRL) attribute in the panel attribute section and by defining a panel)AREA section. You can scroll each area to see and interact with the total content defined for the area. See “Defining the Area Section” on page 164 for further discussion of the)AREA section and scrollable panel areas.

Syntax Rules and Restrictions for Panel Definition

The following apply to panel definitions:

- All statements, variable names, keywords, and keyword values can be entered in either uppercase or lowercase. ISPF translates variable names within the panel body or within panel statements to uppercase before processing them. Values assigned to dialog variables in the panel body or in the executable sections are stored as entered, in uppercase or lowercase. When symbolic substitution using a double ampersand is attempted, the variable will not be updated because ISPF makes only one pass when scanning for variable replacement.
- The command field cannot be longer than 255 characters. This is the first input field on the panel, unless otherwise specified by using the CMD keyword on the)BODY statement. Fields other than the command field can exceed 255 characters.

Fields are ended by the attribute character of a following field or by the end of the panel body. A panel with a large number of variables can cause the literal table to exceed 32K bytes. ISPF issues a message when this occurs. To proceed, the panel containing the variables must be divided into two or more panels.

- All header statements, such as)ATTR and)BODY, must be coded starting in column 1. Statements following the header need not begin in column 1.
- At least one attribute must be defined within the panel)BODY section. If the entire)BODY section is defined as an AREA, (DYNAMIC, SCRL, ...), then that AREA variable must contain at least one attribute. For example, if the panel)BODY is defined as a **char AREA(DYNAMIC)**, there must be at least one attribute variable defined within the Dynamic Area variable **char**.
- If a section is omitted, the corresponding header statement is also omitted. The)BODY header can be omitted if all previous sections are omitted, and there is no need to override the default attribute bytes by using a keyword on the)BODY statement.
- An)END statement is required as the last line of each panel definition. ISPF ignores any data that appears on lines following the)END statement.

Using Blanks and Comments

The following rules apply to the use of blanks and comment statements:

- In the attribute section, the attribute character and all keywords that follow must be separated by one or more blanks. At least one keyword must follow the attribute character on the same line. Keywords can be continued on succeeding lines.
- In the action bar choice, initialization, reinitialization, processing, and help sections, several statements can occur on the same line, separated by one or more blanks. Statements cannot be split between lines, except that listed items within parentheses and long strings within quotes can be continued on succeeding lines (see "Formatting Items in Lists").
- One or more blanks can occur on either side of operators such as an equal sign (=), a not-equal operator (\neq), greater-than symbol (>), and not-greater-than operator (\nrightarrow). Embedded blanks cannot occur in double-character operators such as the not-equal operator.

For example: \neq = is invalid.

- One or more blanks can occur on either side of parentheses, except that a blank cannot follow the right parenthesis that begins a header statement. The following statements are all equivalent:

```
INTENS(LOW)
INTENS (LOW)
INTENS ( LOW )
```

One or more blanks must follow the closing parenthesis to separate it from the next statement or keyword.

- Comments can be coded in the action bar choice, attribute, initialization, reinitialization, processing, ccsid, panel, point-and-shoot, list, and help sections. Comments must be enclosed with the comment delimiters, /* and */. The comment must be the last item on the line. Additional keywords or statements that follow the comment on the same line are ignored. A comment cannot be continued on the next line. For multi-line comments, the comment delimiters must be used on each line.
- Blank lines can occur anywhere within the action bar choice, attribute, initialization, reinitialization, processing, and help sections.

Formatting Items in Lists

The following rules apply to items in lists:

- Listed items within parentheses can be separated by commas or one or more blanks. This rule also applies to paired values within a TRANS statement. For example, the following are equivalent:

```
TRANS (&XYZ 1,A 2,B 3,C MSG=xxxx)
TRANS (&XYZ 1 A 2 B 3 C MSG=xxxx)
TRANS (&XYZ, 1 , A , 2 , B , 3 , C , MSG=xxxx)
```

- Null items within a list are treated as blank items. For example, the following are equivalent:

```
TRANS (&XXX N,' ', Y,YES, *,' ')
TRANS (&XXX N,, Y,YES, *,)
```

- Listed items within parentheses can be continued on one or more lines. For example:

```
TRANS (&CASE 1,'THIS IS THE VALUE FOR CASE 1'
        2,'THIS IS THE VALUE FOR CASE 2')
```

Literal values within a list can be split between lines by coding a plus sign (+) as the last character on each line that is to be continued. That is, the plus sign is used as a continuation character. For example:

```
TRANS (&CASE 1,' THIS IS THE VALUE  +
      FOR CASE 1' 2,'THIS IS THE  +
      VALUE FOR CASE 2')
```

Using Variables and Literal Expressions in Text Fields

The following rules apply to literals and variables in text fields:

- A literal is a character string not beginning with an ampersand or period. A literal value can be enclosed in single quotes ("). It must be enclosed in single quotes if it begins with a single ampersand or a period, or if it contains any of the following special characters:

Blank < (+ |) ; ~ - , > : =

A literal can contain substitutable variables, consisting of a dialog variable name preceded by an ampersand (&). The name and ampersand are replaced with the value of the variable, with trailing blanks stripped, before the statement is processed. Trailing blanks are stripped from the variable before the replacement is done. A double ampersand can be used to specify a literal character string starting with, or containing, an ampersand.

In the DBCS environment, a mixed EBCDIC/DBCS literal can be specified as follows:

```
eeee[DBDBDBDB]eeeeee[DBDBDBDBDBDB]
```

In this example, *e* represents an EBCDIC character and *DB* represents a double-byte character. The brackets [and] represent shift-out and shift-in characters, in which DBCS subfields must be enclosed. These appear as blanks when displayed.

If a mixed literal contains two DBCS subfields, and

- the last character of the first subfield is a shift-in that terminates a DBCS subfield, and
- the first character of the second subfield is a shift-out that begins a DBCS subfield,

the shift-in and shift-out character pair is eliminated.

- In the panel)BODY or)AREA section, a variable can appear within a text field. In the action bar choice, initialization, reinitialization, processing, and help sections, a variable can appear within a literal value. In all three sections, the variable name and the preceding ampersand are replaced with the value of the corresponding dialog variable. Trailing blanks are stripped from the variable before the replacement is done. For example, if variable *V* has the value *ABC* then:

```
'F &V G' yields 'F ABC G'
'F,&V,G' yields 'F,ABC,G'
```

- A period (.) at the end of a variable name causes concatenation with the character string following the variable. For example, if &*V* has the value *ABC*, then:

```
'&V.LMN' yields 'ABCLMN'
```

- A single ampersand followed by a blank or by a line-end is interpreted as a literal ampersand character, not the beginning of a substitutable variable. An ampersand followed by a nonblank is interpreted as the beginning of a substitutable variable.

- A double ampersand can be used to produce a character string starting with, or containing, an ampersand. The double-character rule also applies to single quotes within literal values, if the literal is enclosed within delimiting single quotes, and to a period if it immediately follows a variable name. That is:

```
&& yields &
'' yields ' within delimiting single quotes
.. yields . immediately following a variable name
```

Note: To add another layer of quotes, you must double the number of quotes used in the previous layer. For example:

```
'one o''ne' yields one o'ne
'two t''''wo' yields two t''wo
```

- When variable substitution occurs within a text field in the panel body, left or right shifting extends to the end of the field, defined by the occurrence of the next attribute byte. For left shifting, the right-most character in the field is replicated (shifted in), provided it is a special (non-alphanumeric) character. For example:

```
%DATA SET NAME: &DSNAME -----%
```

Assuming that the value of variable DSNAME is greater than 7 characters, the dashes are *pushed* to the right, up to the next start of field (the next % in this example). If the value of DSNAME is fewer than 7 characters, additional dashes are *pulled* in from the right. Fields defined in a scrollable area end at the end of the line where their definition starts. They will not wrap to the next line.

Validating DBCS Strings

ISPF validates DBCS data as follows:

- All DBCS output values are checked to determine whether they contain valid 16-bit DBCS codes. If an invalid code is found, it is replaced with the hexadecimal value 4195.
- The lengths of DBCS subfields in FORMAT(MIX) fields, and all FORMAT(DBCS) fields, are checked for an even number of bytes. If an exception occurs, the data is displayed in EBCDIC format.
- Split-screen or a floating command line can result in a DBCS field or subfield being divided. If this occurs in the middle of a DBCS character, the remainder of the byte is displayed as a blank and is protected.
- If the division of a DBCS subfield results in no divided DBCS characters, but the shift-in character is separated, the subfield is displayed as a DBCS field and is protected. However, if a divided DBCS character results, the remainder of the byte is displayed as a blank and is protected, and the remainder of the subfield is displayed as a DBCS field and is protected.
- If a DBCS field split results in the division of a DBCS character, the remainder of the byte is displayed as a blank and is protected.

In all of the previous cases, no message is issued to the user.

Special Requirements for Defining Certain Panels

Special requirements exist for defining the following types of panels:

- Menus
- Help tutorials. Refer to Chapter 8, “ISPF Help and Tutorial Panels,” on page 293
- Table displays
- Panels containing dynamic areas
- Panels containing a graphic area.

Defining Menus

A menu, also called a selection panel (Figure 41), is a special type of panel.

```

                                ISPF Master Application Menu

1 Sample 1   Sample application 1                               Userid . : LSACKV
2 .         (Description for option 2)                         Time . . : 11:12
3 .         (Description for option 3)                         Terminal : 3278
4 .         (Description for option 4)                         Pf keys  : 24
5 .         (Description for option 5)                         Screen . : 1
X Exit      Terminate ISPF using list/log defaults            Language : ENGLISH
                                                    Appl ID  : ISP
                                                    Release  : ISPF 5.6

Enter END command to terminate application

5694-A01 (C) COPYRIGHT IBM CORP 1982, 2003

Licensed Materials - Property of IBM
5637-A01 (C) Copyright IBM Corp. 1980, 2004.
All rights reserved.
US Government Users Restricted Rights -
Use, duplication or disclosure restricted
by GSA ADP Schedule Contract with IBM Corp.

Option ==>
F1=Help      F2=Split    F3=Exit      F9=Swap      F10=Actions  F12=Cancel

```

Figure 41. Example of a Menu (ISP@MSTR)

The sections that can be used in a menu definition are the same as those that can be used in other panel definitions. However, a menu requires a processing section in addition to the body section. The processing section must be in a special format.

Menu definitions are processed by the SELECT service. A menu must have an input field to allow users to enter selection options. Generally, this is the command field, and is the first input field on the panel. This field should be named ZCMD to be consistent with the field name used in this manual.

Besides ZCMD, a menu can have input fields to set up dialog variables needed by that application. Any variables other than ZCMD and ZSEL (or OPT and SEL) that are set from a menu are automatically stored in the shared variable pool.

Variables from the shared pool, including system variables, can also be displayed on a menu to provide information to users.

The required processing section must provide for the variable ZCMD to be truncated at the first period and then translated to a character string. The results must be stored in a variable named ZSEL or SEL. Use SEL only if compatibility with System Productivity Facility (SPF) is required.

The processing section of a menu is in the following general format:

```

)PROC
  &ZSEL = TRANS( TRUNC(&ZCMD, '.')
                value, 'string'
                value, 'string'
                :
                value, 'string'
                ', '
                *, '?' )

```

The maximum length for ZSEL is 80 characters. If ZSEL is assigned a string longer than 80 characters, the string is truncated.

The ZCMD variable is truncated before translation to allow users to bypass one or more intermediate menus. For example, 1.2 means primary option 1, suboption 2. This is generally called a *nested option*. ZCMD is automatically stored, untranslated, as entered. When the SELECT service discovers that variable ZCMD contains a period, it causes the next lower-level menu to be selected with an initial option of everything following the first period. As long as the initial option is nonblank, the lower-level menu is processed in the normal fashion but is not displayed to the user.

Each **value** is one of the options that can be entered on the menu. Each *string* contains selection keywords indicating the action to occur. The selection keywords are:

```
'PANEL(panel-name) [NEWAPPL [(appl-id)
[PASSLIB]]|[NEWPOOL] [ADDP] [SUSPEND] [SCRNAME] '
'CMD(command) [NEWAPPL [(appl-id) [PASSLIB]]|[NEWPOOL] [SUSPEND]
[NOCHECK] [LANG(APL|CREX)]
[MODE(LINE|FSCR)]
[BARRIER]
[NEST]
[SCRNAME] '

'PGM(prog-name) [PARM(parameters)]
[NEWAPPL [(appl-id) [PASSLIB]]|[NEWPOOL] [SUSPEND]
[NOCHECK]
[MODE(LINE|FSCR)]
[SCRNAME] '
'WSCMD(workstation-command)
[MODAL|MODELESS]
[WSDIR(DIR)]
[MAX|MIN]
[VIS|INVIS] '

'WSCMDV(var_name)
[MODAL|MODELESS]
[WSDIR(DIR)]
[MAX|MIN]
[VIS|INVIS] '

EXIT
```

Except for EXIT, each string of keywords must be enclosed in single quotes because it contains parentheses, and sometimes blanks.

The following selection keywords are the same as those that can be specified for the SELECT service.

```
PANEL(panel-name)

CMD(command) [LANG(APL|CREX)] [MODE(LINE|FSCR)] [BARRIER] [NEST]

PGM(program-name) [MODE(LINE|FSCR)] PARM(parameters)

[NEWAPPL[(application-id) [PASSLIB]]|[NEWPOOL] [SUSPEND] [SCRNAME(screen_name)]]

WSCMD(workstation-command) [MODAL|MODELESS] [WSDIR(DIR)] [MAX|MIN] [VIS|INVIS]

WSCMDV(var_name) [MODAL|MODELESS] [WSDIR(DIR)] [MAX|MIN] [VIS|INVIS]
```

The PANEL keyword, for example, is used to specify the name of a lower-level menu to be displayed. The CMD and PGM keywords are used to invoke a dialog

function coded in a command procedure or programming language, respectively. NOCHECK, MODE, and EXIT are described following.

NOCHECK Keyword

Normally, nested options are allowed only when each component of the option (up to, but not including the last component) specifies a lower-level menu. For example, given the following ZSEL keywords on a selection panel definition

```
&ZSEL = TRANS (TRUNC(&ZCMD, '.'))
          1, 'PANEL(DEF)'
          .
          .
          8, 'PGM(ABC)'
          9, 'PGM(XYZ)'
```

A user can enter 1.x as a selection. This selection would be accepted by ISPF. However, if the developer wants to allow a user to enter a nested option that selects a dialog function, in this case 8.x or 9.x, the developer specifies the NOCHECK keyword as in the following example:

```
&ZSEL = TRANS (TRUNC(&ZCMD, '.'))
          1, 'PANEL(DEF)'
          .
          .
          8, 'PGM(ABC) NOCHECK'
          9, 'PGM(XYZ) NOCHECK'
```

The NOCHECK keyword specifies that normal checking for validity is suspended. It is the responsibility of the dialog function to interpret the meaning of the lower-level options. To allow this, the remaining options, those to the right of the first period, are usually passed to the dialog function through any appropriate variable that has been set equal to the .TRAIL panel control variable in the menu definition.

Example:

```
&ZSEL = TRANS (TRUNC (&ZCMD, '.'))
          1, 'PANEL(DEF)'
          8, 'PGM(ABC) NOCHECK'
          9, 'PGM(XYZ) NOCHECK'
&NEXTOPT = .TRAIL
```

In this example, variable NEXTOPT contains the remainder of the TRUNC operation. If the user enters 8.5.2, program ABC is invoked and NEXTOPT is set to 5.2. If the user enters 9.7, program XYZ is invoked and NEXTOPT is set to 7. Since variable NEXTOPT is unknown to the SELECT service, it is automatically stored in the shared variable pool, where it can be accessed by the dialog function.

When the NOCHECK keyword is specified, a return code of 20 from the dialog function indicates that the remaining options are invalid. If return code 20 is passed back from the function, ISPF displays an *invalid option*.

MODE Keyword

You can use the MODE keyword, with either the LINE or the FSCR option, on a SELECT service request to control whether ISPF enters line mode or full-screen mode when a TSO command or dialog program is invoked. This eliminates the need to control line mode by prefixing TSO commands with a percent sign.

EXIT Keyword

The EXIT keyword, if used, applies only to a primary option menu. It terminates ISPF, using defaults for list/log data set processing. EXIT need not be enclosed in single quotes.

Blank or Invalid Options (' or *, '?')

If you use a blank ' ' for the value (ZCMD variable is blank), use a blank as the string. This causes the SELECT service to redisplay the menu. For primary option menus, the menu is redisplayed without a message. For lower-level menus, an *enter option* message is displayed if the option field was left blank.

If you use an asterisk (*) for the value, indicating an invalid option was entered, use a question mark (?) as the string. This causes the SELECT service to redisplay the menu with an *invalid option* message.

Defining Primary Option Menus

A **primary option menu** is a selection panel that has special significance in terms of the way the RETURN command operates, and in terms of the way a *jump function*, an option number preceded by an equal sign, works. One type of primary option menu is the master application menu.

The first menu displayed when ISPF is invoked is usually treated as a primary option menu. For example, if ISPF is invoked with:

```
ISPSTART PANEL(XYZTOP)
```

panel XYZTOP is treated as a primary option menu.

Similarly, if ISPF is invoked with:

```
ISPSTART CMD(XYZ) or  
ISPSTART PGM(XYZ)
```

and dialog XYZ subsequently issues:

```
SELECT PANEL(XYZTOP)
```

panel XYZTOP is treated as a primary option menu because it is the first invoked menu.

It is possible to write a dialog with no primary option menu by setting the variable ZPRIM to NO on the first selection panel, panel XYZTOP in this example:

```
)INIT  
  &ZPRIM = NO
```

In general, this approach is not recommended because the RETURN command then causes an immediate exit from the dialog, which can be confusing to the user.

A dialog can have lower-level (nested) primary option menus. This technique is implemented by setting variable ZPRIM to YES on a lower-level selection panel:

```
)INIT  
  &ZPRIM = YES
```

Nested primary option menus should be used sparingly, since they can confuse the user. It is recommended that there be only one primary option menu per **major** application.

Specifying the Next Menu to Display

ISPF allows the display of menus that are arranged in a hierarchy. The path through the hierarchy is automatically preserved as the user selects options from the various menus. As the user moves back up through the hierarchy, the menus are redisplayed in reverse sequence from which they were selected. While this is the standard mode of operation, it can be overridden. A developer can specify an alternative mode of menu processing called *explicit chain mode*. In this mode, the *parent* menu is specified explicitly in a system variable named ZPARENT. This variable can be set in a panel definition or in a dialog function. It has the following effect:

- From a menu, ZPARENT specifies the name of the next menu to be displayed when the user enters the END command. A menu that specifies itself as the parent is interpreted as a primary option menu. The RETURN command *stops* at that menu.
- From a function, ZPARENT specifies the name of the next menu to be displayed when the function completes execution. If a function is invoked from another function by the SELECT service, the lower-level function can set ZPARENT. Upon completion of the lower-level function, the higher-level function resumes execution. The setting of ZPARENT does not take effect until the higher-level function, the one originally invoked from a menu, completes execution.

Notes:

1. A value can be stored in ZPARENT in a function, or it can be stored in the)INIT,)REINIT,)PROC, or)BODY section of a panel.
2. The value in ZPARENT takes effect only after display of a selection panel when the user enters the END command.
3. When the ZPARENT variable is set from a dialog function, it must be explicitly copied to the shared pool, using VPUT, to ensure that ISPF still has access to it after the function completes.
4. Once the ZPARENT variable is set:
 - The hierarchy of menus traversed by the user is not preserved by ISPF.
 - The NEWAPPL and NEWPOOL selection keywords are inoperable (ignored) while the dialog is in explicit chain mode.
5. The ZPARENT variable is automatically reset to blank by ISPF each time it is used. If the dialog does not continue to set ZPARENT, ISPF resumes normal mode. The hierarchy of menus, if any, up to the point at which explicit chain mode was started is then restored.
6. Generally, a dialog should use either explicit chain mode or hierarchical chaining, the standard mode. Chaining should *not* be mixed. If they are mixed, a function that sets ZPARENT should do so only after completion of any hierarchical dialog that it invokes. For example, the setting of ZPARENT should be the last thing the function does before returning control. Otherwise, results are unpredictable.
7. The ZPRIM variable is not applicable and is ignored when operating in explicit chain mode.

Example of a Master Application Menu

A master application menu, named ISP@MSTR (See Figure 41 on page 115), is distributed with ISPF as part of the panel library. This menu can be used, if desired, to allow selection of the various applications available at an installation.

If used, the master menu should be the first menu displayed when the user logs on. It can be displayed automatically by including the following command in the user's TSO LOGON procedure:

```
ISPSTART [PANEL(ISP@MSTR)]
```

When no keywords are specified on the ISPSTART command, PANEL (ISP@MSTR) is assumed.

The master application menu is generated from a DTL source file (Figure 43 on page 121). The menu selections are enabled for point-and-shoot selection.

The master application menu)INIT,)PROC, and)PNTS sections are included in Figure 42 to illustrate some of the special menu statement formats discussed above.

```
)INIT
.ZVARS = '(ZCMD ZUSER ZTIME ZTERM ZKEYS ZSCREEN ZLANG ZAPPLID ZENVIR) '
.HELP = ISP00005
&ZPRIM = YES /* This is a primary option menu */
IF (&ZLOGO = 'YES') /* Not in split screen CT@MJC*/
  IF (&ZSPLIT = 'NO') /* No command pending @L5A*/
    IF (&ZCMD = &Z) /* No logo displayed yet @L5A*/
      IF (&ZLOGOPAN ^= 'DONE') /* Set logo information @L5A*/
        .MSG = ISPL0999 /* Simulate enter @L5A*/
        .RESP = ENTER /* Simulate enter @L5A*/
        &ZLOGOPAN = 'DONE' /* @L5A*/
        &ZCLEAN = 'NO' /* @L5A*/
      IF (&ZCMD ^= &Z) /* Command pending @L5A*/
        &ZLOGOPAN = 'DONE' /* @L5A*/
      VPUT (ZLOGOPAN) SHARED /* @L5A*/
    IF (&ZSPLIT = 'YES') /* In split screen @V5A*/
      &ZLOGOPAN = 'DONE'
)PROC
/* This in a GML based panel generated by ISPDTLC. */
/* */
/* Make changes by updating the GML source file */
/* and reconvertting ISP@MSTR. */
&ZCMDWRK = TRUNC(&ZCMD, '.')
&ZTRAIL=.TRAIL
&ZSEL = TRANS (TRUNC (&ZCMD, '.'))
  1, 'PANEL(ISP@PRIM) SCRNAME(PRIM) '
  X,EXIT
  ' ' ' ' ' '
  *, '?' )
)PNTS
FIELD(ZPS01001) VAR(ZCMD) VAL(1)
FIELD(ZPS01002) VAR(ZCMD) VAL(2)
FIELD(ZPS01003) VAR(ZCMD) VAL(3)
FIELD(ZPS01004) VAR(ZCMD) VAL(4)
FIELD(ZPS01005) VAR(ZCMD) VAL(5)
FIELD(ZPS01006) VAR(ZCMD) VAL(X)
FIELD(ZPS00001) VAR(ZCMD) VAL(END)
)END
/* 5655-042 (C) COPYRIGHT IBM CORP 1982, 2003 */
```

Figure 42. Master Application Menu Definition

The following figure shows the DTL source for panel ISP@MSTR. All of the translatable text is defined with ENTITY tags and is placed at the beginning of the file. Special comments bordered by a DTL comment line:

```
<!-- ##### -->
```

identify the places where the source file can be modified and provide an explanation for including additional options.

```

<!-- ISR@MSTR selection menu -->

<:doctype dm system(
  <:ENTITY ispzmsr system -- common logic file imbed -->

<!-- Start of translatable panel text section -->
<!-- text delimited by " is to be translated -->
<!-- text should end with '>' as shown. -->
<!-- the '>' can be moved to the right for text expansion -->

  <!-- panel title text follows - maximum length = 74 bytes -->
  <:ENTITY panel_title
    "ISPF Master Application Menu">

  <!-- choice selection text entries follow -->
  <!-- choice text for this panel consists of 2 parts: -->
  <!-- part 1 - point and shoot - primary description -->
  <!-- part 2 - additional descriptive text -->
  <!-- if combined length of text for part 1 plus part 2 exceeds -->
  <!-- 54 bytes, the part 2 text will be folded into multiple lines -->

  <!-- part 1 - point and shoot - primary description follows -->
  <!-- pad short text with blanks, aligning the ending quote mark -->
  <!-- all text strings must be the same length, including blanks -->
  <!-- ##### -->
  <!-- To add options 2, 3, 4, or 5 to this panel: -->
  <!-- - Replace the text below for "choice_n_pnts" -->
  <!-- (where "n" is the option number) -->
  <!-- with the point-and-shoot key identifying option text. -->
  <!-- -->
  <!-- To add new options to this panel: -->
  <!-- - repeat the text below for "choice_n_pnts" -->
  <!-- (where "n" is the option number) -->
  <!-- for the new option number and add it to the list -->
  <!-- with the point-and-shoot key identifying option text. -->
  <!-- for example: -->
  <!-- <:ENTITY choice_6_pnts "New option 6"> -->
  <!-- ##### -->
  <:ENTITY choice_1_pnts "Sample 1 ">
  <:ENTITY choice_2_pnts ". ">
  <:ENTITY choice_3_pnts ". ">
  <:ENTITY choice_4_pnts ". ">
  <:ENTITY choice_5_pnts ". ">
  <:ENTITY choice_X_pnts "Exit ">

```

Figure 43. Master Application Menu DTL Source (Part 1 of 4)

```

<:-- part 2 - additional descriptive text -->
<:-- ##### -->
<:-- To add options 2, 3, 4, or 5 to this panel: -->
<:-- - Replace the text below for "choice_n_text" -->
<:-- (where "n" is the option number) -->
<:-- with the additional option description text. -->
<:-- -->
<:-- To add new options to this panel: -->
<:-- - repeat the text below for "choice_n_text" -->
<:-- (where "n" is the option number) -->
<:-- for the new option number and add it to the list -->
<:-- with the additional option description text. -->
<:-- for example: -->
<:-- <:ENTITY choice_6_text "(Description for option 6) ">-->
<:-- ##### -->
<:ENTITY choice_1_text
"Sample application 1 ">
<:ENTITY choice_2_text
"(Description for option 2) ">
<:ENTITY choice_3_text
"(Description for option 3) ">
<:ENTITY choice_4_text
"(Description for option 4) ">
<:ENTITY choice_5_text
"(Description for option 5) ">
<:ENTITY choice_X_text
"Terminate ISPF using list/log defaults">

<:-- Status area labels - maximum text length = 10 bytes -->
<:ENTITY status_userid "Userid . :">
<:ENTITY status_time "Time . . :">
<:ENTITY status_term "Terminal :">
<:ENTITY status_pfkeys "Pf keys :">
<:ENTITY status_scrnum "Screen . :">
<:ENTITY status_lang "Language :">
<:ENTITY status_appl "Appl ID :">
<:ENTITY status_rel "Release :">

<:-- Generated panel comments - maximum text length = 66 bytes -->
<:ENTITY panel_cmnt1
"This in a GML based panel generated by ISPDTLC.">
<:ENTITY panel_cmnt2
" ">
<:ENTITY panel_cmnt3
"Make changes by updating the GML source file ">
<:ENTITY panel_cmnt4
"and reconverting ISP@MSTR. ">

<:-- panel instruction text line - maximum text length = 78 bytes -->
<:-- panel instruction entities will be concatenated -->
<:ENTITY panel_instruct_1
"Enter <ps var=zcmd value=END csrgrp=99>END</ps> ">
<:ENTITY panel_instruct_2
"command to terminate application">

<:-- End of translatable panel text section -->
)> <:-- DO NOT DELETE THIS LINE -->

```

Figure 43. Master Application Menu DTL Source (Part 2 of 4)

```

<varclass name=vcc type='char 80'>
<xlat1 format=upper>
</xlat1>

<varclass name=vco type='char 7'>

<varlist>
  <vardcl name=zcmd varclass=vcc>
  <vardcl name=zuser varclass=vco>
  <vardcl name=ztime varclass=vco>
</varlist>

<copyr>5694-A01 (C) COPYRIGHT IBM CORP 1982, 2004
<panel name=isp@mstr help=isp00005 padc=user keylist=isrnsab applid=isr
  width=80 depth=24 menu prime window=no>&panel_title;

<cmdarea noinit>
<area depth=8 extend=force width=59 dir=horiz>

  <!-- selection options follow - left side of panel -->
  <selfld type=menu selwidth=* trail=ztrail fchoice=1 entwidth=1
    tsize=12 selcheck=yes>
    <choice> <ps var=zcmd value=1 csrgrp=99>
      &choice_1_pnts;</ps>
      &choice_1_text;
    <action run=isp@prim type=panel scrname=prim>
  <!-- ##### -->
  <!-- To add options 2, 3, 4, or 5 to this panel: -->
  <!-- add a <ACTION> tag provide the selection -->
  <!-- information for the generated ZSEL statement. -->
  <!-- -->
  <!-- <action run=newoptn2 type=panel scrname=opt2> -->
  <!-- where: -->
  <!-- run=newoptn2 - provides the name of the panel, -->
  <!-- pgm, cmd, wscmd, wscmdv -->
  <!-- type=panel - provides the selection choice: -->
  <!-- panel, pgm, cmd, wscmd, wscmdv -->
  <!-- scrname=opt2 - provides an optional screen name -->
  <!-- ##### -->
  <choice> <ps var=zcmd value=2 csrgrp=99>
    &choice_2_pnts;</ps>
    &choice_2_text;
  <choice> <ps var=zcmd value=3 csrgrp=99>
    &choice_3_pnts;</ps>
    &choice_3_text;
  <choice> <ps var=zcmd value=4 csrgrp=99>
    &choice_4_pnts;</ps>
    &choice_4_text;
  <choice> <ps var=zcmd value=5 csrgrp=99>
    &choice_5_pnts;</ps>
    &choice_5_text;

```

Figure 43. Master Application Menu DTL Source (Part 3 of 4)

```

<!-- ##### -->
<!-- To add new options to this panel: -->
<!-- - add a new <choice> tag to this list following the -->
<!-- pattern of the <choice> tags above. -->
<!-- a new <ACTION> tag is required to provide the selection -->
<!-- information for the generated ZSEL statement. -->
<!-- -->
<!-- <choice> <ps var=zcmd value=6 csrgrp=99> -->
<!-- &choice_6_pnts;</ps> -->
<!-- &choice_6_text; -->
<!-- <action run=newoptn6 type=panel scrname=opt6> -->
<!-- where: -->
<!-- run=newoptn6 - provides the name of the panel, -->
<!-- pgm, cmd, wscmd, wscmdv -->
<!-- type=panel - provides the selection choice: -->
<!-- panel, pgm, cmd, wscmd, wscmdv -->
<!-- scrname=opt6 - provides an optional screen name -->
<!-- ##### -->
<choice selchar=X> <ps var=zcmd value=X csrgrp=99>
&choice_X_pnts;</ps>
&choice_X_text;
<action run=exit type=exit>
<comment type=proc>&panel_cmnt1;
<comment type=proc>&panel_cmnt2;
<comment type=proc>&panel_cmnt3;
<comment type=proc>&panel_cmnt4;
</selfld>
</area>

<!-- right side of option menu panel follows, status area -->
<area dir=horiz>
<region dir = vert>
<divider>
<dtacol pmtwidth=10 entwidth=8>
<dtafld datavar=ZUSER usage=out> &status_userid;
<dtafld datavar=ZTIME usage=out> &status_time;
<dtafld datavar=ZTERM usage=out> &status_term;
<dtafld datavar=ZKEYS usage=out> &status_pfkeys;
<dtafld datavar=ZSCREEN usage=out>&status_scrnum;
<dtafld datavar=ZLANG usage=out> &status_lang;
<dtafld datavar=ZAPPLID usage=out>&status_appl;
<dtafld datavar=ZENVIR usage=out> &status_rel;
</dtacol>
</region>

<!-- panel logic file imbed -->
&ispzmstr;
</area>
<region>
<info width=78>
<lines>
&panel_instruct_1;&panel_instruct_2;
</lines>
<p>5694-A01 (C) COPYRIGHT IBM CORP 1982, 2003
</info>
</region>
</panel>

```

Figure 43. Master Application Menu DTL Source (Part 4 of 4)

To add a new application to the master menu, copy the ISP@MSTR DTL source file from the GML library to a private data set. Locate the sections of code within the DTL comment lines:

```

<!-- ##### -->

```

and modify the DTL source code to:

1. Define the point-and-shoot option text
2. Define the option description text
3. Add an <ACTION> tag for each additional option.

Refer to the *z/OS ISPF Dialog Tag Language Guide and Reference* for a description of Dialog Tag Language syntax and information about compiling DTL panels.

Compile the modified DTL source file using the ISPD TLC command, and review the generated panel to confirm that your changes have been processed.

Example of a Primary Option Menu

Figure 45 on page 127 shows a primary option menu panel DTL source file definition. This is the sample primary option menu ISP@PRIM, distributed with ISPF. &ZPRIM=YES specifies that this panel is a primary option menu.

The primary option menu)INIT,)PROC, and)PNTS sections are included in Figure 44 on page 126 to illustrate some of the special menu statement formats discussed above.

The initialization section sets the control variable .HELP to the name of a tutorial page to be displayed if a user enters the HELP command from this menu. It also initializes two system variables that specify the tutorial table of contents and first index page.

The processing section specifies the action to be taken for each option entered by the user. If option 0 is selected, program ISPISM is invoked. If option 1 is selected, panel ISPUCMA is displayed; and so on.

For the tutorial, program ISPTUTOR is invoked and passed a parameter, ISP00000, which ISPTUTOR interprets as the name of the first panel to be displayed. Panel ISP00000 is the first panel in the tutorial for ISPF. Other applications should pass the name of the first tutorial page for that application.

```

)INIT
.ZVARS = '(ZCMD ZUSER ZTIME ZTERM ZKEYS ZSCREEN ZLANG ZAPPLID ZENVIR)'
.HELP = ISP00003
&ZPRIM = YES
&ZHTOP = ISP00003 /* Tutorial table of contents for this appl*/
&ZHINDEX = ISP91000 /* Tutorial index - 1st page for this appl */
VPUT (ZHTOP,ZHINDEX) PROFILE
)PROC
/* This in a GML based panel generated by ISPD TLC. */
/* */
/* Make changes by updating the GML source file */
/* and reconvertting ISP@PRIM. */
&ZSEL = TRANS (TRUNC (&ZCMD,','))
0,'PGM(ISPISM) SCRNAME(SETTINGS)'
1,'PANEL(ISPUCMA) SCRNAME(CMDS)'
2,'PGM(ISPPREP) NEWAPPL SCRNAME(PREP)'
3,'CMD(ISPD TLC) SCRNAME(DTLC)'
7,'PGM(ISPYXDR) PARM(&ZTAPPLID) SCRNAME(DTEST) NOCHECK'
T,'PGM(ISPTUTOR) PARM(ISP00000) SCRNAME(TUTOR)'
X,EXIT
' ' ' '
*, '?' )
&ZTRAIL=TRAIL
)PNTS
FIELD(ZPS01001) VAR(ZCMD) VAL(0)
FIELD(ZPS01002) VAR(ZCMD) VAL(1)
FIELD(ZPS01003) VAR(ZCMD) VAL(2)
FIELD(ZPS01004) VAR(ZCMD) VAL(3)
FIELD(ZPS01005) VAR(ZCMD) VAL(4)
FIELD(ZPS01006) VAR(ZCMD) VAL(5)
FIELD(ZPS01007) VAR(ZCMD) VAL(7)
FIELD(ZPS01008) VAR(ZCMD) VAL(T)
FIELD(ZPS01009) VAR(ZCMD) VAL(X)
FIELD(ZPS00001) VAR(ZCMD) VAL(END)
)END

```

Figure 44. ISPF Primary Option Menu Definition

The following figure shows the DTL source for panel ISP@PRIM. All of the translatable text is defined with ENTITY tags and is placed at the beginning of the file. Special comments bordered by a DTL comment line:

```
<!-- ##### -->
```

identify the places where the source file can be modified and provide an explanation for including additional options.

```

<!-- ISR@PRIM selection menu -->

<!doctype dm system(
  <!ENTITY ispzprim system -- common logic file embed -->

<!-- Start of translatable panel text section -->
<!-- text delimited by " is to be translated -->
<!-- text should end with '>' as shown. -->
<!-- the '>' can be moved to the right for text expansion -->

  <!-- panel title text follows - maximum length = 74 bytes -->
  <!ENTITY panel_title
    "Sample Primary Option Menu">

  <!-- choice selection text entries follow -->
  <!-- choice text for this panel consists of 2 parts: -->
  <!-- part 1 - point and shoot - primary description -->
  <!-- part 2 - additional descriptive text -->
  <!-- if combined length of text for part 1 plus part 2 exceeds -->
  <!-- 54 bytes, the part 2 text will be folded into multiple lines -->

  <!-- part 1 - point and shoot - primary description follows -->
  <!-- pad short text with blanks, aligning the ending quote mark -->
  <!-- all text strings must be the same length, including blanks -->
  <!-- ##### -->
  <!-- To add options 4, or 5 to this panel: -->
  <!-- - Replace the text below for "choice_n_pnts" -->
  <!-- (where "n" is the option number) -->
  <!-- with the point-and-shoot key identifying option text. -->
  <!-- -->
  <!-- To add new options to this panel: -->
  <!-- - repeat the text below for "choice_n_pnts" -->
  <!-- (where "n" is the option number) -->
  <!-- for the new option number and add it to the list -->
  <!-- with the point-and-shoot key identifying option text. -->
  <!-- for example: -->
  <!-- <!ENTITY choice_8_pnts "New option 8"> -->
  <!-- ##### -->
  <!ENTITY choice_0_pnts "Settings ">
  <!ENTITY choice_1_pnts "Commands ">
  <!ENTITY choice_2_pnts "ISPPREP ">
  <!ENTITY choice_3_pnts "ISPDTLC ">
  <!ENTITY choice_4_pnts "." ">
  <!ENTITY choice_5_pnts "." ">
  <!ENTITY choice_6_pnts "." ">
  <!ENTITY choice_7_pnts "Dialog Test">
  <!ENTITY choice_T_pnts "Tutorial ">
  <!ENTITY choice_X_pnts "Exit ">

```

Figure 45. ISPF Primary Option Menu DTL Source (Part 1 of 4)

```

<!-- part 2 - additional descriptive text -->
<!-- ##### -->
<!-- To add options 4, or 5 to this panel: -->
<!-- - Replace the text below for "choice_n_text" -->
<!-- (where "n" is the option number) -->
<!-- with the additional option description text. -->
<!-- -->
<!-- To add new options to this panel: -->
<!-- - repeat the text below for "choice_n_text" -->
<!-- (where "n" is the option number) -->
<!-- for the new option number and add it to the list -->
<!-- with the additional option description text. -->
<!-- for example: -->
<!-- <'ENTITY choice_8_text "(Description for option 8) ">-->
<!-- ##### -->
<'ENTITY choice_0_text
  "Terminal and user parameters">
<'ENTITY choice_1_text
  "Create/change command table ">
<'ENTITY choice_2_text
  "Preprocessed panel utility ">
<'ENTITY choice_3_text
  "ISPF DTL Conversion Utility ">
<'ENTITY choice_4_text
  "(Description for option 4) ">
<'ENTITY choice_5_text
  "(Description for option 5) ">
<'ENTITY choice_6_text
  "(Description for option 6) ">
<'ENTITY choice_7_text
  "Perform dialog testing">
<'ENTITY choice_T_text
  "Display information about this application">
<'ENTITY choice_X_text
  "Terminate ISPF using list/log defaults">
<!-- Status area labels - maximum text length = 10 bytes -->
<'ENTITY status_userid "Userid . :">
<'ENTITY status_time "Time . . :">
<'ENTITY status_term "Terminal :">
<'ENTITY status_pfkeys "Pf keys :">
<'ENTITY status_scrnum "Screen . :">
<'ENTITY status_lang "Language :">
<'ENTITY status_appl "Appl ID :">
<'ENTITY status_rel "Release :">

<!-- Generated panel comments - maximum text length = 66 bytes -->
<'ENTITY panel_cmnt1
  "This in a GML based panel generated by ISPD TLC.">
<'ENTITY panel_cmnt2
  ">
<'ENTITY panel_cmnt3
  "Make changes by updating the GML source file ">
<'ENTITY panel_cmnt4
  "and reconverting ISP@PRIM. ">

<!-- panel instruction text line - maximum text length = 78 bytes -->
<!-- panel instruction entities will be concatenated -->
<'ENTITY panel_instruct_1
  "Enter <ps var=zcmd value=END csrgrp=99>END</ps> ">
<'ENTITY panel_instruct_2
  "command to terminate application">

<!-- End of translatable panel text section -->
)> <!-- DO NOT DELETE THIS LINE -->

```

Figure 45. ISPF Primary Option Menu DTL Source (Part 2 of 4)

```

<varclass name=vcc type='char 80'>
<xlat1 format=upper>
</xlat1>

<varclass name=vco type='char 7'>

<varlist>
  <vardcl name=zcmd varclass=vcc>
  <vardcl name=zuser varclass=vco>
  <vardcl name=ztime varclass=vco>
</varlist>

<copyr>5655-042 (C) COPYRIGHT IBM CORP 1982, 1996
<panel name=isp@prim help=isp00003 padc=user keylist=isrnsab applid=isr
  width=80 depth=24 menu prime window=no>&panel_title;

<cmdarea noinit>
<area depth=11 extend=force width=59 dir=horiz>

  <!-- selection options follow - left side of panel -->
  <selfld type=menu selwidth=* trail=ztrail fchoice=0 entwidth=1
    tsize=12>
    <choice> <ps var=zcmd value=0 csrgrp=99>
      &choice_0_pnts;</ps>
      &choice_0_text;
      <action run=ispism type=pgm scrname=settings>
    <choice> <ps var=zcmd value=1 csrgrp=99>
      &choice_1_pnts;</ps>
      &choice_1_text;
      <action run=ispucma type=panel scrname=cmds>
    <choice> <ps var=zcmd value=2 csrgrp=99>
      &choice_2_pnts;</ps>
      &choice_2_text;
      <action run=ispprep type=pgm newappl scrname=prep>
    <choice> <ps var=zcmd value=3 csrgrp=99>
      &choice_3_pnts;</ps>
      &choice_3_text;
      <action run=ispdtlc type=cmd scrname=dtlc>
  <!-- ##### -->
  <!-- To add options 4, or 5 to this panel: -->
  <!-- add a <ACTION> tag provide the selection -->
  <!-- information for the generated ZSEL statement. -->
  <!-- -->
  <!-- <action run=newoptn4 type=panel scrname=opt4> -->
  <!-- where:run= -->
  <!-- run=newoptn4 - provides the name of the panel, -->
  <!-- pgm, cmd, wscmd, wscmdv -->
  <!-- type=panel - provides the selection choice: -->
  <!-- panel, pgm, cmd, wscmd, wscmdv -->
  <!-- scrname=opt4 - provides an optional screen name -->
  <!-- ##### -->
  <choice> <ps var=zcmd value=4 csrgrp=99>
    &choice_4_pnts;</ps>
    &choice_4_text;
  <choice> <ps var=zcmd value=5 csrgrp=99>
    &choice_5_pnts;</ps>
    &choice_5_text;
  <choice hide> <ps var=zcmd value=6 csrgrp=99>
    &choice_6_pnts;</ps>
    &choice_6_text;
  <choice> <ps var=zcmd value=7 csrgrp=99>
    &choice_7_pnts;</ps>
    &choice_7_text;
  <action run=ispyxdr type=pgm parm=&ZTAPPLID nocheck scrname=dtest>

```

Figure 45. ISPF Primary Option Menu DTL Source (Part 3 of 4)

```

<!-- ##### -->
<!-- To add new options to this panel: -->
<!-- - add a new <choice> tag to this list following the -->
<!-- pattern of the <choice> tags above. -->
<!-- a new <ACTION> tag is required to provide the selection -->
<!-- information for the generated ZSEL statement. -->
<!-- -->
<!-- <choice> <ps var=zcmd value=8 csrgrp=99> -->
<!-- &choice_8_pnts;</ps> -->
<!-- &choice_8_text; -->
<!-- <action run=newoptn8 type=panel scrname=opt8> -->
<!-- where:run= -->
<!-- run=newoptn8 - provides the name of the panel, -->
<!-- pgm, cmd, wscmd, wscmdv -->
<!-- type=panel - provides the selection choice: -->
<!-- panel, pgm, cmd, wscmd, wscmdv -->
<!-- scrname=opt8 - provides an optional screen name -->
<!-- ##### -->
<choice selchar=T> <ps var=zcmd value=T csrgrp=99>
&choice_T_pnts;</ps>
&choice_T_text;
<action run=isptutor type=pgm parm=ISP00000 scrname=tutor>
<choice selchar=X> <ps var=zcmd value=X csrgrp=99>
&choice_X_pnts;</ps>
&choice_X_text;
<action run=exit type=exit>
<comment type=proc>&panel_cmnt1;
<comment type=proc>&panel_cmnt2;
<comment type=proc>&panel_cmnt3;
<comment type=proc>&panel_cmnt4;
</selfld>
</area>

<!-- right side of option menu panel follows, status area -->
<area dir=horiz>
<region dir = vert>
<divider>
<dtacol pmtwidth=10 entwidth=8>
<dtafld datavar=ZUSER usage=out> &status_userid;
<dtafld datavar=ZTIME usage=out> &status_time;
<dtafld datavar=ZTERM usage=out> &status_term;
<dtafld datavar=ZKEYS usage=out> &status_pfkeys;
<dtafld datavar=ZSCREEN usage=out>&status_scrnum;
<dtafld datavar=ZLANG usage=out> &status_lang;
<dtafld datavar=ZAPPLID usage=out>&status_appl;
<dtafld datavar=ZENVIR usage=out> &status_rel;
</dtacol>
</region>

<!-- panel logic file embed -->
&ispzprim;
</area>
<region>
<info width=78>
<lines>
&panel_instruct_1;&panel_instruct_2;
</lines>
<p>5655-042 (C) COPYRIGHT IBM CORP 1982, 1996
</info>
</region>
</panel>

```

Figure 45. ISPF Primary Option Menu DTL Source (Part 4 of 4)

To add a new application to the primary option menu, copy the ISP@PRIM DTL source file from the GML library to a private data set. Locate the sections of code within the DTL comment lines:

```
<!-- ##### -->
```

and modify the DTL source code to:

1. Define the point-and-shoot option text
2. Define the option description text
3. Add an <ACTION> tag for each additional option.

Refer to the *z/OS ISPF Dialog Tag Language Guide and Reference* for a description of Dialog Tag Language syntax and information about compiling DTL panels.

Compile the modified DTL source file using the ISPD TLC command, and review the generated panel to confirm that your changes have been processed.

The required input field, ZCMD, appears in the second line of the panel body. It is followed by a description of the various options.

This menu also has eight variables within text fields at the upper-right corner of the screen. These reference system variables from the shared variable pool that display user ID, time, terminal type, number of function keys, screen number, language, application ID, and ISPF release number.

Defining Table Display Panels

A table display panel is a special panel that is processed by the TBDISPL service. When it is displayed, it has a fixed (nonscrollable) portion followed by a scrollable table portion. The fixed portion is defined by the)BODY section in the panel definition. The scrollable portion is defined by the)MODEL section.

The fixed portion contains the command field and usually the scroll amount field. It can also include other input fields as well as output fields, action bars, text, dynamic areas, scrollable areas, and a graphic area.

The scrollable portion is defined by up to eight *model* lines. These lines describe how each table row is to be formatted within the scrollable data area. Attribute characters in the model lines indicate whether each field is protected or user-modifiable.

If a single model line is specified in the panel definition, each row from the table corresponds to the format of that line. This results in scrollable data that is in tabular format. For many applications, it may be useful to define the left-most column in each line as an input field. The application user can enter a code to be used by the dialog function to determine the particular processing for that row.

If multiple model lines are specified in the panel definition, each row from the table corresponds to multiple lines on the screen. If desired, a separator line, consisting of blanks or dashes, for example, can be specified as the first or last model line. This format may be useful for address lists or other repetitive data in which each unit will not fit on a single line.

Each definition using the model lines on the display is known as a *model set*.

Table Display Vocabulary

This topic defines some terms related to table display. Figure 46 on page 132 illustrates those terms that refer to parts of a TBDISPL display. The two main parts of a TBDISPL display are the fixed portion and the scrollable portion. The fixed portion contains the command field and commonly a scroll amount field and a

top-row-displayed indicator. The scrollable portion contains the table information and usually, if the screen is not filled, a bottom-of-data marker.

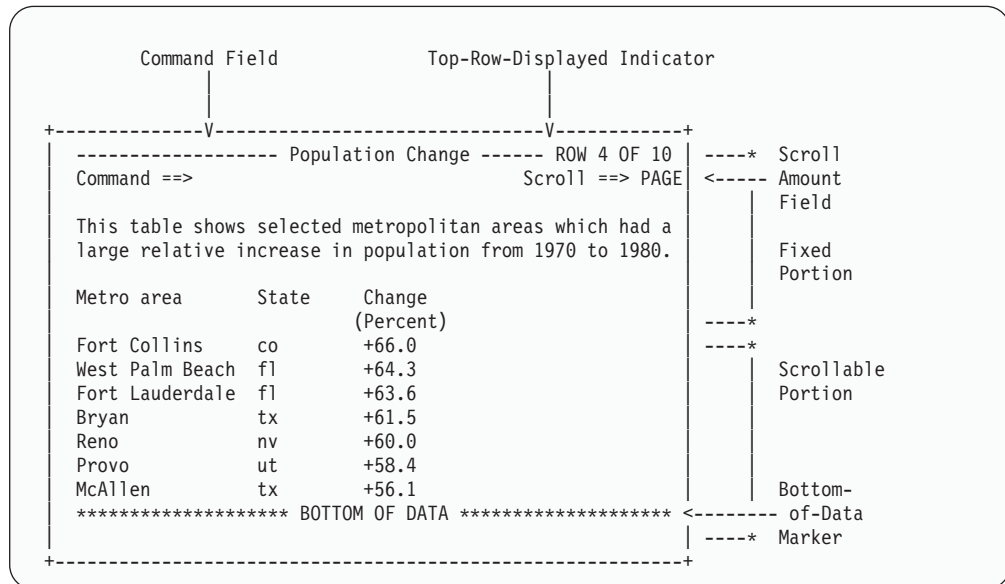

Figure 46. Parts of a TBDISPL display

auto-selection

The process by which the row specified in the CSRROW parameter or .CSRROW control variable is selected, even if the user did not explicitly select that row by modifying the corresponding model set displayed on the screen.

Relevant concepts include: selected row, user-selection, CSRROW parameter, .CSRROW control variable, AUTOSEL parameter, and .AUTOSEL control variable.

bottom-of-data marker

The low-intensity text that appears after the last displayed row in the last page of data in a TBDISPL display. If there are no displayed rows, this marker will be the only information displayed in the scrollable portion. The text BOTTOM OF DATA, with asterisks on each side, appears after the last row on a table display. The dialog can define an alternate marker by assigning text to ZTDMARK.

ISPF uses the + default attribute character for the bottom-of-data marker. The default attribute characters are %, +, and -. For a description of the default attribute characters see "Using Default Attribute Characters" on page 171. You can change the default attribute characters by using the DEFAULT keyword on either the)ATTR or)BODY head statement. For example: DEFAULT(abc) where a, b, and c are the 3 characters that take the place of %, +, and -, respectively. The default attribute characters are position-sensitive. Thus, if you change the default character "b" in the second position of the DEFAULT keyword parameter (ISPF's default character is +), it must maintain the characteristics of TYPE(TEXT), INTENS(LOW), COLOR(BLUE) for the bottom-of-data marker to display correctly.

Relevant concepts include: system variable ZTDMARK.

command field

A required field in the fixed portion of a TBDISPL display where

commands are entered. The command field can be identified in the panel definition through use of the CMD parameter on the)BODY statement. If the CMD parameter is not specified, the first input field is assumed to be the command field.

Relevant concepts include: system commands, application commands, and function commands.

dynamic expansion

The process by which a table being displayed is expanded as needed if a user scrolls beyond the top or bottom of data contained in the table at the time of the scroll request.

Relevant concepts include: scrolling and TBDISPL.

fixed portion

The nonscrollable portion of a TBDISPL display. That is, the part of the display that is not affected by the UP or DOWN commands. Note that both the fixed and scrollable portions are unaffected by the LEFT and RIGHT commands. The fixed portion is defined by the)BODY section of the panel definition.

Relevant concepts include: scrollable portion,)BODY section.

model lines

The lines in the)MODEL section of a TBDISPL panel definition, which form a template, or *model*, for the scrollable portion of a TBDISPL display.

Relevant concepts include:)MODEL section, model set, scrollable portion.

model set

The lines in the scrollable portion of a TBDISPL display that correspond to a particular table row. Model sets are created by ISPF by replicating the model lines in the panel definition and then filling in the fields with variable and table row information. Each model set on the display corresponds to a table row. If there are n model lines, where n can be from 1 to 8, then each model set is made up of n lines on the display.

Relevant concepts include: model lines, and scrollable portion.

pending END request

The situation that exists when a user has selected more than one row and has entered the END or RETURN command. The dialog can choose to ignore the selected rows, or it can process the selected rows in a TBDISPL series. In the latter case, each call of TBDISPL results in a return code of 8. When all the selected rows have been processed, the dialog commonly honors the pending END request by not invoking the TBDISPL service again.

Relevant concepts include: TBDISPL series, pending scroll request, and pending selected row.

pending scroll request

The situation that exists when a user has selected one or more rows, and has entered the UP or DOWN command. After the dialog has processed all the selected rows, it can invoke TBDISPL without the PANEL and MSG parameters to display the table and panel and have the pending scroll request honored. A pending scroll request can also exist when a user has issued the UP or DOWN command and the dialog is dynamically building the table. After adding the rows needed to satisfy the scroll request, the dialog can invoke TBDISPL without the PANEL or MSG parameters and ISPF will honor the pending scroll request.

Relevant concepts include: TBDISPL series, pending END request, pending selected row, and controlling the top-row-displayed.

pending selected rows

Occurs when a user has selected more than one row in a single interaction. Upon return from the TBDISPL display, the CRP is positioned to the first of the selected rows. The other rows, which remain to be processed, are the *pending selected rows*.

Relevant concepts include: selected row, TBDISPL series, pending END request, pending scroll request, system variable ZTDSELS.

scroll amount field

An optional field in the fixed portion of a TBDISPL display where scroll amounts, for example, PAGE, HALF, or 10, are entered. If the input field immediately following the command field is exactly 4 characters long, it is assumed to be the scroll amount field.

Relevant concepts include: scrolling, and system variables ZSCROLLA and ZSCROLLN.

scrollable portion

The part of a TBDISPL display defined by the)MODEL section of the panel definition and made up of model sets. It contains the ISPF table information. It is affected by the UP and DOWN commands.

Relevant concepts include: fixed portion,)MODEL section, model lines, and model sets.

select field

A field in the scrollable portion where line commands are entered. For example, a d entered into the select field of a model set can indicate that the corresponding table row is to be deleted. TBDISPL does not *officially* identify any field as a select field. It is up to the dialog to determine the characteristics or meaning of a select field.

Relevant concepts include: line commands, scrollable portion, model set, selected row, and user-selection.

selected row

A row in an ISPF table that has been auto-selected or user-selected.

Relevant concepts include: auto-selection, user-selection, model set, pending selected row, system variable ZTDSELS, POSITION parameter, and ROWID parameter.

TBDISPL series

A call of the TBDISPL service that results in a display where the user selects more than one row, followed by calls of the TBDISPL service without the PANEL and MSG parameters to process the pending selected rows.

Relevant concepts include: pending selected rows, pending END request, pending scroll request, and system variable ZTDSELS.

top-row-displayed indicator

There are three possible texts for the top-row-displayed indicator:

- ROW x OF y
x is the current row pointer of the top row displayed. y is the total number of rows in the table.
- ROW x TO z OF y

x is the current row pointer of the top row displayed. z is the row pointer of the last visible table row. z is calculated as the current row pointer of the top row displayed plus the number of lines displayed minus one. y is the total number of rows in the table.

- ROW x FROM y

x is the row pointer of the table row that has met the criteria of the SCAN. y is the total number of rows in the table.

The text used for the top-row-displayed indicator is determined by the CUA mode selected and by whether ROWS is set to ALL or SCAN in the panel model section. Table 5 is a summary of the CUA mode and ROWS(ALL) or ROWS(SCAN) combinations and the resulting top-row-displayed messages. CUA mode of YES is determined by the presence of a panel statement or by specifying CUA MODE=YES on Option 0.

Table 5. Text for Top-Row-Displayed Indicator

CUA Mode	ROWS	Top-Row-Displayed Message	Message ID
YES	ALL	ROW x TO z OF y	ISPZZ102
YES	SCAN	ROW x FROM y	ISPZZ103
NO	ALL	ROW x OF y	ISPZZ100
NO	SCAN	ROW x OF y	ISPZZ100

The message text appears right-justified on the top line of the display, or just below the action bar separator line if an action bar is defined. Your dialog can define an alternate indicator if you assign a message ID to ZTDMMSG. TBDISPL invokes the GETMSG to get the short and long message text. If a short message is found, it is used as the top-row-displayed indicator; if not, the long message text is used. In either case, any variables in the messages are substituted with their current values. If ZTDMMSG does not exist, the long form of message ISPZZ100, ISPZZ102, or ISPZZ103 is used.

If the model section for a table contains more than one line, it is possible that the entire model section will not fit on the screen. In this case, the last rows of the table area are left blank. A partial model section is not displayed. The only way to display a partial model section is if you request your function keys to appear over your table display, or if you split your screen over your table display.

When you specify ROWS(SCAN) in your panel model section, ISPF finds only enough rows to fill the display, thus providing a performance boost. Therefore, you cannot know the entire number of table rows that meet your search criteria without scrolling through the complete table.

When a table is being built dynamically to satisfy scroll requests, you can make the top-row-displayed indicator reflect the positioning in the logical table instead of the physical table. See the description of ZTDLTOP and ZTDLROWS in *z/OS ISPF Services Guide*.

Relevant concepts include: system variables ZTDMMSG, ZTDTOP, ZTDLTOP, ZTDROWS, and ZTDLROWS; messages ISPZZ100, ISPZZ101, ISPZZ102, and ISPZZ103; and controlling the top-row-displayed.

user-selection

The process by which ISPF table rows are chosen or *selected* for processing by the user modifying the corresponding model sets on the display. A user

modifies a model set by entering data into that model set. Overtyping a model set with the same data does not cause the row to be selected.

Relevant concepts include: auto-selection, selected row, model set, and system variable ZTDSLS.

Requirements for Attribute Section

Attribute characters can be defined for use in the panel body and the model lines. In the)BODY section, any attribute except EXTEND(ON) and SCROLL(ON) can be associated with any field or area. In the)MODEL section, any attribute except those associated with dynamic and graphic areas can be used with any field. That is, the attributes AREA, EXTEND, SCROLL, USERMOD, and DATAMOD are not allowed in model lines.

Input and output fields default to CAPS(ON) and JUST(LEFT), in the)BODY section, but they default to CAPS(OFF) and JUST(ASIS) in the)MODEL section.

An attribute section is required if the model line contains output fields. There is no default attribute character for output fields.

Requirements for Body Section

The panel body section is required. It contains the nonscrollable data, which is the command field and, commonly, the scroll amount field. The rules for their definition are:

Command field (required)

This field must not be longer than 255 characters.

The command field can have any desired name. The position of the command field can be specified through use of the CMD parameter on the)BODY statement. If the CMD parameter is not specified, the first input field is assumed to be the command field.

The command field is used, as on other types of panels, to enter ISPF commands and application-defined commands, if any. Any commands entered in this field that are not recognized by ISPF are automatically stored in the corresponding dialog variable. Upon return from TBDISPL, the dialog function can interpret this field and take appropriate action. The ZCMD field is cleared each time a TBDISPL request is received with the MSG or PANEL parameter. If the TBDISPL request contains a table name and no other parameters, the ZCMD field contains what was entered on the previous TBDISPL.

The ISPF commands are system commands, while the application-defined commands are application commands. The commands processed by the dialog function are function commands.

Scroll amount field (optional)

If the input field immediately following the command field is exactly 4 characters long, it is assumed to be the scroll amount field.

The field can have any desired name. Its initial value can be set in the)INIT section of the panel definition to any valid scroll amount.

If no scroll amount field is specified, the system variable ZSCROLLD, which can be set by a dialog, is used to determine the default scroll amount. If there is no scroll amount field and ZSCROLLD has not been set, PAGE is assumed.

When a user enters a scroll request, variables ZSCROLLA and ZSCROLLN are set. ZSCROLLA contains the value of the scroll amount field (MAX,

CSR, for example). ZSCROLLN contains the number of lines or columns to scroll, computed from the value in the scroll amount field. For example, if a dialog is in split-screen mode and if 12 lines are currently visible and a user requests DOWN HALF, ZSCROLLN contains a '6'. The system variable ZVERB contains the scroll direction, DOWN in this case. If ZSCROLLA has a value of MAX, the value of ZSCROLLN is not meaningful.

The following can appear in the)BODY section:

- Action bars
- Text
- Variables within text; for example, &XYZ
- Input fields
- Output fields
- Dynamic areas
- Scrollable areas
- Graphic areas.

Notes:

1. Only one extendable area is allowed on a panel. This includes dynamic, scrollable, and graphic areas.
2. Graphic areas are not supported when you are running in GUI mode. When a GRINIT statement is encountered, you will receive a message that panels with graphics will not be displayed. You may choose to continue. When a panel with graphics is encountered, you will receive an error message that the panel cannot be displayed.

If you are running in split-screen mode, the graphic area panel cannot be displayed on the host session.

If you specified GUISCRD or GUISCRW values on the ISPSTRT invocation which are different from the actual host screen size, GDDM cannot be initialized and the GRINIT service will end with a return code of 20.

Requirements for Model Section

The panel body must be followed by a model section. This section begins with a)MODEL header statement and is immediately followed by one or more model lines.

The)MODEL header statement must begin in column 1. The following optional keywords can be specified on this header:

- CLEAR(var-name,var-name ...)
- ROWS(ALL|SCAN).
- SFIHDR

The CLEAR keyword identifies the dialog variable names, from the model lines, that are to be cleared to blank before each row in the table is read. Thus, if the variable is an *extension* variable in the table, which cannot exist in all rows, previous values are erased and, thereby, are not repeated in other lines for which they do not apply.

The ROWS keyword indicates whether all rows from the table are to be displayed, or whether the table is to be scanned for certain rows to be displayed. The default is ROWS(ALL), which causes all rows to be displayed. If ROWS(SCAN) is specified, the dialog must invoke the TBSARG service before invoking TBDISPL. The search argument set up by the TBSARG service is used to scan the table. Only rows that match the search argument are displayed.

The SFIHDR keyword is used when a variable model line (see below) defines scrollable fields and scroll indicators are required for the scrollable fields. SFIHDR indicates that the first variable model line defines scroll indicator fields for scrollable fields that are defined on subsequent variable model lines.

One or more model lines must appear following the)MODEL header statement. A maximum of eight model lines is allowed. Any attribute except those associated with dynamic, graphic, or scrollable areas (AREA, EXTEND, SCROLL, USERMOD, and DATAMOD) can be used with any fields in the model lines. The following can appear in the)MODEL section:

- Text
- Variable model lines (see below)
- Input fields
- Output fields.

The following cannot appear in the)MODEL section:

- Action bars
- Variables within text
- Dynamic areas
- Graphic areas
- Scrollable areas.

Typically, the first field within the model lines specifies the dialog variable into which a selection code, entered by a user, will be stored. All remaining names correspond to columns in the table. However, this arrangement is not required. Any name may or may not correspond to a column in the table, and a selection code field need not be specified.

Text fields can be specified in the model line. A text attribute character can appear by itself to terminate the preceding input or output field. Any characters that appear within a text field in the model line are repeated in each line of the scrollable data. This includes the letter Z. It is not treated as a variable name if it occurs in a text field.

Variable model lines can be specified in the panel definition. If a variable, a name preceded by an ampersand, begins in column 1 of any model line, the value of that variable defines the model line.

The following rules apply to variable model lines:

- The variable must be the only information on the model line. If any other data is present, an error results.
- If the value of the variable is greater than the screen width, an error results.
- The variable can contain any character string that is a valid panel definition model line, except that the variable cannot define a variable model line. A variable whose value is all blanks is acceptable.
- If the variable contains the character string OMIT starting in column 1, that variable model line will not be used in the model definition.
- All model line variables must be initialized before the table display service is called with a nonblank panel name. Changes to the variables that occur within the panel or the dialog function are not honored until table display is called again with a nonblank panel name.
- If variable model lines are being used, the panel is retrieved from disk every time that table display is called with a nonblank panel name and the value of the variable model line has changed.

- If the SFIHDR keyword is specified on the)MODEL header statement, the first variable model line is assumed to define scroll indicator fields for scrollable fields that are defined on subsequent variable model lines.

Requirements for Initialization Section

An initialization section, if present, is processed when the TBDISPL service is invoked with the panel name specified.

If Z variables occur as name placeholders within the model lines or the fixed portion, an)INIT section is needed. The real names of these fields are defined by assigning a name list, enclosed in parentheses if more than one name is given, to the control variable, .ZVARS. For example:

```
)INIT
.ZVARS = '(NAME1,NAME2,NAME3)'
```

where NAME1, NAME2, and NAME3 are the actual variable names corresponding to the first, second, and third Z variables in the body or model sections. For example, if one Z variable occurs as a placeholder within the panel body and two Z variables occur as placeholders within the model lines, then NAME1 corresponds to the field in the body and NAME2 and NAME3 correspond to the two fields in the model lines.

For compatibility with SPF, Z variables in the model lines of a table display panel can be assigned to the VARS variable, rather than to the control variable, .ZVARS. For example:

```
)INIT
&VARS = '(NAME2,NAME3)'
```

It is recommended, however, that table display panels use the .ZVARS control variable. It *must* be used if the CLEAR keyword is added to the)MODEL header statement, if explicit cursor placement is used for table display, or if Z variable placeholders are in the)BODY section.

The)INIT section of a TBDISPL panel definition can contain any statement that is valid in an)INIT section of a DISPLAY panel definition.

Requirements for Reinitialization Section

If a)REINIT section is included, it is executed when TBDISPL is reinvoked without a panel name or when a redisplay occurs automatically because of the .MSG control variable being nonblank.

The)REINIT section of a TBDISPL panel definition can contain any statement that is valid in a)REINIT section of a DISPLAY panel definition.

Any control variable except .ZVARS can be set within the)REINIT section. If table variables that are in the model lines are referenced within the)REINIT section, then the values for the current row, as specified by the CRP, are used. For example, if the .ATTR control variable is set for fields that are in the)MODEL section, then only fields in the model set on the display that corresponds to the current selected row will have their attributes changed.

Requirements for Processing Section

If a)PROC section is included, it is executed before control returns to the dialog function. It is not executed while the user is scrolling.

The)PROC section of a TBDISPL panel definition can contain any statement that is valid in a)PROC section of a DISPLAY panel definition.

Any control variable except .AUTOSEL and .ZVARS can be used in the)PROC section. If table variables that are in the model lines are referenced within the)PROC section, then the values for the current row, as specified by the CRP, are used. For example, if the .ATTR control variable is set for fields that are in the)MODEL section, only fields in the model set on the display that corresponds to the current selected row will have their attributes changed.

The)PROC section can check the value of ZTDSELS to determine if any rows were selected. This value and its interpretation are:

0000 No selected rows
0001 One selected row (now the current row)
0002 Two selected rows, consisting of the current row and a pending selected row
0003 Three selected rows, consisting of the current row and two pending selected rows
... And so forth.

Using Control Variables

Two control variables, .AUTOSEL and .CSRROW, can be used in the executable—)INIT,)REINIT, and)PROC—sections of a TBDISPL panel definition. They are ignored in a DISPLAY panel definition.

The .AUTOSEL and .CSRROW control variables can be used to control the selection (and preselection) of a row in a table display. For more information about these variables, see “.AUTOSEL” on page 285 and “.CSRROW” on page 286.

Processing Panels by Using the TBDISPL Service

When a panel is displayed by the TBDISPL service, the model lines in the)MODEL section are duplicated at the end of the logical screen. When the scrollable portion of the screen is being formatted, only full units or duplications of these model lines are usually displayed. Two exceptions are:

- When the command line is repositioned to the bottom of the screen, the line above it, which can be a model line, may be overlaid with a blank line and used as the long message line. This prevents table display data from being overlaid with long message data.
- When the PFSHOW command is in effect, up to four additional lines can be overlaid.

Each input or output field that has a corresponding column in the table is initialized with data from succeeding rows from the table. The first row displayed is the row pointed to by the CRP when TBDISPL was issued.

Input or output fields in a model line that do not correspond to columns in the table are initialized, in all rows, with the current contents of the corresponding dialog variables. If these fields are to be blank, the corresponding variables must be set to blanks or null before each call of TBDISPL. The CLEAR keyword can be used to specify that they are to be blanked.

A user can scroll the data up and down. Scroll commands, such as DOWN 5, apply to the number of table entries to scroll up or down. For example, if three model lines are specified, DOWN 5 would scroll by 5 table entries, which corresponds to 15 lines on the display.

A user can enter information in any of the input fields within the fixed or scrollable portion of the panel.

Figure 47 shows a sample panel definition for table display.

```

)ATTR
  @ TYPE(OUTPUT) INTENS(LOW)
)BODY
%----- EMPLOYEE LIST -----
%COMMAND INPUT ==>_ZCMD                                %SCROLL ==>_AMT +
+
%EMPLOYEES IN DEPARTMENT@Z +
+
+SELECT      ----- EMPLOYEE NAME -----          -- PHONE ---      EMPLOYEE
+ CODE      LAST      FIRST      MI          AREA NUMBER      SERIAL
)MODEL
  _Z+      @LNAME      @FNAME      @I          @PHA @PHNUM          @EMP SER
)INIT
  .ZVARS = '(DEPT SELECT) '
  &AMT = PAGE
  .HELP = PERS123
)REINIT
  IF (.MSG = ' ')
    &SELECT = ' '
    REFRESH (SELECT)
)PROC
  IF (&ZTDSELS ^= 0000)
    VER (&SELECT, LIST, A, D, U)
)END

```

Figure 47. Table Display Panel Definition

Assuming that the current contents of the table are as shown in Table 6 and that dialog variable DEPT contains '27', the resulting display is shown in Figure 48.

Table 6. Table Display Data

EMP SER	LNAME	FNAME	I	PHA	PHNUM
598304	Robertson	Richard	P	301	840-1224
172397	Smith	Susan	A	301	547-8465
813058	Russell	Charles	L	202	338-9557
395733	Adams	John	Q	202	477-1776
502774	Kelvey	Ann	A	914	555-4156

```

----- EMPLOYEE LIST ----- ROW 1 OF 5
COMMAND INPUT ==> _ SCROLL ==> PAGE

EMPLOYEES IN DEPARTMENT 27

SELECT  ----- EMPLOYEE NAME -----   --- PHONE ---   EMPLOYEE
CODE    LAST      FIRST      MI      AREA  NUMBER   SERIAL
Robertson  Richard  P      301    840-1224  598304
Smith      Susan    A      301    547-8465  172397
Russell    Charles  L      202    338-9557  813058
Adams      John     Q      202    477-1776  395733
Caruso     Vincent  A      914    294-1168  502774
***** BOTTOM OF DATA *****

```

Figure 48. Table as Displayed

In this example, the select field (left-most column) does not correspond to a column in the table. It is used to return a selection code, entered by the user and placed in a variable named SELECT. The other variables in the model line correspond to variables in the table. The example also illustrates the use of two Z variables as placeholders in the body of the panel and in the model line, the initialization of the scroll amount field to PAGE, and the specification of a corresponding help panel.

The same table might be displayed by using several model lines with the panel definition shown in Figure 49.

```

)ATTR
@ TYPE(OUTPUT) INTENS(LOW)
# TYPE(INPUT) PAD('_ ')
)BODY
%----- EMPLOYEE LIST -----
%COMMAND INPUT ==>_ZCMD SCROLL ==>_AMT +
+
%EMPLOYEES IN DEPARTMENT@Z +
+
+ENTER CHANGES ON THE LINES BELOW.
+
)MODEL
#Z + SERIAL: @EMP SER + LAST NAME: @LNAME +
PHONE: @PHA@PHNUM + FIRST NAME: @FNAME +
INITIAL: @I +
-----
)INIT
.ZVARS = '(DEPT SELECT)'
&AMT = PAGE
.HELP = PERS123
)END

```

Figure 49. Table Display Panel Definition with Several Model Lines

The resulting display is shown in Figure 50 on page 143. An entry separator, consisting of a dashed line, is also included as the last model line. In this example, the SELECT field has been increased to 4 characters, with underscores used as pad characters.

```

----- EMPLOYEE LIST ----- ROW 1 OF 5
COMMAND INPUT ==> _ SCROLL ==> PAGE

EMPLOYEES IN DEPARTMENT 27

ENTER CHANGES ON THE LINES BELOW.

--- SERIAL: 598304 LAST NAME: Robertson
PHONE: 301 840-1224 FIRST NAME: Richard
INITIAL: P
-----
--- SERIAL: 172397 LAST NAME: Smith
PHONE: 301 547-8465 FIRST NAME: Susan
INITIAL: A
-----
--- SERIAL: 813058 LAST NAME: Russell
PHONE: 202 338-9557 FIRST NAME: Charles
INITIAL: L
-----
--- SERIAL: 395733 LAST NAME: Adams
PHONE: 202 477-1776 FIRST NAME: John
INITIAL: Q
-----
--- SERIAL: 502774 LAST NAME: Caruso
PHONE: 914 294-1168 FIRST NAME: Vincent
INITIAL: J
-----
***** BOTTOM OF DATA *****

```

Figure 50. Table as Displayed with Several Model Lines

Formatting Panels That Contain Dynamic Areas

ISPF facilities permit the format and content of a display to be determined in the same dialog in which it is displayed. This is called dynamic formatting. See "Specifying Dynamic Areas" on page 200 for information about how to specify a dynamic area in the)ATTR section header.

Areas are reserved for this purpose in a panel definition and are called dynamic areas. A dynamic area can encompass all or part of a panel display.

The format of a dynamic area is specified by a string of control and data characters, stored in a dialog variable. This variable may have been produced either in the current dialog or, earlier, in another dialog or program. The string usually contains a mixture of nondisplayable attribute characters and data to be displayed. The name of the dialog variable is chosen by the panel designer. This name is placed in the panel definition within the dynamic area.

A dialog uses the DISPLAY, TBDISPL, or SELECT service to display a panel containing a dynamic area. After the display and after entry of any input by the user, data from within the dynamic area is stored in the variable, associated with the area, and is available for processing by the dialog function.

When a panel is displayed, the number of lines in a dynamic area can be increased automatically to accommodate the number of lines available on the terminal being used for the display.

Panel Processing Considerations

When you are defining a dynamic area and generating a dynamic character string that defines the format of the data to be placed within that area on the panel, a number of rules apply:

- The area cannot be specified by using a Z-variable *place-holder* within the panel body.
- Within the dynamic area, all nonattribute characters are treated as data to be displayed. Unlike other parts of the panel body, a variable name does not follow an attribute character.
- The dialog is responsible for insuring data integrity, validity of attribute codes, and so on, for the dynamic character string.
- If the dynamic area has a width that is less than the screen size, the panel designer must place the appropriate attribute characters around this *box* so that the data within the area is not inadvertently affected. For example, the panel designer can place fields with SKIP attributes following the right-most boundaries so that the cursor is properly placed to the next or continued input field within the area.
- If the dialog must know the dimensions of the dynamic area before the data is formatted, this information is available by invoking the PQUERY dialog service. All dialog services are described in *z/OS ISPF Services Guide*.
- The scroll amount field is optional. On a panel with a scrollable area, if the input field following the command field in the panel body is exactly 4 characters long, it is assumed to be the scroll amount field. Otherwise, the system variable ZSCROLLD, which can be set by the dialog, is used to determine the default scroll amount. If there is no scroll amount field and ZSCROLLD has not been set, PAGE is assumed. ZSCROLLA contains the value of the scroll amount field, such as MAX or CSR. ZSCROLLN contains the scroll number computed from the value in the scroll amount field (number of lines or columns to scroll). For example, if a user is in split-screen mode, 12 lines are currently visible, and the user requests DOWN HALF, ZSCROLLN contains a '6'. The system variable ZVERB contains the scroll direction, DOWN in this case. If ZSCROLLA has a value of MAX, the value of ZSCROLLN is not meaningful.
- A nonblank input or output field preceding a dynamic area must be terminated by an attribute character.
- When variable substitution occurs within a text field in the panel body, the field must be terminated by an attribute character, before a special character defining a dynamic area. See "Using Variables and Literal Expressions in Text Fields" on page 113 for additional information about text field variable substitution.

Although panel display processing cannot provide point-and-shoot support for dynamic areas, it does provide the PAS(ON) keyword for TYPE(DATAOUT). The PAS(ON) keyword reflects the CUA point-and-shoot color. It is up to application developers to provide the point-and-shoot function in programs they develop.

Similarly, while the panel display service does not perform the scrolling for dynamic or graphic areas, it does provide an interpretation of the user's scroll request.

The *value* for the SCROLL keyword cannot be specified as a dialog variable.

A panel cannot have more than one scrollable area or more than one extended area. The scrollable area can be a panel with a scrollable area or a table display.

These rules are applied in Figure 51.

```
)ATTR
# AREA(DYNAMIC) SCROLL(ON) EXTEND(ON)
)BODY
%----- TITLE -----
%COMMAND ==>_ZCMD +SCROLL ==>_AMT +
+
+ (Instructions for this panel ...)
+
#SAREA -----#
+
+ (More instructions for this panel ...)
+
```

Figure 51. Panel Definition Illustrating SCROLL and EXTEND

In this example, there are:

- 5 lines in the panel body before the extended area
- 3 more lines after the extended area.

This makes a total of 8 lines that are outside the dynamic area. Therefore, if the panel were displayed on a 3278 Model 4, which has 43 lines, the depth or extent of the dynamic area would be 43 minus 8, or 35 lines. In split-screen mode, the panel is still considered to have a 35-line scrollable area, even though part of it is not visible.

In this example, the dynamically generated data string to be placed in the area is taken from the dialog variable SAREA. If, for example, the dynamic area is 60 characters wide and 10 lines deep, the first 60 characters of the string are placed in the first line of the area, the next 60 characters are placed in the second line of the area, and so on, until the last 60 characters are placed in the tenth line of the area. Following a user interaction, the contents of the area are stored in the same variable.

The width of the dynamic area includes the special characters that designate the vertical sides. These delimiter characters do not represent attribute characters.

A number of the capabilities described in the previous sections have implications for panel areas as well as panel fields. These include:

- A REFRESH statement can be used to reset an *area* when reinitializing or redisplaying a panel. The variable value is again read and placed in the area. Since the value also contains attribute information that may have changed, the characteristics for each field are again analyzed.
- The cursor placement capability applies to dynamic areas. That is, .CURSOR can be assigned to a dynamic area name and .CSRPOS can be assigned to a position within the dynamic area. The position within an area applies within the rectangular bounds of that area.
- The .ATTRCHAR control variable can be used to override attribute characters that are used within dynamic areas. In addition, .ATTRCHAR can be used to define a new attribute character that has not been previously listed within the panel)ATTR section. Using .ATTRCHAR as a vehicle for defining new attribute characters can be done only within the)INIT section and only for fields within dynamic areas (TYPE(DATAIN) or TYPE(DATAOUT)).
- The PQUERY service can be invoked by the dialog function to determine the characteristics of the dynamic area before the dialog function constructs the dynamic character string.

Character-Level Attribute Support for Dynamic Areas

ISPF allows you to associate character-level attributes with individual characters within a dynamic area. Each character in the dynamic area can be assigned characteristics of color and extended highlighting, which override these attribute values identified in the field attribute. You can also specify that a graphic escape (GE) order be used to display a graphic character from an alternate character set. See “Defining the Attribute Section” on page 170 for more information.

Note: Character-level color and extended highlighting will be ignored when running in GUI mode.

These attributes are treated as character attributes only if they are used in the *shadow* variable for the dynamic area (see the description of shadow variable below); otherwise, they are treated as text.

Variables may be substituted for the values of the COLOR, HILITE, and GE keywords in the same way they are substituted for field attributes.

The .ATTRCHAR control variable may be used to override the COLOR, HILITE, and GE keywords for character attributes in the same way it is used to override field attributes. The TYPE keyword cannot be overridden from TYPE(CHAR) to any other type, nor can a different type value be overridden as TYPE(CHAR). See “Relationship to Control Variables .ATTR and .ATTRCHAR” on page 205.

Refer to the *z/OS ISPF Dialog Tag Language Guide and Reference* for details on defining character attributes within dynamic areas in panels created using DTL.

Specifying Character Attributes in a Dynamic Area

If a dynamic area is to contain character attributes, a shadow variable must be defined. The TYPE(CHAR) attributes must be placed in this variable such that they map to the characters in the dynamic area affected by the attribute. ISPF ignores any other characters or field attributes that are placed in this shadow variable, but it is recommended that blanks be used as filler characters.

Note: If consecutive characters have the same character attributes (an entire word, for example), the attribute character must be repeated in the shadow variable for EACH character affected. For panels to be displayed on DBCS terminals, a TYPE(CHAR) attribute should only map to the first byte of a double-byte character.

The shadow variable is associated with the dynamic area by placing the shadow variable name after the dynamic area name in the panel definition. The two variable names must be separated by a comma only, and the shadow variable name must be followed by a blank.

Note: The dynamic area and shadow variables cannot be Z variables in the panel source.

Refer to the *z/OS ISPF Dialog Tag Language Guide and Reference* for details on specifying a shadow variable using Dialog Tag Language.

Conflict Resolution Between Attributes

If the terminal does not support the specified TYPE(CHAR) attribute of color or extended highlighting, this attribute is ignored and defaults to the field attribute.

If the terminal does not support the graphic escape order, or if the character defined by TYPE(CHAR) GE(ON) is not in the range '40'X through 'FE'X, ISPF does not place a GE order in the order stream before this character and displays this character as a blank.

- The dialog can check the system variable ZGE to determine if the terminal supports the graphic escape order. If it does not, the dialog can substitute different characters in the dynamic area.

Table 7. Characteristics of the ZGE system variable

Name	Pool	Type	Len	Description
ZGE	shr	non	3	Terminal support for graphic escape order: <ul style="list-style-type: none"> • YES — graphic escape is supported • NO — graphic escape is not supported <p>Note: When running in GUI mode, ZGE is set to OFF. Any character defined with GE(ON) will display as a blank.</p>

If a TYPE(CHAR) attribute is defined with other keywords such as INTENS, CAPS, JUST, or PAD in addition to COLOR, HILITE, or GE, only the COLOR, HILITE, and GE keywords are recognized. If the GE keyword is specified for any type other than TYPE(CHAR), TYPE(ABSL), TYPE(WASL), or TYPE(CH), it is ignored. If a TYPE(CHAR) attribute is specified in the shadow variable that contains neither the COLOR nor the HILITE keywords, the character defaults to the field attribute.

Any character attribute specified in the shadow variable that maps to the location of a field attribute character in the dynamic area variable is ignored. (For instance, see Figure 52 on page 148. A \$ in the first character position of the variable SHADOW is ignored because the first character position in the variable CATTAREA is a ~ indicating a field attribute.)

On DBCS terminals, ISPF ignores any TYPE(CHAR) attribute that maps to a character that precedes the first field attribute. Following the first field attribute, any TYPE(CHAR) attribute that maps to the second byte of a double-byte character is ignored. In addition, the GE(ON) keyword specified for a TYPE(CHAR) attribute that maps to a double-byte character is ignored.

A character attribute specifying the GE(ON) keyword can be defined within a TYPE(DATAIN) field. However, any data typed into this character position might be returned to the dialog as an unpredictable character.

Character attributes are associated with a character and not with the character's position in the buffer. If a character is moved, for example, because of an insert or delete operation, the attribute moves with the character.

The screen image recorded in the list data set as a result of the PRINT, PRINT-HI, PRINTL, or PRINTLHI contains a blank character for all character attributes defined with the GE(ON) keyword.

Figure 52 on page 148 shows an example of the panel source for a panel with a dynamic area containing character attributes.

```

)ATTR
* AREA(DYNAMIC)
$ TYPE(CHAR) HILITE(REVERSE) COLOR(YELLOW)
> TYPE(CHAR) COLOR(RED)
# TYPE(CHAR) COLOR(BLUE) HILITE(USCORE)
^ TYPE(DATAOUT) INTENS(LOW) COLOR(WHITE)
)BODY
%-----CHARACTER ATTRIBUTE PANEL-----
%COMMAND ==>_ZCMD

+The following will contain character attributes:
*CATTAREA,SHADOW -----*

)END

```

Figure 52. Dynamic Area with Character Attributes

The next example shows how the dynamic area and shadow variables are defined and initialized in a PL/I program to display the above panel.

```

DECLARE CATTAREA CHAR(50) INIT /* Dynamic Area Variable */
('These words contain character attributes: Fox Cat');
DECLARE SHADOW CHAR(50) INIT /* Shadow of Dynamic Area Variable */
(' $## 0 ');

```

In the panel displayed from the examples above, the F in the word Fox is yellow and displayed in reverse video, the ox in the word Fox is blue and underscored, the C in the word Cat is red with no highlighting, and the at in the word Cat as well as the rest of the sentence, defaults to the field attribute and is displayed low intensity and white with no highlight.

Formatting Panels That Contain a Graphic Area

ISPF panel definition syntax allows specification of a graphic area within a panel. An ISPF display can contain a picture or graph generated through use of the Graphical Data Display Manager (GDDM) licensed program. A graphic area defined within a panel definition provides part of the interface between ISPF and GDDM. A graphic area can contain either a picture, constructed by use of GDDM services or a graph, constructed by use of the GDDM Presentation Graphics Feature (PGF). Graphic areas can contain alphanumeric fields within them, represented in the usual panel field syntax. These fields can partially overlap the graphic area.

Formatting of a graphic area display is controlled by GDDM.

When specifying a graphic area display, the dialog developer issues a request for the ISPF GRINIT service specifying the name of the panel definition in which the graphic area is defined. This request establishes the interface to GDDM. Next, calls to GDDM that request GDDM services specify the picture to appear in that graphic area. Then the ISPF DISPLAY service is used to display the panel.

The dialog must provide an 8-byte area, called an application anchor block (AAB), which is on a full-word boundary, to the GRINIT call. This AAB identifies the ISPF/GDDM instance and must be used in all GDDM calls made by the dialog. Within the ISPF/GDDM instance, the dialog cannot perform any of the following GDDM calls:

ASREAD	FSSHOR	ISFLD	MSPCRT	MSQMOD	PTNSEL	WSCRT
FSSHOW	ISQFLD	MSPQRY	MSQPOS	PTSCRT	WSDDEL	WSIO
FSENAB	FSTERM	ISXCTL	MSPUT	MSREAD	PTSDEL	WSMOD
FSEXIT	GSREAD	MSCPOS	MSQADS	PTNCRT	PTSSEL	WSSEL
FSINIT	ISCTL	MSDFLD	MSQGRP	PTNDEL	PTSSPP	WSSWP
FSRNIT	ISESCA	MSGET	MSQMAP	PTNMOD	SPINIT	

ISPF GDDM services do not run in the background, and thus, cannot be requested in a batch environment. See “Defining the Attribute Section” on page 170 for information using the AREA keyword in the)ATTR section to define a graphic area.

Graphics Panel Processing Considerations

ISPF automatically switches into graphics interface mode when the GRINIT service is requested. This mode continues for the life of the ISPF session. GDDM is called to perform all full-screen displays from this point on, or until a request for the dialog service GRTERM is issued. The following notes apply to graphics interface mode:

Stacked TSO commands

The field mark key is not available to enter commands at one time.

5550 terminals

GDDM graphics are supported through the Japanese 3270PC/G Version 3 emulator program. The ISPF-GDDM interface allows DBCS and mixed-character fields in the panel body, outside the graphics area, to be displayed through GDDM. Full color and highlighting are supported through use of the Japanese 3270PC/G Version 3 and 3270PC Version 5 emulator programs.

3290 terminals

The vertical split function is disabled. Panels are displayed with a larger-size character set. The partition jump key is *not* functional.

Alternate screen widths

You cannot use GDDM with terminal devices whose primary width is different from their alternate width. For example, 3278 model 5.

Autoskip facility

When entering data in a field, GDDM automatically moves the cursor to the next input field when the preceding field is full.

First field attribute

GDDM requires that the first field on a panel begin with an attribute character. Therefore, the ISPF/GDDM interface copies the attribute character for the last field on a panel to the first panel position. This can result in the first byte of the panel data being overlaid.

Data transfer

The entire screen buffer is sent to the terminal even if no fields have been modified.

NUMERIC (ON)

The numeric lock feature is not active when using GDDM.

Graphic output

GDDM calls issued from an application are used to define graphic primitives for the next full-screen output and are unknown to ISPF. Any full-screen output, following the ISPF full-screen output containing the graphic area, can cause the loss of the graphic primitives on the ISPF panel. Hence, the application can be required to reissue the GDDM calls.

Pop-up windows

Pop-up windows cannot be displayed over graphic areas nor can graphic areas be displayed over pop-up windows.

GUI mode

Graphic areas are not supported if you are running in GUI mode. When a GRINIT statement is encountered, you will receive a message that panels with graphics will not be displayed. You may choose to continue. When a panel with graphics is encountered, a pop-up window is displayed asking if you want the panel displayed on your host emulator session or on your workstation without the graph.

Notes:

1. If you are in split-screen mode, the graphic area panel cannot be displayed on the host session.
2. If you specified GUISCRD and GUISCRW values on the ISPSTRT invocation which are different from the actual host screen size, GDDM cannot be initialized and the GRINIT service will end with a return code of 20.

Using DBCS-Related Variables in Panels

The following rules apply to substituting DBCS-related variables in panel text fields.

- If the variable contains MIX format data, each DBCS subfield must be enclosed with shift-out and shift-in characters.

Example:

```
eeee[DBDBDBDBDB]eee[DBDBDB]
```

ee... represents a field of EBCDIC characters; DBDB... represents a field of DBCS characters; [and] represent shift-out and shift-in characters.

- If the variable contains DBCS format data only, the variable must be preceded by the ZE system variable, without an intervening blank.

Example:

```
...text...&ZE&DBCSVAR..text...
```

- If the variable contains EBCDIC format data, and it is to be converted to the corresponding DBCS format data before substitution, the variable must be preceded by the ZC system variable, without an intervening blank.

Example:

```
...text...&ZC&DBCSVAR..text...
```

The ZC and ZE system variables can be used only for the two purposes described above. When variable substitution causes a subfield length of zero, the adjacent shift-out and shift-in characters are removed.

Using Preprocessed Panels

You can store preprocessed panel definitions to reduce transition time. These preprocessed panel definitions are in an encoded format, and cannot be edited directly.

Preprocessed panel data sets must be defined to ISPF as you would define other data sets. This can be either by normal allocation before invoking ISPF, or

dynamically during an ISPF session by using the LIBDEF service. ISPF provides a dialog, ISPPREP, for creating preprocessed panels. This dialog can be run either in batch mode or interactively.

You invoke the ISPPREP dialog by:

- Issuing the ISPPREP command from the command line
- Selecting it from the Compilers pull-down on the ISR@PRIM panel.
- Specifying ISPPREP with the PGM keyword on the SELECT service request

To run ISPPREP by using the SELECT service, issue ISPPREP with no parameters. For example, entering ISPEXEC SELECT PGM(ISPPREP) displays the following selection panel:

```

Preprocessed Panel Utility

Specify input and output data set names below:

Panel input data set:
Data set name . .
Member . . . . . (* for all members)
Volume serial . . (If not cataloged )

Panel output data set:
Data set name . .
Member . . . . . (blank or member name)
Volume serial . . (If not cataloged )

Enter "/" to select option
  Replace like-named members
/ Save statistics for members

Command ==>
F1=Help      F2=Split    F3=Exit     F9=Swap     F10=Actions  F12=Cancel

```

Figure 53. Panel for Specifying Preprocessed Panel Data Sets (ISPPREPA)

Entering ISPPREP from a command line or invoking ISPPREP from the Functions choice on the action bar of the ISPF Primary Option Menu also causes this selection panel to be displayed.

To run ISPPREP in batch mode, include the PARM keyword and the panel-input and panel-output identifiers on the SELECT service request. For example:

```
ISPEXEC SELECT PGM(ISPPREP) PARM(INPAN('ISPFPROJ.GRE.PANELS(PANA)'),
OUTPAN('ISPFPROJ.PXY.PANELS(PANB)') EXEC)
```

requests the SELECT service to convert member PANA in ISPFPROJ.GRE.PANELS to the internal format and to write it to member PANB in ISPFPROJ.PXY.PANELS.

Note: The previous example must be run from a REXX or CLIST command procedure.

You can control whether existing members in the output data set having the same identification as that specified will be replaced. In batch mode, use the NOREPL|REPLACE parameter with the PARM keyword for specifying whether members are to be replaced. In interactive mode, use the line provided on the panel shown in Figure 53 for specifying whether members are to be replaced.

ISPPREP converts panel input data set members to an internal format and writes them to the specified output panel data set members. A given panel file can contain a mixture of preprocessed panels and regular panel definitions.

ISPPREP does not destroy the source panels from which it creates preprocessed panels. However, you should save those panels in case they must be updated in the future. When the preprocessed panels are ready for use, you can use them to replace the corresponding source files for the ISPLIB defaults.

ISPPREP provides an option to generate statistics for preprocessed panels. ISPF provides the version (always 1), modification counter, creation date last-modified date, current number of lines, initial number of lines, number of modified lines (always 0), and user ID for the message or panel. These statistics are visible on memberlist displays such as ISPF BROWSE and EDIT. The statistics are placed in the SPF directory.

Restrictions for Using ISPPREP

When using ISPPREP, you should note that certain restrictions apply to those panel definitions that can be converted to their internal format. These restrictions apply only when creating preprocessed panels and are based on the fact that preprocessed panels cannot have a dynamically defined width and depth.

The following restrictions apply to panel definitions to be converted:

1. The use of a dialog variable with the WIDTH keyword on the)BODY header statement of a panel definition is not allowed.
2. The specification of EXTEND(ON) for the attribute character of a dynamic, graphic, or scrollable area is not allowed.
3. The use of a dialog variable to define a model line in a table display panel definition is not allowed.
4. For DBCS panels, the correct character set must be loaded before invoking ISPPREP. Panels to be displayed on a 5550 3270 Kanji Emulation terminal must be converted using the 3278KN character set (set in option 0.1).

Preprocessed panel objects should not be copied from a fixed to a variable record format data set. Blank data could be lost. This can cause the product to abend or can create a display error when the copied panel object is used by display processing. Use ISPPREP to transfer preprocessed panel objects to a variable record format data set or when the receiving data set logical record length or logical record format is not the same as the source data set.

ISPPREP output data sets must conform to the same LRECL limits as ISPLIB.

Using ISPPREP with the SELECT Service

You can use the PGM keyword of the SELECT service to invoke ISPPREP. The syntax for invoking ISPPREP is as follows:

```
ISPEXEC SELECT PGM(ISPPREP) [PARM(INPAN(PDSin),
                                OUTPAN(PDSout)
                                [, INVOL(volser#)]
                                [, OUTVOL(volser#)]
                                [, NOREPL|REPLACE]
                                [, STATS|NOSTATS]
                                [, EXEC])]
```

The PARM keyword on the SELECT indicates that ISPPREP is to be run in batch mode. The absence of the PARM keyword indicates that ISPPREP is to be run as an interactive dialog and that **PDSin**, the panel input library, and **PDSout**, the panel output library, are to be specified on a data-entry panel. Both the ISPPREP command and option 2 on the ISP@PRIM primary option panel select ISPPREP in interactive mode.

The panel input and panel output library identifiers, whether specified on the SELECT statement when in batch mode or on the data entry panel when in interactive mode, follow the same guidelines.

PDSin (panel input library)

The name of the library of panel definitions to be converted to their internal format. PDSin must be in the form:

```
('partitioned data set name[(member)]')
```

The member name can be specified either by indicating the specific name or by coding an asterisk. Coding an asterisk for the member name indicates that all members in the specified data set are to be converted to preprocessed panels. This allows conversion of all panel definitions within a data set in one call of ISPPREP.

You cannot specify the same name for the input partitioned data set and for the output data set, even if you specify REPLACE unless the data sets exist on different volumes and you specify the appropriate volume serial numbers by using the INVOL and/or OUTVOL parameters.

When running in batch mode, you are not required to enter a member name. The absence of the member name is equivalent to coding an asterisk for the member name. In interactive mode, failure to explicitly state a member name or an asterisk causes the data-entry panel to be redisplayed with a message prompting the user for the member name.

PDSout (panel output library)

The name of the library to which the preprocessed panels will be written.

The form of PDSout is the same as that of PDSin. You can specify a blank or name for the member name. A blank indicates that the member name specified for PDSin is to be used as the member name for PDSout.

Coding an asterisk for a member name in PDSout is invalid.

INVOL (input PDS volume serial number)

Specifies the serial number of the volume on which PDSin is stored. If this parameter is omitted, the system catalog is searched.

It must be used when the data set exists but is not cataloged. INVOL is optionally specified in batch mode as well as in interactive mode. In batch mode the keyword (INVOL) is specified along with the volume serial number as part of the SELECT statement.

OUTVOL (output PDS volume serial number)

Specifies the serial number of the volume on which PDSout resides. If this parameter is omitted, the system catalog is searched.

It must be used when the data set exists but is not cataloged. OUTVOL is optionally specified in batch mode as well as in interactive mode. In batch mode the keyword (OUTVOL) is specified along with the volume serial number as part of the SELECT statement.

NOREPL|REPLACE

A keyword that specifies whether existing partitioned data set members are to be replaced in PDSout. The default is NOREPL in batch mode. In interactive mode, an option must be specified.

STATS|NOSTATS

User controls whether member statistics are to be saved in the SPF directory. The default option is STATS.

EXEC Specifies that ISPPREP is being executed from a CLIST or REXX command procedure. The EXEC parameter causes the return code to be set to 24 if a space-related abend occurs on the output file.

Any panel specified in the panel input library that is already a preprocessed panel is copied directly to the panel output library (contingent on the NOREPL|REPLACE specification).

ISPPREP should be invoked with the NEWAPPL keyword specified on the SELECT statement. (This is necessary because ISPPREP issues LIBDEF service calls.) If NEWAPPL is not specified, any LIBDEF issued before the execution of ISPPREP can no longer be in effect.

Examples of Using ISPPREP

- Convert PDS member PANA, in ISPFPROJ.GRE.PANELS, and write the preprocessed panel to member PANB, in ISPFPROJ.PXY.PANELS, if it does not already exist. Both PDSs are cataloged.

```
SELECT PGM(ISPPREP) PARM(INPAN(' ISPFPROJ.GRE.PANELS(PANA)'),
                          OUTPAN(' ISPFPROJ.PXY.PANELS(PANB)'),
                          NOREPL) NEWAPPL
```

- Convert PDS member PANA, in ISPFPROJ.GRE.PANELS, and unconditionally write the preprocessed panel to member PANB, in ISPFPROJ.PXY.PANELS. Both PDSs are cataloged.

```
SELECT PGM(ISPPREP) PARM(INPAN(' ISPFPROJ.GRE.PANELS(PANA)'),
                          OUTPAN(' ISPFPROJ.PXY.PANELS(PANB)'),
                          REPLACE) NEWAPPL
```

- Convert the entire PDS ISPFPROJ.GRE.PANELS, which contains three members (PANA, PANB, and PANC), and unconditionally write the preprocessed panels to PDS ISPFPROJ.PXY.PANELS, which contains three members also (PANA, PANB, and PANC). Both PDSs are cataloged.

```
SELECT PGM(ISPPREP) PARM(INPAN(' ISPFPROJ.GRE.PANELS(*)'),
                          OUTPAN(' ISPFPROJ.PXY.PANELS( )'),
                          REPLACE) NEWAPPL
```

- Convert the entire PDS ISPFPROJ.GRE.PANELS, which contains four members (PAN1, PAN2, PAN3, and PAN4) and is cataloged. If the members do not already exist, write the preprocessed panels to PDS ISPFPROJ.PXY.PANELS, which is not cataloged

```
SELECT PGM(ISPPREP) PARM(INPAN(' ISPFPROJ.GRE.PANELS(*)'),
                          OUTPAN(' ISPFPROJ.PXY.PANELS( )'),
                          OUTVOL(TSOPK7),NOREPL) NEWAPPL
```

- Convert the entire PDS ISPFPROJ.GRE.PANELS and unconditionally write the preprocessed panels to PDS ISPFPROJ.PXY.PANELS. Both PDSs are not cataloged.

```
SELECT PGM(ISPPREP) PARM(INPAN(' ISPFPROJ.GRE.PANELS(*)'),
                          INVOL(TSOPK7),
                          OUTPAN(' ISPFPROJ.PXY.PANELS( )'),
                          OUTVOL(TSOPK7),REPLACE) NEWAPPL
```

Handling Error Conditions and Return Codes

There are two general classes of error conditions involved with ISPPREP: those associated with the dialog itself, and those associated with the conversion of individual panel definitions.

The dialog error conditions encountered cause immediate termination of ISPPREP conversion processing. If you are operating in interactive mode and recovery is possible, the data-entry panel is redisplayed with an appropriate message. Otherwise, ISPPREP will terminate. Dialog errors include conditions such as: invalid input or output PDS names; a reference to a nonexistent PDS; or a reference to an uncataloged PDS without providing the correct volume serial number.

Panel conversion error conditions apply only to the current panel being converted. They are usually due to an error in the panel definition. If such an error is encountered, processing of the current panel definition halts, and processing of the next panel definition (if it exists) begins. A panel conversion error associated with one panel definition does not affect the conversion of subsequent panel definitions.

ISPPREP logs error and informational messages in ISPLOG. Any error conditions encountered cause an appropriate message and return code to be written to the log. This is also true for any conditions that warrant an informational message.

The following return codes are possible from ISPPREP:

- 0 Normal completion.
- 4 Panel definition cannot be processed (see restrictions); NOREPL is specified and the panel (member) already exists in the output library.
- 8 Panel definition contains syntax errors; panel already in use (enqueue failed) or panel (member) not found.
- 12 Invalid syntax or keyword in parameter string; data set is not found.
- 16 Data set allocation or open failure.
- 20 Severe error.
- 24 A space-related abend occurred while ISPPREP was being executed from a CLIST or REXX command procedure with the EXEC parameter specified.

Since ISPPREP can convert a number of panel definitions to their internal format in one call, a number of conditions may arise that generate a return code other than '0'. ISPPREP returns the highest return code generated. However, if invoked in interactive mode, ISPPREP will return '0' unless an unrecoverable dialog error is encountered, in which case the code returned is '20'. Refer to the log for a more comprehensive look at ISPPREP's results.

Chapter 7. Panel Definition Statement Reference

This chapter is divided into three sections that provide reference information for:

- Panel sections—page 157
- Panel definition statements—page 234
- Control variables—page 279.

The information in each section is arranged in alphabetical order.

Defining Panel Sections

Table 4 on page 104 describes the panel sections *in the order in which they must be defined*.

This section provides reference information for each of the following panel sections in *alphabetical order*:

-)ABC—page 157
-)ABCINIT—page 163
-)ABCPROC—page 164
-)AREA—page 164
-)ATTR—page 170
-)BODY—page 207
-)CCSID—page 213
-)END—page 213
-)FIELD—page 214
-)HELP—page 220
-)INIT—page 221
-)LIST—page 222
-)MODEL—page 223
-)PANEL—page 223
-)PNTS—page 227
-)PROC—page 231
-)REINIT—page 231.

Defining the Action Bar Choice Section

The)ABC (action bar choice) section defines an action bar choice for a panel and its associated pull-down choices. An)ABC section must exist for each action bar choice displayed in the Action Bar area on a panel. The maximum number of)ABC sections on a panel is 40.

<code>)ABC DESC(choice-description-text) [MNEM(number)]</code>
--

where:

DESC(*choice-description-text*)

Text displayed in the panel's action bar area for the action bar choice. The maximum length of the text is 64 characters.

The action bar choice-description-text must match the choice-description-text specified in the)BODY section of the panel. ISPF does not translate the value to uppercase. If choice-description-text contains any special characters or blanks, you must enclose it in quotes in the)ABC DESC parameter. However,

)ABC Section

when it is specified in the)BODY section of the panel, you should not enclose it in quotes. Each action bar choice should be unique.

MNEM(*number*)

Specifies the position of the character that will be the mnemonic for the action bar text. The letter is designated by an underscore on the display. This keyword, if it exists, must follow the DESC keyword. *number* is the position of the character (not byte position).

```
)ATTR
# TYPE(AB)
@ TYPE(NT)
? TYPE(PT)
$ TYPE ABSL
:
:
)ABC DESC('Menu') MNEM(1)
:
:
)BODY CMD(ZCMD)
@# Menu# Utilities# Compilers# Options# Status# Help@
$-----
@                               ?ISPF Primary Option Menu+
:
:
:
```

For SBCS/DBCS mixed choice-description-text, *number* cannot be the position of a double-byte character position. Shift-in/shift-out bytes are not considered characters. For action bar text containing double-byte characters, add a single-byte character, enclosed in parentheses, to the end of the double-byte text. The MNEM(*number*) is the position of this single-byte character. For example:

```
)ATTR
# TYPE(AB)
@ TYPE(NT)
? TYPE(PT)
$ TYPE ABSL
:
:
)ABC DESC('OEDD00UUBLLLE0F(M)') MNEM(8)
:
:
)BODY CMD(ZCMD)
@# OEDD00UUBLLLE0F(M)# Utilities# Compilers# Options# Status# Help@
$-----
@                               ?ISPF Primary Option Menu+
:
:
:
```

where DD,OO,UU,BB,LL, and EE represent double-byte characters, 0E and 0F are shift-out and shift-in characters. The single-byte character, M, enclosed in parentheses is the mnemonic letter. The MNEM(*number*), 8, indicates the underscored mnemonic letter is in the eighth character position (not byte position). Shift-out and shift-in characters are not considered as character positions.

In 3270 mode you access the action bar choice in one of the following ways, where "x" is the mnemonic letter that is underscored:

1. Enter "ACTIONS x" in the command field
2. Enter "x" in the command field and press the function key assigned to the ACTIONS command.

The pull-down menu for that action bar choice displays. If you enter a mnemonic letter, "x", that is not found to be an underscored mnemonic letter on the panel, then the cursor is placed on the first action bar choice.

In 3720 mode, panels without a command line will not display mnemonic characters, because there is no command line on which to enter the ACTIONS command and parameter. Terminals or emulators that do not support extended highlighting will not display host mnemonics.

In GUI mode you use a *hot key* to access an action bar choice; that is, you can press the ALT key in combination with the letter that is underscored in the choice. A hot key is also referred to as an *accelerator key* or *shortcut key*. If the character in the ALT character combination is not found to be an underscored mnemonic letter in the panel, then no action is taken.

Note: If you specify duplicate characters (case insensitive) for the mnemonics within the action bar, the result of invoking the mnemonics is operating system dependent.

Note: For each separate action bar choice section, you must define a corresponding)ABCINIT (action bar choice initialization) section. An)APCPROC (action bar choice processing) section is optional. You must include these sections in the panel source definition in the proper order as shown in the following example:

```
)ABC
)ABCINIT
)ABCPROC
```

Specifying Action Bar Choices in Panel)BODY Section

The specification of an action bar choice is included in the panel source immediately following the)BODY panel definition statement header. The order in which the action bar choices are specified indicates to ISPF how the choices will appear in the action bar area on the displayed panel. Internally, action bar choices are numbered sequentially starting from left to right and from top to bottom. The first action bar choice will be numbered one.

```
)ATTR
@ TYPE(AB)
# TYPE(NT)
:
)BODY
@ choice1@ choice2@ choice3#
```

Notes:

1. A blank must separate the choice-description-text and the AB attribute character. The attribute byte for the first choice can be in any column *except* column 1. A text attribute character to delimit an action bar line should be coded immediately following the last character of the last choice-description-text on each action bar line.
2. A separator line should follow the last action bar line.
When the panel is displayed in GUI mode, the separator line (the line following the last action bar choice) is not displayed.
3. ISPF considers the panel line following the last action bar choice as part of the action bar area.

The action bar can consist of multiple lines by specifying action bar choices on more than one line in the panel)BODY section.

```
)ATTR
@ TYPE(AB)
# TYPE(NT)
```

)ABC Section

```
⋮  
)BODY  
@ choice1@ choice2@ choice3#  
@ choice4@ choice5@ choice6#
```

Defining Pull-Down Choices within the)ABC Section

Within each action bar section, pull-down choices are defined with the PDC statement.

```
PDC DESC(choice-description-text)  
[UNAVAIL(unavail_variable_name)]  
[MNEM(number)]  
[ACC(key1[+key2][+key3])]  
[PDSEP(OFF|ON)]
```

where:

DESC(*choice-description-text*)

Actual text that is displayed for the pull-down choice it defines. Special characters or blanks must be enclosed within quotes. The maximum length of the text is limited to 64 characters. ISPF numbers each choice. Do not include choice numbers in your text. The pull-down choices defined in each)ABC section are internally numbered sequentially starting with the number one (1,2,...,n) and the number is prefixed to the pull-down choice-description-text.

Note: Numbers do not appear with pull-down choices when you are running in GUI mode.

UNAVAIL(*unavail_variable_name*)

Name of a variable that contains a value to indicate whether the pull-down choice is available for selection when the panel is displayed. When the variable contains a value other than 0 (false, therefore available) or 1 (true, therefore unavailable), the variable is ignored and the choice is available. The choice is available even if the specified variable cannot be found.

Note: The current setting is shown as an unavailable choice; that is, it displays in blue (the default) with an asterisk as the first digit of the selection number. If you are running in GUI mode, the choice is *grayed*. ISPF issues an error message if you try to select it. You can change the color, highlight, and intensity of an unavailable choice by using the CUA Attribute Utility.

MNEM(*number*)

Specifies the position of the character that will be the mnemonic for the pull-down choice text. The letter is designated by an underscore on the GUI display. *number* is the position of the character (not byte position). For SBCS/DBCS mixed choice-description-text, *number* cannot be the position of a double-byte character. Shift-in/shift-out bytes are not considered characters.

Note: If you specify duplicate characters (case insensitive) for the mnemonics within the action bar, the result of invoking the mnemonics is operating system dependent.

This keyword is ignored on a 3270 display.

ACC(*key1*[+*key2*][+*key3*])

Specifies an *accelerator*, or shortcut, key. This is a key or combination of keys

assigned to a menu choice that initiates that choice, even if the associated menu is not currently displayed. The accelerator key text is displayed next to the choice it pertains to on the menu.

The variables *key1*, *key2*, and *key3* can be any of the following keys: Ctrl, Shift, Alt, Insert, Delete, Backspace, *Fn*, the single keys a through z, and 0 through 9. The keys Ctrl, Shift, Alt, a through z, and 0 through 9 cannot be used as single accelerator keys. They must be used in combination with other keys.

Rules for accelerator keys

- Avoid using the Alt key combined with a single character key as an accelerator. Use Alt + char for mnemonic access only. Also, avoid using a function key, or Shift + function key, as an accelerator.
- The following single keys must be used in combination with some other key: Ctrl, Shift, Alt, A–Z, a–z, and 0–9.
- Only one key can be a function key.
- If you use a two key combination, one key must be Ctrl, Shift, or Alt, and the other must be Insert, Delete, Backspace, F1–F12, A–Z, a–z, or 0–9.
- If you use a three key combination, two key must be Ctrl, Shift, or Alt, and the other must be Insert, Delete, Backspace, F1–F12, A–Z, a–z, or 0–9.
- The combined text string cannot exceed 30 characters.

After you define your accelerators, remember to keep the following accelerator search order in mind when you press a key or combination of keys:

1. Operating system specific definitions. For example, in Windows XP, Ctrl+Alt+Delete displays the Windows Security dialog box instead of invoking a menu choice that might have this key combination specified as an accelerator.
2. Menu choice accelerator definitions.
3. Accelerator assigned with the panel. For example, a function key.
4. System menu-type definitions. For example, Alt+F4 is defined in Windows XP as an accelerator for closing the current window.

For example, if F2 is defined as an accelerator key on the ISPF Primary Option Panel's Menu pull-down for the EDIT option, and the F2 function key is set to the ISPF SPLIT command, when you press the F2 key, EDIT is started instead of the screen being split.

Accelerators are a GUI-specific function. An option appears on the ISPF Settings Panel (under GUI settings) that specifies whether or not accelerators are supported. The default is to have the support. If you turn this setting off, accelerators are not functional, and do not appear in the pull-down menus.

PDSEP(OFF | ON)

Specifies a *pull-down choice separator bar*. These are separators within a pull-down that group logically related choices.

The separator is a solid line between the previous choice and the first choice in the logical group. You code the PDSEP keyword on the pull-down choice AFTER the separator bar. That is, the separator bar is displayed above the choice it is coded on.

Any separator coded on the first pull-down choice is ignored, and because the function is GUI-specific, separator bars are ignored in the host environment.

You must associate the pull-down choice entry field with a variable name. To do this, code a .ZVARS statement in the)ABCINIT section. This variable is used as the pull-down entry field name of each pull-down.

The PDC statement is paired with an optional ACTION statement. When some action is to be performed for a pull-down choice, an ACTION statement must immediately follow the PDC statement defining the pull-down choice.

```
ACTION RUN(command-name) [PARM(command-params)]
```

where:

RUN(*command-name*)

Required keyword. Specifies the name of a command to be executed. The command name must be 2–8 characters. Coding the keyword ACTION RUN(*x*), where *x* is a 1-character command name, results in an error condition. ISPF searches for the command in the application, user, site, and system command tables, if they are defined.

You can use the ISRRROUTE command, which is an ISPF command in ISPCMDs, to invoke the SELECT service. The ACTION RUN statement is as follows:

```
ACTION RUN(ISRRROUTE) PARM('SELECT your-select-command-params')
```

where *your-select-command-params* contains all the required parameters for the invocation of the SELECT service. This allows your dialog not to have to create a separate command in the application command table for every RUN statement coded within your dialog panels.

Here is an example of invoking the SELECT service from an ACTION RUN statement:

```
ACTION RUN(ISRRROUTE) PARM('SELECT PGM(USERLIST) NEWAPPL(USR)')
```

PARM(*command-params*)

Optional keyword. Specifies the parameters to use when processing the command in the application, user, site, or system command table. Enclose the *command-params* value in quotes.

You can define only one ACTION statement per PDC statement in the)ABC panel section. You can specify the RUN() or PARM() keywords in any order on an ACTION statement. Also, if the RUN() or PARM() keywords are duplicated within an ACTION statement, ISPF will use the last occurrence of the keyword. Figure 54 on page 163 shows an example of an action bar section definition.

```

)PANEL
)ATTR
@ TYPE(AB)
# TYPE(NT)
:
)ABC DESC(FILE) MNEM(1)
  PDC DESC(file-choice1) ACC(Alt+F1)
  ACTION RUN(command-name) PARM(command-parms)
  PDC DESC(file-choice2) UNAVAIL(&unvar2)
  ACTION RUN(command-name) PARM(command-parms)
  PDC DESC(file-choice3) PDSEP(ON)
  ACTION RUN(command-name) PARM(command-parms)
)ABCINIT
  .ZVARS = PDCHOICE
  &PDCHOICE = '
  &unvar2 = 1
  :
)ABCPROC
  VER (&PDCHOICE,LIST,1,2,3)
  :
)ABC DESC(HELP)
  PDC DESC(help-choice1) MNEM(6)
  ACTION RUN(command-name) PARM(command-parms)
  PDC DESC(help-choice2)
  ACTION RUN(command-name)
  PDC DESC(help-choice3)
  ACTION RUN(command-name) PARM(command-parms)
  :
)ABCINIT
  .ZVARS = PDCHOICE
  &PDCHOICE = '
  :
)ABCPROC
  VER (&PDCHOICE,LIST,1,2,3)
  :
)BODY
@ FILE@ HELP#
:
)END

```

Figure 54. Action Bar Section Example

Defining the Action Bar Choice Initialization Section

The)ABCINIT section header statement has no parameters. ISPF associates the first)ABCINIT section it encounters before another panel definition statement header with the previous)ABC section.

)ABCINIT

The rules that apply to the)ABCINIT section and its contents are the same as those that apply to the ISPF)INIT panel definition statements. However, the processing is limited to the action bar choice and its pull-down.

The)ABCINIT section runs when the user selects that action bar choice.

Note: If you are running in GUI mode, the)ABCINIT section runs prior to sending the panel to the workstation.

)ABCINIT Section

At least one statement must be specified in the)ABCINIT section. The)ABCINIT section must contain a .ZVARS control variable assignment statement to associate a field name with the pull-down entry field.

See “Formatting Panel Definition Statements” on page 234 for additional information.

Defining the Action Bar Choice Processing Section

The)ABCPROC section header statement has no parameters. ISPF associates the first)ABCPROC section it encounters before another panel definition statement header with the previous)ABC section.

```
)ABCPROC
```

The rules that apply to the)ABCPROC section and its contents are the same as those that apply to the ISPF)PROC panel definition statement. However, the processing is limited to the action bar choice and its pull-down.

The)ABCPROC section runs when the user completes interaction with the pull-down choice.

Note: If you are running in GUI mode, the)ABCPROC section runs after the pull-down has been selected at the workstation.

The)ABCPROC section is not required. ISPF verifies all valid pull-down choices for you.

When you manually position the cursor in the action bar area with the CANCEL, END, or RETURN command on the command line, and you press ENTER, or if you manually position the cursor in the action bar area and you press a function key to execute the CANCEL, END, or RETURN commands, the cursor is repositioned to the first input field in the body of the panel. If there is not an input field, the cursor is repositioned under the action bar area. If the request is to execute the EXIT command, the action taken is controlled by the application.

When you use the ACTIONS command to position the cursor in the action bar area and you execute the CANCEL command, the cursor is returned to where it was before the ACTIONS command was executed. A CANCEL command executed from a pull-down removes the pull-down.

See “Formatting Panel Definition Statements” on page 234 for additional information.

Defining the Area Section

The)AREA (scrollable area definition) section allows you to define scrollable areas on a panel. See “Defining the Attribute Section” on page 170 for information about using the AREA(SCRL) keyword to specify that you want a scrollable area. You can see and interact with the total content defined for the panel area by scrolling the area.

Use the)AREA section header to describe the scrollable area.

```
)AREA name [DEPTH(depth)]
```

name

Specifies the name of the scrollable area that is to be matched with the name specified in the)BODY section. This name cannot be specified as a dialog variable.

DEPTH(*depth*)

Optional. Specifies the minimum number of lines in the scrollable area (not including the scroll indicator line) when EXTEND(ON) has been specified. DEPTH has no effect when EXTEND(OFF) is used. The top line is always reserved for the scroll information and is not considered part of the depth value. DEPTH can be used to insure that a required number of lines are displayed. The depth value cannot be specified as a dialog variable. It must be greater than or equal to the number of lines defined for the area in the)BODY section and less than or equal to the number of lines in the)AREA definition.

A panel)AREA section defines the size and the contents of the information to be scrolled. The contents of the)AREA section generally follow the same rules as the)BODY section. See "Panel Definition Considerations" on page 166 for rules concerning the definition of a scrollable area. Multiple scrollable areas can be defined. The name specified immediately following an AREA(SCRL) character in the)BODY section is used to match each scrollable area to its corresponding)AREA section. If the default EXTEND(OFF) is used, you designate the desired depth of the scrollable area by repeating the AREA(SCRL) attribute. If EXTEND(ON) is specified, the minimum depth is the DEPTH specified in the)AREA section.

The width of the scrollable area includes the special characters that designate the vertical sides. These delimiter characters do not represent attribute characters.

The scrollable area is identified in the panel source with a new attribute defined in the)ATTR section. This new attribute designates the borders of the scrollable area. For example:

```
)ATTR
# AREA(SCRL) EXTEND(ON)
)BODY
#myarea-----#
#                #
#                #
#                #
```

A single character, Z, can be used in the)AREA section, just as it can be used in the)BODY section, as a place-holder for an input or output field. The actual name of the field is defined in the INIT section with the control variable .ZVARS. The actual field names are in a name list, with all the actual field names for the)BODY and)MODEL sections. The actual field names must appear in the name list in the order they appear in the panel definition, not in the order they will appear when the panel is displayed. The names must appear in the)BODY section, then)MODEL section, and then)AREA section order.

If you have defined several)AREA sections, the .ZVARS must be listed in order from top-to-bottom left-to-right as they appear in the panel definition.

Cursor position determines how an area scrolls. This is called cursor-dependent scrolling. If scroll down is requested, the line on which the cursor is placed is moved to the top line. If the cursor is currently on the top line of the scrollable area, the section is scrolled as total visible lines minus one. On a panel with only one scrollable area, if the cursor is not within the area and scrolling is requested,

)AREA Section

the area is scrolled by the total visible lines minus one. If scrolling an area causes the last line of an area to not be the last visible line in the area, the cursor is moved so that the last line of the area appears at the last visible line of the scrollable area.

The top line of the scrollable area is reserved for the scroll indicators. Actual information from the)AREA section is displayed beginning on the second line of the scrollable area. The scroll indicators are displayed only if more data was defined in the)AREA section than fits in the panel area.

The scroll indicators are displayed as follows:

- More:** + You can only scroll forward.
- More:** - You can only scroll backward.
- More:** - + You can scroll forward or backward.

Forward and backward function keys should be defined in the keylist for any application panel that has scrollable areas.

The)AREA section can contain any of the items that can be included in the)BODY section except for the following:

- Action Bar lines
- Graphics Area
- Model Section
- Command Line
- Alternate Message Locations
- Another scrollable area using AREA(SCRL)
- Dynamic Area using EXTEND(ON) or SCROLL(ON).

The)AREA section must fit within the general panel limit of 32K.

Panel Definition Considerations

When you are defining a scrollable area, a number of rules apply:

- The area cannot be specified by using a Z-variable place-holder within the panel body.
- To allow for the scroll information, the minimum width for a scrollable area is 20. The minimum depth of the scrollable area is 2.
- If the width of the scrollable area is less than the screen size, you must place appropriate attribute characters around this area so that the data within the area is not inadvertently affected. For example, by using place fields with SKIP attributes following the right-most boundaries of the area, you can insure that the cursor will tab correctly to the next or continued input field within the area.
- You must terminate an input or output field preceding a scrollable area with an attribute character.
- A text field's attribute character is only processed if the start of the field is visible in the scrollable area. This means that text fields defined to wrap in a scrollable area may not show their defined attribute when they are only partially displayed. For example, if a field has the attribute HILITE(REVERSE), the text will only appear in reverse video if the start of the field is visible in the scrollable area.
- The initialization of variables in the scrollable area has nothing to do with Z variables. The setting of .ZVARS simply associates the name of a variable with a Z place holder. It does not initialize the variable value.

An explicit setting of the variable in the)INIT section will initialize the variable whether it is in a scrollable area or not. Normally, variables that are not explicitly defined are set to null by ISPF. This occurs because ISPF tries to retrieve an existing value from the variable pool and finds that it is not defined. ISPF then defines the variable and sets it to null.

For scrollable areas, ISPF does not retrieve the variable unless it is to be displayed. Therefore, a variable in a scrollable area that is not visible on the screen does not get implicitly initialized. This is true for all the variables. If the user wishes to initialize a variable it can be done by setting the variable to null in the)INIT section.

If an EXTEND(ON) scrollable area is defined on a panel that does not have a)BODY definition that covers the entire depth of the screen on which it is displayed, the)BODY line over which the last line of the scrollable area is defined is repeated for the remaining depth of the glass, or for the remaining number of lines of data in the scrollable area, whichever is larger.

It is good practice to frame a scrollable area or to allow enough blank space so that the definition of the scrollable area is clear. You should consult your own usability standards to determine the best implementation.

Help Panels

When a help panel is defined with a scrollable area, the Left, Right, and Enter keys that currently scroll through the tutorial panels also scroll the scrollable area. When running under tutorial and trying to scroll past the end of the scrollable area, a message will be displayed indicating that no more information is available in the scrollable area. If RIGHT or ENTER is pressed again, ISPF will follow the normal tutorial flow and display the next help panel if one has been defined. The same is true when scrolling to the TOP of the scrollable AREA; a message indicating that no more information is available will be displayed, and if LEFT is pressed, the previous tutorial panel will be displayed if one has been defined.

Cursor positioning usually defines which scrollable area will be scrolled. However, when in tutorial, if the cursor is not within a scrollable area, the first area defined in the)BODY section will be scrolled. The LEFT and RIGHT commands should be included in any keylist specified for a scrollable help panel.

Panel Processing

When a DISPLAY service is issued, the)INIT section is processed before the panel is displayed on the glass. Each time you scroll and the panel is redisplayed, the)PROC and)REINIT sections are not processed. The)PROC section is only processed when the panel is submitted for processing as when the Enter or End key is pressed.

When panel processing is complete and ISPF returns control to the dialog, it is possible that required fields were not displayed. Therefore, unless a VER NB was coded in the panel for a required field, it is possible that the application user never scrolled the panel to see the field. It is your responsibility to insure that all required information is obtained.

When fields are displayed on a panel, their characteristics can change without the user interacting with the fields. For example, when CAPS(ON) is set for a field, this only affects fields that actually are displayed. If a field is initialized with lowercase letters and it appears on a portion of the panel that is never displayed, the data remains in lowercase even if CAPS(ON) was set for the field.

Scrollable Area Examples

Figure 55 shows an invalid scrollable area definition. The last line of the extendable scrollable area also contains a line of nonextendable text to its right.

```

)ATTR
  # AREA(SCRL)  EXTEND(ON)
  $ AREA(SCRL)
)BODY
%                               New Patient Information
%Command  ==>_ZCMD
%
+Name . . . . . _pname %
+
#area1 -----#           $area2 -----$
#           #           $           $
#           #           $           $
#           #           $           $
#           #           $           $
#           #           $           $
#           #           $           $
#           #           $           $
#           #           $           $
#           #           $           $
+
+Please fill in all information.
+
)AREA AREA1 DEPTH(5)
:
)AREA AREA2 DEPTH(5)
:

```

Figure 55. Invalid Scrollable Area Definition

Figure 56 shows a valid scrollable area definition. It is followed by the actual scrollable panel displays.

```

)ATTR
  # AREA(SCRL)  EXTEND(ON)
)BODY
%
%Command  ==>_ZCMD
%
+Patient name . . . . . _pname %
+
#myarea -----#
+
+Please fill in all information.
+

```

Figure 56. Valid Scrollable Area Definition (Part 1 of 2)

```

)AREA MYAREA DEPTH(5)
+Personal information
+ Address . . . . . _address           %
+ City, State . . . . . _ctyst         %
+ Zip Code . . . . . _zip %
+ Birth date . . . . . _birth %
+ Sex . . . . . _SX% (M=Male or F=Female)
+ Marital Status . . . _MS+1. Married
+                               2. Single
+                               3. Divorced
+                               4. Widowed
+
+ Home phone . . . . . _hphone         %
+ Work phone . . . . . _wphone        %
+
+Emergency Contact
+ Name . . . . . _ename               %
+ Home phone . . . . . _ehphone       %
+ Work phone . . . . . _ewphone       %
++Emergency Contact
+ Name . . . . . _ename               %
+ Home phone . . . . . _ehphone       %
+ Work phone . . . . . _ewphone       %
+
+Insurance Coverage
+ Insurance Company . . _insure        %
+ Group number . . . . _gn%
+ ID number . . . . . _ID %
+ Cardholder's name . . _cname         %
+ Relationship . . . . . _RL+1. Self
+                               +2. Spouse
+                               +3. Parent
+                               +4. Relative
+                               +5. Other
+ Signature on file . . _SG+ (Y=Yes N=No)
)INIT
:
)PROC
:
)HELP
:
)END

```

Figure 56. Valid Scrollable Area Definition (Part 2 of 2)

Figure 57 on page 170 shows the initial panel display, which contains a scrollable area. More: + indicates that you can now scroll forward in the scrollable area.

```
Command ==>

Patient name . . . . . CECILIA COFRANDESCO

Personal information                                     More:  +
Address . . . . . 2825 N. OCEAN BOULEVARD
City, State . . . . . BOCA RATON, FL
Zip Code . . . . . 33432
Birth date . . . . . 00/00/00
Sex . . . . . F (M=Male or F=Female)
Marital Status . . . 1 1. Married
                    2. Single
                    3. Divorced
                    4. Widowed

Home phone . . . . . (407)395-9446
Work phone . . . . . (407)982-6449

Please fill in all information.
```

Figure 57. Scrollable Area Screen Display (Part 1 of 2)

Figure 58 shows the panel display after one scroll request has been processed. More: - + indicates that you can now scroll forward or backward in the scrollable area.

```
Command ==>

Patient name . . . . . CECILIA COFRANDESCO

Home phone . . . . . (407)395-9446
Work phone . . . . . (407)982-6449

Emergency Contact
Name . . . . . PAULO COFRANDESCO
Home phone . . . . . (407)395-9446
Work phone . . . . . (407)982-6449

Insurance Coverage
Insurance Company . . BLUE CROSS BLUE SHIELD
Group number . . . . . 22
ID number . . . . . 45463
Cardholder's name . . CECILIA COFRANDESCO
Relationship . . . . . 1 1. Self
                    2. Spouse

Please fill in all information.
```

Figure 58. Scrollable Area Screen Display (Part 2 of 2)

After you have completely scrolled through the scrollable area, More: - indicates that you can now only scroll backward.

Defining the Attribute Section

The)ATTR (attribute) section of a panel contains the definitions for the special characters or two-digit hexadecimal codes that are to be used in the definition of the body of the panel to represent attribute (start-of-field/end-of-field) bytes. When the panel is displayed, these characters are replaced with the appropriate hardware attribute bytes and appear on the screen as blanks. If you do not define attribute characters, ISPF uses defaults.

If specified, the attribute section precedes the panel body. It begins with the)ATTR header statement.

```
)ATTR [DEFAULT(def1def2def3)]
[FORMAT(EBCDIC|DBCS|MIX)]
[OUTLINE([L][R][O][U]|BOX|
NONE)]
```

where:

DEFAULT(*def1def2def3*)

You can use the DEFAULT keyword to specify the characters that define a high-intensity text field, a low-intensity text field, and a high-intensity input field, respectively. The value inside the parentheses must consist of exactly three characters, not enclosed in single quotes and not separated by commas or blanks.

The DEFAULT keyword can also be specified on the)BODY header statement.

FORMAT(EBCDIC|DBCS|MIX)

The default value for a TYPE(INPUT) and a TYPE(DATAIN) field is FORMAT(EBCDIC). These two default values can be changed by using the)ATTR statement or the)BODY statement. These values, in turn, can be overridden if explicitly specified on a subsequent statement. For example, the net result of the following two statements is FORMAT(DBCS):

```
)ATTR FORMAT(MIX)
$ TYPE(INPUT) FORMAT(DBCS)
```

OUTLINE([L][R][O][U]|BOX| NONE)

The default value for OUTLINE is NONE. The default value for TYPE(INPUT) and TYPE(DATAIN) fields can be specified on the)ATTR or)BODY statement and can be overridden by the OUTLINE keyword. For example:

```
)ATTR OUTLINE(U)
@ TYPE(INPUT) OUTLINE(BOX)
```

The attribute section ends with the)BODY header statement. The number of lines allowed in an)ATTR section depends upon the storage size available.

Using Default Attribute Characters

If not specified explicitly with the DEFAULT keyword, the default attribute characters are:

```
% (percent sign) - text (protected) field, high intensity
+ (plus sign)    - text (protected) field, low intensity
_ (underscore)  - input (unprotected) field, high intensity
```

These three defaults are the equivalent to specifying:

```
)ATTR
% TYPE(TEXT) INTENS(HIGH)
+ TYPE(TEXT) INTENS(LOW)
_ TYPE(INPUT) INTENS(HIGH)
```

The default values for the JUST (justification) and CAPS (uppercase and lowercase) keywords vary according to how the field is used. JUST and CAPS are attribute statement keywords that are described in "Formatting Attribute Section Statements" on page 172.

You can change the default characters by using a keyword on either the)ATTR or)BODY header statement. For example:

)ATTR Section

```
DEFAULT(abc)
```

where *a*, *b*, and *c* are the three characters that take the place of %, +, and _ respectively.

Typically, you use the DEFAULT keyword on the)ATTR header statement if the 3 default characters are to be changed, and additional attribute characters are also to be defined. For example:

```
)ATTR DEFAULT($ø_)
  ▸ TYPE(INPUT) INTENS(NON)
  # TYPE(OUTPUT) INTENS(LOW) JUST(RIGHT) PAD(0)
```

In this example, the default characters for text fields are changed to \$ for high intensity, and ø for low intensity. The default character for high-intensity input fields is _, the same as the ISPF-supplied default. The example defines two additional attribute characters: ▸ for nondisplay input fields and # for low-intensity output fields. The output fields are to be right-justified and padded with zeros.

You could use DEFAULT on the)BODY header statement, with the entire attribute section omitted, if the only change is to redefine the default characters. For example:

```
)BODY DEFAULT($ø_)
```

If you use DEFAULT on both the)ATTR and the)BODY header statements, the)BODY specification takes precedence.

Formatting Attribute Section Statements

Each attribute statement defines the attribute character for a particular kind of field. You can define a given attribute character only once. The remainder of the statement contains keyword parameters that define the nature of the field.

Generally, you should choose special (non-alphanumeric) characters for attribute characters so that they will not conflict with the panel text. An ampersand (&), blank (hexadecimal 40), shift-out (hexadecimal 0E), shift-in (hexadecimal 0F), or null (hexadecimal 00) cannot be used as an attribute character.

You can specify a maximum of 127 attribute characters. This limit includes the 3 default characters, attribute overrides, and TBDISPL dual defaults. For action bar panels or panels with scrollable areas, you can specify a maximum of 110 attribute characters. This is because ISPF uses some attribute characters internally.

Note: In attribute keywords, the *value* can be expressed as a literal or as a dialog variable name, preceded by an ampersand (&). For example:

```
INTENS(&A)
```

Variable substitution is done after processing of the)INIT section. The current value of the dialog variable must be valid for the particular keyword. In the previous example, the value of dialog variable A must be HIGH, LOW, or NON.

```

attrchar
[ AREA(DYNAMIC) [EXTEND(ON|OFF)] [SCROLL(ON|OFF)]
[USERMOD(usermod-code)]
[DATAMOD(datamod-code)]
[AREA(GRAPHIC) [EXTEND(ON|OFF)]]
[AREA(SCRL) [EXTEND(ON|OFF)]]
[ATTN(ON|OFF)]
[CAPS(ON|OFF|IN|OUT)]
[CKBOX(ON|OFF)]
[COLOR(value)]
[CSRGRP(x)]
[COMBO(ON|OFF|name)]
[CUADYN(value)]
[DDLST(ON|OFF|name)]
[DEPTH(d)]
[FORMAT(EBCDIC|DBCS|MIX)]
[HILITE(value)]
[GE(ON|OFF)]
[INTENS(HIGH|LOW|NON)]
[JUST(LEFT|RIGHT|ASIS)]
[LISTBOX(ON|OFF|name)]
[NOJUMP(ON|OFF)]
[NUMERIC(ON|OFF)]
[OUTLINE([L][R][O][U]|BOX|NONE)]
[PAD(char|NULLS|USER)]
[PADC(char|NULLS|USER)]
[PAS(ON|OFF)]
[RADIO(ON|OFF)]
[REP(char)]
[SKIP(ON|OFF)]
[TYPE(value)]
[UNAVAIL(ON|OFF)]
[WIDTH(w)]

```

where:

attrchar

The single-character or two-digit hexadecimal code that is assigned to the attributes that follow.

AREA(DYNAMIC) EXTEND(ON|OFF) SCROLL(ON|OFF) USERMOD(usermod-code) DATAMOD(datamod-code)

The value in *attrchar* specifies the special character or two-position hexadecimal value that is used to define the dynamic area within the panel body section. In the panel body section, the name immediately following this character identifies the dialog variable that contains the dynamically formatted string to be displayed in the area. Subsequent lines of the dynamic area are defined in the panel body by placing this character in the starting and ending columns of the dynamic area. Except on the first line of the dynamic area, where the area name immediately follows the left delimiter character, at least one blank must follow the delimiter characters on the left side of the dynamic area. This is a special character, not an actual attribute character. Other fields must not be defined within or overlapping a DYNAMIC area.

EXTEND(ON|OFF)

Specifies whether the depth of an area can be automatically increased.

ON Specifies that the depth (number of lines) of an area can be automatically increased, if required, so that the depth of the entire body of the panel matches the depth of the physical screen on which it is being displayed. Accordingly, an *extendable* area can be

designated in the panel definition by a single line unless text or other fields are to appear along the graphic area. Only one extendable area can be specified in a panel definition.

Note: Using EXTEND(ON) is not recommended if your dynamic area is displayed in a pop-up. When EXTEND(ON) is used, the panel is extended to the size of the logical screen. If the panel is then displayed in a pop-up, the panel may be truncated at the pop-up border.

The value for the EXTEND keyword cannot be specified as a dialog variable.

OFF The default. Specifies that the depth (number of lines) of an area cannot be automatically increased.

SCROLL(ON|OFF)

Specifies whether the area can be treated as a scrollable area.

ON Specifies that the area can be treated as a scrollable area. When a panel containing a scrollable area is displayed, the scrolling commands are automatically enabled. Only one scrollable area can be specified in a panel definition.

The value for the SCROLL keyword cannot be specified as a dialog variable.

A panel cannot have more than one scrollable area or more than one extended area.

A panel displayed using TBDISPL cannot have a dynamic area defined by SCROLL ON.

Although the panel display service does not perform the scrolling, it does provide an interpretation of the user's scroll request.

OFF The default. Specifies that the area cannot be treated as a scrollable area.

USERMOD(*usermod-code*) and DATAMOD(*datamod-code*)

Specifies a character or two-position hexadecimal value to be substituted for attribute characters in a dynamic area variable following a user interaction. The attribute characters used within the dynamic area are intermixed with the data. These attribute characters designate the beginning of a new data field within the area. When the dynamic area variable is returned to the dialog, *usermod-code* and *datamod-code* are used to replace the attribute character of each field that has been modified, according to the following rules:

- USERMOD specified but DATAMOD not specified
If there has been any user entry into the field, even if the field was overtyped with identical characters, the attribute byte for that field is replaced with usermod-code.
- DATAMOD specified but USERMOD not specified
If there has been any user entry into the field, and if the value in the field has changed, either by the user entry or by ISPF capitalization or justification, the attribute byte for that field is replaced with datamod-code.
- Both USERMOD and DATAMOD specified
If there has been any user entry into the field but the value in the field has not changed, the attribute byte for that field is replaced with usermod-code.

If there has been any user entry into the field and the value in the field has changed, either by the user entry or by ISPF capitalization or justification, then the attribute byte for that field is replaced with datamod-code.

- Neither DATAMOD nor USERMOD specified
The attribute byte for the field is unchanged.

You can specify more than one dynamic area on a panel. The number of dynamic areas in a panel definition is limited only by physical space limitations of the particular terminal being used for the display.

Examples:

```
)ATTR
# AREA(DYNAMIC) EXTEND(ON) USERMOD(!)
```

The character '!' replaces the attribute byte for each field in the dynamic area that has been touched, not necessarily changed in value, by the user. All other attribute bytes remain as they are.

```
)ATTR
# AREA(DYNAMIC) EXTEND(ON) DATAMOD(01)
```

The hexadecimal code '01' replaces the attribute byte for each field in the dynamic area that has been touched by the user and has changed in value. All other attribute bytes remain as they are.

```
)ATTR
# AREA(DYNAMIC) EXTEND(ON) USERMOD(0C) DATAMOD(03)
```

The hexadecimal code '0C' replaces the attribute byte for each field in the dynamic area that has been touched by the user, but has not changed in value. The hexadecimal code '03' replaces the attribute byte for each field in the dynamic area that has been touched by the user and has changed in value. All other attribute bytes remain as they are.

If the datamod or usermod code is one of the following special characters, it must be enclosed in single quotes in the)ATTR section:

```
blank < ( + | ) ; ~ - , > : =
```

If the desired character is a single quote, use four single quotes:
DATAMOD(''').

AREA(GRAPHIC) EXTEND(ON|OFF)

The value in *attrchar* specifies a character or two-digit hexadecimal value, called the graphic attribute character, to be used to define the graphic area (4 corners) within the panel body. If you use a graphics area, this character must be defined; there is no default value. A panel definition can contain only one graphic area.

EXTEND(ON|OFF)

Specifies whether the depth of an area can be automatically increased.

- ON** Specifies that the depth (number of lines) of an area can be automatically increased, if required, so that the depth of the entire body of the panel matches the depth of the physical screen on which it is being displayed. Accordingly, an *extendable* area can be designated in the panel definition by a single line unless text or other fields are to appear along the graphic area. Only one extendable area can be specified in a panel definition.

)ATTR Section

Note: Using EXTEND(ON) is not recommended if your graphic area is displayed in a pop-up. When EXTEND(ON) is used, the panel is extended to the size of the logical screen. If the panel is then displayed in a pop-up, the panel may be truncated at the pop-up border.

The value for the EXTEND keyword cannot be specified as a dialog variable.

OFF The default. Specifies that the depth (number of lines) of an area cannot be automatically increased.

A graphic attribute character cannot have any other attribute properties. For example, it cannot be mixed with attributes such as INTENS, CAPS, JUST, or PAD.

The graphic attribute character is used to define the boundaries of the graphic area in the panel body, as follows:

- The graphic area is defined on the panel as a rectangle. The graphic attribute character is used to define the 4 corners plus the remaining characters of the vertical sides of this rectangle. You delineate the top and bottom of the rectangle with the characters you use to complete the area outline on the screen. For example, in Figure 59 on page 177, the 4 corners and vertical sides are defined by the asterisk character in the)ATTR section. The top and bottom of the area have been completed with dashes.
- A graphic area must be identified with a name that appears in the left top corner, immediately following the first graphic attribute character of that area. The name of the graphic area must be followed by a blank. This name is used when retrieving information about the area through the PQUERY dialog service or the LVLIN panel built-in function. The PQUERY service is described in *z/OS ISPF Services Guide*.
- A graphic area can contain ISPF-defined alphanumeric fields.
- ISPF-defined alphanumeric fields can partially overlap graphic areas.
- The first line of the graphic area in the panel definition must have the graphic attribute character in the starting and ending columns of the area. If an alphanumeric field overlaps one of the subsequent lines of the graphic area, it must be delimited by a graphic attribute character. See Figure 61 on page 178 for an example.
- Any field preceding a graphic attribute character should be terminated by an ISPF attribute character to prevent GDDM from overlaying the left-most boundary characters of the area. When variable substitution occurs within a text field in the panel body, the field must be terminated by an attribute character before a special character defining a graphic area. "Using Variables and Literal Expressions in Text Fields" on page 113 provides additional information about variable substitution in text fields.
- The width of the graphic area includes the graphic attribute character positions.
- The PQUERY service and the LVLIN panel built-in function can be used to obtain information about the size of the graphic area.

These rules are applied in Figure 59 on page 177.

```

)ATTR
 * AREA(GRAPHIC)
)BODY
%----- TITLE -----
%COMMAND ==>_ZCMD %
%
+ (Text or other fields that are part of the
+ normal panel body ... )
+
+  +*PICT1 -----*
+  * *
+  * *
+  * *
+  * *
+  * *
+  * *
+  * -----*
)END

```

Figure 59. Panel Definition Illustrating a Graphic Area

In this example, a graphic area is defined. PICT1 is specified as the name of the area. An asterisk (*) is the delimiter character for the vertical sides of the area, and hyphens (-) are the delimiter character for the top and bottom. Note that a blank follows the area name and follows all asterisks (*) other than the asterisk adjacent to PICT1.

Figure 60 and Figure 61 on page 178 are examples of panel definitions with a graphic area. In Figure 61 on page 178, note that the alphanumeric field INPUT1 starts at '_' and ends at '|'.

```

)ATTR
 * AREA(GRAPHIC)
)BODY
%          MY COMPANY OPTION PANEL
% Your selection ==>_ZCMD %
+
+ 1 Our application 1    +*LOGO -----*
+ 2 Our application 2    +* *
+ 3 Our application 3    +* *
+ 4 Our application 4    +* *
+ 5 Our application 5    +* *
+
+ X Exit                +* -----*
+ T Tutorial            <--- Graphic Area --->
)END

```

Figure 60. Panel Definition with Graphic Area

CAPS(ON|OFF|IN|OUT)

Specifies the uppercase or lowercase attribute of a field. CAPS is not valid for text fields. The CAPS keyword can have any one of the following values:

- ON** Data is translated to uppercase before being displayed and all input fields are translated to uppercase before being stored.
- OFF** Data is displayed as it appears in the variable pool and all input fields are stored as they appear on the screen.
- IN** Data is displayed as it appears in the variable pool, but all input fields on the screen are translated to uppercase before being stored.
- OUT** Data is translated to uppercase before being displayed. All input fields are stored as they appear on the screen.

Unless you specify a CONTROL ASIS command procedure (CLIST) statement, the use of CAPS(OFF), CAPS(IN), and CAPS(OUT) is negated if the dialog variable is referred to in the command procedure.

If you omit the CAPS parameter, the default is:

- CAPS(OFF) for input or output fields in the)MODEL section of a table display panel
- CAPS(OFF) for DATAIN and DATAOUT fields in dynamic areas
- CAPS(ON) for all other input or output fields.

CKBOX(ON|OFF)

Allows a 1-character input field followed by a protected (text or output) field to be processed as a check box in GUI mode. The input field is displayed as a check box and the protected field is the check box description.

The CKBOX keyword can have one of the following values:

- ON** Process the input field as a check box.
- OFF** Process the input field as non-check box field. This is the default setting.

If the check box input field is not blank, the check box is initialized as selected (checked). If the check box is selected, a slash character (/) is placed in the check box input field when the panel is processed.

The CKBOX keyword is ignored if the input field is greater than one character, or if the field following the check box field is not a protected field. An error message is issued if the CKBOX keyword is used on any fields other than input fields, or the selected choice (SC) output field.

)ATTR Section

```

)ATTR
@ TYPE(CEF) CKBOX(ON)
$ TYPE(SAC)
)BODY
% ----- CHECK BOX PANEL ----- +

+ Select options:
  &INSTR+
  @Z$Check box #1 description+
  @Z$Check box #2 description+
  @Z$Check box #3 description+
  @Z$Check box #4 description+

)INIT
.ZVARS = '(BOX1 BOX2 BOX3 BOX4)'
IF (&ZGUI = ' ')
  &INSTR = 'Enter '/' to select option.'
ELSE
  &INSTR = 'Check box to select option.'
)END

```

Figure 62. Example of CKBOX keyword

COLOR(*value*)

For 3279-B terminals (or other ISPF-supported seven-color terminals), the COLOR keyword defines the color of a field. The value can be: WHITE, RED, BLUE, GREEN, PINK, YELLOW, or TURQ (turquoise). If a color has not been specified and the panel is displayed on a terminal, a default color is generated based on the protection (TYPE) and intensity attributes of the field. Table 8 shows which defaults are the same as the hardware-generated colors for 3279-A (or other ISPF-supported four-color terminals).

Table 8. Color Defaults

Field Type	Intensity	Default Color
Text/Output	HIGH	WHITE
Text/Output	LOW	BLUE
Input	HIGH	RED
Input	LOW	GREEN

If a color has been specified and the panel is displayed on a terminal other than one with features such as those on the 3279-B, the following occurs:

- If an explicit intensity has also been specified for the field, the color specification is ignored. For example:

```

)ATTR
  @ TYPE(INPUT) INTENS(HIGH) COLOR(YELLOW)

```

 In this example, COLOR(YELLOW) is ignored except on terminals like the 3279-B. On a 3279-A terminal, for example, the resulting color is red.
- If an explicit intensity has not been specified for the field, the color is used to generate a default intensity. Specification of blue, green, or turquoise defaults to low intensity. Specification of red, yellow, pink, or white defaults to high intensity. For example:

```

)ATTR
  $ TYPE(OUTPUT) COLOR(GREEN)

```

 In this example, a low-intensity output field results.
- If neither color nor intensity has been specified for a field, the default intensity is HIGH.

Note: You can make global changes to one or more of the ISPF-supported colors by using the COLOR command or by selecting the Global Color Change choice from the Colors pull-down on the ISPF Settings panel (Option 0). You can control the colors when you are in GUI mode. Refer to the *z/OS ISPF User's Guide Vol II* for more information.

COMBO(ON|OFF|name)

Enables you to define choices for a combination box in GUI mode. This keyword is used in conjunction with the)LIST section. See “Defining the LIST Section” on page 222 for more information about the)LIST section.

The COMBO attribute keyword is valid on input type fields only. The combination box combines the functions of an entry field and a drop-down list (see “DDLIST Keyword” on page 182). It has an entry field and contains a list of choices that you can scroll through to select from to complete the entry field. The list of choices is hidden until you take an action to make the list visible. As an alternative, you can type text directly into the entry field. The typed text does not need to match one of the choices in the list.

The width of the input field determines the width of the combination box. If a COMBOBOX field is immediately followed by three or more consecutive attributes, the COMBOBOX will be displayed for the entire length of the field, since the three attributes allow space for the COMBOBOX button without overlaying data in the next field. If a COMBOBOX field is not followed by three or more consecutive attributes, the COMBOBOX will be displayed for the length of the field, to avoid overlaying data in the next field, but the COMBOBOX field will scroll to the right so that the user will be able to type in more than enough data to fill the field.

On the host, the application must be made to implement this function. One method to do this is to code the input field with a field-level help panel containing a scrollable list of choices.

The COMBO keyword can have one of the following values:

- ON** Specifies an input field is to display as a combination box when running in GUI mode.
- OFF** Specifies an input field is NOT to display as a combination box when running in GUI mode. This is the default setting.
- name** Specifies a name that is matched with the)LIST section name parameter (see “Defining the LIST Section” on page 222). This name is valid only on a CEF or other input type field. The name is composed of 1 to 8 characters. Alphanumeric characters A-Z, a-z, 0-9, #, \$, or @ can be used in the name, but the first character cannot be numeric. Lowercase characters are converted into uppercase equivalents.

Note: The COMBO keyword is supported for any input field type. To keep the following discussion simple, CEF is used to mean any input field type, and SAC is used to mean any text or output field type.

The COMBO keyword must be used in conjunction with the CSRGRP(x) keyword (see page 182). The CSRGRP(x) keyword must appear on the CEF field that is used to enter the selection on the host, and on the SAC field that identifies the choices in the list. The x value is a number that ties the choices to the correct input field, which has the same COMBO keyword and CSRGRP(x) number.

To specify the attributes of a combination box use the following syntax:

)ATTR Section

attribute-char TYPE(input) COMBO(ON|OFF|name) CSRGRP(x) DEPTH(d)

where *attribute-char* is the special character or 2-position hexadecimal value that is used to define the field within the panel body section. The *x* in CSRGRP(*x*) can be a number between 1 and 99. The number is used to group all of the fields with the same value into cursor groups.

The TYPE value must be an input type field. The DEPTH(*d*) sets the number of rows for the combination box. Values can be from 0 to 99. For example, if you specify DEPTH(8), the combination box contains eight rows of data. If the depth specified is 0, or if the depth is not specified, the default depth is 4.

CSRGRP(*x*)

Enables you to determine which pushbuttons and checkbox fields are grouped together for cursor movement purposes. When pushbuttons or checkboxes are grouped into cursor groups, the cursor up and down keys move the focus through each of the fields within the group. The TAB key moves the focus out of the group, to the next field that is not within this particular group.

To specify the CSRGRP(*x*) keyword for cursor groups use the following syntax:

```
attribute-char TYPE(PS) CSRGRP(x)
attribute-char TYPE(OUTPUT) PAS(ON) CSRGRP(x)
attribute-char TYPE(CEF) CKBOX(ON) CSRGRP(x)
```

where *attribute-char* is the special character or 2-position hexadecimal value that is used to define the field within the panel body section. The *x* in CSRGRP(*x*) can be a number between 1 and 99. The number is used to group all of the fields with the same value into cursor groups. If you specify a CSRGRP on a field that is not displayed as a pushbutton, a checkbox, a radio button, list box, combination box, or drop-down list, then the CSRGRP keyword is ignored.

All pushbuttons and checkbox fields that do not have a CSRGRP defined do not have a cursor group set in GUI mode, which has the same effect as having them all in the same cursor group.

CUADYN(*value*)

Enables you to define dynamic area DATAIN and DATAOUT attributes with CUA attribute characteristics. For more information, see “Specifying Dynamic Areas” on page 200.

DDLIST(ON|OFF|name)

Enables you to define choices for a single choice selection list and display the list in a drop-down box in GUI mode. A drop-down list is a variation of a list box (see “LISTBOX Keyword” on page 188). A drop-down list initially displays only one item until you take action to display the rest of the items in the list.

The DDLIST keyword can have one of the following values:

- ON** Specifies a single selection list to display as a drop-down list when running in GUI mode.
- OFF** Specifies a single selection list is NOT to display as a drop-down list when running in GUI mode. This is the default setting.
- name** Specifies a name that is matched with the)LIST section name parameter (see “Defining the LIST Section” on page 222). This name is valid only on a CEF or other input type field. The name is composed of 1-8 characters. Alphanumeric characters A-Z, a-z, 0-9, #, \$, or @ can be used in the name, but the first character cannot be numeric. Lowercase characters are converted into uppercase equivalents.

Note: To keep the following discussion simple, **CEF** is used to mean any input field type, and **SAC** is used to mean any protected text or output type.

The DDLIST keyword must be used in conjunction with the CSRGRP(*x*) keyword (see page 182). The CSRGRP(*x*) keyword must appear on the CEF field that is used to enter the selection on the host, and on the SAC field that identifies the choices in the list. The *x* value is a number that ties the choices to the correct input field, which has the same DDLIST keyword and CSRGRP(*x*) number.

Defining a DDLIST Without a)LIST Section

The following describes how to define a drop-down list using just the attribute keywords DDLIST and CSRGRP. Define the drop-down list by coding the DDLIST(ON) keyword on the CEF field and on the SAC field that identifies the choices that go with the CEF field. The SAC choice fields that have the same keyword settings (DDLIST and CSRGRP) as the CEF field are used to build the list of choices in the list. They are not built into the panel body when the panel is displayed. The fields following the SAC fields should be text or output fields, they are used as the list choice text. If a field following an SAC field is not a text or output field, no entry is built in the list for that field. The data in the drop-down list is displayed in the order that ISPF processes the defined panel body, that is, left to right, and top to bottom.

ISPF initially compares the CEF field with each SAC field for the drop-down list. If a CEF and SAC match is found the drop-down list field is set to the matching SAC choice text field. If no match is found, or if the CEF field is blank, the drop-down list field is set to blank.

To specify the attributes of a drop-down list use the following syntax in the)ATTR section:

```
attr-char TYPE(CEF) DDLIST(ON) CSRGRP(x) WIDTH(w) DEPTH(d)
attr-char TYPE(SAC) DDLIST(ON) CSRGRP(x)
```

Where *attr-char* is the special character or 2-position hexadecimal value used to define the choice entry field, or the SAC field within the panel body section. The other variables listed in the example are:

WIDTH(*w*)

The value of *w* sets the width of the drop-down list. Values can be from 0 to 99. This parameter is only used when it is specified on a CEF field. If you specify a width, ISPF makes the drop-down list that is displayed the specified width. If you do not specify, or specify a width of zero, ISPF scans the next field that is not one of the choice numbers or choice text fields for the CEF field to determine the available space for the list. In this case, ISPF sets the width to the smaller value between the available space and the length of the longest choice text string.

This value does not include the DDLIST borders. If you specify WIDTH(5), the DDLIST can contain 5 characters of data. The width you specify should be large enough to hold the longest choice text string. Also ensure that there is enough panel space for it to fit without overlaying other fields on the panel.

)ATTR Section

Note: Ensure that, from the starting position of the drop-down list, the width that you specify does not extend past the right border of the panel.

DEPTH(*d*)

The value of *d* sets the number of rows for the list to display. Values can be from 0 to 99. This parameter is only used when it is specified on a CEF field. If you specify a depth, ISPF makes the drop-down list that is displayed the specified depth.

If you specify DEPTH(8), the DDLIST can contain 8 lines of data. If the depth specified is 0, or if the depth is not specified, the default depth is 4.

Example Panel Definition for DDLIST

```
)ATTR
@ TYPE(CEF) DDLIST(ON) CSRGRP(1)
$ TYPE(SAC) DDLIST(ON) CSRGRP(1)
# TYPE(SAC)
)BODY
%-----Sample List Panel-----

+Terminal Characteristics:
+Screen format
@Z $1.#Data+   $3.#Max+
   $2.#STD+    $4.#Part+

)END
-----
```

Defining a DDLIST With a)LIST Section

Another way to define a DDLIST is to build the choices into the)LIST section of the panel. See “Defining the LIST Section” on page 222 for more information about the LIST section.

To specify the attributes of a drop-down list use this syntax:

```
)ATTR
  attr-char TYPE(CEF) DDLIST(name) CSRGRP(x) WIDTH(w) DEPTH(d)
  attr-char TYPE(SAC) DDLIST(ON) CSRGRP(x)
  :
)LIST name
  VAL(value1) CHOICE(choice1)
  VAL(value2) CHOICE(choice2)
```

Where the DDLIST(name) on the CEF field in the)ATTR section matches the name on the)LIST statement. The)LIST section contains the list of choices and the values for the drop-down list. The data in the drop-down list is displayed in the order in which you define the choices in the)LIST section.

If the choices are also built into the panel body, the SAC attribute must have DDLIST(ON) so that ISPF does not display the choices in the panel body, but uses the choices specified in the)LIST section.

ISPF initially compares the CEF field with each VAL(value) in the named)LIST section. If a CEF and VAL match is found the drop-down list field is set to the matching VAL's choice text. If no match is found, or if the CEF field is blank, the drop-down list field is set to blank.

Note: Defining drop-down lists is not a trivial task. You might find it simpler to use Dialog Tag Language to define panels that contain drop-down lists. Refer to *z/OS ISPF Dialog Tag Language Guide and Reference* for more information.

When you define drop-down lists, keep the following points in mind:

- The CEF field (or other input field) receives the selection number and the SAC field (or other output or text field) that contains the selection number. The SAC field must be followed by another output or text field with the choice description to be placed in the list.
- The CEF field should not be more than 3 characters long. Only 3 characters are checked and set for CEF fields processed as drop-down lists.
- If the text following the SAC attribute is longer than 3 characters or the CEF field, then the text is truncated to the size of the CEF field, or 3 characters (whichever is smaller when that list choice is selected). Periods at the end of the string are ignored, they are not set into the list entry field with the other text when the choice is selected and the panel is processed.
- If a CEF field has the same CSRGRP value as a previous CEF field, and both of them have the same DDLIST(ON) keyword, then the second CEF field is displayed as an input field and all of the choices with the same keywords are grouped under the first CEF field.
- If a CEF field has a DDLIST(ON) and a CSRGRP value that does not match an SAC field with DDLIST(ON) and a CSRGRP value that comes after it, then the CEF field is displayed as an input field.
- If an SAC field has a DDLIST(ON) and a CSRGRP value that does not match a previous CEF field with DDLIST(ON) and a CSRGRP value, then the SAC field and the description following it do not display.
- If an SAC field is not followed by an output or text field to be used as the list choice text, then the SAC field is not displayed, and there is no entry in the list for that choice.

DEPTH(*d*)

The value of *d* sets the number of rows for a list box, drop-down list, or combination box to display. Values can be from 0 to 99. This parameter is only used when it is specified on an input field. See the appropriate sections on list boxes, drop-down lists, and combination boxes for more information.

FORMAT(EBCDIC | DBCS | MIX)

For DBCS terminals, the FORMAT keyword specifies the character format for a field.

EBCDIC	EBCDIC characters only
DBCS	DBCS characters only
MIX	EBCDIC and DBCS characters

In a FORMAT(MIX) field, any DBCS character string must be enclosed by a shift-out (hexadecimal 0E) and a shift-in (hexadecimal 0F).

The default value for a TYPE(INPUT) and a TYPE(DATAIN) field is FORMAT(EBCDIC). These two default values can be changed by using the)ATTR statement or the)BODY statement. These values, in turn, can be overridden if explicitly specified on a subsequent statement. For example, the net result of the following two statements is FORMAT(DBCS):

```
)ATTR FORMAT(MIX) $ TYPE(INPUT) FORMAT(DBCS)
```

)ATTR Section

The default value for a TYPE(TEXT) and a TYPE(OUTPUT) field is FORMAT(MIX). The format of a TYPE(TEXT) field cannot be overridden by the execution of an .ATTR or .ATTRCHAR statement. Attempting to do so results in a dialog error.

The pad character for a DBCS field is converted to the corresponding 16-bit character and is then used for padding. Other format fields are padded normally.

The CAPS attribute is meaningful only for EBCDIC and MIX fields. In addition, within a MIX field, the CAPS attribute applies only to the EBCDIC subfields.

GE(ON | OFF)

The GE keyword indicates that a specific character attribute should be preceded in the order stream by the graphic escape order, provided the terminal supports GE order. The GE order indicates that the character comes from the APL/TEXT character set. This keyword is supported on TYPE(CHAR) within a Dynamic Area, action bar separator lines (TYPE(ABSL)), work area separator lines (TYPE(WASL)), and column headings (TYPE(CH)).

The GE keyword can have one of the following values:

- ON** Specifies that ISPF will place a graphic escape order before the attribute character when building the order stream.
- OFF** The default. Specifies that ISPF will not place a graphic escape order before the attribute character.

If GE(ON) is specified on TYPE(ABSL), TYPE(WASL), or TYPE(CH), and if the characters following these TYPE's in the panel definition are dashes (-) or vertical bars (|), then the appropriate APL character will be used. This results in these panel elements displaying as solid horizontal or vertical lines, instead of broken lines.

Note: If the terminal does not support graphic escape or if you are running under GDDM (i.e., GRINIT service has been issued) then these panel elements will be displayed as coded in the panel definition.

For more information about the GE keyword support on TYPE(CHAR) within a dynamic area, see page "Specifying Character Attributes in a Dynamic Area" on page 146.

HILITE(value)

For ISPF-supported terminals with the extended highlighting feature, the HILITE keyword defines the extended highlighting attribute for a field. The *value* can be:

- USCORE** Underscore
- BLINK** Blinking
- REVERSE** Reverse video

No default is assumed if highlighting is not specified. When you are running in GUI mode, the HILITE keyword is ignored.

If highlighting is specified and the panel is displayed on a terminal without the extended highlighting feature, the following occurs:

- If an explicit intensity has also been specified, the highlighting is ignored.

- If an explicit intensity has not been specified for the field, a high-intensity field results. On a 3279-A terminal, there is also color provided by default, as described in Table 8 on page 180.

Examples of Using COLOR and HILITE Keywords

```
@ TYPE(OUTPUT) INTENS(HIGH) COLOR(YELLOW) HILITE(BLINK)
```

the results are as follows:

```
3277,8 - TYPE(OUTPUT) INTENS(HIGH)
3279-A - TYPE(OUTPUT) INTENS(HIGH) *
3279-B - TYPE(OUTPUT) COLOR(YELLOW) HILITE(BLINK)
3290   - TYPE(OUTPUT) HILITE(BLINK)
```

* Results in white.

INTENS(HIGH|LOW|NON)

Specifies the intensity of the field (HIGH is the default):

HIGH	High-intensity field
LOW	Low-intensity (normal) field
NON	Nondisplay field

You can specify these operands for the basic attribute types (TEXT|INPUT|OUTPUT). NEF is the only CUA panel-element type that supports the INTENS(NON) operand. The remaining CUA panel-element types do not allow the COLOR, INTENS, and HILITE keyword default values to be changed. The NON operand allows you to optionally display comments or directive lines.

For a panel displayed on a color terminal, you can also use the INTENS keyword to generate a default color for the field, as described for the COLOR keyword. INTENS(HIGH) and INTENS(LOW) are ignored for a 3290 terminal and in GUI mode.

JUST(LEFT|RIGHT|ASIS)

Specifies how the contents of the field are to be justified when displayed. JUST is valid only for input and output fields.

LEFT	Left justification
RIGHT	Right justification
ASIS	No justification

Justification occurs if the initial value of a field is shorter than the length of the field as described in the panel body. Normally, right justification should be used only with output fields, since a right-justified input field would be difficult to type over.

For LEFT or RIGHT, the justification applies only to how the field appears on the screen. Leading blanks are automatically deleted when the field is processed. For ASIS, leading blanks are not deleted when the field is processed, nor when it is initialized. Trailing blanks are automatically deleted when a field is processed, regardless of its justification.

If you omit the JUST parameter, the default is:

- JUST(ASIS) for input or output fields in the)MODEL section of a table display panel
- JUST(ASIS) for DATAIN and DATAOUT fields in dynamic areas
- JUST(LEFT) for all other input or output fields.

LISTBOX(ON|OFF|*name*)

Enables you to define choices for a single choice selection list and display the list in a list box in GUI mode. A list box displays a scrollable list of choices in a box on the display.

The LISTBOX keyword can have one of the following values:

- ON** Specifies a single selection list to display as a list box when running in GUI mode.
- OFF** Specifies a single selection list is NOT to display as a list box when running in GUI mode. This is the default setting.
- name** Specifies a name that is matched with the)LIST section name parameter (see “Defining the LIST Section” on page 222). This name is valid only on a CEF or other input type field. The name can be 1 to 8 characters long. Alphanumeric characters A-Z, a-z, 0-9, #, \$, or @ can be used in the name, but the first character cannot be numeric. Lowercase characters are converted into uppercase equivalents.

Note: To keep the following discussion simple, **CEF** is used to mean any input field type, and **SAC** is used to mean any protected text or output type.

The LISTBOX keyword must be used with the CSRGRP(*x*) keyword (see 182). The CSRGRP(*x*) keyword must appear on the CEF field that is used to enter the selection on the host, and on the SAC field that identifies the choices in the list. The *x* value is a number that ties the choices to the correct input field, which has the same LISTBOX keyword and CSRGRP(*x*) number.

Defining a LISTBOX Without a)LIST Section

Define the list box by coding the LISTBOX(ON) keyword on the CEF field and on the SAC field that identifies the choices that go with the CEF field. The SAC choice fields that have the same keyword settings (LISTBOX and CSRGRP) as the CEF field are used to build the list of choices in the list. They are not built into the panel body when the panel is displayed. The fields following the SAC fields should be text or output fields, they are used as the list choice text. If a field following an SAC field is not a text or output field, no entry is built in the list for that field.

To specify the attributes of a list box use the following syntax in the)ATTR section:

```
attr-char TYPE(CEF) LISTBOX(ON) CSRGRP(x) WIDTH(w) DEPTH(d)
attr-char TYPE(SAC) LISTBOX(ON) CSRGRP(x)
```

Where *attr-char* is the special character or 2-position hexadecimal value used to define the choice entry field, or the SAC field within the panel body section. The other variables listed in the example are:

WIDTH(*w*)

The value of *w* sets the width of the list box. Values can be from 0 to 99. This parameter is only used when it is specified on a CEF field. If you specify a width, ISPF makes the list box that is displayed the specified width. If you do not specify, or specify a width of zero, ISPF scans the next field that is not one of the choice numbers or choice text fields for the CEF field to determine the available space for the list. In this case, ISPF sets the width to the smaller value between the available space and the length of the longest choice text string.

This value does not include the LISTBOX borders. If you specify WIDTH(5), the LISTBOX can contain 5 characters of data.

DEPTH(d)

The value of *d* sets the number of rows for the list to display. Values can be from 0 to 99. This parameter is only used when it is specified on a CEF field. If you specify a depth, ISPF makes the list box that is displayed the specified depth. If the depth specified is 0, or if the depth is not specified, the default depth is 4.

This value does not include the horizontal scroll bar. If you specify DEPTH(8), the list box can contain 8 lines of data.

Note: Ensure that from the starting position of the List Box, the width specified does not extend past the right border of the panel. Also ensure that from the starting position of the List Box, the depth specified does not extend past the bottom edge of the panel.

Example Panel Definition for LISTBOX

```
)ATTR
@ TYPE(CEF) LISTBOX(ON) CSRGRP(1) DEPTH(4)
$ TYPE(SAC) LISTBOX(ON) CSRGRP(1)
# TYPE(SAC)
)BODY
%-----Sample List Panel-----

+Terminal Characteristics:
+Terminal Type
@Z $1.#3277+   $5.#3290A+
   $2.#3277A+  $6.#3278T+
   $3.#3278+   $7.#3278CF+
   $4.#3278A+  $8.#3277KN+

)END
-----
```

Defining a LISTBOX With a)LIST Section

Another way to define a LISTBOX is to build the choices into the)LIST section of the panel. See “Defining the LIST Section” on page 222 for more information about the LIST section.

To specify the attributes of a list box use this syntax:

```
)ATTR
  attr-char TYPE(CEF) LISTBOX(name) CSRGRP(x) WIDTH(w) DEPTH(d)
  attr-char TYPE(SAC) LISTBOX(ON) CSRGRP(x)
  :
)LIST name
  VAL(value1) CHOICE(choice1)
  VAL(value2) CHOICE(choice2)
```

Where the LISTBOX(name) on the CEF field in the)ATTR section matches the name on the)LIST statement. The)LIST section contains the list of choices and the values for the drop-down list. The data in the drop-down list is displayed in the order in which you define the choices in the)LIST section.

If the choices are also built into the panel body, the SAC attribute must have LISTBOX(ON) so that ISPF does not display the choices in the panel body, but uses the choices specified in the)LIST section.

Note: Defining list box lists is not a trivial task. You might find it simpler to use Dialog Tag Language to define panels that contain list box lists. Refer to *z/OS ISPF Dialog Tag Language Guide and Reference* for more information.

When you define listboxes, keep the following points in mind:

- The CEF field (or other input field) receives the selection number and the SAC field (or other output or text field) that contains the selection number. The SAC field must be followed by another output or text field with the choice description to be placed in the list.
- The CEF field should not be more than 3 characters long. Only 3 characters are checked and set for CEF fields processed as drop-down lists.
- If the text following the SAC attribute is longer than 3 characters or the CEF field, then the text is truncated to the size of the CEF field, or 3 characters (whichever is smaller when that list choice is selected). Periods at the end of the string are ignored, they are not set into the list entry field with the other text when the choice is selected and the panel is processed.
- If a CEF field has the same CSRGRP value as a previous CEF field, and both of them have the same LISTBOX(ON) keyword, then the second CEF field is displayed as an input field and all of the choices with the same keywords are grouped under the first CEF field.
- If a CEF field has a LISTBOX(ON) and a CSRGRP value that does not match an SAC field with LISTBOX(ON) and a CSRGRP value that comes after it, then the CEF field is displayed as an input field.
- If an SAC field has a LISTBOX(ON) and a CSRGRP value that does not match a previous CEF field with LISTBOX(ON) and a CSRGRP value, then the SAC field and the description following it do not display.
- If an SAC field is not followed by an output or text field to be used as the list choice text, then the SAC field is not displayed, and there is no entry in the list for that choice.

NOJUMP(ON|OFF)

Specifies whether the jump function is disabled for a specific input field. It is ignored on text and output fields. NOJUMP(OFF), jump function enabled, is the default for fields with field prompts of ==> and for fields with field prompts of leader dots (. . or ...), provided that jump from leader dots is set to YES in the Configuration table or "jump from leader dots" is selected in the Settings panel.

ON Specifies that the jump function is disabled and the data entered is passed to the dialog as it was entered.

OFF Specifies that the jump function is enabled for fields with field prompts of ==> and for fields with field prompts of leader dots (. . or ...) provided that "jump from leader dots" is set to YES in the Configuration table or selected in the Settings panel. This is the default.

Note: If the application developer defines the NOJUMP(ON) attribute keyword on a specific input field, this disables the "jump from leader dots" setting for that field, and takes precedence over the "jump from leader dots" setting on the Settings panel or the Configuration setting of YES for "jump from leader dots".

NUMERIC(ON|OFF)

For terminals with the Numeric Lock feature, the NUMERIC attribute keyword

allows users to be alerted to certain keying errors. The NUMERIC attribute keyword is used to specify, for a panel field, whether Numeric Lock is to be activated for data keyed into that field.

ON Specifies that the Numeric Lock feature is to be activated. The terminal keyboard locks if the operator presses any key other than 0 through 9, minus(-), period (.), or duplicate (DUP). ON is valid only for unprotected fields.

OFF Specifies that the Numeric Lock feature is not to be activated. The user can type in any characters. NUMERIC(OFF) is the default value.

On a data-entry keyboard with the Numeric Lock feature, when the user moves the cursor into a field defined by the NUMERIC(ON) attribute keyword, the display shifts to numeric mode. If the user presses any key other than those allowed by the Numeric Lock feature, the DO NOT ENTER message displays in the operator information area and the terminal is disabled. The user can continue by pressing the reset key.

Note: On non-English keyboards with the Numeric Lock feature, the comma sometimes replaces the period as a valid numeric character.

NUMERIC(ON) and SKIP(ON) attributes cannot be specified for the same field. If attempted, ISPF issues an error message.

The NUMERIC(ON) attribute is not supported when GDDM is active.

When running in GUI mode, any panel field defined as NUMERIC(ON) is verified at the workstation. That is, only numeric characters 0 through 9 and special characters comma (,), dash (-), and period (.) are accepted in a numeric only defined field.

OUTLINE([L][R][O][U] | BOX | NONE)

For DBCS terminals, the **OUTLINE** keyword lets you display lines around any type of field. The keyword parameters specify where the line or lines are displayed.

L	Line to the left side of the field
R	Line to the right side of the field
O	Line over the field
U	Line under the field
BOX	Line surrounding the field (equivalent to LROU)
NONE	No lines

You can specify any combination of the L, R, O, or U parameters in any order, without intervening blanks.

The default value for **OUTLINE** is **NONE**. The default value for **TYPE(INPUT)** and **TYPE(DATAIN)** fields can be specified on the)ATTR or)BODY statement, and can be overridden by the **OUTLINE** keyword. For example:

```
)ATTR OUTLINE(U)
  @ TYPE(INPUT) OUTLINE(BOX)
```

When you are running in GUI mode, the **OUTLINE** keyword is ignored.

PAD(char | NULLS | USER)

Specifies the pad character for initializing the field. This is not valid for text fields. If **PAD** is omitted, the default is **PAD(' ')** for output fields.

char Any character, including blank (' '), can be specified as the padding character. If the character is any of the following, it must be enclosed in single quotes:

blank < (+) ; ~ , > : =

If the desired pad character is a single quote, use four single quotes:
PAD('').

NULLS

Nulls are used for padding.

USER Padding character is specified by a user through the ISPF Settings panel.

If the field is initialized to blanks or the corresponding dialog variable is blank, the entire field contains the pad character when the panel is first displayed. If the field is initialized with a value, the remaining field positions, if any, contain the pad character.

Padding and justification work together as follows. At initialization, unless you have specified ASIS, the field is justified and then padded. For left-justified and ASIS fields, the padding extends to the right. For right-justified fields, the padding extends to the left.

When ISPF processes an input field, it automatically deletes leading or trailing pad characters as follows:

- For a left-justified field, ISPF deletes leading and trailing pad characters.
- For a right-justified field, ISPF deletes leading pad characters and stores trailing pad characters.
- For an ASIS field, ISPF deletes trailing pad characters and stores leading pad characters.

Regardless of the type of justification, ISPF deletes leading and trailing pad characters for command fields.

In no case does ISPF delete embedded pad characters. It deletes only leading or trailing pad characters.

PADC(*char* | NULLS | USER)

Specifies conditional padding with the specified pad character. The pad character is used as a field filler only if the value of the input or output field is initially blank. The pad character is not displayed in the remaining unfilled character positions if the field has an initial value. Instead, the unfilled positions contain nulls. Otherwise, ISPF treats the PADC keyword like the PAD keyword, including justification and deletion of pad characters before storing variables in the pool.

char Any character, including blank (' '), can be specified as the padding character. If the character is any of the following, it must be enclosed in single quotes:

blank < (+) ; ~ , > : =

If the desired pad character is a single quote, use four single quotes:
PAD(''').

NULLS

Nulls are used for padding.

USER Specifies that a user-defined character be used for padding. You define the character by using the ISPF Settings panel. PAD and PADC are incompatible. It is not valid to specify both PAD and PADC for the same attribute character.

If PADC is omitted, the default is PADC(USER) for input fields.

PAS(ON | OFF)

PAS is valid for input and output fields only (not for text fields). The point-and-shoot keyword specifies the field as a point-and-shoot field. In GUI mode, output fields specified as point-and-shoot fields are displayed as buttons. The PAS keyword is used in conjunction with the)PNTS point-and-shoot panel section. See “Defining the Point-and-Shoot Section” on page 227 for more information.

For each field on the panel that has been designated as a point-and-shoot field, there must be a corresponding entry in the)PNTS point-and-shoot panel section. If the cursor is placed on a point-and-shoot panel field and the Enter key is pressed, the action associated with the field is executed. In the example below, if the cursor is placed on the point-and-shoot field, BLUE1, and the Enter key is pressed, the variable RED1 is set to RED. In GUI mode, the action is executed when the pushbutton point-and-shoot field is selected. The cursor only remains positioned on the point-and-shoot field if no intermediate panel is displayed and if the dialog does not set the cursor position.

Note: You can use option 0 (Settings) to set the tab key to move the cursor point-and-shoot fields. This changes output fields to input fields, but data is not altered. However, if a variable is used on an output field that is changed to an input field by the tab to point-and-shoot option, and the variable is VDEFINEd to the application, the variable will be truncated. In this case, the application developer should have a temporary panel variable.

ON The field is a point-and-shoot field.

OFF The default. This field is not a point-and-shoot field.

Example:

```
)PANEL
)ATTR
  $ TYPE(PIN)
  } TYPE(PS)
  + TYPE(NT)
  | AREA(SCRL) EXTEND(ON)
  ! TYPE(OUTPUT) PAS(ON) COLOR(RED)
  * TYPE(OUTPUT) PAS(ON) COLOR(BLUE)
  @ TYPE(TEXT) INTENS(LOW) COLOR(RED) PAD(NULLS)
  ø TYPE(TEXT) INTENS(LOW) COLOR(BLUE) PAD(NULLS)
)BODY WINDOW(60,23)
$
%COMMAND ==>_ZCMD
$
$ Press }DEFAULTS$to reinstate defaults
$
+
|S1
)AREA S1
+
+
+      øBLUE . . . .*BLUE1
+      @RED . . . .!RED1
)INIT
.cursor = blue1
&blue1 = ' '
)PROC
REFRESH(*)
```

)ATTR Section

```
)PNTS  
  FIELD(BLUE1) VAR(RED1) VAL(RED)  
  FIELD(ZPS00001) VAR(BLUE1) VAL(DEFAULT)  
)END
```

RADIO(ON|OFF) CSRGRP(x)

Displays mutually exclusive textual settings choices. These fields must contain at least two choices, one of which is usually selected. A single-choice selection list is the equivalent function on the host. In GUI mode, they appear as radio button groups.

To have a single-choice selection list display as a radio button group, use the RADIO(ON) keyword with the CSRGRP(x) keyword on the CEF type (or other input type) field that is used to enter the selection on the host.

Note: The RADIO keyword is supported for any input, output, or text field type. To keep the following discussion simple, CEF is used to mean any input field type, and SAC is used to mean any protected text or output type.

For a list of possible selections, attribute type SAC (select available choice) or another text or output field type must be used before the choice selection number. The attribute used for the choice selection number also must have the RADIO(ON) keyword with the CSRGRP(x) keyword. The *x* on the CSRGRP keyword is a number used to identify each radio button group. The CSRGRP number on both the CEF type field and the SAC type field must match. (For more information about CSRGRP, see 182.) The next field must be a text or output field, used as the radio button choice text.

ISPF initially sets the radio button in the group that corresponds to the value in the CEF field. If the CEF field is blank or the value in the field does not correspond with any of the radio button selections, then no radio button is set by default. ISPF then uses the characters following the SAC attribute to set the value into the CEF field with the same CSRGRP(*x*) number.

The CEF field must be no more than 3 characters, because only 3 characters are checked and set for the CEF fields processed as radio buttons. If the text following the SAC attribute is longer than 3 characters, or longer than the value in the CEF field, then the text is truncated to the size of the CEF field or 3 characters, whichever is smaller when the radio button corresponding to that choice is selected. Periods at the end of the string are ignored.

To specify the RADIO(ON/OFF) CSRGRP(*xx*) keyword for radio buttons, use the following syntax:

```
attribute-char TYPE(CEF) RADIO(ON/OFF) CSRGRP(x)  
attribute-char TYPE(SAC) RADIO(ON/OFF) CSRGRP(x)
```

attribute-char

the special character or 2-position hexadecimal value used to define the choice entry field, or the SAC field within the panel body section. The radio button group is defined in the panel body section by using the special character to define the radio button entry field and the radio button choices that go with it.

TYPE(CEF)

field attribute overrides for the CEF fields can be used to set the RADIO(ON) and CSRGRP(*x*) value for the CEF field.

TYPE(SAC)

or other text or output field type to be used before each of the choice selection numbers.

RADIO(ON|OFF)

ON if the radio button is implemented, OFF if it is not.

CSRGRP(x)

x can be any number from 1 to 99. The number refers to the number of the radio button *group* as a whole, not the individual choices with the radio button group.

For example:

```
)ATTR
@ TYPE(CEF) RADIO(ON) CSRGRP(1)
$ TYPE(SAC) RADIO(ON) CSRGRP(1)
! TYPE(CEF) RADIO(ON) CSRGRP(2)
^ TYPE(SAC) RADIO(ON) CSRGRP(2)
#TYPE(SAC)
)BODY
% ----- Radio Button PANEL ----- +

+Terminal Characteristics:
+Screen format @Z $1.#Data+ $2.#Std+ $3.#Max+ $4.#Part+

+Terminal Type !Z ^1.#3277+ ^3.#3278+ ^5.#3290A+ ^7.#3278CF+
^2.#3277A+ ^4.#3278A+ ^6.#3278T+ ^8.#3277KN+

)END
```

Notes about Syntax:

1. If a CEF field has the same CSRGRP(*x*) value as a previous CEF field, and both of them have RADIO(ON), then the new CEF field is displayed as an input field.
2. If a CEF field has a RADIO(ON) and a CSRGRP(*x*) value that does not match an SAC with RADIO(ON) and a CSRGRP(*x*) value that comes after it, then the CEF field is displayed as an input field.
3. If an SAC field has a RADIO(ON) and a CSRGRP(*x*) value that does not match a previous CEF field with RADIO(ON) and a CSRGRP(*x*) value, then the SAC field is displayed as an output field instead of a radio button.
4. If an SAC field is not followed by an output field to be used as the radio button text, then the SAC field is displayed as an output field.
5. If the radio button choice text wraps from one row to the next, then the text on the next line is not displayed as part of the radio button choice text, but as normal text.

Restrictions on radio buttons and scrollable areas

- Radio button groups can appear in a scrollable area, but choices that do not appear in the visible portion of the area are not displayed.
- If a radio button group does appear in a scrollable area, and the panel cannot be scrolled to show all of the choices and the CEF field, then it might not be possible to select some of the choices in the radio button group.
- If the CEF field is scrolled out of the visible area of a scrollable area, the SAC field and the choice text field that follow it are displayed in the panel body as text or output fields.

Because of the scrolling restrictions mentioned above, instead of using radio buttons, try using a LISTBOX or DDLIST with the)LIST section for your application.

REP(character)

For DBCS terminals, the REP keyword allows users to view, on panel definitions, the displayable replacements for nondisplayable attribute characters. This provides for the use of a wider range of BODY record attribute characters that can be viewed on panel definitions. These replacement characters are not visible on the actual panel displays.

You can specify any replacement character, but those that must be enclosed in single quotes are as follows: < > () + ; : , = blank.

Replacement characters are defined in the attribute section. Then, in the body section of the panel definition, a record containing only the defined attribute replacement characters is inserted immediately below any field defined by a corresponding statement in the attribute section. Each replacement character must be in the same column position as the attribute character position in the field above.

When the panel definition, for example, is viewed for editing, the data field and the characters that replace the attribute positions are both displayed. However, when the panel is displayed, the record containing the replacement characters is *not* displayed.

Any character immediately above an attribute replacement character in the panel definition is overlaid by the attribute character's hexadecimal code, not by the displayable replacement character.

In the following example, hexadecimal codes 38, 31, 32, and 34 are in the field attribute positions when the panel is displayed. Because these codes are not visible on a display, replacement characters *, !, \$, and # are specified for viewing the panel definition.

When the panel is displayed, the attribute position above the asterisk (*) contains hexadecimal 38; the one above the exclamation marks (!) contain hexadecimal 31; the one above the dollar sign (\$) contains hexadecimal 32, and the one above the pound sign (#) contains hexadecimal 34. None of these attribute characters is visible on the display, and the panel definition record containing the replacement characters is not displayed.

The field attribute positions on the panel definition can contain any character, illustrated as x in the example below, because they are overlaid by the replacement characters when the panel is displayed.

Example:

```
)ATTR
 38 TYPE(INPUT) FORMAT(DBCS) REP(*)
 31 TYPE(INPUT) FORMAT(EBCDIC) REP(!)
 32 TYPE(TEXT) FORMAT(EBCDIC) REP($)
 34 TYPE(TEXT) FORMAT(MIX) REP(#)

)BODY
+ DBCS input field %===>x VARDBCS +
      *
      [DBDBDBDBDBDBDBDBDBDB]===>x VAREBC +
      #                          $      !
```

Any characters used to replace shift-out or shift-in characters must be less than hexadecimal 40 and must not be hexadecimal 00, 0E, or 0F.

The EXPAND keyword cannot be used for records containing only those characters defined by the REP keyword.

SKIP(ON | OFF)

The SKIP keyword defines the autoskip attribute of the field. It is valid only for text or output (protected) fields (OFF is the default).

ON Specifies that the cursor automatically skips the field. When a character is entered into the last character location of the preceding unprotected data field, ISPF positions the cursor at the first character location of the next unprotected field.

OFF Specifies that the cursor does not automatically skip the field when the condition described for SKIP(ON) occurs.

When you are running in GUI mode, the SKIP keyword is ignored.

TYPE(value)

Specifies the TYPE category of the panel element. The default is TYPE(INPUT). The following TYPE values must be coded explicitly; it is not valid to assign any of these values to dialog variables: AB, ABSL, CH, CHAR, CT, DATAIN, DATAOUT, DT, ET, FP, GRPBOX, NT, PIN, PT, RP, SAC, SI, SUC, TEXT, WASL, and WT. For simplicity, the values in examples are shown as literals.

value may be:

Value	Description
AB	AB unselected choices
ABSL	AB separator line
CEF	Choice entry field
CH	Column heading
CHAR	Character attributes in a dynamic area
CT	Caution text
DATAIN	Input (unprotected) field in a dynamic area
DATAOUT	Output (protected) field in a dynamic area
DT	Descriptive text
EE	Error emphasis
ET	Emphasized text
FP	Field prompt
GRPBOX	Group box
INPUT	Input (unprotected) field
LEF	List entry field
LI	List items
LID	List item description

)ATTR Section

NEF	Normal entry field
NT	Normal text
OUTPUT	Output (protected) field
PIN	Panel instruction
PS	Point-and-shoot
PT	Panel title
RP	Reference phrase
SAC	Select available choices
SC	Selected choice
SI	Scroll information
SUC	Select unavailable choices
TEXT	Text (protected) field
VOI	Variable output information
WASL	Work area separator line
WT	Warning text

Note: TYPE values are grouped into four categories:

- Basic attribute types (TEXT|INPUT|OUTPUT). See page 198.
- Dynamic area types (CHAR|DATAIN|DATAOUT). See page 200.
- CUA panel-element types. See page 201.
- Other attribute types. See page 203.

UNAVAIL(ON|OFF)

The UNAVAIL attribute keyword is used to show the availability of a choice in conjunction with radio buttons, checkboxes, and pushbuttons.

The UNAVAIL attribute keyword can also be used with the LISTBOX, DDLIST, and COMBO attribute keywords on choices specified in the)LIST section to show the availability of a choice.

In GUI mode, if a LISTBOX, DDLIST, or COMBO choice is set as unavailable, that choice does not appear in the LISTBOX, DDLIST, or COMBO list of choices.

ON Specifies that the choice is *not* available. In GUI mode this means that the choice cannot be selected in the current context. In host mode, you can still select the choice. It is up to the application you are running to display an error message or ignore the choice. You can use the VER statement keywords LISTX or LISTVX to handle an unavailable choice selection.

OFF Specifies the choice is available and can be selected. This is the default setting.

WIDTH(*w*)

The value of *w* sets the width for a list box or drop-down list. Values can be from 0 to 99. This parameter is only used when it is specified on an input field. See the appropriate sections on list boxes, and drop-down lists for more information.

Basic Attribute Types

For text (protected) fields, the information in the body of the panel following the attribute character is the data to be displayed. Text fields can contain substitutable variables which consist of a dialog variable name preceded by an ampersand (&). The name and ampersand are replaced with the value of the variable, with trailing blanks stripped, before the panel is displayed.

For input (unprotected) or output (protected) fields in the body of the panel, a dialog variable name immediately follows the attribute character, with no intervening ampersand. The name is replaced with the value of the variable before displaying the panel. For input fields, any user-entered information is stored in the variable after the panel has been displayed.

An output field is different from a text field in that an output field has a variable name associated with the field. It also permits padding, capitalization, justification, and refreshing of the data. There is no default attribute character for output fields.

ISPF initializes input fields before displaying them. They can be entered (or typed over) by the user. ISPF also initializes output fields before displaying them, but output fields cannot be changed by the user. Both input and output fields can have associated caps, justification, and pad attributes. There is no default attribute character for output fields.

The default values for the data-manipulation attribute keywords, by TYPE, are summarized in Table 9.

Table 9. Default Values for Data-Manipulation Keywords

TYPE	CAPS	JUST	PADDING
TEXT	N/A	N/A	N/A
INPUT	ON	LEFT	PADC(USER)
OUTPUT	ON	LEFT	PAD(' ')

The ISPF basic attribute type rules for field types (defined in Table 9) determine which attribute keywords can be used in conjunction with the basic attribute TYPE keywords.

Keyword	Valid For
CAPS	Not valid for text fields
PAD	Not valid for text fields
JUST	Valid only for input and output fields
ATTN	Valid only for text fields
SKIP	Valid only for text or output (protected) fields
NUMERIC	Valid only for input fields
PADC	Valid only for input or output fields
FORMAT(EBCDIC DBCS MIX)	
	EBCDIC Default value for input fields
	MIX Default value for text and output fields
	DBCS Valid for text, input, and output fields

Example of Basic Attribute Types: Figure 63 on page 200 shows a panel definition in which an attribute section is included. As previously mentioned, an attribute section is not required in a panel definition if only the default attributes are to be used in the panel body.

)ATTR Section

```

)ATTR
* TYPE(TEXT) INTENS(HIGH) COLOR(WHITE) CAPS(OFF)
# TYPE(TEXT) INTENS(HIGH) COLOR(BLUE) CAPS(OFF)
@ TYPE(TEXT) INTENS(LOW) COLOR(BLUE) HILITE(REVERSE)
? TYPE(TEXT) INTENS(LOW) COLOR(TURQ) CAPS(OFF)
_ TYPE(INPUT) INTENS(HIGH) COLOR(YELLOW)
$ TYPE(INPUT) INTENS(NON)
ø TYPE(OUTPUT) INTENS(LOW) COLOR(TURQ) CAPS(OFF)
)BODY
* -----@EMPLOYEE RECORD*-----
# SERIAL NO.*====>_SERNUM +&rb1 %
#
#
# NAME: ?&LAST, &FIRST
#
# ADDRESS:øADDR1 +
# øADDR2 +
# øADDR3 +
# øADDR4 +
#
# POSITION:øPOSIT +
#
# YEARS EXPERIENCE:øYRS+
#
# SALARY:øSALARY + # PASSWORD*====>$PSW +
# (Password is required for salary)
#
#
* Enter#END*command to terminate application.
#
)PROC
VER(&SERNUM,NB,NUM)
.ATTR(.CURSOR) = 'COLOR(RED) HILITE(BLINK)'
)END

```

Figure 63. Attribute Section in a Panel Definition

Specifying Dynamic Areas

TYPE(DATAIN|DATAOUT|CHAR) can be specified for dynamic areas. Use DATAIN and DATAOUT values only for specifying unprotected or protected fields, respectively, within a dynamic area.

You can specify the ATTN, CAPS, COLOR, HILITE, INTENS, JUST, PAD, PADC, and SKIP keywords for DATAIN and DATAOUT fields. You can specify NUMERIC for DATAIN fields. The defaults for CAPS, JUST, and padding are different from those for other panel fields.

The default values for the DATAIN and DATAOUT attribute keywords, by TYPE, are summarized in Table 10.

Table 10. Default Values for DATAIN and DATAOUT Keywords

TYPE	CAPS	JUST	PADDING
DATAIN	OFF	ASIS	PAD(' ')
DATAOUT	OFF	ASIS	PADC(' ')

For more information about TYPE(CHAR) see “Character-Level Attribute Support for Dynamic Areas” on page 146.

CUA Attribute Characteristics in Dynamic Areas: You can define dynamic area DATAIN and DATAOUT attributes with CUA attribute characteristics. You do this

with the attribute keyword CUADYN(value) on the TYPE(DATAIN) or TYPE(DATAOUT) attribute statements. DATAIN and DATAOUT fields that you define with the CUADYN(value) keyword are not true CUA attribute fields, but are DATAIN and DATAOUT fields that have taken on CUA attribute characteristics.

The valid values of CUADYN for each TYPE keyword are:

Field Type	Valid Attribute Keyword
DATAIN	CEF, EE, LEF, NEF
DATAOUT	CH, CT, DT, ET, FP, LI, LID, NT, PIN, PT, SAC, SI, SUC, VOI, WASL, WT

The CUADYN(value) keyword is ignored on any type other than DATAIN or DATAOUT. The values allowed on the TYPE(DATAOUT) statement are ignored if specified on the TYPE(DATAIN) statement, and the reverse is also true.

After the DATAIN or DATAOUT attribute is defined with CUA attribute characteristics, the color, intensity, and highlighting of the attribute can only be overridden using the CUA Attribute Color Change utility.

CUA Panel-Element Types

The CUA guidelines define the default colors and emphasis techniques for individual panel elements. The CUA guidelines also request that application users be allowed to change the color and emphasis for individual panel elements. To conform with CUA principles, ISPF provides the following panel-element attributes. The CUA Attribute Change Utility, which is invoked with the CUAATTR command or by selecting the CUA attributes... choice from the Colors pull-down on the ISPF Settings panel, allows you to change the color and emphasis for individual panel elements.

You can define those panel-element attributes that have a TYPE keyword value in the panel attribute section. The panel-element attributes without a TYPE keyword value are used internally by ISPF in response to user interactions.

The following field types of the CUA panel-element attributes play a major role in determining which attribute keywords can be used with the CUA panel-element attribute values.

Field Type	Valid Attribute Keyword
Input, Unprotected	CEF, EE, LEF, NEF
Output, Protected	VOI, LID, LI
Text, Protected	ABSL, CH, CT, DT, ET, FP, NT, PIN, PS, PT, SAC, SI, SUC, WASL, WT
Text, Unprotected	AB, RP

The ISPF CUA attribute type rules for field types (defined in Table 11 on page 202) determine which attribute keywords can be used in conjunction with the CUA panel-element TYPE keywords.

Table 11 on page 202 lists the CUA values for the TYPE keyword. With each TYPE keyword are listed additional attribute keywords and their default values.

ATTR Section – TYPE Keyword

Table 11. CUA TYPE Default Keyword Values

TYPE Keyword Value	COLOR *	INTENS *	HILITE *	CAPS	JUST	PAD	PADC	SKIP	NUM- ERIC	FORMAT
AB	WHITE	HIGH	NONE	N/A	N/A	N/A	N/A	N/A	N/A	MIX
CEF	TURQ	LOW	USCORE	OFF	LEFT		B	N/A	OFF	EBCDIC
EE	YELLOW	HIGH	REVERSE	OFF	LEFT		6D	N/A	OFF	EBCDIC
LEF	TURQ	LOW	USCORE	OFF	ASIS		B	N/A	OFF	EBCDIC
NEF	TURQ	LOW ¹	USCORE	OFF	LEFT		B	N/A	OFF	EBCDIC
RP	WHITE	HIGH	NONE	N/A	N/A	N/A	N/A	N/A	N/A	MIX
ABSL	BLUE	LOW	NONE	N/A	N/A	N/A	N/A	OFF	N/A	MIX
CH	BLUE	HIGH	NONE	N/A	N/A	N/A	N/A	OFF	N/A	MIX
CT	YELLOW	HIGH	NONE	N/A	N/A	N/A	N/A	OFF	N/A	MIX
DT	GREEN	LOW	NONE	N/A	N/A	N/A	N/A	OFF	N/A	MIX
ET	TURQ	HIGH	NONE	N/A	N/A	N/A	N/A	OFF	N/A	MIX
FP	GREEN	LOW	NONE	N/A	N/A	N/A	N/A	OFF	N/A	MIX
NT	GREEN	LOW	NONE	N/A	N/A	N/A	N/A	OFF	N/A	MIX
PIN	GREEN	LOW	NONE	N/A	N/A	N/A	N/A	OFF	N/A	MIX
PS	TURQ	HIGH	NONE	N/A	LEFT	B		OFF	N/A	MIX
PT	BLUE	LOW	NONE	N/A	N/A	N/A	N/A	OFF	N/A	MIX
SAC	WHITE	LOW	NONE	N/A	N/A	N/A	N/A	OFF	N/A	MIX
SI	WHITE	HIGH	NONE	N/A	N/A	N/A	N/A	OFF	N/A	MIX
SUC	BLUE	LOW	NONE	N/A	N/A	N/A	N/A	OFF	N/A	MIX
WASL	BLUE	LOW	NONE	N/A	N/A	N/A	N/A	OFF	N/A	MIX
WT	RED	HIGH	NONE	N/A	N/A	N/A	N/A	OFF	N/A	MIX
LI	WHITE	LOW	NONE	OFF	ASIS	B		OFF	N/A	MIX
LID	GREEN	LOW	NONE	OFF	ASIS	B		OFF	N/A	MIX
VOI	TURQ	LOW	NONE	OFF	LEFT	B		OFF	N/A	MIX

Notes:

1. The attribute keywords whose value is denoted with N/A (not applicable) are not valid to use in conjunction with the corresponding TYPE keyword value.
2. It is not valid to use the attribute keywords FORMAT, REP, and OUTLINE with TYPE(AB). If used, the default values remain in effect.
3. You *cannot* change the keyword values for COLOR, INTENS, or HILITE. This is indicated with an * in the preceding table. If you attempt to change these keyword values, you will get an error condition. The exceptions are the CUA attribute types NEF, LEF, VOI, LID, and LI. NEF, LEF, VOI, LID, and LI support the INTENS(NON) keyword value.
4. You can change the default values of COLOR, INTENS, and HIGHLIGHT by using the CUAATTR command or by selecting the CUA attributes... choice from the Colors pull-down on the ISPF Settings panel.

1. You may specify the INTENS(NON) keyword with the CUA type NEF.

5. The character B in the PAD column stands for *blank*. The PAD and PADC keywords are mutually exclusive, so when PAD is set to B (blank, X'40') PADC cannot be set. The EE pad character is X'6D', underscore.
6. Three keywords not shown on this table are ATTN, REP, and OUTLINE. ATTN always is N/A, REP is defined by the dialog, and OUTLINE is NONE.
7. Another keyword not shown on this table is CKBOX. CKBOX is only used with TYPE(CEF). This keyword is ignored when running in non-GUI mode. For more information about using CKBOX, see the “CKBOX Keyword” on page 179.

Table 12 lists the CUA panel-element attributes that are used *internally* by ISPF in response to user interactions. These panel-element attributes do not have a TYPE keyword, so you cannot code them in the panel attribute section. They are considered as field-type text (that is, protected). The related attribute keywords and their default values are shown for each.

Table 12. Internal Attributes without TYPE Keyword Values

Panel Element Attribute	COLOR	INTENS	HILITE
AB Selected Choices	YELLOW	LOW	NONE
PD Choices	BLUE	LOW	NONE
Function Keys	BLUE	LOW	NONE
Informational Message Text	WHITE	HIGH	NONE
Warning Message Text	YELLOW	HIGH	NONE
Action Message Text	RED	HIGH	NONE
Panel ID	BLUE	LOW	NONE

You can change the default values of COLOR, INTENS, and HIGHLIGHT by using the CUAATTR command or by selecting the CUA attributes... choice from the Colors pull-down on the ISPF Settings panel.

Other Attribute Types

The *other attribute types* consist of the Group Box (GRPBOX) and Selected Choice (SC).

Group Box: A *group box* is a rectangle that is drawn around a group of related fields. The upper-left corner of the box contains a label for the group. Group boxes display in GUI mode only.

To specify a group box, use the type keyword **GRPBOX**. Its syntax is:
attribute-char TYPE(GRPBOX) WIDTH(wvalue) DEPTH(dvalue)

Where:

- *attribute-char* is the special character or 2-position hexadecimal value used to define the group box area within the panel body section. The area is defined by using the special character to position the upper-left corner of the group box in the panel body section.
- *wvalue* is the width of the group box, not including the borders. This value can be 0 to 99. For example, a specification of WIDTH(9) means the box can contain data 9 characters wide.
- *dvalue* is the depth of the group box, including the group box title line. This value can be 0 to 99. A minimum of 2 lines must be defined for the box. The top

)ATTR Section – TYPE Keyword

line is reserved for the label. For example, a specification of DEPTH(5) means the box consists of a group box title and 4 lines of data.

In the panel body section, the name immediately following the special character for the upper-left corner of the group box identifies the dialog variable that contains the text for the group box label. In Figure 64 on page 205, that name is *gbar*. The name cannot be specified by using a Z-variable placeholder within the panel body.

Some things to remember when defining group boxes are:

- Input/output/text fields should have ending attributes within the group box, or blanks where the box border falls.
- Dynamic areas are allowed within group boxes, and should be entirely contained within the box.
- Group boxes cannot be defined within dynamic areas.
- Dynamic areas and group boxes should not overlap.
- Scrollable areas are allowed within group boxes, and should be entirely contained within the box.
- Group boxes are allowed within scrollable areas, and should be entirely contained within the area.
- Scrollable areas and group boxes should not overlap.
- Group boxes should not be used with graphic areas.
- If the parameters WIDTH and DEPTH are not specified, the group box does not display.
- If you specify WIDTH with no DEPTH, DEPTH(0) is assumed. This means the group box ends at the bottom of the panel.
- If you specify DEPTH with no WIDTH, WIDTH(0) is assumed. This means the group box does not display.
- If the group box DEPTH is coded as zero and the group box is within a scrollable area, the group box expands to the bottom of the scrollable area.
- If the depth of the scrollable area is less than the group box DEPTH, the group box ends at the bottom of the visible scrollable area. The group box DEPTH is expanded when scrolling up, as long as the maximum group box depth has not been reached and the group box title is within the displayed portion of the scrollable area. After the group box title is no longer displayed in the scrollable area, the group box no longer appears.

Note: Even though the type GRPBOX is considered an output field, it maps to the CUA panel-element type Column Heading (CH). Therefore, its color, intensity, and highlight values can only be changed through the CUA Attribute Change Utility.

```

)ATTR
+ TYPE(TEXT) INTENS(1ow) SKIP(on)
% TYPE(TEXT) INTENS(HIGH) SKIP(on)
- TYPE(INPUT) INTENS(HIGH) CAPS(ON)
# TYPE(GRPBOX) WIDTH(44) DEPTH(7)
)BODY
* -----Group Box Example-----
%COMMAND ==>_ZCMD
+
+ #gbar
+
+ +Available          Desired+
+ +Cruise Control    Sunroof+
+ +AM/FM Stereo      AM/FM Stereo
+ +Power Brakes+
+ +Sunroof+
+
+
+
)INIT
&zcmd = &z
&gbar = 'Options'
)REINIT
&zcmd = &z
)PROC
)END

```

Figure 64. Group Box Definition

Selected Choice: The Select Choice (SC) type is an output (protected) field to be used in conjunction with the UNAVAIL attribute keyword.

When TYPE(SC) is coded with the UNAVAIL(OFF) attribute, the field has the color, intensity, and highlighting characteristics of TYPE(SAC).

When TYPE(SC) is coded with the UNAVAIL(ON) attribute, the field has the color, intensity, and highlighting characteristics of TYPE(SUC).

You can use field overrides on the choices.

Relationship to Control Variables .ATTR and .ATTRCHAR

This section describes appropriate and inappropriate override conditions for CUA and basic panel-element attributes. See “.ATTR and .ATTRCHAR” on page 282 for information on .ATTR and .ATTRCHAR.

- TYPE

CUA panel-element attribute TYPE keywords can be overridden by .ATTR or by .ATTRCHAR. You can change the TYPE:

- From INPUT/CUA input types to OUTPUT/CUA output and input types
- From OUTPUT/CUA output types to INPUT/CUA input and output types
- From TEXT/CUA text types to TEXT/CUA text types

Some exceptions are:

- Only TYPE keyword values that have a field type of input can be overridden with TYPE(EF)—error emphasis.
- CUA attribute types AB, RP, ABSL, and PS cannot be overridden, nor can they be used to override text fields.
- TYPE keyword GRPBOX can only be overridden with .ATTR(*field*), where *field* is the dialog variable name for the group box as specified in the)BODY section.

- COLOR, INTENS, HILITE

)ATTR Section – TYPE Keyword

If you change a basic attribute type to a CUA attribute type, the attribute takes on the characteristics of that particular CUA type, including the default COLOR, HILITE, and INTENS keyword values. For example, if you change a TYPE(INPUT) INTENS(HIGH) attribute to TYPE(NEF), the default color for the attribute changes from red to turquoise, the default color of the NEF attribute type. Also, after you change a basic attribute type into a CUA attribute type, the color, highlight, and intensity can only be overridden by using the CUA Attribute Color Change utility.

For example, hoping to change the TYPE(INPUT) to CUA TYPE(NEF) with the color pink, you enter the following:

```
.ATTR(FIELD1) = 'TYPE(NEF) COLOR(PINK)'
```

The result is that the field is changed to CUA TYPE(NEF), but when the COLOR(PINK) keyword is processed a dialog error message is given stating that the color of the CUA attribute cannot be overridden.

If you try to enter:

```
.ATTR(FIELD1) = 'COLOR(PINK) TYPE(NEF)'
```

The COLOR(PINK) keyword is processed before the TYPE(NEF) keyword. Thus, no error message is given concerning the changing of the color of a CUA attribute. However, when the TYPE(NEF) keyword is processed, the attribute type is changed to the CUA default color, and subsequent attempts to change the attribute's color, intensity, or highlighting result in a dialog error message.

If you change a CUA attribute type to a basic attribute type, only the type changes. The other characteristics associated with the type do not change. For example, the color associated with the CUA type does not change unless you specifically override the color using the COLOR keyword. If you change the CUA type ET to basic type TEXT, the color remains turquoise unless you purposely override it.

- CAPS, JUST, PAD, PADC, SKIP, ATTN, NUMERIC, FORMAT, REP, OUTLINE
If the keyword is applicable on the)ATTR statement, it can be overridden using the attribute override statements. Those panel attribute keywords whose value is denoted as N/A (not applicable) are not valid in attribute override statements.
- CUADYN(value) keyword
The CUADYN(value) attribute keyword can be used in .ATTRCHAR statements for DATAIN or DATAOUT attribute characters. The keyword values listed in "CUA Attribute Characteristics in Dynamic Areas" on page 200 for DATAOUT attributes can only override DATAOUT attribute characters. Those listed for DATAIN attributes can only override DATAIN attribute characters.
- Input fields with LISTBOX(ON|name) or DDLIST(ON|name)
You can override input fields with LISTBOX(ON|name) or DDLIST(ON|name) that are coded in the)ATTR section. You do this by using the .ATTR or .ATTRCHAR statements to set LISTBOX, DDLIST, CSRGRP, WIDTH, and DEPTH values for the input field.
- Input fields with COMBO(ON|name)
You can override input fields with COMBO(ON|name) that are coded in the)ATTR section. You do this by using the .ATTR or .ATTRCHAR statements to set COMBO, CSRGRP, and DEPTH values for the input field.

Defining the Body Section

The)BODY (panel body) section of the panel definition specifies the format of the panel as the user sees it. Each record in the body section corresponds to a line on the display.

The section begins with the)BODY header statement, which can be omitted if there are no preceding sections and no change to the default attribute characters. The)BODY header statement and all associated keywords must be specified on the same line. The panel body ends with any of the following statements:

-)MODEL
-)AREA
-)INIT
-)REINIT
-)PROC
-)FIELD
-)HELP
-)PNTS
-)LIST
-)END.

```
)BODY
[KANA]
[WINDOW(width,depth)]
[CMD(field name)]
[SMSG(field name)]
[LMSG(field name)]
[ASIS]
[WIDTH(width)]
[EXPAND(xy)]
[DEFAULT(def1def2def3)]
[FORMAT (EBCDIC|DBCS|MIX)]
[OUTLINE ([L] [R] [O] [U] |BOX|NONE)]
```

Notes:

1. There are system-defined (default) areas for the display of messages and the command field. You can specify alternate locations using the WINDOW, CMD, SMSG, LMSG, and ASIS keywords on the)BODY header statement.
2. The WIDTH and EXPAND keywords on the)BODY header statement control the width of a panel. Both keywords are optional. You can specify either or both. However, if the panel definition width is greater than 80 characters, the WIDTH keyword must be used. If the WIDTH keyword is used, the WIDTH variable must be set in the variable pool before the panel is displayed.
3. DEFAULT, FORMAT, and OUTLINE can also be specified on the)ATTR section statement. The values specified on the)BODY section statement take precedence.

where:

KANA

Include the KANA keyword when Katakana characters will appear within the panel and you have not specified an extended code page using the)CCSID section.

WINDOW(*width,depth*)

Identifies the width and depth of the window that the Dialog Manager uses

)BODY Section

when displaying the panel in a pop-up window. The values do not include the panel borders; the Dialog Manager adds them outside of the dimension of the width and depth values.

Note: When you are running in GUI mode, the width you specify is respected regardless of whether the panel is displayed in a pop-up window. The depth is honored when the panel is displayed in a pop-up window. If you specify a depth greater than the depth of the panel definition, extra lines are generated to fill the space. Any extendable areas (such as AREA(DYNAMIC), or AREA(SCRL) with EXTEND(ON)) might be truncated at the depth of the pop-up window.

For panels not displayed in a pop-up window, the depth is the minimum of the specified depth and the actual number of)BODY records in the panel definition. Extendable areas are not truncated. That is, the depth expands to the length of the logical screen.

The width that you specify must be a numeric value greater than or equal to the minimum width of 8 characters. The depth that you specify must be a numeric value greater than 0.

Note: The width and depth cannot be specified by a dialog variable.

For panels that are not being displayed in a pop-up window (no active ADDPOP), ISPF validates the width and depth values against the screen size and issues an error message if either of the following is true:

- The width is greater than the current device width.
- The depth is greater than the current device depth.

For help panels and panels that are being displayed in a pop-up window (after ADDPOP service), ISPF validates the width and depth values against the screen size minus the frame and issues an error message if:

- The depth is greater than the screen depth minus 2.
- The depth is less than the screen depth minus 2 and the width is greater than the screen width minus 3.
- The depth is equal to the screen depth minus 2 and the width is greater than the screen width minus 4.

When running in GUI mode, the frame will be what you specified on ISPSTART unless its ADDPOP was specified in a dialog. In this case, the frame is a dialog frame.

The Dialog Manager recognizes the WINDOW keyword for panels displayed in a pop-up window (after an ADDPOP service request has been issued), and when running in GUI mode. If the panel is not being displayed in a pop-up window and you are not in GUI mode, ISPF validates the keyword, but ignores it. If the text on the panel you are defining exceeds the width of the window, the panel fields do not wrap. All fields end at the window width.

Note: Text coded in column 1 of the panel body does not appear when a panel is displayed in a pop-up window. This occurs because ISPF places a field attribute in the column following the pop-up border character, due to hardware requirements. Without the field attribute after the border character, subsequent panel text would have the attributes (color, intensity, and so on) of the window frame. Therefore, your panel text should be coded so that it does not start in column 1 of the body if you are going to display your panel in a pop-up window.

Attributes coded in column 1 of the panel body overlay the field attributes that ISPF generates following the left side of the window frame. Therefore, an attribute coded in column 1 of the panel will be in effect for subsequent text.

CMD*(field-name)*

Identifies the panel field (variable name) to be treated as the command field. The field type must be a CUA input type. If the CMD keyword is omitted from a)BODY statement, ISPF uses the first input field as a default command field. You can specify that you do not want a command field by using CMD(). Do not use this option for a table display. You must have a command field for a table display.

SMSG*(field-name)*

Identifies the panel field (variable name) where the short message, if any, is to be placed. The field type must be a CUA output type. If the message is longer than the length of this field, the message is placed in a pop-up window. The SMSG keyword does not effect placement of the TOP-ROW-DISPLAYED indicator which is right-justified on the top line of the display, or just below the action bar separator line if an action bar is defined.

LMSG*(field-name)*

Identifies the panel field (variable name) where the long message, if any, is to be placed. The field type must be a CUA output type. If the message is longer than the length of this field, the message is placed in a pop-up window.

Notes:

1. For CMD, SMSG, and LMSG the field-name must be within the)BODY section, not within a scrollable area or table.
2. For long or short messages in pop-up windows, if the message originates from panel processing, as in a verification error message, the message pop-up window is placed adjacent to the field that is the object of the validation.
3. The format of the command, long-message, and short-message fields must not be FORMAT(DBCS). Because a FORMAT(EBCDIC) field does not display DBCS characters correctly, FORMAT(MIX) is recommended.
4. For additional information about the placement of the command and long message fields, see the section on understanding ISPF panels in the *z/OS ISPF User's Guide Vol I*.

ASIS

Specifies that the command and long message fields are to appear on the display as specified in the panel definition. When ASIS is specified, any user request, using SETTINGS option 0 or by setting system variable ZPLACE, to reposition the command and long message fields is ignored.

WIDTH*(width)*

The number of columns to use in formatting the panel. *width* can be a constant or a dialog variable, including the system variable &ZSCREENW. The specified width must not be less than 80 or greater than the width of the terminal on which the panel is to be displayed. If the WIDTH keyword is not specified, the default is 80.

EXPAND*(xy)*

The repetition delimiter characters. The delimiters can be used on any line within the panel body to enclose a single character that is repeated to expand the line to the required width. The starting and ending delimiter can be the same character. If no delimiters are specified, or if any line does not contain

)BODY Section

the delimiters, then the line is expanded to the required width by adding blanks on the right. The delimiter characters *cannot* be specified with a dialog variable.

Before the panel is displayed, it is formatted according to the WIDTH and EXPAND keyword values as if the *expanded format* of the body were originally coded in the panel definition. For example:

```
)BODY WIDTH(&EDWIDTH) EXPAND(//)
+-- &TITLE -----/-----
%COMMAND ==>_ZCMD / / +SCROLL%==>_SCRL +
+
%EMPLOYEE NUMBER:@EMPLN / / @
```

In the title line, hyphens are repeated to expand the line to the width specified by &EDWIDTH. The command field and the employee number field would both be expanded with repeated blanks.

If more than one repetition character appears in a line of the panel body, each of the characters is repeated an equal number of times. For example:

```
)BODY EXPAND(#@)
TUTORIAL #-@ TITLE OF PAGE #-@ TUTORIAL
```

would become:

```
TUTORIAL ----- TITLE OF PAGE ----- TUTORIAL
```

ISPF treats as an error a request to display a panel that is wider than the physical screen or current logical screen for a 3290 terminal. ISPF displays a *box* panel indicating the error. For the 3290, if a panel that is wider than 80 characters is being displayed, and the user attempts to divide the screen vertically (SPLITV command), ISPF denies the request and displays an error message. Remember that the panel is displayed as though the *expanded format* of the body were originally coded in the panel definition. Therefore, be careful when expanding text fields that contain substitutable variables, so that meaningful text is not truncated. For example:

```
)BODY EXPAND(//)
TUTORIAL /-/ &VAR1 /-/ TUTORIAL
```

would become:

```
TUTORIAL ----- &VAR1 ----- TUTORIAL
```

Then, if &VAR1 had the value 'ABCDEFGF' when the screen was displayed, the following line would result:

```
TUTORIAL ----- ABCDEFG ----- TUTORI
```

To avoid this problem, provide a few blanks at the end of the text string, as follows:

```
TUTORIAL /-/ &VAR1 /-/ TUTORIAL      +
```

Table 13 on page 211 and Table 14 on page 211 describe the display width, data expansion width (resulting from EXPAND keyword on the)BODY statement), and the pop-up window width based on various WINDOW/WIDTH keyword combinations.

Table 13. Display in Primary Window

WINDOW/WIDTH Combinations	DISPLAY	EXPANSION
no WINDOW, no WIDTH	WIDTH (def. 80)	WIDTH (def. 80)
WINDOW, no WIDTH	WIDTH (def. 80)	WINDOW value
no WINDOW, WIDTH	WIDTH	WIDTH value
WINDOW <= WIDTH	WIDTH	WINDOW value
WINDOW > WIDTH	ERROR	ERROR

Table 14. Display in Pop-up Window

WINDOW/WIDTH Combinations	DISPLAY	EXPANSION	WINDOW
no WINDOW, no WIDTH	WIDTH (def. 80)	WIDTH (def. 80)	(76, 22)
WINDOW, no WIDTH	WIDTH (def. 80)	WINDOW value	WINDOW (w, d)
no WINDOW, WIDTH	WIDTH	WIDTH value	(76, 22)
WINDOW <= WIDTH	WIDTH	WINDOW value	WINDOW (w, d)
WINDOW > WIDTH	ERROR	ERROR	ERROR

Note: ISPF will issue an error message if you attempt to display a panel in a pop-up window where the WINDOW width value is greater than the width of the underlying panel.

DEFAULT(*def1def2def3*)

You can use the DEFAULT keyword to specify the characters that define a high-intensity text field, a low-intensity text field, and a high-intensity input field, respectively. The value inside the parentheses must consist of exactly three characters, not enclosed in single quotes and not separated by commas or blanks.

The DEFAULT keyword can also be specified on the)ATTR section statement.

FORMAT(EBCDIC | DBCS | MIX)

The default value for a TYPE(INPUT) and a TYPE(DATAIN) field is FORMAT(EBCDIC). These two default values can be changed by using the)ATTR statement or the)BODY statement. These values, in turn, can be overridden if explicitly specified on a subsequent statement. For example, the net result of the following two statements is FORMAT(DBCS):

```
)BODY FORMAT(MIX)
$ TYPE(INPUT) FORMAT(DBCS)
```

OUTLINE([L][R][O][U] | BOX | NONE)

The default value for OUTLINE is NONE. The default value for TYPE(INPUT) and TYPE(DATAIN) fields can be specified on the)ATTR or)BODY statement and can be overridden by the OUTLINE keyword. For example:

```
)BODY OUTLINE(U)
@ TYPE(INPUT) OUTLINE(BOX)
```

A Sample Panel Body Section

The sample panel definition, shown in Figure 65 on page 212, consists of a panel body followed by an)END control statement. It has no attribute, initialization, reinitialization, or processing sections, and uses the default attribute characters.

)BODY Section

This data entry panel has 11 input fields (for example, ZCMD and TYPECHG) indicated with the underscore attribute character. It also has a substitutable variable (EMPSER) within a text field. The first two lines of the panel and the arrows preceding the input fields are all highlighted, as indicated by the percent sign attribute characters. The other text fields are low intensity, as indicated by the plus sign attribute characters.

```
)Body
%------ EMPLOYEE RECORDS -----
%COMMAND ==>_ZCMD %
%
%EMPLOYEE SERIAL: &EMPSER
+
+ TYPE OF CHANGE==>_TYPECHG + (NEW, UPDATE, OR DELETE)
+
+ EMPLOYEE NAME:
+ LAST %>_LNAME +
+ FIRST %>_FNAME +
+ INITIAL%>_I+
+
+ HOME ADDRESS:
+ LINE 1 %>_ADDR1 +
+ LINE 2 %>_ADDR2 +
+ LINE 3 %>_ADDR3 +
+ LINE 4 %>_ADDR4 +
+
+ HOME PHONE:
+ AREA CODE %>_PHA+
+ LOCAL NUMBER%>_PHNUM +
+
)End
```

Figure 65. Sample Panel Definition

Figure 66 shows the panel as it appears when displayed, assuming that the current value of EMPSER is 123456 and that the other variables are initially null.

```
----- EMPLOYEE RECORDS -----
COMMAND ==>

EMPLOYEE SERIAL: 123456

TYPE OF CHANGE ==> (NEW, UPDATE, OR DELETE)

EMPLOYEE NAME:
LAST ==>
FIRST ==>
INITIAL ==>

HOME ADDRESS:
LINE 1 ==>
LINE 2 ==>
LINE 3 ==>
LINE 4 ==>

HOME PHONE:
AREA CODE ==>
LOCAL NUMBER ==>
```

Figure 66. Sample Panel—When Displayed

Defining the CCSID Section

The)CCSID section identifies the Coded Character Set Identifier used in the panel definition.

```
)CCSID [NUMBER(XXXXX)]
```

where:

NUMBER(XXXXX)

The CCSID of the EXTENDED CODE PAGE as defined by Character Data Representation Architecture. Refer to “Supported CCSIDs” on page 333 for which CCSIDs are supported.

The)CCSID section must be the first section in the panel as illustrated in the following example:

```
)CCSID NUMBER(00037)
)PANEL
)BODY
%----- NAME OF PANEL -----
%COMMAND ==> __ZCMD
  :
)END
```

If the CCSID section is used, the single-byte text characters in the)BODY,)MODEL, or)AREA section of the panel are translated to the equivalent character (or a period if the character does not exist) in the terminal code page for display. ISPF scans the panel for a text attribute, notes the position, and then scans for a non-text attribute. When the non-text attribute is found, ISPF translates the text between the text attribute and the non-text attribute. Thus you must have one text attribute defined before any text you want translated. This translation occurs only if the code page indicated by the CCSID is different from the code page of the terminal.

The ISPF program scans the panel record for a text attribute, notes the position, then scans for a non-text attribute. When the non-text attribute is found, ISPF translates the text found between the text attribute and the non-text attribute. Therefore, you must have one text attribute defined prior to any text you want translated.

All characters in the panel source that are not in the)BODY text must be in the Syntactic Character Set:

- A–Z
- a–z
- 0–9
- + < = > % & * " '
- () , _ - . / : ; ?

Note: Lowercase a–z can be used for any CCSID supported by ISPF except the Japanese (Katakana) Extended CCSID 930.

See Chapter 11, “Extended Code Page Support,” on page 329

Defining the END Section

The)END section identifies the end of the panel definition. It is a required section.

```
)END
```

)END Section

The definition consists only of the)END statement. Any lines placed after the END statement are ignored.

```
)PANEL
)BODY
%----- NAME OF PANEL -----
%COMMAND ==> __ZCMD
:
)END
```

Defining the FIELD Section

The)FIELD section of a panel definition specifies what fields, if any, are scrollable fields. Defining a field as scrollable provides the ability to display and input a variable larger than the display area that the dialog variable occupies. The LEFT, RIGHT, and EXPAND primary commands are active when the cursor is positioned within the variable on the display panel. These enable left and right scrolling and expansion of the variable into a pop-up window.

```
)FIELD
  FIELD(field-name)
  [LEN(value | field-name)]
  [IND(field-name,value)]
  [LIND(field-name,value)]
  [RIND(field-name,value)]
  [SIND(field-name,value)]
  [LCOL(field-name)]
  [RCOL(field-name)]
  [SCALE(field-name)]
  [SCROLL(value | field-name)]
```

Notes:

1. Each entry in the)FIELD section must begin with the keyword FIELD.
2. With the exception of the LCOL parameter, all dialog variable names must be unique to each parameter.
3. Scrollable field support is panel specific. A subsequent panel display that references the same variable but does not define it as scrollable may cause data truncation (depending on the data lengths involved).

where:

FIELD(*field-name*)

The name of the field on the panel that this statement controls.

LEN(*value* | *field-name*)

Length of the displayed variable.

value: Specify a value between 1 and 32 767.

field-name: The length dialog variable can be used to specify an initial length if it contains a value between 1 and 32 767. After the display, this variable will contain the calculated display length.

Calculated display length: The length of the variable will be the maximum value of the default display variable length and the specified length.

Default: If the LEN parameter is not specified, the field will default to the length of the dialog variable, if it exists. For variables referenced in a)MODEL section, the dialog variable length will be the maximum of all instances on the current display for that variable.

IND(*field-name,value*)

Left and right scroll indicator dialog variable.

field-name: This must refer to a 2 byte scroll indicator dialog variable that will be updated on the panel to indicate whether left and right scrolling can be performed.

value: (Default -+) Specify a 2 byte literal (enclosed in quotes) to override the default scroll indicator values. Each byte must be nonblank.

Displays as:

-+ : Indicates that you can scroll left and right
 - : Indicates that you can only scroll left
 + : Indicates that you can only scroll right.

Panel definition:

```
)ATTR
| TYPE(OUTPUT) CAPS(OFF) JUST(ASIS )
| TYPE(INPUT) CAPS(OFF) JUST(ASIS )
)BODY
+Scrollable Variable:_SCRFLD          |SCRIND+
)FIELD
FIELD(SCRFLD) IND(SCRIND,'<>') /* replace -+ with <> */
```

Panel display:

Scrollable Variable: CDEFGHIJKLMNOPQRST <>

LIND(*field-name,value*)

Left scroll indicator dialog variable.

field-name: This must refer to a 1 byte left scroll indicator dialog variable that will be updated on the panel to indicate whether left scrolling can be performed.

value: (Default -) Specify a 1 byte nonblank literal (enclosed in quotes) to override the default left indicator value.

Displays as:

value : Indicates that you can scroll left
 blank : Indicates you are positioned at the start of the field.

Panel definition:

```
)FIELD
FIELD(SCRFLD) LIND(LSCRIND,'<') /* replace - with < */
```

RIND(*field-name,value*)

Right scroll indicator dialog variable.

field-name: This must refer to a 1 byte right scroll indicator dialog variable that will be updated on the panel to indicate whether right scrolling can be performed.

value: (Default +) Specify a 1 byte nonblank literal (enclosed in quotes) to override the default right indicator value.

Displays as:

value : Indicates that you can scroll right
 blank : Indicates you are positioned at the end of the field.

)FIELD Section

Panel definition:

```
)FIELD  
FIELD(SCRFLD) RIND(RSCRIND,'>') /* replace - with > */
```

SIND(*field-name,value*)

Separator scroll indicator dialog variable. This field will be initialized with the value repeated for the length of the field on the panel. If the field is scrollable to the left, the leftmost byte will be the value of the left indicator (default '-'). If the field is right scrollable, the rightmost byte will be the value of the right indicator (default '+').

field-name: This must refer to a 3 byte scroll indicator dialog variable that will be updated on the panel to indicate whether left and right scrolling can be performed.

value: (Default '<->') Specify a 3 byte literal (enclosed in quotes) to override the default separator indicator values. The 3 bytes represent the left scroll indicator, the separator value and the right scroll indicator respectively. Each byte must be nonblank.

Panel definition:

```
)ATTR  
| TYPE(OUTPUT) CAPS(OFF) JUST(ASIS )  
_ TYPE(INPUT) CAPS(OFF) JUST(ASIS )  
)BODY  
+Separator Variable:|SEPIND  
+Scrollable Variable:|_SCRFLD  
)FIELD  
FIELD(SCRFLD) SIND(SEPIND)
```

Panel display:

```
Separator Variable: <----->  
Scrollable Variable: CDEFGHIJKLMNOPQRST
```

LCOL(*field-name*)

Left column dialog variable - to display current left position.

field_name: This must refer to a dialog variable that will be updated when the field is scrolled to contain the left column value. You can use this to specify an initial left column position for the scrollable field. It must be a numeric value greater than or equal to 1. Values greater than the maximum left column position will be set to the maximum left column position.

Note: Fields with the same left column dialog variable will scroll simultaneously and will have the same left column value up to the maximum for each field.

RCOL(*field-name*)

Right column dialog variable - to display current right position.

field_name: This must refer to a dialog variable that will be updated when the field is scrolled to contain the right column value. It is an output field only. Any pre-existing values will be ignored and will be replaced with the current right column value.

SCALE(*field-name*)

Scale indicator dialog variable. This field will be initialized with a scale line reflecting the current columns within the field being displayed. The variable will occupy the display length on the panel with the a value as follows:

```
-----1-----2-----3... etc.
```

field_name: This must refer to the dialog variable that is placed on the panel in the position at which the scale line is to be initialized.

Panel definition:

```
)ATTR
| TYPE(OUTPUT) CAPS(OFF) JUST(ASIS )
_ TYPE(INPUT) CAPS(OFF) JUST(ASIS )
)BODY
+Scale Line          :|SCLIND
+Scrollable Variable:_SCRFLD
)FIELD
  FIELD(SCRFLD) SCALE(SCLIND)
```

Panel display:

```
Scale Line          : --+-----1-----+-----2
Scrollable Variable: CDEFGHIJKLMNOPQRST
```

SCROLL(*value* | *field-name*)

Scroll control field.

value: OFF - field is not scrollable
ON - field is scrollable

field_name: specifies a scroll control dialog variable which you can set to a value of OFF to turn scrolling off from the application or from the panel.

Default: If the SCROLL parameter is not specified, the default for the scroll control is ON.

Primary Commands for Scrollable Fields

The following commands will apply when the cursor has been placed within a scrollable field.

LEFT Scroll left the specified scroll amount.

RIGHT

Scroll right the specified scroll amount.

EXPAND

Display the variable in a dynamic area in a popup expand window. If the scrollable field is input then you will be able to update the variable in the expand window.

The expand panel displays the variable in a scrollable dynamic area. Standard up and down scrolling is supported. You can display the variable in character and hexadecimal using the following primary command.

HEX ON/OFF Turn hexadecimal display on and off

The setting will be remembered for subsequent expand processing.

If a scroll field is found on the current panel, then the scroll amount will be honored as for up and down scrolling, where:

PAGE is the equivalent of the length of the display field

DATA is the equivalent of the length of the display field minus 1

HALF is half the length of the display field

CSR will scroll relative to the cursor position

You can enter **M** in the command line to scroll the maximum distance in the left or right direction. The maximum right position is the field length minus the display

)FIELD Section

length. The maximum left position is 1. You can also enter a number in the command line to specify the number of characters to scroll to the left or right.

Example

Panel source:

```
)ATTR
| TYPE(OUTPUT) CAPS(OFF) JUST(ASIS )
|_ TYPE(INPUT) CAPS(OFF) JUST(ASIS )
)BODY
%-----LEFT / RIGHT / Expand Example 1 -----
%OPTION ==>_ZCMD
%
+ Testcase 1
+
+ Field          Value          Scroll
+ -----
+ Value          : SCRFLD      |SFIND
+ Left & Right   : |SFLIND      |SFRIND
+ Left column    :_SFLCOL
+ Right column   :_SFRCOL
+ Length        :_SFLEN
)INIT
.CURSOR = ZCMD
)FIELD
FIELD(SCRFLD) LEN(SFLEN)
LCOL(SFLCOL) RCOL(SFRCOL)
IND(SFIND) LIND(SFLIND) RIND(SFRIND)
SCROLL(SFCTL)
)END
```

REXX to display panel:

```
/* REXX - Example 1 FOR LEFT/RIGHT/EXPAND PANEL FUNCTIONS */
ARG SFCTL
SCRFLD = 'abcdefghijklmnopqrstuvwxyz' /* initialize field */
SFLCOL = 3 /* initial left position */
SFLEN = 84 /* initial length */
DO UNTIL RC = 8
ADDRESS ISPEXEC
'DISPLAY PANEL(SFSAMP1)' /* display panel */
END
```

Initial panel display:

```
-----LEFT / RIGHT / Expand Example 1 -----
OPTION ==>

Testcase 1

Field          Value          Scroll
-----
Value          : cdefghijklmn -+
Left & Right   : -              +
Left column    : 3
Right column   : 14
Length        : 84
```

Changing the scroll indicators in the panel definition to the following:

```
)FIELD
FIELD(SCRFLD) LEN(SFLEN)
LCOL(SFLCOL) RCOL(SFRCOL)
IND(SFIND, '<>') LIND(SFLIND, '<') RIND(SFRIND, '>')
SCROLL(SFCTL)
)END
```

will change the panel display to:

```
-----LEFT / RIGHT / Expand Example 1 -----
OPTION ==>>

Testcase 1

Field          Value          Scroll
-----
Value          : cdefghijklmn <>
Left & Right   : <              >
Left column    : 3
Right column   : 14
Length        : 84
```

If PF4 is set to the value EXPAND and PF4 is pressed while the cursor is positioned within the scrollable field, the following will be displayed:

```
----- SCRFLD+0 -----
Command ==>>
Line 1 of 2
Scroll ==>> CSR
abcdefghijklmnopqrstuvwxyz
```

PASSTHRU

The PASSTHRU keyword is intended for use on dynamic-area fields. When help is requested on the field, control returns to the dialog. No help panel or message is displayed.

Notes:

1. Using the PASSTHRU keyword on reference phrases within scrollable areas can cause unpredictable results.
2. System variables ZCURFLD and ZCURPOS can be used to determine the cursor position. You must define a)PANEL section for ZCURFLD and ZCURPOS to be set.

Specifying the Value for the Field-Name and Help-Panel-Name

When modifying or adding statements to the)HELP section of a new or existing source panel, you must adhere to these rules to prevent unexpected results and errors when the source panel is processed.

The field-name must have the following characteristics:

- 1-8 characters in length
- First, or only, character must be A-Z or a-z
- Remaining characters, if any, must be A-Z, a-z, or 0-9.

Lowercase characters are translated to their uppercase equivalents.

The help-panel-name must have the following characteristics:

- 1-8 characters in length
- The first (or only) character must be A-Z or a-z
- Remaining characters must be A-Z, a-z, or 0-9.

Lowercase characters are translated to their uppercase equivalents.

The action bar choice and pull-down choice elements, have no associated field name. ISPF uses the following convention when generating a field-name value for these panel elements.

Action bar choice field-names will have the following format:

ZABCxx

where:

ZABC The field-name prefix

xx The number of the action bar choice

Pull-down choice field-names have the following format:

ZPDCxxyy

where:

ZPDC The field-name prefix

xx The number of the action bar choice

yy The number of the pull-down choice within this action bar choice

See "Specifying Action Bar Choices in Panel)BODY Section" on page 159 to determine the numbering sequence ISPF uses for these panel elements.

Defining the Initialization Section

The initialization section specifies the initial processing that is to occur before the panel is displayed.

)INIT

)INIT Section

It begins with the)INIT header statement and ends with either the)REINIT,)PROC,)HELP, or)END header statement. The number of lines allowed in an)INIT section depends upon the storage size available for panel processing at execution time.

The variables that are displayed in the panel body reflect the contents of the corresponding dialog variables after the)INIT section has been processed, just before the panel is displayed. The input fields are automatically stored into the corresponding dialog variables immediately following display and before processing the)PROC section.

See “Formatting Panel Definition Statements” on page 234 for additional information.

Defining the LIST Section

The)LIST section of the panel definition specifies what list choices appear on your screen. It can be useful if the selection list is displayed in a scrollable area and some of the list choices might not be visible. With the)LIST section coded, all of the choices are built into the list box, drop-down list, or combination box even if some are not immediately visible in the scrollable area.

It is used in conjunction with the attribute keywords DDLIST(name), LISTBOX(name), and COMBO(name). These keywords match the list box attributes to the corresponding list choices found in the)LIST list-name section of the panel.

The)LIST section, if you use it, follows the)PROC section. The)LIST section contains the following parameters when used with list boxes and drop-down lists:

```
)LIST list-name  
VAL(value) CHOICE(value)
```

The)LIST section contains the following parameters when used with combination boxes:

```
)LIST list-name  
CHOICE(value)
```

where:

list-name

The name of the list. It must match a LISTBOX(name), DDLIST(name), or COMBO(name) specified on an input field in the)ATTR section. The name can be 1 to 8 characters long. Alphanumeric characters A-Z, a-z, 0-9, #, \$, or @ can be used in the name, but the first character cannot be numeric. Lowercase characters are converted to their uppercase equivalents.

VAL(*value*)

This parameter is used for list boxes and drop-down lists only. It is *not* used for combination boxes. The value can be a variable or text. It must be 3 characters or less (more than three characters are truncated without warning) and is used as the value placed into the CEF field when the choice is selected.

CHOICE(*value*)

This parameter is used with list boxes, drop-down lists, and combination

boxes. The value can be a variable or text. If the value is a variable, the ampersand (&) must be in the first column following the left parenthesis of the CHOICE keyword. The length of the variable data is limited to 99 single-byte characters. If the variable data is longer than 99 bytes, it will be truncated.

```
CHOICE(&var)
```

If the value is a single word text string it is not necessary to enclose it in single quotation marks.

```
CHOICE(3278)
```

If the value is more than a single word of text, the phrase must be enclosed in single quotation marks.

```
CHOICE('3278 terminal type')
```

Literal values can be split between lines by coding a plus sign (+) as the last character on each line that is to be continued. The plus sign is used as a continuation character.

```
CHOICE('This is an example of a continuation +  
of the literal string')
```

The)LIST section must contain a list-name. For list boxes and drop-down lists, it also must contain a VAL and a CHOICE for each of the choices to display in the list. Each entry in the)LIST section must contain the keywords in the following order: VAL(value) CHOICE(value). For combination boxes, the list section must contain a CHOICE(value) for each of the choices to display in the list. The data in the lists is displayed in the order in which you define the choices in the)LIST section.

Defining the Model Section

The)MODEL section defines how each table row is to be formatted. Because the model section is used only for table display panels, it is discussed under the section Defining Table Display Panels—see “Requirements for Model Section” on page 137.

Defining the Panel Section

The)PANEL section specifies the keylist that will be used for the panel, identifies where the keylist is to be found, controls specific CUA display characteristics of the panel, specifies the image that will be used on the panel, and specifies the row and column placement for the upper left corner of the image.

The IMAGE keyword is used to show images on panels in GUI mode. It is ignored in 3270 mode. ISPF supports image files in the Graphical Interchange Format (GIF).

ISPF ships image files in sample library SISPSAMP. The panel ISR@PRIM uses three of the GIF image files: ISPFGIFL, ISPFGIFS, and ISPEXIT.

To use images, store the image files on the host in a partitioned data set and allocate this image data set to ddname ISPILIB before invoking ISPF. For more information about allocating this image library, see the section called Allocating Optional Image ISPF Library in the *z/OS ISPF User's Guide Vol 1*.

Images can be placed on unused panel space. They should not be positioned on text or panel fields. When an image is requested, ISPF does a query and file transfer to download the image specified to the workstation. The image is

)PANEL Section

downloaded to the *image path*, which the user specifies from the GUI Panel Settings window (Option 0). See the *z/OS ISPF User's Guide Vol II* for details. If no image path is specified, ISPF downloads the images to the workstation's working directory.

```
)PANEL [KEYLIST (keylist-name [,keylist-applid,SHARED])]
[IMAGE (image-name,row,col)]
```

where:

KEYLIST

keylist-name

Required when KEYLIST is specified. The keylist name must have the following characteristics:

- 1–8 characters in length
- First, or only, character must be A–Z or a–z
- Remaining characters, if any, must be A–Z, a–z, or 0–9.

Lowercase characters are translated to their uppercase equivalents.

keylist-applid

Optional. Application ID used at run time to find the keylist. It has a maximum length of 4 characters, the first of which must be alphabetic. Any remaining characters can be alphabetic or numeric.

SHARED

Optional. When specified, ISPF looks *only* at the shared keylist for the panel. If the user issues the KEYLIST OFF or KEYLIST PRIVATE commands, they have no effect; the keylist in xxxxKEYS table allocated to ISPTLIB is used.

IMAGE

image-name

Required when IMAGE is specified. The image-name identifies the image to be displayed. The image-name can be a variable, which should follow ISPF's variable naming conventions.

Note: ISPF downloads images only in panel initialization processing.

Variables for images should only be set in the)INIT section of your panel definition. Variables for images in panel sections other than the)INIT section are not supported unless the image exists on the PC Image Path you specify.

row,col

The row and column specify the starting position, upper left corner, of the image. The row and column can be numeric or variables. Variables for the row and column should follow ISPF's variable naming conventions. If no row or column is specified, you must code commas as place holders, and the row and column will default to 0,0. For example:

```
IMAGE(imagea,,)
```

It is left to the dialog developer to select appropriate row and column values such that the image will display. ISPF checks for valid numeric values 0-9, but does not check for any limits.

When a *keylist-name* is specified without a *keylist-applid*, ISPF searches for the named keylist in the:

- Keylists for the application ID that is currently running
- ISP applid (if not found in the above applid and the name of the application ID is not ISP).

If the KEYLIST keyword is not found on the)PANEL statement, then the default keylist, ISPKYLST, is used.

Before runtime processing, any keylist (other than the default ISPKYLST) referenced in a panel's definitions must have been created and stored. If you add or modify the)PANEL KEYLIST statement in the definition of an existing source panel, you must create the keylist if it does not already exist. New keylists can be created using ISPF option 0 or using the Dialog Tag Language.

Keylist variables

The following variables are used by the keylist function:

ZKLUSE	Y or N, this variable indicates whether the keylists are being used for an application ID or not. For example, if KEYLIST OFF has been issued, &ZKLUSE is N. This variable is stored in the application profile. The VPUT service can be used by your application to set this value. Putting a value of N in &ZKLUSE to the profile pool is equivalent to issuing the KEYLIST OFF command. Putting a value of Y in &ZKLUSE to the profile pool is equivalent to issuing the KEYLIST ON command.
ZKLNAME	contains the name of the keylist of the panel currently being displayed. If no keylist is defined for the panel or the keylist is not being used, &ZKLNAME is blank.
ZKLAPPL	contains the application ID where the keylist of the panel currently being displayed is found. If no keylist is defined for the panel or the keylist is not being used, &ZKLAPPL is blank.
ZKLTYPE	P or S, this variable indicates that the keylist for the panel currently being displayed is a private (P) copy defined in the profile table, or a shared (S) copy defined in the xxxxKEYS table (where xxxx is the application ID of the keylist (ZKLAPPL)).
ZKLPRIV	Y or N, this variable indicates that ISPF is to look at both the private and shared keylist (Y, the default) or that it is to look at only the shared keylists (N). This variable is stored in the application profile. The VPUT service can be used by the application to set this value. Putting a value of N in &ZKLPRIV to the profile pool is equivalent to issuing the KEYLIST SHARED command. Putting a value of Y in &ZKLPRIV to the profile pool is equivalent to issuing the KEYLIST PRIVATE command.

Note: This variable shows and determines where ISPF *looks* for a keylist. &ZKLTYPE is a non-modifiable variable that shows where ISPF found the keylist.

CUA Display Characteristics

The)PANEL section controls specific CUA display characteristics of a panel. Specifying the)PANEL statement in the panel source definition affects the same display characteristics controlled by selecting the Panel display CUA mode option on the ISPF Settings panel (Option 0). See the *z/OS ISPF User's Guide Vol II* for more information.

The)PANEL statement controls the following CUA display characteristics:

)PANEL Section

- Display and placement of the command line and long message text
- Building and display of the named keylist in the Function Key Area (FKA)
- Handling of undefined or null function key definitions
- Execution of the CANCEL and EXIT commands
- Setting of three system control variables that relate to the position of the cursor after panel display.

Command Lines and Long Messages

When the)PANEL section is used, the ISPF default command line placement is at the bottom of the panel (above the function key area, if it is displayed). Long messages are displayed above the command line. To override the ISPF default, go to the ISPF Settings panel and specify Command line placement - ASIS. This setting places the command line and long message as they are specified in your panel definition (usually at the top of the panel). See *z/OS ISPF User's Guide Vol I*. Changes to the)BODY section also affect command line and long message placement. The ASIS keyword on the)BODY section overrides ISPF defaults. The WINDOW keyword also affects the displaying of the command line and long messages. See "Defining the Body Section" on page 207.

You can specify to not have a command line by including the keyword CMD() with no value on the)BODY statement. This is valid only for displaying panels with the DISPLAY service. In this case, the default position of the long message is at the bottom of the panel above the FKA, if it is displayed. Panels (tables) displayed with the TBDISPL service must specify a command area either by coding a CMD() with a value or by coding the system control variable ZCMD in the panel body.

Because the)PANEL statement affects the same display characteristics as if you had selected the Panel display CUA mode option on the ISPF Settings panel, the color and intensity of the short and long messages is affected by the presence of the)PANEL statement. If you specify the LMSG or SMSG keywords on the)BODY statement, you control the color and intensity in which both the short and long messages are displayed, regardless of CUA mode or the presence of a)PANEL statement. Table 20 on page 308 illustrates default message placement.

Keylist Building and Display

The format and display of the named keylist or an ISPF default keylist for a panel containing the)PANEL statement is as follows:

- The maximum number of function keys that can be formatted on each line is displayed.
- Each displayed function key definition appears as *Fnn=label* or *Fn=label* (where *nn* or *n* is the numeric value of the function key).

ISPF attempts to build the FKA with the named keylist or an ISPF default keylist. However, the display of the keylist in the FKA area depends upon the settings of the FKA or PFSHOW commands and the keylist format (SHORT or LONG) specified for the function key definition. The number and set of function keys displayed also varies.

Note: The system control variable ZPFCTL setting is ignored for panel source definitions that contain the)PANEL statement.

Undefined or Null Function Keys

When you press an undefined or null function key, ISPF displays an error message.

CANCEL and EXIT Execution

When the CANCEL or EXIT commands (specified on a function key or entered in a command field) are processed, ISPF returns the entered command in the system control variable ZVERB and sets a return code of 8 from the display service.

If the panel contains an action bar and the cursor is on the action bar, CANCEL moves the cursor to the panel body. ZVERB is not updated.

Setting System Control Variables

When panels with a)PANEL section specified are displayed, ISPF sets the following system control variables:

ZCURFLD	Name of the field (or list column) containing the cursor when the user exits the panel.
ZCURPOS	Position of the cursor within the field specified by ZCURFLD when the user exits the panel.
ZCURINX	Current row number of the table row containing the cursor.

These system variables are stored in the function pool as output variables.

Defining the Point-and-Shoot Section

The)PNTS (point-and-shoot) section of a panel definition specifies what fields, if any, are point-and-shoot fields. Input and output fields are specified as point-and-shoot fields by the use of the attribute keyword, PAS(ON). Text fields are specified as point-and-shoot fields by the attribute type keyword, TYPE(PS). For each panel field specified as a point-and-shoot field, there must be a corresponding entry in the)PNTS section. If a field specified as a point-and-shoot field has no corresponding entry in the)PNTS section, no action will be taken if the point-and-shoot field is selected. The examples below show a)PNTS section point-and-shoot phrase definition for input/output fields and for text fields.

Note: You can use option 0 (Settings) to set the tab key to move the cursor point-and-shoot fields. This changes output fields to input fields, but data is not altered. However, if a variable is used on an output field that is changed to an input field by the tab to point-and-shoot option, and the variable is VDEFINED to the application, the variable will be truncated. In this case, the application developer should have a temporary panel variable.

GUI Mode

If you are running in GUI mode, fields designated as point-and-shoot output and text fields will appear as pushbuttons. Point-and-shoot input fields will appear as selection fields.

Large pushbuttons are point-and-shoot output or text fields which display with a depth greater than one. Large pushbuttons are built by coding the DEPTH keyword on the point-and-shoot statement in the)PNTS panel section.

In GUI mode, images can be displayed on these pushbuttons. The keywords that provide the support for images are DEPTH, IMAGE, IMAGEP, TEXT, and PLACE. These keywords are used in GUI mode and ignored in 3270 mode.

Although you can define images on point-and-shoot output fields and point-and-shoot text fields, if you define an image for a point-and-shoot output field, the field cannot be a Z-variable in the panel body.

)PNTS Section

You can specify where to place an image on a large pushbutton. It can be above or below the pushbutton text, or to the left or right of the pushbutton text. When you specify the placement of the image to be above or below the text, the image is always centered relative to the text.

ISPF ships sample images in sample library SISPSAMP. The panel ISR@PRIM uses three of the GIF image files: ISPFGIFL, ISPFGIFS, and ISPEXIT.

To use images, store the image files on the host in a partitioned data set and allocate this image data set to ddname ISPILIB before invoking ISPF. For more information about allocating this image library see the section called Allocating Optional Image ISPF Library in the *z/OS ISPF User's Guide Vol I*.

When an image is requested, ISPF does a query and file transfer to download the image specified to the workstation. The image is downloaded to the *image path* that you specify from the GUI Panel Settings window (Option 0). See the *z/OS ISPF User's Guide Vol II* for details. If no image path is specified, ISPF downloads the image to the workstation's working directory.

```
)PNTS  
FIELD(field_name|ZPSxxyyyy) VAR(value) VAL(value)  
[DEPTH(depth)] [IMAGE(image-name)] [IMAGEP(image-name)]  
[TEXT('text')] [PLACE(a,b,l,r)]
```

Note: Each entry in the)PNTS section must contain the keywords in the following order: FIELD, VAR, VAL, [DEPTH]. When defining large pushbuttons or large pushbuttons with images the DEPTH keyword must immediately follow the VAL keyword on the)PNTS entry statement. The remaining keywords, [IMAGE] [IMAGEP], [TEXT], [PLACE], follow the DEPTH keyword. Both the DEPTH keyword and the TEXT keyword must be coded on the PNTS entry for point-and-shoot text fields if you are defining a large pushbutton, or an image for the field.

where:

FIELD(*field_name*|ZPS*xxyyyy*)

The name of the field on the panel that this statement controls.

For point-and-shoot input/output fields, the format is:

FIELD(*field_name*)

where:

field_name

The name of the field on the panel that this statement controls.

For point-and-shoot text fields, the format is:

FIELD(ZPS*xxyyyy*)

where:

xx 00 for a point-and-shoot field defined in the)BODY section and 01 to 99 for the number of the scrollable area in which the point-and-shoot text field is defined.

Each scrollable area is assigned a sequential number based on its relative position within the panel body. The scrollable area closest to the upper-left corner of the panel body is assigned number 01.

Each additional scrollable area, scanning left to right, top to bottom, is assigned the next sequential number. A maximum of 99 scrollable areas in any given panel can contain point-and-shoot text fields.

yyy 001 to 999 for the relative number of the point-and-shoot text field within the panel body or within a particular scrollable area.

A point-and-shoot text field can wrap around multiple terminal lines in panels that are not displayed in a window. A point-and-shoot text field that logically wraps in a pop-up window requires the beginning of each wrapped line to contain a PS field attribute and an entry must exist in the)PNTS section for each wrapped line. This is also true for panels containing the WINDOW() keyword that are not displayed in a pop-up window. The additional)PNTS section entries should result in the same action as the first line of the wrapped text field.

VAR(*value*)

The name, or a variable containing the name, of the variable to be set when the field named in this)PNTS statement is selected. If the value is a variable, an ampersand (&) must be in the first column following the left parenthesis of the VAR keyword, and it must follow dialog variable naming conventions. If the value is a variable it is limited to the leading ampersand plus 7 characters.

VAL(*value*)

The value assigned to the variable named in this statement. The value can be a variable or text. If the value is a variable, an ampersand (&) must be in the first column following the left parenthesis of the VAL keyword. The length of the variable data is limited to 255 single-byte characters. If the variable data is longer than 255 bytes, it is truncated. If the value is a variable it is limited to the leading ampersand plus 7 characters.

VAL(&var)

If the value is a single word text string it is not necessary to enclose it in single quotation marks.

VAL(Batch)

If the value is more than a single word of text, the phrase must be enclosed in single quotation marks.

VAL('List of products')

Literal values can be split between lines by coding a plus sign (+) as the last character on each line that is to be continued. The plus sign is used as a continuation character.

VAL('This is an example of a continuation +
of the literal string')

DEPTH(*depth*)

The *depth* of the point-and-shoot field (pushbutton). The DEPTH keyword is required and must be specified immediately following the VAL keyword on the)PNTS section statement. ISPF allows *depth* values from zero to sixty-two (0-62). The maximum screen depth is 62. It is up to the dialog developer to define the *depth* such that other items on the panel body will not be overlaid by the point-and-shoot field (pushbutton). If *depth* is specified as 0, the default depth of two (2) is used. The *depth* can be a variable, whose value is from 0-62.

IMAGE(*image-name*)

The *image-name* identifies the image to be displayed. The *image-name* is used when the images are stored on the host in a partitioned data set, with a data set definition of ISPILIB. The *image-name* must follow TSO data set member naming conventions. The *image-name* can be a variable, which should follow ISPF's variable naming conventions.

IMAGEP(*image-name*)

The *image-name* identifies the image to be displayed, when the point-and-shoot pushbutton is pressed. For example, a pushbutton might normally display a closed door image, but when you press the button, an 'open door' image appears. The *image-name* is used when the images are stored on the host in a partitioned data set, with a data set definition of ISPILIB. The *image-name* must follow TSO data set member naming conventions. The *image-name* can be a variable, which should follow ISPF's variable naming conventions.

Note: ISPF downloads images only in panel initialization processing. Variables for images should only be set in the)INIT section of your panel definition. Variables for images in panel sections other than the)INIT section are not supported unless the image exists on the PC Image Path you specify.

TEXT('text')

The TEXT keyword is required for point-and-shoot text fields. The *text* ties the point-and-shoot text field defined in the panel body with its point-and-shoot entry in the)PNTS section. The *text* must match the text for the point-and-shoot field in the body. If the text in the body contains variables, the *text* of the TEXT keyword must allow for the possible expansion once the variable has been substituted, just as the point-and-shoot text field in the body should. If the *text* consists of more than a single word of text, the phrase must be enclosed in single quotation marks.

PLACE(*a|b|l|r*)

The values *a* (above), *b* (below), *l* (left), and *r* (right) specify the position of the image relative to the pushbutton text. The PLACE keyword is optional. If not specified, the default image position is above (*a*) the text in the pushbutton. The text for pushbuttons is always centered within the pushbutton. The text for a pushbutton does not wrap, thus one line of text is the maximum. The image is placed either above or below the text, or to the left or the right of the text. It is up to the dialog developer to allow for space for the pushbutton text and the image. The value for PLACE can be a variable whose value is *a*, *b*, *l*, or *r*.

Example:

```

)PANEL
)ATTR
  $ TYPE(PIN)
  } TYPE(PS)
  + TYPE(NT)
  | AREA(SCRL) EXTEND(ON)
  ! TYPE(OUTPUT) PAS(ON) COLOR(RED)
  * TYPE(OUTPUT) PAS(ON) COLOR(BLUE)
  @ TYPE(TEXT) INTENS(LOW) COLOR(RED) PAD(NULLS)
  ø TYPE(TEXT) INTENS(LOW) COLOR(BLUE) PAD(NULLS)
)BODY WINDOW(60,23)
$
%COMMAND ===>_ZCMD
$
$ Press }DEFAULTS$to reinstate defaults
$
+
|S1
)AREA S1
+
+
+   øBLUE . . . .*BLUE1
+   @RED . . . . !RED1
)INIT
  .CURSOR = blue1
  &blue1 = ' '
)PROC
  REFRESH(*)
)PNTS
  FIELD(BLUE1) VAR(RED1) VAL(RED)
  FIELD(ZPS00001) VAR(BLUE1) VAL(DEFAULT)
)END

```

Figure 67. Sample Point-and-Shoot Definition

Defining the Processing Section

The processing section specifies additional processing that is to occur after the panel has been displayed. It begins with the)PROC header statement and ends with the)HELP or)END statement. The number of lines allowed in a)PROC section depends upon the storage size available.

```
)PROC
```

A statement can be continued over as many lines as necessary as long as it is broken at the end of a word, or a continuation symbol (+) is used within a literal. In menus, the processing section is required and must be in a special format, as described in “Defining Menus” on page 115.

See “Formatting Panel Definition Statements” on page 234 for additional information.

Defining the Reinitialization Section

The reinitialization section specifies processing that is to occur prior to redisplay of a panel. If it is present, it follows the initialization section and precedes the processing section.

```
)REINIT
```

)REINIT Section

Panel redisplay occurs in either of the following situations:

- Redisplay occurs automatically after the)PROC section has been processed if the .MSG control variable is nonblank and the user has not requested END or RETURN. The .MSG control variable is set automatically if a translation or verification error occurs. It can also be set explicitly by use of an assignment statement in the)PROC section.
- Redisplay occurs if a dialog function invokes the DISPLAY or TBDISPL service with no panel name specified (a blank).

Note: See *z/OS ISPF Services Guide* under the description of TBDISPL for a explanation of how redisplay processing for the TBDISPL service differs from that for the DISPLAY service described here.

Processing of the)INIT section is intentionally bypassed when a redisplay occurs. Instead, the)REINIT section is processed. The automatic fetching of variables to be displayed in the panel body is also bypassed on a redisplay. Thus, the panel is redisplayed exactly as the user last saw it, except:

- An error message can appear on a redisplay.
- Field attribute overrides, assignment statements, or REFRESH statements can be used, as noted in the following paragraph.
- A scrollable area can be scrolled to position the cursor or to verify failure.

Typically, a)REINIT section contains:

- Field attribute overrides, specified by the .ATTR control variable
- Changes to displayed panel fields, specified by assignment statements and the REFRESH statement.

See “Formatting Panel Definition Statements” on page 234 for additional information.

Figure 68 on page 233 shows panel processing and the point at which attribute settings can be modified for redisplay of a panel.

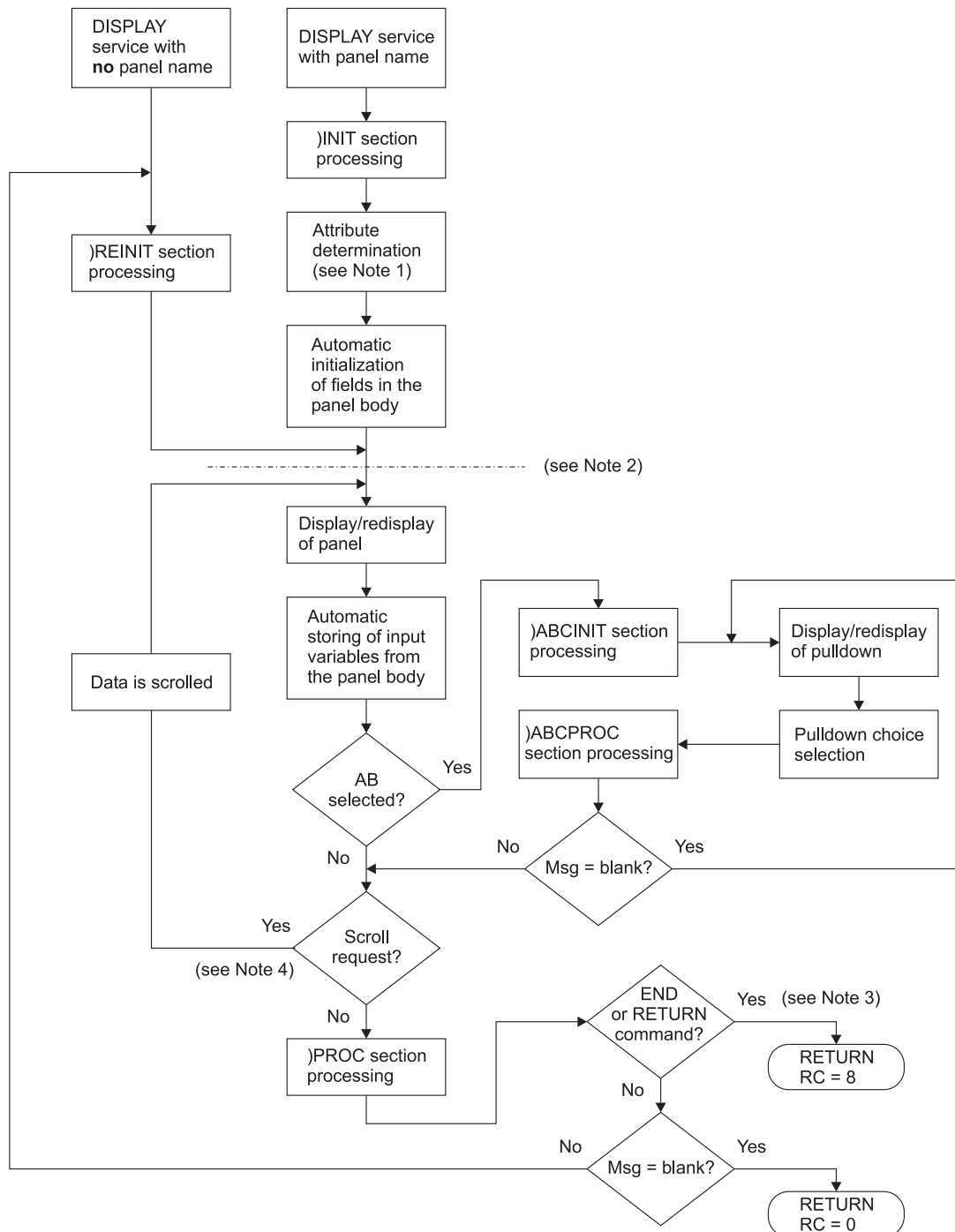

Notes:

1. Any attributes specified in variables in the)ATTR or)INIT sections are determined after the)INIT section has been processed.
2. Any attributes set above this line are permanent across redisplay of the panel. Those set below the line hold for a single redisplay only.
3. On panels created using the Dialog Tag Language (DTL), the next EXIT and CANCEL commands also produce return code 8.
4. The Yes branch is taken if there is a scroll request, a scrollable area is defined for the panel, and the cursor is within a scrollable area.

Figure 68. Panel Processing

Formatting Panel Definition Statements

This section provides reference information for the following panel definition statements:

- Assignment – page 235

Note: You can use ten built-in functions in an assignment statement:

- TRUNC (truncate)
 - TRANS (translate)
 - PFK (function key)
 - LENGTH (return length of variable)
 - UPPER (return uppercase value of variable)
 - LVLIN (last visible line)
 - ADDSOSI (add shift-out character)
 - DELSOSI (delete shift-out character)
 - ONEBYTE (convert to a 1-byte code)
 - TWOBYTE (convert to a 2-byte code)
- ELSE – page 241
 - EXIT – page 242
 - GOTO – page 242
 - IF – page 244
 - PANEXIT – page 248
 - REFRESH – page 255
 - *REXX ... *ENDREXX – page 256
 - TOG – page 264
 - VEDIT – page 266
 - VER – page 266
 - VGET – page 277
 - VPUT – page 279

The following types of data references can appear within panel section statements:

Dialog variable

A name preceded by an ampersand (&)

Control variable

A name preceded by a period (.)

Literal value

A character string not beginning with an ampersand or period. A literal value can be enclosed in single quotes ('). It *must* be enclosed in single quotes if it begins with a single ampersand or a period, or if it contains any of the following special characters:

Blank < (+ |) ; ~ - , > : =

A literal can contain substitutable variables, consisting of a dialog variable name preceded by an ampersand (&). The name and ampersand are replaced with the value of the variable before processing the statement. Trailing blanks are removed from the variable before the replacement. You can use a double ampersand to specify a literal character string starting with, or containing, an ampersand.

In the description of statements and built-in functions that follows, a *variable* can be either a dialog variable or a control variable. A *value* can be either type of variable or a literal value.

The Assignment Statement

Assignment statements can be used in the)INIT section to set the contents of dialog variables before the automatic initialization of variables in the panel body. Also, they can be used in the)REINIT section before redisplay of the panel body. Assignment statements can also be used in the)PROC section, typically to set the contents of dialog variables that do not correspond to fields in the panel body.

```
variable = value
```

where:

value

Specifies the contents of the dialog variable.

Example:

```
&A      = ''
&COUNT = 5
&DSN    = '''SYS1.MACLIB'''
&BB     = &C
```

The first example sets variable A to blanks. The second example sets variable COUNT to a literal character string (the number 5). The third example sets variable DSN to a character string that begins and ends with a single quote. See Chapter 6, “Panel Definition Statement Guide” for information about syntax rules and restrictions. The fourth example sets variable BB to the contents of another variable, C.

The literal ' ' represents a single blank. To define a null, you must use the &Z literal.

The TRUNC Built-In Function

The TRUNC built-in function can occur on the right side of an assignment statement to cause truncation.

```
variable = TRUNC (variable,value)
```

where:

variable

(Inside the parentheses). Specifies the variable to be truncated.

value

A numeric quantity indicating the length of the truncated result or any special character indicating truncation at the first occurrence of that character.

Examples:

```
&A = TRUNC (&XYZ,3)
&INTEG = TRUNC (&NUMB, '.')
```

In the first example, the contents of variable XYZ are truncated to a length of 3 characters and stored in variable A. Variable XYZ remains unchanged. In the second example, the contents of variable NUMB are truncated at the first occurrence of a period and stored in variable INTEG. Variable NUMB remains unchanged. If NUMB contains 3.2.4, INTEG contains 3.

Assignment Statement

The control variable `.TRAIL` contains the *remainder* following a TRUNC operation. When the contents of a variable are truncated to a specified length, all remaining characters are stored in `.TRAIL`. If the contents of a variable are truncated at the first occurrence of a special character, the remaining characters *following* the special character are stored in `.TRAIL`. The special character is not stored, nor is it retained in the assignment variable's value. For example:

```
)PROC
  &AAA = TRUNC (&ZCMD, '.')
  &BBB = .TRAIL
```

If variable `ZCMD` contains 9.4.6, variable `AAA` contains 9. The `.TRAIL` control variable and variable `BBB` contain 4.6. The value of `ZCMD` remains as 9.4.6.

Because the control variable `.TRAIL` is set to blanks before the truncation function is performed, it should not be specified as the truncation variable in the TRUNC statement. For example: `&ERROR = TRUNC(.TRAIL,1)` would always result in `&ERROR` being set to blank.

For the TRUNC built-in function, the source and destination variables can be the same. Figure 69 on page 238 shows an example in which it is assumed that variable `TYPECHG` was originally set (in the dialog function) to a single character `N`, `U`, or `D`. In the `)INIT` section, `TYPECHG` is translated to `NEW`, `UPDATE`, or `DELETE` and stored into itself before the panel is displayed. In the `)PROC` section, `TYPECHG` is truncated back to a single character.

Use of this technique allows you to change the valid options for `TYPECHG` by simply typing over the first character.

The TRUNC and TRANS built-in functions can be nested. For example:

```
&XYZ = TRUNC( TRANS(&A ---),1 )
&ZSEL = TRANS( TRUNC(&ZCMD, '.') --- )
```

In the first example, the current value of variable `A` is translated. The translated value is then truncated to a length of one, and the result is stored in variable `XYZ`. In the second example, the contents of variable `ZCMD` are truncated at the first period, the truncated value is then translated, and the result is stored in variable `ZSEL`.

The TRANS Built-In Function

The TRANS built-in function can occur on the right side of an assignment statement to cause translation.

```
variable = TRANS (variable value,value ... [MSG=value] )
```

where:

variable

(Inside the parentheses). Specifies the variable to be translated.

value,value

Paired values. The maximum number of paired values allowed is 126. The first value in each pair indicates a possible value of the variable, and the second indicates the translated result.

Example:

```
&REPL = TRANS (&MOD Y,YES N,NO)
```

The current value of variable MOD is translated, and the result is stored in variable REPL. Variable MOD remains unchanged. The translation is as follows: if the current value of MOD is Y, it is translated to YES. If the current value is N, it is translated to NO. If the current value is anything else (neither Y nor N), it is translated to blank.

The anything-else condition can be specified by using an asterisk in the last set of paired values. For example:

```
&REPL = TRANS (&MOD ... *,'?')
&REPL = TRANS (&MOD ... *,*)
```

In the first example, if the current value of MOD does not match any of the listed values, a question mark is stored in variable REPL. In the second example, if the current value of MOD does not match any of the listed values, the value of MOD is stored untranslated into REPL.

MSG=value

A message ID. Another option for the anything-else condition is to cause a message to be displayed to the user. Typically, this technique is used in the processing section of the panel definition.

Example:

```
&DISP = TRANS (&D 1,SHR 2,NEW 3,MOD MSG=PQRS001)
```

The contents of variable D are translated as follows: 1 is translated to SHR, 2 is translated to NEW, and 3 is translated to MOD. If none of the listed values is encountered, message PQRS001 is displayed. Message PQRS001 can be an error message indicating that the user has entered an invalid option.

For the TRANS built-in function, the source and destination variables can be the same. Figure 69 on page 238 shows an example in which it is assumed that variable TYPECHG was originally set (in the dialog function) to a single character N, U, or D. In the)INIT section, TYPECHG is translated to NEW, UPDATE, or DELETE and stored into itself before display of the panel. In the)PROC section, TYPECHG is truncated back to a single character.

Use of this technique allows you to change the valid options for TYPECHG by simply typing over the first character.

The TRANS and TRUNC built-in functions can be nested. For example:

```
&XYZ = TRUNC( TRANS(&A ---),1 )
&ZSEL = TRANS( TRUNC(&ZCMD,'.') --- )
```

In the first example, the current value of variable A is translated. The translated value is then truncated to a length of one, and the result is stored in variable XYZ. In the second example, the contents of variable ZCMD are truncated at the first period, the truncated value is then translated, and the result is stored in variable ZSEL.

Assignment Statement

```
)Body
%----- EMPLOYEE RECORDS -----%
%COMMAND==>_ZCMD %
+
+%EMPLOYEE SERIAL: &EMPSE
+
+ TYPE OF CHANGE%==>_TYPECHG + (NEW, UPDATE, OR DELETE)
+
+ EMPLOYEE NAME:
+ LAST %==>_LNAME +
+ FIRST %==>_FNAME +
+ INITIAL%==>_I+
+
+ HOME ADDRESS:
+ LINE 1 %==>_ADDR1 +
+ LINE 2 %==>_ADDR2 +
+ LINE 3 %==>_ADDR3 +
+ LINE 4 %==>_ADDR4 +
+
+ HOME PHONE:
+ AREA CODE %==>_PHA+
+ LOCAL NUMBER%==>_PHNUM +
+
)Init
 &TYPECHG = Trans (&TYPECHG N,NEW U,UPDATE D,DELETE)

)Proc
 &TYPECHG = Trunc (&TYPECHG,1)

)End
```

Figure 69. Sample Panel Definition with TRANS and TRUNC

The PFK Built-In Function

The PFK built-in function provides function key assignment information by command or key number.

```
variable = PFK(value)
```

where:

value

Either a command or a key number.

Example:

```
&X = PFK (HELP)
```

```
&Y = PFK (2)
```

In the first example, the first function key that is assigned to the HELP command is returned in variable X as a character string PFnn, where *nn* is the function key number. If CUA mode is set, or the panel has an active keylist, the character string is Fnn, where *nn* is the function key number. If the HELP command is not assigned to a function key, a blank value is returned.

In scanning the current function key definitions, the *primary* keys are scanned first, then the *secondary* keys. If KEYLIST OFF has been issued, ISPF searches the ZPF variables. On a 24-key terminal, for example, if both function keys 13 and 1 are assigned to HELP, the function returns F13.

In the second example, the command assigned to F2 is returned in variable Y. If no command is assigned to the key requested, a blank value is returned.

The LENGTH Built-In Function

The LENGTH built-in function can occur on the right side of an assignment statement to evaluate the length of a dialog variable. The variable length returned will be the maximum value of the actual length of the variable if it exists and the length specified in the)FIELD section if any.

```
variable = LENGTH(field-name)
```

where:

field-name

Specifies the dialog variable name.

Example

```
&A = LENGTH(ABC)
```

The length of dialog variable ABC is stored in &A. If ABC does not exist, zero is returned. If we added the following section to the panel:

```
)FIELD  
FIELD(ABC) LEN(105)
```

then the length calculated for &A will be 105 if ABC does not exist or exists with a length less than 105.

The UPPER Built-In Function

The UPPER built-in function can occur on the right side of an assignment statement and will return the uppercase value of a variable.

```
variable = UPPER(field-name)
```

where:

field-name

Specifies the dialog variable name.

Example

```
&A = UPPER(ABC)
```

The uppercase value of ABC dialog variable will be returned.

The LVLIN Built-In Function

The LVLIN built-in function (used on an assignment statement in the)INIT,)REINIT, or)PROC section) provides the line number of the last visible line within a graphic or dynamic area of the currently displayed panel.

```
variable = LVLIN(value)
```

where:

value

Name of the GRAPHIC or DYNAMIC area. In split-screen mode, this value could be less than the number of lines defined in the area.

This built-in function provides the line number of the last line within a graphic or dynamic area that is visible to the user on the currently displayed panel. The *value*

Assignment Statement

parameter is the name of the graphic or dynamic area. In split-screen mode, this value could be less than the number of lines defined in the area. If the area is defined within a scrollable area, the number returned is the last visible line when the user submitted the panel, even if the user could have scrolled to see more.

Note: When coding the command line after the dynamic area on a non-TBDISPL panel, ISPF might not be able to calculate the LVLIN value correctly based on the location of the command line following the dynamic area, the number of lines after the dynamic area, the function key settings, SPLIT or SPLITV command processing, or other ISPF commands that affect the screen size displayed. To achieve the correct LVLIN value with the command line displayed at the bottom of the ISPF dynamic area panel, the command line will have to be coded above the dynamic area on the panel, ZPLACE set to BOTTOM, and CUA mode set to YES.

Example:

```
&L1 = LVLIN(AREA1)
```

The ADDSOSI and DELSOSI Built-In Functions

These built-in functions are used to add to or delete from a value-string the shift-out and shift-in characters that mark the start and end of a DBCS field, without changing the value of the input string.

<pre>variable = ADDSOSI(variable name) variable = DELSOSI(variable name DBCS literal)</pre>

where:

variable name

Name of the variable that the function will process.

Examples:

```
&VAR2 = ADDSOSI(&VAR1)
&VAR2; = DELSOSI(' [DBDBDBDB] ')
```

The bracket characters [and] represent the shift-out and shift-in characters.

The target variable must not contain mixed (DBCS/EBCDIC) data. Only variables, not literals, can be specified with the ADDSOSI function. Variables or literals can be specified with the DELSOSI function. An odd input-value length is not permitted for either function. The input-value length does not include trailing blanks or nulls. Nested built-in functions are not allowed on the DELSOSI function. The ADDSOSI function allows nesting of the TWOBYTE built-in function, described below.

Example:

```
&VARB = ADDSOSI(TWOBYTE(&VARA))
```

Variable VARA is converted to a 2-byte character code and shift-out and shift-in characters are added to the character string. Then, variable VARB is set to the resulting value.

The ONEBYTE and TWOBYTE Built-In Functions

The ONEBYTE function is used to convert a variable from a 1-byte character code to the corresponding 1-byte code without changing the value of the variable. The TWOBYTE function is used to convert a variable from a 1-byte character code to

the corresponding 2-byte code without changing the value of the variable.

```
variable = ONEBYTE(variable name)
variable = TWOBYTE(variable name)
```

where:

variable name

Name of the variable the function will process.

Examples:

```
&VARA = ONEBYTE(&VARB)
&VARA = TWOBYTE(&VARB)
```

The variable being converted must not contain mixed (DBCS/EBCDIC) data. Only variables, not literals, can be converted. An odd input value length is permitted for the TWOBYTE function, but is not permitted for the ONEBYTE function. The input value length does not include trailing blanks or nulls. Literals cannot be used as input parameters for either function. Nested built-in functions are not allowed on the TWOBYTE function. The ONEBYTE function allows nesting of the DELSOSI built-in function.

Example:

```
&VARB = ONEBYTE(DELSOSI(&VARA))
```

The ELSE Statement

The ELSE statement specifies that alternate processing is to take place when the conditions of the matching IF statement are not satisfied.

ELSE

The ELSE statement has no parameters. The ELSE statement must be column-aligned with the matching IF statement. Only one ELSE statement is allowed on the same line, even though each can align with a prior IF statement. You can nest IF statements within ELSE statements. The only limitation on the number of nested IF statements is the maximum number of columns available for indented statements due to the panel record length.

The ELSE statement is indentation sensitive. If the conditional expression is true, the ELSE statement that is column-aligned with the IF plus all statements to the right of that column are skipped. Processing continues with the next statement that begins in the same column as the ELSE or in a column to the left of the ELSE.

An example of using the ELSE statement:

```
IF (&DOW = UP)
  &ACTION = SELL
ELSE
  IF (&DOW = DOWN)
    &ACTION = BUY
  ELSE
    &ACTION = HOLD
&DOW = &BEAR
```

In this example, if the value of &DOW is UP, variable &ACTION is set to SELL and processing continues at the statement &DOW = &BEAR. The indented processing statements following the first ELSE statement execute if variable &DOW

ELSE Statement

does not have a value of UP. The assignment statement, `&ACTION = HOLD`, executes only if the value of `&DOW` is not UP or DOWN.

Figure 70 shows a sample panel definition with an IF/ELSE statement pair. The current value of variable PHA is tested for the local area code, 919. If the value of PHA is 919, variable RATE is set to the value of variable `&LOCAL`. If the value of PHA is not 919, variable RATE is set to the value of variable `&LONGD`.

```
)BODY
%----- EMPLOYEE RECORDS -----
%COMMAND====>_ZCMD %
+
%EMPLOYEE SERIAL: &EMPSER
+
+ TYPE OF CHANGE====>_TYPECHG + (NEW, UPDATE, OR DELETE)
+
+ EMPLOYEE NAME:
+ LAST %====>_LNAME +
+ FIRST %====>_FNAME +
+ INITIAL%====>_I+
+
+ HOME ADDRESS:
+ LINE 1 %====>_ADDR1 +
+ LINE 2 %====>_ADDR2 +
+ LINE 3 %====>_ADDR3 +
+ LINE 4 %====>_ADDR4 +
+
+ HOME PHONE:
+ AREA CODE %====>_PHA+
+ LOCAL NUMBER%====>_PHNUM +
+
)INIT
&TYPECHG = TRANS (&TYPECHG N,NEW U,UPDATE D,DELETE)

)PROC
&TYPECHG = TRUNC (&TYPECHG,1)
IF (&PHA = '919')
&RATE = &LOCAL
ELSE
&RATE = &LONGD

)END
```

Figure 70. Sample Panel Definition with IF and ELSE Statement

EXIT and GOTO Statements

Nested IF/ELSE statements can easily become complex, especially since the IF statement is indentation sensitive. The GOTO and EXIT statements allow you to avoid these complexities and achieve enhanced performance during panel processing. You can transfer control back to the user as soon as processing errors are detected.

The GOTO and the EXIT statements are both allowed in the `)INIT`, `)REINIT`, `)PROC`, `)ABCINIT`, and `)ABCPROC` sections of the panel source definitions.

EXIT Statement

```
EXIT
```

The EXIT statement has no parameters. When an EXIT statement is encountered during panel processing, ISPF halts processing of the section in which the statement was found and bypasses all remaining statements in that section. Further processing of the panel continues normally.

- Example 1: Simple GOTO/EXIT

```

)PROC
  IF (&CUSTNAME = ' ')
    GOTO NAMERR
  IF (&CUSTNUM = ' ')
    .msg=xxxxx /* message indicating number is required */
    EXIT /* exit )PROC section */
  VER (&CUSTNAME,ALPHA,msg=xxxxx) /* messages specific to */
  VER (&CUSTNUM,NUM,msg=xxxxx) /* data type - alpha or num */
  GOTO NXTSECT
NAMERR:
  .msg=xxxxx /* message indicating name must be entered */
  EXIT /* exit )PROC section */
NXTSECT:
  zero, one, or more statements

```

In this example, the VER statements are skipped if no values are entered for the CUSTNAME or CUSTNUM variable fields. Processing for the)PROC is halted after the .msg variable is set.

- Example 2: Multiple GOTOs

```

)INIT
  &var2 = ' '
  IF (&newcust = ' ')
    GOTO BYPASS
  IF (&newcust = 'renew')
    &var2 = 1
    GOTO NXTCHK1
  IF (&newcust = 'initial')
    &var2 = 2
    GOTO NXTCHK1
  ELSE
    GOTO BYPASS
NXTCHK1:
  IF (&var2 = 1)
    &var3 = 1
    &var4 = 0
    GOTO NXTSECT
  ELSE
    &var4 = 1
    &var3 = 0
    GOTO NXTSECT
BYPASS:
  &var3 = 0
  &var4 = 0
NXTSECT:
  zero, one, or more statements

```

Assuming that the variable NEWCUST was entered and verified to contain one of the two values on a previous panel display, this example illustrates that certain fields on the panel currently being processed will or will not be set depending on the value of NEWCUST.

- Example 3: GOTO Label within IF/ELSE

EXIT and GOTO Statements

```
)INIT
  IF (&var1 = ' ')
    GOTO BYPASS
  IF (&var2 = 1)
    &var5 = 1
    &var6 = 0
  BYPASS:
    &var7 = 1
  ELSE
    zero, one, or more statements
```

If variable *var1* is blank, control is transferred to the label BYPASS. Variables *var5* and *var6* are not set and processing will continue as if the IF statement were TRUE. Variable *var7* will be set to 1. The ELSE branch is not executed.

GOTO Statement

GOTO <i>label</i>

where:

label

Literal value of the label to which you will branch. The label:

- Must be from 1 to 8 characters in length
- Must begin with an alphabetic character (A–Z, a–z)
- May contain any other alphameric character (A–Z, a–z, 0–9).

The literal value of the label used must be followed by a colon when it appears by itself as a label. For example:

```
label:
```

ISPF translates the value for the label to uppercase before it is processed.

There are no indentation restrictions on a GOTO and its corresponding label. They may be at different indentation levels.

ISPF processes the GOTO statement as follows:

- ISPF assumes that transfer of control to the named label is downward.
- ISPF continues processing with the next sequential statement after the first occurrence of the named label.
- ISPF ignores duplicate labels.
- ISPF may transfer control within the IF or ELSE branch of an IF/ELSE statement. If the label is within the IF branch, processing continues with the next statement following the label as if the IF were true. If the label is within the ELSE branch, processing continues with the next statement following the label as if the IF were false.

ISPF issues a severe error message if it does not find a matching label below the GOTO statement and within the same section in which the GOTO statement is coded. The label need not be on a line by itself.

The IF Statement

The IF statement is a valuable tool used to verify a conditional expression. The conditional expression can be as basic as testing the value of a variable or can be expanded to use VER statement constructs and Boolean capabilities. This section first defines the complete syntax of the IF statement. More detailed sections follow to describe:

- Basic IF value testing
- IF statement with VER constructs
- IF statement with Boolean operators

IF statements are valid in the)INIT,)REINIT,)PROC,)ABCINIT, and)ABCPROC panel sections.

```
IF (conditional-expression [ boolean-operator conditional-expression]..)
:
:
[ELSE]
:
:
```

where:

conditional-expression

Is either:

Basic value test expression:

variable operator value[,value...]

VER statement construct coded without the MSG= parameter:

VER (*variable* [, NONBLANK], *keyword* [, *value1*, *value2*,...])

Boolean-operator

The character symbol & or characters AND (AND Boolean operator) or the character symbol | or characters OR (OR Boolean operator).

ELSE

The optional statement that specifies alternate processing if the IF condition is not satisfied.

Basic IF Value Testing

```
IF (variable operator value [,value ...])
:
:
[ELSE]
:
:
```

The parentheses in the syntax contain a conditional expression, in which the operator is expressed in either uppercase character symbols, such as EQ, or in special symbols, such as =. These symbols can be any of:

= or EQ	(equal to)
≠ or NE	(not equal)
> or GT	(greater than)
< or LT	(less than)
≥ or GE	(greater than or equal)
≤ or LE	(less than or equal)
¬> or NG	(not greater than)
¬< or NL	(not less than).

You can specify comparison against up to 255 values for the EQ (=) and NE (≠) operators. For the remaining operators, you can specify comparison against only one value.

IF Statement

If you use a character symbol operator, it must be separated from the variable name and comparison value by one or more blanks. For example:

```
IF (&ABC EQ 365)
```

Separation of a special symbol operator from the variable name and comparison value is optional.

```
IF (&ABC = 365) is the same as IF (&ABC=365)
```

A compound symbol operator, such as <= or NG, must not contain intervening blanks. For example:

```
<= cannot be < =
```

In determining whether the criteria of a conditional expression are met, ISPF uses a numeric compare if the value of the variable and the value being compared are whole numbers between -2147483648 and +2147483647. Thus, if &A is set to +1, the expression IF (&A=1) is evaluated as being true, using the numeric compare. If the value of the variable and the value being compared are not whole numbers between -2147483648 and +2147483647, ISPF uses a character compare, using the EBCDIC collating sequence to evaluate the IF expression. For both numeric and character compares, trailing blanks are ignored.

Examples of basic value testing:

- IF (&DSN = '') — True if variable DSN is null or contains blanks.
- IF (&OPT EQ 1,2,5) — True if variable OPT contains any of the literal values 1, 2, or 5.
- IF (&A GE &B) — True if the value of variable A is greater than or equal to the value of variable B.
- IF (&A \neq AAA,BBB) — True if variable A is not equal to AAA *and* not equal to BBB.

The IF statement is indentation sensitive. If the conditional expression is true, then processing continues with the next statement. Otherwise, all following statements are skipped up to a column-aligned ELSE statement, if one exists, or up to the next statement that begins in the same column as the IF or in a column to the left of the IF. Example:

```
IF (&XYZ = '')
  &A = &B
  &B = &PQR
  IF (&B = YES)
    &C = NO
&D = &ZZZ
```

In this example, processing skips to statement &D = &ZZZ from either IF statement if the stated condition is false.

Note that the scope of the IF statement is not terminated by a blank line.

IF Statement with VER Constructs

The conditional expression on the IF statement now includes VER statement constructs with one exception: the MSG= parameter is not allowed. The IF conditional-expression evaluates to TRUE (1) for successful verifications and to FALSE (0) for failing verifications. See “The VER Statement” on page 266 for complete explanation of the VER statement. An example of using VER statements with IF statements:

```

IF (VER (valid keyword parameters and values))
  ⋮
ELSE
  .MSG = n1d122
  IF (VER (valid keyword parameters and values))
    ⋮

```

The VER statement can be split over more than one line, but the VER statement and the left parenthesis of its keyword parameters must be on the same line. The following example is invalid:

```

IF (VER
(valid keyword parameters and values))
  ⋮

```

IF Statement and Boolean Operators

You can combine two or more conditional expressions on the IF statement. ISPF evaluates the conditional expressions on the IF statement from left to right, starting with the first expression and proceeding to the next and subsequent expressions on the IF statement until processing is complete.

The use of the **AND** Boolean operator takes precedence over the **OR** Boolean operator as shown in the following examples.

The number of conditional expressions you can specify on the IF statement is limited to 255.

The accepted symbols for the Boolean operators are:

- **&** or **AND** (AND Boolean operator)
AND processing returns a TRUE result for the IF statement only if all the conditional expressions evaluate as TRUE.
- **|** or **OR** (OR Boolean operator)
OR processing returns a TRUE result for the IF statement if any of the conditional expressions evaluate as TRUE. Also, for an IF statement to be evaluated as FALSE, all conditional expressions must be evaluated as FALSE.
 The Boolean operators must be separated by a preceding and following blank or blanks.

Examples of Boolean operators in the IF statement:

- Example 1: Comparison of two expressions using different Boolean operators in two separate IF statements.

```

IF (VER (&vara,NB,ALPHA) & VER (&varb,NB,ALPHA))
  ⋮
ELSE
  IF (&varc = 123 OR VER (&vard,NB,NUM))
    ⋮

```

The first IF statement will be successful only if both VER expressions are satisfied, while the IF statement under the ELSE will be successful if either of the expressions on the IF statement are satisfied.

- Example 2: Comparison of three expressions using the AND Boolean operator in the same IF statement, with additional OR Boolean operators.

```

IF (VER (&vara,NB,ALPHA) & VER (&varb,NB,ALPHA) &
&varc = abc,xyz | &vard = 123 | &vard = 456)
  ⋮
ELSE
  .msg = n1d123

```

IF Statement

The IF statement will be successful if the comparisons of the first three expressions evaluate to TRUE, or if expressions four or five evaluate to TRUE.

- Example 3: Comparison of two pairs of expressions using the AND Boolean operator combined on the same IF statement by the OR Boolean operator.

```
IF (VER (&vara,NB,ALPHA) AND &varb = abc OR
    VER (&vara,NB,ALPHA) AND &varb = xyz)
  :
ELSE
  .msg = nld124
  .attr (vara) = 'color(yellow)'
  .attr (varb) = 'color(yellow)'
```

Either of the pairs of expressions must evaluate to TRUE to achieve a successful IF statement.

- Example 4: Comparison of three expressions showing that the AND operator has precedence.

```
IF (Expression-1 OR Expression-2 AND Expression-3)
  :
ELSE
  .msg = nld125
```

Because the IF statement AND Boolean operator has precedence over the IF statement OR Boolean operator, the specifying an IF statement similar to the one above might not give you the results you expected.

If you expected the previous statement to be evaluated like this:

```
IF ( (expression1 OR expression2) AND expression3)
```

You would need to write either two separate IF statements:

```
IF (Expression-1 OR Expression-2)
  IF (Expression-3)
  :
Else
  .msg = nld126
```

Or two separate comparison pairs:

```
IF (Expression-1 AND Expression-3 OR
    Expression-2 AND Expression-3)
  :
Else
  .msg = nld127
```

The PANEXIT Statement

The ISPF panel user exit provides a way for you to extend the panel language processing of dialog variables. This processing can include operations such as verification, transformation, translation, and formatting of dialog variables passed to the panel user exit routine. Performing these operations in a panel user exit routine reduces the logic required in the ISPF function programs.

Use the PANEXIT statement in a panel's)INIT,)REINIT, or)PROC section to invoke the panel user exit. This statement causes ISPF to branch to the panel user exit routine. When the routine processing completes, control returns to the next sequential panel language statement.

```
PANEXIT ((value,value,...),{PGM,exit-add
        [,exit-data]
        [,MSG=msgid]
LOAD,exit-mod
        [,exit-data]
        [,MSG=msgid]
REXX,rex-name
        [,exit-data]
        [,MSG=msgid]})
```

where:

- value** Specifies the names of dialog variables being passed to the exit. The string of values, including the parenthesis, cannot exceed 255 characters. The string of values can be represented by the name of a dialog variable that contains a list of names of variables being passed to the exit routine.
- PGM** Keyword that indicates that the exit routine being invoked was loaded when ISPF loaded the application dialog or was loaded from the application. The application passes ISPF the address of the exit routine in exit-add.
- exit-add** This is the name of a 4-byte, FIXED format dialog variable that contains the address of the exit routine, which can reside above or below the 16Mb line. The exit routine receives control in AMODE=31 mode. This parameter is used in conjunction with the keyword PGM.
- exit-data** This is the name of a 4-byte FIXED format dialog variable that contains a value, such as the address of an information area, to be passed to the exit routine.
- msgid** If no message identification is returned to ISPF from the exit routine, this parameter identifies the message to be displayed if a variable fails the exit routine evaluation. If this parameter is not specified, and no message identification is returned from the exit routine, ISPF issues a generic message indicating that the exit routine evaluation failed.
- LOAD** Keyword that indicates that the exit routine is to be loaded dynamically. The application passes ISPF the module name of the exit routine that is to be dynamically loaded. The module name is passed in the exit-mod parm.
- exit-mod** This parameter identifies the name of the panel user exit routine module that is to be dynamically loaded by ISPF. The panel user exit name can be passed as a literal or as a dialog variable that contains the panel user exit name. This parameter is used in conjunction with the LOAD keyword.
- REXX** Keyword that indicates the name of the Rexx panel exit that is to be loaded and run. The exit can be an interpreted Rexx exec or an exec that was compiled into load module form. Standard search sequences are used to load the Rexx program.
- rex-name** This parameter is the name of the Rexx program that is to be used as the panel exit. If the exit is an interpreted Rexx exec and might conflict with an existing load module name, the name can be

PANEXIT Statement

| preceded by a percent sign (%) to avoid using the load module. If
| the REXX program is in load module format, ensure that it was
| linked with the MVS stub.

On the PANEXIT statement you can specify that the following be passed to the panel user exit routine:

- A list of dialog variables to be processed by the exit routine in one call. Rules that apply to the variables being passed are:
 - Variable values must be in character format when passed, and must remain in character format.
 - The exit routine can change a variable's value but it cannot change its length. Thus, if a dialog uses the VDEFINE service to define any of these variables to be passed, it should specify the NOBSCAN option. Otherwise, the variable value's length is considered to be the length of the actual data with blanks being ignored.
For implicitly defined variables, the variable length is considered to be the same as the length of its value.
- A 4-byte area that you can use to pass the address of data to be used by the exit routine.
- The identification of a message to be issued if a variable fails the exit routine evaluation. ISPF uses this value to set the .MSG control variable or, in the case of a panel user exit severe error (RC=20 or invalid value), to set ZERRMSG.

Notes:

1. A panel user exit routine cannot access any dialog variables except those passed on the call.
2. A panel user exit routine cannot issue requests for any ISPF services.
3. ISPF ignores any PANEXIT statement issued from dialog test option 7.2.
4. A PANEXIT statement cannot be issued from a selection panel that initiates a dialog before defining the exit address.
5. Although panel exits can be written in Language Environment-conforming languages, the overhead of initializing Language Environment each time the exit is called needs to be considered.

Following a successful validation exit, during which one or more dialog variable values are changed, ISPF updates the values for all dialog variable names included on the PANEXIT statement. This allows the exit routine to define dialog variables for cursor field or cursor position, and to return these values to ISPF when an error has been detected.

How to LOAD the Panel User Exit Routine

If the dialog function routine and the panel user exit routine are separate object modules, you can load the panel user exit routine by either:

- Linking the exit routine object module to the dialog function object module containing the display request for the panel from which the PANEXIT statement is issued. Thus, when ISPF loads the application, it also loads the exit routine.
- Loading the exit routine from the application and passing to ISPF the address of the exit routine.
- Letting ISPF load the exit routine dynamically.

How to LOAD a REXX Panel Exit

REXX panel exits can be interpreted REXX programs or compiled REXX programs (CREXX or load modules). ISPF automatically loads the REXX program by using

standard system interfaces. For non-load module programs, ISPF calls TSO to pre-process the program. The program remains loaded for as long as the current screen is active. If you change your Rexx program and want to run the new copy, you must end any split screens that used the previous copy.

REXX exits receive only one parameter — a hexadecimal representation of the address of the list of addresses shown in Figure 71. You can use the Rexx storage() function to view and modify the parameters that are pointed to by that list, or you can use the ISPF function named ISPREXPX, described in “Using ISPREXPX to Read and Modify Parameters” on page 253.

Note that you can also code REXX statements directly within the source of a panel. See “The *REXX Statement” on page 256.

Invoking the Panel User Exit Routine

A dialog invokes the panel user exit by issuing the PANEXIT statement from a panel’s)PROC,)INIT, or)REINIT section. If the LOAD keyword is specified, ISPF will issue an OS load to bring the load module into virtual storage. ISPF then invokes the exit routine through a call (BALR 14,15). You must use standard OS linkage conventions when invoking the panel user exit. The exit routine (called in AMODE 31) must support 31-bit addressing.

Panel exits can be written in languages that use the Language Environment runtime environment. However, a mixture of Language Environment-conforming main dialog code and service routine code is not supported. Dialogs and service routines must either all be Language Environment-conforming or all be Language Environment-nonconforming.

ISPF uses the standard parameter list format to pass parameters. Register one points to a list of addresses; each address points to a different parameter as shown in Figure 71. See “Parameters Passed from ISPF to the Panel User Exit Routine” on page 252 for information on these parameters.

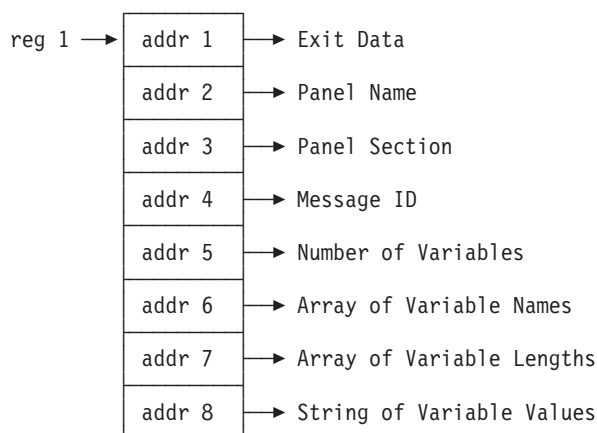

Figure 71. Standard Parameter List Format

The keyword, LOAD, on the PANEXIT panel statement, provides the option of dynamically loading a panel user exit routine. PGM and LOAD are the only valid keywords. PGM indicates that a panel user exit using a compiled source is being invoked. LOAD indicates that the panel user exit routine named by the exit-mod parameter is to be dynamically loaded by ISPF.

PANEXIT Statement

ISPF checks the keyword to determine if the panel user exit routine is to be dynamically loaded. If it is, ISPF issues an OS load to bring the load module into virtual storage. The search sequence for link libraries is: job pack area, ISPLLIB, steplib, link pack area, linklib. See *z/OS ISPF Services Guide* for further discussion of the search order using LIBDEF.

The panel user exit routine is loaded only once per SELECT level the first time the panel is displayed. The loaded panel user exit routine is not deleted until the SELECT, which first displayed the panel, is terminated.

Parameters Passed from ISPF to the Panel User Exit Routine

Parameters passed to the panel user exit routine are (*in the order passed*):

1. Exit Data

The value of the dialog variable identified on the PANEXIT statement to contain exit data. Its format is a fullword fixed value. If no exit data area is provided, ISPF passes binary zeros.

2. Panel Name

The name of the panel from which the panel user exit is being invoked. Its format is CHAR(8), left-justified in the field. ISPF ignores any changes made to this parameter by the exit routine.

3. Panel Section

A 1-character code that identifies the panel section from which the panel user exit is being invoked. Its format is CHAR(1). Its value is:

I for the)INIT section
R for the)REINIT section
P for the)PROC section.

4. Message ID

The identification of the message used to set the .MSG value if the variable evaluation fails. In case of a severe error in the exit routine processing, ISPF uses this value to set variable ZERRMSG. Its format is CHAR(8). When the exit routine is invoked, it contains eight blanks (X'40'). On return to ISPF, if the value in Message ID is not blank, ISPF assumes the value to be a message ID, which must be left-justified in the field.

5. Number of Variables

The dimension of the array of variable names and the array of variable lengths passed to the panel user exit routine. Its format is a fullword fixed value. ISPF ignores any changes made to this parameter by the exit routine.

6. Array of Variable Names

An array of dialog variable names being passed to the panel user exit routine. Each array entry has a format of CHAR(8), left-justified in the array. ISPF ignores any changes made to this parameter by the exit routine.

7. Array of Variable Lengths

An array of dialog variable lengths being passed to the panel user exit routine. Each array entry format is a fullword fixed value. If the exit routine changes any of the variable length values, a severe error results.

8. String of Variable Values

A character buffer of dialog variable values mapped by the array of variable lengths and the array of variable names. The length of the buffer is the sum of the lengths in the array of variable lengths. The exit routine returns updated dialog variable values to ISPF in this buffer.

Return Codes and Error Processing

Return codes, set in the panel user exit routine, recognized by ISPF are:

- 0 Successful operation.
- 8 Exit-defined failure. ISPF sets the .MSG control variable and displays or redisplay the panel with the message.
- 20 (or code unrecognized by ISPF)**
Severe error in the exit routine.

For an exit routine return code of 8, ISPF sets the .MSG control variable by using the following search order:

1. If the value in the Message ID parameter is not blank on return to ISPF, that value is used for setting the .MSG control variable.
2. If the value in the Message ID parameter is blank on return, the value (if any) specified for the MSG= keyword on the PANEXIT statement is used for setting the .MSG control variable.
3. If neither the Message ID parameter nor the MSG= keyword has been given a value, the default ISPF exit error message is used for setting the .MSG control variable.

The panel section in which the .MSG control variable is set affects the message display as follows:

-)INIT or)REINIT section: the message is displayed on the panel.
-)PROC section: the panel, including the message to be displayed, is redisplayed.

If the return code from the exit routine is either 20 or not one of the recognized codes, the display service terminates with a severe error condition. ISPF sets the ZERRMSG system variable by using the following search order:

1. If the value in the Message ID parameter is not blank on return to ISPF, it is used for setting the ZERRMSG system variable. This allows the exit routine to define the message to be used in case of a severe error.
2. If the value in the Message ID parameter is blank on return, the value (if any) specified for the MSG= keyword on the PANEXIT statement is used for setting the ZERRMSG system variable.
3. If neither the Message ID parameter nor the MSG= keyword has been given a value, the default ISPF exit error message is used for setting ZERRMSG.

If CONTROL ERRORS CANCEL is in effect, ISPF displays on the severe error panel the message indicated by the value of ZERRMSG.

Using ISPREXPX to Read and Modify Parameters

A Rexx panel exit receives only the storage address of the standard panel exit parameter list. Although you can use the standard Rexx storage() function to read and modify the list, ISPF supplies a program called ISPREXPX to set local Rexx variables that reflect the information passed to and from the panel exit.

ISPREXPX Syntax:

- Call ISPREXPX('I')** to initialize Rexx variables
- Call ISPREXPX('T')** to set ISPF variables from the Rexx variables of the same name

PANEXIT Statement

ISPREXPX establishes several variables within the Rexx program. The stem variable VARNAMES.n contains the names of the variables passed to the program. ISPREXPX then creates variables of those names, called "named variables".

The Rexx program must insure that changes to the variables are done to the named variables and not to the VARNAMES.n stem variable. For example, if the PANEXIT statement on the panel passes in a variable named ZDATA, then ISPREXPX creates a named variable called ZDATA. The Rexx program must refer to and update that variable. If you do not know the exact name that is specified on the PANEXIT statement in the panel that calls the Rexx exit, you can get the name from the VARNAMES.n stem variable and use the INTERPRET instruction to get and set the actual variable.

Because the lengths of variables cannot be changed by a panel exit, ISPREXPX('T') insures that the length does not change by padding or truncating the variable values (VARVALS.n) as needed.

Variable	Explanation
user variables	The variables as named in the PANEXIT statement. For example, a PANEXIT statement like PANEXIT((ZDATA,USER),REXX...) creates variables ZDATA and USER. Changes to the variables are returned to ISPF. If the length changes, the new value is truncated or padded with blanks as needed to keep the original length.
VARNAMES.0 VARVALS.0 VARLENS.0	All of these variables contain the number of variable names passed to the panel exit. Changes to these variables are ignored.
MSGID	Message ID to set in case of error. It is blank on entry to the exit. Changes to this variable are used.
PANELNAME	The name of the panel being processed. Changes to this variable are ignored.
PANELSECTION	Panel section 'I', 'R', or 'P'. Changes to this variable are ignored.
EXDATA	A hexadecimal representation of the address of the user data. Changes to this variable are ignored, but the program might change the data to which this address points.

Return Codes: The following return codes are possible:

- 0 Normal result. Variables were retrieved or set successfully.
- 16 Parameter error. Incorrect parameter passed to ISPREXPX.
- 20 Error. Another error occurred. Most likely there is a failing return code from a Rexx service called by ISPREXPX.

Example: This sample exit changes the case of all data in the variable ZDATA. It also overlays the beginning of the variable ZDATA with the string '**REXX**'. The name ZDATA is used on the PANEXIT statement in the panel source and is assigned to the variable name VARNAMES.1.

```
/* REXX panel exit: panexit((zdata),REXX,sample) */
call ISPREXPX 'i'
zdata=overlay('02'x'** REXX **'01'x,translate(zdata, ,
'abcdefghijklmnopqrstuvwxyzABCDEFGHIJKLMNopqrstuvwxyz', ,
'ABCDEFGHIJKLMNopqrstuvwxyzZabcdefghijklmnopqrstuvwxyz'))
call ISPREXPX 't'
```

Note: You can see how this panel works by saving this example in a REXX library using the name SAMPLE and changing the Browse panel ISRBROBA to include the following line in the)INIT and)REINIT sections:

```
panexit((zdata),REXX,sample)
```

The REFRESH Statement

The REFRESH statement provides a means to force specified fields in the panel body to be retrieved before a redisplay.

```
REFRESH (value, value, ...)
```

where:

value Name of an input or output field in the panel body.

Typically, when a panel is redisplayed, the automatic fetching of variables that appear in the panel body is bypassed. As a result, all variables are normally displayed as the user last saw them, even though the variable contents can have been changed. REFRESH causes the contents of specified fields to be retrieved and allows the user to see any changes that have occurred since the panel was last displayed.

The REFRESH statement can appear within the)PROC or)REINIT section of a panel definition. ISPF flags it as an error if it appears in the)INIT section. When this statement is encountered, the specified input/output fields within the panel body are retrieved from the corresponding dialog variables prior to redisplay of the panel.

A value of * indicates that *all* input/output fields on the panel are retrieved. You can omit the parentheses if only one field is refreshed.

- Example 1:

```
)PROC
  ⋮
  IF (.MSG ^= '')
    &STMT = 'Correct invalid field and press Enter key'.
  IF (.MSG = ' ')
    &STMT = ' '
  REFRESH STMT
```

If the panel is displayed again and if the control variable .MSG is set to nonblank in the)PROC section, the panel field STMT is reset to Correct the ... Enter key. Otherwise, the field is set to blank.

- Example 2:

```
)REINIT
  REFRESH(SEL, RENAME)
```

Both panel fields SEL and RENAME are reset with their current values before any redisplay.

- Example 3:

```
)REINIT
  REFRESH(*)
```

All of the panel fields are reset to their current values.

- Example 4:

REFRESH Statement

```
)REINIT  
  REFRESH(&RVARS)
```

The variable RVARS will contain a list of one or more panel fields to be refreshed.

A field that is refreshed on the screen remains unchanged for multiple redispays unless it is again refreshed.

The *REXX Statement

The *REXX statement is used to invoke REXX code in a panel's)INIT,)REINIT, or)PROC section. The REXX can be coded within the panel source immediately after the *REXX statement, or the name of a member containing a REXX program can be supplied.

```
*REXX[[[*],value,value,...[, (member)]]]
```

where:

- | | |
|---------------|---|
| <i>*</i> | Specifies that all the dialog variables defined in the panel)BODY section are to be passed to the REXX code for processing. |
| <i>value</i> | Specifies the names of dialog variables passed to the REXX code for processing. |
| <i>member</i> | Specifies the name of a member in the standard search sequences used to load REXX programs. This member can contain interpreted REXX or compiled REXX. Compiled REXX can be either the output generated by the REXX compiler when using the CEXEC option or a load module generated when link-editing the output generated by the REXX compiler when using the OBJECT option. |

Notes:

1. The string of values, including the parentheses, cannot exceed 255 characters. The string of values can be represented by the name of a dialog variable containing a list of variables being passed to the REXX code.
2. The REXX code within a panel procedure is stored in an internal table which contains the statements for the)INIT,)REINIT,)AREA, and)PROC sections of the panel. The size of this table is limited to 32KB, so a large number of REXX statements coded directly within a panel procedure could cause this table to overflow, resulting in error message ISPP321. If this error occurs, consider using the (*member*) option on the *REXX statement so the REXX is loaded from a member in the standard search sequences used for REXX programs.
3. When the REXX program has been compiled into load module format, it needs to have been linked with the MVS stub.
4. The REXX code cannot access any dialog variables *except* those specified on the *REXX statement.
5. The REXX code cannot issue requests for any ISPF services.
6. REXX coded within the panel source must be terminated by a *ENDREXX statement.

Processing ISPF Dialog Variables with Panel REXX

ISPF dialog variable can be processed by panel REXX code. Dialog variables are made available to the REXX code via the parameters specified on the *REXX statement:

- Specifying * as the first parameter causes all the dialog variables associated with the input and output fields on the panel to be passed to the panel REXX code.
- Specifying a dialog variable name causes that dialog variable to be passed to the REXX code.

The following rules apply to the dialog variables passed to panel REXX:

- The variable values must be in character format when passed, and must remain in character format.
- Panel REXX can change the value of a variable but it cannot change its length.
- For implicitly defined variables that are fields on the panel, the length of the associated REXX variable is the larger of the length of the panel field and the length of the variable's value.

For other implicitly defined variables, the variable length is considered to be the same as the length of its value.

ISPPRXVP: Dialog Variable Processor for Panel REXX: The ISPF module ISPPRXVP is used to make ISPF dialog variables available to panel REXX, and to update the dialog variables after they have been processed by panel REXX.

When the panel REXX is *interpreted REXX* (that is, the REXX statements are coded directly in a panel procedure or the member specified on *REXX statement contains interpreted REXX) ISPF creates calls to ISPPRXVP to perform the following tasks:

- Set up corresponding REXX variables for the ISPF dialog variables before the panel REXX is invoked
- Update the ISPF dialog variables with any changes made by the panel REXX after it has finished.

This is done by ISPF generating the following REXX statements before and after the supplied panel REXX code:

```

Call ISPPRXVP 'I'
If rc!=0 then do
  say 'ISPPRXVP Init failed rc=' rc
  Return
End
Call p_01A2B3C0
Call ISPPRXVP 'T'
If rc!=0 then
  say 'ISPPRXVP Term failed rc=' rc
Return
P_01A2B3C0:
:
panel REXX code
:
Return

```

(**Bold text** indicates REXX generated by ISPF.)

Note: The 11 lines of REXX code generated by ISPF before the supplied panel REXX and the line of REXX code generated by ISPF after the supplied panel REXX will affect the results obtained from the SOURCELINE function. For example using SOURCELINE() in interpreted panel REXX returns a value that is 12 more than the number of source lines of panel REXX.

Interpreted panel REXX and the EXIT statement

If the interpreted panel REXX code uses the EXIT statement to terminate REXX processing, the termination call to ISPPRXVP generated by ISPF will not be executed. Therefore, any changes made to REXX variables will not be applied to the corresponding ISPF dialog variables. If you need to use the EXIT statement in your panel REXX and you want changes applied to the ISPF dialog variables, ensure a termination call to ISPPRXVP (that is, Call ISPPRXVP 'T') is executed before the EXIT statement.

When the panel REXX is *compiled REXX*, ISPF does not create these initialization and termination calls to ISPPRXVP. Therefore, panel developers must include these calls in their panel REXX code.

Return Codes and Error Processing

ISPF provides the following system dialog variables for return code and error processing in panel REXX:

- | | |
|---------------|--|
| ZRXRC | Available for panel REXX to pass a return code back to ISPF. Length is 2 bytes. The corresponding REXX variable is initialized with a value of 0. |
| ZRXMSG | Available for panel REXX to provide a message ID used to set the .MSG value. Length is 8 bytes. The corresponding REXX variable is initialized with a value of 8 blanks. |

ISPF recognizes the following return codes passed back by panel REXX in the dialog variable ZRXRC:

- | | |
|-----------|---|
| 0 | Successful operation. |
| 8 | Panel REXX defined failure. ISPF sets the .MSG control variable and displays or redisplay the panel with the message. |
| 20 | Severe error in the panel REXX. |

Any other return code not recognized by ISPF is treated as a severe error in the panel REXX.

When control returns to ISPF after the panel REXX has executed, if ZRXRC contains a return code of 8, ISPF sets the .MSG control variable using the following search order:

1. If the value in ZRXMSG is not blank on return to ISPF, that value is used to set the .MSG control variable.
2. If the value in ZRXMSG is blank on return, the default ISPF panel REXX error message ISPP335 is used to set the .MSG control variable.

The panel section in which the .MSG control variable is set affects the message display as follows:

-)INIT or)REINIT section: The message is displayed on the panel.
-)PROC section: The panel, including the message to be displayed, is redisplayed.

If the return code in ZRXRC is either 20 or is not one of the recognized codes, the display service terminates with a severe error condition. ISPF sets the ZERRMSG system variable using the following search order:

1. If the value in ZRXMSG is not blank when control returns to ISPF, it is used to set the ZERRMSG system variable. This allows the panel REXX to define the message to be used in case of a severe error.
2. If the value in ZRXMSG is blank when control returns to ISPF, ZERRMSG is set to ISPP336. This is the default ISPF message for severe errors relating to panel REXX.

If CONTROL ERRORS CANCEL is in effect, ISPF displays on the severe error panel the message indicated by the value of ZERRMSG.

An Example of Using Panel REXX

The following panel demonstrates the use of the *REXX statement to invoke REXX code from the)INIT and)PROC sections. The application displays cost, tax, and sales commission values for an order quote.

```

)PANEL
)ATTR DEFAULT(%+_ ) FORMAT(MIX)
~ TYPE(PT)
^ TYPE(PIN)
! TYPE(FP)
@ TYPE(NT)
% TYPE(NEF)
# TYPE(NEF) JUST(RIGHT)
* TYPE(VOI) JUST(RIGHT)
)BODY WINDOW(70,20) CMD(ZCMD)
@                ^Widget Order Quotes@                @
@Command ==>%Z                @
@
^Enter the number of widgets to be ordered and the quoted price.
@
!Number of Widgets. . .#Z      @
!Quoted Price . . . . #Z      @
@
!Total Cost ex Tax. . .*Z      @
!Total Tax. . . . . .*Z      @
!Total Cost . . . . . .*Z      @
@
!Sales Commission . . .*Z      @
@
)INIT
.ZVARS = '(ZCMD NWIDGETS QPRICE TCSTXTAX TOTTX TOTCOST SCOMM)'
/* Call REXX routine VALUSER to validate the user is allowed to use */
/* this application. */
*REXX(ZPANELID,ZUSER,(VALUSER))
/* If the user is not allowed, display a message and protect the */
/* input fields. */
IF (.MSG ^= &Z)
  .ATTRCHAR(#) = 'TYPE(LI)'
)PROC
/* Call REXX routine VALUSER to validate the user is allowed to use */
/* this application. */
*REXX(ZPANELID,ZUSER,(VALUSER))
/* If the user is not allowed, display a message and protect the */
/* input fields. */
IF (.MSG ^= &Z)
  .ATTRCHAR(#) = 'TYPE(LI)'
EXIT

```

Figure 72. Panel REXX example (Part 1 of 3)

*REXX Statement

```
/* Initialize the cursor position variable. */
&CPOS = '-----'
&HPRICE = '      '
&LPRICE = '      '
/* Invoke panel REXX to validate input and calculate quote values. */
*REXX(*,CPOS,LPRICE,HPRICE)
Trace 0
upper zcmd
cpos = "'ZCMD'"
/*****/
/* If the CLR command is entered in the command field, */
/* clear all input/output fields and return to redisplay */
/* the panel. */
/*****/
If zcmd = 'CLR' then do
    nwidgets = ''
    qprice = ''
    call Clear_Output
    return
End
/*****/
/* Ensure the output fields are cleared. */
/*****/
Call Clear_Output
/*****/
/* Verify the value entered for the number of widgets is */
/* a positive whole number. */
/*****/
if datatype(nwidgets,'N') = 0 |,
   pos('.',nwidgets) ^= 0 |,
   pos('-',nwidgets) ^= 0 then do
    cpos = 'NWIDGETS'
    zrxmsg = 'TPRX001'
    zrxrc = 8
    return
end
/*****/
/* Verify the quoted price is a monetary value. */
/*****/
qprice = strip(qprice)
if substr(qprice,1,1) = '$' then
    qprice = substr(qprice,2)
if datatype(qprice,'N') = 0 |,
   (pos('.',qprice) ^= 0 & ((length(qprice) - pos('.',qprice)) > 2)) then do
    cpos = 'QPRICE '
    zrxmsg = 'TPRX002'
    zrxrc = 8
    return
end
/*****/
/* Verify the quoted price is above the lowest possible */
/* value. */
/*****/
lprice = 12.50
if qprice < lprice then do
    cpos = 'QPRICE '
    zrxmsg = 'TPRX003'
    lprice = '$'||lprice
    zrxrc = 8
    return
end
```

Figure 72. Panel REXX example (Part 2 of 3)

```

/*****
/* Verify the quoted price is above the highest possible */
/* value. */
/*****
hprice = 25.00
if qprice > hprice then do
  cpos = 'QPRICE '
  zrxmsg = 'TPRX004'
  hprice = '$'||hprice
  zrxrc = 8
  return
end
/*****
/* Calculate the total pre-tax cost. */
/*****
tcstxtax = format(nwidgets*qprice,5,2)
/*****
/* Calculate the total sales tax at a rate of 6.25%. */
/*****
tottax = format(tcstxtax*0.0625,5,2)
/*****
/* Calculate the total cost after tax. */
/*****
totcost = format(tcstxtax+tottax,5,2)
/*****
/* Calculate the sales commission at a rate of 12.5% of the */
/* profit. */
/*****
scomm = format((tcstxtax-(nwidgets*lprice))*0.125,5,2)
/*****
/* Format the output fields for display. */
/*****
qprice = '$'||strip(qprice)
tcstxtax = '$'||strip(tcstxtax)
totcost = '$'||strip(totcost)
tottax = '$'||strip(tottax)
scomm = '$'||strip(scomm)
return
/*****
/* This routine clears the output fields. */
/*****
clear_output:
  tcstxtax = ''
  tottax = ''
  totcost = ''
  zcmd = ''
  scomm = ''
return
*ENDREXX
IF (.MSG ^= &Z)
  .CURSOR = &CPOS
  REFRESH(*)
ELSE
  .CURSOR = ZCMD
/* IF (.MSG ^= &Z AND .MSG NE TPRX000 AND &ZVERB NE CANCEL) .RESP = ENTER */
)END

```

Figure 72. Panel REXX example (Part 3 of 3)

The user of this application enters the number of widgets to be ordered and the price quoted to the customer. The panel REXX coded directly in the)PROC section receives all the panel input and output fields for processing. It also receives the CPOS variable used to set the cursor position, and the LPRICE and HPRICE variables used to check that the quoted price is in a valid range. This panel REXX performs the following functions:

*REXX Statement

- Validates the values entered by the user. If any values are invalid, variable ZRXRC is set to 8, the appropriate error message ID is set in variable ZRXMSG, the appropriate field name is stored in the variable CPOS, and control is returned to ISPF.
- Calculates and formats the values displayed for the cost (ex tax), tax, total cost, and sales commission.
- Checks if the user has entered 'CLR' in the command. If so, all the input/output fields on the panel are set to blanks.

The panel REXX routine in member VALUSER is invoked in the)INIT and)PROC sections. This routine receives the system variables ZPANELID and ZUSER and checks if the user is allowed to use the panel. The following is the REXX code for VALUSER:

```

/*****/
/* Call ISPPRXVP to get the ISPF dialog variables into */
/* REXX. */
/*****/
Call ISPPRXVP 'I'
/*****/
/* This common REXX routine checks whether the user is */
/* allowed to use the panel being displayed. */
/*****/
say 'zpanelid = ' zpanelid
say 'zuser = ' zuser
found = 0
users = ''
/*****/
/* Set up the user list based on the panel Id. */
/*****/
if zpanelid = 'QUOTE' then
  users = 'ADAMS MITCHELL JACKSON JAMES JONES WEBSTER'
else
if zpanelid = 'PORDER' then
  users = 'BRADLEY CONNOR EVANS PRINCE WALLS'
else
if zpanelid = 'INVENTORY' then
  users = 'BAXTER HILL NELSON SWAN WILSON'
/*****/
/* Check that the user Id is in the user list. */
/*****/
do i = 1 to words(users)
  if zuser = word(users,i) then do
    found = 1
    leave
  end
end
/*****/
/* If not found, pass back error message TPRX009 in */
/* dialog variable ZRXMSG and set a return code of 8 */
/* in dialog variable ZRXRC. */
/*****/
if ~found then do
  zrxmsg = 'TPRX009'
  zrxrc = 8
end
/*****/
/* Call ISPPRXVP to get update the ISPF dialog */
/* variables with the changes made in this REXX. */
/*****/
Call ISPPRXVP 'T'
Return

```

Figure 73. Sample member VALUSER to invoke panel REXX

Member VALUSER contains compiled REXX, so processing commences with a call to ISPPRXVP to initialize REXX variables for the ISPF dialog variables ZPANELID, ZUSER, ZRXRC and ZRXMSG. Before returning to ISPF there is also a call to ISPPRXVP to update these dialog variables with the values in the corresponding REXX variables.

The following are the messages used by this application:

*REXX Statement

```
TPRX001 'Invalid number          ' .TYPE=N NOKANA
'The value entered is not a positive whole number.'
TPRX002 'Invalid price           ' .TYPE=N NOKANA
'The value entered is not in the form $xx.yy'
TPRX003 'Quoted price too low    ' .TYPE=N NOKANA
'The quoted price cannot be lower than &LPRICE'
TPRX004 'Quoted price too high   ' .TYPE=N NOKANA
'The quoted price cannot be greater than &HPRICE'
TPRX009 'Not available           ' .TYPE=A .W=NORESP NOKANA
'This application is not available to user &ZUSER'
```

Panel REXX Example Supplied with ISPF: The member ISRVCALP in the ISPF panel library contains a panel which makes use of panel REXX. The)INIT procedure section of the panel contains a *REXX statement which invokes the REXX in member ISRVCHIL in the ISPF REXX exec library. This panel REXX code is used to enable color highlighting of the entries in the trace data set generated by the ISPVCALL utility. ISPVCALL is used by the ISPF product support team to assist in debugging customer reported problems.

The TOG Statement

Use the TOG statement to alternate the value of a variable between two values.

```
TOG(mode, fld, &variable[, value1, value2])
```

where:

mode Mode in which TOG is to function:

- S—single, used for pull-downs and single-choice selection fields.
- M—multiple, used for multiple choice selection fields.

fld Panel field used to determine whether &variable alternates.

&variable

Variable whose value may alternate between value1 and value2.

value1 Value &variable receives if &variable is not equal to value1. The default is 0. Value1 can be a dialog variable or literal.

value2 Value &variable receives if &variable is equal to value1. The default is 1. Value2 can be a dialog variable or literal.

Examples:

```
Value1 = 0
Value2 = 1
```

```
IF &variable = Value2
  &variable = Value1
ELSE
  &variable = Value2
```

The statement accepts numeric or alphabetic values. A numeric compare is performed on numeric data. When scan encounters a comma (even if it is followed immediately by another comma or a right parenthesis) it assumes a value is given. The TOG value will be assigned a blank in this case. For example:

```
TOG(S, fld1, test,) value1 = ' ' value2 = 1
TOG(S, fld1, test,,) value1 = ' ' value2 = ' '
TOG(S, fld1, test) value1 = 0 value2 = 1 (both will use defaults)
```

If the TOG is in single mode, a check is made to determine if the data has been modified. If it has been modified, then the TOG is performed.

If the TOG is in multiple mode, and a check determines that the data has been modified, then:

- If the field contained a character at the last display and it has not been changed to a blank, the TOG is not performed.
- If the field contained a blank and now contains a character, the TOG is performed.

This is to ensure the selection is not deselected by a different character. Only by blanking the field should the variable be deselected.

The following TOG statement example in Figure 74 uses both single and multiple mode combinations. The single mode TOG statements are prefaced with IF statements and are performed based on the IF statement condition. The multiple mode TOG statements are not conditional. They are performed with each pass through this processing section.

```
)PROC
IF ( &CLS = 1 )
  TOG (S,CLS,&CHSPORT,'0','1')
IF ( &CLS = 2 )
  TOG (S,CLS,&CHSEDAN,'0','1')
IF ( &CLS = 3 )
  TOG (S,CLS,&CHLUXRY,'0','1')
IF ( &PERFMOD ^= ' ' )
  &PERFMOD = '/'
  &PERFORM = 'MODERATE'
ELSE &PERFORM = '0'
TOG (M,PERFMOD,&CHPERFO,'0','1')
IF ( &PERFSUP ^= ' ' )
  &PERFSUP = '/'
  &PERFORM = 'SUPER'
ELSE &PERFORM = '0'
TOG (M,PERFSUP,&CHSUPER,'0','1')
IF ( &PERFULT ^= ' ' )
  &PERFULT = '/'
  &PERFORM = 'ULTRA'
ELSE &PERFORM = '0'
TOG (M,PERFULT,&CHULTRA,'0','1')
)END
```

Figure 74. TOG Statement Example

The VEDIT Statement

The VEDIT statement identifies the variables on which ISPF must do mask validation. The VEDIT statement should precede all other)PROC statements that involve variables, such as the VER statement or the VPUT statement. It must precede any statements that refer to a VMASKed variable. A VEDIT statement must be coded for all masked variables defined in the panel. An example is shown in Figure 75 on page 266.

VEDIT (<i>variable</i> [,MSG= <i>value</i>])

where:

variable

Specifies the name of a dialog variable, whose value is to be verified against the mask pattern specified by the VMASK service.

VEDIT Statement

MSG=value

Optional. Can be set to a message ID in the processing section to cause a message to be displayed.

```
)ATTR DEFAULT(%+_)
  @ TYPE(INPUT) INTENS(LOW)
)BODY
%-----TEST PANEL-----
%COMMAND ==>_ZCMD
%
+   PHONE %====>@CVAR      + (999)999-999
+   TIME  %====>@FVAR +    HH:MM
+
+
+
+   Press%ENTER+to leave this panel
)INIT
)PROC
  VEDIT (CVAR)
  VEDIT (FVAR)
)END
```

Figure 75. VEDIT Example

The VER Statement

Use the verify statement, VER, to check that the current value of a variable meets some criteria. Typically, it is used in the processing section to verify the data stored in a dialog variable. Verification of an input variable value is performed after the value has been stored in the variable pool. The current rules for padding, justification, and VDEFINE apply to the value stored in the pool. ISPF provides several types of verification, as described below.

```

VER (variable [NONBLANK] keyword [,MSG=value])
    ALPHA
    ALPHAB
    BIT
    DBCS
    DSNAME
    DSNAMEF
    DSNAMEFM
    DSNAMEPQ
    DSNAMEQ
    EBCDIC
    ENUM
    FILEID
    HEX
    IDATE
    INCLUDE [,IMBLK],value1 [,value2]
    IPADDR4
    ITIME
    JDATE
    JSTD
    LEN,relational-operator,expected-length
    LIST,value1 [value2...]
    LISTV,varlist
    LISTVX,varlist
    LISTX,value1,value2,...
    MIX
    NAME
    NAMEF
    NUM
    PICT,string
    PICTCN,mask-character,field-mask,string
    RANGE,lower,upper
    STDDATE
    STDTIME

```

where:

variable

Name of the variable to be checked.

NONBLANK

Optional keyword. Specifies that the variable must contain a value and not all blanks. NONBLANK, or NB, can be specified with another type verification, such as ALPHA, NUM, or HEX. Do this by specifying the NONBLANK keyword after the variable name but before the other keyword. Example:

```
VER (&A,NB,PICT,NNN-NNNN)
```

is equivalent to:

```
VER (&A,NONBLANK)
VER (&A,PICT,NNN-NNNN)
```

If the variable does not meet the verification criteria, ISPF displays a message. The message can be specified in the MSG=*value* parameter, where *value* is a message ID. If no message is specified, an ISPF-supplied message is displayed, based on the type of verification. Even if a VER fails, processing of the panel's)PROC and)REINIT statements is performed.

keyword

Specifies the verification criteria. One of the following keywords must be specified:

ALPHA

The variable must contain only lowercase or uppercase alphabetic characters (A–Z, a–z, #, \$, or @). Blanks are not allowed.

ALPHAB

The variable must contain only lowercase or uppercase alphabetic characters (A–Z or a–z). Blanks are not allowed.

BIT

The variable must contain all zeros and ones.

DBCS

The variable must contain only valid DBCS characters.

DSNAME

The variable must contain a valid TSO data set name. A data set name qualifier must begin with an alphabetic character (A–Z, \$, @, or #). The remaining characters must be either uppercase alphanumeric or a hyphen (-). A period is used to connect each qualifier in the data set name.

ISPF first determines if the TSO/E NOPREFIX PROFILE option is in use. If it is, ISPF does use a prefix in the calculation of the data set length. A maximum of 44 characters can be entered for a data set name, if that data set name is enclosed in quotes. If the TSO/E NOPREFIX PROFILE option is in use, a maximum of 44 characters can be entered for a data set name when it is not enclosed within quotes. If the TSO/E NOPREFIX PROFILE option is not in use, a maximum of 42 characters can be entered for a data set name, not enclosed in quotes. ISPF uses the minimum data set prefix of two characters (one character and a period separator) during its calculation of the data set name length.

DSNAMEF

This parameter provides the same function as DSNAME with the additional feature that asterisks (*) and percent signs (%) can be used within the qualifiers. You can use DSNAMEF to filter a list of data sets.

A single asterisk within a qualifier indicates that zero or more characters can occupy that position. Consecutive asterisks are not valid within a qualifier.

A single percent sign indicates that any **one** alphanumeric or national character can occupy that position. One to eight percent signs can be specified in each qualifier.

DSNAMEFM

This parameter provides the same function as DSNAMEF, but asterisks (*) and percent signs (%) can only be used within a member name, not within the qualifiers. You can use DSNAMEFM to filter members in a data set.

A single asterisk within a member name indicates that zero or more characters can occupy that position.

A single percent sign indicates that any **one** alphanumeric or national character can occupy that position. One to eight percent signs can be specified in each member name.

DSNAMEPQ

This parameter provides the same function as DSNAMEEQ, except if the TSO data set name starts with a parenthesis and no closing parenthesis is found, DSNAMEPQ adds the closing parenthesis and the end quote.

DSNAMEQ

This parameter provides the same function as DSNAME with the additional feature that if the TSO data set name starts with a quotation mark and no ending quotation mark is found, DSNAMEQ adds the ending quotation mark for you.

EBCDIC

The variable must contain only valid EBCDIC characters.

ENUM

The variable can contain, in addition to numeric characters:

- Plus sign (+)
- Negative number indicators
- Delimiter symbols
- Decimal symbol (.)
- Certain national language decimal symbol (,).

ISPF ignores leading blanks. Blanks between characters (except the French language delimiter) and trailing blanks are not allowed. This includes blanks between leading or trailing signs and the adjacent character. Use of any characters other than those listed just above results in ISPF issuing an appropriate error message.

The ENUM parameter allows verification of a numeric variable that has been expressed in a more natural style. ISPF verifies variable values for correct decimal and comma notation plus correct sign placement.

Negative number indicators include a leading or trailing minus sign and a number enclosed by parentheses. The decimal and delimiter symbols can vary according to national language. The negative number indicators are common to all national languages.

Use of delimiter symbols is optional. However, if they are used, ISPF validates the delimiter symbols beginning at the left-most symbol that it finds in the variable being verified. In case of an invalid placement or omission of a delimiter symbol, ISPF issues an appropriate error message.

Use of the decimal symbol is optional. A maximum of one decimal symbol is allowed. If used, the decimal must be correctly placed in relation to any delimiter symbols used. Delimiter symbols are not allowed to the right of a decimal symbol. In case of an invalid placement of a decimal symbol, ISPF issues an appropriate error message. Table 15 illustrates decimal and delimiter symbol use for each of the national languages supported by ISPF.

Table 15. Decimal and Delimiter Symbols

Language	Whole	Fractional
Danish	999,999.88	0.789
English	999,999.88	0.789
French	999.999,88	0,789
German	999.999,88	0,789
Italian	999.999,88	0,789
Japanese	999,999.88	0.789
Korean	999,999.88	0.789
Portuguese	999.999,88	0,789
Spanish	999.999,88	0,789
Traditional Chinese	999,999.88	0.789

Table 15. Decimal and Delimiter Symbols (continued)

Language	Whole	Fractional
Simplified Chinese	999,999.88	0.789
Swiss-German	999.999,88	0,789

The variable being verified can contain leading blanks. Any trailing blanks in the variable's value in the variable pool cause a verify error condition. Trailing blanks result from defining the variable by using the VDEFINE service with the NOBSCAN option specified. These trailing blanks are not overlaid when the variable is updated by a panel operation if the corresponding panel field has a justification attribute of LEFT or ASIS.

Note: ISPF treats fields containing the nonnumeric characters allowed when using VER ENUM as character fields. To use these fields in numeric operations, an installation can need to provide a routine to convert the fields from character to numeric data. The ISPF VDEFINE exit routine is one option available for incorporating these conversion routines.

Table 16 shows examples of results when verifying variable values (English) with the ENUM keyword specified.

Table 16. Verifying Variable Values with the ENUM Keyword Specified

Value	Results	Reason
+2574	Valid	Leading plus sign is allowed
-2574	Valid	Leading minus sign allowed
25.74	Valid	Decimal allowed
.2574	Valid	Leading decimal allowed
2,574	Valid	Delimiter character allowed (but not required)
(2,574)	Valid	Alternate method of showing a negative value allowed
2574-	Valid	Trailing minus sign allowed
2574+	Invalid	Trailing plus sign not allowed
-2574-	Invalid	Double negative indication not allowed
(2,574)	Invalid	Two errors; blanks not allowed between either sign indicator and the adjacent character
35,543785	Invalid	If used, the delimiter character must be inserted at every appropriate point (35,543,785)
4,5932.673	Invalid	Delimiter must be positioned in relation to decimal (45,932.673)
33.452.78	Invalid	Only one decimal allowed in numeric field
8.364,798	Invalid	Delimiter not allowed to right of decimal

FILEID

The variable must contain a valid file ID in CMS syntax. The file name and file type, if given, must be from 1–8 alphanumeric characters, including A–Z, 0–9, \$, #, @, +, - (hyphen), : (colon), and _ (underscore). The filemode must be a single letter (A–Z), optionally followed by a single digit (0–9). In addition, one or more fields of the fileid can be an asterisk (*) or a string of characters followed by an asterisk. For example:

- tr* status** All files having a file name beginning with the letters tr and having a file type of status.
- * exec** All files having a file type of exec.

HEX

The variable must contain only hexadecimal characters (0–9, A–F, a–f).

IDATE

The international date (IDATE) format contains 8 characters, including the national language date delimiter. The format represents a date expressed in a 2-digit year (YY), month (MM), and day (DD). Valid values for YY are 00–99. Valid values for MM are 01–12. Valid values for DD are 01–31. ISPF verifies for a valid date and national language date delimiter. For the United States, the format is YY/MM/DD.

INCLUDE [,IMBLK],value1[,value2]

Defines a list of value parameters, each specifying the character types a verify field is allowed to contain.

IMBLK

Optional positional subparameter. Indicates that the variable is allowed to contain embedded blanks. Any leading or trailing blank characters are ignored.

value1,value2

Specifies ALPHA, ALPHAB, or NUM; at least one value must be specified. The specification of two different values are combined and indicate to ISPF that the field can contain data of either type. ISPF issues an error message if more than two values are specified.

Example:

```
)PROC
  VER (&vara,NB,INCLUDE,IMBLK,ALPHAB,NUM,MSG=NSL001)
  VER (&varb,NB,INCLUDE,IMBLK,NUM,MSG=NSL002)
  VER (&varc,NB,INCLUDE,ALPHA,NUM,MSG=NSL003)
  :
```

This example illustrates that the variable *vara* can contain any alphabetic (A–Z or a–z) or numeric character as well as embedded blanks; *varb* can contain numeric characters only and embedded blanks; and variable *varc* can only contain alphabetic characters (A–Z, a–z, #, \$, or @) and numeric characters (0–9), but no embedded blanks.

IPADDR4

The variable must contain a valid IP (Internet Protocol) address in dotted decimal notation (as the decimal representation of four 8-bit values, concatenated with dots). For example, 128.2.7.9 is a valid IP version 4 address. The first octet (8-bit value) can range from 0 to 223 in decimal notation. The remaining three octets of the IP version 4 address can range from 0 to 255 in decimal notation. IPADDR4 verifies standard IP version 4 IP addresses. IPADDR4 does not support Classless Inter-Domain Routing (CIDR) notation.

ITIME

The international date (ITIME) format contains 5 characters, including the national language time delimiter. The format represents a date expressed in a 2-digit hour (HH), and a 2-digit minute (MM). Valid values for HH are 00–23. Valid values for MM are 00–59. For the United States, the format is HH:MM.

JDATE

The Julian date (JDATE) format contains 6 characters, including the period (.) delimiter. The format represents a date expressed in a 2-digit year (YY), and a 3-digit day of the year (DDD). Valid values for YY are 00-99. Valid values for DDD are 001-365 (or 001-366 for leap years). The format is YY.DDD.

JSTD

The Julian standard date (JSTD) format contains 8 characters, including the period (.) delimiter. The format represents a date expressed in a 4-digit year (YYYY), and a 3-digit day of the year (DDD). Valid values for YYYY are 0000-9999. Valid values for DDD are 001-365 (or 001-366 for leap years). The format is YYYY.DDD.

LEN,relational-operator,expected-length

The length of the variable (number of characters) must satisfy the condition expressed by the relational operator and expected length.

You can use the LEN function in a panel's)INIT,)REINIT, or)PROC section to verify the number of characters (bytes) in a variable that is currently residing in the variable pool.

For DBCS character strings the number of bytes in the string is twice the number of characters.

relational-operator

Valid relational operators are:

= or EQ	Equal to
< or LT	Less than
> or GT	Greater than
<= or LE	Less than or equal
>= or GE	Greater than or equal
≠ or NE	Not equal
¬> or NG	Not greater than
¬< or NL	Not less than.

You can specify the relational operator either as a special symbol (=, <, and so forth) or as a character symbol (EQ, LT, and so forth) expressed in uppercase. A relational operator can be expressed either as a literal value (remember to enclose special symbol values in quotes) or as a dialog variable containing the value.

expected-length

The expected-length operand is a positive number having a maximum of 5 characters, with which ISPF compares the number of characters in the variable data. Like the relational operator, the expected-length operand can be expressed as a literal value or as a dialog variable containing the value.

Example:

```
VER (&NAME,LEN,'<=' ,8)
```

This statement verifies that the number of characters defining the value of variable &NAME is less than or equal to 8.

Example:

```
VER (&NAME,LEN,NG,&SIZE)
```

This statement verifies that the number of characters defining the value of variable &NAME is not greater than the value of dialog variable &SIZE

When input fields are stored in their corresponding dialog variables, any keyed leading or trailing pad characters associated with right or left justification of the variable field are deleted before being stored.

The length of a variable, used by ISPF for comparison, is the total number of characters in the variable as it is currently stored in the variable pool. Thus, for a variable created using the VDEFINE service with NOBSCAN specified, any trailing blanks are included in the length value used for comparison.

If a variable has been defined using the VDEFINE service but currently has no value, ISPF uses a length value of zero for comparison.

LIST,value1,value2, ...

The variable must contain one of the listed values. The maximum number of listed values allowed is 100.

LISTV,varlist

Allows the use of a variable containing a list of values to be used for variable field verification.

varlist

When defined within the panel, this is the name of a variable, preceded by an &, that contains a list of values that will be compared to the value contained in the verify variable. The *varlist* variable can contain up to 100 values. Each value in the *varlist* variable must be delimited by a comma or at least one blank. A value in the *varlist* variable containing any of the following special characters should be enclosed in single quotes (' '):

Blank < (+ |) ; ~ - , > : =

To specify the ampersand character in a value contained in the *varlist* variable, or a period in a value contained in the *varlist* variable when it immediately follows a dialog variable name, you must double these characters. To specify the single quote character in a value contained in the *varlist* variable, use two single quote characters enclosed within single quotes ("").

If the varlist is set in the dialog, use the notation that is correct for the programming language used to code the dialog.

Example:

```
)PROC
  :
  :
  VER (&areacode, NONBLANK, LISTV, &varlist, MSG=NSL011)
  :
  :
```

The variable specified in the VER LISTV variable parameter must be set before being referenced in the statement. (The variable used in the previous example could have been assigned the following values in the)INIT section of the panel definition.)

```
&varlist = '919 914 212'
```

Note: To have quotes as part of an assignment, you must double the number of quotes used in each previous layer. For example:

```
&list1 = 'one o''ne' yields one o'ne  
&list2 = 'two t''''wo' yields two t''wo
```

LISTVX,varlist

The *varlist exclude* (LISTVX) keyword enables you to use a variable containing a list of values that the field variable must *NOT* contain. The use of this parameter implies that the keyword *nonblank* is used. The varlist follows the same rules as the varlist for LISTV.

LISTX,value1,value2,...

The *list exclude* (LISTX) keyword enables you to list values that the field variable must *NOT* contain. The use of this parameter implies that the keyword **nonblank** is used. The maximum number of listed values allowed is 100.

MIX

The variable must contain all valid DBCS, EBCDIC, shift-in, and shift-out characters.

NAME

The variable must contain a valid name, following the rules of member names, up to eight alphanumeric characters (A–Z, #, \$, @, 0–9). The first character must be alphabetic (A–Z, \$, @, or #).

NAMEF

This parameter provides the same function as NAME with the additional feature that asterisks (*) and percent signs (%) can be used within the qualifiers. You can use DSNAMEF to filter a list of data sets.

A single asterisk within a qualifier indicates that zero or more characters can occupy that position. Consecutive asterisks are not valid within a qualifier.

A single percent sign indicates that any **one** alphanumeric or national character can occupy that position. One to eight percent signs can be specified in each qualifier.

NUM

The variable must contain all numeric characters (0–9). However, leading blanks are acceptable.

PICT,string

The variable must contain characters that match the corresponding type of character in the picture string. The *string* parameter can be composed of the following characters:

C	any character
A	any alphabetic character (A–Z, a–z, #, \$, @)
N	any numeric character (0–9)
9	any numeric character (same as N)
X	any hexadecimal character (0–9, A–F, a–f)

In addition, the string can contain any special characters that represent themselves. For example:

```
VER (xxx,PICT,'A/NNN')
```

In this example, the value must start with an alphabetic character, followed by a slash, followed by 3 numeric characters. The length of the variable value and the picture string must be the same. Trailing blanks are not included.

PICTCN,mask-character,field-mask,string

The VER statement keyword PICTCN, with its three parameters, enables you to check a variable for specific constants within the variable.

VER (variable,PICTCN,mask-character,field-mask,string)

variable

Name of the variable to be checked.

mask-character

Any special character that represents itself. If you select one of the following special characters as a mask-character, the mask-character and the field-mask containing the mask-character must be enclosed in quotes:

- ¬ 'not' symbol
- = equal sign
- . period
- > greater than symbol
- < less than symbol
-) right parenthesis
- (left parenthesis
- ' single quote

Note: The mask-character **cannot** be one of the picture string characters (C, A, N, 9, X, c, a, n, x).

field-mask

A combination of constants and the mask-character. The field-mask is used to audit the string. For example, your mask-character is a slash mark (/) and the constants are V, R, and M in the positions shown: 'V//R//M//'. A single quote can be used as a constant but avoid using a mask-character that must be enclosed in single quotes when a single quote is a constant.

string

A combination of constants and picture string characters. The picture string characters can be:

- C** any character
- A** any alphabetic character (A-Z, a-z, #, \$, @)
- N** any numeric character (0-9)
- 9** any numeric character (same as N)
- X** any hexadecimal character (0-9, A-F, a-f)

The picture string characters must be in the positions indicated by the mask-character in the field-mask parameter. For example, 'VNNRNNMNN'.

The three parameters mask-character, field-mask, and string can be dialog variables.

Examples

VER Statement

In the following VER PICTCN statement the mask-character is the not symbol (¬), the constants are V,R, and M. The picture string characters are N (any numeric character 0–9). If **fld1** = V10R20M00 it passes the verification. If **fld1** = V10R20M0Y it fails because Y is not a numeric character.

```
VER (&fld1,PICTCN,'¬','V¬¬R¬¬M¬¬',VNNRNNMNN)
```

In this VER PICTCN statement the mask-character is the asterisk (*), the constants are O and S. The picture string characters are N (any numeric character 0–9) and A (any alphabetic character A-Z, a-z,#,\$,@). If **fld1** = OS390R8 it passes verification. If **fld1** = OS39018 it fails because 1 is not an alphabetic character.

```
VER (&fld1,PICTCN,*,OS*****OSNNNAN)
```

RANGE,lower,upper

The variable must contain all numeric characters (0–9). It can also contain a leading plus (+) or minus (–). Its value must fall within the specified lower and upper limits, which can be either positive or negative. The length of the specified variable is limited to 16 digits, in addition to the plus or minus sign. Further, the *lower* and *upper* parameters can consist of no more than 16 digits each, in addition to the plus or minus sign, if used. Any characters in excess of the 16 allowed are truncated.

STDDATE

The standard date (STDDATE) format contains 10 characters, including the national language date delimiter. The format represents a date expressed in a 4-digit year (YYYY), 2-digit month (MM), and a 2-digit day (DD). Valid values for YYYY are 0000-9999. Valid values for MM are 01-12. Valid values for DD are 01-31. ISPF verifies for a valid date and national language date delimiter. For the United States, the format is YYYY/MM/DD.

STDTIME

The standard time (STDTIME) format contains 8 characters, including the national language time delimiter. The format represents a time expressed in a 2-digit hour (HH), 2-digit minute (MM), and a 2-digit second (SS). Valid values for HH are 00-23. Valid values for MM are 00-59. Valid values for SS are 00-59. For the United States, the format is HH:MM:SS.

MSG=value

value contains the message issued if the current value of the variable does not meet the criteria being checked.

For all tests except NONBLANK, a blank value is acceptable. That is, if you enter a value, or leave a nonblank initial value unchanged, it must conform to the specified condition. If a variable value is stored as all blanks, the value passes any verification test except NONBLANK.

Figure 76 on page 277 shows a sample panel with VER statements to verify that information entered meets the following criteria:

- The truncated value of TYPECHG is N, U, or D.
- The three name variables, LNAME, FNAME, and I, contain all alphabetic characters.
- The PHA (area code) field contains all numeric characters and a length of 3.
- The PHNUM (local number) field contains 3 numeric characters followed by a hyphen, followed by 4 numeric characters.

For the TYPECHG test, a message ID has been specified in the event that the test fails. In all the other cases, an ISPF-provided message is displayed if the variable fails the verification test.

```

)BODY
%----- EMPLOYEE RECORDS -----
%COMMAND==>_ZCMD %
+
%EMPLOYEE SERIAL: &EMPSER
+
+ TYPE OF CHANGE%==>_TYPECHG + (NEW, UPDATE, OR DELETE)
+
+ EMPLOYEE NAME:
+ LAST %==>_LNAME +
+ FIRST %==>_FNAME +
+ INITIAL%==>_I+
+
+ HOME ADDRESS:
+ LINE 1 %==>_ADDR1 +
+ LINE 2 %==>_ADDR2 +
+ LINE 3 %==>_ADDR3 +
+ LINE 4 %==>_ADDR4 +
+
+ HOME PHONE:
+ AREA CODE %==>_PHA+
+ LOCAL NUMBER%==>_PHNUM +
+
)INIT
IF (&PHA = ' ')
  &PHA = 301
  &TYPECHG = TRANS (&TYPECHG N,NEW U,UPDATE D,DELETE)
)PROC
&TYPECHG = TRUNC (&TYPECHG,1)
VER (&TYPECHG,LIST,N,U,D,MSG=EMPX210)
VER (&LNAME,ALPHAB)
VER (&FNAME,ALPHAB)
VER (&I,ALPHAB)
VER (&PHA,LEN,' ',3)
VER (&PHA,NUM)
VER (&PHNUM,PICT,'NNN-NNNN')

)END

```

Figure 76. Sample Panel Definition with Verification

The VGET Statement

The VGET statement copies variables from the shared or application profile variable pool.

```
VGET name-list [ASIS|SHARED|PROFILE]
```

where:

name-list Specifies one or more dialog variables, separated by commas or blanks, whose values are to be copied from the shared or application profile pool. The names are passed in standard name-list format. A name-list of more than one name must be enclosed in parentheses.

ASIS Variable values are to be copied from the shared variable pool, if found there; otherwise, they are to be copied from the application profile pool. ASIS is the default value.

VGET Statement

SHARED	Variable values are to be copied from the shared variable pool.
PROFILE	Variable values are to be copied from the application profile variable pool. ISPF deletes any shared pool variables having the same name, even if they do not exist in the application profile pool.

Note: Specifying a non-modifiable variable in a VGET statement in a selection panel results in a severe error.

DISPLAY Service Panel

When processing a DISPLAY or TBDISPL service request, ISPF normally searches for dialog variable values in the order:

1. Function pool
2. Shared pool
3. Application profile pool

To give you control over the pool from which ISPF retrieves variable values, the VGET statement in a panel's)INIT,)REINIT, or)PROC section allows you to specify that ISPF is to copy one or more variable values from either the shared pool or application profile pool to the function pool. If one or more of these variables already exist in the function pool, their values are updated with the values of the corresponding variables accessed by the VGET statement. Any of these variables that do not exist in the function pool are created and updated with the values of those accessed by the VGET statement.

Example:

```
)PROC  
  VGET (XYZ ABC) PROFILE
```

This VGET statement in a panel's)PROC section causes the current values for variables XYZ and ABC to be copied from the profile pool and updated in the function pool and used as the variable values for display of a panel field. If XYZ and ABC do not already exist in the function pool, they are created then updated.

SELECT Service Panel

At the time ISPF processes a SELECT service request, there is no function pool. Therefore, ISPF normally searches for dialog variable values in the order:

1. Shared pool
2. Profile pool

When specified on a selection panel, the VGET statement functions as follows:

- If the variable value is taken from the profile pool, the shared pool value, if it exists, is deleted.
- Otherwise, the VGET statement has no effect.

Further processing of the variables on the selection panel, other than by the VGET statement, is described in "SELECT Service and Variable Access" on page 60.

The following is an example of a VGET statement on a selection panel, where the specified variable exists in both the shared and profile pools:

```
VGET FNAME PROFILE
```

This statement causes ISPF to retrieve the current value of variable FNAME from the profile pool and display it in the corresponding panel field. Any updates to the variable are made to the profile pool. ISPF deletes the variable from the shared pool.

The VPUT Statement

While variables entered from a panel are automatically stored in the function variable pool, variables can also be stored in the shared and profile variable pools by VPUT statements used in the)INIT,) REINIT,)ABCINIT,)ABCPROC, or)PROC sections of the panel definition.

VPUT <i>name-list</i> [ASIS SHARED PROFILE]

where:

name-list	Specifies the names of one or more dialog variables whose values are to be copied from the function pool to the shared or profile pool.
ASIS	Specifies that the variables are to be copied to the pool in which they already exist or that they are to be copied to the shared pool, if they are new. If the variables exist in both the shared and profile pools, they are copied only to the shared pool.
SHARED	Specifies that the variables are to be copied to the shared pool.
PROFILE	Specifies that the variables are to be copied to the application profile pool. Any shared pool variables with the same names are deleted.

Example:

```
)PROC
  VPUT (XYZ ABC) PROFILE
```

This statement causes current values for variables XYZ and ABC to be stored in the profile pool by a VPUT operation.

The syntax for the VPUT statement is the same as that for the VPUT service when it is invoked from a command procedure except that the ISPEXEC command verb is omitted.

Using ISPF Control Variables

Control variables are used to control and test certain conditions pertaining to the display of a panel or message. Only those that apply to displays are discussed in this section. They can be used only in the)INIT,)REINIT, and)PROC sections of a panel definition.

This section describes the following control variables:

- .ALARM – page 281
- .ATTR – page 282
- .ATTRCHAR – page 282
- .AUTOSEL – page 285
- .CSRPOS – page 285
- .CSRROW – page 286
- .CURSOR – page 286
- .HELP – page 287

Using ISPF Control Variables

- .MSG – page 288
- .NRET – page 289
- .PFKEY – page 290
- .RESP – page 290
- .TRAIL – page 291
- .ZVARS – page 291.

Control variables are automatically reset to blank when the panel display service first receives control. If .MSG, .CURSOR, and .CSRPOS are still blank after processing of the initialization section, they are set to the values passed by the calling sequence, if any, for an initial message or cursor placement. Under certain conditions, processing of the initialization section is bypassed.

Once .CURSOR, .CSRPOS, .MSG, and .RESP have been set to nonblank by panel processing, they retain their initial values until the panel is displayed, or redisplayed, at which time they are reset.

The control variables

.ALARM
.AUTOSEL
.CURSOR
.HELP
.MSG
.PFKEY
.RESP

have a length of 8 bytes. When set in an assignment statement to a longer value, the value is truncated. If these control variables are tested in a conditional expression, the compare value (literal or dialog variable) must not be longer than 8 bytes.

Figure 77 on page 281 shows an example in which both .HELP and .CURSOR have been set in the)INIT section of the panel definition.

```

)BODY
%----- EMPLOYEE RECORDS ----- %
%COMMAND==>_ZCMD %
+
%EMPLOYEE SERIAL: &EMPSER
+
+ TYPE OF CHANGE==>_TYPECHG + (NEW, UPDATE, OR DELETE)
+
+ EMPLOYEE NAME:
+ LAST %==>_LNAME +
+ FIRST %==>_FNAME +
+ INITIAL%==>_I+
+
+ HOME ADDRESS:
+ LINE 1 %==>_ADDR1 +
+ LINE 2 %==>_ADDR2 +
+ LINE 3 %==>_ADDR3 +
+ LINE 4 %==>_ADDR4 +
+
+ HOME PHONE:
+ AREA CODE %==>_PHA+
+ LOCAL NUMBER%==>_PHNUM +
+
)INIT
.HELP = PERS032
.CURSOR = TYPECHG
IF (&PHA = ' ')
&PHA = 301
&TYPECHG = TRANS (&TYPECHG N,NEW U,UPDATE D,DELETE)

)PROC
&TYPECHG = TRUNC (&TYPECHG,1)
VER (&TYPECHG,LIST,N,U,D,MSG=EMPX210)
VER (&LNAME,ALPHAB)
VER (&FNAME,ALPHAB)
VER (&I,ALPHAB)
VER (&PHA,NUM)
VER (&PHNUM,PICT,'NNN-NNNN')

)END

```

Figure 77. Sample Panel Definition with Control Variables

.ALARM

The **.ALARM** control variable can be set in an assignment statement within the **)INIT**, **)REINIT**, or **)PROC** sections to control the terminal alarm.

```
.ALARM = value
```

where:

value YES, NO, a blank, or null.

YES Causes the terminal alarm to sound when the panel is displayed.

NO Causes the terminal alarm to be silent when the panel is displayed.

blank Causes the terminal alarm to be silent when the panel is displayed.

null Causes the terminal alarm to be silent when the panel is displayed.

Note: *value* can also be a variable containing the value YES, NO, a blank or null.

Examples:

.ALARM Control Variable

```
.ALARM = YES  
.ALARM = &ALRM
```

In the first example, the .ALARM setting is YES, which causes the terminal alarm to sound when the panel is displayed. In the second example, the alarm setting can be turned on (YES) or off (NO) according to the current value of the variable ALRM. If the panel is displayed with a message that has .ALARM = YES, the alarm sounds regardless of the setting of .ALARM within the panel assignment statement.

Control variable .ALARM can also appear on the right side of an assignment statement. For example:

```
&ALRM = .ALARM
```

might be used to save the setting of .ALARM in variable ALRM.

.ATTR and .ATTRCHAR

.ATTR

The .ATTR control variable can be set in the)INIT,)REINIT, or)PROC section to allow attributes to be changed on a field basis.

```
.ATTR (field) = 'keyword (value),keyword (value)....'
```

where:

field Can be:

- The name of any input or output field that occurs in the panel body or area section.
- The .CURSOR control variable, which indicates the field where the cursor is currently positioned.
- The name of a dialog variable, preceded by an ampersand. The variable must contain the name of an input or output field that occurs in the panel body, .CURSOR, or a blank.

keyword (value)

A legitimate attribute keyword and value for that attribute.

Examples:

```
.ATTR (.CURSOR) = 'COLOR(YELLOW) HILITE(REVERSE) '  
.ATTR (&FLD) = 'HILITE(&HLTE) '  
.ATTR (&FLD) = 'PAS(ON) '
```

In the first example, the color and highlighting of the field containing the cursor is overridden. In the second example, the name of the field whose highlighting attribute is to be overridden is found in dialog variable FLD and the highlighting value is in variable HLTE.

Overriding the cursor field (.CURSOR) and the alternate long or short message field attributes can be particularly useful if the panel is being redisplayed because of a translation or verification failure. When such a failure occurs, the cursor is automatically placed on the field in error and the message ID to be displayed is automatically placed in the message area.

For example, if SMFIELD is specified on the)BODY statement as the alternate short message field, a)REINIT section could be specified as follows:

.ATTR and .ATTRCHAR Control Variables

```
)REINIT  
.ATTR (.CURSOR) = 'COLOR(RED) HILITE(USCORE) '  
.ATTR (SMFIELD) = 'HILITE(BLINK) '
```

This will cause the field in error to be redisplayed in red and underscored, and the error message to blink.

Only the specified attributes are overridden. Any other attributes associated with the field remain in effect.

When a field attribute is overridden in the)INIT section of a panel, the override remains in effect if the panel is redisplayed (unless the attribute is again overridden by another statement in the)REINIT section). However, an attribute override in the)PROC or)REINIT section of the panel remains in effect only for a single redisplay of that panel, should a redisplay occur. This allows one field at a time to be highlighted as errors are found. Once the user corrects the error, the field reverts to its normal attributes.

.ATTRCHAR

The .ATTRCHAR control variable can be set in the)INIT,)REINIT, or)PROC section to override attributes for all fields related to an existing attribute character.

```
.ATTRCHAR(<char>)='keyword(value),keyword(value) ....'
```

where:

char Can be:

- One of the special characters, one-digit character, or two-digit hexadecimal codes used to denote attribute characters within the panel.
- The name of a dialog variable, the value of which must contain an attribute character, two-digit hexadecimal code, or a blank.

char follows the rules for literals. That is, it must be enclosed in single quotes if it contains any of the special characters listed in “Using Variables and Literal Expressions in Text Fields” on page 113.

keyword (value)

A legitimate attribute keyword and value for that attribute.

When a field attribute is overridden in the)INIT section of a panel, the override remains in effect if the panel is redisplayed unless the attribute is again overridden by another statement in the)REINIT section. However, an attribute override in the)PROC or)REINIT section of the panel remains in effect only for a single redisplay of that panel, should a redisplay occur.

See “Relationship to Control Variables .ATTR and .ATTRCHAR” on page 205 for a description of appropriate and inappropriate override conditions for CUA and basic panel-element attributes.

Using .ATTR and .ATTRCHAR with Table Display Panels

The effect that an attribute override has on a table display panel depends on whether the override is permanent (overridden in the)INIT section) or temporary (overridden in the)REINIT or)PROC section). If the attribute override for a field or attribute character in the scrollable section of a panel is:

- Permanent, the override for the specified field or character is effective for every model set displayed

.ATTR and .ATTRCHAR Control Variables

- Temporary, the override for the specified field or character is effective for only the last selected model set processed

Any scrolling activity performed when temporary overrides are in effect causes the affected attributes to be cleared, including any temporary overrides in the fixed portion of the panel, and the original attributes to be put into effect. In addition, if a table is redisplayed after model sets have been selected and a scroll has taken place, any .ATTR or .ATTRCHAR temporary overrides are not put into effect.

Things to Remember When Using Attribute Override Control Variables

- The .ATTR or .ATTRCHAR control variable cannot appear on the right side of an assignment statement.
- Several characteristics (for example, INTENSITY, COLOR, and CAPS) can be changed with one attribute override statement. However, only one field can be changed by a single .ATTR statement, and only one attribute character or hexadecimal code can be changed by a single .ATTRCHAR statement.
- The TYPE keyword can be overridden by .ATTR or .ATTRCHAR. You can change the TYPE:

from INPUT/CUA input types	to OUTPUT/CUA output types
from OUTPUT/CUA output types	to INPUT/CUA input types
from TEXT/CUA text types	to TEXT/CUA text types
from DATAIN	to DATAOUT
from DATAOUT	to DATAIN

Exceptions: CUA TEXT types AB, ABSL, PS, RP

However, if you attempt to change the TYPE of a field from TEXT to INPUT, a dialog error will result.

See “Relationship to Control Variables .ATTR and .ATTRCHAR” on page 205 for a description of appropriate and inappropriate override conditions for CUA and basic panel-element attributes.

- The command field or scroll amount field cannot be changed to TYPE(OUTPUT) by an attribute override assignment.
- The first .ATTR assignment that is encountered within a panel section for a particular field is the one that is honored. Subsequent .ATTR assignments for that field are ignored. In the following example, FIELD1 will be blue and FIELD2 will be yellow:

```
)INIT
  .ATTR(FIELD1) = COLOR(BLUE)
  .ATTR(FIELD2) = COLOR(YELLOW)
  .ATTR(FIELD1) = COLOR(RED)
```

- Similarly, the first .ATTRCHAR assignment that is encountered within a panel section for a particular attribute character or hexadecimal code is the one that is honored.
- Be careful when overriding the pad character. Since the string of overridden attribute keywords is in quotes, the new pad character must be specified either without quotes or in double quotes, as follows:

```
.ATTR(FIELD1) = 'PAD($)'
.ATTR(FIELD2) = 'PAD('*')'
```

- If both an .ATTRCHAR assignment and an .ATTR assignment apply to the same field, the .ATTR assignment takes precedence.

Example:

```
)BODY
  ⋮
%==>_FIELD1      +
)INIT
  .ATTRCHAR(_) = 'COLOR(YELLOW)'
  .ATTR(FIELD1) = 'COLOR(WHITE)'
)REINIT
  IF (.MSG ^= ' ')
    .ATTR(FIELD1) = 'COLOR(RED) HILITE(BLINK)'
    .ATTRCHAR(_) = 'COLOR(BLUE)'
)PROC
  VER(&FIELD1,NB)
)END
```

When this panel is initially displayed, FIELD1 will be white and all other input fields will be yellow. If the panel is redisplayed with a message, FIELD1 will be blinking red and all other input fields will be blue. If the panel is redisplayed without a message, FIELD1 will revert to white, and all other input fields will revert to yellow.

.AUTOSEL

The .AUTOSEL control variable is used in conjunction with table display panels to specify auto-selection.

```
.AUTOSEL = YES | NO
```

where:

- YES** Indicates that if the CSRROW parameter or control variable is specified, the row is to be retrieved even if the user did not explicitly select the row. This is called auto-selection.
- NO** Indicates that if the CSRROW parameter or control variable is specified, the row is to be retrieved only if the user explicitly selects the row by entering data in the corresponding model set on the screen.

If the CSRROW parameter or control variable is not specified, .AUTOSEL is ignored. .AUTOSEL can be set in the)INIT or)REINIT section. Any assignment made to .AUTOSEL in the)PROC section is ignored.

.CSRPOS

The .CSRPOS control variable can be set in the)INIT or)REINIT section and controls where in a field the cursor is to be set.

```
.CSRPOS = integer
variable = .CSRPOS
```

where:

integer

Specifies the position in the field to which the cursor is set. This position applies regardless of whether the cursor placement was specified using the CURSOR calling sequence parameter, the .CURSOR control variable in the)INIT or)REINIT section, or the default cursor placement. If cursor-position is not specified or is not within the field, the default is one, the first position of the field.

.CSRPOS Control Variable

The .CSRPOS control variable can appear on the right side of an assignment statement, making it act like a function. Thus, the cursor field name and its position within a field can be stored in variables.

Example:

```
&CPOS = .CSRPOS
```

In the preceding statement, the position (an integer value) of the cursor within the input or output field or area is returned in variable CPOS.

.CSRROW

The .CSRROW control variable is used in conjunction with table display panels.

```
.CSRROW = CRP-number  
variable = .CSRROW
```

where:

CRP-number

Table current-row-pointer number corresponding to the model set on the display where the cursor is to be placed. If the specified row does not have a corresponding model set displayed on the screen, the cursor is placed at the command field. The row will be auto-selected under either of the following conditions:

- If the CSRROW parameter is specified on the TBDISPL service either without AUTOSEL(NO) being specified on TBDISPL or .AUTOSEL(NO) specified as a panel definition statement.
- If the .CSRROW control variable is specified as a panel definition statement either without AUTOSEL(NO) being specified on TBDISPL or .AUTOSEL(NO) specified as a panel definition statement.

The .CSRROW control variable can appear on the right side of an assignment statement, making it act like a function. Thus, the table row number corresponding to the model set on the display where the cursor is to be placed can be stored in a variable.

Example:

```
&CROW = .CSRROW
```

.CURSOR

The .CURSOR control variable can be set in the)INIT or)REINIT section to control the placement of the cursor.

```
.CURSOR = string  
variable = .CURSOR
```

where:

string A character string that matches a field name or a DYNAMIC or GRAPHIC area name in the panel body. Its value cannot be a character string that matches a scrollable area name, but it can be a character string that matches a field name within the scrollable area.

Example:

```
.CURSOR = DSN
```

This example causes the cursor to be placed at field DSN. This variable is automatically set to the field last referred to whenever .MSG is set explicitly or indirectly by TRANS or VER statements. The .CURSOR control variable overrides any cursor position specified on the DISPLAY or TDISPL service request.

Note: In GUI mode, .CURSOR can be set only to an input or pushbutton (point-and-shoot) field. If the application attempts to set the cursor to any other field, ISPF ignores the placement and uses the default cursor placement.

The .CURSOR control variable can appear on the right side of an assignment statement, making it look like a function.

Example:

```
&CNAME = .CURSOR
```

If the control variable .CURSOR is not explicitly initialized, or if it is set to blank, the initial field where the cursor is positioned (default placement) is determined as follows:

1. The panel body is scanned from top to bottom, and the cursor is placed at the beginning of the first input field that meets the following criteria:
 - It must be the first or only input field on a line.
 - It must not have an initial value; that is, the corresponding dialog variable must be null or blank.
 - It must not have a field name of ZCMD.
2. If the stated criteria are not met in the panel body, the scrollable areas are searched using the same criteria.
3. If the criteria are still not met, the cursor is placed on the first input field in the panel body or scrollable area, usually the command field.
4. If the panel has no input fields, the cursor is placed at the upper-left corner of the screen.

The cursor is automatically placed at the beginning of the field that was last referred to in any panel definition statement when a message is displayed because of:

- A verification failure that sets .MSG
- A .MSG=value condition in a TRANS
- An explicit setting of .MSG

Examples:

```
&XYZ = TRANS (&A ... MSG=xxxxx)  
&A = TRANS (&XYZ ... MSG=xxxxx)  
VER (&XYZ, NONBLANK) VER (&B, ALPHA)
```

Assume that field XYZ exists in the panel body, but there are no fields corresponding to variables A or B. In all the preceding examples, the cursor would be placed on field XYZ if a message is displayed.

.HELP

The .HELP control variable can be set in the initialization section to establish a tutorial (extended help) panel to be displayed if the user enters the HELP command.

.HELP Control Variable

```
.HELP = panelname variable = .HELP
```

where:

panelname Name of the tutorial panel to be displayed.

Example:

```
.HELP = ISPTE
```

This example causes tutorial panel ISPTE to be displayed when the user enters the HELP command.

The .HELP control variable can appear on the right side of an assignment statement, making it act like a function.

.HHELP

The .HHELP control variable can be set in the initialization section to establish a tutorial (extended help) panel to be displayed if the user enters the HELP command from within HELP.

```
.HHELP = panelname
```

where:

panelname Name of the tutorial panel for help to be displayed.

Example:

```
.HHELP = ISP00006
```

This example causes tutorial panel ISP00006 to be displayed when the user enters the HELP command from HELP. This also happens to be the default setting. The Dialog Tag Language generates the setting .HHELP = ISP00006 for any help panels it builds.

.MSG

The .MSG control variable can be set to a message ID, typically in the processing section, to cause a message to be displayed.

```
.MSG = msgid variable = .MSG
```

where:

msgid The message ID of the message to be displayed.

Example:

```
.MSG = ISPE016
```

This variable is automatically set by use of the MSG=value keyword on a TRANS statement if there is no match with the listed values, or on a VER statement if the verification fails.

The .MSG control variable can appear on the right side of an assignment statement, making it act like a function.

.NRET

On enabled panels, the .NRET key retrieves the library names from the current library referral list or data set, or workstation file name from the current data set referral list. Unlike some other dot variables, .NRET **can** be assigned multiple times in panel logic.

```
.NRET = ON|OFF|DSN|LIB
```

where:

- ON** Sets the NRETRIEV command table entry active.
- OFF** Sets the NRETRIEV command table entry inactive.
- DSN** Tells ISPF that the NRETRIEV command retrieved a name from the current data set referral list.
- LIB** Tells ISPF that the NRETRIEV command retrieved a name from the current library referral list.

Other values are reserved by ISPF. No messages are given in case of an assignment that is not valid.

When .NRET is used as the source for an assignment statement it always returns a null.

The user is responsible for assigning NRETRIEV to a PF key. NRETRIEV is normally inactive but can be made active by using the .NRET=ON assignment in the)INIT and)REINIT section of a panel. If it is turned on, .NRET=OFF **must** be executed in the)PROC section of the panel. Failure to turn off .NRET in the)PROC section of the panel can lead to errors when the NRETRIEV key is pressed on subsequent panels.

NRETRIEV sets the following variables in the FUNCTION pool:

Variable	Function
ZNRPROJ	Project name
ZNRGRP1	First group name
ZNRGRP2	Second group name
ZNRGRP3	Third group name
ZNRGRP4	Fourth group name
ZNRTYPE	Type name
ZNRMEM	Member name
ZNRODSN	Other data set name
ZNRVOL	Volume associated with the other data set name
ZNRLIB	Successful library retrieve (YES or NO)
ZNRDS	Successful data set retrieve (YES or NO)
ZNRWSN	Workstation name indicator for other data set name (H = Host, W = Workstation)

.PFKEY Control Variable

.PFKEY

The .PFKEY control variable is set to a value that reflects the function key pressed by a user while the panel is being displayed.

```
.PFKEY = value  
variable = .PFKEY
```

where:

value The function key (F01–F24) pressed by a user.

The value of .PFKEY can be examined in the)PROC section of the panel and copied into dialog variables through use of assignment statements. If no function key is pressed by the user, .PFKEY contains blanks. .PFKEY is blank during processing of the)INIT and)REINIT sections.

The .PFKEY control variable can appear on the right side of an assignment statement, making it act like a function.

.RESP

The .RESP control variable indicates *normal* or *exception* response on the part of the user.

```
.RESP = ENTER | END  
variable = .RESP
```

where:

ENTER

Normal response. ISPF always sets .RESP to ENTER unless the user enters an END or RETURN command.

END Exception response. ISPF sets .RESP to END if the user enters an END or RETURN command.

The value in .RESP can be tested in the processing section to determine the user's response.

Example:

```
IF (.RESP = END)
```

Setting .RESP in the)INIT or)REINIT section of the panel definition has no effect if a message is being displayed.

The)INIT or)REINIT section can be coded with the following statements to assure that the panel is not displayed, regardless of whether a message was specified on the DISPLAY service request.

Example:

```
)INIT or )REINIT  
  IF (.MSG ^= &Z)  
    .MSG = &Z  
    .RESP = END
```

This variable can be set in a panel processing section to force an END or ENTER response. This can be particularly useful if a verification has failed (or .MSG was set) and you want that panel to be redisplayed with the message even if the user entered END or RETURN.

The .RESP control variable can appear on the right side of an assignment statement, making it act like a function.

.TRAIL

The .TRAIL control variable contains the *remainder* following a truncate (TRUNC) operation.

```
variable = .TRAIL
```

where:

variable Assigned the value in .TRAIL.

If the contents of a variable are truncated to a specified length, all remaining characters are stored in .TRAIL. If the contents of a variable are truncated at the first occurrence of a special character, the remaining characters following the special character are stored in .TRAIL.

.ZVARS

The .ZVARS control variable can be set in the initialization section to a list of variable names that correspond to Z place-holders in the body and/or model lines.

```
.ZVARS = var | '(varlist)'  
variable = .ZVARS
```

where:

var Name that corresponds to a Z place-holder.

varlist One or more variable names that correspond to Z place-holders.

The .ZVARS control variable can appear on the right side of an assignment statement, making it act like a function.

Using Z Variables as Field Name Place-Holders

In the body and area sections of a panel definition and in the model lines for a table display panel, the name of an input or output field can be represented by the single character Z. This serves as a place-holder; the actual name of the field is defined in the initialization section of the panel definition.

Use of place-holders allows the definition of short fields for which the lengths of the variable names exceed the lengths of the fields.

The actual names of these fields are assigned in the initialization section of the panel definition. The names are in a name list, enclosed in parentheses if more than one name is specified, assigned to the control variable .ZVARS. The first name in the list corresponds to the first Z place-holder that appears in the body or model lines. The second name in the list corresponds to the second Z, and so forth.

.ZVARS Control Variable

In the example shown in Figure 78, the input field labeled TYPE is 1 character long and the next two input fields are each 2 characters long. The names of these three fields are TYPFLD, LNGFLD, and OFFSET, respectively.

```
)BODY
----- TITLE LINE -----
%COMMAND==>_ZCMD %
%
.
.
.
+ TYPE %==>_Z+ (A for alpha, N for numeric)
+ LENGTH%==>_Z + (0 to 99)
+ OFFSET%==>_Z + (0 to 99)
.
.
)INIT
.ZVARS = '(TYPFLD LNGFLD OFFSET)'
```

Figure 78. Example of Z Variable Place-Holders

The name list assigned to .ZVARS must be enclosed in single quotes because the list contains special characters (parentheses) and blanks. As with other name lists, either commas or blanks can be used to separate the names in the list. .ZVARS can also be set to a dialog variable that has a valid name list as its value. For example:

```
.ZVARS = &NLIST
```

where the value of &NLIST is (TYPFLD LNGFLD OFFSET). See “Defining the Area Section” on page 164 for the description of how to use Z place-holders in scrollable panel areas.

Chapter 8. ISPF Help and Tutorial Panels

Online help and tutorial panels are a set of panels that a developer can include to provide online information for an application user. Help and tutorial panels can contain information that is helpful to a first-time user. They also can instruct a user to take specific actions based on a particular condition that has occurred during the application processing.

All ISPF help panels that are created using the Dialog Tag Language display in a pop-up window. ISPF help panels created using the ISPF panel source statements and containing the WINDOW keyword on the panel's)BODY statement also display in a pop-up window. If field-level help is being displayed, the ISPF help facility attempts to position the pop-up window relative to the object field.

The width and depth values specified on the HELP tag or on the WINDOW keyword must be valid for the device on which these help panels are displayed. Refer to the *z/OS ISPF Dialog Tag Language Guide and Reference* for details on the HELP tag. See page 207 for details on the WINDOW keyword.

You can provide the following types of help or tutorial panels. The ISPF tutorial is shipped with the product.

Extended help (panel help)

Provides general information about the contents of a panel. The information in extended help can be an overall explanation of items on the panel, an explanation of the panel's purpose in the application, or instructions for the user to interact with the panel.

See the description of the .HELP variable in ".HELP" on page 287 for more information.

Field-level help

Provides help panels for fields defined on an application panel.

When the user enters the HELP command, ISPF displays the help panel defined for the field on which the cursor is located.

You may define field-level help for action bar choices and pull-down choices, as well as for fields within the panel body. If you are creating panels with field level help using Dialog Tag Language, refer to the *z/OS ISPF Dialog Tag Language Guide and Reference* for a description of the tag attributes you should use. Otherwise, for more information about defining the)HELP section of the panel, refer to "Defining the HELP Section" on page 220.

HELP FOR HELP

Provides help for using the help or tutorial facility.

Keys help

Provides a brief description of each key defined for a panel. See "Keys Help" on page 93 for more information about keys help.

Message help

Provides help for ISPF messages. See "How to Define a Message" on page 304 for more information.

Reference phrase help

Provides help for reference phrases. See “Reference Phrase Help” on page 94 for more information.

Tutorial

Describes the ISPF product. The tutorial is shipped with ISPF. See “The ISPF Tutorial Panels” on page 297 for more information.

TUTOR command

Provides a direct path to specific tutorial panels, in effect indexing Help hierarchies by panel identifiers.

Processing Help

You can request help from an application panel or a help panel. You can also specify a keylist to be associated with a help panel.

Help Requests from an Application Panel

When the user enters the HELP command, ISPF displays a help or tutorial panel according to the following sequence.

1. When a short message appears on an application panel and the user requests HELP, ISPF displays the long message.
2. If a long message is on the screen and the user requests HELP, ISPF checks to see if message help is defined.
 - If message help is defined, ISPF displays that panel. If the user requests help from the message help panel, the Help Tutorial panel is displayed.
 - If message help is not defined, ISPF checks to see if field-level help is defined for the field on which the cursor is located.
 - If field-level help is defined, ISPF displays that panel. If the user requests HELP from the field-level help panel, the Help Tutorial panel is displayed.
 - If field-level help is not defined, ISPF checks for panel help.
 - If panel help is defined, ISPF displays that panel. If the user requests HELP from the panel help panel, the Help Tutorial panel is displayed.
 - If panel help is not defined, ISPF displays the first panel within the application’s tutorial.
3. When an application panel has been displayed and the user requests HELP, ISPF checks to see if field-level help is defined for the field on which the cursor is located.
 - If field-level help is defined, ISPF displays that panel. If the user requests HELP from the field-level help panel, the Help Tutorial panel is displayed.
 - If field-level help is not defined, ISPF checks for panel help.
 - If panel help is defined, ISPF displays that panel. If the user requests HELP from the panel help panel, the Help Tutorial panel is displayed.
 - If panel help is not defined, ISPF displays the first panel within the application’s tutorial.

Figure 79 on page 295 illustrates the panel flow for help according to the ISPF search sequences.

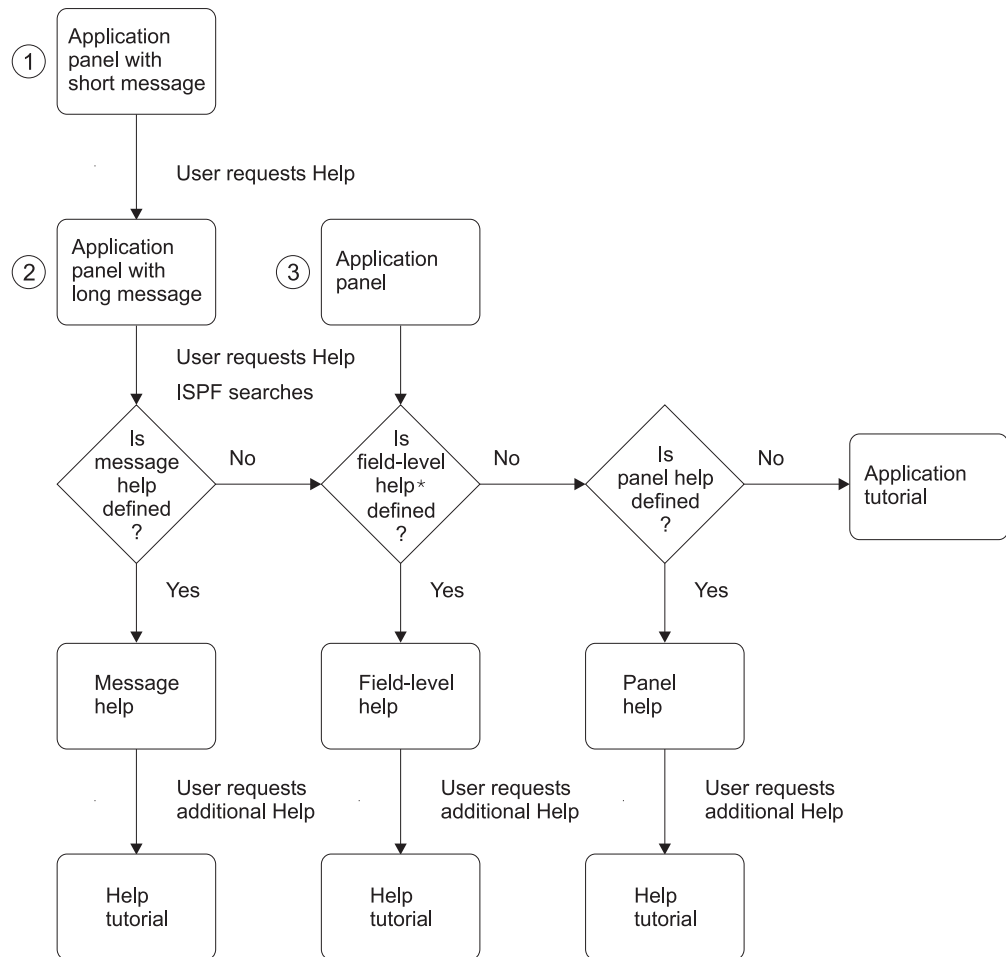

* ISPF searches for field-level help for the field on which the cursor is located

Figure 79. Help Panel Flow

Keys Help Request from an Application Panel

When an application panel is displayed and the user requests KEYSHELP, ISPF displays the keys help panel (provided that keys help is defined).

If the panel contains a short message, and/or long message and the user requests KEYSHELP, ISPF displays the keys help panel without following the search sequence as illustrated in Figure 79.

Extended Help Request from an Application Panel

When an application panel is displayed and the user requests EXHELP, ISPF displays the extended help panel (provided that extended help is defined).

If the panel contains a short message, and/or long message and the user requests EXHELP, ISPF displays the extended help panel without following the search sequence as illustrated in Figure 79.

Help Available from a Help Panel

The following list describes the ISPF help facilities available when a help panel or tutorial panel is displayed.

- If the user requests HELP from any help or tutorial panel, ISPF displays the help for help panel defined by the .HHELP control variable. If the variable is not defined, then ISPF displays the Help Tutorial panel.
- If the user requests EXHELP from any help or tutorial panel (except from the extended help panel), ISPF displays extended help.

Note: If the user requests EXHELP from the extended help panel, ISPF issues a message stating that extended help is currently displayed.

- If the user requests KEYSHELP from any help or tutorial panel (except the keys help panel), ISPF displays keys help.

Note: If the user requests KEYSHELP from the keys help panel, ISPF issues a message stating that keys help is currently displayed.

- If the help panel contains a reference phrase, and the user requests HELP while the cursor is positioned on a reference phrase, ISPF displays the reference phrase help panel defined. When a reference phrase help panel is canceled, the help panel from which reference phrase help was requested is redisplayed. All other help facilities are available from a reference phrase help panel.

Ending Help

When the user requests END or EXIT from any help panel (except the Help Tutorial panel), ISPF returns to the original application panel. If the user requests END or EXIT from the Help Tutorial panel, ISPF returns to the previous panel.

If the user requests CANCEL from any help or tutorial panel, ISPF returns to the previous panel.

ISPF Default Keylist for Help Panels

You can specify a keylist to be associated with a help panel by using the keylist attribute on the HELP tag (DTL) or by using the)PANEL statement in your panel definition. If you do not specify a keylist, ISPF uses the keys defined for ISPHELP to display in the function area of the help panel when it is displayed.

The key settings and forms for ISPHELP are shown in Table 17. For more information about keylists, refer to the Settings (option 0) chapter in the *z/OS ISPF User's Guide Vol II*.

Table 17. ISPHELP Key Settings

Key	Command	Form
F1	HELP	Short
F2	SPLIT	Long
F3	EXIT	Short
F5	EXHELP	Short
F6	KEYSHELP	Short
F7	UP	Long
F8	DOWN	Long
F9	SWAP	Long

Table 17. ISPHELP Key Settings (continued)

Key	Command	Form
F10	LEFT	Long
F11	RIGHT	Long
F12	CANCEL	Short

The ISPF Tutorial Panels

A tutorial panel is a special type of panel that is processed by the ISPF tutorial program. This program invokes the panel display service to display the panel.

A user invokes the ISPF program that displays tutorial panels in four ways:

- As an option from a menu
- Directly or indirectly from any non-tutorial panel by entering the HELP command or by pressing the function key assigned to the HELP command.
- By selecting a choice from a Help pull-down
- Through the use of the TUTOR command

Transfer into and out of the tutorial using the HELP command is transparent (no action required) to ISPF functions.

ISPF tutorial panels are arranged in a hierarchy. Generally, this hierarchy is a table of contents, each succeeding level of which contains a more detailed list of topics. When the tutorial is entered from a menu, the first panel to be displayed is usually the top of the hierarchy. The name of the first panel is passed as a parameter to the ISPTUTOR program.

When the tutorial is entered by use of the HELP command, the first panel to be displayed is a panel within the hierarchy, appropriate to what you were doing when help was requested.

When viewing the tutorial, you can select topics by entering a selection code or by simply pressing Enter to view the next topic. On any panel, you can also enter the following commands:

BACK or B To return to the previously viewed panel
SKIP or S To advance to the next topic
UP or U To display a higher-level list of topics
TOC or T To display the table of contents
INDEX or I To display the tutorial index

Note: If you enter the UP command after viewing a portion of a tutorial sequentially and if you do not select a new topic from the displayed list, you can resume the tutorial at the next sequential topic on the list by entering the NEXT command or by pressing Enter.

You can use the following keys whenever you are in the tutorial:

ENTER To display the next sequential page or scroll a scrollable help panel
HELP To redisplay this page for *help* information
END To terminate the tutorial
UP To display a higher level list of topics (rather than typing UP)

DOWN	To skip to the next topic (rather than typing SKIP)
RIGHT	To display the next page (rather than pressing Enter) or to scroll a scrollable help panel
LEFT	To display the previous page (rather than typing BACK) or to scroll a scrollable help panel

When running under tutorial and trying to scroll past the end of the scrollable area, a message will be displayed indicating that no more information is available in the scrollable area. If RIGHT or ENTER is pressed again, ISPF will follow the normal tutorial flow and display the next help panel if one has been defined. The same is true when scrolling to the TOP of the scrollable AREA; a message indicating that no more information is available will be displayed, and if LEFT is pressed, the previous tutorial panel will be displayed if one has been defined.

Cursor positioning usually defines which scrollable area will be scrolled. However, when in tutorial, if the cursor is not within a scrollable area, the first area defined in the)BODY section will be scrolled. The LEFT and RIGHT commands should be included in any keylist specified for a scrollable help panel.

If you issue the HELP command while viewing a tutorial, ISPF displays a tutorial panel that contains a summary of commands that are available to the tutorial user.

When you end the tutorial, using the END or RETURN command, the panel from which you entered the tutorial is displayed again.

The name of the top panel must be specified by dialog variable ZHTOP. The name of the first index panel must be specified by ZHINDEX. It is recommended that these two dialog variables be initialized at the beginning of the application to ensure that the user can always display the tutorial top or index, regardless of how the tutorial was entered. One way to initialize these variables is to set them from the primary option menu, as shown in "Example of a Primary Option Menu" on page 125.

The index is optional. It is a collection of panels in which topics are arranged in alphabetical order. You can jump to the index from any point by using the INDEX command. The index need not be connected to the main tutorial hierarchy. It can be a topic that you can select from the main table of contents or other panels. A list of the last 20 tutorial panels displayed, including the current panel, is maintained by ISPF. You should issue the TOP or INDEX command instead of the BACK command if you want to view panels displayed before the last 20 panels.

Each tutorial panel must have a *next selection* input field. Generally, you should use the name ZCMD for this field. A tutorial panel should also have a processing section in which the following variables are set:

ZSEL or SEL

Specifies the name of the next panel to be displayed based on the topic selected by the user, by translating ZCMD to a panel name. The panel name can be preceded by an asterisk (*) to indicate a topic that can be explicitly selected by the user, but which is bypassed if the user presses Enter to view the next topic.

The maximum number of entries allowed is 100.

If a panel does not have any selectable topics, omit ZSEL.

ZUP or UP

Specifies the name of the parent panel from which this panel was selected. Generally, ZUP can be omitted since the tutorial program remembers the sequence of selections that lead to the display of this panel. ZUP is used only if this panel is the first to be displayed by a user entering the HELP command, or if it is selected from the tutorial index and the user then enters the UP command.

ZCONT or CONT

Specifies the name of the next continuation panel. If there is no continuation panel, ZCONT should be omitted.

ZIND When set to a value of YES, specifies that a page in the tutorial is an index page. For example:

```
)PROC  
  &ZIND = YES
```

The ZIND variable is used only on index pages; it should not be set on other tutorial panels.

Variables SEL, UP, and CONT are provided for compatibility with the previous SPF product. Use of variable names ZSEL, ZUP, and ZCONT is recommended.

A panel cannot have both a continuation panel and selectable topics. However, the last panel in a sequence of continuation panels can have selectable topics.

Help/tutorial panels can contain variables so that dialog information, including information entered by a user, can be displayed on the help panel. Function variables, as well as shared and profile variables, can be displayed.

Figure 80 on page 300 shows a sample hierarchy of tutorial panels. Panels A and B have three selectable topics each. Panels C and D2 have two selectable topics each. The other panels have no selectable topics. Panel D1 has a continuation page (D2), and panel F1 has two continuation pages (F2 and F3).

In Figure 80 on page 300, assuming that panel A is the highest-level table of contents, the viewer can get to A from any point by issuing the TOC command. A viewer currently on panel F1, F2, or F3 can return to panel B by issuing the BACK command. Then, from B, the SKIP command would take the viewer to panel C. If the user enters the TUTOR command along with a panel identifier parameter, a specific tutorial panel within the Help hierarchy is displayed. From that point on, any movement within the hierarchy is the same as if the user had reached the panel by any other means.

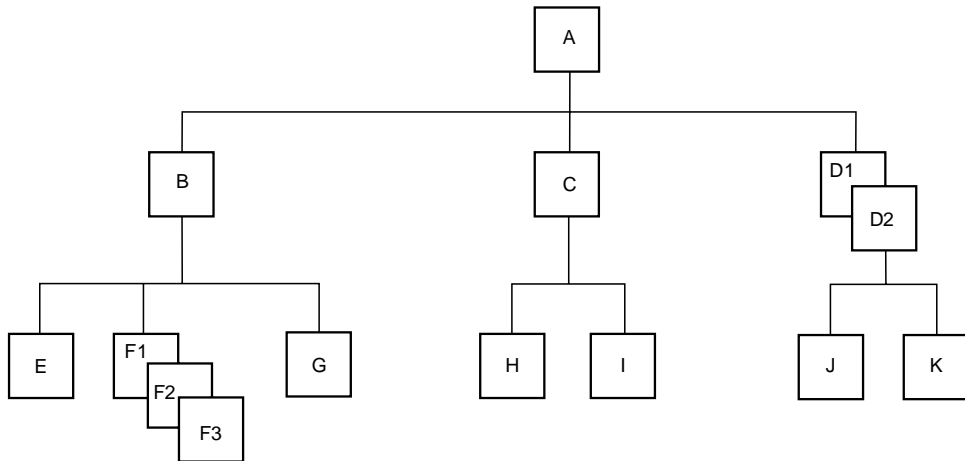

Figure 80. Sample Tutorial Hierarchy

Two sample tutorial panels are shown in Figure 81 and Figure 82 on page 301. These are assumed to be panels B and F2, respectively, in the hierarchy in Figure 80.

```

%TUTORIAL ----- 3270 DISPLAY TERMINAL -----TUTORIAL
%NEXT SELECTION ==>_ZCMD
+
%
+-----+
|          |
|  General Information  |
|  3270 Key Usage      |
|          |
+-----+
+
+ The IBM 3270 display terminal has several keys which will assist you
+ in entering information. These are hardware defined keys; they do not
+ cause a program interruption.
+
+ The following topics are presented in sequence,
+ or can be selected by number:
+
+   %1+ Insert and Delete Keys
+   %2+ Erase EOF (to End-of-Field) Key
+
+ The following topic will be presented only if
+ explicitly selected by number:
+
+   %3+ New Line and TAB Keys
+
+ )PROC
+   &ZSEL = TRANS(&ZCMD 1,E 2,F1 3,*G *,'?')
+   &ZUP  = A
+ )END
  
```

Figure 81. Sample Tutorial Panel Definition (Panel B)

Panel B has three selectable topics. In the processing section, ZCMD is translated to a panel name (E, F1, or G) corresponding to the selected option, and the result is stored in ZSEL. If none of the valid options is selected, a question mark (?) is returned as the translated string, which causes the tutorial program to display an *invalid option* message.

Note that option 3 is translated to *G. This indicates that panel G is displayed if the user selects option 3, but is bypassed if the user repeatedly presses Enter to view

each topic. The order in which topics are presented when Enter is pressed is the same as the order in which they appear in the TRANS function. If option 3 is selected, pressing the Enter key does not display the other topics.

In panel B, the name of the parent panel (A) is stored in variable ZUP.

```
%TUTORIAL ----- ERASE EOF KEY ----- TUTORIAL
%NEXT SELECTION ==>_ZCMD
+
+
  When the erase EOF (erase to end-of-field) key is used, it will appear
  to blank out the field. Actually, null characters are used in erasing
  to the next attribute byte, thus making it easy to use the insert
  mode, which requires null characters.
+
+
  If the erase EOF key is pressed when the cursor is not within an input
  field, the keyboard will lock. Press the RESET key to unlock the
  keyboard.
+
+
  You can try out the erase EOF key by entering data on line 2, then
  moving the cursor back over part or all of the data and pressing the
  key.
+
+
  (Continued on next page)
+
)PROC
  &ZCONT = F3
)END
```

Figure 82. Sample Tutorial Panel Definition (Panel F2)

Panel F2 (Figure 82) has no selectable topics, but does have a continuation page. The name of the continuation panel (F3) is stored in variable ZCONT. The name of the parent panel (B) could have been stored in ZUP, but this was omitted assuming that F2 cannot be directly entered by use of the HELP command or from the tutorial index.

If you call ISPTUTOR from an edit macro, be sure to save and restore the environment at that point. For example:

```
ISREDIT MACRO
ISPEXEC CONTROL DISPLAY SAVE
ISPEXEC SELECT PGM(ISPTUTOR) PARM(panel-id)
ISPEXEC CONTROL DISPLAY RESTORE
EXIT
```

Chapter 9. Defining Messages

This chapter describes how to create and change ISPF messages. You can create messages in two ways:

- Using the existing message definition.
- Using the MSG and MSGMBR tags of the Dialog Tag Language (DTL). Refer to the *z/OS ISPF Dialog Tag Language Guide and Reference* for more information about these tags.

ISPF message definitions are stored in a message library and displayed by using the DISPLAY, TBDISPL, or SETMSG service, written to the ISPF log file by the LOG service, or copied to variables specified in a GETMSG service request. You create or change messages by editing directly into the message library. ISPF interprets the messages during processing. No compile or preprocessing step is required.

Note: When not in TEST mode, the most recently accessed message definitions are retained in virtual storage for performance reasons. If you have modified a message, using TEST mode will ensure that the updated version of the message will be picked up by ISPF services. See “ISPF Test and Trace Modes” on page 24 for more information.

Several messages can be within each member of the message library. When using the PDF editor to create a message file, prevent numbers from appearing in the file by specifying NUMBER OFF.

The member name is determined by truncating the message ID after the second digit of the number.

For example:

Message ID	Member Name
G015	G01
ISPE241	ISPE24
XYZ123A	XYZ12
ABCDE965	ABCDE96
EMPX214	EMPX21

All messages that have IDs beginning with the characters G01, for example, must be in member G01. Figure 83 on page 304 shows an example of a member in the message library. This member contains all message IDs that begin with EMPX21.

```

EMPX210  'INVALID TYPE OF CHANGE' .HELP=PERS033  .ALARM=YES
'TYPE OF CHANGE MUST BE NEW, UPDATE, OR DELETE.'

EMPX213  'ENTER FIRST NAME'          .HELP=PERS034  .ALARM=YES
'EMPLOYEE NAME MUST BE ENTERED FOR TYPE OF CHANGE=NEW OR UPDATE.'

EMPX214  'ENTER LAST NAME'          .HELP=PERS034  .ALARM=YES
'EMPLOYEE NAME MUST BE ENTERED FOR TYPE OF CHANGE=NEW OR UPDATE.'

EMPX215  'ENTER HOME ADDRESS'       .HELP=PERS035  .ALARM=YES
'EMPLOYEE NAME MUST BE ENTERED FOR TYPE OF CHANGE=NEW OR UPDATE.'

EMPX216  'AREA CODE INVALID'        .ALARM=YES
'AREA CODE &PHA IS NOT DEFINED. PLEASE CHECK THE PHONE BOOK.'

EMPX217  '&EMP SER ADDED'
'EMPLOYEE &LNAME, &FNAME &I ADDED TO FILE'

EMPX218  '&EMP SER UPDATED'
'RECORDS FOR &LNAME, &FNAME &I UPDATED'

EMPX219  '&EMP SER DELETED'
'RECORDS FOR &LNAME, &FNAME &I DELETED'

```

Figure 83. Sample Messages

How to Define a Message

Messages generally should appear in collating sequence by message ID. Each message within the library consists of two required lines and (optionally) additional long message lines. The additional lines can contain up to 512 bytes of long message text. Figure 84 illustrates the syntax for defining messages.

```

Line 1:
msgid ['short message'] [.HELP=panel|*] [.ALARM=YES|NO]
[NOKANA|KANA] [.WINDOW=RESP|NORESP|LRESP|LNORESP]
[.TYPE=NOTIFY|WARNING|ACTION|CRITICAL]
Line 2:
'long message' [+]

Additional long message text lines - optional

Line 3:
['long message' [+] ]
Line 4:
['long message' [+] ]
Line n:
['long message'      ]

```

Figure 84. Example Syntax for Defining Messages

msgid

Required. Each message is referred to by a message identifier (ID). A message ID can be four to eight characters long. It is defined as follows:

- Prefix: one to five alphabetic characters (A-Z, #, \$, or @)
- Number: three numeric characters (0-9)
- Suffix (optional): one alphabetic character.

If the prefix is five characters long, the suffix must be omitted so that the total length does not exceed eight characters. Use the message ID suffix if more than 10 messages are to be included in one member.

short message

Optional. If a short message is specified on an ISPF panel, it is displayed first (before the long message). Its maximum length is 24 bytes. The short message is displayed in a pop-up window if the text is longer than will fit in the short message area or if you defined a message window using the `.WINDOW` keyword for the message. Otherwise, the short messages are right-justified and displayed, with a high intensity attribute, either:

- At the right end of the first line on the screen, if an action bar is not defined
- At the right end of the line following the action bar

If the user enters the `HELP` command, the long message is displayed, with a high intensity attribute. If the user enters the `HELP` command again, tutorial mode is entered.

The location of the short and long messages in a user-designed panel is specified by the `SMSG` and `LMSG` keywords. These keywords are defined under “Defining the Body Section” on page 207.

When messages are written to the ISPF log file, both the short message, if any, and the long message are written in the same output line. The short message comes first, followed by the long message.

Note: For long or short messages in pop-up windows, if the message originates from panel processing, such as a verification error message, the message pop-up window is placed adjacent to the field that is the object of the validation.

`.HELP=panel | *`

Optional. (Can be abbreviated to `.H`) If the user enters tutorial mode, the panel name specified by `.HELP` is the first tutorial page displayed. If `.HELP=*` is specified, the first tutorial page is the one specified in the panel definition, that is, the panel on which this message is being displayed. The default is `*`.

`NOKANA | KANA`

Optional. The `NOKANA` keyword allows messages to contain lowercase characters, and still display correctly on a Katakana terminal. Because hexadecimal codes for some lowercase characters overlap those of some Katakana characters, they would display as meaningless characters on a Katakana terminal. If the `NOKANA` keyword is present in a message definition, ISPF translates any lowercase message characters to uppercase before displaying the message on a Katakana terminal.

In summary, if the terminal is Katakana, and:

- `KANA` is specified, all characters are left as is.
- `NOKANA` is specified, lowercase characters are translated to uppercase.
- If neither `KANA` nor `NOKANA` is specified, all characters are left as is.

If the terminal is not Katakana, and:

- `KANA` is specified, lowercase characters are displayed as periods
- `NOKANA` is specified, all characters are left as is.
- If neither `KANA` nor `NOKANA` is specified, all characters are left as is.

Notes:

1. On non-Katakana terminals, the `KANA` keyword can be used to display overlapping Katakana characters as periods rather than as meaningless lowercase characters.
2. On Katakana terminals, the `NOKANA` keyword is necessary in messages containing lowercase English characters.

- See Chapter 11, “Extended Code Page Support,” on page 329 for the discussion of the treatment of the KANA or NOKANA keywords if a CCSID is specified.

.ALARM=YES|NO

Optional. (Can be abbreviated to `.A`) If `.ALARM=YES` is specified, the audible alarm sounds when the message displays. If `.ALARM=NO` is specified, the alarm does not sound unless `.ALARM` is set to YES in the panel definition. The default is NO.

.WINDOW=RESP|NORESP|LRESP|LNORESP

Optional. (Can be abbreviated to `.W`) The `.WINDOW` keyword tells ISPF to display the message in a message pop-up window.

`.WINDOW=RESP` (R is a valid abbreviation for RESP) requests ISPF to display both long and short messages in a message pop-up window that requires the user to press Enter before data can be entered into the underlying panel. The user cannot enter data or interact with the underlying panel until Enter (or some other attention key) is pressed.

`.WINDOW=NORESP` (N is a valid abbreviation for NORESP) requests ISPF to display both long and short messages in a message pop-up window that does not require direct user response. The user can enter data into the underlying panel while this message is being displayed.

`.WINDOW=LRESP` (LR is a valid abbreviation for LRESP) requests ISPF to display only long messages in a message pop-up window that requires the user to press Enter before data can be entered into the underlying panel. The user cannot enter data or interact with the underlying panel until Enter (or some other attention key) is pressed.

`.WINDOW=LNORESP` (LN is a valid abbreviation for LNORESP) requests ISPF to display only long messages in a message pop-up window that does not require direct user response. The user can enter data into the underlying panel while this message is being displayed.

The MSGLOC parameter on the DISPLAY, TBDISPL, and SETMSG services controls the placement of the message pop-up window. For messages that originate from panel processing, such as a verification error message, the message pop-up window is placed adjacent to the field which is the object of the validation. The window placement will be such that it does not overlay the object field, if possible. If no correlation can be made between the validation and a field (such as when the variable being validated is not a panel field name), the message pop-up window is displayed at the bottom of the logical screen or below the active pop-up window, if one exists. See the sections on these services in the *z/OS ISPF Services Guide* for a complete description of the MSGLOC parameter.

.TYPE=NOTIFY|WARNING|ACTION|CRITICAL

Optional. (Can be abbreviated to `.T`) The `.TYPE` keyword in the message definition identifies the type of message. There are four types of messages, NOTIFY, WARNING, ACTION, and CRITICAL. N, W, A, and C are valid abbreviations.

Table 18 summarizes the characteristics of the different types of messages.

Table 18. Message Characteristics

Type	Color	Intensity	Placement	Response	Alarm
NOTIFY	White	High	Message area or pop-up window	Optional	Off

Table 18. Message Characteristics (continued)

Type	Color	Intensity	Placement	Response	Alarm
WARNING	Yellow	High	Message area or pop-up window	Optional	On
ACTION	Red	High	Message area or pop-up window	Optional	On
CRITICAL	Red	High	Pop-up window	Required	On

The .TYPE keyword overrides any .ALARM value that can be specified. A .TYPE=CRITICAL message is always displayed as though .WINDOW=RESP was specified. The color and highlighting characteristics defined above apply to messages displayed in the default short/long location and a pop-up message window. The dialog application controls the field attributes for alternate message location fields.

long message

Required. If a short message is not specified, the long message is automatically displayed first, with a high intensity attribute, in the long message area or in a message pop-up window. The long message is displayed in a pop-up window if the text is longer than will fit in the long message area, if you defined a message window using the .WINDOW keyword for the message, or if you have selected this option on the Settings panel.

The location of the short and long messages in a user-designed panel is specified by the SMSG and LMSG keywords. These keywords are defined under “Defining the Body Section” on page 207.

The maximum length of the long message text is 512 bytes. If the message text is greater than 512 bytes, it will be truncated. Messages greater than 78 bytes require multiple long message lines. The continuation of the long message text into additional lines is indicated by one or more spaces following the ending quote (') followed by a plus (+) sign. For example:

```
ISPX001 'short message text'
'Long message text' +
' continued over ' +
'multiple lines. The maximum length is ' +
'512 bytes.'
```

For the best results, use the fewest number of message lines possible.

```
ISPX001 'short message text'
'Long message text continued over multiple lines. The maximum' +
' length is 512 bytes.'
```

Consecutive SOSI characters resulting from multiple lines of DBCS data are automatically removed. For example,

```
'Long messageSDBS' +
      0 I
'SCSSdata.'
0 I
```

```
Result: Long messageSDBCSSdata.
      0 I
```

The ending SI in the first record and the beginning SO in the second record are automatically removed.

When messages are written to the ISPF log file, both the short message, if any, and the long message are written in the same output line. The short message comes first, followed by the long message.

The long message text will be written to multiple records if the text is greater than 78 characters.

Existing dialogs which have VDEFINED the system variable ZERRLM as 78 characters should be updated to VDEFINE this variable as 512 characters.

Note: For long or short messages in pop-up windows, if the message originates from panel processing, such as a verification error message, the message pop-up window is placed adjacent to the field which is the object of the validation.

Message Display Variations

The following tables show various message display situations and the effect of the .TYPE keyword and the PANEL DISPLAY CUA MODE field on the color and highlighting of the message text. The variations are dependent on whether you used the Dialog Tag Language (DTL) or the panel definition statements to define your panels.

Note: If you are running in GUI mode, messages that would appear in a pop-up window in non-GUI mode will be displayed in a message box. The message box will include the appropriate icon as defined by CUA guidelines:

- .TYPE=NOTIFY produces an *i* in a circle, the international symbol for information
- .TYPE=WARNING produces an exclamation point (!)
- .TYPE=ACTION or .TYPE=CRITICAL produces a red circle with a diagonal line across it

If your dialog application panels are generated using the DTL, the dialog manager displays the messages as shown in Table 19.

Table 19. Message Display Using DTL

Message Definition	Text	Intensity
.TYPE=NOTIFY .ALARM=YES NO	White	High
.TYPE=WARNING .ALARM=YES NO	Yellow	High
.TYPE=ACTION .ALARM=YES NO	Red	High
.TYPE=CRITICAL .ALARM=YES NO	Red	High
.TYPE not specified .ALARM=NO	White	High
.TYPE not specified .ALARM=YES	Yellow	High

If your application panels are generated from the panel definition statements and you use the default message placement, the dialog manager displays the messages as documented in Table 20.

Table 20. Message Display Using Panel Definition Statements

Message Definition	Text	Intensity
.TYPE=NOTIFY .ALARM=YES NO	White	High

Table 20. Message Display Using Panel Definition Statements (continued)

Message Definition	Text	Intensity
.TYPE=WARNING .ALARM=YES NO	Yellow	High
.TYPE=ACTION .ALARM=YES NO	Red	High
.TYPE=CRITICAL .ALARM=YES NO	Red	High
.TYPE not specified .ALARM=NO CUA mode=YES	White	High
.TYPE not specified .ALARM=YES CUA mode=YES	Yellow	High
.TYPE not specified .ALARM=NO CUA mode=NO	White	High
.TYPE not specified .ALARM=YES CUA mode=NO	White	High

If you define your panels using the panel definition statements and you use an alternate message placement, the dialog (using the field attributes) controls the message text color and highlighting.

Messages Tagged with CCSID

An ISPF message can be defined with `.CCSID=xxxxx` where `xxxxx` is the CCSID of the EXTENDED CODE PAGE as defined by Character Data Representation Architecture. Refer to “Supported CCSIDs” on page 333 for which CCSIDs are supported.

Panels or messages tagged with the CCSID keyword invoke the TRANS service. The *to* CCSID is the value in ZTERMCID. This value is filled in during ISPF initialization as the result of the terminal query done by ISPF. The *from* CCSID is the CCSID entered following the CCSID keyword.

If the CCSID keyword is used, the characters in the message are translated to the equivalent characters in the terminal code page for display. This translation occurs only if the terminal has returned information to allow ISPF to determine its CCSID and only if the code page indicated by the CCSID is different from the code page of the terminal.

Note: The same CCSID is used for all messages within a message member. Therefore, this keyword should be in the first record and start in the first column of the message member. If the `.CCSID` keyword is not in the first record or does not start in the first column of the first record, it is ignored and character translation does not occur.

```
.CCSID=xxxxx
ISPX001 'short message text'
'Long message text' +
' continued over ' +
'multiple lines. The maximum length is ' +
'512 bytes.'
```

All characters in the message member which are not short or long message text must be in the Syntactic Character Set:

- A–Z
- a–z
- 0–9
- + < = > % & * " ' .
- () , _ - . / : ; ?

The beginning and ending inhibited character tables are enhanced to include characters from the extended code pages for the supported Asian Pacific languages in formatting message text. The CCSID of the message is used to determine which tables to use. If no CCSID is specified, the session language ID and terminal type determine the tables used. See Chapter 11, “Extended Code Page Support,” on page 329 and “Message Pop-Up Text Formatting.”

Modeless Message Pop-Ups

ISPF allows you to cancel a modeless message pop-up by positioning the cursor within the bounds of the message pop-up and requesting CANCEL or ENTER. This allows you to remove the message pop-up without submitting the underlying panel for processing.

For the cursor to be within the bounds of the message pop-up, it must be inside the window frame of the message. Placing the cursor on the message window frame does not result in the message window being canceled. Note that asynchronous command processing is not suspended when the cursor is placed inside a message window. Therefore, commands such as PRINT and SPLIT are executed when typed on the command line and Enter pressed, even if the cursor is placed inside a modeless message pop-up window.

The HELP command will not display message help for a message window that has been canceled.

Message Pop-Up Text Formatting

The message text is retrieved from the message member. If it is more than one line (that is, if ISPF finds at least one blank and a plus sign following the closing quote) the lines are concatenated, including blanks within or at the end of the text. Trailing blanks are stripped from any variable values before the values are substituted into the text string.

The width of the message pop-up window is determined based on the location where the window will be placed. If the message is displayed as a result of a panel verification error, the message pop-up is displayed relative to the field in error. If the MSGLOC parameter is specified on the DISPLAY or SETMSG service, the message pop-up is displayed relative to the specified field name. If the MSGLOC parameter is not specified, the message pop-up will be displayed at the bottom of the logical screen or below the active ADDPOP pop-up window, if one exists.

The width of the window will be the width from this determined location to the right edge of the screen. Note that this width will vary based on the screen size the user is running with.

ISPF determines if the message text is to be formatted according to English rules or Asian rules based on the type of data in the message text, MIXED or EBCDIC, together with the message CCSID or the current ISPF session language variable, ZLANG.

If the data contains double-byte characters and the message CCSID is 00930, 00933, 00935, 00937, or 00939, the Japanese (Katakana), Korean, Simplified Chinese, Traditional Chinese, or Japanese (Latin) text formatting rules are used, respectively. If the data contains double-byte characters and the message does not have a CCSID or the CCSID is not 00930, 00933, 00935, 00937, or 00939 and the ZLANG value is JAPANESE, CHINESET, CHINESES, or KOREAN, the Japanese,

Traditional Chinese, Simplified Chinese, or Korean text formatting rules are used, respectively. If the data contains double-byte characters and the message does not have a CCSID, or if the message CCSID is not 00930, 00933, 00935, 00937, or 00939, or if the ZLANG is not JAPANESE, CHINESE, CHINESE, or KOREAN, the Japanese text formatting rules are used by default.

If the data is all single-byte data and there is no CCSID for the message, ISPF determines if the application is running on a Japanese Katakana terminal and if the NOKANA keyword was specified on the message definition. If so, ISPF uses the English formatting rules. If NOKANA was not specified, ISPF uses the Japanese Katakana formatting rules. If the application is not running on a Katakana terminal and there is no CCSID for the message, ISPF uses the English formatting rules.

English Rules for Message Text Formatting

Message text exceeding the width of the message window is wrapped to the next line. The text is split at blanks only. If a word is longer than the message window width, the window is expanded to the width of this word. However, if a word exceeds the maximum window size (screen width minus 3), the word will be split and continued on the next line. Once the message formatting is complete, the message pop-up window width will be decreased to the length of the longest line, excluding trailing blanks.

Asian Rules for Message Text Formatting

Some characters should not be placed at the beginning of a line, and some should not be placed at the end of a line. These beginning-inhibited and ending-inhibited characters are different among the languages, yet the required process is the same. Thus, ISPF uses the same text formatting process for the Asian languages, but it uses a different beginning-and-ending-inhibited character table for each language. The CCSID of the message is used to determine which tables to use. If no CCSID is specified, the session language ID and terminal type determine the tables used. See Chapter 11, "Extended Code Page Support," on page 329.

The message text is first split into *words*. An SBCS "word" is delimited by blanks, or SO/SI characters. Then any beginning inhibitors are stripped from the beginning of the word and treated as separate words, and any ending inhibitors are stripped from the end of the word and treated as separate words.

Adjoining DBCS alphanumeric characters (that is, Ward 42 characters) are treated as one DBCS "word". Then any beginning inhibitors are stripped from the beginning of the word and treated as separate words, and any ending inhibitors are stripped from the end of the word and treated as separate words. All other non-Ward 42 double-byte characters are treated as separate DBCS words.

If a word is longer than the message window width, the window is expanded to the width of this word. However, if a word exceeds the maximum window size (screen width = 3), the word will be split and continued on the next line. If the text consists of mixed data and does not fit in one line within the specified width, the first position will always be reserved for an SO character (if first word is double-byte) or for a blank (if the first word is single byte). This will allow the text to be aligned properly.

Words that exceed the width of the message window are wrapped to the next line according to following rules:

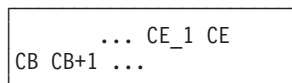

CE_1	CE	CB	CB+1	Process
any	B,X	B	X,E	Backward
E	E	X,B	X,E	Backward
X,B	E	any	any	Forward
X,B	- X -	B -	B	Forward
_____	any	other	_____	No process

where:

CE-1 and CE	Last two words that fit on line
CB and CB+1	First two words on next line
E	Ending inhibitor
B	Beginning inhibitor
X	Neither
Forward	Move CE to next line
Backward	Move CB to previous line
No process	Split as is.

Note: If words CE or CB are single-byte words and are more than one character, or if CE or CB are double-byte words and are more than one double-byte character, no special processing is used; the line is split as is.

SBCS and DBCS blanks that end or begin a line will be deleted.

Substitutable Parameters in Messages

A substitutable parameter, a dialog variable name preceded by an ampersand (&), can appear anywhere within the short and long message text. For example:

```
'Volume &VOL not mounted'
```

Substitutable parameters can also be used to specify the value of .HELP or .ALARM, as follows:

```
'Volume &VOL not mounted' .HELP = &H .ALARM = &A
```

where variable H must contain a panel name or single asterisk, and variable A must contain YES or NO. Substitutable parameters can also be used to specify the value of .TYPE and .WINDOW.

Substitutable parameters in messages are normally replaced with values immediately before the message displays. If the message is specified for display by using the SETMSG service, substitutable parameters are replaced during SETMSG processing. When the GETMSG service is invoked, substitutable parameters are replaced at the time of the GETMSG call. After substitution of the variables, the short message is truncated to 24 characters and the long message is truncated to 512 characters.

Syntax Rules for Consistent Message Definition

The following rules apply to the syntax of messages as they appear in the message library (Figure 83 on page 304):

- The message ID must begin in column 1 of the first line, and the long message must begin in column 1 of the second line. For readability, one or more blank lines can separate the two-line message specifications within the member.
- Comments can precede or follow a two-line message specified within a member. A comment begins with the characters /* starting in column one.
- In the first line, the fields must be separated by at least one blank. One or more blanks can optionally occur on either side of an equal sign (=).
- The short message, if specified, and the long message must each be enclosed in single quotes ('). If the short message is omitted, the enclosing single quotes are also omitted.
- Within the short or long message text, any non-alphanumeric character can terminate a variable name. For example:

```
'Enter &X, &Y, or &Z'
```

 where a comma terminates the variable names X and Y. The name Z is delimited by the single quote that marks the end of the message.
- A period (.) at the end of a variable name has a special meaning. It causes concatenation with the character string following the variable. For example, if the value of variable V is ABC, then:

```
'&V.DEF' yields 'ABCDEF'
```
- A single ampersand followed by a blank is interpreted as a literal ampersand character, not the beginning of a substitutable variable. An ampersand followed by a nonblank is interpreted as the beginning of a substitutable variable.
- A double ampersand can be used to produce a character string starting with an ampersand. The double character rule also applies to single quotes within the delimiting single quotes required for the short and long message text, and to a period, if it immediately follows a variable name. For example:

```
&& yields &  
' ' yields ' within delimiting single quotes  
.. yields . immediately following a variable name.
```

DBCS-Related Variables in Messages

The following rules apply to substituting DBCS related variables in messages. These rules also apply to file skeletons and file-tailoring operations.

- If the variable contains MIX format data, each DBCS subfield must be enclosed with shift-out and shift-in characters.

Example:

```
eeee[DBDBDBDBDB]eee[DBDBDB]
ee... represents a field of EBCDIC characters
DBDB... represents a field of DBCS characters
-[ ]- represent shift-out and shift-in characters.
```

- If the variable contains DBCS format data only, the variable must be preceded by the ZE system variable, without an intervening blank.

Example:

```
...text...&ZE&DBCSVAR..text...
```

- If the variable contains EBCDIC format data and is to be converted to the corresponding DBCS format data before substitution, the variable must be preceded by the ZC system variable, without an intervening blank.

Example:

```
...text...&ZC&EBCSVAR..text...
```

The ZC and ZE system variables can only be used for the two purposes described above.

Chapter 10. Defining File-Tailoring Skeletons

ISPF skeleton definitions are stored in a skeleton library and accessed through the ISPF file-tailoring services. You create or change skeletons by editing directly into the skeleton library. ISPF interprets the skeletons during execution. No compile or preprocessing step is required.

There are two types of records that can appear in the skeleton file:

Data records

A continuous stream of intermixed text, variables, and control characters that are processed to create an output record.

Control statements

Control the file-tailoring process. Control statements start with a right parenthesis in column 1. Records containing a) in column 1 and a blank in column 2 are interpreted as data records. Records containing a) in column 1 and a nonblank character in column 2, are interpreted as control statements.

A)DEFAULT control statement can be used to assign different special characters for syntactical purposes. The available control statements are:

-)BLANK
-)CM
-)DEFAULT
-)DO
-)DOT
-)ELSE
-)ENDSEL
-)ENDDO
-)ENDDOT
-)IF
-)IM
-)ITERATE
-)LEAVE
-)NOP
-)SEL
-)SET
-)TB
-)TBA

| You can use the ISPFTTRC command to trace both the execution of file tailoring
| service calls (FTOPEN, FTINCL, FTCLOSE, and FTERASE) and the processing that
| occurs within the file tailoring code and processing of each statement. For more
| information, refer to “File tailoring trace command (ISPFTTRC)” on page 355.

Control characters

The following characters are control characters and have special meanings in a skeleton. They can appear in either a data record or a control statement.

) (right parenthesis)

Defines the following:

Control characters

- The start of a control statement when placed in column 1 and followed by a nonblank character in column 2.
- The start of a data record when placed in column 1 and followed by a blank in column 2.

? (question mark)

The question mark is used as a continuation character when more than one input record maps to a single output record or control statement.

Data records

A question mark in the last input column of a data record indicates record continuation. If any character other than a question mark appears in the last input column of an input data record, it is copied to that column of the output record. Continuation of data records is not permitted for variable-length input records.

Control statements

Continuation of control statements is permitted for both fixed-length and variable-length input records.

In a **fixed-length** record, continuation of a control statement is identified by a question mark in the last input column:

```
)SEL &RC = 0 ? ?
  && &VARNAME = &ZUSER ?
  && &VARI <= 10
```

In a **variable-length** record, continuation of a control statement is identified by a question mark in the last nonblank input column that is preceded by a space:

```
)SEL &RC = 0 ?
  && &VARNAME = &ZUSER ?
  && &VARI <= 10
```

& (ampersand)

Indicates the start of a variable name. The value of the corresponding dialog variable is substituted in the output record. A value of all blanks is treated as null. The following characters implicitly delimit the end of a variable name:

(blank) 0 < (+ | & ! *) ; ~ - / , % _ > : ' = "

Note: File tailoring treats an ampersand-blank combination in the input record as an invalid variable name.

. (period)

Causes the value of the variable to be concatenated with the character string following the period when used at the end of a variable name.

Example:

If variable *V* has the value ABC, then "&V.DEF" yields "ABCDEF".

Two consecutive control characters in the input record result in one control character being placed in the output record:

```
)) yields )
?? yields ?
&& yields &
```

.. yields . immediately following a variable name.

Note: If any of these characters is overridden by the)DEFAULT control statement, the same rule applies to the new control character. For example, if a)DEFAULT statement substitutes the ^ character for), then two consecutive ^ characters in the input record will result in one ^ character being placed in the output record.

Considerations for data records

Input records can have a maximum length of 255 bytes. For fixed-length records, the last eight character positions are considered to be a sequence number. The character preceding the last eight characters is considered to be the last input column. Variable-length input records are scanned up to the end of the record.

If variable substitution results in an output record larger than the logical record length of the output file, file tailoring terminates and a message is displayed.

Any blank data records in the input data are deleted from file-tailoring output. However, the)BLANK control statement can be used to produce blank lines in the output file.

Control characters for data records

The following characters have special meanings in data records:

! (exclamation point)

Serves as the default tab character for the)TB and the)TBA control statements. The file-tailoring tabbing function works either similarly to that of a typewriter tabbing operation, or you can specify in the)TB syntax that tabbing is not to take place if a tab stop is sensed at the same record position as the tab character.

< (less-than)

| (vertical bar)

> (greater-than)

Specify, respectively, the beginning, middle, and end of a conditional substitution string. For example:

```
<string1|string2>
```

where *string1* must contain at least one variable name. *string2* can be null.

If the first variable in *string1* is not null, *string1* is substituted in the output record. If the first variable in *string1* is null, *string2* is substituted in the output record.

Example:

An input skeleton contains these lines:

```
)SET I = &Z
)SET J = VALUE_OF_J
)SET K = VALUE_OF_K
FIRST CONDITIONAL SUBSTITUTION RESULT: <&J|&K>;
SECOND CONDITIONAL SUBSTITUTION RESULT: <&I|&J>;
```

After processing, the file-tailoring output file contains:

```
FIRST CONDITIONAL SUBSTITUTION RESULT: VALUE_OF_J
SECOND CONDITIONAL SUBSTITUTION RESULT: VALUE_OF_J
```

Considerations for data records

Two consecutive control characters in the input record result in one control character being placed in the output record:

```
!! yields !
<< yields <
|| yields |
>> yields >
```

Note: If any of these characters is overridden by the)DEFAULT control statement, the same rule applies to the new control character. For example, if a)DEFAULT statement substitutes the ^ character for !, then two consecutive ^ characters in the input record will result in one ^ character being placed in the output record.

Considerations for control statements

The general format of a control statement is:

```
)control-word parameter1 parameter2 ... parameter63
```

where each parameter represents a name, value, operator, or keyword.

Notes about formatting control statements:

1. Control statements must begin in column 1. Note that an)IF or)ELSE control statement can contain another control statement on the same line, as long as the)IF or)ELSE statement begins in column 1.
2. All control words must be entered in uppercase.
3. The parameters must be separated by one or more blanks, and cannot contain embedded blanks. A parameter can be coded as:
 - A character string
 - A dialog variable name, preceded by an ampersand
 - A concatenation of variable names and character strings
4. The current value of each variable is substituted before the control statement is evaluated. The rules for delimiting variable names and for using ampersands, periods, double ampersands, and double periods are the same as for data records, as described in "Control characters for data records" on page 317.

The)N comment statement of PDF edit models is not a valid control statement for file tailoring and will cause file tailoring to terminate with a severe error.

Control statements

The following sections describe each of the ISPF file tailoring control statements:

)BLANK [*number*]

The specified number of blank lines are placed in the output file at the point where the)BLANK statement is encountered. If the *number* parameter is omitted, the default value is 1. The *number* parameter can be specified as a symbolic variable.

Examples:

```
)BLANK
```

```
)BLANK &SPACER
```

The first example inserts a single blank line into the output file. In the second example, the number of blank lines inserted into the output file is equal to the current value of the variable SPACER.

)CM *comment*

The statement is treated as a comment. No tailoring is performed, and the record is not placed in the output file. Comment statements cannot be continued.

In addition, comment control statements are ignored in the following cases:

- When specified as the control statement for either the)IF or)ELSE control statements.
- When imbedded within another control statement that includes continuation across two or more input records

)DEFAULT *abcdefg*

The seven characters represented by *abcdefg* override the use of the), &, ?, !, <, |, and > characters, respectively. Exactly seven characters must be specified.

If you are using a non-U.S. keyboard, refer to Appendix A, "Character Translations for APL, TEXT, and Katakana," on page 343 for text keyboard character translations.

The)DEFAULT statement takes effect immediately when it is encountered. It remains in effect until the end of FTINCL processing, or until another)DEFAULT statement is encountered. If the)DEFAULT statement is used to change defaults during an imbed, it is only in effect for that imbed level. It does not apply to deeper or previous imbed levels. The DEFAULTS will not be in effect for any skeletons that are imbedded but will be in effect for any data in the skeleton after the)IM. The)DEFAULT statement cannot be continued.

Example 1:

This example demonstrates that defaults changed using)DEFAULT do not take effect in imbedded skeletons.

The following skeleton changes the variable name control character & to the ø sign:

```
)DEFAULT )ø?!<|>
)SET A = USERNAME
A: øA
)IM SKEL2
A: øA
```

An FTINCL of this skeleton imbeds SKEL2, which contains:

```
AA: øA
AA: &A
```

This results in the following data in the output data set:

```
A: USERNAME
AA: øA
AA: USERNAME
A: USERNAME
```

Example 2:

This example demonstrates that defaults changed in an imbedded skeleton are not passed back to the skeleton doing the)IMBED.

An FTINCL of the following skeleton imbeds SKEL3:

Considerations for control statements

```
)SET A = USERNAME  
A: øA  
)IM SKEL3  
A: øA
```

SKEL3 changes the variable name control character & to the ø sign:

```
)DEFAULT )ø?!<|>  
AA: øA  
AA: &A
```

This results in the following data in the output data set:

```
A: øA  
AA: USERNAME  
AA: &A  
A: øA
```

Example 3:

The following example demonstrates how to use the NT parameter to prevent tailoring from occurring when imbedding a file. Using NT eliminates having to change defaults in the imbedded skeleton when it contains default control characters.

An FTINCL of the following skeleton imbeds a skeleton with the NT parameter:

```
)SET A = LBL1  
&A:  
)IM SKEL4 NT  
GO TO &A
```

The imbedded skeleton SKEL4 contains:

```
IF (&A < 0) | (&A > 10) THEN  
  &A = 0  
ELSE
```

This results in the following data in the output data set:

```
LBL1:  
IF (&A < 0) | (&A > 10) THEN  
  &A = 0  
ELSE  
GO TO LBL1
```

```
)DO  
)ENDDO
```

The skeleton input records between the)DO and the corresponding)ENDDO statements are repeatedly processed until a condition causes the)DO loop to terminate. Processing then continues with the input record immediately following the)ENDDO statement.

The processing of a)DO loop can be prematurely ended using the)LEAVE statement, or the current iteration of the)DO loop can be terminated using the)ITERATE statement.

There are several different formats of the)DO statement supported by file tailoring. The possible syntaxes are:

```
)DO [do-expression] [WHILE while-expression | UNTIL until-expression]  
)DO FOREVER  
)DO count
```

Where:

do-expression is of the form:

```
var = n [TO m] [BY incr] [FOR cnt]
```

var The control variable name.

n The starting value, which can be either a positive or a negative integer in the range -2147483648 to 2147483647.

m The ending value, which can be either a positive or a negative integer in the range -2147483648 to 2147483647.

incr The increment value, which can be either a positive or a negative integer in the range -2147483648 to 2147483647. Default value is 1.

cnt The maximum number of iterations of the)DO loop to be performed. The number can be either a positive or a negative integer in the range -2147483648 to 2147483647. If *cnt* is less than 1, the)DO statement is skipped.

until-expression is a relational expression that is evaluated for a true or false condition. The)DO loop continues while the *until-expression* evaluates to a false condition. The test is performed at the end of each loop prior to updating the control variable. The loop is always performed at least once.

while-expression is a relational expression that is evaluated for a true or false condition. The)DO loop continues while the *while-expression* evaluates to a true condition. The test is performed at the start of each loop, once the control variables are initialized.

count is an integer number used to control the number of iterations of the)DO loop. The number can be either a positive or a negative integer in the range -2147483648 to 2147483647. If the count is less than 1, the)DO statement is skipped. The default value for *count* is 1.

FOREVER continues processing the)DO loop until a)LEAVE statement within the loop terminates the)DO loop. All other parameters are ignored when using the FOREVER parameter. File tailoring makes no attempt to determine if a)DO FOREVER loop can be suitably terminated.

Example 1

This example performs a loop 10 times with the control variable, I, starting at 1 and increasing by 1 each time. The control variable will have the value 11 at the end of the loop.

```
)DO I = 1 TO 10
. . .
)ENDDO
```

Example 2

This example shows a)DO loop that is to continue until the variable RC is nonzero.

```
)SET RC = 0
)DO FOREVER
. . .
)IF &RC ^= 0 THEN )LEAVE
. . .
)ENDDO
```

Example 3

Considerations for control statements

This is another example of a)DO loop that is to continue until the variable RC is nonzero. Note that testing of the variable RC is performed at the start of each loop.

```
)SET RC = 0  
)DO WHILE &RC = 0  
  . . .  
)ENDDO
```

Example 4

This example performs a loop 10 times. There is no control variable.

```
)DO 10  
  . . .  
)ENDDO
```

```
)DOT table-name [SCAN [(name-cond-pairs)] ]  
)ENDDOT
```

Note: The)DOT command parameter *table-name* must be in uppercase for use with ISPF table services.

The skeleton input records between the)DOT and the corresponding)ENDDOT are iteratively processed as follows:

- Where the SCAN keyword is not provided, each row of the table is processed, beginning with the first row.
- Where the SCAN keyword is provided, only those rows of the table that match the current scan arguments are processed.
 - Where the additional *name-cond-pairs* parameter is not specified, a search argument must have already been established for the ISPF table, *table-name*. This requires *table-name* to have been opened and a valid search argument established using the TBSARG service before the file tailoring services are invoked. A severe dialog error will occur if the SCAN keyword is specified and valid search arguments have not yet been established for the table.
 - Where the additional *name-cond-pairs* parameter is specified, ISPF file tailoring services will establish the search arguments using the TBSARG service prior to processing table. The dialog variable must already be initialized to the required values for the TBSARG service.

At the start of each iteration, the contents of the current table row are stored into the corresponding dialog variables. Those values can then be used as parameters in control statements or substituted into data records. Up to four levels of)DOT nesting are permitted. The same table cannot be processed recursively. The list of records must end with the)ENDDOT statement.

If the table was already open, it remains open after file tailoring with the CRP positioned at TOP. If it was not open, it is opened automatically and then closed upon completion of file tailoring.

Any of the other control statements can be used between the)DOT and the)ENDDOT control statements.

Example 1

This example takes the information from table ABC, and writes any blank table row as a blank line:

```
)DOT ABC
)SEL &LNAME = &Z && &FNAME = &Z
)BLANK 1
)ENDSEL
    &FNAME &LNAME
)ENDDOT
```

Example 2

This example takes the information from table ABC, and writes out the records containing the value in the dialog variable &VAR2, where the table variable VAR1 matches the current value in the dialog variable &VAR1:

```
)DOT ABC SCAN(VAR1,EQ)
&VAR2
)ENDDOT
```

)IF *relational-expression* **THEN** [*control-statement*]
)ELSE [*control-statement*]

The *relational-expression* is evaluated for a true or false condition.

- If the condition is true, then either the *control-statement* on the)IF control statement is processed or the next non-comment line is processed. The)ELSE statement, if one is present, is skipped.
- If the condition is false, the *control-statement* or next non-comment line is skipped and the subsequent)ELSE statement, if one is present, is processed.

Up to 32 levels of)IF and)SEL nesting are permitted.

The *control-statement* can be any ISPF file tailoring control statement, except)CM (comment), which is ignored. Some control statements, namely)DO,)SEL, and)DOT require more than one input record. Similarly, the)IM control statement imbeds another ISPF skeleton member. The processing of the)IF or)ELSE statement is not completed until the control statement specified on the)IF or)ELSE statement is also completed.

Only a control statement can be included on the same input record after the THEN parameter or)ELSE control word. Put data records that are to be processed as part of the)IF or)ELSE on the next input record. The *control-statement* is optional on the same line as either the)IF or)ELSE control words, but a valid statement must be supplied for an)IF and)ELSE control statement before the end of the skeleton member. A severe error will occur if the control statement is missing after the THEN parameter or)ELSE control word. Use the)NOP control statement to provide a null statement.

Example 1

This example combines the)IF and)DO statements to process a block of input records when the variable RC has a value of zero, or another block of input records when its value is nonzero.

```
)IF &RC = 0 THEN )DO
. . .
)ENDDO
)ELSE )DO
. . .
)ENDDO
```

Example 2

Considerations for control statements

This example sets the dialog variable RC back to zero when it has a value of 4. Note that the comment statement is ignored.

```
)IF &RC = 4 THEN  
)CM RESET RETURN CODE TO ZERO  
)SET RC = 0
```

)IM *skel-name* [NT] [OPT]

The specified skeleton is imbedded at the point where the)IM statement is encountered. Up to 15 levels of imbedding are permitted.

The optional NT parameter indicates that no tailoring is to be performed on the imbedded skeleton. Because the NT parameter causes the data to be imbedded as it is, without any processing of control characters or control statements, using the NT option improves performance.

The optional OPT parameter indicates that the skeleton is not required to be present in the skeleton library. If OPT is coded and the skeleton is not present, no error indication is given, and the record is ignored. If OPT is not coded, and the skeleton is not present, a severe error occurs.

)ITERATE

The)ITERATE statement terminates the current iteration of the)DO structure and repeats the loop, providing any conditions that would cause the loop to terminate have not yet been reached. A severe dialog error will occur if the)ITERATE statement is used outside a)DO structure.

)LEAVE [DOT]

The)LEAVE statement immediately terminates the innermost)DO statement. A severe dialog error will occur if the)LEAVE statement is used outside a)DO structure.

The optional DOT parameter permits the termination of the current table via the)DOT ...)ENDDOT control statements. The)LEAVE DOT statement must be found within an active)DOT ...)ENDDOT sequence.

)NOP The)NOP control statement does not generate any output and can be used anywhere in a skeleton input file. It can be used as a null control-statement for either the)IF or)ELSE control statements.

)SEL *relational-expression*

)ENDSEL

The relational expression is evaluated for a true or false condition.

- If the condition is true, the skeleton input records between the)SEL and the corresponding)ENDSEL are processed.
- If the condition is false, these records are skipped.

Up to 32 levels of)SEL and)IF nesting are permitted. The list of records must end with an)ENDSEL statement.

Any of the other control statements can be used between the)SEL and the)ENDSEL control statements. For example, if you want to write information from a table only if variable ABC is set to the name of that table, specify:

```
)SEL &ABC='TABNAME'  
)DOT TABNAME  
    &FNAME &LNAME  
)ENDDOT  
)ENDSEL
```

The relational expression consists of a simple comparison of the form:

value1 operator value2

or a combination of up to eight simple comparisons joined by connectors. The system variable Z can be used to represent a null or blank value.

The allowable operators are:

EQ or =	LE or <=
NE or ≠	GE or >=
GT or >	NG or →
LT or <	NL or ↯

The allowable connectors are | (OR) and && (AND). ISPF evaluates connected expressions from left to right and evaluates the connectors with equal priority.

Examples:

```
)SEL &COND = YES
)SEL &TEST1 ≠ &Z | &ABC = 5
)SEL &TEST1 ≠ &Z && &ABC = 5
```

)SET *variable = expression*

)SET allows a value to be assigned to a dialog variable. The variable name should not be preceded by an ampersand, unless the variable name is itself stored as a variable. A blank is required between the variable and the equal sign and between the equal sign and the expression.

The expression can be specified in either of the following ways:

value1

value1 operator value2 operator ... value31

where *operator* can be a plus sign (+) or a minus sign (-).

To assign a null value to a dialog variable, use the system variable &Z.

Example:

An input skeleton file contains:

```
)SET A = 1
)SET B = 2
)SET C = &A + &B
)SET D = &Z
A is &A, B is &B, C is &C, D is &D
```

The resulting output file contains:

```
A is 1, B is 2, C is 3, D is
```

)TB <i>value1 ... value16</i>	(standard tabbing)
)TB <i>value1[A] ... value16[A]</i>	(alternate tabbing: designated positions)
)TBA <i>value1 ... value16</i>	(alternate tabbing: all positions)

An exclamation point (!) is used as the default tab character for the)TB control statement. It tabs the output record to the next tab stop and fills the intervening spaces with blanks. The next character following an exclamation point in the input record is put at the tab stop location in the output record. Up to 16 tab stops can be specified. A tab stop specifies a tab position in the output record, and must be in the range 1–255. The default is one tab stop at location 255.

Considerations for control statements

When you use the *standard* tabbing syntax, `)TB value1 ... value16`, and the tab stop value equals the current output position, the tabbing skips to the next tab stop value that is greater than the current output position. The input character following the tab character is then inserted into the position skipped to in the output record.

When you use *alternate* tabbing syntax, specified with an 'A' in the `)TB` tabbing syntax, and the tab stop value equals the current output position, the input character following the tab character is inserted into the current position in the output record. This allows you to write to the current position of the output record if a tab character in the input record is encountered at the same time as a tab stop is encountered in the output record.

The way you specify alternate tabbing syntax on the `)TB` control statement determines whether only designated or all tab stop values are affected, even if the tab stop value equals the current position in the output record when a tab character is encountered in the input record. If you specify:

```
)TB value1A ... value16A
```

only the tab stop values to which the character A is appended selectively cause tabbing to stop in any of those positions. If you specify:

```
)TBA value1 ... value16
```

any tab stop value that equals the current position in the output record when a tab character is encountered in the input record causes tabbing to stop.

Be sure the character that you append for alternate tabbing is an uppercase A. Appending an A to the `)TB` control word (that is, `)TBA`) has the same effect as appending an A to all individual tab stop values. When you use the `)TBA` control word, appending an A to an individual tab stop value has no additional effect.

Example 1:

This example uses the standard tabbing syntax:

```
)TB value1 ... value16
```

An input skeleton file contains:

```
)TB 5 10 20  
!ABCDE!F
```

After processing, the file-tailoring output record contains the following characters:

- Positions 1–4 contain the blanks inserted by the first tab operation.
- Positions 5–9 contain ABCDE. Standard tabbing occurs between E and F because tab stop 10 is at the same (not greater than) position of the output record at which the tab character is encountered in the input record.
- Positions 10–19 contain blanks inserted by the second tab operation.
- Position 20 contains F.

Example 2:

This example uses alternate tabbing syntax for designated tab positions:

```
)TB value1[A] ... value16[A]
```

An input skeleton file contains:

```
)TB 5 10A 20  
!ABCDE!F
```

After processing, the file-tailoring output record contains the following characters:

- Positions 1–4 contain the blanks inserted by the first tab operation.
- Positions 5–10 contain ABCDEF. F immediately follows E because alternate tabbing is specified for tab position 10. This allows tabbing to stop in the current output record position (10) when the tab character was encountered in the input record.

Example 3:

This example uses the alternate tabbing syntax for all tab positions:

```
)TBA value1 ... value16
```

An input skeleton file contains:

```
)TBA 3 6 10  
!ABC!DEF!GH
```

After processing, the file-tailoring output record contains:

- Positions 1–2 contain the blanks inserted by the first tab operation.
- Positions 3–5 contain ABC. D immediately follows C because alternate tabbing is specified and a tab stop is set at the current output position (6).
- Positions 6–8 contain DEF.
- Position 9 contains a blank inserted by normal tabbing.
- Positions 10–11 contain GH.

Sample skeleton file

Figure 85 on page 328 shows a sample skeleton file. The sample skeleton refers to several dialog variables (for example, ASMPARMS, ASMIN, and MEMBER). It also illustrates use of the select statements)SEL and)ENDSEL to conditionally include records. The first part of the example has nested selects to include concatenated macro libraries if the library names have been specified by the user, that is, if variables ASMMAC1 and ASMMAC2 are not equal to the null variable Z.

In the second part of the example,)IF ...)ELSE statements are used to conditionally execute a load-and-go step. An imbed statement,)IM, is used to bring in a separate skeleton for the load-and-go step.

DBCS-related variables

```
//ASM EXEC PGM=IFOX00,REGION=128K
// PARM=(&ASMPARMS)
//SYSIN DD DSN=&ASMIN(&MEMBER),DISP=SHR
//SYSLIB DD DSN=SYS1.MACLIB,DISP=SHR
)SEL &ASMMAC1 ^= &Z
// DD DSN=&ASMMAC1,DISP=SHR
)SEL &ASMMAC2 ^= &Z
// DD DSN=&ASMMAC2,DISP=SHR
)ENDSEL
)ENDSEL
//SYSUT1 DD UNIT=SYSDA,SPACE=(CYL,(5,2))
//SYSUT2 DD UNIT=SYSDA,SPACE=(CYL,(2,1))
//SYSUT3 DD UNIT=SYSDA,SPACE=(CYL,(2,1))
//SYSPRINT DD SYSOUT=(&ASMPRT)
)CM IF USER SPECIFIED "GO," WRITE OUTPUT IN TEMP DATA SET
)CM THEN IMBED "LINK AND GO" SKELETON
)IF &GOSTEP = YES THEN )DO
//SYSGO DD DSN=&&&OBJSET,UNIT=SYSDA,SPACE=(CYL,(2,1)),
// DISP=(MOD,PASS)
)IM LINKGO
)ENDDO
)CM ELSE (NOGO), WRITE OUTPUT TO USER DATA SET
)ELSE )DO
//SYSGO DD DSN=&ASMOUT(&MEMBER),DISP=OLD
)ENDDO
//*
```

Figure 85. Sample Skeleton File

DBCS-related variables in file skeletons

The following rules apply to substituting DBCS-related variables in file skeletons. These rules also apply to messages and file-tailoring operations.

- If the variable contains MIX format data, each DBCS subfield must be enclosed with shift-out and shift-in characters.

Example:

```
eeee[DBDBDBDBDB]eee[DBDBDB]
ee... represents a field of EBCDIC characters
DBDB... represents a field of DBCS characters
-[ ]- represent shift-out and shift-in characters.
```

- If the variable contains DBCS format data only, the variable must be preceded by the ZE system variable, without an intervening blank.

Example:

```
...text...&ZE&DBCSVAR..text...
```

- If the variable contains EBCDIC format data and is to be converted to the corresponding DBCS format data before substitution, the variable must be preceded by the ZC system variable, without an intervening blank.

Example:

```
...text...&ZC&EBCSVAR..text...
```

The ZC and ZE system variables can be used only for the two purposes described above. For file skeleton definition and file tailoring, these two variables can be used only between)DOT and)ENDDOT statements. When variable substitution causes a subfield-length of zero, the adjacent shift-out and shift-in characters are removed.

Chapter 11. Extended Code Page Support

EXTENDED CODE PAGE support allows panels, messages, and variable application data to be displayed correctly on terminals using any of the supported code pages. For example, a German panel can be displayed on a French Country Extended Code Page (CECP) terminal, with all common characters displayed correctly. Any characters in the panel that do not exist in the terminal code page are displayed as periods (.).

ISPF supports the EXTENDED CODE PAGES listed in “Supported CCSIDs” on page 333. CCSID stands for Coded Character Set IDentifier. The CCSID is a short identifier, representing a code page and character set combination. An extended CCSID has the same code page as its base CCSID, but has a larger character set.

Translating Common Characters

ISPF translates common characters from EXTENDED CODE PAGES to the code page of the terminal for panel)BODY,)MODEL, and)AREA text, if the panel is tagged with a CCSID, and for the long and short message text if the message member is tagged with a CCSID.

The TRANS service is provided to allow the application to translate variable application data from one CCSID to another CCSID (see *z/OS ISPF Services Guide*).

In a panel tagged with a CCSID, all characters that are not)BODY,)MODEL, and)AREA text and all characters in variable names within the)BODY,)MODEL, and)AREA text of a tagged panel and within the message text of a tagged message member must be in the syntactic character set:

- A–Z
- a–z
- 0–9
- + < = > % & * " ' ,
- () , _ - . / : ; ?

Note: Lowercase a–z can be used for any CCSID supported by ISPF except the Japanese (Katakana) Extended CCSID 930.

If an EXTENDED CODE PAGE is specified and the terminal code page and character set is one of those recognized by ISPF, all displayable code points are available for display (no displayable code points are invalidated by ISPF).

If an EXTENDED CODE PAGE is not indicated in a panel or message member, a base character set and code page is assumed based on the terminal type specified in option 0 (see *z/OS ISPF User’s Guide Vol II*).

Z Variables

The following Z variables are available for code page processing:

- | | |
|----------------|--|
| ZTERMCP | Terminal code page. Returned as a 4-digit decimal number (4 characters). |
| ZTERMCS | Terminal character set. Returned as a 4-digit decimal number (4 characters). |

- ZTERMCID** Terminal CCSID. Returned as a 5-digit decimal number (5 characters).
- ZERRCSID** Contains the 5-digit decimal CCSID of a dialog error message, or blanks if the error message is not tagged with a CCSID. Returned as a 5-digit decimal number (5 characters).

If an extended code page is specified for a panel or message and the terminal code page cannot be determined, there is no transformation of characters.

Table 21 illustrates when characters will be transformed for Extended Code Page support and when they will not be transformed:

Table 21. Character Transformation Table

	Terminal Query Reply CP/CS Valid for ISPF	Terminal Query Reply CP/CS Not Returned	Terminal Query Reply CP/CS Invalid for ISPF
CCSID Tag Present	Characters transformed	Characters not transformed	Characters not transformed
No CCSID Tag Present	Characters not transformed	Characters not transformed	Characters not transformed

For DBCS languages, the beginning and ending inhibited character tables are enhanced to include characters from the extended code pages for the text formatting of messages and panels.

Panels Tagged with CCSID

Panels can be defined with a)CCSID section and the NUMBER(*xxxxx*) keyword where *xxxxx* is the CCSID of the extended code page as defined by Character Data Representation Architecture. The)CCSID section must be the first section in the panel. See "Defining the CCSID Section" on page 213.

Messages Tagged with CCSID

An ISPF message can be defined with .CCSID=*xxxxx*. See "Messages Tagged with CCSID" on page 309.

GETMSG Service

The GETMSG service can be called with a CCSID parameter. If the message is tagged with a CCSID, the CCSID will be returned; otherwise, blanks will be returned.

TRANS Service

Users can call the TRANS Service in ISPF to translate variable data specified by the user from one CCSID to another CCSID. The *to* and *from* CCSIDs are also specified by the user in the TRANS call (see *z/OS ISPF Services Guide*). For a list of the EXTENDED CODE PAGE translate tables provided by ISPF, see "Extended Code Page Translate Tables Provided by ISPF" on page 338.

ISPccsid Translate Load Modules

The ISPccsid translate load modules provide ISPF with the information needed to translate data from one CCSID to another. There is one ISPccsid translate load module for each of the supported CCSIDs. The name (or alias for those ISPccsid

modules provided by ISPF) of each CCSID translate load module is made up of the 5-digit CCSID, prefixed with ISP. For example, load module ISP00111 supports translation of the CCSID 00111. Each CCSID translate load module must contain two translate tables. The required translate tables permit data to be translated between the respective CCSID and CCSID 00500. Additionally, each CCSID load module can contain up to 256 pairs of optional direct translate tables. ISPF will use direct translate tables when available. Otherwise, ISPF translates through CCSID 00500. Translating through CCSID 00500 can result in valid characters being lost. This is due to CCSID 00500 not having all possible code points defined.

ISPccsid Translate Load Module Generation Macro

An assembler macro that permits the user to generate customized ISPccsid translate load modules is supplied with ISPF. The macro also allows the user to add direct translate tables to the ISPccsid translate load modules ISPF supplies with the product.

Only the values for the hex digits X'40' through X'FE' are defined in a given translate table. These are the only code points that vary from CCSID to CCSID.

The assembler macro is:

```
ISPCCSID CCSID=nnnnn,TO=to-address,FROM=from-address
```

ISPCCSID Macro

The initial ISPCCSID macro usage identifies the CCSID associated with the particular ISPccsid translate load module and provides addresses of the *to* and *from* CCSID 00500 translate tables.

Subsequent usage of the ISPCCSID macro in a particular ISPccsid translate load module generation identifies the CCSID and translate table addresses of optional direct *to* and *from* translate tables.

Description of Parameters

nnnnn

Required parameter. The nnnnn value is a 5-digit decimal (5 characters) number that specifies a CCSID number. The nnnnn value on the first or only ISPCCSID macro definition is the CCSID associated with the ISPccsid translate load module. The nnnnn value on other than the first ISPCCSID macro definition is the CCSID associated with direct *to* and *from* translate tables. Assembly errors will occur if this parameter is not 5 digits.

to-address

Required parameter. On the first or only ISPCCSID macro definition, this parameter specifies the address of the translate table that converts data from the CCSID associated with the respective ISPccsid translate load module to CCSID 00500. On subsequent ISPCCSID macro definitions within the same ISPccsid translate load module, it specifies the address of the translate table that converts data from the CCSID associated with the respective ISPccsid translate load module to the CCSID specified on this ISPCCSID macro definition.

from-address

Required parameter. On the first or only ISPCCSID macro definition, this parameter specifies the address of the translate table that converts data from CCSID 00500 to the CCSID associated with the respective ISPccsid translate load module. On subsequent ISPCCSID macro definitions within the same

ISPccsid translate load module, it specifies the address of the translate table that converts data from the CCSID specified on this ISPCCSID macro definition to the CCSID associate with the respective ISPccsid translate load module.

ISPccsid Translate Load Module Definition Examples

Each ISPccsid translate load module must be compiled separately using Assembler H (or functional equivalent). Figure 86 shows an example of a basic translate model, and Figure 87 shows an example of a translate model with two direct CCSID entries.

```

                ISPCCSID CCSID=00111,TO=TRT0500,FROM=TRFR500
*
*
TRT0500  DC    XL191'...          00111 TO 00500
TRFR500  DC    XL191'...          00111 FROM 00500 (00500 TO 00111)
                END

```

Figure 86. Basic ISP00111 Translate Module.

```

                ISPCCSID CCSID=00222,TO=TRT0500,FROM=TRFR500
                ISPCCSID CCSID=00333,TO=TRT00333,FROM=TRF00333
                ISPCCSID CCSID=00444,TO=TRT00444,FROM=TRF00444
*
*
TRT0500  DC    XL191'...          00222 TO 00500
TRFR500  DC    XL191'...          00222 FROM 00500 (00500 TO 00222)
*
*
TRT00333 DC    XL191'...          00222 TO 00333

```

Figure 87. ISP00222 Translate Module with Two Direct CCSID Entries

KANA and NOKANA Keywords

If a CCSID is specified, the KANA (panels and messages) and NOKANA (messages) keywords are ignored by ISPF. Panels and messages that specify the Japanese (Katakana) Extended CCSID (CCSID=00930) are handled as follows regardless of whether KANA or NOKANA (for messages) keywords are specified:

- If the terminal code page is the base Katakana code page, all characters in the panel)BODY,)MODEL, or)AREA text or short and long message text, except lowercase English characters, are left as is. Because the base Katakana code page does not support lowercase English characters, all lowercase English characters are translated to uppercase English characters. All other parts of the panel or message must be in the syntactic character set, excluding characters a–z.
- If the terminal code page is non-Katakana, all lowercase English characters in the)BODY,)MODEL, or)AREA text or short and long message text in a panel or message that has been tagged with the extended Katakana code page (CCSID=05026) are translated to the equivalent lowercase English characters in the terminal code page for display. All Katakana characters are displayed as periods (.). For example, the lowercase a, which is X'62' in the extended Katakana code page, is translated to X'81' (lowercase a) in the U.S. English code page. The Katakana character which is X'81' is translated to a period (X'4B') in the U.S. English code page. All other parts of the panel or message must be in the syntactic character set, excluding characters a–z.

Character Translation

Table 22 illustrates the character translation from the extended Katakana code page and from the extended Japanese (Latin) code page (if CCSID=00930 or CCSID=00939 is specified in a panel, message, or in the TRANS service) to the U.S. English (CECP and base) code page, to the extended and base Katakana, and to the Japanese (Latin) Extended code pages for code points X'81', X'62' and X'59'.

Table 22. Character Translation from Extended Katakana Code Page

Destination Code Page	Source		Source	
	CCSID=00930	Translation	CCSID=00939	Translation
Base Katakana (base code page)	X'81'	X'81'	X'81'	X'C1'
	X'62'	X'C1'	X'59'	X'81'
Extended Katakana (CCSID=00930)	X'81'	X'81'	X'81'	X'62'
	X'62'	X'62'	X'59'	X'81'
U.S. English CECP and Non-CECP	X'81'	X'4B'	X'81'	X'81'
	X'62'	X'81'	X'59'	X'4B'
Japanese (Latin) Non-Extended				
Japanese (Latin) Extended (CCSID=00939)	X'81'	X'59'	X'81'	X'81'
	X'62'	X'81'	X'59'	X'59'

Code Points Character Translation

X'81'	A Katakana character in the Katakana code pages and is lowercase a in the U.S. English (CECP and base) and Japanese (Latin) (Extended and base) code pages.
X'62'	Lowercase a in the extended Katakana (CCSID=00930) code page, a Katakana character in the extended Japanese (Latin) (CCSID=00939) code page, and is an unknown character in the U.S. English, base Japanese (Latin), and base Katakana code pages.
X'59'	A Katakana character in the Japanese (Latin) Extended (CCSID=00939) code page, and an unknown character in the other code pages.
X'C1'	Uppercase A and X'4B' is a period (.) in all of the previously mentioned code pages.

Supported CCSIDs

The CCSIDs listed in Table 23 are supported for panels and messages that specify an EXTENDED CODE PAGE and for the TRANS service.

Table 23. Extended CCSID1 Supported

CCSID	Character Set	Code Page	Country/Language
00037	697	37	U.S.A. Canada Netherlands Portugal Brazil Australia New Zealand
00273	697	273	Austria Germany

Table 23. Extended CCSID1 Supported (continued)

CCSID	Character Set	Code Page	Country/Language
00277	697	277	Denmark Norway
00278	697	278	Finland Sweden
00280	697	280	Italy
00284	697	284	Spain L.A. Spanish
00285	697	285	United Kingdom
00297	697	297	France
00420	235	420	Arabic
00424	941	424	Hebrew
00500	697	500	Switzerland Belgium
00838	1176	838	Thailand
00870	959	870	Latin-2
00871	697	871	Iceland
00875	923	875	Greece
00880	960	880	Cyrillic
01025	1150	1025	Cyrillic
01026	1126	1026	Turkey
01047	697	1047	Latin1
01123	1326	1123	Ukraine

Table 24. Extended CCSID1 Supported (EURO)

CCSID	Character Set	Code Page	Country/Language
00924	1353	0924	Latin9
01140	695	1140	U.S.A. Canada Netherlands Portugal Brazil Australia New Zealand
01141	695	1141	Austria Germany
01142	695	1142	Denmark Norway
01143	695	1143	Finland Sweden
01144	695	1144	Italy
01145	695	1145	Spain L.A. Spanish
01146	695	1146	United Kingdom
01147	695	1147	France

Table 24. Extended CCSID1 Supported (EURO) (continued)

CCSID	Character Set	Code Page	Country/Language
01148	695	1148	Switzerland Belgium
01149	695	1149	Iceland
01153	1375	1153	Latin2
01154	1381	1154	Cyrillic
01155	1378	1155	Turkey
01158	1388	1158	Ukraine
01160	1395	1160	Thailand
04899	1356	0803	Hebrew
04971	1371	0875	Greece
12712	1357	0424	Hebrew
16804	1461	0420	Arabic

The extended CCSIDs shown in Table 24 on page 334 and Table 25 are supported for the TRANS service, and also with the use of the CCSID keyword in panels and messages. These are the mixed SBCS/DBCS CCSIDs for these languages.

Japanese (Katakana) and Simplified Chinese EXTENDED CODE PAGES are not supported on any terminal, but these CCSIDs are supported by ISPF for the TRANS service and for tagging panels and messages.

Note: Although the following CCSIDs represent both SBCS and DBCS character sets and code pages, only the SBCS character set and code page are involved in the EXTENDED CODE PAGE support in ISPF.

Table 25. Extended SBCS and DBCS CCSIDs Supported

CCSID	Character Set	Code Page	Country
00930	1172	290	Japanese (Katakana)
00939	1172	1027	Japanese (Latin)
00933	1173	833	Korean
00935	1174	836	Simplified Chinese
00937	1175	037	Traditional Chinese
01159	65535	1159	Traditional Chinese
01364	65535	0834	Korean
01371	65535	0835	Traditional Chinese
01388	65535	0837	Simplified Chinese
01390	65535	0300	Japanese
01399	65535	0300	Japanese
05123	65535	1027	Japanese
08482	65535	0290	Japanese

Base Code Pages for Terminals

Translation to base character sets and code pages is supported for panels, messages, and the TRANS service. See “Base CCSIDs” on page 338.

Direct translation between each base code page and its EXTENDED CODE PAGE is provided. Also, direct translation between both base and extended Japanese (Katakana) and both base and extended Japanese (Latin or English) is provided. All translation between the single-byte EXTENDED CODE PAGES for the double-byte languages and the CECP code pages is through CCSID 00500.

Adding Translate Tables for Extended Code Page Support

You can add code pages to be used for messages and panels that specify code page and for the TRANS service by creating the following translate tables using the sample assembler module ISPEXCP as an example. (ISPEXCP is provided in the SYS1.SAMPLIB library in the MVS environment.) The tables to translate between the new code page and CCSID 00500 are needed to reduce the number of translate tables necessary to translate characters between the new code page and any other supported (or added) code page. For example, to translate characters from a panel with CCSID=xxxxx to a terminal with CCSID=yyyyy, the characters in the panel are first translated to CCSID 00500 and then from CCSID 00500 to CCSID yyyyy for display on the terminal.

Note: The translate tables for the CCSIDs listed in Table 23 on page 333 and Table 25 on page 335 are provided and shipped with ISPF. Also, see “Extended Code Page Translate Tables Provided by ISPF” on page 338.

Any translate tables that are added must be named ISPnnnnn, where nnnnn is the CCSID. The translate tables should include code points X'40' through X'FE'.

- The following example illustrates the translation to CCSID 00500 from CCSID xxxxx, where xxxxx is the CCSID for the new code page. This CCSID must be different from any of the supported CCSIDs previously listed, and should be a CCSID defined in the Character Data Representation Architecture. In Figure 88, xxxxx is 00037.

Table	Hexadecimal Code	Position
TO_500	DC X'4041424344454647'	(X'40' to X'47')
	DC X'4849B04B4C4D4EBB'	(X'48' to X'4F')
	DC X'5051525354555657'	(X'50' to X'57')
	DC X'58594F5B5C5D5EBA'	(X'58' to X'5F')
	. . .	
	DC X'78797A7B7C7D7E7F'	(X'78' to X'7F')
	DC X'8081828384858687'	(X'80' to X'87')
	. . .	
	DC X'E8E9EAEBECEDEEEF'	(X'E8' to X'EF')
	DC X'F0F1F2F3F4F5F6F7'	(X'F0' to X'F7')
	DC X'F8F9FAFBFCFDFE'	(X'F8' to X'FE')

Figure 88. Translation to CCSID 00500 from CCSID XXXXX

- Figure 89 on page 337 illustrates the translation to CCSID xxxxx from CCSID 00500, where xxxxx is the CCSID for the new code page. This CCSID must be

different from any of the supported CCSIDs listed above, and should be a CCSID defined in the Character Data Representation Architecture. In this example, *xxxxx* is 00037.

Table	Hexadecimal Code	Position
FROM_500	DC X'4041424344454647'	(X'40' to X'47')
	DC X'4849BA4B4C4D4E5A'	(X'48' to X'4F')
	DC X'5051525354555657'	(X'50' to X'57')
	DC X'5859BB5B5C5D5EB0'	(X'58' to X'5F')
. . .		
	DC X'78797A7B7C7D7E7F'	(X'78' to X'7F')
	DC X'8081828384858687'	(X'80' to X'87')
. . .		
	DC X'E8E9EAEBECEDEEEF'	(X'E8' to X'EF')
	DC X'F0F1F2F3F4F5F6F7'	(X'F0' to X'F7')
	DC X'F8F9FAFBFCFDFF'	(X'F8' to X'FE')

Figure 89. Translation to CCSID XXXXX from CCSID 00500

- Optionally, any number of pairs of *to* and *from* tables can be provided for direct translation from the new CCSID to and from another CCSID.

The assembler macro, `ISPCCSID`, is supplied with ISPF to allow you to generate custom `ISPxxxx` translate load modules (where *xxxxx* is the new CCSID). Calls to this macro must also be coded for the `To_500` and `From_500` tables and any *to* and *from* tables for direct translation. The load module must either have the name `ISPxxxx` (where *xxxxx* is the new CCSID) or an alias of `ISPxxxx`. See “`ISPccsid Translate Load Modules`” on page 330, “`ISPccsid Translate Load Module Generation Macro`” on page 331, and “`ISPCCSID Macro`” on page 331.

Note: New translate tables can still be added based on terminal type as described in *z/OS ISPF Planning and Customizing* for untagged messages and panels.

Direct *to* and *from* translate tables can be added for direct translation (to prevent possible loss of characters through CCSID 00500 for character sets other than 697). Additional direct translation tables can also be added to the extended code page translate tables provided by ISPF. The direct translation CCSID must be one of the CCSIDs supported by ISPF, or added by the user. If the CCSID of the terminal is the same as the CCSID in any of the direct translation tables, those tables are used. Otherwise, the `To_500` and `From_500` tables are used to translate through CCSID 00500.

Note: Both *to* and *from* translate tables must be provided for direct translation tables as well as CCSID 00500 tables, even though there may be no translation needed. For example, to translate from a base CCSID to an extended CCSID for the same code page, all characters will translate to themselves.

Base CCSIDs

The CCSIDs for the BASE CODE PAGES supported by ISPF (that include mixed SBCS/DBCS CCSIDs for the DBCS languages) are listed in Table 26.

Table 26. Base CCSIDs Supported

CCSID	Character Set	Code Page	Country/Language
00803	1147	424	Hebrew (Old)
00931	101	037	Japan (English)
04369	265	273	Germany and Austria
04371	273	275	Brazil
04373	281	277	Denmark and Norway
04374	285	278	Finland and Sweden
04376	293	280	Italy
04380	309	284	L.A. (Spanish Speaking)
04381	313	285	U.K. English
04393	1129	297	France
04934	938	838	Thailand
04966	959	870	Latin-2
04976	960	880	Cyrillic
05029	933	833	Korean
05031	936	836	Simplified Chinese
05033	101	037	Traditional Chinese
08229	101	037	U.S. English and Netherlands
08476	650	284	Spain
09122	332	290	Japan (Katakana)
41460	904	500	Switzerland
45556	908	500	Switzerland

Note: Although the CCSIDs for the DBCS languages (Japanese, Korean, and Chinese) represent both SBCS and DBCS character sets and code pages, only the SBCS character set and code page are involved in the EXTENDED CODE PAGE support in ISPF.

Extended Code Page Translate Tables Provided by ISPF

The translate tables provided by ISPF that can be updated by the user are as follows:

- ISPSTC1 (CCSID=00037 / 01140 U.S.A., Canada, Netherlands, Portugal, Brazil, Australia, New Zealand)
- ISPSTC2 (CCSID=00273 / 01141 Austria and Germany)
- ISPSTC3 (CCSID=00277 / 01142 Denmark and Norway)
- ISPSTC4 (CCSID=00278 / 01143 Finland and Sweden)
- ISPSTC5 (CCSID=00280 / 01144 Italy)
- ISPSTC6 (CCSID=00284 / 01145 Spain and Spanish-Speaking)
- ISPSTC7 (CCSID=00285 / 01146 United Kingdom)
- ISPSTC8 (CCSID=00297 / 01147 France)
- ISPSTC9 (CCSID=00500 / 01148 Switzerland and Belgium)

- ISPSTC10 (CCSID=00939 Japan (Latin))
- ISPSTC11 (CCSID=00930 Japan (Katakana))
- ISPSTC12 (CCSID=00933 Korea)
- ISPSTC13 (CCSID=00935 Simplified Chinese)
- ISPSTC14 (CCSID=00937 Traditional Chinese)
- ISPSTC15 (CCSID=00870 Latin-2)
- ISPSTC16 (CCSID=00880 Cyrillic)
- ISPSTC17 (CCSID=01025 Cyrillic)
- ISPSTC18 (CCSID=00420 Arabic)
- ISPSTC19 (CCSID=00424 Hebrew)
- ISPSTC20 (CCSID=00838 Thai)
- ISPSTC21 (CCSID=00871 / 1149 Iceland)
- ISPSTC22 (CCSID=00875 Greek)
- ISPSTC23 (CCSID=01026 Turkish).

The source for the above modules is provided in the SYS1.SAMPLIB library in the MVS environment.

Example of User-Modifiable ISPF Translate Table

The following is the module for CCSID 00037 (ISPSTC1). The existing tables can be modified, or more pairs of direct translation tables can be added. To add direct translation tables, add a new ISPCCSID macro call for the new direct translate tables, and add the new tables. Rename the assembler program to ISPTTCx(x), where x(x) is the last 1- or 2-digit number of the ISPSTCx(x) name. For example, ISPSTC1 should be renamed ISPTTC1, and ISPSTC14 renamed ISPTTC14.

```
* THE FOLLOWING MACROS WILL GENERATE THE CCSID 00037 MODULE.
```

```
*
*
```

```
ISPCCSID CCSID=00037,TO=TTC1T5H,FROM=TTC1F5H
ISPCCSID CCSID=08229,TO=TTC1TB1,FROM=TTC1FB2
ISPCCSID CCSID=04371,TO=TTC1TB2,FROM=TTC1FB2
```

```
*
```

```
* TTC1T5H - CCSID 00037 TO CCSID 00500 Table
```

```
*
```

```
TTC1T5H DS 0XL191
DC X'4041424344454647' (X'40' TO X'47')
DC X'4849B04B4C4D4EBB' (X'48' TO X'4F')
DC X'5051525354555657' (X'50' TO X'57')
DC X'58594F5B5C5D5EBA' (X'58' TO X'5F')
DC X'6061626364656667' (X'60' TO X'67')
DC X'68696A6B6C6D6E6F' (X'68' TO X'6F')
DC X'7071727374757677' (X'70' TO X'77')
DC X'78797A7B7C7D7E7F' (X'78' TO X'7F')
DC X'8081828384858687' (X'80' TO X'87')
DC X'88898A8B8C8D8E8F' (X'88' TO X'8F')
DC X'9091929394959697' (X'90' TO X'97')
DC X'98999A9B9C9D9E9F' (X'98' TO X'9F')
DC X'A0A1A2A3A4A5A6A7' (X'A0' TO X'A7')
DC X'A8A9AAAABACADAEAF' (X'A8' TO X'AF')
DC X'5FB1B2B3B4B5B6B7' (X'B0' TO X'B7')
DC X'B8B9AA5ABCDBEBEF' (X'B8' TO X'BF')
DC X'C0C1C2C3C4C5C6C7' (X'C0' TO X'C7')
DC X'C8C9CACBCCDCECF' (X'C8' TO X'CF')
DC X'D0D1D2D3D4D5D6D7' (X'D0' TO X'D7')
DC X'D8D9DADBDCDDDEDF' (X'D8' TO X'DF')
DC X'E0E1E2E3E4E5E6E7' (X'E0' TO X'E7')
DC X'E8E9EAEBECEDEEEF' (X'E8' TO X'EF')
DC X'F0F1F2F3F4F5F6F7' (X'F0' TO X'F7')
DC X'F8F9FAFBFCFDFE' (X'F8' TO X'FE')
```

```
*
```

```
* TTC1F5H - CCSID 00037 FROM CCSID 00500 Table
```

```

*
TTC1F5H DS    0XL191
DC X'4041424344454647'      (X'40' TO X'47')
DC X'4849BA4B4C4D4E5A'      (X'48' TO X'4F')
DC X'5051525354555657'      (X'50' TO X'57')
DC X'5859BB5B5C5D5E60'      (X'58' TO X'5F')
DC X'6061626364656667'      (X'60' TO X'67')
DC X'68696A6B6C6D6E6F'      (X'68' TO X'6F')
DC X'7071727374757677'      (X'70' TO X'77')
DC X'78797A7B7C7D7E7F'      (X'78' TO X'7F')
DC X'8081828384858687'      (X'80' TO X'87')
DC X'88898A8B8C8D8E8F'      (X'88' TO X'8F')
DC X'9091929394959697'      (X'90' TO X'97')
DC X'98999A9B9C9D9E9F'      (X'98' TO X'9F')
DC X'A0A1A2A3A4A5A6A7'      (X'A0' TO X'A7')
DC X'A8A9AAABACADAFAF'      (X'A8' TO X'AF')
DC X'4AB1B2B3B4B5B6B7'      (X'B0' TO X'B7')
DC X'B8B9BF4FBCBDBEBF'      (X'B8' TO X'BF')
DC X'C0C1C2C3C4C5C6C7'      (X'C0' TO X'C7')
DC X'C8C9CACBCCDCECF'      (X'C8' TO X'CF')
DC X'D0D1D2D3D4D5D6D7'      (X'D0' TO X'D7')
DC X'D8D9DADBDCDDDEDF'      (X'D8' TO X'DF')
DC X'E0E1E2E3E4E5E6E7'      (X'E0' TO X'E7')
DC X'E8E9EAEBECEDEEEF'      (X'E8' TO X'EF')
DC X'F0F1F2F3F4F5F6F7'      (X'F0' TO X'F7')
DC X'F8F9FAFBFCFDFE'      (X'F8' TO X'FE')

```

```

*
*   TTC1TB1 - CCSID 00037 TO CCSID 08229 Table
*

```

```

TTC1TB1 DS    0XL191
DC X'404B4B4B4B4B4B4B'      (X'40' TO X'47')
DC X'4B4B4A4B4C4D4E4F'      (X'48' TO X'4F')
DC X'504B4B4B4B4B4B4B'      (X'50' TO X'57')
DC X'4B4B5A5B5C5D5E5F'      (X'58' TO X'5F')
DC X'60614B4B4B4B4B4B'      (X'60' TO X'67')
DC X'4B4B6A6B6C6D6E6F'      (X'68' TO X'6F')
DC X'4B4B4B4B4B4B4B4B'      (X'70' TO X'77')
DC X'4B797A7B7C7D7E7F'      (X'78' TO X'7F')
DC X'4B81828384858687'      (X'80' TO X'87')
DC X'88894B4B4B4B4B4B'      (X'88' TO X'8F')
DC X'4B91929394959697'      (X'90' TO X'97')
DC X'98994B4B4B4B4B4B'      (X'98' TO X'9F')
DC X'4BA1A2A3A4A5A6A7'      (X'A0' TO X'A7')
DC X'A8A94B4B4B4B4B4B'      (X'A8' TO X'AF')
DC X'4B4B4B4B4B4B4B4B'      (X'B0' TO X'B7')
DC X'4B4B4B4B4B4B4B4B'      (X'B8' TO X'BF')
DC X'C0C1C2C3C4C5C6C7'      (X'C0' TO X'C7')
DC X'C8C94B4B4B4B4B4B'      (X'C8' TO X'CF')
DC X'D0D1D2D3D4D5D6D7'      (X'D0' TO X'D7')
DC X'D8D94B4B4B4B4B4B'      (X'D8' TO X'DF')
DC X'E04BE2E3E4E5E6E7'      (X'E0' TO X'E7')
DC X'E8E94B4B4B4B4B4B'      (X'E8' TO X'EF')
DC X'F0F1F2F3F4F5F6F7'      (X'F0' TO X'F7')
DC X'F8F94B4B4B4B4B4B'      (X'F8' TO X'FE')

```

```

*
*   TTC1FB1 - CCSID 00037 FROM CCSID 08229 Table
*

```

```

TTC1FB1 DS    0XL191
DC X'4041424344454647'      (X'40' TO X'47')
DC X'48494A4B4C4D4E4F'      (X'48' TO X'4F')
DC X'5051525354555657'      (X'50' TO X'57')
DC X'58595A5B5C5D5E5F'      (X'58' TO X'5F')
DC X'6061626364656667'      (X'60' TO X'67')
DC X'68696A6B6C6D6E6F'      (X'68' TO X'6F')
DC X'7071727374757677'      (X'70' TO X'77')
DC X'78797A7B7C7D7E7F'      (X'78' TO X'7F')
DC X'8081828384858687'      (X'80' TO X'87')

```

DC X'88898A8B8C8D8E8F'	(X'88' TO X'8F')
DC X'9091929394959697'	(X'90' TO X'97')
DC X'98999A9B9C9D9E9F'	(X'98' TO X'9F')
DC X'A0A1A2A3A4A5A6A7'	(X'A0' TO X'A7')
DC X'A8A9AAAABACADAFAF'	(X'A8' TO X'AF')
DC X'B0B1B2B3B4B5B6B7'	(X'B0' TO X'B7')
DC X'B8B9BABBBBCDBEBF'	(X'B8' TO X'BF')
DC X'C0C1C2C3C4C5C6C7'	(X'C0' TO X'C7')
DC X'C8C9CACBCCCDCECF'	(X'C8' TO X'CF')
DC X'D0D1D2D3D4D5D6D7'	(X'D0' TO X'D7')
DC X'D8D9DADBDCDDDEDF'	(X'D8' TO X'DF')
DC X'E0E1E2E3E4E5E6E7'	(X'E0' TO X'E7')
DC X'E8E9EAEBECEDEEEF'	(X'E8' TO X'EF')
DC X'F0F1F2F3F4F5F6F7'	(X'F0' TO X'F7')
DC X'F8F9FAFBFCFDFF'	(X'F8' TO X'FE')

*
* TTC1TB2 - CCSID 00037 TO CCSID 04371 Table
*

TTC1TB2 DS 0XL191	
DC X'404B4B4B4B4B794B'	(X'40' TO X'47')
DC X'4B4B4B4B4C4D4E4B'	(X'48' TO X'4F')
DC X'50D04B4B4B4B4B4B'	(X'50' TO X'57')
DC X'4B4B4B4B5A5C5D5E4B'	(X'58' TO X'5F')
DC X'60614B4B4B4B7C4B'	(X'60' TO X'67')
DC X'5B4B4B6B6C6D6E6F'	(X'68' TO X'6F')
DC X'4B4A4B4B4B4B4B4B'	(X'70' TO X'77')
DC X'4B4B7A4B4B7D7E7F'	(X'78' TO X'7F')
DC X'4B81828384858687'	(X'80' TO X'87')
DC X'88894B4B4B4B4B4B'	(X'88' TO X'8F')
DC X'4B91929394959697'	(X'90' TO X'97')
DC X'98994B4B4B4B4B4B'	(X'98' TO X'9F')
DC X'4BA1A2A3A4A5A6A7'	(X'A0' TO X'A7')
DC X'A8A94B4B4B4B4B4B'	(X'A8' TO X'AF')
DC X'5F44B4BB4B4B4B4B'	(X'B0' TO X'B7')
DC X'4B4B4B4B4B4B4B4B'	(X'B8' TO X'BF')
DC X'4BC1C2C3C4C5C6C7'	(X'C0' TO X'C7')
DC X'C8C94B4B4B4B4BC0'	(X'C8' TO X'CF')
DC X'4BD1D2D3D4D5D6D7'	(X'D0' TO X'D7')
DC X'D8D94B4B4B4B4B4B'	(X'D8' TO X'DF')
DC X'E04BE2E3E4E5E6E7'	(X'E0' TO X'E7')
DC X'E8E94B4B4B4B4B7B'	(X'E8' TO X'EF')
DC X'F0F1F2F3F4F5F6F7'	(X'F0' TO X'F7')
DC X'F8F94B4B4B4B4B4B'	(X'F8' TO X'FE')

*
* TTC1FB2 - CCSID 00037 FROM CCSID 04371 Table
*

TTC1FB2 DS 0XL191	
DC X'4041424344454647'	(X'40' TO X'47')
DC X'4849714B4C4D4E5A'	(X'48' TO X'4F')
DC X'5051525354555657'	(X'50' TO X'57')
DC X'58595B685C5D5EBO'	(X'58' TO X'5F')
DC X'6061626364656667'	(X'60' TO X'67')
DC X'6869486B6C6D6E6F'	(X'68' TO X'6F')
DC X'7071727374757677'	(X'70' TO X'77')
DC X'78467AEF667D7E7F'	(X'78' TO X'7F')
DC X'8081828384858687'	(X'80' TO X'87')
DC X'88898A8B8C8D8E8F'	(X'88' TO X'8F')
DC X'9091929394959697'	(X'90' TO X'97')
DC X'98999A9B9C9D9E9F'	(X'98' TO X'9F')
DC X'A0A1A2A3A4A5A6A7'	(X'A0' TO X'A7')
DC X'A8A9AAAABACADAFAF'	(X'A8' TO X'AF')
DC X'B0B1B2B3B4B5B6B7'	(X'B0' TO X'B7')
DC X'B8B9BABBBBCDBEBF'	(X'B8' TO X'BF')
DC X'CFC1C2C3C4C5C6C7'	(X'C0' TO X'C7')
DC X'C8C9CACBCCCDCECF'	(X'C8' TO X'CF')
DC X'51D1D2D3D4D5D6D7'	(X'D0' TO X'D7')
DC X'D8D9DADBDCDDDEDF'	(X'D8' TO X'DF')

```
DC X'E0E1E2E3E4E5E6E7'      (X'E0' TO X'E7')
DC X'E8E9EAEBECEDEEEF'      (X'E8' TO X'EF')
DC X'F0F1F2F3F4F5F6F7'      (X'F0' TO X'F7')
DC X'F8F9FAFBFCFDFF'        (X'F8' TO X'FE')
END
```

Appendix A. Character Translations for APL, TEXT, and Katakana

This appendix contains the character translation tables for APL, TEXT, and Katakana. This information does not include Extended Code Page Support. See Chapter 11, “Extended Code Page Support,” on page 329.

ISPF permits use of all keyboards for all models of 3270 and 3290 terminals, and text keyboards for 3278 and 3279 terminals. The 2-byte transmission codes for APL and text characters are translated by ISPF into 1-byte codes for internal storage as shown in Figure 90 on page 344 and Figure 91 on page 345. ISPF also permits use of 3277 and 3278 Japanese Katakana terminals. ISPF does not permit the use of 3277 and 3278 Katakana terminals and an APL terminal at the same time.

The character codes are documented in IBM 3270 hardware manuals. Many of the Katakana codes overlay the lowercase EBCDIC codes. In a panel definition, it is assumed that lowercase EBCDIC characters are to be displayed for these codes, unless the)BODY header statement includes the keyword KANA. Example:

```
)BODY KANA
```

The keyword, KANA, is used on a)BODY header statement when Katakana characters are included within the panel. Input and output fields and model line fields are not affected by use of the KANA keyword. Rules for display of text fields are as follows:

- If the terminal type is Katakana, and
 - The KANA keyword is present, text characters are left as is.
 - The KANA keyword is not present, any lowercase text characters are translated to uppercase and uppercase text characters are left as is.
- If the terminal type is not Katakana, and
 - The KANA keyword is present, any lowercase text characters are treated as being nondisplayable and are translated to a period. Any uppercase text characters are left as is.
 - The KANA keyword is not present, lowercase and uppercase text characters are left as is.

See “How to Define a Message” on page 304 for a description of how the KANA keyword provides a similar function for messages containing lowercase characters that must be displayed on a Katakana terminal.

Note: The KANA keyword is not needed for panels and messages that specify a CCSID for Extended Code Page Support. See Chapter 11, “Extended Code Page Support,” on page 329.

Character Translations

 3278 only; character is not valid on 3277

 National use character. Graphics shown are for U.S. Keyboards; graphics differ in other countries.

00																
10																
20																
30																
40	sp	<u>A</u>	<u>B</u>	<u>C</u>	<u>D</u>	<u>E</u>	<u>F</u>	<u>G</u>	<u>H</u>	<u>I</u>	¢	.	<	(+	
50	&	<u>J</u>	<u>K</u>	<u>L</u>	<u>M</u>	<u>N</u>	<u>O</u>	<u>P</u>	<u>Q</u>	<u>R</u>	!	\$	*)	;	┌
60	—	/	<u>S</u>	<u>T</u>	<u>U</u>	<u>V</u>	<u>W</u>	<u>X</u>	<u>Y</u>	<u>Z</u>		,	%	_	>	?
70		^	..					v	\	:	#	@	'	=		
80	~	a	b	c	d	e	f	g	h	i	↑	↓	≤	┌	└	→
90	□	j	k	l	m	n	o	p	q	r	⊃	⊂		o		←
A0	—	~	s	t	u	v	w	x	y	z	∩	∪	⊥	[≥	◦
B0	α	ε	ι	ρ	ω		×	\	÷		∇	Δ	T]	≠	
C0	{	A	B	C	D	E	F	G	H	I	∞	∞		Φ		∅
D0	}	J	K	L	M	N	O	P	Q	R	∫	!	∇	Δ	⊠	⊡
E0	\		S	T	U	V	W	X	Y	Z	≠	≠		⊖	⊠	⊡
F0	0	1	2	3	4	5	6	7	8	9		∞	∞	⊕	⊕	
	0	1	2	3	4	5	6	7	8	9	A	B	C	D	E	F

Figure 90. Internal Character Representations for APL Keyboards

 3278 only; character is not valid on 3277

00															
10															
20															
30															
40	sp									¢	.	<	(+	
50	&	1	2	3					↓	!	\$	*)	;	┐
60	—	/								,	%	_	>	?	
70	n	o							\	:	#	@	'	=	
80		a	b	c	d	e	f	g	h	i	↑	{	≤	(+
90	□	j	k	l	m	n	o	p	q	r		}	□)	±
A0	—	~	s	t	u	v	w	x	y	z	⊕	└	┌	[≥
B0	o	1	2	3	4	5	6	7	8	9	▽	└	┌]	≠
C0	{	A	B	C	D	E	F	G	H	I	△	⊥	⊤	V	≠
D0	}	J	K	L	M	N	O	P	Q	R	⊞	△	§	¶	←
E0	\	\	S	T	U	V	W	X	Y	Z	∇	└	┌	⊥	⊤
F0		1	2	3	4	5	6	7	8	9		└	⊥	⊤	┌
	0	1	2	3	4	5	6	7	8	9	A	B	C	D	E

Figure 91. Internal Character Representations for Text Keyboards

Appendix B. ISPTTDEF Specify Translate Table Set

ISPF provides a program, ISPTTDEF, for specifying the set of terminal translate tables to be used. This program lets you specify private sets of translate tables.

Note: This program is not used for Extended Code Page Support translate tables. See Chapter 11, "Extended Code Page Support," on page 329.

You can invoke ISPTTDEF from a selection panel, as a command, or from a dialog function. The format of the ISPTTDEF program call is:

```
SELECT PGM(ISPTTDEF) PARM(xxx)
```

where *xxx* is the terminal type or the name of the load module containing translate tables.

Return codes from invoking ISPTTDEF are as follows:

- 0 Normal completion
- 4 Translate tables could not be loaded

Valid terminal types are those that can be specified using the ISPF Settings panel. If the name specified is not a valid terminal type, ISPF attempts to load a module having that name.

Appendix C. Diagnostic Tools and Information

This chapter covers the following topics:

- debugging tools
- the panel trace and file-tailoring trace utilities
- diagnostic information
- common problems that can occur when developing dialogs and using ISPF

ISPF debug tools

The following tools ship with ISPF as samples.

- ISRABEND** A CLIST that provides a step-by-step explanation of how to diagnose an abend interactively. It uses TSO TEST to gather the information that the IBM support organization normally requires.
- ISRCSECT** A REXX exec used in conjunction with ISRTCB exec. It takes the entry point of a load module and begins searching for a specific CSECT. If it finds one, the exec displays the CSECT's eye-catcher.
- ISRFIND** A REXX exec that issues a LISTA STATUS and searches for a specified member or load module. Also, the exec optionally calls AMBLIST to check the MODIFIED, FIXED, and PAGEABLE LPAs and checks LPALIST and LNKLIST (pointed to by system control blocks) for the specified load module. If invoked under ISPF, the information is displayed via an ISPF table display (panel ISRFINDP) and allows the user to BROWSE or EDIT the specified member.
- ISRPOINT** A REXX exec used in conjunction with the ISRTCB exec. This exec uses the entry point address obtained from ISRTCB and lists the CSECT eye-catchers associated with that load module.
- ISRTCB** A REXX exec that emulates the TSO TEST command LISTMAP. It lists the TCBs and the load modules (with their entry points) associated with each TCB, without using TSO TEST.
- ISRTEST** A CLIST that uses TSO TEST to load the job pack area (JPA) and set breakpoints on entry to a specific ISPF or PDF CSECT. This allows for the verification of the compile date associated with the CSECT with the most recent maintenance level for that version or release. Additionally, you can modify this sample to set specific breakpoints within the CSECT to identify the failing instruction.

Panel trace command (ISPDPTRC)

The ISPDPTRC command traces the Dialog Manager panel processing that occurs within any screen in the current ISPF session. You can trace both the execution of panel service calls (DISPLAY, TBDISPL, and TBQUERY) and the processing that occurs within the Dialog Manager panel code, including the processing of statements in the)ABCINIT,)ABCPROC,)INIT,)REINIT, and)PROC sections of the panel.

Panel trace command (ISDPTRC)

The output from the trace is written to a dynamically allocated VB (variable blocked) data set that has a record length of 255. Where the ddname ISDPTRC is preallocated, this data set will be used, providing it refers to a sequential, VB data set with a record length of at least 255.

The ISDPTRC command starts the trace if it is not running. If the trace is already active, ISDPTRC allows you to stop and optionally to view or edit the trace output. ISDPTRC must be executed while ISPF is active.

The syntax of the command is:

```
ISDPTRC  [END]
         [VIEW]
         [QUIET]
         [DSP|DISPLAY( None | In | Out | Both ) ]
         [PNL|PANEL( * | panel_name | panel_mask ) ]
         [READ( None | Summary | Detail ) ]
         [SCR|SCREEN( 0 | * | screen_id )]
         [SECT|SECTION( * | All | None | [Init] [Reinit] [Proc] |
                   [NOInit] [NOReinit] [NOProc] ) ]
         [SVC|SERVICE( None | Detail ) ]
```

Where:

END Terminates the trace if it is active. No attempt is made to edit or view the trace data set.

VIEW Terminates the trace if it is active and views the trace data set. If an allocation for the DD ISDPTRC is present, this data set is viewed. SYSOUT data sets are not supported.

QUIET

Prevents trace initialization and termination messages being displayed. Error messages continue to be displayed on the screen.

DISPLAY

Controls the generation of trace records resembling the panel as displayed at the terminal. Only the panel for the active screen is shown when a panel is being read into memory.

None No trace records are produced during panel display processing.

In Generates trace records showing the panel, including data entered after the user has pressed the Enter key or a function key.

Out Generates trace records showing the panel as it shown on the screen. Attribute bytes are also represented in the screen display.

Both Generates both the In and Out display traces. This is the default.

PANEL

Controls the generation of trace records based on the panel name.

***** Generate trace records for all panels. This is the default.

panel_name Generates trace records only for the panel name as specified.

panel_mask Generates trace records for panels matching *panel_mask*. The mask can contain % to represent a single character or * to represent any number of characters.

Panel trace command (ISDPTRC)

Note: Panel service calls (DISPLAY, TBDISPL, and TBQUERY) continue to be traced for all panels, regardless of the *panel_name* or *panel_mask* parameter specified.

READ Controls the generation of trace records when a panel is being read into memory.

None No trace records are produced during the read processing.

Summary

Generates summary information, including where the panel was loaded from (either an ISPLIB or LIBDEF data set), and the number of records read until the)END statement was detected. This is the default setting.

Detail Generates the same information as for the summary trace, but includes the panel source. Preprocessed panels can not be displayed.

SCREEN

Controls the generation of trace records based on the screen ID.

0 Generate trace records for the all logical screens. This is the default.

***** Generate trace records for the current screen ID.

screen_id

Generate trace records only for the logical screen ID as specified. The screen ID is a single character in the range 1-9, A-W.

SECTION

Controls the generation of trace records for the different panel logic sections. The default is all sections.

*** | All** Generates trace records for all sections. Either form of this parameter can only be specified by itself, and not with any of the other SECTION parameter values.

None Generates no trace records for any of the panel processing logic sections. This parameter can only be specified by itself and not in conjunction with any of the other SECTION parameter values.

Init Generates trace records for the)ABCINIT and)INIT sections.

Reinit Generates trace records for the)REINIT section.

Proc Generates trace records for the)ABCPROC and)PROC sections.

NOInit Turns off the generation of trace records for the)ABCINIT and)INIT sections.

NOREinit Turns off the generation of trace records for the)REINIT section.

NOProc Turns off the generation of trace records for the)ABCPROC and)PROC sections.

SERVICE

Controls the generation of trace records for the panel processing service calls, namely DISPLAY, TBDISPL and TBQUERY.

None No trace records are produced during the service call processing.

Panel trace command (ISPDPTRC)

Detail Generates trace records for the DISPLAY, TBDISPL, and TBQUERY service calls, showing all the parameters. A trace record is produced both before and after the call processing, with the post record showing the return code from the service. This is the default setting.

Notes:

1. Where neither the END nor VIEW parameters is provided, the panel trace is started if it is not already active, otherwise the trace is stopped and where possible you are put into an edit session with the trace output.
2. When the panel trace is already active, only the END and VIEW parameters have any effect on the command. All other valid parameters are ignored. If invalid parameters are entered the command terminates without starting to process the trace.

Trace format

Panel trace header

```
===== ISPF Panel Trace ===== 2004.243 04:53:20 GMT =====
ZISPFOS: ISPF FOR z/OS 02.07.00          ZOS390RL: z/OS 02.07.00
ISPDPTRC Command: ISPDPTRC
Options in Effect: PANEL(*) SCREEN(0) SECTION(INIT REINIT PROC)
                  SERVICE(DETAIL) SOURCE(SUMMARY) DISPLAY(BOTH)

Physical Display: PRI=24x80 ALT=60x132 GUI=OFF

ISPCDI  Version: ISPCDI 04237-BASE z/27
ISPDPA  Version: ISPDPA 04243-BASE z/27
ISPDPE  Version: ISPDPE 04237-BASE z/27
ISPDPL  Version: ISPDPL 04243-BASE z/27
ISPDPP  Version: ISPDPP 04237-BASE z/27
ISPDPR  Version: ISPDPR 04237-BASE z/27
ISPDPS  Version: ISPDPS 04237-BASE z/27
ISPDTD  Version: ISPDTD 04237-BASE z/27
ISPPQR  Version: ISPPQR 04237-BASE z/27
ISPDPTR0 Version: ISPDPTR0 04243-BASE z/27
=====
TLD# Type Panel Section Cd RC Data
-----
```

Figure 92. Sample Panel Trace header

The trace header shows the following information:

1. Current date and time (GMT) when the trace was initialized
2. ISPF level information as found in dialog variable ZISPFOS
3. z/OS level information as found in dialog variable ZOS390RL
4. ISPDPTRC command with the invocation parameters
5. The options that are in effect for the current execution of the panel trace
6. Module level information for each of the modules associated with ISPF Panel Processing

The remainder of the trace is broken into a number of columns to show each trace record. The columns are:

TLD# The task or screen identifier from which the panel service is being invoked.

Type The trace entry type. The valid types are:

Panel trace command (ISDPTRC)

- | **Svc** These records are generated for calls to the ISPF Display Services and show all the call parameters. This is limited to the DISPLAY, TBDISPL, and TBQUERY services. The generation of this type of trace record is control by the ISDPTRC SERVICE parameter.
- | **SvcR** These records are generated returning from the ISPF Display services. The trace includes the return code from the service.
- | **Read** These records are generated reading a panel into storage. The generation of this type of trace record is controlled by the ISDPTRC READ parameter. A summary trace does not show the panel source records. The source of preprocessed panels can not be displayed.
- | **DspO** These records are generated displaying an ISPF panel at the screen. Attribute bytes are also included in the display. The generation of this type of trace record is controlled by the ISDPTRC DISPLAY parameter.
- | **DspI** These records are generated after a user has pressed the Enter key or a function key, and show the data displayed on the ISPF panel at that time. Attribute bytes are also included in the display. The generation of this type of trace record is controlled by the ISDPTRC DISPLAY parameter.
- | **PrcR** These records are generated during the processing of the panel logic sections, including)INIT,)REINIT,)PROC,)ABCINIT and)ABCPROC. The data as displayed resembles that of the original panel, but may not be identical to it. Where an assignment statement includes dialog variables or functions, an additional record is displayed showing the result of the assignment. The generation of this type of trace records is controlled by the ISDPTRC SECTION parameter.
- | **Err** These records are generated when a ISPF panel processing error occurs and ISPF issues an error message. The records generated include both the short and long error messages.

| **Panel** The ISPF panel name associated with the trace record.

Section

| The logic section associated with the PrcR type trace record.

| **Cd** The Condition value returned for IF and ELSE panel statements:

| **T** Indicates a True condition

| **F** Indicates a False condition

| **Note:** A plus (+) character in this field indicates a record continuation.

| **RC** The Return Code, shown only for SvcR, and PrcR type trace records.

| **Data** Trace data for the particular trace entry. The trace data extends the full width of the output file and will wrap if required.

Panel display

| Figure 93 on page 354 shows the output and input trace generated for panel ISRUTIL. It includes a scale line across the top and down the side of the panel, and includes panel size and cursor position information. The input trace also gives an indication of the key or command entered.

Panel trace command (ISPDPTRC)

```

TLD1 Dsp0          0-----1-----2-----3-----4-----5-----6-----7-----
TLD1 Dsp0 ISRUTIL |   Menu Help
TLD1 Dsp0 ISRUTIL | -----
TLD1 Dsp0 ISRUTIL |                               Utility Selection Panel
TLD1 Dsp0 ISRUTIL | Option ==>&
TLD1 Dsp0 ISRUTIL | +
TLD1 Dsp0 ISRUTIL | 1 Library      Compress or print data set. Print index listing. Print,
TLD1 Dsp0 ISRUTIL |                rename, delete, browse, edit or view members
TLD1 Dsp0 ISRUTIL | 2 Data Set     Allocate, rename, delete, catalog, uncatalog, or display
TLD1 Dsp0 ISRUTIL |                information of an entire data set
TLD1 Dsp0 ISRUTIL | 3 Move/Copy    Move, or copy members or data sets
TLD1 Dsp0 ISRUTIL | 4 Dslist       Print or display (to process) list of data set names.
TLD1 Dsp0 ISRUTIL |                Print or display VTOC information
TLD1 Dsp0 ISRUTIL | 5 Reset        Reset statistics for members of ISPF library
TLD1 Dsp0 ISRUTIL | 6 Hardcopy     Initiate hardcopy output
TLD1 Dsp0 ISRUTIL | + 7 Transfer   Download ISPF Client/Server or Transfer data set
TLD1 Dsp0 ISRUTIL | 8 Outlist      Display, delete, or print held job output
TLD1 Dsp0 ISRUTIL | 9 Commands     Create/change an application command table
TLD1 Dsp0 ISRUTIL | 11 Format       Format definition for formatted data Edit/Browse
TLD1 Dsp0 ISRUTIL | 12 SuperC      Compare data sets (Standard Dialog)
TLD1 Dsp0 ISRUTIL | 2 13 SuperCE   Compare data sets Extended (Extended Dialog)
TLD1 Dsp0 ISRUTIL | 14 Search-For Search data sets for strings of data (Standard Dialog)
TLD1 Dsp0 ISRUTIL | 15 Search-ForE Search data sets for strings of data Extended (Extended Dialog)
TLD1 Dsp0 ISRUTIL | 16 Tables      ISPF Table Utility
TLD1 Dsp0 ISRUTIL | - ... --- Screen=23x80 Cursor=4/14
TLD1 DspI          0-----1-----2-----3-----4-----5-----6-----7-----
TLD1 DspI ISRUTIL |   Menu Help
TLD1 DspI ISRUTIL | -----
TLD1 DspI ISRUTIL |                               Utility Selection Panel
TLD1 DspI ISRUTIL | Option ==>&4
TLD1 DspI ISRUTIL | +
TLD1 DspI ISRUTIL | 1 Library      Compress or print data set. Print index listing. Print,
TLD1 DspI ISRUTIL |                rename, delete, browse, edit or view members
TLD1 DspI ISRUTIL | 2 Data Set     Allocate, rename, delete, catalog, uncatalog, or display
TLD1 DspI ISRUTIL |                information of an entire data set
TLD1 DspI ISRUTIL | 3 Move/Copy    Move, or copy members or data sets
TLD1 DspI ISRUTIL | 4 Dslist       Print or display (to process) list of data set names.
TLD1 DspI ISRUTIL |                Print or display VTOC information
TLD1 DspI ISRUTIL | 5 Reset        Reset statistics for members of ISPF library
TLD1 DspI ISRUTIL | 6 Hardcopy     Initiate hardcopy output
TLD1 DspI ISRUTIL | + 7 Transfer   Download ISPF Client/Server or Transfer data set
TLD1 DspI ISRUTIL | 8 Outlist      Display, delete, or print held job output
TLD1 DspI ISRUTIL | 9 Commands     Create/change an application command table
TLD1 DspI ISRUTIL | 11 Format       Format definition for formatted data Edit/Browse
TLD1 DspI ISRUTIL | 12 SuperC      Compare data sets (Standard Dialog)
TLD1 DspI ISRUTIL | 2 13 SuperCE   Compare data sets Extended (Extended Dialog)
TLD1 DspI ISRUTIL | 14 Search-For Search data sets for strings of data (Standard Dialog)
TLD1 DspI ISRUTIL | 15 Search-ForE Search data sets for strings of data Extended (Extended Dialog)
TLD1 DspI ISRUTIL | 16 Tables      ISPF Table Utility
TLD1 DspI ISRUTIL | - ... --- Screen=23x80 Cursor=4/15 Key=ENTER

```

Figure 93. Sample DISPLAY trace

Panel processing trace

Figure 94 on page 355 shows an example of the trace generated when processing the PROC section of panel ISRUTIL after the number 4 was entered in the command field. Statements skipped as the result of a “false” condition on an IF or ELSE statement are never displayed. In addition, the panel trace always splits the value pairs for the TRANS functions into separate records, making the trace more readable. The result of an assignment statement is only shown when the assignment statement includes a dialog variable, an including panel control variable, or a panel function.

Panel REXX is not traced. This should be traced using normal REXX trace capabilities.

```

TLD1 PrcR ISRUTIL PROC      0 &ZCMDWRK=&Z
TLD1 PrcR ISRUTIL PROC      -> &ZCMDWRK=' '
TLD1 PrcR ISRUTIL PROC      T  0 IF(&ZCMD = &Z)
TLD1 PrcR ISRUTIL PROC      0 &ZCMDWRK=TRUNC(&ZCMD, '.')
TLD1 PrcR ISRUTIL PROC      -> &ZCMDWRK=4
TLD1 PrcR ISRUTIL PROC      0 &ZTRAIL=.TRAIL
TLD1 PrcR ISRUTIL PROC      -> &ZTRAIL=' '
TLD1 PrcR ISRUTIL PROC      F  0 IF(&ZCMDWRK = &Z)
TLD1 PrcR ISRUTIL PROC      0 &ZSEL=TRANS(TRUNC(&ZCMD, '.'))
TLD1 PrcR ISRUTIL PROC      +      1, 'PGM(ISRUDA) PARM(ISRUDA1) SCRNAME(LIBUTIL)'
TLD1 PrcR ISRUTIL PROC      +      2, 'PGM(ISRUDA) PARM(ISRUDA2) SCRNAME(DSUTIL)'
TLD1 PrcR ISRUTIL PROC      +      3, 'PGM(ISRUMC) SCRNAME(MCOPY)'
TLD1 PrcR ISRUTIL PROC      +      4, 'PGM(ISRUDL) PARM(ISRUDLP) SCRNAME(DSLIST)'
TLD1 PrcR ISRUTIL PROC      +      5, 'PGM(ISRURS) SCRNAME(RESET)'
TLD1 PrcR ISRUTIL PROC      +      6, 'PGM(ISRUHC) SCRNAME(HARDCOPY)'
TLD1 PrcR ISRUTIL PROC      +      7, 'PANEL(ISPUDL) SCRNAME(DOWNLOAD)'
TLD1 PrcR ISRUTIL PROC      +      8, 'PGM(ISRUOLP) SCRNAME(OUTLIST)'
TLD1 PrcR ISRUTIL PROC      +      9, 'PANEL(ISPUCMA) ADDPOP SCRNAME(CMDTABLE)'
TLD1 PrcR ISRUTIL PROC      +     11, 'PGM(ISRFMT) SCRNAME(FORMAT)'
TLD1 PrcR ISRUTIL PROC      +     12, 'PGM(ISRSSM) SCRNAME(SUPERC)'
TLD1 PrcR ISRUTIL PROC      +     13, 'PGM(ISRSEPRM) SCRNAME(SUPERCE) NOCHECK'
TLD1 PrcR ISRUTIL PROC      +     14, 'PGM(ISRSFM) SCRNAME(SRCHFOR)'
TLD1 PrcR ISRUTIL PROC      +     15, 'PGM(ISRSEPRM) PARM(S4) SCRNAME(SRCHFORE) NOCHECK'
TLD1 PrcR ISRUTIL PROC      +     16, 'PGM(ISRUTABL) NEWPOOL SCRNAME(TBLUTIL)'
TLD1 PrcR ISRUTIL PROC      +      ' ', ' '
TLD1 PrcR ISRUTIL PROC      +      '* ', '?'
TLD1 PrcR ISRUTIL PROC      -> &ZSEL='PGM(ISRUDL) PARM(ISRUDLP) SCRNAME(DSLIST)'

```

Figure 94. Sample PROCESS trace

File tailoring trace command (ISPFTRC)

The ISPFTRC command traces the processing of file tailoring services that are invoked from any screen within the current ISPF session. You can trace both the execution of file tailoring service calls (FTOPEN, FTINCL, FTCLOSE, and FTERASE) and the processing that occurs within the file tailoring code and processing of each statement.

The output from the trace is written to a dynamically allocated VB (variable blocked) data set that has a record length of 255. Where the ddname ISPFTRC is preallocated, this data set will be used, providing it refers to a sequential, VB data set with a record length of at least 255.

The ISPFTRC command starts the trace if it is not running. If the trace is already active, ISPFTRC allows you to stop and optionally to view or edit the trace output. ISPFTRC must be executed while ISPF is active.

The syntax of the command is:

File tailoring trace command (ISPFTRC)

```
ISPFTRC [END]
        [VIEW]
        [QUIET]
        [READ( None | Summary | Detail ) ]
        [REC|RECORDS( * | All | None | [Src|Source] [Data] [Cntl] |
                    [NOSrc|NOSource] [NOData] [NOCntl] ) ]
        [SCR|SCREEN( 0 | * | screen_id )]
        [SVC|SERVICE( None | Detail ) ]
        [SKL|SKEL|SKELETON( * | skel_name | skel_mask ) ]
        [TBV|TBVARS( None | Detail ) ]
```

Where:

END Terminates the trace if it is active. No attempt is made to edit or view the trace data set.

VIEW Terminates the trace if it is active and views the trace data set. If an allocation for the DD ISPFTRC is present, this data set is viewed. SYSOUT data sets are not supported.

QUIET

Prevents trace initialization and termination messages being displayed. Error messages continue to be displayed on the screen.

READ Controls the generation of trace records when a skeleton member is being read into memory.

None No trace records are produced during the read processing.

Summary

Generates summary information, including where the skeleton was loaded from (either an ISPSLIB or LIBDEF data set), and the number of records read.

Detail Generates the same information as for the summary trace, but includes the skeleton source. This is the default setting.

RECORDS

Controls the generation of trace records during record processing of the skeleton member.

*** | All**

Generates trace records for all skeleton record processing. Either form of this parameter can only be specified by itself, and not with any of the other RECORDS parameter values.

None Generates no trace records for any of the skeleton record processing. This parameter can only be specified by itself and not in conjunction with any of the other RECORDS parameter values.

Source

Generates trace records for the source skeleton record. This is performed before any processing is done to determine if it is a data or control record.

Data Generates trace records for the data records. This is performed after record processing has completed.

Cntl Generates trace records for the control statements. This is performed after record processing has completed.

NOSource

Turns off the generation of trace records for the source skeleton records.

File tailoring trace command (ISPFTRRC)

NOData

Turns off the generation of trace records for the data records.

NOCntl

Turns off the generation of trace records for the control statements.

SCREEN

Controls the generation of trace records based on the screen ID.

0 Generate trace records for the all logical screens. This is the default.

***** Generate trace records for the current screen ID.

screen_id

Generate trace records only for the logical screen ID as specified. The screen ID is a single character in the range 1-9, A-W.

SERVICE

Controls the generation of trace records for the file tailoring service calls, namely OPEN, FTINCL, FTCLOSE, and FTERASE.

None No trace records are produced during the service call processing.

Detail Generates trace records for the OPEN, FTINCL, FTCLOSE, and FTERASE service calls, showing all the parameters. A trace record is produced both before and after the call processing, with the post record showing the return code from the service. This is the default setting.

SKELETON

Controls the generation of trace records based on the skeleton name.

*** | All** Generate trace records for all skeletons. This is the default.

skel_name Generates trace records only for the skeleton name as specified.

skel_mask Generates trace records for skeletons matching *skel_mask*. The mask can contain % to represent a single character or * to represent any number of characters.

Note: File tailoring service calls (OPEN, FTINCL, FTCLOSE, and FTERASE) continue to be traced for all skeleton processing, regardless of the *skel_name* or *skel_mask* parameter specified.

TBVARs

Used on a)DOT control word to display key variables and named variables on each iteration through the table.

None No trace records are produced during)DOT processing.

Detail Generates trace records for the)DOT control word, displaying key variables and named table variables on each iteration. Extension variables are not displayed. This is the default setting.

Notes:

1. Where neither the END nor VIEW parameters are provided, the file tailoring trace is started if it is not already active, otherwise the trace is stopped and where possible you are put into an edit session with the trace output.
2. When the file tailoring trace is already active, only the END and VIEW parameters have any effect on the command. All other valid parameters are ignored. If invalid parameters are entered the command terminates without starting to process the trace.

File tailoring trace command (ISPFTRC)

CtlR These records are generated when record processing has completed and the record was determined to be a control statement. The generation of this type of trace record is controlled by the ISPFTRC RECORDS parameter.

DatR These records are generated when record processing has completed and the record was determined to be a data record. The generation of this type of trace record is controlled by the ISPFTRC RECORDS parameter.

NoFT These records are generated after the point where the NOFT parameter is specified on the FTINCL service call, or the point where the NT option is specified on the)IM control statement. The generation of this type of trace record is controlled by the ISPFTRC RECORDS parameter.

Err These records are generated when a file tailoring processing error occurs and ISPF issues an error message. The generated records include both the short and long error messages.

Skeleton

The ISPF skeleton name associated with the trace record.

Record

Display the record number associated with the trace entry type. For **Read**, **Src**, and **CtlR** the input record number from the skeleton member is displayed. (For control statements that are continued over more than one line this is always the record number associated with the first line of the control statement.) For **DatR** and **NoFT**, the output record number is displayed. This field is blank for all other record types.

IM The current imbed level. The skeleton name specified on the FTINCL service is always level 1.

IF The current IF or SEL level. This field is blank if no)IF or)SEL statement is being processed.

DO The current DO level. This field is blank if no)DO structure is being processed.

TB The current Table level. This field is blank if no)DOT structure is being processed.

Cd The Condition value returned for the following skeleton control statements:

-)IF,)SEL,)UNTIL, or)WHILE statement
 - T** Indicates a True condition
 - F** Indicates a False condition
-)ENDDO, or)ENDDOT statement
 - X** Indicates the corresponding)DO or)DOT control statement is terminating. In other words, the exit condition has been met.
-)IM statement with OPT parameter
 - X** Imbed member was not found. File tailoring processing will continue.

Note: A plus (+) character in this field indicates a record continuation.

RC The Return Code, shown only for SvcR, DatR, and CtlR trace entries.

File tailoring trace command (ISPFTRRC)

Data Trace data for the particular trace entry. The trace data extends the full width of the output file and will wrap if required.

File tailoring processing trace

```
TLD# Type Skeleton Rec# IM IF DO TB Cd RC Data
-----
TLD1 Svc FTOPEN TEMP
----- DD=ISP14484 DSN=LSACKVI.SPFTEMP1.CNTL
TLD1 SvcR 0 FTOPEN TEMP
TLD1 Svc FTINCL SKIF3
----- DD=ISPSLIB DSN=LSACKV2.ISPSLIB
TLD1 Read SKIF3 1 >>3>>START>> IF >>
TLD1 Read SKIF3 2 )SET RC = 0
TLD1 Read SKIF3 3 )IF &RC = 0 THEN )DO
TLD1 Read SKIF3 4 >>3>>DO<<<<
TLD1 Read SKIF3 5 )SET RC = 4
TLD1 Read SKIF3 6 )ENDDO
TLD1 Read SKIF3 7 >>3>>END<<<< RC=&RC
TLD1 Read SKIF3 ----- Total Records=7
TLD1 Src SKIF3 1 1 >>3>>START>> IF >>
TLD1 DatR SKIF3 1 1 0 >3>START> IF >
TLD1 Src SKIF3 2 1 )SET RC = 0
TLD1 Ct1R SKIF3 2 1 0 )SET RC = 0
TLD1 Src SKIF3 3 1 )IF &RC = 0 THEN )DO
TLD1 Ct1R SKIF3 3 1 1 T 0 )IF 0 = 0 THEN
TLD1 Src SKIF3 3 1 1 )DO
TLD1 Ct1R SKIF3 3 1 1 1 0 )DO
TLD1 Src SKIF3 4 1 1 1 >>3>>DO<<<<
TLD1 DatR SKIF3 2 1 1 1 0 >3>DO<<
TLD1 Src SKIF3 5 1 1 1 )SET RC = 4
TLD1 Ct1R SKIF3 5 1 1 1 0 )SET RC = 4
TLD1 Src SKIF3 6 1 1 1 )ENDDO
TLD1 Ct1R SKIF3 6 1 1 X 0 )ENDDO
TLD1 Src SKIF3 7 1 >>3>>END<<<< RC=&RC
TLD1 DatR SKIF3 3 1 0 >3>END<< RC=4
TLD1 SvcR 0 FTINCL SKIF3
TLD1 Svc FTCLOSE
----- DD=ISP14484 DSN=LSACKVI.SPFTEMP1.CNTL
TLD1 SvcR 0 FTCLOSE
TLD1 SvcR ----- Total Records=3
```

Figure 96. Sample file tailoring process trace

Diagnostic information

This section is intended to help you gather information to diagnose ISPF problems.

Using the ENVIRON system command

ISPF provides the ENVIRON command to assist you in gathering data that can be helpful in diagnosing problems, thus reducing service time. The ISPF session does not have to be running in any ISPF TEST/TRACE mode when you use the ENVIRON command.

The ENVIRON command can help you to:

- Produce system abend dumps when not running in ISPF TEST mode (ENBLDUMP parameter)
- Trace the TPUT, TGET, and PUTLINE buffers and obtain dump information for TPUT and TGET errors (TERMTRAC parameter)
- Gather terminal status information (TERMSTAT parameter)

You can display a panel (Figure 97) for selecting command options by entering the ENVIRON command with no parameters, or display the panel through the use of the Environ settings... choice from the Environ pull-down on the ISPF Settings panel. This panel includes the current values of the ENVIRON command parameters (ENBLDUMP and TERMTRAC) and the ddname, if any, allocated for a dump data set. The values can be changed by entering new values directly on the panel.

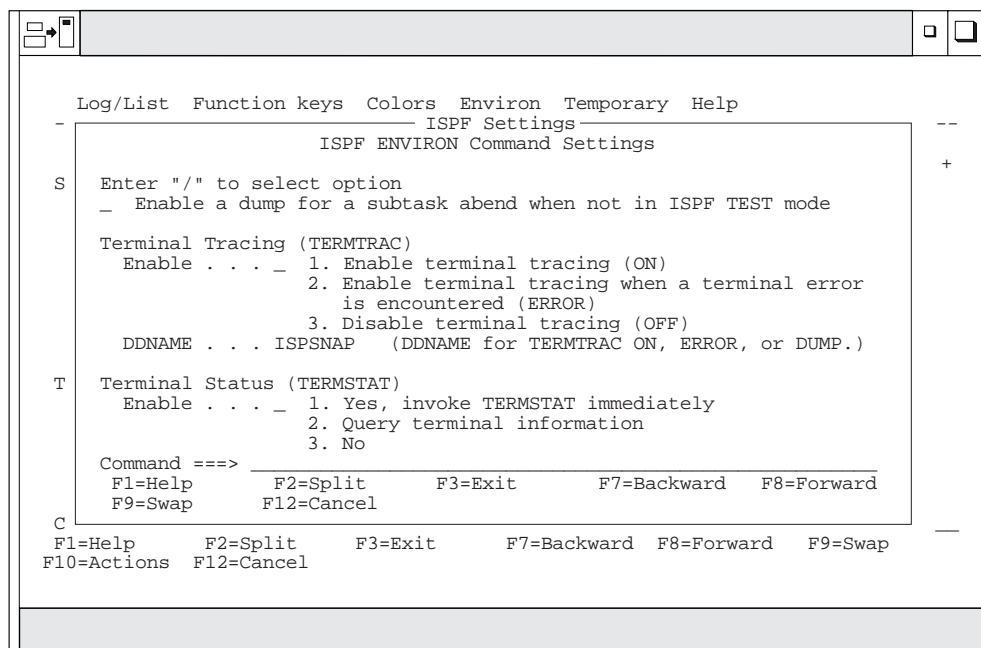

Figure 97. ENVIRON Settings Panel (ISPENVA)

You can issue the ENVIRON command at any time during an ISPF session.

ENVIRON command syntax and parameter descriptions

The general syntax for the ENVIRON command is:

```
ENVIRON [ENBLDUMP [ON|OFF]]
        [TERMTRAC [ON|ERROR|DUMP|OFF]]
        [TERMSTAT [QUERY]]
```

The parameter descriptions for the ENVIRON command are as follows:

ENBLDUMP

Specifying the ENBLDUMP parameter enables ISPF to produce an abend dump if a subtask abnormally terminates when ISPF is not running in TEST mode. The ENBLDUMP parameter does not apply to attached commands. Before a dump is taken you must allocate either the SYSUDUMP, SYSMDUMP, or SYSABEND ddname. For more information about these data sets, refer to *z/OS MVS Diagnosis: Tools and Service Aids*.

The default value for the ENBLDUMP parameter is ON. ENVIRON ENBLDUMP ON specifies to ISPF that a dump is to be generated for the subtask that abended.

Diagnostic information

Issuing ENVIRON ENBLDUMP OFF cancels the effect of the ON status.

The ENBLDUMP parameter value is preserved across ISPF sessions in the ISPSPROF profile.

With ENBLDUMP active, even when ISPF is not running in TEST mode, abnormal termination of a subtask results in a dump being taken and control being returned to TSO. ISPF execution is not resumed.

When running in ISPF TEST mode, issuing ENVIRON ENBLDUMP has no effect on dump processing.

TERMTRAC

Specifying the TERMTRAC parameter allows you to trace all terminal input and output data (TPUT, TGET, PUTLINE) during an ISPF session. The TERMTRAC parameter also allows you to turn on in-core tracing and cause ISPF to produce a SNAP dump if the TPUT or TGET service results in an error. ISPF does not have to be running in TSO TEST mode.

Note: The ENVIRON TERMTRAC buffer does not include:

- The TPUT/TGET instructions issued to query the terminal:
 - At ISPF initialization
 - By the ENVIRON TERMSTAT command
- The TPUT instruction issued to clear the screen at ISPF termination
- Under certain severe ISPF error conditions, the TPUT instruction issued to display a severe error line message

Before issuing the ENVIRON TERMTRAC DUMP command you must have first issued the ENVIRON TERMTRAC ON or ENVIRON TERMTRAC ERROR command.

Before using the TERMTRAC option, you must define to ISPF the ddname for the data set to be used for the SNAP macro, which ISPF invokes to provide data stream dumps. The ddname can be defined by specifying it on the panel displayed as a result of either issuing the ENVIRON command with no parameters, or selecting the “Environ settings” choice from the Environ pull-down on the ISPF Settings panel. You must follow the data set characteristics guidelines defined by MVS for the SNAP macro. See *z/OS MVS Programming: Assembler Services Guide* for DCB information that can be specified for the SNAP ddname.

The terminal data stream buffer used for ENVIRON TERMTRAC data collection is not reset to zeros.

Subparameters define terminal data tracing as follows:

- *ENVIRON TERMTRAC ON*

Activates TPUT, TGET, and PUTLINE buffer tracing of the terminal data stream. All data is retained in a 24K buffer provided by ISPF. No buffer entry is fragmented. If an entry will not fit into the remaining buffer space, ISPF issues a SNAP to capture the buffer data. The next trace entry is stored at the top of the buffer, regardless of the status of the SNAP execution. Messages are displayed to the user only for errors during SNAP execution. No messages are displayed during dumps taken as a result of the data buffer filling.

Because ENVIRON TERMTRAC ON causes a SNAP dump to be taken each time the buffer fills, the ddname that you allocate for the SNAP macro should have a disposition of MOD. This assures that no trace data is lost.

The layout of the terminal data buffer for all SNAP dumps is:

- 1 TPUT/TGET/PUTLINE BUFFER TRACE
 - 2 Header of 8 bytes initialized to TERMTRAC
 - 2 4-byte pointer to where the next entry is to be placed
 - 2 Reserved (20 bytes, for 32-byte boundary alignment)
 - 2 TPUT/TGET/PUTLINE DATA (*)
 - 3 8-byte TPUT/TGET/PUTLINE identifier
 - 3 4-byte pointer to previous entry
 - 3 Information specific to the terminal type identifier.

The TPUT/TGET identifiers and specific information for each is as follows. Each buffer entry is aligned on a 32-byte boundary.

- TGET** Before issuing TGET SVC. 4-byte pointer to previous entry. General purpose registers 0, 1, and 15:
 - R0 = input data area size
 - R1 = input data area pointer
 - R15 = TGET option byte
- TGETR** Return from TGET SVC. 4-byte pointer to previous entry. General purpose registers 1 and 15:
 - R1 = input data length
 - R15 = TGET return code

4-byte length of data stream.
Data stream.
- TPUT** Before issuing edit TPUT macro. 4-byte pointer to previous entry. General purpose registers 0, 1, and 15:
 - R0 = output data area
 - R1 = output data area pointer
 - R15 = TPUT option byte

4-byte length of data stream.
Data stream.
- TPUTR** Return from edit TPUT macro. 4-byte pointer to previous entry. General purpose register 15:
 - R15 = TPUT return code
- TPUTNE** before issuing the noedit TPUT macro. 4-byte pointer to previous entry. General purpose registers 0, 1, and 15:
 - R1 = address of plist
 - R15 = TPUT option byte

16-byte noedit plist:

 - Reserved (2 bytes)
 - 2-byte length of data stream
 - Code (1 byte)
 - 3-byte addr of data stream
 - Reserved (8 bytes)

Data stream.
- TPUTNER** Return from noedit TPUT macro. 4-byte pointer to previous entry. General purpose register 15:
 - R15 = TPUT return code
- PUTLINE** Before issuing the PUTLINE macro. 4-byte pointer to previous entry 12-byte PUTLINE parameter block:

Diagnostic information

Control flags (2 bytes)
2-byte TPUT options field
4-byte address of message
4-byte address of format-only line

125-byte message description:

2-byte message length
2-byte message offset
121-byte message

Actions that occur as a result of issuing the ENVIRON TERMTRAC command when ENVIRON TERMTRAC ON is already in effect are listed by command subparameter below:

- ON** ENVIRON TERMTRAC ON continues to function normally.
- OFF** Tracing is turned off and ISPF issues a SNAP macro. If ENVIRON TERMTRAC tracing is requested again, the next entry is written at the top of the buffer, regardless of whether the prior SNAP was successful.
- ERROR** Changes the setting of the command to ENVIRON TERMTRAC ERROR. Tracing continues, with the next buffer entry being written after the last entry written by the ENVIRON TERMTRAC ON setting.
- DUMP** The ENVIRON TERMTRAC ON condition continues. In addition, ISPF issues a SNAP macro and, if the SNAP is successful, the next trace entry is written at the top of the buffer. If the SNAP fails, the next entry is written after the last entry before the SNAP.

- *ENVIRON TERMTRAC ERROR*

Initiates tracing of the TPUT, TGET, and PUTLINE buffers. In addition, it causes ISPF to initiate a SNAP dump if a TPUT or TGET error occurs. The dump includes the storage trace buffer, the current TCB, all system control program information, and all problem program information. The SNAP macro definition provides more specific information about the areas dumped when all system control program and problem program information is requested.

ISPF issues the SNAP macro on the first occurrence of a TPUT failure. ISPF makes three consecutive attempts to correct a TPUT error.

Before using this option, you must have defined the ddname for the SNAP macro as described earlier in this topic under TERMTRAC.

Actions that occur as a result of issuing the ENVIRON TERMTRAC command when ENVIRON TERMTRAC ERROR is already in effect are listed by command subparameter below:

- ON** Changes the setting of the command to ENVIRON TERMTRAC ON. Tracing continues, with the next buffer entry being written after the last entry written by the ENVIRON TERMTRAC ON setting.
- ERROR** ENVIRON TERMTRAC ERROR continues to function normally, with the next trace entry written after the last ERROR trace entry.
- OFF** The setting for ENVIRON TERMTRAC is set to OFF. If ENVIRON TERMTRAC tracing is requested again, the next entry is written at the top of the buffer, regardless of whether the prior SNAP was successful.

DUMP The ENVIRON TERMTRAC ERROR condition continues. In addition, ISPF issues a SNAP macro and, if the SNAP is successful, the next trace entry is written at the top of the buffer. If the SNAP fails, the next entry is written after the last entry before the SNAP.

- *ENVIRON TERMTRAC DUMP*

Causes ISPF to immediately issue a SNAP macro, but only if ENVIRON TERMTRAC ON or ENVIRON TERMTRAC ERROR is active. The resulting dump includes the storage trace buffer, the current TCB, all system control program information, and all problem program information. The SNAP macro definition provides more specific information about the areas dumped when all system control program and problem program information is requested.

Notes:

1. This command execution does not turn off terminal data stream tracing if it is active at the time.
2. The next entry is written to the top of the terminal data buffer if the SNAP was successful; otherwise, tracing continues immediately after the last trace buffer entry.

- *ENVIRON TERMTRAC OFF*

Resets active ENVIRON TERMTRAC ON and ENVIRON TERMTRAC ERROR commands. If ENVIRON TERMTRAC is active, ISPF issues a SNAP macro.

The TERMTRAC parameter value is preserved across ISPF sessions in the ISPSPROF profile. The ddname specified for TERMTRAC on the ENVIRON option panel is also saved across sessions.

TERMSTAT

Specifying the TERMSTAT option of the ENVIRON command allows you to collect information about the characteristics of the terminal you are using and the line to which it is attached. The information is returned to your terminal by using line mode, and is written to the ISPF log data set.

The description below of the information returned from an ENVIRON TERMSTAT request is divided into three parts:

- A list of terminal characteristics as defined in ISPF variables. In other words, this list defines what ISPF thinks your terminal characteristics are.
- A list of terminal characteristics as defined within TSO.
- A list of structured fields that apply only to terminals with extended data stream (EDS) capability.

If you issue ENVIRON TERMSTAT (without the QUERY parameter) ISPF unconditionally returns information from lists A and B (below). In addition, if your terminal is connected to a port that supports extended data streams, ISPF returns information from list C (below).

If your terminal is one that supports extended data streams, such as an IBM 3279, but is connected to a non-EDS port, you can issue ENVIRON TERMSTAT QUERY to force ISPF to return information from list C. Be aware that if you issue ENVIRON TERMSTAT QUERY, and your terminal is not a type that supports extended data streams, such as the IBM 3277, you will receive an ORDER STREAM CHECK error.

Diagnostic information

Information returned as a result of issuing the ENVIRON TERMSTAT command is as follows:

List A – Terminal Characteristics as Defined Within ISPF

- 14-bit terminal addressing mode (ON or OFF)
- 16-bit terminal addressing mode (ON or OFF)
- Color mode (ON or OFF)
- Highlighting mode (ON or OFF)
- DBCS mode (ON or OFF)
- Primary screen size (length, width, total bytes)
- Alternate screen size (length, width, total bytes)
- Partition screen size (length, width, total bytes)
- ISPF terminal buffer data (TSB ptr., TSB size, TPP addr.)

List B – Terminal Characteristics as Defined Within TSO

- Return code from GTTERM
- Primary screen information (rows, columns)
- Alternate screen information (rows, columns)
- Screen attribute value
- Character set (ASCII or EBCDIC)
- Extended data streams or non-EDS support
- Return code from GTSIZE
- GTSIZE information (rows, columns)
- Access method being used (VTAM* or TCAM)

List C – Terminals Supporting EDS (structured fields)

- Usable areas
- Partitions
- Character sets
- Color
- Highlighting
- Reply modes
- PC 3270
- Implicit partition
- Input control
- Field rule
- *ENVIRON TERMSTAT QUERY*
 - The QUERY parameter allows you to request terminal data related to extended data stream capability, even though your terminal is connected to a port that does not support extended data streams.

Abend panels provide diagnostic information

When ISPF processing ends abnormally, diagnostic panels are available for displaying:

- Task abend code
- Reason code
- Module name
- Entry point address
- Program-Status Word (PSW)
- Register content at the time of the abend

This information is used in logged abend messages. A tutorial panel displays a list of the common abend codes.

On abnormal ISPF termination, the Error Recovery panel shown in Figure 98 on page 367 indicates the abend code and reason code.

```

                                Error Recovery
Command ===>

* * * * *
* * * * *
* *           ISPF processor ended abnormally           * *
* *
* *           System abend code      0C1                * *
* *                   Reason code 01                    * *
* *
* *
* *
* * Note: The ABEND and REASON codes displayed above are * *
* *           HEXADECIMAL values for "SYSTEM" abends and * *
* *           values for "USER" abends.                  * *
* *
* * Enter HELP command for list of common ABEND codes.  * *
* * Press ENTER key for additional DIAGNOSTIC information. * *
* * Enter END command to display primary option menu.   * *
* *
* * * * *
* * * * *

```

Figure 98. Error Recovery Panel (ISPPRS1)

If the SDWA (System Diagnostic Work Area) Reason Code is not supplied, that is, the SDWA reason code flag bit is OFF, the Reason Code panel field will be blank. If the abend code documentation indicates that the reason code is in a particular register, see the contents of that register, which can be displayed on the Additional Diagnostic Information panel as shown in Figure 99 on page 368.

If you enter HELP, ISPF displays a list of the common abend codes. To return to the Error Recovery panel, enter END from the Common ABEND panel.

|
|
|
|

If you press Enter from the Error Recovery panel, the Additional Diagnostic Information panel is displayed. Figure 99 on page 368 shows sample data where the SDWA extension is installed. The format for the register content is slightly different if the SDWA extension is not present.

```

Additional Diagnostic Information
Command ==>
More: +

System abend code      = 0C1
Reason code           = 01

ISPF Release Level : 5.7.0000

Module name . . . : ASMTST
Entry point address 0000D488

PSW . . . . . : 078D1000 0000D4BC

Register content:

R0 00000000 - 16308E22 R1 00000000 - 00048EA4
R2 00000000 - 0000D4D0 R3 00000000 - 00048AC0
R4 00000000 - 00048AAC R5 00000000 - FFFFFFFF
R6 00000000 - 00000000 R7 00000000 - 00000001
R8 00000000 - 00000000 R9 00000000 - 00039060
R10 00000000 - 00048AA8 R11 00000000 - 00000000
R12 00000000 - 0000D488 R13 00000000 - 0000D4D0
R14 00000000 - 80FCC860 R15 00000000 - 0000D488

```

Figure 99. Additional Diagnostic Information panel (ISPPRS3)

Entry point, PSW, and register values are in hexadecimal. Abend code and reason code are in hexadecimal for system abends and in decimal for user abends. Meanings for the entries on the Additional Diagnostic Information panel are:

Abend code

Abend completion code, identified on the panel as “user” or “system”.

Reason code

Component reason code or return code associated with the abend.

ISPF Release Level

ISPF version/release/modification level.

Module Name

Name of abending program or *NOT SPECIFIED* if no name is available.

Entry Point Address

Entry point address of abending program.

PSW Program-Status Word at time of error.

Register content

General Purpose register content at time of error.

If the Recovery Termination Manager (RTM) could not get storage for the System Diagnostic Work Area (SDWA) or an error occurred within the error routine, all fields on this panel will contain 0’s, with the exception of the abend code and ISPF release level. Those fields will contain the correct data.

You can enter the HELP command from this panel as well to display the list of common abend codes. Information associated with an abend is available from the ISPF log file.

Press the END function key to return to the primary option menu.

ISPF statistics entry in a PDS directory

The following is the format of the information that ISPF writes to the PDS directory to maintain statistics for a member. If you suspect the statistics data has been corrupted, you can compare the existing entry against these formats to help in problem determination.

Byte Description and Format

1	Version number, in hexadecimal format. Value is between X'01' and X'99'.				
2	Modification level, in hexadecimal format. Value is between X'00' and X'99'.				
3	Flags: <table> <tbody> <tr> <td>Bit 1</td> <td>SCLM indicator. SCLM uses this to determine whether the member and any related SCLM information are still in sync. <ul style="list-style-type: none"> • ON means the member was last edited by SCLM, the Software Configuration and Library Manager. • OFF means the member was somehow processed outside SCLM. </td> </tr> <tr> <td>Bit 2–8</td> <td>Reserved for future ISPF use.</td> </tr> </tbody> </table>	Bit 1	SCLM indicator. SCLM uses this to determine whether the member and any related SCLM information are still in sync. <ul style="list-style-type: none"> • ON means the member was last edited by SCLM, the Software Configuration and Library Manager. • OFF means the member was somehow processed outside SCLM. 	Bit 2–8	Reserved for future ISPF use.
Bit 1	SCLM indicator. SCLM uses this to determine whether the member and any related SCLM information are still in sync. <ul style="list-style-type: none"> • ON means the member was last edited by SCLM, the Software Configuration and Library Manager. • OFF means the member was somehow processed outside SCLM. 				
Bit 2–8	Reserved for future ISPF use.				
4	The seconds portion of the time last modified, in packed decimal format.				
5–8	Creation date: <table> <tbody> <tr> <td>Byte 5</td> <td>Century indicator. X'00' = 1900. X'01' = 2000.</td> </tr> <tr> <td>Byte 6–8</td> <td>Julian date, in packed decimal format</td> </tr> </tbody> </table>	Byte 5	Century indicator. X'00' = 1900. X'01' = 2000.	Byte 6–8	Julian date, in packed decimal format
Byte 5	Century indicator. X'00' = 1900. X'01' = 2000.				
Byte 6–8	Julian date, in packed decimal format				
9–12	Date last modified: <table> <tbody> <tr> <td>Byte 9</td> <td>Century indicator. X'00' = 1900. X'01' = 2000.</td> </tr> <tr> <td>Byte 10–12</td> <td>Julian date, in packed decimal format</td> </tr> </tbody> </table>	Byte 9	Century indicator. X'00' = 1900. X'01' = 2000.	Byte 10–12	Julian date, in packed decimal format
Byte 9	Century indicator. X'00' = 1900. X'01' = 2000.				
Byte 10–12	Julian date, in packed decimal format				
13–14	Time last modified, in packed format: <table> <tbody> <tr> <td>Byte 13</td> <td>Hours, in packed decimal format</td> </tr> <tr> <td>Byte 14</td> <td>Minutes, in packed decimal format</td> </tr> </tbody> </table>	Byte 13	Hours, in packed decimal format	Byte 14	Minutes, in packed decimal format
Byte 13	Hours, in packed decimal format				
Byte 14	Minutes, in packed decimal format				
15–16	Current number of lines, in hexadecimal format				
17–18	Initial number of lines, in hexadecimal format				
19–20	Number of modified lines, in hexadecimal format				
21–27	Userid, in character format				
28–30	Reserved for future ISPF use				

Common problems using ISPF

This section contains some common error messages that may be encountered while using ISPF. Error resolutions and explanations are also included.

Messages

- IKJ56500I COMMAND NOT FOUND

If a command processor exists only in LPA, there must be an entry in the ISPTCM for the command processor. Refer to *z/OS ISPF Planning and Customizing* for more details on customizing the ISPF TSO command table.

Common problems using ISPF

- IKJ5686II FILE ddname NOT FREED, DATA SET IS OPEN

If the LIBRARY parameter is used with a table service, the user is not able to free the ddname for the table library pointed to by the LIBRARY parameter. ISPF keeps this library open until a new ddname is used in the LIBRARY parameter with another table service. ISPF functions in this manner for performance reasons.

Issuing a table service with a LIBRARY parameter containing a ddname that does not exist causes the previous library to be closed and therefore allows the user to free the previous ddname. Use of CONTROL ERRORS RETURN may be used to guard against a severe error as a result of a ddname not existing.

For example:

```
ALLOC FILE(DD1) DATASET('USERID.YOUR.TABLES') SHR
ISPEXEC TBOPEN MYLIB LIBRARY(DD1)
.
.                               /*ISPF services against your table*/
.
ISPEXEC TBCLOSE MYLIB LIBRARY(DD1)
ISPEXEC CONTROL ERRORS RETURN
ISPEXEC TBOPEN JUNK LIBRARY(DDJUNK) /*nonexistent table in a */
                                   /*nonexistent library */
ISPEXEC CONTROL ERRORS CANCEL
FREE F(DD1)
```

- ISPP150 Panel 'name' error—At least one of the CLEAR names listed is not a panel field name.

or:

ISPP121 Panel 'name' error—Panel definition too large, greater than screen size.

when entering KEYLIST, when requesting field-level help in ISPF panels, or when displaying panels created using DTL.

These messages are often caused by having a GML library in the ISPPLIB concatenation or by having GML source code in the panel library. Check your ISPPLIB concatenation to make sure that the ISPF-supplied GML library is not concatenated first. The ISPF-supplied GML library should not be in any of the ISPF library concatenations. Make sure that the libraries in your ISPPLIB concatenation do not contain GML source code.

- ISPT036 Table in use—'table service' issued for table 'table name' that is in use, ENQUEUE failed.

This message frequently occurs when batch jobs that use ISPF services run concurrently. This occurs because most batch jobs allocate a new profile each time they run. ISPF issues a TBOPEN against ISPPROF DD card for member ISPSPROF. The TBOPEN fails since ISPPROF does not contain this member. ISPF then issues a TBOPEN against ISPTLIB to copy the default ISPSPROF from ISPTLIB to ISPPROF.

If the first data set in the ISPTLIB concatenation sequence is the same for two batch jobs running concurrently, message ISPT036 is issued. To ensure that this condition does not occur, the first data set in the ISPTLIB concatenation should be user unique. For example, '*sysuid*..ISPPROF' would be a user unique data set, which could be used as the first data set concatenated to the ISPTLIB DD.

For the same reasons, this problem can also occur when two users log on to ISPF for the first time if they have the same data set concatenated first in the ISPTLIB concatenation.

- ISPT016, ISPT017, and other I/O Errors

ISPF has various messages that reference I/O errors on either GET or PUT (READ and WRITE macros) such as message ISPT017. These errors are typically caused by concatenation problems on one of the ISPF libraries.

Allocating data sets that do not have consistent DCB parameters in ISPF library concatenations often causes these messages. Also, ISPTABL, ISPFIL, and ISPPROF are used for output and therefore must have only a single data set allocated to their ddnames.

- For I/O errors during panel services, check your ISPPLIB concatenation for inconsistent DCBs.
- For I/O errors during file tailoring services, check your ISPSLIB concatenation for inconsistent DCBs and make sure that only one data set is allocated to ddname ISPFIL.
- For I/O errors during table services, check your ISPTLIB concatenation for inconsistent DCBs and make sure that only one data set is allocated to ddname ISPTABL.

I/O error messages cannot be issued when there is a problem with the ISPMLIB concatenation since messages cannot be located due to the I/O error. Message CMG999 occurs when there is an I/O error due to an ISPMLIB concatenation problem.

- CMG999

CMG999 is issued with an appropriate description of the error condition for any problem with accessing a message. Refer to *z/OS ISPF Dialog Developer's Guide and Reference* for further information on how to define a message.

Unexpected output

- ISPF services do not pick up updated copies of messages or panels.
When not in TEST mode, the most recently accessed panel and message definitions are retained in virtual storage for performance reasons. If you have modified a panel or message file, using TEST mode ensures that the latest copy of each message or panel is accessed. Refer to *z/OS ISPF Services Guide* for more information on executing ISPF in TEST mode.
- ISPF commands such as WINDOW, COLOR, CUAATTR, EXIT, CANCEL, ACTIONS, KEYSHELP, KEYSLIST, EXHELP, FKA, and ISPD TLC are not recognized as valid commands, or function keys defined as these commands do not function properly.

The user issuing these commands or pressing the function keys defined as these commands has a private copy of ISPCMD5 in the ISPTLIB concatenation. The user's private copy of ISPCMD5 is missing some or all of the new commands supplied in the new command table, ISPCMD5.

Users experiencing this problem should either replace their private copy of ISPCMD5 with the ISPF-supplied copy, or update their private ISPCMD5 with the missing commands.

Abend codes and information

ISPF controller and processor task abends are controlled by STAE and STAI exit routines and by ISPF execution modes set using the ISPSTART TEST parameters.

Under normal conditions (that is, when processor and controller dumps have not been requested by specifying the ISPSTART TEST command):

- When a processor task abends:
 - No dump is taken.
 - The controller reattaches the processor main drive (ISPPMD).
 - The primary option menu is redisplayed for that logical screen.
- When the controller task abends:

Abend codes and information

- ISPF terminates with *** ISPF MAIN TASK ABEND *** message.
- Control returns to TSO.
- Pressing Enter causes a dump to be taken if a dump data set has been allocated.

The controller and processor tasks issue the ABEND system service and allow dumps under certain situations. The ISPF modules that issue ABENDs and their associated codes and reasons are listed below:

Abend code 0C1 in various common ISPF subroutines

In several ISPF modules, an invalid operation code of (X'00') is executed to force an abend at the point that an unexpected condition occurs. Contact IBM support if this condition occurs within an ISPF module.

Abend code 0C4 in ISPDVCGT, ISPDVCPT, or ISPDVCFD

These abends are often caused by mismatched VDEFINE and VDELETE services in a user's program. The VDEFINE service gives ISPF addressability to user storage. This storage is used by variable services any time the variable that has been established by the VDEFINE service is referenced. If this storage is released back to the system, an 0C4 abend may occur depending on whether the storage is still accessible. Following are two common scenarios that often show these abends:

- A program establishes a variable in a called subroutine using the VDEFINE service and subsequently uses an ISPF service that references this variable in another routine. If the called subroutine was dynamically loaded and therefore released its storage, an 0C4 abend could occur when the subroutine references a VDEFINEd variable.
- A program establishes a variable in a called subroutine using the VDEFINE service and then calls another program without using the SELECT service. Then the called program VDEFINES a variable with the same name, but does not VDELETE it on exit. If the calling program references that variable after the called program returns control to it, an 0C4 abend can occur. Since a VDELETE has not been done, ISPF services still reference the variable VDEFINEd by the called program.

If the program intent is to use the same variable in the main and called routines, the variable should be VDEFINEd only in the main routine. If the program intent to isolate a variable to be used only in the routine in which it is VDEFINEd, then the program should also VDELETE the variable before it ends. To diagnose whether the user application has this problem, a function trace on VDEFINE, VDELETE, and the SELECT services (Option 7.7.1) is very helpful.

Abend codes 111 or 222

To produce these abends, the user must be in test mode and request processor dumps by entering one of the following commands on the ISPF command line. With exception of the user completion code, both commands function in the same manner.

ABEND Terminates ISPF with user completion code 111.

CRASH Terminates ISPF with user completion code 222.

Abend code 908

ZISPFRC value was not valid

Abend code 920

ISPSTART command syntax was not valid

Abend code 985

An attempt was made to start a GUI in batch mode, but no workstation connection was made.

Abend code 987

An attempt was made to start GUI with GUISCRW or GUISCRD and the GUI initialization failed.

Abend code 988

Invalid TSO environment. Refer to *z/OS ISPF Planning and Customizing* for the proper TSO version.

Abend code 989

The ISPF C/S component window was closed while still running ISPF in GUI mode

Abend code 990

An error occurred running in batch mode. If ZISPFRC has not been set previously, and ISPF encounters a severe error that terminates the product, then 990 is set.

Abend code 995

Configuration table is not compatible with current ISPF release. Configuration table must be release 4.8 or later.

Abend code 996 (or X'3E5')

ISPF was not able to load the terminal translate table during initialization. Check that the load module defined in the configuration table is available in the ISPLLIB or MVS load library search concatenation. The value is stored in the user's profile data set, so a reset may be required to load the correct value.

Abend code 997 (or X'3E5')

A TPUT returned a return code other than 0 or 8. A message is displayed and an attempt is made to redisplay the full screen. If the redisplay fails twice, this abend is issued.

Abend code 998 (or X'3E6')

An ISPF severe error that occurs while not in CONTROL ERRORS RETURN mode and before ISPF is fully initialized. ISPF is considered to be fully initialized when the Enter key on the primary option menu has been processed without a severe error occurring.

Abend code 999 (or X'3E7')

This abend is issued for the following reasons:

- No function pool is established for a command processor.
For example, a command processor that uses ISPF services is invoked using option 6 or SELECT CMD, but the command processor does not have a function pool. The user needs to have an entry for the command processor in the ISPTCM with the X'40' flag set on. The X'40' flag indicates that the command requires a function pool. Refer to *z/OS ISPF Planning and Customizing* for more information on customizing the ISPTCM.
- An error occurs while another error is already being processed.
ISPF issues the abend code 999 in this case to protect against an infinite loop.
- An error occurred during ISPF initialization.
For example:

Abend codes and information

- An I/O error occurred due to ISPF library allocations such as ISPSLIB, ISPPLIB, ISPMLIB, and so forth, containing inconsistent or incorrect DCB attributes.
- An ISPF library allocation does not contain the required ISPF libraries in its concatenation. For example, the ISPMLIB contains user product libraries but not ISPF libraries.

Terminal I/O error codes

Below is a list of terminal I/O error codes that you may see while using ISPF.

- ISPF screen output error code
 - 41 TPUT return code not equal to 0 or 8
- ISPF screen input error code
 - 21 TGET return code other than 0, 4, or 8.
 - 22 Input stream size greater than input buffer size or 0.
 - 23 Unknown attention identifier (AID).
 - 24 Invalid input AID.
 - 25 Input stream size invalid for input AID.
 - 26 Input cursor location not within physical screen.
 - 28 First byte of input buffer field not an SBA (invalid input data).
 - 31 Byte preceding the physical screen field is past the end of the physical screen (input data from invalid screen position).
 - 32 Byte preceding the physical screen field is not an input attribute (input data from invalid screen position).
 - 33 Physical screen field not defined on panel (input data from invalid screen position).
 - 51 Physical screen field attribute not found in logical screen.
 - 52 Byte preceding logical screen field is not an input attribute.
 - 55 Physical screen size is greater than corresponding logical screen size.

Notes:

1. The physical screen size is determined by ISPF during initialization.
2. The input buffer size is a variable based on the physical screen size.
3. The logical screen is the same size as the physical screen, and is the size that the processor task uses for screen I/O. When the 3290 is running in 62 X 160 partition mode, the SPLITV command makes the logical screen width equal to 80. When a 3278 mod 5 is running in standard mode, the logical screen size is 24 X 80.
4. Only part of the logical screen appears on the physical screen when ISPF is running in split-screen mode. When the 3290 is running in 62 X 160 partition mode, the entire logical screen may be visible, depending on the position of the horizontal split line.
5. An input buffer field extends from an SBA to either the next SBA or the end of the input buffer.
6. A physical screen field extends from the location indicated in the input buffer SBA to the location of the next attribute byte in the physical screen.

Register linkage conventions

ISPF uses standard linkage conventions:

- **SELECT PGM(program-name)**

REGISTER	CONTENTS
1	Points to the address of the parameter data (from the PARM keyword) field (half-word length) followed by the data
2 - 12	Not used
13	72-byte save area
14	Return address
15	Entry address / Return code on exit

- **ISPF EXITS / Call to ISPLINK**

REGISTER	CONTENTS
1	On entry, points to a parameter list; each address in the list in turn points to a parameter. On return to the caller of ISPLINK, the user's parameter list starts at the second parameter. ISPF has inserted a parameter in front of the user's parameters for ISPF use.
2 - 12	Not used
13	72-byte save area
14	Return address
15	Entry address / Return code on exit

- **SELECT CMD(cmdname)** where *cmdname* is a program that will be attached as a command processor by ISPF:

REGISTER	CONTENTS
1	Points to a CPPL (Command Processor Parameter List) which is a list of four addresses that point respectively to: Command buffer, UPT, PSCB, ECT. See the TSO programming services manual for descriptions of these parameters.
2 - 12	Not used
13	72-byte save area
14	Not applicable
15	Return code on exit

Usually when an abend occurs within ISPF code, register 12 points to the entry point of the abending CSECT.

Obtaining message IDs

In order to obtain the message ID associated with an error message in ISPF, you need to be in ISPF TEST mode.

ISPF is in TEST mode if:

- ISPF is invoked with the TEST, TESTX, TRACE, or TRACEX parameter specified on the ISPSTART, PDF, or ISPF command, or

Obtaining message IDs

- Restore TEST/TRACE option is not selected in option 0 and you go into option 7, Dialog Test, at some point in your current ISPF session.

If you are not in TEST mode, split the screen, enter option 7, Dialog Test, and swap back to the screen containing the error.

You can use either of the following methods to get the message ID:

- Enter print on the panel displaying the error message. The message ID, along with the displayed message text and screen output, appears in the LIST data set. The LIST data set can be printed using the LIST command.
- With the short message displayed:
 1. Press the function key assigned to Help (default is F1) or type help on the command line. This displays the long message text for the error.
 2. Press the function key assigned to Help or type help on the command line once more to display the Tutorial panel associated with the error. The bottom lines of the Tutorial panel contain fields that list the current panel name, the previous panel name, and the message ID. The value following LAST MSG= is the message ID associated with the error.

Installation, maintenance, and migration diagnostics

The following information describes common situations you may encounter during installation, maintenance, and migration.

Problem:

Unpredictable results such as 0C4 or 0C1 abends upon invocation of ISPF.

Cause: This problem can occur when internal LINKs and LOADs are used in conjunction with the ISPF ISPLLIB DCB.

Solution:

When using STEPLIB to test new maintenance, releases, or versions of products and an ISPLLIB is allocated, data sets allocated to STEPLIB should also be allocated to ISPLLIB.

Problem:

New levels of code residing in STEPLIB do not appear to be executed. This includes changes to customer applications, new levels of code, and changes made by PTFs, for example.

Cause: This problem can occur when internal LINKs and LOADs are used in conjunction with the ISPF ISPLLIB DCB.

Solution:

When using STEPLIB to test new maintenance, releases, or versions of products and an ISPLLIB is allocated, data sets allocated to STEPLIB should also be allocated to ISPLLIB.

Problem:

Abends occur when invoking or exiting HELP, KEYS, or ISPPREP.

Cause: An older level of ISPF exists in LPA or LINKLIB; an ISPLLIB or STEPLIB is used to allocate libraries for the new release of ISPF; and a LIBDEF for ISPLLIB that does not include the new level of ISPF libraries has been issued.

Not all of ISPF is loaded at initialization, for example, ISPTUTOR is linked when HELP is requested. The LIBDEF of ISPLLIB results in the older level of any modules that are not loaded on ISPF entry to be picked up from

Installation, maintenance, and migration diagnostics

LPA or LINKLIB due to internal search orders. For more information, refer to the LIBDEF command in *z/OS ISPF Services Guide*.

Solution:

Include the new level of ISPF in any LIBDEFs issued for ISPLLIB.

Problem:

Abend code 806 for ISPLINK or Abend code 0C1 in user application.

Cause: During installation, the SMP/E install logic for ISPF deletes the existing ISPLINK load module.

Solution:

Relink-edit ISPLINK to user application.

Problem:

Abends in load modules IGC0009C and IGC0009D.

Cause: Failure to install ISPF in the same zone as TSO/E will result in the supplied ISPF SVC 93 and SVC 94 exits (ISPSC93, ISPSC94), creating SVC 93 and SVC 94 load modules without the proper link-edit information.

Failure to use the correct version of either IGC0009C or IGC0009D or both.

Solution:

TSO/E, ISPF, and ISPF/PDF must all be installed in the same zone. Verify that the correct versions are copied from a test system to the production system.

Problem:

Attempting to start an ISPF session with a workstation connection using ISPF C/S causes error messages like: 'CSV003I REQUESTED MODULE LSCSIO NOT FOUND' +LSCX012 Unable to load runtime I/O routines, execution cannot continue.

Cause: Library SISPSASC is not in the usual MVS load module search order. This library is *not* searched using the ISPLLIB allocation. It must be in STEPLIB or LNKLST.

Solution:

Put the SISPSASC library in STEPLIB or LNKLST. For more information about SISPSASC, refer to *z/OS ISPF Planning and Customizing*.

Installation, maintenance, and migration diagnostics

Appendix D. Dialog Variables

This appendix describes the ISPF dialog variables.

The following table lists the dialog function pool variables that are both read from and written to by several of the PDF library access services. For details of function pool variables written by other services, refer to the *z/OS ISPF Services Guide*.

The variables are listed in alphabetical order. The first column lists the variable name. The second column indicates the variable's type, which corresponds to the format parameter of the ISPF VDEFINE service. The third column specifies the variable's length, which corresponds to the length parameter of the VDEFINE service.

The fourth column lists the PDF services that either read from or write to the variable. An R in parentheses (R) after a service name indicates that the service, when called, reads from the given variable. A W in parentheses (W) after a service name indicates that the service, when called, writes to the given variable. All variables are available to a dialog unless otherwise indicated.

The last column contains a brief description of the contents of the variable and any restrictions on the value of the variable.

Dialog Variables

Variable Name	Format	Length	Service (Access)	Description
ZCMD	Char	256	LMMDISP(W)	Primary Command field from member list panel if the command is not a valid ISPF or PDF primary command.
ZDLBLKSZ	Char	5	LMDLIST(W)	Block size.
ZDLCATNM	Char	44	LMDDISP(R), LMDLIST(W)	Name of the catalog in which the data set was located.
ZDLCDATE	Char	10	LMDLIST(W)	Creation date.
ZDLDEV	Char	8	LMDLIST(W)	Device type.
ZDLDSNTP	Char	8	LMDLIST(W)	DS name type ('PDS', 'LIBRARY', or ' ').
ZDLDSORG	Char	4	LMDLIST(W)	Data set organization.
ZDLEDATE	Char	10	LMDLIST(W)	Expiration date.
ZDLEXT	Char	3	LMDLIST(W)	Number of extents used.
ZDLEXTX	Char	5	LMDLIST(W)	Number of extents used (long format).
ZDLLRECL	Char	5	LMDLIST(W)	Logical record length.
ZDLMIGR	Char	3	LMDLIST(W)	Whether the data set is migrated ('YES' or 'NO').
ZDLRDATE	Char	10	LMDLIST(W)	Date last referenced.
ZDLRECFM	Char	5	LMDLIST(W)	Record format.
ZDLSIZE	Char	6	LMDLIST(W)	Data set size in tracks.
ZDLSIZEX	Char	12	LMDLIST(W)	Data set size in tracks (long format).
ZDLSPACU	Char	10	LMDLIST(W)	Space units, one of the following: CYLINDERS, MEGABYTES, KILOBYTES, BYTES, BLOCKS or TRACKS.
ZDLUSED	Char	3	LMDLIST(W)	Percentage of used tracks or pages (PDSE).
ZDLVOL	Char	6	LMDLIST(W)	Volume serial.
ZDSN	Char	44	LMMDISP(W)	Name of the first or only data set in the concatenation of the member list being displayed. This variable is only available for member list panels.
ZDST	Char	54	BRIF (W) EDIF (W)	Title line data name for EDIF and BRIF.
ZEDBDSN	Char	44	EDIT (R) EDREC(W)	Backup data set name for standard edit recovery.
ZEDITCMD	Char	8	Any EDIT macro	The last primary command entered in Edit.
ZEDROW	Fixed	4	EDIT (R) EDREC(W)	Row number of entry in standard edit recovery table.
ZEDSAVE	Char	8	Data_changed EDIT macro command	END command will save data (SAVE or NOSAVE).
ZEDTDSN	Char	44	EDIT (R) EDREC(W)	Target data set name for standard edit recovery.
ZEDTMCMD	Char	8	Any Edit macro	The edit command entered that caused an edit macro to run. Can be the macro name or other name is the edit DEFINE command was used to define an alias.
ZEDTMEM	Char	8	EDIT (R) EDREC(W)	Target member name (if applicable) for standard edit recovery.
ZEDTRD	Char	6	EDIT (R) EDREC(W)	Volume serial of target data set for standard edit recovery.
ZEDUSER	Char	²	EDIT (R) EDREC(W)	User data table extension for standard edit recovery.

Variable Name	Format	Length	Service (Access)	Description
ZEIBSDN	Char	54	EDIF (R) EDIREC(W)	Backup data name for EDIF edit recovery.
ZEIROW	Fixed	4	EDIF (R) EDIREC(W)	Row number of entry in EDIF edit recovery table.
ZEITDSN	Char	54	EDIF (R) EDIREC(W)	Target data name for EDIF edit recovery.
ZEIUSER	Char	2	EDIF (R) EDIREC(W)	User data table extension variable for EDIF edit recovery.
ZERRALRM	Char	3	ALL(W)	The value YES if an alarm was specified in the message definition; otherwise, the value NO. Set when ISPF services issue a return code of 8 or greater.
ZERRHM	Char	8	ALL(W)	The name of a Help panel, if one was specified in the message definition. Set when ISPF services issue a return code of 8 or greater.
ZERRLM	Char	512	ALL(W)	Long-message text in which variables have been resolved. Set when ISPF services issue a return code of 8 or greater.
ZERRMSG	Char	8	ALL(W)	Message ID. Set when ISPF services issue a return code of 8 or greater.
ZERRSM	Char	24	ALL(W)	Short-message text in which variables have been resolved. Set when ISPF services issue a return code of 8 or greater.
ZGRPLVL	Char	8	LMHIER (W)	ISPF table variable that contains the level of this ISPF library in the controlled hierarchy.
ZGRPNME	Char	8	LMHIER (W)	ISPF table variable that contains the ISPF library group name.
ZLAC	Char	2	LMMDISP(W) LMMFIND(W) LMMLIST(W)	Authorization code of the member.
ZLALIAS	Char	8	LMMDISP(W) LMMFIND(W) LMMLIST(W)	Name of the real member of which this member is an alias.
ZLAMODE	Char	3	LMMDISP(W) LMMFIND(W) LMMLIST(W)	AMODE of the member.
ZLATTR	Char	20	LMMDISP(W) LMMFIND(W) LMMLIST(W)	Load module attributes. Refer to the <i>ISPF Services Guide</i> .
ZLCDATE	Char	8	LMMADD(R) LMMDISP(W) LMMFIND(W) LMMLIST(W) LMMREP(R)	Date on which the specified member was created. A character string in the national format. For example, yy/mm/dd or mm/dd/yy. If no value exists for this variable, the PDF component will set the value to blanks.
ZLC4DATE	Char	10	LMMADD(R) LMMDISP(W) LMMFIND(W) LMMLIST(W) LMMREP(W)	Date on which the specified member was created, in 4-character year format. A character string in the national format. For example, yyyy/mm/dd or mm/dd/yyyy. If no value exists for this variable, the PDF component will set the value to blanks.

Dialog Variables

Variable Name	Format	Length	Service (Access)	Description
ZLCNORC	Fixed	4	LMMADD(R) LMMDISP(W) LMMFIND(W) LMMLIST(W) LMMREP(R)	Current number of records in the specified member. A number from 0 to 65 535. If no value exists for this variable, the PDF component will set the value to blanks.
ZLINORC	Fixed	4	LMMADD(R) LMMDISP(W) LMMFIND(W) LMMLIST(W) LMMREP(R)	Number of records in the specified member when it was first created. A number from 0 to 65 535.
ZLLIB	Fixed	4	LMMDISP(W) LMMFIND(W) LMMLIST(W)	Position of the specified member in the concatenated data sets. A number from 1 to 4.
ZLMDATE	Char	8	LMMADD(R) LMMDISP(W) LMMFIND(W) LMMLIST(W) LMMREP(R)	Date on which the specified member was last modified. A character string in the national format. (For example, <i>yy/mm/dd</i> or <i>mm/dd/yy</i> .) If no value exists for this variable, the PDF component will set the value to blanks.
ZLM4DATE	Char	10	LMMADD(R) LMMDISP(W) LMMFIND(W) LMMLIST(W) LMMREP(W)	Date on which the specified member was last modified, in 4-character year format. A character string in the national format. (For example, <i>yyyy/mm/dd</i> or <i>mm/dd/yyyy</i> .) If no value exists for this variable, the PDF component will set the value to blanks.
ZLMEMBER	Char	8	LMMDISP(W)	Name of the current selected member.
ZLMNORC	Fixed	4	LMMADD(R) LMMDISP(W) LMMFIND(W) LMMLIST(W) LMMREP(R)	The number of records that have been modified in the specified member. A number from 0 to 65 535.
ZLMOD	Fixed	4	LMMADD(R) LMMDISP(W) LMMFIND(W) LMMLIST(W) LMMREP(R)	Modification level of the specified member. A number from 0 to 99.
ZLMTIME	Char	5	LMMADD(R) LMMDISP(W) LMMFIND(W) LMMLIST(W) LMMREP(R)	Time when the specified member was last modified. A character string in the form hh:mm.
ZLMSEC	Char	2	LMMADD(R) LMMDISP(W) LMMFIND(W) LMMLIST(W) LMMREP(R)	Seconds value of last modified time.
ZLSSI	Char	8	LMMDISP(W) LMMFIND(W) LMMLIST(W)	SSI (System Status Index) of the load module.
ZLPDSUDA	Char	62	LMMDISP(W)	A character string containing the contents of the user data area in the PDS directory entry of the specified member if the member's statistics are not in PDF format.

Variable Name	Format	Length	Service (Access)	Description
ZLRMODE	Char	3	LMMDISP(W) LMMFIND(W) LMMLIST(W)	RMODE of the member.
ZLSIZE	Char	8	LMMDISP(W) LMMFIND(W) LMMLIST(W)	Load module size (in Hex).
ZLTTR	Char	6	LMMDISP(W) LMMFIND(W) LMMLIST(W)	TTR of the member.
ZLUSER	Char	7	LMMADD(R) LMMDISP(W) LMMFIND(W) LMMLIST(W) LMMREP(R)	User ID of user who last modified the specified member.
ZLVERS	Fixed	4	LMMADD(R) LMMDISP(W) LMMFIND(W) LMMLIST(W) LMMREP(R)	Version number of the specified member. A number from 1 to 99. If no value exists for this variable, the PDF component will set the value to blanks.
ZMEMCNT	Char	8	LMMLIST(W)	Number of members in the member list.
ZMLCOLS	Char	80	LMMDISP(W)	A character string that contains the member statistics column headings that appear on the member list panel display. This variable is only available for member list panels.
ZMLCR	Fixed	4	LMMDISP(W)	The relative number in the member list of the member that appears at the top of the member list display. Its range is from 1-99 999. This variable is only available for member list panels.
ZMLTR	Fixed	4	LMMDISP(W)	Number of members in the member list. Its range is from 1-99 999. This variable is only available for member list panels.
ZMSRTFLD	Char	8	ALL(W)	Contains the field name used to sort a member list. Field name corresponds to the title line used in member list panels, with the exceptions of the 'VV MM' field which is returned as VVMM, and the attributes field which is returned as ATTRIBUT.
ZSCALIAS	Char	1	LMINIT(W)	Data set name is an alias ('Y' or 'N').
ZSCLM	Char	1	LMMDISP(W) LMMFIND(W) LMMLIST(W)	Last updater of member. 'Y' indicates SCLM was last updater. 'N' indicates PDF.
ZSCMVOL	Char	1	LMINIT(W)	Data set name is multivolume ('Y' or 'N').
ZUSERMAC	Char	9	EDIT(R) EDIF(R) VIEW(R) VIIF(R)	Application-wide edit macro.

2. Length limited only by ISPF restrictions on the length of table extension variables.

PDF Non-Modifiable Variables

The following read-only variables are available to PDF component dialogs:

Variable Name	Format	Length	Service (Access)	Description
ZCUNIT	Char	8	none	Unit name to be used for temporary allocations. This variable comes from ISPF configuration table keyword PDF_DEFAULT_UNIT.
ZCUSIZE	Fixed	4	none	Number of kilobytes available for use by the edit UNDO command when running in SETUNDO STORAGE mode. This variable comes from ISPF configuration table Keyword UNDO_STORAGE_SIZE. See <i>z/OS ISPF Edit and Edit Macros</i> for further information.
ZICFPRT	Char	3	none	ICF indicator. 'YES' - All foreground print requests will be processed using ICF. 'NO' - ICF will not be used. This variable comes from ISPF configuration table keyword PRINT_USING_ICF.
ZPDFREL	Char	8	none	PDF version number in the form "PDF x.y ". The x.y is a sequence number. If x.y: <ul style="list-style-type: none"> • <= 4.2 means the x.y version.release of PDF • = 4.3 means ISPF for OS/390 Release 2 • = 4.4 means PDF 4.2.1 and ISPF OS/390 Release 3
ZSESS	Char	8	none	This variable contains either 'Y' or 'N' and comes from the ISPF configuration table keyword USE_SESSION_MANAGER. See the description of the general system variable ZSM for additional information.
ZSWIND	Char	4	none	Sliding window value used by PDF for determining the century of 2-character years. This variable comes from ISPF configuration table keyword YEAR_2000_SLIDING_RULE. Dates less than or equal to this value are 20xx. Dates greater than this value are 19xx.

Appendix E. System Variables

The system variables are described with type and pool information in the following tables. The variables are also discussed with the ISPF service to which they apply.

Commonly used system variables that a dialog can access are listed below. They are grouped by topic.

The first column gives the name of the variable. The second column indicates in which pool the variable resides. The following abbreviations are used:

func Function pool
shr Shared pool
prof Profile pool
any Any pool.

The third column indicates the variable's type. The following abbreviations are used:

in Input variable, set by a dialog to provide information to ISPF
out Output variable, set by ISPF to provide information to dialogs
non Non-modifiable output variable
i/o Both an input and an output variable.

The fourth column gives the length of the variable.

The fifth column gives a brief description of the variable.

Numeric system variables set by ISPF are right-justified and padded with zeros on the left, if necessary. If a program function uses the VCOPY service to access the variable, the value will be in character string format rather than in fixed binary format.

Configuration Utility

Name	Pool	Type	Len	Description
ZCFGCMPT	shr	non	10	Current Configuration module compile date. ZCFGCMPT contains the national language delimiter and contains the date in the format YYYY/MM/DD. For countries that use a delimiter other than a slash (/), that delimiter replaces the slash in the date representation.
ZCFGCMPT	shr	non	5	Current Configuration module compile time. ZCFGCMPT contains the national language delimiter and contains the time in the format HH:MM. For countries that use a delimiter other than a colon (:), that delimiter replaces the colon in the time representation. Note: This field will be blank for a configuration module compiled with a previous version of ISPF.
ZCFGKSR	shr	non	54	Keyword source data set and member for the current configuration module. Note: This field will be blank for a configuration module compiled with a previous version of ISPF.
ZCFGGLVL	shr	non	8	Current Configuration module level.
ZCFGMOD	shr	non	8	Current Configuration module name.

Time and Date

Name	Pool	Type	Len	Description
ZDATE	shr	non	8	Current date. The format of ZDATE depends on the current national language (see ZDATEF and ZDATEFD).
ZDATEF	shr	non	8	Current national language date format using the characters DD for day, MM for month, and YY for year. ZDATEF contains the national language delimiter. For example, DD/MM/YY, YY/MM/DD, MM.DD.YY. For countries that use a delimiter other than a slash (/), that delimiter replaces the slash in the date representation.
ZDATEFD	shr	non	8	The date format as described under ZDATEF but with the national language convention instead of DD, MM, and YY.
ZDATESTD	shr	non	8	Current date with a 4-digit year (YYYY/MM/DD). The format of ZDATESTD depends on the current national language (see ZDATEF and ZDATEFD).
ZDAYOFWK	shr	non	8	The name of the day of the week.
ZDAY	shr	non	2	Day of month (2 characters)
ZJDATE	shr	non	6	Day-of-year date (format yy.ddd)
ZJ4DATE	shr	non	8	Day-of-year date (format yyyy.ddd)
ZMONTH	shr	non	2	Month of year (2 characters)
ZSTDYEAR	shr	non	4	All 4 digits of the current year (4 characters).
ZTIME	shr	non	5	Time of day (format hh:mm)
ZTIMEL	shr	non		Time of day (format hh:mm:ss:TQ —where T is tenths of a second, and Q is hundredths)
ZYEAR	shr	non	2	Year (2 characters)

The current date is displayed in the appropriate format for the session language, where DD=DAY, MM=MONTH, and YY=YEAR. For countries that use a delimiter other than a slash (/), that delimiter replaces the slash in the date representation.

General

Name	Pool	Type	Len	Description
Z	shr	non	0	Null Variable
ZACCTNUM	shr	non	40	The MVS account number specified at logon time.
ZAPLCNT	shr	non	4	Number of times APL invoked for a logical screen
ZAPPLID	shr	non	8	Application identifier
ZAPPTTL	any	in	N/A	When running in GUI mode, the title to be displayed in the window frame. Note: If the panel is to be displayed in a pop-up window, the value specified in ZWINTTL will be used instead of ZAPPTTL.
ZBDMAX	shr	i/o	9	Maximum number of displays that can occur within a batch mode session. This value is obtained from the BDISPMAX keyword on the ISPSTART command. See "Avoiding Panel Loop Conditions in the Batch Environment" on page 38.
ZBDMXCNT	shr	non	9	Count of current number of displays in a batch mode session
ZCS	shr	non	5	NLS currency symbol
ZCSDLL	shr	non	8	File name of the DLL required for this level of code for the Client/Server
ZDECS	shr	non	1	NLS decimal separator character
ZDEL	shr	i/o	1	The delimiter is used to separate stacked commands. The default delimiter is a semicolon (;).
ZENTKTX	any	in	12	When you are running in GUI mode, the name that appears on the Enter key push button. If this variable is not found, "Enter" appears on the push button.
ZENVIR	shr	non	32	Environment description: <ul style="list-style-type: none"> Characters 1 to 8 contain the product name and sequence number, in the form ISPF x.y. The sequence number x.y indicates the following: <ul style="list-style-type: none"> 5.7 means ISPF for z/OS Version 1 Release 7.0 5.6 means ISPF for z/OS Version 1 Release 6.0 5.5 means ISPF for z/OS Version 1 Release 5.0 5.2 means ISPF for z/OS Version 1 Release 2.0 5.0 means ISPF for z/OS Version 1 Release 1.0 OR 5.0 means ISPF for OS/390 Version 2 Release 10.0 4.8 means ISPF for OS/390 Version 2 Release 8.0 Note: See also the system variables ZISPFOS and ZOS390RL. <ul style="list-style-type: none"> Characters 9 to 16 contain the generic operating system name (MVS). Characters 17 to 24 contain the operating system environment (TSO or BATCH). Characters 25 to 32 contain blanks and are reserved.
ZEURO	shr	non	1	The EURO currency symbol.
ZGUI	shr	non	68	Workstation address or name (in character format) if ISPSTART is issued with the GUI parameter or if specified on the Settings GUI invocation panel. ZGUI will be set to blank if ISPSTART is issued without the GUI parameter or if GUI is not invoked from the Settings panel.
ZISPFOS	shr	non	30	The level of ISPF code that is running as part of z/OS on your system. This level might or might not match the z/OS level found in ZOS390RL.
ZISPFRC	shr	in	8	Return code from ISPSTART-selected dialog to invoking application.

System Variables

Name	Pool	Type	Len	Description
ZKEYHELP	any	in	8	Keys help panel identifier. If a keys help panel is not specified on the referenced keylist, the application can provide the keys help panel name in this variable. If the help panel name is present as part of the referenced keylist definition, it takes precedence over the ZKEYHELP value. This system variable must be redefined each time the keys help panel is to change.
ZLANG	prof	non	8	Session language
ZLOGO	shr	non	3	Indicates whether the user has requested bypass of LOGO panel. NO indicates that the user has specified the NOLOGO keyword at the time ISPF was called, thus, requesting that the LOGO panel be bypassed. Otherwise, the value of the variable will be YES.
ZLOGON	shr	non	8	Stepname of TSO logon procedure
ZOS390RL	shr	non	16	Indicates the z/OS release running on your system.
ZPANELID	shr	non	8	The name of the currently displayed panel.
ZPFKEY	shr	non	4	The name of the PF key (PFxx) in effect when the user exits the panel. If ZPFKEY = PF00 then no PF key is in effect.
ZPLACE	prof	i/o	7	Command line placement (ASIS or BOTTOM)
ZPREFIX	shr	non	8	TSO user prefix
ZPROFAPP	prof	in	8	Name of application profile pool extension table
ZSCRCUR	shr	non	4	Displays the number of logical screens currently in use.
ZSCREENC	shr	non	5	Cursor position within the logical screen data.
ZSCREENI	shr	non	?	Logical screen data. Size depends upon your screen size.
ZSCRNAME	shr	in	8	Screen name set by dialog. The screen name is in effect only for the select level in which it was defined. Option 7.3 can alter ZSCRNAME, but this will have no impact. See "ZSCRNAME Examples" on page 390 for examples of its use.
ZSCRMAX	shr	non	4	Displays the number of logical screens allowed by the installation.
ZSCTPREF	shr	non	4	First site command table prefix
ZSCTPRE2	shr	non	4	Second site command table prefix
ZSCTPRE3	shr	non	4	Third site command table prefix
ZSCTSRCH	shr	non	1	Search order for site command tables relative to system command table. Set to either B (Before ISP) or A (After ISP).
ZSM	shr	i/o	3	Indicates whether session manager panels will be used for ISPF options 4 and 6. This variable is initialized from the ISPF configuration table keyword USE_SESSION_MANAGER at startup and stored in the shared variable pool. Once initialized it can only be changed with Option 0 - Settings or by use of the RESET_USE_SESSION_MANAGER configuration option.
ZSYSICON	shr	non	8	The 8-character variable that contains the command to be executed when the system icon is double-clicked or close is selected.
ZSYSID	shr	non	8	The 8-character SYSNAME obtained from the SYS1.PARMLIB member IEASYSxx which is read at IPL time. NONAME is the default value of SYSNAME. The operator can change this value at IPL time. See the z/OS <i>MVS Initialization and Tuning Reference</i> for more information.

Name	Pool	Type	Len	Description
ZSYSNODE	shr	non	12	<p>The network node name of your installation's JES. This name identifies the local JES in a network of systems or system complexes being used for network job entry (NJE) tasks. The node name returned in ZSYSNODE derives from the NODE initialization statement of JES.</p> <p>If the system finds that the subsystem is not active, the ZSYSNODE variable contains the string <code>-INACTIVE-</code> (note the string delimiters).</p> <p>If the system finds that the subsystem is neither JES2 4.3 or later, nor JES3 5.1.1 or later, the ZSYSNODE variable contains the string <code>'-DOWNLEVEL-'</code> (note the string delimiters).</p> <p>The value in ZSYSNODE remains the same throughout the ISPF session. Note: If, for instance, the JES subsystem is taken down during an ISPF session and the node name is changed, the value in ZSYSNODE will still contain the value as determined at ISPF initialization.</p>
ZSYSPLEX	shr	non	8	The MVS sysplex name as found in the COUPLExx or LOADxx member of SYS1.PARMLIB. If no sysplex name is specified in SYS1.PARMLIB, ZSYSPLEX contains blanks.
ZSYSPROC	shr	non	8	TSO Logon Procedure name. In foreground, will have the name of the current logon procedure; in batch, will have the value 'INIT'; a Started Task will have the Started Task procedure name.
ZTEMPF	shr	non	44	Name of temporary data set for file tailoring output
ZTEMPN	shr	non	8	DDNAME of temporary data set for file tailoring output
ZTERMCID	shr	non	5	CCSID coded character set identifier of the terminal. Set by ISPF based on the code page and character set of the terminal. If the terminal code page and character set cannot be queried or if they are not supported by ISPF, this variable will be blank.
ZTERMCP	shr	non	4	CECP support 4-digit code page. Note: ZTERMCS is defined as character length 4. It cannot handle 5-character Character Sets. For example, the Character Set 65535 is displayed in ZTERMCS as "5535". This does not mean that ISPF has defined Character Set 5535 (X'159F'). Two other Z variables, ZTERMCS5 and ZTERMCP5, for Character Set and Code Page respectively, were created to handle 5-character Character Sets and Code Pages. For example, the Character Set 65535 is displayed in ZTERMCP5 as 65535.
ZTERMCP5	shr	non	5	CECP support 5-digit code page
ZTERMCS5	shr	non	5	CECP support 5-character set
ZTERMCS	shr	non	4	CECP support 4-digit character set
ZTHS	shr	non	1	NLS thousands separator character
ZTS	shr	non	1	NLS time separator character
ZTSICMD	shr	non	32767	The entire initial invocation command string which invoked the ISPF environment. If storage cannot be obtained at startup, only the first 50 characters will be saved. The maximum length is 32767.
ZTSSCMD	shr	non	32767	SELECT portion of the initial invocation command. The maximum length is 32767.
ZUCTPREF	shr	non	4	First user command table name
ZUCTPRE2	shr	non	4	Second user command table name
ZUCTPRE3	shr	non	4	Third user command table name
ZUSER	shr	non	8	User ID
ZVERB	shr	out	8	Command verb after a SETVERB command table action

System Variables

Name	Pool	Type	Len	Description
ZWINTTL	any	in	N/A	Title to be displayed in pop-up window frame
ZWSCDPG	shr	non	4	When running in GUI mode, the code page of the workstation. When not running in GUI mode, value will be blank.
ZWSCON	shr	non	68	TCP/IP or APPC address when ISPF session is connected to a workstation.
ZWSOPSYS	shr	non	16	Operating system of workstation to which the session is connected. The first 10 characters are the operating system name, followed by a blank, followed by two 2-digit numbers separated by a blank. These numbers are returned to ISPF from the operating system and change by version and release.

ZSCRNAME Examples

Example 1

On the ISPF primary option panel the user issues the command SCRNAME POP. The primary option panel's screen name is now POP. The user then invokes CLIST1.

```
CLIST1
  PROC 0
  ISPEXEC DISPLAY PANEL(PANELA)
  SET &ZSCRNAME = EDIT1
  ISPEXEC VPUT (ZSCRNAME) SHARED
  ISPEXEC EDIT DATASET ('PROJECT.GROUP.TYPE(BBBBBB)')
  SET &ZSCRNAME = EDIT2
  ISPEXEC VPUT (ZSCRNAME) SHARED
  ISPEXEC EDIT DATASET ('PROJECT.GROUP.TYPE(CCCCCC)')
  SET &ZSCRNAME = BROWSE1
  ISPEXEC VPUT (ZSCRNAME) SHARED
  ISPEXEC BROWSE DATASET ('PROJECT.GROUP.TYPE(DDDDDD)')
  SET &ZSCRNAME = LASTPAN
  ISPEXEC VPUT (ZSCRNAME) SHARED
  ISPEXEC DISPLAY PANEL(PANELA)
```

After the CLIST processes, the following results occur:

1. PANELA displays with screen name POP.
2. The EDIT session displays with the screen name EDIT1.
3. The next EDIT session displays with the screen name EDIT2.
4. The BROWSE session displays with the screen name BROWSE1.
5. PANELA displays with the screen name LASTPAN.
6. End from PANELA and the primary option panel displays with screen name POP.

Example 2

On the ISPF primary option panel the user issues the command SCRNAME POP. The primary option panel's screen name is now POP. The user then invokes CLIST1 with the following results:

1. PANELA displays with screen name POP.
2. The EDIT session displays with the screen name EDIT1.
3. The user enters SCRNAME MYEDIT, so the screen name becomes MYEDIT.
4. After the EDIT session ends, the CLIST sets ZSCRNAME to EDIT2.
5. The EDIT session displays with the screen name EDIT2.
6. After this EDIT session ends, the CLIST sets ZSCRNAME to BROWSE1.

7. The BROWSE session displays with the screen name BROWSE1.
8. The user enters SCRNAME MYBROWSE PERM, so the screen name becomes MYBROWSE.
9. After the BROWSE session ends, the CLIST sets ZSCRNAME to LASTPAN.
10. PANELA displays with the screen name MYBROWSE. The CLIST command ZSCRNAME=LASTPAN is ignored because the user issued the SCRNAME MYBROWSE command with the PERM parameter.
11. The CLIST completes and the primary option panel displays with the screen name MYBROWSE (again because the user issued the SCRNAME MYBROWSE command with the PERM parameter).

Example 3

On the ISPF primary option panel the user issues the command SCRNAME POP. The primary option panel's screen name is now POP. The user then invokes CLIST2.

```
CLIST2
  PROC 0
  SET &ZSCRNAME = STATE
  ISPEXEC VPUT (ZSCRNAME) SHARED
  ISPEXEC SELECT PANEL(MENUA) SCRNAME(NATION)
  ISPEXEC DISPLAY PANEL(PANELA)
```

After the CLIST processes, the following results occur:

1. MENUA displays with screen name NATION.
2. PANELA displays with the screen name STATE.
3. End from PANELA and the primary option panel displays with screen name POP.

Terminal and Function Keys

Name	Pool	Type	Len	Description
ZCOLORS	shr	non	4	Number of colors supported by the terminal type (either 1 or 7)
ZDBCS	shr	non	3	DBCS terminal capability (YES or NO)
ZFKA	prof	non	8	Current state of the function key area form (LONG, SHORT, OFF (no display))
ZGE	shr	non	3	Terminal support for graphic escape order: <ul style="list-style-type: none"> • YES — graphic escape is supported • NO — graphic escape is not supported. Note: If you are running in GUI mode, ZGE will be set to Off.
ZHILITE	shr	non	3	Extended highlighting availability (YES or NO)
ZKEYS	prof	out	4	Number of Function keys
ZKLAPPL	shr	non	4	If KEYLIST is ON and it is a panel with the)PANEL statement, this contains the application id where the current keylist came from.
ZKLNAME	shr	non	8	If KEYLIST is ON and it is a panel with the)PANEL statement, this contains the name of the current keylist.
ZKLTYPE	shr	non	1	If KEYLIST is ON and it is a panel with the)PANEL statement, this contains either P (for Private) or S (for Shared) for the current keylist.
ZKLUSE	prof	i/o	1	If KEYLIST is ON this contains Y, if it is OFF, it contains an N.

System Variables

Name	Pool	Type	Len	Description
ZPFCTL	prof	i/o	5	User authorization to use PFSHOW command <ul style="list-style-type: none"> • USER—User controls function key display with PFSHOW command • ON—Display function key definitions on all panels • OFF—Do not display function key definitions
ZPFFMT	prof	i/o	4	Number of Function key definitions displayed per line <ul style="list-style-type: none"> • SIX—Always display six keys per line • MAX—Display as many keys as will fit on each line
ZPFSET	prof	i/o	4	Function key definition set displayed <ul style="list-style-type: none"> • PRI—Primary set (1–12) • ALT—Alternate set (13–24) • ALL—All keys (1–24)
ZPFSHOW	prof	out	4	PFSHOW command status
ZPFxx	prof	i/o	255	Setting for Function keys: ZPF13-ZPF24 contain settings for the primary keys (for 12-key terminals: physical keys 1-12; for 24-key terminals: physical keys 13-24) ZPF01-ZPF12 contain settings for the alternate keys (for 24-key terminals only: physical keys 1-12) The maximum length is 255.
ZPFLxx	prof	i/o	8	Setting for Function key labels: ZPFL13-ZPFL24 contain labels for the primary keys ZPFL01-ZPFL12 contain labels for the alternate keys
ZPRIKEYS	prof	i/o	4	Indicates the set of Function keys that will be the primary keys <ul style="list-style-type: none"> • LOW—1 to 12 are primary keys • UPP—13 to 24 are primary keys
ZSCREEN	shr	non	1	Logical screen number up to 32 screens (1–9, A–W)
ZSCREEND	shr	non	4	Screen depth available for dialog use. In batch mode, this variable is set by the value specified for BATSCRD on the ISPSTART call.
ZSCREENW	shr	non	4	Screen width available for dialog use. In batch mode this variable is set by the value specified for BATSCRW on the ISPSTART call. ZSCREEND and ZSCREENW are generally the dimensions of the physical display screen. There are two exceptions: <ol style="list-style-type: none"> 1. On a 3290, if a dialog is executing on a display with a width of 160 characters and the user does a vertical split, then ZSCREENW is 80. 2. On a 3278 model 5, if a user has specified SCREEN FORMAT IS STD, then ZSCREENW is 80 and ZSCREEND is 24, rather than the maximum physical size of 132 by 27.
ZSCRMAXD	shr	non	4	Maximum screen depth available for dialog use. In batch mode, this variable is set by the value specified for BATSCRD on the ISPSTART call.

Name	Pool	Type	Len	Description
ZSCRMAXW	shr	non	4	Maximum screen width available for dialog use. In batch mode, this variable is set by the value specified for BATSCRW on the ISPSTART call. ZSCRMAXD and ZSCRMAXW are identical to ZSCREEND and ZSCREENW, except for terminals on which an alternate size is available. In that case, ZSCRMAXD and ZSCRMAXW contain the screen configuration size that produces the largest screen. For the 3290, these variables contain sizes of the hardware partition on which ISPF is operating.
ZSPLIT	shr	non	3	Split-screen mode in effect (YES or NO)
ZTERM	prof	out	8	Terminal type as defined by option 0

Scrolling

Name	Pool	Type	Len	Description
ZAMT	prof	i/o	4	Scroll amount for functions such as Dialog Test, the Keylist Utility, the Command Table Utility, and the LIBDEF Utility
ZSCBR	prof	i/o	4	Scroll amount for the BROWSE service
ZSCED	prof	i/o	4	Scroll amount for the EDIT service
ZSCML	prof	i/o	4	Scroll amount for member lists
ZSCRML	shr	non	1	Specifies if ISPF should scroll to the first member selected in the member list after processing or disable the member list from automatic scrolling and instead place the cursor in front of the last member selected.
ZSCROLLA	shr	out	4	Value from scroll amount field (PAGE, MAX, number)
ZSCROLLD	any	in	4	Value to be used as default scroll value for scrollable dynamic areas and table display
ZSCROLLN	shr	out	4	Scroll number as computed from the value in the scroll amount field
ZXSMAX	shr	non	4	Maximum scroll amount allowed to be used in any scroll operation.
ZXSMIN	shr	non	4	Minimum scroll amount allowed to be used in any scroll operation.
ZUSC	prof	i/o	4	Scroll amount for the Data Set List Utility

PRINTG Command

Name	Pool	Type	Len	Description
ZASPECT	func	in	4	Aspect ratio of printed output from PRINTG
ZDEVNAM	func	in	8	Device name for PRINTG
ZFAMPRT	func	non	4	Family printer type for PRINTG

Table Display Service

Name	Pool	Type	Len	Description
ZTDADD	func	out	3	More rows needed to satisfy scroll request (YES NO)
ZTDAMT	func	out	4	Number of rows that the dialog should add to satisfy scroll
ZTDLROWS	func	in	6	Number of rows in the logical table (dynamic table expansion)

System Variables

Name	Pool	Type	Len	Description
ZTDLTOP	func	in	6	Maps current top row in physical table to its position in logical table.
ZTDMARK	any	in	See note	User-defined text for table display Bottom-of-Data marker Note: Value can be any length that is not more than the screen width.
ZTDMMSG	any	in	8	User-defined message ID for table display top-row-displayed indicator
ZTDRET	func	in	8	Defines whether dialog wants to use scroll return feature.
ZTDROWS	func	out	6	Number of table rows upon return from table display
ZTDSCRIP	func	in/out	6	CRP of top row to be displayed after the scroll
ZTDSELS	func	out	4	Number of selected table rows upon return from each table display
ZTDSIZE	func	out	4	Size (number of model sets) of the table display scrollable section
ZTDSRID	func	out	6	Rowid of the row pointed to by ZTDSCRIP
ZTDTOP	func	out	6	Row number (CRP) of top row displayed during most recent table display

LIST Service

Name	Pool	Type	Len	Description
ZLSTLPP	shr	non	4	Number of lines per page in list data set
ZLSTNUML	shr	non	4	Number of lines written to current list data set page
ZLSTTRUN	shr	non	4	List data set record length truncation value

LOG and LIST Data Sets

Name	Pool	Type	Len	Description
ZLOGNAME	shr	non	44	Contains the fully qualified data set name of the log data set.
ZLSTNAME	shr	non	44	Contains the fully qualified data set name of the list data set.

Dialog Error

Name	Pool	Type	Len	Description
ZERRALRM	func	out	3	Message alarm indicator (YES or NO)
ZERRHM	func	out	8	Name of help panel associated with error message
ZERRLM	func	out	512	Long error message text
ZERRMSG	func	out	8	Error message-id
ZERRSM	func	out	24	Short error message text
ZERRTYPE	func	out	8	Error message type
ZERRWIND	func	out	6	Error message window type

Tutorial Panels

Name	Description
ZCONT	Name of next continuation panel

Name	Description
ZHINDEX	Name of first index panel
ZHTOP	Name of top panel
ZIND	YES specifies an index page
ZUP	Name of parent panel

Selection Panels

Name	Description
ZCMD	Command input field
ZPARENT	Parent menu name (when in <i>explicit chain mode</i>)
ZPRIM	YES specifies panel is a primary option menu
ZSEL	Command input field truncated at first period

DTL Panels or Panels Containing a)PANEL Section

Name	Pool	Type	Len	Description
ZCURFLD	func	out	8	Name of field (or list column) containing the cursor when the user exits the panel.
ZCURINX	func	out	8	For table display panels, the current row number of the table row containing the cursor. The value ZCURINX is in character format. If the cursor is not within a table row, this value will be 0.
ZCURPOS	func	out	4	Position of the cursor within the field specified by ZCURFLD when the user exits the panel. The value in ZCURPOS is in character format. If the cursor is not within a field, ZCURPOS will contain a 1.

Note: These variables will contain the values that would result if they were set to `.CURSOR`, `.CSRPOS`, and `.CSRROW`, as the first statements in the panel's `)PROC` section.

System Variables

Appendix F. Accessibility

Accessibility features help a user who has a physical disability, such as restricted mobility or limited vision, to use software products successfully. The major accessibility features in z/OS enable users to:

- Use assistive technologies such as screen readers and screen magnifier software
- Operate specific or equivalent features using only the keyboard
- Customize display attributes such as color, contrast, and font size

Using assistive technologies

Assistive technology products, such as screen readers, function with the user interfaces found in z/OS. Consult the assistive technology documentation for specific information when using such products to access z/OS interfaces.

Keyboard navigation of the user interface

Users can access z/OS user interfaces using TSO/E or ISPF. Refer to *z/OS TSO/E Primer*, *z/OS TSO/E User's Guide*, and *z/OS ISPF User's Guide Vol I* for information about accessing TSO/E and ISPF interfaces. These guides describe how to use TSO/E and ISPF, including the use of keyboard shortcuts or function keys (PF keys). Each guide includes the default settings for the PF keys and explains how to modify their functions.

z/OS information

z/OS information is accessible using screen readers with the BookServer/Library Server versions of z/OS books in the Internet library at:

www.ibm.com/servers/eserver/zseries/zos/bkserv/

Notices

This information was developed for products and services offered in the USA.

IBM may not offer the products, services, or features discussed in this document in other countries. Consult your local IBM representative for information on the products and services currently available in your area. Any reference to an IBM product, program, or service is not intended to state or imply that only that IBM product, program, or service may be used. Any functionally equivalent product, program, or service that does not infringe any IBM intellectual property right may be used instead. However, it is the user's responsibility to evaluate and verify the operation of any non-IBM product, program, or service.

IBM may have patents or pending patent applications covering subject matter described in this document. The furnishing of this document does not give you any license to these patents. You can send license inquiries, in writing, to:

IBM Director of Licensing
IBM Corporation
North Castle Drive
Armonk, NY 10504-1785
USA

For license inquiries regarding double-byte (DBCS) information, contact the IBM Intellectual Property Department in your country or send inquiries, in writing, to:

IBM World Trade Asia Corporation
Licensing
2-31 Roppongi 3-chome, Minato-ku
Tokyo 106, Japan

The following paragraph does not apply to the United Kingdom or any other country where such provisions are inconsistent with local law:

INTERNATIONAL BUSINESS MACHINES CORPORATION PROVIDES THIS PUBLICATION "AS IS" WITHOUT WARRANTY OF ANY KIND, EITHER EXPRESS OR IMPLIED, INCLUDING, BUT NOT LIMITED TO, THE IMPLIED WARRANTIES OF NON-INFRINGEMENT, MERCHANTABILITY OR FITNESS FOR A PARTICULAR PURPOSE. Some states do not allow disclaimer of express or implied warranties in certain transactions, therefore, this statement may not apply to you.

This information could include technical inaccuracies or typographical errors. Changes are periodically made to the information herein; these changes will be incorporated in new editions of the publication. IBM may make improvements and/or changes in the product(s) and/or the program(s) described in this publication at any time without notice.

Any references in this information to non-IBM Web sites are provided for convenience only and do not in any manner serve as an endorsement of those Web sites. The materials at those Web sites are not part of the materials for this IBM product and use of those Web sites is at your own risk.

IBM may use or distribute any of the information you supply in any way it believes appropriate without incurring any obligation to you.

Licensees of this program who wish to have information about it for the purpose of enabling: (i) the exchange of information between independently created programs and other programs (including this one) and (ii) the mutual use of the information which has been exchanged, should contact:

IBM Corporation
Mail Station P300
2455 South Road
Poughkeepsie, NY 12601-5400
USA

Such information may be available, subject to appropriate terms and conditions, including in some cases, payment of a fee.

The licensed program described in this information and all licensed material available for it are provided by IBM under terms of the IBM Customer Agreement, IBM International Program License Agreement, or any equivalent agreement between us.

If you are viewing this information softcopy, the photographs and color illustrations may not appear.

This information contains examples of data and reports used in daily business operations. To illustrate them as completely as possible, the examples include the names of individuals, companies, brands, and products. All of these names are fictitious and any similarity to the names and addresses used by an actual business enterprise is entirely coincidental.

COPYRIGHT LICENSE:

This information contains sample application programs in source language, which illustrates programming techniques on various operating platforms. You may copy, modify, and distribute these sample programs in any form without payment to IBM, for the purposes of developing, using, marketing or distributing application programs conforming to the application programming interface for the operating platform for which the sample programs are written. These examples have not been thoroughly tested under all conditions. IBM, therefore, cannot guarantee or imply reliability, serviceability, or function of these programs. You may copy, modify, and distribute these sample programs in any form without payment to IBM for the purposes of developing, using, marketing, or distributing application programs conforming to IBM's application programming interfaces.

Programming Interface Information

This publication primarily documents information that is NOT intended to be used as Programming Interfaces of ISPF.

This publication also documents intended Programming Interfaces that allow the customer to write programs to obtain the services of ISPF. This information is identified where it occurs, either by an introductory statement to a chapter or section or by the following marking:

+-----Programming Interface information-----+

+-----End of Programming Interface information-----+

Trademarks

The following terms are trademarks of International Business Machines Corporation in the United States, other countries, or both:

AD/Cycle	GDDM
APL2	IBM
BookManager	Language Environment
BookMaster	MVS
C++/MVS	MVS/XA
COBOL/370	OS/390
Common User Access	RACF
CUA	SAA
DFSMSrmm	Systems Application Architecture
DFSMS/MVS	Tivoli
DFSORT	VTAM
FFST	z/OS

Microsoft, Windows, and Windows NT are trademarks of Microsoft Corporation in the United States, other countries, or both.

UNIX is a registered trademark of The Open Group in the United States and other countries.

Linux is a trademark of Linus Torvalds in the United States, other countries, or both.

Other company, product, and service names may be trademarks or service marks of others.

Index

Special characters

_ (underscore) character, default attribute 171
.ALARM control variable 281
.ATTR control variable
 considerations 284
 description 282
 override conditions 205
 using with table display panels 283
.ATTRCHAR control variable
 description of 283
 dynamic area override 145
 override conditions 205
.AUTOSEL control variable 285
.CCSID section of message
 definition 309
.CSRPOS control variable 285
.CSRROW control variable 286
.CURSOR control variable
 description 286
 example 281
 when not initialized or set to blank 287
.HELP control variable
 description 287, 297, 305
 example 281
.HHELP control variable
 description 288
.KANJI control variable in messages 305
.MSG control variable
 description 288
 in batch mode 37
 panel user exit messages 253
.NRET control variable 289
.PFKEY control variable 290
.RESP control variable
 description 290
 in batch mode 36
.TRAIL control variable
 description 291
 example 117, 236
.TYPE keyword, message definition 306
.WINDOW keyword, message
 definition 306
.ZVARS control variable
 description 291
 example 292
.ZVARS control variable, associating a PDC with a variable name in)ABCINIT 161
)ABC section of panel definition 157
)ABC section, defining pull-down choice 160
)ABCINIT section of panel
 definition 163
)ABCPROC section of panel
 definition 164
)AREA section of panel definition 164
)ATTR section of panel definition 170
)BLANK file-tailoring control
 statement 317, 318

)BODY section of panel definition 207
)BODY statement, WINDOW
 keyword 110
)CCSID section of panel definition 213
)CM file-tailoring control statement 319
)DEFAULT skeleton control
 statement 319
)DO file-tailoring control statement 320
)DOT file-tailoring control statement 322
)ELSE file-tailoring control
 statement 323
)END section of panel definition 213
)END statement, required on panel
 definition 111
)ENDDO file-tailoring control
 statement 320
)ENDDOT file-tailoring control
 statement 322
)ENDSEL file-tailoring control
 statement 324
)FIELD section of panel definition 214
)HELP section of panel definition 220
)IF file-tailoring control statement 323
)IM file-tailoring control statement 324
)INIT section of panel definition 221
)ITERATE file-tailoring control
 statement 324
)LEAVE file-tailoring control
 statement 324
)LIST section of panel definition 222
)MODEL section of panel definition 223
)N comment statement 318
)NOP file-tailoring control statement 324
)PANEL statement KEYLIST
 parameter 223
)PNTS statement 227
)PROC section of panel definition 231
)REINIT section of panel definition 231
)SEL file-tailoring control statement 324
)SET file-tailoring control statement 325
)TB file-tailoring control statement 325
)TBA file-tailoring control statement 325
*REXX panel statement 256
 SOURCELINE function 257
" (quotation marks), enclosing
 literals 113
% sign
 beginning a command procedure
 name with 12
 default attribute character 171
÷> operator on the IF statement 245
÷< operator on the IF statement 245
÷= operator on the IF statement 245
> (greater than) operator on the IF
 statement 245
>= operator on the IF statement 245
< operator on the IF statement 245
<= operator on the IF statement 245
+ sign
 continuation character for literals 113
 default attribute character 171

= (equal sign) operator on the IF
 statement 245

Numerics

3278 Mod 5
 batch mode 36
 graphics interface mode 149
3290
 batch mode 37
 graphics interface mode 149
908 error return code 22
920 error return code 22
985 error return code 22
987 error return code 22
988 error return code 22
989 error return code 22
990 error return code 22
997 error return code 22
998 error return code 22
999 error return code 23

A

A, used to specify alternate tabbing 326
ABCINIT section of panel definition 163
ABCPROC section of panel
 definition 164
abend
 description 25
 diagnostic panels 366
ABEND
 codes 367
 accelerators 100
 accessibility 397
 accessing table data 70
action bar choice initialization panel
 definition section
 definition 163
action bar choice processing section of
 panel definition
 definition 164
action bar choice section of panel
 definition
 definition 157
action bars and pull-down choices 90
activities
 nesting xviii
ADDDPOP parameter on ISPSTART
 command 11
ADDDPOP service 89, 90
address, APPC 97
address, TCP/IP 97
ADDSOSI built-in function on assignment
 statement 240
alarm indicator message 394
ALARM keyword, message
 definition 306
ALPHA parameter on VER
 statement 267

- ALPHAB parameter on VER
 - Statement 268
- alternate tabbing 326
- APL keyboard character translations 343
- APL2
 - multiple calls of 31
 - number of times invoked, system variable containing 387
 - using 29
 - workspace used as the function pool 32
- APPC address
 - definition 97
- application identifier, system variable 387
- application keylist 89
- application profile pool 60, 65
- application profile pool extension name, system variable 388
- application-id parameter on ISPSTART 11, 16
- area section of panel definition
 - definition 164
- AREA(DYNAMIC) parameter in)ATTR section 173
- AREA(SCRL) parameter in)ATTR section 178
- array of variable lengths on panel user exit parameter 252
- array of variable names on panel user exit parameter 252
- ASIS parameter
 - in)BODY header statement 209
 - on VGET panel statement 277
 - on VPUT panel statement 279
 - on VPUT statement 277
 - with JUST keyword 187
- aspect ratio system variable for PRINTG 393
- assignment statement in panel
 - definition 235
- attention exits (CLIST) 27
- ATTN keyword in)ATTR section 178
- ATTN statement 27
- attribute characters
 - default 171
 - restriction 172
- attribute section of panel definition
 - basic attribute types 198
 - CUA attribute types 201
 - default characters 171
 - definition 170
 - other attribute types 203
 - requirements for table display panel 136
- authorized programs, invoking 26
- authorized TSO commands, invoking 26
- AUTOSEL (.AUTOSEL) control variable 285
- AUTOSEL (auto-selection) 132
- autoskip
 - description 197
 - graphic area 149

B

- BACK tutorial command 297
- background display execution 35
- background panel processing 35
- BARRIER keyword 116
- batch display facility, using 35
- batch environment
 - avoiding loops in batch 38
 - display error processing 37
 - log and list data sets 38
 - maximum number of panel displays 38
 - processing commands 37
 - terminal characteristics 36
 - TSO 33
- batch execution
 - description 33
 - TSO error processing 35
 - TSO sample job 34
- BATSCRD keyword on ISPSTART command 11, 36
- BATSCRW keyword on ISPSTART command 11, 36
- BDBCS keyword on ISPSTART command 11, 37
- BDISPMAX keyword
 - and ZBDMAX system variable 387
 - on ISPSTART command 11, 38
- BIT parameter on VER statement 268
- BKGRND keyword on ISPSTART command 11
- BKGRND parameter on ISPSTART 15
- BLANK file-tailoring control statement 318
- blinking, specifying for HILITE keyword 186
- body section of panel definition
 - controlling width of panel 207
 - defining 207
 - definition 207
 - formatting message field 209
 - requirements 136
 - requirements for table display panel 136
 - sample 211
- Boolean operators on the IF statement 247
- bottom-of-data marker
 - definition 132
 - system variable containing for table display, user defined 394
- BREDIMAX keyword on ISPSTART command 11, 37
- BRIF service 85
- BROWSE service 84
- browse service scroll amount, system variable 393
- browse services panel definition, scroll field location 106

C

- call of ISPF 9, 10
- CAPS keyword in panel)ATTR section 136, 172, 179

- CCSID parameter of the GETMSG service 330
- CCSID section of message definition
 - messages tagged 309
- CCSID section of panel definition
 - definition 213
 - extended code page support 330
- chain mode, explicit 119
- char parameter
 - with PAD keyword 191
 - with PADC keyword 192
 - with PAS keyword 193
- character compare on IF statement 246
- character level attribute 146
- character translations for APL, TEXT and Katakana keyboards 343
- CHINESES keyword on ISPSTART command 11, 17
- CHINESET keyword on ISPSTART command 11, 17
- CKBOX keyword in panel)ATTR section 179
- CLEAR keyword on)MODEL statement in table display panel 137
- CLIST
 - attention exits 27
 - invoking procedure from ISPSTART command 17
 - variables used in procedure 8
- CM file-tailoring control statement 319
- CMD
 - keyword
 - in)PROC section 116
 - in panel)BODY section 209
 - parameter on ISPSTART command 11
- code page parameter for ISPSTART 15
- coded character set identifier, system variable 389
- CODEPAGE 15
- COLOR keyword in panel)ATTR section 180
- Combination boxes 100
- COMBO keyword in panel)ATTR section 181
- command field
 - naming of 106
 - naming with the CMD keyword 209
 - panel)BODY section 207
 - position in panel definition 106
- command field of a table display panel 132
- command line placement, system variable 388
- COMMAND parameter, in panel)PROC section 116
- command procedure 61
- command tables
 - and application IDs 16
 - definition of 2
 - ISPCMDs system command table 2
- command verb after a SETVERB
 - command table action, system variable 389
- commands
 - ISPF, in batch environment 36
 - nesting xviii

- commands (*continued*)
 - processing in batch environment 37
- comment statements 112
- comments, optional display 187
- Common User Access (CUA)
 - description of ISPF support 89
 - dot leaders 108
 - keyword values 202
- compare character vs. numeric 246
- compiled REXX 27, 250
- COMPOUND variables 8
- concatenation of variables 113
- conditional padding of panel field 172
- conditional substitution string 317
- configuration utility (system variables) 386
- CONT system variable on tutorial panels 298
- continuation character for literals 113
- continuation panel 299
- control characters
 - in skeleton definition 315
- control characters in skeleton definition 317
- CONTROL NONDISPL in batch mode 36
- CONTROL service 86
- control variables
 - example 281
 - in panels 279
 - initialization 280
 - list of 279
 - when reset 280
- conversion utility 89
- CRASH 25
- creating action bars 162
- creating panel display dialog elements 5
- CRP of top row displayed in most recent table display, system variable 394
- CSRGRP(x) keyword in panel)ATTR section 182
- CSRPOS (.CSRPOS) control variable 285
- CUA guidelines, dot leaders 108
- CUADYN 200
- CUADYN keyword in panel)ATTR section 182
- cursor placement, default 287
- cursor position
 - system variable 388

D

- DANISH keyword on ISPSTART
 - command 11, 17
- data records in skeleton definition 315
 - control characters 317
- DATAMOD keyword in)ATTR section of dynamic panels 174
- date and time information (system variables) 386
- DBCS
 - batch mode 37
 - command and message fields 208
 - data validation 114
 - parameter on VER statement 268
 - replacement characters 196
 - specifying format 185

- DBCS (*continued*)
 - specifying search argument format for table services 81
 - system variable containing terminal capability 391
 - variables
 - in messages and file skeletons 150
 - on panel definitions 313, 328
 - verifying string length (VER LEN) 272
- DDL file name
 - system variable 387
- DDLIST keyword in panel)ATTR section 182
- ddname of file tailoring temporary file, system variable 389
- debug tools 349
- DEFAULT
 - attribute or body section statement 171
 - skeleton control statement 319
- default attribute characters 171
- default keylist for DTL Help Panels 296
- defining messages 303
- delimiter
 - system variable 387
- delimiters in verified variable 269
- DELSOSI built-in function on assignment statement 240
- DEPTH keyword in panel)ATTR section 185
- determining table size 72
- device name system variable for PRINTG 393
- diagnosing ISPF abends 366
- dialog
 - beginning with menu or function 6, 10
 - call by using application master menu 18
 - control 5
 - definition 1
 - development of 4
 - elements 1
 - example 73
 - function, languages used for
 - coding 2
 - initiation 19
 - organization 5
 - return codes 21
 - running of 10
 - scope 20
 - termination 21
 - variables 7
 - writing
 - using display services 41
 - using file-tailoring services 81
 - using miscellaneous services 86
 - using PDF services 84
 - using table services 69
 - using variable services 59
- dialog elements
 - description 4, 5
 - test of 4
- dialog function 1
 - creation of 4

- dialog function (*continued*)
 - description of 2
 - dialog, languages used for coding 2
 - example 73
 - function pools 61
 - naming 12
 - scope 20
- Dialog Tag Language (DTL) 89
- dialog variables
 - format of 67
 - ISPPRXVP processor 257
 - processing with panel REXX 256
- dialog variables, list of 379
- directive lines, optional display 187
- disability 397
- display error processing in the batch environment 37
- display message variations 308
- display services
 - DBCS-related variables 150, 313, 328
 - in batch mode 35
- displaying a pop-up window 90
- DO
 - file-tailoring control statement 320
- DOT file-tailoring control statement 322
- Drop-down List 100
- DSNAME parameter on VER statement 268
- DSNAMEF parameter on VER statement 268
- DSNAMEFM parameter on VER statement 268
- DSNAMEPQ parameter on VER statement 268
- DSNAMEEQ parameter on VER statement 269
- DUMP keyword on ENVIRON
 - command 365
- dynamic area
 - character level attribute support 146
 - formatting panels 143
- dynamic table expansion 45, 133

E

- EBCDIC
 - parameter on VER statement 269
 - specifying format 185
- EDIF service 85
- EDIREC service 85
- EDIT service 84
- edit service panel definition, specifying location of scroll field 106
- edit service scroll amount, system variable 393
- EDREC service 84
- elements of a dialog 1
- ELSE file-tailoring control statement 323
- ELSE statement in panel sections 244
- ENBLDUMP parameter on ENVIRON
 - command 361
- end of displayed data specification 132
- END section of panel definition
 - definition 213
- ENDDO file-tailoring control statement 320

ENDDOT file-tailoring control statement 322
 ENDSEL file-tailoring control statement 324
 ENGLISH keyword on ISPSTART command 11, 17
 Enter Key, in GUI mode 101
 entry point address on diagnostic panel 366
 ENUM parameter on VER statement 269
 ENVIRON system command 360
 environment 1
 environment description, system variable 387
 EQ operator on the IF statement 245
 error conditions for panel user exit 253
 ERROR keyword on ENVIRON command 364
 error message-id, system variable 394
 error panel 37
 error processing
 SYSVRT file 21
 TSO batch execution 35
 when put into effect 21
 error recovery panel at abend 366
 error return codes from dialog to invoking application 22
 ESTAE restrictions 33
 executable section of a dialog 221, 231
 executing APL2 functions 31
 EXHELP 93, 293
 exit data on panel user exit parameter 252
 EXIT keyword in)PROC section 116, 118, 120
 EXIT statement
 panel REXX 258
 EXIT statements 242
 exits, CLIST attention 27
 EXPAND keyword in panel)BODY section 207
 expected-length operand (on VER LEN) 272
 explicit chain mode 119
 EXTEND parameter
 in)ATTR section 173, 178
 in graphic areas 175
 Extended Code Page Support
 base code pages 336
 CCSIDs supported 333
 description 329
 ISPF-provided translate tables 338
 messages tagged 330
 panels tagged 330
 translate load modules 330
 Z variables 329
 Extended Code Page Translate Tables
 Provided by ISPF 338
 extended help 93, 293
 extended highlighting availability, system variable 391

F

FI: parameter for GUI mode 98

FIELD keyword
 in panel)FIELD section 214
 field section of panel definition definition 214
 field-level help 93, 220, 293
 field-type specification in panel)ATTR section 197
 file tailoring temporary file name, system variable 389
 file-tailoring services
 example 83
 skeleton files 82
 writing dialogs 81
 file-tailoring skeleton
 control statement considerations 318
 data record considerations 82, 317
 DBCS considerations 328
 debugging 355
 defining 315
 definition 3
 sample 327
 trace command (ISPFTRC) 355
 FILEID parameter on VER statement 270
 fixed portion of a TBDISPL display 133
 FORMAT keyword
 in panel)ATTR section 172, 185
 in panel)BODY section 207
 formatting guidelines for panels 223
 FRAME parameter on ISPSTART 15
 FRENCH keyword on ISPSTART command 11, 17
 function commands, definition 136
 Function key set displayed, system variable 392
 Function key settings, system variables 392
 Function keys, system variable containing number of 391
 function pool 60, 61
 function, definition 1

G

GDDM
 in batch environment 36
 interface to 148
 GDDM service 86
 GE keyword
 in panel)ATTR section 186
 GE operator on the IF statement 245
 GERMAN keyword on ISPSTART command 11, 17
 GETMSG service 87
 GIF 223
 GOTO statement in panel section 242, 244
 graphic area, panel definition 175
 graphical user interface
 batch mode 38
 Group Boxes 100
 GRPBOX 203
 GT operator on the IF statement 245
 GUI in batch mode 38
 GUI parameter on ISPSTART 11, 14, 97
 GUISCRD 15
 GUISCRD parameter on ISPSTART 11

GUISCRW 14
 GUISCRW parameter on ISPSTART 11

H

help
 extended 93, 293
 field-level 93, 293
 help for help 293
 keys 93, 293
 message 293, 294
 panel 293, 294
 reference phrase 94, 294
 TUTOR command 294
 tutorial 294
 help for help command 293
 help panel
 See also tutorial
 name associated with error message 394
 system variable containing name associated with error message 395
 with scrollable areas 167
 help section of panel definition definition 220
 HELP system command
 entry to tutorial 297
 on ABEND panels 367
 HEX parameter on VER statement 271
 HIGH parameter with INTENS keyword 187
 HILITE keyword in panel)ATTR section 186

I

IDATE parameter on VER statement 271
 IF file-tailoring control statement 323
 IF statement
 basic IF 245
 with Boolean operators 247
 with VER constructs 246
 IM file-tailoring control statement 324
 IMAGE keyword 224
 Images, in a GUI display 101
 IN parameter used with CAPS keyword 179
 INCLUDE parameter on VER Statement 271
 IND keyword
 in panel)FIELD section 215
 index page, specifying for tutorials 299
 INDEX tutorial command 297
 initialization of control variables 280
 initialization section of panel definition definition 221
 requirements for table display 139
 initiating dialog execution 19
 INPUT parameter used with TYPE keyword 198
 INTENS keyword in panel)ATTR section 172
 interpreted REXX 250
 invoking
 authorized commands 26
 authorized programs 26

- invoking (*continued*)
 - authorized TSO commands 26
 - TSO commands 26
- invoking a dialog
 - from a selection panel 18
 - from the ISPF master application menu 18
 - the ISPSTART command 17
- IP address 14
- ISP@MSTR, ISPF Master Application Menu 119
- ISP@PRIM on the ISPF Primary Option Menu 125
- ISPCMDS system command table 2
- ISPDPTRC (panel trace command) 349
- ISPF
 - command 26
 - Common User Access support 89
 - default keylist 296
 - EDIF service 32
 - help panels 293
 - interface with APL2 32
 - overview 4
 - tutorial panels 293
 - variables 66
- ISPF Client/Server Component
 - dialog developer's details
 - action bars 99
 - APL/TEXT character sets 101
 - check boxes 100
 - closing a window 100
 - cursor placement 101
 - displaying application in GUI mode 97
 - function keys 100
 - long messages 100
 - pull-down menus 99
 - short messages 100
 - title bars 99
 - Restrictions
 - 3290 partition mode 102
 - character-level color, intensity, and highlighting 101
 - cursor placement 101
 - field-level intensity and highlighting 101
 - graphic areas 101
 - OUTLINE attribute 102
 - pop-up window and message pop-up positioning 102
 - SKIP attribute 102
- ISPF conversion utility 89
- ISPF dialog variables
 - panel REXX 258
- ISPF Services in Batch Mode 33
- ISPFTRC (file tailoring trace command) 355
- ISPPREP preprocessed panel routine
 - batch environment 37
 - error conditions 155
 - examples 154
 - restrictions 152
 - return codes 155
 - using 150
- ISPPRXVP dialog variable processor 257
- ISPREXPX 253

- ISPSTART command
 - description 9, 10
 - example 10
 - syntax 10
 - TSO 26
- ISPTTDEF, using to specify translate tables 347
- ISPTUTOR 297
- ISRABEND debug tool 349
- ISRCSECT debug tool 349
- ISRFIND debug tool 349
- ISRPOINT debug tool 349
- ISRROUTE command 162
- ISRTCB debug tool 349
- ISRTTEST debug tool 349
- ISRVCALP panel REXX example 264
- ITALIAN keyword on ISPSTART command 11, 17
- ITERATE file-tailoring control statement 324
- ITIME parameter on VER statement 271

J

- JAPANESE keyword on ISPSTART command 11, 17
- JDATE parameter on VER statement 272
- JSTD parameter on VER statement 272
- jump function xviii
- JUST keyword in panel)ATTR section 136, 172, 187
- justifying a panel field 187

K

- KANA keyword
 - extended code page support 332
 - on panel)BODY section 207, 343
- Katakana
 - keyboard character translations 343
 - terminal displaying messages 305
- key assignment 89
- keyboard 397
- keylist
 - application 89
 - system 89
- keylist defaults for DTL Help Panels 296
- KEYLIST parameter on)PANEL statement 223
- keylist utility 110
- keys 296
- keys help 93, 293
- KEYS system command, batch environment 37
- KEYSHELP 93, 293
- KOREAN keyword on ISPSTART command 11, 17

L

- LANG(APL) parameter
 - in panel)PROC section 116
 - on ISPSTART command 11
- languages used for coding functions 2
- last visible line function (LVLIN) 239

- LCOL keyword
 - in panel)FIELD section 216
- LE operator on the IF statement 245
- leading blanks in verified variable 269
- LEAVE file-tailoring control statement 324
- LEFT parameter used with JUST keyword 187
- LEN keyword
 - in panel)FIELD section 214
- LEN keyword on VER statement 272
- LENGTH built-in function on assignment statement 239
- LIBDEF service 87
- library access services 85
- light pen, using to select a field 178
- LIND keyword
 - in panel)FIELD section 215
- line display mode, automatic and nonautomatic entry into line mode 12
- list boxes 100
- list data set in a batch environment 38
- LIST parameter on VER statement 273
- list section of panel definition
 - definition 222
- LIST service 87
- LISTBOX keyword in panel)ATTR section 188
- LISTV parameter on VER Statement 273
- LISTVX parameter on VER Statement 274
- LISTX parameter on VER Statement 274
- LMSG parameter on panel)BODY section 209
- loading a panel user exit routine 250
- loading a REXX panel exit 250
- log data set
 - batch messages 37
 - in batch environment 38
- LOG service 87
- logical screens
 - system variable 388
- logical screens, maximum
 - system variable 388
- LOGO parameter on ISPSTART command 16
- LOGOFF command 26
- LOGON command 26
- long error message text, system variable 394
- LookAt message retrieval tool xi
- loops, avoiding in batch 38
- LOW parameter used with INTENS keyword 187
- LT operator on the IF statement 245
- LVLIN built-in function on assignment statement 239

M

- master application menu
 - example of definition 119
 - example of display 18
- member lists scroll position, system variable 393
- member lists, scrolling 393

- menu
 - definition of primary option 118
 - entry to tutorial 297
 - example of a master application menu 119
 - example of primary option 131
 - special definition requirements 114, 115
 - use of ZPARENT to set next display 119
- message alarm indicator 394
- message definition
 - DBCS considerations 313, 328
 - description of 3
 - example of short and long 304
 - Katakana considerations 305
 - message ID 304
 - processing 303
 - syntax 304, 312
- message field location 105
- message fields in panel)BODY section 207
- message help 293, 294, 305
- message ID on panel user exit parameter 252
- message library
 - description of 303
 - example 304
- message retrieval tool, LookAt xi
- message text
 - long error 394
 - short error 394
 - system variable containing 394
- message-id, system variable containing error 394
- messages
 - display variations 308
 - in batch environment 37
- miscellaneous services, used in writing dialogs 86
- MIX parameter on VER statement 274
- mixed characters, specifying format 185
- mnemonics, in a GUI session 100
- MODE keyword 116, 117
- model lines
 - definition of 133
 - specified in a variable 138
- model section of panel definition
 - definition 223
 - requirements for table display panel 137
- model sets
 - description of 133
 - example 43
- modeless message pop-ups 310
- module name on diagnostic panel 366
- movable pop-ups
 - manual movement 92
 - WINDOW command 91
- MSG=value parameter on assignment statement 236
- msgid keyword 304

N

- NAME parameter on VER statement 274

- named variables 254
- NAMEF parameter on VER statement 274
- naming defined and implicit variables 63
- naming restrictions for dialog functions 13
- NB parameter on VER statement 267
- NE operator on the IF statement 245
- negative number indicators 269
- NEST keyword 116
- nested CLISTS, attention exits 28
- nested commands xviii
- NEWAPPL, (application-id) parameter 11, 116
- NEWPOOL parameter in)PROC section 116
- NG operator on the IF statement 245
- NL operator on the IF statement 245
- NLS
 - common characters 329
 - GETMSG service 330
 - messages tagged with CCSID 309
 - TRANS service 330
- NOCHECK parameter
 - example 117
 - in)PROC section 116
- NOJUMP keyword in panel)ATTR section 190
- NOKANA keyword in message definition 305
- NOLOGO parameter on ISPSTART command 16
- NON parameter used with INTENS keyword 187
- NONBLANK parameter on VER statement 267
- NOP file-tailoring control statement 324
- Notices 399
- null system variable 387
- NULLS parameter used with PAD keyword 191
- NUM parameter on VER statement 274
- number of colors supported by the terminal type, system variable 391
- number of Function keys, system variable 391
- number of variables on panel user exit parameter 252
- numeric (extended) verification 269
- numeric compare on IF statement 246
- NUMERIC keyword in panel)ATTR section 190
- Numeric Lock feature (with NUMERIC attribute keyword) 190

O

- OFF parameter
 - with ATTN keyword 178
 - with CAPS keyword 179
 - with NOJUMP keyword 190
 - with NUMERIC keyword 191
 - with SKIP keyword 197
- ON parameter
 - with ATTN keyword 178
 - with CAPS keyword 179

- ON parameter (*continued*)
 - with NOJUMP keyword 190
 - with NUMERIC keyword 191
 - with SKIP keyword 197
- ONEBYTE built-in function on assignment statement 240
- online tutorial 297
- OPT system variable 115
- OPT(option) parameter on ISPSTART command 11
- OUT parameter used with CAPS keyword 179
- OUTLINE keyword
 - in panel)ATTR section 171, 172, 191
 - in panel)BODY section 207, 211
- OUTPUT parameter used with TYPE keyword 198

P

- PAD keyword in panel)ATTR section 172, 191
- PADC keyword in panel)ATTR section 192
- panel definition 104
 -)PNTS statement 227
 - attribute section
 - default characters 171
 - blanks 112
 - body section
 - sample 211
 - command field
 - description 105
 - specifying 207
 - comment statement 112
 - creation of 5
 - description 104, 105
 - design suggestions 107
 - dynamic areas 200
 - graphic areas 175
 - GUI considerations 137, 150
 - help and tutorial panels 297
 - initialization section
 - statement formats 234
 - line 1 content 105
 - line 2 content 106
 - line 3 content 106
 - location 105
 - menus 115
 - model section 137
 - panel title, location 105
 - reinitialization section
 - statement formats 234
 - restrictions 111
 - sections 104
 - short message for TBDISPL operations 106
 - size 110
 - special requirements 114
 - specifying a message field 209
 - split-screen consideration 107
 - syntax rules 111
 - table display 131
 - tutorial and help panels 297
 - using)PANEL 223
- panel help 293, 294

- panel name on panel user exit
 - parameter 252
- PANEL parameter
 - in)PROC section 116
 - on ISPSTART command 11
- panel redisplay 232
- panel REXX 256
 - EXIT statement 258
 - ISPF dialog variables 258
 - ISRVCALP example panel 264
 - SOURCELINE function 257
- panel section of panel definition
 - formatting panel 223
- panel section on panel user exit
 - parameter 252
- panel trace command (ISPDPTRC) 349
- panel user exit routine
 - description 248
 - how to invoke 251
 - how to load 250
 - parameters passed 252
 - return codes 253
- panels
 - debug/trace 349
 - preprocessed 150
 - vertically scrollable 111
- PANEXIT statement 248
- PARM
 - keyword
 - in)PROC section 116
 - on preprocessed panels 151
 - parameter on ISPSTART
 - command 11
- parts of a dialog 1
- PAS keyword in panel)ATTR
 - section 193
- passing control from program-coded to
 - command-coded function 6
- PDF command 26
- PDF service
 - library access 85
 - writing dialogs 84
- pending END request 133
- pending scroll request 133
- pending selected rows 134
- percent (%) sign, beginning a command
 - procedure name with 12
- PF key, system variable 388
- PFK built-in function on assignment
 - statement 238
- PGM keyword in)PROC section 116
- PGM parameter on ISPSTART
 - command 11
- PICT parameter on VER statement 274
- PICTCN parameter on VER
 - statement 275
- PNTS section of panel definition 227
- Point-and-shoot section of panel
 - definition 227
- pools, variable
 - application profile 60
 - function 60
 - shared 60
- pop-up window
 - ADDPop service 90
 - movable 91
 - processing considerations 150

- pop-up window (*continued*)
 - size 207
- PORTUGUESE keyword on ISPSTART
 - command 11, 17
- POSITION, TBDISPL parameter 134
- PQUERY
 - in batch environment 36
 - used with dynamic area 145
- PQUERY service 87
- prefix system variable 388
- preprocessed panels
 - creating (ISPPREP) 151
 - definition 150
 - ISPPREP call 152
 - PARM keyword 151
 - SELECT service 151
- Primary Option Menu 118
- printer family type for PRINTG 393
- processing section of panel definition
 - definition 231
 - requirements for table display 139
- PROFILE parameter
 - on VGET panel statement 278
 - on VPUT panel statement 277, 279
- program status word on diagnostic
 - panel 366
- program-name parameter
 - in panel)PROC section 116
 - on ISPSTART command 11
- protecting table resources 71
- PSW on diagnostic panel 366
- pull-down choice, defining within the
 -)ABC section 160
- pushbuttons 227
- pushbuttons, large 227

Q

- QUERY parameter on the ENVIRON
 - command 366
- quotation mark, enclosing literals 113
- quote mark, enclosing literals 113

R

- radio buttons 101
- RADIO keyword in panel)ATTR
 - section 194
- RANGE parameter on VER
 - statement 276
- RCOL keyword
 - in panel)FIELD section 216
- read-only profile pool extension
 - variables 65
- reason code on diagnostic panel 366
- recovery termination manager at
 - abend 368
- redisplay of a panel 232
- reference phrase help 94, 294
- REFRESH statement in panel
 - sections 255
- register content at abend on diagnostic
 - panel 366
- reinitialization section of panel definition
 - definition 231
 - requirements for table display 139

- relational operators (on VER LEN) 272
- removing a pop-up window 90
- removing variables from the shared or
 - profile pool 65
- REMPop service 89, 90
- REP keyword in panel)ATTR
 - section 172, 196
- replacement characters 196
- reset of control variables 280
- return codes
 - for panel user exit routine 253
 - from terminating dialog 21
- return to function when scrolling 45
- REVERSE parameter used with HILITE
 - keyword 186
- reverse video, specifying 186
- REXX panel exit
 - how to load 250
- REXX panel statement 256
 - SOURCELINE function 257
- REXX variables 258
- RIGHT parameter used with JUST
 - keyword 187
- RIND keyword
 - in panel)FIELD section 215
- ROWS keyword on)MODEL statement in
 - table display panel 137
- rows of a table, adding dynamically 45,
 - 49
- running a dialog 10

S

- SCALE keyword
 - in panel)FIELD section 216
- scope of a function 20
- screen
 - logical number of 392
 - system variable containing 392
- screen depth and width available for use
 - by a dialog
 - system variable containing 393
 - by a dialog, system variable 392
- screen depth on ISPSTART command for
 - batch 11
- screen depth parameter for
 - ISPSTART 15
- screen name
 - system variable 388
- screen width for batch mode on
 - ISPSTART command 11
- screen width parameter for
 - ISPSTART 14
- scroll amount
 - field of a TBDISPL display, definition
 - of 134
 - for browse service, system variable
 - containing 393
 - for edit service, system variable
 - containing 393
 - for member lists, system variable
 - containing 393
 - location 105
 - maximum for member lists 393
 - minimum for member lists 393
 - number of lines or columns 393

scroll amount (*continued*)
 system variable containing 393
 system variable containing field value 393
 value default for dynamic areas and table display 393

SCROLL keyword
 in panel)FIELD section 217

SCROLL parameter in)ATTR section 174

scroll position
 for member lists, system variable containing 393

scrollable areas
 definition, section of panel 164
 in the)BODY section 178
 vertically scrollable panels 111
 with help panel 167

scrollable portion of a TBDISPL display 134

scrolling, expanding displayed table 46

SDWA reason code at abend 367

searching variable pools 60

SEL
 file-tailoring control statement 324
 system variable 115, 298

select field of a TBDISPL display 134

SELECT service 60
 call 21
 description 19
 panel (VGET) 278
 panel processing 116
 passing control in a dialog 60
 preprocessed panels 151

Selected Choice (SC) attribute 205

selected row, defined 134

selection panel, system variables 395

separator
 system variable 387
 system variable containing 388, 389

separator bars 100

services
 to dialogs 1
 to interactive applications 1

services description, SELECT 19

SET file-tailoring control statement 325

SFIHDR keyword on)MODEL statement in table display panel 137

SGERMAN keyword on ISPSTART command 11, 17

shadow variable 146

SHARED parameter
 on VGET panel statement 278
 on VPUT panel statement 277, 279

shared pool 60

sharing variables among dialogs 64

shift-in character (DBCS) 185, 240

shift-out character (DBCS) 185, 240

short error message text, system variable 394

short message syntax 305

shortcut keys 397

SIND keyword
 in panel)FIELD section 216

site command table prefix, system variable 388

skeleton
 description of 3

skeleton definition
 assigning a value to a variable 325
 comment statement 319
 control characters 315
 control statements 315, 318
 data records 315
 defining 315
 example 328
 IF-THEN-ELSE statement 323
 imbedding 324
 imbedding blank lines 318
 loop processing 324
 null statement 324
 specifying table processing 322
 tab stop 325

SKIP
 keyword in panel)ATTR section 172, 197
 tutorial command 297

SMSG parameter on panel)BODY section 209

SOURCELINE function, and panel REXX 257

SPANISH keyword on ISPSTART command 11, 17

specifying DBCS search argument format 81

SPF command 26

SPLIT command, disabled in batch environment 37

split-screen in effect, system variable 393

SPLITV system command, disabled in batch environment 37

stacked commands, graphics interface mode restriction 149

START service 95

starting a dialog
 methods 10
 using the ISPSTART command 17
 using the SELECT service 19

starting a GUI session
 using ISPSTART 97

starting ISPF 9, 10

STDDATE parameter on VER statement 276

STDTIME parameter on VER statement 276

STEM variables 8

stepname of TSO logon, system variable 388

storing variables from a panel in shared and profile pools (VPUT) 279

string of variable values on panel user exit parameter 252

substitution string, conditional 317

subtasking support 33

suspending an activity xviii

syntax rules
 message definition 304, 312
 panel definition 111
 skeleton definitions 315

System keylist 89

system variables
 list of 385

system variables (*continued*)
 used for communication between dialogs and ISPF 395

Z 387

ZACCTNUM 387

ZAMT 393

ZAPLCNT 387

ZAPPLID 387

ZAPPTTL 387

ZASPECT 393

ZBDMAX 387

ZBDMXCNT 387

ZCFGCMPT 386

ZCFGKSRG 386

ZCFGKSRG 386

ZCFGKSRG 386

ZCFGMOD 386

ZCMD 395

ZCOLORS 391

ZCONT 394

ZCS 387

ZCSDLL 387

ZCURFLD 395

ZCURINX 395

ZCURPOS 395

ZDATE 386

ZDATEF 386

ZDATEFD 386

ZDATESTD 386

ZDAY 386

ZDBCS 391

ZDECS 387

ZDEL 387

ZDEVNAM 393

ZENTKTX 387

ZENVIR 387

ZERRALRM 394

ZERRHM 394

ZERRLM 394

ZERRMSG 394

ZERRSM 394

ZERRTYPE 394

ZERRWIND 394

ZEURO 387

ZFAMPRT 393

ZFKA 391

ZGE 147, 391

ZGUI 387

ZHILITE 391

ZHINDEX 395

ZHTOP 395

ZIND 395

ZISPFOS 387

ZISPFRC 387

ZJ4DATE 386

ZJDATE 386

ZKEYHELP 388

ZKEYS 391

ZKLAPPL 391

ZKLNAME 391

ZKLTYPE 391

ZKLUSE 391

ZLANG 388

ZLOGNAME 394

ZLOGO 388

ZLOGON 388

ZLSTLPP 394

system variables (*continued*)

ZLSTNAME 394
 ZLSTNUML 394
 ZLSTTRUN 394
 ZMONTH 386
 ZOS390RL 388
 ZPANELID 388
 ZPARENT 395
 ZPF01-24 392
 ZPFCTL 392
 ZPFFMT 392
 ZPFKEY 388
 ZPFLxx 392
 ZPFSET 392
 ZPFSHOW 392
 ZPLACE 388
 ZPREFIX 388
 ZPRIKEYS 392
 ZPRIM 395
 ZPROFAPP 388
 ZRXRC 258
 ZSCBR 393
 ZSCED 393
 ZSCML 393
 ZSCRCUR 388
 ZSCREEN 392
 ZSCRENC 388
 ZSCREEND 392
 ZSCREENI 388
 ZSCREENW 392
 ZSCRMX 388
 ZSCRMXD 392
 ZSCRMXW 393
 ZSCRML 393
 ZSCROLLA 393
 ZSCROLLD 393
 ZSCROLLN 393
 ZSCTPRE2 388
 ZSCTPRE3 388
 ZSCTPREF 388
 ZSCTSRCH 388
 ZSEL 395
 ZSM 388
 ZSPLIT 393
 ZSTDYEAR 386
 ZSYSICON 388
 ZSYSID 388
 ZSYSNODE 389
 ZSYSPLEX 389
 ZSYSPROC 389
 ZTDADD 393
 ZTDAMT 393
 ZTDLROWS 393
 ZTDLTOP 394
 ZTDMARK 394
 ZTDMSG 394
 ZTDRET 394
 ZTDROWS 394
 ZTDSCRIP 394
 ZTDSELS 394
 ZTDSIZE 394
 ZTDSRID 394
 ZTDTOP 394
 ZTEMPF 389
 ZTEMPN 389
 ZTERM 393
 ZTERMCID 389

system variables (*continued*)

ZTERMCP 389
 ZTERMCS 389
 ZTHS 389
 ZTIME 386
 ZTIMEL 386
 ZTS 389
 ZTSICMD 389
 ZTSSCMD 389
 ZUCTPRE2 389
 ZUCTPRE3 389
 ZUCTPREF 389
 ZUP 395
 ZUSC 393
 ZUSER 389
 ZVERB 389
 ZWINTTL 390
 ZWSCDPG 390
 ZWSCON 390
 ZWSOPSYS 390
 ZXSMAX 393
 ZXSMIN 393
 ZYEAR 386

SYSTSPRT file for error messages 35

T

tab stop in skeleton definition 325
 tabbing
 alternate 326
 table
 accessing data 70
 adding rows dynamically 45
 definition 3
 dynamic expansion 133
 temporary or permanent 69
 when created or updated 3
 table display (TBDISPL), terms related to 131
 table display output example 142, 143
 table display panel definition
 attribute section 136
 body section 136
 example 141
 example of multiple model lines 142
 initialization section 139
 message location 106
 model line 43, 131
 model section 137
 scroll field location 106
 short message area content 106
 using the TBDISPL service 131
 table rows
 number of selected upon return from table display 394
 number of system variable containing upon return from table display 394
 system variable containing 394
 table services
 determining table size 72
 example 72, 73
 protecting resources 71
 row operation 71
 using 69, 70
 tags, creating dialog elements 89
 task abend code on diagnostic panel 366
 TB file-tailoring control statement 325

TBA file-tailoring control statement 325
 TBDISPL series 134
 TBDISPL service
 description 140
 dynamically building the table 46
 terms related to 131
 writing dialogs 41
 TCP/IP 14
 TCP/IP address
 definition 97
 terminal data in batch mode 36
 terminal type
 specifying ISPTTDEF 347
 system variable containing 393
 terminating
 a dialog 21
 ISPF 9, 10
 TERMSTAT parameter on ENVIRON command 365
 TERMTRAC parameter on ENVIRON command 362
 TEST
 difference from TESTX 25
 mode 24
 parameter on ISPSTART command 11
 testing dialog elements 4
 TESTX
 difference from TEST 25
 mode 25
 parameter on ISPSTART command 16
 TEXT keyboard character translations 343
 TEXT parameter used with TYPE keyword 198
 time and date information (system variables) 386
 title displayed in window frame 387
 TOC tutorial command 297
 TOG statement 264
 top-row-displayed indicator 48, 134, 394
 trace
 file-tailoring execution 355
 panel execution 349
 TRACE
 difference from TEST and TRACEX 26
 mode 26
 parameter on ISPSTART command 11
 TRACEX
 difference from TEST and TRACE 26
 mode 26
 parameter on ISPSTART command 16
 trailing blanks in verified variable 269
 TRANS built-in function on assignment statement
 description 236, 237
 example 117, 238, 287
 example, nested 236, 237
 translate tables, specifying 347
 translation
 common characters 329
 GETMSG service 330
 messages tagged with CCSID 309

translation (*continued*)
 TRANS service 330
 TRUNC built-in function on assignment statement
 description 235
 example 117, 235, 238
 example, nested 236, 237
 truncation, system variable containing list data set 394
 TSO
 batch environment 33
 batch execution 34
 command restrictions 26
 invoking authorized commands 26
 invoking commands 26
 TSO command 26
 TSOEXEC interface 26
 TUTOR command 294
 tutorial 114
 call of 297
 commands 297
 defining panels 297
 description 294
 ending of 298
 entry to 297
 sample hierarchy of panels 299
 sample panel 300
 specifying an index page 299
 use 297
 tutorial panels, system variables that contain information about 394
 TWOBYTE built-in function on assignment statement 240
 TYPE keyword in panel)ATTR section 172

U

unavail specification in panel)ATTR section 198
 unavailable choices 100
 underscore, specifying 186
 UP tutorial scroll command 297
 UPPER built-in function on assignment statement 239
 UPPERENG keyword on ISPSTART command 11, 17
 USCORE parameter used with HILITE keyword 186
 used for communication between dialogs and ISPF 67
 user exit for panel processing 248
 USER parameter used with PAD keyword 191
 user-selection 135
 userid, system variable 389
 USERMOD parameter in)ATTR section 174

V

validation of DBCS data 114
 value from scroll amount field, system variable 393
 variable model lines 138

variable services
 creating or deleting defined variables 63
 summary 69
 writing dialogs 59
 variables
 assignment statement 235
 COMPOUND 8
 creating implicit 63
 description of 7
 dialog 60
 dialog, format 67
 in IF or ELSE statements 244
 in message definition 312
 in VER statements 266
 maximum size 7
 names too long for panel definition 291
 naming 7
 naming defined and implicit 63
 on panels, restricted size 111
 owned by ISPF 66
 panel REXX 258
 processing using panel user exit 250
 read-only extension 65
 removing from the shared or profile pool 65
 saving across ISPF sessions 64
 sharing among dialogs 64
 STEM 8
 storing from a panel to shared and profile pools (VPUT) 279
 system variable charts 385
 testing the value of 244
 to function pool from shared or profile pools (VGET) 277
 value test during panel processing 246
 ZERRCSID 329
 ZKEYHELP 93
 ZTERMCID 329
 ZTERMCP 329
 ZTERMCS 329
 Variables for ISPSTART parameters 11
 VARS variable in table display panel 139
 VCOPY service 68
 VDEFINE service
 in panel user exit routine 250
 writing dialogs 68
 VDELETE service 68
 VEDIT statement 265
 VER statement in panel section description 266
 syntax 267
 VERASE service 68
 verifying variable content 267
 VGET statement
 in panel)INIT,)REINIT, or)PROC section 277
 on DISPLAY panel 277
 on SELECT panel 278
 syntax 277
 using 68
 VMASK service 68
 VPUT statement
 example 279

VPUT statement (*continued*)
 in panel)INIT,)REINIT, or)PROC section 279
 syntax 279
 using 68
 VREPLACE service 68
 VRESET service 68

W

WIDTH keyword in panel)ATTR section 198
 WIDTH keyword in panel)BODY section 207
 WINDOW command 91
 WINDOW keyword
 defining pop-up windows 110
 in panel)BODY section 207
 window title variable 89, 90
 workstation command 13
 workstation command var 14
 writing dialogs
 display services 41
 file-tailoring services 81
 miscellaneous services 86
 PDF services 84
 table services 69
 variable services 59
 WSCMD 13
 WSCMD parameter on ISPSTART command 11
 WSCMDV 14
 WSCMDV parameter on ISPSTART command 11

Z

Z system variable 387
 Z variables used for field name place-holders 291
 ZACCTNUM system variable 387
 ZAMT system variable 393
 ZAPLCNT system variable 387
 ZAPPLID system variable 387
 ZAPPTTL system variable 387
 ZASPECT system variable 393
 ZBDMAX system variable 387
 and BDISPMAX keyword 38
 ZBDMXCNT system variable 387
 ZC system variable 313, 328
 ZCFGCMPT system variable 386
 ZCFGCMPT system variable 386
 ZCFGKSR system variable 386
 ZCFGVLV system variable 386
 ZCFGMOD system variable 386
 ZCMD 380
 ZCMD system variable 395
 example 117
 on tutorial panels 298
 processing
 blank 118
 invalid option 118
 truncation 116
 versus other names for command field 106
 ZCOLORS system variable 391

ZCOLORS system variable *(continued)*
 in batch mode 37

ZCONT system variable 299, 301, 394

ZCS system variable 387

ZCSDLL system variable 387

ZCUNIT 384

ZCURFLD
 general description 227

ZCURFLD system variable 395

ZCURINX
 general description 227

ZCURINX system variable 395

ZCURPOS
 general description 227

ZCURPOS system variable 395

ZCUSIZE 384

ZDATE system variable 386

ZDATEF system variable 386

ZDATEFD system variable 386

ZDATESTD system variable 386

ZDAY system variable 386

ZDBCS system variable 391
 in batch mode 37

ZDECS system variable 387

ZDEL system variable 387

ZDEVNAM system variable 393

ZDLBLSZ 380

ZDLCATNM 380

ZDLCDATE 380

ZDLDEV 380

ZDLDSNTP 380

ZDLDSORG 380

ZDLEDATE 380

ZDLEXT 380

ZDLEXTX 380

ZDLLRECL 380

ZDLMIGR 380

ZDLRDATE 380

ZDLRECFM 380

ZDLSIZE 380

ZDLSIZEX 380

ZDLSPACU 380

ZDLUSED 380

ZDLVOL 380

ZDSN 380

ZDST 380

ZE system variable 313, 328

ZEDBDN 380

ZEDROW 380

ZEDSAVE 380

ZEDTDSN 380

ZEDTMCMD 380

ZEDTMEM 380

ZEDTRD 380

ZEDUSER 380

ZEIBSDN 381

ZEIROW 381

ZEITDSN 381

ZEIUSER 381

ZENVIR system variable 34, 387

ZERRALRM 381

ZERRALRM system variable 394

ZERRHM 381

ZERRHM system variable 394

ZERRLM 381

ZERRLM system variable 394

ZERRMSG 381

ZERRMSG system variable 394
 for panel user exit messages 253

ZERRSM 381

ZERRSM system variable 394

ZERRTYPE system variable 394

ZERRWIND system variable 394

ZEURO system variable 387

ZFAMPRT system variable 393

ZFKA system variable 391

ZGE system variable 147, 391

ZGRPLVL 381

ZGRPNME 381

ZGUI system variable 387

ZHILITE system variable 391
 in batch mode 37

ZHINDEX system variable 395
 example 125
 specifying top indexed panel 298

ZHTOP system variable 395
 example 125
 specifying top tutorial panel 298

ZICFPRT 384

ZIND system variable 395
 using on tutorial panels 299

ZISPFOS system variable 387

ZISPFRC system variable
 description 21
 example of using 23
 return codes 387

ZJ4DATE system variable 386

ZJDATE system variable 386

ZKEYHELP system variable 93, 388

ZKEYS system variable 391

ZKLAPPL system variable 391

ZKLNAME system variable 391

ZKLTYPE system variable 391

ZKLUSE system variable 391

ZLAC 381

ZLALIAS 381

ZLAMODE 381

ZLANG system variable 388

ZLATTR 381

ZLC4DATE 381

ZLCDATE 381

ZLCNORC 382

ZLINORC 382

ZLLIB 382

ZLIM4DATE 382

ZLMDATE 382

ZLMEMBER 382

ZLMNORC 380, 382

ZLMOD 382, 383

ZLMSEC 382

ZLMTIME 382, 383

ZLOGNAME system variable 394

ZLOGO system variable 388

ZLOGON system variable 388

ZLPDSUDA 382

ZLRMODE 383

ZLSIZE 383

ZLSSI 382

ZLSTLPP system variable 394

ZLSTNAME system variable 394

ZLSTNUML system variable 394

ZLSTTRUN system variable 394

ZLITR 383

ZLUSER 383

ZLVERS 383

ZMLCOLS 383

ZMLCR 383

ZMLTR 383

ZMONTH system variable 386

ZMSRTFLD 383

ZPARENT system variable 119, 395

ZPDFREL 384

ZPF01-24 system variables 392

ZPFCTL system variable 392

ZPFFMT system variable 392

ZPFKEY system variable 388

ZPFSET system variable 392

ZPFSHOW system variable 392

ZPLACE system variable 388

ZPREFIX system variable 388

ZPRIKEYS system variable 392

ZPRIM system variable 395
 example 118, 125
 ignored in explicit chain mode 119
 using 119

ZPROFAPP system variable 388

ZRXMSG system variable 258

ZRXMSGsystem variables
 ZRXMSG 258

ZRXRC system variable 258

ZSCBR system variable 393

ZSCED system variable 393

ZSCLM 383

ZSCML system variable 393

ZSCRCUR system variable 388

ZSCREEN system variable 392

ZSCREENC system variable 388

ZSCREEND system variable 392
 in batch environment 36

ZSCREENI system variable 388

ZSCREENW system variable 392
 in batch environment 36

ZSCRMAS system variable 388

ZSCRMASD system variable 392
 in batch environment 36
 panel definition 110

ZSCRMASW system variable 393
 in batch environment 36
 panel definition 110

ZSCRML system variable 393

ZSCROLLA system variable 137, 393

ZSCROLLD system variable 136, 393

ZSCROLLN system variable 137, 393

ZSCTPRE2 system variable 388

ZSCTPRE3 system variable 388

ZSCTPREF system variable 388

ZSCTSRCH system variable 388

ZSEL system variable 395
 contains result of truncating
 ZCMD 115
 example 117
 on menus 115
 on tutorial panels 298
 parameters and keywords used
 with 116
 restriction for 298

ZSESS 384

ZSM system variable 388

ZSPLIT system variable 393

ZSTDYEAR system variable 386

ZSWIND 384

ZSYSICON system variable 388
 ZSYSID system variable 388
 ZSYSNODE system variable 389
 ZSYSPLEX system variable 389
 ZSYSPROC system variable 389
 ZTDADD function variable
 definition of 45
 using 47
 ZTDADD system variable 393
 ZTDAMT function variable
 definition of 46
 using 47
 ZTDAMT system variable 393
 ZTDLROWS function variable
 definition of 46
 using 48
 ZTDLROWS system variable 393
 ZTDLTOP function variable
 definition of 46
 using 47, 48
 ZTDLTOP system variable 394
 ZTDMARK system variable 132, 394
 ZTDMMSG system variable 394
 ZTDRET function variable
 definition of 45
 using 45
 ZTDRET system variable 394
 ZTDROWS system variable 394
 ZTDSCRIP function variable
 definition of 45
 using 47
 ZTDSCRIP system variable 394
 ZTDSELS system variable 140, 394
 description 44
 example 44
 ZTDSIZE function variable
 definition of 46
 using 48
 ZTDSIZE system variable 394
 ZTDSRID function variable
 definition of 46
 using 47
 ZTDSRID system variable 394
 ZTDTOP system variable 394
 ZTEMPF system variable 389
 ZTEMPN system variable 389
 ZTERM system variable 393
 ZTERM, mapped to APL2 terminals 30
 ZTERMCID system variable 389
 ZTERMCP system variable 389
 ZTERMCS system variable 389
 ZTHS system variable 389
 ZTIME system variable 386
 ZTIMEL system variable 386
 ZTS system variable 389
 ZTSICMD system variable 389
 ZTSSCMD system variable 389
 ZUCTPRE2 system variable 389
 ZUCTPRE3 system variable 389
 ZUCTPREF system variable 389
 ZUP system variable 395
 on tutorial panels 298
 ZUSC system variable 393
 ZUSER system variable 389
 ZUSERMAC 383
 ZVERB system variable 137, 389
 ZWINTTL 90
 ZWINTTL system variable 390
 ZWSCDPG system variable 390
 ZWSCON system variable 390
 ZWSOPSYS system variable 390
 ZXSMAX system variable 393
 ZXSMIN system variable 393
 ZYEAR system variable 386

Readers' Comments — We'd Like to Hear from You

Interactive System Productivity Facility (ISPF)
Dialog Developer's Guide and Reference
z/OS Version 1 Release 7.0

Publication No. SC34-4821-04

Overall, how satisfied are you with the information in this book?

	Very Satisfied	Satisfied	Neutral	Dissatisfied	Very Dissatisfied
Overall satisfaction	<input type="checkbox"/>	<input type="checkbox"/>	<input type="checkbox"/>	<input type="checkbox"/>	<input type="checkbox"/>

How satisfied are you that the information in this book is:

	Very Satisfied	Satisfied	Neutral	Dissatisfied	Very Dissatisfied
Accurate	<input type="checkbox"/>	<input type="checkbox"/>	<input type="checkbox"/>	<input type="checkbox"/>	<input type="checkbox"/>
Complete	<input type="checkbox"/>	<input type="checkbox"/>	<input type="checkbox"/>	<input type="checkbox"/>	<input type="checkbox"/>
Easy to find	<input type="checkbox"/>	<input type="checkbox"/>	<input type="checkbox"/>	<input type="checkbox"/>	<input type="checkbox"/>
Easy to understand	<input type="checkbox"/>	<input type="checkbox"/>	<input type="checkbox"/>	<input type="checkbox"/>	<input type="checkbox"/>
Well organized	<input type="checkbox"/>	<input type="checkbox"/>	<input type="checkbox"/>	<input type="checkbox"/>	<input type="checkbox"/>
Applicable to your tasks	<input type="checkbox"/>	<input type="checkbox"/>	<input type="checkbox"/>	<input type="checkbox"/>	<input type="checkbox"/>

Please tell us how we can improve this book:

Thank you for your responses. May we contact you? Yes No

When you send comments to IBM, you grant IBM a nonexclusive right to use or distribute your comments in any way it believes appropriate without incurring any obligation to you.

Name

Address

Company or Organization

Phone No.



Fold and Tape

Please do not staple

Fold and Tape



NO POSTAGE
NECESSARY
IF MAILED IN THE
UNITED STATES

BUSINESS REPLY MAIL

FIRST-CLASS MAIL PERMIT NO. 40 ARMONK, NEW YORK

POSTAGE WILL BE PAID BY ADDRESSEE

IBM Corporation
Department J87/D325
555 Bailey Avenue
San Jose, CA
U.S.A. 95141-9989



Fold and Tape

Please do not staple

Fold and Tape



File Number: S370/4300-39
Program Number: 5694-A01

Printed in USA

SC34-4821-04

