



Contents

1 Welcome

Before Starting	1
Using the Menu.....	1
Using Keys.....	1
What's in the Box?.....	2
Important Phone Numbers.....	2

2 Getting Started

Getting Started.....	3
Setting the Language	5
Installing the Memory Backup Batteries	5
Installing the Paper Roll	6
Setting the Date And Time	7
Programming the Sales Tax.....	7
PC-Based Software.....	8

3 Getting To Know the Cash Register

About the Displays.....	10
Lifting and Lowering the Customer Display.....	11
Adjusting the Clerk Display	11
About the Menus on the Clerk Display.....	11
Using the Keyboard	13

Turning the Register Off and On 16
 Using the Cash Drawer 16
 Using the Accessory Drawer 18

4 Setting Up Your Cash Register - the Basics

Using the Displays 19
 The Clerk Screen.....20
 Navigating the Clerk Screen20
 Adjusting the Contrast on the Clerk Screen.....21
 Using Power Saving Mode21
 Setting Alphanumeric Descriptions.....22
 Using Double Wide Characters.....24
 Setting Header Messages and Footer Messages.....24
 Printing Options on Receipts27
 Setting Clerk Numbers and Names27
 Using the Clerk System.....29
 Setting X and Manager Passcodes30
 Setting the Machine Number.....31
 Programming Department Keys32
 Setting Department Number Keys33
 Programming Department Names33
 Programming Department Preset Price35
 Programming Tax Status.....35
 Setting Department Type36
 Setting Standard, Gallonage or Negative Mode.....36
 Setting High Amount Lock-out (HALO)36
 Setting Age Limits36
 Scrolling Messages.....37
 Types of Scrolling Messages38
 Default Scrolling Messages38
 Programming Scrolling Messages.....39
 Setting the Scroll Speed39
 Programming the Credit Keys.....40
 Programming PLU Descriptions.....42
 Programming PLUs without a Barcode Reader42

Programming PLUs with the Optional Barcode Reader.....43
 Printing the Program Confirmation Report44
 Before Going to Register Mode.....44
 Error Codes45
 Clearing an Error47

5 Setting Up Your Cash Register Parameters

Print Options48
 1. Header.....49
 2. Footer49
 3. Date.....49
 4. Time49
 5. Clerk.....49
 6. Each Tax Rate.....49
 7. Tax Total49
 8. Blank Line.....49
 9. Multiple Receipts50
 10. Receipt - Real time or End of Sale50
 11. Tax.....50
 12. Sub-Total50
 13. Receipt - Name Only vs. PLU & Name.....50
 14. Machine #51
 15. Consecutive #.....51
 To Default.....51
 System Options51
 1. Key Lay-out.....52
 2. Zero Price52
 3. Electronic Journal52
 4. Amount Tend.52
 5. % In Dept.....53
 6. Scroll Speed53
 7. CONS #53
 8. ZCT Reset53
 9. GT Reset.....53
 10. Rounding.....53

11. Decimal.....	54
To Default	54
Others Set Up	55
[+%] Rate.....	55
[-%] Rate	56
[-] HALO	56
Credit-1 Name	56
Credit-2 Name	56
FC Set Up.....	56
AGE-1 Set Up	57
AGE-2 Set Up	57
Currency Symbol.....	57
Z-Report #.....	57
Zero Skip	58
Z-Report	58
Compressed.....	58
Machine Number	58
Daily Z Counter.....	58
Periodic Z Counter.....	58
Grand Total Amount.....	59
Config Options	59
Language.....	59
Date	59
Date Format.....	60
Time	60
Time Format	60
Contrast.....	60
Power Saving.....	60
Tax System	60
Options Dump	61
6 Ringing up Sales and Using Training Mode	
Ringing up Sales.....	62
Ringing up Sales without a PLU Number	63
Ringing up Sales with a PLU Number	64

Ring up Sales with the Optional Barcode Reader	64
Verifying the PLU Information for an Item	65
Printing Receipts.....	66
Receipt on Demand.....	66
Using Training Mode.....	67
Setting the Training Passcode	67
Entering and Exiting Training Mode.....	68
7 Programming Complex Tax Rates	
Selecting the Tax System.....	70
Programming Straight Add-on Tax in the United States.....	71
Programming Table Tax in the United States	72
Calculating Your Tax.....	73
Example Tax Chart	75
The Worksheet.....	76
Using Canadian Tax Rates	76
Using VAT Tax Rates	78
Printing a Confirmation Report.....	78
8 Running Reports	
Running the Options Dump Report	79
Running the Department Confirmation Report.....	80
Running the PLU Confirmation Report	81
Running Management Reports.....	82
About X Reports.....	82
About Z Reports.....	82
About Management Reports	83
Running Reports.....	83
Financial Report Example.....	84
Additional Information in Electronic Journal (EJ) Reports.....	85
9 Maintenance and Options	
Installing a New Paper Roll	89
Using the Battery System	90
About the Serial Port.....	91
Connecting the Cash Register to a PC	92

10 Troubleshooting

Paper End or Printer Errors.....	93
No Receipt Printing.....	94
No Printing on the Receipt.....	94
The Cash Register Turns Itself Off.....	94
Electronic Journal Memory Errors.....	94
The Cash Register Does Not Work at All.....	95
The Cash Register Does Not Work at All.....	96
Opening the Drawer When There is no Power.....	96
Half System Clear.....	96
Partial Reset.....	97
Full System Clear.....	97
If Nothing Helps.....	97

11 Examples

Transaction Codes.....	100
Sample Receipt.....	101
Adding Tax to a Non-Taxable Department.....	101
Cash Sale With Tendering Change.....	102
Cash Sale Without Tendering Change.....	102
Charge Sale.....	102
Charge Return.....	103
Check Sale.....	103
Coupon Discount Sale.....	103
Credit Sale.....	103
Credit Return.....	104
Dept Shift Key.....	104
Exempting Tax On An Item.....	105
Exempting Tax on the Entire Sale.....	105
Gallonage Sales Transaction.....	106
Minus Percentage Discount Sale.....	106
Multiplication of a Department Unit Price.....	107
Multiplication Sale and Overriding a Preset Department Price.....	107
Multiplying By A Fraction.....	108
No-Sale Function (Opening the Cash Drawer).....	108

Temporarily Overriding a PLU Price 108

Paid-Out Sale 109

PLU Sale 109

Plus Percentage Sale 109

Received-On-Account Sale 110

Registering A Department Unit Price..... 110

Registering A Reference Number 111

Return Sale..... 111

Split Tendering Sale..... 112

Use the Error-Correct /Void Key 112

Voiding A Coupon Sale 112

Voiding a Department Preset Price 113

Voiding a Department Preset with a Minus Percentage Discount..... 113

Voiding A Minus Percentage Discount Sale 114

Voiding a Multiplication of a Department Preset Price 114

Voiding A Department Multiplication Sale 115

Voiding a PLU Sale 115

Voiding a PLU Multiplication Sale 115

Voiding a PLU Sale with a Minus Percentage Discount..... 116

Voiding a PLU Sale with a Plus Percentage Rate..... 116

Voiding a Plus Percentage Sale 117

Voiding an Entire Sale before Finishing the Sale 117

Voiding A Sale..... 117

A Product Information

Specifications and Safety..... 118

Safety and Legal Notices 119

Software Licensing Agreement..... 120

Manufacturer’s Limited Warranty..... 121

Ordering Supplies and Accessories 123

Index 124

Welcome

Congratulations on purchasing your new Royal cash register! This register is designed to be easy to use, helping you to focus on running your business.

Before Starting

Before you start using this manual to set up and customize your cash register, you should know the following.

Using the Menu

This cash register has a menu system that prompts you through many tasks you perform. To help you quickly navigate through the menu system, we use the following:

Programming ▶ More Options ▶ Print Options

Using Keys

When you need to press a key, you see a picture of the key you need to press and the name of the key is in another font. For example:



1 If you are ringing up a check, press the **Check** key.

If you need to type something in the round Number keys area, what you need to type is shown in a special font. For example:

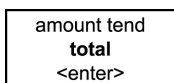

2 Using the round Number keys, press 444444 and then press the **Amount Tend Total <Enter>** key.

What's in the Box?

Look for and unwrap the following:

- Cash Register
- 1 starter roll of standard thermal paper, Royal Reorder Number 013127 (2¼ inch or 57.5 mm wide).
- Journal Spindle, installed in the printer compartment
- RegisterLink™ software and 6 foot serial cable
- 1 set of keys, consisting of 2 Cash Drawer keys (515).
- This user's guide

Important Phone Numbers

If you need help or want to order additional supplies, use the following contact information.

Customer Service:	1-800-272-6229 (USA)
	1-888-266-9380 (Canada)
	01-800-849-4826 (Mexico)
Ordering Supplies:	1-888-261-4555
Website:	www.royal.com

To order items, see Ordering Supplies and Accessories on page 123.

Getting Started

Setting up your cash register consists of the following steps:

- 1 Unpacking the cash register
- 2 Plugging the cash register into a power source
- 3 Turning on the cash register by pressing the **Main menu (on)** key.
- 4 Setting the Language
- 5 Installing the Memory Backup Batteries
- 6 Installing the Paper Roll
- 7 Setting the Date And Time
- 8 Programming the Sales Tax



Do all the steps and follow the detailed instructions shown on the cash register display to make sure your cash register is set up correctly.

When you are done with this chapter, see the chapter called Getting To Know the Cash Register, starting on page 10 and the chapter called Setting Up Your Cash Register - the Basics, starting on page 19 for more information about your cash register.

Getting Started

Because the Alpha 710ML has a 5-line LCD screen, you are prompted through setup after you plug in the cash register. This chapter helps you understand what the setup options are as you are walked through the setup.

amount tend
total
<enter>

If you make a mistake or enter a wrong setting during initial setup, just continue with the rest of the initial setup. During initial setup, you cannot change settings after you press the **Amount Tend Total <Enter>** key. When you complete the initial setup, you can correct any setting by following the instructions listed in this manual.

Make sure that you plug the cash register into the electrical outlet before you put in the batteries.

Caution

If you put the batteries in first, they can damage the cash register. Do not use this cash register outdoors in the rain or near any source of liquid.



After you get the cash register ready to use, the 5-line LCD screen prompts you through the rest of the set up. Use the **Up** and **Down** arrow keys to move through the items on the screen.

clear

Note

If you make a mistake while you are programming, press the **Clear** key.

To get the cash register ready to use

1 Remove the cash register and the parts from the box. Store the box and packing material in a safe, dry place. If you need to move the register in the future, you can put it back in the box.

2 Remove the tape holding the parts of the cash register in place. For example, there may be tape on the Journal Compartment Cover.

Put the register on a hard, level surface, away from rain and spilled drinks. A hard, level surface makes it easier for the cash drawer to go in and out smoothly.

Do not put the register on a porous surface. Depending on the surface or any cleaning solution used on the surface, the rubber feet may leave marks on the surface. Do not place the register on any valuable surface, such as antique or fine wood tables, desks, and so on.

3 Plug the cash register into a grounded three-hole electrical wall outlet. (115-120 volt, 60 hertz). Make sure the electrical cord is not going to be tripped over or accidentally pulled from the electrical outlet.

Put the cash register on an electrical circuit with no other electrical device or appliance. Other appliances can overload the circuit or cause electrical interference with the cash register. It is best that you use a circuit without other appliances already on it.

Now follow the prompts on the screen. The rest of this chapter explains the setup options.

Setting the Language

At the prompt, you can select English, Spanish, or French. Changing the language changes the factory programmed words you and the customer see on the displays. However, changing the language does not translate any words you program in the cash register, such as PLU descriptions, header information, and so on.

Note

If you start programming the cash register and then change the language, you lose all your programming changes.

To set the language when you first set up the cash register

- 1 When you first turn the register on, you are prompted through all setup options. Setting the language is the first option.
- 2 Select the language you want and press the **Amount Tend Total <Enter>** key. The language your cash register shows on the operator display is set.

amount tend
total
<enter>

Installing the Memory Backup Batteries

Your cash register uses 3 AA 1.5 volt batteries for the memory backup system. These batteries did not come with your cash register and you must purchase them additionally.

Caution

If you put the batteries in the cash register first, they can damage your cash register. Put the batteries in when you are prompted.

- 1 At the prompt, open the Journal Compartment Cover. Remove the Journal Compartment Cover and set aside.
- 2 Move the paper roller bar up and out of the way. Grab the small handle on the right of the print roller bar. Push the little handle towards the back of the cash register and raise the paper roller bar up. You see a slope down to the paper compartment. The battery cover is located under the print roller bar, on the slope.
- 3 Remove the battery cover. Press the edge at the top of the cover and push to the back. The cover pops off.
 - Put the batteries in the slots. Make sure that the positive and negative ends are in the right place. The batteries have a little plus (positive) and minus (negative) sign on each end to help you.

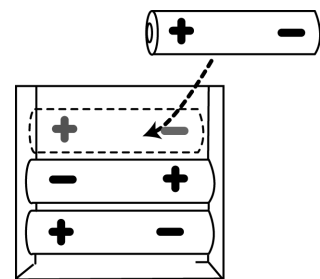
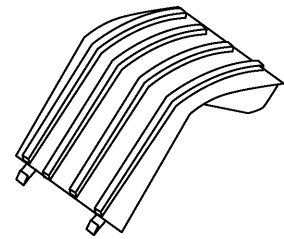

- Replace the battery cover. Slide the bottom tabs into the long slit in the bottom position and snap the cover into place. Do not put the tabs in the 2 holes in the bottom of the compartment. The cover will not close and you will break the tabs.

Installing the Paper Roll

Your cash register has a thermal printer that prints receipts for the customer or a journal tape. Use 2¼ inch (57.5 mm) wide standard thermal register paper. Do not use bond paper because the register does not use a ribbon or ink for printing.

feed

Caution

Do not manually pull the receipt paper. Always use the **Feed** key to remove or advance the paper. Do not use sharp or pointed instruments in the printer area. This can seriously damage the printer.

- 1 At the prompt on the clerk display during set up, open the Journal Compartment Cover. Remove the Journal Compartment Cover and set aside. Remove the tape on the black Journal Tape spindle inside the printer compartment of the cash register.

- 2 Remove the Journal Takeup spindle. Place the paper roll in the little round area at the bottom of the compartment. Make sure the paper feeds out from the bottom of the roll, towards the front of the cash register.

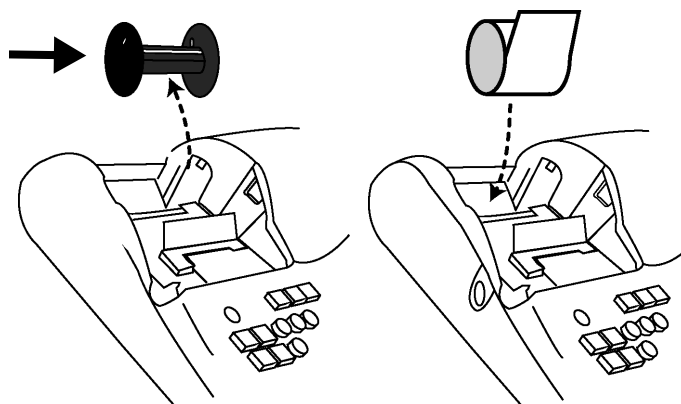

- 3 Grab the small handle on the right of the print roller. Push the little handle towards the back of the cash register and raise the roller bar up.

- 4 Lay the end of the paper across the printer as shown. Move the print roller down onto the paper and snap into place. Make sure both sides are snapped down.

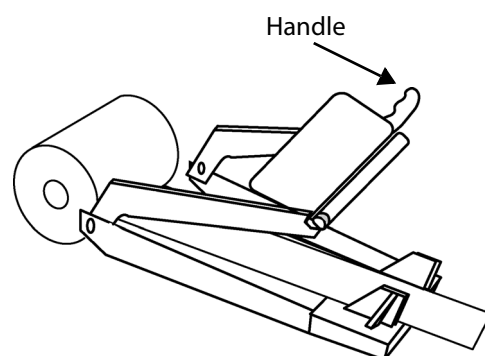

feed

- 5 Press the **Feed** key to move the paper through the printer to make sure there is no jam and the paper is properly installed before continuing.
- 6 Follow the instructions on the clerk display.

Setting the Date And Time

The date changes every day and prints in the month-day-year format. You can prevent the date from printing on the transaction receipts. The date format can also be changed to print day-month-year. For more information, see Date Format on page 60.

The time can print in either the 12 or 24 hour (military time) format. The default setting is to print in the 12 hour format, which is normally used. To change to the 24 hour format, see Date Format on page 60. You can set the cash register so that it does not print the time on receipts. For more information, see Printing Options on Receipts on page 27.

amount tend total <enter>

As you are prompted through entering the date and time, press the **Amount Tend Total <Enter>** key to enter the information you specify.

To set the date

0	6
---	---

1 At the prompt, use the rounded Number keys to enter the last 2 digits of the year. For example, for 2006, press 06. Press the **Amount Tend Total <Enter>** key.

0	2
---	---

2 Use the rounded Number keys to enter the 2 digits of the month. For example, for February, press 02. Press the **Amount Tend Total <Enter>** key.

2	4
---	---

3 Use the rounded Number keys to enter the 2 digits of the day. For example, 24. Press the **Amount Tend Total <Enter>** key.

2	0
---	---

4 Use the rounded Number keys to enter the 2 digit hour. For example, 09. Use military, or 24 hour, time for hours after 12 noon. For example, if you want to enter 8pm, press 20. Press the **Amount Tend Total <Enter>** key.

5	4
---	---

5 Use the rounded Number keys to enter the 2 digits of the minutes. For example, 54. Press the **Amount Tend Total <Enter>** key.

Using the information in this example, the date and time are set to 02-24-06 8:54pm.

Programming the Sales Tax

Now you need to select and program the sales tax for your area. You can use 1 of 2 tax types in the US:

- **Straight tax:** The sales amount is multiplied by a flat percentage rate such as 5%. For example, on a \$1.00 item, \$.05 is added for tax.
- **Table tax:** The tax is charged based on a tax table you obtain from your local or state government tax office.

Straight tax is the easiest and most commonly used tax rate. Most states and areas use straight tax. To find out which sales tax type and percentage rate you should use, contact your local government office.

This section explains setting simple sales tax in the United States. See *Selecting the Tax System* on page 70 for other sales tax systems.

amount tend total <enter>

As you are prompted through setting the sales tax, press the **Amount Tend Total <Enter>** key to enter the information you specify.

To set Straight USA (add-on tax)

- 1 Select USA (ADD-ON) TAX and press the **Amount Tend Total <Enter>** key.
- 2 Select tax type, STRAIGHT TAX and press the **Amount Tend Total <Enter>** key.
- 3 For straight tax, use the rounded Number keys to enter the sales tax rate for your area. For example, if your local sales tax rate is 10%, enter 10000. To program other tax rates, press the following:

For this tax rate...	Press these keys...
7.75%	7750
5.5%	5500
10.5%	10500

- 4 Press the **Amount Tend Total <Enter>** key.

For tax tables and more advanced tax rate programming, see *Programming Complex Tax Rates* on page 69.

For more information about the other features of your cash register, see *Setting Up Your Cash Register - the Basics* on page 19 and *Setting Up Your Cash Register Parameters* on page 48.

PC-Based Software

Your cash register includes:

- RegisterLink PC-based software.
 - This software allows you to connect the cash register to your PC to download your sales information and transfer it to QuickBooks® Pro 2002 or later accounting software. For instructions about using the software, see the RegisterLink manual.
 - Program your cash register from the PC - You can program clerk names, PLUs, departments, the header, the footer, and scrolling

messages on your PC and download these settings to your cash register.

- **Back-Up and Restore** - Whether you programmed your cash register data on the cash register or on your PC, you can back-up that programming and store the data on your PC. Should you lose the memory in your cash register, you can simply restore the data from your PC back to the cash register without having to reprogram all the PLU's, Departments and other data.
- **Additional Cash Registers** - When you buy additional cash registers, you can use the back-up-and-restore feature with multiple registers of the same model number. Just program one register, back-up the data to your PC, and then restore or download the data from your PC to the other registers, as long as they are all the same model number. This saves you the time of having to program each register individually.

Check the Royal web site for any new features and upgrades to RegisterLink.

Using the RegisterLink software requires connecting your computer to the cash register using the serial port. To connect your computer to the serial port, you need to use the included null-modem serial cable. For technical details about the serial connection, see About the Serial Port on page 91.

For information for connecting the cash register to your PC, see Connecting the Cash Register to a PC on page 92.

The RegisterLink software is on a CD. Please install the software from this CD. Then check for updates on the Royal web site (www.royal.com). If a later version of the RegisterLink software is available on the web site, download it from the web site and install it on your PC. It is important that the CD version of the software is already installed on your PC before you download and install any updates.

RegisterLink software instructions are separate from this manual. The RegisterLink instruction manual is on the CD that contains the software. An updated and revised version of the instruction manual accompanies any newer version of the software that is downloaded from our web site. Please refer to the RegisterLink instruction manual for all software related operational instructions and assistance.

Getting To Know the Cash Register

This chapter shows you the basics of using your cash register after you set it up. If you have not yet set up your cash register, see the Quick Start sheet that came in the box with your cash register or Getting Started on page 3.

About the Displays

Your cash register has 2 displays.

Customer Display

You can lift, tilt, and rotate the customer display so customers can see what is happening. When you move the register or store it, lower the display so it doesn't get damaged.

Your cash register has a 1 line customer display that shows letters and numbers (alphanumeric) The alphanumeric display shows 10 digits for descriptions, scrolling text messages, and sales dollar amounts.

Clerk screen

Your cash register has a 5 line LCD display. The fifth line on this screen shows you helpful text about what you are doing when you are programming. This display slides to different angles to make it easier for you to read.

Lifting and Lowering the Customer Display

You can lift and lower the customer display so that customers can easily see what is happening.

Adjusting the Clerk Display

Your cash register has a 5 line display for the operator. All lines shows letters and numbers (alphanumeric).



You can adjust the angle of the clerk display to more easily see the screen.

To adjust the clerk display

- 1 Place your thumb at the bottom of the clerk display nearest the keyboard.
- 2 Gently press down on the display. The display rotates within its track. Do not force the display past the maximum position.

About the Menus on the Clerk Display

This cash register uses menus on the 5 line LCD clerk display to prompt you through both programming and using the cash register. The 5 line LCD clerk screen looks like:









The menu system prompts you through programming and sales. Always follow the instructions on the screen. Refer to this manual for detailed information about the options on the screen.

You may see a scroll bar on the right side of the screen. This means that there are more options to see if you use the **Arrow Up** and **Arrow Down** keys.



When you are programming, you also see text that moves across the bottom of the screen. This text provides a brief explanation of the selected option.

As you use the cash register, you notice symbols on the lower left of the 5th line. These symbols are:

-  Enter uppercase alphabetical letters using the **Department** key in Caps On mode.
-  Enter lowercase alphabetical letters using the **Department** key in Caps Off mode.
-  Enter numbers using the rounded number keys.
-  Enter symbols and international characters by pressing the **#/ NS** **<sym>** key.
-  Scan a barcode using the optional barcode reader.
-  The cash register is in Training Mode.
-  Receipt printer is turned off in Sales Registration mode.

Using the Keyboard

The keyboard on your cash register looks like the following:

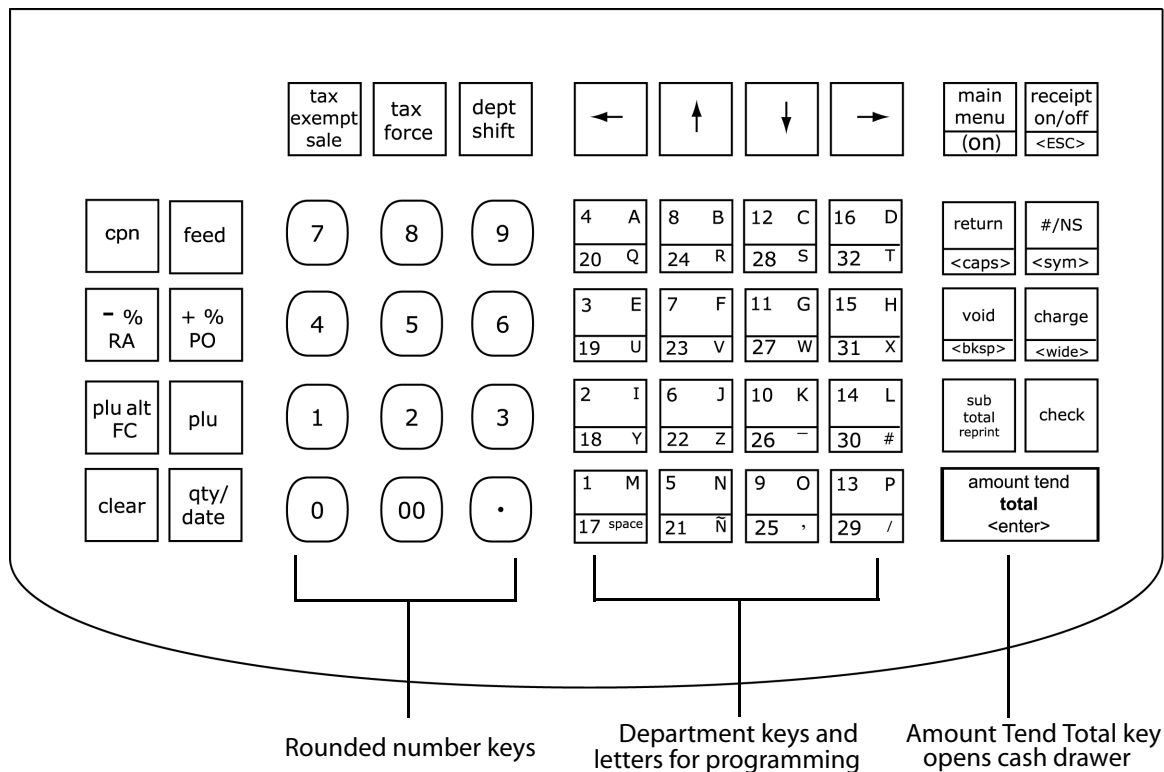

To use the keyboard, do the following:

amount tend
total
<enter>

- To use the cash register, press the **Main menu (on)** key. Select Sales Registration and press the **Amount Tend Total <Enter>** key. Now you can press the round Number keys and Department keys to ring up a sale. For more information about ringing up sales, see Ringing up Sales and Using Training Mode on page 62.

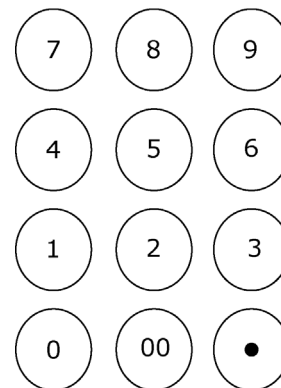

amount tend
total
<enter>

- To program the cash register, press the **Main menu (on)** key. Select Programming and press the **Amount Tend Total <Enter>** key. For more information about programming the cash register, see Setting Up Your Cash Register - the Basics on page 19 and Setting Up Your Cash Register Parameters on page 48.

The following identifies some of the keys on the keyboard and what you can use them for

Table 1 Navigating keyboard

Use this key...	To do this...
cpn	<ul style="list-style-type: none"> enter single entry coupon discounts
feed	<ul style="list-style-type: none"> feed paper through the printer
- % RA	<ul style="list-style-type: none"> use Percent Discount use Received On Account
+ % PO	<ul style="list-style-type: none"> use Percent Add-On use Cash Paid-Out
plu alt FC	<ul style="list-style-type: none"> override PLU preset price use Foreign Currency conversion
plu	<ul style="list-style-type: none"> enter a PLU number manually
clear	<ul style="list-style-type: none"> clear an entry
qty/ date	<ul style="list-style-type: none"> enter multiple quantities of a PLU or Department during a sale show the default date/time/status screen on the clerk display between sales in the Sales Registration mode
tax exempt sale	<ul style="list-style-type: none"> set an entire sales transaction as tax exempt, before pressing the Amount Tend Total key. For example, you might be selling to a non-profit organization or a reseller.
tax force	<ul style="list-style-type: none"> override the pre-programmed tax rate for an item with a different tax rate or tax exempt a single item

Table 1 Navigating keyboard

Use this key...	To do this...
<div style="display: flex; flex-wrap: wrap;"> <div style="border: 1px solid black; padding: 2px; margin-right: 2px; margin-bottom: 2px;">←</div> <div style="border: 1px solid black; padding: 2px; margin-right: 2px; margin-bottom: 2px;">↑</div> <div style="border: 1px solid black; padding: 2px; margin-right: 2px;">↓</div> <div style="border: 1px solid black; padding: 2px; margin-right: 2px;">→</div> </div>	<ul style="list-style-type: none"> • select items from the menus in the clerk display • move the cursor on the screen
<div style="border: 1px solid black; padding: 2px; width: fit-content;">main menu (on)</div>	<ul style="list-style-type: none"> • go directly back to the Main menu from any point in the cash register menus • turn the cash register on
<div style="border: 1px solid black; padding: 2px; width: fit-content;">receipt on/off <ESC></div>	<ul style="list-style-type: none"> • turn the receipt printer on or off • exit the current screen and go back to the previous screen
<div style="border: 1px solid black; padding: 2px; width: fit-content;">return <caps></div>	<ul style="list-style-type: none"> • process a returned item as a credit sale • use caps key for typing capital letters or lower-case letters using the alphabet on the Department keys
<div style="border: 1px solid black; padding: 2px; width: fit-content;">#/NS <sym></div>	<ul style="list-style-type: none"> • enter a descriptive or reference number during a sale, such as an invoice number or product serial number • open the cash drawer and ring a No-Sale transaction • see the symbol and international character set screen
<div style="border: 1px solid black; padding: 2px; width: fit-content;">void <bksp></div>	<ul style="list-style-type: none"> • void a line item in a sales transaction or • ring an entire voided sale transaction • backspace and delete one character at a time during text and description entries in Programming mode
<div style="border: 1px solid black; padding: 2px; width: fit-content;">charge <wide></div>	<ul style="list-style-type: none"> • end a sale as a Charge sale paid for by a credit card • enter a character as double-wide during text and description entries in Programming mode
<div style="border: 1px solid black; padding: 2px; width: fit-content;">sub total reprint</div>	<ul style="list-style-type: none"> • subtotal a sales transaction • reprint the sales receipt for the previous sales transaction before another transaction is started
<div style="border: 1px solid black; padding: 2px; width: fit-content;">check</div>	<ul style="list-style-type: none"> • end a sale paid for with check or money order

Table 1 Navigating keyboard

Use this key...	To do this...
<div style="border: 1px solid black; padding: 2px; display: inline-block;"> amount tend total <enter> </div>	<ul style="list-style-type: none"> • end a sale paid for with cash • enter the dollar amount the customer gave you for a cash sale and the register calculates change • to enter and accept all entries in the Program mode and Reports mode

Turning the Register Off and On

You should turn the cash register off when you are not using it. The keyboard does not work and the cash drawer is electronically locked. A small amount of power maintains the programming and transaction data totals.

Note

You cannot turn the cash register off while you are in a transaction. You must complete all transactions before you turn the cash register off.

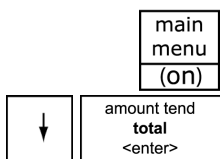

To turn the cash register off

- 1 Press the **Main menu (on)** key.
- 2 Press the **Arrow Down** key to select Off on the operator display. Press the **Amount Tend Total <Enter>** key. The cash register turns off.



To turn the cash register on

- ◆ To turn the register on again, press **Main menu (on)**.

Using the Cash Drawer

The cash drawer is where you put the money after you ring up a sale. The cash drawer has slots for putting paper bills and a removable tray for coins. You can store paper items such as checks and charge slips under the removable coin tray.

When you ring up a sale, the cash drawer automatically opens so you can make change and put money away. You can also electronically open the cash drawer without making a sale. This is handy if you need to make change for someone or forgot to put something away. Press the **#/NS <SYM>** key.



The cash drawer locks in 2 different ways. Locking the cash drawer is a good idea if you need to leave the cash register.

- The cash drawer automatically locks electronically when you turn the cash register off. The emergency open lever will still open the cash drawer when it is electronically locked.
- You can also use the 515 key to mechanically lock the cash drawer. If you lock the cash drawer this way, you must have the key to open it again. Even the emergency open lever will not open the cash drawer when it is locked with the key.

Important

If the cash drawer will not open, see if the lock on the cash drawer is turned to the right. If it is, the drawer is locked with the 515 key. You need the key to unlock the cash drawer. If the key is lost or locked in the cash drawer, contact Royal.

When you are using the cash drawer, make sure you lower the bill arms before you close the cash drawer. Never slam the drawer closed.

To open the cash drawer after a sale

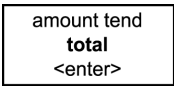

- 1 When you are done ringing up a sale, press the **Amount Tend Total <Enter>** key at the bottom right of the keyboard. The cash drawer opens. You can make change and put the money in the drawer.
- 2 When you are done, push the cash drawer closed.

To open the cash drawer without making a sale



- 1 Press the **#/NS <SYM>** key at the bottom right of the keyboard. The cash drawer opens and a No Sale receipt prints.
- 2 When you are done, push the cash drawer closed. These “no-sale transactions” are recorded in the Electronic Journal for an audit trail if the Electronic Journal is turned on. For more information, see 3. Electronic Journal on page 52.

To lock and unlock the cash drawer using the key

- 1 Using the small key labeled 515, put the key in the lock in the front of the cash drawer.
- 2 To lock the cash drawer, turn the key to the right and remove the key from the lock.
- 3 To unlock the cash drawer, turn the key to the left and remove the key from the lock.

To open the cash drawer using the emergency lever

- 1 With your hands on the cash drawer, carefully tip the front of the register up. Underneath the cash register, toward the back of the register, you see a small lever.

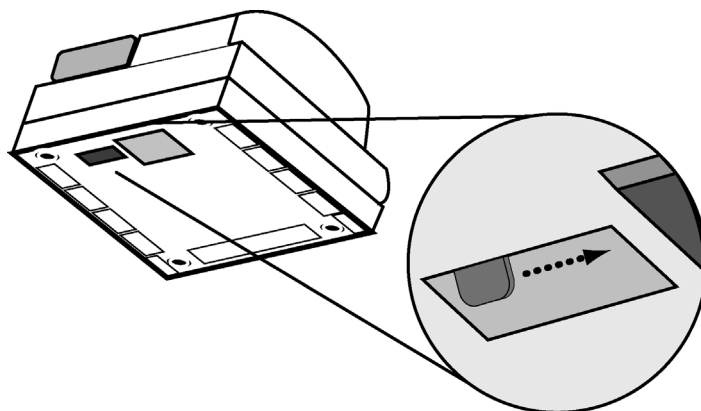

- 2 Push the lever in the only direction it will move. The cash drawer opens. If the cash drawer will not open, make sure it is not locked with the 515 Drawer key.

Using the Accessory Drawer

Your cash register has a small drawer above the cash drawer. The Accessory drawer can be opened at any time by anyone. It is a good place to put things like pens, pencils, and note pads.

Because the drawer cannot be locked, it is not a good idea to put checks or valuables in it. You should put those in the cash drawer, under the coin tray.

Setting Up Your Cash Register - the Basics

This chapter includes explanations for:

- Specifying messages on the display and on receipts
- Setting clerk names and numbers
- Setting machine numbers
- Setting clerk and manager passcodes
- Programming department keys
- Programming PLUs
- Clearing error codes
- and more

Using the Displays

Your cash register includes two displays: 1 for the clerk, or operator, and 1 for the customer. The customer display shows large, easy to read fluorescent digits for easy viewing.

The Clerk Screen

The clerk screen prompts you through setting up the cash register and using it to ring up sales. The main screen on the display looks like this:

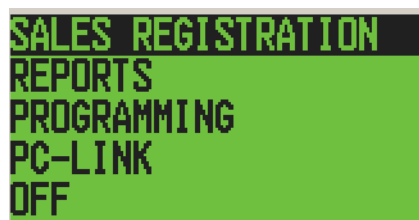

When ringing up sales, you see the department number or PLU number on the clerk screen. If a description or name is programmed, this description appears.

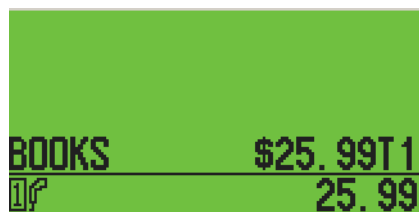

Navigating the Clerk Screen

Navigating the clerk screen is easy. Use these following keys:

Table 2 Navigating the clerk screen

To do this...	Press this...
See the main menu	main menu (on)
Move up and down through the menu options	← ↑ ↓ →
Select the highlighted option	amount tend total <enter>
Go back one menu level	receipt on/off <ESC>
Clear your typed entry and start over	clear
Clear the last character entered	void <bksp>

Adjusting the Contrast on the Clerk Screen

You can adjust the contrast on the clerk screen to make it brighter or darker. This makes it easier for you to see the display in different lighting.

To adjust the contrast

Programming ▶ More Options ▶ Config ▶ Contrast

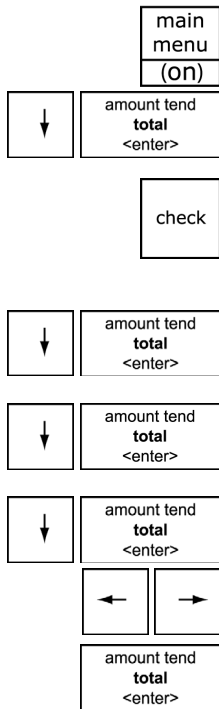

- 1 Press the **Main menu (on)** key.
- 2 Press the **Arrow Down** key to select Programming. Press the **Amount Tend Total <Enter>** key.
- 3 If you are prompted for a Manager Passcode, type the passcode number and then press the **Check** key. If you did not program a Manager Passcode, go to the next step.
- 4 Press the **Arrow Down** key to select More Options. Press the **Amount Tend Total <Enter>** key.
- 5 Press the **Arrow Down** key to select Config. Press the **Amount Tend Total <Enter>** key.
- 6 Press the **Arrow Down** key to select Contrast. Press the **Amount Tend Total <Enter>** key.
- 7 Use the **Left Arrow** and **Right Arrow** keys to adjust the contrast.
- 8 When you are done, press the **Amount Tend Total <Enter>** key.

Using Power Saving Mode

The cash register includes a power saving, or “sleep” mode. This mode saves energy and prevents the clerk display from getting damaged by “burn-in”—just like a screen saver on your laptop or PC.

After a specified period of minutes of inactivity, the cash register goes into sleep mode and the clerk display goes dark. The cash register does not actually turn all the way off, it just goes to sleep.

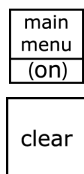

To wake the unit up, press the **Main menu <On>** key or the **Clear** key. The **Main menu <On>** key turns the cash register on if it is in sleep mode or it was turned off using the main menu.

The **Clear** key turns the display on if the cash register is in sleep mode. The **Clear** key does not turn the cash register on if it was turned off on using the main menu.

The default time before the cash register goes to sleep is 3 minutes, but you can change this.

To change the power saving time

Programming ▶ More Options ▶ Config ▶ Power Saving

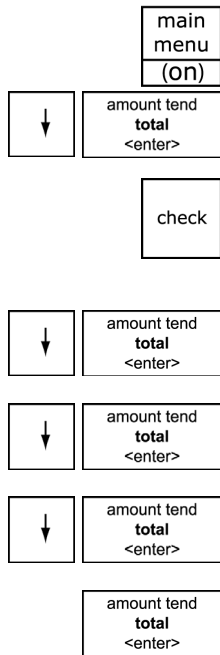

- 1 Press the **Main menu (on)** key.
- 2 Press the **Arrow Down** key to select Programming. Press the **Amount Tend Total <Enter>** key.
- 3 If you are prompted for a Manager Passcode, type the passcode number and then press the **Check** key. If you did not program a Manager Passcode, go to the next step.
- 4 Press the **Arrow Down** key to select More Options. Press the **Amount Tend Total <Enter>** key.
- 5 Press the **Arrow Down** key to select Config. Press the **Amount Tend Total <Enter>** key.
- 6 Press the **Arrow Down** key to select Power Saving. Press the **Amount Tend Total <Enter>** key.
- 7 Make your selection. When you are done, press the **Amount Tend Total <Enter>** key.

Setting Alphanumeric Descriptions

You can program custom header and footer messages, clerk names, departments, and item descriptions. These text messages and descriptions appear on the receipt and on the customer display.

When you are programming the alpha descriptions for Departments, PLUs, Clerks, the Header and Footer messages, use the Alpha Keyboard.



Note
Only capital letters of the alphabet are on the Alpha Keyboard. To use lower case letters, press the **Return <caps>** key.

The department keys are clearly labeled with all the letters needed to program these descriptions. When you are programming alpha descriptions, use the department keys to spell out the words you want.



To use the letters in the white part of the Department keys, simply press the Department key.

4 A	8 B	12 C	16 D
20 Q	24 R	28 S	32 T
3 E	7 F	11 G	15 H
19 U	23 V	27 W	31 X
2 I	6 J	10 K	14 L
18 Y	22 Z	26 -	30 #
1 M	5 N	9 O	13 P
17 space	21 Ñ	25 ,	29 /



To use the letters and characters in the lower green area of the keys, press the **Dept Shift** key and then press the key with the letter you want.

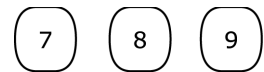

Use the round number keys to enter any numbers you want.



You may need certain special symbols on the Alpha Keyboard. For example, if you need a space between words, if you need the / symbol, or if you need a comma, press the **Dept Shift** key and then press the Department key that has the character you want.

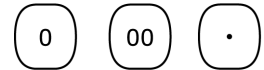
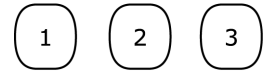

Some symbols and international characters are only available using the **# / NS <sym>** key. When you press the **# / NS <sym>** key, use the arrow keys to move through the symbols to highlight the symbol you want. Press the **Amount Tend Total <Enter>** key to select the highlighted symbol. Press the **# / NS <sym>** key again to exit this from screen.

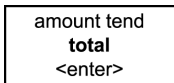

Important

If you enter the wrong character, press the **Void <bkspace>** key to delete the character. Now you can continue.

07

The maximum number of characters that can be programmed for each item description are shown below. As you enter text descriptions, the lower left of the clerk screen also shows you the remaining characters available.

- Department 12 Characters
- PLU 12 Characters
- Clerk Name 24 Characters
- Header and Footer messages 5 Lines (24 characters each)
- For programming text messages that appear on the customer display and the receipt, see Setting Header Messages and Footer Messages on page 24.
- For programming department keys, see Programming Department Keys on page 32.
- For programming PLUs, see Programming PLU Descriptions on page 42.
- For programming Clerk names and numbers, see Setting Clerk Numbers and Names on page 27.

Using Double Wide Characters

For extra emphasis, you can program double wide characters for a specific character or a line of characters.

Normal Size

```
*****
*   YOUR RECEIPT   *
*   THANK YOU      *
*                   *
*****
11-10-01  MC #:0000
APPLE          $1.00
BANANA         $1.00
PEAR           $1.00
-----
TOTAL          $3.00
CASH           $3.00
AM10-49  0013
```

Double Wide

```
*****
*   YOUR RECEIPT   *
*   THANK YOU      *
*                   *
*****
11-10-01  MC #:0000
APPLE          $1.00
BANANA         $1.00
PEAR           $1.00
-----
TOTAL          $3.00
CASH           $3.00
AM10-51  0015
```

If you use double wide characters, the maximum number of characters you can use is reduced by half.

- Department 6 Characters
- PLU 6 Characters
- Clerk Name 12 Characters
- Header and Footer messages 5 Lines (12 characters each)



To make a character print extra wide, press the **Charge <wide>** key before each character as you type in the description.

Setting Header Messages and Footer Messages

You can specify a header message and/or footer message to print on customer receipts. Each message can be a maximum of 5 lines. Each line can have 24 characters.

```
YOUR RECEIPT
  THANK YOU
```

is the default printout for the header message.

```
HAVE A NICE DAY
PLEASE COME AGAIN
```

is the default printout for the footer message.

Make a copy of the blank Worksheet below for future changes or revisions to your header message or footer message.

Header Message or Footer Message Worksheet

Use this worksheet to make your header message or footer message. Make a copy of the blank worksheet before you start, in case you make a mistake or change your mind.

Line 1																				
Line 2																				
Line 3																				
Line 4																				
Line 5																				



Important

If you enter the wrong character, press the **Void <bksp>** key to delete the character. Now you can continue.

The text in the header message and the footer message is automatically centered. If you do not want the message to be centered, enter the rest of the characters as spaces at the beginning or the end of the text to right or left align your text.

Before programming your header or footer message

- 1 Write out your store name and the header message you want to program.
- 2 After writing out your message, count the number of characters on each line. The following example shows a message and the letter count, including spaces.

```
INTERNATIONAL COFFEES           21
999-555-1212                     12
222 EAST MAIN STREET            20
OPEN 7AM TO 6PM                 15
COFFEES OF THE WORLD            20
```

- 3 Complete the chart, filling in extra unused characters with blank spaces. The text for each line is automatically centered.

Line 1		I	N	T	E	R	N	A	T	I	O	N	A	L		C	O	F	F	E	E	S		
Line 2						9	9	9	-	5	5	5	-	1	2	1	2							
Line 3			2	2	2		E	A	S	T		M	A	I	N		S	T	R	E	E	T		
Line 4						O	P	E	N		7	A	M		T	O		6	P	M				
Line 5			C	O	F	F	E	E	S		O	F		T	H	E		W	O	R	L	D		

Remember, you can make the characters double width but you can only use half the total number of characters if you do this. For example, if you want `Coffee` to be double wide, you need 12 spaces. For more information about double wide characters, see *Using Double Wide Characters* on page 24.

#/NS
<sym>

You can also use characters other than those on the Department keys, such as numbers, punctuation, and international letters by pressing the **#\NS <SYM>** key.

This is an example of the programmed header message:

```
INTERNATIONAL COFFEES
      999-555-1212
222 EAST MAIN STREET
      OPEN 7AM TO 6PM
COFFEES OF THE WORLD
```

dept shift	1 M
	17 space

To add a space to separate words, press the **Department Shift** key and then the **Department 17** key.

void
<bksp>

Important

If you enter the wrong character, press the **Void <bksp>** key to delete the character. Now you can continue.

To program header messages or footer messages

Programming ▶ More Options ▶ Text Messages

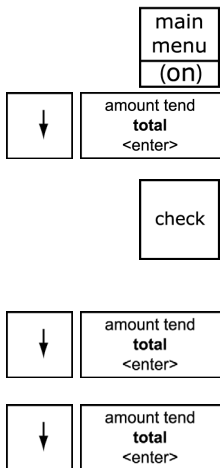

- 1 Press the **Main menu (on)** key.
- 2 Press the **Arrow Down** key to select Programming. Press the **Amount Tend Total <Enter>** key.
- 3 If you are prompted for a Manager Passcode, type the passcode number and then press the **Check** key. If you did not program a Manager Passcode, go to the next step.
- 4 Press the **Arrow Down** key to select More Options. Press the **Amount Tend Total <Enter>** key.
- 5 Press the **Arrow Down** key to select Text Messages. Press the **Amount Tend Total <Enter>** key.
- 6 Select the text message you want to program.
- 7 Follow the instructions on the display.

Printing Options on Receipts

You can specify if the following prints on receipts:

- Headers and footers
- Clerk name and number
- Machine number
- Transaction number
- Date and time
- Tax total, amount and location
- Department name or PLU name
- and more

To set receipt printing options

Programming ▶ More Options ▶ Print Options

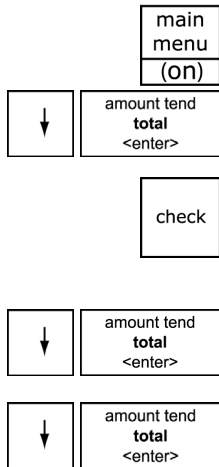

- 1 Press the **Main menu (on)** key.
- 2 Press the **Arrow Down** key to select Programming. Press the **Amount Tend Total <Enter>** key.
- 3 If you are prompted for a Manager Passcode, type the passcode number and then press the **Check** key. If you did not program a Manager Passcode, go to the next step.
- 4 Press the **Arrow Down** key to select More Options. Press the **Amount Tend Total <Enter>** key.
- 5 Press the **Arrow Down** key to select Print Options. Press the **Amount Tend Total <Enter>** key.
- 6 Follow the instructions on the display.

Setting Clerk Numbers and Names

You can program and assign up to 40 Clerk Numbers so you can monitor sales by individual employees. Each clerk number can also be assigned a 24 character name.

To see the sales totals for each clerk, a Clerk Report is available in both the X and Z modes.

You can spell names by using department keys. For more information, see Setting Alphanumeric Descriptions on page 22.

After you specify Clerk Numbers and Names, you must set Clerk System to On so clerks must enter their clerk number each time they enter Sales Registration mode.

You must turn on Clerk passcodes separately if you want passcodes to be required when the clerk number is entered.

Note

When clerks enter passcodes, passcodes appear as asterisks *** on the displays for extra security.

After you are done programming clerk numbers, you can check your results. See Running the Options Dump Report on page 79.

Important

If you enter the wrong character, press the **Void <bksp>** key to delete the character. Now you can continue.



To set a clerk number and program a name and passcode

Programming ▶ Security Set Up ▶ Clerk Set Up

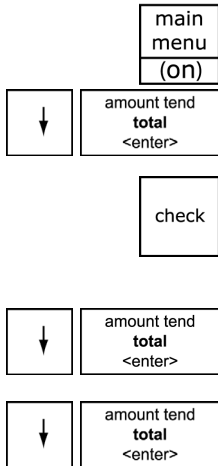

- 1 Press the **Main menu (on)** key.
- 2 Press the **Arrow Down** key to select Programming. Press the **Amount Tend Total <Enter>** key.
- 3 If you are prompted for a Manager Passcode, type the passcode number and then press the **Check** key. If you did not program a Manager Passcode, go to the next step.
- 4 Press the **Arrow Down** key to select Security Set Up. Press the **Amount Tend Total <Enter>** key.
- 5 Press the **Arrow Down** key to select Clerk Set Up. Press the **Amount Tend Total <Enter>** key.
- 6 Follow the instructions on the display.
Now you need to turn on Clerk Security.

To turn on Clerk Security

Programming ▶ Security Set Up ▶ Clerk System

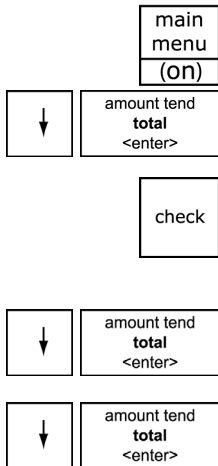

- 1 Press the press the **Main menu (on)** key.
- 2 Press the **Arrow Down** key to select Programming. Press the **Amount Tend Total <Enter>** key.
- 3 If you are prompted for a Manager Passcode, type the passcode number and then press the **Check** key. If you did not program a Manager Passcode, go to the next step.
- 4 Press the **Arrow Down** key to select Security Set Up. Press the **Amount Tend Total <Enter>** key.
- 5 Press the **Arrow Down** key to select Clerk System. Press the **Amount Tend Total <Enter>** key.

amount tend
total
<enter>

- 6 Select On. Press the **Amount Tend Total <Enter>** key. Now when the clerk enters Sales Registration mode, s/he is prompted for the clerk number.

To turn on Clerk Passcodes

Programming ▶ Security Set Up ▶ Clerk Passcode

main
menu
(On)

↓

amount tend
total
<enter>

- 1 Press the **Main menu (on)** key.
- 2 Press the **Arrow Down** key to select Programming. Press the **Amount Tend Total <Enter>** key.

check

- 3 If you are prompted for a Manager Passcode, type the passcode number and then press the **Check** key. If you did not program a Manager Passcode, go to the next step.

↓

amount tend
total
<enter>

- 4 Press the **Arrow Down** key to select Security Set Up. Press the **Amount Tend Total <Enter>** key.

↓

amount tend
total
<enter>

- 5 Press the **Arrow Down** key to select Clerk Passcode. Press the **Amount Tend Total <Enter>** key.

amount tend
total
<enter>

- 6 Select On. Press the **Amount Tend Total <Enter>** key. Now when the clerk enters Sales Registration mode, s/he is prompted for the clerk number and passcode.

Using the Clerk System

If the clerk security system is active, the clerk is prompted to enter the clerk number and passcode when they enter the Sales Registration mode.

To use the clerk system

amount tend
total
<enter>

- 1 Make sure Sales Registration is highlighted on the main menu and press the **Amount Tend Total <enter>** key.

amount tend
total
<enter>

- 2 Using the round Number keys, enter the clerk number and then press the **Amount Tend Total <enter>** key.

check

- 3 If prompted for a passcode, use the round Number keys and press the three digit passcode. Then press the **Check** key.

To use clerk numbers (example)

Example 1: Clerk #1 has a passcode of 234

amount tend
total
<enter>

- 1 At the main menu, select Sales Registration and press the **Amount Tend Total <Enter>** key.

amount tend
total
<enter>

- 2 Using the round Number keys, press 1, then press the **Amount Tend Total <Enter>** key.

check

- 3 Press 234 and then press the **Check** key.

Setting X and Manager Passcodes

Manager passcodes are available for added security:

- to go to the PRG and Z modes
- to go to the X mode.

Important

The Manager passcode cannot be 0000 (zeros). The cash register will not accept this passcode.

Caution

Write your passcodes down in a safe place. If you forget the passcodes, you must do a Full System Clear procedure. A Full System Clear erases all transaction information and programming. For details on the Full System Clear, see Full System Clear on page 97.

After you program a passcode, you must use it every time you go to the program mode or to go to X or Z report modes, depending on which you set the passcode for.

When you enter a passcode, it appears as asterisks **** on the displays for extra security.

To set manager passcodes (also known as PRG/Z passcodes)

Programming ▶ Security Set Up ▶ Manager Passcode

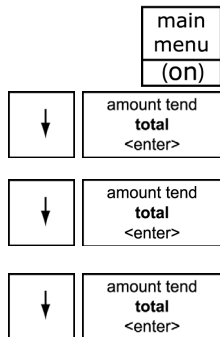

- 1 Press the **Main menu (on)** key.
- 2 Press the **Arrow Down** key to select Programming. Press the **Amount Tend Total <Enter>** key.
- 3 Press the **Arrow Down** key to select Security Set Up. Press the **Amount Tend Total <Enter>** key.
- 4 Press the **Arrow Down** key to select Manager Passcode. Press the **Amount Tend Total <Enter>** key.
- 5 Follow the instructions on the display.

To set the X passcode

Programming ▶ Security Set Up ▶ X Mode Passcode

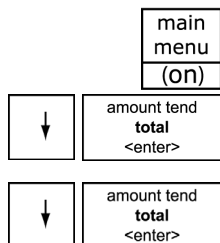

- 1 Press the **Main menu (on)** key.
- 2 Press the **Arrow Down** key to select Programming. Press the **Amount Tend Total <Enter>** key.
- 3 Press the **Arrow Down** key to select Security Set Up. Press the **Amount Tend Total <Enter>** key.

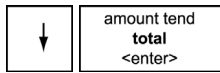

- 4 Press the **Arrow Down** key to select X Mode Passcode. Press the **Amount Tend Total <Enter>** key.
- 5 Follow the instructions on the display.

To use the X mode passcode

Example 2: Go to the X mode, using the X Passcode 1212

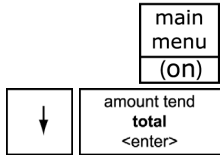

- 1 Press the **Main menu (on)** key.
- 2 Press the **Arrow Down** key to select Reports. Press the **Amount Tend Total <Enter>** key.
- 3 Select X Reports. Press the **Amount Tend Total <Enter>** key.
- 4 Using the round Number keys, press 1212 and then press the **Check** key.
- 5 You are now ready to run X Reports.

To use the manager passcode

Example 3: Go to the Z mode, using the Manager Passcode 1313

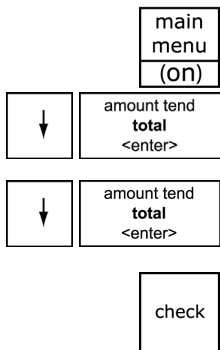

- 1 Press the **Main menu (on)** key.
- 2 Press the **Arrow Down** key to select Reports. Press the **Amount Tend Total <Enter>** key.
- 3 Press the **Arrow Down** key to select Z Reports. Press the **Amount Tend Total <Enter>** key.
- 4 Using the round Number keys, press 1313 and then press the **Check** key.
- 5 You are now ready to run Z reports.

Setting the Machine Number

You can assign your cash register its own number. This is useful if you have several cash registers and want to track which one creates which receipts and transactions.

The machine number prints on all receipts/journal records, and management reports. The machine number can be up to 4 digits long.

After you are done programming the machine number, you can check your results. See Printing the Program Confirmation Report on page 44.

To set the machine number

Programming ▶ More Options ▶ Others Set Up ▶ Machine Number



- 1 Press the **Main menu (on)** key.

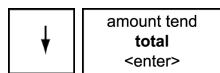

2 Press the **Arrow Down** key to select Programming. Press the **Amount Tend Total <Enter>** key.



3 If you are prompted for a Manager Passcode, type the passcode number and then press the **Check** key. If you did not program a Manager Passcode, go to the next step.

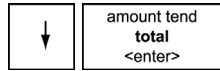

4 Press the **Arrow Down** key to select More Options. Press the **Amount Tend Total <Enter>** key.

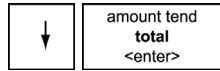

5 Press the **Arrow Down** key to select Others Set Up. Press the **Amount Tend Total <Enter>** key.

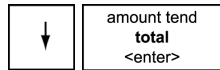

6 Press the **Arrow Down** key to select Machine Number. Press the **Amount Tend Total <Enter>** key.

7 Follow the instructions on the display.

Programming Department Keys

Departments are a category of merchandise. For example, Department 1 can be Housewares, Department 2 can be Food, Department 3 can be Womens Clothing, and so on. This helps you track what you are selling.

Each department can be programmed as taxable or non-taxable, so that if an item needs to be taxed, the proper tax amount is added automatically when you ring up an item in a taxable department.

You can have as many as 200 departments on your cash register. If you have many departments, you may want to make a list so other people who use the cash register can correctly use the department keys.

Programming departments includes up to 8 steps. Not all steps listed below may apply to your specific needs.

- 1** Setting Department numbers and assigning to a Department Number key (for Department numbers 1 through 32)
- 2** Programming Department Names
- 3** Programming Department Preset Price
- 4** Programming Tax Status
- 5** Setting Standard, Gallonage or Negative Mode
- 6** Setting Department Type
- 7** Setting High Amount Lock-out (HALO)
- 8** Programming Age Verification

For specific information about each of the items above, see the next sections.

After you are done, you can check your results. See Running the Department Confirmation Report on page 80.

To program department keys

Programming ▶ Department Set Up

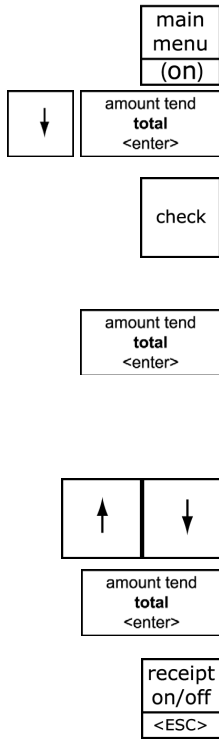

- 1 Press the **Main menu (on)** key.
- 2 Press the **Arrow Down** key to select Programming. Press the **Amount Tend Total <Enter>** key.
- 3 If you are prompted for a Manager Passcode, type the passcode number and then press the **Check** key. If you did not program a Manager Passcode, go to the next step.
- 4 Select Department Set Up and press the **Amount Tend Total <Enter>** key.
- 5 Follow the prompts on the screen to program the information for your departments.

Use the **Arrow Up** and **Arrow Down** keys to highlight items on the screen. Press the **Amount Tend Total <Enter>** key to enter your selections.

The next sections explain what you can program for each department.

- 6 When you are done programming all departments, press the **Receipt on/off <esc>** key. To add another department, press the **Arrow Down** key to select Next Department.

Setting Department Number Keys

You must assign a department number. You can specify up to 200 Department numbers. At the prompt, use the round Number keys to enter the department number you want to program. Press the **Amount Tend/Total <enter>** key to save your programming.

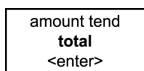

Programming Department Names

A name or description can be assigned to each department key. This name appears on the clerk screen and prints when ringing up sales.

For example, Clothing can print on the receipt in place of Dept 1, Shoes can print on the receipt in place of Dept 2, Sportswear can print on the receipt in place of Department 3, and so on.

When you are programming the alpha descriptions for Departments and PLUs use the Alpha Keyboard.

4 A	8 B	12 C	16 D
20 Q	24 R	28 S	32 T
3 E	7 F	11 G	15 H
19 U	23 V	27 W	31 X
2 I	6 J	10 K	14 L
18 Y	22 Z	26 -	30 #
1 M	5 N	9 O	13 P
17 space	21 Ñ	25 ,	29 /

return
<caps>

Note
Only capital letters of the alphabet are on the Alpha Keyboard. To use lower case letters, press the **Return <caps>** key.

The department keys are clearly labeled with all the letters needed to program these descriptions. When you are programming alpha descriptions, use the department keys to spell out the words you want.

1 M
17 space

To use the letters in the white part of the Department keys, simply press the Department key.

dept shift

To use the letters and characters in the lower green area of the keys, press the **Dept Shift** key and then press the key with the letter you want.

7	8	9
4	5	6
1	2	3
0	00	.

Use the round number keys to enter any numbers you want.

dept shift

You may need certain special symbols on the Alpha Keyboard. For example, if you need a space between words, if you need the / symbol, or if you need a comma, press the **Dept Shift** key and then press the Department key that has the character you want.

#/NS
<sym>

amount tend total <enter>

Some symbols and international characters are only available using the **# / NS <sym>** key. When you press the **# / NS <sym>** key, use the arrow keys to move through the symbols to highlight the symbol you want. Press the **Amount Tend Total <Enter>** key to select the highlighted symbol. Press the **# / NS <sym>** key again to exit this from screen.

void
<bksp>

Important
If you enter the wrong character, press the **Void <bksp>** key to delete the character. Now you can continue.

amount tend total <enter>

When you are done programming the department description, press the **Amount Tend Total <Enter>** key to save your programming. The information is saved in the cash register and you can program the next item.

Programming Department Preset Price

Department Preset Price programs a preset price in a department to save time when ringing up an entry. Even if a price has been pre-programmed, you can override the price at the time of sale.

The price automatically rings up each time that department key is pressed.

Programming Tax Status

Some items must have tax collected by law. You can program your cash register to automatically assign the right amount of tax, based on the department the item is assigned to.

You can set no tax, or link to a single tax rate (Tax 1, Tax 2, Tax 3, or Tax 4) or multiple tax rates to a department key. For information about setting the tax rates, see *Selecting the Tax System* on page 70. You must program non-tax or a tax rate for the department programming to be accepted.

Table 3 Tax status settings

Available tax status settings

Non-Tax (use this if you do not want to charge tax)

TAX 1

TAX 2

TAX 3

TAX 4

TAX 1 and TAX 2

TAX 1 and TAX 3

TAX 1 and TAX 4

TAX 2 and TAX 3

TAX 2 and TAX 4

TAX 3 and TAX 4

TAX 1, TAX 2 and TAX 3

TAX 1, TAX 2 and TAX 4

TAX 1, TAX 3 and TAX 4

TAX 2, TAX 3 and TAX 4

TAX 1, TAX 2, TAX 3 and TAX 4

Setting Department Type

Normal Item Entry allows you to ring up two or more items into a department. For example, if you want to ring up 5 of the same items, you can tell the cash register to multiply the one price by the number of items.

Single Item Entry allows you to ring up only one item in a department and ends the sale as a cash sale as soon as the Department key is pressed.

Setting Standard, Gallonage or Negative Mode

A department can be set for Standard Mode, Gallonage Mode, or Negative Mode.

Gallonage Mode allows entering a price with 3 decimal places, representing the cost per gallon, pound, kilogram, yard, meter, or other unit of measurement. For example, \$2.899 per gallon.

The quantity, representing the unit of measurement, can also be entered in up to 3 decimal places. This lets you enter 10.931 gallons of gasoline at \$2.899 a gallon.

Standard Mode enters the price using the normal 2 decimal place setting.

Negative Mode allows you to set the price to a negative number. This is useful when you need to assign preset discounts or coupons. Using Negative Mode allows you to track the number of discounts given or the number of times the discounts were given more closely than simply assigning a discount amount with the **Coupon** key.

Setting High Amount Lock-out (HALO)



You can specify the largest amount that can be rung up in an entry. This feature helps to prevent against large over-rings. If too many digits are entered, the error beep sounds and the keypad locks up. Use the **Arrow Up** and **Arrow Down** keys to select the HALO limit you want.

Setting Age Limits

When you are setting up departments, you can specify that the cash register prompts the clerk to validate an age requirement before the item is rung up in that department. This helps meet legal requirements if you are selling items that are restricted to age groups, such as alcohol or tobacco.

This reminds the clerk to check ID and prompts the clerk with the appropriate age needed. This feature does not prevent sales to age

inappropriate customers; it simply provides a reminder to the clerk that this is an age-controlled item.

You have 3 default options:

- No age No age validation (the default setting for each department.)
- Age 1 Prompts the clerk with a date 18 years ago from date of sale.
- Age 2 Prompts the clerk with a date 21 years ago from date of sale.

You can change the exact ages for Age 1 and Age 2.

To change the default ages for Age 1 and Age 2

Programming ▶ More Options ▶ Others Set Up

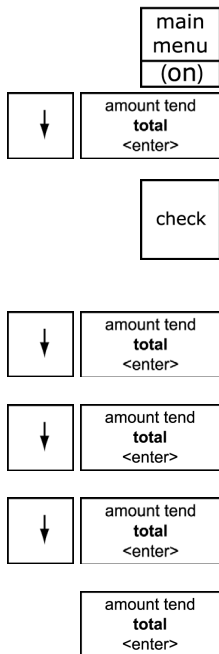

- 1 Press the **Main menu (on)** key.
- 2 Press the Arrow Down key to select Programming. Press the **Amount Tend Total <Enter>** key.
- 3 If you are prompted for a Manager Passcode, type the passcode number and then press the **Check** key. If you did not program a Manager Passcode, go to the next step.
- 4 Press the Arrow Down key to select More Options. Press the **Amount Tend Total <Enter>** key.
- 5 Press the Arrow Down key to select Others Setup. Press the **Amount Tend Total <Enter>** key.
- 6 Press the Arrow Down key to select either Age 1 Setup or Age 2 Setup. Press the **Amount Tend Total <Enter>** key.
- 7 Using the rounded Number keys, enter the age you want. Press the **Amount Tend Total <Enter>** key.

Scrolling Messages

Your cash register shows messages that move across the customer display when the register is not in use. You can use the pre-programmed default messages or you can program your own.

You can change one or more messages at any time. For example, if you have a new promotion, you can change the Idle 1 message to say something about the promotion. You can also specify if the messages scroll slow, medium or fast across the customer display.

Types of Scrolling Messages

You can program the following types of scrolling messages

Table 4 Scrolling messages

Message Type	This message shows:.
OFF message	When the register is in the OFF position
Prg X Z Mode	During the idle state when the register is in Programming, X Report, or Z Report modes
SALES message	After the sales transaction
IDLE message AM	When the register is in the idle state while in Sales Registration mode during the morning hours
IDLE message PM	When the register is in the idle state while in Sales Registration mode during the afternoon hours

Default Scrolling Messages

The following customer messages appear automatically.

Off Message	CLOSED, NEXT REGISTER PLEASE
Prg, X, Z Message	PLEASE WAIT
Sales Message	PLEASE TAKE YOUR RECEIPT
Idle Message 1	GOOD MORNING
Idle Message 2	GOOD AFTERNOON

You can change these default messages, using the following instructions.

Sample Scrolling Messages

Here are some samples of messages that you can program:

Ask About Our Daily Specials
We Deliver
10% Discount On Thursdays
Free Soda With Any Sandwich Order
STORE HOURS 9AM TO 10 PM

Programming Scrolling Messages

Use the steps below to program your scrolling message.

To program a scrolling message

Programming ▶ More Options ▶ Text Messages ▶ Scroll Messages

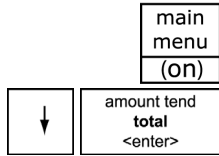

1 Press the **Main menu (on)** key.

2 Press the **Arrow Down** key to select Programming. Press the **Amount Tend Total <Enter>** key.



3 If you are prompted for a Manager Passcode, type the passcode number and then press the **Check** key. If you did not program a Manager Passcode, go to the next step.

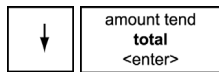

4 Press the **Arrow Down** key to select More Options. Press the **Amount Tend Total <Enter>** key.

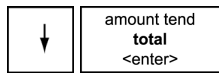

5 Press the **Arrow Down** key to select Text Messages. Press the **Amount Tend Total <Enter>** key.

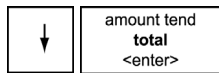

6 Press the **Arrow Down** key to select Scroll Messages. Press the **Amount Tend Total <Enter>** key.

7 Select the scroll message you want to change and follow the instructions on the screen. For more information about using the Alphanumeric keys to type letters, see Setting Alphanumeric Descriptions on page 22.

Important

If you enter the wrong character, press the **Void <bksp>** key to delete the character. Now you can continue.



8 When you are done, press the **Amount Tend Total <Enter>** key.

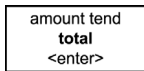

Setting the Scroll Speed

You can set the amount of scroll speed to all scrolling messages. This includes the customer messages and the programming instructions that scroll across the bottom of the clerk display in Programming mode. You can select Slow, Medium, or Fast.

To program the amount of time letters appears

Programming ▶ More Options ▶ System Options ▶ 6. Scroll Speed

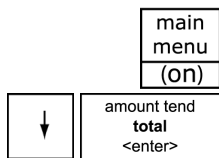

1 Press the **Main menu (on)** key.

2 Press the **Arrow Down** key to select Programming. Press the **Amount Tend Total <Enter>** key.

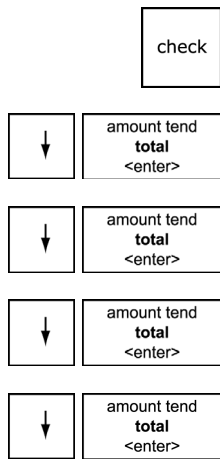

- 3 If you are prompted for a Manager Passcode, type the passcode number and then press the **Check** key. If you did not program a Manager Passcode, go to the next step.
- 4 Press the **Arrow Down** key to select More Options. Press the **Amount Tend Total <Enter>** key.
- 5 Press the **Arrow Down** key to select System Options. Press the **Amount Tend Total <Enter>** key.
- 6 Press the **Arrow Down** key to select 6. Scroll Speed. Press the **Amount Tend Total <Enter>** key.
- 7 Press the **Arrow Down** key to select the speed option you want. Press the **Amount Tend Total <Enter>** key.

Programming the Credit Keys

15	H	16	D
31	X	32	T

You can use 2 department keys as credit card-only keys, in addition to the **Charge <wide>** key. You can use one or both keys if you want. For example, you can customize the name of Department 15 to be a Visa® card and Department 16 to be a MasterCard®. You can also program the cash register to print the name of the credit card key on the receipt or journal tape.

When you ring up a sale, you can use Department 15 and/or Department 16 to finalize the credit card sale, open the cash drawer, and print the receipt or journal tape.

Note

If you want to use Departments 15 and/or 16 as credit card keys, they no longer work as department keys until you reset the department keys to be Normal Layout.

To program a credit key description

Programming ▶ More Options ▶ Others Set Up

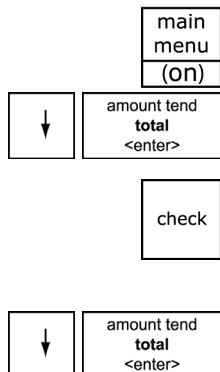

- 1 Press the **Main menu (on)** key.
- 2 Press the **Arrow Down** key to select Programming. Press the **Amount Tend Total <Enter>** key.
- 3 If you are prompted for a Manager Passcode, type the passcode number and then press the **Check** key. If you did not program a Manager Passcode, go to the next step.
- 4 Press the **Arrow Down** key to select More Options. Press the **Amount Tend Total <Enter>** key.

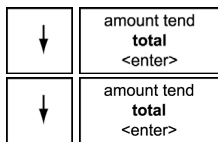

5 Press the **Arrow Down** key to select Others Setup. Press the **Amount Tend Total <Enter>** key.

6 Press the **Arrow Down** key to select the Credit Name you want to change. Press the **Amount Tend Total <Enter>** key.

- Credit 1 = Dept 16 key
- Credit 2 = Dept 15 key

7 Type the name of the credit card just as you did when you programmed Department names. You can type up to 12 characters and spaces.

- For more information about using the Department keys to type letters, see Programming Department Keys on page 32.



Important

If you enter the wrong character, press the **Void <bkspace>** key to delete the character. Now you can continue.

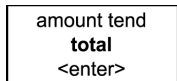

8 When you are done, press the **Amount Tend Total <Enter>** key.

To specify using Department 15 and/or Department 16 as credit keys
Programming ▶ More Options ▶ System Options



1 Press the **Main menu (on)** key.

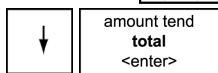

2 Press the **Arrow Down** key to select Programming. Press the **Amount Tend Total <Enter>** key.



3 If you are prompted for a Manager Passcode, type the passcode number and then press the **Check** key. If you did not program a Manager Passcode, go to the next step.

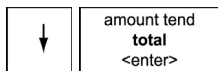

4 Press the **Arrow Down** key to select More Options. Press the **Amount Tend Total <Enter>** key.

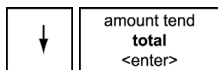

5 Press the **Arrow Down** key to select System Options. Press the **Amount Tend Total <Enter>** key.

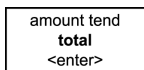

6 Select 1. Key Layout and press the **Amount Tend Total <Enter>** key.

- Credit 1 = Dept 16 key
- Credit 2 = Dept 15 key

Note

To stop using Department 15 and/or Department 16 as credit keys, select Normal Layout.

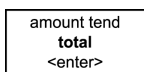

7 Follow the instructions on the screen. When you are done, press the **Amount Tend Total <Enter>** key.

Programming PLU Descriptions

The Price-Look Up system allows for fast, accurate entry of an item and automatically records the number of items sold. If you want to use the optional barcode reader, you can scan UPC codes to ring up items.

To scan barcodes, they must be numeric only, 13 digits or less, and must be one of the following barcode types and standards:

- UPC-A
- UPC-E
- EAN-8
- EAN-13

Note

This cash register cannot generate barcodes for you. To generate and print barcodes, purchase barcode software.

Each PLU must be programmed with up to a 12 character description that appears on the display and prints on the tape. You can have up to 2000 PLU items programmed.

Programming PLUs consists of the following:

- 1 Assign a PLU number (from 1 to a maximum of 13 digits long) to each sales item or scan the barcode.
- 2 Enter a name description for the PLU. You must enter a description, even if it is as simple as PLU4.
- 3 Assign a price.
- 4 Link the PLU to a department key with the appropriate Tax Status for that PLU.

For example, if PLU #1 is a taxable item, you can link it to a Department key which is set up for tax. If PLU #2 is not a taxable item, you can link it to a Department key which is programmed for no tax.

Important

Do not press the decimal point key when entering a price.

After you are done, you can check your results. See Running the PLU Confirmation Report on page 81.

Programming PLUs without a Barcode Reader

You can program PLUs without using a barcode reader. Use the following instructions.



Important

If you enter the wrong character, press the **Void <bksp>** key to delete the character. Now you can continue.

To program PLUs without a barcode reader

Programming ▶ PLU Set Up

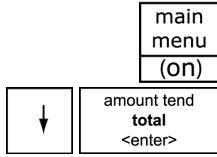

1 Press the **Main menu (on)** key.

2 Press the **Arrow Down** key to select Programming. Press the **Amount Tend Total <Enter>** key.



3 If you are prompted for a Manager Passcode, type the passcode number and then press the **Check** key. If you did not program a Manager Passcode, go to the next step.

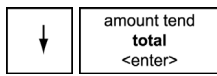

4 Press the **Arrow Down** key to select PLU Set Up. Press the **Amount Tend Total <Enter>** key.

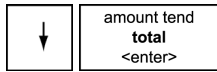

5 Press the **Arrow Down** key to select New & Edit. Press the **Amount Tend Total <Enter>** key.

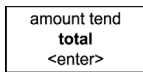

6 Using the rounded Number keys, enter the PLU number. Press the **Amount Tend Total <Enter>** key.

7 Follow the instructions on the display

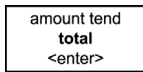

8 To program the next PLU, go to Next PLU and press the **Amount Tend Total <Enter>** key.



9 When you are done programming, press the **Main menu (on)** key.

Programming PLUs with the Optional Barcode Reader

You can use the optional Royal model PS700 barcode reader to scan items and automatically ring them up. Using the barcode reader saves time and reduces errors caused by people ringing up items incorrectly. The barcode reader must be held about 1/2 inch or closer above the symbol on the product to read the UPC or other barcode properly.



Important

If you enter the wrong character, press the **Void <bksp>** key to delete the character. Now you can continue.

To program PLUs using the barcode reader

Programming ▶ PLU Set Up

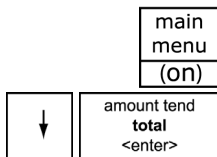

1 Press the **Main menu (on)** key.

2 Press the **Arrow Down** key to select Programming. Press the **Amount Tend Total <Enter>** key.

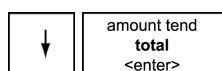
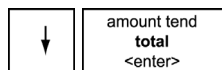
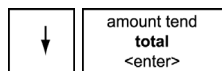
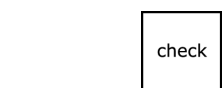

- 3 If you are prompted for a Manager Passcode, type the passcode number and then press the **Check** key. If you did not program a Manager Passcode, go to the next step.
- 4 Press the **Arrow Down** key to select PLU Set Up. Press the **Amount Tend Total <Enter>** key.
- 5 Press the **Arrow Down** key to select New & Edit. Press the **Amount Tend Total <Enter>** key.
- 6 Using the barcode reader, scan the barcode you want for this PLU. Hold the barcode reader less than 1/2 inch from the barcode you want to scan. Press the button on the bottom of the reader. Flick the reader slightly to move the LED light along the barcode to read it. The barcode reader beeps when it properly reads the barcode. Follow the instructions on the display.
- 7 To program the next PLU, go to Next PLU and press the **Amount Tend Total <Enter>** key.
- 8 When you are done programming, press the **Main menu (on)** key.

Printing the Program Confirmation Report

Now that basic programming is complete, check your results with a Program Confirmation Report.

If you made a mistake during programming, repeat only the step you made the mistake in. For example, if only the tax rate is incorrect, just re-program the tax—you do not need to re-set the time, date, and so on.

There are 4 types of confirmation reports:

- Dept All the department programming. See Running the Department Confirmation Report on page 80.
- PLUs All PLU programming. See Running the PLU Confirmation Report on page 81.
- Clerks All clerks. See Running the Options Dump Report on page 79.
- Options All the parameters for setting the register, including header, footer, scrolling messages, tax rates and so on. See Running the Options Dump Report on page 79.

Before Going to Register Mode

Your cash register offers many other features not covered in this chapter. Other options are covered in the chapter called Setting Up Your Cash Register Parameters, starting on page 48. We also provide examples to help you learn how to use your cash register. For information about the examples, see Examples on page 98.

Error Codes

Your cash register makes beeps and shows you messages in the display. Some beeps and messages let you know everything is working and others let you know you need to do something.

Table 5 Common errors

This error...	Means this...
Register Beep	The cash register makes a short beep each time a key is pressed. This is normal and not a cause for concern.
Entry Error Beep	When using your cash register, you must perform all operations in the correct order. If you press the wrong key at the wrong time, a continuous alarm beep sounds and you see a message on the display. The keyboard also locks. Press the Clear key to stop the beep and continue or follow the instructions on the display.

When a transaction is started in the Sales Registration mode, you must finish the sale before changing to another mode. The cash register does not allow you to return to the main menu until you finish the transaction you started.

The following table shows you error messages you may see on the clerk display.

Table 6 Common errors

This error...	Means this...
CHECK PRINTER	The printer has a problem. There may be a paper jam or the paper may need to be replaced. See page 89.
CLERK# ERROR	An invalid clerk number was entered.
ELECT. JOURNAL FULL	Finish the current transaction. As soon as you are done, run the EJ Report to clear the Electronic Memory. See page 94.
ELECTRONIC JOURNAL MEMORY NEARLY FULL	Finish the current transaction. As soon as you are done, run the EJ Report to clear the Electronic Memory. See page 94.

Table 6 Common errors

This error...	Means this...
ENTER AMT. TEND	The cash register is set to require the amount tendered to be entered.
INVALID PASSCODE	An invalid passcode was entered.
MAX. \$ REACHED	The maximum dollar amount is reached.
NO ZERO-PRICES	The cash register is set in System Options to not accept zero price entries for departments or PLUs in Sales Registration mode. Enter a valid price and continue.
OPERATION ERROR	You pressed an incorrect key.
PAPER ERROR	See if you are out of paper. Check for a paper jam. For more information about other solutions, see page 93.
PLU NOT FOUND	The PLU number is not valid or has not been programmed. It is also possible that no PLU numbers are programmed yet. Check the PLU number entered and check your PLU programming. See page 81 for help.
PRINTER OVERHEAT	The printer is too warm. Finish the current transaction and then open the Journal cover. Wait at least 20 minutes before resuming transactions.
PRINTER PWR. DOWN	The printer power is disrupted. Unplug the cash register and plug it into a valid power source. If you still see the error, contact Customer Service.
TOO MANY ITEMS	Too many items are entered in this transaction. End the sale and ring the remaining items as a second sale.
WARNING! CHECK ID	The cash register is programmed to prompt the clerk to check ID for this purchase.

Clearing an Error



The **Clear** key stops an alarm beep that happened because a key was pressed that was not correct for that operation.

The **Clear** key does not erase a transaction that was registered by an operating key and printed on the register tape.



To erase an entry after you press a key that printed the entry on the tape during a sales transaction, use the **Void <bkspace>** key to correct the error and undo the last entry.



If the cash register makes a loud error beep, press the **Clear** key to stop it.

If your cash register will not stop making a beeping sound after you press the **Clear** key, you can do three more things.

Half System Clear

If you pressed the **Clear** key and the error beep does not stop, you can do a Half System Clear. For more information about a Half System Clear, see Half System Clear on page 96.

Partial Reset

A Partial Reset can help if the Half System clear did not help. For more information, see Partial Reset on page 97.

Full System Clear

If you did a Half System Clear and a Partial Clear and the error beep still does not stop, as a last resort, you can do a Full System Clear. For more information about the Full System Clear, see Full System Clear on page 97.

Setting Up Your Cash Register Parameters

This chapter shows you more advanced programming for your cash register. This chapter is organized to show you the menu options shown in the clerk display. Use this chapter to quickly find a menu option you want.

Some of the menu options in this chapter are already discussed elsewhere in this manual. In those cases, we provide references where you can see more detailed information.

Print Options

The Print Options menu includes the options listed in this section.

To open the Print Options menu

Programming ▶ More Options ▶ Print Options

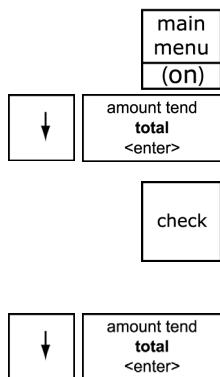

- 1 Press the **Main menu (on)** key.
- 2 Press the **Arrow Down** key to select Programming. Press the **Amount Tend Total <Enter>** key.
- 3 If you are prompted for a Manager Passcode, type the passcode number and then press the **Check** key. If you did not program a Manager Passcode, go to the next step.
- 4 Press the **Arrow Down** key to select More Options. Press the **Amount Tend Total <Enter>** key.

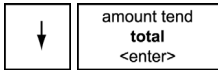

5 Press the **Arrow Down** key to select Print Options. Press the **Amount Tend Total <Enter>** key.

The rest of this section explains each menu option.

1. Header

Specifies if the Header prints on the customer receipt. For more information about header messages, see *Setting Header Messages and Footer Messages* on page 24.

2. Footer

Specifies if the Footer prints on the customer receipt. For more information about footer messages, see *Setting Header Messages and Footer Messages* on page 24.

3. Date

Specifies if the Date prints on the customer receipt.

4. Time

Specifies if the Time prints on the customer receipt.

5. Clerk

Specifies if a Clerk name prints on the customer receipt. For information about setting clerk names, see *Using the Clerk System* on page 29.

6. Each Tax Rate

Specifies if each individual tax rate amount (Tax-1, Tax-2, Tax-3 and Tax-4) prints on the receipt as separate amounts. For more information about tax rates, see *Programming Tax Status* on page 35 and *Programming Complex Tax Rates* on page 69.

7. Tax Total

Specifies if a Tax Total of all the tax rates is printed on the receipt or not printed.

8. Blank Line

Specifies if blank lines are printed in the Header and Footer or whether blank lines are skipped. For example, if you only wanted a 2-line header,

you can program the first two lines and then make the remaining 3-lines blank. Then you can either set this option to print those blank lines for extra spacing or to skip those 3 blank lines to save on paper.

9. Multiple Receipts

Specifies if multiple receipts are allowed. You may not want to allow issuing a second receipt for security reasons. Issuing a second receipt can be useful for rebates, or to reprint the receipt in case the printer runs out of paper or jams in the middle of a sale. This option does **not** affect the ability to reprint a single copy of the receipt if the receipt printer was turned off during a sales transaction or operating in receipt-on-demand mode.

10. Receipt - Real time or End of Sale

Specifies if you want the customer receipt to print:

- per-line as each item is rung up in the sale
- print all at one time at the end of the sale

If you select “at end of the sale”, then the printer does not print anything when the sale is first started or during any entry of the sale. The printer only prints the entire, detailed receipt after the **Amount Tend Total** **<Enter>** key is pressed. No details on the receipt are lost. All the information is still there, just saved in memory to be printed at the end of the sale.

amount tend total <enter>

11. Tax

Specifies to print the Tax information before the Total amount on the receipt or after the Total amount.

12. Sub-Total

sub total reprint

Specifies to automatically print the Sub-Total on all receipts. The Sub-total amount still prints if you press the **Sub-total reprint** key, regardless of this option setting.

13. Receipt - Name Only vs. PLU & Name

Specifies if just the PLU name/description is printed on the receipt on one line; or both, the PLU name/description and the PLU number (or the UPC bar code number, if it was a bar code) are printed on the receipt over 2 lines.

Because the receipt paper is not wide enough to print both pieces of information on one line, it is split over 2 lines. Each PLU prints on 2 lines of the receipt with the second option.

The PLU number and name option is more descriptive and helps in a retail setting when a customer might return a product or where there are warranty claims.

The Name Only option saves on receipt paper and is fine for simpler settings, such as a pizza parlor, restaurants and other smaller retail where you do not have returns or warranty claims on products.

14. Machine

Specifies if the Machine number is printed on the receipt. For more information about setting machine numbers, see Setting the Machine Number on page 31.

15. Consecutive

Specifies if the Consecutive Transaction number is printed on the sales receipt and on the X and Z reports.

To Default

Returns all the Print Options (print options only) to factory default settings. It is strongly recommended that you run a Z-report and any other reports first, because resetting to default settings may affect these reports.

After running the Z-report, return to this option and continue with resetting to factory default settings.

System Options

The System Options menu includes the options listed in this section.

To open the System Options menu

Programming ▶ More Options ▶ System Options

- 1 Press the **Main menu (on)** key.
- 2 Press the **Arrow Down** key to select Programming. Press the **Amount Tend Total <Enter>** key.
- 3 If you are prompted for a Manager Passcode, type the passcode number and then press the **Check** key. If you did not program a Manager Passcode, go to the next step.

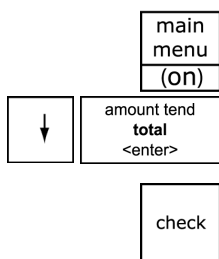

↓	amount tend total <enter>
↓	amount tend total <enter>

- 4** Press the **Arrow Down** key to select More Options. Press the **Amount Tend Total <Enter>** key.
- 5** Press the **Arrow Down** key to select System Options. Press the **Amount Tend Total <Enter>** key.

The rest of this section explains each menu option.

1. Key Lay-out

Specifies to use Credit Keys:

- Normal key layout - for a normal Department Key layout with Departments 1 through 32, no credit keys used.
- Credit 1 Used - change the Department keyboard layout to use Dept. 16 as the Credit 1 key.
- Credit 1 & 2 Used - change the Department keyboard layout to use Dept. 16 as the Credit 1 key and the Dept. 15 key as the Credit 2 key.

For more information, see Programming the Credit Keys on page 40.

2. Zero Price

Specifies if zero price entry for PLUs and Departments is allowed.

3. Electronic Journal

Turns the Electronic Journal on or off.

The Electronic Journal can hold 4,000-lines of transactions in memory. When it is turned on, the Electronic Journal records in the internal memory the line-by-line details of all the transactions and items completed on the cash register and printed on the built-in printer.

#/NS
<sym>

All sales transactions, any reports run during the day and even using the **#/NS <sym>** key for no-sale rings to open the cash drawer are recorded.

4. Amount Tend.

Specifies if the clerk must always enter the amount of money the customer gives the clerk so the clerk sees the amount of change to give back to the customer. This can reduce cash drawer shortages.

5. % In Dept.

Specifies if -% is subtracted and +% is added to individual department totals on the X & Z Reports. Or if these % amounts are not included in the individual department totals and only listed at the bottom of the report in the Discount and Add-On totals.

6. Scroll Speed

Specifies the Scrolling Message Speeds - select from Slow, Medium and Fast. This will set the speed for both, the instructional messages during the Programming and Reports modes and the five customer messages on the customer display.

7. CONS

Specifies to reset the Consecutive Transaction number found on each sales receipt and on most reports after running each Z report.

8. ZCT Reset

Specifies to reset the Z-Count number found only on Z-Reports, after running each Z-report

9. GT Reset

Specifies to reset the Grand Total Amount on the Z-report after running each Z-report.

10. Rounding

Rounding allows you to select how the cash register rounds-off numbers that it generates from internal calculations, like multiplying the sales dollar amount by the tax rate percentage, which may generate a long string of numbers or an amount below a penny. For example \$1.00 multiplied by an 8.75% tax would equal an amount of 1.0875. This would need to be rounded to 2-decimal places, and would be rounded-off to \$1.09 if 5/4-Rounding was selected.

Select from the following options to set the rounding.

Table 7 Rounding

This...	Rounds to this...
Down	Numbers from .1 - .9 to 0
5/4	Numbers from .5 - .9 to 1 (U.S. Standard)
Up	Numbers from .1 - .9 to 1

After you are done, you can check your results. See *Running the Options Dump Report* on page 79.

11. Decimal

The decimal point is set by selecting from the following 4 options:

This decimal point...	Looks like...
zero decimal point	0 = \$ X
one decimal point	1 = \$ X.X
two decimal point	2 = \$ X.XX (U.S. Standard)
three decimal point	3 = \$ X.XXX

After you program the decimal point, you do not need to specify a decimal when you ring up sales or during programming. If you use a decimal point when you enter a price, you hear an error beep.

The only time you use the decimal point key is when you are ringing up the quantity of a sale under a gallonage department. For example, 10.25 gallons of gasoline or 1.875 pounds of deli meat.

After you are done, you can check your results. See *Running the Options Dump Report* on page 79.

To Default

Resets all the SYSTEM Options (System options only) to factory default settings. It is strongly recommended that you run a Z-report and any other reports first (i.e. PLU, Clerk, Electronic Journal, etc.), since resetting to default settings may affect these reports. After running the Z-reports, then return to this Parameter Option and proceed with resetting to factory default settings.

Others Set Up

The Others Set Up menu includes the options listed in this section.

To open the Others Set Up menu

Programming ▶ More Options ▶ Others Set Up

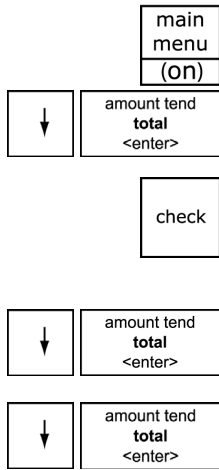

- 1 Press the **Main menu (on)** key.
- 2 Press the **Arrow Down** key to select Programming. Press the **Amount Tend Total <Enter>** key.
- 3 If you are prompted for a Manager Passcode, type the passcode number and then press the **Check** key. If you did not program a Manager Passcode, go to the next step.
- 4 Press the **Arrow Down** key to select More Options. Press the **Amount Tend Total <Enter>** key.
- 5 Press the **Arrow Down** key to select Others Set Up. Press the **Amount Tend Total <Enter>** key.

The rest of this section explains each menu option.

[+ %] Rate



You may want to add a default percentage amount to an individual item or to a total, such as a fixed tip or other service charge. The **+ % PO** key adds a percent additional charge to an individual item if you press it immediately after you ring up an item or adds a percent additional charge to the sub-total amount of an entire sale if you press it after you press the **Sub-total reprint** key.

You can program a default percentage rate for the **+ % PO** key or you can enter the rate manually each time the **+ % PO** key is pressed. When you enter the default pre-programmed Plus Percentage amount, use 2 decimal places. For example, enter a 5% Plus Percentage as 500.

When you manually enter the Plus Percentage rate during a sale, use a whole number without any decimal places. For example, enter 5% as 5, or enter 10% as 10.

When you use the **+ % PO** key, the words **ADD ON** appear on the display and print on the receipt.

[-%] Rate



You may want to deduct a default Minus Percentage rate from an individual item or from a total, such as an employee discount or standard sale discount. The **- % RA** key subtracts a discount percentage amount from an individual item if you press it immediately after you ring up an item or from the sub-total amount of an entire sale if you press it after you press the **Sub-total reprint** key.

You can program a default percentage discount for the **- % RA** key or you can enter the discount rate manually each time you press the **- % RA** key. When you enter the pre-programmed default Minus Percentage amount use 2 decimal places. For example, enter a 5% discount as 500.

When you manually enter the Minus Percentage rate during a sale, enter a whole number without any decimal places. For example, enter 5% as 5, or enter 10% as 10.

When you use the **- % RA** key, the word DISCOUNT appears on the display and prints on the receipt.

[-] HALO

Specifies setting a HALO (High Amount Lock-Out) Limit to the Coupon key. For more information, see Setting High Amount Lock-out (HALO) on page 36.

Credit-1 Name

Programming the name and description for the Credit 1 key. For more information, see Programming the Credit Keys on page 40.

Credit-2 Name

Programming the name and description for the Credit 2 key. For more information, see Programming the Credit Keys on page 40.

FC Set Up

You can specify a foreign currency to accept as payment when you total sales and program the exchange rate for when you accept this currency.



This is useful if you are working in a multiple currency situation and want to accept another currency, such as stores near a border with another country. When you are ready to complete the sale, you can press the **plu alt FC** key to see the total sale in the foreign currency. Enter the amount of

foreign currency the customer gives you and press the **Amount Tend Total** <Enter> key.

Note

You can only program one foreign currency.

Follow the instructions on the screen, providing the following information.

- **FC Name** The name of the foreign currency. For example, Pesos.
- **Local** Your local currency unit to exchange against. For example, \$1.00.
- **FC Rate** The amount of the foreign currency equal to the local currency amount mentioned above. For example, if US \$1.00 is equal to 8.00 pesos, then enter 8.00 in the FC Rate.
- **FC Decimal** The number of decimals in the foreign currency.
- **Currency Symbol** The currency symbol for the foreign currency.

AGE-1 Set Up

Specifies the minimum age for AGE-1 of the Age Verification feature. The factory default for Age-1 is 18 years old. For more information, see Setting Age Limits on page 36.

AGE-2 Set Up

Specifies the minimum age for AGE-2 of the Age Verification feature. The factory default for Age-2 is 21 years old. For more information, see Setting Age Limits on page 36.

Currency Symbol

Specifies the Currency Symbol for the register for the Local Currency. This is the symbol for the main currency of the register and not the foreign currency. You can only select from the list of symbols offered on the register screen.

Z-Report

Specifies to print the Z-Report Counter number on each Z-Report.

Zero Skip

Specifies to print items with a zero total on all reports or to skip items that have a zero total.

Z-Report

Specifies to allow reprinting a second copy of the Z report. If you set this option to “single”, then you cannot recover or print another copy of the Z-Report after it is generated. If the printer runs out of paper or jams, there is no way to re-print the Z-report or to recover that information.

Allowing a second copy lets you install a new roll of paper or correct a jam or some other problem and then reprint the same Z-report one time for a second copy. Additional copies are not allowed.

Compressed

Specifies if the Electronic Journal and certain Reports are automatically printed in Compressed print or in regular print. The selections are:

- compressed print for Electronic Journal and Reports,
- compressed print for Electronic Journal and regular print for reports,
- regular print for Electronic Journal and all reports.

Compressed print is slightly smaller, but saves on paper, especially on longer reports such as PLU Sales and Electronic Journal.

Machine Number

Sets a machine number. For more information, see *Setting the Machine Number* on page 31.

Daily Z Counter

You can program the starting number for the Daily Z1Report Counter number. If you were using a different cash register before this one and wanted to carry that numbering sequence and start with a specific number on this cash register, set that number here.

Periodic Z Counter

You can program the starting number for the Periodic Z2 Report Counter number. If you were using a different cash register before this one and wanted to carry that numbering sequence and start with a specific number on this cash register, set that number here.

Grand Total Amount

You can program the starting Grand Total Sales Amount. If you were using a different cash register before this one and want to carry the Grand Total Sales amount over from all the sales rung on the previous cash register and to continue adding to that amount with this register, set that starting Grand Total Sales amount here. The Grand Total Sales Amount appears at the bottom of the Z1 and Z2 Reports.

Config Options

Most of the parameter options under Config Options are the settings that were programmed or set during the Initial Set-up of the register.

If you made an error during the Initial Set-up, come to the Config Options to correct the entry or setting.

The Config Options menu includes the options listed in this section.

To open the Config Options menu

Programming ▶ More Options ▶ Config

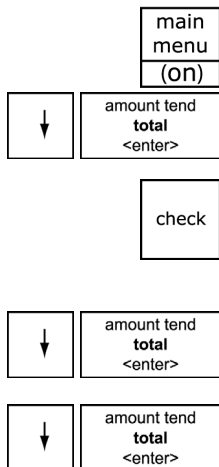

- 1 Press the **Main menu (on)** key.
- 2 Press the **Arrow Down** key to select Programming. Press the **Amount Tend Total <Enter>** key.
- 3 If you are prompted for a Manager Passcode, type the passcode number and then press the **Check** key. If you did not program a Manager Passcode, go to the next step.
- 4 Press the **Arrow Down** key to select More Options. Press the **Amount Tend Total <Enter>** key.
- 5 Press the **Arrow Down** key to select Config. Press the **Amount Tend Total <Enter>** key.

The rest of this section explains each menu option.

Language

Specify the default language of the machine for all the prompts, messages, on-screen instructions, and so on.

Date

Specify the date, including month, date, year.

Date Format

Select from MM-DD-YY or DD-MM-YY.

Time

Adjust the time: hours and minutes.

Time Format

Specify between 12-Hour format with AM and PM designations or 24-hour format (Military time).

Note

Regardless of this setting, when you are programming the cash register, the Hour must always be entered in 24-hour mode.

Contrast

Adjust the contrast of the LCD clerk display.

Power Saving

Select the amount of time before the LCD display turns-off and goes-to-sleep into Power Saving mode. The cash register only “goes to sleep” after the specified number of minutes of no activity. It does not go to sleep in the middle of a sales transaction.

For more information, see Using Power Saving Mode on page 21.

Tax System

Select the Tax System

- Add-on (USA)
- Canadian
- VAT (Value-Add Tax).

See Programming Complex Tax Rates on page 69 for detailed explanation of the Tax Systems and setting taxes.

Options Dump

This report contains all the parameter option settings for the cash register and in the following order:

- Print Options
- System Options
- Header text
- Footer text
- Scrolling Messages text
- Others Set-Up options programming
- Tax System

This report can use a lot of paper. Before you print, make sure you have enough paper installed in the cash register.

To print the Options Dump

Programming ▶ More Options ▶ Options Dump

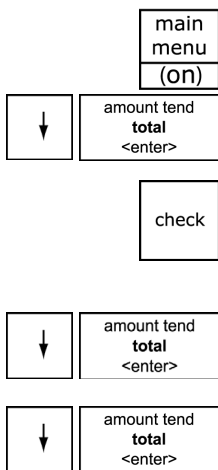

- 1 Press the **Main menu (on)** key.
- 2 Press the **Arrow Down** key to select Programming. Press the **Amount Tend Total <Enter>** key.
- 3 If you are prompted for a Manager Passcode, type the passcode number and then press the **Check** key. If you did not program a Manager Passcode, go to the next step.
- 4 Press the **Arrow Down** key to select More Options. Press the **Amount Tend Total <Enter>** key.
- 5 Press the **Arrow Down** key to select Options Dump. Press the **Amount Tend Total <Enter>** key.

Ringling up Sales and Using Training Mode

After you set up your cash register, ringing up sales is easy. For information about ringing up complicated sales, see Examples on page 98.

If you want to learn about using the cash register without affecting the daily total, you can use the Training mode. You or someone else can learn how to use the cash register without creating real sales that show up on reports. For example, you can train a new person about using the department keys and completing sales.

Training mode lets someone use the cash register without actually recording the sales in the sales history. When you exit from the Training mode, the training sales information is deleted.

To use Training mode, you need to have a training passcode set. For more information, see Setting the Training Passcode on page 67.

Ringling up Sales

After you have the basics programmed in your cash register, you are ready to ring up sales. For more information about setting up the basics on your cash register, see Setting Up Your Cash Register - the Basics on page 19.



Reminder

Do not press the **Decimal Point** key when ringing up a price.

Ringling up Sales without a PLU Number

You can ring up a sale for an item that does not have a PLU number.

To ring up a straight cash sale without a PLU number

amount tend
total
<enter>

amount tend
total
<enter>

check

1 Make sure Sales Registration is highlighted on the main menu and press the **Amount Tend Total <enter>** key.

2 If the clerk numbers are set, do the following:

- Enter the clerk number and then press the **Amount Tend Total <enter>** key.
- Using the round Number keys, press the three digit passcode and then press the **Check** key.

3 Using the round Number keys area, enter the price of the first item.

4 Press the **Department** key for that item.

To use the Department keys from 17 to 32, do the following:

- Press the **Dept Shift** key and press the department number you want to use.

To use department numbers from 33 to 200, do the following:

- Press the **Dept Shift** key.
- Using the round Number keys, type the Department number from 33 to 200 that you want to use. For example, for Department 63, press the 6 key and then press the 3 key.
- Press the **Dept Shift** key again.

5 Repeat for the rest of the items.

amount tend
total
<enter>

6 When you are done ringing up items, press the **Amount Tend Total <enter>** key. The cash drawer opens and the receipt or journal prints.

7 Make any change needed and place the money you are given in the cash drawer. Close the cash drawer.

8 Give the customer the receipt, if the cash register is set to print receipts. You are ready to ring up another sale.

Ring up Sales with a PLU Number

You can ring up a sale for an item that has a PLU number.

To ring up a straight cash sale with a PLU number and not using the barcode reader

amount tend
total
<enter>

amount tend
total
<enter>

check

plu

amount tend
total
<enter>

- 1 Make sure Sales Registration is highlighted and press the **Amount Tend Total <enter>** key.
- 2 If the clerk numbers are set, do the following:
 - Enter the clerk number and then press the **Amount Tend Total <enter>** key.
 - Using the round Number keys, press the three digit passcode and then press the **Check** key.
- 3 Using the round Number keys area, type the PLU number of the first item.
- 4 Press the **PLU** key.
- 5 Repeat for the rest of the items.
- 6 When you are done ringing up items, press the **Amount Tend Total <enter>** key. The cash drawer opens and the receipt or journal prints.
- 7 Make any change needed and place the money you are given in the cash drawer.
- 8 Close the cash drawer.
- 9 Give the customer the receipt, if the cash register is set to print receipts. You are ready to ring up another sale.

Ring up Sales with the Optional Barcode Reader

You can also ring up sales using the optional model PS 700 barcode reader. Before you can ring up sales with the barcode reader, the barcode number must be programmed into the cash register with the barcode reader. For more information, see Programming PLUs with the Optional Barcode Reader on page 43.

To ring up a cash sale with the barcode reader

amount tend
total
<enter>

amount tend
total
<enter>

check

- 1 Make sure Sales Registration is highlighted and press the **Amount Tend Total <enter>** key.
- 2 If the clerk numbers are set, do the following:
 - Enter the clerk number and then press the **Amount Tend Total <enter>** key.

- Using the round Number keys, press the three digit passcode and then press the **Check** key.

- 3 Put the barcode reader light over the barcode, about 1/2 inch or closer above the UPC symbol on the product to read the barcode properly.
- 4 Press the button on the scanner and flick the scanner slightly to move the red LED over the barcode. The barcode scanner makes a beep sound and the item appears on the display.
- 5 Continue using the barcode scanner to scan bar code symbols until you are done.
- 6 When you are done, press the **Amount Tend Total <enter>** key. The cash drawer opens and the receipt or journal prints.
- 7 Make any change needed and place the money you are given in the cash drawer. Close the cash drawer.
- 8 Give the customer the receipt, if you set the cash register to print receipts. You are ready to ring up another sale.

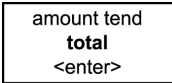

Verifying the PLU Information for an Item

You can verify the PLU information, including price, using a PLU number or barcode. You can verify the PLU information while you are in the middle of a sales transaction or when you are not ringing up any sales. This is helpful if a customer wants to know the price of an item before ringing up the item.

You can verify the PLU information for an item by either entering the PLU number or by scanning the barcode using the optional barcode reader. After you verify the PLU information, you can also easily ring the item up.

To find the price of an item using the PLU

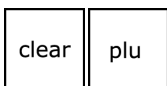

- 1 Either in a sales transaction or just in Sales Registration mode, press the **Clear** key and then press the **PLU** key.



- 2 Either enter the PLU number or scan the barcode.
- 3 If you entered the PLU number manually, press the **PLU** key again. The PLU information appears on the clerk display.

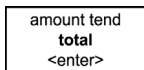

- 4 Do one of the following:
 - Ring this item up by pressing the **Amount Tend Total <enter>** key.

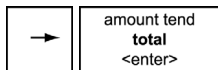

- Exit this screen by pressing the **Arrow Right** key and pressing the **Amount Tend Total <enter>** key.

Printing Receipts

You can turn the customer receipt printer on or off in the Sales Registration mode.

The receipt printer is on by default and prints the customer receipt for all transactions. All features of the cash register are activated as programmed. A customer receipt is printed for every transaction.

Turning the customer receipt off doesn't print the customer receipt. The built-in printer is turned off so that customer receipts are **not** automatically printed. The transaction details are still saved in memory if the Electronic Journal is turned on.

If you are a smaller merchant or business, you may not need to print customer receipts. This controls the amount of receipt paper you use. In this case, you do not print a receipt for every transaction and only print a receipt for those transactions where one is required.

You must have paper installed in the cash register even if you have customer receipt printing off and are not printing receipts.



You can see the receipt printer is turned off by looking at the clerk screen. If you see the R OFF symbol, receipts are not automatically printed.

Note

You cannot change printing receipts in the middle of a transaction.

To turn printing receipt on or off

- 1 End any transaction.
- 2 Do one of the following:



- To turn receipt printing off, press the **Receipt on\off <esc>** key. The R OFF symbol appears on the clerk screen.



- To turn receipt printing on again, press the **Receipt on\off <esc>** key. The R OFF symbol disappears from the clerk screen.

Receipt on Demand

If the receipt printer is turned off, you can still print a receipt on demand if the customer requests one after the transaction is completed but before you start another transaction.



To print a receipt after a transaction is complete, press the **Subtotal reprint** key.

Using Training Mode

We provide examples to help learn how to use this cash register. For information about the examples, see Examples on page 98. Using the examples can help you learn to use the cash register and the available features.

You can enter the Training mode at any time in the Sales Registration mode because it does not record activity in the machine totals. However, you cannot enter Training mode in the middle of a transaction. Complete any transactions, running reports, or programming before you enter Training mode.

When you are using the cash register in Training mode, you cannot use any of the operations in the PRG, X, or Z modes. The transaction numbers and amounts do not count in the Register mode until you exit Training mode.



When the cash register is in Training mode, the TR symbol appears in the lower left of the clerk display and asterisks **** print instead of transaction numbers. When you stop Training mode, the transaction numbers continue from the last number printed before you entered Training mode.

Setting the Training Passcode

You can set the cash register to include a training mode. This training mode requires a 6 digit passcode.

To set the training mode passcode

Programming ▶ More Options ▶ Training Passcode

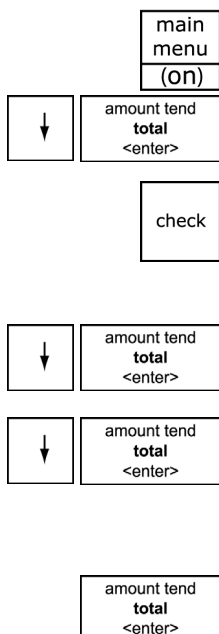

- 1 Press the **Main menu (on)** key.
- 2 Press the **Arrow Down** key to select Programming. Press the **Amount Tend Total <Enter>** key.
- 3 If you are prompted for a Manager Passcode, type the passcode number and then press the **Check** key. If you did not program a Manager Passcode, go to the next step.
- 4 Press the **Arrow Down** key to select More Options. Press the **Amount Tend Total <Enter>** key.
- 5 Press the **Arrow Down** key to select Training Passcode. Press the **Amount Tend Total <Enter>** key.
- 6 Using the Round number keys, enter a 6 digit passcode. The passcode cannot be zeros.
- 7 When you are done, press the **Amount Tend Total <Enter>** key.

Entering and Exiting Training Mode

After a training passcode is programmed, you can enter and exit Training mode.



When the cash register is in Training mode, a symbol appears in the lower left of the clerk screen. Some transactions may also print DEMO or asterisks **** on the receipt.

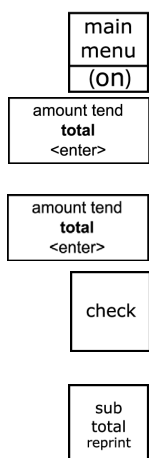

To start Training mode

- 1 Press the **Main menu (on)** key.
- 2 Select Sales Registration. Press the **Amount Tend Total <Enter>** key.
- 3 If the clerk numbers are set, do the following:
 - Enter the clerk number and then press the **Amount Tend Total <enter>** key.
 - Using the round Number keys, press the three digit passcode and then press the **Check** key.
- 4 Using the Round number keys, enter the 6 digit passcode. Press the **Subtotal reprint** key. The TR symbol appears on the screen.
- 5 Now you can ring up sales in training mode. These sales do not appear in the sales reports.

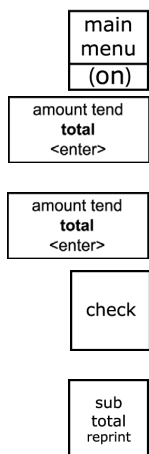

To stop Training mode

- 1 Press the **Main menu (on)** key.
- 2 Select Sales Registration. Press the **Amount Tend Total <Enter>** key.
- 3 If the clerk numbers are set, do the following:
 - Enter the clerk number and then press the **Amount Tend Total <enter>** key.
 - Using the round Number keys, press the three digit passcode and then press the **Check** key.
- 4 Using the Round number keys, enter the 6 digit passcode. Press the **Subtotal reprint** key. The TR symbol disappears from the screen.
- 5 Now you can ring up sales normally. These sales do appear on sales reports.

Programming Complex Tax Rates

Your cash register can manage complex tax rates and assignments. This chapter explains how to set these up.

Many people do not need the information in this chapter. If this information does not relate to your business needs, you can skip it. If some information is related to your specific needs, then skip any sections which you do not need to set up your cash register.

If you do not know your sales tax rate and base amount, contact your local government office and ask for your local tax chart. The base tax amount is the maximum point up to which no tax is charged. Sometimes this is also called the *maximum tax exempt amount*. By default, your cash register does not set any base amount, resulting in all amounts being taxable. If your base tax amount is other than zero cents, see Programming Table Tax in the United States on page 72.

When you set up your cash register, you programmed the cash register to use a simple sales tax, appropriate for your area. Chapter 2 explains how to program a simple sales tax. Chapter 5 explains how to link sales tax to departments.

You do not need to reprogram all options if you want to update or change one thing. Save this manual in a safe place so you have it for future programming. After you are done programming, you can print Confirmation Reports to check your results. For more information, see Running Reports on page 79.

Selecting the Tax System

tax
force

Within the tax system you select, you can program up to 4 different tax rates on your cash register. Each tax rate can be linked directly to a department key (see Programming Tax Status on page 35), or by pressing the **Tax Force** key before ringing up a sales entry.

Contact your local state government office for your current tax rates.

You must first select one of 3 tax systems:

- Select USA (ADD-ON RATE) - the tax amount is added onto the price of the item sold. Add-on Tax is most common in the United States. Add-on Tax can be programmed as either:
 - straight tax, which charges tax based on a flat percentage rate. For example, 7.75% of the price of the item. This form of add-on tax is most common in the United States.
 - tax table codes, which is a calculation based on an approved tax chart issued by your local or state government. This method lists a range of prices and the exact tax for each range. For example, from 11 cents to 24 cents, the tax is 3 cents.
- Select Canadian Tax System - allows you to program the Goods and Services tax (GST) and Provincial Sales Tax (PST) tax system required in Canada.
- Select VAT (Value Added Tax) - includes the tax amount in the price of the item.

You can only use one tax system at a time. After you select the tax system you want to use, you can program up to 4 different tax rates. If needed, you can also link these tax rates together.

For example, you can select Add-on Tax and program 4 different tax rates. When you program a department or PLU, you can select to link 1 or more of these tax rates together. You can also select a specific tax for an item by pressing the **Tax Force** key while ringing up an item.

tax
force

You can specify that the cash register does not print the tax rate on receipts. For more information, see Print Options on page 48.

clear

Note

If you hear an error tone while you are programming, press the **Clear** key and continue by repeating the step.

To select a tax system

Programming ▶ More Options ▶ Config ▶ Tax System

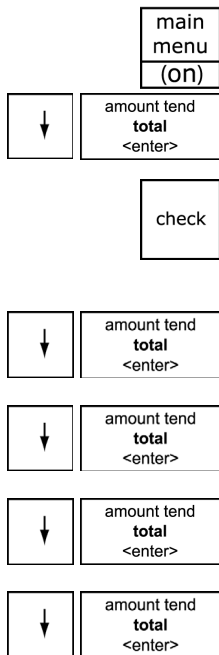

- 1 Press the **Main menu (on)** key.
- 2 Press the **Arrow Down** key to select Programming. Press the **Amount Tend Total <Enter>** key.
- 3 If you are prompted for a Manager Passcode, type the passcode number and then press the **Check** key. If you did not program a Manager Passcode, go to the next step.
- 4 Press the **Arrow Down** key to select More Options. Press the **Amount Tend Total <Enter>** key.
- 5 Press the **Arrow Down** key to select Config. Press the **Amount Tend Total <Enter>** key.
- 6 Press the **Arrow Down** key to select Tax System. Press the **Amount Tend Total <Enter>** key.
- 7 Select the tax system you want to use. Press the **Amount Tend Total <Enter>** key.
- 8 Now you need to specify the values for the tax rate(s):
 - Straight tax values for Tax 1 and, optionally, Tax 2 through 4. See the next section.
 - Table tax values. See Programming Table Tax in the United States on page 72.
 - Canadian tax rates. Using Canadian Tax Rates on page 76.
 - VAT tax rates. See Using VAT Tax Rates on page 78.

Programming Straight Add-on Tax in the United States

After you select the tax system to use, you must specify values. This section explains how to specify straight add-on tax rates for the United States. Straight add-on tax is the most common in the United States. You must specify at least 1 tax rate and, optionally, you can specify up to 3 others.

To program straight Add-on tax rates for the United States

Programming ▶ Tax Set Up

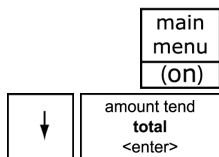

- 1 Press the **Main menu (on)** key.
- 2 Press the **Arrow Down** key to select Programming. Press the **Amount Tend Total <Enter>** key.

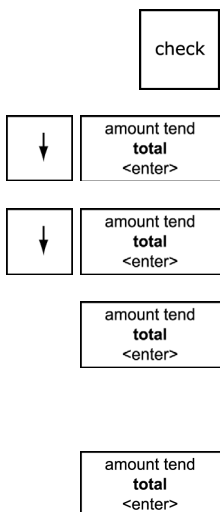

- 3 If you are prompted for a Manager Passcode, type the passcode number and then press the **Check** key. If you did not program a Manager Passcode, go to the next step.
- 4 Press the **Arrow Down** key to select Tax Setup. Press the **Amount Tend Total <Enter>** key.
- 5 Press the **Arrow Down** key to select the tax you want to change. Press the **Amount Tend Total <Enter>** key.
- 6 Select Straight. Press the **Amount Tend Total <Enter>** key.
- 7 Using the round Number keys area, enter the tax you want to add. For example, 7750 is 7.75% tax.
- 8 When you are done, press the **Amount Tend Total <Enter>** key.
- 9 Repeat for each tax you want to set.

Programming Table Tax in the United States

If your area uses a tax code table, you must calculate your tax codes before you continue with this section. For instructions, see Calculating Your Tax on page 73. When you are done calculating your tax codes, return to this section.

Before you start, you must know where the first **irregular breakpoint** and the first **regular breakpoint** are.

Note

If you make an error when you are entering the price ranges, press **receipt on/off <ESC>** and start over.



To program table tax rates for the United States

Programming ▶ Tax Set Up

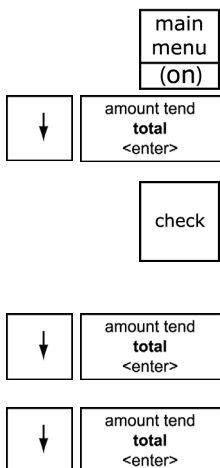

- 1 Press the **Main menu (on)** key.
- 2 Press the **Arrow Down** key to select Programming. Press the **Amount Tend Total <Enter>** key.
- 3 If you are prompted for a Manager Passcode, type the passcode number and then press the **Check** key. If you did not program a Manager Passcode, go to the next step.
- 4 Press the **Arrow Down** key to select Tax Setup. Press the **Amount Tend Total <Enter>** key.
- 5 Press the **Arrow Down** key to select the tax you want to change. Press the **Amount Tend Total <Enter>** key.

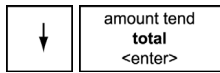

6 Press the **Arrow Down** key to select Table. Press the **Amount Tend Total <Enter>** key.

7 Do the following:



- Enter the price ranges and the amount of tax for each range. At the start of the **regular repeating breakpoint**, after you enter the **first** value of the first regular breakpoint, press the **#/NS <sym>** key.



- Continue entering price ranges and the amount of tax for each range until you completely enter an entire sequence of repeating **regular breakpoints**. Press the **#/NS <sym>** key. You return to the Tax selection screen.

8 Repeat for each tax you want to set.

Calculating Your Tax

This section provides instructions for figuring your own tax code if your specific state uses a tax table. Take the time to follow the Example Tax Chart on page 75. Familiarize yourself with the method of determining the tax code.

Then, using the worksheet on page 76, duplicate the method of calculating your state tax code by the steps described in this section. To do this you need to get a copy of your state's Retail Tax Chart from your local Tax Office. After you are done, write down the tax code and save the information for future reference.

Every tax table consists of tax brackets. Each consecutive tax bracket is assigned a tax which is exactly one cent higher than that assigned to the previous tax bracket. For example, part of a tax table might look like:

SALES	TAX	SALES	TAX
.00 - .08	.00	9.59 - 9.74	.58
.09 - .24	.01	9.75 - 9.91	.59
.25 - .41	.02	9.92 - 10.08	.60
.42 - .58	.03	10.09 - 10.24	.61
.59 - .74	.04	10.25 - 10.41	.62
.75 - .91	.05	10.42 - 10.58	.63
.92 - 1.08	.06	10.59 - 10.74	.64
1.09 - 1.24	.07	10.75 - 10.91	.65
1.25 - 1.41	.08	10.92 - 11.08	.66
1.42 - 1.58	.09	11.09 - 11.24	.67
1.59 - 1.74	.10	11.25 - 11.41	.68
1.75 - 1.91	.11	11.42 - 11.58	.69
1.92 - 2.08	.12	11.59 - 11.74	.70
2.09 - 2.24	.13	11.75 - 11.91	.71
2.25 - 2.41	.14	11.92 - 12.08	.72
2.42 - 2.58	.15	12.09 - 12.24	.73
2.59 - 2.74	.16	12.25 - 12.41	.74
2.75 - 2.91	.17	12.42 - 12.58	.75

In our Example Tax Chart, a sale from .00 to .08 is not taxed. The next tax bracket a sale from .09 to .24 is taxed one cent. The next tax bracket a sale from .25 to .41 is taxed two cents. The tax table progresses in a similar manner.

To calculate your tax rate

- 1 Using The Worksheet on page 76, complete Step A with the appropriate amounts from your state's Retail Tax Chart.
- 2 For the following, see the Example Tax Chart, Step B:

The difference between the starting amounts of each consecutive tax bracket is called a breakpoint. Every tax table consists of a particular sequence of breakpoints.

In our Example Tax Chart, the difference between .00 and .13 is .13 cents. This 13 is the first breakpoint. The difference between .13 and .32 is .19 cents, which means 19 is the second breakpoint.

The breakpoints continue in a particular sequence through the entire tax table.

- Using The Worksheet, complete Step B by calculating the breakpoints based on your state's Retail Tax Chart.
- The sequence of breakpoints is divided into *Regular* and *Irregular* patterns. All tax tables have a pattern of irregular breakpoints that leads into a repeating pattern of regular breakpoints.

To determine the breakpoint pattern, continue calculating the breakpoints in Part B until you have found the Regular repeat breakpoint pattern.

From our example:

Breakpoints 13, 19, 23, 27, 27, 29 are the Irregular breakpoint pattern.
Breakpoints 25, 25, 25, 25 are the Regular repeating breakpoint pattern.

The Regular repeating breakpoint pattern is a point where you first see a repetition of one or more numbers, which then add up evenly to 100, 200, 300, and so on. In our programming example, the Regular breakpoint pattern (25, 25, 25, and 25) adds up to 100.

It is possible that your specific regular breakpoint pattern can never add up to 100, 200 or 300. For example, your regular breakpoint pattern may be 33. In this case, make sure you enter **at least 4** examples of the regular breakpoint pattern.

Using The Worksheet on page 76, determine the Regular breakpoint pattern based on your state's Retail Tax Chart.

Example Tax Chart

The following is an example of how a tax chart can look.

Note

A total of 63 breakpoints can be programmed on this cash register.

		STEP A		
		SALE AMOUNT		TAX AMOUNT
STEP B		from	to	
Breakpoints		0	12	0
Irregular breakpoints (no pattern)	13	13	31	1
	19	32	54	2
	23	55	81	3
	27	82	108	4
	27	109	137	5
Regular breakpoints (at least 4 examples of the pattern)	29	138	162	6
	25	163	187	7
	25	188	212	8
	25	213	237	9
	25	238	---	10

Enter these values when you set the table tax

Press the #/NS <sym> key before you enter the first values for the first regular breakpoint

After at least 4 examples of the regular breakpoint, press the #/NS <sym> key again

Use the worksheet on the next page to calculate the irregular breakpoints and regular breakpoints for your local tax.

The Worksheet

Write down your results as you go.

<u>STEP B</u>		<u>STEP A</u>		
		SALE AMOUNT		TAX
Breakpoints		from	to	AMOUNT

Using Canadian Tax Rates

If you are in Canada, this cash register can be set for Canadian tax rates. If you are using Canadian tax rates, you see the following 4 tax rate options:

- GST
- PST1
- PST2
- PST3

For each tax rate (GST, and each PST), in addition to setting the tax percentage rate, you can also set a “minimum taxable amount”. Set this

dollar amount when setting the tax percentage amount. Just follow the instructions on the screen.

You can also set Tax-On-Tax or Piggy Back Tax.

To set Canadian tax rates

Programming ▶ Tax Set Up

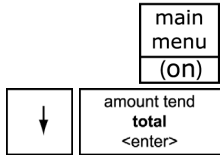

- 1 Press the **Main menu (on)** key.
- 2 Press the **Arrow Down** key to select Programming. Press the **Amount Tend Total <Enter>** key.



- 3 If you are prompted for a Manager Passcode, type the passcode number and then press the **Check** key. If you did not program a Manager Passcode, go to the next step.

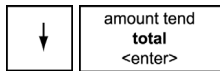

- 4 Press the **Arrow Down** key to select Tax Set Up. Press the **Amount Tend Total <Enter>** key.

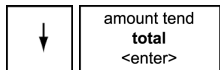

- 5 Press the **Arrow Down** key to select the tax you want to add or change. Press the **Amount Tend Total <Enter>** key.

- 6 Using the round Number keys area, enter the tax you want to add or change. For example, 7750 is 7.75% tax.

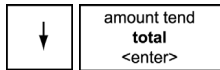

- 7 When you are done, press the **Amount Tend Total <Enter>** key.

- 8 Repeat for each tax you want to set.

To set Tax-On-Tax

Programming ▶ Tax Set Up ▶ Tax-On-Tax

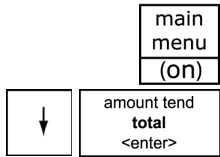

- 1 Press the **Main menu (on)** key.
- 2 Press the **Arrow Down** key to select Programming. Press the **Amount Tend Total <Enter>** key.



- 3 If you are prompted for a Manager Passcode, type the passcode number and then press the **Check** key. If you did not program a Manager Passcode, go to the next step.

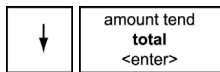

- 4 Press the **Arrow Down** key to select Tax Setup. Press the **Amount Tend Total <Enter>** key.

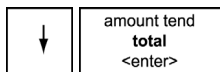

- 5 Press the **Arrow Down** key to select Tax-on-Tax. Press the **Amount Tend Total <Enter>** key.

- 6 Select from:

- No tax-on-tax
- Tax-on-Tax (Piggy Back)
- Tax-on-Tax-on-Tax (triple Piggy Back)

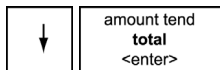

- 7 Make your selection and press the **Amount Tend Total <Enter>** key.

Using VAT Tax Rates

The Value Added Tax is commonly used in Mexico and Europe but other locations use it as well.

To set a VAT tax

Programming ▶ Tax Set Up

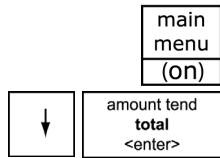

1 Press the **Main menu (on)** key.

2 Press the **Arrow Down** key to select Programming. Press the **Amount Tend Total <Enter>** key.



3 If you are prompted for a Manager Passcode, type the passcode number and then press the **Check** key. If you did not program a Manager Passcode, go to the next step.

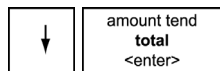

4 Press the **Arrow Down** key to select Tax Setup. Press the **Amount Tend Total <Enter>** key.

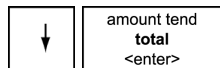

5 Press the **Arrow Down** key to select the tax you want to change. Press the **Amount Tend Total <Enter>** key.

6 Using the round Number keys area, enter the tax you want to add. You must use a 5 digit number.

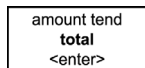

7 When you are done, press the **Amount Tend Total <Enter>** key.

8 Repeat for each tax you want to set.

Printing a Confirmation Report

To check your results, see Running the Options Dump Report on page 79.

Running Reports

Your cash register includes many reports. In this chapter, we explain:

- Programming confirmation reports
- Assigned Department keys reports
- Assigned PLUs reports
- Financial reports, such as sales totals and End-of-day Z reports
- Other management reports
- Electronic Journal

Note

Make sure you have a lot of cash register paper installed before you start printing any report.

Running the Options Dump Report

You can print the Options Dump Report to check your programming results. For more information about programming the cash register, see Chapter 5 Setting Up Your Cash Register Parameters on page 48.

The Options Dump report includes:

- All parameter settings
 - Print options

- System options
- Others setup
- Config options
- Header, footer, and scrolling messages
- Tax settings and rates

To run a program confirmation report

Programming ▶ More Options ▶ Options Dump

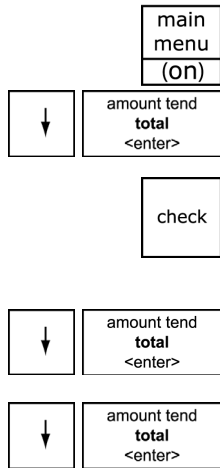

- 1 Press the **Main menu (on)** key.
- 2 Press the **Arrow Down** key to select Programming. Press the **Amount Tend Total <Enter>** key.
- 3 If you are prompted for a Manager Passcode, type the passcode number and then press the **Check** key. If you did not program a Manager Passcode, go to the next step.
- 4 Press the **Arrow Down** key to select More Options. Press the **Amount Tend Total <Enter>** key.
- 5 Press the **Arrow Down** key to select Options Dump. Press the **Amount Tend Total <Enter>** key.
- 6 Select the print format you want. Press the **Amount Tend Total <Enter>** key. The report prints.

Running the Department Confirmation Report

You can print a report that shows the programmed information for a range of departments or for all departments. The range report is helpful if you want to see the programmed names of some of the departments, but do not need to see all the departments and other cash register programming.

You can also print a report that shows department information and sales. For more information, see Running Management Reports on page 82.

Note

Unless you specify a department range, all departments print in the Department Range Report. This will take a few minutes.

To run a department confirmation report

Programming ▶ Department Set Up ▶ Depart Conf Report

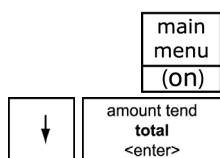

- 1 Press the **Main menu (on)** key.
- 2 Press the **Arrow Down** key to select Programming. Press the **Amount Tend Total <Enter>** key.

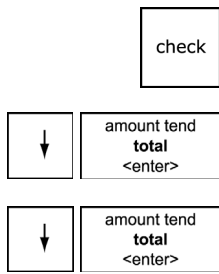

- 3 If you are prompted for a Manager Passcode, type the passcode number and then press the **Check** key. If you did not program a Manager Passcode, go to the next step.
- 4 Press the **Arrow Down** key to select Department Set up. Press the **Amount Tend Total <Enter>** key.
- 5 Press the **Arrow Down** key to select Depart Conf Report. Press the **Amount Tend Total <Enter>** key.
- 6 Select how you want to see the report. If you select Display, use the arrow keys to review the report in the clerk screen.

Running the PLU Confirmation Report

The PLU Confirmation Report allows you to check all PLUs programmed or a range of PLUs by PLU numbers or by the linked department. For more information about programming PLUs, see Programming PLU Descriptions on page 42.

To run the PLU confirmation report
Programming ▶ PLU Set Up ▶ Dump Report

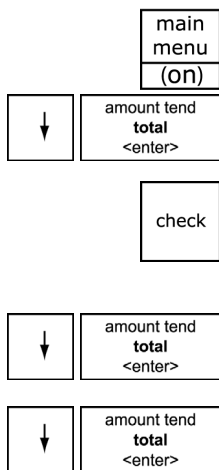

- 1 Press the **Main menu (on)** key.
- 2 Press the **Arrow Down** key to select Programming. Press the **Amount Tend Total <Enter>** key.
- 3 If you are prompted for a Manager Passcode, type the passcode number and then press the **Check** key. If you did not program a Manager Passcode, go to the next step.
- 4 Press the **Arrow Down** key to select PLU Set Up. Press the **Amount Tend Total <Enter>** key.
- 5 Press the **Arrow Down** key to select Dump Report. Press the **Amount Tend Total <Enter>** key.
- 6 Select All PLU, PLU Range, or Linked Department.
- 7 Select how you want to see the report. If you select Display, use the arrow keys to review the report in the clerk display.

Running Management Reports

The cash register maintains totals of all transaction information. This information is saved in the memory of the cash register as long as the register is plugged in to an electrical outlet or, if the cash register is unplugged, the batteries are charged.

Management reports show you information about how sales are progressing. You can run most reports as X reports or as Z reports.

- Run X reports during the day to check transactions. These reports do not clear the transaction memory in the cash register. You can run all reports in the X mode.
- Run Z reports at end of day, end of the week, or end of the month. These reports **CLEAR** the transaction memory in the cash register and reset all totals to zero. When you are done printing these reports, the information only exists on the cash register tape. You can run almost all reports in the Z mode.

To prevent someone from accidentally printing these reports, you can set a manager passcode for X reports and a manager passcode for Z reports. After the passcode is set, these reports do not print until the passcode is entered. For information about setting manager passcodes, see Setting X and Manager Passcodes on page 30.

About X Reports

There are two kinds of financial reports that can be taken in the X mode: an X1 report and an X2 report.

- Daily report (X1 report) - Commonly known as a *mid-day* reading. Use this report to print periodic readings of transaction totals during the course of the day. This report does not reset to zero.
- Periodic (X2 report) - Commonly known as a *mid-week* or *mid-month* reading. Use this report to print periodic readings of transaction totals during the course of several days. This report does not reset to zero.

About Z Reports

There are two types of financial reports that can be taken in the Z mode: a Z1 report and a Z2 report.

- Daily report (Z1 report) – Commonly known as a *end-of-day/daily-closeout* report. This report prints all transaction data and resets all totals to zero, except the Running Grand Total.

You can also print a duplicate Z1 Report. This is useful if the register runs out of paper or if there is a power outage while the Z1 Report is printing. However, you must set the parameter in Others Setup to allow a second report to be printed.

- Periodic report (Z2 report) – Commonly known as a *weekly* or *monthly* reading. This reading prints transaction totals either on a weekly or monthly basis (not both) and resets all transaction totals to zero except the Running Grand Total.

About Management Reports

The following management reports are available in both X mode and Z mode, unless noted otherwise:

- 1** Cash-in-Drawer Report - Available in the X mode only. Prints how much cash is in the drawer at the time of the report.
- 2** Financial Report - Also called X and Z reports. Prints totals of departments, tax, net sales, voids, returns, coupons, refunds, minus percentage, plus percentage, receipts-on-account, paid out, cash, check, charge and the running grand total.
- 3** PLU Report - Prints quantity and dollar amount of each PLU number rung up.
- 4** Department Range Report - Prints the sales information, quantity, and dollar amount totals for the specified departments. X mode only.
- 5** Clerk Report - Prints total sales amounts of each Clerk Number.
- 6** Hourly Report - Provides total sales amounts rung up each hour.
- 7** Periodic X-2 and Z-2 Reports - Prints the transaction totals for a period of time, such as a week or a month.
- 8** Electronic Journal Report - Prints the information in the Electronic Journal. Can be run in the X or Z modes.

Running Reports

Running reports are easy - just follow the prompts on the clerk display. Before you start printing reports, remember the following:

- All Z reports will print on the cash register tape to provide a permanent record before the totals are reset.
- For many X reports, you can view the report on the clerk display or print the report for a permanent record.

Note

Make sure you have a lot of cash register paper installed before you start printing any report.

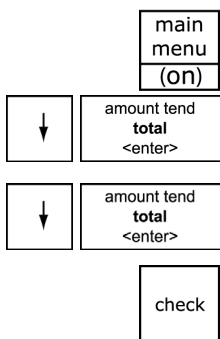

To run reports

- 1 Press the **Main menu (on)** key.
- 2 Press the **Arrow Down** key to select Reports. Press the **Amount Tend Total <Enter>** key.
- 3 Select X or Z mode reports. Press the **Amount Tend Total <Enter>** key.
- 4 If you are prompted for a Manager Passcode, type the passcode number and then press the **Check** key. If you did not program a Manager Passcode, go to the next step.
- 5 Select the report you want to run.
- 6 Answer any questions on the clerk display and follow the instructions on the clerk display.

Financial Report Example

Totals are calculated for the Management Reports in the following way.

- **NET SALES TOTAL (NET)** - Shows the true sales for the day. The Net sales total includes department total (DEPTTL), tax total (T1, T2, T3, T4), and less the coupon discount (COUPON) and less the percentage discount.

Note

Minus percentage discount (DISCOUNT), voids (VOID/CORR) and returns/refunds (REFUND) are all deducted from the department totals and the plus percentage (ADD ON) is added to the department totals, depending on the parameter settings.

- **GROSS SALES TOTAL (GROSS)** - Shows the total of all sales registered. The Gross Sales Total includes net sales total (NET), coupon discount (COUPON), minus percentage discount (DISCOUNT), return/refund (REFUND), and void (VOID/CORR).

Note

The Percentage Discount [-%] must be done after each item, not on the subtotal amount, for the formula given above to balance as shown.

The Financial report looks like the following. Your specific report looks different, because of your unique cash register activity. (Actual report may vary slightly)

TIME -->	09:14	04-11-2006	--> DATE
MACHINE NUMBER -->	MC NO.0000	0019	--> CONSECUTIVE NUMBER
	Z 1	0003	--> X1 OR Z1 COUNTER
	DEPT 1	0016	--> QUANTITY
		\$100.23T1	--> DEPARTMENT 1 SALES TOTAL (TAX 1)
	DEPT 2	0010	
		\$200.00T2	--> DEPARTMENT 2 SALES TOTAL (TAX 2)
	DEPT 3	0011	
		\$100.00TX	--> DEPARTMENT 3 SALES TOTAL (TAX 1 & TAX 2)
	DEPT 4	0010	
		\$109.00	--> DEPARTMENT 4 SALES TOTAL (NON-TAXABLE)
	DEPT TOTAL	\$509.23	--> ALL DEPARTMENTS SALES TOTAL
	TAX1 10%	\$8.22	--> TAX AMOUNT TOTAL
	TAX2 20%	\$36.02	
	COUPON	\$-0.50	--> COUPON (-) TOTAL
	ST-COUPON	\$0.00	--> SUBTOTAL COUPON (-) TOTAL
	DISCOUNT	\$0.00	--> -% TOTAL
	ST-DISCNT.	\$-5.05	--> SUBTOTAL -% TOTAL
	ADD ON	\$3.15	--> +% TOTAL
	ST-ADD ON	\$3.40	--> SUBTOTAL +% TOTAL
	NET	\$551.82	--> NET SALES TOTAL
	REFUND	\$-12.00	--> RETURN TOTAL
	VOID/CORR	\$-3.00	--> VOID TOTAL
	GROSS	\$509.23	--> GROSS SALES TOTAL
	CASH	0006	--> CASH SALES COUNTER
		\$265.86	--> CASH SALES TOTAL
	CHECK	0001	--> CHECK COUNTER
		\$50.00	--> CHECK SALES TOTAL
	CHARGE	0001	--> CHARGE COUNTER
		\$44.14	--> CHARGE SALES TOTAL
	CREDIT1	0001	--> CREDIT 1 COUNTER
		\$0.03	--> CREDIT 1 SALES TOTAL
	CREDIT2	0001	--> CREDIT 2 COUNTER
		\$191.79	--> CREDIT 2 SALES TOTAL
	TL-RECD AC	0002	--> RECEIVED ON ACCOUNT COUNTER
		\$5005.20	--> RECEIVED ON ACCOUNT TOTAL
	T-PAID OUT	0002	--> PAID OUT COUNTER
		\$663.00	--> PAID OUT TOTAL
	TL-NS	0003	--> NO SALE COUNTER
	C - I - D	\$4608.06	--> CASH-IN-DRAWER TOTAL
	FC	\$50.87	--> FORGEIN CURRENCY TOTAL
	GT	\$1042.22*	--> RUNNING GRAND TOTAL SALES AMOUNT

Additional Information in Electronic Journal (EJ) Reports

The Electronic Journal can hold 4,000-lines of transactions in memory. When the cash register memory is full, no more transactions or information can be stored in EJ memory. Sales totals will still be recorded in the financial or sales reports. Transactions already in memory are kept in memory until the Electronic Journal record is printed in Z-mode or the memory is manually reset.

The Electronic Journal records in the internal memory the line-by-line details of all the transactions and items completed on the cash register, both transactions printed on the built-in printer and transactions run with

the printer off and no receipt printed. This includes all sales transactions, any Z reports run during the day and even using the **#/NS <sym>** key for no-sale rings to open the cash drawer.

The cash register warns you when the Electronic Journal memory is nearly full to let you finish the current transaction. Then you can print the Electronic Journal record to prevent any loss of information. When the memory is completely full, the cash register warns you and no additional transaction information can be saved.

You can print the entire Electronic Journal record on the printer in the cash register in either the X Mode or the Z Mode.

- **X-Mode:** You can print the Electronic Journal record anytime during the day. This prints what is currently in the Electronic Journal memory and **does not** reset the memory. You can also review the electronic journal on the clerk screen.
- **Z-Mode:** You can print the entire Electronic Journal record and reset the journal memory so everything in memory is erased after printing. Only run this report at the end of the day, after running the standard Z Report for the end-of-the-day sales totals.

Make sure there is a lot of paper on the receipt paper roll so the Electronic Journal reports can print completely.

You can download the Electronic Journal record to the PC using the serial connection. For more information, see the RegisterLink manual.

Print a Mid-Day Electronic Journal Report

You can print the Electronic Journal report at anytime during the day without resetting the memory. You can run an EJ report for a specific date or time period.

To print in the X Mode

Reports ▶ X Report ▶ Electr. Journal

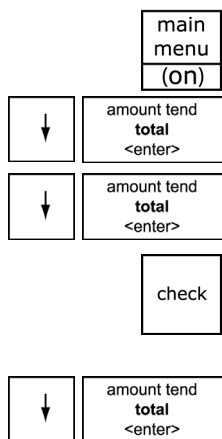

- 1 Press the **Main menu (on)** key.
- 2 Press the **Arrow Down** key to select Reports. Press the **Amount Tend Total <Enter>** key.
- 3 Press the **Arrow Down** key to select X Report. Press the **Amount Tend Total <Enter>** key.
- 4 If you are prompted for an X Mode Passcode, type the passcode number and then press the **Check** key. If you did not program an X Mode Passcode, go to the next step.
- 5 Press the **Arrow Down** key to select Electr. Journal. Press the **Amount Tend Total <Enter>** key.

- 6 Follow the instructions on the screen. You can review the report on the clerk screen and then print it. Use the arrow keys to move through the report.
The Electronic Journal record prints and the Electronic Journal memory is not reset.

Print an End-of-Day Electronic Journal Report

You can print the Electronic Journal Z report at the end of the day. This report prints all transactions and clears the memory at the same time.

To print in the Z Mode

Reports ▶ Z Report ▶ Electr. Journal

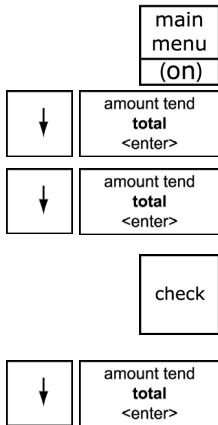

- 1 Press the **Main menu (on)** key.
- 2 Press the **Arrow Down** key to select Reports. Press the **Amount Tend Total <Enter>** key.
- 3 Press the **Arrow Down** key to select Z Report. Press the **Amount Tend Total <Enter>** key.
- 4 If you are prompted for a Manager Passcode, type the passcode number and then press the **Check** key. If you did not program a Manager Passcode, go to the next step.
- 5 Press the **Arrow Down** key to select Electr. Journal. Press the **Amount Tend Total <Enter>** key.
- 6 Follow the instructions on the screen. The Electronic Journal record prints and the Electronic Journal memory is cleared.

Check the Electronic Journal Memory

You can check the current status of the Electronic Journal memory for the number of lines used in memory and how many lines remain free. This lets you know if you should print the Electronic Journal soon.

To check the Electronic Journal memory



- ◆ In Sales Registration mode after or between transactions, press the **QTY/DATE** key.

The memory status with the number of lines that the memory can still accept appear on the operator display.

If you do not see the number of lines that the memory can still accept, the Electronic Journal is turned off. Go to the System Options and turn it on.

Maintenance and Options

Follow these steps to make sure your cash register works well.

- Your register must remain uncovered when turned on. This allows the electronic components to properly cool.
- Use a dust cover when the register is not in operation and the cash register is set to the OFF position to protect mechanical components from dust.
- Keep beverages and other liquids away from the machine to avoid spills which can damage electronic components. Use the optional protective keytop cover to prevent damage to the cash register, especially in restaurants and other locations where food and drinks are sold or prepared.
- Keep the cash register away from dust, dampness, or extreme hot or cold temperatures.
- To clean your cash register, use a soft dry cloth. Do not use harsh solutions containing alcohol or ammonia.
- After storing your cash register in extreme temperatures (below 32 degrees Fahrenheit or above 104 degrees Fahrenheit), allow the temperature inside the machine enough time to reach room temperature before turning it on.
- If you need electronic service, take the cash register to a Royal authorized service center. For more information, see Manufacturer's Limited Warranty on page 121.

Installing a New Paper Roll

As you use the cash register, you will need to replace the paper roll. Your cash register has a thermal printer that prints receipts for the customer or a journal tape. Use 2¼ inch (57.5 mm) wide standard thermal register paper. Do not use bond paper because the register does not use a ribbon or ink for printing.

feed

Caution

Do not manually pull the receipt paper. Always use the **Feed** key to remove or advance the paper. Do not use sharp or pointed instruments in the printer area. This can seriously damage the printer.

To install the paper roll

- 1 Open the Journal Compartment Cover. Remove the Journal Compartment Cover and set aside. Remove the tape on the black Journal Tape spindle inside the printer compartment of the cash register.

- 2 Remove the Journal Takeup spindle. Place the paper roll in the little round area at the bottom of the compartment. Make sure the paper feeds out from the bottom of the roll, towards the front of the cash register.

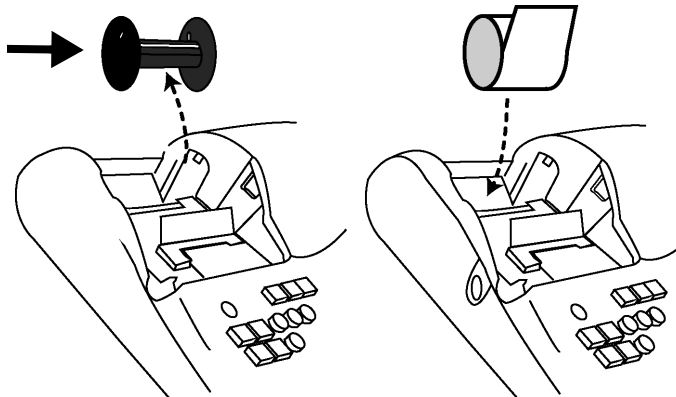

- 3 Grab the small handle on the right of the print roller. Push the little handle towards the back of the cash register and raise the roller bar up.

- 4 Lay the end of the paper across the printer as shown. Move the print roller down onto the paper and snap into place. Make sure both sides are snapped down.

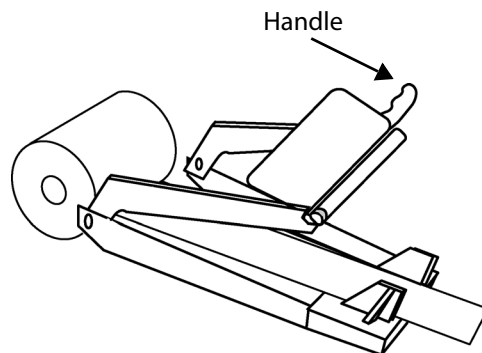

feed

Press the **Feed** key until the paper catches and moves through the printer.

5 Do one of the following:

feed

- If you do not need to print receipts: Place the black plastic Journal Takeup spindle on its grooves above the Battery compartment. The spindle sits above the paper roll. Press the **Feed** key to move the paper through the printer about 10-12 inches. Push the paper through one of the narrow openings in the center of the Journal Takeup spindle. Press the **Feed** key until the paper catches and begins to wind securely around the Journal Takeup spindle. Replace the Journal Compartment Cover.

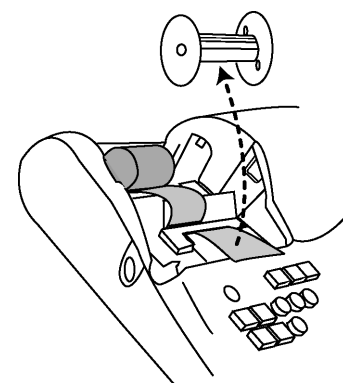

- If you want to print receipts: Lay the customer receipt paper over the receipt slot and close the Journal Compartment Cover.

Using the Battery System

Your cash register has a memory where information about your programming and transactions are stored. This memory stores the information that lets you print reports, such as the total sales for the day, week, or month. The cash register memory also stores information about any special programming you have done.

If your cash register is unplugged or if there is a power outage, the batteries keep the information in the memory until you plug the cash register into a power source or the power is restored.

To make sure the battery back-up protection is working, replace the batteries at least once a year. To help you remember, consider replacing the batteries on New Years Day. The cash register can be off or unplugged for as long as 700 hours (about 28 days) and the information in the memory is still there when you are ready to use the register again.

If there was a power outage, replace the batteries as soon as there is power again. **DO NOT** remove or replace the batteries until you plug the cash register into a power source and you see messages on the display.

If you will not use the cash register for an extended period of time, you can remove the batteries to prolong their life. However, all information in the cash register will be erased if you do this.

Caution

You must plug the cash register in before installing or replacing the back-up batteries. All data is erased when you remove the batteries if the cash register is not plugged in before you remove the batteries.

To install or replace the batteries

1 Before you start, make sure you have 3 new AA batteries.

1 Open the Journal Compartment Cover. Remove the Journal Compartment Cover and set aside.

2 Move the paper roller bar up and out of the way. Grab the small handle on the right of the print roller bar. Push the little handle towards the back of the cash register and raise the paper roller bar up. You see a slope down to the paper compartment. The battery cover is located under the print roller bar, on the slope.

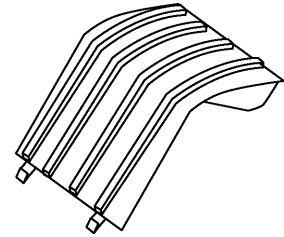

3 Remove the battery cover. Press the edge at the top of the cover and push to the back. The cover pops off.

- Put the batteries in the slots. Make sure that the positive and negative ends are in the right place. The batteries have a little plus (positive) and minus (negative) sign on each end to help you.

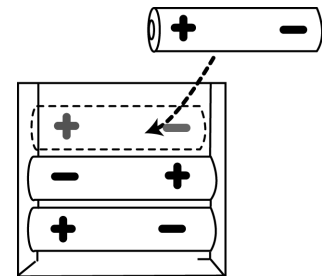

- Replace the battery cover. Slide the bottom tabs into the long slit in the bottom position and snap the cover into place. Do not put the tabs in the 2 holes in the bottom of the compartment. The cover will not close and you will break the tabs.

About the Serial Port

Your cash register includes a serial port on the right side of the cash register. You can connect items to the cash register using this serial port. You can only connect one device to the serial port at a time.

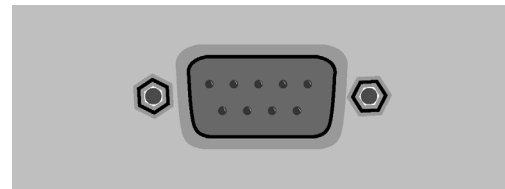

To use the optional barcode reader, you must connect it to the serial port. You can also use the serial port to connect the cash register to a PC and use the RegisterLink software.

To connect your computer to the serial port, you need a null-modem serial cable. A 6 foot null modem serial cable is included in the box with the cash register.

The pin description for the serial port on the cash register is shown below.

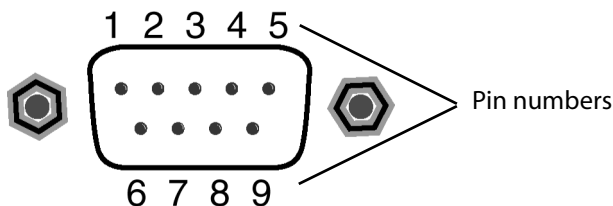

Pin No.	I/O	Signal Name	Abbreviation
1	NC		
2	IN	Receive Data	RXD
3	OUT	Transmit Data	TXD
4	NC		
5	N/A	Signal Grand	SG
6	NC		
7	OUT	(Request to send)	RTS
8	IN	(Clear to send)	CTS
9	OUT(+5V)	Power supply for BCR	+5V

Connecting the Cash Register to a PC

Using the RegisterLink software, you can connect your cash register to a PC to download the information.

Note

You must use RegisterLink version K or later.

RegisterLink must be installed and the PC restarted if it was the first time you installed RegisterLink. For specific information about using the RegisterLink software, see the RegisterLink manual.

Before you start, you must have the null modem serial cable. For more information, see About the Serial Port on page 91.

To set up the cash register to connect to a PC

- 1 Connect the cash register to the PC using a null modem serial cable.
- 2 Open the RegisterLink software on your PC
- 3 On the cash register, go to the main menu, scroll down to PC-LINK and press the **Amount Tend Total <Enter>** key.
- 4 Go to the RegisterLink software on the PC and follow the directions in RegisterLink.

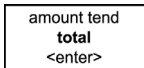

Troubleshooting

Most errors are described on the clerk screen and you are prompted with the corrective action to take. For a list of common error messages and what they mean, see Error Codes on page 45. This section generally describes other possible issues and what to do. Select and follow the procedure which best describes what is happening.

Paper End or Printer Errors

Both prompts means there is a paper problem.

feed

Caution

Do not manually pull the receipt paper. Always use the **Feed** key to remove or advance the paper. Do not use sharp or pointed instruments in the printer area. This can seriously damage the printer.

- 1 Check if you are out of paper. If so, replace with a new roll.
- 2 Check for a paper jam. If so, carefully remove any paper obstructing the printer.
- 3 Check and make sure the paper was aligned properly in the printer and that the printer bar is snapped into place.
- 4 After the paper jam is successfully removed, press the **Clear** key. If an error message still appears, unplug the cash register, wait 10 seconds, and plug it back in.
- 5 If there is a FUNCTION error and an error message still appears on the display, press the **Clear** key.
- 6 As a last resort, follow the directions for a Full System Clear. See Full System Clear on page 97.

clear

clear

No Receipt Printing



If no receipt is printing for a sales transaction, look for the **R OFF** symbol on the clerk display.



If the **R OFF** symbol appears, press the **Receipt on/off <esc>** key one time to turn the symbol off.

If the **R OFF** symbol does not appear, check for a paper jam.

No Printing on the Receipt

If the cash register is not printing on the receipt, make sure you are using **thermal paper**. Bond paper will not work in this cash register. If needed, contact the Royal Customer Support hotline at 1-800-272-6229 for additional help.

The Cash Register Turns Itself Off

This is normal. This cash register has a “go to sleep mode” that turns the cash register off after a specified time period. For more information, see Using Power Saving Mode on page 21.

Electronic Journal Memory Errors

You may see 2 messages about the Electronic Journal:

ELECTRONIC JOURNAL MEMORY NEARLY FULL means the Electronic Journal is almost full, with less than 700 lines remaining.

ELECT. JOURNAL FULL means the Electronic Journal memory is completely full and must be cleared.



The Electronic Journal can hold up to 4,000 lines of transactions. When the memory gets close to full, a message appears telling you that the memory is nearly full. If you are in the middle of a transaction, press the **Clear** key to clear the error message, follow the instructions on the clerk display, and finish the transaction.

Immediately after the current transaction is finished, either print the Electronic Journal record in Z Mode or manually clear the Electronic Journal record memory. This section explains how to do both.

Before you start, make sure there is a lot of paper on the receipt paper roll so the Z Electronic Journal reports can print completely.

To print and clear the Electronic Journal
Reports ▶ Z Report ▶ Electr. Journal

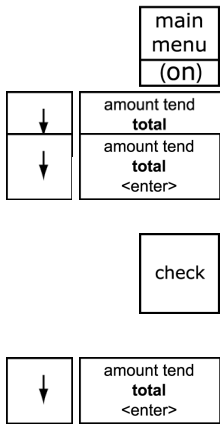

- 1 Press the **Main menu (on)** key.
- 2 Press the **Arrow Down** key to select Reports. Press the **Amount Tend Total <Enter>** key.
- 3 Press the **Arrow Down** key to select Z Report. Press the **Amount Tend Total <Enter>** key.
- 4 If you are prompted for a Manager Passcode, type the passcode number and then press the **Check** key. If you did not program a Manager Passcode, go to the next step.
- 5 Press the **Arrow Down** key to select Electr. Journal. Press the **Amount Tend Total <Enter>** key.
- 6 Follow any instructions on the screen. The Electronic Journal record prints and the Electronic Journal memory is cleared.

To manually reset the Electronic Journal memory without printing

Caution

This procedure cannot be undone. All information stored in the Electronic Journal memory is permanently deleted and cannot be recovered.

Reports ▶ Z Report ▶ EJ Clear

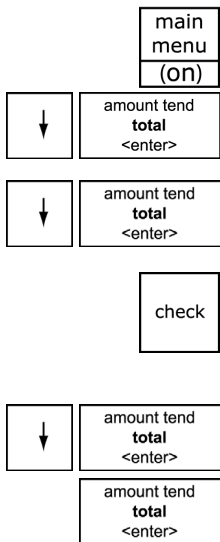

- 1 Press the **Main menu (on)** key.
- 2 Press the **Arrow Down** key to select Reports. Press the **Amount Tend Total <Enter>** key.
- 3 Press the **Arrow Down** key to select Z Report. Press the **Amount Tend Total <Enter>** key.
- 4 If you are prompted for a Manager Passcode, type the passcode number and then press the **Check** key. If you did not program a Manager Passcode, go to the next step.
- 5 Press the **Arrow Down** key to select EJ Clear. Press the **Amount Tend Total <Enter>** key. At the prompt, select Yes and press **Amount Tend Total <Enter>** key.

The Electronic Journal memory is reset and all information stored in the memory is erased. A verification prints that the Electronic Journal reset and the memory is cleared.

The Cash Register Does Not Work at All

If the cash register does not respond except with an error:

- Make sure you are not in the middle of a sales transaction.

amount tend total <enter>

- Enter a price, press a department key, and press the **Amount Tend Total <Enter>** key to end the sale. Now continue with what you were trying to do.

The Cash Register Does Not Work at All

- 1 Be sure the cash register is plugged into a working electrical outlet and no other electrical device is using the same power source. Another electrical motor on the same circuit can keep the cash register from working properly.
 - If error still persists, perform a Half System Clear procedure. See Half System Clear.
 - If the Half System Clear did not work, perform a Partial Reset. See Partial Reset.
 - As a last resort, perform a Full System Clear procedure. See Full System Clear.
- 2 If needed, contact the Royal Customer Support hotline at 1-800-272-6229 for additional help.

Opening the Drawer When There is no Power

If there is no power and you need to open the drawer, follow these instructions.

- 1 With your hands on the cash drawer, carefully tip the front of the register up. Underneath the cash register, toward the back of the register, you see a small lever.
- 2 Push the lever in the only direction it will move. The cash drawer opens.

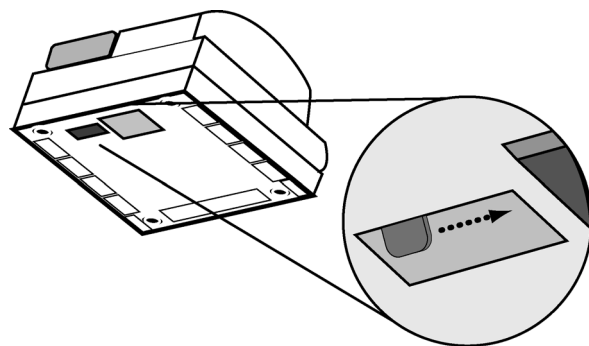

Half System Clear

If you cannot get the cash register to respond, try a half system clear.

To do a half system clear

- 1 Unplug the cash register from the power source.
- 2 Wait 30 seconds.
- 3 Plug the cash register in again.
- 4 Continue with normal operations.

Partial Reset

If the cash register did not respond to the Half System Clear, try a Partial Reset. This procedure requires both your hands or a friend to help.

To do a partial reset

- 1 Unplug the cash register from the power source.
- 2 Using the round Number keys, press and hold the 3 key and the 7 key at the same time. Continue to hold these keys down.
- 3 While you are still holding down the 3 and 7 keys, plug the cash register back into the power source.
- 4 Release the 3 and 7 keys.
- 5 Continue with normal operations.

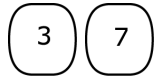

Full System Clear

If nothing else works, perform the following procedure.

Caution

This procedure resets the cash register to the factory settings. You lose all your transaction information and programming information.

To do a full system clear

- 1 Remove all back-up batteries.
- 2 Unplug the cash register from the power source and wait 5 minutes.
- 3 Plug in the cash register.
- 4 Replace the batteries.
- 5 Reprogram the cash register.
- 6 Continue with normal operations.

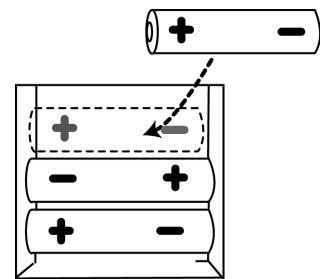

If Nothing Helps

If a problem still persists, call our Customer Service Support Line toll-free at 1-800-272-6229.

Examples

The examples in this section show how to ring up different types of transactions. You can enter a maximum of 7 digits to enter a price, including dollars and cents.

To ring up a sale

amount tend
total
<enter>

◆ At the main menu screen, select Sales Registration. Press the **Amount Tend Total <Enter>** key. You are ready to ring up sales.

amount tend
total
<enter>

check

Reminder

If Clerk Numbers are programmed, be sure to type the **CLERK #**, then press the **Amount Tend Total <Enter>** key. Enter the passcode, if programmed and the passcode system is activated, and press the **CHECK** key before ringing up a sale.

○ .

Reminder

Do not press the **Decimal Point** key when ringing up a price.

The following examples are in this chapter.

- Adding Tax to a Non-Taxable Department
- Cash Sale With Tendering Change
- Cash Sale Without Tendering Change
- Charge Sale
- Charge Return
- Check Sale
- Coupon Discount Sale

- Credit Sale
- Credit Return
- Dept Shift Key
- Exempting Tax On An Item
- Exempting Tax on the Entire Sale
- Gallonage Sales Transaction
- Minus Percentage Discount Sale
- Multiplication of a Department Unit Price
- Multiplication Sale and Overriding a Preset Department Price
- Multiplying By A Fraction
- No-Sale Function (Opening the Cash Drawer)
- Temporarily Overriding a PLU Price
- Paid-Out Sale
- PLU Sale
- Plus Percentage Sale
- Received-On-Account Sale
- Registering A Department Unit Price
- Registering A Reference Number
- Return Sale
- Split Tendering Sale
- Use the Error-Correct /Void Key
- Voiding A Minus Percentage Discount Sale
- Voiding a Multiplication of a Department Preset Price
- Voiding A Department Multiplication Sale
- Voiding a PLU Sale
- Voiding a PLU Multiplication Sale
- Voiding a PLU Sale with a Minus Percentage Discount
- Voiding a PLU Sale with a Plus Percentage Rate
- Voiding a Plus Percentage Sale
- Voiding an Entire Sale before Finishing the Sale
- Voiding A Sale

Transaction Codes

The following codes appear on transaction receipts:

Table 8 Transaction Codes

The code...	Means this...
#	Reference Number
@	Amount Being Multiplied
ADD ON	Plus Percent
CASH	Cash Transaction Total
CHANGE	Change
CHARGE	Charge Transaction Total
CHECK	Check Transaction Total
Clerk #1 to Clerk #n	Clerk number 1 to number n where n= the maximum number of clerks
CREDIT	Credit card transaction
DISCOUNT	Minus Percent Discount
NO SALE	No-Sale Function or Open Cash Drawer
PAID OUT	Paid Out
PRICE	Overriding of a PLU Price
RECD ACCT	Received on Account
REFUND	Return (Refund)
SUBTTL	Subtotal (Excludes Tax)
T1	Tax 1 Rate Applied to a Sale
T2	Tax 2 Rate Applied to a Sale
T3	Tax 3 Rate Applied to a Sale
T4	Tax 4 Rate Applied to a Sale
TOTAL	Total of Sale
TX	Represents Tax Total if selected in Print Options.
VOID/CORR	Void
X	Number of Items Being Multiplied

Sample Receipt

The example below shows the general transaction information you see printed on a receipt. Your actual receipt may vary.

	* YOUR RECEIPT *				HEADER MESSAGE (5 lines)
	* THANK YOU *				STANDARD CHARACTER...24/line
	* * *				DOUBLE-WIDE CHARACTER...12/line

TIME	14:06	04-12-2006		DATE	
MACHINE NUMBER	MC NO.1234	0015		CONSECUTIVE TRANSACTION NUMBER	
CLERK NAME	CLERK01				
DEPARTMENT	DEPT 1	\$1.00T1		DEPARTMENT 1 LINKED TO TAX 1	
NAME	DEPT 2	\$2.00T2		DEPARTMENT 2 LINKED TO TAX 2	
	DEPT 3	\$3.00		NON-TAXABLE DEPARTMENT	
	DEPT 4	\$4.00		NON-TAXABLE DEPARTMENT	

	SUBTOTAL	\$10.00		SUBTOTAL	
	TAX1	\$0.20		TAX 1 AMOUNT	
	TAX2	\$0.20		TAX 2 AMOUNT	
	TOTAL-TAX	\$0.40		TAX TOTAL	

SALES TRANSACTION					
TOTAL	TOTAL	\$10.40			
CASH AMOUNT TENDERED	CASH	\$15.00			CHANGE COMPUTATION
CHANGE DUE TO	CHANGE	\$4.60			
CUSTOMER					
	HAVE A NICE DAY				FOOTER MESSAGE (5 lines)
	PLEASE COME AGAIN				STANDARD CHARACTER...24/line
					DOUBLE-WIDE CHARACTER...12/line

The rest of this chapter shows you example transactions.

Adding Tax to a Non-Taxable Department

Example 4: Assume the Department 2 key is programmed for no tax and the TAX 1 rate is programmed for 6%. Ring up a \$1.00 item in Department 2, charging the 6% tax rate.

To add or force tax to a non-taxable department or a different tax rate

- 1 Press the

tax force

 key.
- 2 Press the

↓

 key and select Tax 1.
- 3 Press the

amount tend total <enter>

 key.
- 4 In the Number keys area, press 100, and then press the

2	I
18	Y

 key.
- 5 Press the

amount tend total <enter>

 key.

Cash Sale With Tendering Change

Example 5: Ring up a \$1.00 item in Department 1 and compute change from \$5.00 cash tendered.

To ring up a sale with tendering change

1 In the Number keys area, press 100, and then press the

1	M
17	space

 key.

2 Press the

sub total reprint

 key

You do not need to press the **Subtotal reprint** key if you do not want the subtotal with tax amount to be shown on the bottom line of the screen.

3 In the Number keys area, press 500, and then press the

amount tend total <enter>

 key.

Cash Sale Without Tendering Change

Example 6: Ring up a \$1.00 item in Department 1.

To ring up a sale without tendering change

1 In the Number keys area, press 100, and then press the

1	M
17	space

 key.

2 Press the

sub total reprint

 key.

You do not need to press the **Subtotal reprint** key if you do not want the subtotal of the sale to print.

3 Press the

amount tend total <enter>

 key.

Charge Sale

Example 7: Ring up a \$1.00 item in Department 1 and finalize the sale with the charge key.

To ring a charge sale

1 In the Number keys area, press 100, and then press the

1	M
17	space

 key.

2 Press the

charge
<wide>

 key.

You do not have to enter any amounts before pressing the

charge
<wide>

 key.

Charge Return

Example 8: Refund \$1.00 in Department 1 and credit the return to charge.

To ring a charge return

- 1 Press the

return
<caps>

 key.
- 2 In the Number keys area, press 100, and then press the

1	M
17	space

 key.
- 3 Press the

charge
<wide>

 key.

Check Sale

Example 9: Ring up a \$1.00 item in Department 1 and finalize the sale with the Check key.

To ring a check sale

- 1 In the Number keys area, press 100, and then press the

1	M
17	space

 key.
- 2 Press the

check

 key.

You do not have to enter any amount before pressing the

check

 key.

Coupon Discount Sale

Example 10: Ring up a \$1.00 item and then apply a 20% off coupon.

To ring a coupon discount sale

- 1 In the Number keys area, press 100 and then press the

2	I
18	Y

 key.
- 2 In the Number keys area, press 20 and then press the

cpn

 key.
- 3 Press the

amount tend
total
<enter>

 key.

Sales tax is charged on the net amount after the coupon is deducted. For more complex coupons or to charge tax on the original amount before the coupon is deducted, set up and use a negative department. See Customer Service for help.

Credit Sale

Example 11: Ring up a \$1.00 item in Department 1 and \$2.00 in Department 2 and finalize the sale with the Credit key.

Note

Dept. 15 and/or Dept. 16 keys must be programmed as Credit keys and turned on for this example to work. See Programming the Credit Keys on page 40.

To ring a credit sale

1 In the Number keys area, press 100, and then press the

1	M
17	space

 key.

2 In the Number keys area, press 200, and then press the

2	I
18	Y

 key.

3 Press the

15	H
31	X

 or the

16	D
32	T

 key.

Note

You do not have to enter an amount before pressing either of the credit keys.

Credit Return

Example 12: Refund \$1.00 in Department 1 and credit to a Credit key.

Note

Dept. 15 and/or Dept. 16 keys must be programmed as Credit keys and turned on for this example to work. See Programming the Credit Keys on page 40.

To ring a credit return

1 Press the

return
<caps>

 key.

2 In the Number keys area, press 100 and then press the

1	M
17	space

 key.

3 Press the

15	H
31	X

 or the

16	D
32	T

 key.

It is not necessary to enter any amount before pressing either of the credit keys.

Dept Shift Key

Example 13: Ring up a \$1.00 item in Department 1 (taxable), \$2.00 in Department 21 (non-taxable) and \$3.00 in Department 33 and compute change from \$10.00 cash tendered.

Note

Departments 21 and 33 must be programmed.

To ring a sale using the Dept Shift key

1 In the Number keys area, press 100, and then press the

1	M
17	space

 key.

2 In the Number keys area, press 200, then press the

dept
shift

 key, and then press the

5	N
21	N

 key.

3 In the Number keys area, press 300, press

dept
shift

, in the rounded Number keys, press 33, and press

dept
shift

 again.

- 4 Press the

sub total reprint

 key.
- 5 In the Number keys area, press 1000, and then press the

amount tend total <enter>

 key.

Note

The register returns to the Non-Shift Mode after each department entry.

Exempting Tax On An Item

Example 14: Assume the Department 1 key is programmed as a taxable department. Ring up a \$1.00 item in Department 1 without charging tax.

To ring an item without charging tax

- 1 Press the

tax force

 key.
- 2 Select Non Tax.
- 3 Press the

amount tend total <enter>

 key.
- 4 In the Number keys area, press 100, and then press the

2	I
18	Y

 key.
- 5 Press the

amount tend total <enter>

 key.

Exempting Tax on the Entire Sale

Example 15: Assume the Department 1 key is programmed as a taxable department. Ring up a \$1.00 item and a \$1.50 item in Department 1 without charging tax.

To ring an entire sale without charging tax

- 1 In the Number keys area, press 100, and then press the

1	M
17	space

 key.
- 2 In the Number keys area press 150, and then press the

1	M
17	space

 key.
- 3 Press the

tax exempt sale

 key.

Note

After Pressing the **Tax Exempt Sale** key, you must end the sale. You cannot enter additional items to the transaction.

- 4 Press the

amount tend total <enter>

 key.

Gallonage Sales Transaction

Example 16: In this example, Department 4 is programmed for Gallonage Mode and is non-taxable. Ring 10.759 gallons at \$2.749 per gallon.

Note

Department 4 must be programmed as gallonage for this to work.

To ring a gallonage sales transaction

- 1 In the Number keys area, press 10.759, and then press the

qty/ date

 key.
- 2 In the Number keys area, press 2749, then press the

4	A
20	Q

 key.
- 3 Press the

amount tend total <enter>

 key.

Minus Percentage Discount Sale

Example 17: The following are two versions of Minus Percentage Discount Sales.

Version 1

Note

If no tax is programmed in your cash register, ring up a \$1.00 item in Department 2 and apply a preprogrammed discount rate of 10%.

To ring a minus percentage discount sale

- 1 In the Number keys area, press 100, and then press the

2	I
18	Y

 key.
- 2 Press the

- %
RA

 key.

Note

If the Minus Percentage Discount Rate is NOT programmed, type in the 10% discount rate by entering 10 before pressing the

- %
RA

 key.

- 3 Press the

amount tend total <enter>

 key.

Version 2

Note

When ringing a taxable item with a percentage discount, tax will automatically be charged on the discounted amount, the amount after the percentage discount is deducted.

To ring a minus percentage discount sale

- 1 In the Number keys area, press 100, and then press the

1	M
17	space

 key.
- 2 Press the

- %
RA

 key.

Note

If the Minus Percentage Discount Rate is NOT programmed, type in the 10% discount rate by pressing 10 before pressing the  key.

3 Press the  key.

Multiplication of a Department Unit Price

Example 18: Assume the Department 1 key is pre-programmed for \$1.00. Ring up this price three times.

To multiply a department unit price

1 In the Number keys area, press 3, and then press the  key.

2 Press the  key.

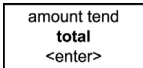
3 Press the  key.

Note

You can ring up to 32 prices by using the 32 Department keys for quick ring-ups.

Multiplication Sale and Overriding a Preset Department Price

Example 19: Ring up three \$4.00 items in Department 1, overriding the \$1.00 preprogrammed price.

To ring a multiplication sale

1 In the Number keys area, press 3, and then press the  key.

2 In the Number keys area, press 400, and then press the  key.

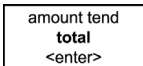
3 Press the  key.

Note

You can use from .001 to 999.999 when ringing up the quantity of an item.



Multiplying By A Fraction

Example 20: Multiply the quantity of 1.25, as in 1¼ yards of fabric at \$1.00 per yard in Department 1.

Caution

When multiplying by a fraction, you must use the decimal point in the fraction but not in the dollar amount.

To multiply an item by a fraction

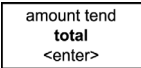
- 1 In the Number keys area, press 1 . 25, and then press the  key.
- 2 In the Number keys area, press 100, and then press the  key.
- 3 Press the  key.

Note

You can use from .001 to 999.999 when ringing up the quantity of an item.

No-Sale Function (Opening the Cash Drawer)

Example 21: Used to open the drawer without ringing up a sale. For example, to give change.

To use the No Sale function

- ◆ Press the  key. The cash register drawer opens.



Note

The number of times the No Sale key is used appears on the Management Reports. For more information about these reports, see Running Management Reports on page 82.

Temporarily Overriding a PLU Price

Example 22: If you need to enter a different price than what is programmed into a PLU #: Enter the price 100, press the **plu alt** key, enter the PLU #, then press the **PLU** key. The word *PRICE* appears above the PLU description or PLU number.

To override a PLU sale

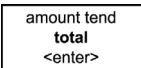
- 1 In the Number keys area, press 100, press the  key.
- 2 In the Number keys area, enter the PLU number, and press the  key.
- 3 Press the  key.

The word *PRICE* appears above the description or PLU #.

Paid-Out Sale

Example 23: Indicates money taken out of the cash drawer. Ring up \$10.00 to show money paid out of the cash drawer.

To record monies paid out

- ◆ In the Number keys area, press 1000, then press the

+ % PO

 key.

PLU Sale

Example 24: Assume the PLU # is preset for the price of \$1.99 in Department 1. Ring up the PLU #1.

To ring a PLU sale

- 1 In the Number keys area, press 1, and then press the

plu

 key.
- 2 Press the

amount tend total <enter>

 key.

Note

PLUs follow the same procedure for ringing up Coupons, Refunds, Minus Percentage Discounts, Plus Percentages, and so on, as with ringing these items up for a Dept # sale.

Plus Percentage Sale

Example 25: The following are two versions of the Plus Percentage Sale.

Version 1

Note

If no tax is programmed in your cash register, ring up a \$1.00 item in Department 2 and apply a pre-programmed Plus Percentage Rate of 10%.

To ring a PLU percentage sale

- 1 In the Number keys area, press 100, and then press the

2	I
18	Y

 key.
- 2 Press the

+ % PO

 key.

Note

If the Plus Percentage Rate is NOT pre-programmed, type in the 10% plus percentage rate by pressing 10 in the round Number keys before pressing the

+ % PO

 key.

- 3 Press the

amount tend total <enter>

 key.

Version 2

Note

When ringing a taxable item with a Plus Percentage the tax will automatically be charged on the amount after the PLUs percentage is added.

To ring a PLUs percentage sale

- 1 In the Number keys area, press 100, and then press the

1	M
17	space

 key.
- 2 Press the

+ %
PO

 key.

Note

If the Plus Percentage Rate is not pre-programmed, type in the Plus Percentage Rate before pressing the

+ %
PO

 key.

- 3 Press the

amount tend
total
<enter>

 key.

Received-On-Account Sale

Example 26: Indicates money put in the cash drawer. Ring up \$50.00 to show the beginning cash-in-drawer amount for the day.

To receive monies on account

- ◆ In the Number keys area, press 5000, and then press the

- %
RA

 key.

Registering A Department Unit Price

Example 27: Assume Department 1 is pre-programmed for \$1.00. Ring up this price.

To register a department unit price

- 1 Press the

1	M
17	space

 key.
- 2 Press the

amount tend
total
<enter>

 key.

Note

You can ring up to 32 prices by using the total of the 32 Department keys for quick ring-ups.

Registering A Reference Number

Example 28: Used to print a number, up to 10 digits, to identify an invoice number or any other number on receipts. Ring up the number 1234567 in a standard sale.

Note

Using the reference number is not recorded in any activity counter or sales totals on the Management Reports.

To register a reference number

- 1 In the Number keys area, enter the Reference Number 1234567, and then press the

#/NS
<sym>

 key.
- 2 In the Number keys area, press 100, and then press the

1	M
17	space

 key.
- 3 Press the

amount tend
total
<enter>

 key.

Return Sale

Example 29: Refund a \$1.00 item in Department 1 and refund a \$1.50 item three times in Department 1.

To ring a return sale

- 1 Press the

return
<caps>

 key.
- 2 In the Number keys area, press 100, and then press the

1	M
17	space

 key.
- 3 Press the

return
<caps>

 key.
- 4 In the Number keys area, press 3, and then press the

qty/
date

 key.
- 5 In the Number keys area, press 150, and then press the

1	M
17	space

 key.
- 6 Press the

amount tend
total
<enter>

 key.

Note

The Return function can be performed in the middle of any sales transactions or by itself in a separate transaction.

Split Tendering Sale

Example 30: Ring up a \$15.00 item in Department 1 with 6% sales tax, split the total of the sale between \$5.00 in cash payment and \$10.90 in charge payment.

To ring up a Split Tendering sale

- 1 In the Number keys area, press 1500, and then press the

1	M
17 space	

 key.
- 2 Press the

sub total reprint

 key.
- 3 In the Number keys area, press 500, and then press the

amount tend total <enter>

 key.
- 4 Press the

charge <wide>

 key.

Note

When using the Split Tendering function, the sale can also be finalized with the Check key. Substitute the

check

 key in Step 4 in the example above.

Use the Error-Correct /Void Key

Example 31: Corrects the last entry rung up during a sale. Ring up a \$1.00 item in Department 1, then use the **Void** key to cancel this entry and ring up a \$10.00 item in Department 1 to register a new entry.

To use the error-correct/void key

- 1 In the Number keys area, press 100, and then press the

1	M
17 space	

 key.
- 2 Press the

void <bksp>

 key.
- 3 In the Number keys area, press 1000, and then press the

1	M
17 space	

 key.
- 4 Press the

amount tend total <enter>

 key.

Voiding A Coupon Sale

Example 32: Void a \$1.00 item in Department 1, void a 20¢ coupon.

To void a coupon sale

- 1 In the Number keys area, press 100, press the

void <bksp>

 key, and then press the

1	M
17 space	

 key.
- 2 In the Number keys area, press 20, press the

cpn

 key.
- 3 Press the

amount tend total <enter>

 key.

Voiding a Department Preset Price

Example 33: Department 1 is programmed for the price of \$1.00 and Department 2 is programmed for the price of \$2.00. Ring up Department 1 and Department 2 prices, then void the Department 1 entry.

To void a department preset price

- 1 Press the

1	M
17 space	

 key.
- 2 Press the

2	I
18 Y	

 key.
- 3 Press the

clear

 key.
- 4 Press the

void
<bksp>

 key and then press the

1	M
17 space	

 key.
- 5 Press the

amount tend
total
<enter>

 key.

You can also use the **Arrow Up** key to scroll the clerk display, select the entry you want to void and then press the **Void** key. Press the **Clear** key and then continue with the transaction.

Voiding a Department Preset with a Minus Percentage Discount

Example 34: Assume Department 1 is programmed for \$1.00, Department 2 is programmed for \$2.00, and the [-%/RA] key is pre-programmed for 10%. Ring up Department 1 and deduct 10%, ring up Department 2 and deduct 10%, then void the Department 1 entry with the 10% discount.

To void a department preset with a minus percentage discount

- 1 Press the

1	M
17 space	

 key and then press the

- %
RA

 key.
- 2 Press the

2	I
18 Y	

 key and then press the

- %
RA

 key.
- 3 Press the

clear

 key.
- 4 Press the

void
<bksp>

 key, press the

1	M
17 space	

 key, and then press the

- %
RA

 key.

Note

If the Minus Percentage Discount Rate is not pre-programmed, type in the discount rate before pressing the

- %
RA

 key.

- 5 Press the

amount tend
total
<enter>

 key.

Voiding A Minus Percentage Discount Sale

Example 35: Void a \$1.00 item in Department 1 and void a pre-programmed Minus Percentage Discount Rate of 10%.

To void a minus percentage discount sale

- 1 In the Number keys area, press 100, press the

void
<bksp>

 key, and then press the

1	M
17	space

 key.
- 2 Press the

- %
RA

 key.

Note

If the Minus Percentage Discount Rate is NOT pre-programmed, type in the discount rate before pressing the [-%/RA] key.

- 3 Press the

amount tend
total
<enter>

 key.

Voiding a Multiplication of a Department Preset Price

Example 36: Assume Department 1 is programmed for the price of \$1.00 and Department 2 is programmed for the price of \$2.00. Ring up Department 1 three times and Department 2 two times, then void the Department 1 entry rung up three times.

To void a multiplication of a department preset price

- 1 In the Number keys area, press 3, and then press the

qty/
date

 key.
- 2 Press the

1	M
17	space

 key.
- 3 In the Number keys area, press 2, and press the

qty/
date

 key.
- 4 Press the

2	I
18	Y

 key.
- 5 Press the

clear

 key.
- 6 Press the

void
<bksp>

 key.
- 7 In the Number keys area, press 3, and then press the

qty/
date

 key.
- 8 Press the

1	M
17	space

 key.
- 9 Press the

amount tend
total
<enter>

 key.

Voiding A Department Multiplication Sale

Example 37: Void a \$1.00 item in Department 1 three times.

To void a department multiplication sale

- 1 In the Number keys area, press 3 and then press the

qty/ date

 key.
- 2 Press the

void <bkspace>

 key, in the Number keys area, press 100, and then press the

1 M 17 space

 key.
- 3 Press the

amount tend total <enter>

 key.

Voiding a PLU Sale

Example 38: Assume PLU #1 is preset for the price of \$1.00 in Department 1. Void PLU #1.

To void a PLU sale

- 1 Press the

void <bkspace>

 key, in the Number keys area, press 1, and then press the

plu

 key.
- 2 Press the

amount tend total <enter>

 key.

Voiding a PLU Multiplication Sale

Example 39: Assume PLU #1 is preset for the price of \$1.00 in Department 1. Void PLU #1 three times.

To void a PLU multiplication sale

- 1 In the Number keys area, press 3, press the

qty/ date

 key.
- 2 Press the

void <bkspace>

 key, in the Number keys area, press 1, and then press the

plu

 key.
- 3 Press the

amount tend total <enter>

 key.

Voiding a PLU Sale with a Minus Percentage Discount

Example 40: Assume PLU #1 is preset for the price of \$1.00 in Department 1 and the **-%/RA** key is preprogrammed for 10%. Void a sale with PLU #1 and a 10% discount.

To void a PLU sale with a minus percentage discount

- 1 Press the

void
<bksp>

 key, in the Number keys area, press 1, and then press the

plu

 key.
- 2 Press the

- %
RA

 key.
If the Minus Percentage Discount is not pre-programmed, type the discount rate before pressing the

- %
RA

 key.
- 3 Press the

amount tend
total
<enter>

 key.

Voiding a PLU Sale with a Plus Percentage Rate

Example 41: Assume PLU #1 is preset for the price of \$1.00 in Department 1 and the **+%/PO** key is pre-programmed for 10%. Void a sale for PLU #1 and add a 10% add-on amount.

To void a PLU sale with a plus percentage rate

- 1 Press the

void
<bksp>

 key, in the Number keys area, press 1, and then press the

plu

 key.
- 2 Press the

+ %
PO

 key.
If the Plus Percentage Rate is not pre-programmed, type in the discount rate before pressing the

+ %
PO

 key.
- 3 Press the

amount tend
total
<enter>

 key.

Voiding a Plus Percentage Sale

Example 42: Void a \$1.00 item in Department 1 and void a pre-programmed Plus Percentage Rate of 10%.

To void a plus percentage sale

- 1 Press the

void
<bksp>

 key, in the Number keys area, press 100, and then press the

1	M
17	space

 key.
- 2 Press the

+ %
PO

 key.

Note

If the Plus Percentage rate is NOT pre-programmed, type in the Plus Percentage Rate before pressing the +%/PO key.

- 3 Press the

amount tend
total
<enter>

 key.

Voiding an Entire Sale before Finishing the Sale

Example 43: Void an entire sale before you press the **Amount Tend Total** <Enter> key. Void a sale for a \$1.00 item in Department 1, a \$2.00 item in Department 2, a \$3.00 item in Department 3.

To void a sale

- 1 In the Number keys area, press 100, and then press the

1	M
17	space

 key.
- 2 In the Number keys area, press 200, and then press the

2	I
18	Y

 key.
- 3 In the Number keys area, press 300, and then press the

3	E
19	U

 key.
- 4 Press the

sub
total
reprint

 key.
- 5 Press the

void
<bksp>

 key.

Voiding A Sale

Example 44: Void a \$1.00 item in Department 1.

To void a sale that is already completed

- 1 Press the

void
<bksp>

 key, in the Number keys area, press 100, and then press the

1	M
17	space

 key.
- 2 Press the

amount tend
total
<enter>

 key.

Product Information

Specifications and Safety

Table 9 Specifications And Safety

Feature	Description
Type	Electronic cash register
Displays	Five line alphanumeric LCD clerk display One line alphanumeric LED customer display
Printer	57mm alphanumeric thermal printer.
Ink Source	Thermal printer - no ribbon or ink needed
Paper Supply	2¼ inch or 57.5 mm wide standard thermal paper (Royal Reorder # 013127)
Memory Battery Protection	Roughly 28 days after power interruption
Technology	CMOS RAM
Electrical Characteristics	115V ~ 60Hz, 0.40A
Operating Temperature	0-40 Degrees Centigrade (32-104 Degrees Fahrenheit)
Dimensions	12.75"W x 16.75"D x 11.75"H
Weight	14.4-lbs. (6.5-kg)

Safety and Legal Notices

- The power outlet for this cash register must be located near the unit and be easily accessible.
- Do not use this cash register outdoors in the rain or near any source of liquid, such as a pool.

FEDERAL COMMUNICATIONS COMMISSION (FCC) RADIO FREQUENCY INTERFERENCE STATEMENT INFORMATION TO THE USER

CAUTION: Changes or modifications to this unit not expressly approved by the party responsible for compliance could void the user's authority to operate the equipment.

NOTE: This equipment has been tested and found to comply with the limits for a ClassB digital device, pursuant to Part15 of the FCC Rules. These limits are designed to provide reasonable protection against harmful interference in a residential installation. This equipment generates, uses and can radiate radio frequency energy and, if not installed and used in accordance with the instructions, may cause harmful interference to radio communications. However, there is no guarantee that interference will not occur in a particular installation. If this equipment does cause harmful interference to radio or television reception, which can be determined by turning the equipment off and on, the user is encouraged to try to correct the interference by one or more of the following measures:

1. Reorient or relocate the receiving antenna.
2. Increase the separation between the equipment and receiver.
3. If applicable, connect the equipment into an outlet on a circuit different from that to
4. which the receiver is connected.

Consult the dealer or an experienced radio / TV technician for assistance.

Connection of peripherals to this unit requires the use of grounded, shielded cables to ensure compliance with the ClassB FCC limits.

IN CANADA:

This digital apparatus does not exceed the Class limits for radio noise emissions from digital apparatuses set forth in the Radio Interference Regulations of the Canadian Department of Communications.

- **The back-up power system:** When you are not using your cash register, keep it plugged in with the cash register turned OFF from the main menu. If the unit is unplugged, back-up power for the memory is provided through the batteries, but this should not be used for long periods of time.

Proposition 65 Notice

The following is given in accordance with California Proposition 65.

WARNING: This product contains chemicals known to the State of California to cause cancer, birth defects, or other reproductive harm.

Wash hands after handling.

Trademark Notice

All trademarks, registered trademarks and service marks mentioned in this manual and with this product are for identification purposes only and are the property of their respective holders.

Copyright

© 2006 by Royal Consumer Information Products, Inc.

Software Licensing Agreement

TERMS. The product which you have purchased from Royal contains software (“the Software”) which is owned by Royal and/or third parties which have provided the same to Royal and which is protected by the United States copyright laws and treaty provisions. By purchasing this product containing the Software, you are agreeing to be bound by the terms of this license. If you do not agree to this license, you must not use the product but rather immediately return it to your point of purchase for a full refund. Any such return must be made within any applicable time period established for returns at the point of purchase, but in no event later than 30 days after purchase. Your use of the product shall be deemed acceptance of this license.

GRANT OF LICENSE. With the purchase of your product from Royal, Royal grants you the right to use the Software, which is contained in the product. This grant is only for the specific person, which has purchased the product. In other words, the license, which accompanies each product, is only for one person.

RESTRICTIONS. You may not copy the Software, decompile it, duplicate it, modify it or reverse engineer it in any fashion.

RIGHTS. The Software is provided to you in an “as is” condition by Royal. **ROYAL MAKES NO WARRANTY WHATSOEVER WITH RESPECT TO THE SOFTWARE AND ALL EXPRESS OR IMPLIED WARRANTIES, INCLUDING ANY IMPLIED WARRANTY OF MERCHANTABILITY, FITNESS FOR A PARTICULAR PURPOSE OR NON-INFRINGEMENT, ARE SPECIFICALLY DISCLAIMED.** All other rights with respect to the Software, except as set forth in this license, are specifically retained by Royal or the owner of the Software. Nothing in this license constitutes a waiver of any rights Royal or the owners of the Software may have under any applicable copyright law or any other United States federal or state law.

GOVERNING LAW. This license is governed by the laws of the State of New Jersey.

Manufacturer's Limited Warranty

ROYAL ELECTRONIC CASH REGISTER AND TIME CLOCK LIMITED WARRANTY

Royal Consumer Information Products, Inc. ("Royal") at 379 Campus Drive, 2nd Floor, in Somerset, NJ 08875 USA warrants that your NEW Royal Electronic Cash Register or Time Clock ("Product") is free of defects of workmanship and materials. If there is a defect or malfunction of this Product, Royal will repair the Product free of charge as follows:

PARTS:New or comparable rebuilt parts in exchange for defective parts for ONE YEAR from the date of purchase.

LABOR:All labor charges incurred from a Royal Authorized Service Center or the Royal Corporate Service Center are covered for 90 DAYS from the date of purchase. After 90 days there will be a labor charge for repair of the Product and/or assemblies such as the keyboard, display(s), logic board, power supply and printer(s) at the Royal Corporate Service Center's or the Royal Authorized Service Center's then prevailing rates. The Product must be brought to a Royal Authorized Service Center nearest to your location; or the Product must be shipped postage prepaid, insured and via a traceable shipping method to a Royal Authorized Service Center or to the Royal Corporate Service Center. Royal will pay return postage from the Royal Corporate Service Center during the labor warranty period only.

This warranty does not apply to persons who purchased this Product second hand or used.

This warranty does not include the replacement of ink rolls, ribbons, time cards, paper rolls or any other consumable or supplies used in the cash register or time clock and consumed through the normal use of the Product.

This warranty does not include cleaning, adjustments, parts, or repairs required by circumstances beyond the control of Royal, including, but not limited to, fire or other casualty, accident, neglect, abuse, abnormal use, misuse or battery leakage damages. THERE ARE NO OTHER EXPRESSED WARRANTIES EXCEPT AS STATED HEREIN. AFTER THE PERIOD OF EXPRESSED WARRANTY SET FORTH HEREIN, THERE ARE NO EXPRESSED OR IMPLIED WARRANTIES AND THOSE EXCLUDED INCLUDE THOSE OF MERCHANTABILITY AND FITNESS FOR A PARTICULAR PURPOSE. Royal shall NOT be liable for CONSEQUENTIAL DAMAGES resulting from any failure, defect, or malfunction of this Product. Some states do not allow limitations on how long an implied warranty lasts and some states do not allow the exclusion or limitation of incidental or consequential damages, so the above limitations or exclusions may not apply to you.

TO OBTAIN SERVICE UNDER THE TERMS OF THIS WARRANTY:

- Pack your Product in the original carton or equivalent.
- Enclose a copy of the bill of sale or other documentation showing original purchase date.
- Enclose a card or note describing the difficulty you have had with the Product.
- Be sure to include your complete name, address and day-time telephone number.
- Bring or ship, prepaid and insured, via a traceable shipping method the above Product to the nearest Royal Authorized Service Center location or to the Royal Corporate

Service Center. Royal and/or the Service Center cannot be held responsible for any loss or damage that occurs while in transit.

For Authorized Service Centers within your local area, call 1-888-261-3888 or 1-800-272-6229. In Canada call 1-888-266-9380. Or you can call the Royal Corporate Service Center directly at 1-630-315-2603 for shipping instructions and additional information.

Please retain the original proof of purchase for your records to establish date of original purchase. Your warranty starts with the date of original purchase. This warranty gives you specific legal rights, and you may also have other rights which vary from State to State.

This warranty is valid only on cash registers and time clocks purchased, delivered and used in the United States and/or Canada.



Ordering Supplies and Accessories

Item	Part Number
Thermal Register Tape (3-roll package) 2¼" (57mm) wide, 2" (50mm) diameter, 85' (26m) long	013127
Protective Keytop Cover	013218
Replacement 4 Slot Bill Tray & Drawer (Coin Tray not included)	CD510002-A
Replacement 5 Slot Coin Tray	CD500002-A
Duplicate Cash Drawer 1 set of 2 keys	47300511
Replacement Journal Paper Roll Spindle	E16900150
Owner's Manual	A710MLIM0606A
Model PS700 Barcode Reader	16881W
RegisterLink PC-based software, replacement	RLNC
RegisterLink serial cable, replacement	RLCC
RegisterLink software and serial cable	RLKIT

For Prices and Availability
Call 1-888-261-4555 or visit our web site at www.royal.com.

Prices and Availability Subject to Change Without Notice



Index

A

about
 management reports 83
 serial port 91
 X readings 82
 Z readings 82
accessories, ordering 123
adding tax to a non taxable
 department, example 101
adjust the contrast on the clerk
 screen 21
age verification 36
amount of time messages appear 39
amount tendered 52

B

barcode reader
 programming PLUs 43
 purchasing 123
 ringing up sales 64
 setting up PLUs 43
batteries, replacing 90
before going to register mode 44

C

Canadian, tax system 70

cash drawer
 closing 16
 opening 16
 using 16
cash in drawer report 83, 85
cash register turns off 94
cash sale with tendering change,
 example 102
cash sale without tendering change,
 example 102
change computer 52
changing tax rates 70
charge sale, example 102
check the Electronic Journal
 memory 87
C-I-D report 83, 85
clearing errors 47
clerk
 names, setting 27
 system 27
clerk display, symbols 12
clerk numbers
 setting 27
 using 29
clerk screen
 adjust the contrast 21

 adjusting 11
 navigating 20
clerk system, using 29
closing, cash drawer 16
codes, transaction 100
complex tax rates 70
confirming your settings 44
connecting to a PC 92
contacting Royal 2
contrast, adjust on clerk screen 21
coupon discount sale, example 103
credit return, example 104
credit sale, example 103
credit, keys, programming 40
currency
 receiving foreign 56
 setting up for foreign 56
customer display
 closing 10
 opening 10
customer service, contacting 2

D

debit purchase, example 104
department

- keys, programming 32
- names, programming 33
- number keys, using 33
- preset price, programming 35
- dept shift key, example 104
- display messages, changing languages 5
- displays, using 19
- double wide characters
 - programming 24
 - receipts 24

E

- EJ Full error, troubleshooting 94
- EJ FULL, error 94
- EJ reports, running 85
- Electronic Journal memory, checking 87
- Electronic Journal, reports 85
- error
 - codes 45
 - EJ FULL 94
 - fixing 45
 - PE Printer 93
 - sounds 45
- errors, clearing 47
- example
 - adding tax to a non taxable department 101
 - cash sale with tendering change 102
 - cash sale without tendering change 102
 - charge sale 102
 - coupon discount sale 103
 - credit return 104
 - credit sale 103
 - debit purchase 104
 - dept shift key 104
 - exempting tax on an item 105
 - exempting tax on the entire sale 105
 - gallage sales transaction 106
 - minus percentage discount sale 106
 - modify tip 107

- multiplication of a department unit price 107
- multiplication sale 107
- multiplying by a fraction 108
- no-sale function 108
- overriding a PLU sale 108
- paid-out sale 109
- PLU sale 109
- PLUs percentage sale 109
- received-on-account sale 110
- registering a department unit price 110
- registering a reference number 111
- return sale 111
- split tendering sale 112
- tax chart 75
- using error-correct (void) key 112
- voiding a coupon sale 112
- voiding a department multiplication sale 115
- voiding a department preset price 113
- voiding a department preset with a minus percentage discount 113
- voiding a minus percentage discount sale 114
- voiding a multiplication of a department preset price 114
- voiding a PLU multiplication sale 115
- voiding a PLU sale 115
- voiding a PLU sale with a minus percentage discount 116
- voiding a PLU sale with a PLUs percentage rate 116
- voiding a PLUs percentage sale 117
- voiding a sale 117
- voiding an entire sale before finishing the sale 117
- exempting tax on an item, example 105
- exempting tax on the entire sale, example 105

F

- FCC warning 119
- footer message
 - double wide 24
 - programming 24
 - setting 26
 - worksheet 25
- foreign currency
 - receiving 56
 - setting up for 56
 - using 56
- full report example 84
- full system clear
 - about 47
 - troubleshooting 97

G

- gallage sales transaction, example 106
- getting help 2

H

- half system clear
 - about 47
 - troubleshooting 96
- HALO, programming 36
- header message
 - double wide characters 24
 - programming 24
 - worksheet 25
- high amount lock-out 36

K

- keyboard, using 13
- knowing how much change to give the customer 52

L

- languages 5
 - setting 5
- location of keys 13
- lookup prices 65

M

making messages scroll fast or slow 39
 management reports, about 83
 manager, passcodes, setting 30
 maximum PLUs allowed 42
 menu system, using 11
 messages, setting footer 26
 minus percentage discount sale, example 106
 modify tip, example 107
 multiple currencies 57
 multiplication of a department unit price, example 107
 multiplication sale, example 107
 multiplying by a fraction, example 108

N

navigating the clerk screen 20
 no-sale function, example 108

O

opening, cash drawer 16
 ordering
 accessories 123
 more register tape 123
 supplies 2
 overriding a PLU sale, example 108

P

paid-out sale, example 109
 partial reset, troubleshooting 97
 partial system clear, about 47
 parts, ordering 123
 passcodes
 clerk, setting 27
 manager 30
 setting manager 30
 setting X 30
 PE Printer error 93
 piggy back tax 77
 PLU

 programming 42
 total number allowed 42
 PLU description, programming 42
 PLU information, verifying 65
 PLU sale, example 109
 PLUs percentage sale, example 109
 PLUs, programming the barcode scanner 43
 prices, lookup 65
 printing, receipts after transactions 66
 programming
 cash register 11
 clerk numbers 27
 credit keys 40
 department keys 32
 department names 33
 department preset price 35
 double wide characters 24
 footer messages 24
 HALO 36
 header messages 24
 high amount lock-out (HALO) 36
 manager passcode 30
 PLU description 42
 PLUs with the barcode scanner 43
 tax rates 70
 tax status 35
 Proposition 65 warning 119

Q

quick start program confirmation report, printing 44

R

receipt on demand 66
 receipt printing
 errors 94
 receipt, messages, setting 26
 received-on-account sale, example 110
 register does not work, troubleshooting 95, 96

register mode, before going to 44
 register tape, ordering replacement 123
 registering a department unit price, example 110
 registering a reference number, example 111
 RegisterLink software 8
 RegisterLink, using 92
 replacement register tape 123
 replacing batteries 90
 reports
 about 83
 C-I-D 83, 85
 confirmation 81
 EJ reports 85
 Electronic Journal 85
 example 84
 management 82
 program confirmation 79
 quick start program confirmation 44
 running 83
 return sale, example 111
 ringing up
 sales 62
 sales, barcode reader 64
 Royal, contacting 2
 running
 an Electronic Journal reports 85
 management reports 82
 PLU confirmation reports 81
 program confirmation reports 79
 reports 83

S

safety notice 119
 scanning items 64
 scrolling messages
 amount of time messages appear 39
 faster or slower 39
 serial port
 about 91

- connectors 91
- setting
 - alphanumeric descriptions 22
 - amount of time messages
 - appear on the display 39
 - clerk names 27
 - clerk numbers 27
 - footer messages 26
 - languages 5
 - machine numbers 31
 - manager passcodes 30
 - standard or gallonage mode 36
 - tax rates 70
 - up 5
 - X passcodes 30
- setting up, barcode scanner 43
- settings, confirming 44
- software
 - for PCs 8
 - licensing agreement 120
 - RegisterLink 8
- specifying tax rates 70
- split tendering sale, example 112
- supplies, ordering 2
- symbols on the clerk display 12

T

- tax
 - piggy back 77
 - tax-on-tax 77
- tax chart, example 75
- tax rates
 - Canadian 70
 - setting 70
 - VAT 70
- tax worksheet 76
- tax, status, programming 35

- tax-on-tax, setting 77
- technical information, serial port 91
- total number allowed, PLUs 42
- training mode, setting passcode 67
- training mode, using 67
- transaction codes 100
- troubleshooting 93
 - EJ Full error 94
 - full system clear 97
 - half system clear 96
 - partial reset 97
 - register does not work 95, 96
- turn the cash register
 - off 16
 - on 16

U

- using
 - cash drawer 16
 - clerk system 29
 - department number keys 33
 - displays 19
 - double wide characters 24
 - keyboard 13
 - training mode 67
- using error-correct (void) key, example 112

V

- VAT, tax system 70
- verifying, PLU information 65
- voiding
 - coupon sale example 112
 - department multiplication sale example 115
 - department preset price example 113

- department preset with a minus percentage discount example 113
- minus percentage discount sale example 114
- multiplication of a department preset price example 114
- PLU multiplication sale example 115
- PLU sale example 115
- PLU sale with a minus percentage discount example 116
- PLU sale with a PLUs percentage rate example 116
- PLUs percentage sale example 117
- sale example 117
- voiding an entire sale before finishing the sale, example 117

W

- warning
 - FCC 119
 - Proposition 65 119
- warranty 121
- worksheet
 - footer message 25
 - header message 25
 - table tax 76

X

- X passcodes, setting 30
- X readings, about 82

Z

- Z readings, about 82