



Contents

1 Welcome

- Before Starting 1
- What is in the Box? 2
- Important Phone Numbers 2

2 Getting Started

- Plugging in and Putting in the Batteries 3
- Installing the Paper Roll 5
 - Installing the Barcode Reader 6
- Setting the Date And Time 7
- Programming the Sales Tax 8
- Programming Department Keys 9

3 Getting To Know the Cash Register

- Opening and Closing the Customer Display 10
- Using the Mode Key Area 12
- Using the Keyboard 13
- Using the Cash Drawer 14
- Using the Accessory Drawer 15

4 Setting Up Your Cash Register - the Basics

Using the Displays	16
The Clerk Display	17
Setting Alphanumeric Descriptions	17
Alphanumeric Code Chart	18
Using Single Width Characters	20
About Programming Numbers in Logo Messages.....	20
Using Double Wide Characters	20
Programming a Store Logo or a Commercial Message.....	21
Setting the Commercial Message in the Footer.....	24
Setting Clerk Numbers and Names	25
Using the Clerk System	27
Setting the Machine Number	27
Setting X and Manager Passwords	28
Printing the Quick Start Program Confirmation Report.....	29
Before Going to Register Mode.....	30
Error Codes	31
Clearing an Error	31

5 Setting Up Your Cash Register - Advanced

Programming Department Keys.....	34
Setting Standard and Gallonage Mode.....	36
Programming Multiple and Single Items	36
Programming High Digit Lock-out (HDLO).....	36
Programming Tax Status	37
Programming Department Preset Price	38
Assigning Department Number Keys	38
Programming Department Names	39
Programming Scrolling Messages	42
Programming Scrolling Message Display Times.....	43
Setting the Off Message	43
Setting the Mode Message	44
Setting the Sales Message Start and Stop Times.....	44
Setting the Idle Messages	45
Setting the Amount of Time Letters Appear in the Display.....	46

Programming the Credit Keys	46
Programming PLU Descriptions	48
Programming PLUs without a Barcode Reader	48
Programming PLUs with the Barcode Reader	49
Setting the Decimal Points	50
Setting the Rounding Rates	51
Programming Discounts	51
Programming Minus Percentage Discounts	51
Programming Coupon Discounts	52
Programming Plus Percentage Add-ons	55
Programming Flag Options.....	56
6 Ringing up Sales and Using Training Mode	
Ringing up Sales.....	62
Ringing up Sales with the Barcode Reader.....	64
Using Training Mode	64
7 Programming Complex Tax Rates	
Setting the Tax Rates	67
8 Running Reports	
Running the Program Confirmation Report	70
Running the Department Confirmation Report	72
Running the PLU Confirmation Report.....	72
Running the Department Sales Report.....	73
Running Management Reports	73
About X Readings	74
About Z Readings	74
About Management Reports	75
Running a Cash-In-Drawer Report.....	75
Running a Clerk Report.....	76
Running a Financial Report	76
Financial Report Example	77
Running an Hourly Report.....	79
Running PLU Reports.....	80

9 Maintenance and Options

Optional Accessories.....	82
Installing a New Paper Roll	82
Using the Battery System	83
Ordering Accessories	85

10 Troubleshooting

Error Codes	86
I Hear an Error Beep.....	86
Sec code error appears in PRG, X OR Z modes	87
If Clerk E12 Displays In REG 1 or REG 2 Modes.....	87
PE Printer Error	87
The Register Does Not Work at All	88
Opening the Drawer When There is no Power.....	88
Half System Clear	89
Full System Clear	89
If Nothing Helps.....	89

11 Examples

Sample Receipt	92
Transaction Codes	93
Adding Tax to a Non-Taxable Department.....	94
Cash Sale With Tendering Change	94
Cash Sale Without Tendering Change.....	95
Charge Sale.....	95
Coupon Discount Sale	96
Credit Return.....	97
Credit Sale.....	97
Dept Shift Key.....	97
Exempting Tax On An Item.....	98
Exempting Tax on the Entire Sale	98
Gallonage Sales Transaction	99
Minus Percentage Discount Sale.....	99
Multiplication of a Department Unit Price.....	100
Multiplication Sale	100
Multiplying By A Fraction.....	101

No-Sale Function..... 101

Overriding a PLU Sale 102

Paid-Out Sale 102

PLU Sale 102

PLU Sale With PLU Description 103

Plus Percentage Sale..... 103

Received-On-Account Sale..... 104

Registering A Department Unit Price 104

Registering A Reference Number 104

Return Sale 105

Split Tendering Sale 105

Temporarily Overriding a PLU Price 106

Use the Error-Correct /Void Key..... 106

Voiding A Coupon Sale..... 107

Voiding a Department Preset Price 107

Voiding a Department Preset with a Coupon Discount 108

Voiding a Department Preset with a Minus Percentage Discount 108

Voiding A Minus Percentage Discount Sale 109

Voiding a Multiplication of a Department Preset Price..... 109

Voiding A Multiplication Sale 110

Voiding a PLU Multiplication Sale..... 110

Voiding a PLU Sale..... 111

Voiding a PLU Sale with a Coupon Discount 111

Voiding a Plu Sale with a Minus Percentage Discount..... 112

Voiding a PLU Sale with a Plus Percentage Rate 112

Voiding a Plus Percentage Sale..... 113

Voiding A Sale 113

A Calculating State Tax Table Codes 114

Calculating Your Tax..... 114

 Example Tax Chart..... 118

 The Worksheet 119

Programming the State Tax..... 120

B GST/PST System for Canada	121
Canadian Tax Programming Example	121
C Product Information	124
Specifications and Safety	124
Safety Notice	125
Limited Warranty	126
Description Tables	127
Index	130

Welcome

Congratulations on purchasing your new Royal cash register! This register is designed to be easy to use, helping you to focus on running your business.

Before Starting

Before you start using this manual to set up and customize your cash register, you should know the following.

When you need to press a key, you see a picture of the key you need to press and the name of the key is in another font. For example:



- 1 If you are prompted for a Manager Password, type the password number and then press the **Check** key. If you did not program a Manager Password, go to the next step.

If you need to type something in the round Number keys area, what you need to type is shown in a special font. For example:

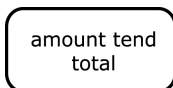

- 2 Using the round Number keys, press 444444 and then press the **Amount Tend Total** key.

What is in the Box?

Look for and unwrap the following:

- Cash Register
- 1 starter roll of standard thermal paper, Royal Reorder Number 013127 (57.5mm).
- The black Journal spindle in the packing material.
- 4 standard AA (1.5 volt) batteries for the memory back-up system.
- 1 set of keys, consisting of:
 - 2 Cash Drawer/Journal Lock keys (515).
 - 2 PRG Program keys (427-023).
 - 2 REG Register keys (427-024).
 - 2 Z keys (427-012).

Important Phone Numbers

If you need help or want to order additional supplies, use the following contact information.

Customer Service:	1-800-272-6229 (USA) 1-888-266-9380 (Canada)
Ordering Supplies:	1-888-261-4555
Website:	www.royal.com

To order items, see Ordering Accessories on page 85.

Getting Started

Setting up your cash register consists of the following steps:

- Plugging in and Putting in the Batteries
- Installing the Paper Roll
- Setting the Date And Time
- Programming the Sales Tax
- Setting at least 2 Department Keys

Do all the steps to make sure you have your cash register set up correctly.

When you are done with this chapter, see the chapter called Getting To Know the Cash Register, starting on page 10 and the chapter called Setting Up Your Cash Register - the Basics, starting on page 16 for more information about your cash register.

Plugging in and Putting in the Batteries

Make sure that you plug the cash register into the electrical outlet before you put in the batteries.

Caution

If you put the batteries in first, they can damage the cash register. Do not use this cash register outdoors in the rain or near any source of liquid.

To get the cash register ready to use

- 1 Remove the cash register and the parts from the box. Store the box and packing material in a safe, dry place. If you need to move the register in the future, you can put it back in the box.
- 2 Remove the tape holding the parts of the cash register in place. For example, there may be tape on the back of the Journal Compartment Cover.
- 3 Put the register on a hard, level surface, away from rain and spilled drinks. A hard level surface makes it easier for the cash drawer to go in and out smoothly.

Do not put the register on a porous surface. Depending on the surface or any cleaning solution used on the surface, the rubber feet may leave marks on the surface. Do not place the register on any valuable surface, such as antique or fine wood tables, desks, and so on.

- 4 Plug the cash register into a standard three-hole electrical wall outlet. (115-120 volt, 60 hertz). Make sure the electrical cord is not going to get tripped over or accidentally pulled from the electrical outlet.

Put the cash register on an electrical circuit with no other electrical device or appliance. Other appliances can overload the circuit or cause electrical interference with the cash register. It is best that you use a circuit without other appliances already on it.

- 5 Install the memory backup batteries.

- Open the Journal Compartment cover. Unlock the compartment cover with the Cash Drawer/Journal Lock key #515. Grip the left side of the journal cover and gently pull upward. Remove the cover and put it aside.
- Remove the battery cover, located in the rear left section of the compartment. Press the indentation at the bottom of the cover and slide up. See the graphic to the right for details.
- Put the batteries in the slots. Make sure that the positive and negative ends are in the right place. The batteries have a little plus (positive) and minus (negative) sign on each end to help you.
- Replace the battery cover by sliding it back down into position.

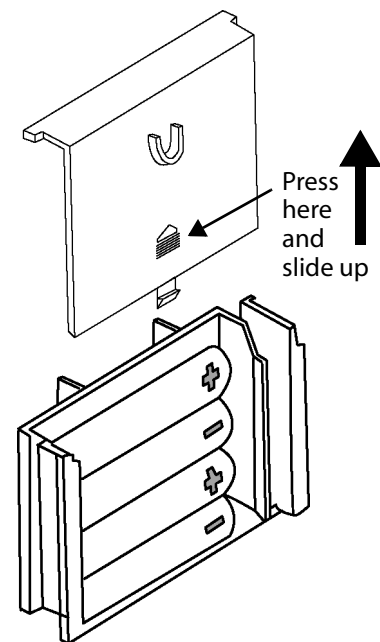

- 6 Now you are ready to put the paper in the cash register and set the time and the date. See the next section for more information.

Installing the Paper Roll

Your cash register has a thermal printer that prints receipts for the customer or a journal tape. You can use 2¼ inch (57.5 mm) wide standard thermal register paper.

To install the paper roll

1 Insert the PRG key and turn it to either REG1 or REG2.

- If you need a customer receipt, turn the Mode key to the REG1 position.
- If you do not need a customer receipt, turn the mode key to the REG2 position.

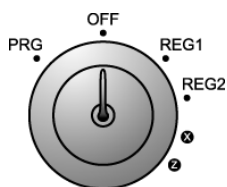

2 Unlock and open the Journal Compartment Cover. Grip the left side of the cover and gently pull upward. Remove the Journal Compartment Cover and set aside.

3 Remove the Journal Takeup spindle. Place the paper roll in the little round area at the bottom of the compartment. Make sure the paper feeds out from the bottom of the roll, towards the front of the cash register.

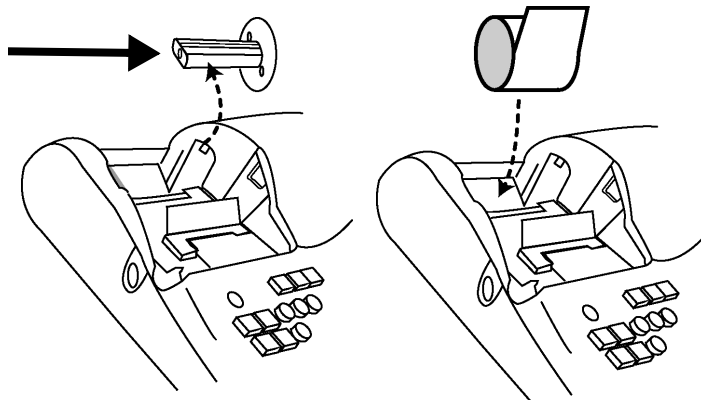

4 Grab the small handle on the right of the print roller. Push the little handle towards the back of the cash register and raise the roller bar up.

5 Lay the end of the paper across the printer as shown. Move the print roller down onto the paper and snap into place. Make sure both sides are snapped down.

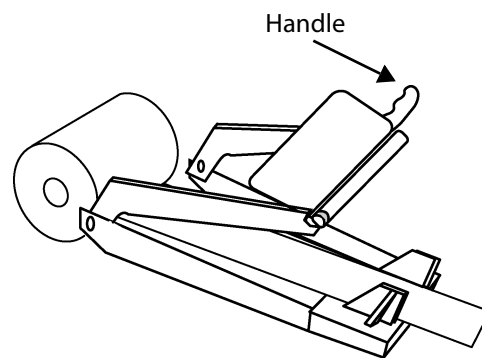

- Press the **Feed** key until the paper catches and moves through the printer.

6 Do one of the following:



- If you do not need to print receipts:
Place the black plastic Journal Takeup spindle on its grooves above the Battery compartment. The spindle sits above the paper roll. Press the **Feed** key to move the paper through the printer about 10-12 inches. Push the paper through one of the narrow openings in the center of the Journal Takeup spindle. Press the **Feed** key until the paper catches and begins to wind securely around the Journal Takeup spindle. Replace the Journal Compartment Cover.
- If you want to print receipts:
Put the customer receipt paper in the receipt window of the Journal Compartment Cover. Make sure you get the paper in the little guides in the window. Use the Cash Drawer/Journal Lock key #515 to lock it.

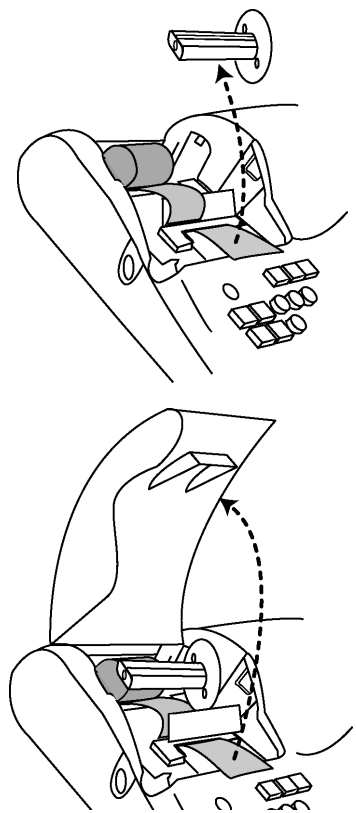

Installing the Barcode Reader

Your cash register optionally comes with a barcode reader. It allows you to scan items with a UPC symbols, instead of using the keyboard to type the PLU number. If you want to order the barcode reader, contact Royal.

The barcode reader plugs into the port on the lower right side of the cash register. Use the directions below to install it.

To install and program the barcode reader

- 1 Unpack the reader from the box.
- 2 Turn the Mode key to OFF.
- 3 Locate the port for the scanner on the lower right side of the cash register. Plug the reader into the port.
- 4 Now you can program the barcode reader so that you can scan UPC symbols to ring up items. For specifics, see Programming PLUs with the Barcode Reader on page 49.

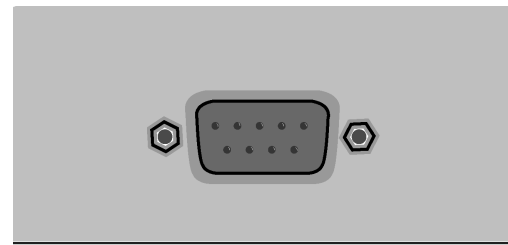
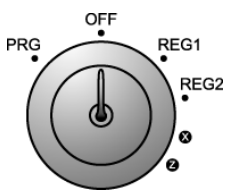

Setting the Date And Time

The date changes every day and prints in the month-day-year format. You can prevent the date from printing on the transaction receipts. The date format can also be changed to print day-month-year. For more information, see Programming Flag Options on page 56.

You can set the cash register so that it does not print the time on receipts. For more information, see Programming Flag Options on page 56.

The time can print in either the 12 or 24 hour (military time) format. The default setting is to print in the 12 hour format, which is normally used. To change to the 24 hour format, see Programming Flag Options on page 56.

Reminder

When you set the time, you need to type the time in a 24 hour format. To convert the current time to a 24 hour format, add the number 12 to every hour after 12 noon. For example: 1:15 P.M. programs as 1315. 8:20 A.M. programs as 0820.

To set the date

Example 1: To program June 30, 2002

- 1 Put the PRG key in the Mode key slot and turn it to the PRG position.
- 2 In the round Number keys area, press 063002 and then press the **#/ST/NS** key.

#/st/
ns

To set the time

Example 2: To program 9:45 P.M.

- 1 Put the PRG key in the Mode key slot and turn it to the PRG position.
- 2 In the round Number keys area, press 2145 and then press the **Qty/Date** key.

qty/
date

Programming the Sales Tax

Now you need to program the sales tax for your area. If you do not know your sales tax rate, contact your local government office.

Tip

You must press at least 4 digits in step 4.



Note

If you make a mistake or you hear an error beep, press **Clear** and start over with Step 3.

Example 3: To program a sales tax rate of 6%

- 1 Find your sales tax rate. You may need to contact your local government office.
- 2 Put the PRG key in the Mode key slot and turn it to the PRG position.
- 3 In the round Number keys area, press 1 **and** then press the **Tax 1** key.
- 4 Press 6000 and press the **Amount Tend Total** key. Your sales tax is programmed.

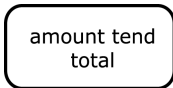

To program other tax rates, in Step 4, press the following:

Table 1 Additional tax rate programming

For this tax rate...	Press these keys...
7.75%	7750
5.5%	5500
10.5%	10500

For more advanced tax rate programming, see Programming Complex Tax Rates on page 66.

Programming Department Keys

You are done with the basic programming of your cash register. After you program at least 2 department keys, you are ready to use the cash register, if you do not want to use any of the other features.

For more information about the other features of your cash register, see *Setting Up Your Cash Register - the Basics* on page 16 and *Setting Up Your Cash Register - Advanced* on page 33.

To program Department 1 as taxable with no preset price and no description

1 Using the round Number keys, press 00001 and press the **Subtotal/w/Tax** key.

2 Using the round Number keys, press 0 and press the **Dept 1** key.

3 Press the **Amount Tend/Total** key. The department information is saved in the cash register.

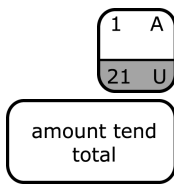

To program Department 2 as non-taxable with no preset price and no description

1 Using the round Number keys, press 00000 and press the **Subtotal/w/Tax** key.

2 Using the round Number keys, press 0 and press the **Dept 2** key.

3 Press the **Amount Tend/Total** key. The department information is saved in the cash register.

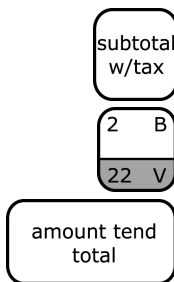

For more information about programming department keys, see *Programming Department Keys* on page 34.

Getting To Know the Cash Register

This chapter shows you the basics of using your cash register after you set it up. If you have not yet set up your cash register, see the *Quick Start* sheet that came in the box with your cash register or *Getting Started* on page 3.

Opening and Closing the Customer Display

You can open and rotate the customer display so customers can see what is happening. When you move the register or store it, close the display so it doesn't get damaged.

Your cash register has 1 display line:

- 1 line that shows letters and numbers (Alphanumeric)
The Alphanumeric display shows 10 digits for character descriptions in both register and programming modes. It also shows numbers.

To open and close the display

- 1 To open the rear customer display, pull up and rotate to view from any direction.
- 2 To close, turn the display to face the rear of the machine and press down.

The following codes can appear in the display:

Table 2 Codes and words that can appear in the display

This code...	Appears when...
:	the -%/RA key registers a percent discount amount. Also appears in the Customer Display.
=	the Charge, Check, Amount Tend Total keys are pressed. Also appears in the Customer Display.
ADD ON	the +%/PO key registers a plus percentage amount. *
CASH	the Amount Tend Total key finalizes a cash sale. *
CHANGE or C	change is due. *
CHARGE	the Charge key finalizes a sale. *
CHECK	the Check key finalizes a sale. *
CLERK ERR or CLERK E12	clerk numbers have been programmed and the clerk system is active. When this appears, the clerk number must be entered.
COUPON	the -/CPN key is pressed. *
DISCOUNT	the -%/RA key registers a percent discount amount. *
ERROR	an incorrect key is pressed. Press the Clear key to clear.
NO SALE	the #/ST/NS key is pressed. *
NON TAX	the Non Tax key is pressed.
P	you are in the middle of a programming step. Also appears in the Customer Display.
PE	if an error is detected in the printer.
P-O	the +%/PO key is used for a paid out function. *
R-A	the -%/RA key is used for a received on account function. *
REFUND	the Return key is pressed. *
SEC CODE	a manager password is programmed. When this appears, you must enter the password.
SUBTTL	the Subtotal w/Tax or #/ST/NS key is pressed. *
TAX 1/TAX 2	the TAX 1 or TAX 2 key is pressed.
VOID/CORR	the Void key is operated. *
* also prints on the receipt or journal tape.	

When ringing up sales, the department number or PLU number can also appear. If a description or name has been programmed, this description also appears.

Using the Mode Key Area

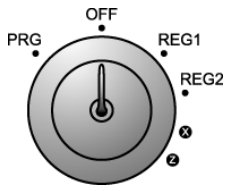

The Mode key area allows you to do the following.

Table 3 Mode key settings

This setting...	Does this...
• PRG	Programs the cash register and sets the cash register to Training mode. Use the key marked PRG.
• OFF	Turns the cash register off. It also electronically locks the cash drawer. All keys do this.
• REG1	Prints just receipts, does not print a journal tape in the cash register. All keys do this.
• REG2	Prints just a journal tape in the cash register, does not print a receipt. All keys do this.
• X	Lets you read all transaction totals without clearing any totals. This is useful for mid day reports. Use the key marked Z.
• Z	Lets you read all transaction totals and clears all transaction totals to zero, except the end of day, or close of day, totals. Use the key marked Z.

If you need to keep the register plugged in when you are not using it, turn the Mode key to the OFF position. The keyboard will not work and the cash drawer is electronically locked. A small amount of power maintains the program and transaction data totals.

- For more information about programming the cash register, see *Setting Up Your Cash Register - the Basics* on page 16 and *Setting Up Your Cash Register - Advanced* on page 33.
- For more information about using the cash register to ring up sales, see *Ring up Sales and Using Training Mode* on page 62.
- For more information about running reports, see *Running Reports* on page 70.

Using the Keyboard

The keyboard on your cash register looks like the following:

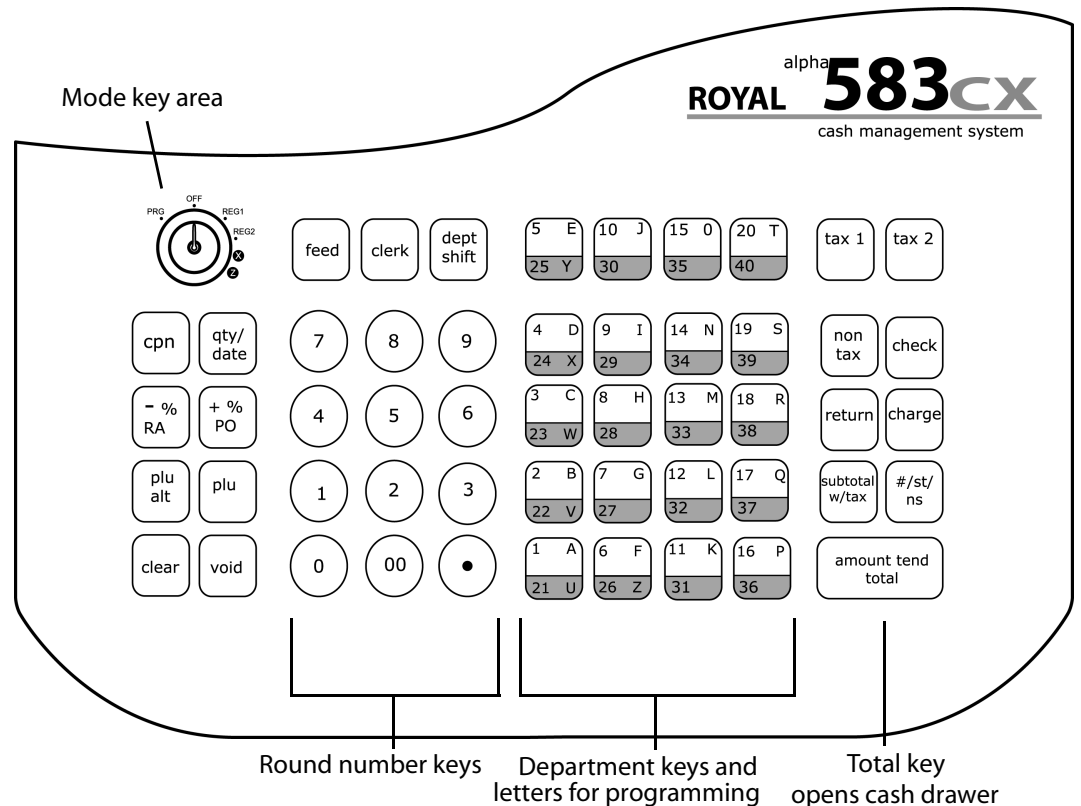

To use the keyboard, do the following:

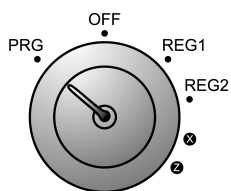
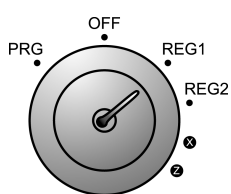

- To use the cash register, put the key marked REG in the Mode key hole and turn to Reg1 or Reg 2. Now you can press the round Number keys and Department keys to ring up a sale. For more information about ringing up sales, see Ringing up Sales and Using Training Mode on page 62.

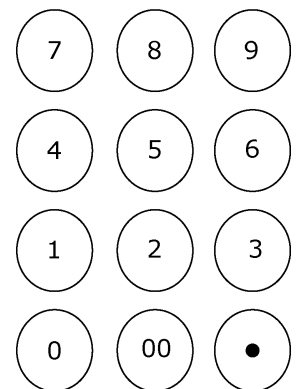

- To program the cash register, put the key marked PRG in the Mode key slot and turn to PRG. For more information about programming the cash register, see Setting Up Your Cash Register - the Basics on page 16 and Setting Up Your Cash Register - Advanced on page 33.

Using the Cash Drawer

The cash drawer is where you put the money after you ring up a sale. The cash drawer has slots for putting paper bills and a tray for coins. You can store paper items such as checks and charge slips under the removable coin tray.

When you ring up a sale, the cash drawer automatically opens so you can make change and put money away. You can also open the cash drawer without making a sale. This is handy if you need to make change for someone or forgot to put something away.

The cash drawer locks in 2 different ways. Locking the cash drawer is a good idea if you need to leave the cash register.

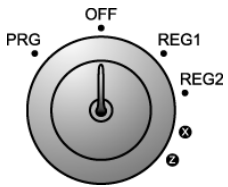

- The cash drawer automatically locks electronically when you move the register key to the Off position. Remember to take the register key out if you are leaving the register. The emergency open lever will still open the cash drawer when it is electronically locked.
- You can also use the 515 key to mechanically lock the cash drawer. If you lock the cash drawer this way, you must have the key to open it again. Even the emergency open lever will not open the cash drawer when it is locked with the key.

Important

If the cash drawer will not open, see if the lock on the cash drawer is turned to the right. If it is, the drawer is locked with the 515 key. You need the key to unlock the cash drawer. If the key is lost or locked in the cash drawer, contact Royal.

To open the cash drawer after a sale

amount tend
total

- 1 When you are done ringing up a sale, press the **Amount Tend Total** key at the bottom right of the keyboard. The cash drawer opens. You can make change and put the money in the drawer.
- 2 When you are done, push the cash drawer closed.

To open the cash drawer without making a sale

#/st/
ns

- 1 Press the **#/ST/NS** key at the bottom right of the keyboard. The cash drawer opens and a No Sale receipt prints.
- 2 When you are done, push the cash drawer closed.

To lock and unlock the cash drawer using the key

- 1 Using the small key labeled 515, put the key in the lock in the front of the cash drawer.

- 2 To lock the cash drawer, turn the key to the right and remove the key from the lock.
- 3 To unlock the cash drawer, turn the key to the left and remove the key from the lock.

To open the cash drawer using the emergency lever

- 1 With your hands on the cash drawer, carefully tip the front of the register up. Underneath the cash register, toward the back of the register, you see a small lever.

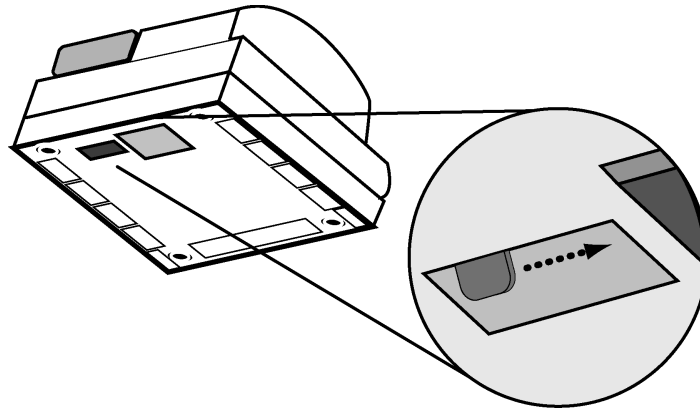

- 2 Push the lever in the only direction it will move. The cash drawer opens. If the cash drawer will not open, make sure it is not locked with the 515 Drawer key.

Using the Accessory Drawer

Your cash register has a small drawer above the cash drawer. The Accessory drawer can be opened at any time by anyone. It is a good place to put things like pens, pencils, and note pads.

Because anyone can open the drawer, it is not a good idea to put checks or charge slips in it. You should put those in the cash drawer, under the coin drawer.

Make sure that you never put anything valuable in the Accessory drawer.

Setting Up Your Cash Register - the Basics

This chapter includes explanations for setting:

- Messages on the display and on receipts
- Setting clerk numbers
- Setting machine numbers
- Setting clerk and manager passwords
- Clearing error codes

Using the Displays

Your cash register includes two displays: 1 for the clerk and 1 for the customer. The displays feature large, easy to read fluorescent digits for easy viewing.

The Clerk Display

When ringing up sales, you see the department number or PLU number on the clerk display.

For information about all the messages that can appear on the display and how to open and close the display, see Opening and Closing the Customer Display on page 10.

Setting Alphanumeric Descriptions

You can program a custom logo and message, clerk names, departments, and item descriptions. These text messages and descriptions appear on the receipt.

When you are programming the alpha descriptions for Departments, PLUs, Clerks, the Store Name/Logo Message, use the Alpha Keyboard.

Note
Only capital letters of the alphabet are on the Alpha Keyboard. You can use lower case letters. See Alphanumeric Code Chart on page 18.

The department keys are clearly labeled with all the letters needed to program these descriptions. When you are programming alpha descriptions, use the department keys to spell out the words you want.

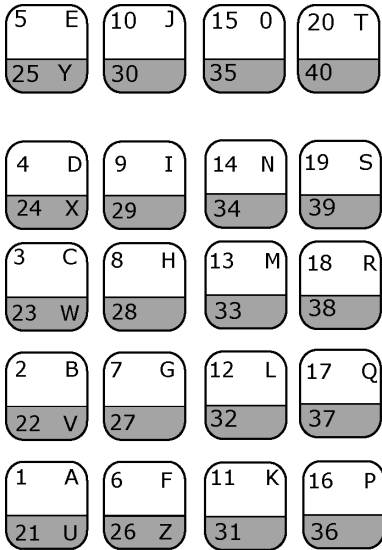

To use the letters in the white part of the Department keys, simply press the Department key.



To use the letters in the lower green area of the keys, press the **Dept Shift** key and then press the key with the letter you want.

You might need certain symbols or lower case characters that are not found on the Alpha Keyboard. For example, if you require a space between words, or if you need the / symbol, or the - symbol, see the Alphanumeric Code Chart shown in the next section.



Important
If you enter the wrong character, press the **Void** key to backspace and delete that character. Now you can continue.

Alphanumeric Code Chart

Other characters are also available. Use the tables in this section to help you find the ones you need.

Use this table for lower case letters and numbers.

Table 4 Letters and numbers

Character	Code Number	Character	Code Number
Space	00	s	20
Wide Character	01	t	21
a	02	u	22
b	03	v	23
c	04	w	24
d	05	x	25
e	06	y	26
f	07	z	27
g	08		
h	09	Numbers	
i	10	0	30
j	11	1	31
k	12	2	32
l	13	3	33
m	14	4	34
n	15	5	34
o	16	6	36
p	17	7	37
q	18	8	38
r	19	9	39

Use this table for punctuation and foreign characters.

Table 5 Special Characters and Punctuation

Character	Code Number	Character	Code Number
ı	80	?	28
ı	81	!	29
á	82	@	40
é	83	/	67
ı	84	:	68
ó	85	#	69
ú	86	&	70
Ä	93	%	71
Ü	94	\$	72
Ö	95	,	73
		(comma)	
İ	96	(74
ü	97)	75
Ñ	98	*	76
ñ	99	+	77
		-	78
		.	79
		(period)	
		;	87
		(semi colon)	
		>	88
		'	89
		(apostrophe)	
		"	90
		<	91
		=	92

Using Single Width Characters

The following describes the maximum number of characters that can be programmed for each item description in single width.

- Department 12 Characters
- PLU 12 Characters
- Clerk Name 24 Characters
- Store Logo/message 5 Lines (24 characters each)



To make a space to separate words, press the round Number 0 key twice or press the round Number 00 key one time.

- For double wide characters, see Using Double Wide Characters.
- For programming department keys, see Programming Department Keys on page 34.
- For programming PLUs, see Programming PLU Descriptions on page 48.
- For programming Clerk names and numbers, see Setting Clerk Numbers and Names on page 25.

About Programming Numbers in Logo Messages

If you need to print numbers, you must enter the numbers using the Alphanumeric Code Chart. For example, for the telephone number 999-555-1212, the number 9 is programmed using the character code 39, the number 5 is programmed using the code 35, and so on.

Using Double Wide Characters

For extra emphasis, you can program double wide characters for a specific character or a line of characters.

Normal Size

```

*****
* YOUR RECEIPT *
*   THANK YOU   *
*               *
*****
11-10-01 MC #:0000
APPLE      $1.00
BANANA     $1.00
PEAR       $1.00
-----
TOTAL      $3.00
CASH       $3.00
          AM10-49 0013
    
```

Double Wide

```

*****
* YOUR RECEIPT *
*   THANK YOU   *
*               *
*****
11-10-01 MC #:0000
APPLE      $1.00
BANANA     $1.00
PEAR       $1.00
-----
TOTAL      $3.00
CASH       $3.00
          AM10-51 0015
    
```

Before programming your logo or message

- 1 Write out your store name and the logo message you want to program.
- 2 After writing out your message, count the number of characters on each line. The following example shows a message and the letter count, including spaces.

```
INTERNATIONAL COFFEES      21
999-555-1212                12
222 EAST MAIN STREET       20
OPEN 7AM TO 6PM            15
COFFEES OF THE WORLD       20
```

- 3 Complete the chart, filling in extra unused characters with blank spaces.

Line 1			I	N	T	E	R	N	A	T	I	O	N	A	L		C	O	F	F	E	E		
Line 2							9	9	9	-	5	5	5	-	1	2	1	2						
Line 3			2	2	2		E	A	S	T		M	A	I	N		S	T	R	E	E	T		
Line 4							O	P	E	N		7	A	M		T	O		6	P	M			
Line 5			C	O	F	F	E	E	S		O	F		T	H	E		W	O	R	L	D		

In the example, blank spaces are added at the beginning and end of each line so the message is centered.

Remember, you can make the characters double width but you can only use half the total number of characters if you do this. For example, if you want `Coffee` to be double wide, you need 12 spaces. For more information about double wide characters, see *Using Double Wide Characters* on page 20.

You can also use characters other than those on the Department keys, such as numbers, punctuation, and international letters. See the *Alphanumeric Code Chart* on page 18.

This is an example of a programmed Store Logo:

```
INTERNATIONAL COFFEES
  999-555-1212
  222 EAST MAIN STREET
    OPEN 7AM TO 6PM
    COFFEES OF THE WORLD
```



To make a space to separate words, press the 0 key twice or press the 00 key one time.

**Note**

If you enter the wrong character, press the **Void** key to backspace and delete that character and then continue.

To program your logo



1 Put the PRG key in the Mode key slot and turn it to the PRG position.



2 If you are prompted for a Manager Password, type the password number and then press the **Check** key. If you did not program a Manager Password, go to the next step.



3 For the 1st line, do the following:

- Using the round Number keys area, press 31.
- Press the **Return** key. The Logo line 1 appears on the display.
- Enter the 1st line of the logo, up to 24 characters and then press the **Check** key.

4 If you want a 2nd line, do the following:



- Using the round Number keys area, press 32.
- Press the **Return** key. Logo line 2 appears on the display.



- Enter the 2nd line of the logo, up to 24 characters and then press the **Check** key.

5 If you want a 3rd line, do the following:



- Using the round Number keys area, press 33.
- Press the **Return** key. Logo line 3 appears on the display.



- Enter the 3rd line of the logo, up to 24 characters and then press the **Check** key.

6 If you want a 4th line, do the following:



- Using the round Number keys area, press 34.
- Press the **Return** key. Logo line 4 appears on the display.



- Enter the 4th line of the logo, up to 24 characters and then press the **Check** key.

7 If you want a 5th line, do the following:



- Using the round Number keys area, press 35.
- Press the **Return** key. Logo line 5 appears on the display.



- Enter the 5th line of the logo, up to 24 characters and then press the **Check** key.

8 When you are done, turn the Mode key to Off.

Setting the Commercial Message in the Footer

You can also program a message that automatically prints at the bottom of the receipt. For example, you can list your hours of operation or a special promotion at the bottom of every receipt.

The Commercial message can have up to 5 lines. Each line can have 24 characters in single width or 12 characters in double width. For more information about double-width messages, see *Using Double Wide Characters* on page 20.

For example, the message at the bottom of the receipt can say:

```
TUESDAY IS 10% OFF DAY!
    STOCK UP AND SAVE
```

Use the worksheet on page 21 to plan your message before you start.

Note

If you enter the wrong character, press the **Void** key to backspace and delete that character and then continue.



To program your commercial message

1 Put the PRG key in the Mode key slot and turn it to the PRG position.



2 If you are prompted for a Manager Password, type the password number and then press the **Check** key. If you did not program a Manager Password, go to the next step.

3 For the 1st line, do the following:



- Using the round Number keys area, press 71.

- Press the **Return** key. The Footer line 1 appears on the display.



- Enter the 1st line of the logo, up to 24 characters and then press the **Check** key.

4 If you want a 2nd line, do the following:



- Using the round Number keys area, press 72.

- Press the **Return** key. Footer line 2 appears on the display.



- Enter the 2nd line of the logo, up to 24 characters and then press the **Check** key.

5 If you want a 3rd line, do the following:



- Using the round Number keys area, press 73.

- Press the **Return** key. Footer line 3 appears on the display.



- Enter the 3rd line of the logo, up to 24 characters and then press the **Check** key.

6 If you want a 4th line, do the following:

return

- Using the round Number keys area, press 74.

check

- Press the **Return** key. Footer line 4 appears on the display.

- Enter the 4th line of the logo, up to 24 characters and then press the **Check** key.

7 If you want a 5th line, do the following:

return

- Using the round Number keys area, press 75.

check

- Press the **Return** key. Footer line 5 appears on the display.

- Enter the 5th line of the logo, up to 24 characters and then press the **Check** key.

8 When you are done, turn the Mode key to Off.

Setting Clerk Numbers and Names

You can program and assign up to 26 Clerk Numbers so you can monitor sales by individual employees. Each clerk number can also be assigned a 24 character name.

The Clerk Numbers are used in the register modes REG1 and REG2 only. To see the sales totals for each clerk, a Clerk Report is available in both the X and Z modes.

You can spell names by using department keys. For more information, see Setting Alphanumeric Descriptions on page 17.

Note

When entering the clerk passwords, they appear as asterisks **** on the displays for extra security.

After you specify Clerk Number and Names, you must set a flag option so that clerks must enter their clerk number before every transaction. For more information, see Programming Flag Options on page 56. If you do not set the flag option to turn on Clerk Numbers, all transactions listed on reports and receipts will appear under Clerk 1.

After you are done programming clerk numbers, you can check your results. See Printing the Quick Start Program Confirmation Report on page 29.

clear

Note

If you make a mistake while you are programming the Clerk Numbers, press the **Clear** key and begin again with Step 3.

To set clerk numbers

Example 4: For Clerk #1, Security number is 234

- 1 Put the PRG key in the Mode key slot and turn it to the PRG position.
- 2 If you are prompted for a Manager Password, type the password number and then press the **Check** key. If you did not program a Manager Password, go to the next step.
- 3 Using the round Number keys, press 444444 and then press the **Amount Tend Total** key. The letter C appears in the Customer Display and Clerk Pass appears in the clerk display until Step 6 is complete.
- 4 Using the round Number keys, press 1 for Clerk #1 and then press 234 for the Security number and press the **Clerk** key.
- 5 Repeat Step 4 for adding Clerks 2 through 26.
- 6 When you are done programming Clerk Numbers, press the **Clear** key.
- 7 Before you can use Clerk Numbers, you must activate the Clerk System by selecting Option #1 on Flag 12. Do the following:
Press 121 and then press the **Void** key.

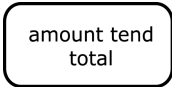

To program a clerk name

Example 5: For Clerk #1, program name as Sally Smith

- 1 Put the PRG key in the Mode key slot and turn it to the PRG position.
- 2 If you are prompted for a Manager Password, type the password number and then press the **Check** key. If you did not program a Manager Password, go to the next step.
- 3 Using the round Number keys, press 1 for Clerk #1 and then press the **Return** key.
- 4 To program a name, press the Department keys or the Alphanumeric Code Chart, as needed. For an explanation of how to use the Department keys to spell words, see Setting Alphanumeric Descriptions on page 17. Remember, the Department Shift key lets you use the letters in the lower green section on the Department keys. To make a space to separate words, press the 0 key twice or press the 00 key one time.
- 5 Press the **Check** key when you are done.

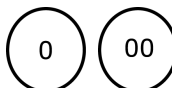

To use clerk numbers

Example 6: Clerk #1 has a passcode of 234

- 1 Put the PRG key in the Mode key slot and turn it to either the REG1 or REG2 position.
- 2 Using the round Number keys, press 1, then press the **Clerk** key. Press 234 and then press the **Check** key.



- 3 The first 2 digits of the display show the Clerk Number when entered and the display shows the Clerk Name. The cash register is now ready for operation.

Using the Clerk System

If you see the message `CLERK E12, RE-CLERK#,` or `CLERK ERR` in the display and you hear the error beep, clerk numbers are programmed and the clerk system is active.

To use the Clerk System

- 1 Press the **Clear** key to clear the error condition and then enter a clerk number and press **Clerk**.
- 2 If you programmed a clerk security code, enter the clerk number and then press the **Clerk** key. Using the round Number keys, press the three digit security code and then press the **Check** key.



Setting the Machine Number

You can assign your cash register its own number. This is useful if you have several cash registers and want to track which one creates which receipts and transactions.

The machine number prints on all receipts/journal records, and management reports. The machine number can be up to 4 digits long.

After you are done programming the machine number, you can check your results. See Printing the Quick Start Program Confirmation Report on page 29.

To set the machine number

Example 7: Program the cash register number to 1234

- 1 Put the PRG key in the Mode key slot and turn it to the PRG position.
- 2 If you are prompted for a Manager Password, type the password number and then press the **Check** key. If you did not program a Manager Password, go to the next step.
- 3 Using the round Number keys, press 1234 and then press the **+%/PO** key.



Setting X and Manager Passwords

Two Manager Passwords are available for added security:

- one password to go to the PRG and Z modes
- one password to go to the X mode.

Important

The Manager Password cannot be 0000 (zeros). The cash register will not accept this password.

Caution

Write your passwords down in a safe place. If you forget the passwords, you must do a Full System Clear procedure. A Full System Clear erases all transaction information and programming. For details on the Full System Clear, see Full System Clear on page 89.

After you program a password, you must use it every time you go to the program mode or before every X or Z readings, depending on which you set the password for.

When you enter a password, it appears as asterisks **** on the displays for extra security.

To set manager passwords

Example 8: To set the X password as 1212

- 1 Put the PRG key in the Mode key slot and turn it to the PRG position.
- 2 Using the round Number keys, press 222222, and then press the **Amount Tend Total** key. The X PASS prompt and the letter P appears until you complete step 3.
- 3 Using the round Number keys, press 1212 and then press the **Non Tax** key.

amount tend
total

non
tax

Example 9: If the PRG/Z password is 1313

- 1 Put the PRG key in the Mode key slot and turn it to the PRG position.
- 2 Using the round Number keys, press 111111 and press the **Amount Tend Total** key. The PASS prompt and the letter P appears until you complete step 3.
- 3 Using the round Number keys, press 1313 and press the **Non Tax** key.

amount tend
total

non
tax

To use manager passwords

Example 10: Go to the X mode, using the Manager Password 1212

- 1 Put the PRG key in the Mode key slot and turn it to the X position.

check

- 2 Using the round Number keys, press 1212 and then press the **Check** key.
- 3 You are now ready to run an X Report.

Example 11: Go to the PRG or Z modes, using the Manager Password 1313

check

- 1 Put the PRG key in the Mode key slot and turn it to the PRG or Z position.
- 2 Using the round Number keys, press 1313 and then press the **Check** key.
- 3 You are now ready to program or take any reports based on your selection in the first step.

Printing the Quick Start Program Confirmation Report

Now that basic programming is complete, check your results with a Quick Start Program Confirmation Report.

If you made a mistake during programming, repeat only the step in question. For example, if only the tax rate is incorrect, just re-program the tax—you do not need to re-set the time, date, and so on.

To print the Quick Start Program Confirmation Report

amount tend
total

feed

- 1 Put the PRG key in the Mode key slot and turn it to the PRG position.
- 2 Using the round Number keys, press 999999 and then press the **Amount Tend Total** key.
- 3 After the Program Confirmation Report prints, press the **Feed** key to advance the complete report out of the cash register.

See the next page for an example of this report.

Your tape looks similar to the example Program Confirmation Report shown below.

DATE	09-17-2002	MC #:1234	MACHINE NUMBER
	FOOD	0.00T1	PRE-SET PRICE of zero in Dept. 1; Taxable 1 Status
		00001	DEPARTMENT STATUS - shows Tax Rate 1 programmed for Dept. 1
	BEVERAGES	1.99T2	PRE-SET PRICE of \$1.99 in Dept. 2; Taxable 2 Status
		00002	DEPARTMENT STATUS
	COFFEE	0.00T1	PRE-SET PRICE of zero in Dept. 3 Taxable 1 Status
		10001	DEPARTMENT STATUS
	PAPER GOODS	0.00	
		00000	
	DEPT 5	0.00	
		00000	
	DEPT 6	0.00	
		00000	
			ALL 99 DEPARTMENTS ALWAYS PRINT
	DEPT 99	0.00	
		00000	
	COUPON	001-	COUPON STATUS (Tax Status set at "01")
		1.54T1	TAX 1 RATE (fixed rate programmed)
		50.00T1	
		1.04T2	TAX 2 RATE (fixed rate programmed)
		60.00T2	
		0.00T3	TAX 3 RATE (not programmed)
		0.00T4	TAX 4 RATE (not programmed)
	DISCOUNT	10.00%-	PERCENT DISCOUNT (set at 10%)
	ADD ON	0.00%+	PLUS PERCENTAGE (not programmed)
	CHARGE	50	ROUNDING STATUS (set at 50)
	CHARGE	1 05	
	CHARGE	2 05	
	CHARGE	3 10	
	CHARGE	4 20	
	CHARGE	5 05	
	CHARGE	6 00	
	CHARGE	7 02	
	61 CLOSED, NEXT REGISTER PLEASE		Scroll Message Details
	62 PLEASE WAIT		
	63 PLEASE TAKE YOUR RECEIPT		
	64 GOOD MORNING		
	65 GOOD AFTERNOON		
	VOID/CORR	0000000000	FLAG NUMBERS read from left to right
	VOID/CORR	0000100100	
	VOID/CORR	0000001101	
		0	

TIME	PM 2-44	0003	TRANSACTION NUMBER

Either the Dept. No. or Dept. Description prints

FLAG OPTION STATUS (a total of 34 flag options will print at either "0" or "1", depending upon the program setting)

The Date, Time, Tax Rate and Department Status shows the information based upon your input.

For more details of the symbols printed in the Program Confirmation Report, see Running Reports on page 70.

Before Going to Register Mode

Your cash register offers many other features not covered in this chapter. Other options are covered in the chapter called Setting Up Your Cash Register - Advanced, starting on page 33.

We also provide examples to help you learn how to use your cash register. For information about the examples, see Examples on page 90.

Error Codes

Your cash register makes beeps as well as shows you messages in the display. Some beeps and messages let you know everything is working and others let you know you need to do something.

Table 6 Common errors

This error...	Means this...
Register Beep	The cash register makes a short beep each time a key is pressed. This is normal and not a cause for concern.
Entry Error Beep	<p>When using your cash register, you must perform all operations in the correct order. If you press the wrong key at the wrong time, an alarm beep sounds and you see a message on the display. The keyboard also locks. Press the Clear key to continue.</p> <p>When a transaction is started in the REG1 or REG2 position, you must complete the sale before moving the Mode key to another position. When an operation is started but not finished in the REG1 or REG2 positions, turning the Mode key to another position makes an alarm beep and you see an error message on the display. Press the Clear key to continue.</p>
Printer Error	If a PE appears in the display, check if you are out of paper. Check for a paper jam. For more information about other solutions, see PE Printer Error on page 87.

Clearing an Error



The **Clear** key stops an alarm beep that happened because a key was pressed that was not correct for that operation.

The **Clear** key does not erase a transaction that was registered by an operating key and printed on the register tape.



To erase an entry after you press a key that printed the entry on the tape, use the **Void** key to correct the error.

If the cash register makes a loud error beep, press the **Clear** key to stop it.

If your cash register will not stop making a beeping sound after you press the **Clear** key, you can do two more things.

Half System Clear

If you pressed the **Clear** key and the error beep does not stop, you can do a Half System Clear. For more information about a Half System Clear, see Half System Clear on page 89.

Full System Clear

If you did a Half System Clear and the error beep still does not stop, as a last resort, you can do a Full System Clear. For more information about the Full System Clear, see Full System Clear on page 89.

Setting Up Your Cash Register - Advanced

This chapter shows you more advanced programming for your cash register. This chapter covers:

- Programming Department Keys
- Programming PLU Descriptions
- Setting the Decimal Points
- Setting the Rounding Rates
- Programming Discounts
- Programming Flag Options

When you are done programming your cash register, you can run the Programming Report to see your results. See Running the Program Confirmation Report on page 70.

Note

While you are programming, the letter P often appears in the display.

Programming Department Keys

Departments are a category of merchandise. For example, Department 1 can be Housewares, Department 2 can be Food, Department 3 can be Womens Clothing, and so on. This helps you track what you are selling.

Each department can be programmed as taxable or non-taxable, so that if an item needs to be taxed, it is added automatically when you ring up an item in a taxable department.

You can have as many as 99 departments on your cash register. If you have many departments, you may want to make a list so other people who use the cash register can properly use the department keys.

Programming departments includes up to 6 steps. Not all steps listed below may apply to your specific needs, but you must specify a value for each, even if you do not plan to use that feature.

- 1 Setting Standard and Gallonage Mode
- 2 Programming Multiple and Single Items
- 3 Programming High Digit Lock-out (HDLO)
- 4 Programming Tax Status
- 5 Programming Department Preset Price
- 6 Programming Department Names

For specific information about each of the items above, see the next sections.

After you are done, you can check your results. See Running the Department Sales Report on page 73.

To program department keys

- 1 Put the PRG key in the Mode key slot and turn it to the PRG position.
- 2 If you are prompted for a Manager Password, type the password number and then press the **Check** key. If you did not program a Manager Password, go to the next step.
- 3 Press the following, in this order:

check

Press this...	To specify this...	See this page...
0 or 1	Standard or gallonage	36
0 or 1	Multiple or single items	36
0 to 6	HDLO	36

Press this...	To specify this...	See this page...
00 to 15 and then 	Tax status	37
0 or up to a 7 digit price	Department preset value	38
A department key	The department key for this department	

Note

If you do not want to program a department name, press the **Amount Tend/Total** key. Skip the next steps. You are done with this department.

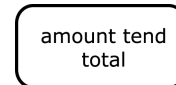

The alphanumeric keys to spell the department name.	The department name	39
---	---------------------	----



The information is saved in the cash register

4 To add another department, do step 3 again.

To program Department 1 as taxable with no preset price and no description

- 1 Put the PRG key in the Mode key slot and turn it to the PRG position.
- 2 If you are prompted for a Manager Password, type the password number and then press the **Check** key. If you did not program a Manager Password, go to the next step.
- 3 Using the round Number keys, press 00001 and then press the **Subtotal/w/Tax** key.
- 4 Using the round Number keys, press 0 and then press the **Dept 1** key.
- 5 Press the **Amount Tend/Total** key. Skip this step if you are going to enter a description. The department information is saved in the cash register.

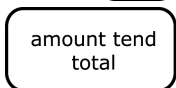

To program Department 2 as non-taxable with no preset price and no description

- 1 Put the PRG key in the Mode key slot and turn it to the PRG position.
- 2 If you are prompted for a Manager Password, type the password number and then press the **Check** key. If you did not program a Manager Password, go to the next step.



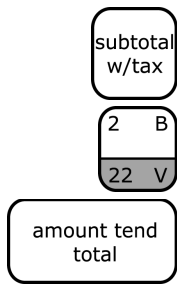

- 3 Using the round Number keys, press 00000 and then press the **Subtotal/w/Tax** key.
- 4 Using the round Number keys, press 0 and then press the **Dept 2** key.
- 5 Press the **Amount Tend/Total** key. Skip this step if you are going to enter a description. The department information is saved in the cash register.

Setting Standard and Gallonage Mode

A department can be set for either Standard Mode or Gallonage Mode.

Gallonage Mode allows entering a price with 3 decimal places, representing the cost per gallon, pound, kilogram, yard, meter, or other unit of measurement. For example, \$1.499 per gallon.

Standard Mode enters the price using the normal 2 decimal place setting.

Table 7 Standard/Gallonage Mode

This number...	Means this...
0	Standard Mode
1	Gallonage Mode

Programming Multiple and Single Items

Multiple Item Entry allows you to ring up two or more items into a department. For example, if you want to ring up 5 of the same items, you can tell the cash register to multiply the one price by the number of items.

Single Item Entry allows you to ring up only one item in a department. For example, if you want to ring up 5 of the same items, you must ring each one up individually.

Table 8 Multiple / single item

This number...	Means this...
0	Multiple Item Sale
1	Single Item Sale

Programming High Digit Lock-out (HDLO)

You can specify the most number of digits that can be rung up in an entry. This feature helps to prevent against large over-rings. If too many digits

are entered, the error beep sounds and the keypad locks up. For example, to limit ring ups of more than \$99.99, set the HDLO to 4.

Table 9 High digit lock out (HDLO) values

This number...	From this...	to this...
0	\$.01	\$ 99,999.99 (Standard setting)
1	.01	.09
2	.01	.99
3	.01	9.99
4	.01	99.99
5	.01	999.99
6	.01	9,999.99

Programming Tax Status

Some items must have tax collected by law. You can program your cash register to automatically assign the right amount of tax, based on the department the item is assigned to.

You can link no tax, a single tax rate (Tax 1), or multiple tax rates (Tax 2, 3 or 4) to a department key.

Table 10 Tax status settings

This tax status number...	Means this...
00	Non-Taxable (use this if you do not want to charge tax)
01	Taxable by TAX 1 Rate
02	Taxable by TAX 2 Rate
03	Taxable by TAX 3 Rate
04	Taxable by TAX 4 Rate
05	Taxable by TAX 1 and TAX 2 Rates
06	Taxable by TAX 1 and TAX 3 Rates
07	Taxable by TAX 1 and TAX 4 Rates
08	Taxable by TAX 2 and TAX 3 Rates
09	Taxable by TAX 2 and TAX 4 Rates
10	Taxable by TAX 3 and TAX 4 Rates

Table 10 Tax status settings (Continued)

This tax status number...	Means this...
11	Taxable by TAX 1, TAX 2 and TAX 3 Rates
12	Taxable by TAX 1, TAX 2 and TAX 4 Rates
13	Taxable by TAX 1, TAX 3 and TAX 4 Rates
14	Taxable by TAX 2, TAX 3 and TAX 4 Rates
15	Taxable by TAX 1, TAX 2, TAX 3 and TAX 4 Rates

Programming Department Preset Price

If you do not want to preset a price, a price of 0 must be assigned to that department key. Department Preset Price programs a price in a department to save time when ringing up an entry. Even if a price has been pre-programmed, you can override the price at the time of sale.

The price automatically rings up each time the department key is pressed.

Important

If you do not need a preset price, enter 0 as the price.

Assigning Department Number Keys

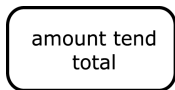

You must assign a department number. After you assign a department number, you can press the **Amount Tend/Total** key to finish programming if you do not want a department description.



The Department number keys from 1 to 20 are easy to use: You just press the Department number key you want. For example, to use Dept 2, press the Dept 2 key.



The Department keys from 21 to 40 are also easy to use. Just press the **Dept Shift** key and then press the Department number key you want. For example, to use Dept 23, press the **Dept 23** key.



To use the Department keys from 41 to 99, do the following:



- Press the **Dept Shift** key.
- Using the round Number keys, type the Department number from 41 to 99 that you want to use. For example, for Department 63, press the 6 key and then press the 3 key.

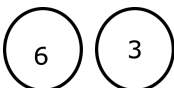

- Press the **Dept Shift** key again.

Programming Department Names

A name or description can be assigned to each department key. This name appears on the clerk display and prints when ringing up sales.

For example, Clothing can print on the receipt in place of Dept 1, Shoes can print on the receipt in place of Dept 2, Sportswear can print on the receipt in place of Department 3, and so on.

When you are programming the descriptions for Departments, use the Alphanumeric Keyboard.



When you are done programming the department description, press the **Check** key to save your programming. The information is saved in the cash register and you can program the next item.

Note

Only capital letters of the alphabet are on the Alphanumeric Keyboard. You can also use lower case letters and numbers, certain symbols, and international characters. See Alphanumeric Code Chart on page 40.

5 E 25 Y	10 J 30	15 O 35	20 T 40
4 D 24 X	9 I 29	14 N 34	19 S 39
3 C 23 W	8 H 28	13 M 33	18 R 38
2 B 22 V	7 G 27	12 L 32	17 Q 37
1 A 21 U	6 F 26 Z	11 K 31	16 P 36

The department keys are clearly labeled with all the letters you need to program these descriptions. When you are programming alphanumeric descriptions, use the department keys to spell out the words you want.



You can use the letters in the lower green area of the keys by pressing the **Dept Shift** key and then pressing the key with the letter you want.

You might need certain symbols, numbers, international characters or lower case characters that are not found on the Alphanumeric Keyboard. For example, if you require a space between words, or if you need the / symbol, or -, you use the round Number keys to type the correct alphanumeric code. See the Alphanumeric Code Chart shown in the next section.



Important

If you enter the wrong character, press the **Void** key to backspace and delete that character. Now you can continue.

Alphanumeric Code Chart

Many characters are also available. Use the tables in this section to help you find the ones you need.

Use the following table for lower case letters and numbers. If you want to use double width characters, press 01 before each character.

For example, to program Y E S, type 01 Department Shift key Y 01 E 01 S. For more information, see [Using Double Wide Characters](#) on page 20.

Table 11 Letters and numbers

Character	Code Number	Character	Code Number
Space	00	s	20
Wide Character	01	t	21
a	02	u	22
b	03	v	23
c	04	w	24
d	05	x	25
e	06	y	26
f	07	z	27
g	08		
h	09	Numbers	
i	10	0	30
j	11	1	31
k	12	2	32
l	13	3	33
m	14	4	34
n	15	5	34
o	16	6	36
p	17	7	37
q	18	8	38
r	19	9	39

Use this table for punctuation and foreign characters.

Table 12 Special Characters and Punctuation

Character	Code Number	Character	Code Number
ı	80	?	28
ı	81	!	29
á	82	@	40
é	83	/	67
ı	84	:	68
ó	85	#	69
ú	86	&	70
Ä	93	%	71
Ü	94	\$	72
Ö	95	,	73
		(comma)	
İ	96	(74
ü	97)	75
Ñ	98	*	76
ñ	99	+	77
		-	78
		.	79
		(period)	
		;	87
		(semi colon)	
		>	88
		'	89
		(apostrophe)	
		"	90
		<	91
		=	92

Programming Scrolling Messages

Your cash register shows messages that move when you are not using it. You can use the default messages or you can program your own. You can change one or more messages at any time. For example, if you have a new promotion, you can change the Idle 1 message to say something about the promotion.

The scrolling messages that can be programmed are the following:

Table 13 Scrolling messages

Message Number	Message Type	This message shows...
1	OFF message	In the OFF position
2	MODE message	During the idle state in PRG, X, Z modes
3	SALES message	After the sales transaction
4	IDLE message 1	In the idle state in REG modes during the morning hours *
5	IDLE message 2	In the idle state in REG modes during the afternoon hours *
* IDLE messages 1 and 2 can be combined for 1 longer message that runs all day.		

You can program up to 42 characters for each scroll message. Messages 4 and 5 (IDLE messages) can be combined for a maximum of 84 characters.

The following messages display automatically. You can change these default messages, using the following instructions.

Off Message	CLOSED, NEXT REGISTER PLEASE
Mode Message	PLEASE WAIT
Sales Message	PLEASE TAKE YOUR RECEIPT
Idle Message 1	GOOD MORNING
Idle Message 2	GOOD AFTERNOON

Here are some samples of messages that can be programmed:

```
ASK ABOUT OUR DAILY SPECIALS
WE DELIVER
10% DISCOUNT ON THURSDAYS
FREE SODA WITH ANY SANDWICH ORDER
STORE HOURS 9AM TO 10 PM
```

To program a message



- 1 Put the PRG key in the Mode key slot and turn it to the PRG position.
- 2 If you are prompted for a Manager Password, type the password number and then press the **Check** key. If you did not program a Manager Password, go to the next step.



- 3 Using the round Number keys, press 6, press the number of the message you want to change, and press the **Return** key.

For example, to change the message that shows when you move the Mode key to the Off position, press 6 1 **Return**.

- 4 Type your message, using either the Alphanumeric keys or the special codes. For more information about using the Alphanumeric keys to type letters, see Setting Alphanumeric Descriptions on page 17.

Important



If you enter the wrong character, press the **Void** key to backspace and delete that character. Now you can continue.



- 5 When you are done, press the **Check** key. You can program another message by starting with step 3.

Programming Scrolling Message Display Times

After you have programed your scrolling message, you can set the length of time you want the message to run.

After you are done, you can check your results. See Running the Program Confirmation Report on page 70.

Setting the Off Message

OFF message	Number of seconds after the register is turned off before the message starts.	Settings in seconds: 00–99 Default=05
	To stop the message after it starts, press the Feed key.	

To program the Off message time setting



- 1 Put the PRG key in the Mode key slot and turn it to the PRG position.
- 2 If you are prompted for a Manager Password, type the password number and then press the **Check** key. If you did not program a Manager Password, go to the next step.



- 3 Using the round Number keys, press 1, press the number of seconds you want to delay as 2 digits, and press the **Charge** key.

Setting the Mode Message

MODE message	Number of seconds before the register turns into idle mode in PRG, X, Z modes and the message starts.	Settings in seconds: 00–99 Default=05
--------------	---	--

This message does not display in REG modes.

To program the Mode message time setting



- 1 Put the PRG key in the Mode key slot and turn it to the PRG position.
- 2 If you are prompted for a Manager Password, type the password number and then press the **Check** key. If you did not program a Manager Password, go to the next step.



- 3 Using the round Number keys, press 2, press the number of seconds you want to delay as 2 digits, and press the **Charge** key.

Setting the Sales Message Start and Stop Times

SALES message start	Number of seconds after a sale is complete before the message starts.	Settings in seconds: 00 – 99 Default=10
---------------------	---	--

The register must be set in REG mode.

To program the Sales message start time setting



- 1 Put the PRG key in the Mode key slot and turn it to the PRG position.
- 2 If you are prompted for a Manager Password, type the password number and then press the **Check** key. If you did not program a Manager Password, go to the next step.



- 3 Using the round Number keys, press 3, press the number of seconds you want to delay as 2 digits, and press the **Charge** key.

SALES message stop	Number of seconds the Sales message runs before the Idle message starts.	Settings in seconds: 00 – 99 Default=20 00 = No Sales message appears
--------------------	--	---

The register must be set in REG mode.

To program the Sales message stop time setting



- 1 Put the PRG key in the Mode key slot and turn it to the PRG position.
- 2 If you are prompted for a Manager Password, type the password number and then press the **Check** key. If you did not program a Manager Password, go to the next step.



- 3 Using the round Number keys, press 4, press the number of seconds you want to delay as 2 digits, and press the **Charge** key.

Setting the Idle Messages

Idle message display after the time appears

Number of seconds for the Time to appear before the Idle message appears again.

Settings in seconds: 0 – 9
0 does not show the time at all.
Default=5

When the Time changes while an Idle message is running, the time appears for a few seconds. After the specified time, the Idle message appears again.

To program the Idle message display after the time appears



- 1 Put the PRG key in the Mode key slot and turn it to the PRG position.
- 2 If you are prompted for a Manager Password, type the password number and then press the **Check** key. If you did not program a Manager Password, go to the next step.



- 3 Using the round Number keys, press 50, press the number of seconds you want to delay as 1 digit, and press the **Charge** key.

Idle message pattern

Setting the Idle message to 0 runs Idle message 1 in the AM and Idle message 2 in the PM.

Settings: 0 – 1
Default=0

Setting the Idle message to 1 combines both Idle messages and runs them all day.

To program the Idle message pattern



- 1 Put the PRG key in the Mode key slot and turn it to the PRG position.
- 2 If you are prompted for a Manager Password, type the password number and then press the **Check** key. If you did not program a Manager Password, go to the next step.



- 3 Using the round Number keys, press 60, press 0 or 1 for your message display choice, and press the **Charge** key.

Setting the Amount of Time Letters Appear in the Display

You can specify the amount of time letters appear in the display. The shorter amount of time, the faster the message scrolls across the display.

To program the amount of time letters appears

check

- 1 Put the PRG key in the Mode key slot and turn it to the PRG position.
- 2 If you are prompted for a Manager Password, type the password number and then press the **Check** key. If you did not program a Manager Password, go to the next step.

charge

- 3 Using the round Number keys, press 70. Press one digit number from the chart below, representing the number of seconds you want to delay, and press the **Charge** key.

Press this number...	To specify...	
0	0.2 seconds	Fast
1	0.3	
2	0.4 - Default	
3	0.5	
4	0.6	
5	0.7	
6	0.8	
7	0.9	
8	1.0	Slow

Programming the Credit Keys

You can use 2 department keys as credit card-only keys. You can use one or both keys if you want. For example, you can set Department 19 to be a Visa® card and Department 20 to be a MasterCard®. You can also program the cash register to print the name of the credit card on the receipt or journal tape.

When you ring up a sale, you can use Department 19 or Department 20 to finalize the credit card sale, open the cash drawer, and print the receipt or journal tape.

You must set Flag 16 Option Number 1, 2, or 3 to use this feature. For more information about setting Flags, see Programming Flag Options on page 56.

Note

If you want to use Departments 19 and 20 as credit card keys, they no longer work as department keys until you set Flag 16 back to 0.

To program a credit key









- Put the PRG key in the Mode key slot and turn it to the PRG position.
- If you are prompted for a Manager Password, type the password number and then press the **Check** key. If you did not program a Manager Password, go to the next step.



- To program a card name that prints on the receipt or journal tape, press 51 for Department key 20 or press 52 for Department key 19 and then press the **Return** key. If you do not program a card name, it prints as CREDIT 1 or CREDIT 2.

- Type the name of the credit card just as you did when you programmed Department names. You can type up to 12 characters and spaces.

For example, to type VISA, press the following keys:

Press this key...	To get this letter...
 	V
	I
	S
 	A

- For more information about using the Department keys to type letters, see Programming Department Keys on page 34.



Important

If you enter the wrong character, press the **Void** key to backspace and delete that character. Now you can continue.



- When you are done, press the **Check** key.

Programming PLU Descriptions

The Price-Look Up system allows for fast, accurate entry of an item and automatically records the number of items sold. If you want to use the optional barcode reader, you can scan UPC codes to ring up items.

A total of 1000 Price Look Up codes (PLUs) are available. Each PLU must be programmed with up to a 12 character description that appears on the display and prints on the tape.

Programming PLUs consists of the following:

- 1 Assign a PLU number between 1 and 1000 to each sales item or scan the UPC barcode.
- 2 Assign a price.
- 3 Link the PLU to a department key with the appropriate Tax Status for that PLU.
- 4 Enter a description for the PLU. You must enter a description, even if it is as simple as PLU4.

For example, if PLU #1 is a taxable item, you can link it to a Department key which is set up for tax. If PLU #2 is not a taxable item, you can link it to a Department key which is programmed for no tax.

Important

You do not need to press the decimal point key when entering a price.

After you are done, you can check your results. See Running the PLU Confirmation Report on page 72.

Programming PLUs without a Barcode Reader

You can program PLUS without using a barcode reader. Use the following instructions.

To program PLUs without a barcode reader

Example 12: Set PLU #1 with a \$2.99 price, linked to Department 1, description of APPLE

- 1 Put the PRG key in the Mode key slot and turn it to the PRG position.
- 2 If you are prompted for a Manager Password, type the password number and then press the **Check** key. If you did not program a Manager Password, go to the next step.
- 3 Press the **Qty/Date** key to begin programming the PLUs. The PLU prompt appears on the display.
- 4 Using the round Number keys, press 1 and press the **PLU** key.





5 Using the round Number keys, press 299 and then press the **Department 1** key. For more information about using the department keys, see Assigning Department Number Keys on page 38.

6 Press the keys to spell APPLE, using the Alphanumeric keys or the Alphanumeric Code Chart, if needed. For an explanation of how to use the Department keys to spell words, see Setting Alphanumeric Descriptions on page 17. The Department Shift key lets you use the letters in the lower green area on the Department keys.

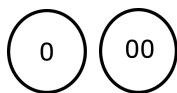

To make a space to separate words, press the round Number 0 key twice or press the round Number 00 key one time.

You must enter a description, even if it is as simple as PLU4.



Important

If you enter the wrong character, press the **Void** key to backspace and delete that character and then continue.



7 Press the **Check** key. The PLU information is saved in the cash register.

If you want to program more PLUs, repeat steps 4 through 7.



8 When you are done programming PLUs, press the **Qty/Date** key.

Programming PLUs with the Barcode Reader

You can use the optional barcode reader to scan items and automatically ring them up. Using the barcode reader reduces errors caused by people ringing up items incorrectly. For more information about getting a barcode reader, contact Royal.

The barcode reader must be held about 1/2 inch or closer above the UPC symbol on the product to read the UPC symbol properly.

To program PLUs using the barcode reader

Example 13: Set a UPC symbol to a \$2.99 price, linked to Department 1, description of BOOK

1 Put the PRG key in the Mode key slot and turn it to the PRG position.



2 If you are prompted for a Manager Password, type the password number and then press the **Check** key. If you did not program a Manager Password, go to the next step.



3 Press the **Qty/Date** key to begin programming the PLUs.

4 Using the barcode reader, scan the UPC you want for this PLU. Hold the barcode reader less than 1/2 inch from the UPC you want to scan. Press the button on the bottom of the reader to read the UPC. The barcode reader beeps.



5 Using the round Number keys, press 299 and then press the **Department 1** key. The PLU name appears on the display. For more information about using the department keys, see Assigning Department Number Keys on page 38.

6 Press the keys to spell BOOK, using the Department keys or the Alphanumeric Code Chart, if needed. For an explanation of how to use the Department keys to spell words, see Setting Alphanumeric Descriptions on page 17. The Department Shift key lets you use the letters in the lower green area on the Department keys.

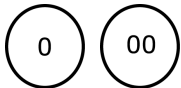

To make a space to separate words, press the 0 key twice or press the 00 key one time.

You must enter a description, even if it is as simple as PLU4.



Important

If you enter the wrong character, press the **Void** key to backspace and delete that character and then continue.



7 Press the **Check** key. The PLU information is saved in the cash register.

8 Repeat steps 4 through 7 to program more PLUs.



9 When you are done programming PLUs, press the **Qty/Date** key.

Setting the Decimal Points

The decimal point is set by selecting from the following 4 options:

This decimal point...	Looks like...
zero decimal point	0 = \$ X
one decimal point	1 = \$ X.X
two decimal point	2 = \$ X.XX (U.S. Standard)
three decimal point	3 = \$ X.XXX

After you program the decimal point, you do not need to specify a decimal when you ring up sales. If you try to use a decimal point, you hear an error beep.

After you are done, you can check your results. See Running the Program Confirmation Report on page 70.

To program the decimal points

Example 14: Program the Decimal Point For Option \$X.XX, 2 decimal places, normally used in the United States

1 Put the PRG key in the Mode key slot and turn it to the PRG position.



2 If you are prompted for a Manager Password, type the password number and then press the **Check** key. If you did not program a Manager Password, go to the next step.



3 Using the round Number keys, press 2 and then press the **-%/RA** key.

Setting the Rounding Rates

You may want to sell 2 items for an odd number price. If someone wants to purchase that item, they cannot pay you a half cent, so you need the cash register to round the half cent to the next nearest penny.

You can select from the following options to set the rounding.

Table 14 Rounding

This number...	Rounds to this...
00	Numbers from .1 - .9 to 0
50	Numbers from .5 - .9 to 1 (U.S. Standard)
99	Numbers from .1 - .9 to 1

After you are done, you can check your results. See Running the Program Confirmation Report on page 70.

To set the rounding

Example 15: Program rounding to 50, normally used in the United States



1 Put the PRG key in the Mode key slot and turn it to the PRG position.

2 If you are prompted for a Manager Password, type the password number and then press the **Check** key. If you did not program a Manager Password, go to the next step.



3 Using the round Number keys, press 50 and then press the **Charge** key.

Programming Discounts

Sometimes you want to have discounts assigned automatically. For example, when you have a sale, you may want to be able to apply a 10% discount to certain items.

Programming Minus Percentage Discounts

You may want to deduct a percentage rate from the usual rate of an item, such as an employee discount. The Minus Percentage Discount [-%/RA] subtracts a percentage rate from an individual item. You can program the rate or you can enter it by hand each time. Regardless of how you specify

a discount, the discount you enter must always be 4 digits. For example, you enter a 25% discount as 2500.

You can also set it so that the Minus Percentage Discount amount is not subtracted from the department totals on the Management Reports. For more information, see Flag 23 on page 60.

After you are done, you can check your results. See Running the Program Confirmation Report on page 70.

To program a Minus Percentage Discount [-%/ra]

Example 16: Program the Percentage Discount rate of 10%



- 1 Put the PRG key in the Mode key slot and turn it to the PRG position.
- 2 If you are prompted for a Manager Password, type the password number and then press the **Check** key. If you did not program a Manager Password, go to the next step.



- 3 Using the round Number keys, press 1000 0 and then press the **-%/RA** key.

You must always enter the percentage rate as a 4-digit number without the decimal point, representing 00.00 through 99.99.

Note

See Minus Percentage Discount Sale on page 99 to ring up a Minus Percentage Discount sale.

Programming Coupon Discounts



You can use the Coupon Discount (CPN) key to subtract a specific amount from an individual item. You can enter a coupon in the middle of a transaction or by itself in a transaction.

After you are done, you can check your results. See Running the Program Confirmation Report on page 70.

Programming the Coupon Discount key includes 2 steps:

- 1 Setting a High Digit Lock Out (HDLO) number
The High Digit Lock Out (HDLO) number limits the number of digits that can be rung up in a coupon discount. This prevents you from accidentally subtracting a large amount.

If large number of digits is entered, you hear an error beep and the keypad locks up. For example: To make sure no one can ring up more than \$99.99 on the Coupon Discount key, set the HDLO to 4.

Table 15 High digit lockout number (HDLO)

This number...	From this...	to this...
0	\$.01	\$ 99,999.99 (Standard setting)
1	.01	.09
2	.01	.99
3	.01	9.99
4	.01	99.99
5	.01	999.99
6	.01	9,999.99

2 Setting the Tax Status.

The tax status determines how you want the tax rate to be charged when using the Coupon Discount key. Contact your local tax authorities to learn your local tax requirements.

The options are:

- To charge tax on the original amount of an item (the amount before the coupon is deducted).
- To charge tax on the discounted amount of an item (the amount after the coupon discount is deducted).

Note

If you have no tax rate programmed in the cash register, use 00 from the Tax Status Numbers table.

The following Tax Status numbers are used to link the Tax Status to the Coupon Discount key.

Table 16 Tax Status Numbers

Number	Taxable by...	To charge the...
00	Non-Taxable	<ul style="list-style-type: none"> • If no tax is programmed in the cash register, or • If you want to charge tax on the original amount of an item (the amount before the coupon is deducted).
01	TAX 1	TAX 1 rate on the discounted amount of an item. *
02	TAX 2	TAX 2 rate on the discounted amount of an item. *

Table 16 Tax Status Numbers (Continued)

Number	Taxable by...	To charge the...
03	TAX 3	TAX 3 rate on the discounted amount of an item. *
04	TAX 4	TAX 4 rate on the discounted amount of an item. *
05	TAX 1 and TAX 2	TAX 1 and TAX 2 rates on the discounted amount of an item. *
06	TAX 1 and TAX 3	TAX 1 and TAX 3 rates on the discounted amount of an item. *
07	TAX 1 and TAX 4	TAX 1 and TAX 4 rates on the discounted amount of an item. *
08	TAX 2 and TAX 3	TAX 2 and TAX 3 rates on the discounted amount of an item. *
09	TAX 2 and TAX 4	TAX 2 and TAX 4 rates on the discounted amount of an item. *
10	TAX 3 and TAX 4	TAX 3 and TAX 4 rates on the discounted amount of an item. *
11	TAX 1, TAX 2 and TAX 3	TAX 1, TAX 2 and TAX 3 rates on the discounted amount of an item. *
12	TAX 1, TAX 2 and TAX 4	TAX 1, TAX 2 and TAX 4 rates on the discounted amount of an item. *
13	TAX 1, TAX 3 and TAX 4	TAX 1, TAX 3 and TAX 4 rates on the discounted amount of an item. *
14	TAX 2, TAX 3 and TAX 4	TAX 2, TAX 3 and TAX 4 rates on the discounted amount of an item. *
15	TAX 1, TAX 2, TAX 3, TAX 4	TAX 1, TAX 2, TAX 3 and TAX 4 rates on the discounted amount of an item. *
* the amount after the coupon is deducted		

To program the Coupon key

The following examples show the most commonly used options in programming the Coupon Discount key.

Method 1

You can select if no tax is programmed in the cash register or if you want to charge the tax rate on the original amount of an item (the amount before the coupon is deducted).

Example 17: If HDLO is set to 0, and the Tax Status Number is set to 0 (non-taxable)

1 Put the PRG key in the Mode key slot and turn it to the PRG position.



2 If you are prompted for a Manager Password, type the password number and then press the **Check** key. If you did not program a Manager Password, go to the next step.



3 Using the round Number keys, press 000 and then press the **Cpn** key.

Note

See page 96 to ring up a coupon sale programmed with Method 1.

Method 2

You can select if you want the tax rate to be charged on the discounted amount of an item (the amount after the coupon is deducted).

Example 18: If HDLO is selected for 0, and the Tax Status is selected for 1 (taxable by TAX 1):

1 Put the PRG key in the Mode key slot and turn it to the PRG position.



2 If you are prompted for a Manager Password, type the password number and then press the **Check** key. If you did not program a Manager Password, go to the next step.



3 Using the round Number keys, press 001 and then press the **Cpn** key.

Note

See page 96 to ring up a coupon sale programmed with Method 2.

Programming Plus Percentage Add-ons

You may want to add an automatic amount to the total, such as a fixed tip or other service charge. Plus Percentage adds a fixed rate additional charge to an individual item. You can program the rate or you can enter it by hand each time. Regardless of how you specify the Plus Percentage, the amount you enter must always be 4 digits. For example, you enter a 25% Plus Percentage as 2500.

When you use the Plus Percentage/Add-On key, the words Add-on appear on the display and print on the receipt.

You can also set the cash register so that the Plus Percentage amount is not added to the department totals on the Management Reports. For more information, see Flag 23 on page 60.

After you are done, you can check your results. See Running the Program Confirmation Report on page 70.

To program the Plus Percentage [+%/PO] key

Example 19: Program a 10% add-on

1 Put the PRG key in the Mode key slot and turn it to the PRG position.



2 If you are prompted for a Manager Password, type the password number and then press the **Check** key. If you did not program a Manager Password, go to the next step.



3 Using the round Number keys, press 1 0 0 0 0 and then press the **+%/PO** key.

You must always enter the percentage rate as a 4-digit number without the decimal point, representing 00.00 through 99.99.

Note

See Plus Percentage Sale on page 103 to ring up a Plus Percentage sale.

Programming Flag Options

Flag options are actions you can set for the cash register. These actions include how the date appears, if the tax rate prints on receipts, if clerk numbers are used, and so on.

34 Flags are available on your cash register. The Flags are preset by the factory to meet the most commonly used actions. Each Flag setting can be changed or updated at any time, if needed.

Note

All Flag action are factory preset at 0, except for Flags 15, 18, 27, 28, 30, 33, and 34 which have a default setting of 1. Flag actions only need to be changed if you want to change any action from the default setting.

If you change the language after programming is complete, descriptions like logo, department and PLU names revert to their default descriptions and you must reprogram them. The numeric amounts that you programmed do not change.

Note

If you program custom messages or department descriptions, changing languages does not translate those messages. Instead, they are deleted and reset to the factory default for the message or description. Before you program your messages, select the language you want the cash register to be in.

After a Full System Clear, all settings go back to the default settings.

To program flag options

Example 20: Select 1 for Flag 3 (Tendering of change is required)

1 Put the PRG key in the Mode key slot and turn it to the PRG position.

check

2 If you are prompted for a Manager Password, type the password number and then press the **Check** key. If you did not program a Manager Password, go to the next step.

void

3 Using the round Number keys, press 31 and then press the **Void** key. Flag #3 is now set with Action 1.

The following table shows all Flags and the actions. Bold numbers are the default.

Table 17 Flag options

This Flag number...	Sets these actions...	Set to...
1	The Grand Total does not reset after a Z reading.	0
	The Grand Total resets after a Z reading.	1
2	Subtotal prints on sales receipts when #/ST/NS key is pressed.	0
	Subtotal does not print on sales receipts when #/ST/NS key is pressed.	1
3	Tendering of change is not required.	0
	Tendering of change is required.	1
4	The Date prints as Month-Day-Year.	0
	The Date prints as Day-Month-Year.	1
5	Z1 and Z2 Counter Numbers does not reset after a Z1 or Z2 reading.	0
	Z1 and Z2 Counter Numbers reset after a Z1 or Z2 Reading.	1
6	Tax Rate Amount prints on sales receipts.	0
	Tax Rate Amount does not print on sales receipts.	1
7	Skips amounts equaling zero on financial reports.	0
	Does not skip amounts equaling zero on financial reports.	1
8	The Date prints on sales receipts and management reports.	0
	The Date does not print on sales receipts and management reports.	1

Table 17 Flag options (Continued)

This Flag number...	Sets these actions...	Set to...
9	The Time prints on sales receipts and management reports.	0
	The Time does not print on sales receipts and management reports.	1
10	The Consecutive Number prints on the receipt.	0
	The Consecutive Number does not print on the receipt.	1
11	The Clerk Name prints on sales receipts.	0
	The Clerk Name does not print on sales receipts.	1
12	Clerk System inactive.	0
	Clerk System active.	1
13	USA Tax System.	0
	Canadian Tax System.	1
	VAT Tax System.	2
14	Z1/Z2 Counter prints.	0
	Z1/Z2 Counter does not print.	1
15	Tax amount prints after the sales total on the sales receipt.	0
	Tax amount prints before the total amount on the sales receipt.	1
16	Standard Department layout.	0
	Department 20 is Credit 1.	1
	Department 19 is Credit 2.	2
	Department 20 is Credit 1 and Department 19 is Credit 2.	3
17	Sets the non-Taxable Limit without GST tax for Canadian tax mode.	0
	Sets the non-Taxable Limit with GST tax for Canadian tax mode.	1

Table 17 Flag options (Continued)

This Flag number...	Sets these actions...	Set to...		
18	Time appears on the display and prints in 24 hour mode.	0		
	Time appears on the display and prints in 12 hour (am/pm) mode.	1		
19	Sets the language for the cash register. The options are:			
	English	0		
	Spanish	1		
	French	2		
	German	3		
20	A Clerk Number is not required before each transaction.	0		
	A Clerk Number is required before each transaction.	1		
21	Do not use Canadian tax system of tax on tax.	0		
	Use Canadian tax system of tax on tax.	1		
22	Pertains only to the Canadian tax system. Must be used with Flag 21 set to 1.			
	Include GST in PST1	Include GST in PST2	Include GST in PST3	
	yes	yes	yes	0
	no	yes	yes	1
	yes	no	yes	2
	no	no	yes	3
	yes	yes	no	4
	no	yes	no	5
	yes	no	no	6
no	no	no	7	

Table 17 Flag options (Continued)

This Flag number...	Sets these actions...	Set to...
23	-% is subtracted and +% is added to department totals on X/Z readings.	0
	-% is not subtracted and +% is not added to department totals on X/Z readings.	1
24	TAX amounts print separately on sales receipts.	0
	TAX amounts print as one figure on sales receipts. The letters "TX" print next to the total of tax.	1
25	Duplicate Z report prints.	0
	Duplicate Z report does not print.	1
26	Consecutive receipt number resets after Z1 Report.	0
	Consecutive receipt number not reset after Z1 Report.	1
27	0 price registration is allowed.	0
	0 price registration is not allowed.	1
28 (Europe Only)	Euro convert function is allowed.	0
	Euro convert function is not allowed.	1
29	Tax rate does not print on financial report in VAT mode.	0
	Tax rate prints on financial report in VAT mode.	1
30 (Europe Only)	Print converted total at convert tender.	0
	Print converted total always tender.	1
31 (Europe Only)	Local base currency.	0
	Euro base currency.	1
32	Allow Clerk numbers without security code.	0
	Clerk must also enter the 3 digit security code.	1

Table 17 Flag options (Continued)

This Flag number...	Sets these actions...	Set to...
33	The Commercial message does not print.	0
	The Commercial logo message prints.	1
34	Second receipt cannot be issued.	0
	Second receipt can be issued.	1

Note

Flags 28, 30 and 31 do not apply to the U.S. market.

Ringling up Sales and Using Training Mode

After you set up your cash register, ringing up sales is easy. For information about ringing up complicated sales, see Examples on page 90.

If you want to learn about using the cash register without affecting the daily total, you can use the Training mode. You or someone else can learn how to use the cash register without creating real sales that show up on reports. For example, you can train a new person about using the department keys and completing sales.

Training mode lets someone use the cash register without actually recording the sales in the sales history. When you stop Training mode, the training sales information is deleted.

Ringling up Sales

After you have the basics programmed in your cash register, you are ready to ring up sales. For more information about setting up the basics on your cash register, see Setting Up Your Cash Register - the Basics on page 16.



Reminder

You do not need to press the **Decimal Point** key when ringing up a price.

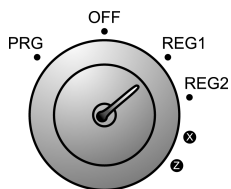

To ring up straight sales without a PLU number

- 1 Put the REG key in the Mode key slot and turn it to the REG1 or REG2 position. You are ready to ring up a sale.
- 2 Using the round Number keys area, type the price of the first item.
- 3 Press the **Department** key for that item.

To use the Department keys above 40, do the following:

- Press the **Dept Shift** key.
- Using the round Number keys, type the Department number from 41 to 99 that you want to use. For example, for Department 63, press the 6 key and then press the 3 key.
- Press the **Dept Shift** key again.

- 4 Repeat for the rest of the items.
- 5 When you are done ringing up items, press the **Amount Tend Total** key. The cash drawer opens and the receipt or journal prints.
- 6 Make any change needed and place the money you are given in the cash drawer.
- 7 Close the cash drawer.
- 8 Give the customer the receipt, if the cash register is set to print receipts. You are ready to ring up another sale.

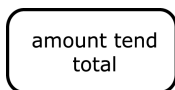

To ring up straight sales with a PLU number and not using the barcode reader

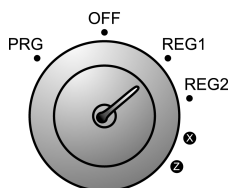

- 1 Put the REG key in the Mode key slot and turn it to the REG1 or REG2 position. You are ready to ring up a sale.
- 2 Using the round Number keys area, type the PLU number of the first item.



- 3 Press the **PLU** key.
- 4 Repeat for the rest of the items.
- 5 When you are done ringing up items, press the **Amount Tend Total** key. The cash drawer opens and the receipt or journal prints.

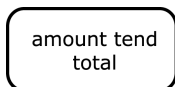

- 6 Make any change needed and place the money you are given in the cash drawer.
- 7 Close the cash drawer.
- 8 Give the customer the receipt, if the cash register is set to print receipts. You are ready to ring up another sale.

Ringling up Sales with the Barcode Reader

You can also ring up sales using the optional barcode reader. Before you can ring up sales with the barcode reader, the UPC symbol must be programmed into the cash register with the barcode reader. For more information, see Programming PLUs with the Barcode Reader on page 49.

To ring up sales with the barcode reader

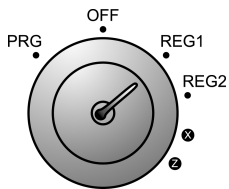

1 Put the REG key in the Mode key slot and turn it to the REG1 or REG2 position. You are ready to ring up a sale.

2 Put the barcode reader light over the UPC symbol, about ½ inch or closer above the UPC symbol on the product to read the UPC symbol properly.

3 Press the button under the scanner. The barcode scanner makes a beep sound and the item appears on the display.

4 Continue using the barcode scanner to scan UPC symbols until you are done.

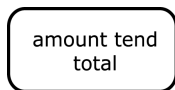

5 When you are done, press the **Amount Tend Total** key. The cash drawer opens and the receipt or journal prints.

6 Make any change needed and place the money you are given in the cash drawer.

7 Close the cash drawer.

8 Give the customer the receipt, if you set the cash register to print receipts. You are ready to ring up another sale.

Using Training Mode

We provide examples to help learn how to use this cash register. For information about the examples, see Examples on page 90. Using the examples can help you learn to use the cash register and the available features.

You can start Training mode at any time because it does not record activity in the machine totals.

When you are using the cash register in Training mode, you cannot use any of the operations in the PRG, X, or Z modes. The transaction numbers and amounts do not count in the Register mode until you stop Training mode.

When the cash register is in Training mode, asterisks **** print instead of transaction numbers. When you stop Training mode, the transaction

numbers continue from the last number printed before you entered Training mode.

When the cash register is in Training mode, a small light appears in the left digit of the Clerk display. Some transactions may also print DEMO on the receipt.

To start Training mode

- 1 Put the PRG key in the Mode key slot and turn it to the PRG position.
- 2 If you are prompted for a Manager Password, type the password number and then press the **Check** key. If you did not program a Manager Password, go to the next step.
- 3 Using the round Number keys, press 666666 and then press the **Amount Tend Total** key.
- 4 Now you can move the Mode key to the REG1 or REG2 position so training can start.

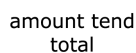
To stop Training mode

- 1 Put the PRG key in the Mode key slot and turn it to the PRG position.
- 2 If you are prompted for a Manager Password, type the password number and then press the **Check** key. If you did not program a Manager Password, go to the next step.
- 3 Using the round Number keys, press 555555 and then press the **Amount Tend Total** key.
- 4 Now you can move the Mode key to the REG1 or REG2 position and use the cash register.

Programming Complex Tax Rates

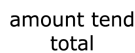
Your cash register can manage complex tax rates and assignments. This chapter explains how to do this.

Many people do not need the information in this chapter. If this information does not relate to your business needs, you can skip it. If some information is related to your specific needs, then skip any sections which you do not need to set up your cash register.

If you do not know your sales tax rate and base amount, contact your local government office and ask for your local tax chart. The base tax amount is the maximum point where no tax is charged. Your cash registers defaults to a base tax amount of 10 cents. If your base tax amount is other than 10 cents, see Calculating State Tax Table Codes on page 114.

When you set up your cash register, you programmed the cash register to use a simple sales tax, appropriate for your area. Chapter 2 explains how to program a simple sales tax. Chapter 5 explains how to set up sales tax related to departments or PLUs.

**Note**

If you hear an error tone while you are programming, press the **CLEAR** key and continue by repeating the step.

You do not need to reprogram all options if you want to update or change one thing. Save this manual in a safe place so you have it for future programming. After you are done programming, you can print Confirmation Reports to check your results. For more information, see Running Reports on page 70.

Setting the Tax Rates

You can program 4 different tax rates on your cash register. Each tax rate can be linked directly to a department key (see Programming Tax Status on page 37), or by pressing the **Tax 1** or **Tax 2** keys before ringing up an entry.

You can set the cash register to not print the tax rate on receipts. For more information, see Programming Flag Options on page 56.

You can program each Tax Rate as follows:

- As an ADD-ON RATE (used in the USA) - means the tax amount prints separately on the receipt. Add-on Tax is most common in the United States. Add-on Tax can be programmed as either a fixed-rate which charges tax based on a percentage, or using the tax table codes, which is a calculation based on an approved tax chart issued by your local or state government.
- Canadian Tax System - allows you to program the GST/PST tax system required in Canada.
- VAT (Value Added Tax) - means that the tax amount is included in the price of the item.

See the Royal website for the tax table codes for your particular state. After you have the tax table codes for your state, see Calculating State Tax Table Codes on page 114 for help or contact your local state government office for the current tax rates.

To program a basic tax rate, see Programming the Sales Tax on page 8.

To program a second fixed tax rate

Example 21: To set Tax 2 for 7%

- 1 Put the PRG key in the Mode key slot and turn it to the PRG position.
- 2 If you are prompted for a Manager Password, type the password number and then press the **Check** key. If you did not program a Manager Password, go to the next step.
- 3 Using the round Number keys area, press 2, then press the **Tax 1** key.
- 4 Using the round Number keys area, press 7000, then press the **Amount Tend Total** key.

check

tax 1

amount tend
total

To program add-on tax table rate

Example 22: The tax code for Arizona's tax rate of 4% is:

121-240096-13-19-23-27-27-1029-25-25-25-1025

- 1 Put the PRG key in the Mode key slot and turn it to the PRG position.

check

2 If you are prompted for a Manager Password, type the password number and then press the **Check** key. If you did not program a Manager Password, go to the next step.

tax 1

3 Using the round Number keys area, press 1 and press the **Tax 1** key.

tax 2

4 Using the round Number keys area, press 121 and press the **Tax 2** key.

5 Using the round Number keys area, press 240096 and press the **Tax 2** key.

6 Continue typing any State Tax Table Codes you need. Press the **Tax 2** key after each code until you are done.

clear

Note

If you make a mistake during programming the State Tax Table Codes, press the **Clear** key and begin again with Step 3.

To program a second add-on tax rate

Example 23: Tax code for Arizona's tax rate of 5% is:

101-190095-11-17-20-21-1021-20-20-20-20-1020

1 Put the PRG key in the Mode key slot and turn it to the PRG position.

check

2 If you are prompted for a Manager Password, type the password number and then press the **Check** key. If you did not program a Manager Password, go to the next step.

tax 1

3 Using the round Number keys area, press 2 and press the **Tax 1** key.

tax 2

4 Using the round Number keys area, press 101 and press the **Tax 2** key.

5 Using the round Number keys area, press 190095 and press the **Tax 2** key.

6 Continue typing any State Tax Table Codes mentioned and **press** the **Tax 2** key after each code until finished.

Confirmation Report

To check your results, see Running the Program Confirmation Report on page 70.

To program a VAT tax rate (commonly used in Europe)

You must program Flag 13, as follows:

1 Put the PRG key in the Mode key slot and turn it to the PRG position.

check

2 If you are prompted for a Manager Password, type the password number and then press the **Check** key. If you did not program a Manager Password, go to the next step.

void

3 Using the round Number keys area, press 132 and press the **Void** key.

To program a First VAT tax rate

Example 24: 10% Tax Programming

- 1 Put the PRG key in the Mode key slot and turn it to the PRG position.
- 2 If you are prompted for a Manager Password, type the password number and then press the **Check** key. If you did not program a Manager Password, go to the next step.
- 3 Using the round Number keys area, press 1, press the **Tax 1** key, press 10000, then press the **Tax 2** key.



To program a Second VAT tax rate

Example 25: 5%

- 1 Put the PRG key in the Mode key slot and turn it to the PRG position.
- 2 If you are prompted for a Manager Password, type the password number and then press the **Check** key. If you did not program a Manager Password, go to the next step.
- 3 Using the round Number keys area, press 2, press the **Tax 1** key, press 5000, and then press the **Tax 2** key.



Running Reports

Your cash register includes many reports. In this chapter, we explain:

- Programming confirmation
- The assigned Department keys
- The assigned PLUs
- The tax status of departments and PLUs
- Management reports, such as sales totals

Running the Program Confirmation Report

The Program Confirmation Report allows you to check your programming results. For more information about programming the cash register, see Chapter 5 Setting Up Your Cash Register - Advanced on page 33.

To run a program confirmation report

- 1 Put the PRG key in the Mode key slot and turn it to the PRG position.
- 2 If you are prompted for a Manager Password, type the password number and then press the **Check** key. If you did not program a Manager Password, go to the next step.
- 3 Using the round Number keys, press 999999 and then press the **Amount Tend Total** key.

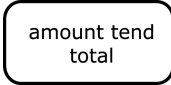
A rounded rectangular button with a black border containing the word "check" in lowercase.A rounded rectangular button with a black border containing the words "amount tend total" in lowercase, stacked vertically.

An example Program Confirmation Report is show below. The figures shown in this example are randomly selected. Your report shows you the specific information about the programming for your cash register.

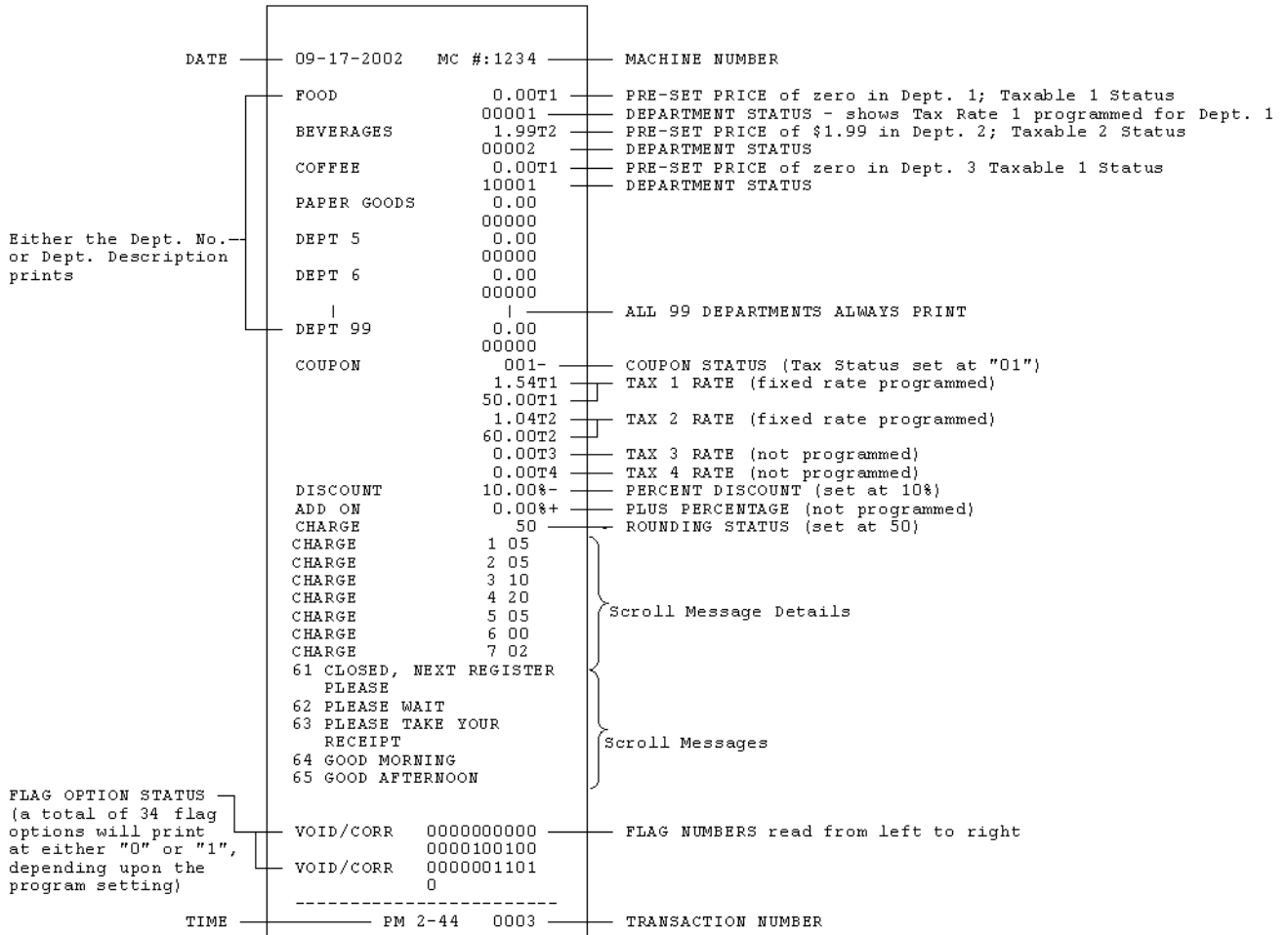

Note

Flags 28, 30 and 31 do not apply to the U.S. market.

Table 18

This code...	Means this...
T1	Taxable status programmed with a single tax rate.
T2	Taxable status programmed with a second tax rate.
T3	Taxable status programmed with Tax 3 rate.
T4	Taxable status programmed with Tax 4 rate.
TX	Taxable status programmed with more than 1 tax rate.

Running the Department Confirmation Report

You can print a report that shows the programmed information for a range of departments. This is helpful if you want to see the programmed names of some of the departments, but do not need to see all other programming information.

You can also print a report that shows department information and sales. For more information, see *Running the Department Sales Report* on page 73.

To run a department confirmation report

check

- 1 Put the PRG key in the Mode key slot and turn it to the PRG position.
- 2 If you are prompted for a Manager Password, type the password number and then press the **Check** key. If you did not program a Manager Password, go to the next step.
- 3 Using the round Number keys, press 88.
- 4 Using the round Number keys, press the number of the first department you want to see. For example, 01.
- 5 Using the round Number keys, press the number of the last department you want to see. For example, 15.
- 6 Press the **Amount Tend Total** key.

amount tend
total

Running the PLU Confirmation Report

The PLU Confirmation Report allows you to check all PLUs programmed. For more information about programming PLUs, see *Programming PLU Descriptions* on page 48.

To run the PLU confirmation report

check

- 1 Put the PRG key in the Mode key slot and turn it to the PRG position.
- 2 If you are prompted for a Manager Password, type the password number and then press the **Check** key. If you did not program a Manager Password, go to the next step.

plu

- 3 Press the **PLU** key.

An example PLU Confirmation Report is shown below. Your report shows you the specific information about your programming.

UPC Barcode is linked to Dept. 1	BARCODE	001	PLU #1 or UPC number, if scanned with a barcode reader
Description of "Apple" programmed to	DEPT 1	1.99T1	PLU price of \$1.99 programmed as taxable (Tax 1 Rate)
PLU #1	APPLE		
UPC Barcode is linked to Dept. 4	BARCODE	002	PLU #2
Description of "Banana" programmed to	DEPT 4	0.69	PLU price of 69¢ programmed as non-taxable
PLU #2	BANANA		
UPC Barcode is linked to Dept. 3	BARCODE	003	PLU #3
Description of "Sandwich" programmed to	DEPT 3	6.99TX	PLU price of \$6.99 programmed with more than one tax rate
PLU #3	SANDWICH		

Running the Department Sales Report

The Department Sales Report allows you to check the current sales information for specified departments.

To run a Department sales report

- 1 Put the Z key in the Mode key slot and turn it to the X or Z position.
- 2 If you are prompted for a Manager Password, type the password number and then press the **Check** key. If you did not program a Manager Password, go to the next step.
- 3 Using the round Number keys, press the number of the first department you want to see. For example, 01.
- 4 Using the round Number keys, press the number of the last department you want to see. For example, 15.
- 5 Press the **Amount Tend Total** key. The Department Sales report prints.

check

amount tend
total

Running Management Reports

The cash register maintains totals of all transaction information. This information is saved in the memory of the cash register as long as the register is plugged in to an electrical outlet or, if the cash register is unplugged, the batteries are charged.

Management reports show you information about how sales are progressing. You can run most reports with the Mode key in either the X position or the Z position. See Running a Financial Report on page 76 for instructions to run X and Z reports.

- X reports are run during the day to check transactions. These reports do not clear the transaction memory in the cash register. You can run all reports in the X position.
- Z reports are run at end of day, end of the week, or end of the month. These reports do clear the transaction memory in the cash register.

When you are done printing these reports, the information only exists on the cash register tape. You can run almost all reports in the Z position.

To prevent someone from accidentally printing these reports, a manager password can be set. After the password is set, these reports do not print until the password is entered. For information about setting manager passwords, see Setting X and Manager Passwords on page 28.

Besides passwords, the keys that came with your cash register are also a form of security. We recommend giving clerks the REG keys and giving managers the Z and PRG keys.

For additional security, only the Z and PRG keys can run Z reports. The REG key cannot run Z reports. This means that people with REG keys cannot run or clear the transaction history.

About X Readings

There are two kinds of readings that can be taken in the X position: an X1 reading and an X2 reading.

- X1 Reading - Commonly known as a *mid-day* reading. Use this position to print periodic readings of transaction totals during the course of the day. This reading position does not reset to zero.
- X2 Reading - Commonly known as a *mid-week* or *mid-month* reading. Use this position to print periodic readings of transaction totals during the course of several days. This reading position does not reset to zero.

About Z Readings

There are two types of readings that can be taken in the Z position: an Z1 reading and an Z2 reading.

- Z1 reading – Commonly known as a *end-of-day/daily-closeout* reading. This reading prints all transaction data and sets all totals to zero, except the Running Grand Total.

You can also print a duplicate Z1 Report. This is useful if the register runs out of paper or if there is a power outage while the Z1 Report is printing. This feature can also be turned off by Flag setting 25. For more information about Flags, see Programming Flag Options on page 56.

- Z2 reading – Commonly known as a *weekly* or *monthly* reading. This reading prints transaction totals either on a weekly or monthly basis (not both) and resets all transaction totals to zero except the Running Grand Total.

About Management Reports

The following management reports are available:

- Cash-in-Drawer Report - Only available in the X position. Tells you how much cash is in the drawer at the time of the report.
- Clerk Report - Prints total sales amounts of each Clerk Number.
- Financial Report - Includes totals of departments, tax, net sales, voids, returns, coupons, refunds, minus percentage, plus percentage, receipts-on-account, paid out, cash, check, charge. The running grand total appears only on Z Reports.
- Hourly Report - Provides total sales amounts rung up each hour.
- All PLU Report - Lists quantity and cost of each PLU number rung up.
- Department Range Report - Shows the sales information for the specified departments.

The different management reports available in the X and Z positions:

This key position...	Prints this report symbol...	This report is available...	This report is also known as...
X	X1	Financial, PLU, Department Range, Clerk, Hourly, Cash-In-Drawer	Mid-Day
X	X2	Financial	Mid-Week or Mid-Month
Z	Z1	Financial, PLU, Clerk, Hourly	End-Of-Day or Daily-Close-out
Z	Z2	Financial	Weekly or Monthly

Running a Cash-In-Drawer Report

This report shows how much cash is in the cash drawer.

To run a Cash-In-Drawer report

1 Put the Z key or the PRG key in the Mode key slot and turn it to the X position.



2 If you are prompted for a Manager Password, type the password number and then press the **Check** key. If you did not program a Manager Password, go to the next step.



3 Press the **Qty/Date** key. The Cash in Drawer report prints.

Running a Clerk Report

The Clerk report shows sales by clerk number. For more information about setting clerk numbers, see [Setting Clerk Numbers and Names](#) on page 25.

- A Clerk report in the X position shows sales up to the current hour.
- A Clerk report in the Z position shows sales for the entire day. A Clerk report must be closed out in the Z position.

Note

If you are not using clerk numbers, then you cannot run a Clerk report. You hear an error beep when you press the **Clerk** key.

To run a Clerk report

- 1 Put the Z key or the PRG key in the Mode key slot and turn it to the X or Z position.
- 2 If you are prompted for a Manager Password, type the password number and then press the **Check** key. If you did not program a Manager Password, go to the next step.
- 3 Press the **Clerk** key. The Clerk report prints.



Running a Financial Report

The Financial report shows totals of departments, tax, net sales, voids, returns, coupons, refunds, minus percentage, plus percentage, receipts-on-account, paid out, cash, check, and charge. The running grand total appears only on Z reports.

You can run a copy of the Financial report in the Z position. If other keys are pressed after the first Z reading, the duplicate Z Report will not print. To turn off the duplicate Z Report printing feature, you must change Flag 25. For more information about Flags, see [Programming Flag Options](#) on page 56.

Important

A Financial Reading must be closed out in the Z position.

For an example Financial report, see [Financial Report Example](#) on page 77.

To print a Financial report

- 1 Put the Z key or the PRG key in the Mode key slot and turn it to the X or Z position.

Note

If you use the Z position, the history is reset in the cash register after the report is printed.



- 2 If you are prompted for a Manager Password, type the password number and then press the **Check** key. If you did not program a Manager Password, go to the next step.

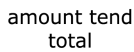

- 3 Press the **Amount Tend Total** key.

To run a duplicate Z report

- 1 Put the Z key or the PRG key in the Mode key slot and turn it to the Z position.



- 2 If you are prompted for a Manager Password, type the password number and then press the **Check** key. If you did not program a Manager Password, go to the next step.



- 3 Press the **#/ST/NS** key and the **Amount Tend Total** key. The duplicate Z report prints.

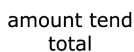

To take a weekly or monthly financial report (Z2 or X2)

- 1 Put the Z key or the PRG key in the Mode key slot and turn it to the X or Z position.



- 2 If you are prompted for a Manager Password, type the password number and then press the **Check** key. If you did not program a Manager Password, go to the next step.

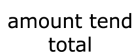

- 3 In the round Number keys area, press 99 and the **Amount Tend Total** key. The report prints.

Financial Report Example

Totals are calculated for the Management Reports in the following way.

- **NET SALES TOTAL (NET)** - Shows the true sales for the day. The Net sales total includes department total (DEPTTL), tax total (T1, T2, T3, T4), and less the coupon discount (COUPON) and less the percentage discount.

Note

Minus percentage discount (DISCOUNT), voids (VOID/CORR) and returns/refunds (REFUND) are all deducted from the department totals and the plus percentage (ADD ON) is added to the department totals. If you do not want the percentage discount and plus percentage reflected in the department totals, see Flag 23 on page 60.

- **GROSS SALES TOTAL (GROSS)** - Shows the total of all sales registered. The Gross Sales Total includes net sales total (NET), coupon

discount (COUPON), minus percentage discount (DISCOUNT), return/refund (REFUND), and void (VOID/CORR).

Note

The Percentage Discount [-%] must be done after sales each item, not on the subtotal amount, for the formula given above to balance as shown.

The Financial report looks like the following. Your specific report looks different, because of your unique cash register activity.

* YOUR RECEIPT *			
* THANK YOU *			

DATE	01-24-2001	MC #:1234	MACHINE NUMBER
	Z 1	0001	Z1 COUNTER
ACTIVITY COUNTER	0016		
	DEPT 1	*20.00T1	DEPARTMENT 1 SALES TOTAL (Tax 1)
	DEPT 2	*28.00T2	DEPARTMENT 2 SALES TOTAL (Tax 2)
	DEPT 3	*33.00TX	DEPART 3 SALES TOTAL (Tax 1 & Tax 2)
	DEPT 4	*40.00	DEPARTMENT 4 SALES TOTAL (Non-Taxable)
	DEPTTL	*121.00	ALL DEPARTMENT TOTALS
	T 1	*2.50	
	T 2	*2.44	TAX AMOUNT TOTAL
	COUPON	*-0.80	COUNT (-) TOTAL
	DISCOUNT	*-1.98%	-% TOTAL
	ADD ON	*2.22%	+% TOTAL
	NET	*125.38	NET SALES TOTAL
REFUND COUNTER	0003		
	REFUND	*-5.00	REFUND TOTAL
VOID COUNTER	0002		
	VOID/CORR	*-5.00	VOID TOTAL
	GROSS	*133.16	GROSS SALES TOTAL
CASH SALES COUNTER	0011		
	CASH	*108.91	CASH SALES TOTAL
CHECK COUNTER	0001		
	CHECK	*0.27	CHECK SALES TOTAL
CHARGE COUNTER	0002		
	CHARGE	*16.00	CHARGE SALES TOTAL
CREDIT COUNTER	0001		
	CREDIT-1	*1.00	CREDIT 1 SALES TOTAL
RECEIVED-ON-ACCOUNT COUNTER	0001		
	RECD ACCT	*10.00	RECEIVED-ON-ACCOUNT TOTAL
PAID OUT COUNTER	0001		
	PAID OUT	*-5.00	PAID OUT TOTAL
NO SALE COUNTER	0003		
	C-I-D	*113.91	CASH-IN-DRAWER TOTAL
	G T	*10296.42*	GRAND TOTAL
TIME REPORT WAS TAKEN	PM 5-42	0049	CONSECUTIVE NUMBER

To reset the Z1 counter

- 1 Put the PRG key in the Mode key slot and turn it to the PRG position.
- 2 If you are prompted for a Manager Password, type the password number and then press the **Check** key. If you did not program a Manager Password, go to the next step.
- 3 In the round Number keys area, press 1 and then press the Z1 Counter starting number as 4 digits (for example 0001) and then press the **Return** key.



To reset the Z2 counter

check

- 1 Put the PRG key in the Mode key slot and turn it to the PRG position.
- 2 If you are prompted for a Manager Password, type the password number and then press the **Check** key. If you did not program a Manager Password, go to the next step.

return

- 3 In the round Number keys area, press 2, then press the Z2 Counter starting number as 4 digits (for example 0001) and press the **Return** key.

To reset the grand total

check

- 1 Put the PRG key in the Mode key slot and turn it to the PRG position.
- 2 If you are prompted for a Manager Password, type the password number and then press the **Check** key. If you did not program a Manager Password, go to the next step.

amount tend
total

- 3 In the round Number keys area, press 777777 and press the **Amount Tend Total** key. Enter the new amount (up to 12 digits) and press the **Non Tax** key.

non
tax

To print a Department Range report

check

- 1 Put the PRG key in the Mode key slot and turn it to the X position.
- 2 If you are prompted for a Manager Password, type the password number and then press the **Check** key. If you did not program a Manager Password, go to the next step.

amount tend
total

- 3 In the round Number keys area, press the Starting Department number as 2 digits (for example 01). Press the Ending Department number as 2 digits and then press the **Amount Tend Total** key.

Running an Hourly Report

The report shows the number of sales and the total sales amount for each hour. All hours print, even if no sales were made in an hour. Times print using a 24 hour format.

Important

An hourly reading must be closed out in the Z position.

To take an hourly report

check

- 1 Put the Z key or the PRG key in the Mode key slot and turn it to the X or Z position.

- 2 If you are prompted for a Manager Password, type the password number and then press the **Check** key. If you did not program a Manager Password, go to the next step.

amount tend
total

- 3 In the round Number keys area, press **11** and the **Amount Tend Total** key. The Hourly report prints.

Running PLU Reports

The PLU report shows the quantity and cost of each PLU Number rung up. Only PLUs that had sales will print.

Important

A PLU Reading must be closed out in the Z position.

To print a PLU report

- 1 Put the Z or PRG key in the Mode key slot and turn it to the X or Z position.
- 2 If you are prompted for a Manager Password, type the password number and then press the **Check** key. If you did not program a Manager Password, go to the next step.
- 3 Press the **PLU** key.

check

amount tend
total

To print a PLU sales report, according to an assigned Department number range

- 1 Put the Z key or the PRG key in the Mode key slot and turn it to the X position.
- 2 If you are prompted for a Manager Password, type the password number and then press the **Check** key. If you did not program a Manager Password, go to the next step.
- 3 In the round Number keys area, specify the Starting Dept Number. It must be 2 digits; for example 01.
- 4 Enter the Ending Dept Number as 2 digits.
- 5 Press the **PLU** key. The sales history for the PLUs assigned to the departments in the specified range prints.

check

plu

Maintenance and Options

Follow these steps to make sure your cash register works well.

- Your register must remain uncovered when turned on. This allows the electronic components to properly cool.
- Use a dust cover when the register is not in operation and the control lock key is turned to the OFF position to protect mechanical components from dust.
- Keep beverages and other liquids away from the machine to avoid spills which can damage electronic components. Use the optional protective keytop cover to prevent damage to the cash register.
- Keep the cash register away from dust, dampness, or extreme hot or cold temperatures.
- To clean your cash register, use a soft dry cloth. Do not use harsh solutions containing alcohol or ammonia.
- After storing your cash register in extreme temperatures (below 32 degrees Fahrenheit or above 104 degrees Fahrenheit), allow the temperature inside the machine enough time to reach room temperature before turning it on.
- If you need electronic service, take the cash register to a Royal authorized service center. For more information, see Limited Warranty on page 126.

Optional Accessories

Your cash register can accommodate optional accessories such as:

- Model PS 700 Barcode Scanner.
- RegisterLink™ PC-based software. This software allows you to connect the cash register to your PC to download your sales information and transfer it to QuickBooks® 2002 or Peachtree® accounting software.

These accessories can be easily connected to your register without any extra hardware or software requirements.

If you want these accessories, order them by calling 1-888-261-4555.

Installing a New Paper Roll

As you use the cash register, you will need to replace the paper roll. Your cash register has a thermal printer that prints receipts or a journal. You can use 2.25" (57.5 mm) wide standard thermal register paper.

To put the paper in the paper roll

- 1 Insert the PRG key and turn it to either REG1 or REG2.

- If you need a customer receipt, turn the Mode key to the REG1 position.
- If you do not need a customer receipt, turn the mode key to the REG2 position.

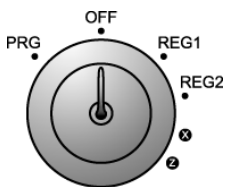

- 2 Open the Journal Compartment Cover. Grip the left side of the journal cover and gently pull upward. Remove the Journal Compartment Cover and set aside.

- 3 Remove the Journal Takeup spindle. Place the paper roll in the little round area at the bottom of the compartment. Make sure the paper feeds out from the bottom of the roll.

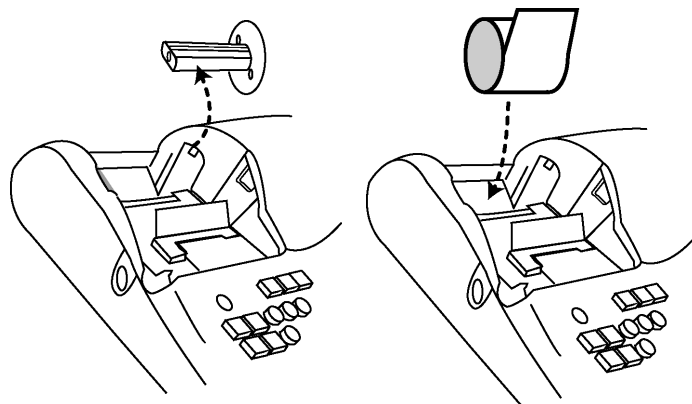

- 4 Grab the small handle on the right of the print roller. Push the little handle towards the back of the cash register and raise the roller bar up.
- 5 Lay the end of the paper across the printer as shown. Move the print roller down onto the paper and snap into place.

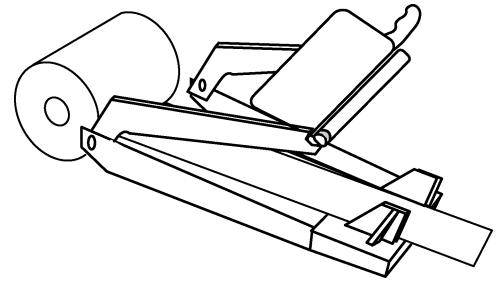

- Press the **Feed** key until the paper catches and moves through the printer.



- 6 Do one of the following:
 - If you do not need to print receipts: Place the black plastic Journal Takeup spindle on its grooves above the Battery compartment. The spindle sits above the paper roll. Press the **Feed** key to move the paper through the printer about 10-12 inches. Push the paper through one of the narrow openings in the center of the Journal Takeup spindle and turn the spindle several times to wind the paper securely. Press the **Feed** key until the paper catches and begins to wind securely around the Journal Takeup spindle. Replace the Journal Compartment Cover.
 - If you want to print receipts: Put the customer receipt paper in the receipt window of the Journal Compartment Cover. Make sure you get the paper in the little guides in the window. Use the Cash Drawer/Journal Lock key #515 to lock it.

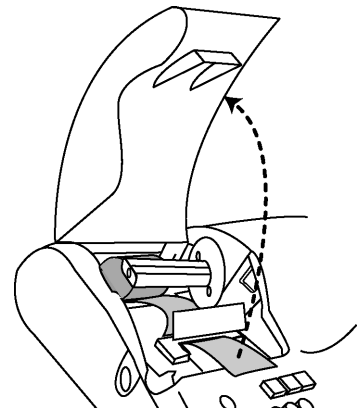
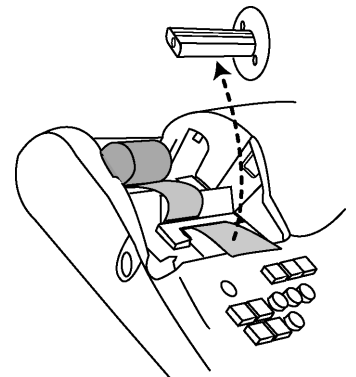

Using the Battery System

Your cash register has a memory where information about your programming and transactions are stored. This memory stores the information that lets you print reports, such as the total sales for the day, week, or month. The cash register memory also stores information about any special programming you have done.

If your cash register is unplugged or if there is a power outage, the batteries keep the information in the memory until you plug the cash register into a power source or the power is restored.

To make sure the battery back-up protection is working, replace the batteries at least once a year. To help you remember, consider replacing the batteries on New Years Day. The cash register can be off or unplugged for as long as 700 hours (about 28 days) and the information in the memory is still there when you are ready to use the register again.

If there was a power outage, replace the batteries as soon as there is power again. **DO NOT** remove or replace the batteries until you plug the cash register into a power source and you see messages on the display.

If you will not use the cash register for an extended period of time, you can remove the batteries to prolong their life. However, all information in the cash register will be erased if you do this.

Caution

You must plug the cash register in before installing or replacing the back-up batteries. All data is erased when you remove the batteries if the cash register is not plugged in before you remove the batteries.

To install or replace the batteries

- 1 Before you start, make sure you have 4 new AA batteries.
- 2 Plug the cash register in and turn the Mode key to the OFF position.
- 3 Open the Journal Compartment cover.
Unlock the compartment cover with the Cash Drawer/Journal Lock key #515. Grip the left side of the journal cover and gently pull upward. Remove the cover and put in aside.
- 4 Remove the battery cover, located in the rear left section of the compartment. Press the indentation at the bottom of the cover and slide up. See the graphic to the right for details.
- 5 Put the batteries in the slots. Make sure that the positive and negative ends are in the right place. The batteries have a little plus (positive) and minus (negative) sign on each end to help you.
- 6 Replace the battery cover by sliding it back down into position.

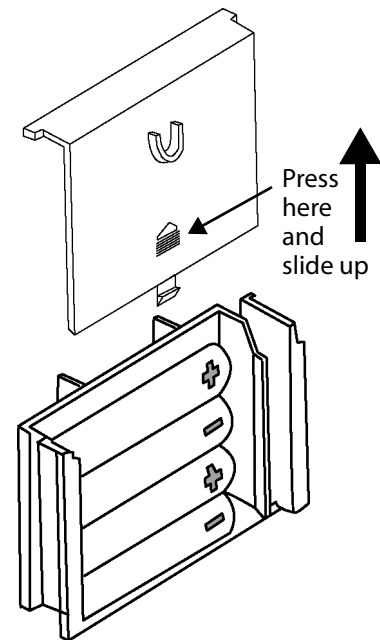

Ordering Accessories

Table 19 Optional Accessories

Item	Part Number
Protective Keypad Cover	013218
Replacement 4 Slot Bill Tray & Drawer (Coin Tray not included)	CD510002
Replacement 5 Coin Tray	CD500002
Duplicate Cash Drawer/Journal Lock Key Set 1 set of 2 keys	47300511
Duplicate Control Lock Key Set 6 keys: PRG-427-023, REG-427-024 & Z-427-012, 2 each	47100324
Replacement Journal Paper Roll Spindle	16900010
Thermal Register Tape (3-roll package) 2¼" (57mm) wide, 2" (50mm) diameter, 85' (26m) long	013127
Owner's Manual	A583CXIM902A
Model PS700 Barcode Reader	16881W
RegisterLink PC-based software	TBD

For Prices and Availability

Call 1-888-261-4555 Monday - Friday 8:30 - 5:00 p.m. (E.S.T.) or visit our web site at www.olivettiofficeusa.com

Prices and Availability Subject to Change Without Notice

Troubleshooting

Select and follow the procedure which best describes what is happening.

Error Codes

You may see these errors on the display. This table explains what they are and how to fix them.

Table 20

The error message...	Do this...
P R I N T E R	Paper jam or printer failure
E R R O R	Misoperation
C L E R K #	Enter clerk number
E R R O R	Communication error

I Hear an Error Beep

Some error beeps are normal. See Error Codes on page 31 for more information about error codes.



- 1 **Press** the **Clear** key.
- 2 Turn the Mode key to the PRG, REG, X or Z position you were in before you got the error.



For example, if the last position you were in was REG, turn the key to the REG position and press the **Clear** key and then press the **Amount Tend Total, Check, or Charge** key to complete a sale. If your last position was PRG, turn the key to the PRG position and press the **Clear** key.

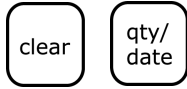

If the last thing you were doing was programming PLUs in the PRG mode, return the PRG key to the PRG position. Press **Clear** and then press **Qty/Date** to leave PLU programming mode.

3 Repeat the procedure you are trying to perform.

- If error still persists, perform a Half System Clear procedure. See Half System Clear on page 89.
- As a last resort, perform a Full System Clear procedure. See Full System Clear on page 89.

Sec code error appears in PRG, X OR Z modes

This prompt means a Manager Password is programmed.



- ▼ Enter the password number and press **Check**.

If Clerk E12 Displays In REG 1 or REG 2 Modes

This prompt means clerk numbers are programmed.

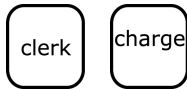

- 1 Enter the clerk number and press **Clerk**.
- 2 Enter the password and press **Charge**.

PE Printer Error

This prompt means there is a paper problem.

- 1 Check if you are out of paper.
- 2 Check for a paper jam. If so, carefully remove any paper obstructing the printer.
- 3 Check and make sure the paper was aligned properly in the printer and that the printer bar is snapped into place.



Caution

Do not manually pull the paper. Always use the **Feed** key to remove or advance the paper. Do not use sharp or pointed instruments in the printer area. This can seriously damage the printer.

- 4 After the paper jam is successfully removed, if PE still appears, turn the Mode key to the OFF position. Unplug the cash register, wait 10 seconds, and plug it back in.



5 If there is a FUNCTION error and an E appears on the display, press the **Clear** key.

6 If an FUNCTION error continues to appear, turn the Mode key to the last position (PRG, REG, X or Z) you were in before the error appeared.

If the last position you were in was REG, turn the Mode key to the REG position and press the **Clear** key, then press the **Amount Tend Total, Check, or Charge** key to complete a pending sale.



If your last position was PRG, turn the Mode key to the PRG position and press the **Clear** key.

7 As a last resort, follow the directions for a Full System Clear. See Full System Clear on page 89.

The Register Does Not Work at All

1 Be sure the cash register is plugged into a working electrical outlet and no other electrical device is using the same power source. Another electrical motor on the same circuit can keep the cash register from working properly.

- If error still persists, perform a Half System Clear procedure. See Half System Clear on page 89.
- As a last resort, perform a Full System Clear procedure. See Full System Clear on page 89.

2 If needed, contact the Royal Customer Support hotline at 1-800-272-6229 for additional assistance.

Opening the Drawer When There is no Power

If there is no power and you need to open the drawer, make sure the drawer is unlocked by using the 515 Drawer key.

1 With your hands on the cash drawer, carefully tip the front of the register up. Underneath the cash register, toward the back of the register, you see a small lever.

2 Push the lever in the only direction it will move. The cash drawer opens.

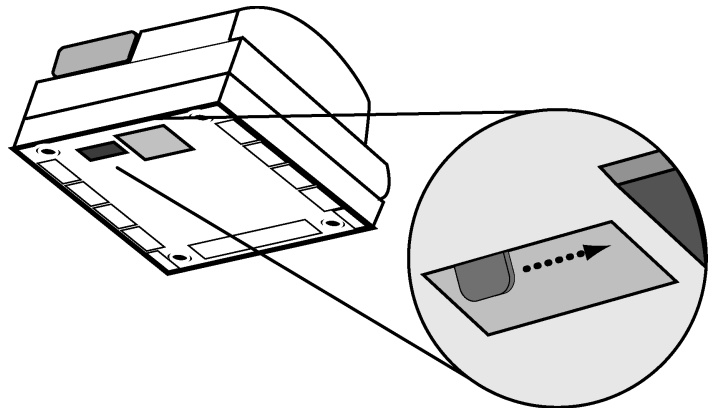

Half System Clear

If you cannot get the cash register to respond, try a half system clear.

To do a half system clear

- 1 Turn the Mode key to the OFF position.
- 2 Unplug the cash register from the power source.
- 3 Wait 30 seconds.
- 4 Plug the cash register in again.
- 5 Continue with normal operations.

Full System Clear

If nothing else works, perform the following procedure.

Caution

This procedure resets the cash register to the factory settings. You lose all your transaction information and programming information.

To do a full system clear

- 1 Turn the Mode key to the OFF position.
- 2 Remove one back-up battery.
- 3 Unplug the cash register from the power source and wait 5 minutes.
- 4 Plug in the cash register.
- 5 Replace the battery.
- 6 Reprogram the cash register.
- 7 Continue with normal operations.

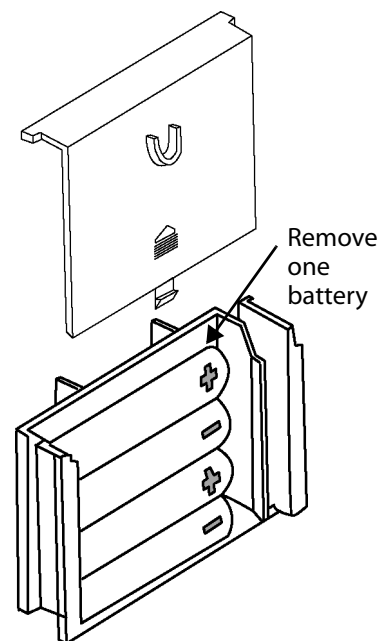

If Nothing Helps

If a problem still persists, call our Customer Service Support Line toll-free at 1-800-272-6229.

Examples

The examples in this section show how to ring up different types of transactions. A maximum of 7 digits may be used to enter a price.

Reminder

If Clerk Numbers are programmed, be sure to type the **CLERK #**, then press the **CLERK** key, the password and the **CHECK** key, if programmed, before ringing up a sale.

To ring up a sale

- ▼ Put the REG key in the Mode key slot and turn it to the REG1 position.
You are ready to ring up sales.

Important

You do not need to press the Decimal Point when ringing up a price.

The following examples are in this chapter.

- Adding Tax to a Non-Taxable Department
- Cash Sale With Tendering Change
- Cash Sale Without Tendering Change
- Charge Sale
- Coupon Discount Sale
- Credit Return
- Credit Sale
- Dept Shift Key
- Exempting Tax On An Item
- Exempting Tax on the Entire Sale
- Gallonage Sales Transaction
- Minus Percentage Discount Sale
- Multiplication of a Department Unit Price
- Multiplication Sale
- Multiplying By A Fraction
- No-Sale Function
- Overriding a PLU Sale
- Paid-Out Sale
- PLU Sale
- PLU Sale With PLU Description
- Plus Percentage Sale
- Received-On-Account Sale
- Registering A Department Unit Price
- Registering A Reference Number
- Return Sale
- Split Tendering Sale
- Temporarily Overriding a PLU Price
- Use the Error-Correct /Void Key
- Voiding A Coupon Sale
- Voiding a Department Preset Price
- Voiding a Department Preset with a Coupon Discount
- Voiding a Department Preset with a Minus Percentage Discount
- Voiding A Minus Percentage Discount Sale
- Voiding a Multiplication of a Department Preset Price
- Voiding A Multiplication Sale

- Voiding a PLU Multiplication Sale
- Voiding a PLU Sale
- Voiding a PLU Sale with a Coupon Discount
- Voiding a Plu Sale with a Minus Percentage Discount
- Voiding a PLU Sale with a Plus Percentage Rate
- Voiding a Plus Percentage Sale
- Voiding A Sale

Sample Receipt

The example below shows the general transaction information you see printed on a receipt.

	* YOUR RECEIPT *		
	* THANK YOU *	—	STORE LOGO OR MESSAGE
	* *		

DATE	01-24-2001	MC #:1234	MACHINE NUMBER
	DEPT 1	*1.00T1	TAX 1 RATE applied to sale
	DEPT 2	*2.00T2	TAX 2 RATE applied to sale
	DEPT 3	*3.00T3	TAX 3 RATE applied to sale
	DEPT 4	*4.00T4	TAX 4 RATE applied to sale
		*0.05T1	TAX 1 AMOUNT
		*0.12T2	TAX 2 AMOUNT
		*0.24T3	TAX 3 AMOUNT
		*0.63T4	TAX 4 AMOUNT

	TOTAL	*11.04	
CASH AMOUNT TENDERED	AMOUNT	*25.00	
	CHANGE	*13.96	
TIME	PM 4-29	0043	TRANSACTION NUMBER

Transaction Codes

The following codes appear on transaction receipts:

Table 21 Transaction Codes

The code...	Means this...
#	Reference Number
@	Amount Being Multiplied
1 AMOUNT	Amount of Cash Tendered
ADD ON	Plus Percent
CASH	Cash Transaction Total
CHANGE	Change
CHARGE	Charge Transaction Total
CHECK	Check Transaction Total
Clerk #1 to Clerk #26	Clerk number 1 to number 26
COUPON	Coupon
CREDIT	Credit card transaction
DEBIT	Debit card transaction
DISCOUNT	Minus Percent Discount
DUPLICATE RECEIPT	After a transaction, you can print a duplicate receipt by pressing the Subtotal w/Tax key immediately after the original receipt has finished printing and before another transaction is started
NO SALE	No-Sale Function or Open Cash Drawer
PAID OUT	Paid Out
PRICE*	Overriding of a PLU Price
RECD ACCT	Received on Account
REFUND	Return (Refund)
SUBTTL	Subtotal (Excludes Tax)
T1	Tax 1 Rate Applied to a Sale
T2	Tax 2 Rate Applied to a Sale
T3	Tax 3 Rate Applied to a Sale

Table 21 Transaction Codes (Continued)

The code...	Means this...
T4	Tax 4 Rate Applied to a Sale
TOTAL	Total of Sale
TX	Represents Tax Total if Option 1 is selected on Flag 24. For more information, see Programming Flag Options on page 56
VOID/CORR	Void
X	Number of Items Being Multiplied

The rest of this chapter shows you example transactions.



Reminder

Put the REG key in the Mode key slot and turn it to the REG1 position. You are ready to ring up sales.

Adding Tax to a Non-Taxable Department

Example 26: Assume the Department 2 key is programmed for no tax and the TAX 1 rate is programmed for 6%. Ring up a \$1.00 item in Department 2, charging the 6% tax rate.

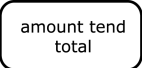

To add tax to a non-taxable department

- 1 Press the  key.
- 2 In the Number keys area, press 100, and then press the  key.
- 3 Press the  key.

Cash Sale With Tendering Change

Example 27: Ring up a \$1.00 item in Department 1 and compute change from \$5.00 cash tendered.

To ring up a sale with tendering change

- 1 In the Number keys area, press 100, and then press the  key.
- 2 Press the  key.

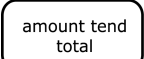

You do not need to press the Subtotal key if you do not want the subtotal of a sale to print.

- 3 Press the  key
- 4 In the Number keys area, press 500, and then press the  key.

Cash Sale Without Tendering Change

Example 28: Ring up a \$1.00 item in Department 1.

To ring up a sale without tendering change

- 1 In the Number keys area, press 100, and then press the  key.
- 2 Press the  key.

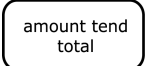

You do not need to press the Subtotal key if you do not want the subtotal of a sale to print.

- 3 Press the  key.
- 4 Press the  key.

Charge Sale

Example 29: Ring up a \$1.00 item in Department 1 and finalize the sale with the charge key.

To ring a charge sale

- 1 In the Number keys area, press 100, and then press the  key.
- 2 Press the  key.

You do not have to enter any amounts before pressing the  key.



Coupon Discount Sale

Example 30: There are various versions of ringing up a Coupon Discount sale. Based on the option selected for the Tax Status Number, select the example below that best serves your needs.

Version 1a

In the following example, the tax status number for the Coupon key is programmed for the option 00. If no tax is programmed in your cash register, ring up \$1.00 item in Department 2 and then deduct the 20¢ coupon.

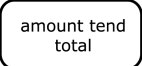

To ring a coupon discount sale

- 1 In the Number keys area, press 100 and then press the  key.
- 2 In the Number keys area, press 20 and then press the  key.
- 3 Press the  key.

Version 1b

If you want to charge the tax rate on the original amount of an item, before the coupon is deducted, ring up a \$1.00 item in Department 1 and then deduct the 20¢ coupon.

To ring a coupon discount sale

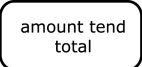
- 1 In the Number keys area, press 100 and then press the  key.
- 2 In the Number keys area, press 20 and then press the  key.
- 3 Press the  key.

Version 2

In the following example, the TAX STATUS NUMBER for the Coupon key is programmed for the option 01.

To ring a coupon discount sale

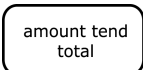

- 1 In the Number keys area, press 100 and then press the  key.

- 2 In the Number keys area, press 20 and then press the  key.
- 3 Press the  key.

Credit Return

Example 31: Refund \$1.00 in Department 1 and credit to a credit card.



To ring a credit return

- 1 Press the  key.
- 2 In the Number keys area, press 100, and then press the  key.
- 3 Press the  key.

Credit Sale

Example 32: Ring up a \$1.00 item in Department 1 and \$2.00 in Department 2 and finalize the sale with the CREDIT key.

To ring a credit sale

- 1 In the Number keys area, press 100, and then press the  key.
- 2 In the Number keys area, press 200, and then press the  key.
- 3 Press the  key.





It is not necessary to enter any amount before pressing the Credit key.

Dept Shift Key

Example 33: Ring up a \$1.00 item in Department 1 (taxable), \$2.00 in Department 21 (non-taxable) and \$3.00 in Department 1 and compute change from \$10.00 cash tendered.

To ring a sale using the Dept Shift key

- 1 In the Number keys area, press 100, and then press the  key.

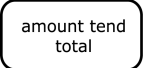
- 2 In the Number keys area, press 200, then press the  key, and then press the  key.
- 3 In the Number keys area, press 300, and then PRESS the  key.
- 4 Press the  key.
- 5 In the Number keys area, press 1000, and then press the  key.



Note

The register returns to the Non-Shift Mode after each department entry.

Exempting Tax On An Item

Example 34: Assume the Department 1 key is programmed as a taxable department. Ring up a \$1.00 item in Department 1 without charging tax.

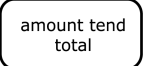

To ring an item without charging tax

- 1 Press the  key.
- 2 In the Number keys area, press 100, and then press the  key.
- 3 Press the  key.

Exempting Tax on the Entire Sale

Example 35: Assume the Department 1 key is programmed as a taxable department. Ring up a \$1.00 item and a \$1.50 item in Department 1 without charging tax.

To ring an entire sale without charging tax

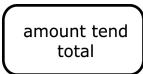

- 1 In the Number keys area, press 100, and then press the  key.
- 1 In the Number keys area press 150, and then press the  key.

- 2 Press the  key.
- 3 Press the  key.

Gallonge Sales Transaction

Example 36: In this example, Department 4 is programmed for Gallonge Mode and is non-taxable. Ring 10.759 gallons at \$1.149 per gallon.

To ring a gallonge sales transaction

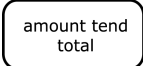
- 1 In the Number keys area, press 10.579, and then press the  key.
- 2 In the Number keys area, press 1149, then press the  key.
- 3 Press the  key.

Minus Percentage Discount Sale



Example 37: The following are two versions of Minus Percentage Discount Sales.

Version 1

Note

If no tax is programmed in your cash register, ring up a \$1.00 item in Department 2 and apply a pre-programmed discount rate of 10%.

To ring a minus percentage discount sale

- 1 In the Number keys area, press 100, and then press the  key.
- 2 Press the  key.

Note

If the Minus Percentage Discount Rate is NOT programmed, type in the discount rate before pressing the  key.

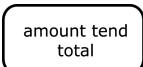
- 3 Press the  key.

Version 2

Note

When ringing a taxable item with a percentage discount, tax will automatically be charged on the discounted amount, the amount after the percentage discount is deducted.

To ring a minus percentage discount sale

1 In the Number keys area, press 100, and then press the  key.

2 Press the  key.

Note

If the Minus Percentage Discount Rate is NOT programmed, type in the discount rate before pressing the  key.

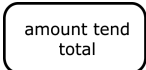
3 Press the  key.

Multiplication of a Department Unit Price

Example 38: Assume the Department 1 key is pre-programmed for \$1.00. Ring up this price three times.

To multiply a department unit price

1 In the Number keys area, press 3, and then press the  key.

2 Press the  key.

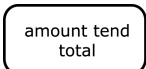
3 Press the  key.

Note

You can up to 32 prices by using the 32 Department keys for quick ring-ups.

Multiplication Sale

Example 39: Ring up three \$1.00 items in Department 1.

To ring a multiplication sale

1 In the Number keys area, press 3, and then press the  key.

2 In the Number keys area, press 100, and then press the  key.

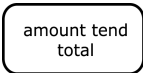
3 Press the  key.

Note

You can use from .01 to 999.99 when ringing up the quantity of an item.

Multiplying By A Fraction

Example 40: Multiply the quantity of 1.25, as in 1¼ yards of fabric at \$1.00 per yard in Department 1.

Caution

When multiplying by a fraction, you must use the decimal point in the fraction but not in the dollar amount.

To multiply an item by a fraction

1 In the Number keys area, press 1.25, and then press the  key.

2 In the Number keys area, press 100, and then press the  key.

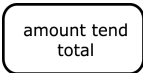
3 Press the  key.

Note

You can use from .01 to 999.99 when ringing up the quantity of an item.

No-Sale Function

Example 41: Used to open the drawer without ringing up a sale. For example, to give change.

To use the No Sale function

▼ Press the  key. The cash register drawer opens.



Note

The number of times the No-Sale key is used appears on the Management Reports. For more information about these reports, see Running Management Reports on page 73.

Overriding a PLU Sale

Example 42: If you need to enter a different price than what is programmed into a PLU #: Enter the price 100, press the **PLU ALT** key, enter the PLU #, then press the **PLU** key. The word *PRICE* appears above the PLU description or PLU number.

To override a PLU sale

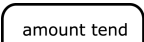
- 1 In the Number keys area, press 100, press the  key.
- 2 In the Number keys area, enter the PLU number, and then press the  key.
- 3 Press the  key.

The word *PRICE* appears above the description or PLU #.

Paid-Out Sale

Example 43: Indicates money taken out of the cash drawer. Ring up \$10.00 to show money paid out of the cash drawer.

To record monies paid out

- ▼ In the Number keys area, press 1000, then press the  key.

PLU Sale

Example 44: Assume the PLU # is preset for the price of \$1.99 in Department 1. Ring up the PLU #1.

To ring a PLU sale

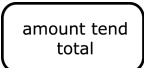
- 1 In the Number keys area, press 1, and then press the  key.
- 2 Press the  key.

Note

PLUs follow the same procedure for ringing up Coupons, Refunds, Minus Percentage Discounts, Plus Percentages, and so on.

PLU Sale With PLU Description

Example 45: PLU #1 has been programmed with the description "APPLE"

To ring a PLU sale with a PLU description

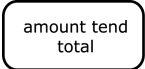
- 1 In the Number keys area, press 1, and then press the  key.
- 2 Press the  key.

Plus Percentage Sale



Example 46: The following are two versions of the Plus Percentage Sale.

Version 1

Note

If no tax is programmed in your cash register, ring up a \$1.00 item in Department 2 and apply a pre-programmed Plus Percentage Rate of 10%.

To ring a PLU percentage sale

- 1 In the Number keys area, press 100, and then press the  key.
- 2 Press the  key.

Note

If the Plus Percentage Rate is NOT pre-programmed, type in the PLUs percentage rate before pressing the  key.

- 3 Press the  key.

Version 2

Note

When ringing a taxable item with a Plus Percentage the tax will automatically be charged on the amount after the PLUs percentage is added.

To ring a PLUs percentage sale

- 1 In the Number keys area, press 100, and then press the  key.

2 Press the  key.

Note

If the Plus Percentage Rate is not pre-programmed, type in the Plus Percentage Rate before pressing the  key.

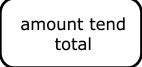
3 Press the  key.

Received-On-Account Sale

Example 47: Indicates money put in the cash drawer. Ring up \$50.00 to show the beginning cash-in-drawer amount for the day.

To receive monies on account

▼ In the Number keys area, press 5000, and then press the  key.

Registering A Department Unit Price

Example 48: Assume Department 1 is pre-programmed for \$1.00. Ring up this price.

To register a department unit price

1 Press the  key.

2 Press the  key.

Note

You can up to 32 prices by using the total of the 32 Department keys for quick ring-ups.



Registering A Reference Number

Example 49: Used to print a number, up to 10 digits, to identify an invoice number, credit card number or any other number on receipts. Ring up the number 1234567 in a standard sale.

Note

Using the reference number is not recorded in any activity counter or sales totals on the Management Reports.



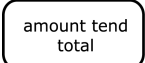

To register a reference number

- 1 In the Number keys area, enter the Reference Number up to 10 digits, and then press the  key.
- 2 In the Number keys area, press 100, and then press the  key.
- 3 Press the  key.

Return Sale

Example 50: Refund a \$1.00 item in Department 1 and refund a \$1.50 item three times in Department 1.

To ring a return sale

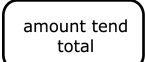
- 1 Press the  key.
- 2 In the Number keys area, press 100, and then press the  key.
- 3 Press the  key.
- 4 In the Number keys area, press 3, and then press the  key.
- 5 In the Number keys area, press 150, and then press the  key.
- 6 Press the  key.

Note



The Return function can be performed in the middle of any sales transactions or by itself in a separate transaction

Split Tendering Sale

Example 51: Ring up a \$15.00 item in Department 1, split the total of the sale between \$5.00 in cash payment and \$10.90 in charge payment.

To ring up a Split Tendering sale

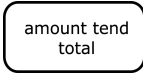
- 1 In the Number keys area, press 1500, and then press the  key.

- 2 Press the  key.
- 3 In the Number keys area, press 500, and then press the  key.
- 4 Press the  key.

Note



When using the Split Tendering function, the amount in cash must always be entered first. The sale can also be finalized with the Check key. Substitute the



Temporarily Overriding a PLU Price

Example 52: If you want to enter a different price than what is programmed into a PLU number.

To override a PLU price



- 1 In the Number keys area, type the price you want, press the  key.
- 2 In the Number keys area, type the PLU number and then press the  key.

The word *PRICE* appears above the PLU description to indicate the overriding of a PLU price.

Use the Error-Correct /Void Key

Example 53: Corrects the last entry run up during a sale. Ring up a \$1.00 item in Department 1, then use the [VOID] key to cancel this entry and ring up a \$10.00 in Department 1 to register a new entry.



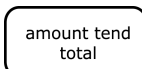

To use the error-correct/void key

- 1 In the Number keys area, press 100, and then press the  key.
- 2 Press the  key.
- 1 In the Number keys area, press 1000, and then press the  key.
- 2 Press the  key.

Voiding A Coupon Sale

Example 54: Void a \$1.00 item in Department 1, void a 20¢ coupon.



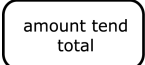

To void a coupon sale

- 1 In the Number keys area, press 100, press the  key, and then press the  key.
- 1 In the Number keys area, press 20, press the  key, and then press the  key.
- 2 Press the  key.

Voiding a Department Preset Price

Example 55: Assume Department 1 is programmed for the price of \$1.00 and Department 2 is programmed for the price of \$2.00. Ring up Department 1 and Department 2 prices, then void the Department 1 entry.



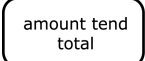





To void a department preset price

- 1 Press the  key.
- 2 Press the  key.
- 3 Press the  key.
- 4 Press the  key and then press the  key.
- 5 Press the  key.

Voiding a Department Preset with a Coupon Discount

Example 56: Assume Department 1 is programmed for \$1.00 and Department 2 is programmed for \$2.00. Ring up Department 1 and deduct 20¢, ring up Department 2 and deduct 20¢, then void the Department 1 entry with the 20¢ coupon discount.



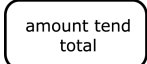

To void a department preset with a coupon discount





- 1 Press the  key.
- 2 In the Number keys area, press 20, and then press the  key.
- 3 Press the  key.
- 4 In the Number keys area, press 20, and then press the  key.
- 5 Press the  key.
- 6 Press the  key and then press the  key.
- 7 In the Number keys area, press 20, press the  key, and then press the  key.
- 8 Press the  key.

Voiding a Department Preset with a Minus Percentage Discount

Example 57: Assume Department 1 is programmed for \$1.00, Department 2 is programmed for \$2.00, and the [-%/RA] key is pre-programmed for 10%. Ring up Department 1 and deduct 10%, ring up Department 2 and deduct 10%, then void the Department 1 entry with the 10% discount.

To void a department preset with a minus percentage discount

- 1 Press the  key and then press the  key.
- 2 Press the  key and then press the  key.

- 3 Press the  key.
- 4 Press the  key, press the  key, and then press the  key.



Note

If the Minus Percentage Discount Rate is not pre-programmed, type in the discount rate before pressing the  key.

Voiding A Minus Percentage Discount Sale

Example 58: Void a \$1.00 item in Department 1 and void a pre-programmed Minus Percentage Discount Rate of 10%.

To void a minus percentage discount sale

- 1 In the Number keys area, press 100, press the  key, and then press the  key.
- 2 Press the  key.

Note



If the Minus Percentage Discount Rate is NOT pre-programmed, type in the discount rate before pressing the [-%/RA] key.







- 3 Press the  key.

Voiding a Multiplication of a Department Preset Price

Example 59: Assume Department 1 is programmed for the price of \$1.00 and Department 2 is programmed for the price of \$2.00. Ring up Department 1 three times and Department 2 two times, then void the Department 1 entry rung up three times.

To void a multiplication of a department preset price

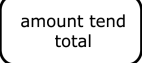

- 1 In the Number keys area, press 3, and then press the  key.
- 2 Press the  key.

- 3 In the Number keys area, press 2, and then press the  key.
- 4 Press the  key.
- 5 Press the  key.
- 6 Press the  key.
- 7 In the Number keys area, press 3, and then press the  key.
- 8 Press the  key.
- 9 Press the  key.

Voiding A Multiplication Sale

Example 60: Void a \$1.00 item in Department 1 three times.



To void a multiplication sale

- 1 In the Number keys area, press 3 and then press the  key.
- 2 In the Number keys area, press 100, press the  key, and then press the  key.

Voiding a PLU Multiplication Sale

Example 61: Assume PLU #1 is preset for the price of \$1.00 in Department 1. Void PLU #1 three times.

To void a PLU multiplication sale



- 1 In the Number keys area, press 3, press the  key.
- 2 In the Number keys area, press 1, press the  key, and then press the  key.

- 3 Press the  key.

Voiding a PLU Sale

Example 62: Assume PLU #1 is preset for the price of \$1.00 in Department 1. Void PLU #1.



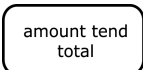

To void a PLU sale

- 1 In the Number keys area, press 1, press the  key, and then press the  key.
- 2 Press the  key.

Voiding a PLU Sale with a Coupon Discount

Example 63: Assume PLU #1 is preset for the price of \$1.00 in Department 1 and deduct a 20¢ coupon. Void this entry.

To void a PLU sale with a coupon discount

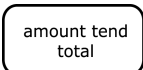
- 1 In the Number keys area, press 1, press the  key, and then press the  key.
- 2 In the Number keys area, press 20, press the  key, and then press the  key.
- 3 Press the  key.



Voiding a Plu Sale with a Minus Percentage Discount

Example 64: Assume PLU #1 is preset for the price of \$1.00 in Department 1 and the  key is pre-programmed for 10%. Ring up PLU #1, deduct 10%,

then void this entry.

To void a PLU sale with a minus percentage discount

1 In the Number keys area, press 1, press the  key, and then press

the  key, and the  key.

2 Press the  key.

If the Minus Percentage Discount is not pre-programmed, type the discount rate before pressing the  key.



3 Press the  key.

Voiding a PLU Sale with a Plus Percentage Rate

Example 65: Assume PLU #1 is preset for the price of \$1.00 in Department 1 and the [+%/PO] key is pre-programmed for 10%. Ring up PLU #1, add 10%, then void this entry.

To void a PLU sale with a PLUs percentage rate

1 In the Number keys area, press 1, press the  key, and then press

the  key, and the  key.

2 Press the  key.

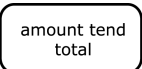

If the Plus Percentage Rate is not pre-programmed, type in the discount rate before pressing the  key.

3 Press the  key.

Voiding a Plus Percentage Sale

Example 66: Void a \$1.00 item in Department 1 and void a pre-programmed Plus Percentage Rate of 10%.

To void a PLUs percentage sale

1 In the Number keys area, press 100, press the  key, and then press the  key.

2 Press the  key.

Note

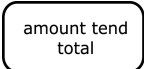

If the Plus Percentage rate is NOT pre-programmed, type in the Plus Percentage Rate before pressing the **+%/PO** key.

3 Press the  key.

Voiding A Sale

Example 67: Void a \$1.00 item in Department 1.

To void a sale

1 In the Number keys area, press 100, press the  key and then press the  key.

2 Press the  key.

Calculating State Tax Table Codes

This appendix shows you how to program your cash register for state tax. Check the Royal website at www.royal.com for the established state tax table rates.

The State Tax Code represents a series of codes which are derived from your State's Retail Tax Chart to give you the highest level of accuracy in charging sales and other taxes.

Calculating Your Tax

This section gives you instructions for figuring your own tax code if your specific state's tax code is not listed in the appendix. Take the time to follow the Example Tax Chart on page 118. Familiarize yourself with the method of determining the tax code.

Then, using The Worksheet on page 119, duplicate the method of calculating your state tax code by the steps described in this section. To do this you need to get a copy of your state's Retail Tax Chart from your local Tax Office. After you are done, write down the tax code and save the information for future reference.

Every tax table consists of tax brackets. Each consecutive tax bracket is assigned a tax which is exactly one cent higher than that assigned to the previous tax bracket. For examples, see Example Tax Chart on page 118.

In our Example Tax Chart, a sale from .00 to .12 is not taxed. The next tax bracket a sale from .13 to .31 is taxed one cent. The next tax bracket a sale

from .32 to .54 is taxed two cents. The tax table progresses in a similar pattern.

To calculate your tax rate

- 1 Using The Worksheet on page 119, complete Step A with the appropriate amounts from your state's Retail Tax Chart.
- 2 For the following, see the Example Tax Chart, Step B:

The difference between the starting amounts of each consecutive tax bracket is called a breakpoint. Every tax table consists of a particular sequence of breakpoints.

In our Example Tax Chart, the difference between .00 and .13 is .13 cents. This 13 is the first breakpoint. The difference between .13 and .32 is .19 cents, which means 19 is the second breakpoint.

The breakpoints continue in a particular sequence through the entire tax table. It is this particular sequence of breakpoints that is used to determine the programming code.

- Using The Worksheet, complete Step B by calculating the breakpoints based on your state's Retail Tax Chart.
- The sequence of breakpoints is divided into *Regular* and *Irregular* patterns. All tax tables repeat a pattern of irregular breakpoints that lead into a pattern of regular breakpoints.

To determine the breakpoint pattern, continue calculating the breakpoints in Part B until you have found the Regular repeat breakpoint pattern.

From our example:

Breakpoints 13, 19, 23, 27, 27, 29 are the Irregular breakpoint pattern. Breakpoints 25, 25, 25, 25 are the Regular repeat breakpoint pattern.

The Regular repeat breakpoint pattern is a point where you first see a repetition of one or more numbers, which must then add up evenly to 100, 200, 300, and so on. In our programming example, the Regular breakpoint pattern (25, 25, 25, and 25) adds up to 100.

Using The Worksheet, determine the Regular breakpoint pattern based on your state's Retail Tax Chart.

- 3 For the following, see the Example Tax Chart, Step C:

tax 2

The first number to be programmed consists of the Base Tax followed by the number 1. In PRG position, type your Base Tax number, followed by the number 1, then press the **Tax 2** key.

- The Base Tax - A base tax is defined by local or state government and refers to the minimum point where no tax is charged. If no tax is charged from .0 cents to .12 cents, then .12 cents is your base tax.

- The Number 1 - The programming mode for a tax table is 1. When programming any tax table code this number does not change.
For example: If the base tax is .12 cents: Type 121, then press **Tax 2**. The display shows 1.21.

Using The Worksheet, complete Step A.

4 For the following, see the Example Tax Chart, Step D:

The second number to be programmed is a six digit number. Follow the instructions and examples below to determine your six digit number. In PRG position, type the six digit number and then press the **Tax 2** key.

Example: 4% State Tax Table:

(2)	100	(1)	4	4% Tax Table Rate
	x 24		x 24	Multiplier
	2400		96	Result: The six digit number to be programmed is 240096

- (1) First determine the multiplier¹. The multiplier is the number which when multiplied by the percentage rate equals a whole number as close as possible to the number 100 and still remaining a 2 digit number. In the example above, the multiplier is 24. The number 4 (the percentage rate) is multiplied by 24 to determine the number 96 which is the last two digits of the 6 digit number to be programmed: (24 x 4 = 96).
- (2) The first four digits of the 6 digit number (2400) are determined by multiplying the number 24 by 100 (24 x 100 = 2400). The final resulting 6 digit number to be programmed is 240096.

Using The Worksheet, complete Step D.

5 For the following, see the Example Tax Chart, Step E:

- In PRG position, type the individual breakpoints of the Irregular breakpoint pattern and press the **Tax 2** key after each breakpoint. Place the number 10 before the last breakpoint entry.

Table 22 Example: Irregular breakpoint sequence: 13, 19, 23, 27, 27, 1029

Type...	Press...	Appears as...
13	Tax 2	0.13
19	Tax 2	0.19
23	Tax 2	0.23

1. The easiest way to determine the multiplier is to divide the number 100 by the percentage rate until the result is a whole number as close to 100 as possible and still remaining a 2 digit number.

Table 22 Example: Irregular breakpoint sequence: 13, 19, 23, 27, 27, 1029 (Continued)

Type...	Press...	Appears as...
27	Tax 2	0.27
27	Tax 2	0.27
1029	Tax 2	10.29

Using The Worksheet, complete Step E.

6 For the following, see the Example Tax Chart, Step F:

In PRG position, type the individual breakpoints of the Regular breakpoint pattern and press the **Tax 2** key after each breakpoint. Place the number 10 before the last breakpoint entry.

Table 23 Example: Regular breakpoint sequence 25, 25, 25, 1025

Type...	Press...	Appears as...
25	Tax 2	0.25
25	Tax 2	0.25
25	Tax 2	0.25
1025	Tax 2	10.25

Using The Worksheet, complete Step F.

7 For the following, see the Example Tax Chart, Step G:

To summarize the steps taken in calculating and programming the State Tax Table Code, combine Steps A through F and maintain for future reference.

Note

Programming the State Tax Table Code is done with the Mode key in the PRG position.

121, **Tax 2**, 240096, **Tax 2**, 13, **Tax 2**, 19, **Tax 2**, 23, **Tax 2**, 23, **Tax 2**, 27, **Tax 2**, 27, **Tax 2**, 1029, **Tax 2**, 25, **Tax 2**, 25, **Tax 2**, 25, **Tax 2**, 1025, **Tax 2**.

Using The Worksheet, complete Step G by using the method described.

Example Tax Chart

The following is an example of how a tax chart can look.

Note

A total of 63 breakpoints can be programmed on this cash register.

STEP C: Enter the base tax amount (the minimum point where no tax is charged) followed by the Number "1". Then press the **TAX 2** key.

STEP D: Enter the 6 digit number (i.e. 4% = 240096).

STEP E: Enter the individual Irregular breakpoint pattern. Press the **TAX 2** key after each breakpoint. Place the number 10 before the last Irregular breakpoint. (13, 19, 23, 27, 27, 1029)

STEP F: Enter the individual breakpoints of the "Regular" breakpoint pattern. Press the **TAX 2** key after each breakpoint. Place the number "10" before the last Regular breakpoint. (25, 25, 25, 1025)

STEP G: To summarize, combine the Steps A through F and keep the information for future use.

121 TAX 2
 240096 TAX 2
 13 TAX 2
 19 TAX 2
 23 TAX 2
 27 TAX 2
 27 TAX 2
 1029 TAX 2
 25 TAX 2
 25 TAX 2
 25 TAX 2
 1025 TAX 2

		SALE AMOUNT		TAX
		from	to	AMOUNT
STEP B				
Breakpoints		0	12	0
13	▲	13	31	1
19	▲	32	54	2
23	▲	55	81	3
27	▲	82	108	4
27	▲	109	137	5
29	▲	138	162	6
25	▲	163	187	7
25	▲	188	212	8
25	▲	213	237	9
25	▲	238		10
	▲			
	▲			
	▲			

Programming the State Tax

You need to get a copy of your state's Retail Tax Chart so you can know the base tax amount. The base tax amount is the maximum price where no tax is charged. For example, if no tax is charged from 0 cents to 10 cents, then 10 cents is the base tax amount.

After you find out your state's tax rate, you can program it into your cash register.



Note

If you make a mistake or you hear an error beep while you are programming the sales tax, press **Clear** and start over with Step 3.

To program a single fixed tax rate using a base tax amount

Example 68: If the Base Tax Amount is 10 cents and the Tax Rate is 6%:



- 1 Put the PRG key in the Mode key slot and turn it to the PRG position.
- 2 If you are prompted for a Manager Password, type the password number and then press the **Check** key. If you did not program a Manager Password, go to the next step.



- 3 In the round Number keys area, press 1 and then press the **Tax 1** key.



- 4 Press 104 and then press the **Tax 2** key.
- 5 Press 6000 and press the **Tax 2** key.

GST/PST System for Canada

This appendix explains programming GST or PST for taxation in Canada. Before you can use GST or PST, you must first program Flag 13. For more information about programming flags, see Programming Flag Options on page 56.

To program Flag 13

check

- 1 Put the PRG key in the Mode key slot and turn it to the PRG position.
- 2 If you are prompted for a Manager Password, type the password number and then press the **Check** key. If you did not program a Manager Password, go to the next step.

void

- 3 In the round Number keys area, press 131 and then press the **Void** key.

Canadian Tax Programming Example

The non-taxable limit is used in certain areas where tax is exempted below a certain amount. For example, any amount below \$4.00 is exempted from tax. If there is no non-taxable limit, simply skip the step in brackets in the procedure.

Example 69: GST Tax: 7%, PST Tax: 8%, GST/PST, Tax: Both 7% and 8% calculated on net amount

check

- 1 Put the PRG key in the Mode key slot and turn it to the PRG position.
- 2 If you are prompted for a Manager Password, type the password number and then press the **Check** key. If you did not program a Manager Password, go to the next step.

Note

Where you see an asterisk (*) in the following steps, enter a preset price or press 0.

- 3 Program Tax 1 as 7%:
Press 1 + **Tax 1** + 7000 + **Tax 2**
- 4 Program Tax 2 as 8%:
Press 2 + **Tax 1** + 8000 + **Tax 2**
- 5 Link Tax 1 (7% GST) to a Department key:
Press 00001 + **Subtotal/w/TAX** + 0* + **Dept Key**
- 6 Type the name of the Department, using the Department keys. For more information about using the Department keys to type letters, see Setting Alphanumeric Descriptions on page 17. When you are done, press the **Check** key.
- 7 Link Tax 2 (8% PST) to specified Department key above:
Press 00002 + **ST/W/TAX** + 0* + **Dept Key**
- 8 Type the name of the Department, using the Department keys. For more information about using the Department keys to type letters, see Setting Alphanumeric Descriptions on page 17. When you are done, press the **Check** key.
- 9 Link both Tax 1 (GST) and Tax 2 (PST) to a Department key:
Press 00005 + **ST/W/TAX** + 0* + **Dept Key**

Example 70: GST Tax: 7%, PST Tax: 8%, GST/PST, Tax: Both 7% and 8% as tax on tax-piggyback calculation

Note

Where you see an asterisk (*) in the following steps, enter a preset price or press 0.

- 1 Program Tax 1 as 7%:
Press 1 + **Tax 1** + 7000 + **Tax 2**
- 2 Program Tax 2 as 8%:
Press 2 + **Tax 1** + 8000 + **Tax 2**
- 3 Program Tax 3 as 8%:
Press 3 + **Tax 1** + 8000 + **Tax 2**
- 4 Link Tax 1 (7% GST) to a Department key:
Press 00001 + **ST/W/TAX** + 0* + **Dept Key**
- 5 Type the name of the Department, using the Department keys. For more information about using the Department keys to type letters, see Setting Alphanumeric Descriptions on page 17. When you are done, press the **Check** key.

- 6 Link Tax 3 (8% PST) to a Department key:
Press 00003 + **ST/W/TAX** + 0* + **Dept Key**
- 7 Type the name of the Department, using the Department keys. For more information about using the Department keys to type letters, see Setting Alphanumeric Descriptions on page 17. When you are done, press the **Check** key.
- 8 Link both Tax 1 (7% GST) and Tax 2 (8% PST) to the desired Department key:
Press + 00005 + **ST/W/TAX** + 0* + **Dept Key**
- 9 Type the name of the Department, using the Department keys. For more information about using the Department keys to type letters, see Setting Alphanumeric Descriptions on page 17. When you are done, press the **Check** key.
- 10 Program for piggyback (tax on tax) calculation for Canada:
Press 21 + 1 + **Void**
Press 22 + 2 + **Void**

For help in Canada, call 888-266-9380.

Product Information

Specifications and Safety

Table 24 Specifications And Safety

Feature	Description
Type	Electronic cash register
Display	One line alphanumeric display
Capacity	7 digit input and 10 digit readout
Printer	Thermal printer
Ink Source	Thermal alphanumeric printer - no ribbon needed
Paper Supply	Standard thermal paper Royal Reorder # 013127
Memory Battery Protection	Roughly 28 days after power interruption
Technology	CMOS RAM
Power Consumption	Standby - 0.8W, Operating - 30W
Operating Temperature	0-40 Degrees Centigrade (32-104 Degrees Fahrenheit)
Dimensions	13"W x 16 ³ / ₄ " D x 11 H"
Weight	18.7 lbs.

Safety Notice

- The power outlet for this cash register must be located near the unit and be easily accessible.
- Do not use this cash register outdoors in the rain or near any source of liquid, such as a pool.

FCC Warning

This equipment generates, uses and can radiate radio frequency energy and if not installed and used in accordance with the instructions manual, may cause interference to radio communications. It has been tested and found to comply with the limits for a Class A computing device pursuant to Subpart J of Part 15 of FCC Rules, which are designed to provide reasonable protection against such interference when operated in a commercial environment. Operation of this equipment in a residential area is likely to cause interference in which case the user at his own expense will be required to correct the interference.

- The back-up power system: When you are not using your cash register, you keep it plugged in with the control lock key in the OFF position. Back-up power is provided through the batteries, but this should not be used for long periods of time.

Limited Warranty

Royal Consumer Information Products, Inc. at 379 Campus Drive, Somerset, New Jersey 08875 warrants that your new Royal Cash Management System is free of defects of workmanship and materials. If there is a defect or malfunction of this cash register, Royal will repair the cash register free of charge as follows:

Parts

New or comparable rebuilt parts in exchange for defective parts for ONE YEAR from the date of purchase.

Labor

All labor charges incurred for 90 DAYS are covered from the date of purchase. After 90 days there will be a labor charge for repair of assemblies such as the keyboard, display, logic board, power supply and printer at the Authorized Service Center's then prevailing rates. The cash register must be taken or sent postage prepaid and insured to a Royal Authorized Service Center. Royal will pay return postage during labor warranty period only.

This warranty does not apply to persons who purchase this product second-hand or used.

This warranty does not include adjustments, parts, or repairs required by circumstances beyond the control of Royal, including but not limited to fire or other casualty, accident, neglect, abuse, abnormal use, or battery leakage damages. **THERE ARE NO OTHER EXPRESSED WARRANTIES EXCEPT AS STATED HEREIN. AFTER THE PERIOD OF EXPRESSED WARRANTY SET FORTH HEREIN, THERE ARE NO EXPRESSED OR IMPLIED WARRANTIES AND THOSE EXCLUDED INCLUDE THOSE OF MERCHANTABILITY AND FITNESS FOR A PARTICULAR PURPOSE.** Royal shall NOT be liable for **CONSEQUENTIAL DAMAGES** resulting from any failure, defect, or malfunction of this cash register. Some states do not allow limitations on how long an implied warranty lasts and some states do not allow the exclusion or limitation of incidental or consequential damages, so the above limitations or exclusions may not apply to you.

To obtain service under the terms of this warranty

Your warranty starts with the date of original purchase. This warranty gives you specific legal rights, and you may also have other rights which vary from State to State.

This warranty is valid only on cash registers purchased, delivered and used in the United States.

For Authorized Service Centers within your local area, please call 1 (888) 261-3888 or 732-563-9944.

Keep proof of purchase to establish date of original purchase.

- Pack your cash register in the original carton or equivalent.
- Enclose a copy of the bill of sale or other documentation showing original purchase date.
- Enclose a card or note describing the difficulty you have had with the cash register.
- Be sure to include your complete name and address.

Mail the above prepaid and insured to the nearest authorized service location. The Service Center cannot be held responsible for any loss or damage in transit.

Description Tables

The following table shows the various text your cash register prints in the languages programmed in your cash register.

Table 25 Language Descriptions

ENGLISH	SPANISH	FRENCH	GERMAN	PRINT LOCATION
COUPON	CUPON	COUPON	MINUS	SALES RECEIPT
DISCOUNT	DESCUENTO	REMISE	RABATT	SALES RECEIPT
ADD ON	INCREMENTO	MAJORATION	AUFSCHLAG	SALES RECEIPT
CHARGE	CARGO	C-CREDIT	KREDIT	SALES RECEIPT
VOID/CORR	ANUL/CORRC	CORRECTION	STORNO	SALES RECEIPT
SUBTTL	SUBTOTAL	SOUS-TOTAL	ZWSUMME	SALES RECEIPT
CHANGE	CAMBIO	RENDU	RUCKGELD	SALES RECEIPT
CASH	METALICO	ESPECES	BAR	SALES RECEIPT
PRICE	PRECIO	PRIX	PREIS	SALES RECEIPT
AMOUNT	CANTIDAD	MONTANT	BETRAG	SALES RECEIPT
CHECK	CHEQUE	CHEQUE	SCHECK	SALES RECEIPT
T1	T1	T1	S1	SALES RECEIPT
T2	T2	T2	S2	SALES RECEIPT
T3	T3	T3	S3	SALES RECEIPT
T4	T4	T4	S4	SALES RECEIPT
REFUND-	REEMBOLSO	RETOUR	RUCKZAHLUNG	SALES RECEIPT
TOTAL	TOTAL	TOTAL	GESAMT	SALES RECEIPT
PAID OUT	SALIDAS	SORTIE	AUSZAHLUNG	SALES RECEIPT
RECD ACCT	CUENTA	ENTREE	EINZAHLUNG	SALES RECEIPT
NO SALE	NO VENTA	NON-VENTE	NULL BON	SALES RECEIPT
COUPON	CUPON	COUPON	MINUS	PROGRAM PRINT
DISCOUNT	DESCUENTO	REMISE	RABATT	PROGRAM PRINT
ADD ON	INCREMENTO	MAJORATION	AUFSCHLAG	PROGRAM PRINT
CHARGE	CARGO	C-CREDIT	KREDIT	PROGRAM PRINT
R-A-	CUENTA	ENTREE	EINZAHLUNG	PROGRAM PRINT
P-O-	SALIDAS	SORTIE	AUSZAHLUNG	PROGRAM PRINT
VOID/CORR	ANUL/CORRC	CORRECTION	STORNO	PROGRAM PRINT
SUBTTL	SUBTOTAL	SOUS-TOTAL	ZWSUMME	PROGRAM PRINT
PLU NO.	PLU NO	PLU-NO	PLU-NR	PROGRAM PRINT
T1	T1	T1	S1	PROGRAM PRINT

Table 25 Language Descriptions (Continued)

ENGLISH	SPANISH	FRENCH	GERMAN	PRINT LOCATION
T2	T2	T2	S2	PROGRAM PRINT
T3	T3	T3	S3	PROGRAM PRINT
T4	T4	T4	S4	PROGRAM PRINT
COUPON	TL-CUPON	TL-COUPON	MINUS	MANAGEMENT REPORT
DISCOUNT	DESCUENTO	TL-REMISE	RABATT	MANAGEMENT REPORT
ADD ON	TL-INCREM	TL-MAJOR	AUFSCHLAG	MANAGEMENT REPORT
CHARGE	CARGO	TL-C-DRED	KREDIT	MANAGEMENT REPORT
VOID/CORR	ANUL/CORRC	TL-CORREC	STORNO	MANAGEMENT REPORT
RECD ACCT	CUENTA	TL-ENTREE	EINZAHLUNG	MANAGEMENT REPORT
PAID OUT	SALIDAS	TL-SORTIE	AUSZAHLUNG	MANAGEMENT REPORT
NO SALE	NO VENTA	TL-NON-VTE	NULL BON	MANAGEMENT REPORT
CHECK	CHEQUE	TL-CHEQUE	SCHECK	MANAGEMENT REPORT
DEPTTL	TOTAL DPTO	TL-DEPART	WG TOTAL	MANAGEMENT REPORT
REFUND	REEMBOLSO	TL-RETOUR	RUCKZAHLNG	MANAGEMENT REPORT
TAX 1	T1	TL-TVA1	T1	MANAGEMENT REPORT
TAX 2	T2	TL-TVA2	T2	MANAGEMENT REPORT
TAX 3	T3	TL-TVA3	T3	MANAGEMENT REPORT
TAX 4	T4	TL-TVA4	T4	MANAGEMENT REPORT
NET	NETO	TL-NET	NETTO	MANAGEMENT REPORT
GROSS	BRUTO	TL-BRUT	BRUTTO	MANAGEMENT REPORT
GT	GRAN TOTAL	GT	GT	MANAGEMENT REPORT
C-I-D	METAL CAJA	NET-TIROIR	G-I-S	MANAGEMENT REPORT
CASH	METALICO	TOT-ESPECE	BARGELD	MANAGEMENT REPORT

Table 25 Language Descriptions (Continued)

ENGLISH	SPANISH	FRENCH	GERMAN	PRINT LOCATION
T1	T1	T1	S1	MANAGEMENT REPORT
T2	T2	T2	S2	MANAGEMENT REPORT
T3	T3	T3	S3	MANAGEMENT REPORT
T4	T4	T4	S4	MANAGEMENT REPORT
TX	TX	TX	TX	MANAGEMENT REPORT
TOTAL	TOTAL	TL-PLU	GESAMT	PLU REPORT
PLU	PLU	PLU	PLU	PLU REPORT
TOTAL	TOTAL	TL-VENDEUR	GESAMT	CLERK REPORT
CLERK	DEPENDIEN	VENDEUR	KASSIERER	CLERK REPORT
C-I-D	METAL CAJA	NET-TIROIR	G-I-S	CASH-IN-DRAWER
NET	NETO	TL-NET	NETTO	MONTHLY REPORT
GROSS	BRUTO	TL-BRUT	BRUTTO	MONTHLY REPORT
T1	T1	TL-TVA1	T1	MONTHLY REPORT
T2	T2	TL-TVA2	T2	MONTHLY REPORT
T3	T3	TL-TVA3	T3	MONTHLY REPORT
T4	T4	TL-TVA4	T4	MONTHLY REPORT
MC #:	MC#	CR-NO	MC#	MACHINE NUMBER
YOUR RECEIPT	SU RECIDO	VOUS REMERCIE*	IHRE RECHNUNG	STORE HEADER
THANK YOU	GRACIAS	DE VOTRE CONFIANCE	VIELEN DANK	STORE HEADER
DEPT	DPTO	DEPT	WARENGRP	DEPT RECEIPT
CLERK	DEPENDIENTE	VENDEUR	KASSIERER	CLERK NAME
TIME	HORA	HEURE	ZEIT	TIME REPORT
CREDIT-1	CRED-1	CART CRED 1	KRED-1	CREDIT-1
CREDIT-2	CRED-2	CART CRED 2	KRED-2	CREDIT-2 t
PLU No	PLU No	ARTICLE	ARTIKEL	PLU NAME



Index

A

about
 management reports 75
 X readings 74
 Z readings 74

accessories
 optional 82
 ordering 85

alphanumeric code chart 18, 40

amount of time messages appear 46

B

barcode reader
 installing 6
 programming 6
 programming PLUs 49
 ringing up sales 64
 setting up PLUs 49

batteries
 locating 3
 putting in 3
 replacing 83

before going to register mode 30

C

Canadian
 tax rates 121–123

Canadian tax system 67

cash drawer
 closing 14
 opening 14

changing tax rates 67

character chart, programming 18

chart, alphanumeric codes 40

clearing errors 31

clerk names
 setting 25

clerk numbers
 setting 25
 using 26

clerk system 25
 using 26

closing
 cash drawer 14
 customer display 10

code chart, alphanumeric 18, 40

codes, transaction 93

commercial messages
 programming 21
 setting 24

complex tax rates 67

confirming your settings 29

contacting Royal 2

coupon discounts
 programming 52

credit keys
 programming 46

custom messages
 programming 21

customer display
 closing 10
 opening 10

customer service, contacting 2

D

department keys
 programming 34

department names
 programming 39

department number keys
 using 38

department preset price
 programming 38

description tables 127
 languages 127

discounts
 programming 51

display messages
 programming 42
 programming display time 43

double wide characters
 programming 20
 receipts 20

E

error codes 31

error sounds 31

errors
 clearing 31
 fixing 31

example
 adding tax to a non taxable
 department 94
 cash sale with tendering
 change 94
 cash sale without tendering
 change 95
 charge sale 95
 coupon discount sale 96
 credit return 97
 credit sale 97
 debit purchase 97
 dept shift key 97
 exempting tax on an item 98
 exempting tax on the entire
 sale 98
 gallonage sales transaction 99
 minus percentage discount sale
 99
 modify tip 100
 multiplication of a department
 unit price 100
 multiplication sale 100
 multiplying by a fraction 101
 no-sale function 101
 overriding a PLU sale 102

paid-out sale 102

PLU sale 102

PLU sale with PLU description
 103

PLUs percentage sale 103

received-on-account sale 104

registering a department unit
 price 104

registering a reference number
 104

return sale 105

split tendering sale 105

using error-correct (void) key
 106

voiding a coupon sale 107

voiding a department preset
 price 107

voiding a department preset
 with a coupon discount 108

voiding a department preset
 with a minus percentage
 discount 108

voiding a minus percentage
 discount sale 109

voiding a multiplication of a
 department preset price 109

voiding a multiplication sale
 110

voiding a PLU multiplication
 sale 110

voiding a PLU sale 111

voiding a PLU sale with a
 coupon discount 111

voiding a PLU sale with a
 minus percentage discount
 112

voiding a PLU sale with a PLUs
 percentage rate 112

voiding a PLUs percentage sale
 113

voiding a sale 113

example tax chart 118

F

financial reports 76

flag options
 programming 56

footer messages, setting 24

full report example 77

full system clear, about 32

G

getting help 2

GST tax rates 121–123

H

half system clear, about 32

HDLO
 programming 36

I

installing
 barcode reader 6
 paper roll 5
 register tape 5

K

keyboard
 using 13

L

languages
 description tables 127
 selecting 59

location of keys 13

M

making messages scroll fast or
 slow 46

manager passwords 28

manager passwords, setting 28

memory backup batteries 3

messages, setting commercial 24

minus percentage discounts
 programming 51

Mode key area, using 12

- O**
- opening
 - cash drawer 14
 - customer display 10
 - optional accessories 82
 - ordering
 - accessories 85
 - supplies 2
- P**
- paper roll
 - installing 5
 - parts, ordering 85
 - passwords
 - clerk, setting 25
 - manager 28
 - setting manager 28
 - setting X 28
 - PLU description
 - programming 48
 - PLUs
 - programming the barcode scanner 49
 - programming
 - barcode reader 6
 - clerk numbers 25
 - commercial messages 21
 - coupon discounts 52
 - credit keys 46
 - custom messages 21
 - department keys 34
 - department names 39
 - department preset price 38
 - discounts 51
 - double wide characters 20
 - flag options 56
 - High Digit Lock-out (HDLO) 36
 - logo messages 20
 - manager password 28
 - message in the display 42, 43
 - minus percentage discounts 51
 - multiple and single items 36
 - numbers in logo messages 20
 - PLU description 48
 - plus percentage add ons 55
 - PLUs with the barcode scanner 49
 - scrolling messages 42, 43
 - single wide characters 20
 - store logos 21
 - tax rates 67
 - tax status 37
- PST**
- tax rates 121–123
- Q**
- quick start program confirmation report, printing 29
- R**
- receipt messages, setting 21, 24
 - register mode, before going to 30
 - register tape
 - installing 5
 - replacing batteries 83
 - reports
 - about 75
 - cash-in-drawer 75
 - clerk reports 76
 - confirmation 72
 - department confirmation 73
 - example 77
 - financial 76
 - full 76
 - hourly 79
 - management 73
 - PLU 80
 - program confirmation 70
 - quick start program confirmation 29
 - X 73
 - Z 73
 - ringing up sales 62
 - barcode reader 64
 - Royal
 - contacting 2
- running**
- cash-in-drawer reports 75
 - clerk reports 76
 - department confirmation reports 73
 - financial reports 76
 - full reports 76
 - hourly reports 79
 - management reports 73
 - PLU confirmation reports 72
 - PLU reports 80
 - program confirmation reports 70
- S**
- scanning items 64
 - scrolling message
 - setting display time 43
 - scrolling messages
 - amount of time messages appear 46
 - faster or slower 46
 - programming 42, 43
 - setting
 - alphanumeric descriptions 17
 - amount of time messages appear on the display 46
 - clerk names 25
 - clerk numbers 25
 - commercial messages 24
 - decimal points 50
 - languages 59
 - machine numbers 27
 - manager passwords 28
 - rounding rates 51
 - scrolling messages 43
 - standard or gallonage mode 36
 - tax rates 67
 - X passwords 28
 - setting up
 - barcode scanner 49
 - settings
 - confirming 29

single wide characters
 programming 20
 receipts 20
software for your cash register 82
specifying tax rates 67
store logos
 double wide characters 20
 programming 21
 single wide characters 20
 worksheet 21
store messages
 programming 21
supplies, ordering 2

T

tables, description 127
tax chart, example 118
tax rates
 Canadian 67, 121–123
 GST 121–123
 PST 121–123
 setting 67
 VAT 67

tax status
 programming 37
tax worksheet 119
Training mode, using 64
transaction codes 93
troubleshooting 86
 Clerk E12 87
 error beeps 86
 error codes 86
 full system clear 89
 half system clear 89
 register does not work 88
 Sec error 87

U

using
 cash drawer 14
 clerk system 26, 27
 department number keys 38
 displays 16
 double wide characters 20
 keyboard 13
 Mode key area 12
 single wide characters 20
 Training mode 64

V

VAT tax system 67

W

warranty 126
worksheet
 store logo 21
 tax 119

X

X passwords, setting 28
X reports 73

Z

Z reports 73