



INVOTEC[®]

ENT and Plastic Surgery Products Catalog



TERMS AND CONDITIONS

PLACING YOUR ORDER

For your convenience, orders may be placed via email, fax, or phone. We will ship ground unless otherwise specified.

Email: orders@invotec.net

Fax: (904) 886-9517

Phone: (800) 998-8580

PAYMENT TERMS

Our payment terms are net thirty (30) days. F.O.B. Jacksonville, FL unless otherwise specified.

ACCEPTANCE

All orders are subject to approval and acceptance from Invotec International, Inc. which reserves the right to alter or suspend credit, cancel unfilled orders or refuse shipment when credit conditions warrant such action.

PRODUCT SPECIFICATIONS AND AVAILABILITY

Invotec reserves the right to discontinue merchandise, make design improvements, change specifications, prices, terms or conditions of sale at any time without notice or obligation.

PACKAGING AND SHIPMENTS

- A. Processing of all orders begins immediately.
- B. All items shall be packaged and shipped in accordance with Invotec's best judgment. Special packaging or shipping instructions must be noted on the original order and acknowledged by Invotec.
- C. Shipment is F.O.B. Jacksonville, FL.
- D. Shipment dates are based on Invotec's best estimates. Invotec will exercise its best efforts to ship on schedule, but shall not be liable for damage or loss because of any delay in delivery.
- E. Invotec reserves the right to fill any order by complete or partial shipments unless otherwise agreed.
- F. Invotec's responsibility for loss or damage to goods ends upon delivery of those goods to the transporting company. If Invotec paid for shipping, we will assist you in any reasonable manner in filing claims for damaged or lost merchandise.
- G. Invotec shall not be liable for any failure or delay in delivery caused in whole or in part by any governmental act or regulation, civil commotion, delay of carriers, destruction of plants, fire, inability to obtain materials or shipping space, lockouts, strikes, wars, or any other cause beyond our control.

COMPLAINT HANDLING

If you encounter a problem or complaint, please do the following: 1) obtain all relevant facts, including the name of user, address, phone number, merchandise number, lot/serial number, date of occurrence and description of circumstances or nature of problem; and 2) report information immediately to Invotec's Customer Service Department at the number listed above. Every effort will be made to address and resolve problems in a manner consistent with our goal of providing quality merchandise and services.

RETURNED GOODS POLICY

No merchandise may be returned without the prior authorization of Invotec. All returns must be accompanied by a Returned Goods Authorization (RGA) number. This number can be obtained by calling our Customer Service Department. To request an RGA number, please have the following information when calling Customer Service: 1) original invoice number or purchase order number, 2) sales order number, 3) catalog number, 4) quantity, 5) lot number, 6) and reason for return. Please display the RGA number prominently on the box and include it on all paperwork. All authorized returns must be sent freight prepaid.

- A. All returned merchandise must be in its original package. Any merchandise returned that is obsolete, beyond its expiration date, defaced, altered, damaged or has come in contact with body tissue or fluids will not be eligible for return or credit. Sterile merchandise must be returned in full-box quantities with the outer seals intact.
- B. Merchandise returned in unopened, unused, undamaged condition within 60 days of the date of purchase will be credited at the customer's purchase price.
- C. Merchandise returned unused after 60 days and before 180 days from date of purchase will be credited at actual purchase prices less 25% restocking fees.
- D. Merchandise returned after 180 days from date of purchase is not eligible for return or credit.
- E. Altered or custom made items are not eligible for return or credit.
- F. If you are enrolled in the New Product Evaluation Guarantee Program and have a return, Invotec will refund you the purchase price for product purchased on an initial evaluation order subject to the conditions outlined in your warranty.
- G. Merchandise returned without prior authorization or not in accordance with the terms and conditions outlined above will be returned to the customer at the customer's expense.

RETURN OF MERCHANDISE FOR REPAIR

To arrange for the return of merchandise for repair, call Customer Service at (800) 998-8580 to obtain a Returned Goods Authorization (RGA) number and to schedule the repair. Please have the original invoice number or purchase order number available to assist in verifying warranty information.

A purchase order number is required to process all repairs. After obtaining a RGA number, Customer Service will inform you of the repair charge that will be billed to your purchase order.

The RGA number should be prominently displayed on the box and should be included on all paperwork enclosed with the merchandise requiring repair. Merchandise returned for repair should be safely packaged in protective wrapping. Customer must include with the returned merchandise the 1) purchase order number, 2) correct shipping and billing address, and 3) Repair Order Form or customer statement of problem/reason for repair.

ALL REPAIRS SHOULD BE SHIPPED FREIGHT PREPAID TO:

Invotec International, Inc.
6833 Phillips Industrial Blvd.
Jacksonville, FL 32256
ATTN: RGA # _____

IMPORTANT

Due to the potential threat to health, all instruments and devices returned for repair must have been decontaminated and/or sterilized. Any product received in an unsanitary condition will be deemed un-repairable and discarded unless Invotec is able to sterilize or decontaminate the product. An additional service fee of \$250.00 will be applied to the cost of the repair of any product requiring sterilization or decontamination by Invotec.

LOANER POLICY FOR REPAIRS

Loaners for merchandise that is being repaired under warranty are provided at no charge and must be returned to Invotec within ten (10) days after customer's receipt of repaired merchandise. If the loaner is not returned within the allotted timeframe, Invotec reserves the right to charge a daily rental fee. Rental fees will continue to be charged until the loaner is returned to Invotec.

Customer shall be responsible for any damage to loaner equipment while in customer's possession or during shipping back to Invotec. Customer is responsible for all shipping charges associated with the loaner's return.

REPAIR WARRANTIES

All repairs are warranted to be free from defects in material and workmanship for ninety (90) days after the date of shipment.

CHANGES TO TERMS

Invotec retains the right to change any of these terms or conditions without notice.

WARRANTY

Invotec International, Inc. warrants that the merchandise is free from defects in material and workmanship. Invotec will replace or provide a refund for any merchandise found to be defective so long as the merchandise is returned according to the Returned Goods Policy. Invotec shall not be liable for any consequential loss, damage or expense directly or indirectly arising from the use or misuse of, or inability to use, this merchandise. THE FOREGOING WARRANTY IS IN LIEU OF AND EXCLUDES ALL OTHER WARRANTIES, EXPRESSED OR IMPLIED, HOWEVER ARISING, INCLUDING MERCHANTABILITY, FITNESS FOR A PARTICULAR PURPOSE, AGAINST INFRINGEMENT OR OTHERWISE. Invotec neither assumes nor authorizes any person to assume for it, any other additional liability or responsibility with respect to this merchandise.

Care and Handling of Surgical Instruments

The methods discussed have been validated for cleaning and sterilizing medical devices distributed by Invotec International and other fine surgical instrument suppliers. They have been developed using standard equipment and practices common to most health care facilities. Manual cleaning methods, steam and ETO sterilization were used as much as possible.

The Sterilization Guidelines presented are based on type of product, placed into specific categories.

Category	Type of Product
Instruments with rough surfaces	Applicators, burs, rasps, brushes, curettes
Instruments with sliding hinges	Adenotomes, forceps, punches, rongeur
Instruments with screw pivot hinges	Scissors, specula, retractors, calipers
Instruments whose surfaces that can be marred, scored, or scratched.	Mallet heads, cutting blocks, Instruments made of or having Delrin® (Dupont™) surfaces, specula, mixing bowls.
Instruments with lumens and channels	Suction tips, cannulas, needles.

Recommended Cleaning Supplies:

- Enzyme solution (i.e. Klenszyme®), detergent (Manu-Klenz®) lukewarm water, soft bristle brush, and a clean soft towel.
- Detergents: Proteolytic enzymatic detergents with a pH range between 6.0 and 8.0 should be used. These detergents have nonionic surfactants. Detergents should be used in a concentration level recommended by the manufacturer. NOTE: Undiluted detergents and those with pH's greater than 8.0 can strip the coloration from metal instruments.
- Ultrasonic Cleaners designed for fine cleaning of medical devices.

Cleaning Procedure:

1. Soak for a minimum of two (2) minutes in enzyme solution
2. Rinse thoroughly under lukewarm water
3. Manually clean with a soft bristle brush while immersed in a detergent solution, paying close attention to crevices and hard-to-clean areas.
 - a. If using a power washer, close adherence to washer manufacturers' procedures should be followed.
4. Rinse thoroughly under lukewarm water
5. Dry with a clean soft cloth
6. Visibly examine for damage, rust deposits, and cleanliness.

Sterilization Recommendations

Device Type	Prevacuum Wrapped	Prevacuum Unwrapped	Gravity Unwrapped	Gravity wrapped	EO	Chemical Disinfectant	Chemical Sterilant	Peracetic Acid	Gas Plasma
Rough Surfaces	YES	YES	YES	YES	YES	YES	YES	YES	YES
Sliding Hinges	YES	YES	YES	YES	YES	YES	YES	YES	YES
Lever Hinges	YES	YES	YES	YES	YES	YES	YES	YES	YES
Screw Pivot	YES	YES	YES	YES	YES	YES	YES	YES	YES
Lumens	YES	YES	YES	YES	YES	YES	YES	NO	YES
Sterilization Trays	YES	YES	YES	YES	YES	YES	YES	NO	NO
Steam Sterilizable Endoscopes	YES	YES	YES	YES	YES	YES	YES	YES	YES

A “**NO**” indicates Invotec International does not have the data to support the recommendation of the specific method of sterilization for a given category.

Cycle Parameters

Prevacuum Cycle (wrapped and unwrapped): Three (3) preconditioning pulses with a minimum exposure time of 4 minutes at 270 °F (132 °C).

Gravity Cycle (wrapped): 270 °F (132 °C) with a minimum exposure time of 15 minutes.

Gravity Cycle (Unwrapped): 270 °F (132 °C) with a minimum exposure time of 10 minutes.

Ethylene Oxide Cycle

Sterilant	Temperature	Humidity	Preconditioning	Concentration	Exposure
100% EO	131 °F (55 °C)	65-75%	1 hour	725 mg/l	120-360 minutes
Aerate a minimum of 12 hours at 131 °F (55 °C)					

Liquid Chemical Cycle

Concentration of Glutaraldehyde	Temperature	Exposure for Disinfection	Exposure for Sterilization
2.4%	77 °F (25 °C)	45 minutes	10 hours

- **Implants** are sold as one-time use items and not intended for re-sterilization.
- Most reusable instruments are sold nonsterile. These devices should be placed into suitable packaging for the sterilization process (i.e., central supply wrap (CSR), autoclave bags, paper/Tyvek® pouches, dedicated sterilization trays and sterilized prior to use. **All instruments should be examined and cleaned prior to sterilization.**

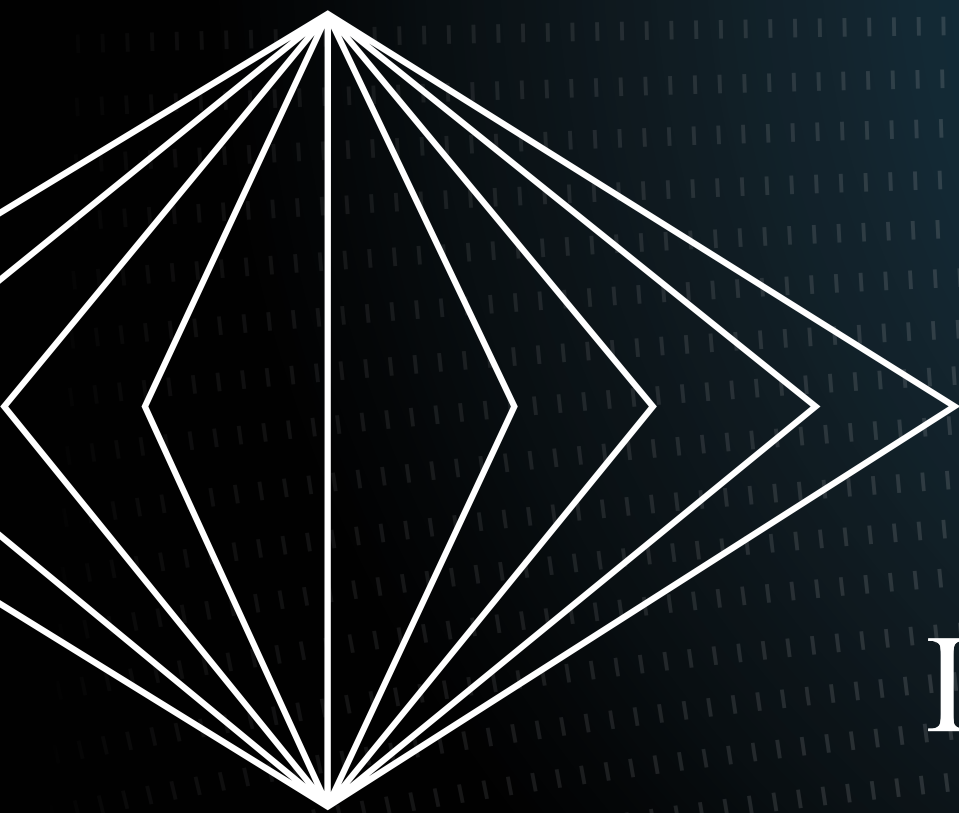

INVOTEC®

ACCESSORIES

RHINOLOGY AND COSMETIC SURGERY	Swiss Therapy™ Cold Therapy	1
	Scar Sheeting	2
	Skin Markers	3
	Micro Electro Dissection Needle	3
	Chin Implants	4
	Malar Implants	5
	Implantable Silicone Blocks	5
	Nasal Dorsal Implants	6-7
	Silicone Sheeting, Tubing and Blocks	8
	Septal Buttons	8
	Internal Nasal Splints	9-10
	External Nasal Splints	11
	Dressing and Packing	12-13
	Gelatin Packing	14
	Hyaluronic Acid Gel	15
	Silicone Epistaxis Balloon	16
	Rhinology Knives and Blades	17
DISPOSABLE SUCTIONS	Rhinologic and Otologic	21-23
OTOLOGY	Dressing and Packing	27
	Burs - Ultrabur Drill	28
	Myringotomy Knives & ENT Blades	29-30
	Phenol Applicator	31
	Myringotomy Kits & Specula	31
	Ventilation Tubes	32-34
	Otovent® Middle Ear Auto Inflation	35
OSSICULAR PROTHESIS	Incus	39-40
	Incus-Stapes	41
	Partial	42-43
	Total	44-45
	Serenocem	46
	Canal Wall	47
	Caps and Shoes	47
	Stapes	48-49
	Bucket Handles	50
	Nitinol Stapes	51-52
	Instrumentation	53
	Trials	54
	Accessories	55
LARYNGEAL	Tracheal T-tubes	59
	Disposable Adenoid Curettes	59
	Surface Electrodes	60
SPECIALTY PRODUCTS	Lighting Systems	63-66
	Ophthalmic Sponge Packing	67
	Cotton Tipped Applicators	68
	Anti-fog	68
	Headrest	68
	Sterilization Trays	69

RHINOLOGY INSTRUMENTS

Telescopes	73-74
Forceps	75-83
Antrum Punches, Back Biters and Kerrisons	84-89
Nasal Scissors	90-94
Knives and Blades	95
Osteotomes, Chisels and Saws	96-99
Elevators and Probes	100-101
Septum Instruments	102-103
Curettes	104-105
Speculas	106-108
Retractors, hooks	109-112
Rasps	113-115
Sinus Suction Tips	116-117
Mallets	118
Needle Holders, Wire Twisters	119-122
Tissue Thumb Forceps	123
Miscellaneous Nasal and Sinus	124-126
Measuring Instruments	127

PARANASAL, SKULL BASE, PITUITARY INSTRUMENTS

Retractors	131
Forceps	132-133

OTOLOGY INSTRUMENTS

TUNING FORKS	Tuning Forks	137
EXTERNAL EAR CANAL INSTRUMENTS	Ear Speculum	138-139
	Ear Curettes	140
	Loops & Hooks	141-143
	Probes	143
	Tympanum Perforators	144-145
	Ear Catheters	146
	Air Bags	147
	Powder Blower	147
MIDDLE EAR INSTRUMENTS	Instrument Set	148
	Suctions	149-150
	Elevators	151-152
	Snares	153
	Rongeurs	154
	Ear Forceps	155-160

Ear Scissors	161
Malleus Forceps	162
Needles/Picks	163
Hooks	164-165
Tympanoplasty Knives	166-169
Micro Elevators	170-171
Stapes Curettes	172
Footplate Drill	173
Mobilizers	174
Measuring & Cutting	175

LARYNGEAL INSTRUMENTS

MICRO LARYNGOSCOPY	Operating Laryngoscopes	179-180
	Scissors and Forceps	181-187
	Micro Knives and Elevators	188-189
	Suctions	190-191
	Injection Needles	192
LASER MICRO SURGERY	Suctions and Protectors	193-194
BRONCHO-ESOPHAGOSCOPY	Forceps	195-198
	Suctions	199
	Accessories	200

ORO-NASOPHARYNGEAL INSTRUMENTS

Adenotomes	203
Adenoid Currettes	204-206
Laryngeal Mirrors	207-208
Mouth Gags - Tongue Depressors	209-215
Retractors	216-218
Tongue Spatulas	219-221
Nasopharynx Forceps	222-225
Tonsil Artery Forceps	226-227
Tonsil Seizing Forceps	228-229
Tonsil Knives	230-231
Tonsil Screws	232
Tonsil Dissectors	233-234
Tonsil Scissors	235-236
Tonsil Snares	237-239
Tonsiltome	240
Tonsillectomy Instruments	241-242
Tonsil Needles	243
Suctions	244-245
Tonsil Accessories	246

RHINOLOGY & COSMETIC

ACCESSORIES

R&CS ACC

DIS

OTO ACC

OSS

LAR ACC

SPE ACC

RHI INS

PSB

OTO INS

LAR INS

ORO/NAS INS

Invotec's Swiss Therapy™ Masks and Sheeting are synthesized from a patented Hydrogel material. It is used as a lightweight and flexible cold compress during and after cosmetic procedures of the face.

- Moist, but not wet
- Lightweight & comfortable
- Gently pliable & conforming
- Non-adherent
- Highly patient compliant
- Convenient, easy to use
- Soothing to skin
- Sterile

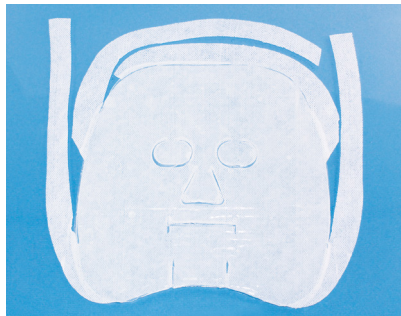

SWISS THERAPY™ EYE AND FULL FACE MASKS

An easy to use, post-operative cold compress for a variety of plastic surgery or cosmetic procedures involving the facial area. While comforting to the patient, it reduces post-operative swelling, redness and discomfort, decreases healing time, and enables the patient to return to normal activities more quickly, increasing the patient's satisfaction.

Superior Post-Operative Compress with Swiss Therapy

- Conforms better to the contours of the face
- Does not leak
- Does not put pressure on or stick to the skin
- Provides superior post-operative wound monitoring, while absorbing and providing pain relief

Number	Description		Qty/Box
10-08803	Swiss Therapy™ eye mask	Sterile	3
10-08813	Swiss Therapy™ eye mask	Reinforced Sterile	3
10-08820	Swiss Therapy™ Full face mask	Sterile	2

LASER & IPL SKIN THERAPY THROUGH SWISS THERAPY™ SHEET

Provides cooling local anesthetic and pain relieving effects during and after Laser and IPL and before or after injectable therapies. The immediate application of Swiss Therapy™ provides a soothing, refreshing, and relaxing feeling. Further, Swiss Therapy™ reduces the risk of hematoma formation and is beneficial in restoring strength and mobility more quickly so that patients can heal faster and feel better sooner.

Injection Therapy with Swiss Therapy

Your injectable therapy patient's aesthetic procedure experience can be optimized via the cooling comfort provided, before and after injection.

- Soothe the skin, reduce redness
- Minimize skin irritation
- Relieve burning sensations
- Control adverse effects commonly associated with Botox® and other injectable therapies

Laser Therapy with Swiss Therapy

Swiss Therapy™ hydrogel sheeting is a convenient and non-aggressive strategy for cooling and protecting the epidermis during and after laser and IPL procedures.

- Virtually no prism effect when performing procedures through Swiss Therapy™ sheeting
- Prevents the escape of tissue splatter and smoke plumes, while maximizing patient comfort

Number	Description		Qty/Box
10-08805	Swiss Therapy™ Sheet, 10 cm x 10 cm x 3.5 mm	Sterile	5
10-08806	Swiss Therapy™ Sheet, 7 cm x 12 cm x 3.5 mm	Sterile	5
10-08807	Swiss Therapy™ Sheet, 5 cm x 9 cm x 3.3 mm	Sterile	5

Swiss Therapy Pad Indications

- Can be used in with all laser systems (Q-switched, pulsed), and arc lamps in the therapeutic wavelength range of 500-1100nm without affecting transmission of the laser energy. Swiss Therapy should not be used with wavelengths less than 500nm or more than 1100nm or in laser therapies using lasers with integrated, liquid coolant based cooling systems.
- Non-ablative dermo-cosmetic medical laser products only.

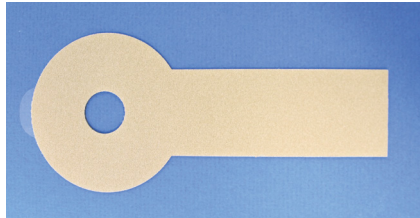
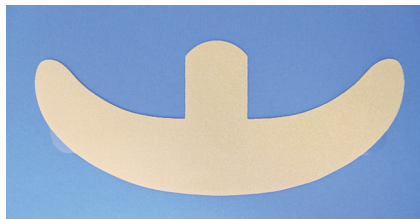
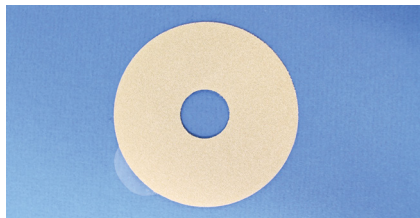
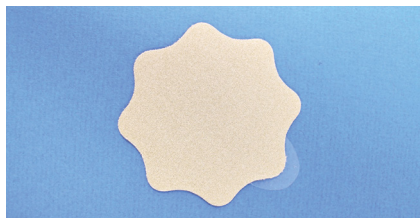
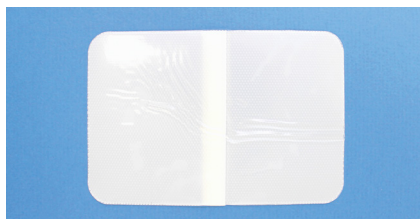
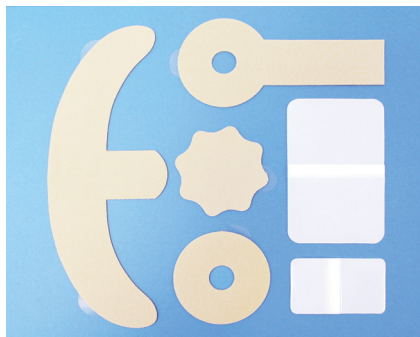

SILICONE SCAR SHEETS

Transparent, soft, elastic and self-adhesive sheet dressing. Effective in preventing the formation of new scars and reducing the appearance of existing scars. It is easily applied to all areas of skin including exposed or hard-to-treat areas like the face, ears, arms, hands and joints.

- Crystal clear 100% medical grade silicone gel sheeting
- Provides elastic protection to the skin for optimal scar healing
- Durable, comfortable and re-usable
- Various in shapes, sizes and backing colors
- No irritation, no maceration
- Latex free
- Trimmable
- Durable and reusable

Number	Description		Size	Gel Thickness	Qty/Box
12-75453	Sheet Dressing		75 mm x 45 mm	0.5 mm	10
12-12080	Sheet Dressing		120 mm x 80 mm	0.5 mm	10
12-07603	Nipple Cover	fabric backing	76 mm	0.3 mm	10
12-17603	Areola	fabric backing	76 mm	0.3 mm	10
12-17076	Mastopexy	fabric backing	170 mm x 76 mm	0.3 mm	10
12-25010	Anchor	fabric backing	250 mm x 100 mm	0.3 mm	10

INK SKIN MARKER

The first prep resistant ink skin marker to virtually eliminate the need for remarking of the patient even after prepping with common alcohol-based antiseptics such as ChloroPrep® or Duraprep™. Successful in millions of clinical trials, the XL features patent-pending ink that remains visible after prepping patients.

- Visible up to 10 times longer than traditional ink skin markers
- Ultra Fine Tip
- Sterile
- Includes ruler



Number	Description	Qty/Box
1448XLSR	XL Prep Resistant Ink	100

ELECTROCAUTERY DISSECTION MICRO-NEEDLE

- Blepharoplasty
- Incising Temporalis Fascia
- Otoplasty
- Bicornal flap
- Cleft lip revision
- Rhinoplasty
- Tungsten tip



Number	Description	Qty/Box
29-10000	55 mm long, exposed 3mm tip, straight blue insulated	1

CHIN IMPLANTS

- Soft and flexible implantable grade silicone, packaged sterile
- Tapered edges provide a natural appearance
- Trims easily for custom fitting
- White opaque color eliminates transillumination

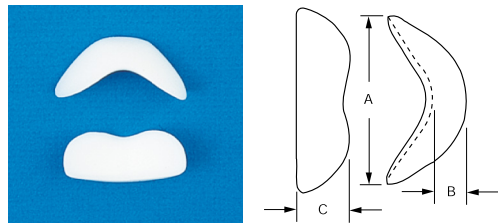
STANDARD CHIN

Catalog No.	A	B	C
SC-01	3.20 cm	0.50 cm	1.30 cm
SC-02	3.60 cm	0.60 cm	1.50 cm
SC-03	3.90 cm	0.70 cm	1.60 cm
SC-04	4.30 cm	0.90 cm	1.80 cm
SC-05	4.50 cm	0.90 cm	1.70 cm

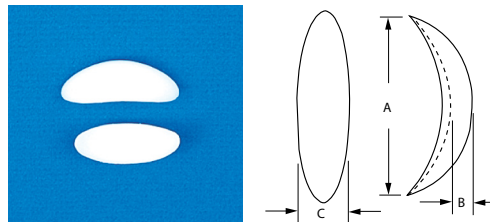
CONCAVE CHIN

Catalog No.	A	B	C
CC-01C	3.20 cm	0.40 cm	1.20 cm
CC-02C	3.40 cm	0.50 cm	1.40 cm
CC-03C	3.90 cm	0.60 cm	1.60 cm
CC-04C	4.20 cm	0.70 cm	1.70 cm
CC-05C	4.70 cm	0.85 cm	1.80 cm

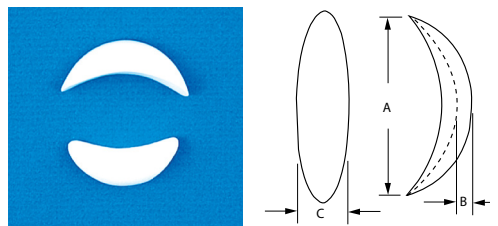
DEEP CONCAVE CHIN

Catalog No.	A	B	C
DCC-1XC	3.50 cm	0.45 cm	1.40 cm
DCC-2XC	3.60 cm	0.52 cm	1.40 cm
DCC-4XC	4.10 cm	0.70 cm	1.60 cm

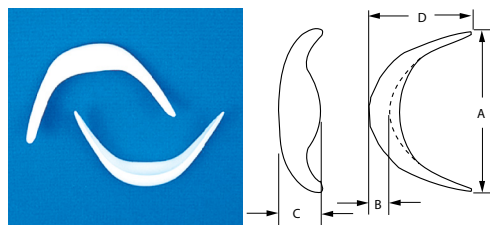
EXTENDED CHIN

Catalog No.	A	B	C	D
EC-01	7.60 cm	0.50 cm	1.60 cm	3.90 cm
EC-02	7.60 cm	0.70 cm	1.60 cm	4.40 cm
EC-03	7.60 cm	0.80 cm	1.70 cm	4.80 cm
EC-04	7.60 cm	0.90 cm	1.70 cm	4.90 cm

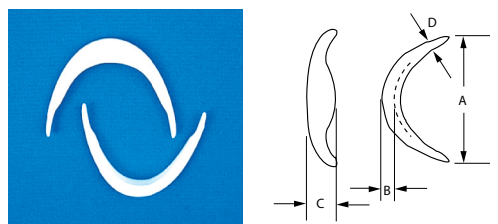
EXTENDED ANATOMICAL CHIN

Catalog No.	A	B	C	D
EAC-01	6.10 cm	0.60 cm	1.20 cm	0.27 cm
EAC-02	6.30 cm	0.70 cm	1.30 cm	0.27 cm
EAC-03	6.30 cm	0.80 cm	1.40 cm	0.27 cm
EAC-04	6.30 cm	0.90 cm	1.40 cm	0.27 cm

MALAR IMPLANTS

- Soft and flexible implantable grade silicone, packaged sterile
- Tapered edges provide a natural appearance
- Trims easily for custom fitting
- White opaque color eliminates transillumination

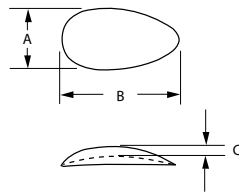
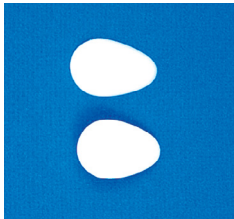

STANDARD MALAR			
Catalog No.	A	B	C
SM-01	2.00 cm	2.70 cm	0.40 cm
SM-02	2.20 cm	3.10 cm	0.50 cm
SM-03	2.50 cm	3.90 cm	0.60 cm
SM-04	2.80 cm	4.50 cm	0.50 cm
SM-05	3.40 cm	5.40 cm	0.60 cm

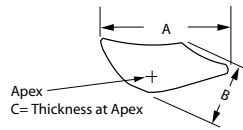
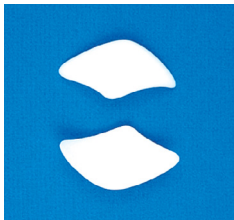

TRAPEZOIDAL MALAR			
Catalog No.	A	B	C
TM-01	4.10 cm	2.10 cm	0.35 cm
TM-02	4.50 cm	2.20 cm	0.40 cm
TM-03	5.00 cm	2.40 cm	0.45 cm
TM-04	5.40 cm	2.80 cm	0.50 cm

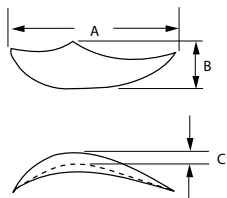

EXTENDED TRAPEZOIDAL MALAR			
Catalog No.	A	B	C
ETM-01	4.60 cm	1.80 cm	0.40 cm
ETM-02	4.90 cm	2.00 cm	0.50 cm
ETM-03	5.20 cm	2.20 cm	0.55 cm
ETM-04	5.50 cm	2.20 cm	0.60 cm

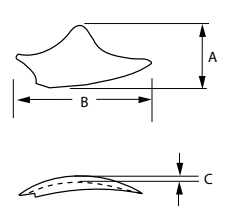

ANATOMICAL MALAR			
Catalog No.	A	B	C
AM-01	3.30 cm	4.20 cm	0.30 cm
AM-02	3.80 cm	4.50 cm	0.40 cm
AM-03	3.90 cm	4.80 cm	0.48 cm
AM-04	4.00 cm	5.40 cm	0.65 cm

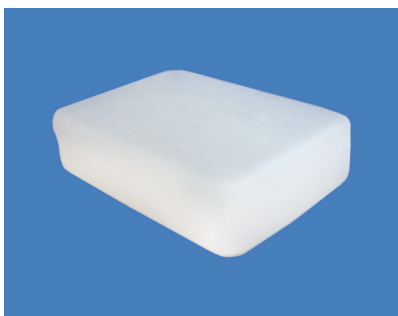

SILICONE BLOCKS

- Non-sterile
- Steam sterilizable
- Implantable grade silicone

SILICONE BLOCKS			
Catalog No.	A	B	C
SB-01	5.00 cm	3.00 cm	1.00 cm
SB-02	6.00 cm	4.00 cm	1.50 cm
SB-03	7.00 cm	5.00 cm	2.00 cm

NASAL DORSAL IMPLANTS

- Soft and flexible implantable grade silicone, packaged sterile
- Tapered edges provide a natural appearance
- Trims easily for custom fitting
- White opaque color eliminates transillumination
- Over 15 years of clinical history¹

¹Straith, R.E., Five, Long-Term Case Reports (Average 15 Years) of Saddlenose Correction Using Cast Silastic Implants. Plastic and Reconstructive Surgery, December, 1991.

NOTE: Custom prosthesis can be produced to physician's specifications. Sizes available for all implants.

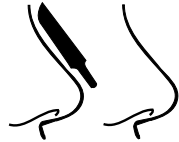

SERIES A, AC
Depression equal in both nasion and lower edge of upper lateral cartilage



SERIES B, BC
Depression only at lower edge of upper lateral cartilage



SERIES C, CC
Depression mostly in nasion area

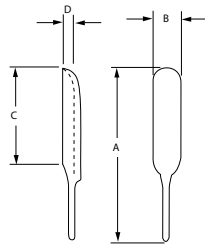

NASAL DORSAL SERIES A				
Catalog No.	A	B	C	D
ND-01A	5.80 cm	0.75 cm	3.50 cm	0.20 cm
ND-02A	5.80 cm	0.90 cm	3.50 cm	0.30 cm
ND-03A	5.80 cm	0.90 cm	3.50 cm	0.40 cm
ND-04A	5.80 cm	0.90 cm	3.50 cm	0.50 cm
ND-05A	5.80 cm	1.50 cm	3.50 cm	0.60 cm

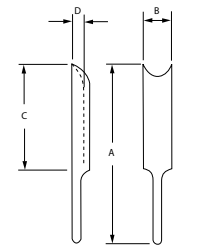
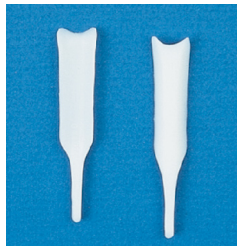

NASAL DORSAL SERIES AC				
Catalog No.	A	B	C	D
CND-1AC	5.80 cm	1.00 cm	3.50 cm	0.20 cm
CND-2AC	5.80 cm	1.00 cm	3.50 cm	0.30 cm
CND-3AC	5.80 cm	1.00 cm	3.50 cm	0.40 cm
CND-4AC	5.80 cm	1.00 cm	3.50 cm	0.50 cm
CND-5AC	5.80 cm	1.00 cm	3.50 cm	0.60 cm

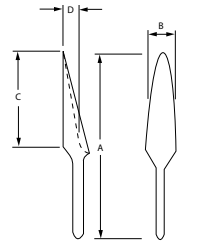
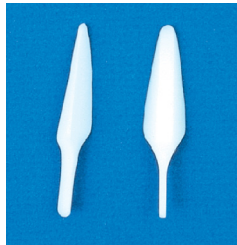

NASAL DORSAL SERIES B				
Catalog No.	A	B	C	D
ND-07B	5.80 cm	0.80 cm	3.50 cm	0.30 cm
ND-08B	5.80 cm	1.00 cm	3.50 cm	0.40 cm
ND-09B	5.80 cm	1.10 cm	3.50 cm	0.50 cm
ND-10B	5.80 cm	1.20 cm	3.50 cm	0.60 cm

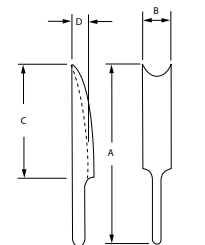
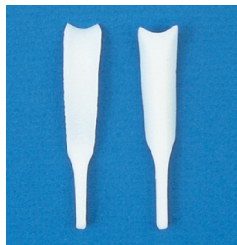

NASAL DORSAL SERIES BC				
Catalog No.	A	B	C	D
CND-9BC	5.80 cm	1.00 cm	3.50 cm	0.50 cm
CND-10BC	5.80 cm	1.00 cm	3.50 cm	0.60 cm
CND-11BC	5.80 cm	1.10 cm	3.50 cm	0.70 cm

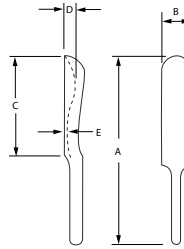
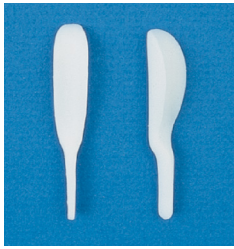

NASAL DORSAL SERIES C

Catalog No.	A	B	C	D	E
ND-11C	5.80 cm	1.00 cm	3.50 cm	0.40 cm	0.20 cm
ND-12C	5.80 cm	1.00 cm	3.50 cm	0.50 cm	0.30 cm
ND-13C	5.80 cm	1.00 cm	3.50 cm	0.50 cm	0.40 cm
ND-14C	5.80 cm	1.00 cm	3.50 cm	0.60 cm	0.20 cm

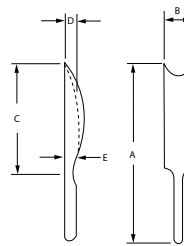

NASAL DORSAL CC

Catalog No.	A	B	C	D	E
CND-11CC	5.80 cm	1.00 cm	3.50 cm	0.40 cm	0.20 cm
CND-16CC	5.80 cm	1.10 cm	3.50 cm	0.60 cm	0.50 cm

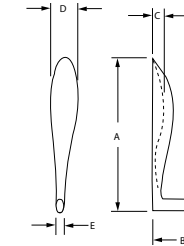

NASAL DORSAL SERIES COLUMELLA

Catalog No.	A	B	C	D	E
DC-06D	4.70 cm	3.00 cm	0.55 cm	1.10 cm	0.60 cm
DC-07D	4.80 cm	3.00 cm	0.60 cm	1.20 cm	0.60 cm
DC-08D	4.80 cm	3.10 cm	0.65 cm	1.20 cm	0.60 cm
DC-09D	4.80 cm	3.00 cm	0.45 cm	1.10 cm	0.60 cm
DC-10D	4.70 cm	2.90 cm	0.50 cm	1.10 cm	0.60 cm

NOTE: Custom prosthesis can be produced to physician's specifications. Call Invotec for details.

MEDICAL GRADE SILICONE SHEETING

Number	I.D. x O.D.	Qty/box
STERILE		
20-10680	55 mm x 75 mm x 1.0 mm (2.2 x 3.0 x .040")	5 pair
20-10680S	55 mm x 75mm x 1.0 mm (2.2 x 3.0 x .040")	10
20-10681	55mm x 75mm x 0.25mm (2.2 x 3.0 x .010")	10
20-10682	55 mm x 75 mm x 0.5 mm (2.2 x 3.0 x .020")	5 pair
20-10682S	55 mm x 75 mm x 0.5 mm (2.2 x 3.0 x .020")	10
20-10685	38 mm x 51 mm x .13 mm (1.5 x 2.0 x .005")	10
20-10685B	38 mm x 51 mm x .13 mm (1.5 x 2.0 x .005")	10
20-10686	55 mm x 75 mm x 1.5 mm (2.2 x 3.0 x .060")	5 pair
20-10686S	55 mm x 75 mm x 1.5 mm (2.2 x 3.0 x .060")	10
NON-STERILE		
20-20680	11 cm x 15 cm x 1.0 mm (4.5 x 6.0 x .040")	10
20-20682	11 cm x 15 cm x 0.5 mm (4.5 x 6.0 x .020")	10
20-20685	11 cm x 15 cm x .13 mm (4.5 x 6.0 x .005")	10
20-20686	11 cm x 15 cm x 1.5 mm (4.5 x 6.0 x .060")	10
20-30002	30 cm x 30 cm x .06 mm (12 x 12 x .0025")	1
20-30005	30 cm x 30 cm x .13 mm (12 x 12 x .005")	1
20-30007	30 cm x 30 cm x .18 mm (12 x 12 x .007")	1
20-30010	30 cm x 30 cm x .25 mm (12 x 12 x .010")	1
20-30015	30 cm x 30 cm x .38 mm (12 x 12 x .015")	1
20-30020	30 cm x 30 cm x .50 mm (12 x 12 x .020")	1
20-30030	30 cm x 30 cm x .75 mm (12 x 12 x .030")	1
20-30040	30 cm x 30 cm x 1.0 mm (12 x 12 x .040")	1
20-30050	30 cm x 30 cm x 1.25 mm (12 x 12 x .050")	1
20-30060	30 cm x 30 cm x 1.5 mm (12 x 12 x .060")	1
20-30015R	30 cm x 30 cm x .38 mm (12 x 12 x .015") Reinforced	1
20-30020R	30 cm x 30 cm x .50 mm (12 x 12 x .020") Reinforced	1
20-30030R	30 cm x 30 cm x .75 mm (12 x 12 x .030") Reinforced	1
20-30040R	30 cm x 30 cm x 1.0 mm (12 x 12 x .040") Reinforced	1

MEDICAL GRADE SILICONE TUBING

Number	I.D. x O.D.	Length
NON-STERILE		
50-01101	0.012 x 0.025	50'
50-01111	0.020 x 0.037	50'
50-01121	0.025 x 0.047	50'
50-01131	0.030 x 0.065	50'
50-01141	0.040 x 0.085	50'
50-01151	0.058 x 0.077	50'
50-01161	0.062 x 0.095	50'
50-01171	0.062 x 0.125	50'
50-01181	0.078 x 0.125	50'
50-01191	0.104 x 0.192	50'
50-01201	0.118 x 0.181	50'
50-01211	0.125 x 0.250	50'
50-01221	0.132 x 0.183	50'
50-01231	0.157 x 0.257	50'
50-01241	0.188 x 0.313	50'
50-01251	0.188 x 0.375	50'
50-01261	0.250 x 0.375	50'
50-01271	0.250 x 0.438	50'
50-01281	0.250 x 0.500	50'

IMPLANTABLE GRADE SILICONE BLOCKS

Number	A	B	C
SB-01	5.0 cm	3.0 cm	1.0 cm
SB-02	6.0 cm	4.0 cm	1.5 cm
SB-03	7.0 cm	5.0 cm	2.0 cm

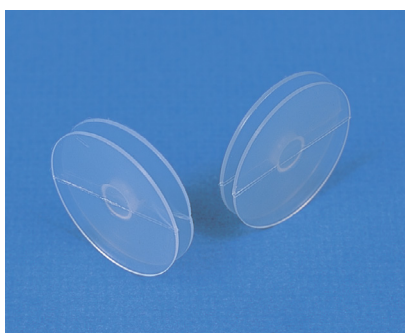

INVOTEC SEPTAL BUTTONS

- For non-surgical closure of nasal perforations
- Can reduce or eliminate crusting, epistaxis, and other symptoms of nasal perforations
- Soft 100% medical grade silicone for patient comfort and ease of insertion
- Provided sterile, ready to use
- Trim to size or custom sizes available upon request

Number	Description	Diameter	IFD	Post Ø	Qty/Box
20-10400	Nasal Septal Button	3.2 cm	2.5 mm	6 mm	Sterile 1
20-10400S	Nasal Septal Button	5.0 cm	1.5 mm	8 mm	Sterile 1

Reference: Kern, E.B., Facer, G.W., McDonald, T.J., Westood, W.B.

Closure of Nasal Septal Perforations with a Silastic Button: Results in 45 Patients. O.R.L. Digest, Vol. 39, July 1977.

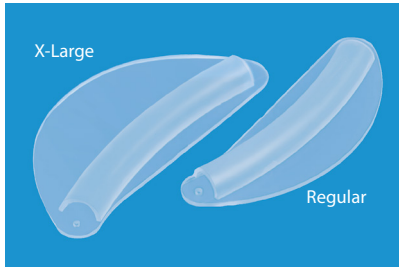

BREATHE-EASY™ SPLINT

Silicone nasal septal splint with integral airway

- Provides septal support
- Allows nasal breathing post-operative through integral airway
- Pre-punched hole in anterior tip for easier suturing to prevent dislodgement and aid in septal stabilization
- 100% medical grade silicone for ease of insertion and removal
- Provided sterile, ready to use

Number	Description	Size	Dimensions	Height	Qty/Box
20-10500	Breathe-Easy Nasal Splint	Regular	70mm x 25mm	6 mm	5 pair
20-10500BSP	Breathe-Easy Nasal Splint	Regular	70mm x 25mm	6 mm	50 pair
20-10510	Breathe-Easy Nasal Splint	X-Large	88mm x 40mm	6 mm	5 pair

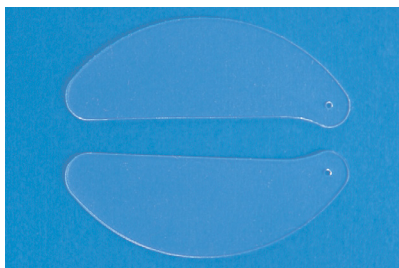

PRE-CUT™ SPLINT

Silicone nasal septal splint

- Provides septal support
- Pre-punched hole in anterior tip for easier suturing to prevent dislodgement and aid in septal stabilization
- 100% medical grade silicone for ease of insertion and removal
- Provided sterile, ready to use

Number	Description	Qty/Box
20-10505	Pre-Cut Nasal Splint	5 pair



DEMPSEY SPLINT

Fluoroplastic internal nasal splint

- 100% Fluoroplastic to reduce or prevent adhesions between the septum and lateral nasal wall by stabilizing the turbinates
- Easy insertion and removal
- Provided sterile, ready to use

Number	Description	Qty/Box
20-10602	Dempsey Medium	10 pair
20-10603	Dempsey Large	10 pair
20-10602C	Dempsey, Medium, Clear	10 pair
20-10603C	Dempsey, Large, Clear	10 pair

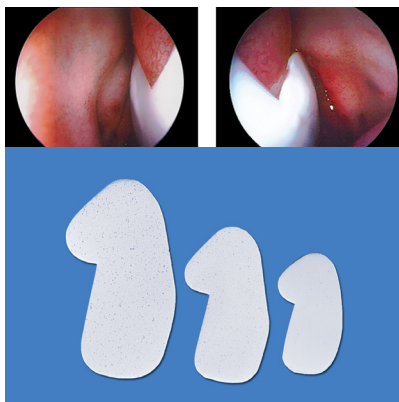

K-SPLINT™

Designed to be used for endoscopic sinus surgery or any other procedure where middle turbinate adhesions or lateralizations are problematic

- Easy to shape and configure to patient's septum and middle turbinate anatomy
- Available in four sizes to reduce sizing time in the operating room
- Made of easy to see white malleable fluoroplastic
- Supplied sterile for immediate surgical usage
- Designed by J. Patrick Shea, M.D.

Number	Description	Qty/Box
20-10640	Small	5 pair
20-10641	Medium/Small	5 pair
20-10642	Medium	5 pair
20-10644	Large	5 pair

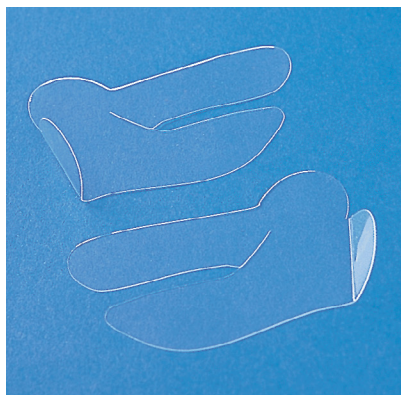

GUASTELLA/MANTOVANI™ INTERNAL NASAL SPLINT

- Designed for functional and/or aesthetic rhinosurgery of the septal valve nose tip and nasal pyramid
- Shaped to support the tip of the nose
- Made from 100% Fluoroplastic
- Packaged sterile, ready to use

Number	Description	Thickness	Qty/Box
20-10630	Guastella/Mantovani Internal Nasal Splint	.25mm	5 pair

Reference: Mantovani, M., Guastella, C., Mazzola, R.
 The Guastella/Mantovani Septal-Valve Splint: An Intranasal Biplanar and Multivectorial Orthopedic Device
 Plastic and Reconstructive Surgery, Vol. 106, August, 2000

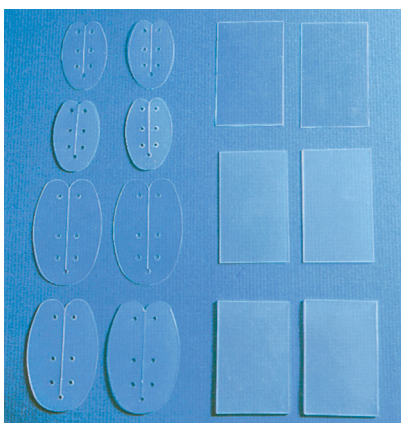

BIVALVE SPLINTS

Nasal Septal Splints

- 100% Fluoroplastic to reduce or prevent adhesions between the septum and lateral nasal wall
- Easy insertion and removal
- Pre-punched suture holes
- Over 30 years of clinical use
- Provided sterile and ready to use

CUSTOM-CUT™ SPLINTS

- Choice of 100% Fluoroplastic or 100% medical grade silicone
- Allows for custom design by the surgeon
- Provided sterile and ready to use
- Five thicknesses available

Number	Size	Description	Thickness		Qty/box
20-10650	Standard	Bivalve Splint	.25mm	Sterile	5 pair
20-10650S	Standard	Bivalve Splint	.25mm	Sterile	10 ea
20-10655	Standard	Bivalve Splint	.50mm	Sterile	5 pair
20-10655S	Standard	Bivalve Splint	.50mm	Sterile	10 ea
20-10660	Large	Bivalve Splint	.25mm	Sterile	5 pair
20-10660S	Large	Bivalve Splint	.25mm	Sterile	10 ea
20-10665	Large	Bivalve Splint	.50mm	Sterile	5 pair
20-10665S	Large	Bivalve Splint	.50mm	Sterile	10 ea
20-10670	38mm x 64mm	Custom-Cut Fluoroplastic	.25mm	Sterile	5 pair
20-10675	38mm x 64mm	Custom-Cut Fluoroplastic	.50mm	Sterile	5 pair
20-10680	55mm x 75mm	Custom-Cut Silicone	1.0mm	Sterile	5 pair
20-10680S	55mm x 75mm	Custom-Cut Silicone	1.0mm	Sterile	10 ea
20-10681	55mm x 75mm	Custom-Cut Silicone	.25mm	Sterile	10 ea
20-10682	55mm x 75mm	Custom-Cut Silicone	.50mm	Sterile	5 pair
20-10682S	55mm x 75mm	Custom-Cut Silicone	.50mm	Sterile	10 ea
20-10685	38mm x 50mm	Custom-Cut Silicone	.13mm	Sterile	10 ea
20-10685B	38mm x 50mm	Custom-Cut Silicone, Blue	.13mm	Sterile	10 ea
20-10686	55mm x 75mm	Custom-Cut Silicone	1.5mm	Sterile	5 pair
20-10686S	55mm x 75mm	Custom-Cut Silicone	1.5mm	Sterile	10 ea



SOFT-FORM™ THERMOPLASTIC NASAL SPLINT

- Standard sizes or exclusive Invotec's Custom-Cut™ to design your own
- Easy to apply - adhesive backing

Number	Description			Qty/Box
20-10100	External Nasal Splint	small	single	10
20-10101	External Nasal Splint	small	kit	5 kits*
20-10110	External Nasal Splint	regular	single	10
20-10111	External Nasal Splint	regular	kit	5 kits*
20-10120	External Nasal Splint	custom-cut, 2 x 3 in	single	10
20-10121	External Nasal Splint	custom-cut, 2 x 3 in	kit	5 kits*
20-10125	Large Sheet	8.5 x 11 in	Cut to size	1
20-10130	External Nasal Splint	large	single	10
20-10131	External Nasal Splint	large	kit	5 kits*

SOFT-FORM AL™ PADDED ALUMINUM NASAL SPLINT

- Easy to remove for patient comfort
- Three standard sizes
- Easy to apply - adhesive backing

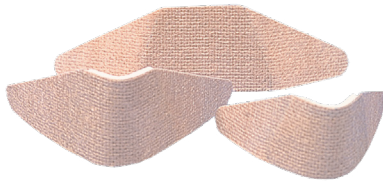

Number	Description			Qty/Box
20-10200	External Nasal Splint	small	single	10
20-10201	External Nasal Splint	small	kit	5 kits*
20-10210	External Nasal Splint	regular	single	10
20-10211	External Nasal Splint	regular	kit	5 kits*
20-10220	External Nasal Splint	large	single	10
20-10221	External Nasal Splint	large	kit	5 kits*

SOFT-FORM AL-D™ PADDED ALUMINUM NASAL SPLINT

- Three standard sizes
- Easy to apply - adhesive backing



Number	Description			Qty/Box
20-10300	External Nasal Splint	small	single	10
20-10301	External Nasal Splint	small	kit	5 kits*
20-10310	External Nasal Splint	regular	single	10
20-10311	External Nasal Splint	regular	kit	5 kits*
20-10320	External Nasal Splint	large	single	10
20-10321	External Nasal Splint	large	kit	5 kits*

* Con (1) (1) (1) (1) (1) (6)

SOFT-FORM AL-B™ ALUMINUM NASAL SPLINT

- Two standard sizes



Number	Description			Qty/Box
20-10300B	External Nasal Splint	small	single	10
20-10310B	External Nasal Splint	medium	single	10

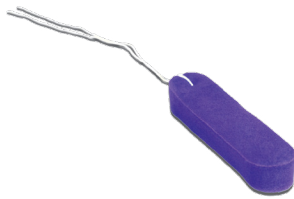

PVA+™ SPONGE PACKING

- Bacteriostatic agent inhibits the growth of bacteria* on the sponge for up to 7 days
- PVA+ helps reduce odor caused by bacteria compared to standard PVA
- Ideal for Nasal, Epistaxis or Sinus control
- Double compressed for easy insertion
- PVA+ is biocompatible, bacteriostatic, and very hydrophilic

Number	Description	Dimensions	Qty/Box
22-66400	PVA+ Nasal Dressing, Small	4.5 x 1.5 x 2 cm	10
22-66402	PVA+ Nasal Dressing, Large	8.0 x 1.5 x 2 cm	10
22-66406	PVA+ Epistaxis Dressing, Large	10 x 1.5 x 2.5 cm	10
22-66409	PVA+ Standard Nasal Dressing with Airway, Small	4.5 x 1.5 x 2.0 cm	10
22-66410	PVA+ Standard nasal Dressing with Airway, Large	8.0 x 1.5 x 2.0 cm	10
22-66411	PVA+ Anatomical Nasal Tampon with Airway	8.0 x 1.5 x 3.0 cm	10
22-66413	PVA+ Anatomical Nasal Tampon	8.0 x 1.5 x 3.0 cm	10
22-66421	PVA+ Epistaxis Dressing, Small	5.5 x 1.5 x 2.5 cm	10
22-66426	PVA+ Sinus Dressing, Small	3.5 x 0.9 x 1.2 cm	10
22-66427	PVA+ Sinus Dressing	2.5 x 0.9 x 2.0 cm	10
22-66428	PVA+ Sinus Dressing	4.5 x 0.9 x 2.0 cm	10

*Yersinia Enterocolitica, Serratia Mecesens and Bacillus Subtilis

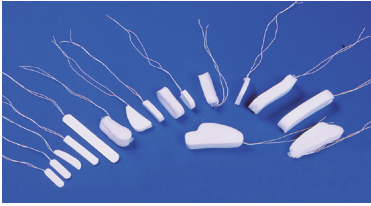

PVA SPONGE PACKING

- Soft, comfortable and conforming
- Packaged compressed and sterile
- Easily trimmed with scissors
- Small pore size minimizes tissue ingrowth



Standard

Invotec Number	Merocel® Number	Description	Dimensions	Qty/Box
22-60400	440400	Nasal Dressing, small	4.5 x 1.5 x 2.0 cm	10
22-60400P	400400	Nasal Dressing without string, small	4.5 x 1.5 x 2.0 cm	10
22-60402	440402	Nasal Dressing, large	8.0 x 1.5 x 2.0 cm	10
22-60402P	400402	Nasal Dressing without string	8.0 x 1.5 x 2.0 cm	20
22-60409	440409	Nasal Dressing with airway, small	4.5 x 1.5 x 2.0 cm	10
22-60409P	400409	Nasal Dressing with airway without string	4.5 x 1.5 x 2.0 cm	10
22-60410	440410	Nasal Dressing, with airway, large	8.0 x 1.5 x 2.0 cm	10
22-60410P	400410	Nasal Dressing, with airway without string, large	8.0 x 1.5 x 2.0 cm	10

Anatomical

22-60411	440411	Anatomical Nasal Tampon with airway	8.0 x 1.5 x 3.0 cm	10
22-60411P	400411	Anatomical Nasal Tampon with airway without string	8.0 x 1.5 x 3.0 cm	10
22-60413	440413	Anatomical Nasal Tampon	8.0 x 1.5 x 3.0 cm	10
22-60413P	400413	Anatomical Nasal Tampon without string	8.0 x 1.5 x 3.0 cm	10
22-60414	440413	Slimline Anatomical Nasal Tampon	8.0 x .75 x 3.0 cm	10

Epistaxis Products

22-60406	440406	Posterior Epistaxis Tampon	10.0 x 1.5 x 2.5 cm	10
22-60406P	400406	Posterior Epistaxis Tampon without string	10.0 x 1.5 x 2.5 cm	10
22-60421	400421	Anterior Epistaxis Tampon	5.5 x 1.5 x 2.5 cm	10

Sinus Packs and Dressings

22-60423	400423	Sinus Kit	4.5cm sinus, 7.5cm nasal	10 pair
22-60426	400426	Sinus Dressing	3.5 x 0.9 x 1.2 cm	10 pair
22-60427	400427	Sinus Dressing	2.5 x 0.9 x 2.0 cm	10 pair
22-60428	400428	Sinus Dressing	4.5 x 0.9 x 2.0cm	10 pair
22-60530	400530	Sinus Dressing, slim	3.5 x 0.6 x 1.2 cm	10 pair
22-60531	400531	Sinus Dressing, slim	2.5 x 0.6 x 2.0 cm	10 pair
22-60582	400582	Sinus Dressing, slim	4.5 x 0.6 x 2.0 cm	10 pair



GELATIN SPONGES AND FILM USP

Indicated for use to control minimal bleeding by tamponade effect, blood absorption and platelet aggregation following ENT surgery and to prevent adhesions in the nasal cavity. Gelitan sponges are effective in supporting the new graft in the outer ear canal after tympanoplasty and buttressing middle ear implants.

Number	Description	Dimensions	Size	Qty/Box
EQU60-20-07	EquiSpon® Sponge	60 x 20 x 7 mm	12-7	Sterile 10
EQU125-80-10	EquiSpon® Sponge	125 x 80 x 10 mm	100	Sterile 5
EQUF200-70-05	EquiSpon® Film	200 x 70 x 5.0 mm		Sterile 10
EQU80-50-10	EquiSpon® Sponge	80 x 50 x 10 mm	50	Sterile 10

EQUI-SPON® POWDER

Number	Description	Qty/Box
EQP-01	Equi-Spon® Powder, 1 gram	Sterile 4
EQP-01K	Equi-Spon® Hemostat Kit Includes: Two (2) 10 cc LL syringes, 18g needle, Flexible applicator cannula, 1gm Equi-Spon Porcine Powder with Mixing container	Sterile 5

GELITAN SPONGE TAMPON

Number	Description	Dimensions	Qty/Box
EQU80-30-00	Gelitan Sponge, Fenestrated Cylinder	80 x 30 mm	Sterile 5

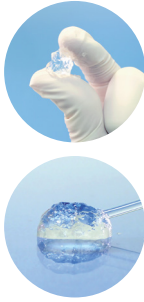

PureRegen™

Injectable Crosslinked Hyaluronic Acid Nasal Packing and Stent

PureRegen® injectable nasal packing is formulated to be used as a nasal dressing and stent, separating nasal structures following nasal and sinus surgical procedures.

PureRegen® bioresorbable nasal packing and stent is a non-pyrogenic, transparent, specifically formulated viscoelastic gel of self-cross-linked hyaluronan derived from nonanimal sources. This patented formulation ensures the material maintains the best possible stability during its storage and clinical use. Unlike esterified HA, PureRegen® Gel has not been reported as osteogenic in the nasal cavities.

PureRegen® Gel absorbs body fluids and blood resulting in its expansion gradually up to 50% by volume. The volume of the injected gel secures its initial stability within sinus cavity and controls minimal bleeding by tamponade effect.

- Controls minimal bleeding and oozing
- Clinically tested effective adhesion prevention
- Facilitates wound healing and functional mucociliary regeneration
- Provides moist wound environment
- Degradable - No need for painful traumatic removal
- Predictable retention - Gradually resorbs over 7-14 days

Number	Description	Qty/ Box
PR-00005	PureRegen™ gel 5 ml prefilled glass syringe with malleable cannula, sterile	1

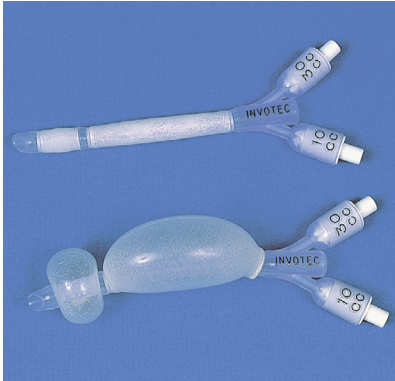

ULTRA-STAT™

Epistaxis nasal balloon with integral airway

- Designed for fast control of intra-nasal bleeding and patient comfort
- Bevelled posterior tip and soft silicone construction provide for easy placement
- Two silicone balloons independently filled facilitate pressure control in both the anterior and posterior chambers
- 100% soft medical grade silicone for patient comfort when inserting
- Integral airway allows for nasal breathing
- Silicone construction prevents adhesion for easy removal
- Provided sterile with or without inflation syringe

Number	Description		Qty/Box
20-10700	Ultra-Stat Epistaxis Balloon with syringe	Sterile	1
20-10701	Ultra-Stat Epistaxis Balloon	Sterile	1

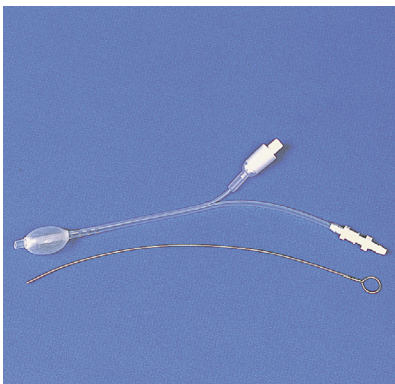

POST-STAT™

Posterior nasal packing and suction channel

- Excellent for control of posterior intra-nasal bleeding
- Low profile design to maximize working space
- Multi-port suction/irrigator catheter inhibits clogging and provides for clear working area
- Soft silicone construction provides for low cuff pressure and re-sterilization
- Silicone construction prevents adhesion for easy removal
- Provided sterile with inflation syringe

Number	Description		Qty/Box
20-10710	Post-Stat Epistaxis Balloon with syringe	Sterile	1



QUICK-PACK™

With airway

- Designed for nasal packing following septal, rhinoplasty, or other intra-nasal procedures
- 100% medical grade silicone reduces or prevents adhesion allowing for patient comfort in use and during removal
- Integral airway allows for nasal breathing
- Provided sterile with inflation syringe

Number	Description		Qty/Box
20-10715	Quick-Pack Nasal Packing with syringe	Sterile	2



Number	Description			Qty/Box
65-8900	Spear Tip with handle	Angled	Sterile	4
65-8920	Sickle Tip with handle	Straight	Sterile	4
65-9610	Uncinate with handle		Sterile	4

R&CS ACC



Number	Description			Qty/Box
65-6001	Septotome	Angled 90°	Sterile	6

DISPOSABLE SUCTIONS

R&CS ACC

DIS

OTO ACC

OSS

LAR ACC

SPE ACC

RHI INS

PSB

OTO INS

LAR INS

ORO/NAS INS



HOUSE/HOUGH STYLE HANDLE

- Used as a connector between the suction tip and the suction tubing
- Sterile, packaged in individual peel pouch

Rhinologic / Otologic

Number	Description	Qty/Box
30-10001	Suction Controller, black	20
30-10000	Elongated House/Hough style handle with finger control hole, 3"	20

HANDLES

Number	Description	Qty/Box
NZ3238-100	Suction controller, black, with finger hole	100

METAL SUCTION TIP

- Applicable for ear examinations, suction of wax and other fluids, paracentesis
- The curved angle is specially designed for microscopic examination and surgery
- Quick connector suction tip handle is easy to change during surgery
- Sterile, packaged in individual peel pouch
- Available in broad variety of lumen sizes



Rhinologic

Number	Description	Color	Qty/Box
30-08004	0.4 mm x 80 mm	Gray	20
30-08007	0.7 mm x 80 mm	Black	20
30-07010	1.0 mm x 70 mm, 3 Fr	White	20
30-08010	1.0 mm x 80 mm, 3 Fr	White	20
30-07014	1.4 mm x 70 mm, 4 Fr	Red	20
30-08014	1.4 mm x 80 mm, 4 Fr	Red	20
30-08020	2.0 mm x 80 mm, 14 g, 6 Fr	Green	20
30-08025	2.5 mm x 80 mm, 7.5 Fr	Transparent	20
30-08030	3.0 mm x 80 mm, 9 Fr	Transparent	20
30-08040	4.0 mm x 80 mm, 12 Fr	Transparent	20
30-10010	1.0 mm x 100 mm, 3 Fr	White	20
30-10014	1.4 mm x 100 mm, 4 Fr	Red	20
30-10020	2.0 mm x 100 mm, 6 Fr	Green	20
30-10025	2.5 mm x 100 mm, 7 Fr	Transparent	20
30-10030	3.0 mm x 100 mm, 9 Fr	Transparent	20

DIS

DIS

METAL ROSEN-HOUSE STYLE SUCTION NEEDLE

Number	Description	Dimensions	Color	Qty/Box
30-07004	Micro suction tip	0.4 mm x 70 mm, 26 G	Gray	20
30-08004	Micro suction tip	0.4 mm x 80 mm, 26 G	Gray	20
30-07007	Micro suction tip	0.7 mm x 70 mm, 22 G	Black	20
30-08007	Micro suction tip	0.7 mm x 80 mm, 22 G	Black	20
30-07010	Micro suction tip	1.0 mm x 70 mm, 20 G, 3 Fr	White	20
30-07014	Micro suction tip	1.4 mm x 70 mm, 18 G, 4 Fr	Red	20
30-08014	Suction tip	1.4 mm x 80 mm	Red	20
30-07020	Suction tip	2.0 mm x 70 mm, 14 G, 5 Fr	Green	20
30-08020	Suction tip	2.0 mm x 80 mm	Green	20
30-08030	Micro suction tip	3.0 mm x 80 mm, 9 Fr	Transparent	20
30-08040	Suction tip	4.0 mm x 80 mm	Transparent	20

FRAZIER/FERGUSON NASAL STYLE SUCTION

- Designed for Rhinology surgery or examination
- Suction tip made of medical grade stainless steel
- Sterile, packed in individual peel pouch
- Available with one side hole (velvet eye) at tip end to avoid biopsy effect (tissue damage)

Number	Description / Dimensions	Color	Qty/Box
30-14020	2.0mm x 140 mm, 6 Fr		10
30-14030	3.0mm x 140 mm, 9 Fr		10
30-14040	4.0mm x 140 mm, 12 Fr		10

SUCTION TUBING

Number	Description	Length	Qty/Box
66153510	Suction Tubing for metal tips	PVC 3.5 mm length	5

OTOLOGY

ACCESSORIES

R&CS ACC

DIS

OTO ACC

OSS

LAR ACC

SPE ACC

RHI INS

PSB

OTO INS

LAR INS

ORO/NAS INS



EAR PROTECTOR KITS

- Lightweight yet stable, will not slide
- Adjustable velcro straps
- Comfortable
- Latex-free
- Easy to apply
- Exerts even, consistent pressure
- Sterile

Number	Description		Qty/Box
90-11000	Hard Ear Dressing Kit - adult size Includes: 10 - 4 x 4" gauze sponges, 1 Telfa™ pad	Sterile	10 kits
90-15005	Soft Ear Dressing Kit Includes: 4 - 4 x 4" gauze sponges, 1 Telfa™ pad	Sterile	10 kits

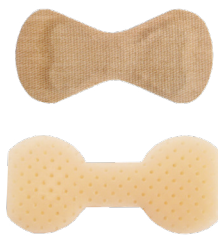

MALLEABLE EAR DRESSING

- A soft malleable bandage that can conform to and retain the shape of the external ear
- Smooth, non-adherent silicone surface with a thin malleable metallic layer
- As suggested by Frederick Godley, MD, Providence, RI

Number	Description	Qty/Box
90-20000	Malleable ear compression dressing	10
90-21000	Thermoplastic ear compression dressing	5

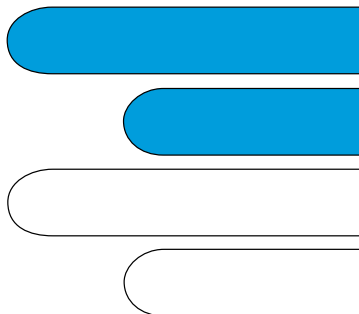

OTOLOGY PACKING STRIPS

- Designed to protect the tympanic membrane following middle ear surgery
- Available in blue to provide greater visibility in the ear canal
- Rosette packing
- Provided sterile, 3 per pack

Number	Description	Dimensions	Qty/Box
27-10000	Clear silicone	6 x 20 x 0.13 mm	30
27-10000B	Blue silicone	6 x 20 x 0.13 mm	30
27-10001	Clear silicone	6 x 40 x 0.13 mm	30
27-10001B	Blue silicone	6 x 40 x 0.13 mm	30
20-10685	Clear silicone sheeting	38 x 50 x 0.13 mm	10
20-10685B	Blue silicone sheeting	38 x 50 x 0.13 mm	10

For a complete line of silicone sheeting available see Sheeting and Tubing.

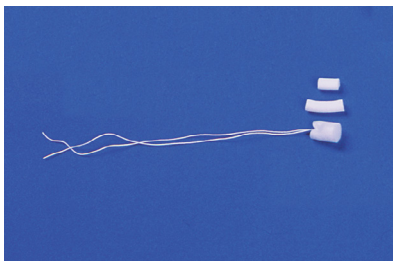

EAR WICKS

- PVA ear packs are soft, comfortable, conforming, absorbs quickly and expands evenly
- Packaged compressed and sterile

Number	Description	Dimensions	Qty/Box
22-60108	Ear Wick	9 mm x 15 mm	20
22-65108	Ear Wick	9 mm x 15 mm	50
22-60110	Ear Wick - long	9 mm x 24 mm	20
22-65110	Ear Wick - long	9 mm x 24 mm	50
22-66108	PVA+ Ear Wick	9 mm x 15 mm	20
22-66110	PVA+ Ear Wick	9 mm x 24 mm	20

OTO ACC



ULTRABUR OTOLOGIC DRILL

- Hand-held microdrill for stapedotomy, stapedectomy, and fashion of homo/auto bone grafts
- Narrow, lightweight design allows for better visualization in middle ear
- Speed: 7,000 rpm max
- Provided sterile

Number			Qty/Box
10-3030	Diamond tip	0.6 mm	1
10-3031	Diamond tip	0.7 mm	1
10-3038	Diamond tip	0.8 mm	1

OTO ACC

BURS

- Designed for use with straight shank drill systems and Xomed® power hand pieces
- Multiple uses
- Provided sterile

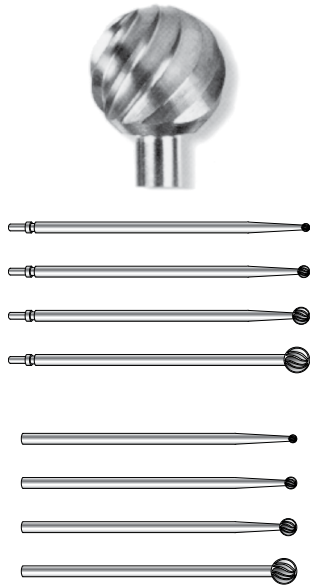

Round Carbide

Number w/ Notch	w/o Notch	Head Diameter (mm)	Length (mm)	Number of Flutes
BC-70050	BC-70050P	0.5	70	4
BC-70100	BC-70100P	1.0	70	6
BC-70150	BC-70150P	1.5	70	6
BC-70200	BC-70200P	2.0	70	6
BC-70250	BC-70250P	2.5	70	6
BC-70300	BC-70300P	3.0	70	8
BC-70350	BC-70350P	3.5	70	8
BC-70400	BC-70400P	4.0	70	8
BC-70450	BC-70450P	4.5	70	10
BC-70500	BC-70500P	5.0	70	10
BC-70550	BC-70550P	5.5	70	10
BC-70600	BC-70600P	6.0	70	10
BC-70650	BC-70650P	6.5	70	10
BC-70700	BC-70700P	7.0	70	12
BC-70000	BC-70000P	Complete Set - one of each		

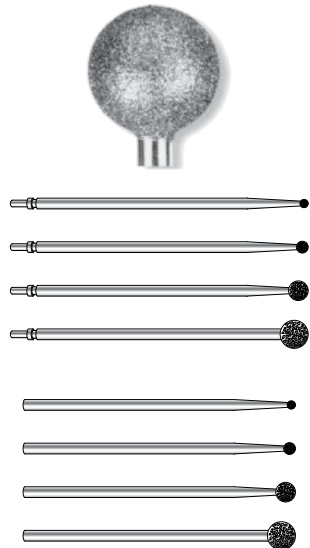

Round Diamond Bur

Number w/ Notch	w/o Notch	Head Diameter (mm)	Length (mm)	Style
BD-70050	BD-70050P	0.5	70	Diamond
BD-70100	BD-70100P	1.0	70	Diamond
BD-70150	BD-70150P	1.5	70	Diamond
BD-70200	BD-70200P	2.0	70	Diamond
BD-70250	BD-70250P	2.5	70	Diamond
BD-70300	BD-70300P	3.0	70	Diamond
BD-70350	BD-70350P	3.5	70	Diamond
BD-70400	BD-70400P	4.0	70	Diamond
BD-70500	BD-70500P	5.0	70	Diamond
BD-70600	BD-70600P	6.0	70	Diamond
BD-70000	BD-70000P	Complete Set - one of each		

Q225300

Bur Rack - Holds 34 straight shaft burs, length 70 mm

Xomed® is a registered trademark of Medtronic - Xomed

MYRINGOTOMY MICRO BLADES, MALLEABLE TAPERED SHAFT

• Sterile



Number	Description			Qty/Box
60-08230	Micro Otologic Blade	Upcutting	Angled	6
60-08231	Micro Otologic Blade	Downcutting	Angled	6
60-08232	Micro Otologic Blade	Razor	Straight shank	6
60-08233	Micro Otologic Blade	Spear	Angled	6
60-08234	Micro Otologic Blade	Spear	Straight shank	6
60-44820	Stainless steel handle for tapered blades			1

MYRINGOTOMY KNIVES AND BLADES, FLAT SHAFT ANGLED

• Sterile

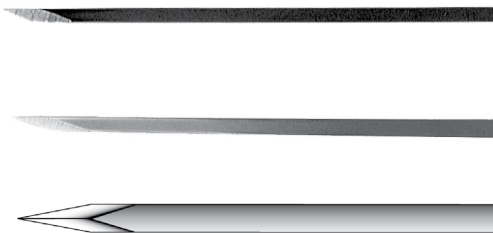

Number	Description			Qty/Box
60-45010	Lance	Adult	Down cut	6
60-45020	Lance w/ handle	Adult	Down cut	6
60-45030	Lance	Adult	Up cut	6
60-45040	Lance	Pediatric	Down cut	6
60-45050	Lance with handle	Pediatric	Down cut	6
60-45070	Spear	Pediatric		6
60-45080	Spear with handle	Pediatric		6
65-8154	Narrow arrow knife		Straight	6

MULTI-USE MYRINGOTOMY KNIVES WITH PROTECTIVE CAP

• Non-sterile, Auto-clavable

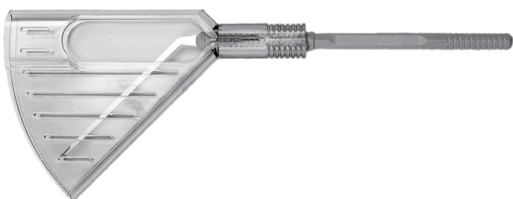

Number	Description		Qty/Box
34-2123	Lance	up cut	3
34-2124	Lance	down cut	3

TYMPANOPLASTY BLADES

• Sterile

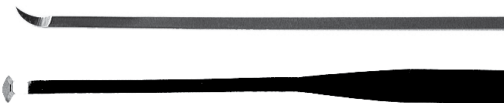

Number	Description		Qty/Box
60-46080	Tympanoplasty	angled	6
60-46090	Tympanoplasty	straight	6
60-46100	Sickle blade		6

SPECIALTY MINI BLADES

• Sterile



Number	Description		Qty/Box
65-6400	Round tip sharp		12
65-6500	15° pointed		12
65-6600	Lamellar blade straight		6
65-6900	Straight 180° cutting surface		6

OTO ACC

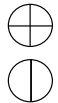
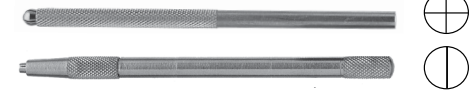
MYRINGOTOMY KNIVES AND BLADES, MALLEABLE ROUND SHAFT

• Sterile

Number	Description			Qty/Box
60-44010	Lance	Straight shaft	Adult	6
60-44015	Lance	Angled shaft	Adult	6
60-44020	Lance w/ handle	Straight shaft	Adult	6
60-44025	Lance w/ handle	Angled shaft	Adult	6
60-44040	Lance on round handle	Straight shaft	Pediatric	6
60-44045	Lance on round handle	Angled shaft	Pediatric	6
60-44046	Lance on round handle	Angled shaft	Pediatric	6
60-44023	Lance w/ handle	Straight shaft		6
60-40716	Lance w/ flat black handle	Straight shaft		6
60-44070	Spear Tip	Straight shaft	Pediatric	6
60-44075	Spear Tip	Angled shaft	Pediatric	6
60-44080	Spear Tip w/ handle	Straight shaft	Pediatric	6
60-44085	Spear Tip w/ handle	Angled shaft	Pediatric	6
65-8324	Bayonet Spear - w/ handle			6
60-40715	Sickle w/ flat black handle	Straight shaft		6
60-45090	Sickle knife	Straight shaft		6
60-44090	Sickle tipped knife on round handle	Round shaft		6

STAINLESS STEEL CHUCK STYLE HANDLES

• Non-Sterile

Number	Description		Qty/Box
60-44200	Stainless steel handle for flat stock knives	10 cm	1
60-44210	Stainless steel handle for round stock knives	10 cm	1
60-44820	Stainless steel handle for tapered knives		1
60-44201	Replacement collet for handle #60-44200		1



EAR CURETTE

- Non-Sterile
- Carbon fiber filled nylon

Number	Description		Qty/Box
NZ3431-100	Ear Curette	3mm loop	100
NZ3432-100	Ear Curette	2.5mm loop	100
NZ3441-100	Cerumen Hook, non-sterile		100
NZ3461-100	Rosen needle, slight curve		100

OTO ACC

Phenol Applicator

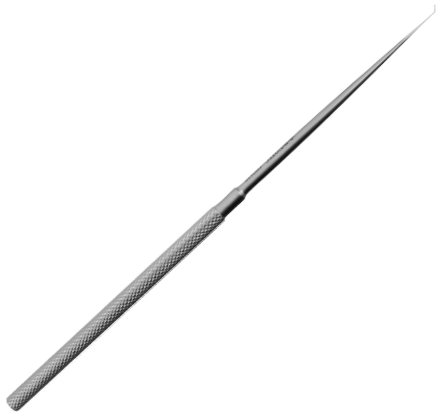

- Reusable

Number	Description	Qty/Box
O99610	Phenol applicator	1

OTO ACC

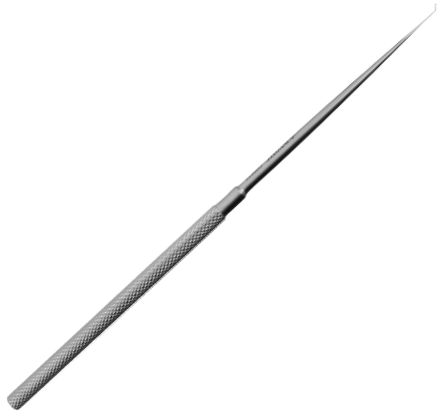

- Reusable

Number	Description	Qty/Box
O99610	Phenol applicator	1



INVOTEC EAR SPECULA

- New oval design of the cone and oblique cut end for improved line of sight
- New, wider, rim on the grip side for better stability when hand held
- For examination procedures
- Fits Peter’s or Siegler’s pneumatic otoscopes
- Hygienically packed
- Latex and PVC-free

Number	Description	Qty/Box
Sterile		
606625S	2.5 mm specula	10
606640S	4 mm specula	10
606650S	5 mm specula	10
606660S	6 mm specula	10
606670S	7 mm specula	10
606680S	8 mm specula	10
Non-Sterile		
606625	2.5 mm specula	20
30-00030	3.0 mm specula	20
30-30040	4 mm specula	20
30-00050	5 mm specula	20
30-00060	6 mm specula	20
606670	7mm specula	20
606680	8mm specula	20

OTO ACC



DISPOSABLE MYRINGOTOMY KIT

- A ready made kit for Paracentesis Surgery
- Sterile, single-use

Number	Description	Qty/Box
NZ3246	Myringotomy Kit: (1) Myringotomy Knife, (1) Jobson Home Probe, (1) Rosen Inserter, (2) Bent suction tubes -16g and 20g, (1) Suction controller, (3) Specula - 4 mm, 5 mm, and 6 mm.	1
NZ3248B-5	Myringotomy Kit with 8 cm Forceps: (1) Myringotomy Knife, (1) Jobson Home Probe, (1) Rosen Inserter, (2) Bent suction tubes -16g and 20g, (1) Suction controller, (3) Specula - 4 mm, 5 mm, and 6 mm, (1) Forceps - Stainless Steel - 7, Jaw.	1
NZ3270	Myringotomy Kit with Stainless Steel Forceps: (1) Myringotomy Knife, (1) Jobson Home Probe, (1) Rosen Inserter, (2) Bent suction tubes -16g and 20g, (1) Suction controller, (3) Specula - 4 mm, 5 mm, and 6 mm, (1) Forceps - Stainless Steel - 3.5 mm, Jaw.	1
NZ3271B-5	Pediatrics Myringotomy Kit: (1) Myringotomy Knife, (1) Jobson Home Probe - Oval, (1) Rosen Inserter, (2) Bent suction tubes -16g and 18g, (1) Suction controller, (3) Ear Specula - 3 mm, 4 mm, and 5 mm, (1) Forceps - Stainless Steel - Ultra fine.	1

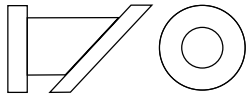
ARMSTRONG GROMMET

Number	Description	Material	ID	Qty/Box
23-50800	Armstrong Grommet	Sterile Silicone	1.14 mm	10

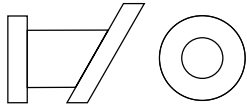
MODIFIED ARMSTRONG GROMMET

Number	Description	Material	ID	Qty/Box
23-40810	Modified Armstrong Grommet	Sterile FLPL	1.14 mm	10

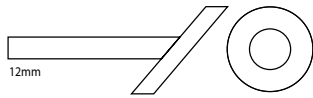
ARMSTRONG STRAIGHT SHANK

Number	Description	Material	ID	Qty/Box
23-50801	Armstrong Straight Shank	Sterile Silicone	1.14 mm	10

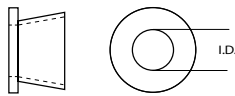
BAXTER BUTTON

Number	Description	Material	ID	Qty/Box
23-41300	Tapered Lumen	Sterile FLPL	1.27 mm	10

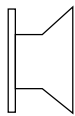
BEVELED BOBBIN

Number	Description	Material	ID	Qty/Box
23-41310	Beveled Bobbin	Sterile FLPL	1.14 mm	10

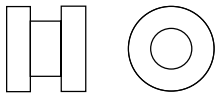
DONALDSON STYLE

Number	Description	Material	ID	Qty/Box
23-40200	Donaldson Grommet	Sterile FLPL	1.14 mm	10
23-40201	Donaldson Grommet with wire	Sterile FLPL	1.14 mm	10
23-50200	Donaldson Grommet with tab	Sterile Silicone	1.14 mm	10
23-50210	Donaldson Grommet without tab	Sterile Silicone	1.14 mm	10

MINI TEF FLUOROPLASTIC

Number	Description	Material	ID	Qty/Box
23-42076	Invotec Tiny Tef	Sterile FLPL	0.76 mm	10

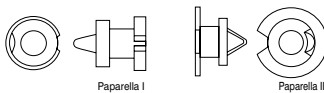
PAPARELLA STYLE

Number	Description	Material	ID	Qty/Box
23-50700	Paperella I	Sterile Silicone	1.00 mm	10
23-50720	Paperella I	Sterile Silicone	1.14 mm	10
23-50710	Paperella II	Sterile Silicone	1.50 mm	10

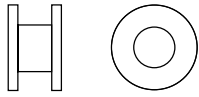

POPE BEVELED GROMMET

Number	Description	Material	ID	Qty/Box
23-41800	Angled Flanges, Blue	Sterile PE	1.14 mm	10

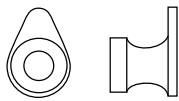

REUTER BOBBIN STYLE

Number	Description	Material	ID	Qty/Box
23-40400	Reuter Bobbin	Sterile FLPL	1.14 mm	10
23-40400B	Reuter Bobbin - Blue	Sterile FLPL	1.14 mm	10
23-40401	Reuter Bobbin with wire	Sterile FLPL	1.14 mm	10
23-60400	Reuter Bobbin	Sterile Titanium	1.14 mm	10
23-60401	Reuter Bobbin with wire	Sterile Titanium	1.14 mm	10
23-60427	Reuter Bobbin	Sterile Titanium	1.27 mm	10
23-61401	Reuter Bobbin	Sterile Titanium	1.09 mm	10



SHAH STYLE

Number	Description	Material	ID	Qty/Box
23-40500	Shah Grommet	Sterile FLPL	1.14 mm	10
23-40501	Shah Grommet with wire	Sterile FLPL	1.14 mm	10

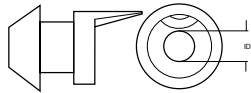

SHEA PARASOL VENT TUBE

Number	Description	Material	ID	Qty/Box
23-50536	Shea Parasol with tab	Sterile Silicone	1.02 mm	10

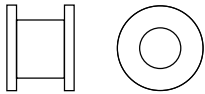

SHEEHY COLLAR BUTTON

Number	Description	Material	ID	Qty/Box
10076	Sheehy Collar Button	Sterile Titanium	0.76 mm	10
10100	Sheehy Collar Button	Sterile Titanium	1.0 mm	10
10100-F	Sheehy Collar Button	Sterile Titanium	1.0 mm	10
10125	Sheehy Collar Button	Sterile Titanium	1.25 mm	10
10125-F	Sheehy Collar Button	Sterile Titanium	1.25 mm	10
10150	Sheehy Collar Button	Sterile Titanium	1.50mm	10
10150-F	Sheehy Collar Button	Sterile Titanium	1.50mm	10
23-40300	Sheehy Collar Button	Sterile FLPL	1.27mm	10
23-40300B	Sheehy Collar Button - Blue	Sterile FLPL	1.27mm	10
23-40301	Sheehy Collar Button with wire	Sterile FLPL	1.27mm	10
23-50300	Sheehy Collar Button	Sterile Silicone	1.27mm	10



SHEPARD STYLE GROMMET

Number	Description	Material	ID	Qty/Box
23-40100-S	Shepard Grommet	Sterile FLPL	1.14 mm	10
23-40100-SB	Shepard Grommet - Blue	Sterile FLPL	1.14 mm	10
23-40101-S	Shepard Grommet with wire	Sterile FLPL	1.14 mm	10
23-40101-SB	Shepard Grommet with wire - Blue	Sterile FLPL	1.14 mm	10
101100	Shepard Grommet	Sterile Titanium	1.0 mm	10
101100-F	Shepard Grommet with wire	Sterile Titanium	1.0 mm	10
101125	Shepard Grommet	Sterile Titanium	1.25 mm	10
101125-F	Shepard Grommet with wire	Sterile Titanium	1.25 mm	10
23-40120	Shepard Grommet	Sterile FLPL	1.02 mm	10
23-40121	Shepard Grommet with wire	Sterile FLPL	1.02 mm	10

OTO ACC

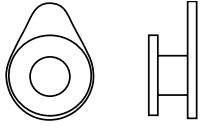

SPOON BOBBIN STYLE

Number	Description	Material	ID	Qty/Box
23-60500	Spoon Bobbin	Sterile Titanium	1.14 mm	10

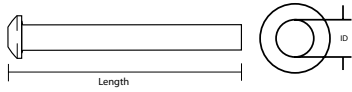

STRAIGHT SHANK VENT TUBE

Number	Description	Material	ID	Length	Qty/Box
23-41100	Straight Shank Vent Tube	Sterile FLPL	.089 mm	12 mm	10
23-41110	Straight Shank Vent Tube	Sterile FLPL	1.14 mm	12 mm	10
23-41120	Straight Shank Vent Tube	Sterile FLPL	.089 mm	7 mm	10
23-41130	Straight Shank Vent Tube	Sterile FLPL	1.14 mm	7 mm	10

OTO ACC

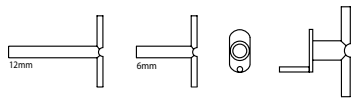

T-TUBES

Number	Description	Material	ID	Qty/Box
23-50600	T-Tube	Sterile Silicone	1.14 mm	10
23-50601	T-Tube Modified	Sterile Silicone	1.32 mm	10
23-50610	T-Grommet	Sterile Silicone	1.14 mm	10

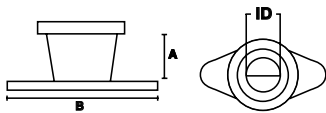

ULTRA VENT

Number	Description	Material	ID	Qty/Box
23-50900	A=1.37 mm, B=4.5 mm	Sterile Silicone	1.27 mm	10

OTOVENT® MIDDLE EAR AUTO INFLATION SYSTEM

The proven alternative to the surgical treatment of symptoms of Otitis Media and Eustachian Tube Dysfunction.



Used around the world, for more than 18 years, the Otovent Middle Ear Auto Inflation System offers Otitis Media Patients and those suffering from Barotrauma a proven protocol to equalize middle ear pressure and relieve painful symptoms. The Valsalva and Politzer treatments have long been used to equalize middle ear pressure in the presence of negative pressure pain of Otitis Media, Barotrauma due to underwater pressure, air flight, or hyperbaric chamber treatments.

BENEFITS OF OTOVENT

Otovent can prevent or treat Otitis Media and be an attractive alternative to surgery. Otovent treats many of the complications associated with negative ear pressure caused by Eustachian tube dysfunction.

- Frequent treatments are painless and regarded as “fun” by children
- Typically satisfying results early on; compliance is very high
- Effective without drugs and with no known side effects
- May avoid or delay recourse to surgery or ventilation tubes
- Very low treatment cost

HOW TO USE OTOVENT®

Otovent® is simple to use. With one nostril pinched shut, and the balloon mounted nose plug held against the other nostrum, the patient inflates the balloon. Once fully extended, the patient then allows the positive pressure of the balloon to reenter the nose, and swallows, achieving trans-Eustachian tube middle ear insufflation.

BEFORE: Otitis Media, Eustachian tube dysfunction
Negative pressure, pain, impaired hearing, learning problems.

DURING: Controlled pressure is transmitted through the nose and Eustachian tube to the middle ear pressure is balanced.

AFTER: Pain relief, hearing restored and improved prognosis.

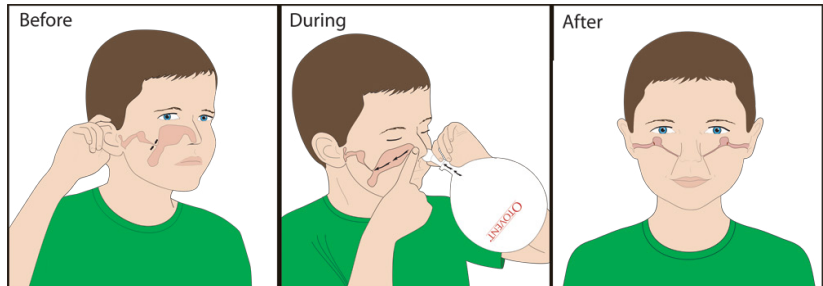

OTOVENT TREATMENT SET

The system consists of a nares bulb and an ample supply of latex balloons to perform safe and effective middle ear auto inflation, 2-3 times daily, for up to 6 weeks.

Each Kit Contains: one nose piece made of PVC, one instruction leaflet, and 10 pressure tested latex balloons



Number	Description	Qty/Box
90-00000	Otovent Kits, 1 Case*	12 patient kits
90-00001	Otovent Kits, 1/2 Case*	6 patient kits
90-00000B	Otovent balloons*	5 per pack

The system consists of a nares bulb and an ample supply of latex balloons to perform safe and effective middle ear auto inflation, 2-3 times daily, for up to 6 weeks.

* Contains latex

R&CS ACC

DIS

OTO ACC

OSS

LAR ACC

SPE ACC

RHI INS

PSB

OTO INS

LAR INS

ORO/NAS INS

OSSICULAR PROSTHESES

L = Total Length
FL = Functional Length

DENSE HA INCUS STRUT

• Columella O.D.: 2.00

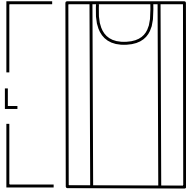

Number	Length (MM)
INCUS 07.17.275C	2.75
INCUS 07.17.325C	3.25
INCUS 07.17.375C	3.75
INCUS07.17.490C	4.90

TITANIUM INCUS STRUT

• Columella O.D.: 2.00 / Columella I.D.: 1.20

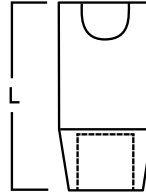

Number	Length (MM)
PAP 07.56.300	3.00
PAP 07.56.400	4.00
PAP 07.56.500	5.00

DENSE HA PARTIAL INCUS ISJ

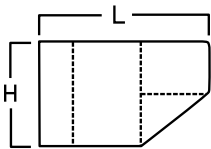

Number	Dimensions
INCUS 07.32	L = 2.50 mm H = 1.60 mm

TITANIUM INCUS GRIP REPLACEMENT

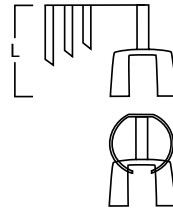

Number	Dimensions
PAP 07.53	Total length: 1.90 mm Thickness: 0.05 mm

POROUS HA ADJUSTABLE PARTIAL WITH MALLEUS SLOT

• Platinum wire
• Columella O.D.: 2.10

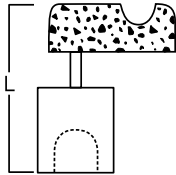

Number	L (MM)	Number	L (MM)
PAP 07.34.400	4.00	PAP 07.34.550	5.50
PAP 07.34.450	4.50	PAP 07.34.600	6.00
PAP 07.34.500	5.00		

DENSE HA AND PE INCUS REPLACEMENT WITH MALLEABLE HEAD

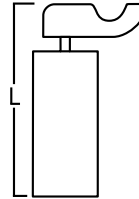

Number	Dimensions
PAP 07.43	Total Length (L): 6.50 mm Head: 3.50 Platinum wire O.D.: 0.25 Columella external O.D.: 2.20

POROUS HA HEAD WITH MALLEUS SLOT, PTFE SHAFT

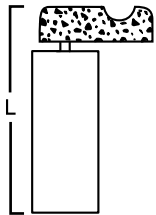

Number	Dimensions
PAP 07.36	Total Length (L): 6.50 to 3.00 mm Head O.D.: 3.50 mm Platinum Wire O.D.: 0.25 mm PTFE Columella O.D.: 2.10 mm

POROUS HA AND PE ADJUSTABLE PARTIAL WITH MALLEUS SLOT

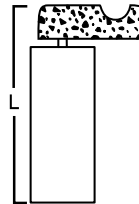

Number	Dimensions
PAP 07.38	Total Length (L): 6.50 to 3.00 mm Head O.D.: 3.50 mm Platinum Wire O.D.: 0.25 mm Audio-PE Columella O.D.: 2.10 mm

POROUS HA / PTFE / TITANIUM UNIVERSAL TOTAL/PARTIAL WITH MALLEUS HOOK

• Columella inside O.D.: 1.10

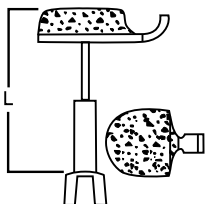

Number	Dimensions
TPL 07.59	Partial: Minimum Length: 3.50 Columella outside O.D.: 1.30 Total: Maximum length: 7.50 Columella O.D.: 0.60

L = Total Length
FL = Functional Length

POROUS HA / TITANIUM INCUS WITH MALLEUS SLOT

• Columella O.D.: 1.30 / Columella I.D.: 1.10

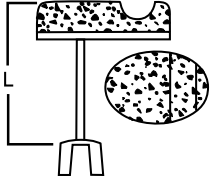

Number	L (MM)	Number	L (MM)
PAP 07.66.175	1.75	PAP 07.66.325	3.25
PAP 07.66.200	2.00	PAP 07.66.350	3.50
PAP 07.66.225	2.25	PAP 07.66.400	4.00
PAP 07.66.250	2.50	PAP 07.66.450	4.50
PAP 07.66.275	2.75	PAP 07.66.500	5.00
PAP 07.66.300	3.00		

POROUS HA / TITANIUM EXTENSIBLE INCUS WITH MALLEUS SLOT

• Extendable Stem

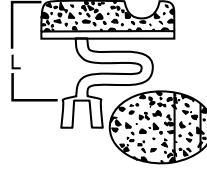

Number	Dimensions
PAP 07.68	Total Length (L): 2.50 to 5.00 mm Head size: 3.50 x 2.50 mm

POROUS HA / TITANIUM INCUS WITH MALLEUS SLOT

• Columella O.D.: 1.30 / Columella I.D.: 1.10

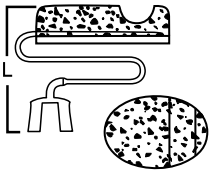

Number	Extended L (MM)	Compressed L (MM)
PAP 07.60.250	2.50	1.80
PAP 07.60.300	3.00	2.30
PAP 07.60.350	3.50	2.80
PAP 07.60.400	4.00	3.30
PAP 07.60.450	4.50	3.80
PAP 07.60.500	5.00	4.30

POROUS HA / TITANIUM REPLACEMENT INCUS WITH MALLEUS SLOT

• Extendable Stem

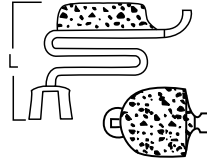

Number	Length
PAP 07.72	2.0 to 5.0 mm

L = Total Length
FL = Functional Length

TITANIUM/PTFE TRIMMABLE INCUS STAPES

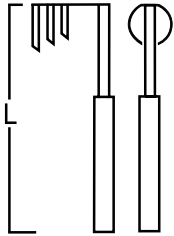

Number	Dimensions
TAP 07.52	Total Length: 6.25 to 4.50 mm Titanium F67 Gr.2 Thickness: 0.05 mm PTFE O.D.: 0.60 mm

DENSE HA I-S "MARPLA" BY E. GARCIA IBANEZ - WEHRS TYPE

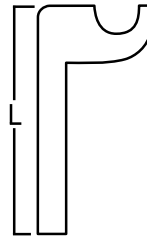

Number	Dimensions
TAP 07.54	Total Length: 8.00 mm Head: 4.00 mm Columella width: 1.00 x 0.80 mm

DENSE HA AND PE I-S PROSTHESIS WITH MALLEABLE HEAD

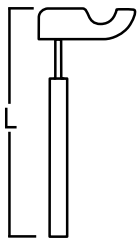

Number	Dimensions
TAP 07.42	Total Length: 8.00 mm Head: 3.50 mm Platinum Wire O.D.: 0.20 Audio-PE O.D.: 0.75

POROUS HA AND PE MALLEABLE I-S WITH MALLEUS SLOT

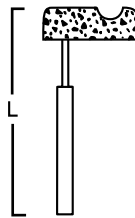

Number	Dimensions
TAP 07.37	Total Length (L): 8.00 to 3.25 mm Head O.D.: 3.50 mm Platinum Wire O.D.: 0.20 mm Audio-PE Columella O.D.: 0.60 mm

POROUS HA AND PTFE MALLEABLE INCUS STAPES WITH MALLEUS SLOT

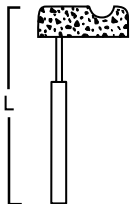

- Platinum wire

Number	Dimensions
TAP 07.35	Total Length (L): 8.00 to 3.25 mm Head O.D.: 3.50 mm Platinum Wire O.D.: 0.20 mm Audio-PE Columella O.D.: 0.60 mm

POROUS AND DENSE HA MALLEABLE I-S

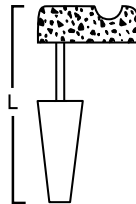

- Platinum wire
- Lower End Columella O.D.: 0.65

Number	Length (mm)
TAP 07.33.550	5.50
TAP 07.33.600	6.00
TAP 07.33.650	6.50
TAP 07.33.700	7.00
TAP 07.33.750	7.50
TAP 07.33.800	8.00

TITANIUM / POROUS HA ADJUSTABLE I-S WITH MALLEUS SLOT

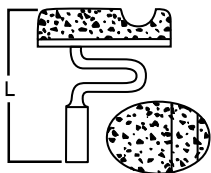

- Extendable stem

Number	Dimensions
TAP 07.67	Total Length (L): 4.00 to 8.00 mm Head size: 3.50 x 2.50 mm

TITANIUM / POROUS HA ADJUSTABLE I-S WITH MALLEUS HOOK

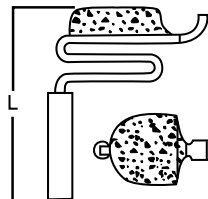

- Extendable stem

Number	Dimensions
TAP 07.58	Total Length (L): 5.00 to 8.50 mm Head size: 3.50 x 2.50 mm Columella O.D.: 0.60 mm

TITANIUM / POROUS HA I-S WITH MALLEUS SLOT

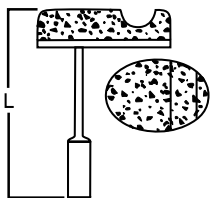

- Columella O.D.: 0.60

Number	L (MM)	Number	L (MM)
TAP 07.65.300	3.00	TAP 07.65.500	5.00
TAP 07.65.325	3.25	TAP 07.65.525	5.25
TAP 07.65.350	3.50	TAP 07.65.550	5.50
TAP 07.65.375	3.75	TAP 07.65.600	6.00
TAP 07.65.400	4.00	TAP 07.65.650	6.50
TAP 07.65.425	4.25	TAP 07.65.700	7.00
TAP 07.65.450	4.50	TAP 07.65.750	7.50
TAP 07.65.475	4.75	TAP 07.65.800	8.00

TITANIUM / PTFE / HAP SPRING TOTAL

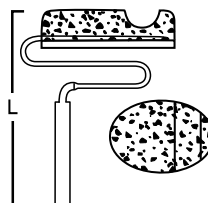

- Wire O.D.: 0.20 mm
- PTFE O.D.: 0.6 mm

Number	Extended L (MM)	Compressed L (MM)
TAP 07.71	8.00 - 4.00	7.30 - 3.30

L = Total Length
FL = Functional Length

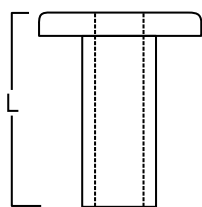
PE PARTIAL

Number	Dimensions
PAP 07.10	Total Length (L): 5.00 mm Columella O.D.: 2.10 mm

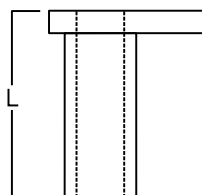
PE OFFSET PARTIAL

Number	Dimensions
TPL 07.02	Total Length (L): 5.00 mm Columella O.D.: 1.80 mm

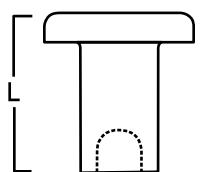
DENSE HA PARTIAL

- Columella O.D.: 2.10

Number	Dimensions
PAP 07.12.300	3.00
PAP 07.12.350	3.50
PAP 07.12.400	4.00
PAP 07.12.450	4.50
PAP 07.12.500	5.00

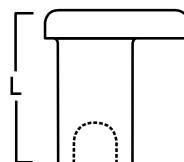
HA OFFSET PARTIAL

- Columella O.D.: 2.00

Number	Dimensions
TPL 07.06.300	3.00
TPL 07.06.350	3.50
TPL 07.06.400	4.00
TPL 07.06.450	4.50
TPL 07.06.500	5.00

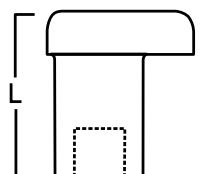
DENSE HA 90° OVAL HEAD PARTIAL

- Columella O.D.: 2.00

Number	Length
PAP 07.15.300	3.00 mm
PAP 07.15.350	3.50 mm
PAP 07.15.400	4.00 mm
PAP 07.15.450	4.50 mm
PAP 07.15.500	5.00 mm

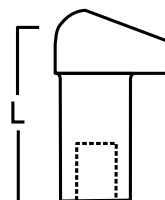
DENSE HA 75° OVAL HEAD PARTIAL

- Columella O.D.: 2.00

Number	Length
PAP 07.16.300	3.00 mm
PAP 07.16.350	3.50 mm
PAP 07.16.400	4.00 mm
PAP 07.16.450	4.50 mm
PAP 07.16.500	5.00 mm

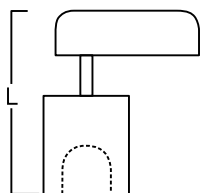
DENSE HA MALLEABLE PARTIAL

- Platinum wire
- Columella O.D.: 2.00

Number	L (MM)	Number	L (MM)
TPL 07.08.350	3.50	TPL 07.08.500	5.00
TPL 07.08.400	4.00	TPL 07.08.550	5.50
TPL 07.08.450	4.50	TPL 07.08.600	6.00

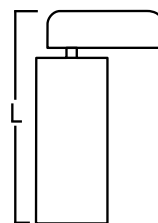
DENSE HA AND PE PARTIAL WITH MALLEABLE HEAD

Number	Dimensions
PAP 07.41	Total Length (L): 6.50 mm Head: 3.50 mm Platinum wire O.D.: 0.25 mm Columella external O.D.: 2.20 mm

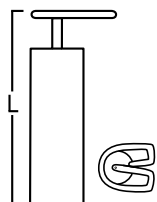
PE PARTIAL WITH MALLEABLE GOLD HEAD

- Trimmable PE columella

Number	Dimensions
PAP 07.47	Total Length (L): 6.50 to 2.75 mm Gold Wire O.D.: 0.30 mm Columella O.D.: 1.80 mm Columella I.D.: 1.20 mm

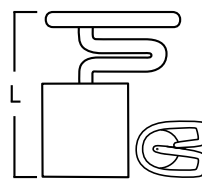
GOLD AND PE PARTIAL WITH MALLEABLE HEAD

- Extendable stem

Number	Dimensions
PAP 07.49	Total Length (L): 2.75 to 6.50 mm Head: 3.00 mm Gold Wire O.D.: 0.30 mm Columella O.D.: 1.80 mm Columella I.D.: 1.20 mm

L = Total Length
FL = Functional Length

DENSE HA TELESCOPIC UNIVERSAL PARTIAL / TOTAL

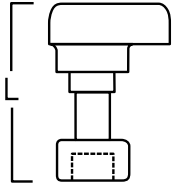

• Columella O.D.: 2.10

Number	Dimensions
PAP 07.19.350	3.50 min / 4.20 max
PAP 07.19.400	4.00 min / 4.70 max
PAP 07.19.450	4.50 min / 5.20 max
PAP 07.19.500	5.00 min / 5.70 max
PAP 07.19.550	5.50 min / 6.20 max
PAP 07.19.600	6.00 min / 6.70 max

TITANIUM PARTIAL

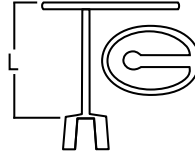

• Columella O.D.: 1.30 / Columella I.D.: 1.10

Number	L (MM)	Number	L (MM)
PAP 07.62.175	1.75	PAP 07.62.325	3.25
PAP 07.62.200	2.00	PAP 07.62.350	3.50
PAP 07.62.225	2.25	PAP 07.62.400	4.00
PAP 07.62.250	2.50	PAP 07.62.450	4.50
PAP 07.62.275	2.75	PAP 07.62.500	5.00
PAP 07.62.300	3.00		

TITANIUM ADJUSTABLE PARTIAL

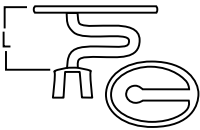

• Extendable Stem

Number	Dimensions
PAP 07.64	Total Length (L): 2.00 to 6.00 mm Head size: 3.50 x 2.50 mm

TITANIUM PARTIAL WITH SLITS IN BELL

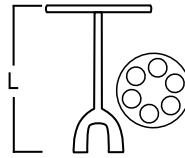

Number	L (MM)	Number	L (MM)
12705	0.50	12720	2.00
12710	1.00	12722	2.25
12712	1.25	12725	2.50
12715	1.50	12730	3.00
12717	1.75	12735	3.50

TITANIUM PARTIAL OFFSET WITH MALLEUS GROOVE

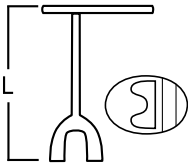

Number	L (MM)	Number	L (MM)
12805	0.50	12820	2.00
12810	1.00	12822	2.25
12812	1.25	12825	2.50
12815	1.50	12830	3.00
12817	1.75	12835	3.50

TITANIUM PARTIAL

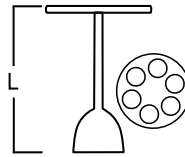

Number	L (MM)	Number	L (MM)
12905	0.50	12920	2.00
12910	1.00	12922	2.25
12912	1.25	12925	2.50
12915	1.50	12830	3.00
12917	1.75	12835	3.50

TITANIUM ADJUSTABLE PARTIAL TRIMMABLE SHAFT

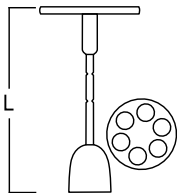

• Trimmable in 1 mm increments

Number	Dimensions
12100	5.50 to 2.50 mm
12200	5.00 to 2.00 mm

L = Total Length
FL = Functional Length

PE TOTAL

• Columella O.D.: 0.70

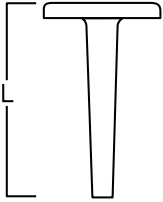

Number	Length (MM)
TAP 07.09.600	6.00
TAP 07.09.700	7.00
TAP 07.09.800	8.00

PE OFFSET TOTAL

• Columella O.D.: 0.65

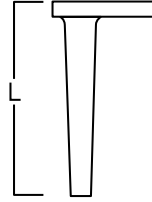

Number	Length (MM)
TPL 07.04.600	6.00
TPL 07.04.700	7.00
TPL 07.04.800	8.00

PE MALLEABLE OFFSET TOTAL

• Platinum core

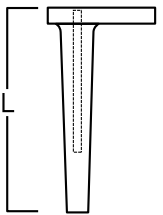

Number	Dimensions
TPL 07.03	Total Length (L): 8.00 mm Columella O.D.: 0.70 mm

DENSE HA TOTAL

• Columella O.D.: 0.65

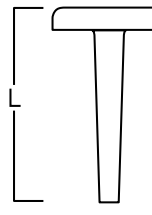

Number	L (MM)	Number	L (MM)
TAP 07.11.500	5.00	TAP 07.11.700	7.00
TAP 07.11.550	5.50	TAP 07.11.750	7.50
TAP 07.11.600	6.00	TAP 07.11.800	8.00
TAP 07.11.650	6.50		

DENSE HA OFFSET TOTAL

• Columella O.D.: 0.70

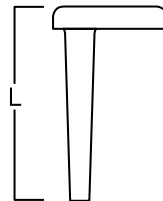

Number	L (MM)	Number	L (MM)
TPL 07.05.500	5.00	TPL 07.05.700	7.00
TPL 07.05.550	5.50	TPL 07.05.750	7.50
TPL 07.05.600	6.00	TPL 07.05.800	8.00
TPL 07.05.650	6.50		

DENSE HA PARTIAL

• Columella O.D.: 0.75

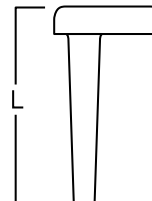

Number	L (MM)	Number	L (MM)
TAP 07.13.500	5.00	TAP 07.13.700	7.00
TAP 07.13.550	5.50	TAP 07.13.750	7.50
TAP 07.13.600	6.00	TAP 07.13.800	8.00
TAP 07.13.650	6.50		

DENSE HA 75° OVAL HEAD TOTAL

• Columella O.D.: 0.70

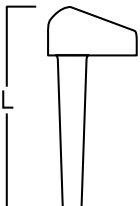

Number	L (MM)	Number	L (MM)
TAP 07.14.500	5.00	TAP 07.14.700	7.00
TAP 07.14.550	5.50	TAP 07.14.750	7.50
TAP 07.14.600	6.00	TAP 07.14.800	8.00
TAP 07.14.650	6.50		

DENSE HA MALLEABLE TOTAL

• Platinum Wire
• Columella O.D.: 0.65

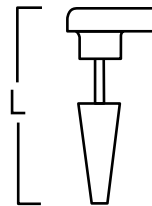

Number	L (MM)	Number	L (MM)
TPL 07.07.550	5.50	TPL 07.07.700	7.00
TPL 07.07.600	6.00	TPL 07.07.750	7.50
TPL 07.07.650	6.50	TPL 07.07.800	8.00

PTFE TOTAL WITH MALLEABLE GOLD HEAD AND SHAFT

• Trimmable PTFE columella

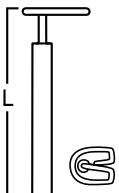

Number	Dimensions
TAP 07.46	Total Length (L): 8.00 to 4.50 mm Head: 3.00 mm Gold wire O.D.: 0.30 mm PTFE O.D.: 0.80 mm

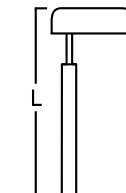
DENSE HA AND PTFE MALLEABLE TOTAL

Number	Dimensions
TAP 07.40	Total Length (L): 8.00 mm Head O.D.: 3.50 mm Platinum Wire O.D.: 0.20 mm Audio-PE Columella O.D.: 0.75 mm

L = Total Length
FL = Functional Length

ADJUSTABLE TOTAL WITH GOLD HEAD AND SHAFT WITH PTFE COLUMELLA

• Extendable stem

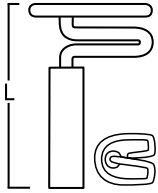

Number	Dimensions
TAP 07.48	Total Length (L): 4.00 to 9.00 mm Head: 3.00 mm Gold Wire O.D.: 0.30 mm PTFE O.D.: 0.80 mm

TITANIUM TOTAL

• Columella O.D.: 0.60

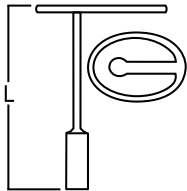

Number	L (MM)	Number	L (MM)
TAP 07.61.300	3.00	TAP 07.61.500	5.00
TAP 07.61.325	3.25	TAP 07.61.525	5.25
TAP 07.61.350	3.50	TAP 07.61.550	5.50
TAP 07.61.375	3.75	TAP 07.61.600	6.00
TAP 07.61.400	4.00	TAP 07.61.650	6.50
TAP 07.61.425	4.25	TAP 07.61.700	7.00
TAP 07.61.450	4.50	TAP 07.61.750	7.50
TAP 07.61.475	4.75	TAP 07.61.800	8.00

TITANIUM ADJUSTABLE TOTAL

• Extendable stem

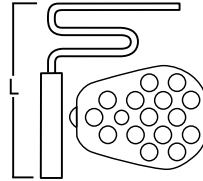

Number	Dimensions
TAP 07.55	Total Length (L): 5.00 to 8.50 mm Head size: 3.80 x 3.00 mm

DENSE HA TELESCOPIC TOTAL TRIMMABLE

• Piston O.D.: 0.80

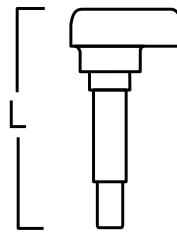

Number	Dimensions (MM)
TAP 07.18.500	5.00 min / 5.70 max
TAP 07.18.550	5.50 min / 6.20 max
TAP 07.18.600	6.00 min / 6.70 max
TAP 07.18.650	6.50 min / 7.20 max
TAP 07.18.700	7.00 min / 7.70 max
TAP 07.18.750	7.50 min / 8.20 max
TAP 07.18.800	8.00 min / 8.70 max

TITANIUM ADJUSTABLE TOTAL AND PARTIAL UNIVERSAL

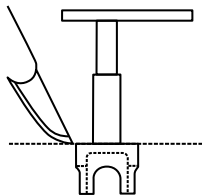

Number	Dimensions
TPL 07.57	Partial: Minimum length: 3.50 mm Columella O.D.: 1.80 mm Columella I.D.: 1.20 mm
	Total: Maximum length: 8.50 mm Columella O.D.: 0.70 mm

TITANIUM ADJUSTABLE TOTAL

• Extendable Stem

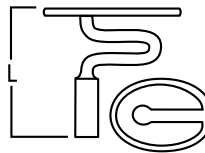

Number	Dimensions
TAP 07.63	Total Length (L): 3.00 to 8.00 mm Head size: 3.50 x 2.50 mm

TITANIUM TRIMMABLE TOTAL WITH SEPARATE HEAD

• Trimmable in 1 mm increments

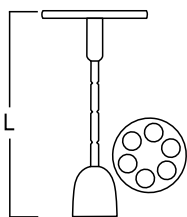

Number	Dimensions
11300	7.5 to 3.50 mm
11400	7.0 to 3.00 mm

TITANIUM TOTAL FIXED LENGTH WITH ADJUSTABLE CENTERED HEAD

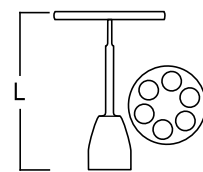

*Fixed head

Number	L (MM)	Number	L (MM)
11930*	3.00	11947	4.75
11935	3.50	11950	5.00
11940	4.00	11960	6.00
11942	4.25	11965	6.50
11945	4.50	11970	7.00

TITANIUM TOTAL FIXED LENGTH WITH ADJUSTABLE OFFSET HEAD

• Trimmable PTFE columella

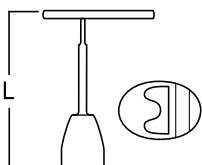

Number	Dimensions
11500	7.50 to 2.80 mm
11600	7.30 to 2.30 mm

TITANIUM MALLEABLE TRIMMABLE TOTAL WITH ADJUSTABLE HEAD AND SEPARATE SHOE

• Trimmable PTFE columella

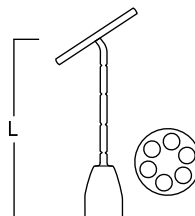

*Fixed head

Number	L (MM)	Number	L (MM)
11830*	3.00	11847	4.75
11835	3.50	11850	5.00
11840	4.00	11860	6.00
11842	4.25	11865	6.50
11845	4.50	11870	7.00

SERENOCEM™ OTOLOGIC CEMENT

Designed specifically for non-weight bearing applications in otologic surgery such as:

- Ideal for bridging an open incudostapedial joint
- Reconstruction of the ossicular chain
- Posterior canal wall reconstruction
- Cementation of cochlear implant electrode array

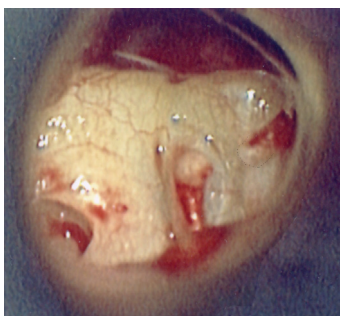

Open ISJ

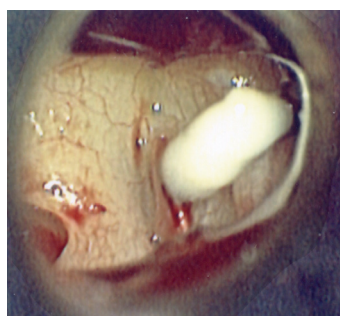

Closed bridge using Serenocem™
(Bridging the open ISJ)

Serenocem™ meets a clinical need in otologic reconstruction surgery, where increasingly sophisticated surgical techniques require new methods of stabilizing implanted devices and bony fragments and for use in the reconstruction.

- Non-exothermic snap set
- Chemical adhesion to bone and metals
- Bioactive/osteoconductive ion release
- Minimal biodegeneration or absorption
- Minimal shrinkage upon setting

BIOCOMPATIBILITY/CLINICAL DATA

Cement rapidly becomes surrounded by a layer of relatively mature bone. Tests conducted with completely hardened cement show a distinct inertia and biocompatibility of the material including its complete integration into the bone structure.

INTERACTION MRI

Serenocem™ is MRI-compatible. Image quality may be impeded in direct vicinity of an implant; radiopacity is comparable to bone.

Note: The area into which the cement is placed must be kept dry, as the material will not harden in a wet field.

Number	Description	Qty/box
BC-010	Serenocem™ Cement	2 individually packaged capsules
BC-010S	Serenocem™ Cement	1 individually packaged capsule

SERENOCEM™ APPLICATOR AND MIXER

These critical components are supplied to provide predictable and timely formulation of Serenocem Otologic Cement, within the time window expected.

Serenocem™ Mixer

Set to operate for 10 seconds, every time, giving the OR team confidence in the Cement, its set up time and its consistency, instillation after instillation.

Serenocem™ Applicator

Used to place the prepared aliquot of cement onto a sterile microscope slide or cutting block, to be added to the surgical field on a Rosen Needle or Micro suction tip.

Number	Description	Qty/box
BC-280	Serenocem™ Mixer (110 V)	1 Unit
BC-150	Applicator	1 each



L = Total Length
 FL = Functional Length

DENSE HA POSTERIOR CANAL WALL

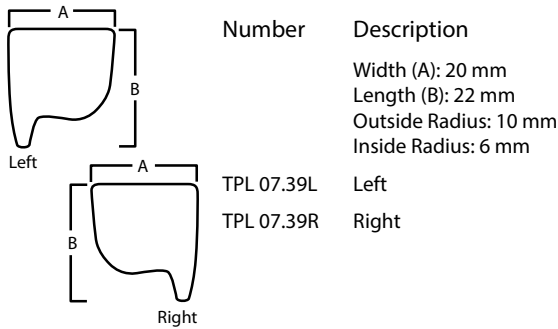

Number	Description
	Width (A): 20 mm
	Length (B): 22 mm
	Outside Radius: 10 mm
	Inside Radius: 6 mm
TPL 07.39L	Left
TPL 07.39R	Right

OSS

DENSE HA FOOTPLATE SHOE

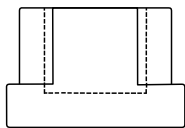

Number	Dimensions
TPL 07.44	Footplate size 2.00 x 1.20 mm
	Inner O.D.: 0.80 mm
	Added implant length: 0.50 mm

DENSE HA PROSTHESIS "MARPLA" BY E. GARCIA IBANEZ

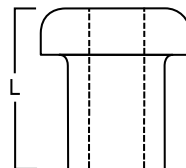

Number	Dimensions
TPL 07.45	Total Length (L): 1 - 3.50 mm
	Total Drilled Head: 4.00 mm
	Inside O.D.: 1.40 mm

POROUS HA CAP

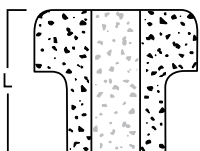

Number	Dimensions
PAP 07.50	Total Length (L): 1.00 - 4.00 mm
	Columella external O.D.: 2.10 mm
	Columella I.D.: 1.20 mm

L = Total Length
FL = Functional Length

PLATINUM AND PTFE PROSTHESES FOR STAPEDECTOMY AND STAPEDOTOMY

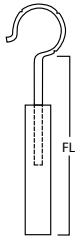

FL / L	Piston O.D.: 0.40	Piston O.D.: 0.50	Piston O.D.: 0.60	Piston O.D.: 0.80
	Number	Number	Number	Number
3.00 / 4.00	SPL 03.08.400	SPL 03.09.400	SPL 03.07.400	SPL 03.10.400
3.25 / 4.25	SPL 03.08.425	SPL 03.09.425	SPL 03.07.425	SPL 03.10.425
3.50 / 4.50	SPL 03.08.450	SPL 03.09.450	SPL 03.07.450	SPL 03.10.450
3.75 / 4.75	SPL 03.08.475	SPL 03.09.475	SPL 03.07.475	SPL 03.10.475
4.00 / 5.00	SPL 03.08.500	SPL 03.09.500	SPL 03.07.500	SPL 03.10.500
4.25 / 5.25	SPL 03.08.525	SPL 03.09.525	SPL 03.07.525	SPL 03.10.525
4.50 / 5.50	SPL 03.08.550	SPL 03.09.550	SPL 03.07.550	SPL 03.10.550
4.75 / 5.75	SPL 03.08.575	SPL 03.09.575	SPL 03.07.575	SPL 03.10.575
5.00 / 6.00	SPL 03.08.600	SPL 03.09.600	SPL 03.07.600	SPL 03.10.600
5.25 / 6.25	SPL 03.08.625	SPL 03.09.625	SPL 03.07.625	SPL 03.10.625
5.50 / 6.50	SPL 03.08.650	SPL 03.09.650	SPL 03.07.650	SPL 03.10.650
8.99 / 9.99	SPL 03.08.999	SPL 03.09.999	SPL 03.07.999	SPL 03.10.999

TITANIUM PROSTHESES FOR STAPEDECTOMY AND STAPEDOTOMY

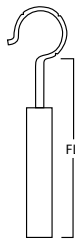

FL / L	Piston O.D.: 0.40	Piston O.D.: 0.50	Piston O.D.: 0.60	Piston O.D.: 0.80
	Number	Number	Number	Number
3.00 / 4.00	SPL 03.21.400	SPL 03.22.400	SPL 03.20.400	SPL 03.23.400
3.25 / 4.25	SPL 03.21.425	SPL 03.22.425	SPL 03.20.425	SPL 03.23.425
3.50 / 4.50	SPL 03.21.450	SPL 03.22.450	SPL 03.20.450	SPL 03.23.450
3.75 / 4.75	SPL 03.21.475	SPL 03.22.475	SPL 03.20.475	SPL 03.23.475
4.00 / 5.00	SPL 03.21.500	SPL 03.22.500	SPL 03.20.500	SPL 03.23.500
4.25 / 5.25	SPL 03.21.525	SPL 03.22.525	SPL 03.20.525	SPL 03.23.525
4.50 / 5.50	SPL 03.21.550	SPL 03.22.550	SPL 03.20.550	SPL 03.23.550
4.75 / 5.75	SPL 03.21.575	SPL 03.22.575	SPL 03.20.575	SPL 03.23.575
5.00 / 6.00	SPL 03.21.600	SPL 03.22.600	SPL 03.20.600	SPL 03.23.600
5.25 / 6.25	SPL 03.21.625	SPL 03.22.625	SPL 03.20.625	SPL 03.23.625
5.50 / 6.50	SPL 03.21.650	SPL 03.22.650	SPL 03.20.650	SPL 03.23.650
8.99 / 9.99	SPL 03.21.999	SPL 03.22.999	SPL 03.20.999	SPL 03.23.999

TRIMMABLE PLATINUM AND PTFE PROSTHESES FOR STAPEDECTOMY AND STAPEDOTOMY

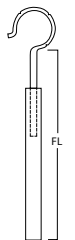

FL / L	Piston O.D.: 0.40	Piston O.D.: 0.50	Piston O.D.: 0.60	Piston O.D.: 0.80
	Number	Number	Number	Number
6.0 - 3.25 / 7.00 - 4.25	SPL 03.08S	SPL 03.09S	SPL 03.07S	SPL 03.10S

TRIMMABLE TITANIUM AND PTFE FOR STAPEDECTOMY AND STAPEDOTOMY

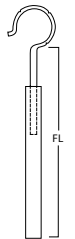

FL / L	Piston O.D.: 0.40	Piston O.D.: 0.50	Piston O.D.: 0.60	Piston O.D.: 0.80
	Number	Number	Number	Number
6.0 - 3.25 / 7.00 - 4.25	SPL 03.27S	SPL 03.28S	SPL 03.29S	SPL 03.30S

L = Total Length
FL = Functional Length

PTFE LOOP PROSTHESIS WITH NOTCH FOR STAPEDECTOMY AND STAPEDOTOMY - TRIMMABLE

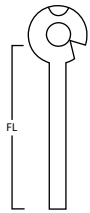

Number	FL (MM)	L (MM)	Piston Ø
SPL 03.16	3.00-6.00	4.00-7.00	0.50
SPL 03.17	3.00-6.00	4.00-7.00	0.60
SPL 03.18	3.00-6.00	4.00-7.00	0.40
SPL 03.19	3.00-6.00	4.00-7.00	0.80

PTFE LOOP PROSTHESIS WITHOUT NOTCH FOR STAPEDECTOMY AND STAPEDOTOMY - TRIMMABLE

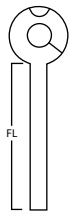

Number	FL (MM)	L (MM)	Piston Ø
SPL 03.16x	3.00-6.00	4.00-7.00	0.50
SPL 03.17x	3.00-6.00	4.00-7.00	0.60
SPL 03.18x	3.00-6.00	4.00-7.00	0.40
SPL 03.19x	3.00-6.00	4.00-7.00	0.80

SULTAN LOOP PISTON PROSTHESIS FOR STAPEDECTOMY AND STAPEDOTOMY

- Silicon loop
- TI joint
- PTFE columella

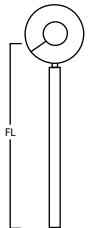

Number	FL (MM)	L (MM)	Piston Ø
SPL 03.24	3.00-6.00	4.00-7.00	0.40
SPL 03.25	3.00-6.00	4.00-7.00	0.50
SPL 03.26	3.00-6.00	4.00-7.00	0.60

PLATINUM AND PE PROSTHESIS FOR STAPEDECTOMY

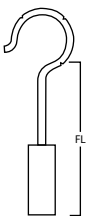

Number	FL (MM)	L (MM)
SPL 03.04.300	2.00	3.00
SPL 03.04.350	2.50	3.50
SPL 03.04.400	3.00	4.00
SPL 03.04.425	3.25	4.25
SPL 03.04.450	3.50	4.50
SPL 03.04.475	3.75	4.75
SPL 03.04.500	4.00	5.00
SPL 03.04.550	4.50	5.50
SPL 03.04.600	5.00	6.00

TRIMMABLE TITANIUM / PTFE SELF CRIMPING PROSTHESIS

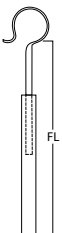

Number	FL (MM)	L (MM)	Piston Ø
SPL 03.355	6.00-3.25	7.00-4.25	0.40
SPL 03.365	6.00-3.25	7.00-4.25	0.50
SPL 03.375	6.00-3.25	7.00-4.25	0.60
SPL 03.385	6.00-3.25	7.00-4.25	0.80

PLATINUM PROSTHESIS FOR STAPEDECTOMY

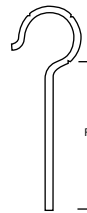

Number	FL (MM)	L (MM)	Piston Ø
SPL 03.05	5.00	6.0	0.30

PTFE LOOP PROSTHESIS WITHOUT NOTCH FOR STAPEDECTOMY AND STAPEDOTOMY - FIXED

- Sterile
- Expand Loop with pick and slip over incus

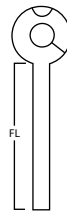

Number	FL (MM)	L (MM)	Piston Ø
24-0450	4.00	5.00	0.40
24-0640	3.00	4.00	0.60
24-0645	3.50	4.50	0.60
24-0650	4.00	5.00	0.60
24-0660	5.00	6.00	0.60

HOUSE TYPE PLATINUM LOOPED FOR STAPEDECTOMY PROSTHESIS

- Platinum loop O.D.: 0.40

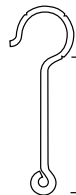

Number	FL (MM)	L (MM)
SPL 03.15.400	3.00	4.00
SPL 03.15.450	3.50	4.50
SPL 03.15.500	4.00	5.00

PLATINUM RIBBON LOOP AND SHAFT FOR STAPEDECTOMY PROSTHESIS



Number	FL (MM)	L (MM)
SPL 03.00.300	2.00	3.00
SPL 03.00.350	2.50	3.50
SPL 03.00.400	3.00	4.00
SPL 03.00.425	3.25	4.25
SPL 03.00.450	3.50	4.50
SPL 03.00.475	3.75	4.75
SPL 03.00.500	4.00	5.00
SPL 03.00.550	4.50	5.50
SPL 03.00.600	5.00	6.00

HOUSE TYPE PLATINUM LOOPED STAPEDECTOMY PROSTHESIS WITH BALL BASE

- Platinum sphere O.D.: 0.40



Number	FL (MM)	L (MM)
SPL 03.13.400	3.00	4.00
SPL 03.13.450	3.50	4.50
SPL 03.13.500	4.00	5.00

OSS

L = Total Length
FL = Functional Length

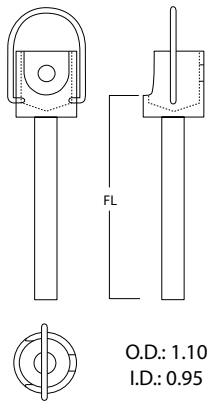
TITANIUM BUCKET HANDLE

FL / L	Number	Number	Number	Number
3.20 / 4.00	SPL 03.48.400	SPL 03.51.400	SPL 03.49.400	SPL 03.50.400
3.45 / 4.25	SPL 03.48.425	SPL 03.51.425	SPL 03.49.425	SPL 03.50.425
3.70 / 4.50	SPL 03.48.450	SPL 03.51.450	SPL 03.49.450	SPL 03.50.450
3.95 / 4.75	SLP 03.48.475	SPL 03.51.475	SLP 03.49.475	SLP 03.50.475
4.20 / 5.00	SPL 03.48.500	SPL 03.51.500	SPL 03.49.500	SPL 03.50.500
4.45 / 5.25	SPL 03.48.525	SPL 03.51.525	SPL 03.49.525	SPL 03.50.525
4.70 / 5.50	SPL 03.48.550	SPL 03.51.550	SPL 03.49.550	SPL 03.50.550
4.95 / 5.75	SPL 03.48.575	SPL 03.51.575	SPL 03.49.575	SPL 03.50.575
5.20 / 6.00	SPL 03.48.600	SPL 03.51.600	SPL 03.49.600	SPL 03.50.600
5.45 / 6.25	SPL 03.48.625	SPL 03.51.625	SPL 03.49.625	SPL 03.50.625
5.70 / 6.50	SPL 03.48.650	SPL 03.51.650	SPL 03.49.650	SPL 03.50.650
5.95 / 6.75	SPL 03.48.675	SPL 03.51.675	SPL 03.49.675	SPL 03.50.675
6.20 / 7.00	SPL 03.48.700	SPL 03.51.700	SPL 03.49.700	SPL 03.50.700
6.45 / 7.25	SPL 03.48.725	SPL 03.51.725	SPL 03.49.725	SPL 03.50.725
6.70 / 7.50	SPL 03.48.750	SPL 03.51.750	SPL 03.49.750	SPL 03.50.750

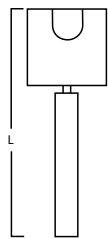
PTFE/AUDIOLITE ADJUSTABLE CUP PROSTHESIS FOR STAPEDECTOMY

- Porous HA
- AUDIOLITE - cup
- PT - joint
- PTFE - columella

Number	Dimensions
SPL 03.14	L: 6.00 mm Cup O.D.: 2.00 mm Cup I.D.: 1.20 mm Columella O.D.: 0.60 mm

L = Total Length
 FL = Functional Length

SUPERE STAPES REPLACEMENT TECHNIQUE

The Invotec SuperE Stapes replacement Piston utilizes state of the art, shape-memory superelastic Nitinol alloy as its piston loop, to take the crimping maneuver out of Stapedectomy and Stapedotomy.

The SuperE Nitinol piston ribbon loop comes programmed in the closed position, to which it will return, once placed onto the incus.

Using the E-gator alligator forceps to grasp, open the piston loop, and to place the implant onto the incus, the surgeon completes the maneuver in one concise motion. The Superelastic Nitinol piston loop gently and securely, closes, fashioning itself around the incus.

Two micro-slots in the distal end of the alligator jaws secure the piston loop during implantation and, while closed, open the piston loop for easy and safe placement.

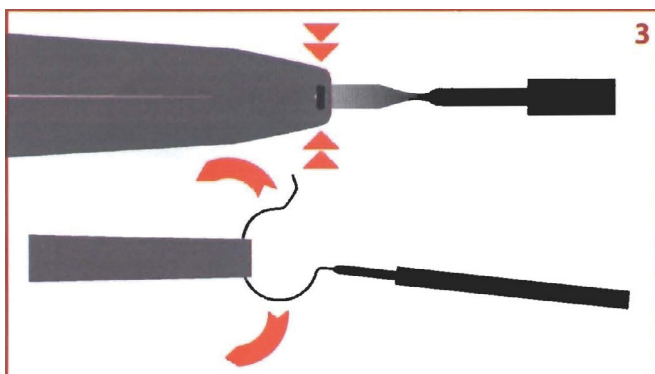
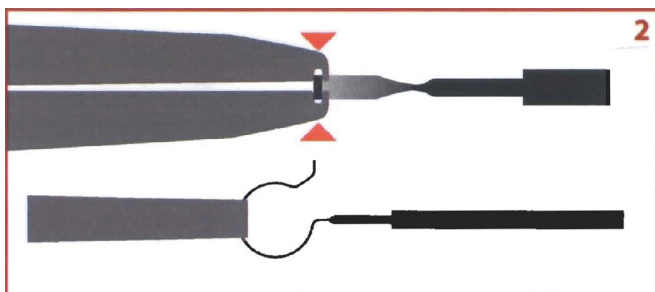
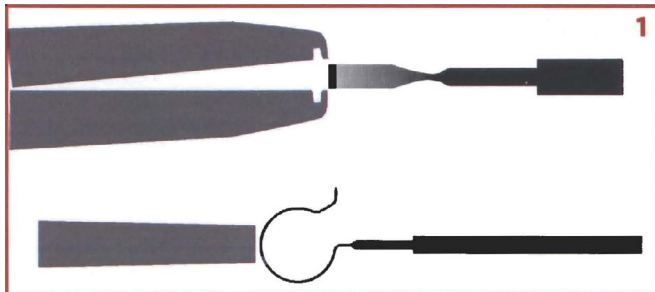
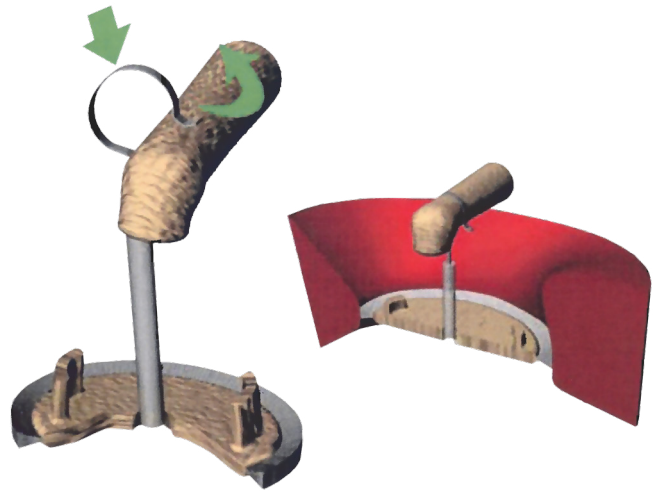

DIRECTIONS FOR USE

1. Utilizing the E-Gator, grasp the SuperE Nitinol Piston loop (as shown), capturing the ribbon within the micro-grooves.
2. When ready to place the implant onto the incus, exert additional closure pressure on the jaws, this will spread the loop.
3. Place the Nitinol piston onto the incus and into the oval window as desired. Opening the alligator jaws releases the implant and allows the loop to self-crimp.
4. The piston loop will close to its programmed, closed position securing the implant onto the incus.

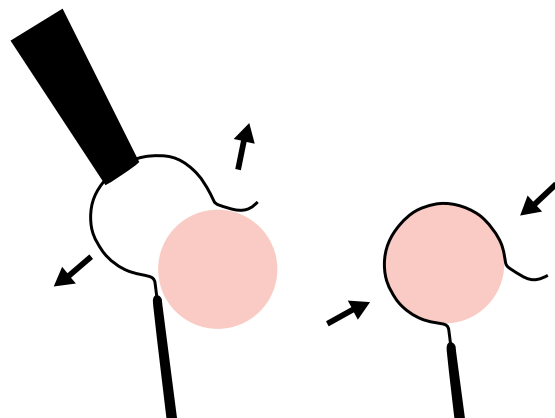

L = Total Length
FL = Functional Length

SELF-CRIMPING SUPERELASTIC NITINOL/PTFE PISTON

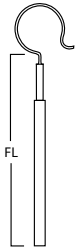

		Columella O.D.: 0.40	Columella O.D.: 0.50	Columella O.D.: 0.60	Columella O.D.: 0.80
FL / L	Number	Number	Number	Number	Number
3.00 / 4.00	SPL 03.43.400	SPL 03.44.400	SPL 03.45.400	SPL 03.46.400	SPL 03.46.400
3.25 / 4.25	SPL 03.43.425	SPL 03.44.425	SPL 03.45.425	SPL 03.46.425	SPL 03.46.425
3.50 / 4.50	SPL 03.43.450	SPL 03.44.450	SPL 03.45.450	SPL 03.46.450	SPL 03.46.450
3.75 / 4.75	SPL 03.43.475	SPL 03.44.475	SPL 03.45.475	SPL 03.46.475	SPL 03.46.475
4.00 / 5.00	SPL 03.43.500	SPL 03.44.500	SPL 03.45.500	SPL 03.46.500	SPL 03.46.500
4.25 / 5.25	SPL 03.43.525	SPL 03.44.525	SPL 03.45.525	SPL 03.46.525	SPL 03.46.525
4.50 / 5.50	SPL 03.43.550	SPL 03.44.550	SPL 03.45.550	SPL 03.46.550	SPL 03.46.550
4.75 / 5.75	SPL 03.43.575	SPL 03.44.575	SPL 03.45.575	SPL 03.46.575	SPL 03.46.575
5.00 / 6.00	SPL 03.43.600	SPL 03.44.600	SPL 03.45.600	SPL 03.46.600	SPL 03.46.600
5.50 / 6.50	SPL 03.43.650	SPL 03.44.650	SPL 03.45.650	SPL 03.46.650	SPL 03.46.650
6.00 / 7.00	SPL 03.43.700	SPL 03.44.700	SPL 03.45.700	SPL 03.46.700	SPL 03.46.700
6.50 / 7.50	SPL 03.43.750	SPL 03.44.750	SPL 03.45.750	SPL 03.46.750	SPL 03.46.750
7.00 / 8.00	SPL 03.43.800	SPL 03.44.800	SPL 03.45.800	SPL 03.46.800	SPL 03.46.800
7.50 / 8.50	SPL 03.43.850	SPL 03.44.850	SPL 03.45.850	SPL 03.46.850	SPL 03.46.850
8.00 / 9.00	SPL 03.43.900	SPL 03.44.900	SPL 03.45.900	SPL 03.46.900	SPL 03.46.900
8.50 / 9.50	SPL 03.43.950	SPL 03.44.950	SPL 03.45.950	SPL 03.46.950	SPL 03.46.950
8.99 / 9.99	SPL 03.43.999	SPL 03.44.999	SPL 03.45.999	SPL 03.46.999	SPL 03.46.999

SSS

SELF-CRIMPING TRIMMABLE SUPERELASTIC NITINOL PISTON



		Columella O.D.: 0.40	Columella O.D.: 0.50	Columella O.D.: 0.60	Columella O.D.: 0.80
FL / L	Number	Number	Number	Number	Number
6.0-6.25 / 7.00-4.25	SPL 03.43S	SPL 03.44S	SPL 03.45S	SPL 03.46S	SPL 03.46S

E-GATOR ALLIGATOR FORCEPS



Number	Description
SPL 03.01	E-Gator, alligator forceps, 4.0x0.9mm jaws, w/micro-slots. Stainless steel, length: 70cm, 2 3/4".



L = Total Length
 FL = Functional Length

BASIC BLOCK FOR THE TOTAL AND PARTIAL IMPLANT SHORTENING SCALES



Number	Dimensions
PF001-10	Shortening Block

SHORTENING SCALES FOR USE WITH THE BASIC BLOCK FOR TOTAL IMPLANTS WITH FIXED HEAD



Number	Dimensions
PF001-11	Tower for Fixed Head (Total)

SHORTENING SCALES FOR USE WITH THE BASIC BLOCK FOR PARTIAL IMPLANTS



Number	Dimensions
PF001-12	Tower for Partial

SHORTENING SCALES FOR USE WITH THE BASIC BLOCK FOR TOTAL IMPLANTS WITH FIXED SHOE



Number	Dimensions
PF001-13	Tower for Fixed Shoe (Total)

MEASURING GAUGE



Number	Dimensions
02.14	Measuring Instrument

HILDMANN CARTILAGE HOLDING AND CUTTING FORCEPS



Number	Dimensions
O10-504-10	Straight, 10 CM, Stainless with set screw

OSS

L = Total Length
FL = Functional Length

TRIALS FOR TITANIUM TOTAL IMPLANTS

• Stainless steel

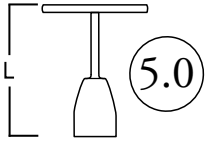

Number	L (MM)	Number	L (MM)
11000-D20	2.0	11000-D50	5.0
11000-D25	2.5	11000-D55	5.5
11000-D30	3.0	11000-D60	6.0
11000-D35	3.5	11000-D65	6.5
11000-D40	4.0	11000-D70	7.0
11000-D45	4.5	11000-D75	7.5

TRIALS FOR TITANIUM PARTIAL IMPLANTS

• Stainless steel

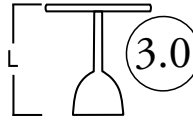

Number	L (MM)	Number	L (MM)
12000-D05	0.5	12000-D30	3.0
12000-D10	1.0	12000-D35	3.5
12000-D15	1.5	12000-D40	4.0
12000-D17	1.75	12000-D45	4.5
12000-D20	2.0	12000-D50	5.0
12000-D25	2.5	12000-D55	5.5

*** NOT FOR IMPLANTATION • REUSABLE ***

L = Total Length
 FL = Functional Length

GELFOAM PRESS

- Stainless, 18 cm



Number	Dimensions
O64500	Platform 11x14 mm
O64501	Platform 30x30 mm
O64502	Platform 22x30 mm

HOUSE STYLE CUTTING BLOCK

- 2.87" x 1.5" x 9.0 mm
- Non-Sterile

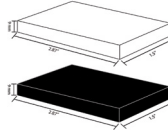

Number	Dimensions
O99131	White Delrin
O99131B	Black Delrin

PHENOL APPLICATOR

- Duberstein Type

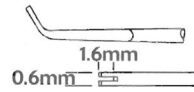

Number	Dimensions
O99610	Round handle, Stainless, Matt, Length 15.7 cm Tynes : 0.63 mm x 1.57 mm

R&CS ACC

DIS

OTO ACC

OSS

LAR ACC

SPE ACC

RHI INS

PSB

OTO INS

LAR INS

ORO/NAS INS

LARYNGEAL

ACCESSORIES

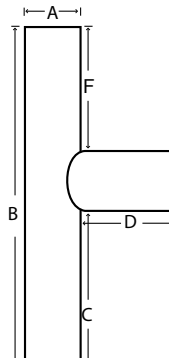
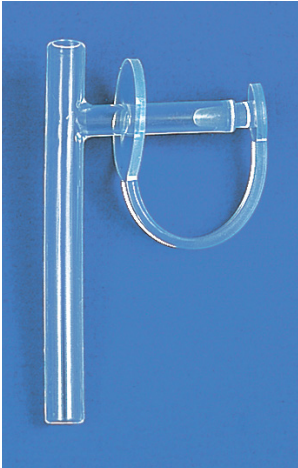

Designed for the surgical management of tracheal and subglottic stenosis and the reconstruction of cervical and thoracic trachea. Packaged 1 each.

- 100% medical grade silicone
- Easily trimmed to meet patient's needs
- Large soft collar with closure attached

Number	Size	A	B	C	D	E	F
70-50080	Standard	8 mm	37 mm	16.5 mm	32 mm	6.5 mm	14 mm
70-50100	Standard	10 mm	50 mm	24 mm	42 mm	8 mm	18 mm
70-50120	Standard	12 mm	66 mm	32 mm	50 mm	10.5 mm	23 mm
70-50140	Standard	14 mm	71 mm	34 mm	50 mm	10.5 mm	26 mm
70-50160	Standard	16 mm	72 mm	34 mm	60 mm	11.5 mm	26 mm
70-50081	Long	8 mm	80 mm	60 mm	32 mm	6.5 mm	14 mm
70-50101	Long	10 mm	96 mm	70 mm	42 mm	8 mm	18 mm
70-50121	Long	12 mm	108 mm	75 mm	50 mm	10.5 mm	23 mm
70-50141	Long	14 mm	112 mm	75 mm	50 mm	10.5 mm	26 mm
70-50161	Long	16 mm	122 mm	85 mm	60 mm	11.5 mm	26 mm

Disposable Adenoid Curettes

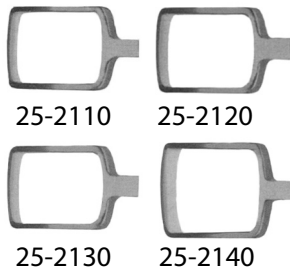

BECKMANN ADENOID CURETTE

- Sterile
- Single-use
- Sharp cutting edge for each case

Number	Description	Length	Size	Head Width	Qty/Box
25-2110	Adenoid Curette Straight	22 cm	1	10 mm	5
25-2120	Adenoid Curette Straight	22 cm	2	12 mm	5
25-2130	Adenoid Curette Straight	22 cm	3	14 mm	5
25-2140	Adenoid Curette Straight	22 cm	4	16 mm	5



• Single use - Sterile

Number	Size		ET Tube	Qty/ Box
29-80500S	Single channel surface electrode	Standard	7.5 - 10 mm	5
29-80500W	Single channel surface electrode	Wrap around	7.5 - 10 mm	5
29-80500DC	Dual Channel Electrode	Standard	6.0 - 7.5 mm	5

Number	Size	Tip O.D.	Effective Length	Qty/ Box
29-3001	Disposable monopolar direct nerve stimulator probe	0.8 mm	80-120 mm	10

R&CS ACC

DIS

OTO ACC

OSS

LAR ACC

SPE ACC

RHI INS

PSB

OTO INS

LAR INS

ORO/NAS INS

SPECIALTY PRODUCTS

ACCESSORIES



BRIGHTSTAR™ HIGH POWER WIRELESS LED HEADLIGHT SYSTEM

- Focusable, battery powered, bright, white LED
- Ultra comfortable, adjustable black head band
- Dual long lasting, rechargeable lithium ion batteries (7 hours continuous)

Light Spot Distance	Spot Ø
20-30 cm	38-55 mm
40 cm	53-85 mm
50 cm	68-110 mm
60 cm	80-135 mm

Number	Description
34-4800	BrightStar™ High Power wireless LED Headlight System Includes: Wireless LED headlight with removable dual battery packs, charging station, black headband
34-4701	Lithium Ion battery pack replacement for 34-4800
34-4803	Dual Charging Station replacement



BRIGHTSTAR™ ULTRA WIRELESS LED HEADLIGHT SYSTEM

- Focusable, battery powered, bright, white LED
- Ultra comfortable, adjustable black head band
- Long lasting, rechargeable lithium ion battery (3-5 hours continuous)

Light Spot Distance	Spot Ø
20 cm	11-40 mm
30 cm	13-63 mm
40 cm	25-130 mm

Number	Description
34-4700	BrightStar™ Ultra wireless LED Headlight System Includes: Wireless LED headlight, removable battery pack, charger 110-220v, black headband
34-4701	Lithium Ion battery pack replacement for 34-4700
34-4702	Charger 110/220 VAC replacement for 34-4700
34-4703	Charging Station



BRIGHTSTAR™ II LED HEADLIGHT SYSTEM

- Focusable, battery powered, bright, white LED
- Ultra comfortable, adjustable black head band
- Dual long lasting, rechargeable lithium ion batteries (5 hours continuous)

Light Spot Distance	Spot Ø
20 cm	11-40 mm
30 cm	13-63 mm
40 cm	25-130 mm

Number	Description
34-4190	BrightStar™ II LED headlight, lithium ion battery, charger 110-220v, black headband
34-4191	Lithium Ion battery pack replacement with belt clip
34-4192	Charger for 34-4190



BRIGHTSTAR™ II WIRELESS LED HEADLIGHT SYSTEM

- Focusable, battery powered, bright, white LED
- Ultra comfortable, adjustable black head band
- Long lasting, rechargeable lithium ion battery (3-5 hours continuous)

Light Spot Distance	Spot Ø
20 cm	11-40 mm
30 cm	13-63 mm
40 cm	25-130 mm

Number	Description
34-4300	BrightStar™ Ultra wireless LED Headlight, headband mounted lithium ion battery, charger 110-220v, complete, black headband
34-4301	Lithium Ion battery pack replacement for 34-4300
34-4302	Charger 110/220 VAC for 34-4300

IFO FIBEROPTIC HEADLIGHT WITH OPEN HEADBAND

- Adjustable lightweight headband, F/O headlight, bifurcated clear cable illumination for long term balance, comfort and wear
- High performance optical system
- Wide focus range and powerful light spot

Light Spot Distance	Spot Ø
20 cm	11-68 mm
30 cm	12-101 mm
40 cm	13-136 mm
50 cm	14-173 mm
60 cm	16-208 mm

Number	Description
--------	-------------

34-4160	IFO Focusable Fiberoptic Headlight, open headband, bifurcated cable illumination, black headband
---------	--

IFO FIBEROPTIC HEADLIGHT WITH CRADLE HEADBAND

- Super adjustable lightweight headband , F/O headlight, bifurcated clear cable illumination for long term balance, stability, comfort and wear
- High performance optical system
- Wide focus range and powerful light spot

Light Spot Distance	Spot Ø
20 cm	11-68 mm
30 cm	12-101 mm
40 cm	13-136 mm
50 cm	14-173 mm
60 cm	16-208 mm

Number	Description
--------	-------------

34-4360	IFO Focusable Fiberoptic Headlight, cradle headband, bifurcated cable illumination, black headband
---------	--

SPE ACC

FIBEROPTIC HEADLIGHT

- Ultra lightweight
- Adjustable for comfortable fit
- Can be used with most standard cables, 3 mm, 9 ft cable available
- Cables available to fit light sources of: K. Storz, Pilling, Olympus, Wolf ACMI

Number	Description
--------	-------------

34-4060	Fiber Optic Headlight (cable not included)
34-4061	Fiber Optic Headlight, Micro Spot (cable not included)
34-4065	Fiber Optic Cable, ACMI fittings, 3.0 mm, 9' long

FIBEROPTIC HEADLIGHT

- 90° focusable headlight
- Headlight module, 10-100mm variable spot
- Detachable joysticks (2)
- Set of cushioned detachable sweatbands
- Bifurcated cable, 9' with Wolf lens proximal as standard

Number	Description
--------	-------------

GMF-H100	Surgical headlight with cradle
----------	--------------------------------



UNIVERSAL HALOGEN LIGHTSOURCE HL 150

- Compact, lightweight halogen lightsource for universal use
- Lamp 1 Halogen reflector lamp, 150 Watt, 15 V
- Color temperature 3.600oK
- Intensity control stepless/mechanical diaphragm
- Light guide adapter exchangeable
- Power supply 110/115 VAC or 230/240 VAC, switchable
- Dimensions (WxHxD) 6.8" x 3" x 8", 175 x 82,5 x 202 mm
- Weight 3,5 kg
- Power consumption max. 160 Watt
- Manufactured/tested acc. IEC 601-1 / EN 60601-1, 93/42 ECC

Number	Description
34-3135	Halogen Light Box 150 watt ACMI connector (pictured)

HALOGEN LIGHT CABLE ADAPTERS

Female connectors for F/O Cables & Flexible scope Light Cable Connectors

Number	Description
34-0754	Light box adapter for ACMI
34-0742	Light box adapter for Olympus
34-0752	Light box adapter for Storz
34-0753	Light box adapter for Wolf
34-0755	Light box adapter for Machita

Stands and Light Box Trolleys – Available upon request



LED LIGHTSOURCE

- Lamp Light emitting diode technology (LED), life > 50,000 hours
- Color temperature 6500° K Normal
- Intensity control Electronic (PWM) from 0 to 100%
- Turret, 4 ports ACMI, Olympus, Storz, Wolf (others available)
- Non-Turret model Available upon request
- Power 52W typical; 10-240V AC, 50/*60 Hz, worldwide operation
- Dimensions (WxHxD) 4.65" x 3.32" x 7.25" mm (~10" overall)
- Weight 2.5lbs (1.14kg), EN60601-1-2
- Regulatory UL60601-1, CAN/CSA C22.2 No. 601.1, **CE** marked

Number	Description
LLS-2000T	Premium light source, 4 -turret, generating 50% greater output than LLS1000T



CABLES

Number	Description
34-3140	Fiber Optic Cable, ACMI fittings, 4.0mm 8' long
34-4065	Fiber Optic Cable, ACMI fittings, 3.0 mm, 9' long

- Other fittings available (ex. Karl Storz Pilling, Olympus, Wolf)
- Custom size cables available upon request

HEAD MIRROR

- Unbreakable exam mirror - Guaranteed!
- Comfortable leather headband with velcro adjustability
- Removable/washable headband liner
- Mirror is approximately 2.9 inches in diameter
- View-hole is 0.5 inches in diameter

Number	Description
34-4010	Unbreakable Head Mirror w/headband
34-4011	Unbreakable Head Mirror only
34-4012	Headband only
34-4075	Replacement liners for head band

POCKET LIGHT

- Small convenient size - very lightweight
- Bright white Xenon bulb
- Otoscopic adapter for standard disposable specula
- Nasal/Oral exam head

Number	Description
34-4000	ENT Pocket Light w/Case

BRIGHTSTAR™ PORTABLE LIGHT SOURCE

- Bright, white, portable, efficient light source for Rod Lens Oscopes, Sinus Scopes, Indirect Vision Rod Lens Laryngoscopes, Flexible Nasopharyngoscopes
- Uses the same belt clipped battery pack as the headlight
- Portable LED, Battery powered light source

Number	Description
34-4020	BrightStar™ LED complete Light Source System
34-4021	ACMI scope adapter
34-4022	Richard Wolf Scope adapter
34-4023	Karl Storz, Gyrus, Olympus scope adaptor
34-4092	Charger and wall connector

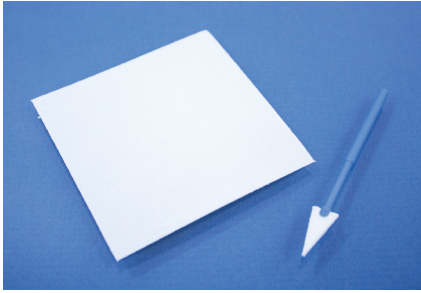

Invotec Number	Merocel® Number	Description		Qty/Box
22-70101	4405101	PVA Eye Spears	Sterile	100 (10/pouch)

Microsurgery

Invotec Number	Merocel® Number	Description		Qty/Box
22-70300	400300	Instrument wipe	3.5" x 3.5"	20

Merocel® is a registered trademark of Medtronic-Xomed

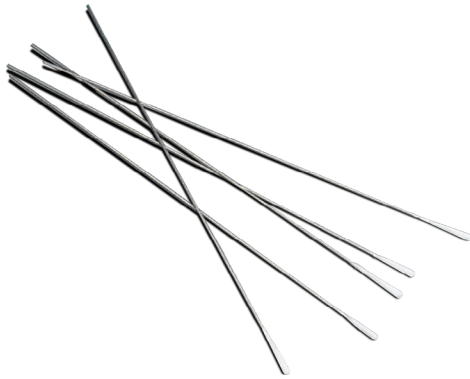

COTTON TIPPED APPLICATORS

- Pure cotton end
- Sterile packed - 5 per pouch

Number	Description		Qty/Box
2011898	Steel Applicator with Cotton Tip	0.9 mm x 150 mm	100



FOG GUARD™

Invotec's Fog-Guard™ anti-fog solution has been formulated, without alcohol, to provide excellent levels of anti fog protection from distortion for your delicate glass optics.

- Will not damage endoscope lens
- Provided sterile, ready to use
- Packaged with a micropore, non-abrasive, radiopaque wiping pad with adhesive back

Number	Description		Qty/Box
30900	Kit- One (1) Screw top dispenser bottles (6 cc) and one (1) Green micropore wiping pad with adhesive backing, 4.3cm x 3.8cm (1 6/10" x 1 1/2")	Sterile	20 kits



COMFORTFOAM™ HEADREST

- Manufactured from high density foam materials
- Non-Slip Surface
- Open Foam Softness
- Flexible Positioning
- Protects Sensitive Skin
- Fire Retardant¹
- Bar Coded for Inventory Management
- Enhanced Patient Stability

Number	Description		Qty/Box
26-71000	Comfortfoam™ sculpted head rest - Blue, with ET-Anesthesia Slot		1
26-72000	Comfortfoam™ sculpted head rest - Blue		1
26-73000	Comfortfoam™ sculpted head rest - Blue		1



Constructed of super-strong, heat resistant, (360°F, 160°C) ULTEM® material, the Invotec trays are designed to protect your valuable delicate instruments during sterilization. Offered in multiple sizes and complimented with tops, stackable trays, silicone finger mats and cradles, you can build your own custom instrument tray system.

Containers

Number	Length x Width x Depth	Description
T602575	6.0 x 2.5 x .75 inches	Base/Lid
T602512	6.0 x 2.5 x 1.25 inches	Base/Lid
T654075	6.5 x 4.0 x .75 inches	Base/Lid
T752575	7.5 x 2.5 x .75 inches	Base/Lid
T754075	7.5 x 4.0 x .75 inches	Base/Lid
T754015	7.5 x 4.0 x 1.5 inches	Base/Lid
T106075	10.0 x 6.0 x .75 inches	Base/Lid
T106015	10.0 x 6.0 x 1.5 inches	Base/Lid
T106020	10.0 x 6.0 x 1.5 inches	Base/Lid, second tray
T151015	15 x 10 x 1.5 inches	Base/Lid
T151010	15 x 10 x .75 inches	Large Tray, base/lid/mat
T151025	15 x 10 x 1.5 inches	Large Tray, base/lid/mat
T151026	15 x 10 x 1.5 inches	Large Tray, base/lid/insert/mats
T162615	16 x 2.6 x 1.5 inches (40.6cm long)	Scope Tray, base/lid
T186515	18 x 6.5 x 1.5 inches (45.7cm long)	Scope Tray, base/lid
T186530	18 x 6.5 x 3.0 inches (45.7cm long)	Scope Tray, base/lid
T-122615	12" x 2.6" x 1.54"	Scope tray, lid/cradles for two 185mm rod lens scopes

Silicone Mats

Number	Length x Width	Description
T602513	6.0 x 2.5 inches	Finger Mat
T654013	6.0 x 4.0 inches	Finger Mat
T752513	7.5 x 2.5 inches	Finger Mat
T754013	7.5 x 4.0 inches	Finger Mat
T106023	10.0 x 6.0 inches	Finger Mat
T151023	15 x 10 inches	Finger Mat
T162613	16 x 2.6 inches	Finger Mat
T186513	18 x 6.5 inches	Finger Mat
T186533	18 x 6.5 x 3.0 inches	Finger Mat

Silicone Cradles

Catalog No.	Description	Instrument Application
T237590	3 slot insert opposite, triple slot	Keeps 3 forceps separated
T237591	Single slot bar, round cut	Knife / instrument
T237592	Double slot bar, round cut	Knife / instrument
T237593	Triple slot bar, round cut	Knife / instrument
T237596	6 slot insert opposite triple slot	Keeps 3 forceps separated
T261691	Scope round cut, 9 and 12mm	Endoscope(s)
T261692	Scope round cut, 9mm (2)	Endoscope(s)
T387512	12 slot insert holding 6 forceps	Keeps 6 forceps separated
T387592	Double slot bar for large tray	Knives / instruments
T387593	Triple slot bar for large tray	Knives / instruments
T387594	Four slot bar for large tray	Knives / instruments
T387595	Five slot bar for large tray	Knives / instruments
T387596	6 slot insert for 6 forceps	Keeps 6 forceps separated

R&CS ACC

DIS

OTO ACC

OSS

LAR ACC

SPE ACC

RHI INS

PSB

OTO INS

LAR INS

ORO/NAS INS

RHINOLOGY & COSMETIC

INSTRUMENTS



TELESCOPES FOR NOSE AND PARANASAL SINUSES

Number	Description	Diameter	Working Length
10-0036-00	Straight Forward Wide Angle Telescope	0° 2.7 mm	110 mm autoclavable
10-0037-00	Straight Forward Wide Angle Telescope	30° 2.7 mm	110 mm autoclavable
10-0038-00	Straight Forward Wide Angle Telescope	70° 2.7 mm	110 mm autoclavable

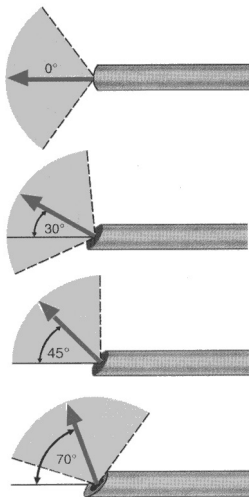

Number	Description	Diameter	Working Length
10-0045-00	Straight Forward Wide Angle Telescope	0° 4 mm	175 mm autoclavable
10-0046-00	Straight Forward Wide Angle Telescope	30° 4 mm	175 mm autoclavable
10-0086-00	Straight Forward Wide Angle Telescope	45° 4 mm	175 mm autoclavable
10-0047-00	Straight Forward Wide Angle Telescope	70° 4 mm	175 mm autoclavable

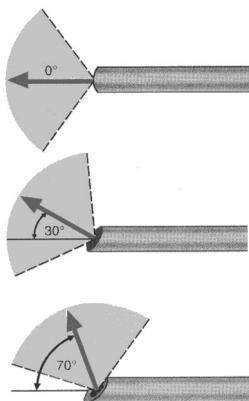

Number	Description	Diameter	Working Length
10-0039-00	Straight Forward Wide Angle Telescope	0° 2.7 mm Ø	175 mm autoclavable
10-0040-00	Straight Forward Wide Angle Telescope	30° 2.7 mm Ø	175 mm autoclavable
10-0041-00	Straight Forward Wide Angle Telescope	70° 2.7 mm Ø	175 mm autoclavable

RH INS

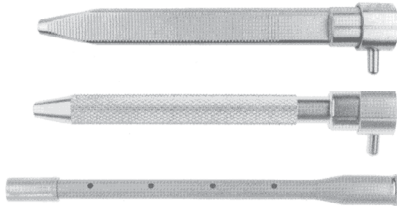

TELESCOPE HANDLES

Number	Description	length	Working Length
S40213	Telescope Handle round	6.5 cm	110 mm

Number	Description	length	Working Length
S40211	Telescope Handle flat straight forward telescopes up to 4 mm Ø	11 cm	175 mm

S40212	Telescope Handle round forward-oblique and lateral telescopes up to 4 mm Ø	11 cm	175 mm
--------	---	-------	--------

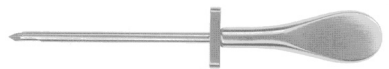
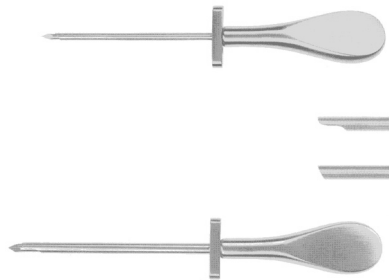
S41100	Protection Tube for Sinuscopy Telescopes		
--------	--	--	--

ENDOSCOPE TROCAR AND CANNULA

Number	Description	OuterØ	Cannula length
S18400	Trocar and Cannula for Sinuscopy with billshaped beak for use with 4 mm telescopes	5 mm	8.5 cm

S18500	Trocar and Cannula for Sinuscopy with oblique beak for use with 4 mm telescopes	5 mm	8.5 cm
--------	--	------	--------

S18503	Trocar and Cannula for Sinuscopy with oblique beak for use with 2.7 mm telescopes	3.3 mm	7.5 cm
--------	--	--------	--------

S18504	Trocar and Cannula for Sinuscopy with oblique beak for use with 3 mm telescopes	4 mm	7.5 cm
--------	--	------	--------

SUCTION IRRIGATION

Number	Description
S42000	Pistol Grip Telescope Suction Irrigation Handle
S42800	Sheath for telescope 2.7mm, 190mm, 0°
S42830	Sheath for telescope 2.7mm, 190mm, 30°
S42870	Sheath for telescope 2.7mm, 190mm, 70°
S42900	Sheath for telescope 2.7mm, 140mm, 0°
S42930	Sheath for telescope 2.7mm, 140mm, 30°
S42970	Sheath for telescope 2.7mm, 140mm, 70°
S44100	Sheath for telescope 4.0mm, 180mm, 0°
S44130	Sheath for telescope 4.0mm, 180mm, 30°
S44145	Sheath for telescope 4.0mm, 180mm, 45°
S44170	Sheath for telescope 4.0mm, 180mm, 70°

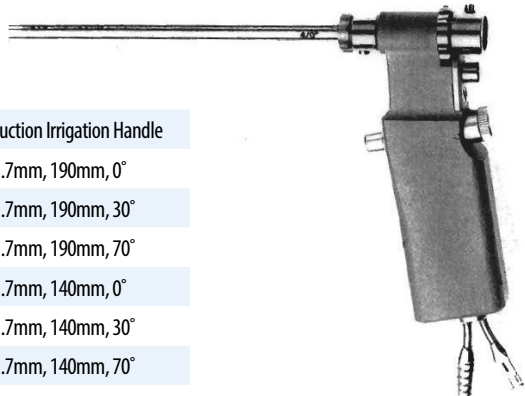

Number	Description
S52100	Pencil Grip Suction Irrigation Handle
S42830	Sheath for 2.7mm , telescopes 0-30°
S52930	Sheath for 4.0mm, telescope 0-30°
S52870	Sheath for 2.7mm. Telescope 70°
S52970	Sheath for 4.0mm, telescope 70°

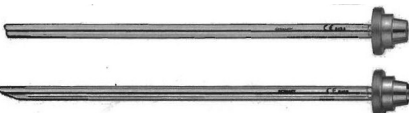
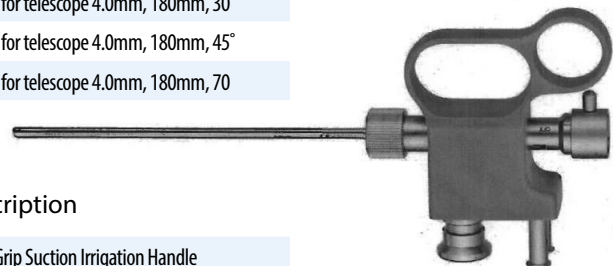



MAXILLARY SINUS

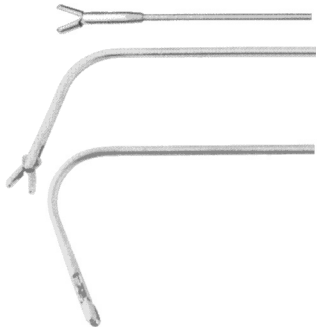

Number	Description	Sheath	Working Length
S15000	Biopsy and Grasping Forceps	double action oval cupped jaws 2.5 mm Ø	15 cm
S15070	Biopsy Forceps	double action oval cupped jaws, 3.0 mm Ø	12 cm
S15110	Biopsy Forceps	double action oval cupped jaws, 3.0 mm Ø	11 cm



ANTRUM GRASPING FORCEPS



Number	Description	Working Length
S15500	Antrum Grasping Forceps, (Heuwieser style)	10 cm

BIOPSY AND GRASPING FORCEPS

Number	Description	Working Length
S15005	Biopsy and Grasping Forceps with malleable sheath end	18 cm



RH INS



THROUGH-CUTTING FRONTAL SINUS PUNCH FORCEPS

Number	Description	Diameter		Working Length
S36201	Double action cup jaws	2 mm	55° upturned	vertical opening 14.5 cm
S36202	Double action cup jaws	2 mm	55° upturned	horizontal opening 14.5 cm
S36203	Double action cup jaws	2 mm	90° upturned	vertical opening 14.5 cm
S36204	Double action cup jaws	2 mm	90° upturned	horizontal opening 14.5 cm

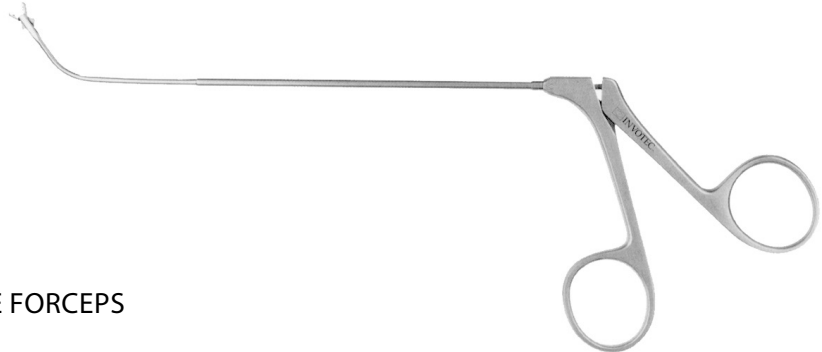

GIRAFFE FORCEPS

Number	Description	Diameter		
S35401	Double action cup jaws	3 mm	55° upturned	vertical opening
S35402	Double action cup jaws	3 mm		horizontal opening
S35403	Double action cup jaws	2 mm		vertical opening
S35404	Double action cup jaws	2 mm		horizontal opening
S35413	Double action cup jaws	4 mm		vertical opening
S35414	Double action cup jaws	4 mm		horizontal opening

Number	Description	Diameter		
S35405	Double action cup jaws	2 mm	90° upturned	vertical opening
S35406	Double action cup jaws	2 mm		horizontal opening
S35409	Double action cup jaws	4 mm		vertical opening
S35410	Double action cup jaws	4 mm		horizontal opening





BIOPSY FORCEPS

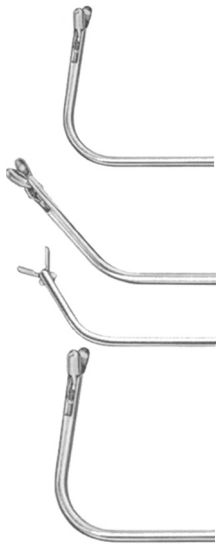

Number	Description	Diameter		
S35110	Oval double action cupped jaws	2.6 mm	110° backwards cutting	horizontal opening
S35111	Oval double action cupped jaws	2.6 mm	110° backwards cutting	vertical opening
S35170	Oval double action cupped jaws	2.6 mm	70° upturned	horizontal opening
S35171	Oval double action cupped jaws	5.6 mm	70° upturned	vertical opening
S35114	Oval double action cupped jaws	4 mm	110° backwards cutting	horizontal opening
S35124	Oval double action cupped jaws	4 mm	110° backwards cutting	vertical opening

PEAR-SHAPED POLYP GRASPING FORCEPS



Number	Description			
S35300	Jaws 3 x 1.5 mm	pear-shaped	80° upturned	horizontal opening
S35304	Jaws 3 x 1.5 mm	pear-shaped	45° upturned	upturned
S35301	Jaws 3 x 1.5 mm	pear-shaped	80° upturned	sheath curved left
S35302	Jaws 3 x 1.5 mm	pear-shaped	80° upturned	sheath curved right

BLAKESLEY NASAL FORCEPS

Number	Description	Diameter	Size	Working Length
S30000	Blakesley nasal forceps	Straight	0 = 3 mm	11 cm
S30001	Blakesley nasal forceps	Straight	1 = 3.5 mm	11 cm
S30002	Blakesley nasal forceps	Straight	2 = 4 mm	11 cm
S30003	Blakesley nasal forceps	Straight	3 = 5 mm	11 cm

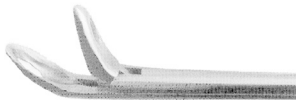
BLAKESLEY-WILDE NASAL FORCEPS

Number	Description	Diameter	Size	Working Length
S30100	Blakesley-Wilde nasal forceps	45° upcurved	0 = 3 mm	11 cm
S30101	Blakesley-Wilde nasal forceps	45° upcurved	1 = 3.5 mm	11 cm
S30102	Blakesley-Wilde nasal forceps	45° upcurved	2 = 4 mm	11 cm
S30103	Blakesley-Wilde nasal forceps	45° upcurved	3 = 5 mm	11 cm

BLAKESLEY-WILDE NASAL FORCEPS

Number	Description	Diameter	Size	Working Length
S30200	Blakesley-Wilde nasal forceps	90° upcurved	0 = 3 mm	11 cm
S30201	Blakesley-Wilde nasal forceps	90° upcurved	1 = 3.5 mm	11 cm
S30202	Blakesley-Wilde nasal forceps	90° upcurved	2 = 4 mm	11 cm
S30203	Blakesley-Wilde nasal forceps	90° upcurved	3 = 5 mm	11 cm

BLAKESLEY THROUGH-CUT FORCEPS

Number	Description	Bite	Size	Working Length	
S35800	Blakesley through-cut forceps	Straight	2 mm	0 = 3 mm	11 cm
S35801	Blakesley through-cut forceps	Straight	2.5 mm	1 = 3.5 mm	11 cm
S35802	Blakesley through-cut forceps	Straight	3.0 mm	2 = 4 mm	11 cm



S35900	Blakesley through-cut forceps	45° upcurved	2 mm	0 = 3 mm	11 cm
S35901	Blakesley through-cut forceps	45° upcurved	2.5 mm	1 = 3.5 mm	11 cm
S35902	Blakesley through-cut forceps	45° upcurved	3.0 mm	2 = 4 mm	11 cm



BLAKESLEY ANTRUM FORCEPS

Number Description Working Length

S30500	Blakesley antrum forceps	tube shaft	curved left	10 cm
S30600	Blakesley antrum forceps	tube shaft	curved right	10 cm

POLYP GRASPING FORCEPS

Number Description Size Working Length

S30400	Polyp grasping forceps	60° upcurved	round	spoon 6 x 14 mm	11 cm
--------	------------------------	--------------	-------	-----------------	-------

HELMS NASAL FORCEPS

Number Description Working Length

S30700	Helms nasal forceps	oval cupped spoon	curved left	13 cm
S30800	Helms nasal forceps	oval cupped spoon	curved right	13 cm

TAKAHASHI NASAL FORCEPS

Number Description Size Working Length

S27001	Takahashi nasal forceps	straight	spoon 3 x 10 mm	11 cm
S27002	Takahashi nasal forceps	30° upturned	spoon 3 x 10 mm	11 cm

STRUYCHEN NASAL CUTTING FORCEPS

Number Description Working Length

S27500	Struychen nasal cutting forceps	11 cm
--------	---------------------------------	-------

HARTMANN NASAL CUTTING FORCEPS

Number Description Size Working Length

S29001	Hartmann nasal cutting forceps	1	11 cm
S29002	Hartmann nasal cutting forceps	2	11 cm
S29003	Hartmann nasal cutting forceps	3	11 cm
S29004	Hartmann nasal cutting forceps	4	11 cm

STRUEMPEL

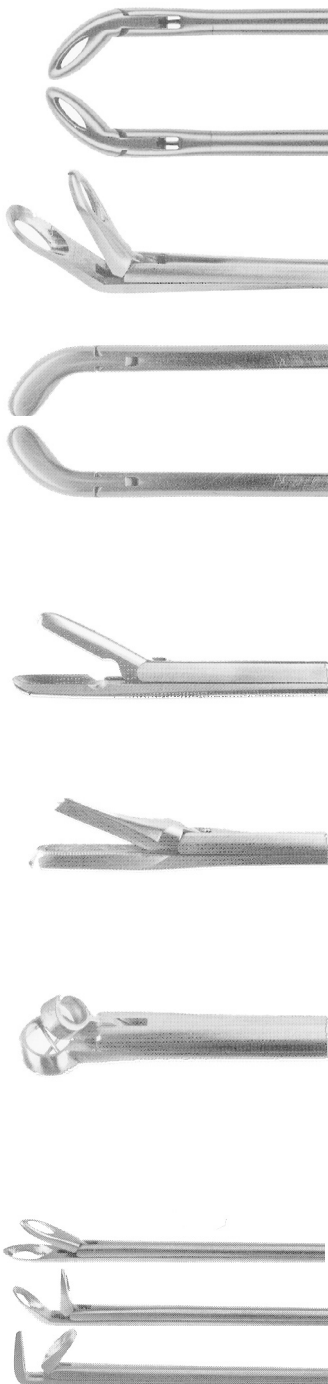

RH INS

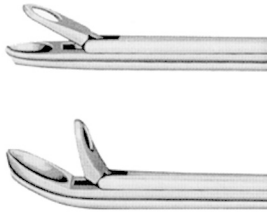
BLAKESLEY SUCTION FORCEPS

Number	Description		Size	Working Length
S37001	Blakesley suction forceps with suction channel	straight	1=3.5 mm	11 cm
S37002	Blakesley suction forceps with suction channel	straight	2=4 mm	11 cm
S37101	Blakesley suction forceps with suction channel	45° upturned	1=3.5 mm	11 cm
S37102	Blakesley suction forceps with suction channel	45° upturned	2=3.5 mm	11 cm

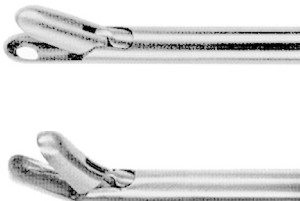
TAKAHASHI SUCTION FORCEPS

Number	Description		Size	Sheath	Working Length
S38001	Takahashi suction forceps with integrated suction channel	straight	1=3.5 mm	4 mm	10 cm
S38002	Takahashi suction forceps with integrated suction channel	straight	2=2.5 mm	4 mm	10 cm
S38101	Takahashi suction forceps with integrated suction channel	45° upturned	1=3.5 mm	4 mm	10 cm
S38102	Takahashi suction forceps with integrated suction channel	45° upturned	2=2.5 mm	4 mm	10 cm



BLAKESLEY SUCTION FORCEPS WITH INTEGRATED SUCTION CHANNEL



Number	Description		Size		Working Length
S36800	BLAKESLEY suction forceps with suction channel	straight	0 = 2.5 mm	4 mm	11 cm
S36801	BLAKESLEY suction forceps with suction channel	straight	1 = 3.5 mm	4 mm	11 cm
S36802	BLAKESLEY suction forceps with suction channel	straight	2 = 4 mm	4 mm	11 cm
S36900	BLAKESLEY suction forceps with suction channel	45° upcurved	0 = 2.5 mm	4 mm	10 cm
S36901	BLAKESLEY suction forceps with suction channel	45° upcurved	1 = 3.5 mm	4 mm	10 cm
S36902	BLAKESLEY suction forceps with suction channel	45° upcurved	2 = 4 mm	4 mm	10 cm



BLAKESLEY SUCTION FORCEPS FOR CHILDREN



Number	Description		Jaw Size	Sheath	Working Length
S36700	Blakesley suction forceps for children with integrated suction channel	straight	2.5 mm	2.7 mm	10 cm
S36745	Blakesley suction forceps for children with integrated suction channel	45° upcurved	2.5 mm	2.7 mm	10 cm

RH INS



THROUGHTCUTTING FORCEPS WITH INTEGRATED SUCTION CHANNEL



Number	Description		Bite	Working Length
S35200	Through cutting forceps with integrated suction channel	straight	2 mm	10 cm
S35201	Through cutting forceps with integrated suction channel	45° upcurved	2 mm	10 cm
S35204	Through cutting forceps with integrated suction channel	shaft 15° upcurved	2 mm	10 cm



FOKKENS BIOPSY FORCEPS



Number	Description		Bite	Working Length
S36000	Fokkens Biopsy Forceps	straight	3 mm Ø	8 cm
S36045	Fokkens Biopsy Forceps	45° upcurved	Round 3 mm Ø	11 cm

RHINS



SUPER PUNCH THRU CUT FORCEPS

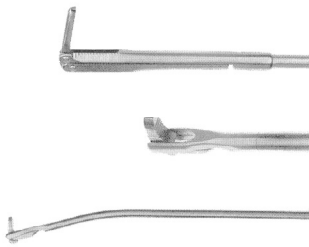

Number	Description		Bite	size	Working Length
S36400	Super Punch Thru Cut forceps	straight	Oval 2 mm	0	13 cm
S36401	Super Punch Thru Cut forceps	straight	Oval 2.5 mm	1	13 cm
S36402	Super Punch Thru Cut forceps	straight	Oval 3 mm	2	13 cm
S36500	Super Punch Thru Cut forceps	upcurved	Oval 2 mm	0	13 cm
S36501	Super Punch Thru Cut forceps	upcurved	Oval 2.5 mm	1	13 cm
S36502	Super Punch Thru Cut forceps	upcurved	Oval 3 mm	2	13 cm

ROTATING BACK BITER

Number	Description	Bite	Working Length
S35015	Rotating Backbiting Antrum Punch, finger post facilitates 360° rotation	pediatric size: 1.5 mm	10 cm
S35025	Rotating Backbiting Antrum Punch, finger post facilitates 360° rotation	2.5 mm	10 cm
S35050	Toby micro backbiter finger post facilitates 360° rotation	curved down	10 cm

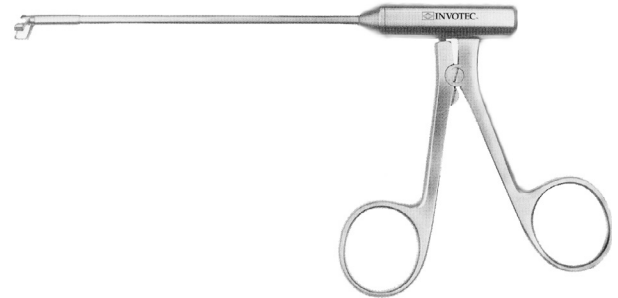
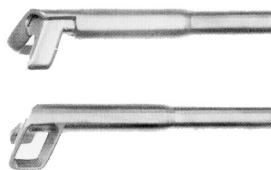

STAMMBERGER TYPE SIDEBITING ANTRUM PUNCH

Number	Description	Bite	Working Length
S34801	Sidebiting antrum punch	leftside downward and forward	throughcut 10 cm
S34802	Sidebiting antrum punch	rightside downward and forward	throughcut 10 cm

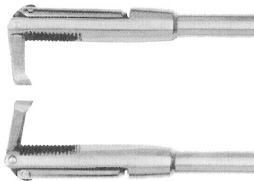

BACKBITING ANTRUM

Number	Description	Bite	Working Length
S35000	Antrum Punch - adult size	upside backwards cutting	2.5 mm 10 cm
S35001	Antrum Punch - adult size	left side backwards cutting	2.5mm 10 cm
S35002	Antrum Punch - adult size	right side backwards cutting	2.5mm 10 cm



Number	Description	Bite	Working Length
S35020	Antrum Punch - pediatric	upside backwards cutting	1.5 mm 10 cm
S35021	Antrum Punch - pediatric	left side backwards cutting	1.5 mm 10 cm
S35022	Antrum Punch - pediatric	right side backward cutting	1.5 mm 10 cm

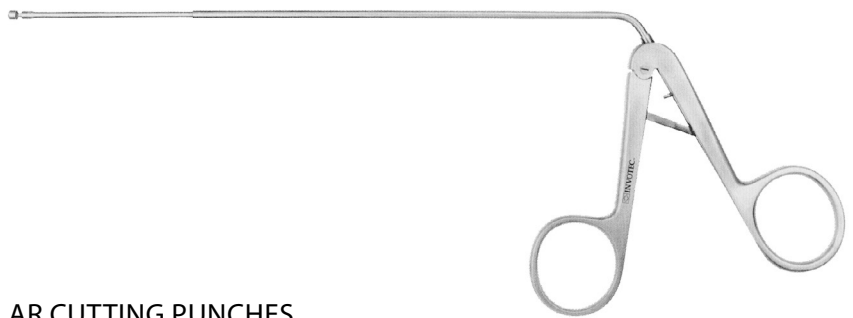

CIRCULAR CUTTING PUNCHES

Number	Description	Diameter	Working length
S34935	Circular Cutting Punch cutting in a full circle of 360°	3.5 mm	18 cm
S34945	Circular Cutting Punch cutting in a full circle of 360°	4.5 mm	18 cm
S34965	Circular Cutting Punch cutting in a full circle of 360°	65° upturned 3.5 mm	17 cm
S34975	Circular Cutting Punch cutting in a full circle of 360°	4.5 mm	18 cm





BIOPSY FORCEPS

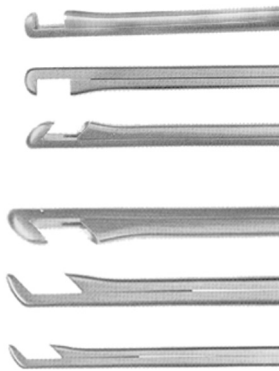

Number	Description		Width	Working Length
S12001	HAJEK Sphenoid Punch	90° upbiting	4 mm	14 cm
S12002	HAJEK Sphenoid Punch	90° downbiting	4 mm	14 cm
S12201	HAJEK Sphenoid Punch	45° upbiting backward	4 mm	14 cm
S12202	HAJEK-KOFLER Sphenoid Punch	45° downbiting backward	4 mm x 4 mm	14 cm
S12301	HAJEK-KOFLER Sphenoid Punch	45° upbiting forward	4 mm x 4 mm	14 cm
S12302	HAJEK-KOFLER Sphenoid Punch bite 2mm x 2mm	45° upbiting forward	4 mm x 4 mm	14 cm



BEYER ANTRUM PUNCH



Number	Description		Width	Working Length
S12500	BEYER Antrum Punch	90° throughbiting upwards	2 mm	9 cm
S12600	BEYER Antrum Punch	90° throughbiting backward	2 mm	9 cm



HAJEK-KOFLER ROTATABLE SPHENOID PUNCH



Number	Description	Working Length
S13000	Hajek-Kofler Sphenoid punch reversible 360° slender pattern	17 cm

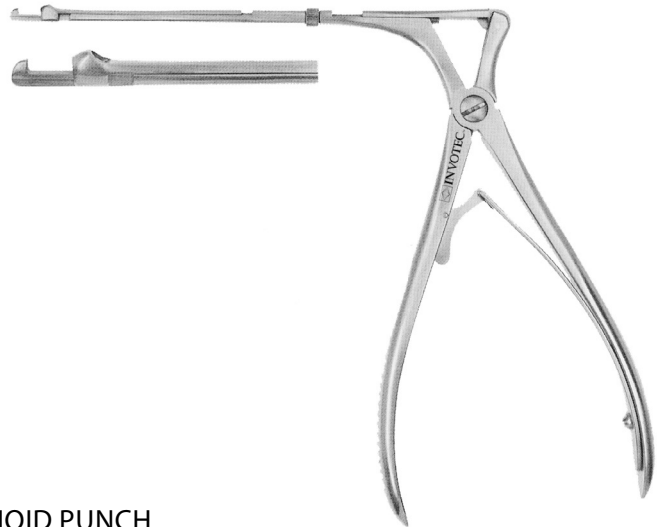

ROTATABLE SPHENOID PUNCH



Number	Description	Bite	Working Length
S13100	Sphenoid punch reversible 360° throughcutting slender pattern	2 mm	14.5 cm

RH INS

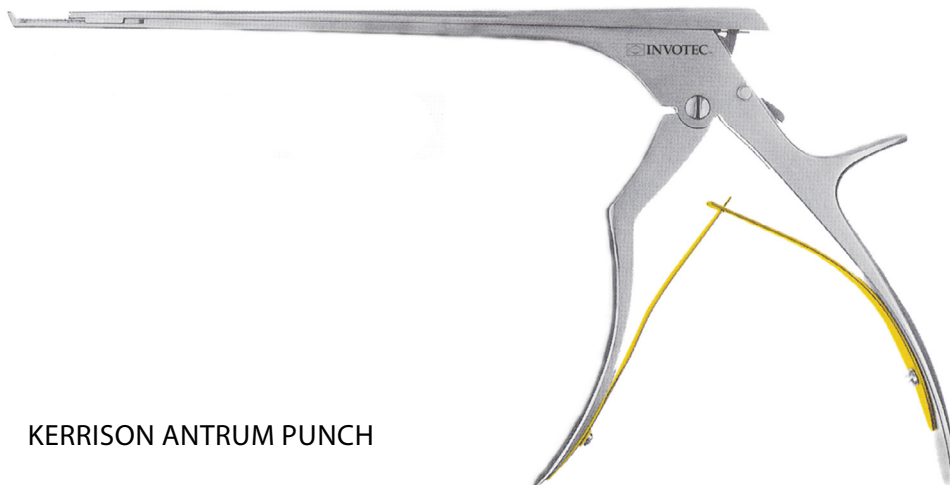
KERRISON ANTRUM PUNCH

Number	Description		Bite	Working Length
S12902	FS-Kerrison sphenoid punch	90° upbiting	2 mm	18 cm
S12903	FS-Kerrison sphenoid punch	90° upbiting	3 mm	18 cm
S12922	FS-Kerrison sphenoid punch	40° upbiting	2 mm	18 cm
S12923	FS-Kerrison sphenoid punch	40° upbiting	3 mm	18 cm



Number	Description		Bite	Working Length
S12402	Antrum punch	throughcutting	2 mm	18 cm
S12403	Antrum punch	throughcutting	3 mm	15 cm
S13100	Sphenoid punch - slender pattern	reversible 360°	2 mm	14.5cm



Number	Description			
S12410	Stylet, for removal of the bone material from the deposit of S12402 and S12403			
S12800	Ethmoid punch	backward cutting	2.5 mm	17 mm

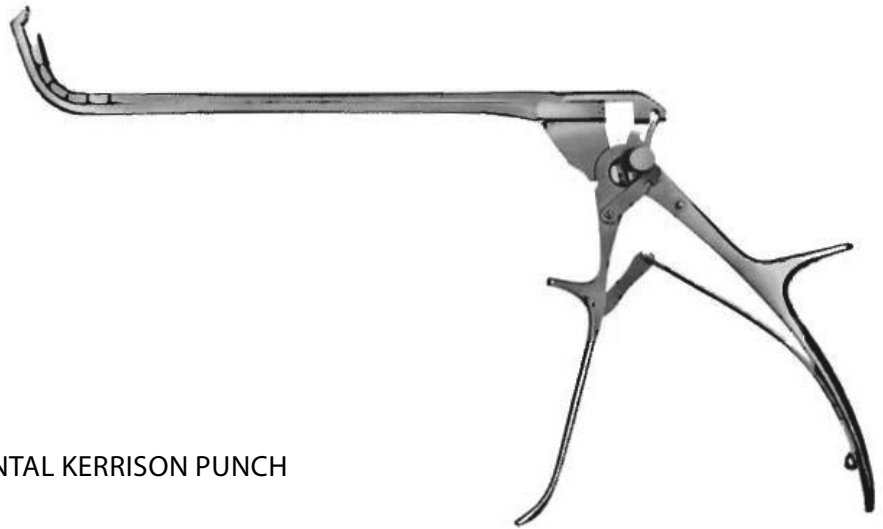

FRONTAL KERRISON PUNCH

Number	Description			Bite	Working Length
S12602	Frontal sinus punch	70° up	40° up biting forward	2 mm	17.5 cm
S12603	Frontal sinus punch	70° up	40° up biting forward	mm	17.5 cm

INTRANASAL SCISSORS

Number	Description				Working Length
S26200	Nasal scissors	serrated blades		straight	13 cm
S26201	Nasal scissors	serrated blades		curved left	13 cm
S26202	Nasal scissors	serrated blades		curved right	13 cm
S26210	Nasal scissors - small	serrated blades	3.5 mm	straight	12 cm
S26211	Nasal scissors - small	serrated blades	3.5 mm	curved right	12 cm
S26212	Nasal scissors - small	serrated blades	3.5 mm	curved left	12 cm

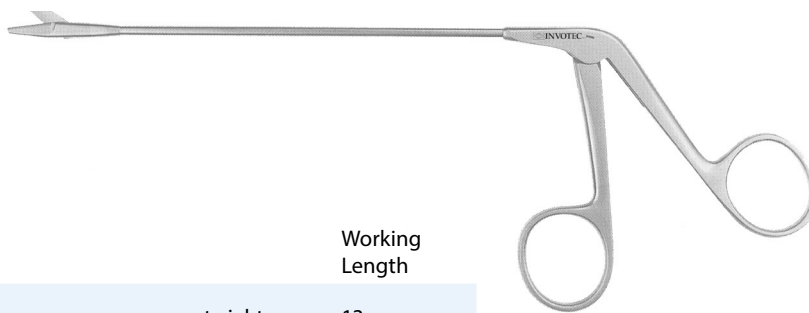

EYMANN NASAL SCISSORS

Number	Description				Working Length
S26000	Heymann nasal scissors	smooth blades		straight	9.5 cm
S26100	Heymann nasal scissors	serrated blades		straight	9.5 cm
S26101	Heymann nasal scissors	smooth blades		curved left	9.5 cm
S26102	Heymann nasal scissors	smooth blades		curved right	9.5 cm
S26009	Heymann nasal scissors	serrated blades		straight	small size 9 cm
S26011	Heymann nasal scissors	serrated blades		straight	small size 11 cm



Number	Description			Working Length
S42000	BELLUCCI Scissors		straight	10 cm

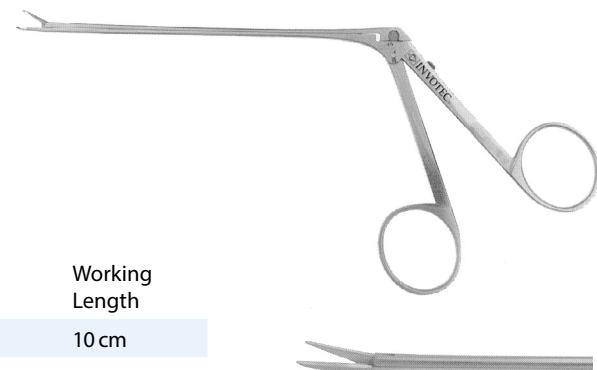

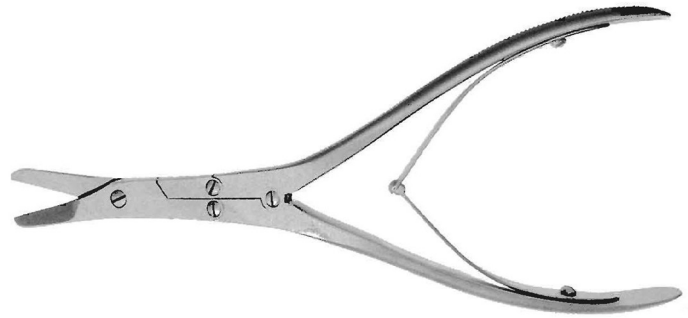

Number	Description		Working Length
R40700	Caplan septum scissors	straight	22 cm
R40600	Caplan septum scissors	angled	22 cm

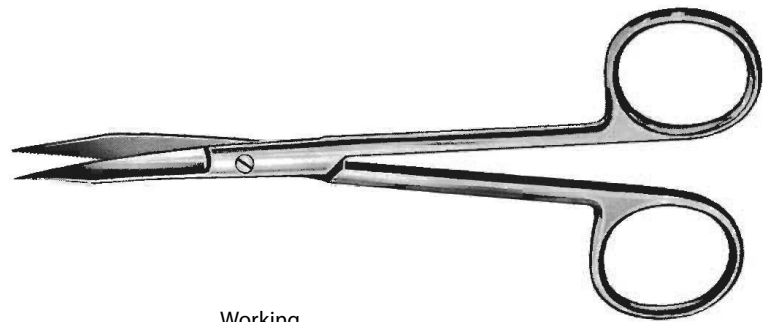

Number	Description					Working Length
R68210	Goldman scissors	Fox	tenotomy	serrated	straight	13 cm
R68310	Goldman scissors	Fox	tenotomy	serrated	curved	13 cm
R68413	Goldman scissors	Fox	tenotomy	TC supercut	straight	13 cm
R68613	Goldman scissors	Fox	tenotomy	TC supercut	curved	13 cm

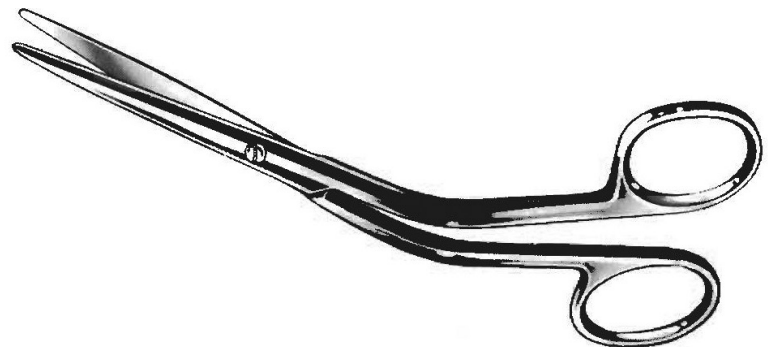

Number	Description		Working Length
R39100	Cottle dorsal scissors	angular	16 cm

RH I NS

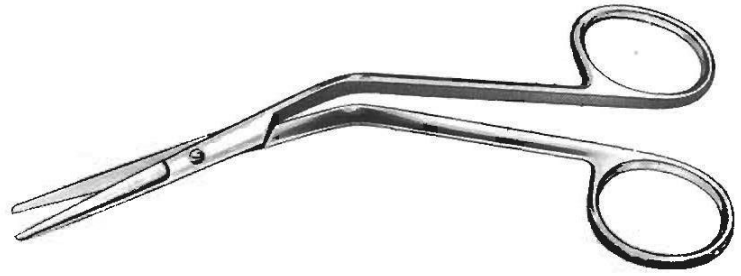

Number	Description	Working Length
R39000	Fomon dorsal scissors angular delicate	13.5 cm
R39001	Fomon dorsal scissors angular standard pattern	13.5 cm



R38612	Fomon lower lateral curved scissors	13.5 cm
--------	-------------------------------------	---------

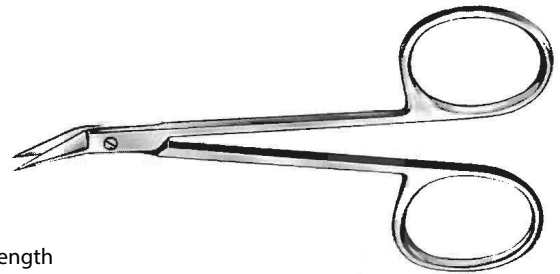

Number	Description	Working Length
R38410	Wilmer Angled sh/sh scissors	10 cm

RHINS

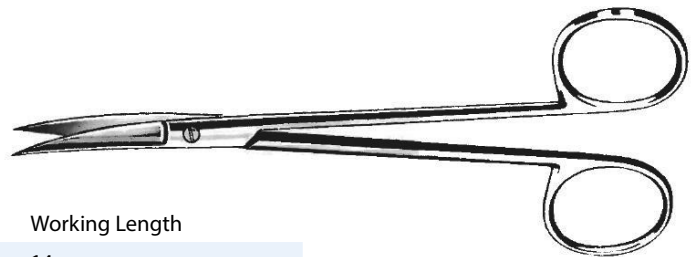

Number	Description	Working Length
R76514	Joseph scissors straight	14 cm
R76614	Joseph scissors curved	14 cm

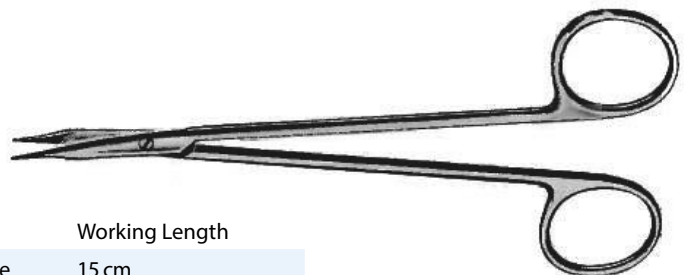

R79615	Reynolds dissection scissors curved delicate	15 cm
--------	--	-------

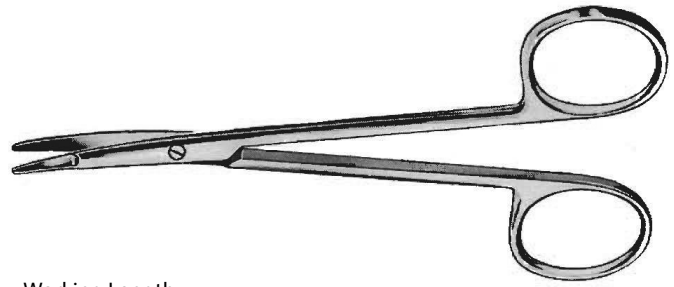

Number	Description	Working Length
R38712	Kilner (Ragnell) scissors curved flat tips	12 cm

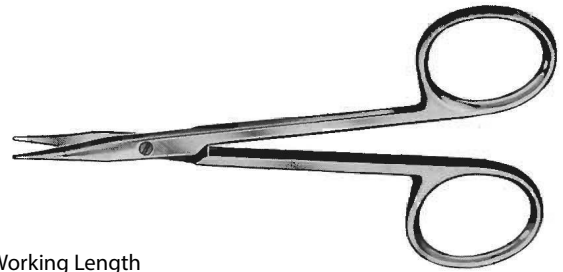

Number	Description	Working Length
R68210	Stevens Tenotomy scissors straight blunt	11.5 cm
R68310	Stevens Tenotomy scissors curved blunt	11.5 cm
R68411	Stevens Tenotomy scissors straight sharp	11.5 cm
R68410	Stevens Tenotomy scissors straight curved	11.5 cm

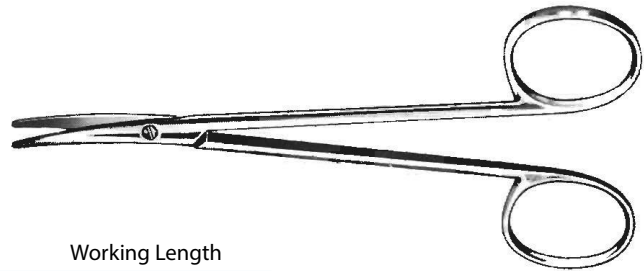

Number	Description	Working Length
R77010	Strabismus scissors blunt/blunt straight	10.5 cm
R77110	Strabismus scissors blunt/blunt curved	10.5 cm
R77212	Strabismus scissors blunt/blunt straight	11.5 cm
R77312	Strabismus scissors blunt/blunt curved	11.5 cm



Number	Description	Working Length
R047712	Kaye Blepharoplasty scissors	11.5 cm

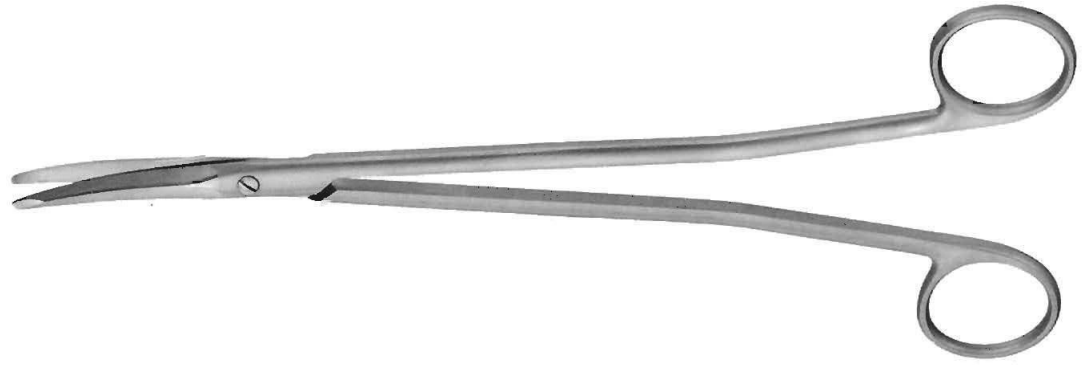

Number	Description	Working Length
R47519	Gorney facelift scissors	19 cm

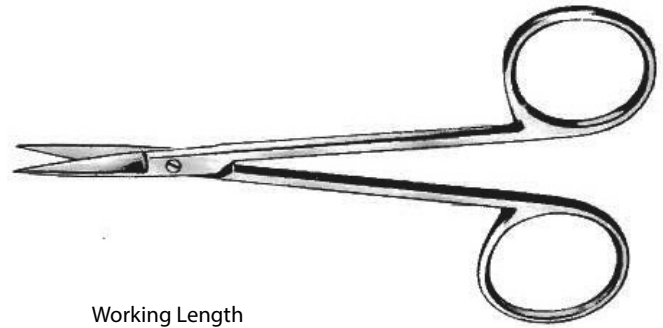

Number	Description	Blade Type	Tip Type	Working Length
R77510	Iris scissors	sharp/sharp	straight	10.5 cm
R77610	Iris scissors	sharp/sharp	curved	10.5 cm
R77712	Iris scissors	sharp/sharp	straight	11.5 cm
R77812	Iris scissors	sharp/sharp	curved	11.5 cm

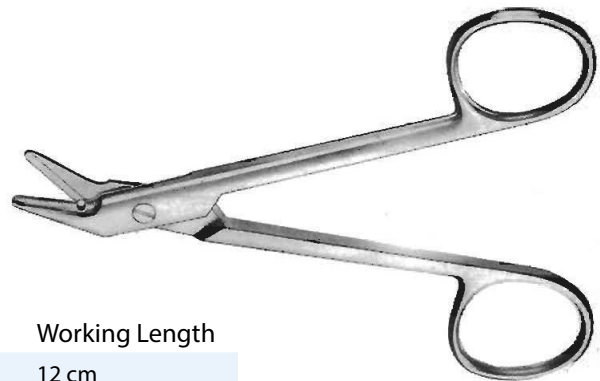

Number	Description	Working Length
R77901	Wire cutter universal	12 cm

RHI INS



Number	Description	Working Length
R13000	Freer Mucosa knife "D"	15 cm



Number	Description	Diameter	Working Length
R19001	Ballenger swivel knife bayonet	3 mm	20 cm
R19002	Ballenger swivel knife bayonet	4 mm	20 cm
R65015	Ballenger swivel knife bayonet	5 mm	20 cm
R65003	Ballenger swivel knife bayonet	3 mm	20 cm
R65004	Ballenger swivel knife bayonet	4 mm	20 cm
R65005	Ballenger swivel knife bayonet	5 mm	20 cm



Number	Description	Working Length
S03000	Cottle nasal knife	15 cm



Number	Description	Working Length
S32000	Masing nasal knife	13 cm



Number	Description
R29003	#3 Knife Handle
R29007	#7 Knife Handle



Number	Description	Working Length
R71065	Maltz cartilage knife	16 cm



Number	Description	Working Length
R353600	Fomon double-edge knife	16 cm



Number	Description	Working Length
R34000	Joseph button-end knife	15 cm



R34100	Joseph-Converse button-end knife (Bistory)	15 cm
--------	--	-------



R35000	Joseph nasal knife	15 cm
--------	--------------------	-------

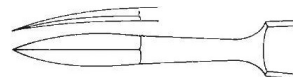

R35100	Joseph nasal knife	15 cm
--------	--------------------	-------



R35200	Joseph nasal knife	15 cm
--------	--------------------	-------



R35300	Joseph nasal knife	15 cm
--------	--------------------	-------



R71060	Joseph angled cartilage knife (Hockey Stick)	15 cm
--------	--	-------

JOSEPH NASAL SAW

Number		Working Length
R48100	straight	19 cm
R48001	bayonet	19 cm
R48002	bayonet	19 cm
R76022	bend to left	17 cm
R76021	bend to right	17 cm

FREER SEPTAL CHISEL

Number		Working Length
R20001	straight	16 cm
R20002	curved	16 cm

BALLENGER "V" SEPTAL GOUGE

Number	Width	Working Length
R60704	4 mm	16 cm
R60706	6 mm	16 cm
R60708	8 mm	16 cm

KILLIAN BAYONET NASAL GOUGE

Number	Working Length
R21000	17cm
R21100	17cm



COTTLE OSTEOTOME

Number		Width	Working Length
R07004	graduated straight	4 mm	18 cm
R07007	graduated straight	7 mm	18 cm
R07009	graduated straight	9 mm	18 cm
R07012	graduated straight	12 mm	18 cm

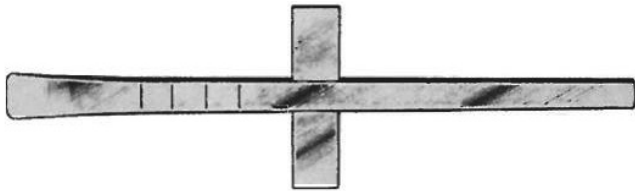

COTTLE DOUBLE GUARDED OSTEOTOME

Number	Width	Working Length
R61516	16 mm	18 cm



COTTLE DOUBLE GUARDED OSTEOTOME

Number	Width	Working Length
R10516	cross bar	16 mm 18 cm



RUBIN DOUBLE GUARDED OSTEOTOME

Number	Width	Working Length
R06010	10 mm	18 cm
R06012	12 mm	18 cm
R06014	14 mm	18 cm



CINELLI DOUBLE GUARDED OSTEOTOME

Number	Width	Working Length
R060510	10 mm	18 cm
R060512	12 mm	18 cm
R060514	14 mm	18 cm
R060516	16 mm	18 cm



FOMON SINGLE GUARDED CHISEL

Number	Width	Working Length
R63904	4 mm	17 cm
R63905	5 mm	17 cm
R63906	6 mm	17 cm
R63907	7 mm	17 cm

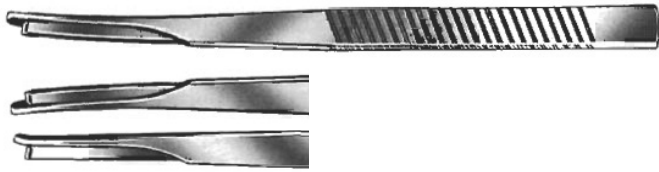
MASING SINGLE GUARDED CHISEL

Number		Working Length
R10000	straight	17.5 cm
R10001	curve left	17.5 cm
R10002	curve right	17.5 cm

CONVERSE SINGLE GUARDED OSTEOTOME

Number		Working Length
R07900	straight	19 cm
R07901	left	19 cm
R07902	right	19 cm

SILVER SINGLE GUARDED OSTEOTOME

Number	Width	Working Length
S12500	straight	18 cm
S12501	left	18 cm
S12502	right	18 cm

NEIVERT SINGLE GUARDED OSTEOTOME

Number		Working Length
R12000	straight	20 cm
R12001	curved	20 cm
R12002	curved	20 cm

WEST CHISEL

Number	Width	Working Length
R11000	4 mm	18 cm



WEST GOUGE

Number	Width	Working Length
R11100	4 mm	18 cm

MINI OSTEOTOME

Number	Width	Working Length
R07602	2 mm	18 cm
R07603	3 mm	18 cm

FREER ELEVATOR

Number	Description		Working Length
N15000	double-ended	USA Model	20 cm
R15100	double-ended	sharp/blunt	18 cm

GORNEY SUCTION ELEVATOR

Number	Description		Working Length
S05800	Elevator with stylet	3mm tip	19 cm

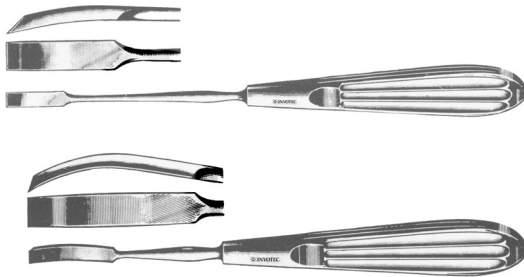
LEMPERT JOSEPH ELEVATOR

Number	Description	Width	Working Length
R26052	straight	2 mm	20 cm
R26057	straight	3 mm	20 cm
R26058	curved	3 mm	20 cm
R26070	wide	6 mm	20 cm
R26071	wide	6 mm	18 cm

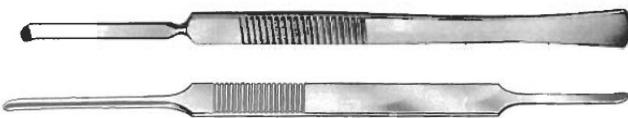
MCKENTY ELEVATOR

Number	Description	Width	Working Length
R02004	single ended	4 mm	14.5 cm
R02005	single ended	5 mm	14.5 cm
R02500	double-ended		21.5 cm



KILLIAN SEPTUM ELEVATOR

Number	Description		Working Length
R16000	sharp/blunt	short	18 cm
R16100	sharp/blunt	long	22 cm

MASING ELEVATOR

Number	Description		Working Length
R05000	double-ended graduated	sharp/blunt	21.5 cm

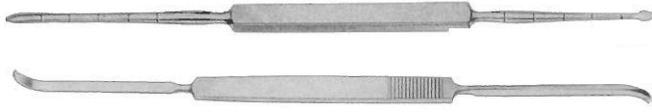
COTTLE ELEVATORS



Number	Description	Working Length
R04500	double-ended, graduated blunt	21 cm
R05500	tunneling elevator	23 cm

PIERCE ELEVATOR



Number	Description	Working Length
R35821	double ended right - left	21 cm

PENNINTON ELEVATOR



Number	Description	Working Length
R05600	double-ended right/left	21 cm

SEWALL ANTRUM



Number	Description	Working Length
R18000	Antrum elevator	19.5 cm

PROBES

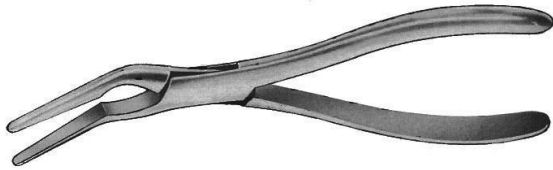

Number	Description	Working Length
S18725	Frontal sinus ostium seeker double-ended curved	19 cm
S18619	Maxillary sinus ostium seeker double-ended ball	19 cm

ASCH SEPTUM STRAIGHTENING FORCEPS

Number	Description	Working Length
R45000	Straightening forceps	23cm

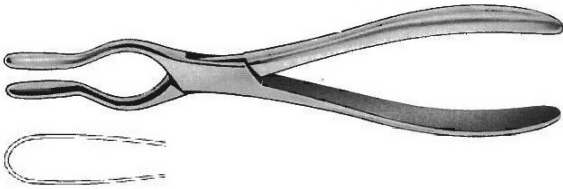
COTTLE-WALSHAM STRAIGHTENING FORCEPS

Number	Description		Working Length
R44000	Septum straightening forceps	both sides	23 cm
R44101	Septum straightening forceps	left	23 cm
R44102	Septum straightening forceps	right	23 cm

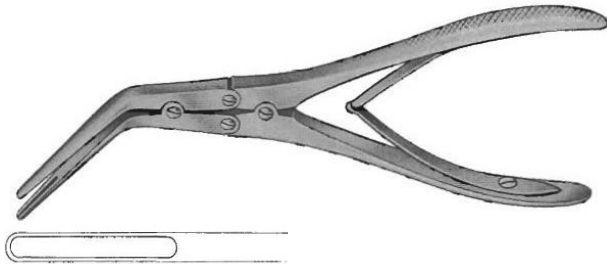
KRESSNER TURBINATE CRUSHING FORCEPS

Number	Description		Working Length
R47003	Crushing forceps	2.5 x 60 mm	20 cm
R47004	Crushing forceps	4 x 70 mm	20 cm
R47005	Crushing forceps	5 x 75 mm	20 cm

BOISE NASAL FRACTURE ELEVATOR

Number	Description		Working Length
R61000	"Butter Knife"	blunt, oval	18 cm

GOLDMAN SEPTUM DISPLACER

Number	Description		Working Length
R61100	Septum displacer	short	20 cm

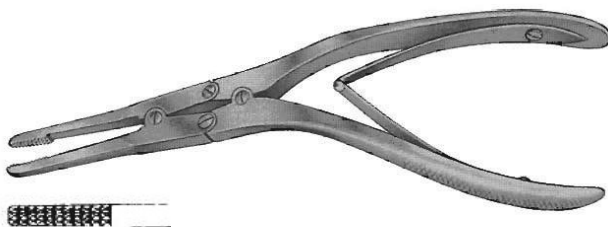
RUBIN SEPTUM MORCELIZER

Number	Description		Working Length
R42000	Rubin septum morcelizer	double action	20 cm
R76570	Guard for Rubin septum morcelizer		



JANSON MIDDLETON DOUBLE ACTION FORCEPS

Number	Description	Working Length
R35600	Double action through-cut septal forceps	19 cm
R35500	Double action oval spoon nasal forceps	19 cm



STRUYCHEN THROUGH-CUT FORCEPS

Number	Description	Working Length
S27500	small through-cut forceps,	11 cm
S27501	large through-cut forceps,	11 cm



ANTRUM CURETTE



Number	Description			Working Length
S18001	Oval	size 1		19 cm
S18002	Oval	size 2		19 cm
S18003	Oval	size 3		19 cm
S18101	Round	small size		19 cm
S18102	Oblong	small size		19 cm
S18103	Oblong	large size		19 cm
S18203	Oblong	small size	forward cutting	19 cm
S18204	Oblong	small size	backward cutting	19 cm

SINUS FRONTAL CURETTE

Number	Description			Working Length
S18104	Oblong	small size	55° curved	19 cm
S18105	Oblong	small size	90° curved	19 cm



HALLE ANTRUM CURETTE



Number	Description			Working Length
S06001	malleable	size 1		21 cm
S06002	malleable	size 2		21 cm
S06003	malleable	size 3		21 cm

ANTRUM CURETTE



Number	Description			Working Length
S06101	curved left			21 cm
S06102	curved right			21 cm



COAKLEY ANTRUM CURETTE

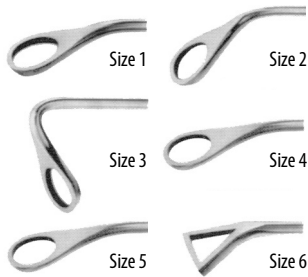

Number	Description	Working Length
S03001	size 1	17 cm
S03002	size 2	17 cm
S03003	size 3	17 cm
S03004	size 4	17 cm
S03005	size 5	17 cm
S03006	size 6	17 cm

FAULKNER ANTRUM CURETTE

Number	Description
S04000	Double ended

TIECK-HALLE NASAL SPECULUM

Number		Working Length
S40000	For infants	13.5 cm
S43001	For adults	13.5 cm

BECKMAN ENDAURAL SPECULUM

Number	Description	Working Length
S06501	Small	15 cm
S06502	Medium	15 cm
S06503	Large	15 cm

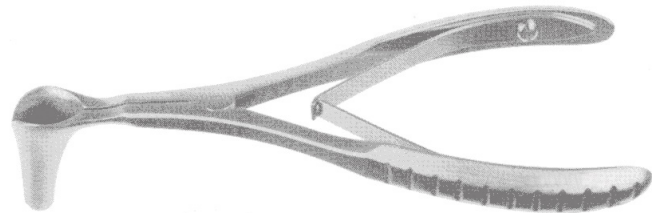
HARTMANN NASAL SPECULUM

Number	Description	Working Length
S43001	Large 35 mm	13.5 cm

HARTMANN-HALLE NASAL SPECULUM

S41001	Size 1	15 cm
S41002	Size 2	15 cm
S41003	Size 3	15 cm

HARTMANN ECONOMY

Number	Description	Working Length
S43500	Office nasal speculum	14 cm

VIENNA NASAL SPECULUM

Number	Description	Working Length
S41601	Small	14.5 cm
S41602	Medium	14.5 cm
S41603	Large	14.5 cm



COTTLE NASAL SPECULUM WITH SET SCREW

Number	Description	Working Length
S00001	35 mm	15 cm
S00002	50 mm	15 cm
S00003	75 mm	15 cm
S00004	90 mm	15 cm



COTTLE NASAL SPECULUM WITHOUT SET SCREW

Number	Description	Working Length
S00101	35 mm	15 cm
S00102	50 mm	15 cm
S00103	75 mm	15 cm
S00104	90 mm	15 cm



KILLIAN NASAL SPECULUM

Number	Description	Working Length
S42001	35 mm	13 cm
S42002	50 mm	13 cm
S42003	75 mm	13 cm
S42004	90 mm	13 cm

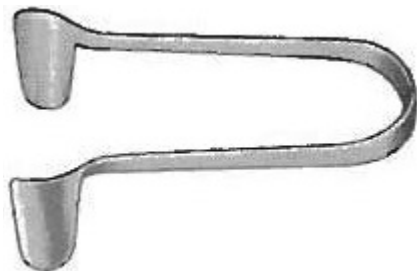

THUDICHUM (GOLDSMITH) SPRING NASAL SPECULUM

Number	Description
S41301	#1
S41302	#2
S41303	#3

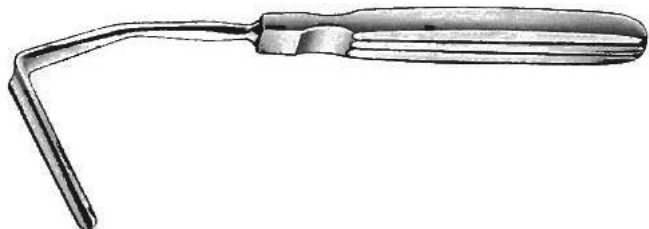

AUFRECHT NASAL RETRACTOR

Number	Description	Working Length
R22500	60 mm blade	16 cm
R22600	45 mm blade	16 cm



COTTLE ALAR RETRACTOR

Number	Description	Working Length
R19000	Vein retractor	15 cm
R19500	Vein retractor	15 cm



SENN RETRACTOR



Number	Description	Working Length
R65000	Sharp retractor	16 cm
R65100	Dull retractor	16 cm



REGNELL-DAVIS RETRACTOR

Number	Description	Working Length
R12514	Retractor	14 cm



PLASTICS RAKES

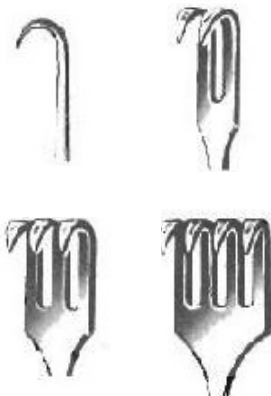

Number	Description	Working Length
R67004	Sharp retractor 4 prong	16 cm
R67003	Sharp retractor 3 prong	16 cm
R67002	Sharp retractor 2 prong	16 cm
R67001	Sharp retractor 1 prong	16 cm

Number	Description	Working Length
R68004	Dull retractor 4 prong	16 cm
R68003	Dull retractor 3 prong	16 cm
R68002	Dull retractor 2 prong	16 cm
R68001	Dull retractor 1 prong	16 cm



COTTLE RETRACTOR

Number	Description	Working Length
R18000	Retractor with 4 prong blunt, middle two teeth shortened	14 cm

RH INS



COTTLE TENACULUM HOOK

Number	Description	Working Length
R15000C	delicate angled	16 cm
R151000	delicate curved	16 cm



COTTLE NARES DOUBLE HOOK

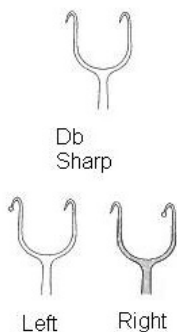

Number	Description	Working Length
R16000	Sharp on Left, dull on right double hook	14 cm
R16100	Sharp on Right, dull on left double hook	14 cm
R16200	Sharp double hook	14 cm



COTTLE-NEIVERT KNIFE GUIDE/NARES DOUBLE BALL HOOK

Number	Description	Working Length
R20000	Large double ball hook/knife guide	20 cm



NEIVERT-MASING KNIFE GUIDE AND NARES RETRACTOR

Number	Description	Working Length
R20500	Knife guide and nares retractor	20 cm



FOMON DOUBLE BALL NASES HOOK

Number	Description	Working Length
R16600	Double ball nases hook 10 mm wide	16 cm,



CONVERSE DOUBLE END HOOK

Number	Description	Working Length
R24200	Alar double hook	12 cm



KILNER ALAR DOUBLE HOOK RETRACTOR

Number	Description	Working Length
R24300	double hook retractor	8 cm

COTTLE (MILLIARD) DOUBLE HOOK THIMBLE RETRACTOR



Number	Description
R22800	double hook thimble retractor



FREER-GUTHRIE MICRO DOUBLE HOOK

Number	Description	Working Length
R16400	Micro double hook sharp	15 cm





JOSEPH DOUBLE HOOK

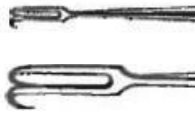

Number	Description	Working Length
R16502	2 mm	16 cm
R16505	5 mm	16 cm
R16507	7 mm	16 cm
R16510	10 mm	16 cm



NERVE HOOK

Number	Description	Working Length
R61301	Blunt hook	18 cm



VOLKMAN BONE HOOK

Number	Description	Working Length
R05701	Sharp bone hook	21.5 cm



WEINER ANTRUM RASP

Number	Description	Working Length
R08101	Sharp rasp	18 cm



Number	Description	Working Length
R08102	Dull rasp	18 cm

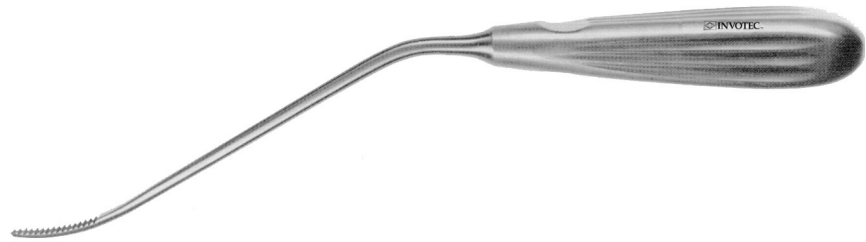

WATSON-WILLIAMS ANTRUM RASP

Number	Description	Working Length
R08500	Antrum Rasp	23 cm



FRONTAL SINUS RASP

Number	Description	Working Length
R18110	Frontal Sinus Rasp	strong pattern
R18111	Frontal Sinus Rasp	slender pattern



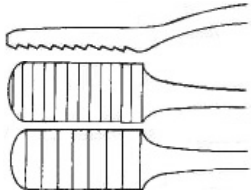

LEWIS "SWEEPER" RASP

Number	Description			Working Length
R56600	Rasp "Sweeper"	Downcut	fine	18 cm
R56700	Rasp "Sweeper"	Downcut	coarse	18 cm

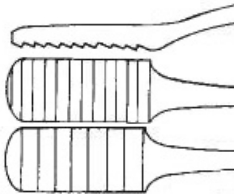

LEWIS "SWEEPER" TC RASP

Number	Description			Working Length
R36501	TC rasp "Sweeper"	Downcut	fine	18 cm
T36502	TC rasp "Sweeper"	Downcut	coarse	18 cm



COTTLE DOWNCUT RASP

Number	Description	Working Length
R54000	Downcut rasp	21 cm

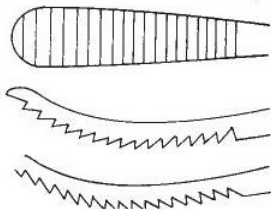

AUFRICHT CURVED GLABELLA RASP

Number	Description	Working Length
R54500	Push up cut rasp	21 cm
R54600	Pull down cut	21 cm



MALTZ SLOTED RASP

Number	Description	Working Length
R53500	Sloted rasp	18 cm



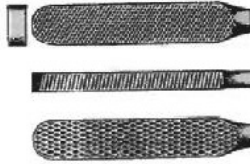

MASING - FOMON DOUBLE ENDED NASAL RASP

Number	Description	Working Length
R53000	Double ended nasal rasp # 1 & 2	21 cm
R53100	Double ended nasal rasp # 3 & 4	21 cm



MILLER-COLBURN DOUBLE ENDED NASAL RASP

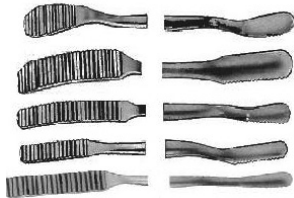

Number	Description	Working Length
R38001	Double ended nasal rasp Serrated Glabella	19 cm
R38002	Double ended nasal rasp Serrated fine wide curved	19 cm
R38003	Double ended nasal rasp Serrated coarse wide straight	19 cm
R38004	Double ended nasal rasp Serrated coarse short	19 cm
R38005	Double ended nasal rasp Serrated coarse wide straight	19 cm

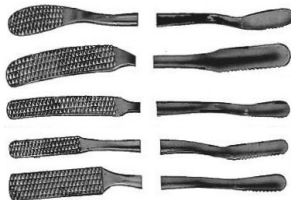

Number	Description	Working Length
R38101	Double ended nasal rasp cross hatched Glabella	19 cm
R38102	Double ended nasal rasp cross hatched fine wide curved	19 cm
R38103	Double ended nasal rasp cross hatched coarse wide straight	19 cm
R38104	Double ended nasal rasp cross hatched coarse short	19 cm
R38105	Double ended nasal rasp cross hatched coarse wide straight	19 cm



FOMON DOUBLE ENDED RASP

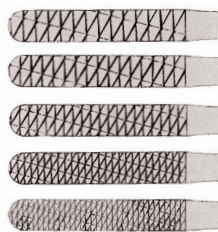

Number	Description	Working Length
R52001	Double ended TC rasp # 1 & 2 xfine - fine	20 cm
R52002	Double ended TC rasp # 3 & 4	20 cm
R52003	Double ended TC rasp # 5 & 6	20 cm
R52004	Double ended TC rasp # 7 & 8	20 cm
R52005	Double ended TC rasp # 9 & 10 coarse - xcoarse	20 cm



COTTLE NASAL TC RASP



Number	Description	Working Length
R39221	TC rasp downcut medium	21 cm

RHINS

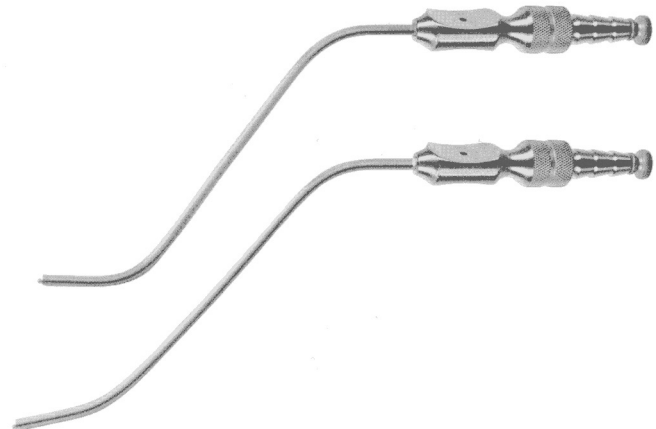

V. EICKEN SINUS ANTRUM CANNULA

Number	Description	Outer diameter	Working Length
S49602	Long curved LUER-Lock	2.5mm	12 cm
S49603	Long curved LUER-Lock	3 mm	12 cm
S49604	Long curved LUER-Lock	4 mm	12 cm
S49612	Short curved LUER-Lock	2.5 mm	12 cm
S49613	Short curved LUER-Lock	3 mm	12 cm
S49614	Short curved LUER-Lock	4 mm	12 cm
S49702	Long curved Malleable	2.5 mm	12 cm
S49703	Long curved Malleable	3.0 mm	12 cm
S49704	Long curved Malleable	4.0 mm	12 cm

KAHN-FRAZIER FRONTAL SINUS SUCTION

Number	Description	Inner ID	Shaft	Size	Working Length
S11610	Frontal Sinus Suction Tube with cut-off hole	10 Fr	malleable	1	slightly curved 15 cm
S11710	Frontal Sinus Suction Tube with cut-off hole	10 Fr	malleable	2	strongly curved 15 cm

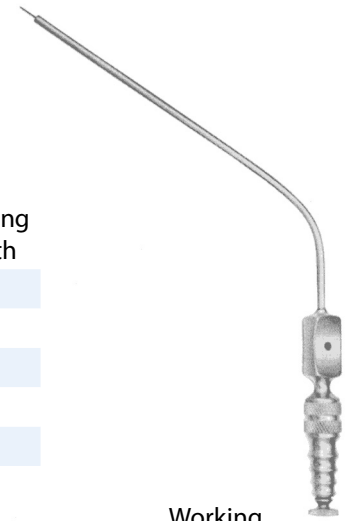
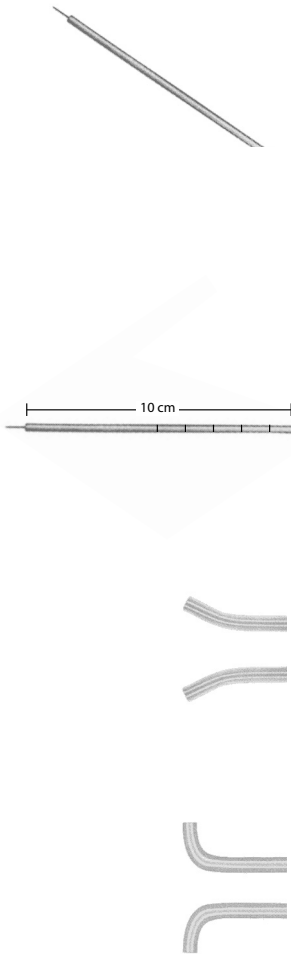
FRAZIER/FERGUSON NASAL STYLE



Number	Description	Working Length
S43006	Frazier suction tube Stainless 6 Fr	10 cm
S10008	Frazier suction tube Stainless 8 Fr	10 cm
S10010	Frazier suction tube Stainless 10 Fr	10 cm
S10012	Frazier suction tube Stainless 12 Fr	10 cm
S10015	Frazier suction tube Stainless 15 Fr	10 cm

Number	Description	Working Length
S11006	FRAZIER Suction Tube with calibrations marked at 5 cm - 9 cm 6 Fr	10 cm
S11008	FRAZIER Suction Tube with calibrations marked at 5 cm - 9 cm 8 Fr	10 cm
S11010	FRAZIER Suction Tube with calibrations marked at 5 cm - 9 cm 10 Fr	10 cm

Number	Description	Working Length
S11210	Frazier suction tube stainless slightly curved right 10 Fr	10 cm
S11212	Frazier suction tube stainless slightly curved right 12 Fr	10 cm
S11310	Frazier suction tube stainless slightly curved left 10 Fr	10 cm
S11312	Frazier suction tube stainless slightly curved left 12 Fr	10 cm

Number	Description	Working Length
S11410	Frazier suction tube stainless strongly curved right 10 Fr	10 cm
S11412	Frazier suction tube stainless strongly curved right 12 Fr	10 cm
S11510	Frazier suction tube stainless strongly curved left 10 Fr	10 cm
S11512	Frazier suction tube stainless strongly curved left 12 Fr	10 cm

FRAZIER/FERGUSON NASAL STYLE WITH BALL END

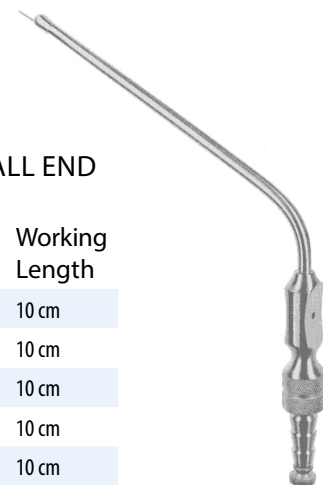

Number	Description	Working Length
S10016	Frazier suction tube stainless ball ended 6 Fr	10 cm
S10018	Frazier suction tube stainless ball ended 8 Fr	10 cm
S10020	Frazier suction tube stainless ball ended 10 Fr	10 cm
S10022	Frazier suction tube stainless ball ended 12 Fr	10 cm
S10025	Frazier suction tube stainless ball ended 15 Fr	10 cm

RH INS

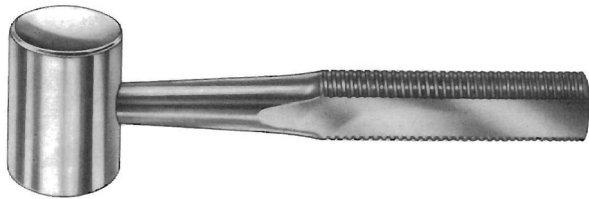
COTTLE MALLET

Number	Description	Weight	Working Length
R13000	Mallet	240 g	19 cm

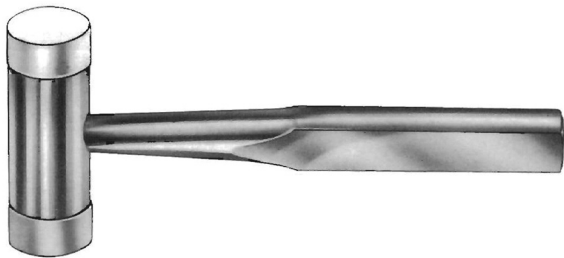
MALLET WITH NYLON CAPS

Number	Description	Weight	Working Length
R13500	Mallet with replaceable nylon caps	140 g	18 cm
R13501	Nylon facings for S13500 mallet, 1 pair		

THEISS MINI MALLET

Number	Description	Weight	Working Length
R53516	Mini mallet	140 g	16.5 cm

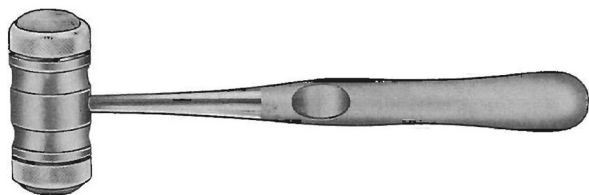
TARDY TYPE MALLET

Number	Description	Weight	Working Length
R528320	Rhinoplasty mallet	320 g	17 cm
R528321	Nylon Facing for Tardy, 1 Pair		

QUISLING INTRANASAL HAMMER

Number	Description
R413900	Quisling Intranasal hammer

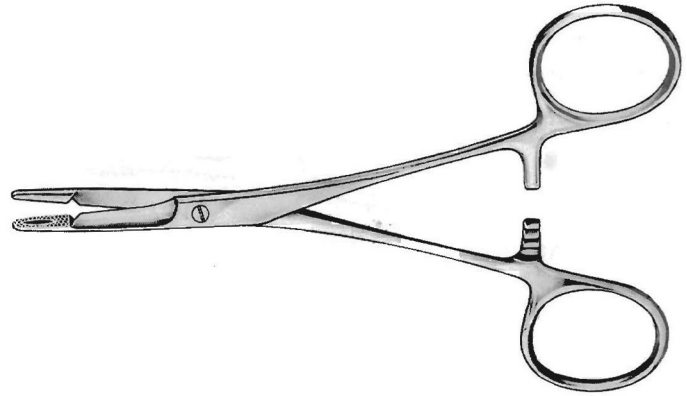

OLSEN-HEGAR NEEDLE HOLDER SCISSORS

Number	Description	Working Length
R14614	Needle holder scissors	14 cm
R14618	Needle holder scissors	17 cm
R15019	Needle holder scissors	19 cm



GILLIES CURVED

Number	Description	Working Length
R15516	Hand grasped needle holder/scissors	16 cm

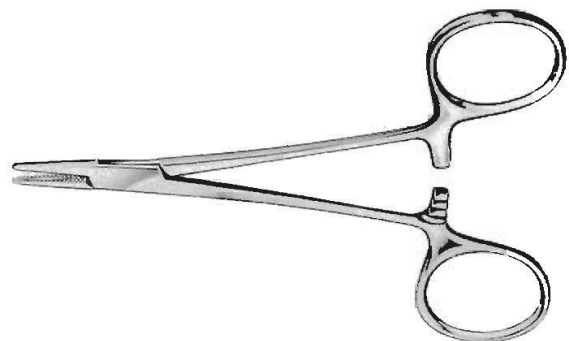
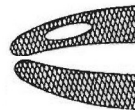

DERF NEEDLE HOLDER

Number	Description	Material	Tip	Working Length
R05012	Needle Holder	stainless	serrated	12 cm
R05012T	Needle Holder	TC	serrated	12 cm



RH INS

WEBSTER NEEDLE HOLDER

Number	Description			Working Length
R06013	Needle holder	smooth	Stainless	13 cm
R46013	Needle holder	smooth	TC	13 cm

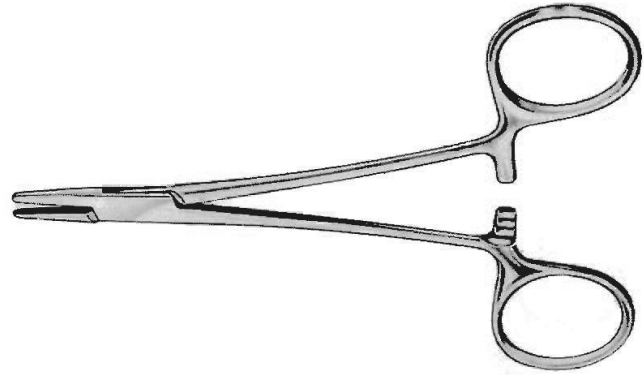

HALSEY NEEDLE HOLDER

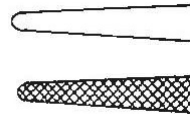
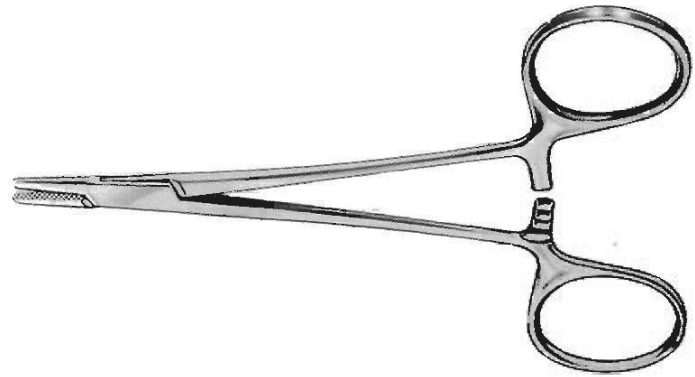
Number	Description			Working Length
R06413	Needle holder	serrated	stainless	13 cm
R46613	Needle holder	serrated	TC	13 cm
R06613	Needle holder	smooth	stainless	13 cm
R46413	Needle holder	smooth	TC	13 cm

CRILE NEEDLE HOLDER

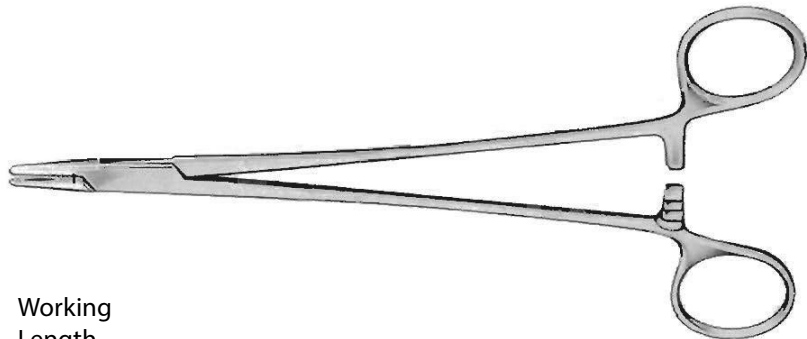
Number	Description			Working Length
R07015	Needle holder	jaw slot	stainless	15 cm
R47015	Needle holder	jaw slot	TC	15 cm
R07215	Baby needle holder	no slot	stainless	15 cm
R46815	Baby needle holder	no slot	TC	15 cm

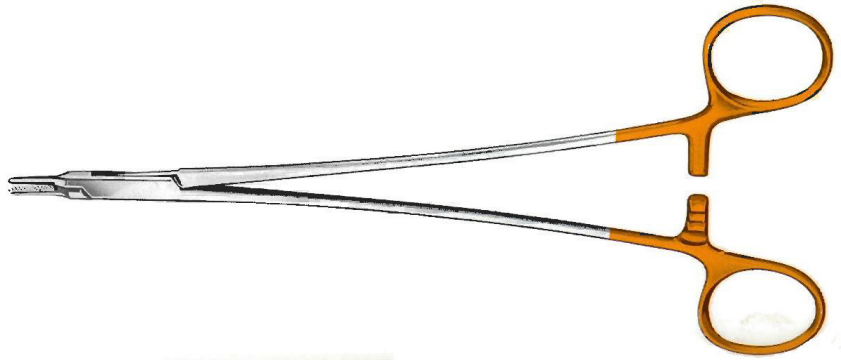



RYDER NEEDLE HOLDER

Number	Description		Length
R43413	Fine tipped needle holder	TC	13 cm
R43415	Fine tipped needle holder	TC	15 cm

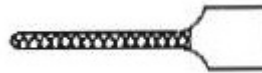

CASTROVIEJO NEEDLE HOLDER

Number	Description			Working Length
R30452	Needle TC holder	straight	smooth	18 cm
R30453	Needle TC holder	curved	smooth	18 cm
R30450	Needle TC holder	straight	serrated	18 cm
R30451	Needle TC holder	curved	serrated	18 cm

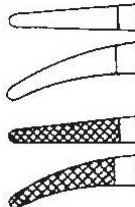

WIRE TWISTERS

Number	Description	Working Length
R0917	MGH Stubby Serrated with Jaw slot	17 cm

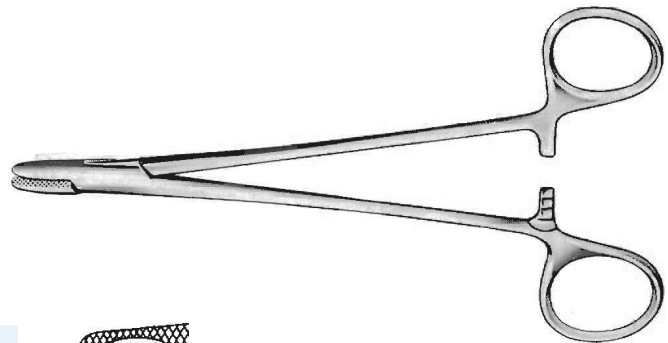

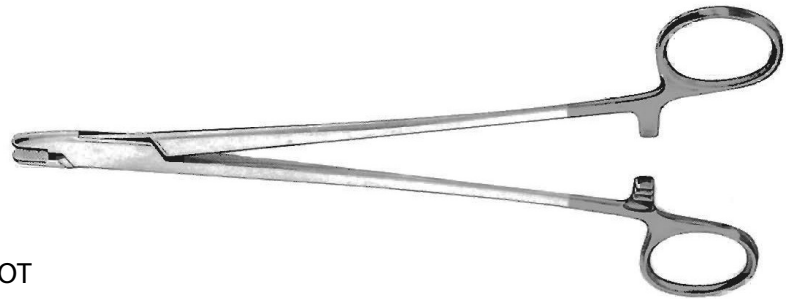

STERUM STUBBY SERRATED WITH JAW SLOT

Number	Description	Working Length
R53353416	Sterum Stubby TC	12.5 cm
R53353918	Sterum Stubby TC	18 cm

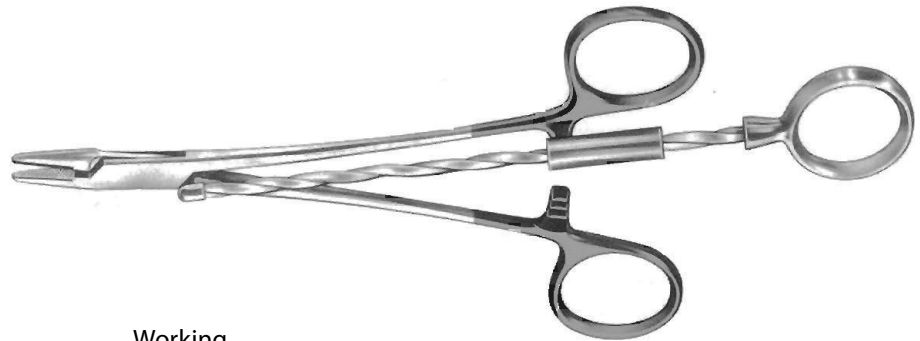

CORWIN FLAT TIP

Number	Description	Working Length
R55601	Finger ring wire twister flat end	flat end
R55602	Finger ring wire twister round end	round end
R55603	Finger ring wire twister oblong end	oblong end

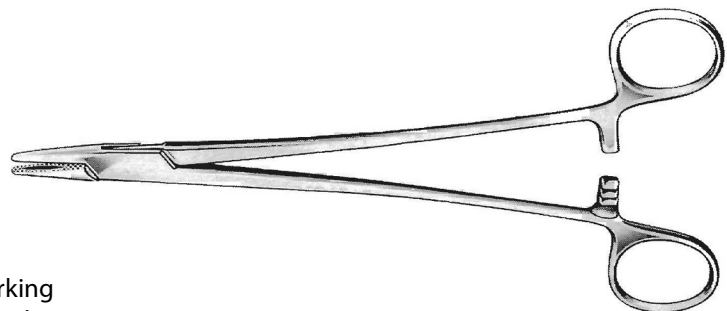
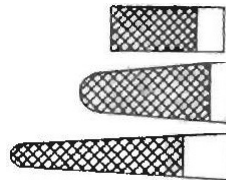

MAYO HEGAR NEEDLE HOLDER

Number	Description	Working Length
S14016	Needle holders stainless	16 cm
S14018	Needle holders stainless	18 cm
S14020	Needle holders stainless	20 cm
R40016	Needle holders with TC Inserts stainless	16 cm
R40018	Needle holders with TC Inserts stainless	18 cm
R40020	Needle holders with TC Inserts stainless	20 cm



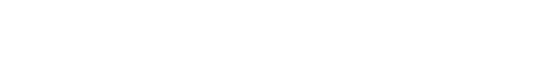
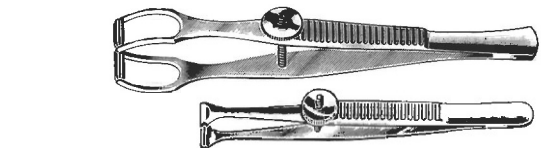
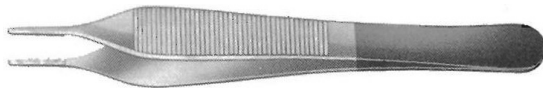
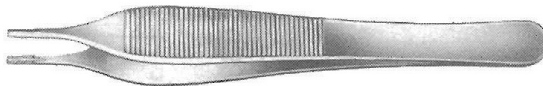
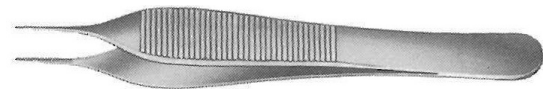
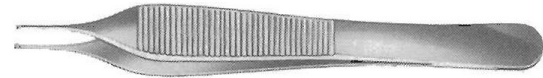
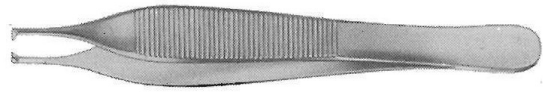

Number	Description		Working Length
R25212	Adson with teeth	Standard 1x2	12 cm

Number	Description		Working Length
R110/12	Micro Adson with teeth	1x2	12 cm

Number	Description		Working Length
R25112	Adson without teeth		12 cm

Number	Description		Working Length
R25312	Micro Adson without teeth		12 cm

Number	Description		Working Length
R25012	Brown adson		12 cm

Number	Description		Working Length
R25612	Adson pickups TC inserts	w/o teeth	12 cm
R25712	Adson pickups TC inserts	1x2 teeth	12 cm

Number	Description		Working Length
R76004	Jewelers forceps straight #4		11 cm
R76005	Jewelers forceps straight #5		11 cm

Number	Description	Tip	Working Length
R04701	Castroviejo forceps	1x2 teeth .12 mm	12 cm

Number	Description		Working Length
R01000	Cottle columella forceps	standard pattern	10.5 cm
R01100	Cottle columella forceps	child/small pattern	8.5 cm

Number	Description		Working Length
R04210	Bishop Harmon fine tissue forceps	serrated	8.5 cm
R04212	Bishop Harmon fine tissue forceps	1x2 teeth	8.5 cm

Number	Description		Working Length
R04211	Bishop Harmon delicate fine tissue forceps	serrated	8.5 cm
R04213	Bishop Harmon delicate fine tissue forceps	1x2 teeth	8.5 cm

Number	Description		
R27015	Cottle fixation forceps with teeth	bayonete with fix screw	

RH INS



UNIVERSAL ATOMIZER KABIERSKE

Number	Description
022810	Universal atomizer Kabierske (S40100)

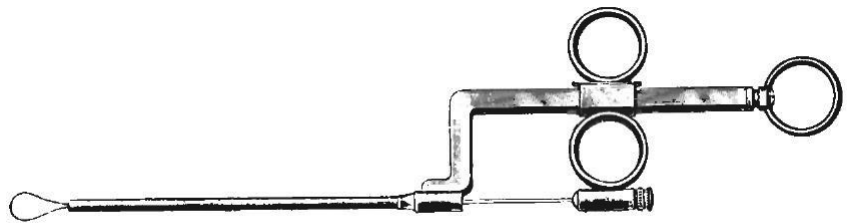

POLYP SNARES AND ACCESSORIES

Number	Description	Working Length
S11500	Wild nasal polyp snare	24 cm

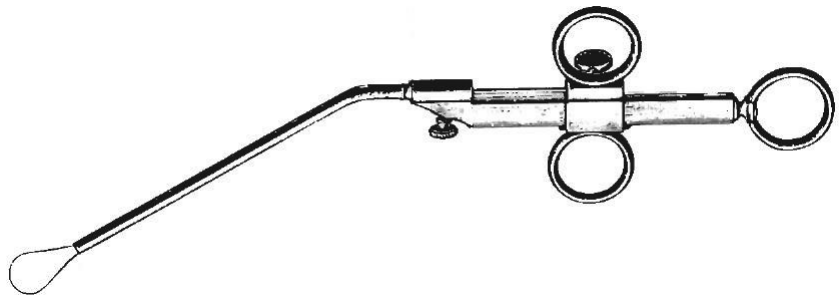

NASAL POLYP SNARE KRAUSE

Number	Description	Working Length
S61520	Nasal polyp snare Krause	26 cm



FRONTAL SINUS RASP

Number	Description	Working Length
S61540	Polyp snare wires precut 12 each	.3 mm
S21042	Polyp snare wire coil	
S21043	Polyp snare wire coil	

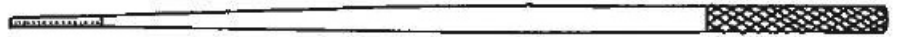

APPLICATORS

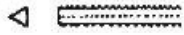

Number	Description			Working Length
S12116	Farrell applicator	triangular	0.9 mm	14 cm
S11513	Farrell applicator	twist tip	1.1 mm	14 cm



GROVED DIRECTOR

Number	Description	Working Length
S91511	Groved director	14 cm



BOWMAN LACRIMAL PROBES SILVER

Number	Description		Working Length
S03400	Bowman silver probes	0000/00	12.5 cm
S03401	Bowman silver probes	00/0	12.5 cm
S03402	Bowman silver probes	0/1	12.5 cm
S03404	Bowman silver probes	1/2	12.5 cm
S03406	Bowman silver probes	2/3	12.5 cm
S03408	Bowman silver probes	3/4	12.5 cm

RH INS

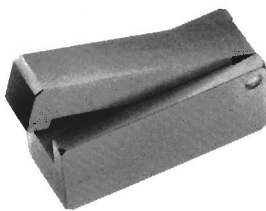

CARTILAGE SMASHER

Number	Description	Working Length
S450000	Cottle cartilage smasher	



SEPTUM TONSIL NEEDLES

Number	Description			Shaft	Tip
S01100	Septum tonsil needle	knee bent angular	LUER-Lock	0.8 mm	22 g
S11400	Septum tonsil needle	straight	LUER-Lock	0.8 mm	22 g
S11300	Septum tonsil needle	right angle tip	LUER-Lock	0.8 mm	22 g
S11700	Septum tonsil needle	bayonet	LUER-Lock	0.8 mm	22 g

SOLUTION BOWLS



Number	Description		
S97030	Stainless solution bowl	30 cc	1 oz
S97050	Stainless solution bowl	50 cc	1.6 oz
S97100	Stainless solution bowl	100 cc	3 oz
S97150	Stainless solution bowl	150 cc	5 oz

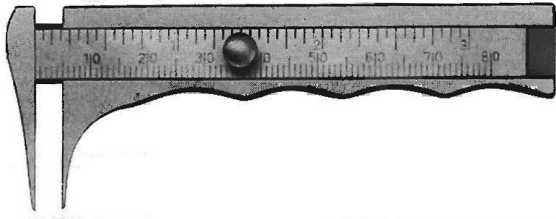

Number	Description	Material	Length
S63100	Jamison Caliper	stainless	0-8 mm

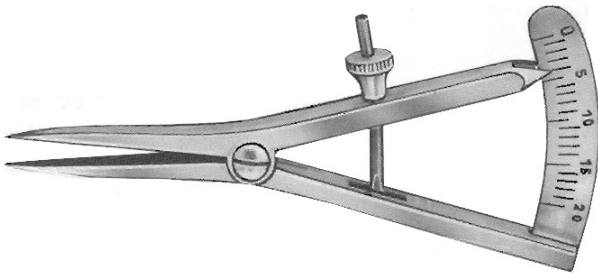

Number	Description	Material	Length
S00040	Castroviejo Caliper	stainless	20 mm 8 cm



Number	Description	Material
S43715	Ruler 6"	stainless

R&CS ACC

DIS

OTO ACC

OSS

LAR ACC

SPE ACC

RHI INS

PARANASAL SKULL BASE

INSTRUMENTS

PSB

OTO INS

LAR INS

ORO/NAS INS



FLEXIBLE TENSION ARM

Number Description

018800	Arm for holding nasal speculum and retractors
018801	Rotation OR table clamp for above

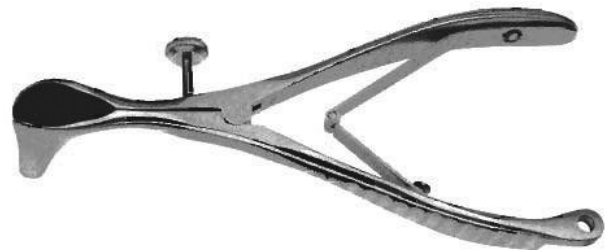

COTTLE MASING NASAL SPECULUM

Number Description

S97635	Nasal speculum for use with flexible tension arm	35 mm
S97650	Nasal speculum for use with flexible tension arm	50 mm
S97675	Nasal speculum for use with flexible tension arm	75 mm
S97690	Nasal speculum for use with flexible tension arm	90 mm



AUFRICHT RETRACTOR

Number Description

S97300	Retractor for use with flexible tension arm	stainless
--------	---	-----------



DOUBLE PRONG RETRACTOR

Number Description

S97400	Dull double prong retractor for use flexible tension arm	stainless
--------	--	-----------

PSB

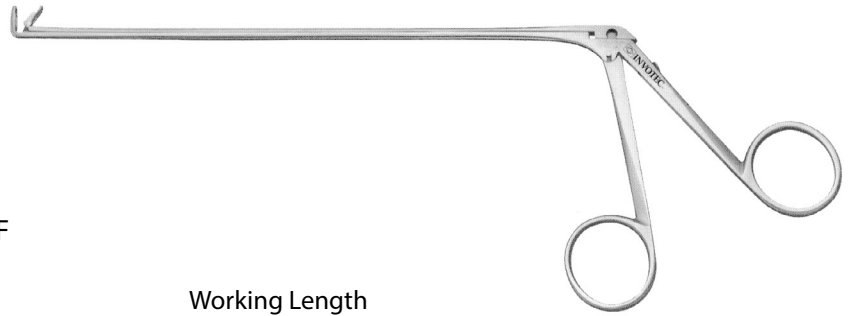

INSTRUMENTS AS DESCRIBED BY DRAF

Number	Description		Working Length
S38413	Ethmoid forceps	straight	13 cm
S38416	Ethmoid forceps	straight	16 cm
S38419	Ethmoid forceps	straight	19 cm
S38513	Ethmoid forceps	60° upcurved	13 cm
S38516	Ethmoid forceps	60° upcurved	16 cm
S38519	Ethmoid forceps	60° upcurved	19 cm
S38613	Ethmoid forceps	90° upcurved	13 cm
S38616	Ethmoid forceps	90° upcurved	16 cm
S38619	Ethmoid forceps	90° upcurved	19 cm
S38713	Ethmoid scissors	straight	13 cm
S38716	Ethmoid scissors	straight	16 cm
S38719	Ethmoid scissors	straight	19 cm

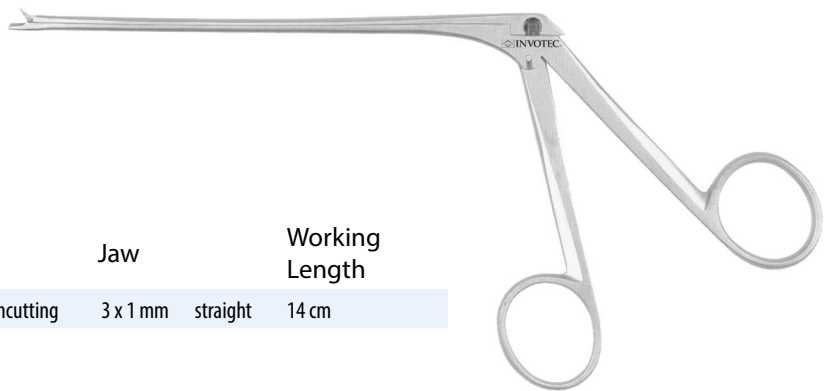

ELONGATED PARANASAL FORCEPS

Number	Description		Jaw	Working Length
S38901	Conchotome	very delicate	oval throughcutting 3 x 1 mm	straight 14 cm





PARANASAL FORCEPS

Number	Description				Working Length
S38423	Ethmoid forceps	straight	oval cupped	3 x 1.5 mm	13 cm
S38426	Ethmoid forceps	straight	oval cupped	3 x 1.5 mm	16 cm
S43010	Ethmoid forceps	straight	delicate serrated		16 cm
S43015	Ethmoid forceps	straight	rough serrated		16 cm

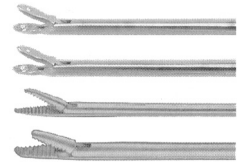

TUBULAR ELONGATED PARANASAL FORCEPS

Number	Description				Working Length
S42100	Ethmoid forceps	"Blakesley Type"	straight	size 0	17 cm
S42101	Ethmoid forceps	"Blakesley Type"	straight	size 1	17 cm
S42102	Ethmoid forceps	"Blakesley Type"	straight	size 2	17 cm
S42200	Ethmoid forceps	"Blakesley Type"	45° upcurved	size 0	17 cm
S42201	Ethmoid forceps	"Blakesley Type"	45° upcurved	size 1	17 cm



Number	Description				Working Length
S42300	Ethmoid forceps	"Takahashi type"	straight	spoon 3 x 10 mm	17 cm

PSB

R&CS ACC

DIS

OTO ACC

OSS

LAR ACC

SPE ACC

RHI INS

PSB

OTO INS

LAR INS

ORO/NAS INS

OTOLOGY

INSTRUMENTS

STEEL TUNING FORKS

Number	Description	
020505	Hartmann tuning fork set with case	Set of 5: c ² -512, c ³ -1024, c ⁴ -2048, c-128, c ¹ -256

Number	Description	
020508	Hartmann tuning fork set with case	Complete set: 020512-020561

Number	Description	
020512	Hartmann tuning fork	c ² -512
020513	Hartmann tuning fork	c ³ -1024
020514	Hartmann tuning fork	c ⁴ -2048
020515	Hartmann tuning fork	c ⁵ -4096
020532	French tuning fork	c ¹ -32
020559	Hartmann tuning fork	c-64
020560	Hartmann tuning fork	c-128
020561	Hartmann tuning fork	c ¹ -256

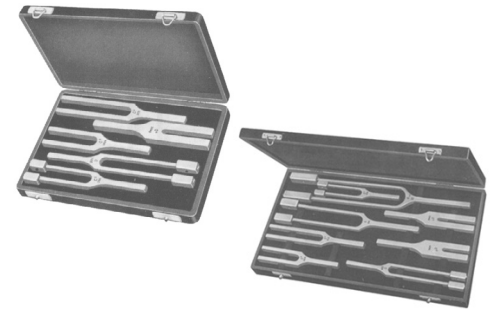

ALUMINUM TUNING FORKS

Number	Description	
020705	Aluminum tuning fork set with case	Set of 5: c-128, c ¹ -256, c-512, c ³ -1024, c-2048

Number	Description	
020710	Aluminum tuning fork	c-128
020711	Aluminum tuning fork	c ¹ -256
020712	Aluminum tuning fork	c-512
020713	Aluminum tuning fork	c ³ -1024
020714	Aluminum tuning fork	c-2048

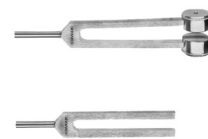

NOISE BOX - OTOSCOPE

Number	Description			
020950	Jansen Otoscope Complete with one physician ear piece and six ear pieces for patient	Black	Rack included	

Number	Description			
020950	Barany Noise Apparatus with hard rubber connector	Black	Rack included	



OTO INS

Number Description

020010	Brunings Pneumatic Ear Speculum Complete Set with lens, 4 speculas, rubber bulb, and wooden case
--------	---



Number Description Diameter

020020	Brunings Ear Speculum	Size 0	5.5 mm
020021	Brunings Ear Speculum	Size 1	6.5 mm
020022	Brunings Ear Speculum	Size 2	7.5 mm
020023	Brunings Ear Speculum	Size 3	8.5 mm
020024	Brunings Ear Speculum	Size 4	9.5 mm
020025	Brunings Ear Speculum	Size 5	10.5 mm



Number Description

020013	Brunings Diagnostic Head	Full lens
--------	--------------------------	-----------



Number Description

020014	Brunings Operating Head	Segmented lens
020015	Rubber Bulb	Fitting the Brunings and Siegle lenses

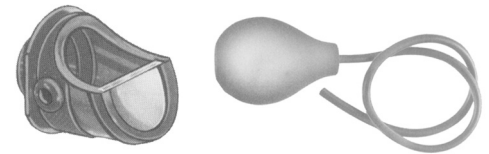

Number Description Diameter

020053	Siegle Pneumatic Ear Speculum lens	
020061	Siegle Ear Speculum	6.0 mm
020062	Siegle Ear Speculum	6.5 mm
020063	Siegle Ear Speculum	7.5 mm

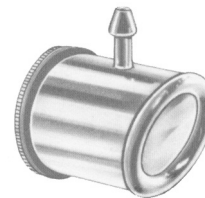

Number Description Diameter

020161	Boucheron Ear Speculum for Adults	Set of 4
020166	Boucheron Ear speculum for adults	4.5 mm
020167	Boucheron Ear speculum for adults	5.5 mm
020168	Boucheron Ear speculum for adults	6.5 mm
020169	Boucheron Ear speculum for adults	4.5 mm



Number	Description		Diameter
020100	Hartmann Ear Speculum for children	Set of 3	3.0, 4.5, 5 mm
020101	Hartmann Ear Speculum for children		3.0 mm
020102	Hartmann Ear Speculum for children		4.5 mm
020103	Hartmann Ear Speculum for children		5 mm

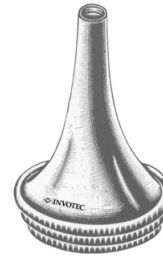

Number	Description		Diameter
020110	Hartmann Ear Speculum for adults	Set of 3	5.5, 6.5, 7.5 mm
020111	Hartmann Ear Speculum for adults		5.5 mm
020112	Hartmann Ear Speculum for adults		6.5 mm
020113	Hartmann Ear Speculum for adults		7.5 mm

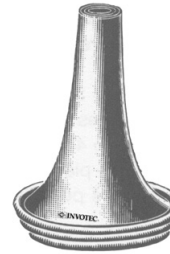

Number	Description		Diameter
020130	Toynbee Ear Speculum for adults	Set of 3	5.5, 6.5, 7.5 mm
020131	Toynbee Ear Speculum for adults	Set of 4	4.5, 5.5, 6.5, 7.5 mm
020136	Toynbee Ear Speculum for adults		4.5 mm
020137	Toynbee Ear Speculum for adults		5.5 mm
020138	Toynbee Ear Speculum for adults		6.5 mm
020139	Toynbee Ear Speculum for adults		7.5 mm



Number	Description		Diameter
020190	Ear Speculum	Set of 6	
020192	Ear Speculum		2 mm
020193	Ear Speculum		3 mm
020194	Ear Speculum		4 mm
020195	Ear Speculum		5 mm
020196	Ear Speculum		6 mm
020197	Ear Speculum		7.5 mm



Number	Description			Diameter
020300	Zoellner Operating Ear Speculum	Black-finish	Oval	Set of 6
020311	Zoellner Operating Ear Speculum	Black-finish	Oval	5.5 x 6.5 mm
020312	Zoellner Operating Ear Speculum	Black-finish	Oval	6.5 x 7.5 mm
020313	Zoellner Operating Ear Speculum	Black-finish	Oval	7.5 x 8.5 mm
020314	Zoellner Operating Ear Speculum	Black-finish	Oval	8.5 x 9.5 mm
020315	Zoellner Operating Ear Speculum	Black-finish	Oval	9.5 x 10.5 mm
020316	Zoellner Operating Ear Speculum	Black-finish	Oval	10.5 x 11.5 mm





Number	Description		length	Size	Diameter
021250	Buck-Wullstein micro ear curettes	blunt	16 cm	0000	0.9 mm
021251	Buck-Wullstein micro ear curettes	blunt	16 cm	000	1.1 mm
021252	Buck-Wullstein micro ear curettes	blunt	16 cm	00	1.3 mm
021253	Buck-Wullstein micro ear curettes	blunt	16 cm	0	1.8 mm
021254	Buck-Wullstein micro ear curettes	blunt	16 cm	1	2.1 mm



Number	Description		length	Size	Diameter
021431	Shapleigh ear curettes	serrated	14 cm	1	
021432	Shapleigh ear curettes	serrated	14 cm	2	

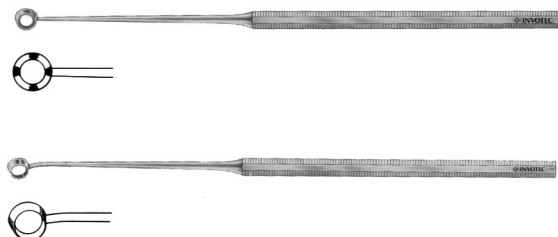

Number	Description		length	Size	Diameter
021109	Buck ear curettes	sharp	15 cm	00	1.5 mm
021110	Buck ear curettes	sharp	15 cm	0	1.9 mm
021111	Buck ear curettes	sharp	15 cm	1	2.5 mm
021112	Buck ear curettes	sharp	15 cm	2	2.7 mm
021113	Buck ear curettes	sharp	15 cm	3	3.4 mm
021114	Buck ear curettes	sharp	15 cm	4	4.0 mm
021115	Buck ear curettes	sharp	15 cm	5	4.5 mm

EAR LOOPS



Number	Description		length	Size	Diameter
021401	Billeau ear loop	straight	15.5 cm	1	
021402	Billeau ear loop	straight	15.5 cm	2	
021403	Billeau ear loop	straight	15.5 cm	3	



Number	Description		length	Size	Diameter
021407	Billeau-Micro ear loop	straight	16 cm	00	2.0 mm
021408	Billeau-Micro ear loop	straight	16 cm	0	2.5 mm
021409	Billeau-Micro ear loop	straight	16 cm	1	3.0 mm



Number	Description		length	Size	Diameter
021410	Langenbeck ear loop	blunt	13.5 cm		



Number	Description		length	Size	Diameter
021415	Coxeter ear loop - Double ended	blunt	14.5 cm		4.5 mm / 5.5 mm



Number	Description		length	Size	Diameter
021420	Weber-Loch ear loop	straight	15 cm	0	
021421	Weber-Loch ear loop	straight	15 cm	1	
021422	Weber-Loch ear loop	straight	15 cm	2	

EAR LEVERS



Number	Description	length
021440	Moldenhauer ear lever	16 cm

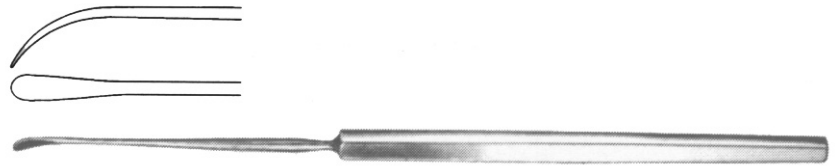

Number	Description	length
021505	Zaufal ear lever	16 cm

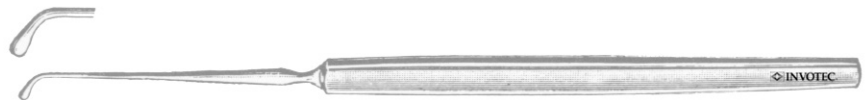

Number	Description	Length
021510	Yankauer-Jansen ear lever 45°	15 cm



Number	Description		Length
021606	Wagener ear lever	sharp	14 cm
021607	Wagener ear lever	blunt	14 cm

EAR HOOKS



Number	Description	Size	length
021470	Gross ear spoon and hook	oval	12 cm



Number	Description	Size	length
021475	Gross ear curette and hook	round	12 cm



Number	Description	Size	length
021511	Jansen ear hook	1	15 cm
021512	Jansen	2	15 cm



Number	Description	Size	length
021520	Allport ear hook		16 cm



Number	Description	Size	length
021571	Hartmann ear hook	1	16 cm
021572	Hartmann ear hook	2	16 cm



Number	Description	Size	length
021601	Wagener ear hook	2.0	14 cm
021602	Wagener ear hook	2.5	14 cm
021603	Wagener ear hook	3.0	14 cm
021604	Wagener ear hook	3.5	14 cm
021605	Wagener ear hook	4.0	14 cm



Number	Description	Size	length
021651	Day ear hook	1	16 cm
021652	Day ear hook	2	16 cm



Ear Probes

Number	Description		length
021681	Stacke ear probe	Nickel silver	11 cm
021684	Stacke-Frenzel ear probe	Sterling silver	9 cm

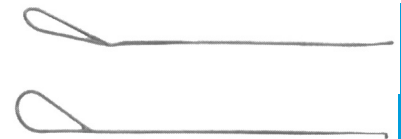

OTO INS

Number	Description		length
021690	Wullstein probe	Silver	26 cm
021695	Bloch ear probe	Sterling silver	11 cm



SICKLE SHAPED KNIVES AND LANCETS

Number	Description	length
021750	Lempert sickle shaped knife	16 cm
021752	Lempert sickle shaped knife	17 cm
021760	Politzer sickle shaped knife	16 cm
021802	Buck lancet	15 cm
021806	Lempert lancet	14 cm
021810	Lempert lancet	15 cm
021811	Lempert lance	45° 15 cm

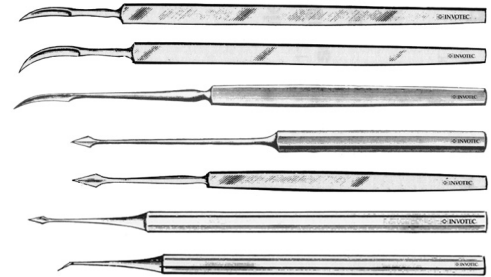

TYMPANUM PERFORATORS

Number	Description	Length
021823	Politzer Tympanum perforator	16 cm

021825	Lucae Tympanum perforator	for children	18 cm
021827	Lucae Tympanum perforator	for adults	18 cm

021830	Politzer Tympanum perforator	reversible	19 cm
021833	Politzer Tympanum perforator	screw locking handle	15 cm

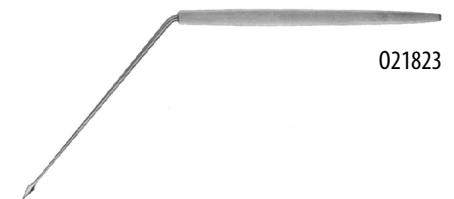
021835	Lucae Tympanum perforator		19 cm
--------	---------------------------	--	-------



021823



021825



021827



021830

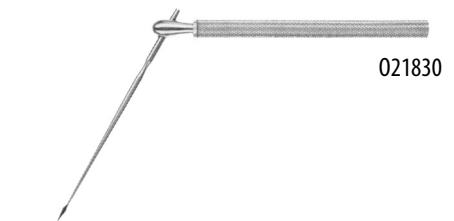

021833

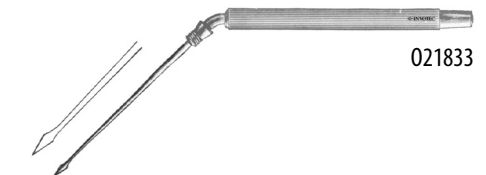

021835

021845	Sexton Tympanum knife		18 cm
021847	Sexton Tympanum knife		18 cm
021850	Sexton Tympanum knife		18 cm
021853	Sexton Tympanum knife		18 cm
021857	Sexton Tympanum knife		18 cm

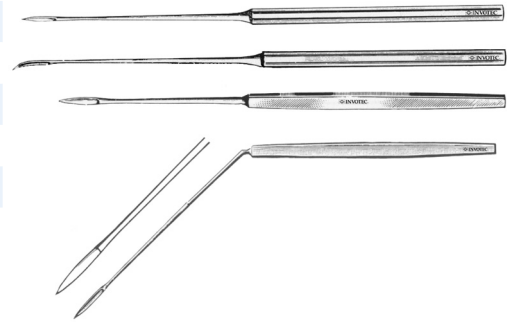

021858	Sexton Tympanum knife	screw locking handle	18 cm
--------	-----------------------	----------------------	-------



EAR CATHETERS

Number	Description	Length	size	Diameter
022011	Hartmann ear catheter	14 cm	1	2.5 mm
022012	Hartmann ear catheter	14 cm	2	3.0 mm
022013	Hartmann ear catheter	14 cm	3	3.5 mm
022014	Hartmann ear catheter	14 cm	4	4.0 mm
022015	Hartmann ear catheter	14 cm	5	5.0 mm



022021	Troeltsch Ear catheter	14 cm	1	2.5 mm
022022	Troeltsch Ear catheter	14 cm	2	3.0 mm
022023	Troeltsch Ear catheter	14 cm	3	3.5 mm
022024	Troeltsch Ear catheter	14 cm	4	4.0 mm
022025	Troeltsch Ear catheter	14 cm	5	5.0 mm



022030	Tube connector for Hartmann/Troeltsch catheters	Olive-shaped		
--------	---	--------------	--	--



AIR BAGS

Number	Description	Diameter
022055	Politzer air bag with conical metal plate - rubber bulb only	
022062	Politzer air bag nasal tip	15 mm
022063	Politzer air bag nasal tip	17 mm
022064	Politzer air bag nasal tip	22 mm
022069	Politzer air bag connector with plugin cone and screw thread	









POWDER BLOWER

Number	Description		
022810	Kabierske powder blower complete set: 3 cannulas for ear, nose, throat and larynx		
022811	Kabierske spare glass bottle	30 ml	
022812	Kabierske valve rubber bulb		
022816	Kabierske laryngeal cannula	curved	13 cm x 5 1/8"
022817	Kabierske nasal cannula	straight	11 cm x 4 3/8"
022818	Kabierske ear cannula	straight	8 cm x 3 1/8"



EAR INSTRUMENT SETS

Number	Description	
021901	Sprague ear instrument	sickle-shaped knife 
021902	Sprague ear instrument	blunt-tip hook 
021903	Sprague ear instrument	button-tip probe 
021904	Sprague ear instrument	tympanum perforating lancet 
021905	Sprague ear instrument	ear curette 
021906	Sprague ear instrument	ear spoon 
021909	Sprague ear instrument	tubular handle 

Number	Description		diameter
022101	Rosen suction tip with Luer-Lock attachment	Straight	0.70 x 80 mm
022102	Rosen suction tip with Luer-Lock attachment	Straight	0.90 x 80 mm
022103	Rosen suction tip with Luer-Lock attachment	Straight	1.20 x 80 mm



022111	Rosen suction tip with Luer-Lock attachment	angled	0.70 x 65 mm
022112	Rosen suction tip with Luer-Lock attachment	angled	0.90 x 65 mm
022113	Rosen suction tip with Luer-Lock attachment	angled	1.20 x 65 mm
022114	Rosen suction tip with Luer-Lock attachment	angled	1.50 x 65 mm
022115	Rosen suction tip with Luer-Lock attachment	angled	2.00 x 65 mm



Number	Description	Diameter
022210	Baron suction tip with finger cut off	1.0 x 75 mm
022215	Baron suction tip with finger cut off	1.5 x 75 mm
022220	Baron suction tip with finger cut off	2.0 x 75 mm

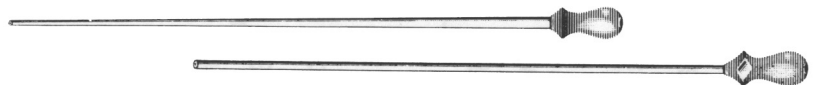
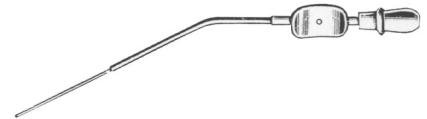

Number	Description		Length	Diameter	
022141	Wullstein flexible suction tip with Luer Cone	cylindrical	Sterling Silver	16 cm	1.5 mm
022142	Wullstein flexible suction tip with Luer Cone	cylindrical	Sterling Silver	16 cm	2.0 mm
022148	Wullstein flexible suction tip with Luer Cone	conical	Sterling Silver	16 cm	1.5 mm

Number	Description
022148	Tube connector with Luer cone and cut off plate for Wellstein and Rosen suction tubes

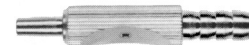

Number	Description
022146	Wullstein irrigating suction handle with Luer cone Compatible with Wullstein irrigating/suction tubes



OTO INS

Number	Description	Working Length	Diameter
022230	Zollner suction tube with finger plate and Luer cone Complete with 1 slip on cannula		0.7 mm
022235	Zollner micro suction cannula only for suction tube	30 mm	0.5 mm
022237	Zollner micro suction cannula only for suction tube	30 mm	0.7 mm

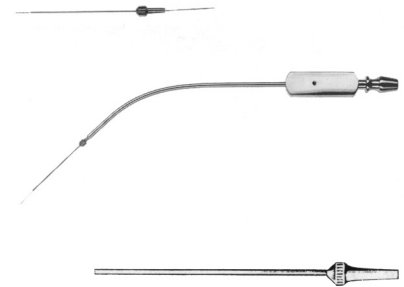

Number	Description	Working Length	Diameter
022261	Frazier suction tube	110 mm	1.00 mm x 190 mm
022262	Frazier suction tube	110 mm	2.00 mm x 190 mm

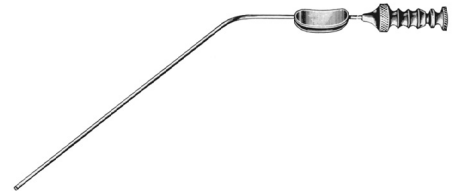

Number	Description	
022271	Hartmann suction tip	right ear
022272	Hartmann suction tip	left ear



Number	Description	Size	diameter
022309	House suction tip	1	0.9 + 0.7 mm
022312	House suction tip	2	1.2 + 0.9 mm
022315	House suction tip	3	1.5 + 1.2 mm
022318	House suction tip	1	1.8 + 1.8 mm
022325	House suction tip	2	2.5 + 2.0 mm
022330	House suction tip	3	3.0 + 2.0 mm
022345	House suction tip	4	4.5 + 2.0 mm

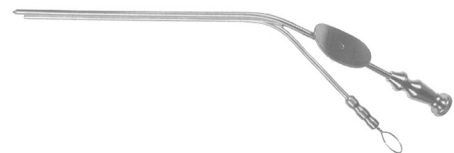

PERIOSTEOTOMES, ELEVATOR



Number	Description	
026010	Muck periosteal knife	13 cm



Number	Description	
026020	Politzer mastoid knife	13 cm

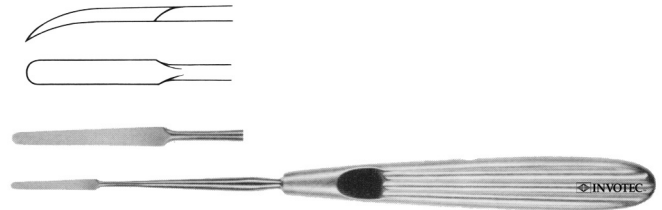

Number	Description	size	shape	length
026052	Lempert elevator	size 2 mm	straight	18 cm
026057	Lempert elevator	size 2 mm	curved	18 cm
026058	Lempert elevator	size 3 mm	curved	18 cm

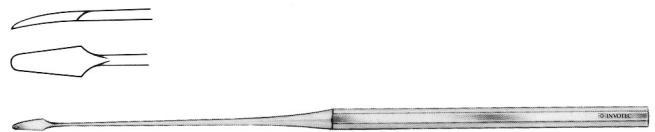

Number	Description	width	length
026040	Wullstein raspatory		17 cm

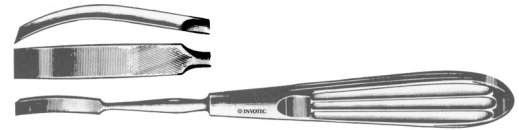

Number	Description	width	length
026070	Lempert raspatory	6 mm	20 cm
026071	Lempert raspatory	6 mm	18 cm

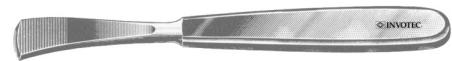

Number	Description	width	length
026080	Jansen raspatory	12 mm	17 cm

EAR POLYPUS SNARES

Number	Description	Size
021010	Krause Ear Polypus Snare	16 cm



Number	Description	Size
021030	Wilde Ear Polypus Snare	16 cm



Number	Description	Size
021042	Snare-Wire, coil	10 meters 0.2 mm Ø
021043	Snare-Wire, coil	10 meters 0.3 mm Ø



Number	Description	Size
021047	Snare-Loops, pre-shaped	bundle/ 100 pieces 0.2mm Ø
021048	Snare-Loops, pre-shaped	bundle/ 100 pieces 0.3 mm Ø
021049	Snare-Loops, pre-shaped	bundle/ 100 pieces 0.35 mm Ø



MASTOID RONGEURS
Number Description

026203	Kerrison Rongeur chisel-edge punch	0	80 mm
026204	Kerrison Rongeur chisel-edge punch	1	80 mm
026205	Kerrison Rongeur chisel-edge punch	2	80 mm
026206	Kerrison Rongeur chisel-edge punch	3	80 mm

Number Description

026251	Citelli Rongeur atticus punch	1	60 mm
026252	Citelli Rongeur atticus punch	2	60 mm
026253	Citelli Rongeur atticus punch	3	60 mm

Number Description

026265	Brunings rongeur, chisel edged punch	4 mm
026266	Brunings rongeur, chisel edged punch	6 mm

Number Description

026272	Beyer rongeur atticus punch	2 mm
--------	-----------------------------	------



PUNCHES, MALLEUS NIPPERS

Number	Description	Width
024805	Davol forceps	3 x 2 mm



Number	Description	Width
024814	Dieter malleus punch	chisel-edge up cutting 1.3 mm
024815	Dieter malleus punch	chisel-edge down cutting 1.3 mm
024816	Dieter malleus punch	chisel-edge right cutting 1.3 mm
024817	Dieter malleus punch	chisel-edge left cutting 1.3 mm



Number	Description	Width
023020	Hartmann ear dressing forceps	delicate pattern 13.5 cm
023021	Hartmann ear dressing forceps	standard pattern 13.5 cm



Number	Description	Width
023040	Tilly ear dressing forceps	standard pattern 14 cm

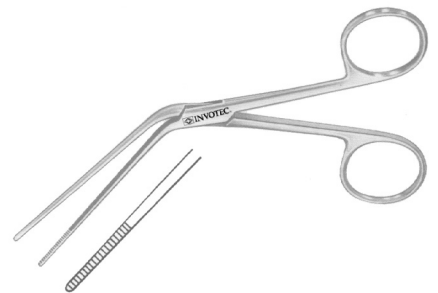

Number	Description	Width
023112	Hartmann ear forceps	14 cm
023122	Hartmann ear forceps	20 cm
023132	Hartmann ear forceps	22 cm





Number	Description	length
023142	Hartmann-Noyes ear forceps	14 cm
023152	Hartmann-Noyes ear forceps duckbill	14 cm
023163	Hartmann ear forceps 1 x 2 teeth	14 cm



023170	Weingartner ear forceps	14 cm
--------	-------------------------	-------



023201	Hartmann-Herzfeld ear forceps	14 cm	2 mm
023202	Hartmann-Herzfeld ear forceps	14 cm	2.2 mm
023203	Hartmann-Herzfeld ear forceps	14 cm	2.5 mm
023204	Hartmann-Herzfeld ear forceps	14 cm	3.0 mm
023211	Hartmann-Herzfeld ear forceps	14 cm	2.0 mm
023212	Hartmann-Herzfeld ear forceps	14 cm	2.2 mm
023213	Hartmann-Herzfeld ear forceps	14 cm	2.5 mm
023214	Hartmann-Herzfeld ear forceps	14 cm	3.0 mm



Number	Description	Length
023250	Hartmann ear forceps	14 cm

023260	Struempel ear forceps	14 cm
--------	-----------------------	-------

023261	Struempel-baby ear forceps	14 cm
--------	----------------------------	-------

023270	Hartmann ear forceps	2.0 mm
--------	----------------------	--------



Number	Description	Length
023301	Hartmann ear forceps smooth jaws	14 cm
023303	Hartmann ear forceps smooth jaws 1 x 2 teeth	14 cm
023312	Hartmann ear forceps serrated jaws	14 cm
023314	Hartmann ear forceps serrated jaws angled up	14 cm

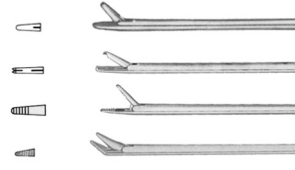

023322	Bellucci grasping forceps*	heavy pattern
--------	----------------------------	---------------

* may also be used as prosthesis applying or wire bending forceps



Number	Description	Length
023401	Ear forceps smooth jaws	4 x 0.5 mm
023412	Ear forceps serrated jaws	4 x 0.5 mm
023414	Ear forceps serrated jaws angled up	3 x 0.5 mm
023416	Ear forceps serrated jaws right	3 x 0.5 mm
023417	Ear forceps serrated jaws left	3 x 0.5 mm
023422	Ear forceps serrated jaws long	7 x 0.5 mm

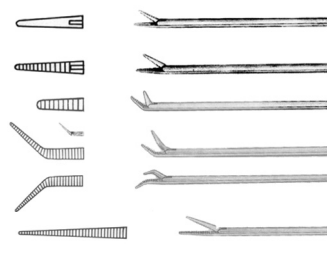

Number	Description	Length
023512	Ear forceps serrated jaws straight	4 x 0.4 mm
023514	Ear forceps serrated jaws angled up	4 x 0.4 mm
023712	Ear forceps delicate with oval cup jaws straight	1 x 0.9 mm
023714	Ear forceps delicate with oval cup jaws angled up	1 x 0.9 mm
023716	Ear forceps delicate with oval cut jaws angled right	1 x 0.9 mm
023717	Ear forceps delicate with oval cut jaws angled left	1 x 0.9 mm

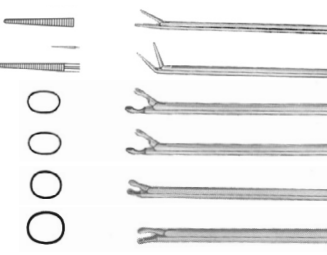



Number	Description			
023912	Ear forceps	oval cup jaws	straight	0.6 x 0.5 mm
023914	Ear forceps	oval cup jaws	up	0.6 x 0.5 mm
023916	Ear forceps	oval cup jaws	right	0.6 x 0.5 mm
023917	Ear forceps	oval cup jaws	left	0.6 x 0.5 mm

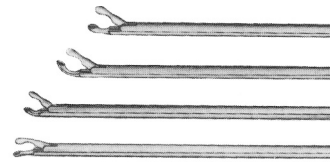

Number	Description		diameter	
025012	Ear forceps	serrated jaws	straight	5 x 0.5 mm
025014	Ear forceps	serrated jaws	up	4 x 0.5 mm
025023	Ear forceps	serrated jaws	long	7 x 0.5 mm
025030	Ear forceps	with round cup jaws	0.9 mm	
025035	Ear forceps	with oval cut jaws	1.2 x 0.9 mm	

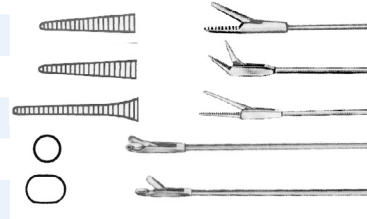

025060	Wullstein-Blakesley Ear forceps	jaws fenestrated		5 x 2 mm
--------	---------------------------------	------------------	--	----------



WIRE BENDING FORCEPS

Number Description

024611	Schuknecht Wire crimper	curved down	6.0 x 0.8 mm
--------	-------------------------	-------------	--------------



Number Description

024614	McGee wire bending forceps	curved down	3.5 x 0.8 mm
--------	----------------------------	-------------	--------------

024615	McGee wire bending forceps	curved down	4.5 x 0.8 mm
--------	----------------------------	-------------	--------------

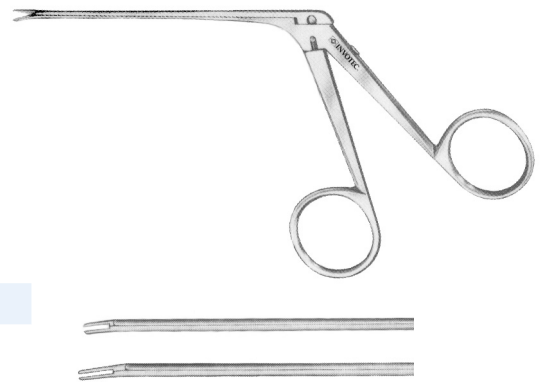

FORCEP PROTECTOR

• autoclavable

Number Description

024990	Teflon forcep protector	Length	80 mm
--------	-------------------------	--------	-------



Number Description

024812	Tabb crura nipper	Shaft Width	Shaft Length	1.5 mm	65 mm
--------	-------------------	-------------	--------------	--------	-------

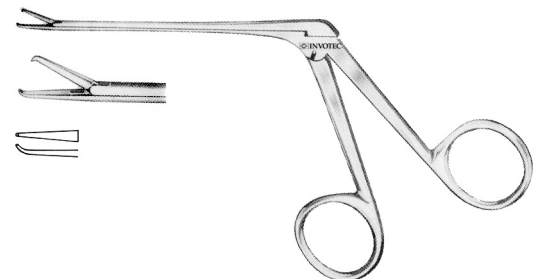



Number	Description			Shaft Length
024910	Graven grasping forceps	serrated jaws	3 x 1 mm	70 mm



Number	Description			Shaft Length
024919	Fuller forceps	smooth jaws	6 x 0.8 mm	75 mm

Number	Description		
024110	Shea-Bellucci Ear scissors	blunt tip blades	straight
024112	Shea-Bellucci Ear scissors	straight tip blades	straight
024116	Shea-Bellucci Ear scissors	semi-sharp tip	curved right
024117	Shea-Bellucci Ear scissors	semi-sharp tip	curved left



Number	Description		
024211	Bellucci ear scissors	sharp/blunt tip	straight
024212	Bellucci ear scissors	sharp tip blades	straight
024213	Bellucci ear scissors	sharp tip	angled up
024216	Bellucci ear scissors	sharp tip	curved right
024217	Bellucci ear scissors	sharp tip	curved left

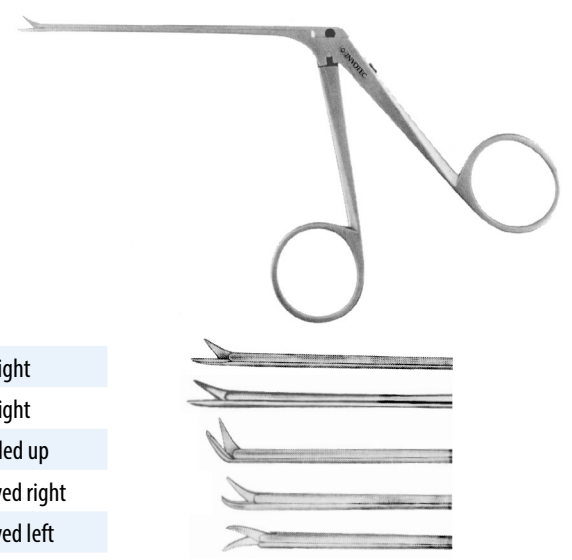

Number	Description		
025052	Ear scissors	sharp tip blades	straight
025054	Ear scissors	sharp tip	angled up
025056	Ear scissors	sharp tip	curved right
025057	Ear scissors	sharp tip	curved left

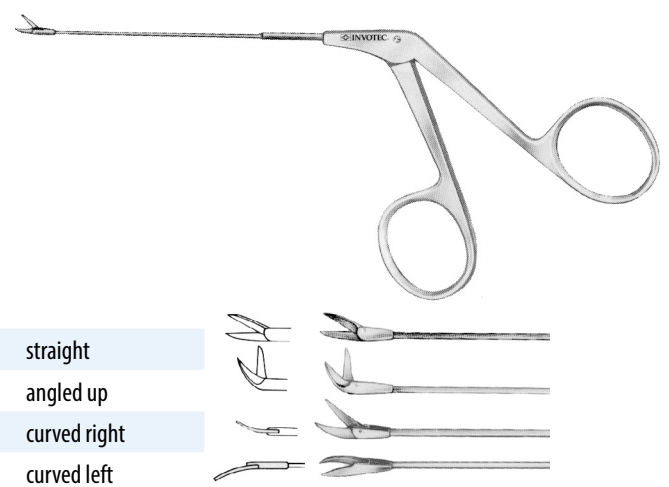

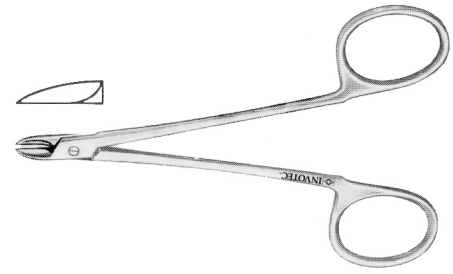

Number	Description	Shaft Length	Length
024810	Lempert Malleus forceps		11.5 cm



Number	Description	Shaft Length	Length
024835	Wullstein malleus nipper chisel edge 3 mm long	80 mm	15 cm

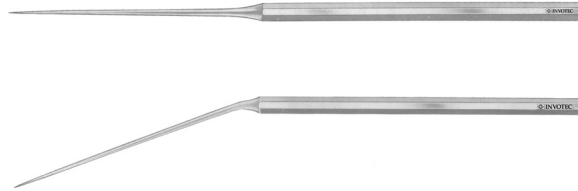

Number	Description
030601	Barbara sharp needle/pick
030603	Barbara sharp needle/pick
030604	Rosen sharp needle/pick
030605	Rosen blunt needle/pick
030606	Rosen blunt needle/pick

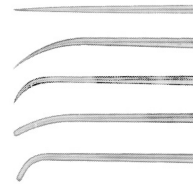



Number	Description				
030607	Austin hook			1.5 mm	90°
030613	Austin hook			0.3 mm	25°
030616	Austin hook			0.6 mm	25°
030620	Austin hook			1.0 mm	25°
030641	Austin hook			1.5 mm	45°
030643	Austin hook			2.5 mm	45°
030645	Shea hook	oblique pick	blunt	2.0 mm	45°
030649	Austin hook	attic dissector	blunt	3.0 mm	90°
030641	Austin hook			1.5 mm	45°
030643	Austin hook			2.5 mm	45°
030645	Shea hook	oblique pick	blunt	2.0 mm	45°
030649	Austin hook	attic dissector	blunt	3.0 mm	90°

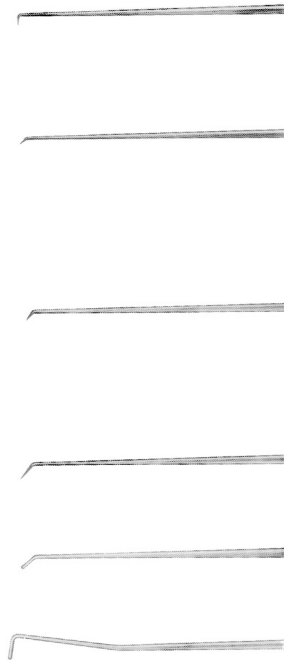

Number	Description				
030772	Antoli-Candela hook	angled right		0.6 mm	90°
030773	Antoli-Candela hook	angled left		0.6 mm	90°
030792	Antoli-Candela hook	right		1.0 mm	90°
030793	Antoli-Candela hook	left		1.0 mm	90°

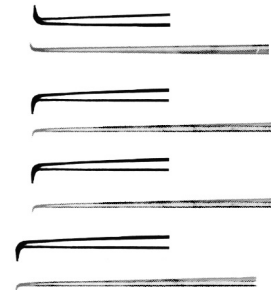



Number Description

030775	McGee hook	curved up	0.5 mm
030780	McGee hook	curved up	1.0 mm
030785	McGee hook	curved down	0.5 mm
030790	McGee hook	curved down	1.0 mm

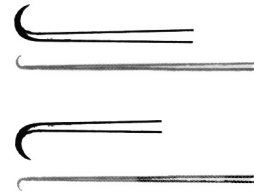

Number Description

030802	Fisch hook	0.2 mm
030806	Plester hook	0.6 mm

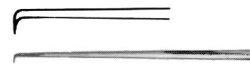



Number	Description	Diameter	Diameter
030810	Antoli-Candela incision knife	1.0 mm	45°
030815	Antoli-Candela incision knife	1.5 mm	45°
030820	Antoli-Candela incision knife	2.0 mm	45°
030823	Antoli-Candela incision knife	2.3 mm	45°
030825	Antoli-Candela incision knife	2.5 mm	45°
030830	Antoli-Candela circular cutting knife	1.0 mm	90°
030835	Antoli-Candela circular cutting knife	1.5 mm	90°
030840	Antoli-Candela circular cutting knife	2.0 mm	90°
030843	Antoli-Candela circular cutting knife	2.3 mm	90°
030845	Antoli-Candela circular cutting knife	2.5 mm	90°

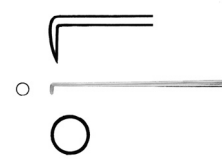
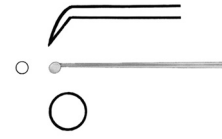

030901	House round knife for incudo-stapedial joint	1.0 mm	30°
--------	--	--------	-----

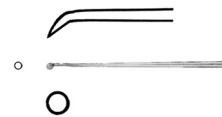

030903	Goldmann knife-elevator for metal wall	3.0 mm	45°
--------	--	--------	-----

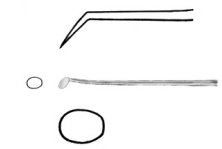

Number	Description	Size	Size
030906	Rosen knife curette	1.5 mm	45°

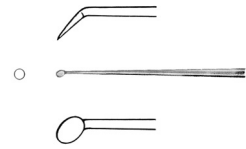

Number	Description	Size	Size
030911	Antoli-Candela Round knife for incudo-stapedial joint	1.0 mm	45°

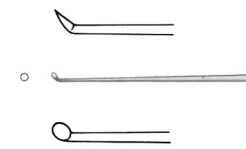

Number	Description	Size	
030922	Austin round knife weapon	2.0 mm	90°

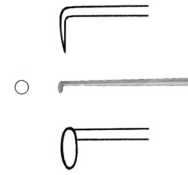

Number	Description	Size	
030925	Gerlach round knife	3.0 mm	90°

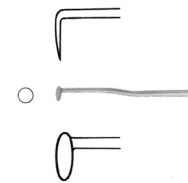

Number	Description	Size	
030935	Shea tympanoplasty knife	1.5 x 1 mm	45°

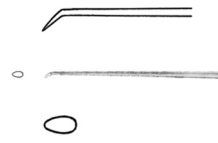

030938	Shea tympanoplasty knife	4.0 x 2.5 mm	60°
--------	--------------------------	--------------	-----

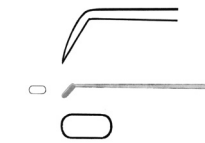

030939	Harrison tympanoplasty knife		45°
--------	------------------------------	--	-----

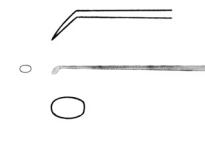

030947	Harrison tympanoplasty knife		90°
--------	------------------------------	--	-----

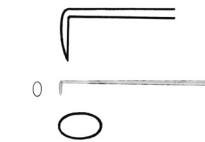

Number	Description	Size
031061	House tympanoplasty knife	4.0 x 1.0 mm
031063	House tympanoplasty knife	3.0 x 1.0 mm
031075	Gray tympanoplasty knife	3.5 mm Ø

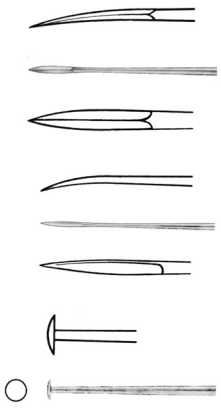

Number	Description	Size	Angle
030953	Rosen incision knife		45°
030955	Hough incision knife	2.0 x 1- 2 mm	45°
030958	House lancet knife	2.0 x 1.0 mm	45°
030965	Shea incision knife	2.0 x 1.5 mm	90°
030967	Austin incision knife	1.8 x 1.2 mm	90°

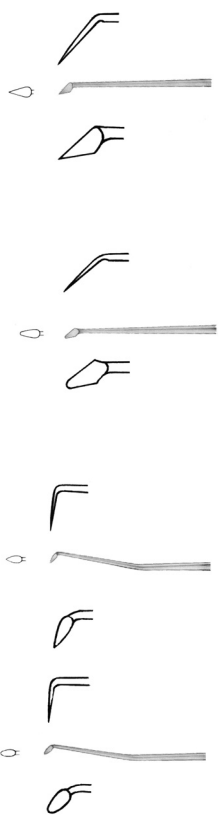



Number Description

031003 Guilford-Wright flap knife 2 mm



031005 Plester flap knife 3.5 mm



031017 Plester incision knife 2.5 mm

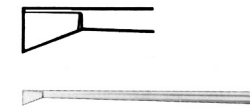

031032 Austin sickle knife 3.0 x 1.0 mm

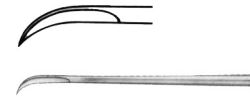

031035 Austin incision knife for footplate



Number Description

031040 Tabb tympanoplasty knife 1.5 x 1 - 1.15 mm



031041 House sickle knife #1 6.0 x 1.5 mm

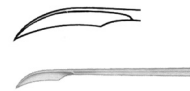

Number Description

031046 Schuknecht sickle knife 5.0 x 1.0 mm

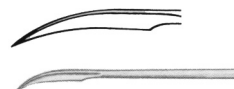



Number	Description	Width	Length
031103	Goldmann elevator oval shape slight curve	2.5 mm	
031111	House stapes elevator		12 mm
031131	Shea elevator right	1.2 mm	
031132	Shea elevator left	1.2 mm	

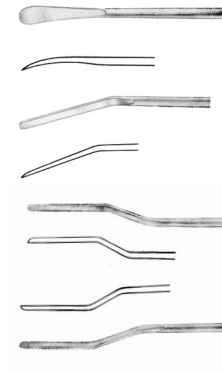

Number	Description	Length
031171	Shambaugh-Derlacki elevator blunt	14 cm



Number	Description	Width
030922	Austin round knife angled up 90°	2 mm Ø
031102	Antoli-Candela elevator curved	1.8 mm
031115	Rosen elevator	15 x 1.5 mm
031121	Rosen elevator	15 x 1.0 mm
031122	Rosen elevator	15 x 1.2 mm

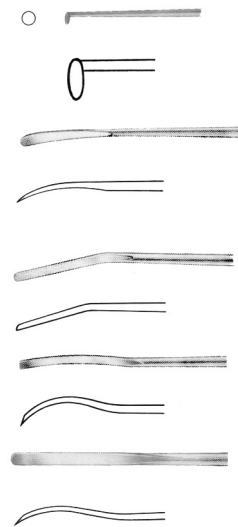



Number	Description	Width
031143	Schuknecht elevator flat tip slightly curved up	1 mm
031150	Hough excavator heavy pattern right	
031151	Hough excavator heavy pattern left	

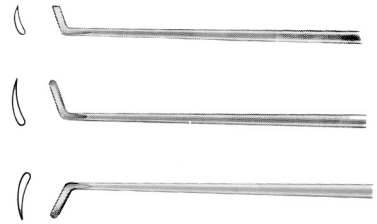

Number	Description	width	length
031175	Shambaugh-Derlacki elevator angled tip	2.0 mm	14.4 cm
031176	Shambaugh-Derlacki duckbill elevator slightly curved	3.0 mm	14.5 cm

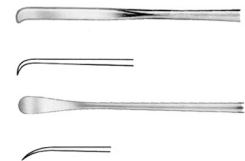

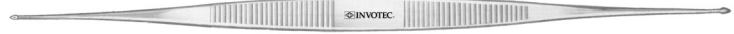

Number	Description			Length
031290	Double-ended curette for Stapedectomy	pointed	small	17 cm
031292	Double-ended curette for Stapedectomy	pointed	large	17 cm

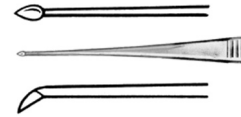

Number	Description		Diameter	
031270	House Double-ended curette for stapedectomy	cups slightly angled forward	1.0 mm	1.2 mm
031275	House Double-ended curette for stapedectomy	cups slightly angled forward	1.5 mm	1.8 mm
031280	House Double-ended curette for stapedectomy	cups strongly angled forward	1.0 mm	1.2 mm
031285	House Double-ended curette for stapedectomy	cups strongly angled forward	1.5 mm	1.8 mm

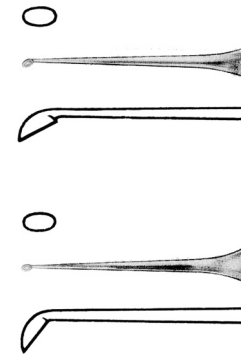



Number	Description		Diameter
036590	Larkin hand perforator	trocar point	0.8 mm
036592	Larkin hand penetrator		0.8 mm
036594	Larkin hand trephine		0.8 mm

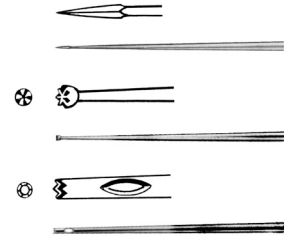



Number	Description	Width	Diameter
031461	Rose Mobilizer	1.8 mm	

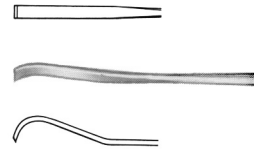

031465	Goldmann Mobilizer with ball tip	angled up 25°	0.8 mm
--------	----------------------------------	---------------	--------



031468	Goldmann pluggar with ball tip		1.0 mm
--------	--------------------------------	--	--------





Number	Description			
031410	Hough measuring rod	markers at 3.5 mm	4 mm	4.5 mm
031433	Austin wire guide and applicator	v-notch	light curve	

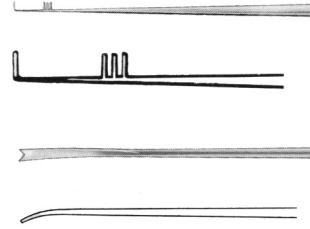

Number	Description
038950	Piston cutting jig

R&CS ACC

DIS

OTO ACC

OSS

LAR ACC

SPE ACC

RHI INS

PSB

OTO INS

LAR INS

ORO/NAS INS

LARYNGEAL

INSTRUMENTS

KLEINSASSAR TYPE

Number	Size	Description
L30001	18 cm	Adult Large
L30002	18 cm	Medium
L30003	18 cm	Small
L30004	18 cm	Anterior commissure
L30005	22 cm	Anterior commissure, long neck
L30006	15 cm	Child
L30007	13 cm	Small Child

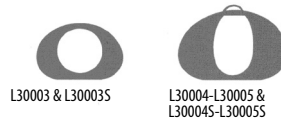
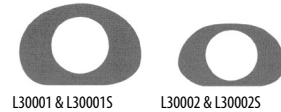
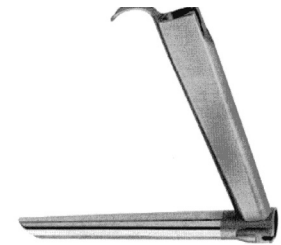

SPREADABLE OPERATING LARYNGOSCOPES

Number	Size	Description
L30001S	17 cm	Adult Large
L30002S	17 cm	Medium
L30003S	18 cm	Small
L30004S	18 cm	Anterior commissure
L30005S	22 cm	Anterior commissure, long neck
L30006S	15 cm	Child
L30007S	13 cm	Small Child



BENJAMIN SLIM

Number	Size	Description
L550-1327	17 cm	Adult Medium



LARYNGOSCOPE HOLDER AND CHEST SUPPORT

Number	Ring Size	Rod Size	Description
L30400	9.5 cm Ø	34 cm	Adult size chest support with rubber ring
L30500	9.5 cm Ø	24 cm	Child size rod only with rubber ring
L30401			Rubber ring replacement for L30400-L30500



LEWY LARYNGOSCOPE HOLDER

Number	Description
L30390	Lewy Laryngoscope holder and chest brace
L3039H	Lewy handle for Kleinsassar, spreadables and Benjamin Slim operating laryngoscopes



DEDO-PILLING MICRO LARYNGOSCOPE TYPE II

- Eliminates light loss though continuous illuminating fibers
- Supplied with two light carriers

Number	Size	Overall length	Minimum ID	Maximum OD	Description
L530-173	Adult	173 mm	11.6 mm	30.1 mm	Dedo-Pilling Micro Laryngoscope Type II

HOLINGER LARYNGOSCOPE

Number	Description	Working Length	Full Length
L740020	Adult Large	157 mm	180 mm
L550-1350	Adult Medium	146 mm	170 mm

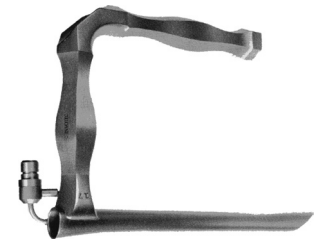
JACKSON LARYNGOSCOPE

Number	Description	Full Length
L740012	Infant Laryngoscope	120 mm
L740017	Child Laryngoscope	170 mm
L740018	Adult Laryngoscope	180 mm

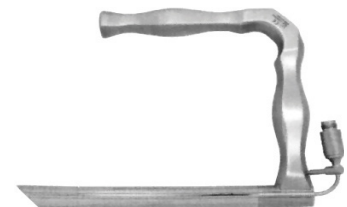

FIBER OPTIC LIGHT CARRIERS

Number	Description	Compatible Laryngoscope Models
L30010	Large, Fiber Optic Light Carrier	Kleinsassar Type L30001 - L30005
L30011	Medium, Fiber Optic Light Carrier	Kleinsassar Type L30006 - L30007
L30012	X-Long, Fiber Optic Light Carrier	Kleinsassar Type L30005
L30013	Light carrier fittings - Storz	
L30014	Light carrier fittings - Wolfe	
L550-1330	Fiber Optic Light Carrier with clip for proximal illumination	

SUCTIONS

Number	Description	Compatible Laryngoscope Models
L30110	Suction / Smoke Evacuator	Kleinsassar Type L30001 - L30005
L30111	Suction / Smoke Evacuator	Kleinsassar Type L30006 - L30007

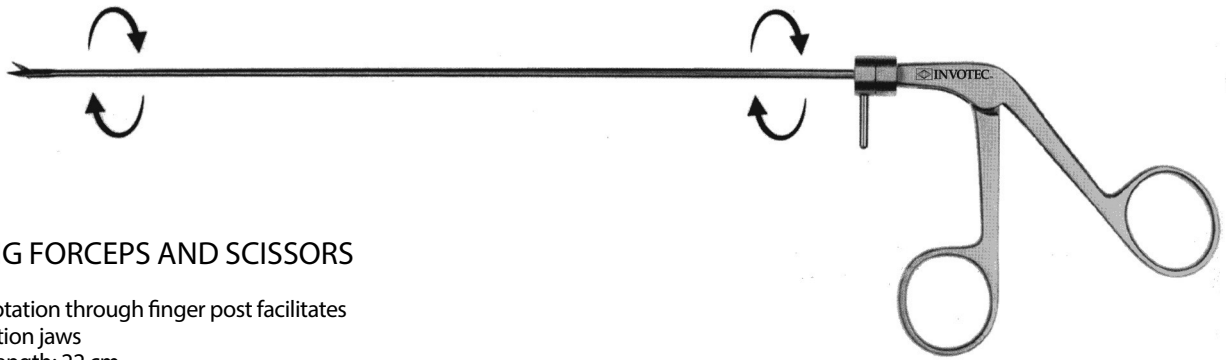



ROTATING FORCEPS AND SCISSORS

- Full 360° rotation through finger post facilitates
- Double action jaws
- Working Length: 22 cm

Forceps

Number	Description		
L32203	Cutting Forceps with round cupped double action jaws	2 mm Ø	curved
L32206	Alligator Forceps with serrated, double action jaws		curved
L32207	Grasping Forceps with triangular, serrated, double action jaws		curved upwards



Scissors

Number	Description	
L32210	Scissors	curved



ANTERIOR COMMISSURE FORCEPS AND SCISSORS

- Conical sheath for high stability and optimal view
- Optimum access in the anterior commissure via 10° upcurved distal end

Cutting Forceps

Number	Description		
L32101	Cutting Forceps with round, cupped jaws	2 mm Ø	straight
L32102	Cutting Forceps with round, cupped jaws	2 mm Ø	curved upwards
L32103	Cutting Forceps with round, cupped jaws	2 mm Ø	curved right
L32104	Cutting Forceps with round, cupped jaws	2 mm Ø	curved left



Scissors

Number	Description	
L32108	Scissors	straight
L32109	Scissors	upcurved 45°
L32110	Scissors	curved right
L32111	Scissors	curved left



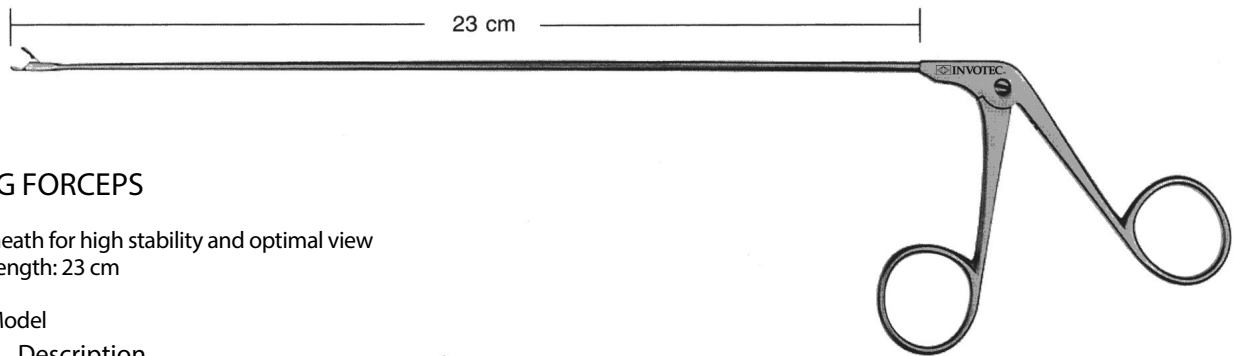

CUTTING FORCEPS

- Conical sheath for high stability and optimal view
- Working length: 23 cm

Standard Model

Number	Description		
L32001	Cutting Forceps with round cupped jaws	2 mm Ø	straight
L32002	Cutting Forceps with round cupped jaws	2 mm Ø	curved upwards
L32003	Cutting Forceps with round cupped jaws	2 mm Ø	curved right
L32004	Cutting Forceps with round cupped jaws	2 mm Ø	curved left
L32050	Cutting Forceps with round cupped jaws	2 mm Ø	curved upwards right
L32051	Cutting Forceps with round cupped jaws	2 mm Ø	curved upwards left
L32052	Cutting Forceps with round cupped jaws, horizontal opening	2 mm Ø	curved right
L32053	Cutting Forceps with round cupped jaws, horizontal opening	2 mm Ø	curved left
L32150	Cutting Forceps with long oval cupped jaws		curved upwards
L32151	Cutting Forceps with long oval cupped jaws, opening right		upcurved
L32152	Cutting Forceps with long oval cupped jaws, opening left		upcurved



Heavy Model

Number	Description		
L32040	Forceps with oval cupped jaws	3x5 mm	straight
L32041	Forceps with round cupped jaws	4 mm Ø	straight
L32042	Forceps with round cupped jaws	4 mm Ø	curved upwards
L32043	Forceps with round cupped jaws	4 mm Ø	curved right
L32044	Forceps with round cupped jaws	4 mm Ø	curved left



Double Action Model

Number	Description		
L32046	Cutting Forceps with round cupped, double action jaws	5 mm Ø	straight



Minature, Very Delicate Model

Number	Description		
L32060	Miniature Cutting Forceps with cupped jaws	1 mm Ø	straight
L32061	Miniature Cutting Forceps with cupped jaws	1 mm Ø	curved upwards
L32062	Miniature Cutting Forceps with cupped jaws	1 mm Ø	curved right
L32063	Miniature Cutting Forceps with cupped jaws	1 mm Ø	curved left
L32064	Miniature Cutting Forceps with cupped jaws	1 mm Ø	curved upwards right
L32065	Miniature Cutting Forceps with cupped jaws	1 mm Ø	curved upwards left



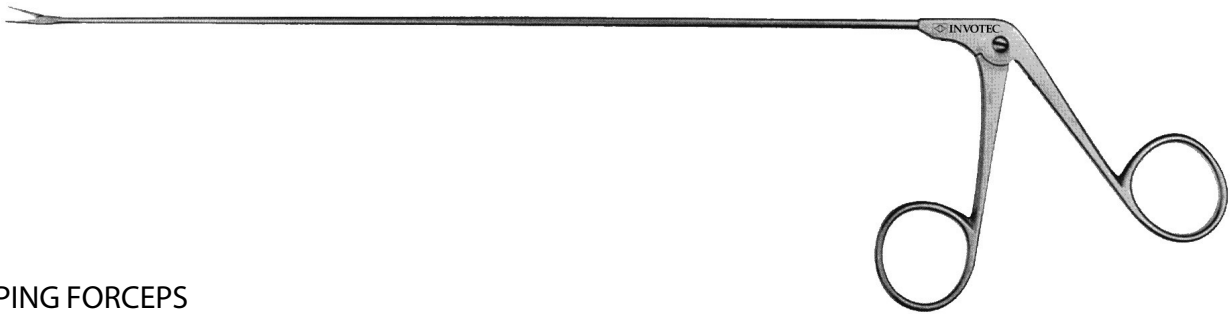

GRASPING FORCEPS

- Conical sheath for high stability and optimal view
- Working length: 23 cm

Standard Model

Number	Description		
L32105	Artery Forceps with ratchet	serrated	straight
L32005	Alligator Forceps	serrated	straight
L32006	Alligator Forceps	serrated	curved right
L32007	Alligator Forceps	serrated	curved left
L32215	Alligator Forceps, horizontal opening	serrated	straight
L32054	Alligator Forceps	serrated	curved up
L32154	Alligator Forceps, horizontal opening	serrated	curved up
L32055	Forceps with triangular jaws	curved up	opening right
L32056	Forceps with triangular jaws	curved up	opening left
L32058	Forceps with triangular jaws	straight	
L32059	Forceps with triangular jaws	curved up	
L32068	ARNOLD Vocal Cord Holding Forceps with triangular jaws		for right side
L32069	ARNOLD Vocal Cord Holding Forceps with triangular jaws		for left side

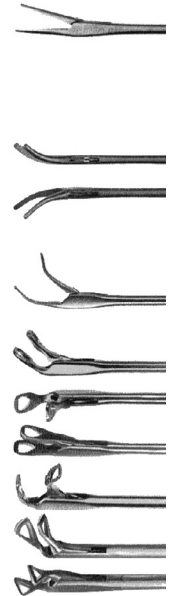

Miniature, Very Delicate Model

Number	Description		
L32070	Miniature Grasping Forceps	serrated	straight
L32071	Miniature Grasping Forceps	serrated	curved upwards
L32072	Miniature Grasping Forceps	serrated	curved right
L32073	Miniature Grasping Forceps	serrated	curved left
L32076	Miniature Grasping Forceps with triangular jaws	serrated	curved right
L32077	Miniature Grasping Forceps with triangular jaws	serrated	curved left

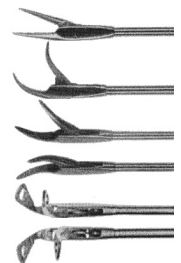



SCISSORS

- Conical sheath for high stability and optimal view
- Working length: 23 cm

Standard Model

Number	Description	
L32008	Scissors	straight
L32009	Scissors	curved up 45°
L32115	Scissors	curved up 15°
L32010	Scissors	curved right
L32011	Scissors	curved left
L32057	Scissors, horizontal cutting	straight

Minature, Very Delicate Model

Number	Description	
L32080	Miniature Scissors	straight
L32081	Miniature Scissors	curved up 45°
L32082	Miniature Scissors	curved right
L32083	Miniature scissors	curved left



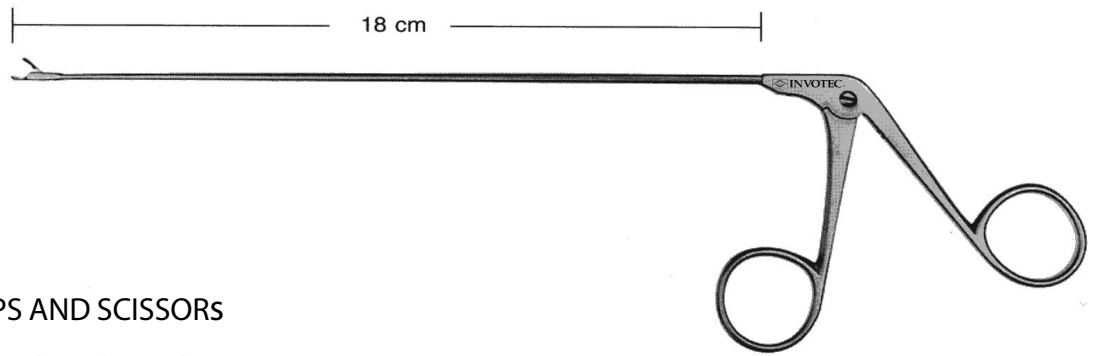

PEDIATRIC FORCEPS AND SCISSORS

- Conical sheath for high stability and optimal view
- Working length: 18 cm

Cutting Forceps

Number	Description		
L31902	Cutting Forceps with cupped jaws	2 mm Ø	straight
L31903	Cutting Forceps with cupped jaws	2 mm Ø	curved up
L31904	Cutting Forceps with cupped jaws	3 mm Ø	straight
L31905	Cutting Forceps with cupped jaws	3 mm Ø	curved up
L31906	Cutting Forceps with cupped jaws	1 mm Ø	straight
L31907	Cutting Forceps with cupped jaws	1 mm Ø	curved up
L31930	Cutting Forceps with cupped jaws with horizontal opening and malleable distal end	4 mm Ø	

Grasping Forceps

L31910	Alligator Forceps with serrated jaws	straight
--------	--------------------------------------	----------

Scissors

Number	Description	
L31920	Scissors	straight
L31921	Scissors	upcurved 45°
L31922	Scissors	curved right
L31923	Scissors	curved left

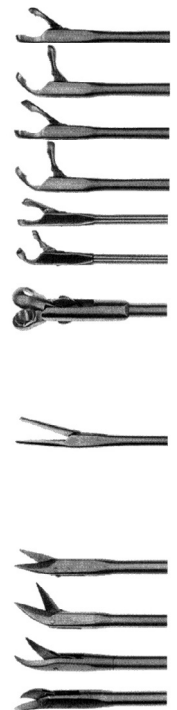



UNIPOLAR COAGULATION FORCEPS

- Unipolar coagulation
- 360° rotatable
- Laser smoke evacuation

Number	Description				Shaft	Working Length
L040023	Unipolar coagulation forceps with smoke evacuation channel	Rotatable	Serrated	Straight	3.0 mm	23 cm
L040223	Unipolar coagulation forceps with smoke evacuation channel	Rotatable	Serrated	Straight	3.0 mm	23 cm
L040423	Unipolar coagulation forceps with smoke evacuation channel	Rotatable	Serrated	Straight	3.0 mm	23 cm
L040623	Unipolar coagulation forceps with smoke evacuation channel	Rotatable	Serrated	Straight	3.0 mm	23 cm



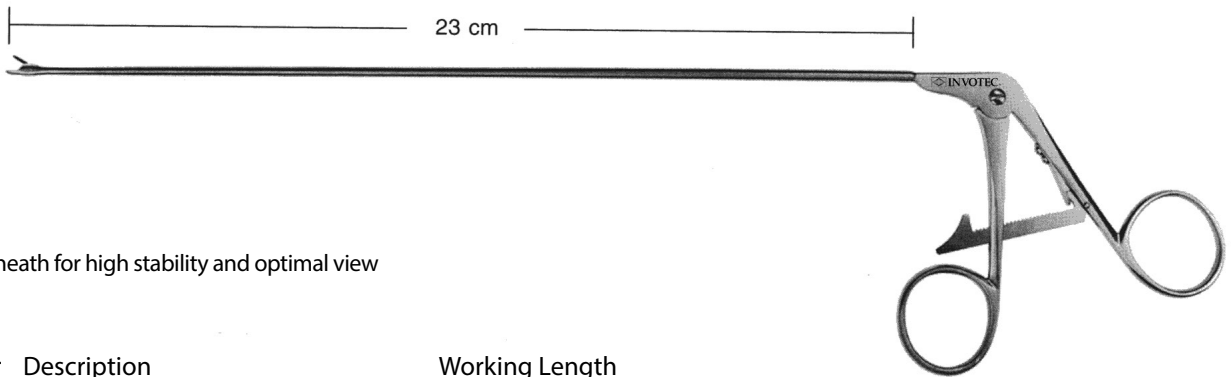

- Conical sheath for high stability and optimal view

Number	Description	Working Length
L32036	Needle Holder with ratchet, conical sheath	23 cm

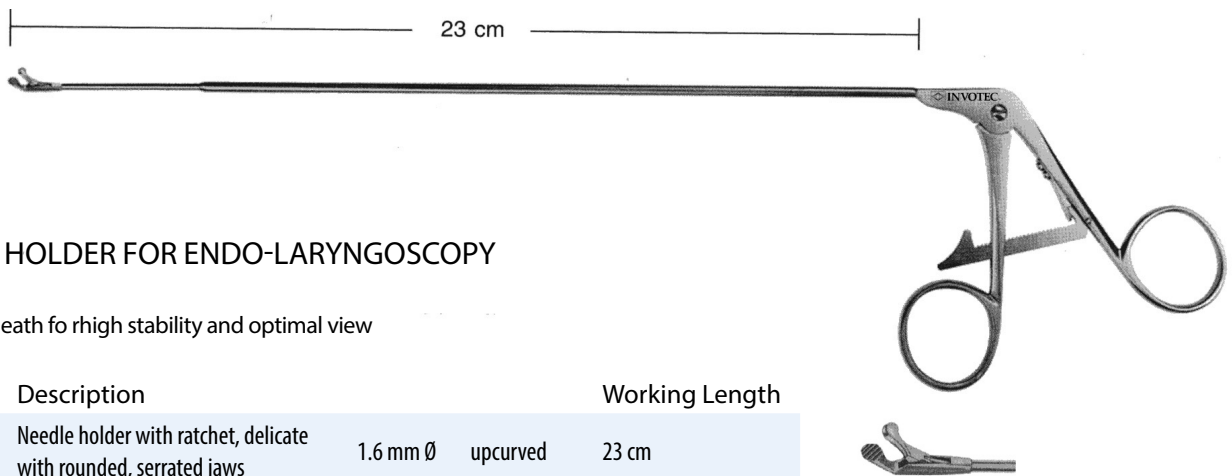

NEEDLE HOLDER FOR ENDO-LARYNGOSCOPY

- Conical sheath for high stability and optimal view

Number	Description	Working Length
L32037	Needle holder with ratchet, delicate with rounded, serrated jaws	1.6 mm Ø upcurved 23 cm



MICROSURGERY INSTRUMENTS

Number Description

L32025	Handle for use with L32013-L32116
--------	-----------------------------------

Number Description

L32013	Knife	Round	45° angle	2.5 mm Ø
L32014	Knife	Round	Verticle cutting	
L32015	Knife	Oval	Straight	
L32016	Knife		Straight cutting	
L32116	Knife	Sickle shaped	Curved	
L32017	Knife	Golf club shaped		
L32018	Hook	Blunt		
L32019	Hook	Sharp		
L32024	Hook	Probe end	90° angle	
L32020	Needle	Curved right		
L32021	Needle	Curved left		
L32022	Elevator with suction channel			
L32023	Knot Tier			

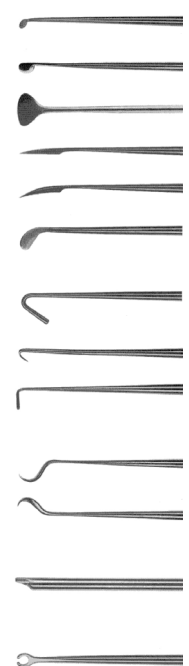

JAKO ENDOLARYNGEAL MICROSURGERY

Number Description

L44510	JAKO Laryngeal Sickle Knife	Knife length: 8 mm
L44511	JAKO Laryngeal Knife	Knife length: 8 mm
L44520	JAKO Laryngeal Probe	
L44521	JAKO Laryngeal Hook	
L44540	JAKO Laryngeal Dissector	Blunt

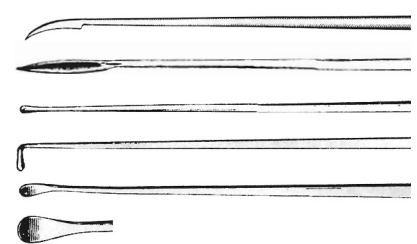

LARINS



MICRO LARYNGEAL BLADE HANDLE

- Collet designed to hold sterile micro blades

Number	Description	Working length	Wing dimension
65-44300	Harris MicroLaryngeal blade handle*	22.5 cm	42 x 25 mm

Number	Description		
60-44030	Microblade	Sterile	6/box

* Designed in conjunction with Thomas Harris MA FRCS, London, UK.

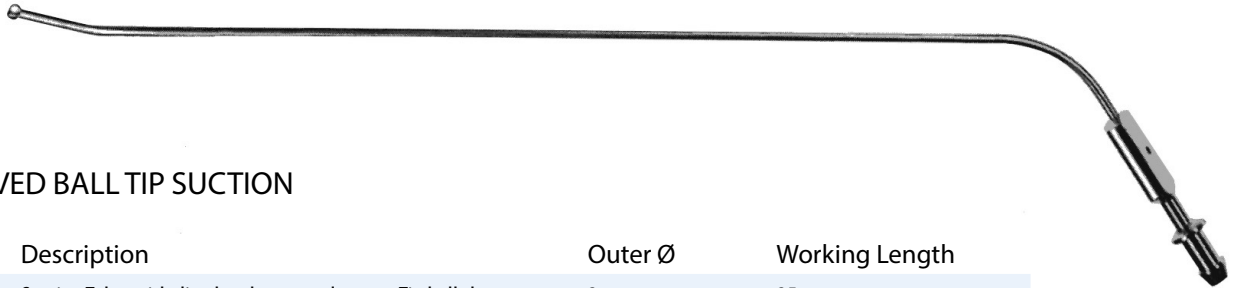
UPCURVED BALL TIP SUCTION

Number	Description		Outer Ø	Working Length
L32029	Suction Tube with distal end upcurved	Tip ball shape	2 mm	25 cm
L32039	Suction Tube with distal end upcurved	Tip ball Shape	3 mm	25 cm

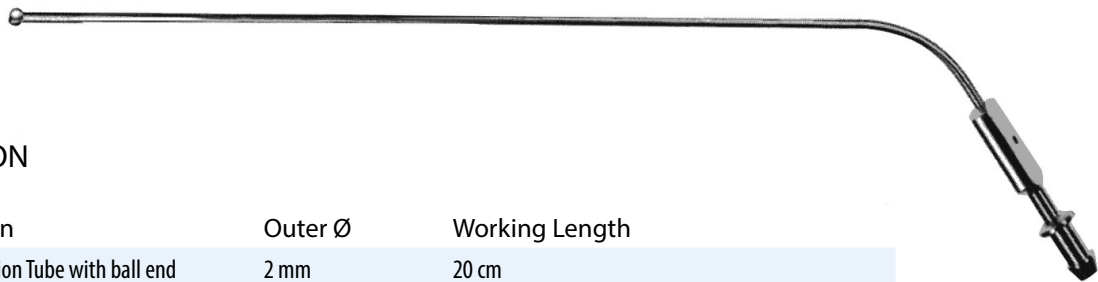
PEDIATRIC SUCTION

Number	Description	Outer Ø	Working Length
L31932	Pediatric Suction Tube with ball end	2 mm	20 cm
L31933	Pediatric Suction Tube with ball end	3 mm	20 cm

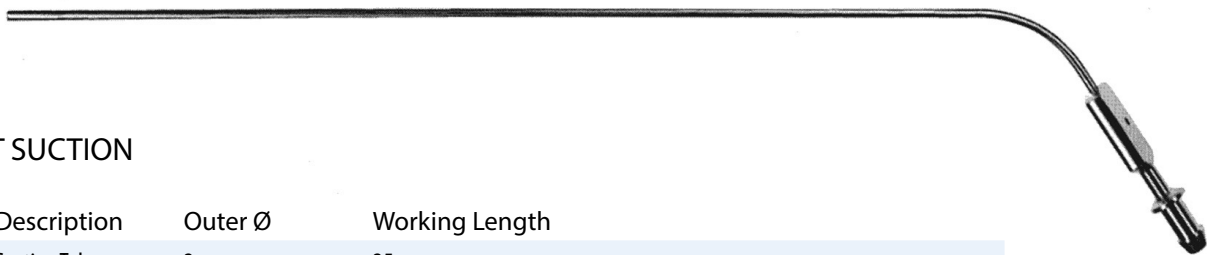
STRAIGHT SUCTION

Number	Description	Outer Ø	Working Length
L32026	Suction Tube	2 mm	25 cm
L32027	Suction Tube	2.5 mm	25 cm
L32028	Suction Tube	3 mm	25

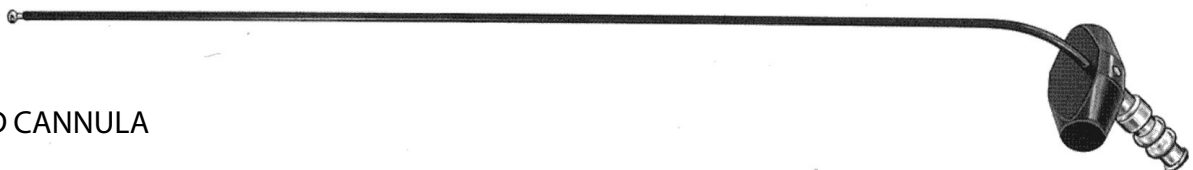

INSULATED CANNULA

Number	Description	Outer Ø
L32030	Insulated Cannula for suction and coagulation	3 mm

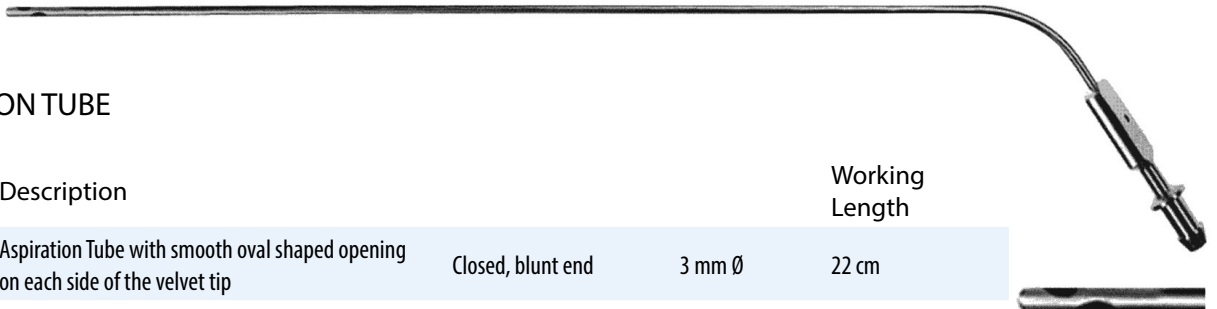

COTTON CARRIER

Number	Description	Working Length	Outer Ø
L32128	Cotton Carrier Twist end serrated	28 cm	2.5 mm



ASPIRATION TUBE

Number	Description	Working Length
L32220	Aspiration Tube with smooth oval shaped opening on each side of the velvet tip	Closed, blunt end 3 mm Ø 22 cm
L32221	Aspiration Tube with smooth oval shaped opening on each side of the velvet tip	Closed, blunt end 4 mm Ø 22 cm

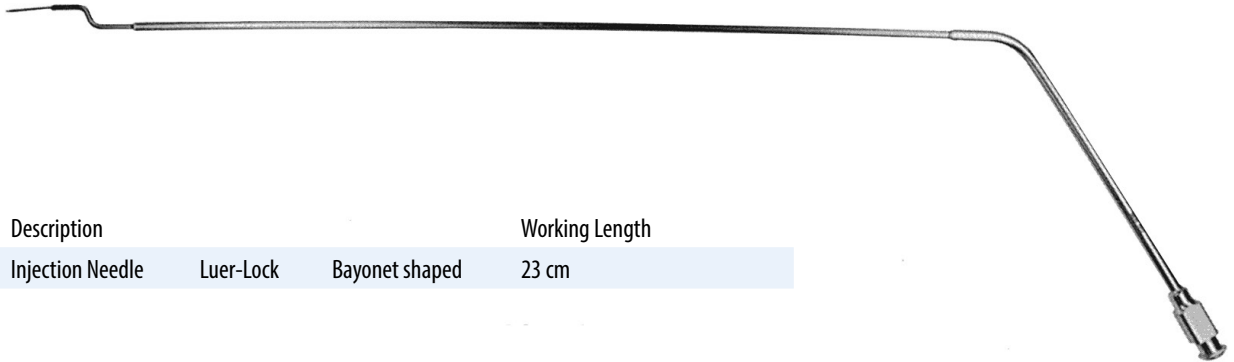

Number	Description	Working Length
L32130	Injection Needle Luer-Lock Bayonet shaped	23 cm

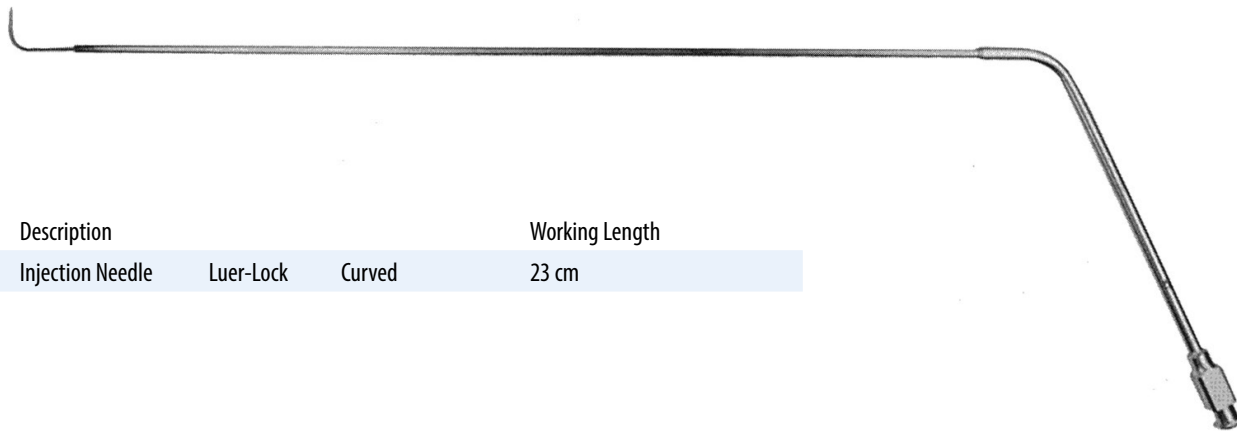

Number	Description	Working Length
L32131	Injection Needle Luer-Lock Curved	23 cm

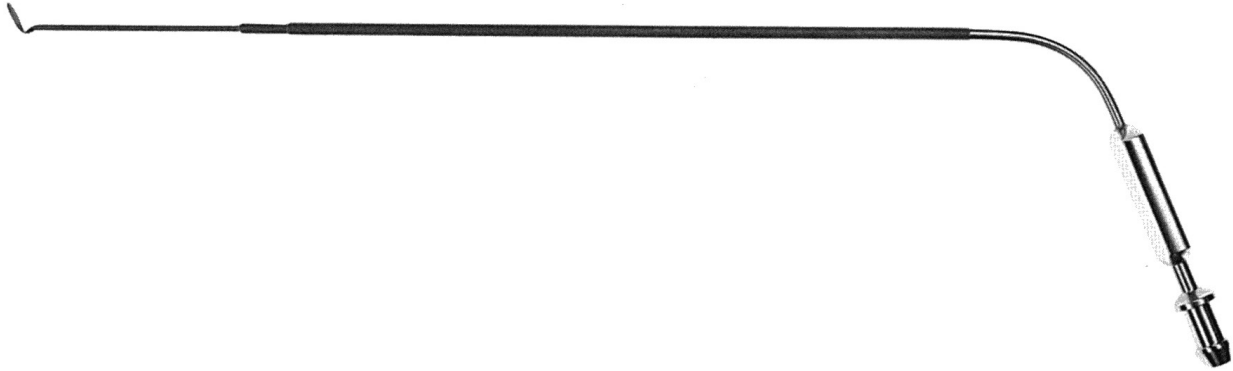

SUCTION WITH LASER PROTECTOR

- Special black finish protects lower regions of the mucous membrane against laserbeam

Number	Description					Working Length
L41003	Suction Tube with laser-protector and smoke evacuation channel	Black	Round	Upcurved	3 mm Ø	23 cm
L41004	Suction Tube with laser-protector and smoke evacuation channel	Black	Round	Upcurved	4 mm Ø	23 cm
L41005	Suction Tube with laser-protector and smoke evacuation channel	Black	Round	Upcurved	5 mm Ø	23 cm
L41007	Suction Tube with laser-protector and smoke evacuation channel	Black	Oval	Upcurved	7 mm Ø	23 cm
L41009	Suction Tube with laser-protector and smoke evacuation channel, distal suction hole left side	Black	Oval	Straight		23 cm
L41010	Suction Tube with laser-protector and smoke evacuation channel, distal suction hole right side	Black	Oval	Straight		23 cm
L41011	Suction Tube with laser-protector and smoke evacuation channel, distal suction hole left side	Black	Corner Shaped			23 cm
L41012	Suction Tube with laser-protector and smoke evacuation channel, distal suction hole right side	Black	Corner Shaped			23 cm
L41013	Suction Tube with laser-protector and smoke evacuation channel, distal suction hole left side	Black	Bayonet Shaped			23 cm
L41014	Suction Tube with laser-protector and smoke evacuation channel, distal suction hole left side	Black	Bayonet Shaped			23cm
L41016	Suction Tube with laser-protector and smoke evacuation channel for larynx and trachea	Black	Upcurved		10x10 mm	26 cm
L41017	Suction Tube with laser-protector and smoke evacuation channel for hypopharyngeal diverticulum, slightly upcurved and 7 mm wide	Black	Upcurved		10x10 mm	23cm

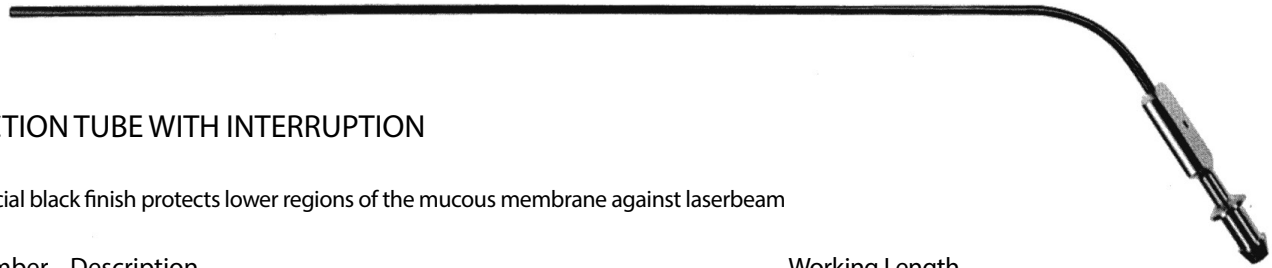

LARINS

SUCTION TUBE WITH INTERRUPTION

- Special black finish protects lower regions of the mucous membrane against laserbeam

Number	Description			Working Length
L41025	Suction Tube with interruption	Black	2.5 mm Ø	23 cm
L41030	Suction Tube with interruption	Black	3 mm Ø	23 cm

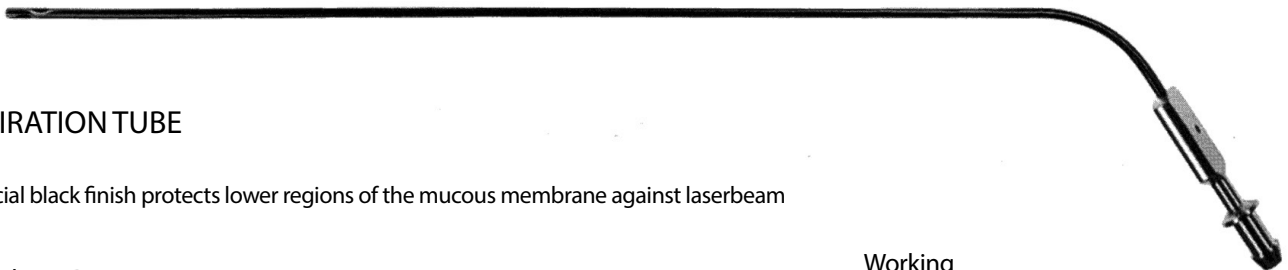
ASPIRATION TUBE

- Special black finish protects lower regions of the mucous membrane against laserbeam

Number	Description			Working Length
L41033	Aspiration Tube with smooth oval shaped opening on each side of velvet tip	Black	Closed, blunt end	3 mm Ø 22 cm

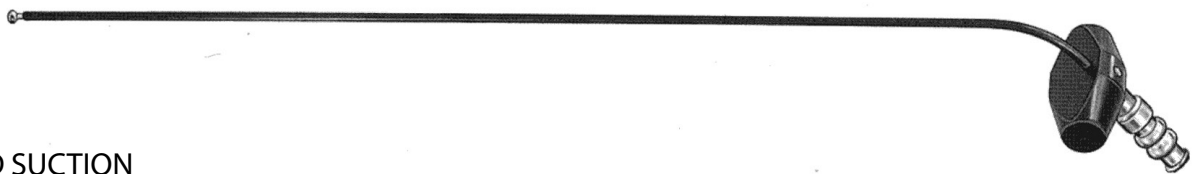
INSULATED SUCTION

Number	Description			Working Length
L41130	Insulated Suction and coagulation cannula	Unipolar	3 mm Ø	23 cm

INSULATED SUCTION

Number	Description			Outer Ø	Working Length
L41225	Suction Tube	Insulated	Ball end	2.5 mm	30 cm
L41230	Suction Tube	Insulated	Ball end	3 mm	30 cm

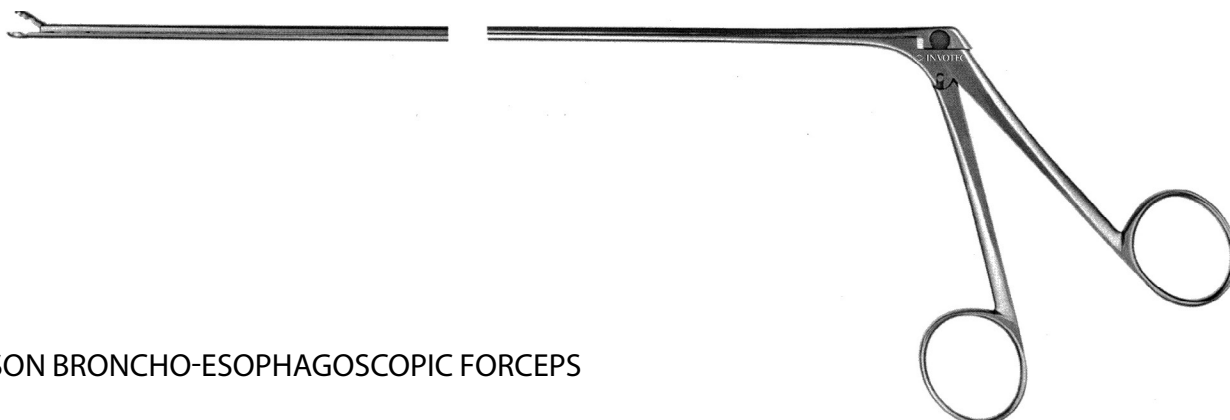

JACKSON BRONCHO-ESOPHAGOSCOPIIC FORCEPS

Single Action Jaws



shaft Length				2 mm Ø	4 mm Ø
30 cm	L31304	L31305	L31306	L31312	L31313
40 cm	L31404	L31405	L31406	L31412	L31413
50 cm	L31504	L31505	L31506	L31512	L31513
60 cm	L31604	L31605	L31606	L31612	L31613

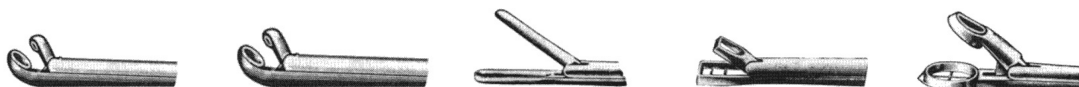

shaft Length	2 mm Ø	4 mm Ø			
30 cm	L31317	L31319	L31320	L31331	L31335
40 cm	L31417	L31419	L31420	L31431	L31435
50 cm	L31517	L31519	L31520	L31531	L31535
60 cm	L31617	L31619	L31620	L31631	L31635

Double Action Jaws

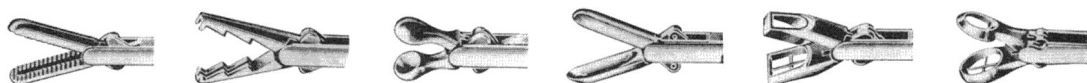

shaft Length						
30 cm	L32304	L32306	L32314	L32320	L31331	L32335
40 cm	L32404	L32406	L32414	L32420	L32431	L32435
50 cm	L32504	L32506	L32514	L32520	L32531	L32535
60 cm	L32604	L32606	L32614	L32620	L32631	L32635

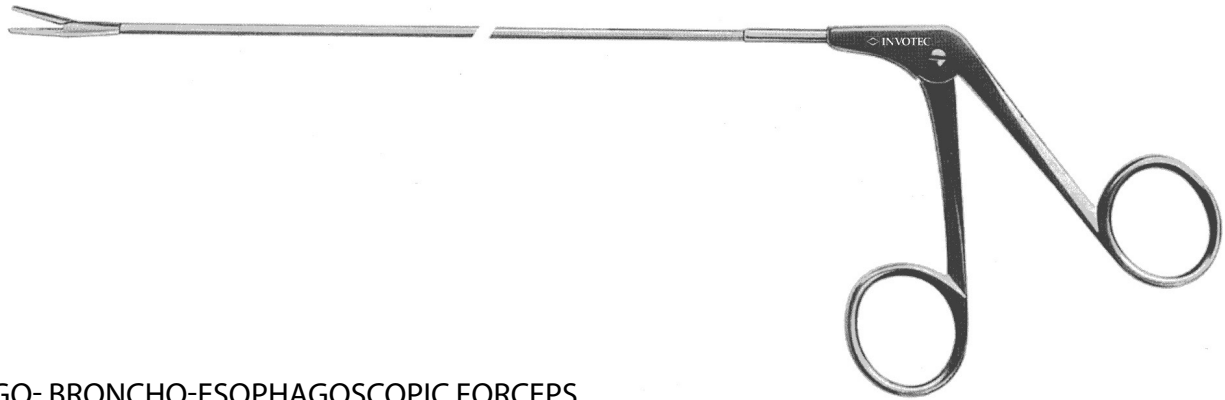

LARYNGO- BRONCHO-ESOPHAGOSCOPIC FORCEPS

shaft Length					
40 cm	L40850	L40862	L40864	L40866	L40876
50 cm	L50850	L50862	L50864	L50866	L50876
60 cm	L60850	L60862	L60864	L60866	L60876

shaft Length					
40 cm	L40878	L40879	L40882	L40884	L40890
50 cm	L50878	L50879	L50882	L50884	L50890
60 cm	L60878	L60879	L60882	L60884	L60890

shaft Length			
40 cm	L40892	L40894	L40896
50 cm	L50892	L50894	L50896
60 cm	L60892	L60894	L60896

Child Sizes

shaft Length						
35 cm	L35710	L35730	L35732	L35790	L35792	L35793

shaft Length					
35 cm	L35794	L35796	L35812	L35814	L35816

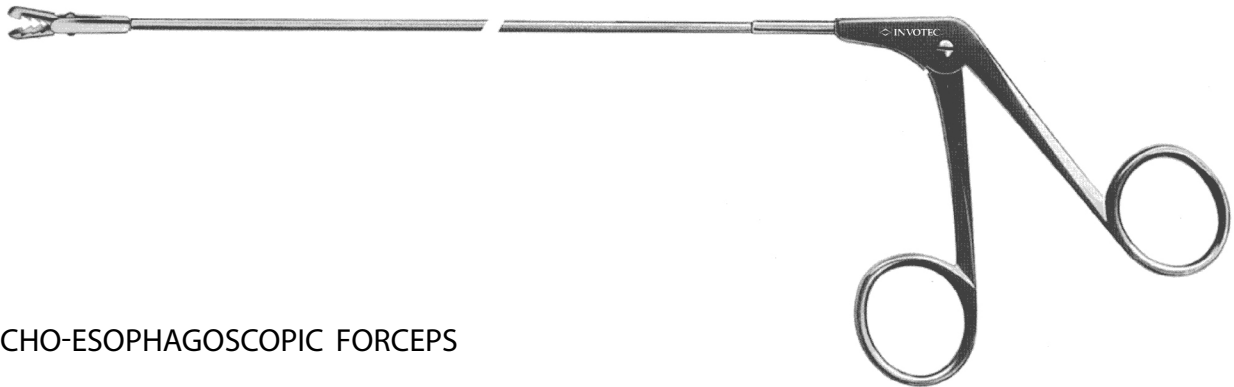

BRONCHO-ESOPHAGOSCOPIC FORCEPS

• Double action jaws



shaft Length	1.5 mm Ø	1.5 mm Ø	1.5mm Ø	1.5 mm Ø
25 cm	L85125	L85225	L85325	L85425
35 cm	L85135	L85235	L85335	L85435
shaft Length	2.0 mm Ø	2.0 mm Ø	2.0 mm Ø	2.0 mm Ø
35 cm	L85140	L85240	L85340	L85440
shaft Length	2.5 mm Ø	2.5 mm Ø	2.5 mm Ø	2.5 mm Ø
55 cm	L85150	L85250	L85350	L85450

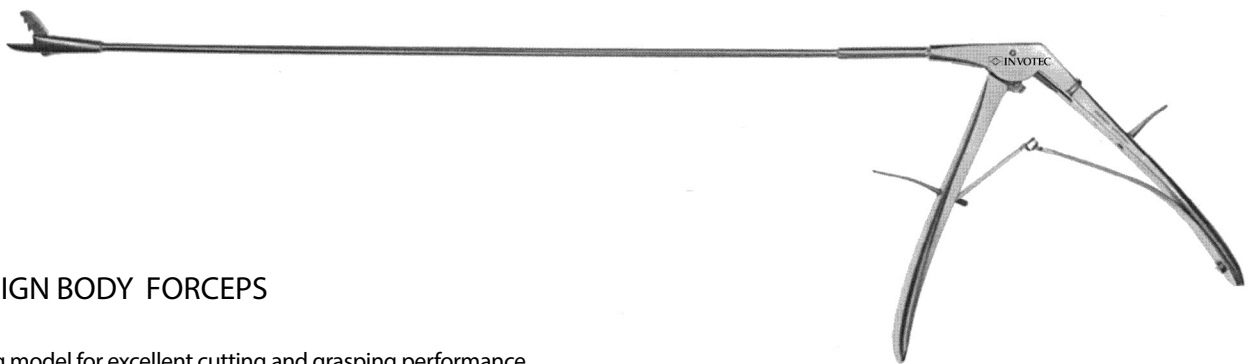

FOREIGN BODY FORCEPS

- Strong model for excellent cutting and grasping performance
- Cuts up to 1.2mm Ø wires

shaft Length	2.5 mm Ø
35 cm	L85535
45 cm	L85545

FLEXIBLE ENDOSCOPY

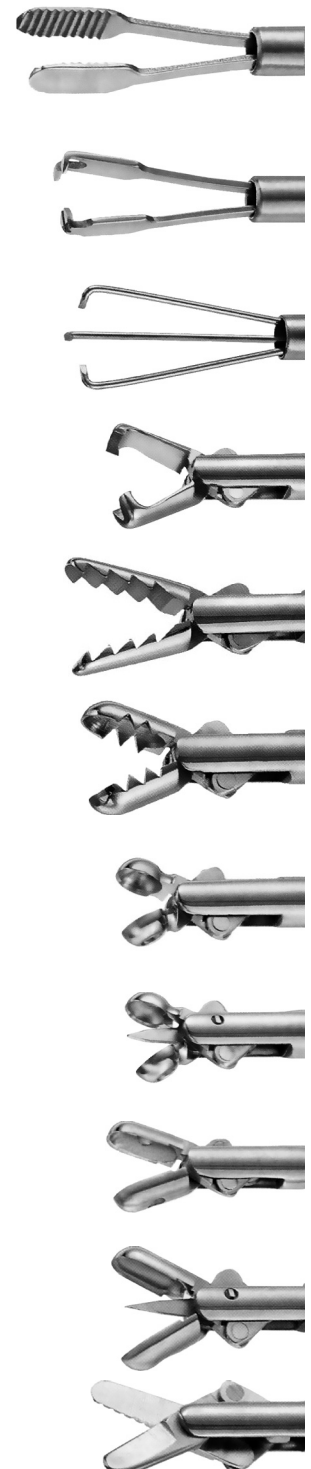

- Stainless steel
- Spiral of highest flexibility
- Solidly constructed handles
- Autoclavable by all the conventional methods

Serrated	90 cm	120 cm	150 cm	180 cm	230 cm
1.8 mm Ø	L47005	L47025	L47055	L47085	L47095
2.3 mm Ø	L47007	L47027	L47057	L47087	L47097
2x2 Teeth	90 cm	120 cm	150 cm	180 cm	230 cm
1.8 mm Ø	L47205	L47225	L47255	L47285	L47295
2.3 mm Ø	L47207	L47227	L47257	L47287	L47297
Three Clawed	90 cm	120 cm	150 cm	180 cm	230 cm
1.8 mm Ø	L47305	L47325	L47355	L47385	L47395
2.3 mm Ø	L47307	L47327	L47357	L47387	L47397
1x2 Teeth	90 cm	120 cm	150 cm	180 cm	230 cm
1.8 mm Ø	L47605	L47625	L47655	L47685	L47695
2.3 mm Ø	L47607	L47627	L47657	L47687	L47697
Pike Teeth	90 cm	120 cm	150 cm	180 cm	230 cm
1.8 mm Ø	L47805	L47825	L47855	L47885	L47895
2.3 mm Ø	L47807	L47827	L47857	L47887	L47897
Serrated Cup Jaws	90 cm	120 cm	150 cm	180 cm	230 cm
1.8 mm Ø	L47905	L47925	L47955	L47985	L47995
2.3 mm Ø	L47907	L47927	L47957	L47987	L47997
Round Cup Jaws	90 cm	120 cm	150 cm	180 cm	230 cm
1.8 mm Ø	L48005	L48025	L48055	L48085	L48095
2.3 mm Ø	L48007	L48027	L48057	L48087	L48097
Round Cup Jaws with Pin	90 cm	120 cm	150 cm	180 cm	230 cm
2.3 mm Ø	L48107	L48127	L48157	L48187	L48197
Oval Cup Jaws	90 cm	120 cm	150 cm	180 cm	230 cm
1.8 mm Ø	L48205	L48225	L48255	L48285	L48295
2.3 mm Ø	L48207	L48227	L48257	L48287	L48297
Oval Cup Jaws with Pin	90 cm	120 cm	150 cm	180 cm	230 cm
2.3 mm Ø	L48307	L48327	L48357	L48387	L48397
1 Blade Serrated	90 cm	120 cm	150 cm	180 cm	230 cm
2.3 mm Ø	L48807	L48827	L48857	L48887	L48897

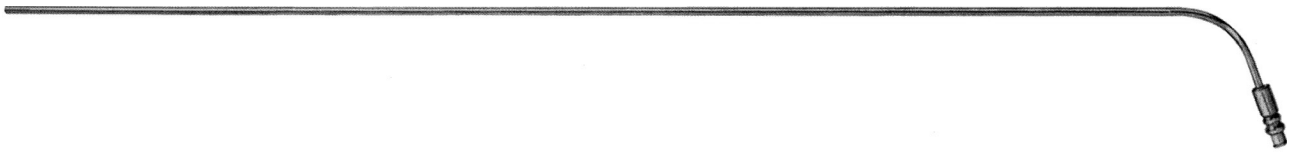

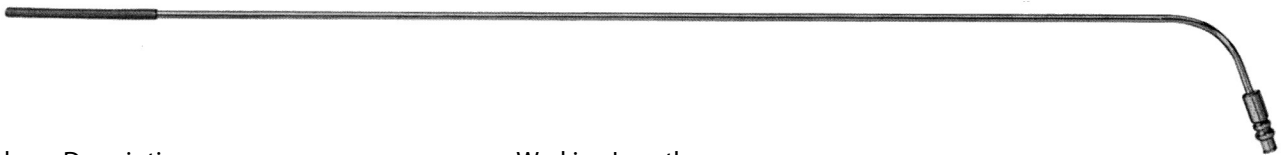

Number	Description		Working Length
L18035	Rigid Suction Tube	2.5 mm Ø	25 cm
L18050	Rigid Suction Tube	4 mm Ø	50 cm



Number	Description		Working Length
L18135	Rigid Suction Tube with flexible rubber tip		35 cm
L18150	Rigid Suction Tube with flexible rubber tip		50 cm



COTTON CARRIERS

Number	Description	Working Length
L18335	Cotton Carrier	35 cm
L18350	Cotton Carrier	50 cm

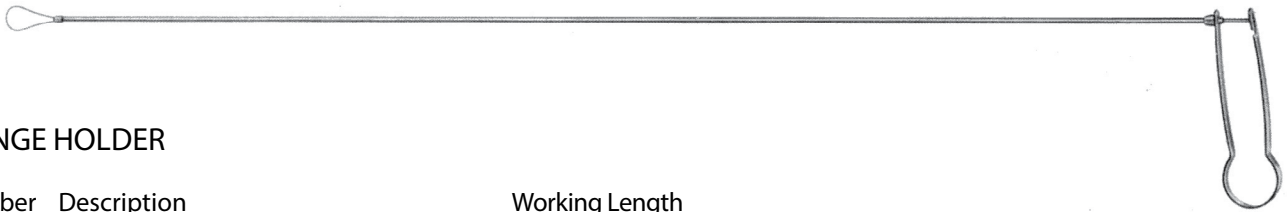

SPONGE HOLDER

Number	Description	Working Length
L18440	Sponge Holder 1 x 2 teeth	38 cm

TEETH PROTECTORS

- Can also be used as inlet for metal teeth protector (non-autoclavable)

Number	Description
L96050	Plastic Teeth Protector



R&CS ACC

DIS

OTO ACC

OSS

LAR ACC

SPE ACC

RHI INS

PSB

OTO INS

LAR INS

ORO/NAS INS

ORO-NASOPHARYNGEAL

INSTRUMENTS

LA FORCE ADENOTOME

Number	Description		Working Length
L11110	Adenotome by La Force	Size 0	23.5 cm
L11111	Adenotome by La Force	Size 1	23.5 cm
L11112	Adenotome by La Force	Size 2	23.5 cm
L11113	Adenotome by La Force	Size 3	23.5 cm



SHAMBAUGH ADENOTOME

Number	Description		Working Length
L11150	Adenotome by Shambaugh	Size 0	23.5 cm
L11151	Adenotome by Shambaugh	Size 1	23.5 cm
L11152	Adenotome by Shambaugh	Size 2	23.5 cm
L11153	Adenotome by Shambaugh	Size 3	23.5 cm



ADENOTOME REPLACEMENT BLADES

Number	Description		Length
L11190	Replacement blades	Size 0	10mm
L11191	Replacement blades	Size 1	13 mm
L11192	Replacement blades	Size 2	16 mm
L11193	Replacement blades	Size 3	19 mm

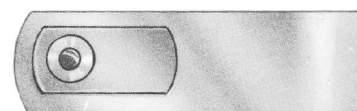

BECKMANN ADENOID CURETTE

Number	Description			Blade Width	Overall Length
L40200	Reverse Curve Curette	Size 0	Straight	10.5 mm	22 cm
L40201	Reverse Curve Curette	Size 1	Straight	13 mm	22 cm
L40202	Reverse Curve Curette	Size 2	Straight	14.5 mm	22 cm
L40203	Reverse Curve Curette	Size 3	Straight	16 mm	22 cm
L40204	Reverse Curve Curette	Size 4	Straight	18 mm	22 cm
L40205	Reverse Curve Curette	Size 5	Straight	20.5 mm	22 cm

Number	Description			Blade Width	Overall Length
L13460	Reverse Curve Curette with basket	Size 1	Straight	10 mm	22 cm
L13461	Reverse Curve Curette with basket	Size 2	Straight	11 mm	22 cm
L13462	Reverse Curve Curette with basket	Size 3	Straight	12 mm	22 cm
L13463	Reverse Curve Curette with basket	Size 4	Straight	13 mm	22 cm
L13465	Reverse Curve Curette with basket	Size 5	Straight	15 mm	22 cm
L13466	Reverse Curve Curette with basket	Size 6	Straight	16 mm	22 cm

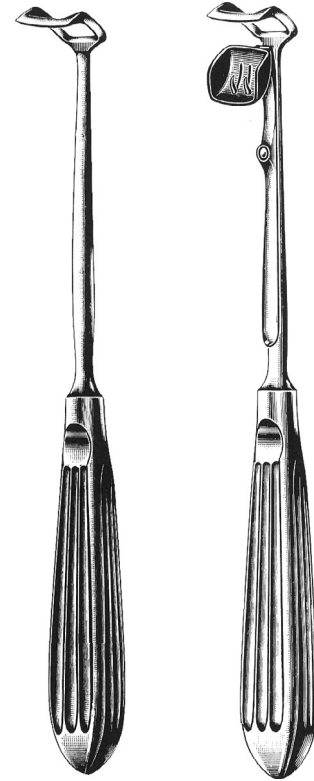
SHAMBAUGH ADENOID CURETTE

Number	Description			Blade Width	Overall Length
L14710	Adenoid Curette	Size 0	Curved backwards	10 mm	22 cm
L14712	Adenoid Curette	Size 2	Curved backwards	12 mm	22 cm
L14714	Adenoid Curette	Size 3	Curved backwards	13 mm	22 cm
L14716	Adenoid Curette	Size 4	Curved backwards	15 mm	22 cm
L14718	Adenoid Curette	Size 5	Curved backwards	16 mm	22 cm

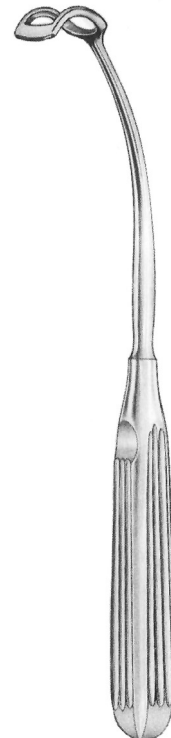



ST. CLAIR-THOMSON ADENOID CURRETTE

Number	Description			Blade Width	Overall Length
L40300	Reverse Curve Curette with basket	Size 0	Straight	10.5 mm	22 cm
L40301	Reverse Curve Curette with basket	Size 1	Straight	13 mm	22 cm
L40302	Reverse Curve Curette with basket	Size 2	Straight	14.5 mm	22 cm
L40303	Reverse Curve Curette with basket	Size 3	Straight	16.5 mm	22 cm
L40304	Reverse Curve Curette with basket	Size 4	Straight	18 mm	22 cm
L40305	Reverse Curve Curette with basket	Size 5	Straight	20.5 mm	22 cm



BARNHILL ADENOID CURRETTE

Number	Description			Blade Width	Overall Length
L40400	Adenoid Curette	Size 0	Curved	10.5 mm	21.5 cm
L40401	Adenoid Curette	Size 1	Curved	13 mm	21.5 cm
L40402	Adenoid Curette	Size 2	Curved	14.5 mm	21.5 cm
L40403	Adenoid Curette	Size 3	Curved	16.5 mm	21.5 cm
L40404	Adenoid Curette	Size 4	Curved	18 mm	21.5 cm



JONES ADENOID CURRETTE

Number	Description			Blade Width	Overall Length
L40701	Adenoid Curette	Infant	Straight	4 mm	22.5 cm
L40702	Adenoid Curette	Child	Straight	6 mm	22.5 cm
L40703	Adenoid Curette	Adult	Straight	8 mm	22.5 cm



VOGEL ADENOID CURRETTE

Number	Description				Blade Width	Overall Length
L40800	Adenoid Curette	Infant	Curved	9 x 12 mm	7 mm	21.5 cm

MIDDLETON ADENOID CURRETTE

Number	Description		Blade Width	Overall Length
L40850	Long and Narrow Adenoid Curette	25 x 10 mm	7 mm	22.5 cm

STUBBS ADENOID CURRETTE

Number	Description			Blade Width	Overall Length
L40900	Adenoid Curette with angulated shaft	Size 0	Curved	11 mm	22 cm
L40901	Adenoid Curette with angulated shaft	Size 1	Curved	14 mm	22 cm
L40902	Adenoid Curette with angulated shaft	Size 2	Curved	16 mm	22 cm
L40903	Adenoid Curette with angulated shaft	Size 3	Curved	18 mm	22 cm

BECKMANN DISPOSIBLE ADENOID CURRETTE

• Sterile

Number	Description			Blade Width	Overall Length
25-2110	Adenoid Curette without basket	Size 1	Straight	10 mm	22 cm
25-2120	Adenoid Curette without basket	Size 2	Straight	11 mm	22 cm
25-2130	Adenoid Curette without basket	Size 3	Straight	12 mm	22 cm
25-2140	Adenoid Curette without basket	Size 4	Straight	13 mm	22 cm

LARYNGEAL MIRROR ON HANDLE

- Autoclavable
- Stainless Steel

Number	Description	Size	Diameter
L34806	Mirror attached on handle	000	6 mm
L34808	Mirror attached on handle	00	8 mm
L34810	Mirror attached on handle	0	10 mm
L34812	Mirror attached on handle	1	12 mm
L34814	Mirror attached on handle	2	14 mm
L34816	Mirror attached on handle	3	16 mm
L34818	Mirror attached on handle	4	18 mm
L34820	Mirror attached on handle	5	20 mm
L34822	Mirror attached on handle	6	22 mm
L34824	Mirror attached on handle	7	24 mm
L34826	Mirror attached on handle	8	26 mm
L34828	Mirror attached on handle	9	28 mm
L34830	Mirror attached on handle	10	30 mm

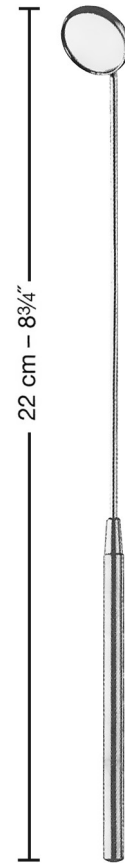

LARYNGEAL MIRROR AND HANDLE

- Autoclavable
- Stainless Steel
- For use with octagonal handle L53700

Number	Description	Size	Diameter
L53620	Mirror with threaded shaft	00	8 mm
L53600	Mirror with threaded shaft	0	10 mm
L53601	Mirror with threaded shaft	1	12 mm
L53602	Mirror with threaded shaft	2	14 mm
L53603	Mirror with threaded shaft	3	16 mm
L53604	Mirror with threaded shaft	4	18 mm
L53605	Mirror with threaded shaft	5	20 mm
L53606	Mirror with threaded shaft	6	22 mm
L53607	Mirror with threaded shaft	7	24 mm
L53608	Mirror with threaded shaft	8	26 mm
L53609	Mirror with threaded shaft	9	28 mm
L53610	Mirror with threaded shaft	10	30 mm

Number	Description	Overall Length
L53700	Octagonal mirror handle For use with mirrors L53600-L53620	75 mm



RHODIUM LARYNGEAL MIRROR AND HANDLE

- Autoclavable
- Stainless Steel
- For use with octagonal handle L54100

Number	Description	Size	Diameter								
L54320	Rhodium plated mirror with standard shaft	00	8 mm								
L54300	Rhodium plated mirror with standard shaft	0	10 mm								
L54301	Rhodium plated mirror with standard shaft	1	12 mm								
L54302	Rhodium plated mirror with standard shaft	2	14 mm								
L54303	Rhodium plated mirror with standard shaft	3	16 mm								
L54304	Rhodium plated mirror with standard shaft	4	18 mm								
L54305	Rhodium plated mirror with standard shaft	5	20 mm								
L54306	Rhodium plated mirror with standard shaft	6	22 mm								
L54307	Rhodium plated mirror with standard shaft	7	24 mm								
L54308	Rhodium plated mirror with standard shaft	8	26 mm </tr <tr> <td>L54309</td> <td>Rhodium plated mirror with standard shaft</td> <td>9</td> <td>28 mm</td> </tr> <tr> <td>L54310</td> <td>Rhodium plated mirror with standard shaft</td> <td>10</td> <td>30 mm</td> </tr>	L54309	Rhodium plated mirror with standard shaft	9	28 mm	L54310	Rhodium plated mirror with standard shaft	10	30 mm
L54309	Rhodium plated mirror with standard shaft	9	28 mm								
L54310	Rhodium plated mirror with standard shaft	10	30 mm								

Number	Description	Overall Length
L54100	Octagonal, stainless steel mirror handle For use with mirrors L53600-L54320	75 mm



MICHEL RHINOSCOPIC MIRROR WITH HANDLE

- Autoclavable
- Stainless Steel
- Thumb mirror orientation control

Number	Description	Size	Diameter	Length
L54110	Michel Mirror with handle	0	10 mm	29 mm
L54112	Michel Mirror with handle	1	12 mm	29 mm
L54114	Michel Mirror with handle	2	14 mm	29 mm
L54116	Michel Mirror with handle	3	16 mm	29 mm
L54118	Michel Mirror with handle	4	18 mm	29 mm

Spare Mirrors for Michel Rhinoscopic Mirror with Handle

Number	Description	Size	Diameter
L54120	Spare Mirror for Michel Rhinoscopic Mirrors	0	10 mm
L54122	Spare Mirror for Michel Rhinoscopic Mirrors	1	12 mm
L54124	Spare Mirror for Michel Rhinoscopic Mirrors	2	14 mm
L54126	Spare Mirror for Michel Rhinoscopic Mirrors	3	16 mm
L54128	Spare Mirror for Michel Rhinoscopic Mirrors	4	18 mm

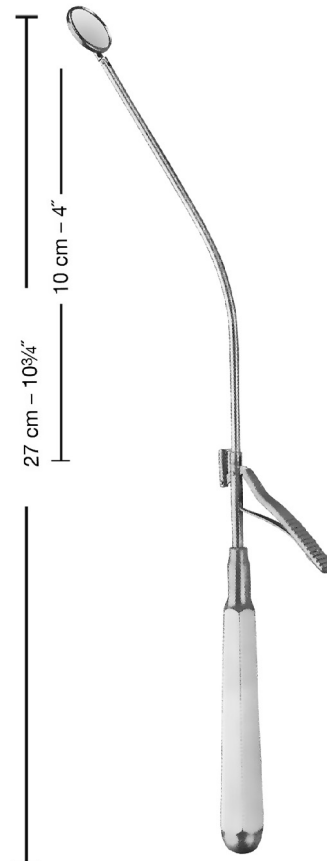

JENNINGS MOUTH GAG

- Stainless Steel

Number	Description		Working Length
N20009	Mouth Gag by Jennings	Open type	9 cm
N20011	Mouth Gag by Jennings	Open type	11 cm
N20013	Mouth Gag by Jennings	Open type	13 cm

Number	Description		Working Length
N23009	Mouth Gag by Jennings	Standard type	9 cm
N23011	Mouth Gag by Jennings	Standard type	11 cm
N23013	Mouth Gag by Jennings	Standard type	13 cm
N23015	Mouth Gag by Jennings	Standard type	15 cm



HEISTER MOUTH GAG

Number	Description	Working Length
N20505	Mouth Gag by Heister	13 cm

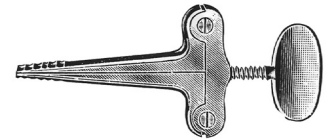

MOLT MOUTH GAG

Number	Description		Working Length
N20510	Mouth Gag by Molt	Child Size	10 cm
N20515	Mouth Gag by Molt	Adult Size	15 cm

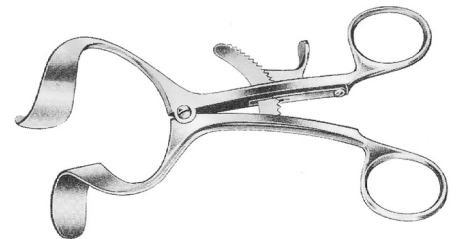

ROSER KÖNIG MOUTH GAG

Number	Description	Working Length
N20545	Mouth Gag by Roser König	16 cm



DENHART MOUTH GAG

Number	Description	Working Length
N20560	Mouth Gag by Denhart	13 cm

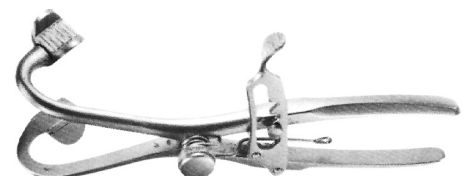

WHITEHEAD MOUTH GAG

Number	Description	Working Length
N20729	Mouth Gag by Whitehead	9 cm
N20731	Mouth Gag by Whitehead	11 cm
N20733	Mouth Gag by Whitehead	13 cm
N20735	Mouth Gag by Whitehead	15 cm

DINGMAN MOUTH GAG

- Stainless Steel

Number	Description
N20800	Dingman Mouth Gag Complete Set including: Frame with 4 spiral springs for the suspension of the thread ends, 2 Movable Tooth Hooks, 2 Cheek Retractors, and 3 Tongue Depressors (1 of each #1-3)
N20820	Dingman Mouth Gag Frame with 4 spiral springs for the suspension of the thread ends, 2 Movable Tooth Hooks and 2 Cheek Retractors

DINGMAN TONGUE DEPRESSORS

Number	Description	Size	Dimensions
N20811	Tongue Depressor	Size 1	55 x 25 mm
N20812	Tongue Depressor	Size 2	60 x 27 mm
N20813	Tongue Depressor	Size 3	70 x 30 mm

SEEMANN-SEIFFERT MOUTH GAG

- Stainless Steel

Number	Description	Working Length
N22009	Self retaining Mouth Gag by Seemann-Seiffert	Small / Child Size 9 cm
N22011	Self retaining Mouth Gag by Seemann-Seiffert	Standard Size 11 cm
N22013	Self retaining Mouth Gag by Seemann-Seiffert	Large Size 13 cm
N20755	Self retaining Mouth Gag by Seemann-Seiffert	X-Large Size 15 cm

Number	Description	Working Length
N24011	Standard Model Mouth Gag by Seemann-Seiffert	11 cm
N24013	Standard Model Mouth Gag by Seemann-Seiffert	13 cm



DAVIS-BOYLE MOUTH GAG

- Stainless Steel

Number	Description	
N26000	Left frame for Mouth Gag by Davis-Boyle	
N26200	Right Frame for Mouth Gag by Davis-Boyle	
N26300	Left frame for Mouth Gag by Davis-Boyle	Child size

Number	Description
N26010	Silicone Bit Liners Removable for Davis-Boyle Autoclavable (Sold in pairs)



DAVIS-BOYLE TONGUE DEPRESSOR

- Stainless Steel

Number	Description	Length
N26001	Tongue Depressor by Davis-Boyle with smooth blades Size 1 20 x 30 mm	13.5 cm
N26002	Tongue Depressor by Davis-Boyle with smooth blades Size 2 23 x 65 mm	13.5 cm
N26003	Tongue Depressor by Davis-Boyle with smooth blades Size 3 24 x 80 mm	13.5 cm
N26004	Tongue Depressor by Davis-Boyle with smooth blades Size 4 25 x 93 mm	13.5 cm
N26005	Tongue Depressor by Davis-Boyle with smooth blades Size 5 26 x 108 mm	13.5 cm

Number	Description	Length
N26102	Tongue Depressor by Davis-Boyle with anaesthetic tube and smooth blades Size 2 23 x 65 mm	13.5 cm
N26103	Tongue Depressor by Davis-Boyle with anaesthetic tube and smooth blades Size 3 24 x 80 mm	13.5 cm
N26104	Tongue Depressor by Davis-Boyle with anaesthetic tube and smooth blades Size 4 25 x 93 mm	13.5 cm
N26105	Tongue Depressor by Davis-Boyle with anaesthetic tube and smooth blades Size 5 26 x 108 mm	13.5 cm

Number	Description	Length
N26301	Tongue Depressor by Davis-Boyle for Children with smooth blades Size 1 17 x 30 mm	9.8 cm
N26302	Tongue Depressor by Davis-Boyle for Children with smooth blades Size 2 19 x 45 mm	9.8 cm
N26303	Tongue Depressor by Davis-Boyle for Children with smooth blades Size 3 20 x 60 mm	9.8 cm
N26304	Tongue Depressor by Davis-Boyle for Children with smooth blades Size 4 22 x 70 mm	9.8 cm
N26305	Tongue Depressor by Davis-Boyle for Children with smooth blades Size 5 22 x 80 mm	9.8 cm

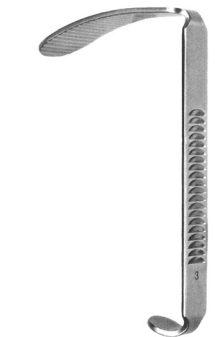

MCIVOR MOUTH GAG

- Stainless Steel

Number Description

N25000 Frame for Mouth Gag by Mclvor for use with tongue depressors N25001 - N25003

Number Description Rod Length

N25001 Tongue Depressor by Mclvor Size 1 23 x 70 mm

N25002 Tongue Depressor by Mclvor Size 2 25 x 86 mm

N25003 Tongue Depressor by Mclvor Size 3 26 x 100 mm

KILNER-DOUGHTY MOUTH GAG

- Stainless Steel

Number Description

N27000 Left frame for Mouth Gag by Kilner-Doughty

N27010 Palate Support for toothless patients for N27000

RUSSEL-DAVIS MOUTH TONGUE DEPRESSOR

- Stainless Steel

Number Description

N27001 Tongue Depressor by Russel-Davis with central channel Size 1 28 x 65 mm

N27002 Tongue Depressor by Russel-Davis with central channel Size 2 32 x 72 mm

N27003 Tongue Depressor by Russel-Davis with central channel Size 3 37 x 80 mm

N27004 Tongue Depressor by Russel-Davis with central channel Size 4 41 x 94 mm

N27005 Tongue Depressor by Russel-Davis with central channel Size 5 46 x 103 mm

Number Description

N28601 Tongue Depressor by Russel-Davis with central channel and lateral outlet Size 1 28 x 65 mm

N28602 Tongue Depressor by Russel-Davis with central channel and lateral outlet Size 2 32 x 72 mm

N28603 Tongue Depressor by Russel-Davis with central channel and lateral outlet Size 3 37 x 80 mm

N28604 Tongue Depressor by Russel-Davis with central channel and lateral outlet Size 4 41 x 94 mm

N28605 Tongue Depressor by Russel-Davis with central channel and lateral outlet Size 5 46 x 103 mm



WUERZBURG MODEL TONGUE DEPRESSOR

- Stainless Steel

Number	Description		
N28001	Wuerzburg Model Tongue Depressor	Size 1	28 x 66 mm
N28002	Wuerzburg Model Tongue Depressor	Size 2	32 x 75 mm
N28003	Wuerzburg Model Tongue Depressor	Size 3	34 x 83 mm
N28004	Wuerzburg Model Tongue Depressor	Size 4	37 x 93 mm
N28005	Wuerzburg Model Tongue Depressor	Size 5	38 x 100 mm



RING TONGUE DEPRESSOR

- Stainless Steel

Number	Description		
N28202	Left Ring Tongue Depressor	Size 2	23 x 58 mm
N28302	Right Ring Tongue Depressor		
N28203	Left Ring Tongue Depressor	Size 3	27 x 72 mm
N28303	Right Ring Tongue Depressor		
N28204	Left Ring Tongue Depressor	Size 4	34 x 87 mm
N28304	Right Ring Tongue Depressor		
N28205	Left Ring Tongue Depressor	Size 5	37 x 95 mm
N28305	Right Ring Tongue Depressor		



DAVIS-MEYER TONGUE DEPRESSOR

- Stainless Steel

Number	Description		
N28401	Tongue Depressor by Davis-Meyer with anesthetic tubes on both sides	Size 1	29.0 x 70 mm
N28402	Tongue Depressor by Davis-Meyer with anesthetic tubes on both sides	Size 2	30.5 x 75 mm
N28403	Tongue Depressor by Davis-Meyer with anesthetic tubes on both sides	Size 3	31.5 x 80 mm
N28404	Tongue Depressor by Davis-Meyer with anesthetic tubes on both sides	Size 4	32.5 x 85 mm
N28405	Tongue Depressor by Davis-Meyer with anesthetic tubes on both sides	Size 5	33.5 x 95 mm
N28406	Tongue Depressor by Davis-Meyer with anesthetic tubes on both sides	Size 6	33.8 x 100 mm
N28407	Tongue Depressor by Davis-Meyer with anesthetic tubes on both sides	Size 7	34.0 x 105 mm



DRAFFIN SUSPENSION APPARATUS BIPOD

Number Description

N24820	Suspension Apparatus Bipod by Draffin for use with Mouth Gags N25000 - N28400
N24810	Chain with ring to suspend the mouth gag at the frame N24880

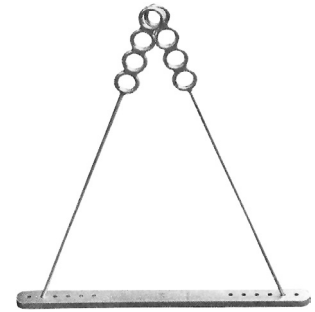
NEGUS CHEST SUPPORT

Number Description Rod Length

N29000	Chest Support by Negus with band N29001	Adult Size	14 cm
N29100	Chest Support by Negus with band N29001	Child Size	8.5 cm
N29001	Chest Support by Negus with band only for N29000 & N29100		13 cm

WUERZURG CHEST SUPPORT

Number Description

N29200	Chest Support by Wuerzburg
--------	----------------------------

TOOTH GUARD

Number Description Diameter

N20410	Wooden Tooth Guard	Pyramid Shaped	Serrated	40 mm
--------	--------------------	----------------	----------	-------



Number Description Diameter

N20420	Latex Tooth Guard	Pyramid Shaped	Serrated	40 mm
--------	-------------------	----------------	----------	-------



Number Description Diameter

N20450	Latex Tooth Guard with Supply Chain	Grooved		40 mm
--------	-------------------------------------	---------	--	-------



MCKESSON MOUTH PROP

• Set of 2

Number	Description		
N21001	Silicone Mouth Prop with airway	Serrated	Small child
N21002	Silicone Mouth Prop with airway	Serrated	Child
N21003	Silicone Mouth Prop with airway	Serrated	Adult

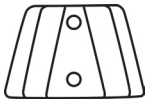

N21001



N21002

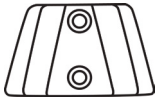

N21003



OBWEGESER RETRACTOR

Number	Description		Length
L20217	Obwegeser Cheek Retractor	Stainless Steel	10 cm

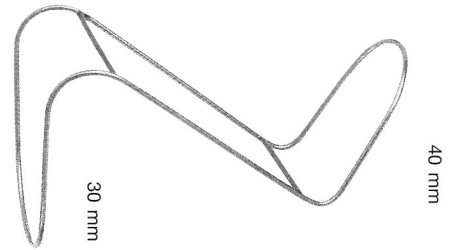
UNIVERSITY OF MINNESOTA RETRACTOR

Number	Description		Length
L20210	University of Minnesota Tongue and Cheek Retractor	Stainless Steel	14 cm

STERNBERG RETRACTOR

Number	Description		Length
L20215	Sternberg Cheek, Lip and Tongue Retractor	Stainless Steel	14.5 cm

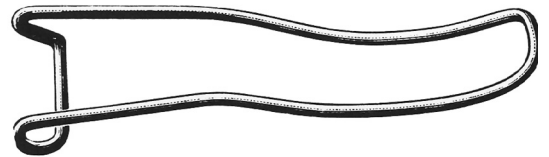
SHUMAN RETRACTOR

Number	Description		Length
L20225	Shuman Cheek and Tongue Retractor	Stainless Steel	19 cm

RING RETRACTOR

Number	Description		
L20245	Cheek Ring Retractor	Stainless Steel	

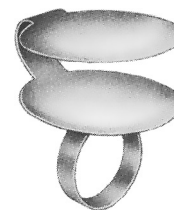

LOVE UVULA RETRACTOR

- Stainless Steel

Number	Description	Width	Working Length
N16318	Love Uvula Retractor	18 mm	15 cm
N16320	Love Uvula Retractor	20 mm	15 cm
N16322	Love Uvula Retractor	22 mm	15 cm

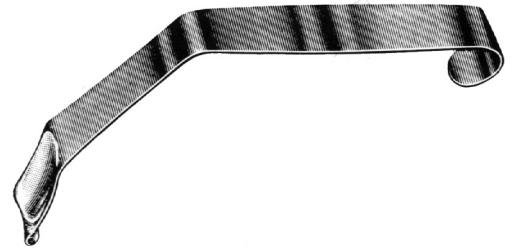

GOODYEAR UVULA RETRACTOR

- Stainless Steel

Number	Description	Width	Working Length
N16348	Goodyear Uvula Retractor	27 mm	9.5 cm

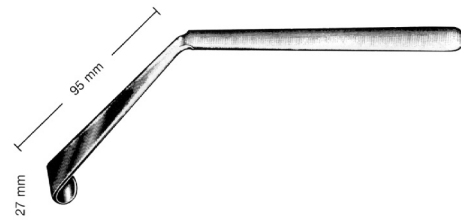

LOTHROP UVULA RETRACTOR

- Stainless Steel

Number	Description	Width	Working Length
N16360	Lothrop Uvula Retractor	18 mm	18 cm

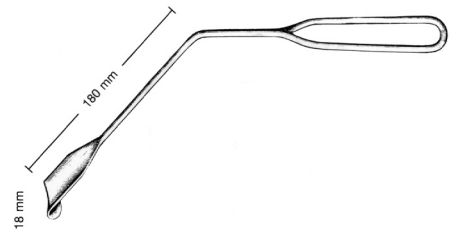

NAGER SOFT PALATE RETRACTOR

- Stainless Steel

Number	Description	Width	Working Length
N16423	Nager Uvula Retractor	13 mm	22 cm

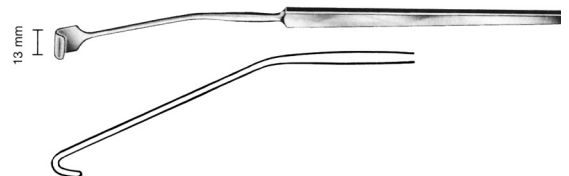

HOFER PALATE ARCH RETRACTOR

- Stainless Steel

Number	Description	Width	Working Length
N16474	Hofer Palate Arch Retractor	20 x 20 mm	24 cm

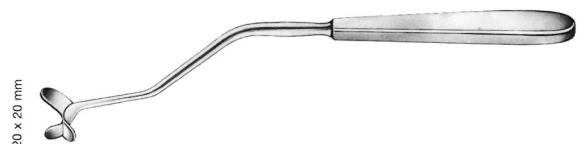

HASLINGER SOFT PALATE RETRACTOR

- Stainless Steel

Number	Description	Working Length
N16520	Haslinger Soft Palate Retractor	17 cm

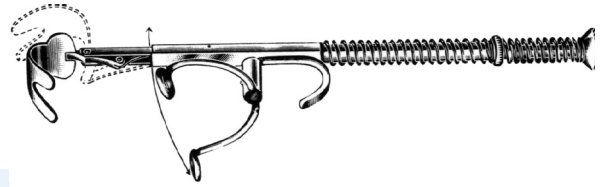

YANKAUER NASO-PHARYNGEAL SPECULUM RETRACTOR

Number	Description
N16570	Yankauer Naso-Pharyngeal Speculum Retractor

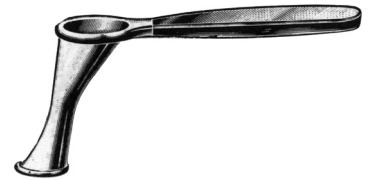

TONGUE SPATULA

• Stainless Steel

Number	Description	Width	Working Length
N20010	Tongue Spatula	18 mm	14.5 cm

18 mm

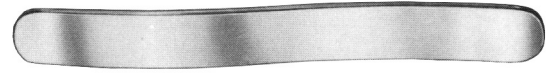

Number	Description	Width	Working Length
N20015	Tongue Spatula	20 mm / 23 mm	14 cm

20 mm

23 mm



BAGINSKI TONGUE SPATULA

• Stainless Steel

Number	Description	Width	Working Length
N20005	Baginski Tongue Spatula	18 mm / 35 mm	15 cm

18 mm

35 mm

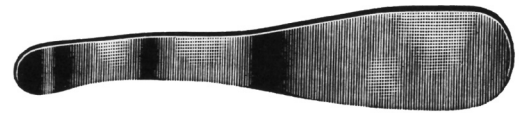

BUCHWALD TONGUE SPATULA

• Stainless Steel

Number	Description	Width	Working Length
N20018	Buchwald Tongue Spatula	18 mm / 23 mm	18 cm

18 mm

23 mm



HASLINGER TONGUE SPATULA

• Stainless Steel

Number	Description	Width	Working Length
N20027	Haslinger Tongue Spatula	22 mm / 29 mm	12 cm
N20028	Haslinger Tongue Spatula	30 mm / 33 mm	16 cm

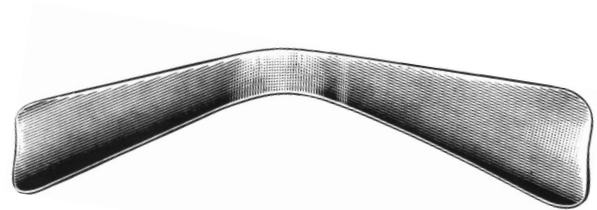

FRENZEL TONGUE SPATULA

- Stainless Steel

Number	Description	Width	Working Length
N20035	Frenzel Tongue Spatula	23 mm / 13 mm	16.5 cm

BRÜNINGS TONGUE SPATULA

- Stainless Steel

Number	Description	Width	Working Length
N20050	Brünings Tongue Spatula	18 mm / 14 mm	19 cm

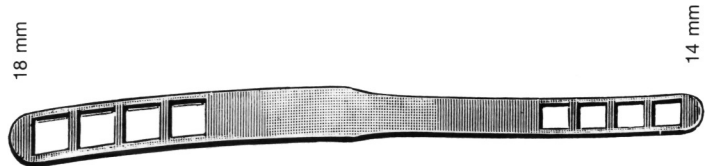
MORITZ-SCHMIDT TONGUE SPATULA

- Stainless Steel

Number	Description	Working Length
N20085	Moritz-Schmidt Tongue Spatula	19 cm

ANDREWS TONGUE SPATULA

- Stainless Steel

Number	Description	Width	Working Length
N20130	Andrews Tongue Spatula	17 mm	8.5 cm

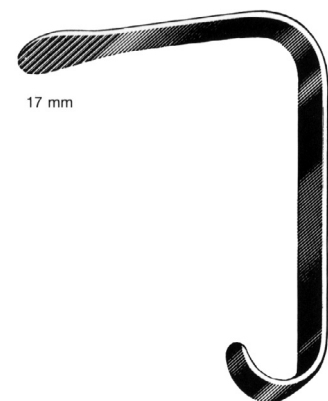
WIEDER TONGUE SPATULA

- Stainless Steel

Number	Description	Width	Working Length
N20140	Wieder Tongue Spatula	28 mm	8 cm
N20141	Wieder Tongue Spatula	38 mm	8 cm

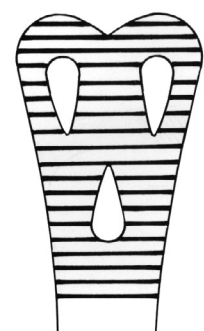

BOSWORTH TONGUE SPATULA

• Stainless Steel

Number	Description	Width	Working Length
N20110	Bosworth Tongue Spatula	25 mm	8 cm

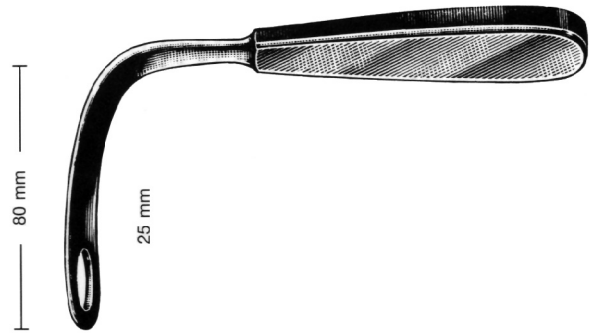

TOBOLD TONGUE SPATULA

• Stainless Steel

Number	Description	Width	Working Length
N20115	Tobold Tongue Spatula	25 mm	8 cm

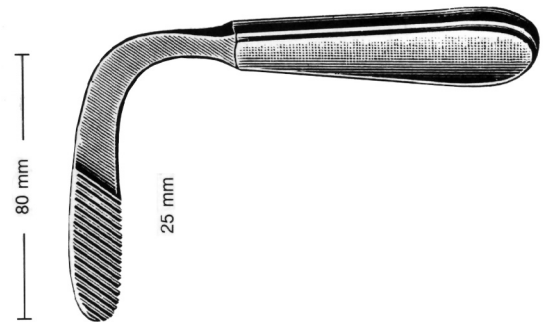

HARTMANN TONGUE SPATULA

• Stainless Steel

Number	Description	Width	Working Length
N20125	Hartmann Tongue Spatula	23 mm	7.5 cm

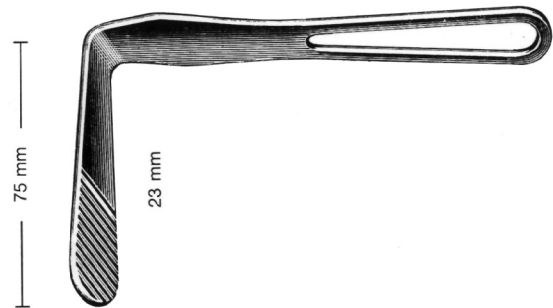

FINGER GUARD

• Stainless Steel

Number	Description	Diameter
N20101	Finger Guard #1	17 - 21 mm
N20102	Finger Guard #2	19 - 24 mm
N20103	Finger Guard #3	21 - 26 mm

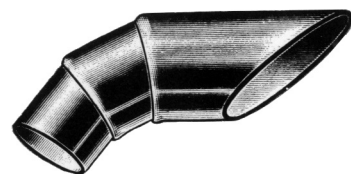

RONIS BIOPSY FORCEPS

• Stainless Steel

Number	Description		Size	Working Length
N02201	Biopsy forceps by Ronis	Upturned with triangular basket	1 = 7 mm	130 mm
N02202	Biopsy forceps by Ronis	Upturned with triangular basket	2 = 8 mm	130 mm

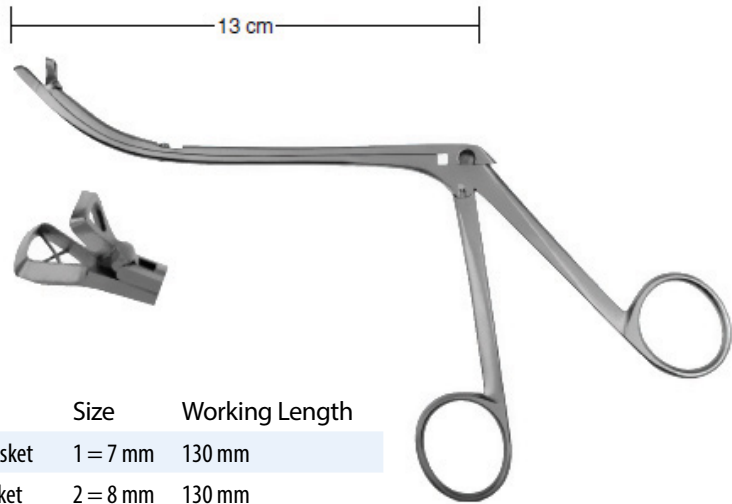

MELTZER ADENOID PUNCH

• Stainless Steel

Number	Description		Size	Working Length
N02300	Adenoid punch by Meltzer	Straight with triangular basket	0 = 6 mm	140 mm
N02301	Adenoid punch by Meltzer	Straight with triangular basket	1 = 7 mm	140 mm
N02302	Adenoid punch by Meltzer	Straight with triangular basket	2 = 8 mm	140 mm
N02303	Adenoid punch by Meltzer	Straight with triangular basket	3 = 10 mm	140 mm

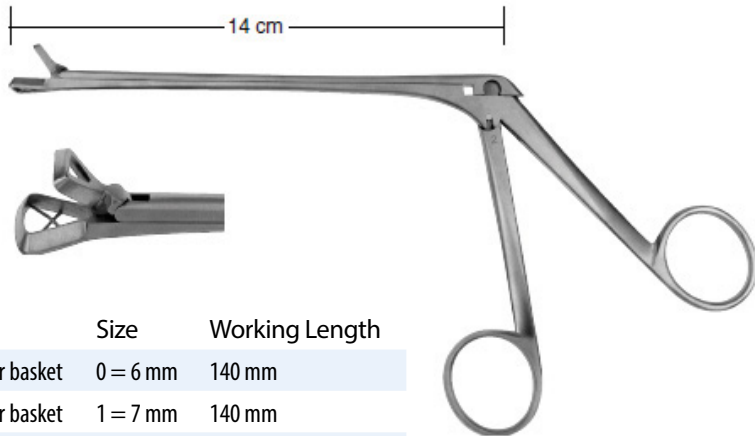

MELTZER ADENOID PUNCH

• Stainless Steel

Number	Description		Size	Working Length
N02311	Adenoid punch by Meltzer	Straight with round basket	1 = 7 mm	140 mm
N02312	Adenoid punch by Meltzer	Straight with round basket	2 = 8 mm	140 mm

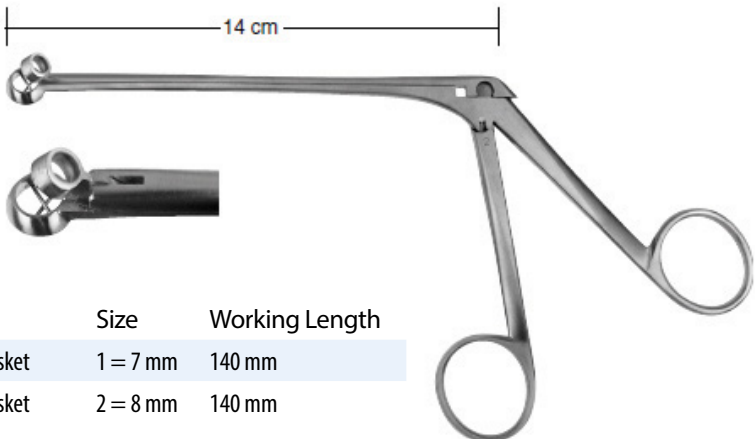

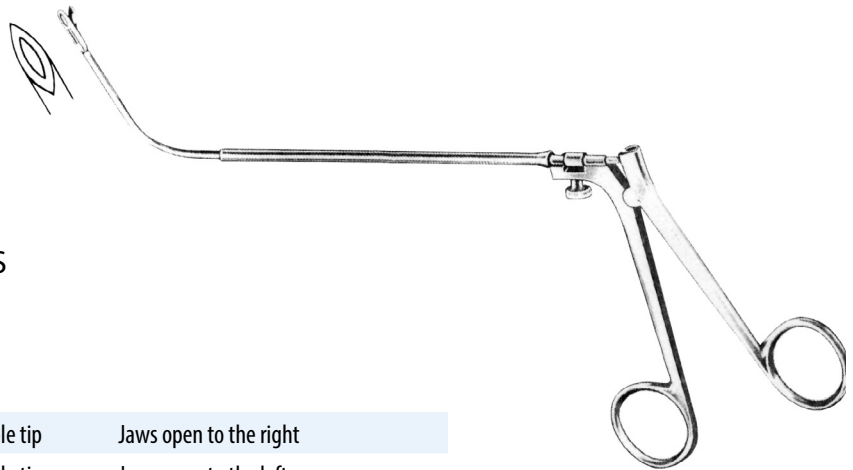

NASO-PHARYNGEAL BIOPSY FORCEPS

- Stainless Steel

Number Description

N15062	Naso-pharyngeal biospy forceps with malleable tip	Jaws open to the right
N15063	Naso-pharyngeal biospy forceps with malleable tip	Jaws open to the left

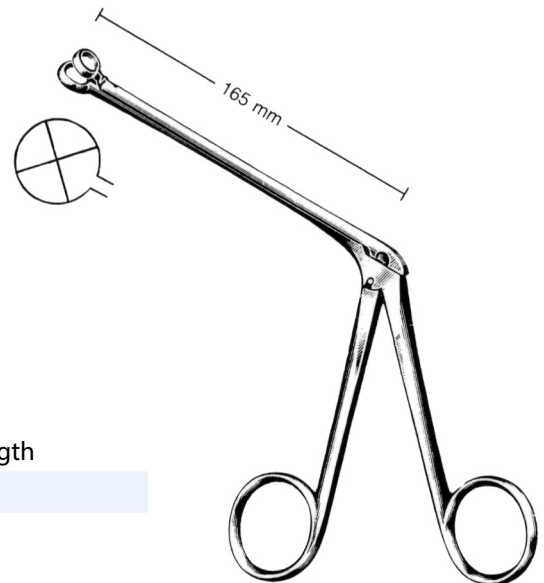

HARTMANN ADENOID PUNCH

- Stainless Steel

Number Description Working Length

N15212	Hartmann adenoid punch with basket	Round	16.5 cm
--------	------------------------------------	-------	---------

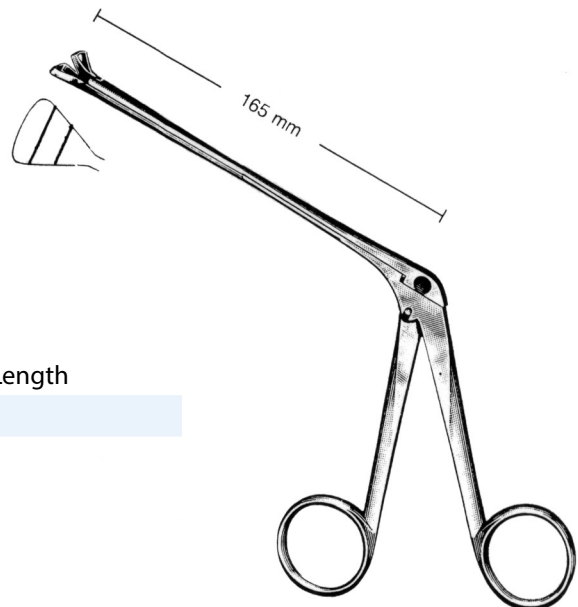

SCHMEDEN ADENOID PUNCH

- Stainless Steel

Number Description Working Length

N15212	Shemedan adenoid punch with basket	Triangular	16.5 cm
--------	------------------------------------	------------	---------

ST. CLAIR-THOMSON NASO-PHARYNGEAL FORCEPS

- Stainless Steel

Number	Description		Working Length
N15018	St. Clair-Thomson Naso-Pharyngeal forceps	sharp	18 cm

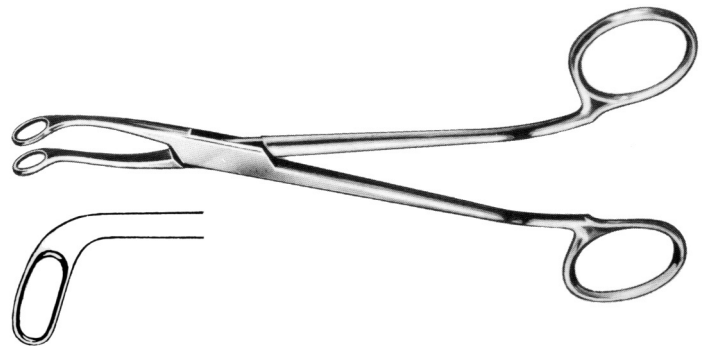
JURASZ NASO-PHARYNGEAL FORCEPS

- Stainless Steel

Number	Description		Working Length
N15019	Jurasz Naso-Pharyngeal forceps for children	sharp	19 cm

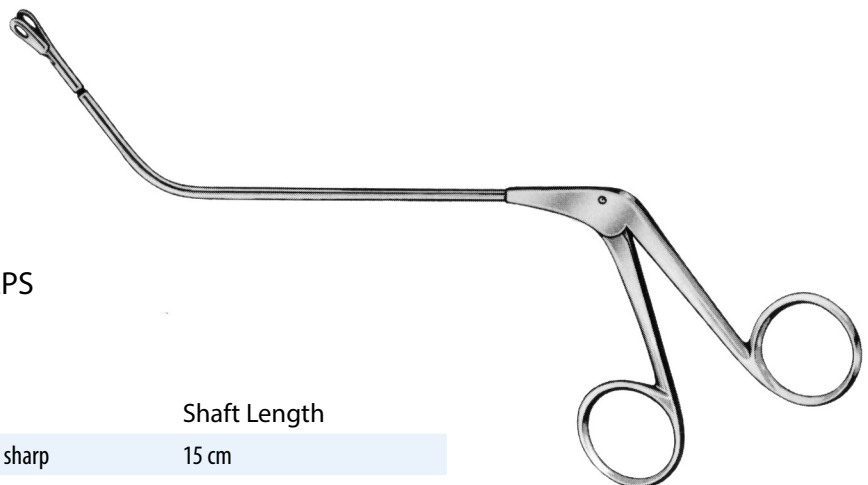
JATHO NASO-PHARYNGEAL FORCEPS

- Stainless Steel

Number	Description		Shaft Length
N15050	Jatho Naso-Pharyngeal forceps	sharp	15 cm

JATHO EPIPHARYNGEAL FORCEPS

• Stainless Steel

Number	Description		Working Length
N01500	Jatho Epipharyngeal forceps with horizontal opening	Upturned with fenestrated cupped jaws	15 cm
N01501	Jatho Epipharyngeal forceps with vertical opening	Upturned with fenestrated cupped jaws	15 cm



FRENZEL CONCHOTOME

• Stainless Steel

Number	Description		diameter	Working Length
N01600	Frenzel Conchotome for adenotomies	Ring shaped jaws Upturned	10 mm	14 cm



HARTMANN TONSIL PUNCH

• Stainless Steel

Number	Description		Diameter	Working Length
N26513	Hartmann tonsil punch	Sharp	13 mm	12 cm
N26515	Hartmann tonsil punch	Sharp	15 mm	12 cm
N26517	Hartmann tonsil punch	Sharp	17 mm	12 cm

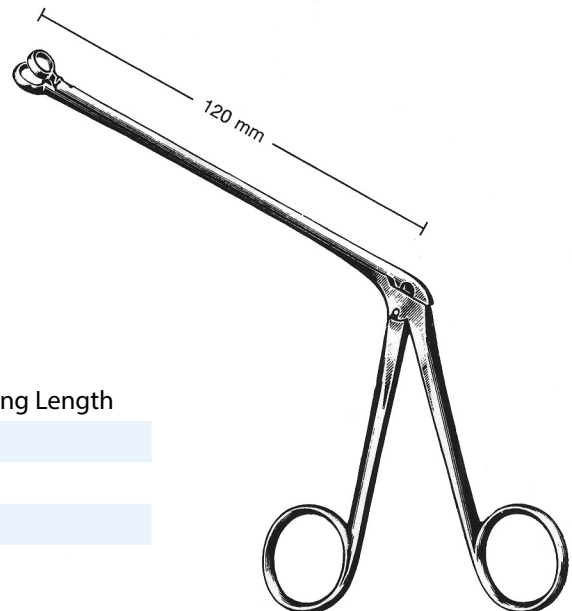

NEGUS TONSIL ARTERY CLAMP

• Stainless Steel

Number	Description	Size	Working Length
N24221	Negus tonsil artery clamp	1	19 cm
N24222	Negus tonsil artery Clamp with long curve	2	19 cm

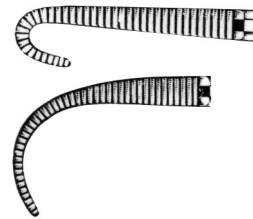
MUCK TONSIL ARTERY CLAMP

• Stainless Steel

Number	Description	Size	Tip	Working Length
N24281	Muck tonsil clamp	1	8 mm	18 cm
N24282	Muck tonsil clamp	2	10 mm	18 cm

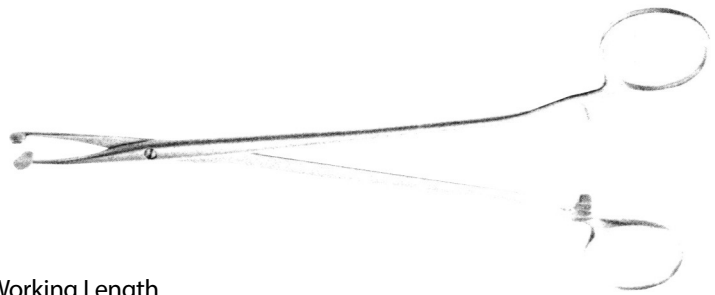
MCWORTHER-LOTHROP TONSIL ARTERY CLAMP

• Stainless Steel

Number	Description	Working Length
N24290	McWorther-Lothrop tonsil artery clamp	18.5 cm

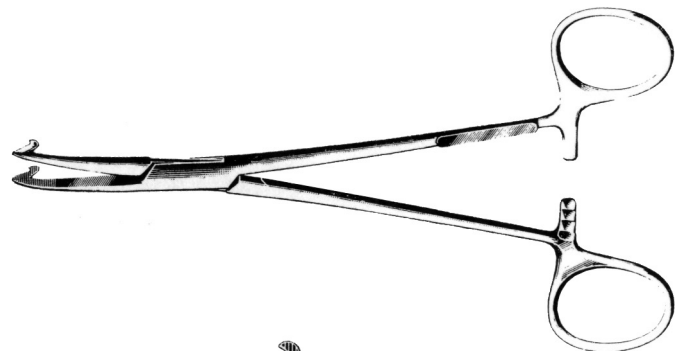



HEISS-BIRKETT TONSIL ARTERY CLAMP

• Stainless Steel

Number	Description			Working Length
N50000	Heiss-Birkett tonsil artery clamp	Straight	Slender	20 cm
N50100	Heiss-Birkett tonsil artery clamp	Slightly curved	Slender	20 cm



SCHNIDT TONSIL ARTERY CLAMP

• Stainless Steel

Number	Description			Working Length
N51000	Schnidt tonsil artery clamp	Slightly curved	Slender	19 cm
N51100	Schnidt tonsil artery clamp	Strong curved	Slender	19 cm

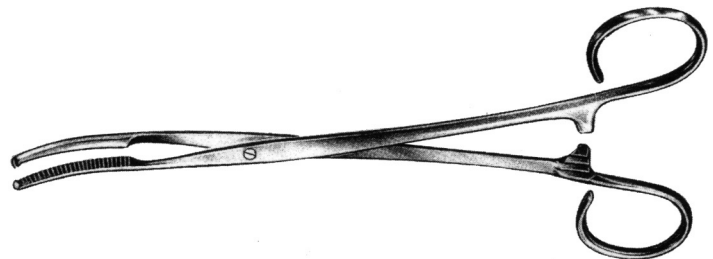

MIKULICZ TONSIL ARTERY CLAMP

• Stainless Steel

Number	Description	Working Length
N24015	Mikulicz tonsil artery clamp	18 cm

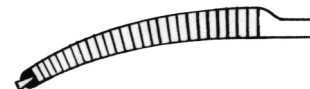

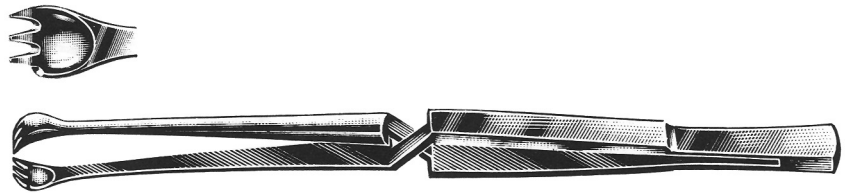
MARSCHIK TONSIL FORCEPS

Number	Description	Working Length
N24005	Tonsil forceps by Marschik	22 cm

WHITE TONSIL SEIZING FORCEPS

- Stainless Steel
- Open ring

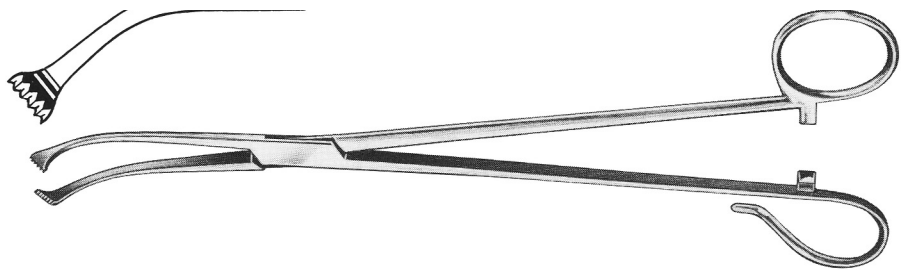

Number	Description	Working Length
N24018	Tonsil seizing forceps by White	18 cm
N24023	Tonsil seizing forceps by White	23 cm

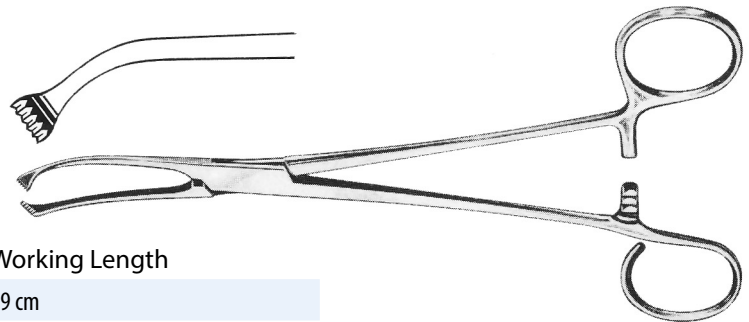
COLVER TONSIL FORCEPS

Number	Description	Working Length
N24019	Tonsil forceps by Colver	19 cm

BLOHMKE TONSIL SEIZING FORCEPS

- Stainless Steel
- Open ring

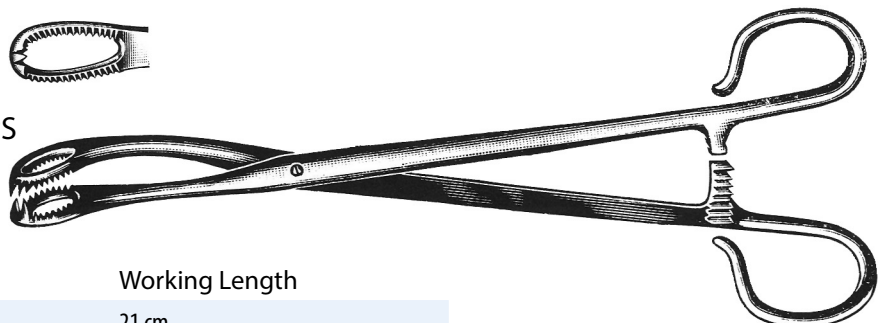

Number	Description	Working Length
N24021	Tonsil seizing forceps by Blohmke	21 cm

ABRAHAM TONSIL FORCEPS

- Open ring

Number	Description	Working Length
N24022	Tonsil forceps by Tyding	20.5 cm

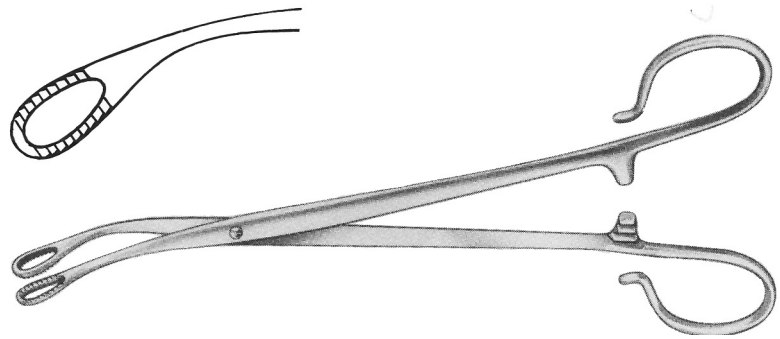

THILENIUS TONSIL ABSCESS FORCEPS

- Stainless Steel

Number	Description	Working Length
N24090	Tonsil seizing forceps by Thilenius	20 cm

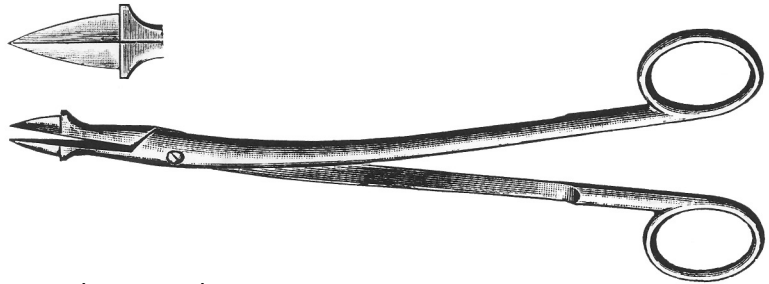

TYDING TONSIL FORCEPS

- Open ring

Number	Description	Working Length
N36000	Tonsil forceps by Tyding	21 cm



Tivnen Tonsil Forceps

Number	Description	Working Length
N36100	Tonsil forceps by Tivnen	21 cm



TONSIL KNIVES

Number	Description	Working Length
N22005	Tonsil knife	18 cm

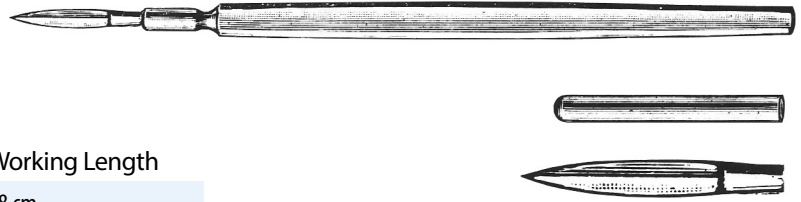

CANFIELD TONSIL KNIVES

Number	Description	Working Length
N22030	Canfield tonsil knife	21 cm

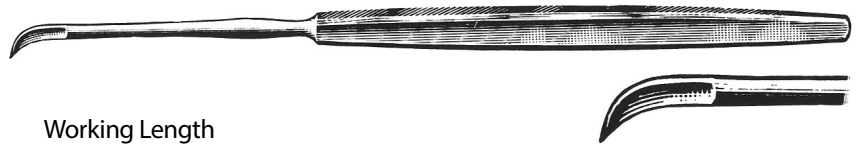

ABRAHAM TONSIL KNIVES

Number	Description	Working Length
N22035	Abraham tonsil knife	21 cm

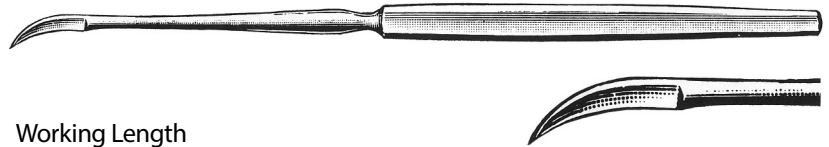

BRÜNINGS TONSIL KNIVES

Number	Description	Working Length
N22040	Brünings tonsil knife	23 cm

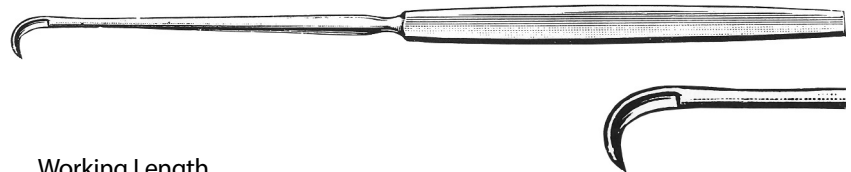

DAY TONSIL KNIVES

Number	Description	Working Length
N22050	Day tonsil knife	23 cm

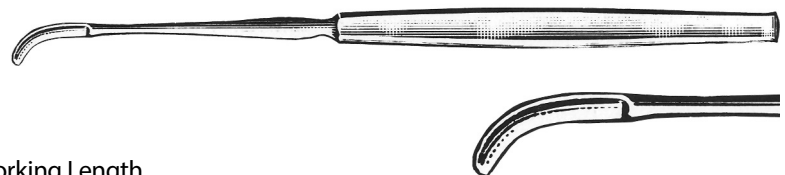



ABRAHAM (TYDING) TONSIL KNIVES



Number	Description	Working Length
N22055	Abraham (Tyding) tonsil knife	20 cm



FISHER (COLVER) TONSIL KNIVES

Number	Description	Working Length
N22070	Fisher (Colver) tonsil knife	22.5 cm



REVERSIBLE SCREWS

Number	Description	Diameter	Working Length
N22085	Reversible screw	7 mm	21 cm
N22087	Reversible screw	4 mm	10 cm

YANKAUER TONSIL DISSECTORS

- Stainless Steel

Number	Description	Working Length
N22505	Yankauer tonsil dissector	21 cm



HURD TONSIL DISSECTORS

- Stainless Steel

Number	Description	Size	Working Length
N22515	Hurd tonsil dissector	6 / 12 mm	22 cm
N22520	Hurd tonsil dissector	10 / 12 mm	22 cm



ALDERDICE TONSIL DISSECTORS

- Stainless Steel

Number	Description	Working Length
N22530	Alderdice tonsil dissector	22 cm

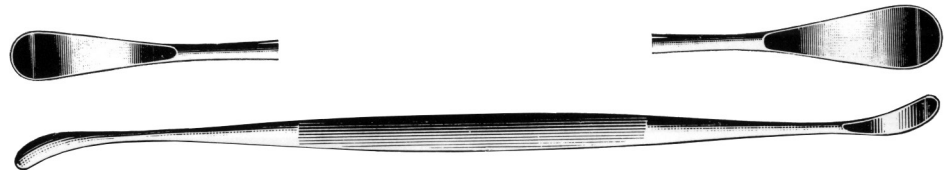

HENKE TONSIL DISSECTORS

- Stainless Steel

Number	Description	Size	Working Length
N22535	Henke tonsil dissector	12 / 18 mm	24 cm



HENKE TONSIL DISSECTORS

Number	Description	Size	Working Length
N22537	Henke tonsil dissector	12 mm	23 cm
N22538	Henke tonsil dissector	17 mm	23 cm

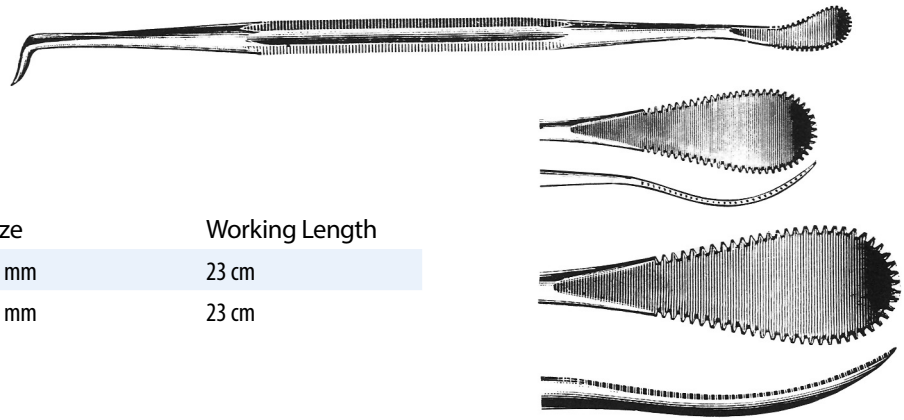

LOPEZ-REINKE TONSIL DISSECTORS

Number	Description	Working Length
N02540	Lopez-Reinke tonsil dissector with suction device	23 cm

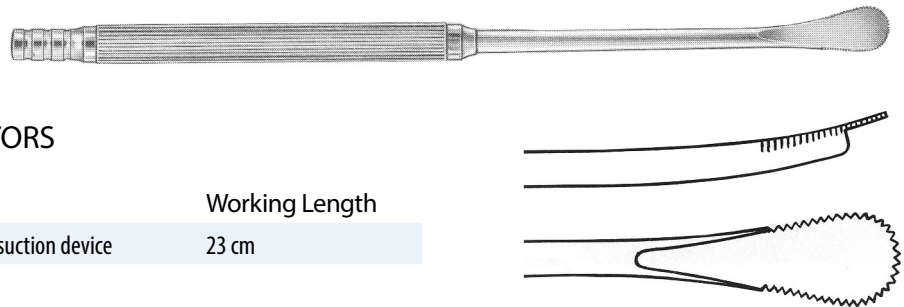

CARPENTER TONSIL DISSECTORS

Number	Description	Working Length
N02540	Carpenter tonsil dissector	25 cm

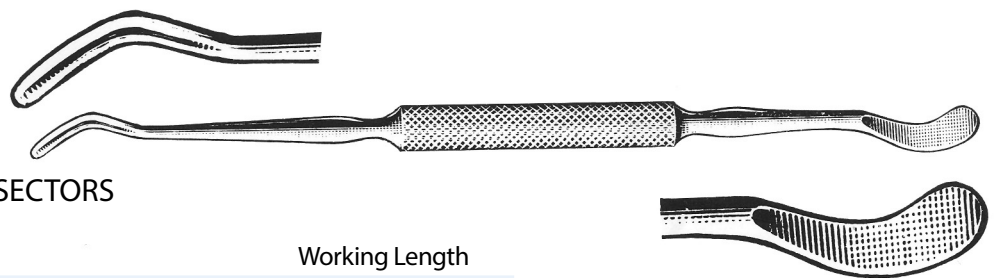

METZENBAUM TONSIL SCISSORS

• Stainless Steel



Number	Description		Working Length
N42018	Tonsil Scissors by Metzenbaum	Curved	18 cm
N42020	Tonsil Scissors by Metzenbaum	Curved	20 cm
N42218	Tonsil Scissors by Metzenbaum with tungsten carbide tip and gold handles	Curved	18 cm
N42220	Tonsil Scissors by Metzenbaum with tungsten carbide tip and gold handles	Curved	20.5 cm

LILLY TONSIL SCISSORS

• Stainless Steel

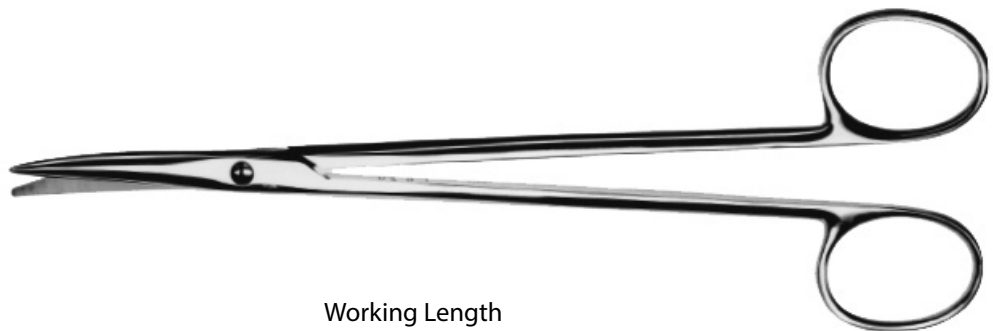

Number	Description		Working Length
N41400	Tonsil Scissors by Lilly	Curved	19 cm

PRINCE TONSIL SCISSORS

• Stainless Steel

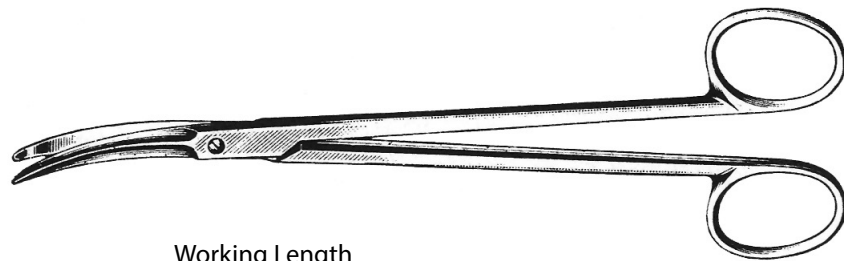

Number	Description		Working Length
N24520	Tonsil Scissors by Prince		18 cm

BOETTCHER TONSIL SCISSORS

• Stainless Steel

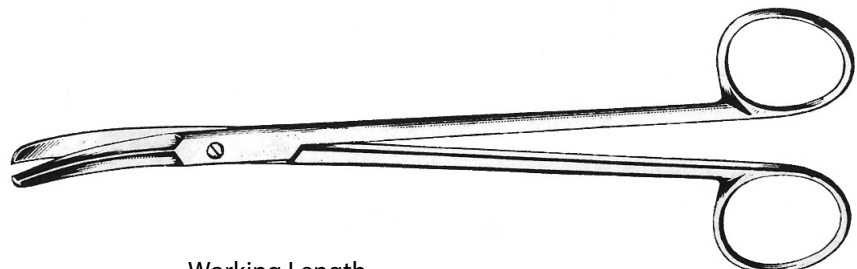

Number	Description		Working Length
N24525	Tonsil Scissors by Boettcher		18 cm

GOOD TONSIL SCISSORS

- Stainless Steel

Number	Description	Working Length
N24530	Tonsil Scissors by Good	19 cm

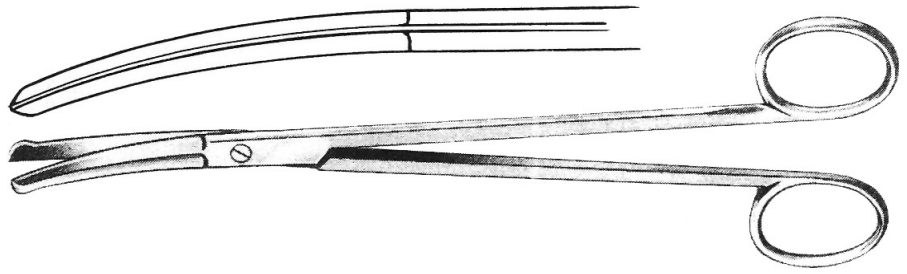

DEAN TONSIL SCISSORS

- Stainless Steel

Number	Description	Working Length
N24550	Tonsil Scissors by Dean 1 serrated blade	17 cm

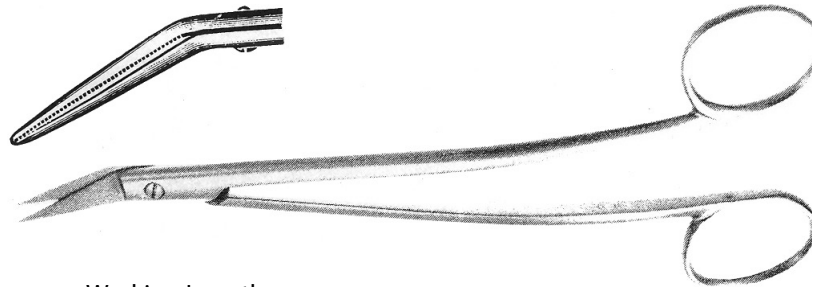

BRÜNINGS TONSIL SNARE

• Stainless Steel

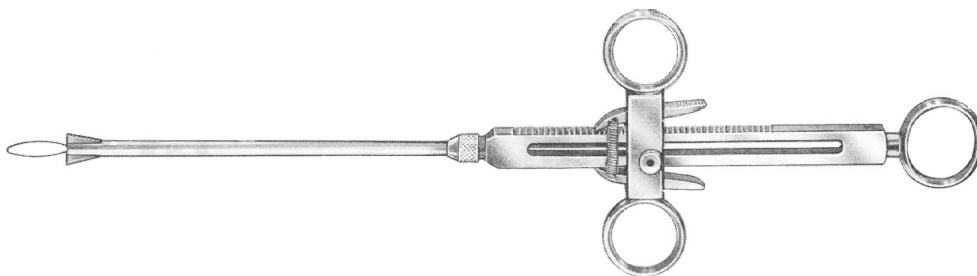

Number	Description	Working Length
N25005	Tonsil snare with catch with Brünings Includes 3 wire loops	29 cm

EVES TONSIL SNARE

• Stainless Steel

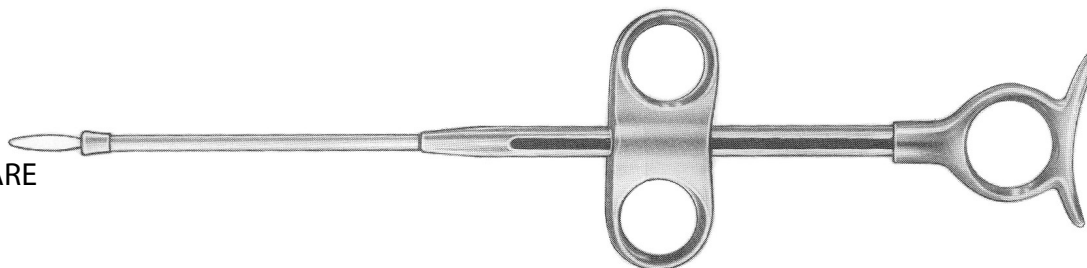

Number	Description	Working Length
N25010	Tonsil snare by Eves Includes 3 preshaped wires	27 cm

EVES TONSIL SNARE

• Stainless Steel

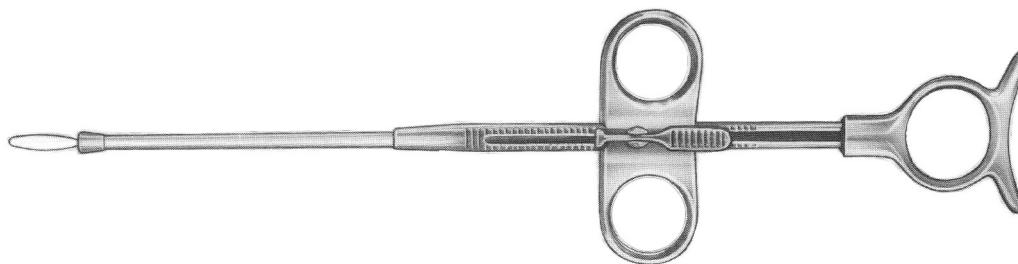

Number	Description	Working Length
N25011	Tonsil snare with catch by Eves	27 cm

LEWIS TONSIL SNARE

• Stainless Steel

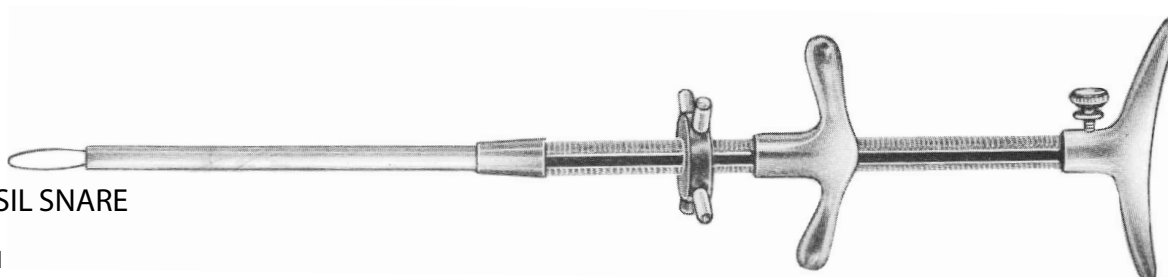

Number	Description	Working Length
N25016	Tonsil snare by Lewis Includes 3 preshaped wires	25.5 cm

ROEDER "E" TONSIL SNARE

• Stainless Steel

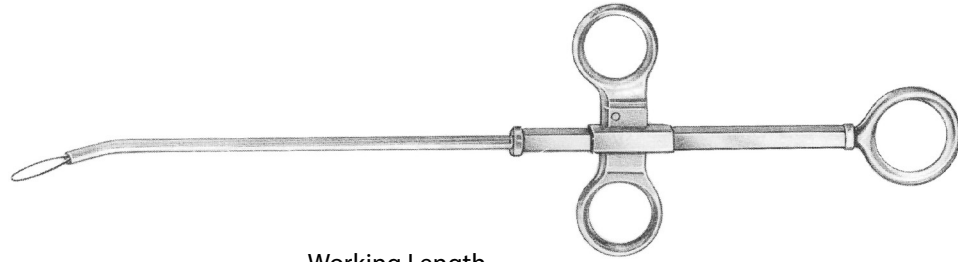

Number	Description	Working Length
N25025	Tonsil snare by Roeder "E" for catgut suture	27 cm

TYDING TONSIL SNARE

• Stainless Steel

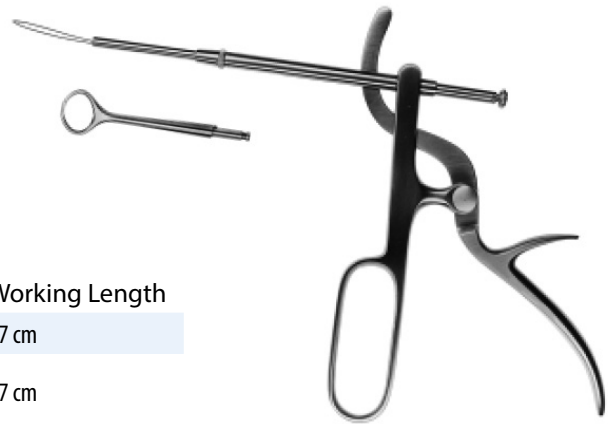

Number	Description	Working Length
N25051	Tonsil Snare by Tyding with 3 preshaped wires Straight tip	27 cm
N25052	Tonsil Snare by Tyding with 3 preshaped wires Straight, Vedder looped tip	27 cm
N25053	Straight tip only	
N25054	Vedder loop tip only	

TONSIL SNARE WIRE LOOPS

Number	Description	
N25095	Soldered tonsil snare wire loops	100 / pack

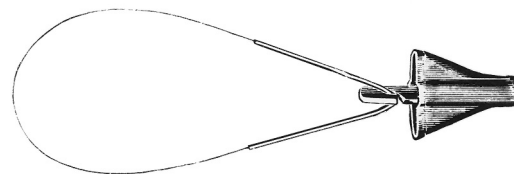

TONSIL SNARE PRE-CUT WIRE

Number	Description	Diameter
N25096	Pre-cut wire for tonsil snares	.35 mm
N25097	Pre-cut wire for tonsil snares (Standard Size)	.40 mm
N25098	Pre-cut wire for tonsil snares	.45 mm
N25099	Pre-cut wire for tonsil snares	.50 mm



SNARE WIRES

Number	Description		Diameter
N61543	Wire for snare	10 m coil	.35 mm
N61544	Wire for snare	10 m coil	.40 mm
N61545	Wire for snare	10 m coil	.45 mm

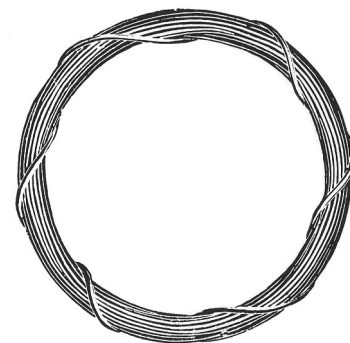

SNARE CATGUT SUTURE LOOPS

Number	Description		
N25025	Catgut suture loops for snares	Sterile	20 / box
N25030	Catgut suture loops for snares Thickness 0	Sterile	20 / box
N25031	Catgut suture loops for snares Thickness 1	Sterile	20 / box

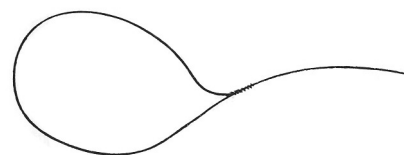

SLUDER-BALLENGER TONSILTOME

- Stainless Steel handle

Number	Description
N26010	Tonsiltome by Sluder-Ballenger, complete with one blade of each size #1-3 Angled-up blades
N26019	Handle only for tonsiltome by Sluder-Ballenger



SLUDER-BALLENGER TONSILTOME BLADES

Number	Description	Size	width
N26021	Blades for tonsiltome by Sluder-Ballenger	1	18 mm
N26022	Blades for tonsiltome by Sluder-Ballenger	2	20 mm
N26023	Blades for tonsiltome by Sluder-Ballenger	2	23 mm

ROEDER LOOP APPLICATOR

- Stainless Steel

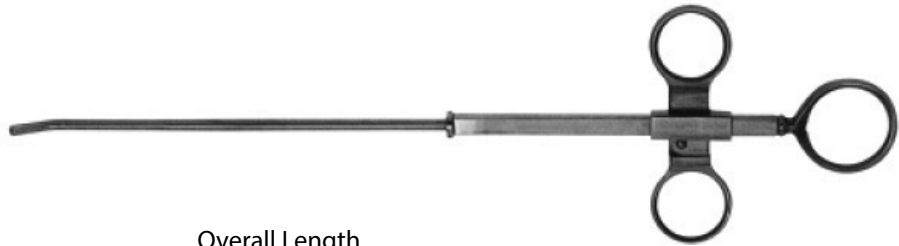

Number	Description		Overall Length
N46400	Loop applicator by Roeder	Type E	27 cm

NAGER TONSIL SUTURE NEEDLE

- Stainless Steel



Number	Description		Overall Length
N46500	Tonsil suture needle by Nager		24 cm

HURD TONSIL SUTURE NEEDLE

- Stainless Steel



Number	Description		Overall Length
N46700	Tonsil Suture Needle by Hurd	Right hand	22.5 cm
N46800	Tonsil Suture Needle by Hurd	Left hand	22.5 cm

SUTURE HOOK

- Stainless Steel



Number	Description		Overall Length
N46900	Suture Hook	Right hand	20.5 cm

KNOT TIER

- Stainless Steel

Number	Description	Overall Length
N47100	Knot tier Fork shaped, blunt	20.5 cm

LUNIATSCHEK TONSIL GAUZE PACKERS



- Stainless Steel

Number	Description	Overall Length
N43700	Tonsil gauze packers by Luniatschek	19 cm

ABRAHAM TONSIL KNIFE

- Stainless Steel

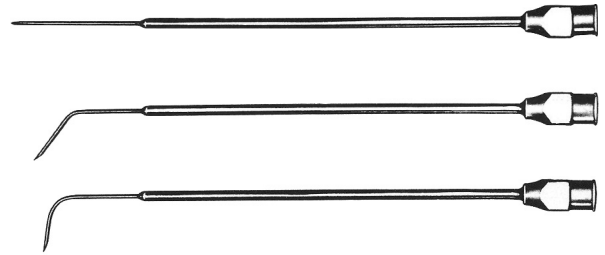
Number	Description	Overall Length
N48000	Tonsil knife by Abraham	21 cm



TONSIL SEPTAL CANNULAS WITH LUER-LOCK HUB

- Stainless Steel

Number	Description		Diameter	Length
L29510	Tonsil Cannulas with Luer-Lock Hub	Straight	0.8 mm (22 g)	75 / 25 mm
L29514	Tonsil Cannulas with Luer-Lock Hub	Knee bent, 45°	0.8 mm (22 g)	75 / 25 mm
L29519	Tonsil Cannulas with Luer-Lock Hub	Curved, 90°	0.8 mm (22 g)	75 / 25 mm

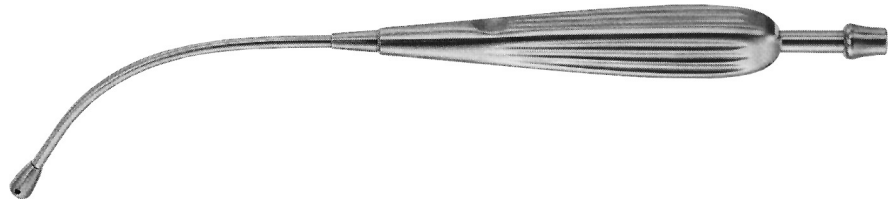
ANDREW PYNCHON PEDIATRIC SUCTION TUBES

Number	Description	Diameter	Length
N506-0421	Andrew Pynchon pediatric suction tubes, tip with lateral holes	3 mm	24 cm
N506-0422	Andrew Pynchon pediatric suction tubes, tip with lateral holes	4.2 mm	24 cm
N506-0424	Andrew Pynchon pediatric suction tubes, tip with lateral holes	6 mm	24 cm

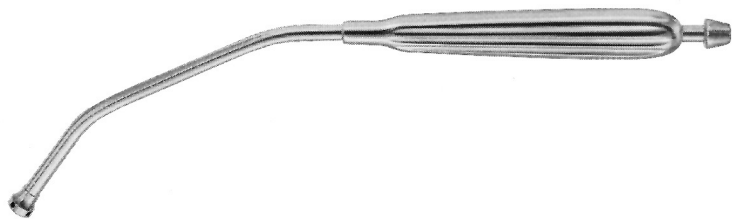
YANKAUER PEDIATRIC SUCTION TUBE

Number	Description	Diameter	Length
N506-0303	Yankauer pediatric suction tube with tube olive	3.5 mm	22 cm

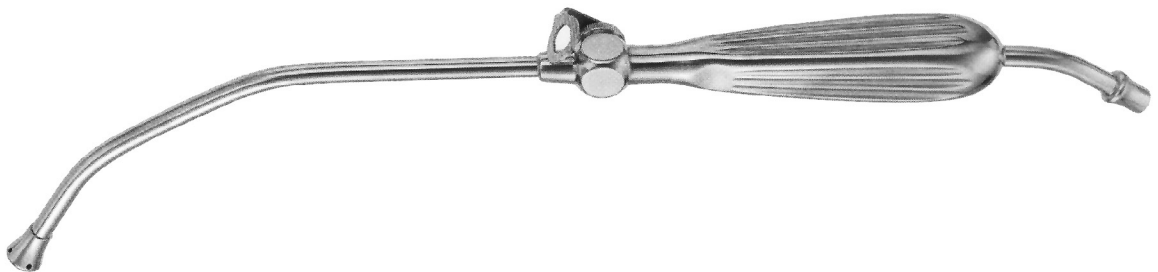
WALTON YANKAUER SUCTION TUBE

Number	Description	Length
N506-0304	Walton Yankauer suction tube regulating valve with tube olive	32 cm

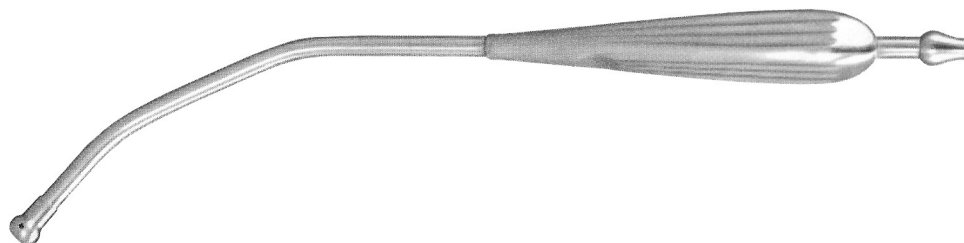

YANKAUER ROUND-TIP SUCTION TUBE

Number	Description	Length
N506-0306	Yankauer suction tube with round suction tip, tube olive	23 cm



YANKAUER SUCTION TUBE

Number	Description	Central bore Ø	Length
N506-0300	Yankauer suction tube with tube olive without light guide	2 mm	28.5 cm
N506-0301	Yankauer suction tube with tube olive without light guide	4.8 mm	28.5 cm
N506-0308	Yankauer suction tube with tube olive with light guide	2 mm	28.5 cm

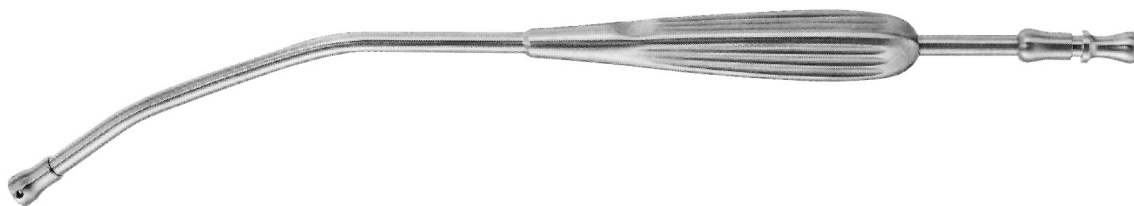

Number	Description	Length
N506-0302	Yankauer suction tube with wall suction extension and tube olive	31 cm
N506-03214	Yankauer suction tube with wall suction extension and tube olive	35.5 cm
N506-03216	Yankauer suction tube with wall suction extension and tube olive	40.5 cm
N506-03218	Yankauer suction tube with wall suction extension and tube olive	45.5 cm

VETTER TONSIL COMPRESSOR

- Stainless Steel

Number Description

N22595 Vetter Tonsil Compressor

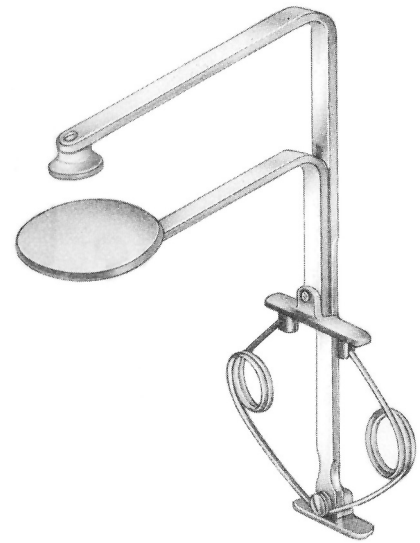

LUNIATSCHECK TONSIL GAUZE PACKER

- Stainless Steel

Number Description

N22595 Luniatscheck Tonsil Gauze Packer



Working Length

18 cm