

burgess



The data used in this Product Overview may be used as a guideline only. Specific operational characteristics of our products may vary according to individual applications. It is strongly recommended that specific operating conditions are clarified with Johnson Electric before application.

Johnson Electric Terms and Conditions of Sale apply.

All data may be subject to change without notice.

# Table of Contents

---

<b>Johnson Electric Group</b>		2
Group		
Looking for a specialized switching solution		4
Table of typical applications & Burgess switch types		7
Terminology		8
Snap-action microswitches		17
<b>Ultraminiature</b>	F1, F4, F5, F1NS, F6, FK4	18
<b>Subminiature</b>	V4L	37
<b>Miniature sealed</b>	V3S	42
<b>Standard</b>	PN4, 3BR, K5	46
<b>Metal housed</b>	V9N, 4BR	56
Positive action switches		63
<b>Miniature</b>	BVM3	64
<b>Standard</b>	KB5	67
Door interlock switches		70
<b>Forced break</b>	XP, XT	71
Table of preferred products		76

## The Johnson Electric Group is one of the world's largest providers of motion actuators for automotive and industrial applications

Over the years, we have shipped billions of motors to more than thirty countries in over one hundred different motor applications. Johnson Electric has an annual production capacity of one billion motors.

to meet all of our commitments and to support our customers' success. Product reliability and assurance of supply are our commitment.

At the heart of Johnson Electric's success is our commitment to make our customers successful. Our customers include many of the world's leading industrial, consumer and automotive companies. We begin by understanding our customers' business needs, and the product application requirements of the end user of our customers' products. Then we design and deliver innovative motion solutions that help our customers to differentiate their products in the marketplace. Our goal is to be instrumental in the successful launch of our customers' products in their respective marketplaces.

### Our Brand Promise

#### Johnson Electric is the most reliable partner

Johnson Electric is responsive and flexible; and has the financial stability and organizational integrity

### Johnson Electric delivers competitive advantage

Johnson Electric delivers differentiation and innovation through its motion products – subsystems comprising of Stepper Motors, DC Motors, AC Motors, Piezo-electric Motors, Switches, Solenoids, Flexi Circuits, Motion Control, Precision Plastics and Precision Gears.

Our business growth hinges with leading "branded" goods producers to deliver differentiation and innovation through our motion products. The core platform for delivering these solutions is a highly developed production base and focused customer support teams throughout the world. This combines scale advantages in production and procurement with skilled and dedicated motion application experts.

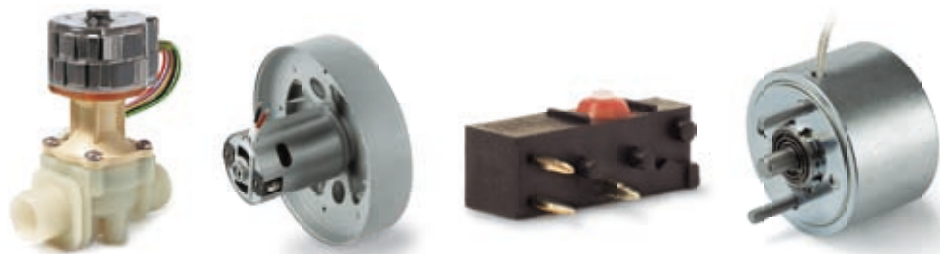

## HOW WE ARE ORGANIZED

**Johnson Electric Holdings Limited is the parent company of the Johnson Electric Group and has been listed on the Stock Exchange of Hong Kong since 1984. The Group structure consists of a number of operating divisions and business units focused on their particular customer application or product segment**

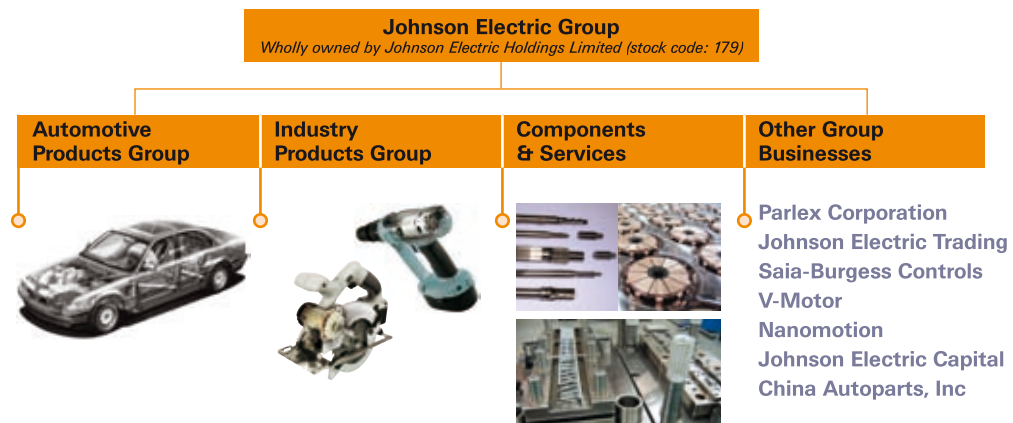

**The Group's motion systems, motors and switches businesses are managed through two primary operating divisions: Automotive Products Group and Industry Products Group.**

The Automotive Products Group, which consists of Johnson Electric's Automotive Motors Group and the Automotive Division of Saia-Burgess Electronics, is focused on providing customized motion solutions for major automotive application segments that include powertrain, body and chassis.

The Industry Products Group is comprised of business units that provide motion products and solutions for various commercial and industrial application sectors, including home appliances, power tools, business equipment, personal care products, medical equipment and healthcare, building automation and security, audio-visual and other industrial products.

Supporting these two operating divisions is the Group's Components & Services function which produces metal and plastic parts, tooling and production equipment for motor and motion related products. Johnson Electric is a highly vertically integrated business that manufactures an exceptionally wide range of components that form the basis for its final assembled end products. We make magnets, bearings, shafts, housings, laminations, commutators and die cast parts. We also build tools, assembly fixtures, plastic molds as well as armature winding and other production machines.

In addition to motion systems and motors, the Group also consists of a number of complementary manufacturing businesses and other subsidiary companies. These include an innovative provider of flexible printed circuits and interconnect solutions; a successful niche player in the programmable controls industry; and a rapidly growing specialty metals and trading services company.

# Looking for a specialized switching solution?

---

## Look no further.

In addition to the wide range of standard products shown in this catalog, we will be happy to work with you to meet your switching needs. If your application requires more than a standard product solution, please consider us early in your design process. Our product development team will be happy to discuss your specification, whether you need a special switch design or a complete value-added assembly. We specialize in developing switches for demanding industrial environments.

The images shown give some examples of our capabilities.

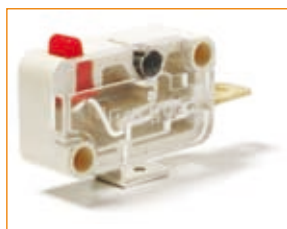

# Burgess is the leading global brand for industrial switches

**Burgess designs have defined industry standards. If you need a specific solution for your switching needs, call us to set your own standard.**

A pioneer of snap-action technology, the Burgess brand stands for innovative, robust solutions for industrial switch requirements.

## Wide range

Snap-action switches have to fulfill a wide variety of functions. The standard Burgess range ensures there will be a switch for your needs, with one of the broadest product portfolios around. From ultra-miniature to metal-housed basic types, we are sure to have the type appropriate to your application, whether it is signal or power switching, high or low force actuation.

## Environmental protection

The sealed switch is a Burgess speciality. In demanding environments – wet, humid or dusty – even the most sensitive signal can be switched reliably with IP67 rated products. Our robust metal-housed switches offer impact resistance outside whilst switching with precision inside.



## Uncompromising reliability

With many UL, CSA and ENEC approvals, the performance of Burgess products is globally recognized. For safety-related applications, such as machine maintenance systems, positive-action mechanisms ensure a physical break in the circuit.

## Precision actuation

Snap-action switches offer high levels of repeat accuracy and switch virtually independently of actuation speed and force. This is the mechanism of choice for pressure sensing, timing and position indicating applications.

## Minimum size

Our F5 range demonstrates our capability to switch relatively high current from a small size envelope – 5A 250 VAC from a switch less than 15 mm long.

## Typical Burgess switch applications

- Circuit breakers
- Special purpose vehicles
- Vending machines

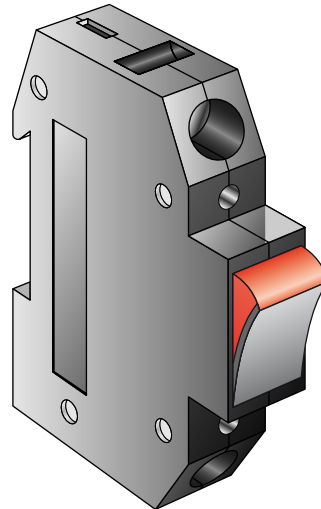

# Switches in General Industry

Switches can be found in a wide variety of applications:

## Burgess switches for special purpose vehicles

Switches used in special purpose vehicle applications must have:

- high levels of environmental protection
- the ability to handle high DC inrush currents
- reliability throughout the life of the product

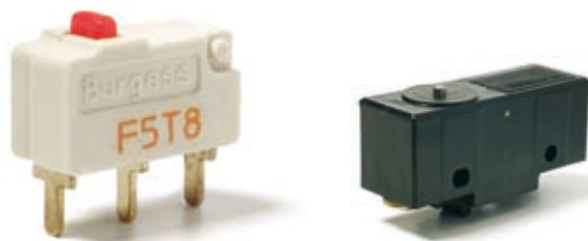

## Burgess switches for circuit breakers

Circuit breaker applications demand:

- dependability and reliability
- a high degree of shock resistance in the mechanism
- the ability to carry high currents and voltages

## Burgess switches for vending machines

Switches used in vending machines must:

- work reliably, time after time
- have appropriate environmental protection to resist dust and moisture



# Switches for locking mechanisms

Switches are found in numerous applications that require a locking device. Whether it is a medical application, an office automation application or a door lock, switches provide an effective, cost-efficient locking mechanism.

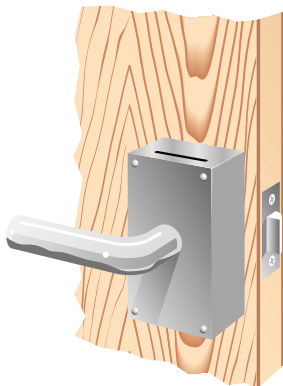

## Security Applications

- Hotel room door lock
- Hotel safe lock
- Prison door lock
- Fire safety door opening lock
- Garage door safety lock

## Office Automation

- Disk drive door lock
- Personal computer chassis lock
- Docking station lock
- Locks to hold peripherals in place
- Tape library index lock

## Medical

- Sterilizer lock
- Centrifuge lock
- Blood analysis machine lock

## Industrial

- Overhead door lock
- Fire safety door lock
- Commercial laundry locks



# Table of typical applications & Burgess switch types

In addition to the products shown in the Product Catalog pages, the Product Mapping table below shows a wide range of switch types for a selection of applications. Also, a switch may be customized to fulfill your specific requirements, please feel free to contact us.

Application & switch Series	F1	F4	F5	F1N	F6	FK4	V4L	V3S	PN4	3BR	K5	V9N	4BR	BVM3	KB5	XP	XT
Circuit Breaker		●	●	●												●	
Commercial Equipment	●	●	●	●		●	●	●	●	●	●	●	●	●	●	●	●
Copier & Printer			●			●		●							●	●	●
Distribution	●	●	●	●	●	●	●	●	●	●	●	●	●	●	●	●	●
Forklifts		●	●				●	●	●	●		●					
Home Appliances		●					●			●		●				●	●
HVAC	●	●	●	●				●			●		●		●		
Industrial automation	●	●	●	●	●	●		●									
Industry general	●	●	●	●	●	●	●	●	●	●	●	●	●	●	●	●	●
Lighting													●				●
Medical	●	●	●	●			●	●	●	●			●	●	●	●	●
Power tools							●	●									
Public transportation								●									
Safety and Security	●	●	●	●		●		●								●	
Specialist vehicles		●					●	●	●	●		●	●				
Telecom		●						●									
Vending/Gaming		●								●						●	●
Page	18	21	24	27	30	33	37	44	48	52	54	58	62	66	69	73	76

# Terminology: Snap-action switches

## ADDITIONAL TECHNICAL INFORMATION

### Contact Resistance

The contact resistance is the electrical resistance measured at the terminals of the switch when the contacts are closed. The resistance specifications refer to unwired switches in new condition.

### Positions – forces – movements

Free position	Position of the actuator, without any influence from an external force.
Operating position	Position of the actuator when contact changeover takes place.
Total travel position	Position of the actuator at the end of the allowed travel.
Release position	Position of the actuator when the switch mechanism resets.
Actuating force	The force required to move the actuator from the free position to the operating position.
Release force	The value to which the applied force must be reduced to allow the mechanism to reset after operation.
Force differential	Difference between actuating force and release force.
Pre-travel	Movement of the switch actuator between free and operating position.
Over-travel	Movement of the switch actuator beyond the operating position.
Total travel	The sum of pre-travel and over-travel.
Movement differential	Distance between operating position and release position.
Release travel	Movement of the switch actuator between release and total travel position.
Post release travel	Movement of the switch actuator between release and free position.

### Contact force – movement – diagram

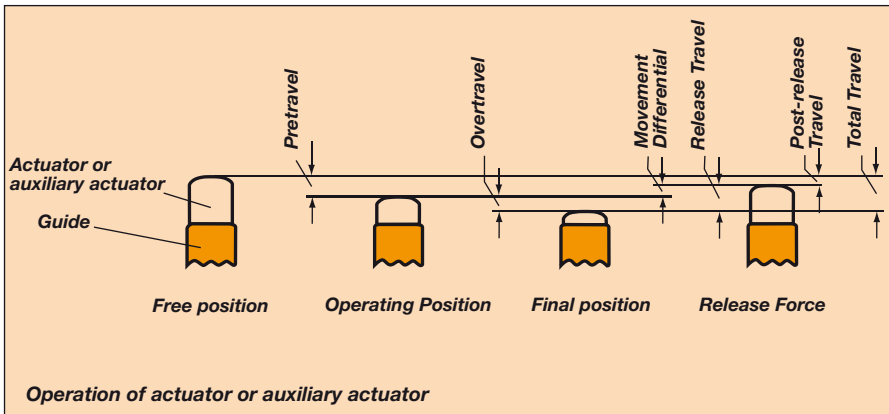

## Actuating force – movement – diagram

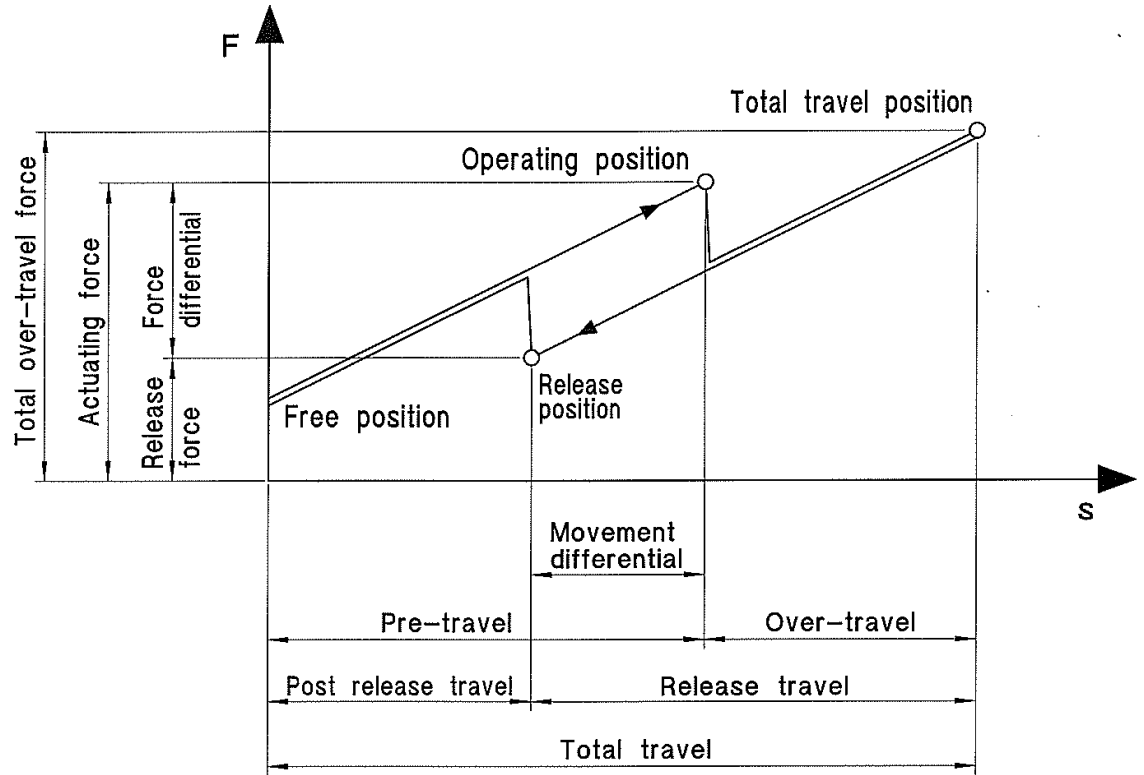

## Contact force – movement – diagram

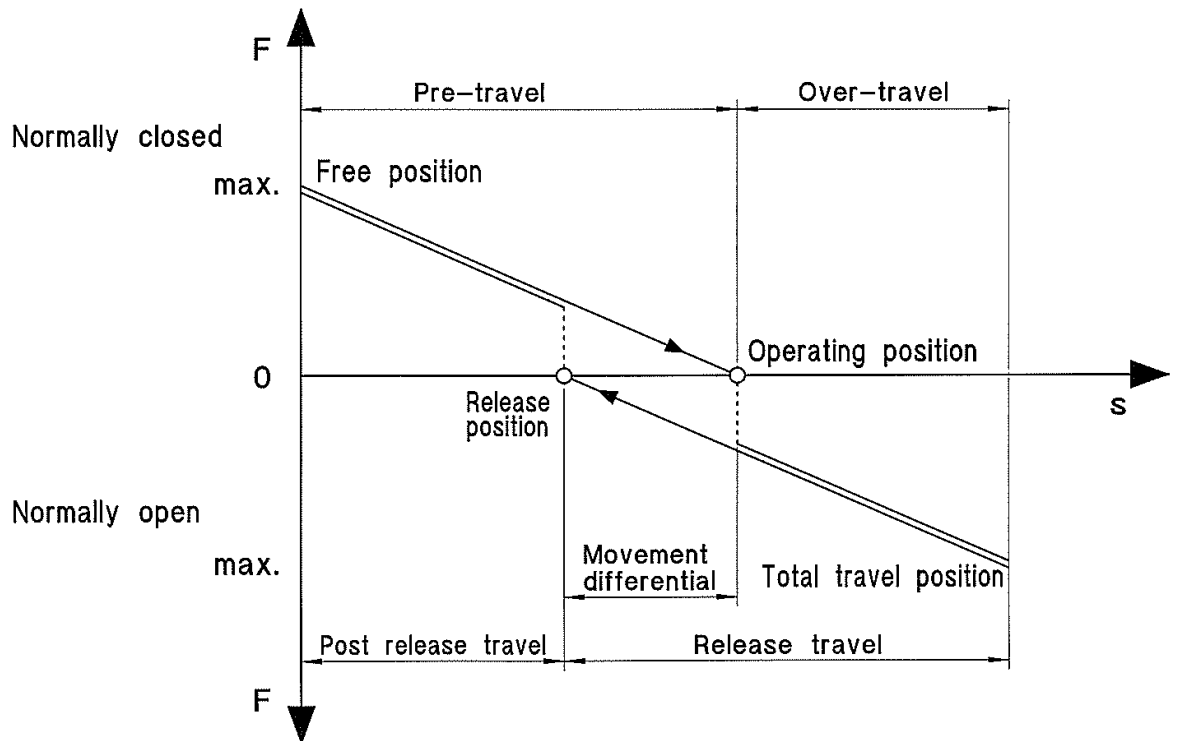

## Switch Technology

**Clearance Distance**—the distance in air between current carrying parts of opposite polarity or between any current carrying part and an earthed-(grounded) metal plate to which the switch is attached.

**Creepage Distance** – the path along the surface of insulating material between current carrying parts of opposite polarity or between any current carrying part and an earthed (grounded) metal plate to which the switch is attached.

**Insulation Resistance** – resistance as measured between the normally closed terminals, or between all terminals connected together and a metal plate to which the switch is mounted. In dry conditions the value would be expected to be greater than 5M $\Omega$ .

**Single Throw** – a switch which provided an ON-OFF or OFF-ON function but does not change over from one conductor to another. Such switches are usually referred to as being «normally-closed only» or «normally-open only».

**Switching Cycle** – one complete switching operating from free position into overtravel and back through release position to free position.

**Switch Resistance** – a total resistance offered by a switch in a circuit, as measured from terminal through mating contacts, to terminal.

**Transit Time** – the time taken by the moving contact in a snap-action mechanism to move from one stable position to another.

## Electrical Ratings

Electrical ratings given in the catalog are ratings according to UL1054, CSA22.55 or IEC61058-1.

Where these are not available, a general rating is given based upon in-house laboratory testing.

The ratings tables should be considered as safe working maximums for most applications. However, switch performance is influenced by a variety of factors, including:

- Frequency of operation
- Type of load
- Amount of travel used
- Temperature
- Humidity

Please do not hesitate to contact Burgess about your specific application.

## Approvals



CSA mark. Switch meets CSA's safety standards



UL Recognized Component Mark for Canada and the United States



ENEC Mark. Switch fulfills European EN standards. The two digit number indicates which certification body has issued the ENEC Certificate



CQC Approval (China) is available for certain switches

## Switch Life

a. **Electrical Life** – the electrical life data contained in this catalog is based on laboratory controlled tests. In practice, frequency and speed of operation, type of load, suppression, actuator travel used, ambient humidity and temperature and other environmental conditions can have a major effect on switch life.

Individual assessments for specific applications are possible and can be undertaken by Burgess on request.

Please ask Burgess if you would like an assessment for your specific application.

b. **Mechanical Life** – the figures quoted relate to the number of switching cycles made without an electrical load.

## Switch Drawings

All drawings in this catalog are third angle projection.

All dimensions in this catalog are nominal, except where specifically shown.

---

## Application Technology

### Shock and Vibration

If switches are likely to be subjected to shock or vibration, select models with the highest available actuating force.

Burgess switches feature low mass mechanisms which are inherently resistant to shock and vibration.

If possible, the switches should be mounted so that the line of acceleration is at right angles to the travel of the plunger. The maximum available overtravel should be used.

### Direct Current

Direct current (DC) ratings where shown should not be exceeded if destructive arcing and contact welding are to be avoided.

Some form of arc suppression is recommended when switches are used in DC circuits containing inductive devices wired in series with the switch and the supply.

### Lamp Loads

Because of the very high inrush currents associated with incandescent lamps, applications should be subject to individual assessment.

### Capacitive Loads (including fluorescent lamps)

These can generate very high peak currents which can cause contact welding. Applications should be subject to individual assessment.

### Inductive Loads

The general ratings tables included in this catalog provide data for switches used to control inductive circuits at a power factor of 0.5 (EN 0.6; UL 0,7 means HP-Rating 0,5).

## Contact Materials

Silver and silver alloys are the primary contact materials used in Burgess switches.

The ratings tables shown refer to switches with silver/silver alloy contacts.

Gold contacts should be specified when switches are to be used in low voltage control or logic circuits, especially when long periods of inactivity are expected or when atmospheres with a high sulphur content may be encountered.

Gold contacts are generally available in two forms; gold plated silver alloy contacts, which can also be used at higher currents or gold alloy cross-point

contacts, which are only suitable for switching low currents.

### Gold

Gold plated contacts are recommended for switches to be used in low voltage control or logic circuits, especially when long periods of inactivity are envisaged. Gold flash, a thinner deposit, is applied to certain switch terminals to ensure good solderability even after prolonged storage.

The selection of the appropriate contact material will depend on a number of factors:

- current and voltage
- resistive or inductive load
- inrush current peak
- frequency of switching operations
- atmospheric conditions
- required switching reliability

### Pure silver contacts (standard)

Burgess Snap-Action Switches are normally equipped with pure silver contacts (Ag999). These are suitable for most applications and have satisfactory electrical and thermal properties.

### Gold-plated contacts

Gold-plated contacts (4 µm) are used for low currents of a few mA and voltages below about 20 V (for DC and AC) and for sulphurous atmospheres. They are unsuitable for higher breaking capacities.

### Silver-cadmium oxide contacts

Silver-cadmium oxide (AgCdO 90/10) contacts should be used where high inrush current peaks (30 A or more) are switched on as they tend to weld less at high current loads. They can resist peaks of 80 A or more for several ms provided that they are used with a Burgess Snap-Action Switch with high operating and contact force (80 cN in the free position and total-travel position).

At high breaking capacities, switches fitted with such contacts have about 50% longer life expectancy than those fitted with pure silver contacts. Normally, silver-cadmium oxide contacts are not suitable for voltages under 50 V.

Please ask Burgess if you would like an assessment for your specific application.

---

## Switch Actuation

### Direct Operation

Actuating plungers should be operated in the direction of their axis. Where this is not possible the use of actuating levers is recommended. For direct actuation the attack angle should not exceed 30°.

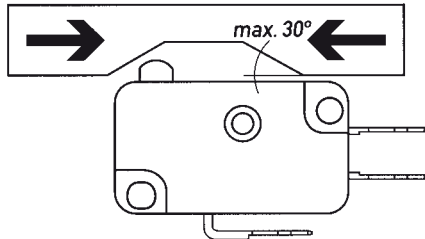

*Actuation by sliding cams.*

### Actuating Levers

Various lever types are available for use with Burgess switches. They are generally stainless steel. If roller or cam-follower levers are approached in the reverse direction, care must be taken to ensure that the angle of approach is small enough not to jam the lever.

### Actuation by Cams

Cam-follower levers are particularly well suited for use with plastic actuating cams. Abrupt actuation or release of switch actuators shortens the life of the switches. For this reason cam should preferably provide a continuous movement. Ideally they should be of cycloidal form.

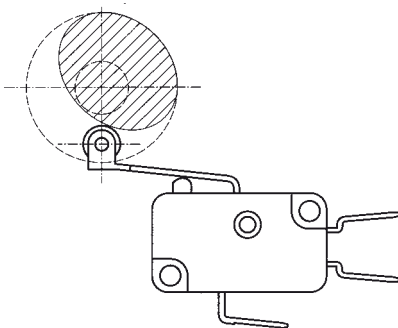

*Long roller lever with continuous actuation*

## Environmental Protection

### Protection Classifications

The protection classes of Burgess switches are in accordance with IEC 529 and are covered by just four codes.

#### IP40

Adequate protection against solids such as probing fingers and small wires >1mm. Liquids however can gain access and, unless externally protected, the switches should be mounted in dry or well-sheltered positions.

#### IP5K4

Good protection against solid foreign bodies, including dust and water splashing against the enclosure from any direction.

Switches may be used out of doors if sheltered from the worst of the elements or on factory machines subjected to normal washing down procedures.

#### IP65

Complete protection against solids, including dust, and against low pressure jets of water from all directions.

#### IP6K7

Complete protection against solids including dust and against immersion in water at a specific pressure for a specified time.

We reserve this code for switches which are factory sealed and tested. Switches should not be immersed in any liquid.

\* International IK code indicates protection against mechanical impact regarding to EN 50102.

### Working Temperatures

For details of the working temperatures applicable to individual types, refer to the appropriate specification sheet. Special versions suitable for temperatures outside these ranges may be possible. Please contact us for information.

All quoted temperatures assume stable operation. They do not imply an ability to withstand excessive cycling within the range.

## Health & Safety

Burgess has ensured, so far as it is reasonably practicable, that their products are as described in this catalog or in other current company publications, or as specified on Burgess

installation drawings. They have been so designed and constructed as to be safe and without risk to health when installed by suitably qualified personnel in accordance with relevant legislation, codes of practice, regulations (including IEE Wiring Regulations), the installation recommendations offered by the company and the accepted rules of the art. Their usage should be confined within the ratings limitations and parameters of application indicated in this catalog and elsewhere.

Please contact us should you need additional information or guidance.

## Service Recommendations

### Maintenance

Burgess switches are not user-maintainable but they should be kept in a reasonably clean, paint-free condition, especially in the actuator area. Regular checks should be made on mounting security and on the actuating medium to switch actuator relationship.

Lubrication or the use of aqueous or chemical cleaning fluids is not recommended.

## Installation Recommendations

The following notes are intended merely to stress the most important and general aspects of good switch installation procedure and to provide some helpful additional information. Safety Consideration

Installation should only be carried out by competent personnel.

### Switch Positioning and Operation

Pre-loading of the switch actuator must be avoided. The actuating medium must be able to operate the switch through the operating position into overtravel and then to retract far enough to allow the switch to regain its free position.

Burgess recommends that the actuating medium should drive the switch into at least 50% of the available overtravel.

All ratings tables shown in this catalog are based on the use of all the available overtravel.

### Mounting

Side mounting switches should be mounted on smooth, firm, flat surfaces using the recommended screw size. Avoid over tightening the screws. For added security, they should be locked using epoxy resin. Do not attempt to enlarge switch mounting holes and avoid over stressing the switch. Use insulating material between the switch and metallic plates to increase clearance on switches with open terminals.

### Connections

When soldering, overheating of the switch insulation must be avoided. In certain circumstances, it may be advisable to use a heat shunt. For optimum mechanical strength, the conductor should be wrapped round the tip of the terminal taking care to avoid loose strands of wire.

The soldering iron tip should be applied to the end of the terminal while simultaneously applying solder. Remove the iron as soon as the solder has wetted the conductor and terminal end. A soldering iron tip temperature of 350°C (260°C/5 seconds for PCB Terminals) applied for a maximum of 2-3 seconds should be adequate.

For lead-free solder, is usually needed an iron tip temperature 15% higher.

## Installation Recommendations (EN 61058-1)

Mounting Holes and Screw sizes				Mounting Screw Torque	
Normal hole Diameter (mm)	Diameter (in)	Metric	Unified Thread	For guidance when using	
		Screw	Screw	mild steel screws:	
2.2/2.5	0.067/0.091	M2	#2	M2 or #2 screws	0.15Nm
3.1/3.2	0.122/0.126	M3	#4	M3 or #4 screws	0.5Nm
3.6/3.7	0.142/0.146	M3.5	#6	M3.5 or #6 screws	0.8Nm
5.1/5.2	0.201/0.205	M5	#10	M5 or #10 screws	3.0Nm

# Snap-action Microswitches

## Ultraminiature



Type	F1	F4	F5	F1NS	F6
Characteristics	<ul style="list-style-type: none"> <li>small size</li> <li>high current</li> <li>long mechanical life</li> <li>PCB mounting</li> </ul>	<ul style="list-style-type: none"> <li>small size</li> <li>long mechanical and electrical life</li> <li>solder</li> <li>2 mm faston</li> <li>PCB terminals</li> </ul>	<ul style="list-style-type: none"> <li>small switch</li> <li>long mechanical and electrical life</li> <li>PCB mounting</li> </ul>	<ul style="list-style-type: none"> <li>small size</li> <li>low current</li> <li>long mechanical life</li> <li>PCB mounting</li> <li>sealed IP54 (option)</li> </ul>	<ul style="list-style-type: none"> <li>small size</li> <li>sealed (IP6K7)</li> <li>PCB mounting</li> </ul>
Rating	250 VAC, 5 A	250 VAC, 5 A	250 VAC, 5 A	up to 250 VAC, 1 A	12–30 VDC, 5–300 mA
Dimensions (mm)	16 × 6 × 6.5	12.8 × 10 × 5	12.8 × 7 × 5	16 × 6.5 × 6	14.7 × 9 × 5.4
Actuator	<ul style="list-style-type: none"> <li>plunger</li> <li>plain lever</li> <li>simulated roller lever/cam follower</li> </ul>	<ul style="list-style-type: none"> <li>plunger</li> <li>plain lever</li> <li>simulated roller lever/cam follower</li> </ul>	<ul style="list-style-type: none"> <li>plunger</li> <li>plain lever</li> <li>simulated roller lever/cam follower</li> </ul>	<ul style="list-style-type: none"> <li>plunger</li> <li>plain lever</li> <li>simulated roller lever/cam follower</li> </ul>	<ul style="list-style-type: none"> <li>plunger</li> <li>plain lever</li> </ul>
Approvals	UL, CSA	UL, CSA	UL, CSA	none	none
Page	18	21	24	27	30

## Subminiature

## Miniature sealed



Type	FK4	V4L	V3S
Characteristics	<ul style="list-style-type: none"> <li>double break switching</li> <li>long mechanical and electrical life</li> <li>solder, 2 mm faston and PCB mounting</li> <li>snap-action</li> </ul>	<ul style="list-style-type: none"> <li>long overtravel of 2.2 mm minimum</li> <li>sealed to IP6K7 option</li> <li>pre-wired option</li> <li>solder terminals</li> <li>compliant to glow wire test IEC 60335-1, 4. ed. as optional item</li> </ul>	<ul style="list-style-type: none"> <li>sealed (IP67)</li> <li>flying leads</li> <li>robust construction</li> </ul>
Rating	250 VAC, 5 A	250 VAC, 5 A	250 VAC, 5 A
Dimensions (mm)	18 × 8 × 5	20 × 11 × 6.4	32 × 24 × 10
Actuator	<ul style="list-style-type: none"> <li>plunger</li> <li>plain lever</li> <li>simulated roller lever/cam follower</li> </ul>	<ul style="list-style-type: none"> <li>plunger</li> <li>plain lever</li> <li>ice break lever</li> </ul>	<ul style="list-style-type: none"> <li>plunger</li> <li>plain levers</li> <li>roller levers</li> </ul>
Approvals	UL, CSA	ENEC, UL, CSA	UL, CSA, ENEC
Page	33	37	42



# Snap-action Microswitches

## Standard



## Metal housed



Type **PN4**

**3BR**

**K5**

**V9N**

**4BR**

Characteristics

- precision switching
- long mechanical life
- screw terminals

- choice of IP54 or IP67 sealed versions
- precise movements and exceptional repeat accuracy
- flying lead version available
- long overtravel

- double break switching
- long mechanical life
- high electrical rating
- faston terminals

- sealed (IP67)
- metal housed
- screw terminals or flying leads

- choice of IP54 or IP67 sealed versions
- precise movements and exceptional repeat accuracy
- robust metal housing
- flying lead version available
- long overtravel

Rating 250 VAC, 15 A

250 VAC, 10 A max.

250 VAC, 16 A

250 VAC, 10 A max.

250 VAC, 15 A max.

Dimensions (mm) 49 × 22 × 17.5

53.1 × 20.6 × 30.8

41 × 19 × 15.5

42 × 24.5 × 16

53.1 × 20.6 × 29.2

Actuator

- plunger
- plain lever
- roller lever

- plunger

- plunger
- ramp plunger
- plain lever
- roller lever

- plunger
- plain levers
- reverse action levers
- roller levers

- plunger

Approvals UL, CSA

UL, CSA

UL, CSA

UL, CSA

UL, CSA

Page 46

50

52

56

60

## Miniature



## Standard



## Forced break



Type **BVM3**

**KB5**

**XP**

**XT**

Characteristics

- positive-action (forced break) contacts
- > 3 mm contact gap at full travel
- internationally recognized V3 housing
- faston terminals

- positive-action forced double break switching
- > 3 mm contact gap at full travel
- high electrical rating
- faston terminals

- double break switching
- positive-action force break option
- > 3 mm contact gap at full travel option
- faston terminals

- 8 mm contact gap, creepage and clearance distances
- double break contacts

Rating 250 VAC, 10 A

up to 250 V, 25 A

400 VAC, 16 A

400 VAC, 16.5 A max.

Dimensions (mm) 28 × 16 × 10.5

41 × 19.5 × 15.5

30 × 32 × 12

30 × 32 × 12

Actuator

- plunger
- plain lever
- roller lever

- plunger
- plain lever
- roller levers

- plain plunger
- mushroom plunger
- plunger with external spring (for increased reset security)

- shrouded plunger
- optional key
- plain plunger

Approvals UL, CSA and ENEC

UL, CSA

ENEC, UL, CSA

UL, cUL, CSA, ENEC

Page 64

67

71

74



# Coil spring mechanism Microswitch



Dimensions

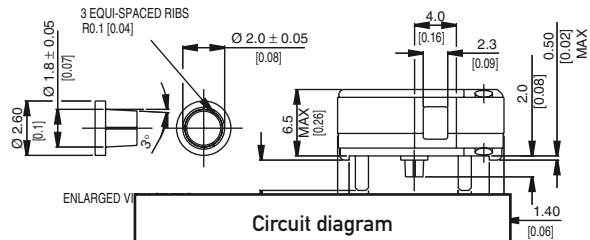

Circuit diagram

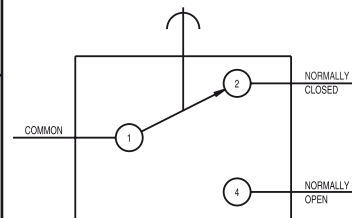

# F1

## F1

- Characteristics
- small size
  - high current
  - long mechanical life
  - PCB mounting

Rating 250 VAC, 5 A

Dimensions (mm) 16 × 6 × 6.5

- Actuator
- plunger
  - plain lever
  - simulated roller lever/cam follower

Approvals UL, CSA



## Preferred Range

Ordering Reference	Actuating Force		Sealing	Operating pos.		Terminal	Circuit	Actuator	Contacts	Electrical rating
	(N)	(ozf)		(mm)	(in)					
F1T8GPUL	1,4	5,00	IP40	6,35	0,25	PCB	CO	Plunger	Gold plate	Up to 250 VAC, 5 A
F1T8Y1GPUL	0,5	1,8	IP40	8,5	0,33	PCB	CO	Lever	Gold plate	Up to 250 VAC, 5 A

## Specifications

Housing	Glass fibre reinforced nylon
Plunger	Nylon
Mechanism	Snap-action, coil spring mechanism with stainless steel spring
Functions	Single pole change-over
Contacts	Gold plate on silver
Terminals	PCB - copper, gold-flashed
Temperature range °C	-40°C to +85°C
Mechanical life	10 <sup>6</sup> cycles minimum (impact-free actuation)
Protection	IP40 (enclosure)
Mounting	Side mount PCB with locating pin on housing
Actuators	Plain plunger, straight lever

Circuit diagram

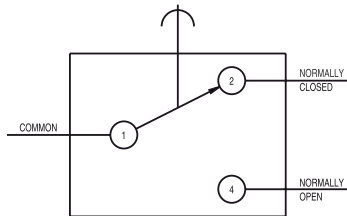

## Dimensions

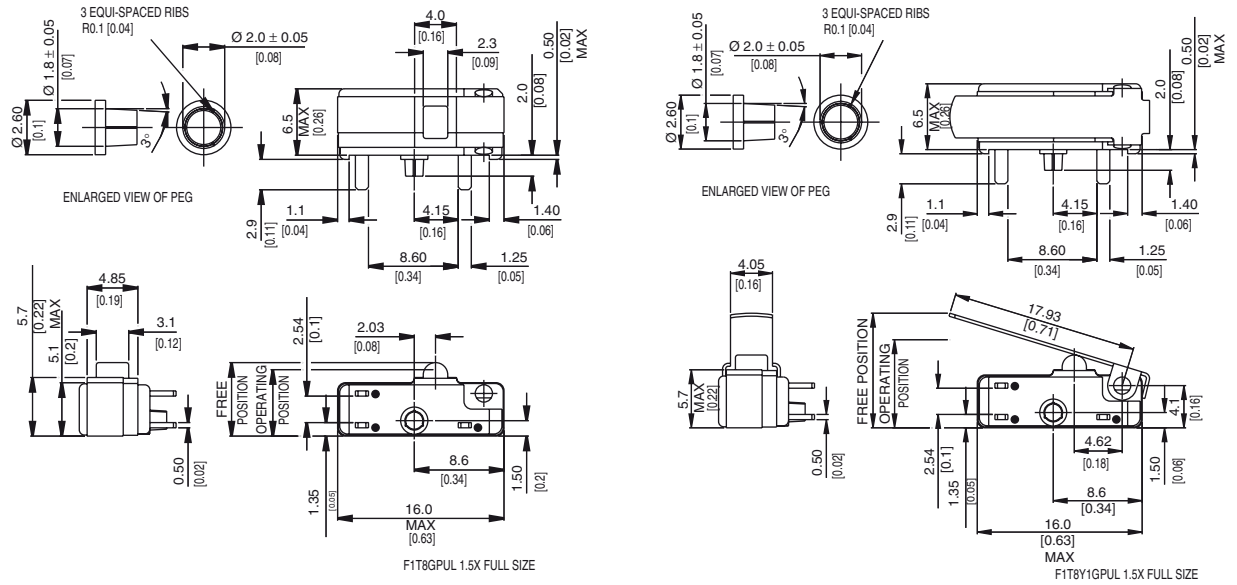

## Recommended maximum electrical ratings

Voltage (max)	Resistive load (A)	Inductive load	Approval
250 VAC	5 (0.75 pf)	5	UL 1054/CSA 22.2 No. 55 - 6,000 operations
0 - 15 VDC	5		General rating - 50,000 operations
15 - 30 VDC	10	10	General rating - 50,000 operations

## Operating Characteristics

Actuator	Reference	Actuating Force		Release Force		Free Position		Operating Position		Movement Differential		Over Travel	
		(N)	(ozf)	(N)	(ozf)	(mm)	(in)	(mm)	(in)	(mm)	(in)	(mm)	(in)
Plunger	F1T8GPUL	1.4	5.00	0.28	1.00	7.1	0.28	6.35 ± 0.38	0.25 ± 0.015	0.1	0.004	*	
Straight lever	F1T8Y1GPUL	0.5	1.8	0.06	0.022	11.0	0.43	8.5 ± 1.5	0.33 ± 0.06	0.5	0.02	*	

Width of lever 4.05 mm/0.16 in

\* Plunger can be depressed flush with housing. The housing should not be used as an end stop.

## Ordering Reference

Basic type	F1	Example: F1   T8   Y1   GP   UL			
Terminals	T8	PCB	1.25 × 0.5 × 2.9 long		
Actuators	Y1	No symbol, without lever			
	YR1	Plain lever 21.0 mm			
		Roller lever 16.0 mm			
Contacts Material	GP	No symbol, Ag			
		Gold plate on Ag (GP)			
Approvals	UL	No symbol, without approval			
		UL and CSA approval			
Special Features	/ <input type="checkbox"/> <input type="checkbox"/> <input type="checkbox"/> <input type="checkbox"/>	Burgess specialise in customer specific solutions. Additional product variants are available or can be provided. If your requirements cannot be satisfied from the options listed, please contact <a href="http://www.saia-burgess.com">www.saia-burgess.com</a> or your local SB outlet.			

## F4

Characteristics	<ul style="list-style-type: none"> <li>■ small size</li> <li>■ long mechanical and electrical life</li> <li>■ solder</li> <li>■ 2 mm faston</li> <li>■ PCB terminals</li> </ul>
Rating	250 VAC, 5 A
Dimensions (mm)	12.8 × 10 × 5
Actuator	<ul style="list-style-type: none"> <li>■ plunger</li> <li>■ plain lever</li> <li>■ simulated roller lever/cam follower</li> </ul>
Approvals	UL, CSA



## Preferred Range

Ordering Reference	Actuating Force (N) (ozf)		Sealing	Operating pos. (mm) (in)		Terminal	Circuit	Actuator	Contacts	Electrical rating
F4T7UL	1.4	5.00	IP40	8.1	0.32	Solder	CO	Plunger	Ag	Up to 250 VAC, 5 A
F4T7GPUL	1.4	5.00	IP40	8.1	0.32	Solder	CO	Plunger	Gold plate	Up to 250 VAC, 5 A
F4T7Y1UL	0.6	2.20	IP40	8.2	0.32	Solder	CO	Plain lever	Ag	Up to 250 VAC, 5 A
F4T7Y1GPUL	0.6	2.20	IP40	8.2	0.32	Solder	CO	Plain lever	Gold plate	Up to 250 VAC, 5 A
F4T7YCUL	0.7	2.50	IP40	10.3	0.41	Solder	CO	Simulated roller	Ag	Up to 250 VAC, 5 A
F4T7YCGPUL	0.7	2.50	IP40	10.3	0.41	Solder	CO	Simulated roller	Gold plate	Up to 250 VAC, 5 A

## Specifications

Housing	Glass fibre reinforced nylon
Plunger	Nylon
Mechanism	Snap-action, single pole
Functions	Change-over, Normally open, Normally closed
Contacts	Fixed, Moving – Ag or Gold plate on Ag
Terminals	2.0 mm (0.08 in) faston and solder - brass, gold flashed
Temperature range °C	-40°C to +85°C
Mechanical life	10 <sup>7</sup> cycles minimum (impact free actuation)
Protection	IP 40 (enclosure)
Mounting	Side mounting
Actuators	Plain lever; simulated roller (cam follower) lever
Accessories	Lug mounting frame, insulating sheet, spring-leaf actuator

Circuit diagram

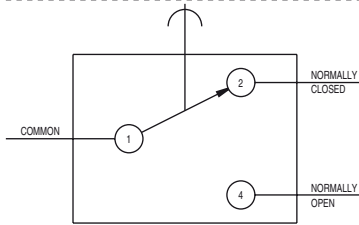

Dimensions

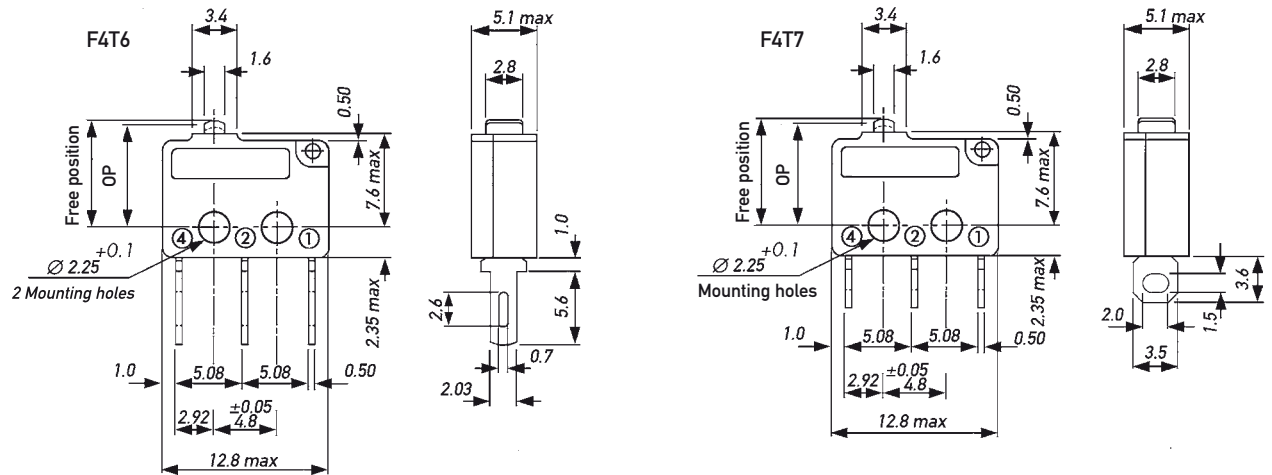

## Recommended maximum electrical ratings

Voltage (max)	Load (A)	Approval
250 VAC	5 (0.75 pf)	UL 1054/CSA 22.2 No. 55 - 6,000 operations
125 VAC	5 (0.75 pf)	UL 1054/CSA 22.2 No. 55 - 6,000 operations
0 - 15 VDC	5	General rating - 50,000 operations
15 - 30 VDC	3	General rating - 50,000 operations



## Operating Characteristics

Actuator	Reference	Actuating Force Maximum		Release Force Minimum		Free Position Maximum		Operating Position		Movement Differential Maximum		Over travel		
		(N)	(ozf)	(N)	(ozf)	(mm)	(in)	(mm)	(in)	(mm)	(in)			
Plunger	F4T6	1.4	5.00	0.25	0.90	8.8	0.35	8.1	+0.3 -0.2	0.32	+0.01 -0.008	0.13	0.005	*
	F4T7													
Y1-Lever	F4T6Y1	0.6	2.20	0.07	0.25	10.0	0.39	8.2	+1.0 -0.7	0.32	+0.04 -0.03	0.70	0.030	*
	F4T7Y1													
YC-Lever	F4T6YC	0.7	2.50	0.09	0.32	11.7	0.46	10.3	+0.8 -0.55	0.41	+0.03 -0.02	0.45	0.020	*
	F4T7YC													

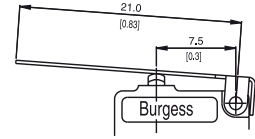
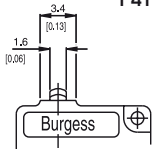

Width of lever 3.0 mm/0.12 in

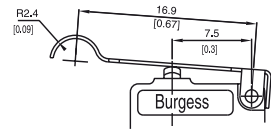

Width of lever 3.0 mm/0.12 in

Operating characteristics are specified from the mounting holes.

\* Plunger can be depressed flush with housing. The housing should not be used as an end stop.

## Ordering Reference

Basic type	F4	Example: F4   T6   C2   Y1   GP   UL											
Terminals	T6	Faston	2.03 × 0.5 × 6.6 long										
	T7	Solder	3.50 × 0.5 × 3.6 long										
	T8	PCB	0.8 × 0.5 × 4.0 long										
Circuit	C2	No symbol, change-over Normally closed											
	C4	Normally open											
Actuators	Y1	No symbol, without lever Plain lever 21.0 mm											
	YC	Cam follower lever 16.9 mm											
Contacts Material	GP	No symbol, Ag Gold plate on Ag (GP)											
Approvals	UL	No symbol, without approval UL and CSA approval											
Special Features	/	Burgess specialise in customer specific solutions. Additional product variants are available or can be provided. If your requirements cannot be satisfied from the options listed, please contact <a href="http://www.saia-burgess.com">www.saia-burgess.com</a> or your local SB outlet.											

# F5

## F5

Characteristics	<ul style="list-style-type: none"> <li>■ small switch</li> <li>■ long mechanical and electrical life</li> <li>■ PCB mounting</li> </ul>
Rating	250 VAC, 5 A
Dimensions (mm)	12.8 × 7 × 5
Actuator	<ul style="list-style-type: none"> <li>■ plunger</li> <li>■ plain lever</li> <li>■ simulated roller lever/cam follower</li> </ul>
Approvals	UL, CSA



## Preferred Range

Ordering Reference	Actuating Force (N) (ozf)		Sealing	Operating pos. (mm) (in)		Terminal	Circuit	Actuator	Contacts	Electrical rating
F5T8UL	1.4	5.00	IP40	8.75	0.34	PCB	CO	Plunger	Ag	Up to 250 VAC, 5 A
F5T8GPUL	1.4	5.00	IP40	8.75	0.34	PCB	CO	Plunger	Gold plate	Up to 250 VAC, 5 A
F5T8Y1UL	0.6	2.20	IP40	8.80	0.35	PCB	CO	Plain lever	Ag	Up to 250 VAC, 5 A
F5T8Y1GPUL	0.6	2.20	IP40	8.80	0.35	PCB	CO	Plain lever	Gold plate	Up to 250 VAC, 5 A
F5T8YCUL	0.7	2.50	IP40	10.90	0.43	PCB	CO	Simulated roller	Ag	Up to 250 VAC, 5 A
F5T8YCGPUL	0.7	2.50	IP40	10.90	0.43	PCB	CO	Simulated roller	Gold plate	Up to 250 VAC, 5 A

## Specifications

Housing	Glass fibre reinforced nylon
Plunger	Nylon
Mechanism	Snap-action, single pole
Functions	Change-over, Normally open, Normally closed
Contacts	Fixed, Moving – Silver or Gold plate on silver
Terminals	PCB – Brass, gold flashed
Temperature range °C	-40°C to +85°C
Mechanical life	10 <sup>7</sup> cycles minimum (impact free actuation)
Protection	IP 40 (enclosure)
Mounting	PCB
Actuators	Plain lever; simulated roller (cam follower) lever

Circuit diagram

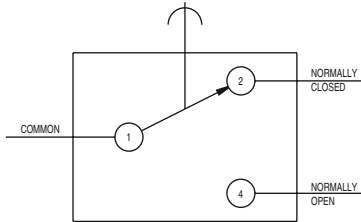

Dimensions

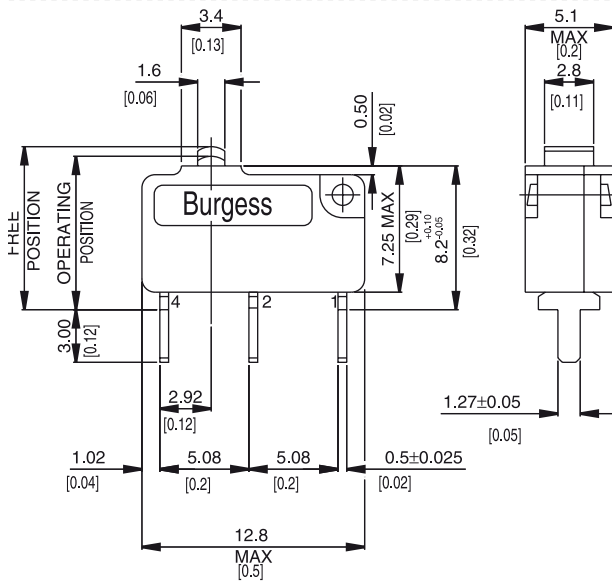

## Recommended maximum electrical ratings

Voltage (max)	Load (A)	Approval
250 VAC	5 (0.75 pf)	UL 1054/CSA 22.2 No. 55 - 6,000 operations
125 VAC	5 (0.75 pf)	UL 1054/CSA 22.2 No. 55 - 6,000 operations
0 - 15 VDC	5	General rating - 50,000 operations
15 - 30 VDC	1	General rating - 50,000 operations

## Operating Characteristics

Actuator	Reference	Actuating Force Maximum		Release Force Minimum		Free Position Maximum		Operating Position		Movement Differential Maximum		Over travel
		(N)	(ozf)	(N)	(ozf)	(mm)	(in)	(mm)	(in)	(mm)	(in)	
Plunger	F5T8	1.4	5.00	0.25	0.90	9.5	0.37	8.75 ± 0.3	0.34 ± 0.012	0.13	0.005	*
Y1-Lever	F5T8Y1	0.6	2.20	0.07	0.25	10.7	0.42	8.8 ± 1.1	0.35 ± 0.04	0.70	0.030	*
<p>Width of lever 3.0 mm/0.12 in</p>												
YC-Lever	F5T8YC	0.7	2.50	0.09	0.32	12.4	0.49	10.9 ± 0.85	0.43 ± 0.03	0.45	0.020	*
<p>Width of lever 3.0 mm/0.12 in</p>												

Operating characteristics are specified from the terminal shoulder.

\* Plunger can be depressed flush with housing. The housing should not be used as an end stop.

## Ordering Reference

Basic type	F5	Example: F5 T8 C2 Y1 GP UL										
Terminals	T8	PCB	1.27 × 0.5 × 3.0 long									
Circuit	C2	No symbol, change-over Normally closed										
	C4	Normally open										
Actuators	Y1	No symbol, without lever Plain lever 21.0 mm										
	YC	Cam follower lever 16.9 mm										
Contact Material	GP	No symbol, Ag Gold plate on Ag (GP)										
Approvals	UL	No symbol, without approval UL and CSA approval										
Special Features	/	<p>Burgess specialise in customer specific solutions. Additional product variants are available or can be provided. If your requirements cannot be satisfied from the options listed, please contact <a href="http://www.saia-burgess.com">www.saia-burgess.com</a> or your local SB outlet.</p>										

# F1NS

## F1NS

- Characteristics
- small size
  - low current
  - long mechanical life
  - PCB mounting
  - sealed IP54 (option)



Rating Up to 250 VAC, 1 A

Dimensions (mm) 16 × 6.5 × 6

- Actuator
- plunger
  - plain lever
  - simulated roller lever/cam follower

Approvals none

## Preferred Range

Ordering Reference	Actuating Force (N) (ozf)		Sealing	Operating pos. (mm)	Terminal	Circuit	Actuator	Contacts	Electrical rating
F1NST8	2,0	7,2	IP5K4	5,9	PCB	CO	Plunger	Ag	250 VAC, 1 A
F1NST8A1	0,6	2,2	IP5K4	7,6	PCB	CO	Plain lever	Ag	250 VAC, 1 A
F1NST8AC	0,6	2,2	IP5K4	10,1	PCB	CO	Cam follower	Ag	250 VAC, 1 A

## Specifications

Housing	Base: PA 6.6; Cowl: Silicon; Lid: PA 6.6
Plunger	POM
Mechanism	Snap-action, coil spring mechanism with stainless steel spring. Single-pole change-over contact
Contacts	Fine silver, Gold plate on silver
Terminals	PCB silver plated
Temperature range °C	-40°C bis +85°C
Mechanical life	10 <sup>7</sup> cycles minimum (impact-free actuation)
Protection	Enclosure IP40 (F1N), IP54 (F1NS)
Mounting	PCB. Locating pins on housing

Circuit diagram

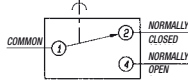

Dimensions

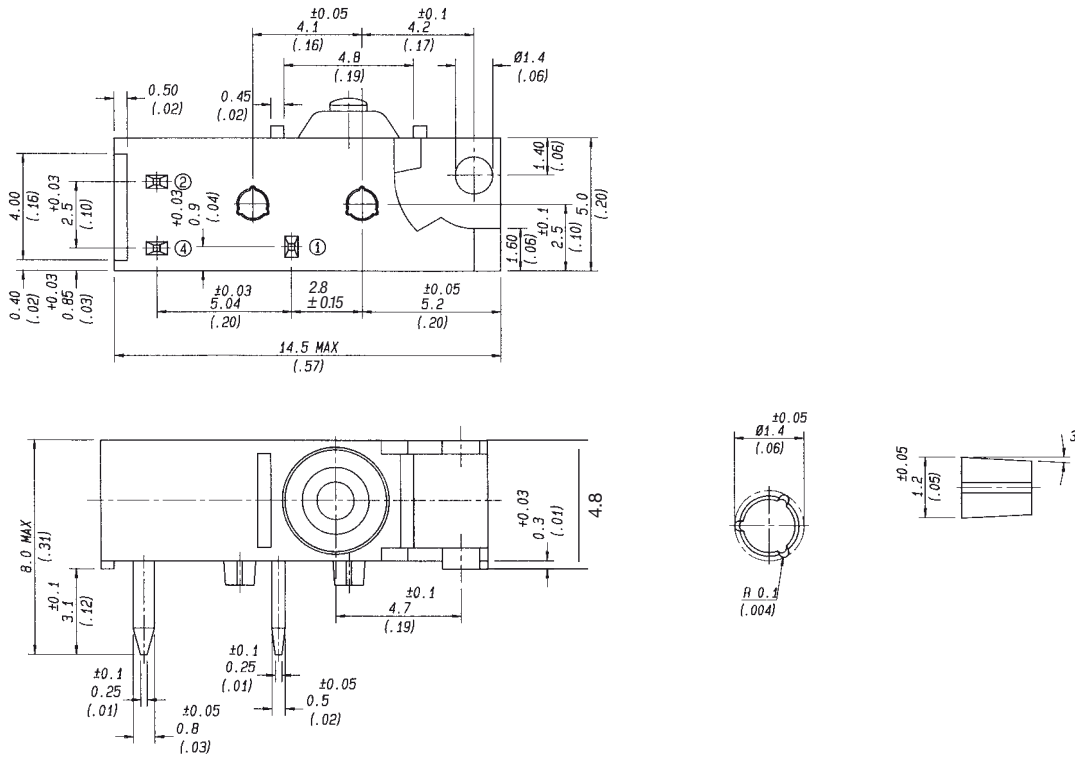

## Recommended maximum electrical ratings

Voltage (VAC)	Resistive load (A)	Inductive load (A)	Voltage (VAC)	Resistive load (A)	Inductive load (A)
125	1	1	up to		
250	1	1	30	2	2
			50	0.5	0.5
			75	0.25	0.25
			125	0.2	0.03

## Operating Characteristics

Actuator	Reference	Actuating Force Maximum		Release Force Minimum		Free Position Maximum		Operating Position		Movement Differential Maximum		Total travelled position Maximum	
		(N)	(ozf)	(N)	(ozf)	(mm)	(in)	(mm)	(in)	(mm)	(in)	(mm)	(in)
Plunger	F1NST8	2	7.20	0.2	0.72	6.5	0.26	5.9 ± 0.2	0.23 ± 0.008	0.2	0.008	*	



A1-Lever	F1NST8A1	0.6	2.20	0.09	0.32	10.5	0.41	7.6 ± 1.2	0.3 ± 0.05	0.7	0.03	*	
----------	----------	-----	------	------	------	------	------	-----------	------------	-----	------	---	--

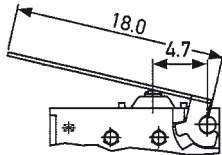

Width of lever 3 mm/0.12 in

AC-Lever	F1NST8AC	0.6	2.20	0.09	0.32	13.3	0.52	10.1 ± 1.2	0.4 ± 0.05	0.7	0.03	*	
----------	----------	-----	------	------	------	------	------	------------	------------	-----	------	---	--

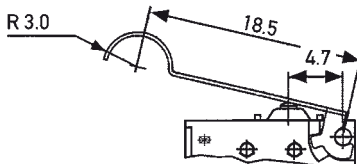

Width of lever 3 mm/0.12 in

Datum for Free Position and Operating Position: base of switch opposite plunger.

\* Flush with case. The case should not be used as an end stop.

## Ordering Reference

Basic type	F1N	Example: F1N	S	T8	C2	A	AU
Type of sealing	S	No symbol, unsealed Sealed IP5K4					
Terminals	T8	PCB 0.8 × 0.5 × 3.45 long					
Circuit	C2 C4	No symbol, change-over Normally closed Normally open					
Actuators	A A1 AC	No symbol, without lever Special lever A type (see specification) Plain lever 18.0 mm Cam follower lever 18.5 mm					
Contact Material	AU GP	No symbol, Ag Gold on nickel Gold plate on Ag (GP)					
Special Features	/ <input type="checkbox"/> <input type="checkbox"/> <input type="checkbox"/> <input type="checkbox"/>	Burgess specialise in customer specific solutions. Additional product variants are available or can be provided. If your requirements cannot be satisfied from the options listed, please contact <a href="http://www.saia-burgess.com">www.saia-burgess.com</a> or your local SB outlet.					

# F6

## F6

Characteristics ■ small size  
■ sealed (IP6K7)  
■ PCB mounting

Rating 12–30 VDC, 5–300 mA

Dimensions (mm) 14.7 × 9 × 5.4

Actuator ■ plunger  
■ plain lever

Approvals none



## Preferred Range

Ordering Reference	Actuating Force (N)	Sealing	Operating pos. (mm)	Terminal	Circuit	Actuator	Contacts	Electrical rating
F6T85	1,6	IP6K7	10,8	PCB	CO	Plunger	Gold plated	30 VDC, 300 mA



## Specifications

Base	PBT
Lid	PP GF30
Plunger	POM
Mechanism	Leaf spring
Contacts	Gold plated on silver
Terminals	CuZn silver plated
Temperature range °C	-40°C up to +90°C
Mechanical life	Up to 1 mio. cycles
Protection	IP67
Actuators	Plain plunger, lever, cam follower
Cowl	TPE

Circuit diagram

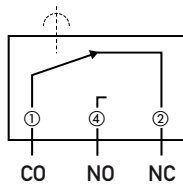

Dimensions

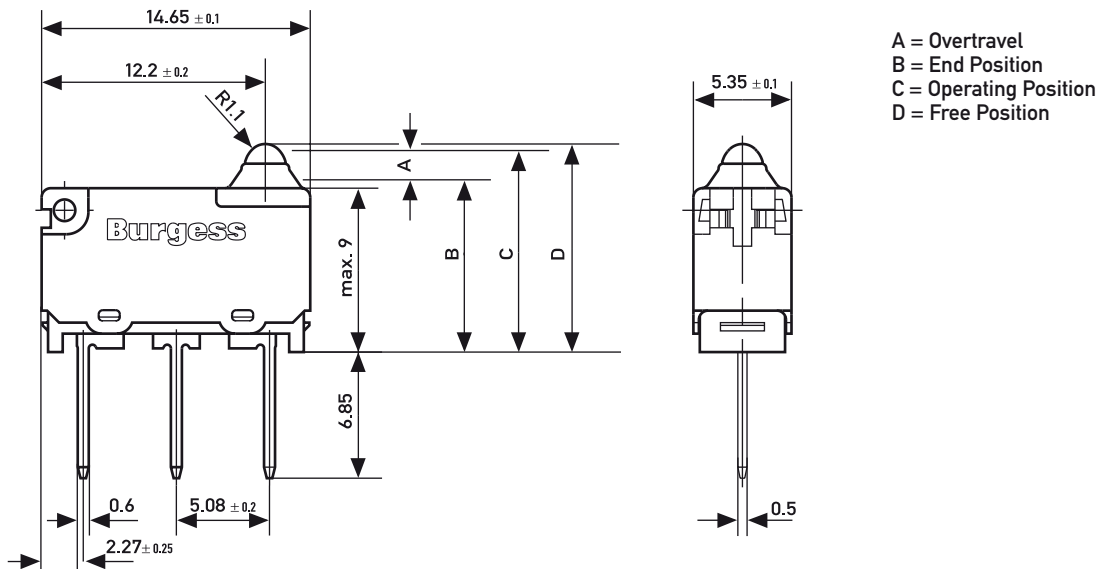

## Recommended maximum electrical ratings

Voltage (VDC)	Resistive load (A)	Cycles
F6 12 to 30	0.005 – 0.3	500.000

## Operating Characteristics

Actuator	Reference	Actuating Force Maximum (N)	Release Force Minimum (N)	Free Position Maximum (mm)	Operating Position (mm)	Movement Differential Maximum (mm)	Total travelled positions Maximum (mm)
Plunger	F6T85	1.6	0.2	11.35	10.8 ± 0.2	0.3	9.5

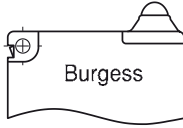

H-Lever	F6T85H	For positions and forces of this actuator please contact Saia Burgess					
		2.5	0.5	12.9	11.3 + 0.35	0.45	

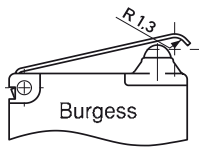

Width of lever 3.0 mm/0.12 in

Datum for free position and operating position is button edge of base (stand-off's).  
The case should not be used as an end stop.

## Ordering Reference

Basic type	F6	Example: F6 T8 C2 H			
Terminals	No symbol, pre-wired 500 mm with cable box K				
T8	PCB	0.6 × 0.5 × 4.0 long			
T81	Formed PCB	side B			
T82	Formed PCB	side A			
T84	Short PCB	0.6 × 0.5 × 2.0 long			
T85	Long PCB	0.6 × 0.5 × 6.85 long			
T87	Long PCB	side A, for flexible PCB			
T88	Long PCB	side B, for flexible PCB			
Circuit	No symbol, change-over				
C2	Normally closed				
C4	Normally open				
Actuators	No symbol, without lever				
H	Formed, lever 0.3 mm thickness				
Y	Special lever Y-clip-on				
Y1	Plain lever mm				
YC	Cam follower lever				
HC	Cam follower				
Contact Material	No symbol, Ag, gold plated				
Special Features	/ <input type="checkbox"/> <input type="checkbox"/> <input type="checkbox"/> <input type="checkbox"/>	Burgess specialise in customer specific solutions. Additional product variants are available or can be provided. If your requirements cannot be satisfied from the options listed, please contact <a href="http://www.saia-burgess.com">www.saia-burgess.com</a> or your local SB outlet.			

## FK4

Characteristics	<ul style="list-style-type: none"> <li>■ double break switching</li> <li>■ long mechanical and electrical life</li> <li>■ solder, 2 mm faston and PCB mounting</li> <li>■ snap-action</li> </ul>
Rating	250 VAC, 5 A
Dimensions (mm)	18 × 8 × 5
Actuator	<ul style="list-style-type: none"> <li>■ plunger</li> <li>■ plain lever</li> <li>■ simulated roller lever/cam follower</li> </ul>
Approvals	UL and CSA



## Preferred Range

Ordering Reference	Actuating Force (N)      (ozf)		Sealing	Operating pos. (mm)      (in)		Terminal	Circuit	Actuator	Contacts	Electrical rating
FK4T7UL	1,8	6,5	IP40	8,25	0,32	Solder	SPDT	Plunger	Ag	Up to 250 VAC, 5 A
FK4T7Y1UL	0,8	2,9	IP40	8,25	0,32	Solder	SPDT	Plain lever	Ag	Up to 250 VAC, 5 A
FK4T7YCUL	1,0	3,6	IP40	10,40	0,41	Solder	SPDT	Simulated roller	Ag	Up to 250 VAC, 5 A

## Specifications

Housing	Glass fibre reinforced nylon
Plunger	Nylon
Mechanism	Double pole, single throw snap-action coil spring mechanism with stainless steel springs
Functions	Change-over, NO, NC
Contacts	Silver
Terminals	Solder, PCB - brass, gold flashed
Temperature range °C	-40°C to +85°C
Mechanical life	10 <sup>7</sup> cycles minimum (impact free actuation)
Protection	IP40 (enclosure)
Mounting	Side mounting or PCB mounting (T8 only)
Actuators	Plain lever, simulated roller lever/cam follower
Accessory	Insulating sheet

Circuit diagram

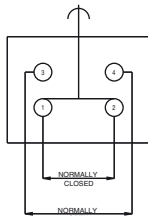

Dimensions

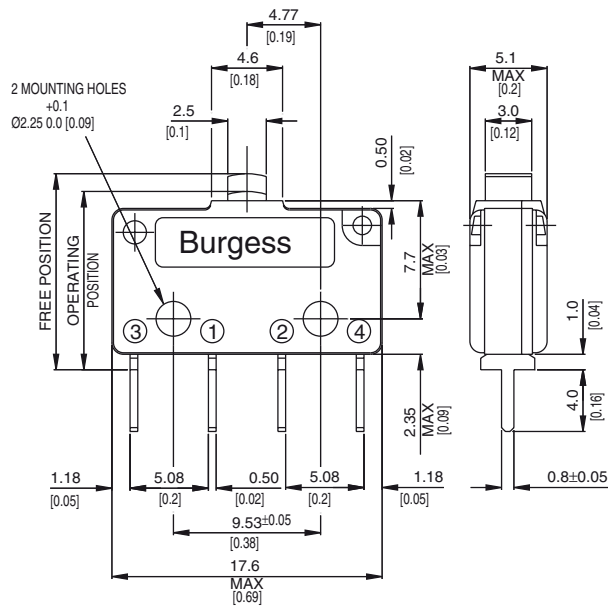

## Recommended maximum electrical ratings

Voltage (max)	Load (A)	Approval
250 VAC	5 (0.75 pf)	UL 1054/CSA 22.2 No. 55 - 6,000 operations
125 VAC	5 (0.75 pf)	UL 1054/CSA 22.2 No. 55 - 6,000 operations
0 - 15 VDC	5	General rating - 50,000 operations
15 - 30 VDC	3	General rating - 50,000 operations

Values shown are recommended maximum ratings for single circuit switching

## Operating Characteristics

Actuator	Reference	Actuating Force Maximum		Release Force Minimum		Free Position Maximum		Operating Position		Movement Differential Maximum	
		(N)	(ozf)	(N)	(ozf)	(mm)	(in)	(mm)	(in)	(mm)	(in)
 Plunger	FK4T7*	1.8	6.50	0.25	0.9	9.4	0.37	8.25 ± 0.25	0.32 ± 0.01	0.50	0.02
	FK4T8 <sup>1)</sup>	1.8	6.50	0.25	0.9	12.75	0.50	11.60 ± 0.45	0.45 ± 0.02	0.50	0.02
 Y1 Lever	FK4T7Y1	0.8	2.90	0.09	0.3	12.1	0.48	8.25 ± 0.9	0.32 ± 0.04	1.85	0.07
	FK4T8Y1	0.8	2.90	0.09	0.3	15.6	0.61	11.55 ± 1.1	0.45 ± 0.04		
Width of lever 3.0 mm/0.12 in											
 YC Lever	FK4T7YC	1.0	3.60	0.1	0.4	13.5	0.53	10.40 ± 0.6	0.41 ± 0.02	1.30	0.05
	FK4T8YC	1.0	3.60	0.1	0.4	17.0	0.67	13.70 ± 0.8	0.54 ± 0.03		
Width of lever 3.0 mm/0.12 in											

Overtravel: Plunger can be depressed flush with housing. The housing should not be used as an end stop.

Datum for free position and operating position

\* FK4T7 – Center of fixing hole

<sup>1)</sup> FK4T8 – Terminal shoulder

## Ordering Reference

Basic type	FK4	Example: FK4 T7 Y1 UL									
Terminals	T7	Solder	0.5 × 3.5								
	T8	PCB	0.5 × 0.8								
Actuators		No symbol, plunger									
	Y1	Plain lever									
	YC	Simulated roller lever/cam follower									
Approvals	UL	UL and CSA									

# Long overtravel Microswitches



Circuit diagram

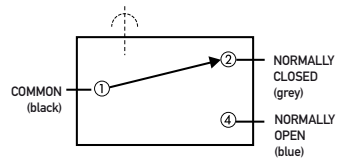

Dimensions

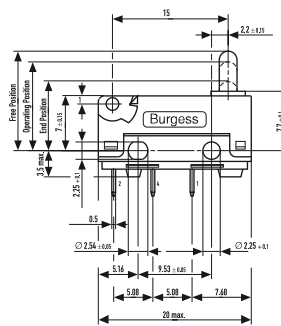

## V4L

Characteristics	<ul style="list-style-type: none"> <li>■ long overtravel of 2.2 mm minimum</li> <li>■ sealed to (IP6K7) option</li> <li>■ pre-wired option</li> <li>■ solder terminals</li> <li>■ compliant to glow wire test IEC 60335-1, 4. ed. as optional item</li> </ul>
Rating	250 VAC, 5 A
Dimensions (mm)	20 × 11 × 6.4
Actuator	<ul style="list-style-type: none"> <li>■ plunger</li> <li>■ plain lever</li> <li>■ ice break lever</li> </ul>
Approvals	ENEC, UL, CSA



## Preferred Range

Ordering Reference	Actuating Force (N)      (ozf)		Sealing	Operating pos. (mm)	Terminal	Circuit	Actuator	Contacts	Electrical rating
V4LS	2.5	9.0	IP6K7	11,7 ± 0,4	Cable 500 mm	CO	Plunger	Ag	250 VAC, 5 A
V4LSA1	2.5	9.0	IP6K7	14,5 ± 0,8	Cable 500 mm	CO	Plain lever	Ag	250 VAC, 5 A
V4LSA2	2.0		IP6K7	16,5 ± 1,0	Cable 500 mm	CO	Plain lever	Ag	250 VAC, 5 A
V4LST7	2.5	9.0	IP6K7	11,7 ± 0,4	Solder	CO	Plunger	Ag	250 VAC, 5 A
V4LST7A1	2.5		IP6K7	14,5 ± 0,8	Solder	CO	Plain lever	Ag	250 VAC, 5 A
V4LST7A2	2.0		IP6K7	14,6 ± 1,0	Solder	CO	Plain lever	Ag	250 VAC, 5 A
V4LT7	2.4	8.6	no symbol	11,7 ± 0,4	Solder	CO	Plunger	Ag	250 VAC, 5 A

## Specifications

Housing	Glass fibre reinforced polyamide (PA 6.6)
Plunger	Polyacetal (POM)
Mechanism	Snap-action coil spring mechanism with stainless steel spring. Change-over, normally closed or normally open
Contact carrier	Brass. Moving contact beryllium-copper
Contacts	Fine silver or gold crosspoint
Terminals	V4L – solder tags V4LS – PVC covered leads 0.5 m long
Temperature range °C	-40°C to +85°C
Mechanical life	V4L $2 \times 10^6$ cycles/min., V4LS $2 \times 10^5$ cycles/min. (impact free actuation)
Protection	V4L series IP40, V4LS series IP6K7, with encapsulated terminals
Mounting	Side mounting to a flat surface
Actuators	Plain lever, Ice break lever
Cowl	Silicon elastomer

Circuit diagram

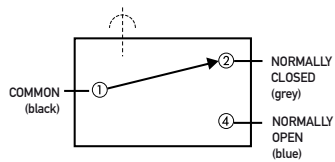

Dimensions

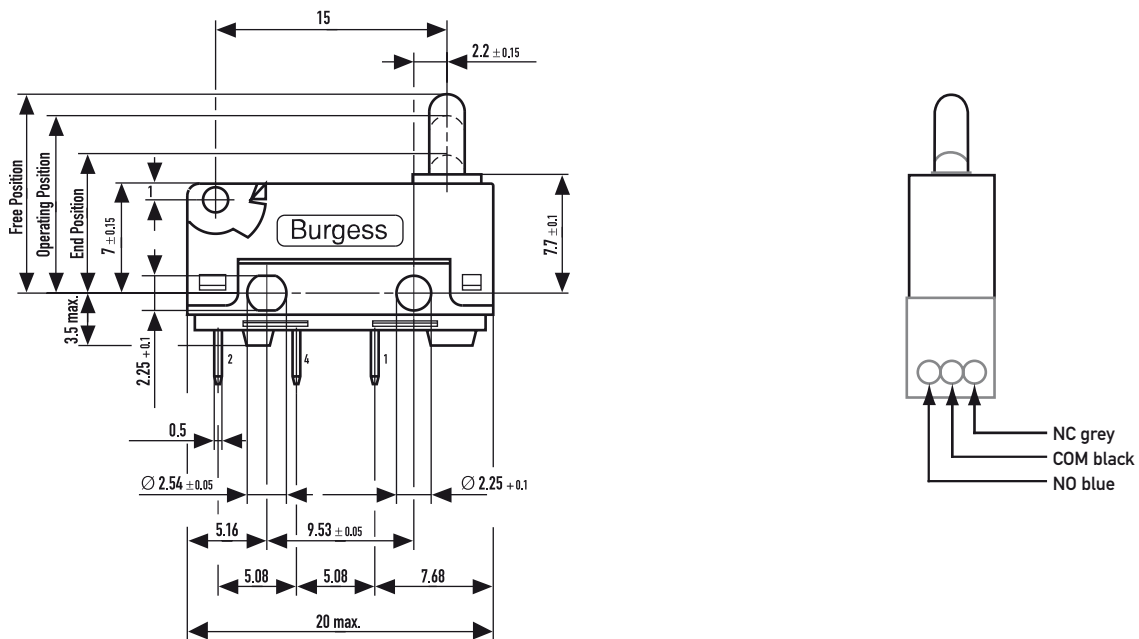

## Recommended maximum electrical ratings

Voltage (VAC)	Resistive load (A) (Ag Contact)	Incandescent lamp load (A) (Ni1 Contact)	Inductive load (A) (Ag Contact)	Voltage (VDC) up to	Resistive load (A) (Ag Contact)	Incandescent lamp load (A) (Ni1 Contact)	Inductive load (A) (Ag Contact)
125	5	2	2	30	5	2	3
250	5	2	2	50	1	0.4	1
				75	0.75	0.3	0.75
				125	0.5	0.2	0.03
				250	0.25	0.1	0.03

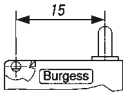
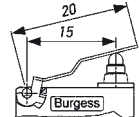
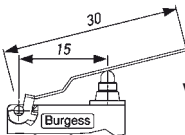
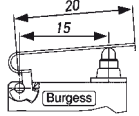

## Ordering Reference

Actuator	Reference	Actuating Force		Release Position		Free Position		Operating		Movement Differential		Total overtravel		Overtravel	
		Maximum (N)	Force (ozf)	Minimum (N)	(ozf)	Maximum (mm)	(in)	(mm)	(in)	Maximum (mm)	(in)	Minimum (mm)	(in)	Minimum (mm)	(in)
Plunger 	V4LT7	2.4	8.60	0.4	1.44	12.9	0.507	11.7 ± 0.4	0.46 ± 0.012	0.9	0.023	9.2	0.36	2.2	0.09
	V4LST7	2.5	9.00	0.5	1.78	12.9	0.507	11.7 ± 0.4	0.46 ± 0.012	0.9	0.023	9.2	0.36	2.2	0.09
A1 Lever 	V4L...	2.4	8.60	0.4	1.44	14.5	0.57	12.6 ± 0.8	0.59 ± 0.03	1.0	0.04	9.6	0.38	2.2	0.09
	V4LS...	2.5	9.00	0.5	1.78	14.5	0.57	12.6 ± 0.8	0.59 ± 0.03	1.0	0.04	9.6	0.38	2.2	0.09
Width of lever 4.0 mm/0.16 in															
A2 Lever 	V4L...	1.5	5.70	0.3	1.08	16.5	0.65	13.5 ± 1.0	0.53 ± 0.04	1.3	0.05	9.6	0.38	2.9	1.1
	V4LS...	2	7.20	0.3	1.08	16.5	0.65	13.5 ± 1.0	0.53 ± 0.04	1.3	0.05	9.6	0.38	2.9	1.1
Width of lever 4.0 mm/0.16 in															
F Lever 	V4L...	For positions and forces of this actuator please contact Burgess													
	V4LS...														
Width of lever 4.0 mm/0.16 in															

## Ordering Reference

Basic type	V4L	Example: V4L	S	T7	C2	A1	G	UL
Type of sealing	No symbol, unsealed S Sealed IP6K7							
Terminals	No symbol, pre-wired 500 mm with cable FLRY 0.5 mm <sup>2</sup> and cable box (V4LS only)							
	T7	Solder	2.95 × 0.5 × 3.55 long					
	T8	PCB	0.8 × 0.5 × 4.0 long					
Circuit	No symbol, change over							
	C2	Normally closed						
	C4	Normally open						
Actuators	No symbol, without lever							
	A1	Plain lever	20.0 mm, fitted at the end opposite to plunger					
	A2	Plain lever	30.0 mm, fitted at the end opposite to plunger					
	F	Special lever F type	20.0 mm, fitted at the end opposite to plunger					
Contact Material	No symbol, Ag							
	G	Gold plate on silver (GP)						
	X	Gold alloy on silver palladium crosspoint (AUX)						
	Other contact materials on special request							
Approvals	No symbol, without approval							
	UL	UL and CSA approval						
	EN	ENEC approval only						
	UN	UL, CSA and ENEC approval						
Special Features	/ <input type="checkbox"/> <input type="checkbox"/> <input type="checkbox"/> <input type="checkbox"/>		Burgess specialise in customer specific solutions. Additional product variants are available or can be provided. If your requirements cannot be satisfied from the options listed, please contact <a href="http://www.saia-burgess.com">www.saia-burgess.com</a> or your local SB outlet.					

# Coin operated Switches



Circuit diagram

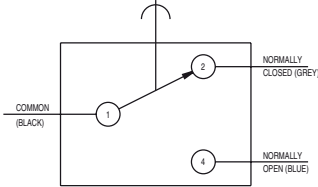

Dimensions

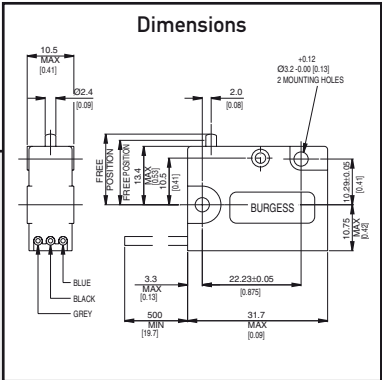

# V3S

## V3S

Characteristics	<ul style="list-style-type: none"> <li>■ sealed (IP67)</li> <li>■ flying leads</li> <li>■ robust construction</li> </ul>
Rating	250 VAC, 5 A
Dimensions (mm)	32 × 24 × 10
Actuator	<ul style="list-style-type: none"> <li>■ plunger</li> <li>■ plain levers</li> <li>■ roller levers</li> </ul>
Approvals	UL, CSA, ENEC



## Preferred Range

Ordering Reference	Actuating Force (N) (ozf)		Sealing	Operating pos. (mm) (in)		Terminal	Circuit	Actuator	Contacts	Electrical rating
V3SUL	3.9	14.00	IP67	14.5	0.57	Pre-wired	CO	Plunger	Ag	Up to 250 VAC, 5 A
V3SYRUL	3.9	14.00	IP67	20.4	0.80	Pre-wired	CO	Roller lever - short	Ag	Up to 250 VAC, 5 A
V3SYR1UL	2.3	8.26	IP67	22.0	0.86	Pre-wired	CO	Roller lever - long	Ag	Up to 250 VAC, 5 A
V3SY1UL	1.7	7.50	IP67	14.9	0.55	Pre-wired	CO	Plain lever	Ag	Up to 250 VAC, 5 A

## Specifications

Housing	Glass fibre reinforced nylon
Plunger	Acetal (lever types), stainless steel (plunger types)
Mechanism	Snap-action, single pole
Functions	Change-over
Cowl	Silicone rubber
Contacts	Silver
Terminals °C	Pre-wired
Temperature range	-40°C to +85°C
Mechanical life	10 <sup>6</sup> cycles minimum, impact-free actuation
Protection	IP67 (enclosure)
Mounting	Side mounting
Actuators	Plain lever - stainless steel, Roller levers - stainless steel, nylon roller

Circuit diagram

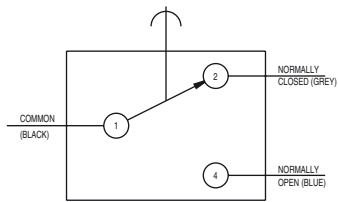

Dimensions

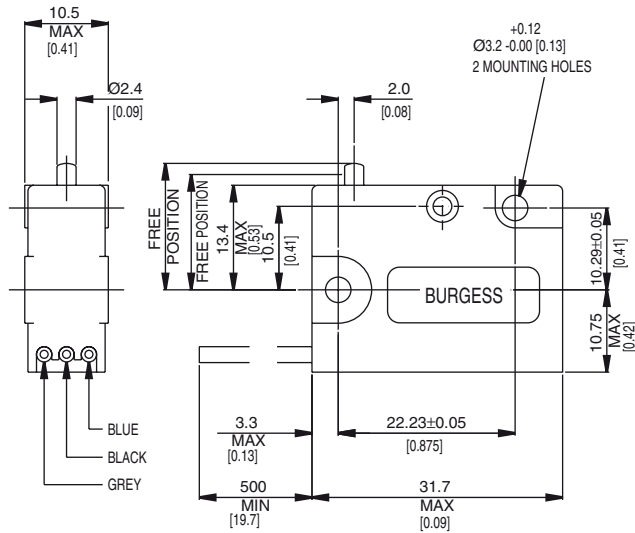

## Recommended maximum electrical ratings

Voltage (max)	Load (A)	Approval
125 VAC	5 (0.75 pf)	UL 1054/CSA 22.2 No. 55 - 6,000 operations (85°C)
250 VAC	5 (0.75 pf)	UL 1054/CSA 22.2 No. 55 - 6,000 operations (85°C)
250 VAC	5	EN61058-1, T85, 10,000 operations
0 - 15 VDC	6	General rating - 50,000 operations (85°C)
15 - 30 VDC	3	General rating - 50,000 operations (85°C)

## Operating Characteristics

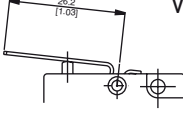
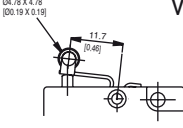
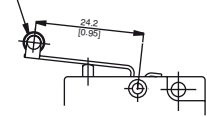
Actuator	Reference	Actuating Force		Release Force		Free Position		Operating Position		Movement	
		Maximum (N)	(ozf)	Minimum (N)	(ozf)	Minimum (mm)	(in)	Maximum (mm)	(in)	Maximum (in)	(mm) (in)
Plunger 	V3SUL	3.90	14.0	1.10	4.00	15.9	0.63	14.5 ± 0.5	0.57 ± 0.02	0.4	0.016
Plain lever 	V3SY1UL	1.65	6.0	0.42	1.50	13.4	0.71	14.9 ± 1.0	0.59 ± 0.4	1.0	0.040
Roller lever - short 	V3SYRUL	3.90	14.0	1.10	4.00	22.1	0.87	20.45 ± 0.64	0.8 ± 0.025	0.40	0.016
Roller lever - long 	V3SYR1UL	1.65	7.5	0.42	1.50	18.1	0.71	14.9 ± 0.1.0	0.55 ± 0.039	1.00	0.040

Over travel: Plunger can be depressed flush with housing. The housing should not be used as an end stop.

## Ordering Reference

Basic type	V3S	Example: V3S	C2	Y1	GP	UL
Circuit	No symbol, change-over C2 Normally closed C4 Normally open					
Actuators	No symbol, without lever or actuator Y1 Plain lever 26.2 mm YR Roller lever 11.7 mm YR1 Roller lever 24.2 mm					
Contact Material	No symbol, Ag GP Gold plate on silver (GP)					
Terminals	No symbol, fitted with standard 500 mm cables					
Approvals	No symbol, without approval UL UL and CSA approval					
Special Features	/ <input type="checkbox"/> <input type="checkbox"/> <input type="checkbox"/> <input type="checkbox"/> Burgess specialise in customer specific solutions. Additional product variants are available or can be provided. If your requirements cannot be satisfied from the options listed, please contact <a href="http://www.saia-burgess.com">www.saia-burgess.com</a> or your local SB outlet.					

# Precision Switches



Circuit diagram

DIAGRAM OF CONNECTIONS

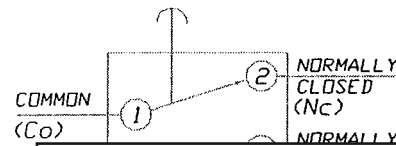

Dimensions

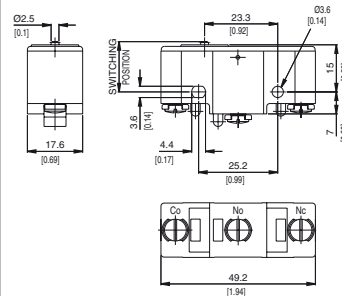

# PN4

## PN4

Characteristics	<ul style="list-style-type: none"> <li>■ precision switching</li> <li>■ long mechanical life</li> <li>■ screw terminals</li> </ul>
Rating	250 VAC, 15 A
Dimensions (mm)	49 × 22 × 17.5
Actuator	<ul style="list-style-type: none"> <li>■ plunger</li> <li>■ plain lever</li> <li>■ roller lever</li> </ul>
Approvals	UL, CSA



## Preferred Range

Ordering Reference	Actuating Force (N)	Actuating Force (ozf)	Sealing	Operating pos. (mm)	Operating pos. (in)	Terminal	Circuit	Actuator	Contacts	Electrical rating
PN401	3.8	13.7	IP40	16.0	0.63	Screw/washer	CO	Plunger	Ag	Up to 250 VAC, 15 A
PN4D2	3.8	13.7	IP40	22.2	0.87	Screw/washer	CO	Spring plunger	Ag	Up to 250 VAC, 15 A
PN4K152	0.3	1.08	IP40	25.0	1.00	Screw/washer	CO	Plain lever (length 152 mm, 6.0 in)	Ag	Up to 250 VAC, 15 A
PN4K63	0.9	3.2	IP40	19.0	0.75	Screw/washer	CO	Plain lever (length 63.5 mm, 2.5 in)	Ag	Up to 250 VAC, 15 A
PN4KZ56	1.5	5.4	IP40	8.5	0.33	Screw/washer	CO	Reverse action plain lever	Ag	Up to 250 VAC, 15 A
PN4GK48	1.1	4.0	IP40	30.2	1.19	Screw/washer	CO	Roller lever (length 48.2 mm, 1.90 in)	Ag	Up to 250 VAC, 15 A
PN4GK26	1.7	6.1	IP40	30.2	1.19	Screw/washer	CO	Roller lever (length 26.7 mm, 1.05 in)	Ag	Up to 250 VAC, 15 A
PN41	3.8	13.7	IP40	21.8	0.86	Screw/washer	CO	Long overtravel plunger	Ag	Up to 250 VAC, 15 A
PN4G	3.8	13.7	IP40	33.3	1.31	Screw/washer	CO	Spring plunger, in-line roller	Ag	Up to 250 VAC, 15 A
PN4GH	3.8	13.7	IP40	33.3	1.31	Screw/washer	CO	Spring plunger, across-line roller	Ag	Up to 250 VAC, 15 A



## Specifications

Housing	PBT thermoplastic polyester resin
Plunger	PBT thermoplastic polyester resin
Mechanism	Snap-action, single pole
Functions	Change-over
Contacts	Silver
Terminals	Screw terminals with cup washers
Temperature range °C	-10°C to +85°C
Mechanical life	10 <sup>6</sup> cycles minimum (impact free actuation)
Protection	IP 40 (enclosure)
Mounting	Side or panel mounting
Actuators	Plain levers - zinc-plated mild steel, Roller levers - zinc-plated mild steel, stainless steel roller

Circuit diagram

DIAGRAM OF CONNECTIONS

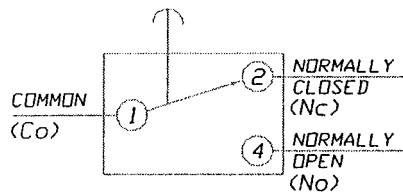

Dimensions

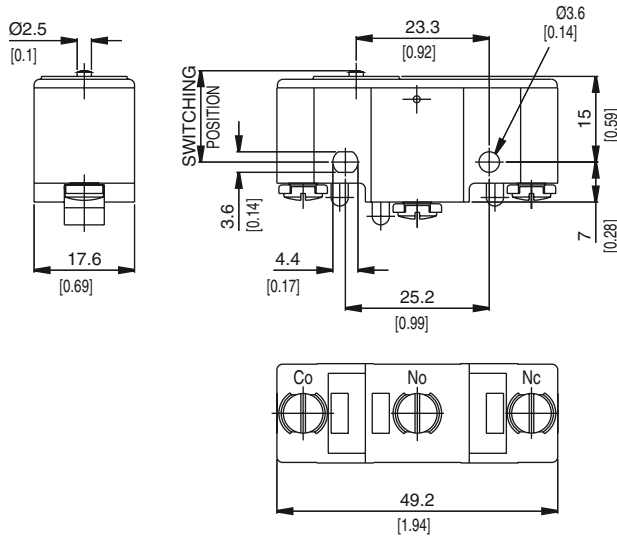

## Recommended maximum electrical ratings

Voltage (max)	Load (A)	Horsepower	Approval
250 VAC	15 (0.75 pf)	-	ULS 1054/CSA 22.2 No. 55 - 6,000 operations
125 VAC	15 (0.75 pf)	-	ULS 1054/CSA 22.2 No. 55 - 6,000 operations
250 VAC	-	¼ HP	ULS 1054 - Horsepower - 6,000 operations
125 VAC	-	¼ HP	ULS 1054 - Horsepower - 6,000 operations
0 - 15 VDC	15	-	General rating - 50,000 operations
15 - 30 VDC	10	-	General rating - 50,000 operations

## Operating Characteristics

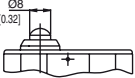
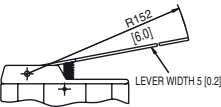
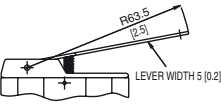
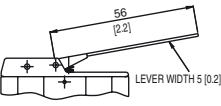
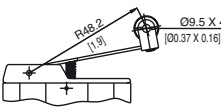
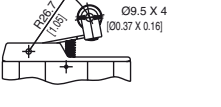
Actuator	Reference	Actuating Force Maximum		Release Force Minimum		Operating Position		Movement Differential Minimum		Over travel	
		(N)	(ozf)	(N)	(ozf)	(mm)	(in)	(mm)	(in)	(mm)	(in)
Plunger 	PN401	3.8	13.70	1.3	4.7	16.0 ± 0.4	0.63 ± 0.016	0.02	0.0008	0.2	0.008
Spring plunger 	PN4D2	3.8	13.70	1.3	4.7	22.2 ± 0.4	0.87 ± 0.016	0.04	0.0016	2.3	0.09
Plain lever 	PN4K152	0.3	1.08	0.1	0.36	25.5 ± 1.5	1.00 ± 0.060	3.0	0.12	10.0	0.39
Lever width: 5 mm, 0.2 in											
Plain lever 	PN4K63	0.9	3.20	0.1	0.36	19 ± 0.8	0.75 ± 0.032	1.2	0.047	5.6	0.22
Lever width: 5 mm, 0.2 in											
Reverse action plain lever 	PN4KZ56	1.5	5.40	0.5	1.80	8.5 ± 0.8	0.33 ± 0.032	1.0	0.004	6.0	0.24
Lever width: 5 mm, 0.2 in											
Roller lever 	PN4GK48	1.1	4.00	0.2	0.72	30.2 ± 0.8	1.19 ± 0.032	0.9	0.035	4.2	0.165
Roller lever 	PN4GK26	1.7	6.11	0.2	0.72	30.2 ± 0.8	1.19 ± 0.032	0.5	0.02	2.0	0.079

## Operating Characteristics

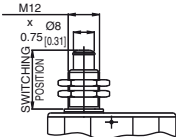
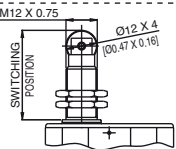
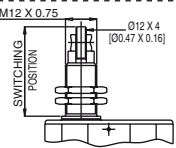
Actuator	Reference	Actuating Force Maximum		Release Force Minimum		Operating Position		Movement Differential Minimum		Over travel	
		(N)	(ozf)	(N)	(ozf)	(mm)	(in)	(mm)	(in)	(mm)	(in)
Long overtravel plunger 	PN41	3.8	13.70	1.3	4.7	21.8 ± 0.7	0.86 ± 0.028	0.04	0.0016	5.5	0.21
Spring plunger - in-line roller 	PN4G	3.8	13.70	1.3	4.7	33.3 ± 1.2	1.31 ± 0.047	0.04	0.0016	3.5	0.14
Spring plunger - across-line roller 	PN4GH	3.8	13.70	1.3	4.7	33.3 ± 1.2	1.31 ± 0.047	0.04	0.0016	3.5	0.14

## Ordering Reference

Basic type	PN4	Example: PN4	01
Actuators	<ul style="list-style-type: none"> <li>01 Plain plunger</li> <li>1 Panel mount plunger</li> <li>D2 Spring plunger</li> <li>G Plunger with in-line roller</li> <li>GH Plunger with across-line roller</li> <li>GK26 Roller lever 26.0 mm</li> <li>GK35 Roller lever 35 mm</li> <li>GK48 Roller lever 48.2 mm</li> <li>GK63 Roller lever 63 mm</li> <li>K48 Plain lever 48 mm</li> <li>K63 Plain lever 63.5 mm</li> <li>K63X Plain lever 63 mm without spring</li> <li>K152 Plain lever 152.0 mm</li> <li>KZ56 Reverse action roller lever 56.0 mm</li> </ul>		
Special Features	/ <input type="checkbox"/> <input type="checkbox"/> <input type="checkbox"/> <input type="checkbox"/>	<p>Burgess specialise in customer specific solutions.            Additional product variants are available or can be provided.            If your requirements cannot be satisfied from the options listed,            please contact <a href="http://www.saia-burgess.com">www.saia-burgess.com</a> or your local SB outlet.</p>	

PN4 Terminal cover / Part No: 3.204.0222

# 3BR

## 3BR

Characteristics	<ul style="list-style-type: none"> <li>■ choice of IP54 or IP67 sealed versions</li> <li>■ precise movements and exceptional repeat accuracy</li> <li>■ flying lead version available</li> <li>■ long overtravel</li> </ul>
Rating	250 VAC, 10 A max.
Dimensions (mm)	53.1 × 20.6 × 30.8
Actuator	■ plunger
Approvals	UL, CSA



## Preferred Range

Ordering Reference	Actuating Force (N)	Actuating Force (ozf)	Sealing	Operating pos. (mm)	Operating pos. (in)	Terminal	Circuit	Actuator	Contacts	Electrical rating
3BR103	7.2	26.00	IP54	39.3	1.55	Screw	CO	Plunger	Ag	Up to 125 VAC, 10 A
3BR510	7.2	26.00	IP67	39.3	1.55	Screw	CO	Plunger	Ag	Up to 125 VAC, 10 A

## Specifications

Housing	Phenolic
Plunger	Stainless steel
Cowl	Silicone rubber
Mechanism	Single pole change-over
Contacts	Silver
Terminals	Screw terminals with captive washers
Temperature	-10°C to +85°C
Mechanical life	10 <sup>6</sup> cycles minimum (impact free actuation)
Protection	3BR / 510 IP67 / 3BR103 IP54 (enclosure)
Mounting	Side mounting

Circuit diagram

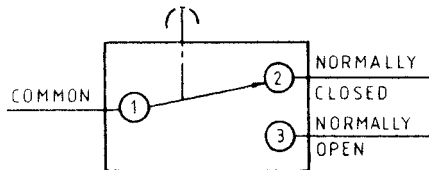

## Dimensions

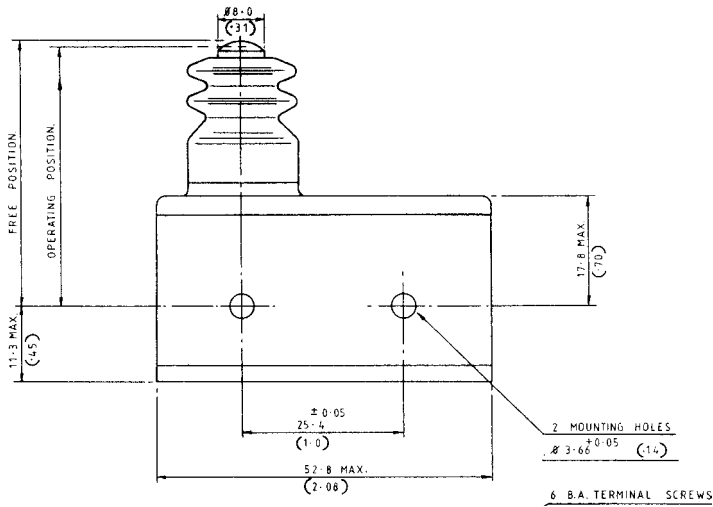

## Recommended maximum electrical ratings

Voltage (max)	Load (A)	Horsepower	Approval
250 VAC	5 (0.75 pf)	-	CSA 22.2 No. 55 - 6,000 operations
125 VAC	10 (0.75 pf)	-	CSA 22.2 No. 55 - 6,000 operations
250 VAC	-	¼ HP (0.45 pf)	CSA 22.2 No. 55 - 6,000 operations
125 VAC	-	¼ HP (0.45 pf)	CSA 22.2 No. 55 - 6,000 operations
0 - 15 VDC	10	-	General rating - 50,000 operations
15 - 30 VDC	5	-	General rating - 50,000 operations

## Operating Characteristics

Actuator	Reference	Actuating Force Maximum		Release Force Minimum		Free Position Maximum		Operating Position		Movement Differential Maximum		Overtravel	
		(N)	(ozf)	(N)	(ozf)	(mm)	(in)	(mm)	(in)	(mm)	(in)		
Plunger	3BR103 3BR/510	7.2	26.00	1.7	6	40.8	1.6	39.3 ± 0.4	1.55 ± 0.016	0.08	0.003	4.6	0.18

## Ordering Reference

Basic type	3BR	Example: 3BR   SH
Environmental sealing	SH 103 510	Sealed terminals with horizontal exiting 500 mm cables Sealed to IP54 Sealed to IP67
Special Features	/ <input type="checkbox"/> <input type="checkbox"/> <input type="checkbox"/> <input type="checkbox"/>	Burgess specialise in customer specific solutions. Additional product variants are available or can be provided. If your requirements cannot be satisfied from the options listed, please contact <a href="http://www.saia-burgess.com">www.saia-burgess.com</a> or your local SB outlet.

# K5

## K5

Characteristics	<ul style="list-style-type: none"> <li>■ double break switching</li> <li>■ long mechanical life</li> <li>■ high electrical rating</li> <li>■ faston terminals</li> </ul>
Rating	250 VAC, 16 A
Dimensions (mm)	41 × 19 × 15.5
Actuator	<ul style="list-style-type: none"> <li>■ plunger</li> <li>■ ramp plunger</li> <li>■ plain lever</li> <li>■ roller lever</li> </ul>
Approvals	UL, CSA

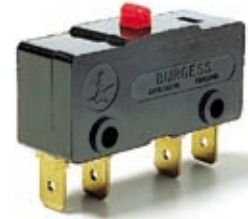

## Preferred Range

Ordering Reference	Actuating Force (N) (ozf)		Sealing	Operating pos. (mm) (in)		Terminal	Circuit	Actuator	Contacts	Electrical rating
K5UL	2.8	10.00	IP40	17.4	0.68	Faston	SPDT	Plunger	Ag	Up to 250 VAC, 16 A
K5CUL	2.8	10.00	IP40	16.7	0.66	Faston	SPDT	Ramp plunger	Ag	Up to 250 VAC, 16 A
K5KUL	1.4	5.00	IP40	20.3	0.80	Faston	SPDT	Plain lever	Ag	Up to 250 VAC, 16 A
K5KRUL	1.5	5.40	IP40	32.0	1.26	Faston	SPDT	Roller lever	Ag	Up to 250 VAC, 16 A
K5QUL	2.8	10.00	IP40	17.9	0.71	Faston	SPDT	Spring plunger	Ag	Up to 250 VAC, 16 A

## Specifications

Housing	Glass fibre reinforced nylon
Plunger	Nylon
Mechanism	Two circuit double break change-over
Contacts	Silver
Terminals	6.3 mm (0.25 in) faston
Temperature range	-10°C to +85°C
Mechanical life	10 <sup>6</sup> cycles minimum (impact free actuation)
Type of protection	IP40 (enclosure)
Mounting	Side mounting
Actuators	Plain lever – stainless steel, roller lever – stainless steel, nylon roller

Circuit diagram

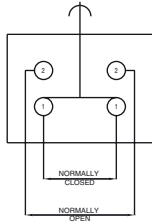

Dimensions

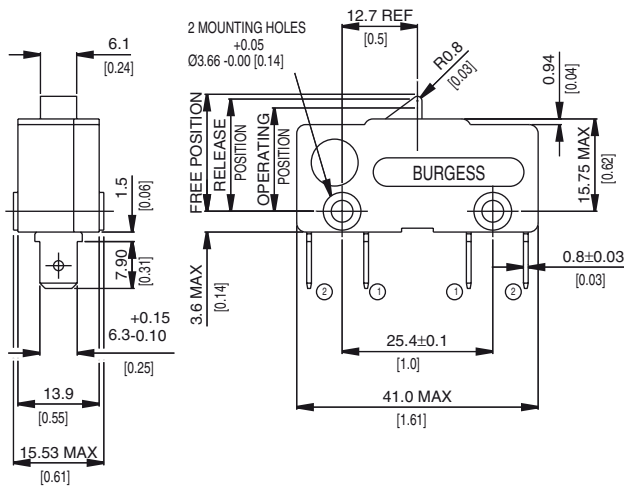

## Recommended maximum electrical ratings

Voltage (max)	Load (A)	Horsepower	Approval
250 VAC	16 (0.75 pf)		UL 1054/CSA 22.2 No. 55 - 6,000 operations
125 VAC	16 (0.75 pf)		UL 1054/CSA 22.2 No. 55 - 6,000 operations
250 VAC		¼ HP	UL 1054 6,000 operations
125 VAC		¼ HP	UL 1054 6,000 operations
0 - 15 VDC	15		General rating - 50,000 operations
15 - 30 VDC	10		General rating - 50,000 operations

Values shown are recommended maximum ratings for single circuit switching

## Operating Characteristics

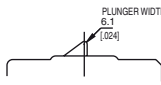
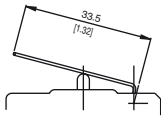
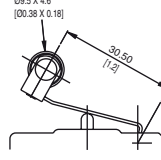
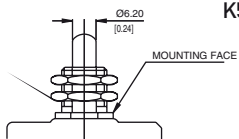
Actuator	Reference	Actuating Force Maximum		Release Force Minimum		Free Position Maximum		Operating Position		Movement Differential Maximum		Overtravel	
		(N)	(ozf)	(N)	(ozf)	(mm)	(in)	(mm)	(in)	(mm)	(in)	(mm)	(in)
Plunger 	K5UL	2.8	10.00	1.1	4	19.7	0.78	17.4 ± 0.7	0.68 ± 0.028	1.27	0.05	*	
Ramp plunger 	K5CUL	2.8	10.00	1.10	4.00	19.7	0.78	16.7 ± 0.7	0.66 ± 0.028	2.2	0.09	*	
Plain lever 	K5KUL	1.4	5.00	0.35	1.25	28.0	1.10	20.3 ± 1.5	0.80 ± 0.06	3.2	0.13	*	
Roller lever 	K5KRUL	1.5	5.40	0.38	1.28	38.6	1.52	32.0 ± 1.5	1.26 ± 0.06	3.2	0.13	*	
Spring plunger 	K5QUL	2.8	10.00	1.10	4.00	20.6	0.81	17.9 ± 0.7	0.71 ± 0.028	1.27	0.05	4.6	0.18

\* Plunger can be depressed flush with housing. The housing should not be used as an end stop.

## Ordering Reference

Basic type	K5	Example: K5	C	UL
Actuators	No symbol, plain plunger C Ramp plunger K Plain lever 33.5 mm KR Roller lever 30.5 mm Q Spring plunger			
Approvals	UL	UL and CSA approval		
Special Features	/ <input type="checkbox"/> <input type="checkbox"/> <input type="checkbox"/> <input type="checkbox"/>	Burgess specialise in customer specific solutions. Additional product variants are available or can be provided. If your requirements cannot be satisfied from the options listed, please contact <a href="http://www.saia-burgess.com">www.saia-burgess.com</a> or your local SB outlet.		



# Metal housed Switches



Circuit diagram

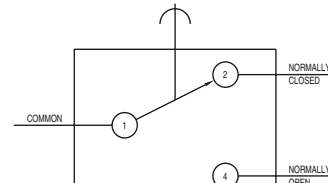

Dimensions

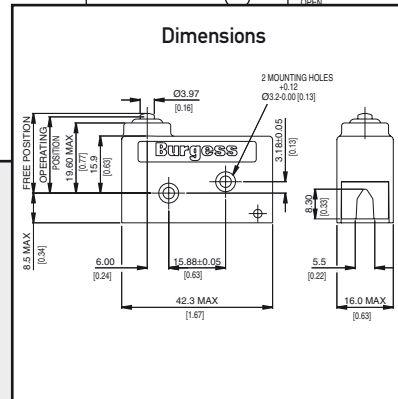

## V9N

Characteristics	<ul style="list-style-type: none"> <li>■ sealed (IP67)</li> <li>■ metal housed</li> <li>■ screw terminals or flying leads</li> </ul>
Rating	250 VAC, 10 A max.
Dimensions (mm)	42 × 24.5 × 16
Actuator	<ul style="list-style-type: none"> <li>■ plunger</li> <li>■ plain levers</li> <li>■ reverse action levers</li> <li>■ roller levers</li> </ul>
Approvals	UL and CSA



## Preferred Range

Ordering Reference	Actuating Force (N) (ozf)		Sealing	Operating pos. (mm) (in)		Terminal	Circuit	Actuator	Contacts	Electrical rating
V9N	5.5	19.80	IP67	21.3	0.840	M3 screw	CO	Plunger	Ag	Up to 250 VAC, 10 A
V9NLR	6.0	21.60	IP67	27.5	1.080	M3 screw	CO	Roller lever - short	Ag	Up to 250 VAC, 10 A
V9NLR1	4.5	16.20	IP67	34.5	1.360	M3 screw	CO	Roller lever - long	Ag	Up to 250 VAC, 10 A
V9NL	3.0	10.80	IP67	24.7	0.970	M3 screw	CO	Plain lever	Ag	Up to 250 VAC, 10 A

## Specifications

Housing	Zinc diecasting
Plunger	Acetal
Mechanism	Snap-action, single pole
Functions	Change-over
Cowl	Silicon rubber
Contacts	Silver
Terminals	M3 screws with captive washers or pre-wired
Temperature range	-40°C to +125°C, switch only -10°C to +85°C pre-wired
Mechanical life	10 <sup>6</sup> cycles minimum, impact-free actuation
Protection	IP67 (enclosure)
Mounting	Side mounting
Actuators	Plain levers - stainless steel, roller levers - stainless steel, nylon roller

Circuit diagram

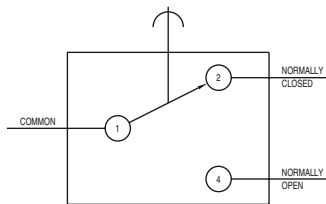

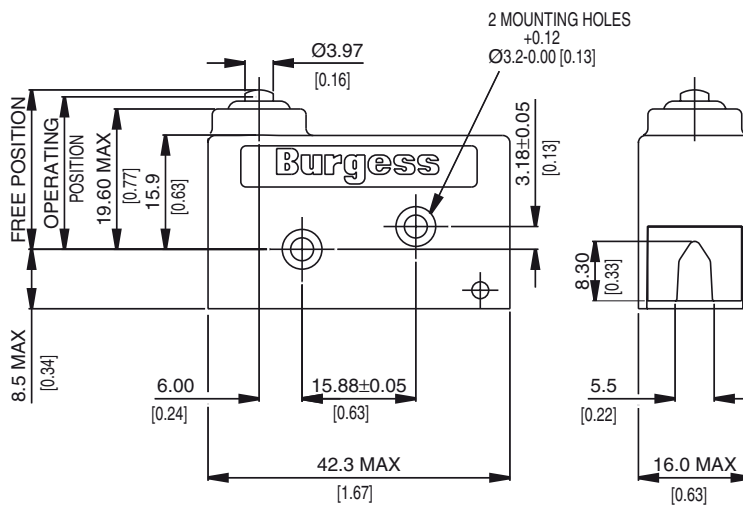

Dimensions



## Recommended maximum electrical ratings

Voltage (max)	Load (A)	Approval
250 VAC	10 (0.75 pf)	UL 1054/CSA 22.2 No. 55 - 6,000 operations (85°C)
0 - 15 VDC	10	General rating - 50,000 operations (85°C)
15 - 30 VDC	10	General rating - 50,000 operations (85°C)

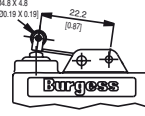
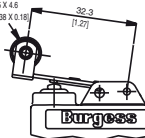
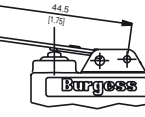
## Operating Characteristics

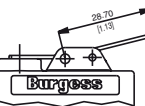
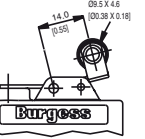
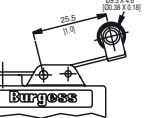
Actuator	Reference	Actuating Force Maximum		Release Force Minimum		Free Position Maximum		Operating Position		Movement Differential		Over travel Maximum	
		(N)	(ozf)	(N)	(ozf)	(mm)	(in)	(mm)	(in)	(mm)	(in)	(mm)	(in)
Plunger 	V9N	5.5	19.8	1.0	3.6	22.6	0.89	21.3 ± 0.3	0.84 ± 0.012	0.35	0.014	*	
Roller lever - short 	V9NLR	6.0	21.6	1.3	4.7	31.0	1.22	27.5 ± 0.5	1.08 ± 0.02	0.35	0.014	*	
Roller lever - long 	V9NLR1	4.5	16.2	0.8	2.9	39.0	1.54	34.5 ± 0.7	1.36 ± 0.028	0.60	0.024	*	
Plain lever 	V9NL	3.0	10.8	0.6	2.1	31.0	1.22	24.7 ± 0.10	0.97 ± 0.039	0.70	0.028	*	
Reverse action roller lever - short 	V9NM	7.5	27.0	1.5	5.4	26.0	1.02	22.4 ± 0.5	0.88 ± 0.02	0.50	0.020	3.50	0.137
Reverse action roller lever - long 	V9NML	4.5	16.2	1.0	3.6	29.0	1.14	23.6 ± 0.10	0.93 ± 0.039	1.20	0.047	6.00	0.236
Reverse action roller lever - short 	V9NMR	9.5	34.2	1.5	5.4	36.0	1.42	32.9 ± 0.5	1.295 ± 0.02	0.45	0.018	2.00	0.079
Reverse action roller lever - long 	V9NMLR	5.0	18.0	1.0	3.6	39.5	1.56	34.0 ± 0.10	1.34 ± 0.039	1.00	0.039	5.50	0.216

Operating characteristics are specified from lower mounting hole

\* Plunger can be depressed flush with housing. The housing should not be used as an end stop.

## Ordering Reference

Basic typ	V9N	Example: V9N	L	H
Actuators	No symbol, without lever			
L	Plain lever 44.5 mm			
LE	Reverse-action lever with uni-directional roller 32.3 mm			
LR	Roller lever 22.2 mm			
LR1	Roller lever 32.3 mm			
M	Reverse action lever 187.2 mm			
ML	Reverse action lever 28.7 mm			
MR	Reverse action roller lever 14.0 mm			
MLR	Reverse action roller lever 25.5 mm			
Terminals	No symbol, unwired			
H	Horizontal pre-wired cable			
V	Vertical pre-wired cable			
Pre-wired with Terminals H + V	No symbol, 1 m cable			
Special Features	/ <input type="checkbox"/> <input type="checkbox"/> <input type="checkbox"/> <input type="checkbox"/>	Burgess specialise in customer specific solutions. Additional product variants are available or can be provided. If your requirements cannot be satisfied from the options listed, please contact <a href="http://www.saia-burgess.com">www.saia-burgess.com</a> or your local SB outlet.		

# 4BR

## 4BR

- Characteristics
- choice of IP54 or IP67 sealed versions
  - precise movements and exceptional repeat accuracy
  - robust metal housing
  - flying lead version available
  - long overtravel

Rating 250 VAC, 15 A max.

Dimensions (mm) 53,1 × 20,6 × 29,2

Actuator ■ plunger

Approvals UL, CSA



## Preferred Range

Ordering Reference	Actuating Force (N)	Actuating Force (ozf)	Sealing	Operating pos. (mm)	Operating pos. (in)	Terminal	Circuit	Actuator	Contacts	Electrical rating
4BR	7.2	26.00	IP54	39.3	1.550	Screw	CO	Plunger	Ag	Up to 250 VAC, 15 A
4BR510	7.2	26.00	IP67	39.3	1.550	Screw	CO	Plunger	Ag	Up to 250 VAC, 15 A
4BRSH	7.2	26.00	IP67	39.3	1.550	Pre-wired	CO	Plunger	Ag	Up to 250 VAC, 15 A

## Specifications

Housing	Zinc based alloy
Base Plate	Phenolic
Plunger	Stainless steel
Cowl	Silicon rubber
Mechanism	Single pole change-over
Contacts	Silver
Terminals	Removable screw terminals, insulated cover plate
Temperature	-10°C to +85°C
Mechanical life	10 <sup>6</sup> cycles minimum (impact free actuation)
Protection	4BR/510 IP67 / 4BR IP54 (enclosure)
Mounting	Side mounting

Circuit diagram

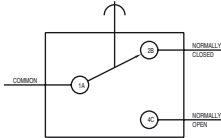

Dimensions

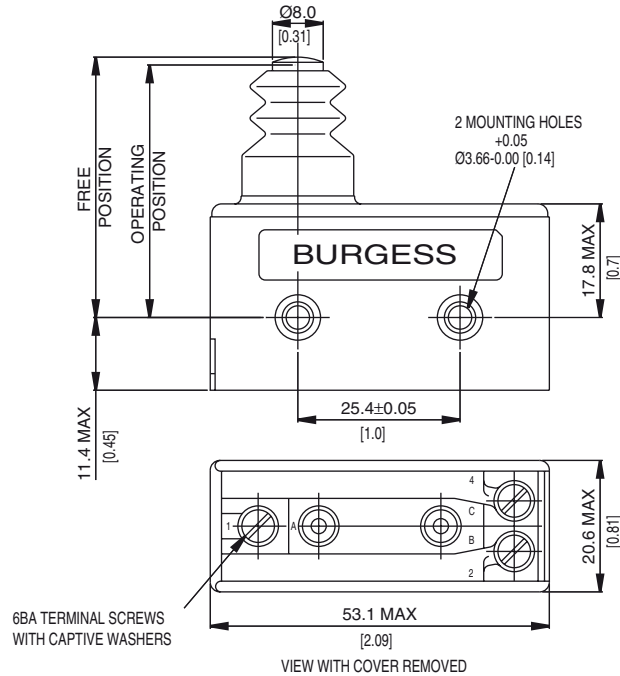

## Recommended maximum electrical ratings

Voltage (max)	Resistive load (A)	Inductive load	Horsepower	Approval
250 VAC	5 (0.75 pf)	5	-	CSA 22.2 No. 55 - 6,000 operations
125 VAC	10 (0.75 pf)	-	-	CSA 22.2 No. 55 - 6,000 operations
250 VAC	-	-	¼ HP (0.45 pf)	CSA 22.2 No. 55 - 6,000 operations
125 VAC	-	-	½ HP (0.45 pf)	CSA 22.2 No. 55 - 6,000 operations
0 - 15 VDC	10	-	-	General rating - 50,000 operations
15 - 30 VDC	5	-	-	General rating - 50,000 operations

## Operating Characteristics

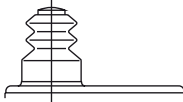
Actuator	Reference	Actuating Force Maximum		Release Force Minimum		Free Position Maximum		Operating Position		Movement Differential Maximum		Over travel	
		(N)	(ozf)	(N)	(ozf)	(mm)	(in)	(mm)	(in)	(mm)	(in)	(mm)	(in)
Plunger 	4BR	7.2	26.00	1.7	6	40.8	1.6	39,3 ± 0.4	1,55 ± 0.016	0.08	0.003	4,6	0.18
	4BR/510	7.2	26.00	1.7	6	40,8	1,6	39,3 ± 0.4	1,55 ± 0.016	0.08	0.003	4,6	0.18
	4BR/SH	7.2	26.00	1.7	6	40,8	1,6	39,3 ± 0.4	1,55 ± 0.016	0.08	0.003	4,6	0.18

## Ordering Reference

Basic type **4BR** Example: 4BR | SH

Environmental sealing  
**SH** Sealed terminals with horizontal exiting 500 mm cables  
**103** Sealed to IP54  
**510** Sealed to IP67

Special Features /     Burgess specialise in customer specific solutions. Additional product variants are available or can be provided. If your requirements cannot be satisfied from the options listed, please contact [www.saia-burgess.com](http://www.saia-burgess.com) or your local SB outlet.



# Positive-action Switches

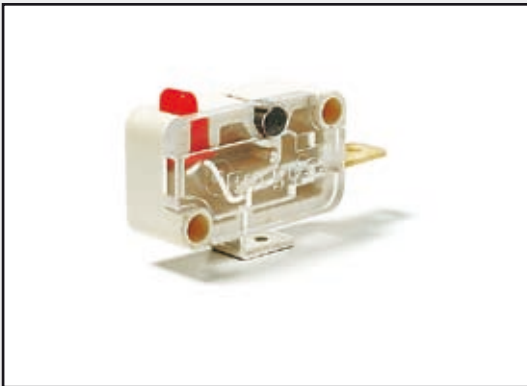

Locknut mounting

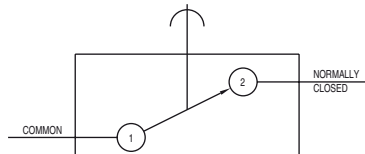

Dimensions

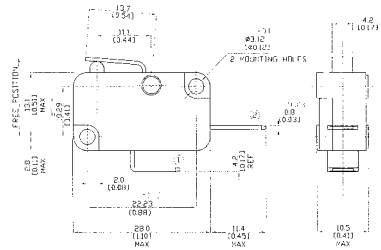

# BVM3

## BVM3F

- Characteristics
- positive-action (forced break) contacts
  - > 3 mm contact gap at full travel
  - internationally recognized V3 housing
  - faston terminals

Rating 250 VAC, 10 A

Dimensions (mm) 28 × 16 × 10.5

- Actuator
- plunger
  - plain lever
  - roller lever

Approvals UL, CSA and ENEC

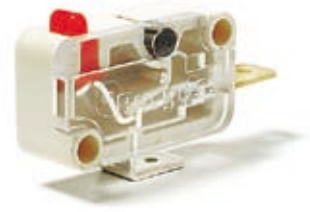

## Preferred Range

Ordering Reference	Actuating Force (N) (ozf)		Sealing	Terminal	Circuit	Actuator	Contacts	Electrical rating
BVM3FULS	4.5	16.2	IP40	Faston	NC	Plunger	Ag/Ag nickel	Up to 250 VAC, 10 A
BVM3FYULS	4.5	16.2	IP40	Faston	NC	Plain lever	Ag/Ag nickel	Up to 250 VAC, 10 A
BVM3FYRULS	5.0	18.0	IP40	Faston	NC	Roller lever	Ag/Ag nickel	Up to 250 VAC, 10 A

## Specifications

Housing	Glass reinforced nylon
Plunger	Nylon
Mechanism	> 3 mm gap, positive-action, single pole
Functions	Normally closed
Contacts	Fixed silver nickel, Moving silver
Terminals	6.3 mm (0.25 in) faston NC (2) - brass, Common (1) - brass, Ag-plated
Temperature range °C	-40°C to +85°C
Mechanical life	10 <sup>6</sup> cycles minimum, impact-free actuation
Protection	IP40 (enclosure)
Mounting	Side mounting
Actuators	Plain lever - stainless steel, roller lever - stainless steel, nylon roller
Lid	Polycarbonate

Circuit diagram

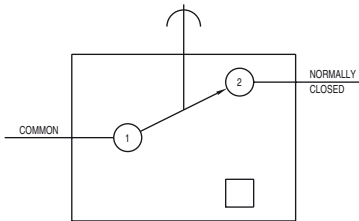

Dimensions

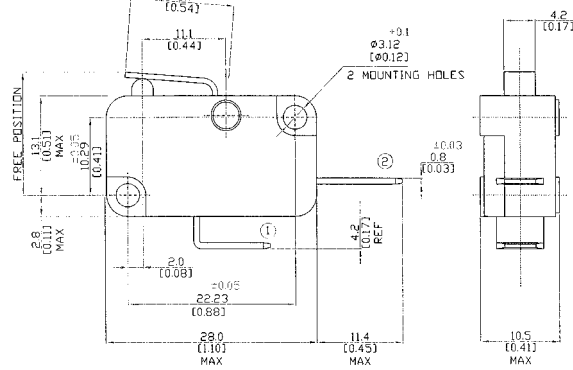

## Recommended maximum electrical ratings

Voltage (max)	Load (A)	Horsepower	Approval
250 VAC	10 (0.75 pf)	-	ULS 1054/CSA 22.2 No. 55 - 100,000 operations
250 VAC	-	½ HP	ULS 1054 - Horsepower - 6,000 operations
250 VAC	10 (3)	-	EN 61058-I T85 50,000 operations
125 VAC	-	½ HP	ULS 1054 - Horsepower - 6,000 operations
0 - 15 VDC	10	-	General rating - 50,000 operations
15 - 30 VDC	7	-	General rating - 50,000 operations

## Operating Characteristics

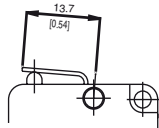
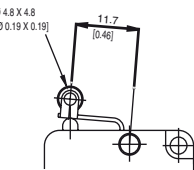
Actuator	Reference	Actuating Force at contact break		Actuating Force at total travel		Free Position		Contact gap at total travel	
		Maximum (N)	(ozf)	Minimum (N)	(ozf)	Maximum (mm)	(in)	Minimum (mm)	(in)
Plunger 	BVM3FULS	4.5	16.2	4.8	17.3	15.8	0.62	3.0	0.12
Y Lever 	BVM3FYULS	4.5	16.2	4.8	17.3	16.8	0.66	3.0	0.12
YR Lever 	BVM3FYRULS	5.0	18.0	5.5	19.8	22.35	0.88	3.0	0.12

Operating characteristics are specified from the mounting holes.

Total travel: Plunger can be depressed flush with housing. The housing should not be used as an end stop.

## Ordering Reference

Basic type	BVM3	Example: BVM3	F	Y	ULS
Terminals	F	Faston 6.3 × 0.8 mm			
Actuators	Y	No symbol, without lever			
	YR	Straight lever 13.7 mm			
		Roller lever 11.7 mm			
Approvals	ULS	UL 100 k operations and CSA approval			
Special Features	/ <input type="checkbox"/> <input type="checkbox"/> <input type="checkbox"/> <input type="checkbox"/>	Burgess specialise in customer specific solutions. Additional product variants are available or can be provided. If your requirements cannot be satisfied from the options listed, please contact <a href="http://www.saia-burgess.com">www.saia-burgess.com</a> or your local SB outlet.			

# KB5

## KB5

Characteristics	<ul style="list-style-type: none"> <li>■ positive-action forced double break switching</li> <li>■ &gt; 3 mm contact gap at full travel</li> <li>■ high electrical rating</li> <li>■ faston terminals</li> </ul>
Rating	Up to 250 VAC, 20 A
Dimensions (mm)	41 × 19.5 × 15.5
Actuator	<ul style="list-style-type: none"> <li>■ plunger</li> <li>■ plain lever</li> <li>■ roller levers</li> </ul>
Approvals	UL, CSA



## Preferred Range

Ordering Reference	Actuating Force (N) (ozf)		Sealing	Operating pos (mm) (in)		Terminal	Circuit	Actuator	Contacts	Electrical rating
KB5FULS	3.00	10.0	IP40	16.8	0.66	Faston	NC	Plunger	Ag	Up to 250 VAC, 20 A
KB5FKULS	2.25	8.0	IP40	19.2	0.76	Faston	NC	Plain lever	Ag	Up to 250 VAC, 20 A
KB5FKRULS	2.25	8.0	IP40	31.0	1.22	Faston	NC	Roller lever	Ag	Up to 250 VAC, 20 A

## Specifications

Housing	Polycarbonate
Plunger	Nylon
Mechanism	Single pole, double break, positive action
Functions	Normally closed
Contacts	Fixed – silver, Moving – silver cadmium oxide
Terminals	6.3 mm (0.25 in) faston, brass
Temperature range	-40°C to +85°C
Mechanical life	10 <sup>7</sup> cycles minimum, impact-free actuation
Protection	IP40 (enclosure)
Mounting	Side mounting
Actuators	Plain lever - stainless steel, roller lever - stainless steel, nylon roller
Approvals	UL and CSA

Circuit diagram

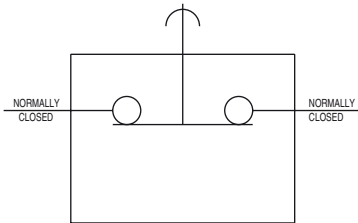

Dimensions

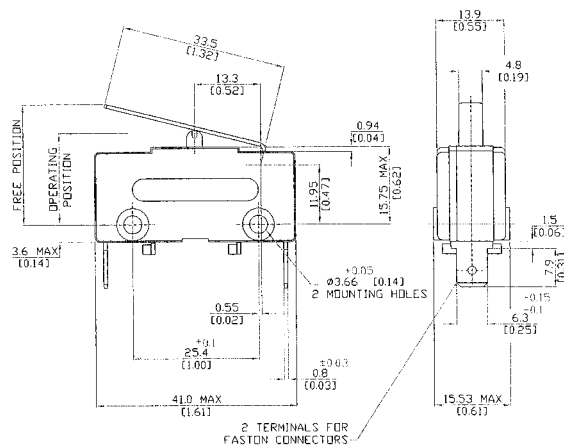

## Recommended maximum electrical ratings

Voltage (max)	Resistive load (A)	Inductive load	Horsepower	Approval
250 VAC	20 (0.75 pf)	-	-	ULS 1054/CSA 22.2 No. 55 - 100,000 operations
250 VAC	-	-	2 HP	ULS 1054 - Horsepower - 6,000 operations
125 VAC	-	-	1 HP	ULS 1054 - Horsepower - 6,000 operations
0 - 15 VDC	15	-	-	General rating - 50,000 operations
15 - 30 VDC	10	-	-	General rating - 50,000 operations

## Operating Characteristics

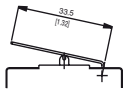
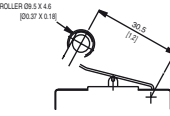
Actuator	Reference	Actuating Force		Operation Position		Free Position Maximum		Contact gap at total travel		
		(N)	(ozf)	(mm)	(in)	(mm)	(in)	Minimum (mm)	(in)	
Plunger 	KB5FULS	3.00	10.8	16.8	0.66	19.3	0.76	2 × 3.0	2 × 0.12	
<sup>1</sup> At contact separation of 2 × 1.5 mm										
K Lever 	KB5FKULS	2.25	8.0	19.2	0.76	26.0	1.02	2 × 3.0	2 × 0.12	
KR Lever 	KB5FKRULS	2.25	8.0	31.0	1.22	36.5	1.40	2 × 3.0	2 × 0.12	

Recommended minimum contact separation 2 × 1.5 mm (2 × .06) indicated when groove in plunger lines up with case. Operating characteristics are specified from mounting holes.

Total travel: Plunger can be depressed flush with housing. The housing should not be used as an end stop.

## Ordering Reference

Basic type	KB5	Example: KB5	F	K	ULS
Terminals	F	Faston 6.3 × 0.8 mm			
Actuators	No symbol, without lever K Plain lever 33.5 mm KR Roller lever 30.5 mm				
Approvals	ULS	UL 100 k operations and CSA approved			
Special Features	/ <input type="checkbox"/> <input type="checkbox"/> <input type="checkbox"/> <input type="checkbox"/>	Burgess specialise in customer specific solutions. Additional product variants are available or can be provided. If your requirements cannot be satisfied from the options listed, please contact <a href="http://www.saia-burgess.com">www.saia-burgess.com</a> or your local SB outlet.			

# Forced break Switches



Circuit diagram

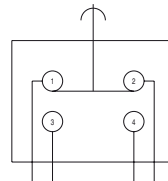

Dimensions

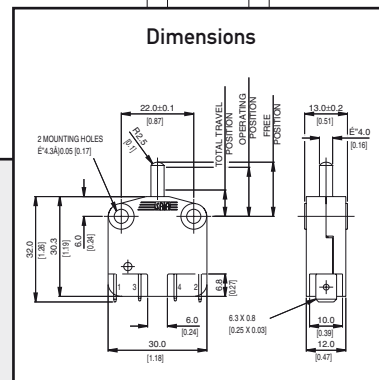



## XP

Characteristics	<ul style="list-style-type: none"> <li>■ forced double break switching</li> <li>■ positive-action force break option</li> <li>■ &gt; 3 mm contact gap at full travel option</li> <li>■ faston terminals</li> </ul>
Rating	400 VAC, 16 A
Dimensions (mm)	30 × 32 × 12
Actuator	<ul style="list-style-type: none"> <li>■ plain plunger</li> <li>■ mushroom plunger</li> <li>■ plunger with external spring (for increased reset security)</li> </ul>
Approvals	ENEC, UL, CSA



## Preferred Range

Ordering Reference	Actuating Force (N)	Actuating Force (ozf)	Operating pos. (mm)	Operating pos. (in)	Terminal	Circuit	Actuator	Contacts	Electrical rating
XP2Z11	3.0	10.0	14.9	0.587	Faston	CO	Straight plunger	Ag nickel	Up to 400 VAC, 16 A
XP4Z11	1.8	6.2	14.9	0.587	Faston	NC	Straight plunger	Ag nickel	Up to 400 VAC, 16 A
XP5Z11	3.0	10.0	13.0	0.511	Faston	NO	Straight plunger	Ag nickel	Up to 400 VAC, 16 A
XP52E1Z11	6.5	23.3	13.0	0.511	Faston	NO	Mushroom plunger, reset	Ag nickel	Up to 400 VAC, 16 A
XP2E2Z11	3.0	10.0	14.9	0.587	Faston	CO	Mushroom plunger, reset	Ag nickel	Up to 400 VAC, 16 A

## Specifications

Housing	Glass fibre reinforced nylon
Plunger	Glass fibre reinforced nylon
Mechanism	Change-over, normally open, normally closed
Contacts	Silver
Terminals	6.3 mm (0.25 in) faston brass
Temperature range °C	-20°C to +140°C
Mechanical life	10 <sup>7</sup> cycles minimum (impact free actuation)
Protection	IP40 (enclosure)
Mounting	Screw mounting
Actuators	Straight or mushroom plunger
Special features	Optional reset spring for increased reset security

Circuit diagram

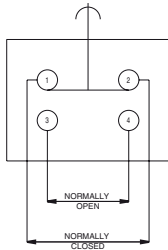

Dimensions

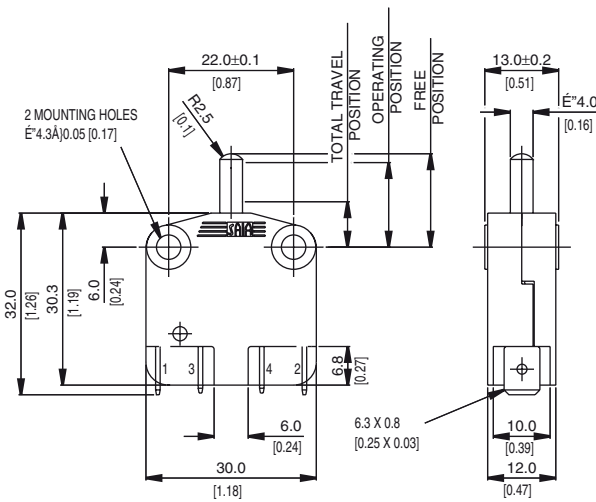

## Recommended maximum electrical ratings

Voltage (max)	Resistive load (A)	Inductive load	Horsepower	Approval
250 VAC	16 (0.75 pf)	-	-	UL 1054/CSA 22.2 No. 55 - 6,000 operations
125 VAC	-	-	¼ HP (0.45 pf)	UL 1054 - Horsepower- 6,000 operations
250 VAC	-	-	¼ HP (0.45 pf)	UL 1054 - Horsepower- 6,000 operations
250 VAC	16	6	-	EN.60158-1 T85 (°C) 50,000 operations
400 VAC	16	4	-	EN.60158-1 T140 (°C) 10,000 operations
0-15 VDC	10	-	-	General rating - 50,000 operations
15-30 VDC	7	-	-	General rating - 50,000 operations

## Operating Characteristics

Actuator	Reference	Actuating Force Maximum		Release Force Minimum		Free Position Maximum		Operating Position		Total Travel Position Maximum		Over travel	
		(N)	(ozf)	(N)	(ozf)	(mm)	(in)	(mm)	(in)	(mm)	(in)	(mm)	(in)
Straight plunger	XP2Z11	3.00	10.0	5.5	19.7	15.3	0.602	14.9 ± 0.4	0.587 ± 0.016	8.0	0.315	4.5	0.177
	XP42Z11	1.75	6.20	5.5	19.7	15.3	0.602	14.9 ± 0.4	0.587 ± 0.016	8.0	0.315	6.5	0.256
	XP52Z11	3.00	10.0	5.5	19.7	16.6	0.653	13.0 ± 0.4	0.511 ± 0.016	8.0	0.315	4.5	0.177
Mushroom plunger with reset spring	XP2E1Z11	6.5	23.3	9.0	32.3	15.3	0.602	14.9 ± 0.4	0.587 ± 0.016	10.5	0.413	2.1	0.082
	XP42E1Z11	3.75	13.4	9.0	32.3	15.3	0.602	14.9 ± 0.4	0.587 ± 0.016	10.5	0.413	4.0	0.157
	XP52E1Z11	6.5	23.3	9.0	32.3	16.6	0.653	13.0 ± 0.4	0.511 ± 0.016	10.5	0.413	2.1	0.082
Mushroom plunger	XP2E2Z11	3.0	10.0	5.5	19.7	15.3	0.602	14.9 ± 0.4	0.587 ± 0.016	8.6	0.339	4.0	0.157

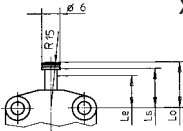
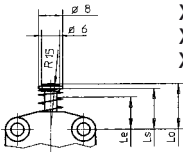
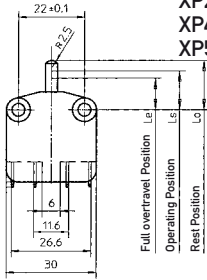

## Ordering Reference

Basic type	XP Momentary XPS Positive action forced break (normally closed only)	Example: XP	2	2	E1	Z11
Circuit	2 Change-over 4 Normally closed 5 Normally open					
Terminals	2 Faston 6.3 × 0.8					
Actuators	No symbol, straight plunger E1 Mushroom plunger with reset spring E2 Mushroom plunger					
Approvals	Z11 UL, cUL, CSA and ENEC					

## XT

Characteristics	<ul style="list-style-type: none"> <li>■ 8 mm contact gap, creepage and clearance distances</li> <li>■ forced double break contacts</li> </ul>
Rating	400 VAC, 16.5 A max.
Dimensions (mm)	30 × 32 × 12
Actuator	<ul style="list-style-type: none"> <li>■ shrouded plunger</li> <li>■ optional key</li> <li>■ plain plunger</li> </ul>
Approvals	UL, cUL, CSA, ENEC



## Preferred Range

Ordering Reference	Actuating Force (N)	Actuating Force (ozf)	Operating pos. (mm)	Operating pos. (in)	Terminal	Circuit	Actuator	Contacts	Electrical rating
XTD22AZ1	3.8	13.6	13.0	0.511	Faston	NO	Plunger	Ag nickel	Up to 400 VAC, 16.5 A

## Specifications

Housing	Glass fibre reinforced polyester
Plunger	Glass fibre reinforced polyester
Mechanism	Normally open
Contacts	Silver nickel
Terminals	6.3 mm (0.25 in) faston - brass
Temperature range °C	-20°C to +85°C
Mechanical life	10 <sup>6</sup> cycles minimum (impact free actuation)
Protection	IP40 (enclosure)
Mounting	Snap-on or screw mounting
Actuator	Plunger (can be held depressed for maintenance with optional key shrouded option only)
Accessories	Maintenance key N41784 and multiplug housing XTMHSG

Circuit diagram

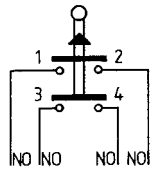

Dimensions

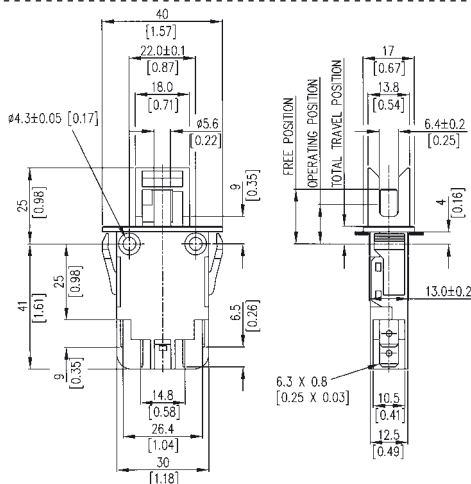

SNAP MOUNTING DETAILS

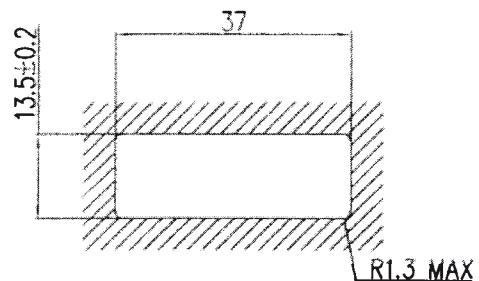

PANEL THICKNESS 1.0 – 2.5

### Recommended maximum electrical ratings

Voltage (max)	Load (A)	Inductive load	Horsepower	Approval
125 VAC	15.5 (0.75 pf)	-	-	UL 1054/CSA 22.2 No. 55 - 100,000 operations
250 VAC	15.5 (0.75 pf)	-	-	UL 1054/CSA 22.2 No. 55 - 100,000 operations
125 VAC	-	-	½ HP (0.45 pf)	UL 1054 - Horsepower- 100,000 operations
250 VAC	-	-	½ HP (0.45 pf)	UL 1054 - Horsepower- 100,000 operations
125 VAC	-	-	1½ HP (0.45 pf)	UL 1054 - Horsepower- 100,000 operations
250 VAC	-	-	1½ HP (0.45 pf)	UL 1054 - Horsepower- 100,000 operations
30 VAC	0.5	-	-	EN.60158-1 T85 (°C) 50,0000 operations
400 VAC	16.5	8	-	EN.60158-1 T85 (°C) 50,0000 operations
30 VDC	0.5	-	-	UL 1054/CSA 22.2 No. 55 - 6,000 operations

### Operating Characteristics

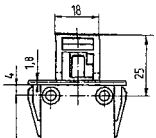
Actuator	Reference	Actuating Force Maximum		Release Force Minimum		Free Position Maximum		Operating Position		Total Travel Position Maximum		Over travel	
		(N)	(ozf)	(N)	(ozf)	(mm)	(in)	(mm)	(in)	(mm)	(in)		
Plunger 	XTD22AZ1	3.8	13,600	5.8	20.8	18.0	0.708	13.0 ± 0.4	0.511 ± 0.016	10.0	0.394	3.0	0.118
		(± 0.5)	(± 3.5)										
								12.6	0.496				
								(main contact)					
								(low voltage contact)					

### Ordering Reference

Basic type	XTD	Example: XTD	22	J	AZ1
Terminals	22	6.3 × 0.8 mm faston terminals			
	66	4.8 × 0.5 mm faston terminals			
Form	-	Without identification: snap-on mounting with shroud			
	J	Snap-on mounting without shroud			
	P	Without shroud, without snap-on mounting			
	K				
Approvals	AZ1	UL, cUL, CSA and ENEC			

Forced break

# Table of preferred products

Snap-action Microswitches	Type	Preferred Products	Preferred Products	Page
Ultraminiature	F1	F1T8GPUL	F1T8Y1GPUL	18
	F4	F4T7UL F4T7GPUL F4T7Y1UL	F4T7Y1GPUL F4T7YCUL F4T7YCGPUL	21
	F5	F5T8UL F5T8GPUL F5T8Y1UL	F5T8Y1GPUL F5T8YCUL F5T8YCGPUL	24
	F1NS	F1NST8 F1NST8A1	F1NST8AC	27
	F6	F6T85		30
	FK4	FK4T7UL FK4T7Y1UL FK4T7YCUL	FK4T8UL FK4T8Y1UL FK4T8YCUL	33
Subminiature	V4L	V4LS V4LSA1 V4LSA2 V4LST7	V4LST7A1 V4LST7A2 V4LT7	37
Miniature sealed	V3S	V3SUL V3SYRUL	V3SYR1UL V3SY1UL	42
Standard	PN4	PN401 PN402 PN402 PN4K152 PN4K63 PN4KZ56	PN4GK48 PN4GK26 PN41 PN4G PN4GH	46
	3BR	3BR103	3BR510	50
	K5	K5UL K5CUL K5KUL	K5KRUL K5QUL	52
Metal housed	V9N	V9N V9NLR V9NLR1 V9NL V9NML V9NV	V9NLRV V9NLR1V V9NLV V9NMLV V9NMRV V9NMLRV	56
	4BR	4BR	4BR510	60
Miniature	BVM3	BVM3FULS BVM3FYULS	BVM3FYRULS	64
	KB5	KB5FULS KB5FKULS	KB5FKRULS	67
Forced break	XP	XP2Z11 XP4Z211 XP5Z211 XP2E1Z11	XP42E1Z11 XP52E1Z11 XP2E2Z11	71
	XT	XTD22AZ1		74

## Headquarters

Johnson Electric Holdings Limited  
Johnson Building, 6-22 Dai Shun St, Tai Po Industrial  
Estate, New Territories

### Hong Kong

T +852 2663 6688

F +852 2897 2054

e-mail: [salesupport@johnsonelectric.com](mailto:salesupport@johnsonelectric.com)

## Sales Offices

### Asia

#### Shanghai, China

12/F, Hua Rong Tower  
1289 Pudong Road South

#### Shanghai

200122 China

T +86 21 5882 2880

F +86 21 5882 2800

#### Shenzhen China

2/F., Block 10,  
Furong Industrial Estate  
Xinqiao, Shajing  
Baoan District

**Shenzhen** 518125 China

T +86 755 2990 0886

F +86 755 2990 0890

#### Tokyo, Japan

Keihin Higashi-Ohi Bldg.  
10/F, 2-13-8 Higashi-Ohi  
Shinagawa-ku

**Tokyo** 140-0011 Japan

T +81 3 5762 1031

F +81 3 5762 1032

#### Seoul, Korea

6<sup>th</sup> Fl, Fine Bldg. 701-6  
Banpo-Dong, Seocho-Ku

**Seoul**, Korea 137-808

T +82 2 518 8347/8341

F +82 2 518 8342

#### Singapore

1 Maritime Square #09-02,  
Harbour Front Centre

**Singapore** 048623

T +65 6224 7570

F +65 6224 4538

### Europe

#### Austria

**Slovenia, Slovakia, Hungary,  
Czech Republic**

Linzer Bundesstrasse 101

A-5023 **Salzburg**

T +43 662 88 4910

F +43 662 88 4910 11

#### France

10 Bld. Louise Michel

F-92230 **Gennevilliers**

T +33 1 46 88 07 70

F +33 1 46 88 07 99

78 Boulevard du 11 Novembre

69003 **Villeurbanne**

T +33 4 37 48 84 60

F +33 4 72 43 90 11

#### Germany

**Sweden, Denmark,**

**Norway, Finland**

Weissenpferd 9

D-58553 **Halver**

T +49 2353 911 0

F +49 2353 911 230

#### Italy

Via Cadamosto 3

I-20094 **Corsico**, Milano

T +39 02 4869 21

F +39 02 4860 0692

#### Switzerland

**Poland, Spain, Turkey, Portugal**

Bahnhofstrasse 18

CH-3280 **Murten**

T +41 26 672 71 11

F +41 26 670 19 83

#### The Netherlands/Belgium

Hanzeweg 12c

NL-2803 MC **Gouda**

T +31 1825 43 154

F +31 1825 43 151

#### United Kingdom/Ireland

Dukesway

Team Valley Trading Estate

**Gateshead**

Tyne & Wear NE11 0UB

United Kingdom

T +44 191 401 61 00

F +44 191 401 63 05

### Americas

#### Connecticut

10 Progress Drive

**Shelton**, CT 06484

T +1 203 447 5362

F +1 203 447 5383

#### Ohio

801 Scholz Drive

**Vandalia**, OH 45377

T +1 937 454 2345

F +1 937 898 8624

#### Ontario, Canada

70 Ironside Crescent Unit 7

Scarborough, **Ontario**

M1X 1G4 Canada

T +1 416 299 0852

F +1 416 299 6756

#### Sao Paulo, Brazil

Av. Papa Joao Paulo I - 1256

CEP 07170-350

Guarulhos **Sao Paulo**, Brazil

T (55) 11-643 156 00

F (55) 11-643 247 11

**Johnson Electric Group**

Johnson Building, 6-22 Dai Shun Street  
Tai Po Industrial Estate, N.T., Hong Kong

Tel: (852) 2663 6688

Fax: (852) 2663 6110

Web Site: [www.johnsonelectric.com](http://www.johnsonelectric.com)