



May 13, 2011

To Our Valued Customers:

At the **close of business Monday, June 13, 2011** we will implement a group of list price changes. We apologize for having to increase prices again so close to the May 9, 2011 price change. Unfortunately we have been left with little choice.

We have received urgent price increase notices from major U.S. manufacturers implementing their increases without notice. What is common to these manufacturers is that they all use chemical components that are petroleum based. The affected products are silicones, sealants, lubricants, solvent cements and primers. Also note that other manufacturers are increasing prices due to fuel, overhead and continued raw material cost increases.

The following page is an initial tab listing of the product groups that are changing at the **close of business Monday, June 13, 2011**. The new list prices will be available on our website at www.americangranby.com on or about June 6, 2011. Changes will be indicated in bold type. Catalog pages with list pricing can be viewed and downloaded for printing to update your AGI catalog. Excel files are also available for download on the site. We will not be mailing a hard-copy price change mailing.

If you do not have access to our website, please contact your sales representative or Customer Service and we will forward you a copy of the Excel spreadsheet or the new catalog pages.

Sincerely,

Gary Palley
V.P. Sales & Marketing

7652 Morgan Road
Liverpool, New York 13090
(315) 451-1100
Fax: (315) 451-6928

INSTRUCTIONS FOR OBTAINING LIST PRICE CHANGE DATA - JUNE 14, 2011

To obtain copies of our list price changes go to www.americangranby.com. Click the DOWNLOAD tab.

There are multiple options for you to download.

- For an Excel file of the latest list price changes in alpha numeric order: On the left under PRICE CHANGE UPDATES click on the **6/14/11 Price Change Excel File**. This Excel file can be re-sorted or filtered as you need and includes both old and new list prices plus the % change. This file can be used as a reference or update to your operating system.
- For a .PDF version of only the updated catalog pages: On the left under PRICE CHANGE UPDATES click on the **6/14/11 Catalog Page Changes PDF file**. Print out only the catalog pages with changes and insert into your current product catalog.
- Click on FULL CATALOG and SECTION DOWNLOADS for .PDF files of the Full Granby Catalog or for specific sections.

Product	Page Numbers	Product	Page Numbers
Pool Rope & Rope Accy	P.03	Galv Compression Ftgs	6.02
Relief Valves	P.05	Pipe Repair Clamps	6.03
Float Valves	P.24	Clear Braided Hose	6.13
Butterfly Valves	P.25	Wax Gaskets	6.18
Clear Braided Hose	P.31	Hanger Strapping	6.27
Boss Silicones	P.41 - P.42	Pipe Straps	6.29 - 6.30
		Pipe Hooks	6.31 - 6.32
Tank Crosses	1.07	Pipe Hangers	6.33 - 6.34
Tank Crosses	1.10a - 1.10b	Pipe Hangers	6.35 - 6.36
Tank Crosses	1.11	Stud Protectors	6.39
Relief Valves / Tank Accy	1.23 - 1.24		
Clear Braided Hose	1.25	Tapes	7.02
Air Volume Controls/Releases	1.27 - 1.28	Boss Silicones	7.09 - 7.12
Installation Accy	1.29 - 1.30	Dow Silicones	7.14
Insert Fittings	1.31 - 1.32	Cements, Primers Cleaners	7.17 - 7.26
Flow Control Valves	1.35 - 1.36		
Pitless Adapters	1.55	Super Lube	8.05 - 8.09
Well Point Supplies	1.68		
Pitcher Pump	1.71	Plumbing Tools	11.09 - 11.10
Cylinder parts	1.78		
Rod Couplings	1.80	Insert Fittings - Red Brass	12.03 - 12.04
Jet Lube	1.90 - 1.94	Insert Fittings - Steel	12.05 - 12.06
		Insert Fittings - Steel / YB	12.07 - 12.08
Check Valves	2.01 - 2.04	Galv Compression Couplings	12.16
Foot Valves	2.05	Pipe Repair Clamps	12.17
Hydrants	2.17	Merchant Couplings	12.25
Hydrants	2.19	Threaded Bronze	12.27 - 12.32
		Import Malleables	12.33 - 12.40
Ball Valves - NEW	3.02	Domestic Malleables	12.41 - 12.48
Ball Valves / Float Valves	3.03 - 3.04	Nipples - RB	12.50
Swing Check Valves	3.06	Nipples - Steel	12.51 - 12.52
Plumbing Valves	3.07 - 3.08		
Butterfly Valves	3.23		
RO Systems - NEW	4.08a		
UV Systems	4.46 - 4.48		



Pool Rope - Twisted/Braided



PR Series



BPR Series

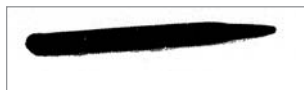

FID

Pool Rope Features:

- Polypropylene.
- Floatable.
- Waterproof.
- Rot Resistant.
- Easy to Handle.
- Resists Oil and Gasoline.
- Resists Most Chemicals.
- Resistant to Abrasion.
- Resistant to Color Fading.

Part Number	Color	Diameter	Length	List Price
Twisted Pool Rope				
PR25-6	Blue/White	1/4"	600'	\$ 69.53
PR38-4	Blue/White	3/8"	400'	111.43
PR38-6	Blue/White	3/8"	600'	166.10
PR50-3	Blue/White	1/2"	300'	131.10
PR50-6	Blue/White	1/2"	600'	262.22
PR58-6	Blue/White	5/8"	600'	448.38
PR75-3	Blue/White	3/4"	300'	294.77
PR75-6	Blue/White	3/4"	600'	589.57
PR38-3R	Red/White	3/8"	300'	83.05
PR38-6R	Red/White	3/8"	600'	166.10
PR50-3R	Red/White	1/2"	300'	131.10
PR50-6R	Red/White	1/2"	600'	262.22
PR75-3R	Red/White	3/4"	300'	294.77
PR75-6R	Red/White	3/4"	600'	589.57
PR38-3O	Orange/White	3/8"	300'	83.05
PR38-6O	Orange/White	3/8"	600'	166.10
PR50-3O	Orange/White	1/2"	300'	131.10
PR50-6O	Orange/White	1/2"	600'	262.22
PR75-3O	Orange/White	3/4"	300'	294.77
PR75-6O	Orange/White	3/4"	600'	589.57
PR38-3W	Solid White	3/8"	300'	83.05
PR38-6W	Solid White	3/8"	600'	166.10
PR50-3W	Solid White	1/2"	300'	131.10
PR50-6W	Solid White	1/2"	600'	262.22
PR75-3W	Solid White	3/4"	300'	294.77
PR75-6W	Solid White	3/4"	600'	589.57
YR25-500	Solid Yellow	1/4"	500'	50.89
YR25-1	Solid Yellow	1/4"	1000'	98.93
Braided Pool Rope				
BPR38-5	Blue/White	3/8"	500'	96.24
Splicing Fid				
FID	Splicing Fid, For 3/8" braided rope			2.18

Pool Rope Anchors & Hooks



Chrome Plated Brass Rope Accessory Features:

- Bright chrome finished brass rope accessories.
- Precision cast from corrosion resistant brass.
- Stainless steel fasteners.
- Black or White EPDM gaskets.
- Fully assembled.



HOE2

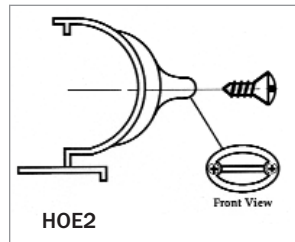

HOE2

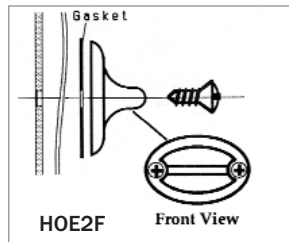

HOE2F

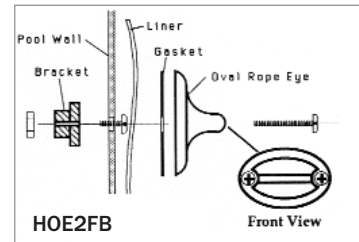

HOE2FB



HCA



HEBA



HPRS



HRH



AGHP

Part Number	Description	Ctn Qty	List Price
HOE2	Chrome Plated Brass CURVED COPING MOUNT Oval Rope Anchor (Set of 2 w/ ss self tap screws)	72	\$ 11.45↓
HOE2F	Chrome Plated Brass FLAT WALL MOUNT Oval Rope Anchor (Set of 2 w/ ss self tap screws, EPDM gasket)	6/72	12.87↓
HOE2FB	Chrome Plated Brass FLAT WALL MOUNT Oval Rope Anchor w/ brass mounting bracket and hardware (Set of 2 w/ ss screws, EPDM gasket, brass mounting brackets)	6/72	20.76↓
HCA	Chrome Plated Brass Cup Anchor for concrete pools.	12/120	9.81↓
HEBA	Chrome Plated Brass wall mount eye with washer gasket and nut for vinyl liners. 1-3/8" long bolt	20/200	12.32
HPRS	Chrome Plated Strap Type Rope Anchor used under coping for vinyl pools. 14" long	12/252	12.47
HRH	Chrome Plated Brass "S" Rope Hook for 1/4"-1/2" rope	500	5.04
AGHP52	CLEAT Style Chrome Plated Brass Hook for 3/8" & 1/2" rope w/ ss screws	125	15.39
AGHP53	CLEAT Style Chrome Plated Brass Hook for 3/4" rope w/ ss screws	125	20.04



Pool Heater Accessories



LR Series

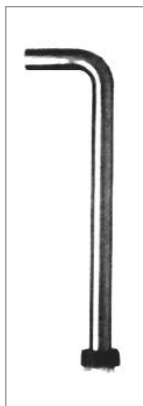

LRUN Series

LR SERIES Features:

- For use with Laars-Raypak pool and spa heaters.
- Available in copper or stainless steel, with plastic quick connect union or bronze male adapter.

Part Number	Size	Ctn Qty	List Price
Copper Tube with 1 Bronze Male Adapter			
LR617	1-1/2" x 6" x 17"	12	\$ 119.95
LR619	1-1/2" x 6" x 19"	12	125.82
LR623	1-1/2" x 6" x 23"	12	136.81
LR626	1-1/2" x 6" x 26"	12	139.01
LR623-2	2" x 6" x 23"	6	186.43
Copper Tube with Plastic Quick Connect Union			
LR617UN	1-1/2" x 6" x 17"	8	108.79
LR623UN	1-1/2" x 6" x 23"	8	119.78
Stainless Steel Tube with Plastic Quick Connect Union			
LR617SSUN	1-1/2" x 6" x 17"	8	104.40
LR619SSUN	1-1/2" x 6" x 19"	8	111.92
LR621SSUN	1-1/2" x 6" x 21"	8	123.24
LR623SSUN	1-1/2" x 6" x 23"	8	128.08
LR626SSUN	1-1/2" x 6" x 26"	8	146.98
LR617-2SSUN	2" X 6" X 17"	6	147.20
LR619-2SSUN	2" X 6" X 19"	6	151.37
LR623-2SSUN	2" X 6" X 23"	6	165.44
Replacement Union Assembly			
PHU150	LR/PL Series-1-1/2"	1	23.41
PHU200	LR/PR Series-2"	1	26.54
Union O-Ring			
PHU150 O-RING	1 1/2" o-ring	1	2.64
PHU200 O-RING	2" o-ring	1	2.64
Heater Union Repair Split Nut			
HSNR150	1 1/2" FBT Heater Split Nut Set w/ screws	125	4.42
HSNR200	2" FBT Heater Split Nut Set w/ screws	100	4.98



10-417-15

Hot Water Swimming Pool Heater

Safety Relief Valve Features:

- Bronze safety relief valve protects ASME Section IV hot water heating boilers and hydronic heating systems.
- High capacity design features corrosion resistant construction.
- Ideal for use in swimming pool heater applications, hot water boilers and hydronic heating systems.
- ASME Section IV.
- Set pressure 75 psi. 20-80 psig certified pressure range.
- Maximum temperature service 250°F
- Stainless steel springs.
- Registered in all Canadian provinces and territories, CRN #0G8547.5C
- Made in USA.

Part Number	Description	Height	Ctn Qty	List Price
10-417-15	3/4" M/F Safety relief valve	3"	100	\$ 42.13



American Granby Inc.™

In the United States: Phone (800) 776-2266 Fax (800) 729-3299
 In Canada: Phone (866) 503-5523 Fax (888) 562-2095

www.americangranby.com

6/14/11

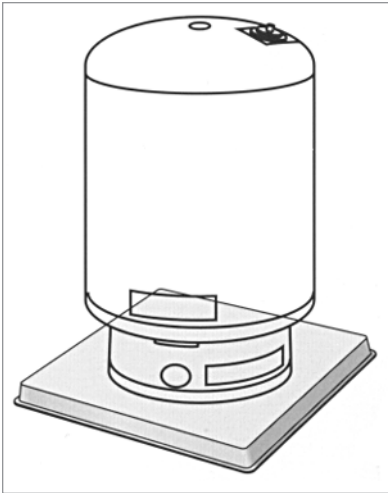

HEF-T-PAD™ Features:

- Injection molded from high impact polyolefin for strength and durability.
- Resistant to impact, UV degradation and weathering.
- Will not crack, flake or warp.
- Virtually impervious to climate changes.
- Drillable, permits installation of refrigerant and electrical lines under and through pad. Also permits equipment to be easily secured to pad.
- Unique, non-creep surface absorbs vibration and noise and keeps equipment in it's original position.
- Gray

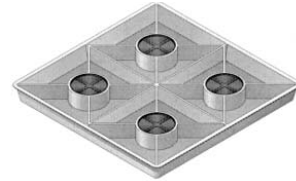

Underside of Hef-T-Pad showing support ribs, stabilization pads and stabilization flange.

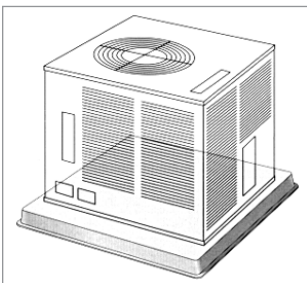
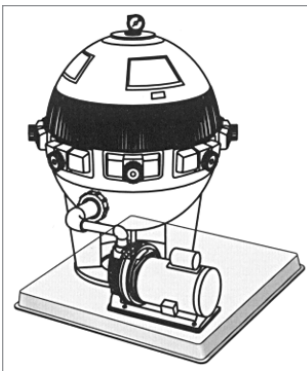

Part Number	Size	Pallet Qty	List Price
2" HEF-T-PADS			
X2424211	24" x 24" x 2" one piece	24	\$ 52.18
X2430211	24" x 30" x 2" one piece	24	66.41
X2436211	24" x 36" x 2" one piece	24	80.24
X3232211	32" x 32" x 2" one piece	24	85.33
X3244211	32" x 44" x 2" one piece	24	107.51
X3636211	36" x 36" x 2" one piece	24	106.67
X3830211	38" x 30" x 2" one piece	24	86.92
X3836211	38" x 36" x 2" one piece	24	110.69
X3842211	38" x 42" x 2" one piece	24	139.77
3" HEF-T-PADS			
X2424311	24" x 24" x 3" one piece	16	63.99
X2436311	24" x 36" x 3" one piece	16	98.62
X3030311	30" x 30" x 3" one piece	16	81.75
X3232311	32" x 32" x 3" one piece	16	98.94
X3244311	32" x 44" x 3" one piece	16	131.40
X3636311	36" x 36" x 3" one piece	16	133.90
X3848311	38" x 48" x 3" one piece	16	172.56
X5055301	50" x 55" x 3" modular	16	308.71
X2600311	26" diameter round x 3" one piece	16	61.03



Check Valves - PVC Spa, By-Pass



1050 Series



PVC Spa Air Valve Features:

- Drip proof seal at low pressure.
- 1 1/2" IPS deep socket connection with 2" IPS OD spigot
- Excess solvent cement trap at base of socket to help prevent solvents from entering sealing area.
- Minimum restriction of air flow, using 1/4 lb. spring resulting in less burden on blower motor.
- Domed shaped seat for even air flow.
- EPDM seal.
- Stainless steel spring.

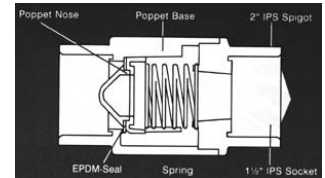

1095 Series

PVC In-Line By-Pass Check Valve Features:

- In-line shape takes less space.
- Raised valve seat prevents excess cement of solvent from affecting the seal area.
- Poppet is equipped with EPDM seal.
- Body is made of Type 1 PVC.
- All metal parts are stainless steel.
- Valve stem is reinforced w/ full length stainless steel shaft.
- Static pressure tested: 150 psi @ 72 °F. Back pressure tested at 150 psi.
- Quick burst test proves in excess of 500 psi
- 2" iron pipe size
- Valve can be used on 1-1 1/2" pipe by use of a PVC Sch 40 bushing.
- Begins to open at 1/2 lb. or 5 lb.
- NSF approved.

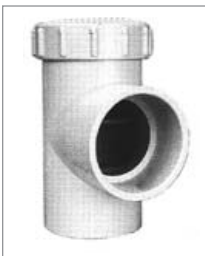
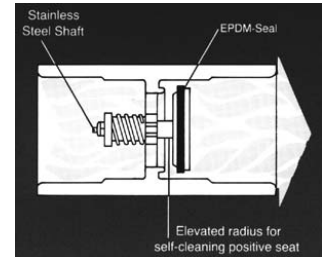

1901/1903 Series

CPVC 90° Spring Check Valve Features:

- Use in pool, spa applications.
- CPVC body with corrosion proof poppet.
- Spring made of 302 stainless.
- Available with 1 lb. or 3 lb. spring tension.
- NSF approved.

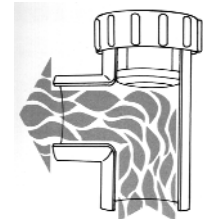

See "FLO/NDS" tab for a complete line of Flo Control PVC check valves.

Part Number	IPS Size	Body Length	Ctn Qty	List Price
PVC Spa Air Valve - 1-1/2" ips socket / 2" ips o.d. spigot				
1050-20	2"	5-1/8"	12	\$ 26.38
PVC In Line By-Pass Check Valve				
1095-20	2" w/ 5# spring	5"	12	33.27
CPVC 90° Spring Check Valve, w/ stainless steel poppet				
1901-15	1 1/2" check valve, 1 lb. tension		12	82.32
1903-15	1 1/2" check valve, 3 lb. tension		12	82.32
1901-20	2" socket x 2 1/2" spigot valve, 1 lb. tension		12	82.32
1903-20	1" socket x 2 1/2" spigot valve, 3 lb. tension		12	82.32

Bronze Float Valves

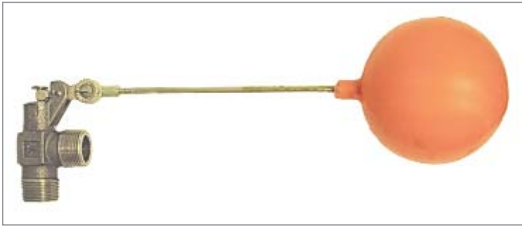

Bronze Float Valve Features:

- Cast bronze body
- Buna-N Disc
- Heavy Duty
- Tapped for 1/4"-20SAE rod
- Threaded outlet
- Rated at 125 psi.



BFV Series

Part Number	Size	Inlet	Outlet	Tapped	Ctn/Case Qty	List Price
BFV1/2	1/2"	1/2" mpt	1/2" mpt	1/4"-20SAE	10/100	\$ 29.70
BFV3/4	3/4"	3/4" mpt	3/4" mpt	1/4"-20SAE	10/80	35.83
BFV1	1"	1" mpt	1" mpt	1/4"-20SAE	10/40	47.34

Brass Rods Features:

- Brass SAE
- Male thread both ends



BFVR Series

Part Number	Length	Thread	Fits Valve Size	Ctn/Case Qty	List Price
BFVR8	8"	1/4"-20SAE	1/2" - 1"	50/400	\$ 6.62
BFVR10	10"	1/4"-20SAE	1/2" - 1"	50/300	7.67
BFVR12	12"	1/4"-20SAE	1/2" - 1"	50/300	8.59



BFVFP Series

Plastic Float Features:

- Lightweight, Corrosion resistant PVC
- Up to 175 °F
- For open tank service only

Part Number	Float Diam.	Buoyancy	Female Connection	Ctn Qty	List Price
BFVFP5	5"	2.17 lbs.	1/4"-20SAE	100	\$ 21.23
BFVFP6	6"	3.8 lbs.	1/4"-20SAE	100	25.00
BFVFP8	8"	9.87 lbs.	1/4"-20SAE	20	31.08



Butterfly Valves - Cast Iron



HBFV Series

ISO 9002



HBFV GEAR Series



Cast Iron Butterfly Valve Features:

- Designed for swimming pool, irrigation and water systems.
- Wafer body features 4 alignment holes.
- Lever lock handle (spring loaded) provides excellent manual control for balancing or shut off services.
- Notched throttling plate allows balancing in 10° increments in any position desired within 90° arc rotation of the disc.
- Positive bubble-tight shutoff with minimum torque.
- Seat face eliminates need for flange gaskets.
- Phenolic backed seats prevent collapse, are stretch resistant, blowout proof and field replaceable.
- EPDM seats temperature rated at -30° F to 275° F.
- 416 stainless steel shaft
- Bidirectional dead-end capability for 250 psi (2" - 12").
- Compatible with ANSI 125/150 flanges.
- Valves meet AWWA C-504-87 section 5 proof of design tests.
- Designed to comply with MSS SP-67 and API 609.
- Ductile iron, ENP plated disc.
- Manufactured for AGI in an ISO 9002 facility.
- Imported

Part No.	Size	Weight(lbs)	Ctn Qty	List Price
Ductile Iron ENP Plated Disc*				
HBFV2	2"	7	1	\$ 107.09
HBFV2 1/2	2-1/2"	8	1	126.65
HBFV3	3"	10	1	162.95
HBFV4	4"	12	1	209.38
HBFV5	5"	15.5	1	229.78
HBFV6	6"	17.5	1	273.75
HBFV8	8"	33	1	461.73
HBFV10	10"	50	1	577.31
HBFV12	12"	74	1	917.27
Ductile Iron ENP Plated Disc - GEAR DRIVE *				
HBFV6-GEAR	6"	28.5	1	351.89
HBFV8 GEAR	8"	54	1	573.50
Replacement Handles for HBFV Series				
BFH2	2"		1	17.46
BFH3	3"		1	17.46
BFH4	4"		1	17.46
BFH5	5"		1	20.87
BFH6	6"		1	20.87
BFH8	8"		1	42.94
BFH10	10"		1	42.94
BFH12	12"		1	48.88

Flanges & Bolt kits available, see page P.28



In the United States: Phone (800) 776-2266 Fax (800) 729-3299
In Canada: Phone (866) 503-5523 Fax (888) 562-2095

www.americangranby.com

6/14/11

Butterfly Valves - Cast Iron

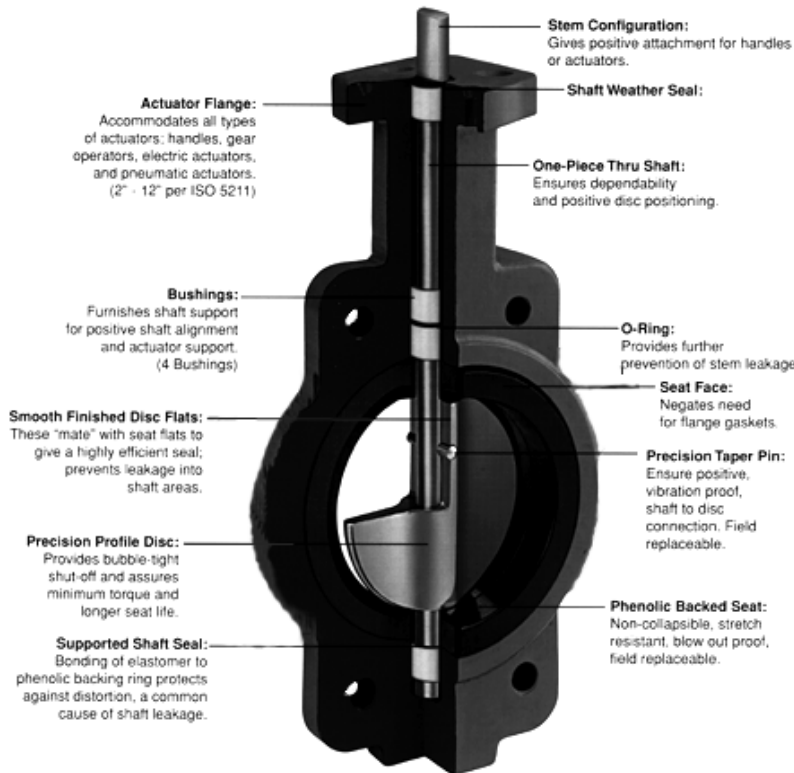

MATERIAL SPECIFICATIONS		
No.	Part	Material
1	Body	Cast Iron
2	Disc	Ductile Iron
3	Seat	EPDM
4	Shaft	416 Stainless Steel
5	Taper Pin	316 Stainless Steel
6	Key	Carbon Steel
7	O-rings	EPDM
8-10	Bushing	PTFE

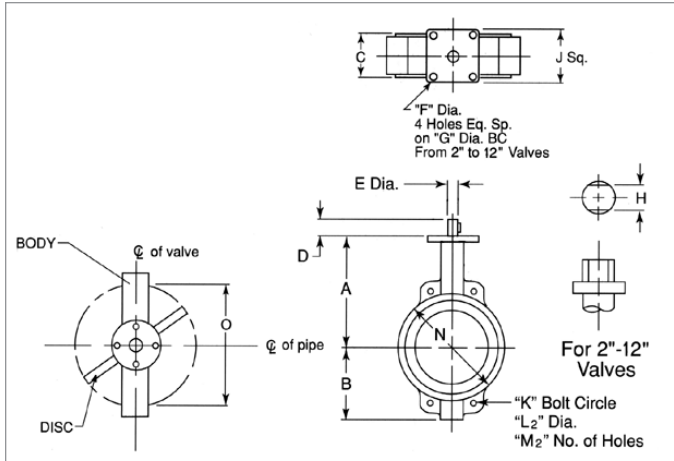
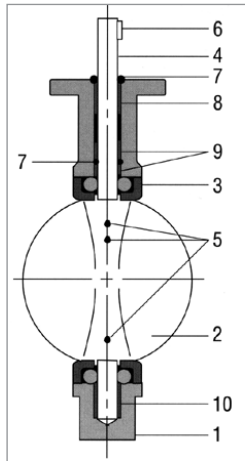

SIZE \ DIMENSION (in) for HBFV Series	A	B	C	D	E	F	G	H	J	K	L ₂	M ₂	N	O
2"	6 3/8	3 1/4	1 3/4	1 1/4	1/2	3/8	2.76	.39	2 3/4	4 3/4	11/16	4	4	1.26
2 1/2"	6 7/8	3 3/4	1 7/8	1 1/4	1/2	3/8	2.76	.39	2 3/4	5 1/2	11/16	4	4 3/4	1.83
3"	7 1/8	4	1 7/8	1 1/4	1/2	3/8	2.76	.39	2 3/4	6	11/16	4	5 1/8	2.54
4"	7 7/8	4 7/8	2 1/8	1 1/4	5/8	3/8	2.76	.47	2 3/4	7 1/2	11/16	4	6 3/4	3.54
5"	8 3/8	5 3/8	2 1/4	1 3/16	3/4	3/8	2.76	.55	2 3/4	8 1/2	13/16	4	7 3/4	4.36
6"	8 7/8	5 7/8	2 1/4	1 1/4	3/4	3/8	2.76	.55	2 3/4	9 1/2	13/16	4	8 5/8	5.72
8"	10 1/4	7 1/8	2 1/2	1 3/4	7/8	7/16	4.02	.67	3 3/4	11 3/4	13/16	4	10 9/16	7.6
10"	11 1/2	8 1/4	2 3/4	1 3/4	1 1/8	7/16	4.02	.87	3 3/4	14.14	15/16	4	13 1/16	9.5
12"	13 1/4	9 3/4	3 1/8	1 3/4	1 1/4	7/16	4.02	.95	3 3/4	17	15/16	4	16 1/8	11.45



Clear Braided PVC Hose



Clear Braided PVC Hose Standard Wall, Class 125 Features:

- Flexible, see through clear hose with braid pattern reinforcement of two polyester spirals.
- Flexible clear PVC NSF 51 certified to 100°F (38°C), USP CLASS V1 rated.
- All hose compound ingredients used are listed in US FDA CFR, Title 21.
- Temperature range + 25° to 150° F / -5° to +65°C.
- Silicone free.
- Food and beverage grade, standard wall.
- Use for air, water lines.



Part Number	Nominal (inches)		Max Working Pressure		Reel Length	Approx Wt per CFT.	List Price Per Reel
	ID	OD	PSI@68°F	PSI@122°F			
CBH316-1	3/16	0.375	250	105	100'	4.5 lbs	\$ 117.06
CBH25-1	1/4	0.438	250	105	100'	5.7 lbs	102.32
CBH516-1	5/16	0.525	250	105	100'	7.5 lbs	150.56
CBH38-1	3/8	0.594	225	97	100'	9.0 lbs	145.37
CBH50-1	1/2	0.750	200	86	100'	13.8 lbs	195.91
CBH50-3	1/2	0.750	200	86	300'	13.8 lbs	587.73
CBH58-1	5/8	0.875	200	86	100'	16.5 lbs	231.09
CBH75-1	3/4	1.030	150	65	100'	21.9 lbs	293.71
CBH75-3	3/4	1.030	150	65	300'	21.9 lbs	881.15
CBH100-1	1	1.300	125	54	100'	31.5 lbs	378.42
CBH100-2	1	1.300	125	54	200'	31.5 lbs	707.34
CBH125-50	1 1/4	1.625	100	43	50'	45.0 lbs	359.08
CBH125-1	1 1/4	1.625	100	43	100'	45.0 lbs	718.17
CBH150-50	1 1/2	1.937	100	43	50'	64.0 lbs	432.96
CBH150-1	1 1/2	1.937	100	43	100'	64.0 lbs	865.91
CBH200-50	2	2.490	75	33	50'	95.0 lbs	739.93
CBH200-1	2	2.490	75	33	100'	95.0 lbs	1479.89

** Temperatures higher than 68° F reduce available working pressure. See next page for temperature, working pressure calculation chart and cautionary note.

Clear Braided PVC Hose



Effects of Elevated Temperatures on Thermoplastic Hose.

The compounds used in clear braided PVC hose are generally referred to as thermoplastics. These materials achieve their optimum physical properties at room temperature, 68°F (20°C). As these materials are exposed to increased ambient temperatures, they will soften and their physical properties will change. This will have the effect of sharply reducing the available working pressure. Coupling retention will also be reduced. The charts below illustrate this effect. In all cases, the product should be tested in a controlled, secure and safe environment, and all operating conditions should be considered prior to use.

All published working pressures of AGI Series CBH hose are based on a room temperature of 68°F (20°C).

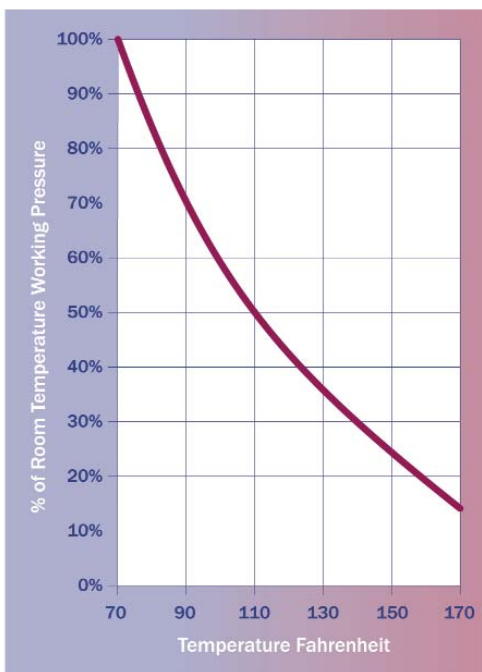

Example from the Fahrenheit Chart

If working pressure at 68°F is 200 psi, then the WP at 110°F is $200 \times 50\%$, or 100 psi

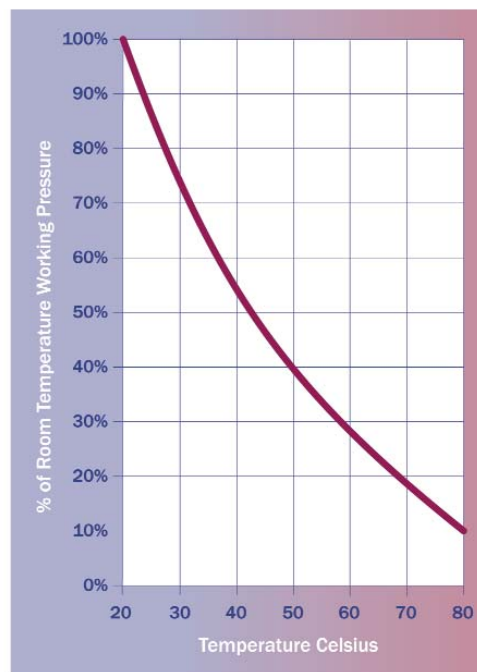

Example from the Celsius Chart

If working pressure at 20° is 14 bar, then the WP at 50°C is $14 \times 50\%$, or 5.6 bar

CAUTIONARY NOTE

The charts are to be used as a guideline only. The information and recommendations contained here are, to the best of our manufacturer's knowledge, accurate and reliable, but no guarantee of their accuracy is made. All products are sold upon the condition that purchasers shall make their own tests to determine the suitability of such products for their particular purposes and uses, and purchasers assume all risks and liability for the results of use of the products, including use in accordance with seller's recommendations. Variability in length of exposure, temperature, pressure, velocity of fluid, and chemical concentration all contribute to reduced working pressure and hose reliability.



BOSS® Pool & Spa Adhesives, Lubricants & Sealants



BOSS® line of adhesives, grouts and lubricants are specifically formulated for use with pools and whirlpool baths.

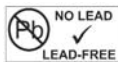

BOSS® 801 Neutral Cure Silicone Adhesive Features:

- A one part, low odor, non-corrosive, oxime cure adhesive and sealant.
- Provides excellent adhesion to ceramic tile, spa jets, skimmers, lighting fixtures, plumbing and fiber optic lighting.
- Adheres well to fiberglass, ABS, acrylic, PVC, wood and masonry.

BOSS® 802 Acetoxy Cure Silicone General Purpose Adhesive Features:

- A one part, acetoxy cure, adhesive/sealant.
- Performs well in jet sealing applications.
- Designed for many other pool and spa maintenance and repair needs.

BOSS® 803 Neutral Cure Silicone Adhesive/Grout Features:

- A one part, low odor, non-corrosive, oxime cure silicone grout.
- Formulated for use in repairing tile installations.
- Adheres well to fiberglass, ABS, acrylic, PVC, wood and masonry.

BOSS® 804 Neutral Cure Silicone Ceramic Tile Grout Features:

- A one part, low odor, non-corrosive, oxime cure silicone grout.
- Spreads easily and provides ample tooling time.
- Excellent adhesion to all ceramic tiles

BOSS® 820 Pool & Spa Silicone Lubricant Features:

- Water washout resistant and non-solidifying compound.
- Provides superb lubricant for rubber o-rings.
- Non-corrosive, silicone lubricant compound.

Part Number	Description	Ctn Qty	List Price
80100B	Silicone Adhesive Clear, 10.3 oz cart	12	\$ 15.31
80101B	Silicone Adhesive White, 10.3 oz cart	12	15.31
80200B	Silicone Adhesive Gen Purpose, Clear 10.3 oz. cart	12	9.37
80201B	Silicone Adhesive Gen Purpose, White 10.3 oz cart	12	9.37
80331B	Silicone Adhesive Grout, Clear 3 oz. tube	12	7.65
80401B	Silicone Ceramic Tile Grout, White 10.3 oz cart	12	15.31
82001B	Pool & Spa Lubricant Clear, 1 oz tube bulk	288	5.18
82002B	Pool & Spa Lubricant Clear, 1 oz tube 36 pc tub	36	249.90
82030B	Pool & Spa Lubricant Clear, 3 oz tube	12	7.88
82000B	Pool & Spa Lubricant Clear, 5.3 oz tube	12	13.21

BOSS® Expanding Foam Sealant



**BOSS®
PRODUCTS**



BOSS® 333 Expanding Foam Sealant Features:

- Easy to use, multi-purpose urethane foam.
- Unlike ordinary sealants, it expands **three** times it's original volume.
- Adheres to all building materials except Teflon®, silicone and polyethelene.
- Seals by expanding into gaps, cracks and crevices.
- Uses including insulating, sealing and filling gaps around pipes, plumbing fixtures, ductwork and foundations.
- UL classified.

DIRECTIONS FOR USE:

1. Shake can before and during use.
2. Surface must be clean and free of grease and oil.
3. Can must be held UPSIDE DOWN during application.
4. Insert straw into void and depress the trigger. The use of protective gloves is highly recommended.
5. Fill void 50% full to allow for expansion.
6. Uncured foam can be cleaned with acetone or paint thinner.
7. Cured foam can be trimmed, sanded, painted or stained. Foam MUST be painted or covered if application is exposed to UV light.

	R19028 CAULKING AND SEALANTS SURFACE BURNING CHARACTERISTICS APPLIED TO INORGANIC REINFORCED CEMENT BOARD* FLAME SPREAD: 5 SMOKE DEVELOPED: 20 38FN
* Tested as applied in three 3/4" beads 5" on center covering 12.5% of the exposed test sample area.	

Part Number	Description	Ctn Qty	List Price
33316B *	Expanding Foam Sealant, 12 oz can w/ application tip	12	\$ 14.55
33324B *	Expanding Foam Sealant, 24 oz can w/ application tip	12	28.47

* SHIPPING NOTE: Ground shipping only. Can NOT be shipped via air.



PERMAPOXY Underwater Repair Epoxy

- Ideal for pool & spa repairs.
- Resin and hardener in same stick
- Hand kneadable.
- Unaffected by chlorinated or salt water.
- Sets in 5 minutes, cures in 1 hour.
- Dries White.
- Can be sanded and drilled.

ISO 9001

Part Number	Size	Ctn Qty	List Price
82093	7" stick	12	\$ 21.22



3M Spray Adhesives

BLUE 72

- Repositionable BLUE pressure sensitive spray adhesive.
- One side bonds in 8 hours, aggressive tack, low soak in.
- Covers 100 sq ft.
- Ideal for pool liner installation.

ORANGE FOAM FAST 74

- Permanent, light orange, fast tack.
- Two sides bond in 15 minutes.
- Covers 260 sq. ft.

Both manufactured for AGI in an ISO 900 facility.

Pallet pricing available. Call your sales rep.

ISO 9001

Part Number	Size	Ctn/Pallet Qty	List Price
BLUE 72	Blue Spray Adhesive 24 fl oz can, 17.3 oz net wt.	12/768	\$ 35.70
ORANGE 74	Orange spray adhesive 24 fl oz can, 17.3 oz net wt	12/768	43.33



HDT Series

POLYKEN

Contractor/Industrial Grade Cloth Reinforced Duct Tape

- Multi-purpose duct tape.
- Polyethylene coated cloth backing.
- Natural rubber based adhesive.
- Temperature range: 40°F to 200 °F.
- Superior tensile strength, adhesion & tack.
- Recommended for pool liner installations.
- Conformable and will not curl or twist during application.
- 10 mil thickness
- Silver
- Manufactured for AGI in an ISO 9002 facility.

ISO 9002

Part Number	Width x Length	Ctn Qty	List Price
HDT260	2" x 60 yards	24	\$ 20.70



FAL32



Fix A Leak Features:

Fix A Leak is a blended material, designed to seal leaks in just about anything. It works in any kind of pool, spa or hot tub, regardless of constructed material, concrete, fiberglass, acrylic, wood, etc. It works equally well in all plumbing materials including PVC, ABS, poly plastics, vulcathen, copper, steel, etc.

- Seals leaks up to 1/8" in diameter.
- Forms a permanent seal.
- One quart is designed to seal leaks in up to 20,000 gallons. Do not use in excess of 1 quart per 5,000 gallons of water.
- Cures in 24-48 hours.
- Patented by Marlig Industries, Inc.

Part Number	Description	Ctn Qty	List Price
FAL32	Fix A Leak Sealant, 32 oz.	12	\$ 49.25
FAL8	Fix A Leak Sealant, 8 oz.	20	20.11

See the "Tapes, Sealants, Cements" and "Permatex Industrial" tabs for more installation & repair materials.





PTC163-6ST



PTC163-6RA

HARVARD CONTRACTOR'S

Power Cord Features:

- Three prong straight (115V) or right angle (115V, 220V) molded plugs.
- 16 gauge, 3 conductor, 13 amp, 125 Volt rating.
- 14 gauge, 3 conductor, 15 amp, 250 Volt rating.
- Six foot cord length.
- Free end is split, stripped 3/8".
- UL and CSA listed in US and Canada.



PTC143-6RA220

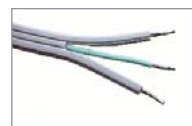

Part Number	Description	Wire Gauge	Volt Rating	Ctn Qty	List Price
PTC163-6ST	Straight plug cord	16	125 V	50	\$ 6.61
PTC163-6RA	Right angle plug cord	16	125 V	50	9.47
PTC143-6RA220	Right angle plug cord	14	250 V	50	14.11



HARVARD CONTRACTOR'S

Anchor Kit Features:

- Anchor kits complete with 100 plastic anchors, 100 screws and 1/4" masonry drill bit in a plastic case.
- Plastic gray ribbed anchors with lip design for electronic timer, pump start relay installations. Use with concrete block, brick and wallboard.
- Anchors have internal ribs for better centering of screws, locking lugs against pull and twist. Exterior design prevents fall out in overhead holes.
- Kit available with combination slotted/phillips head or tri-combination, slotted/phillips/hex head #10 x 1" screws.
- Kits complete with 1/4" x 4" masonry drill bit.
- Clear, unbreakable plastic case with molded-in hanging tab.



Combo Head

Tri Combo Head



Part Number	Description	Ctn Qty	List Price
AK10CSPR	Ribbed Combo Head	36	\$14.11
AK10TCR	Ribbed Tri Combo Head	36	15.00



A simple squeeze to repair horizontal cracks and spalls, and to set anchors

DP600

Horizontal Concrete Repair Features:

Hardenes in as little as 5 minutes,

Cracks and spalls in concrete floors are an eyesore as well as a potential safety risk. Fixing them has meant either hiring and waiting for an outside contractor or doing it yourself with a repair method that takes the floor out of service for up to 24 hours. Now with 3M Concrete Repair, you save money and time.

- Self-leveling urethane flows smoothly into cleaned cracks and gaps and hardens in as little as 5 minutes. A fork lift can pass over a repair in as few as 15 minutes.
- Hardenes to any depth without cracking or shrinking.
- Flexible urethane expands and contracts for durability that outlasts repairs made with concrete.
- Do it yourself with a common caulking gun and eliminate the cost and wait for an outside contractor.
- *Easy to use - Just clean damaged area and fill. With every squeeze of the caulking gun trigger, cartridge nozzle meters and mixes precise proportions for optimum performance.*



Part Number	Description	Ctn Qty	List Price
DP600	Concrete Repair, 8.4 fl oz cartridge supplied with 2 nozzles	6	\$ 111.72



9" Ratchet Style Caulking Gun

Part Number	Size	Color	Ctn Qty	List Price
CG9	9" Ratchet	Blue	20	4.39



Horizontal Concrete Repair Specifications:

- Gray, self-leveling urethane concrete repair.
- 8.4 fl oz. cartridge of concrete repair and 2 nozzles.
- Work life of 70 sec.
- Handling time of 5 minutes
- Cure time of 60 minutes

Applications:

- Repairing cracks and spalls on concrete floors or horizontal surfaces.
- Setting anchors in concrete floors or horizontal surfaces.
- Light-duty custom threading and anchoring.
- Use outdoors or in highly ventilated area.

Approximate coverage:		
Crack Width	Crack Depth	Linear Feet per 8.4 fl. oz.
1/4"	1/4"	19.3
1/2"	1/4"	9.9
3/4"	1/4"	6.4
1"	1/4"	4.9
1/4"	1/2"	9.9
1/2"	1/2"	4.9
3/4"	1/2"	3.0
1"	1/2"	2.0

Bead Size dimension	Linear Feet per 8.4 fl oz.
1/16"	815.0
1/8"	205.0
1/4"	51.9
3/8"	22.2
1/2"	12.4

Quick and Easy Spall Repair



Clean
Remove all loose material from area to be filled. Concrete should be dry and grease-free.



Fill
Dispense product into deepest part of repair areas, slightly overfilling. Product self-levels and is tack-free in as little as one minute.



Finish
In as little as 15 minutes, product can be sanded to remove rough edges. It can be painted within one hour.



Tank Crosses - Short Cast

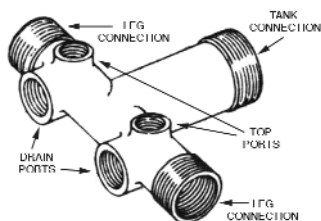

General Tank Cross Features:

- Internal and external threads reduce fittings needed and installation time.
- Reduces turbulence and waterlogging in tanks without separate air chambers.
- Cast bronze, brass, injected molded PVC, galvanized ductile iron.
- **Prices are for bulk packaged tank crosses.**
- **For individually boxed crosses, remove "C" prefix and add \$2.25 to list price.**



Short Cast Crosses with 1 drain and 2 or 3 top ports.

* Do not use teflon tape with PVC tank cross applications.

Part Number	Overall Length	Tank Conn.	Leg Conn.	Drain Ports Size (Qty)	Top Ports Size (Qty)	Material	USA or Import	Ctn Qty	List Price
CHT100FB	2 1/2"	1" fpt	1" X 3/4"	3/4" (1)	1/4" (2)	Bronze	Import	5/40	\$ 34.29
CCAT100B	4 1/4"	1" x 3/4"	1" x 3/4"	1/2" (1)	1/4" (2), 1/2" (1)	Bronze	Import	4/40	52.54
CHC125B	4 1/4"	1 1/4" x 1"	1" x 3/4"	1/2" (1)	1/4" (3)	Bronze	USA	12	51.43
CHC12550BS	4 1/2"	1 1/4" x 1"	1" x 3/4"	3/4" (1)	1/4" (2)	Brass	Import	5/40	41.00
CIC701B	3 3/4"	1 1/4" x 1"	1 1/4" x 1"	3/4" (1)	1/4" (3)	Bronze	USA	12	56.61
CHT125B	3 3/4"	1 1/4" x 1"	1 1/4" x 1"	3/4" (1)	1/4" (2)	Bronze	Import	5/30	34.29
CIC701BS	4 1/2"	1 1/4" x 1"	1 1/4" x 1"	3/4" (1)	1/4" (2)	Brass	Import	4/32	39.82
CIC125B	4 1/4"	1 1/4" x 1"	1" x 3/4"	3/4" (1)	1/4" (2), 1/2" (1)	Bronze	Import	4/40	51.66
CIC125	4 1/4"	1 1/4" x 1"	1" x 3/4"	3/4" (1)	1/4" (2), 1/2" (1)	PVC*	USA	100	12.32



Short Cast Crosses with 2 drain and 2 top ports.

Part Number	Overall Length	Tank Conn.	Leg Conn.	Drain Ports Size (Qty)	Top Ports Size (Qty)	Material	USA or Import	Ctn Qty	List Price
CICS100B	4 3/4"	1"	1" x 3/4"	1/2" (2)	1/4" (2)	Bronze	USA	12	\$ 46.71
CICS100BS	4 1/2"	1" x 3/4"	1" x 3/4"	1/2" (2)	1/4" (2)	Brass	Import	5/40	27.31
CIC3125B	5"	1 1/4" x 1"	1 1/4" x 1"	3/4" (2)	1/4" (2)	Bronze	USA	12	62.87
CIC3125BS	4 1/2"	1 1/4" x 1"	1 1/4" x 1"	3/4" (2)	1/4" (2)	Brass	Import	4/32	41.00
CIC71250BS	4 1/2"	1 1/4" x 1"	1" x 3/4"	1/2" (2)	1/4" (2)	Brass	Import	5/40	39.71
CIC712B	4"	1 1/4" x 1"	1" x 3/4"	3/4" (2)	1/4" (2)	Bronze	USA	12	53.45



Short Cast Crosses with Union Disconnect

* with Teflon gasket seal

** with metal to metal ball joint seal

"E" Series light pattern brass tank crosses compete with Merrill & Boshart equivalents.



Part Number	Overall Length	Tank Conn.	Leg Conn.	Drain Ports Size (Qty)	Top Ports Size (Qty)	Material	USA or Import	Ctn Qty	List Price
CICS100BSUE**	5 1/2"	1"	1"x3/4"	1/2" (2)	1/4" (2)	Brass	Import	4/24	\$ 31.05
CICS100BSU*	5 1/2"	1"	1"x3/4"	1/2" (2)	1/4" (2)	Brass	Import	4/24	46.21
© CICS100BU**	5 1/2"	1"	1" x 3/4"	1/2" (2)	1/4" (2)	Bronze	Import	4/24	29.00
CICS125BSUE**	5 1/2"	1 1/4" x 1"	1 1/4" x 1"	3/4" (2)	1/4" (2)	Brass	Import	4/24	43.48
CICS125BSU*	5 1/2"	1 1/4" x 1"	1 1/4" x 1"	3/4" (2)	1/4" (2)	Brass	Import	4/24	62.78
© CICS125BU**	5 1/2"	1 1/4" x 1"	1 1/4" x 1"	3/4" (2)	1/4" (2)	Bronze	Import	4/24	41.00

Tank Crosses - Short Cast, Specialty

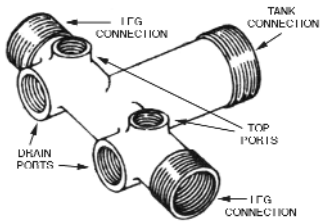

General Tank Cross Features:

- Internal and external threads reduce fittings needed and installation time.
- Reduces turbulence and waterlogging in tanks without separate air chambers.
- Cast bronze, brass, injected molded PVC, galvanized ductile iron.
- **Prices are for bulk packaged tank crosses.**
- **For individually boxed crosses, remove "C" prefix and add \$2.25 to list price.**



Short cast crosses for use with Flexcon Flex-Lite Series, WellMate Tanks



Part Number	Overall Length	Tank Conn.	Leg Conn.	Drain Ports Size (Qty)	Top Ports Size (Qty)	Material	USA or Import	Ctn Qty	List Price
CWM100BS	4 1/2"	1" (FIP)	1"x3/4"	1/2" (2)	1/4" (2)	Brass	Import	5/40	\$ 34.07
CWM125BS	4 3/4"	1 1/4" (FIP)	1 1/4"x1"	3/4" (2)	1/4" (2)	Brass	Import	4/32	42.04
CICS736BS	2 1/2"	1 1/4" MIP x 1" FIP	1"x3/4"	1/2" (2)	1/4" (2)	Brass	Import	5/40	29.12



Short cast female union tank crosses for use with Flexcon "Flex-Lite" Series, WellMate Tanks. FPT brass union w/ American Standard Buna-N o-ring.

- 1" uses AS 568-212 o-ring
- 1 1/4" uses AS 568-320 o-ring.
- CICS100BSFTU65 for use with WellMate Low Profile Series or other 1" mpt connection tanks that need extra length.

Part Number	Overall Length	Tank Conn.	Leg Conn.	Drain Ports Size (Qty)	Top Ports Size (Qty)	Material	USA or Import	Ctn Qty	List Price
CICS100BSFTU	4"	1" fpt union	1" x 3/4"	1/2" (2)	1/4" (2)	Brass	Import	4/32	\$ 46.82
CICS100BSFTU65	6 1/2"	1" fpt union	1" x 3/4"	1/2" (2)	1/4" (2)	Brass	Import	4/32	38.89↓
CICS1251BSFTU	4"	1 1/4" fpt union	1" x 3/4"	1/2" (2)	1/4" (2)	Brass	Import	4/32	43.57
CICS125BSFTU	4"	1 1/4" fpt union	1 1/4" x 1"	3/4" (2)	1/4" (2)	Brass	Import	4/24	60.43



Short cast quick connect (w/ Buna-N oring) tank crosses for use with WellMate "Quick Connect" Series tanks.

- 1" and 1 1/4" uses AS 568-220 o-ring.



Part Number	Overall Length	Tank Conn.	Leg Conn.	Drain Ports Size (Qty)	Top Ports Size (Qty)	Material	USA or Import	Ctn Qty	List Price
CWM100BSQC	4 1/2"	Quick Connect	1" x 3/4"	1/2" (2)	1/4" (2)	Brass	Import	4/32	\$ 35.96
CWM125BSQC	4 1/2"	Quick Connect	1 1/4" x 1"	3/4" (2)	1/4" (2)	Brass	Import	3/24	37.04



Short cast crosses for use with Flexcon Well-Rite, Online Series

Part Number	Overall Length	Tank Conn.	Leg Conn.	Drain Ports Size (Qty)	Top Ports Size (Qty)	Material	USA or Import	Ctn Qty	List Price
CFC100BS	4 1/2"	1" Union Th.	1" x 3/4"	1/2" (2)	1/4" (2)	Brass	Import	5/40	\$ 27.14
CFC125BS	4 1/2"	1 1/4" Union Th.	1 1/4" x 1"	3/4" (2)	1/4" (2)	Brass	Import	5/30	36.20↓



Tank Crosses - Short Cast NO LEAD Brass, Stainless Steel

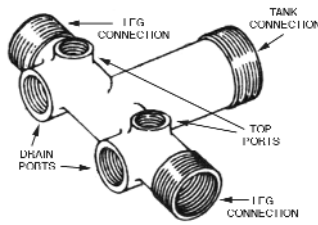

Tank Cross Features:

- Internal and external threads reduce fittings needed and installation time.
- Reduces turbulence and waterlogging in tanks without separate air chambers.
- Cast **NO LEAD** brass or 304 Stainless Steel.
- **NO LEAD** brass tank crosses are CA AB1953 certified.
- 304 Stainless Steel crosses contain no lead.



Short Cast Crosses with 2 drain and 2 top ports.

“E” Series light pattern No Lead brass tank crosses compete with Merrill & Boshart equivalents.



Part Number	Overall Length	Tank Conn.	Leg Conn.	Drain Ports Size (Qty)	Top Ports Size (Qty)	Material	USA or Import	Ctn Qty	List Price
NO LEAD Brass									
CICS100BSENL	4 1/2"	1" x 3/4"	1" x 3/4"	1/2" (2)	1/4" (2)	No Lead Brass	Import	4/24	28.70
CICS125BSENL	4 1/2"	1 1/4" x 1"	1 1/4" x 1"	3/4" (2)	1/4" (2)	No Lead Brass	Import	4/24	40.75



Short Cast Crosses with Union Disconnect

- Metal to metal ball joint seal on **NO LEAD** brass crosses.
- Teflon gasket seal on 304SS crosses.

“E” Series light pattern brass tank crosses compete with Merrill & Boshart equivalents.

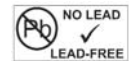

Part Number	Overall Length	Tank Conn.	Leg Conn.	Drain Ports Size (Qty)	Top Ports Size (Qty)	Material	USA or Import	Ctn Qty	List Price
NO LEAD Brass									
CICS100BSUENL	5 1/2"	1"	1"x3/4"	1/2" (2)	1/4" (2)	No Lead Brass	Import	4/24	\$ 42.45
CICS125BSUENL	5 1/2"	1 1/4"x 1"	1 1/4" x 1"	3/4" (2)	1/4" (2)	No Lead Brass	Import	4/24	58.93
304 Stainless Steel									
CICS100SSU	5 1/2"	1"	1"x3/4"	1/2" (2)	1/4" (2)	Stainless	Import	4/24	65.72
CICS125SSU	5 3/4"	1 1/4"x 1"	1 1/4" x 1"	3/4" (2)	1/4" (2)	Stainless	Import	4/24	85.54

Tank Crosses - Long Cast NO LEAD Brass, Stainless Steel

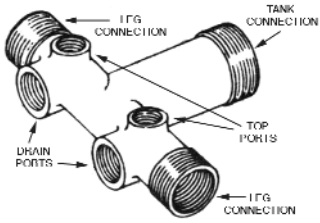

General Tank Cross Features:

- Internal and external threads reduce fittings needed and installation time.
- Reduces turbulence and waterlogging in tanks without separate air chambers.
- Cast **NO LEAD** brass or 304 Stainless Steel.
- **NO LEAD** brass tank crosses are CA AB1953 certified.
- 304 Stainless Steel crosses contain no lead.



NO LEAD Brass Long Cast Tank Crosses with 2 drain and 2 top ports. "E" Series light pattern brass tank crosses compete with Merrill & Boshart equivalents.



Part Number	Overall Length	Tank Conn.	Leg Conn.	Drain Ports Size (Qty)	Top Ports Size (Qty)	Material	USA or Import	Ctn Qty	List Price
NO LEAD Brass									
CIC100BSENL	11"	1"	1" x 3/4"	1/2" (2)	1/4" (2)	No Lead Brass	Import	2/24	\$ 40.89
CIC100BS14ENL	14"	1"	1" x 3/4"	1/2" (2)	1/4" (2)	No Lead Brass	Import	2/12	55.51
CIC125BS14ENL	14"	1 1/4"	1 1/4" x 1"	3/4" (2)	1/4" (2)	No Lead Brass	Import	2/12	76.53



Long Cast Tank Crosses with union disconnect, 2 drain & 2 top ports. "E" Series light pattern brass tank crosses compete with Merrill & Boshart equivalents.



- Metal to metal ball joint seal on **NO LEAD** brass crosses.
- Teflon gasket seal on 304SS crosses.

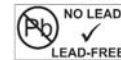

Part Number	Overall Length	Tank Conn.	Leg Conn.	Drain Ports Size (Qty)	Top Ports Size (Qty)	Material	USA or Import	Ctn Qty	List Price
NO LEAD Brass									
CIC100BSUENL	11"	1"	1" x 3/4"	1/2" (2)	1/4" (2)	No Lead Brass	Import	2/20	\$ 53.95
CIC100BSU14ENL	14"	1"	1" x 3/4"	1/2" (2)	1/4" (2)	No Lead Brass	Import	2/12	64.11
CIC125BSU14ENL	14"	1 1/4"	1 1/4" x 1"	3/4" (2)	1/4" (2)	No Lead Brass	Import	2/12	78.75
304 Stainless Steel									
CIC100SSU	11"	1"	1" x 3/4"	1/2" (2)	1/4" (2)	304 Stainless	Import	2/20	77.68
CIC100SSU14	14"	1"	1" x 3/4"	1/2" (2)	1/4" (2)	304 Stainless	Import	2/20	88.75
CIC125SSU14	14"	1 1/4"	1 1/4" x 1"	3/4" (2)	1/4" (2)	304 Stainless	Import	2/12	111.79



Tank Crosses - Long Cast

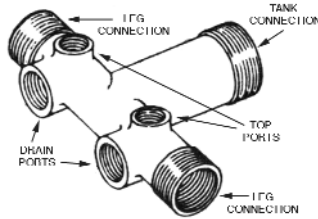

General Tank Cross Features:

- Internal and external threads reduce fittings needed and installation time.
- Reduces turbulence and waterlogging in tanks without separate air chambers.
- Cast bronze, brass, injected molded PVC, galvanized ductile iron.
- For individually boxed crosses, remove "C" prefix and add \$2.25 to list price.



Long Cast Tank Crosses with 1 drain and 2 top ports.

"E" Series light pattern brass tank crosses compete with Merrill & Boshart equiva-

Part Number	Overall Length	Tank Conn.	Leg Conn.	Drain Ports Size (Qty)	Top Ports Size (Qty)	Material	USA or Import	Ctn Qty	List Price
CHC100BSE	11"	1"	1" x 3/4"	1/2" (1)	1/4" (2)	Brass	Import	2/24	\$ 44.29
CHC100BS	11"	1"	1" x 3/4"	1/2" (1)	1/4" (2)	Brass	Import	2/24	50.64
CHC100B	11"	1"	1" x 3/4"	1/2" (1)	1/4" (2)	Bronze	USA	12	62.32



Long Cast Tank Crosses with 2 drain and 2 top ports.

"E" Series light pattern brass tank crosses compete with Merrill & Boshart equivalents.



Part Number	Overall Length	Tank Conn.	Leg Conn.	Drain Ports Size (Qty)	Top Ports Size (Qty)	Material	USA or Import	Ctn Qty	List Price
CIC100BSE	11"	1"	1" x 3/4"	1/2" (2)	1/4" (2)	Brass	Import	2/24	\$ 39.11
CIC100BS	11"	1"	1" x 3/4"	1/2" (2)	1/4" (2)	Brass	Import	2/24	50.64
CIC100B	11"	1"	1" x 3/4"	1/2" (2)	1/4" (2)	Bronze	USA	12	62.89
CIC100BS14	14"	1"	1" x 3/4"	1/2" (2)	1/4" (2)	Brass	Import	2/20	56.39
CIC125BS14E	14"	1 1/4"	1 1/4" x 1"	3/4" (2)	1/4" (2)	Brass	Import	2/12	86.81
CIC125BS14	14"	1 1/4"	1 1/4" x 1"	3/4" (2)	1/4" (2)	Brass	Import	15	101.96



Long Cast Tank Crosses with union disconnect, 1 drain and 2 top ports.

- Metal to metal ball joint seal.

Part Number	Overall Length	Tank Conn.	Leg Conn.	Drain Ports Size (Qty)	Top Ports Size (Qty)	Material	USA or Import	Ctn Qty	List Price
CHC100BU	11"	1"	1" x 3/4"	1/2" (1)	1/4" (2)	Bronze	Import	2/20	\$ 69.77
CHC125BU14	14"	1 1/4"	1 1/4" x 1"	3/4" (1)	1/4" (2)	Bronze	Import	2/12	108.95

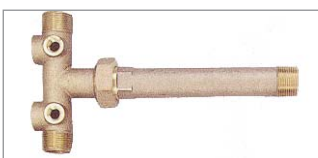

Long Cast Tank Crosses with union disconnect, 2 drain and 2 top ports.

"E" Series light pattern brass tank crosses compete with Merrill & Boshart equivalents.

- Metal to metal ball joint seal.



Part Number	Overall Length	Tank Conn.	Leg Conn.	Drain Ports Size (Qty)	Top Ports Size (Qty)	Material	USA or Import	Ctn Qty	List Price
CIC100BU85	8 1/2"	1"	1" x 3/4"	1/2" (2)	1/4" (2)	Bronze	Import	2/20	\$ 67.61
CIC100BSUE	11"	1"	1" x 3/4"	1/2" (2)	1/4" (2)	Brass	Import	2/20	59.64
CIC100BU	11"	1"	1" x 3/4"	1/2" (2)	1/4" (2)	Bronze	Import	2/20	69.77
CIC100BU14	14"	1"	1" x 3/4"	1/2" (2)	1/4" (2)	Bronze	Import	2/20	74.14
CIC125BSU14E	14"	1 1/4"	1 1/4" x 1"	3/4" (2)	1/4" (2)	Brass	Import	2/12	90.04
CIC125BU14	14"	1 1/4"	1 1/4" x 1"	3/4" (2)	1/4" (2)	Bronze	Import	2/12	103.85



www.americangranby.com

6/14/11

In the United States: Phone (800) 776-2266 Fax (800) 729-3299
 In Canada: Phone (866) 503-5523 Fax (888) 562-2095

1.11

Tank Crosses - Long, Fabricated

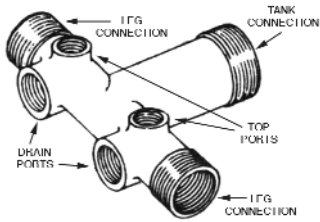

General Tank Cross Features:

- Internal and external threads reduce fittings needed and installation time.
- Reduces turbulence and waterlogging in tanks without separate air chambers.
- Cast bronze, brass, injected molded PVC, galvanized ductile iron.
- Prices are for bulk packaged tank crosses.
- For individually boxed crosses, remove "C" prefix and add \$2.25 to list price.

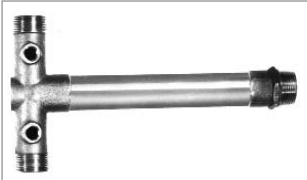

Long Fabricated Tank Crosses with 1 drain and 2 top taps.

- Crosses fabricated with 96.5% tin, 3.5% lead free solder.

Part Number	Overall Length	Tank Conn.	Leg Conn.	Drain Ports Size (Qty)	Top Ports Size (Qty)	Material	USA or Import	Ctn Qty	List Price
CHC100BF	11"	1"	1" x 3/4"	1/2" (1)	1/4" (2)	Bronze/Copper	USA	12	\$ 65.82
CHC100BF13	13"	1"	1" x 3/4"	1/2" (1)	1/4" (2)	Bronze/Copper	USA	12	71.54
CHC125BF	14"	1 1/4"	1 1/4" x 1"	3/4" (1)	1/4" (2)	Bronze/Copper	USA	12	81.94
CHC125BF16	16"	1 1/4"	1 1/4" x 1"	3/4" (1)	1/4" (2)	Bronze/Copper	USA	6	87.04



Long Fabricated Tank Crosses with 2 drain and 2 top taps.

- Crosses fabricated with 96.5% tin, 3.5% lead free solder.

Part Number	Overall Length	Tank Conn.	Leg Conn.	Drain Ports Size (Qty)	Top Ports Size (Qty)	Material	USA or Import	Ctn Qty	List Price
CIC100BF	11"	1"	1" x 3/4"	1/2" (2)	1/4" (2)	Bronze/Copper	USA	12	\$ 65.00
CIC100BF13	13"	1"	1" x 3/4"	1/2" (2)	1/4" (2)	Bronze/Copper	USA	12	71.54
CIC125BF	14"	1 1/4"	1 1/4" x 1"	3/4" (2)	1/4" (2)	Bronze/Copper	USA	12	80.36
CIC125BF16	16"	1 1/4"	1 1/4" x 1"	3/4" (2)	1/4" (2)	Bronze/Copper	USA	6	83.46

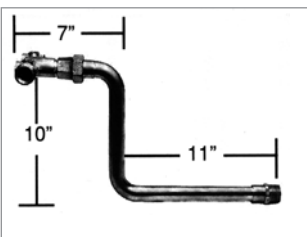

Long Fabricated Elevated Tank Crosses with union disconnect.

- Crosses fabricated with 96.5% tin, 3.5% lead free solder.

Part Number	Overall Length	Tank Conn.	Leg Conn.	Drain Ports Size (Qty)	Top Ports Size (Qty)	Material	USA or Import	Ctn Qty	List Price
CIC740BF	18"	1"	1" x 3/4"	1/2" (2)	1/4" (2)	Bronze/Copper	USA	9	\$ 151.46
CIC741BF	18"	1 1/4"	1 1/4" x 1"	3/4" (2)	1/4" (2)	Bronze/Copper	USA	6	243.05



Pressure Relief Valves

RV and IRV Series Relief Valve Features:

- Heavy duty brass, **no lead** brass (CA AB1953 certified) or 304 stainless steel for shallow, deep well and submersible pumps.
- Spring loaded and pre-set under pressure, **NOT ADJUSTABLE**.
- 1/2" or 3/4" (IRV7575) discharge.
- RV Series are manufactured for AGI in an ISO 9001 facility.
- IRV series imported.

Hamilton Adjustable Safety Relief Valve Features:

- Preset at 75 P.S.I. with concealed adjusting screw to prevent tampering.
- Brass-heavy duty.
- Full-flow design with Buna-N seats.



RV Series **ISO 9001**



IRV IRV-NL Series



IRV SS Series



HRV Series

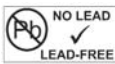

Part Number	Size	Pressure Setting	Ctn/Case	List Price
Bronze Relief Valves - Made in USA				
RV50	1/2" x 1/2"	Set at 75 psi	50/150	\$ 18.52
RV75	3/4" x 1/2"	Set at 75 psi	50/150	19.16
RV50-100	1/2" x 1/2"	Set at 100 psi	50/150	18.52
RV75-100	3/4" x 1/2"	Set at 100 psi	50/150	19.16

Brass Relief Valves - Imported				
IRV50	1/2" x 1/2"	Set at 75 psi	10/100	9.66
IRV75	3/4" x 1/2"	Set at 75 psi	10/100	9.99
IRV7575	3/4" x 3/4"	Set at 75 psi	10/100	11.25
IRV50-100	1/2" x 1/2"	Set at 100 psi	10/100	9.66
IRV75-100	3/4" x 1/2"	Set at 100 psi	10/100	9.99
IRV7575-100	3/4" x 3/4"	Set at 100 psi	10/100	11.25

NO LEAD Brass Relief Valves - Imported				
IRV50NL	1/2" x 1/2"	Set at 75 psi	10/100	10.76
IRV75NL	3/4" x 1/2"	Set at 75 psi	10/100	11.30
IRV50-100NL	1/2" x 1/2"	Set at 100 psi	10/100	10.54
IRV75-100NL	3/4" x 1/2"	Set at 100 psi	10/100	10.54

304 Stainless Steel Relief Valves - Imported				
IRV50SS	1/2" x 1/2"	Set at 75 psi	10/100	21.79
IRV75SS	3/4" x 3/4"	Set at 75 psi	10/100	23.04
IRV50-100SS	1/2" x 1/2"	Set at 100 psi	10/100	21.79
IRV75-100SS	3/4" x 1/2"	Set at 100 psi	10/100	23.04

Hamilton Brass Adjustable Safety Relief Valves		Set at Adjustable to		Sold at Preset Only	
HRV50	1/2" mipt x 1/2" fipt	75 psi	150 psi	25	47.72
HRV75	3/4" mipt x 3/4" fipt	75 psi	100 psi	25	70.26
HRV175	1" mipt x 3/4" fipt	75 psi	200 psi	25	115.72
HRV125	1 1/4" mipt x 1 1/4" fipt	75 psi	200 psi	10	218.37

FLOW RATES							
PSI	85	90	95	100	105	110	115
RV Series gpm	.30	7.3	7.7	9.8	17.9	18.9	20.6
IRV Series gpm	2.0	2.7	3.8	4.7	7.0	12.0	12.7
PSI	10	20	30	40	60	80	100
HRV50	.6	1.5	2.5	3.6	6.1	8.8	11.8
HRV75			2.8	5.5	11.0	13.8	17.9
HRV175	6.0	12.6	19.0	24.6	35.6	44.8	52.3
HRV125	12.0	35.0	48.4	69.2	106.5	132.5	150.0

NOTE: Relief valves on this page are not for use with hot water heaters. Recommended for cold water system installations only.

Preset relief valves are **NOT** intended to be adjusted. Any adjustment to preset relief valves voids warranty.

Installation Accessories - Tank



TL3

Tank Legs Features:

- Elevates tank above floor and out of condensation pools.
- Leveled on uneven floors without the use of tools.
- Custom molded from high strength ABS.



PMB1

Pump Mounting Bracket Features:

- Elevates pump out of corrosive atmosphere.
- Heavy duty 12 gauge cold rolled steel with gray enamel coating. Heaviest steel gauge bracket available in the market.
- Plastic protectors on the pump stand legs prevent scratching of the tank.
- Supplied with 1", 1 1/4" zinc plated steel screws and steel adapter for larger tanks.
- Fits all pumps and comes individually cartoned.



SN18L, SN18, SN25L, SN25

Air Valve Features:

- Used for reciprocating and submersible pumps to admit air to system.
- Used for charging applications and many other uses.
- Available in long and short patterns.



PTG1002

Pressure Test Gauge Features:

- 0-100 psi, 2" plastic lens.
- Brass test fitting with pressure release button.
- Heavy rubber boot to protect gauge from damage.

Part Number	Size	Pressure Setting/Description	Ctn Qty	List Price
Tank Legs				
TL3		(3/Package), ABS	48	\$ 3.45
Pump Mounting Brackets				
PMB1		12 gauge steel plate, Gray	20	24.47
Air Valves				
SN18	1/8"	Short, Light Spring (Snifter)	25/250	2.43
SN18L	1/8"	Long, Light Spring (Snifter)	25/250	3.02
SN25	1/4"	Short, Heavy Spring (Air)	25/250	3.25
SN25L	1/4"	Long, Light Spring (Snifter)	25/250	3.11
LVC18		Replacement Core for light spring models		0.94
Pressure Test Gauge				
PTG1002		Pressure test gauge	50	11.96



Clear Braided PVC Hose



Clear Braided PVC Hose

Standard Wall, Class 125 Features:

- Flexible, see through clear hose with braid pattern reinforcement of two polyester spirals.
- Flexible clear PVC NSF 51 certified to 100°F (38°C), USP CLASS V1 rated.
- All hose compound ingredients used are listed in US FDA CFR, Title 21.
- Temperature range + 25° to 150° F / -5° to +65°C.
- Silicone free.
- Food and beverage grade, standard wall.
- Use for air, water lines.

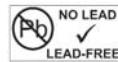

Part Number	Nominal (inches)		Max Working Pressure		Reel Length	Approx Wt per CFT.	List Price Per Reel
	ID	OD	PSI@68°F	PSI@122°F			
CBH316-1	3/16	0.375	250	105	100'	4.5 lbs	\$ 117.06
CBH25-1	1/4	0.438	250	105	100'	5.7 lbs	102.32
CBH516-1	5/16	0.525	250	105	100'	7.5 lbs	150.56
CBH38-1	3/8	0.594	225	97	100'	9.0 lbs	145.37
CBH50-1	1/2	0.750	200	86	100'	13.8 lbs	195.91
CBH50-3	1/2	0.750	200	86	300'	13.8 lbs	587.73
CBH58-1	5/8	0.875	200	86	100'	16.5 lbs	231.09
CBH75-1	3/4	1.030	150	65	100'	21.9 lbs	293.71
CBH75-3	3/4	1.030	150	65	300'	21.9 lbs	881.15
CBH100-1	1	1.300	125	54	100'	31.5 lbs	378.42
CBH100-2	1	1.300	125	54	200'	31.5 lbs	707.34
CBH125-50	1 1/4	1.625	100	43	50'	45.0 lbs	359.08
CBH125-1	1 1/4	1.625	100	43	100'	45.0 lbs	718.17
CBH150-50	1 1/2	1.937	100	43	50'	64.0 lbs	432.96
CBH150-1	1 1/2	1.937	100	43	100'	64.0 lbs	865.91
CBH200-50	2	2.490	75	33	50'	95.0 lbs	739.93
CBH200-1	2	2.490	75	33	100'	95.0 lbs	1479.89

** Temperatures higher than 68° F reduce available working pressure. See next page for temperature, working pressure calculation chart and cautionary note.

Clear Braided PVC Hose



Effects of Elevated Temperatures on Thermoplastic Hose.

The compounds used in clear braided PVC hose are generally referred to as thermoplastics. These materials achieve their optimum physical properties at room temperature, 68°F (20°C). As these materials are exposed to increased ambient temperatures, they will soften and their physical properties will change. This will have the effect of sharply reducing the available working pressure. Coupling retention will also be reduced. The charts below illustrate this effect. In all cases, the product should be tested in a controlled, secure and safe environment, and all operating conditions should be considered prior to use.

All published working pressures of AGI Series CBH hose are based on a room temperature of 68°F (20°C).

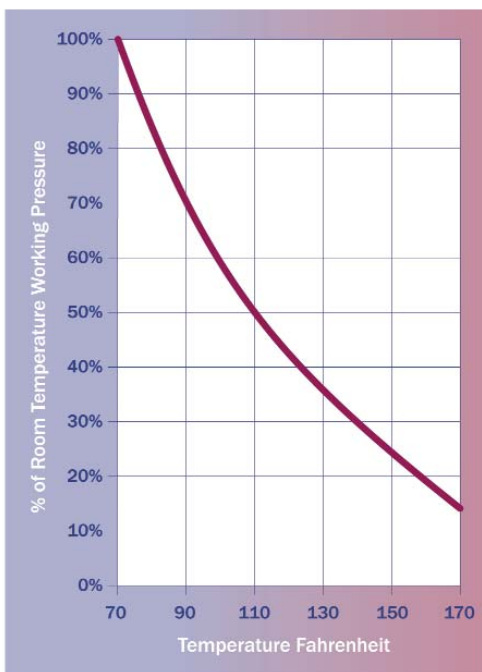

Example from the Fahrenheit Chart

If working pressure at 68°F is 200 psi, then the WP at 110°F is $200 \times 50\%$, or 100 psi

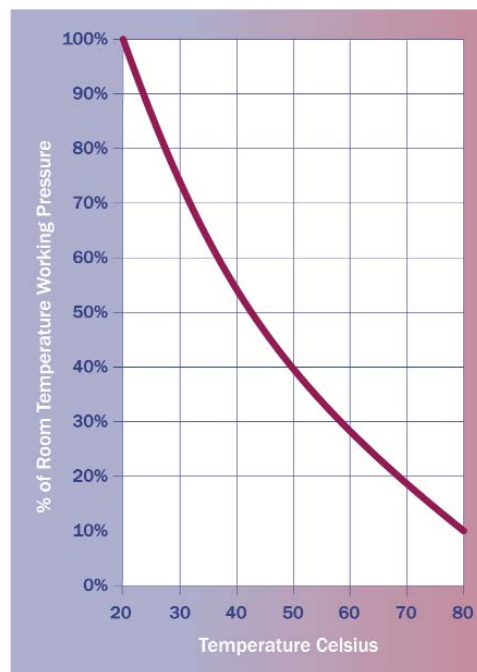

Example from the Celsius Chart

If working pressure at 20° is 14 bar, then the WP at 50°C is $14 \times 50\%$, or 5.6 bar

CAUTIONARY NOTE

The charts are to be used as a guideline only. The information and recommendations contained here are, to the best of our manufacturer's knowledge, accurate and reliable, but no guarantee of their accuracy is made. All products are sold upon the condition that purchasers shall make their own tests to determine the suitability of such products for their particular purposes and uses, and purchasers assume all risks and liability for the results of use of the products, including use in accordance with seller's recommendations. Variability in length of exposure, temperature, pressure, velocity of fluid, and chemical concentration all contribute to reduced working pressure and hose reliability.



Air Volume Controls



AV Non-Repairable



AV Repairable



AC100

Brady Air Volume Control Features:

- Maintains water flow-stretches pump life.
- Repairable and non-repairable offering.
- Diaphragm-type air volume control maintains correct proportions of air & water in jet systems.
- Die Cast, 96% Zinc.
- Individually cartoned.
- Available with or without Tapped Gauge Port.
- "E" Series compares to Boshart "AVC" and Merrill "AV" series non-repairable controls.



Air Charger Features:

- For jet systems.
- Positive action control.
- No flexing diaphragm or metal springs to malfunction.
- Will not corrode in a moist environment.
- Fits all tanks up to and including 82 gallon.
- Available with tube & fittings as an optional extra, specify **AC100TF**. Includes 60" tubing & assortment of special brass fittings & adapters, eliminates duplication of inventories with a single kit for all applications.

Universal Air Charger Installation Kit Features:

- Fits all air volume controls.
- Includes 60" polyethylene tubing and assortment of special brass fittings and adapters, eliminating duplication of inventories with a single kit for all applications.

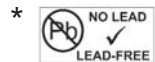

Part Number (Tapped)	Tank Capacity	Tank Port	Suction Port	Ctn Qty	Tapped List Price	Standard List Price
Non-repairable *						
AV45E	80	1/4" pipe	7/16"-24 pipe	50		\$ 12.32
AV45	80	1/4" pipe	7/16"-24 pipe	50		30.14
AV45F	80	1/4" pipe	1/8" pipe tap	50		31.54
AV100E	120	3/8" pipe	7/16"-24 pipe	50		12.32
AV100	120	3/8" PIPE	7/16"-24 PIPE	50		34.13
AV100F	120	3/8" PIPE	1/8" PIPE TAP	50		36.18
Repairable *						
AV30	42	1/4" PIPE	7/16"-24 PIPE	100		33.20
AV42 AV42T	80	1/4" pipe tap	1/4" pipe tap	50	45.36	43.36
AV80 AV80T	120	1/4" pipe tap	1/4" pipe tap	50	53.11	50.28
AV120 AV120T	220	3/8" pipe tap	1/4" pipe tap	25	69.68	66.79
Repair Kits • Fits all makes of repairable diaphragm type controls						
AV30-3A	For Brady AV30 controls			42		26.33
AV42-3A	For Brady AV42 controls			42		30.94
AV80-3A	For Brady AV80 controls			42		36.17
AV120-3A	For Brady AV120 controls			42		47.38
Plastic Air Charger *						
AC100				30		21.13
CAC100				Bulk Packed		17.88
Air Charger with Tubing and Fittings **						
AC100TF				20		27.27
AC100TFBT	Black Tubing			20		27.27
Air Charger Installation Kit with Tubing and Fittings **						
UTF1				24		12.44
UTF1BT	Black Tubing			24		12.93

** See page 6.7 for additional lengths of MV4040 1/2" OD x 0.17" ID translucent and black tubing.



www.americangranby.com
In the United States: Phone (800) 776-2266 Fax (800) 729-3299
In Canada: Phone (866) 503-5523 Fax (888) 562-2095

6/14/11

1.27

Air Releases & Controls



HAE1

HARVARD

All Plastic Deep Well Air Release Features:

- Formerly Robert Shaw* AE10
(*used with permission of Invensys Controls)
- Maintains proper ratio of air to water in submersible water systems.
- All polyethylene construction eliminates corrosion.
- Includes gauge port and 0-40 psi limited bleed adjustment.
- **Made in USA.**



Formerly Robert Shaw/Invensys



BAR125N

Brady Plastic Deep Well Air Release Features:

- Maintains the proper ratio of air to water.
- Constructed of ABS resin grade plastic.
- Non-corrosive, non-conductive and completely serviceable.
- Release mechanism consists of a Buna-N procession ball & 316 stainless steel spring.
- Factory set at 20 P.S.I., adjustable from 0 to 40 P.S.I.



WJ1

Deep Well Air Release Features:

- Maintains proper ratio of air to water in submersible water systems.
- Deluxe deep well air release features ABS float and cast body which prevents galvanic action at pump tank tapping.
- WJ1 Imported.



HF93B1



SWCL

Shallow Well Control Features:

- Preserves correct proportion of water and air in shallow well reciprocating pump systems.
- Imported.



Part Number	Tapping	Manufacturer	Ctn Qty	List Price
All Plastic Deep Well Air Release				
HAE1	1 1/4"	Harvard (formerly Robert Shaw)	49	\$ 45.71
BAR125N	1 1/4"	Brady	50	37.75
Deep Well Air Release				
WJ1	1 1/4"	Ametek	20	58.86
HF93B-1	1 1/4"	Johnson	50	38.62
Shallow Well Control				
SWCL	1 1/4"	Ametek	20	66.35



Installation Accessories - Submersible



TA48



SG Series

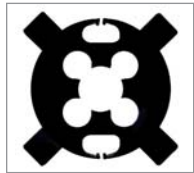

MG6



TA6100



WG Series

Deluxe Torque Arrestor Features:

- Two piece design, molded from PVC or rubber.
- PVC torque arrestor is **40% heavier** than competitors to resist long-term casing abrasion.
- Field adjustable to hold pump centered in well.
- Fits all well casings from 4" to 8" I.D.
- Torque Arrestor is securely fastened to 1" or 1 1/4" drop pipe w/ **2 Ideal all stainless steel** clamps included.
- Available bagged, boxed or bulk without clamps.

Submersible Torque Arrestor Features:

- "Spider" style molded from rubber.
- Installs at discharge cap of submersible pump.
- Tabs are easily cut for field alteration.
- 4"-6" casing, 1" center hole.



Natural Rubber Pump Guide Features:

- Installed at the top of the submersible discharge cap.
- Permits the pump to be lowered without damage from abrading against the well casing & ledge while centering the pump in the well.

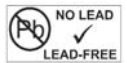

Cable Guard Features:

- Snap-in and self clamping styles.
- Keeps power cable from abrading against well casing.
- A minimum of three to five should be used; one at the pump, one no further than 15' above the pump, and one between 25' and 30' above the pump.
- Adjustable - use in 4", 5" and 6" wells. Available for 1" or 1 1/4" drop pipe.
- Made of polyethylene and will float.



Part Number	Description	Color	Ctn Qty	List Price
Deluxe PVC Torque Arrestor				
TA48	Bagged, with 2 Ideal all stainless steel clamps	Black	16	\$ 12.32
TA48B	Boxed, with 2 Ideal all stainless steel clamps	Black	12	15.00
CTA48	Bulk, no clamps	Black	Bulk	9.36
Deluxe Rubber Torque Arrestor				
TA48R	Bagged with 2 Ideal all stainless steel clamps	Black	16	15.68
TA48RB	Boxed, with 2 Ideal all stainless steel clamps	Black	12	18.36
CTA48R	Bulk, No clamps	Black	Bulk	13.93
Standard Rubber Torque Arrestor				
TA6100	6x1, (spider type)	Black	50	26.19
Natural Rubber Pump Guides Fits Casing ID Guide OD Drop Pipe				
SG400-3X1	4"	3"	1"	Bulk 4.89
SG400-3X1 1/4	4"	3"	1 1/4"	Bulk 4.89
SG500-4X1	5"	4"	1"	Bulk 5.30
SG558-5X1	5-5/8"	5"	1"	Bulk 8.10
SG600-55/8X1	6"	5 5/8"	1"	Bulk 9.00
SG600-55/8X1 1/4	6"	5 5/8"	1 1/4"	Bulk 9.00
SG625-6X1	6 1/4"	6"	1"	Bulk 10.28
SG625-6X2	6 1/4"	6"	2"	Bulk 9.73
Cable Guard				
MG6	With two cable holes, fits 4"-6" casing, Polyethylene		100	0.96
WG100	1" Self-clamping style, fits 4"-6" casing		48	2.93
WG125	1 1/4" Self-clamping style, fits 4"-6" casing		48	4.86





MR Series

Submersible Safety Rope Features:

- Custom extruded from tough polypropylene fiber.
- Highly resistant to chafing, abrasion & corrosion.
- Recommended wherever minimum stretch and maximum strength are required.
- Twisted SR25 Series tested in excess of 1,200 lbs.. Braided MR25 Series tested in excess of 1,000 lbs.
- Plastic or wood reels.

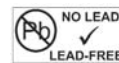

P0100

Bleeder Orifices Features:

- Provides a fast bleed through its large opening.
- Complete closure prevents loss of pumping volume.
- Full 1" size molded of virgin rubber increases bleed capacity & reduces cost of pipe fitting.
- 3/4" available in brass.
- Bleeder orifice tee available. Includes yellow brass insert tee w/ 1" rubber bleeder orifice.

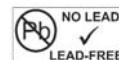

ES

Ejector Screen Features:

- Protects heat pumps against plugged nozzles and clogged venturis.
- Non-corrosive brass or stainless steel screen.
- Installs easily in discharge side of ejector.

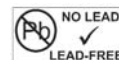

CT Series

Cable Tie Features:

- UL approved, self-clinching nylon fastener.
- Ideal for holding cable to drop pipe, positioning cable guards, etc.
- Withstands -65° to 225°F.
- Packaged in bags of 100.
- Manufactured for AGI in an ISO 9002 facility.

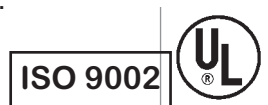

Part Number	Description	Ctn Qty	List Price
Braided Safety Rope			
MR25-500	Blue/White, 1/4" x 500' Plastic Reel, 1000#	1	\$ 34.93
MR25-1	Blue/White, 1/4" x 1000' Plastic Reel, 1000#	1	62.57
MR25-3	Blue/White, 1/4" x 3000' Plastic Reel, 1000#	1	197.32
Twisted Safety Rope			
SR25-500	Black, 1/4" x 500' Plastic Reel, 1200#	1	50.89
SR25-1	Black, 1/4" x 1000' Plastic Reel, 1200#	1	98.93
SR25-3	Black, 1/4" x 3000' Plastic Reel, 1200#	1	305.54
Bleeder Orifices			
P075B	3/4", Brass	25/250	11.61
P0100	1", Rubber, 25 per bag	100	2.04
BOT100	Yellow Brass Insert Tee 1", w/rubber bleeder orifice	6	45.18
Ejector Screen			
ES1	Brass Screen	1	9.40
ES1S	Stainless Steel Screen	1	9.02
Cable Ties			
CT150	Bag of 100 Nylon, 1" to 1 1/4" diameter pipe, 8" long	1	6.18 /100
CT300	Bag of 100 Nylon, 1 1/2" to 4" diameter pipe, 15" long	1	14.42 /100



Pump Installation Adapters & Fittings

Features:

- Heavy pattern, contractor grade cast bronze or stainless steel material.
- Rope adapters have integral pad eye for easy use with submersible rope.



SEE PAGE 12.3 and 12.4 for a complete line of imported cast bronze insert fittings.

☺ Imported



RBMA



RRBMA



XLRBMA



RBMUA



RBRA



RBFA



SSMA

Part Number	Size	Style	# Barbs	Ctn/CaseQty	List Price
Cast Bronze Male Insert Adapters (INS x MIP)					
RBMA1/2	1/2" x 1/2"	Hex	5	10/200	\$ 7.04
RBMA3/4	3/4" x 3/4"	Hex	5	10/200	9.00
RBMA1	1" x 1"	Hex	7	10/100	13.41
RRBMA1	1" x 1"	Round	6	10/100	13.79
RBMA1X3/4	1" x 3/4"	Hex	5	10/100	10.79
RBMA1X11/4	1" x 1 1/4"	Hex	6	10/100	16.75
RBMA11/4	1 1/4" x 1 1/4"	Hex	6	10/100	17.96
RBMA11/4X1	1 1/4" x 1"	Hex	7	10/100	17.32
RBMA11/2	1 1/2" x 1 1/2"	Hex	6	5/50	20.79
RBMA11/2X11/4	1 1/2" x 1 1/4"	Hex	6	10/100	18.89
RBMA2	2" x 2"	Hex	7	5/50	33.71
Cast Bronze Extra Long Male Adapters (INS x MIP)					
XLRBMA1	1" x 1"	Hex	12	10/100	20.18
XLRBMA1x11/4	1" x 1 1/4"	Hex	12	10/100	20.32
XLRBMA11/4	1 1/4" x 1 1/4"	Hex	12	10/100	23.93
XLRBMA2	2" x 2"	Hex	12	5/50	41.64
Cast Bronze Male Union Adapters (INS x MIP)					
RBMUA1	1" x 1"	Hex	6	10/80	22.78
RBMUA11/4	1 1/4" x 1 1/4"	Hex	6	10/40	20.33
Cast Bronze Rope Adapters (INS x MIP) ☺					
RBRA1	1" x 1"	Round w/ rope eye	11	10/100	15.61
RBRA1X11/4	1" x 1 1/4"	Round w/ rope eye	6	10/100	17.51
RBRA11/4	1 1/4" x 1 1/4"	Round w/ rope eye	6	10/100	19.64
Cast Bronze Rope Adapters (INS x MIP)					
BDR125	1"x1 1/4"	Heavy duty ☺	9	10/50	31.55
BW100	1"	HD long pattern ☺	9	10/50	36.23
Cast Bronze Female Adapters (INS x FIP) ☺					
RBFA1/2	1/2" x 1/2"	Round	5	10/200	9.11
RBFA3/4	3/4" x 3/4"	Round	5	10/100	11.57
RBFA1	1" x 1"	Round	5	10/100	16.93
RBFA11/4	1 1/4" x 1 1/4"	Round	7	10/100	19.54
RBFA11/2	1 1/2" x 1 1/2"	Round	6	5/50	23.68
RBFA2	2" x 2"	Round	7	5/50	36.96
Cast Stainless Steel Male Insert Adapters (MIP xINS) ☺					
Grade 304 *					
SSMA1/2	1/2"	Hex	6	10/100	8.18
SSMA3/4	3/4"	Hex	6	10/200	10.26
SSMA1	1"	Hex	6	10/100	17.00
SSMA11/4	1 1/4"	Hex	6	5/100	20.71
SSMA11/4X1	1 1/4" x 1"	Hex	6	5/100	18.00
XLSSMA11/4X1	1 1/4" x 1"	Hex (Heavy pattern xlong)	13	5/60	46.86
SSMA11/2	1 1/2"	Hex	6	5/80	26.89
SSMA2	2"	Hex	6	5/40	37.49

Pump Installation Adapters & Fittings



SS12



SSHB



S99, ISWSE, B99



S86, ISVMA, B86

Part Number	Size	Style	# Barbs	Ctn/CaseQty	List Price
Cast Stainless Steel Male Insert Adapters (MIPxINS) Made in USA Grade 316 *					
SS12-1/2	1/2"	Round	6	25/300	21.17
SS12-3/4	3/4"	Round	7	25/200	19.49
SS12-1	1"	Round	7	20/160	22.08
SS12-11/4	1 1/4"	Round	6	20/120	36.20
SS12-11/2	1 1/2"	Round	6	10/60	49.01
SS12-2	2"	Round	7	10/40	64.41
SS38-11/4 X1	1 1/4" x 1"	Round	7	25	52.13
Cast Stainless Steel Hex Bushing (MIPxFIP) ☺ Grade 304 *					
SSHB1X1/4	1" x 1/4"	Hex	-	10/200	7.54
SSHB1X1/2	1" x 1/2"	Hex	-	10/200	7.54
SSHB1X3/4	1" x 3/4"	Hex	-	10/200	8.61
SSHB11/4x1	1 1/4" x 1"	Hex	-	10/160	11.82
Steel Well Seal Elbows (INS x INS) **					
S99-1	1"			10	26.66
S99-11/4	1 1/4"			10	36.03
Steel Well Seal Elbows (INS x INS) - IMPORTED ☺ *					
ISWSE100	1"			25	13.11
ISWSE125	1 1/4"			15	21.54
Brass Well Seal Elbow, ins x ins**					
B99-1	1"			5	96.50
B99-11/4	1-1/4"			5	181.67
Steel Venturi Adapter, mipt x ins **					
S86-3/4X6	3/4" x 6"			25	18.05
S86-3/4X10	3/4" x 10"			25	21.49
S86-3/4X12	3/4" x 12"			25	21.76
S86-1X6	1" x 6"			25	13.71
S86-1X8	1" x 8"			25	16.56
S86-1x10	1" x 10"			25	18.60
S86-1X12	1" x 12"			25	21.24
S86-11/4X6	1-1/4" x 6"			25	18.66
S86-11/4X8	1-1/4" x 8"			25	21.01
S86-11/4X10	1-1/4" x 10"			20	25.34
S86-11/4X12	1-1/4" x 12"			25	32.46
Steel Venturi Adapter, mipt x ins IMPORTED ☺ *					
ISVMA1X6	1" x 6"			60	5.43
ISVMA1X8	1" x 8"			50	7.95
ISVMA1X10	1" x 10"			40	9.44
ISVMA11/4X6	1-1/4" x 6"			50	7.46
ISVMA11/4X8	1-1/4" x 8"			40	9.27
ISVMA11/4X10	1-1/4" x 10"			30	11.05
Red Brass Venturi Adapter, ins x mipt **					
B86-1X6	1" x 6"			25/100	44.84
B86-1X8	1" x 8"			25/100	59.07
B86-11/4X6	1-1/4" x 6"			25/100	66.40
B86-11/4X8	1-1/4" x 8"			25/100	87.43

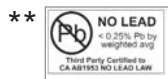

☺ Imported

6/14/11

1.32



In the United States: Phone (800) 776-2266 Fax (800) 729-3299
In Canada: Phone (866) 503-5523 Fax (888) 562-2095

www.americangranby.com



Flow Control Valves - Dole

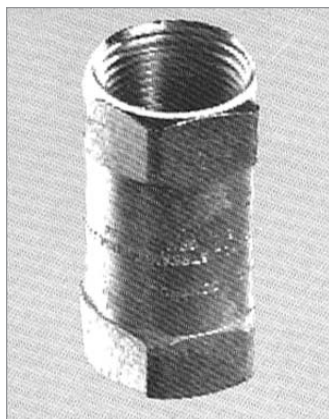

Dole Flow Control Valve Features:

- Prevents over-pumping of low yield wells.
- Installs in the discharge line between check valve and pressure tank.
- Do not use to suspend pipe.
- Self cleaning, designed to deliver constant volume of water over wide pressure drop range.
- Flow rated maintained within +/- 15% up to a pressure drop of 125 psi.
- Maximum system pressure 200 psi.
- Carton Quantity is 1 for all items.



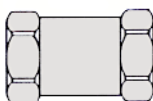

GA, GB, GC, GX Series
3/8" - 1" fipt
Brass Housing/
Nickle Plated

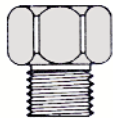

GY Series
3/4 mipt x 3/4" fipt
Brass Housing/
Nickle Plated

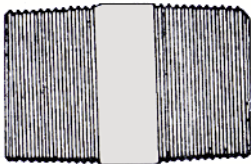

GP GT, GF, GH, GK Series
1 1/4" - 3" mipt
Steel Housing/
Zinc Plated

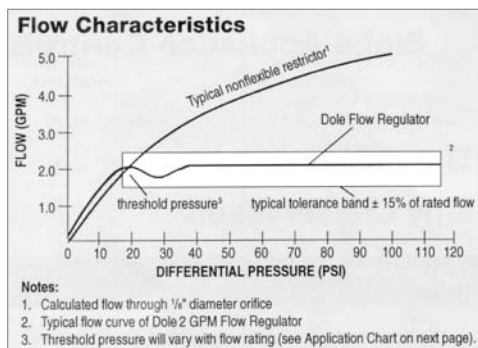

NEW Part Number	OLD	Flow (GPM)	Inlet/Outlet	List Price
Brass Housing/Nickel Plated				
GA.06		0.06	3/8" fIPT	\$ 53.50
GA.13	DV.13	0.13	3/8" fIPT	53.50
GA.19	DV.19	0.19	3/8" fIPT	53.50
GA.25	DV2.5	0.25	3/8" fIPT	53.50
GA.35		0.35	3/8" fIPT	53.50
GA.50	DV5	0.50	3/8" fIPT	53.50
GA.75	DV75	0.75	3/8" fIPT	53.50
GA1.0	DV10	1.0	3/8" fIPT	53.50
<hr/>				
GB1.0	DV10-1/2	1.0	1/2" fIPT	55.48
GB1.5	DV15	1.5	1/2" fIPT	55.48
GB2.0	DV20	2.0	1/2" fIPT	55.48
GB2.5	DV25	2.5	1/2" fIPT	55.48
GB3.0	DV30	3.0	1/2" fIPT	55.48
GB3.5	DV35	3.5	1/2" fIPT	55.48
GB4.0	DV40	4.0	1/2" fIPT	55.48
GB5.0	DV50-1/2	5.0	1/2" fIPT	55.48
GB6.0	DV60-1/2	6.0	1/2" fIPT	55.48
<hr/>				
GC1	DV1.0	1.0	3/4" fIPT	69.09
GC1.5		1.5	3/4" fIPT	69.09
GC2.0	DV2.0	2.0	3/4" fIPT	69.09
GC2.5	DV2.5-3/4	2.5	3/4" fIPT	69.09
GC3.0	DV30-3/4	3.0	3/4" fIPT	69.09
GC3.5	DV3.5-3/4	3.5	3/4" fIPT	69.09
GC4.0	DV40-3/4	4.0	3/4" fIPT	69.09
GC5.0	DV50	5.0	3/4" fIPT	69.09
GC6.0	DV60	6.0	3/4" fIPT	69.09
GC7.0	DV70	7.0	3/4" fIPT	69.09
GC8.0	DV80	8.0	3/4" fIPT	69.09
GC9.0	DV90	9.0	3/4" fIPT	69.09
GC10	DV100	10.0	3/4" fIPT	69.09
GC11.5	DV115	11.5	3/4" fIPT	69.09
<hr/>				
GY1.0	DV1-3/4MXF	1.0	3/4" mIPT x fIPT	65.91
GY1.5	DV1.5-3/4MXF	1.5	3/4" mIPT x fIPT	65.91
GY2.0	DV2-3/4MXF	2.0	3/4" mIPT x fIPT	65.91
GY2.5	DV2.5-3/4MXF	2.5	3/4" mIPT x fIPT	65.91
GY3.0	DV3-3/4MXF	3.0	3/4" mIPT x fIPT	65.91
GY3.5	DV3.5-3/4MXF	3.5	3/4" mIPT x fIPT	65.91
GY4.0	DV4-3/4MXF	4.0	3/4" mIPT x fIPT	65.91
GY5.0	DV5-3/4MXF	5.0	3/4" mIPT x fIPT	65.91
GY6.0	DV6-3/4MXF	6.0	3/4" mIPT x fIPT	65.91
GY7.0	DV7-3/4MXF	7.0	3/4" mIPT x fIPT	65.91

Flow Control Valves - Dole



NEW Part Number	OLD Part Number	Flow (GPM)	Inlet/Outlet	List Price
GY8.0	DV8-3/4MXF	8.0	3/4" mipt x fipt	\$ 65.91
GY9.0	DV9-3/4MXF	9.0	3/4" mipt x fipt	65.91
GY10	DV10-3/4MXF	10.0	3/4" mipt x fipt	65.91
GY11.5		11.5	3/4" mipt x fipt	65.91
Steel Housing/Zinc Plated				
GX1.0	DV10-1	1.0	1" fipt	133.12
GX1.5	DV15-1	1.5	1" fipt	133.12
GX2.0	DV20-1	2.0	1" fipt	133.12
GX2.5	DV25-1	2.5	1" fipt	133.12
GX3.0	DV30-1	3.0	1" fipt	133.12
GX3.5	DV35-1	3.5	1" fipt	133.12
GX4.0	DV40-1	4.0	1" fipt	133.12
GX5.0	DV50-1	5.0	1" fipt	133.12
GX6.0	DV60-1	6.0	1" fipt	133.12
GX7.0	DV70-1	7.0	1" fipt	133.12
GX8.0	DV80-1	8.0	1" fipt	133.12
GX9.0	DV90-1	9.0	1" fipt	133.12
GX10	DV100-1	10.0	1" fipt	133.12
GX12	DV120	12.0	1" fipt	133.12
GX13.5	DV135-1	13.5	1" fipt	133.12
GX15	DV150	15.0	1" fipt	133.12
GX20	DV200	20.0	1" fipt	133.12
GX25	DV250	25.0	1" fipt	133.12
GX30	DV300	30.0	1" fipt	133.12
Steel Housing/Zinc Plated				
GP1.0	DV1.0-11/4	1.0	1 1/4" mipt	140.51
GP1.5		1.5	1 1/4" mipt	140.51
GP2.0		2.0	1 1/4" mipt	140.51
GP2.5		2.5	1 1/4" mipt	140.51
GP3.0		3.0	1 1/4" mipt	140.51
GP3.5		3.5	1 1/4" mipt	140.51
GP4.0		4.0	1 1/4" mipt	140.51
GP5.0		5.0	1 1/4" mipt	140.51
GP6.0		6.0	1 1/4" mipt	140.51
GP7.0	DV75-11/4	7.0	1 1/4" mipt	140.51
GP8.0		8.0	1 1/4" mipt	140.51
GP9.0		9.0	1 1/4" mipt	140.51
GP10	DV10-11/4	10.0	1 1/4" mipt	140.51
GP12	DV12-11/4	12.0	1 1/4" mipt	140.51
GP13.5		13.5	1 1/4" mipt	140.51
GP15	DV15-11/4	15.0	1 1/4" mipt	140.51
GP20	DV20-11/4	20.0	1 1/4" mipt	140.51
GP25	DV25-11/4	25.0	1 1/4" mipt	140.51
GP30	DV30-11/4	30.0	1 1/4" mipt	140.51
Steel Housing/Zinc Plated				
GT1.0		1.0	1 1/2" mipt	155.58
GT1.5		1.5	1 1/2" mipt	155.58
GT2.0	DV2-11/2	2.0	1 1/2" mipt	155.58
GT2.5		2.5	1 1/2" mipt	155.58
GT3.0		3.0	1 1/2" mipt	155.58
GT3.5		3.5	1 1/2" mipt	155.58
GT4.0		4.0	1 1/2" mipt	155.58
GT5.0	DV5-11/2	5.0	1 1/2" mipt	155.58

NEW Part Number	OLD Part Number	Flow (GPM)	Inlet/Outlet	List Price
Steel Housing/Zinc Plated				
GT6.0		6.0	1 1/2" mipt	\$ 155.58
GT7.0	DV7-11/2	7.0	1 1/2" mipt	155.58
GT8.0		8.0	1 1/2" mipt	155.58
GT9.0	DV9-11/2	9.0	1 1/2" mipt	155.58
GT10	DV10-11/2	10.0	1 1/2" mipt	155.58
GT12		12.0	1 1/2" mipt	155.58
GT13.5		13.5	1 1/2" mipt	155.58
GT15	DV15-11/2	15.0	1 1/2" mipt	155.58
GT20	DV20-11/2	20.0	1 1/2" mipt	155.58
GT25	DV25-11/2	25.0	1 1/2" mipt	155.58
GT30	DV30-11/2	30.0	1 1/2" mipt	155.58
Steel Housing/Zinc Plated				
GF10	DV10-2	10.0	2" mipt	265.38
GF11.5		11.5	2" mipt	265.38
GF12	DV12-2	12.0	2" mipt	265.38
GF13.5	DV135-2	13.5	2" mipt	265.38
GF15		15.0	2" mipt	265.38
GF20	DV20-2	20.0	2" mipt	265.38
GF25		25.0	2" mipt	265.38
GF30	DV30-2	30.0	2" mipt	265.38
Steel Housing/Zinc Plated				
GH30		30.0	2-1/2" mipt	587.75
GH35	DV350	35.0	2-1/2" mipt	587.75
GH40	DV400	40.0	2-1/2" mipt	587.75
GH45	DV450	45.0	2-1/2" mipt	587.75
GH50	DV500	50.0	2-1/2" mipt	587.75
GH55	DV550	55.0	2 1/2" mipt	587.75
GH60	DV600	60.0	2-1/2" mipt	587.75
GH65	DV650	65.0	2-1/2" mipt	587.75
GH70	DV700	70.0	2-1/2" mipt	587.75
GH75	DV750	75.0	2-1/2" mipt	587.75
GH80	DV800	80.0	2-1/2" mipt	587.75
GH85		85.0	2-1/2" mipt	587.75
GH90	DV900	90.0	2 1/2" mipt	587.75
Steel Housing/Zinc Plated				
GK30		30.0	3" mipt	611.45
GK35	DV3500	35.0	3" mipt	611.45
GK40	DV4000	40.0	3" mipt	611.45
GK45	DV4500	45.0	3" mipt	611.45
GK50		50.0	3" mipt	611.45
GK55	DV5500	55.0	3" mipt	611.45
GK60		60.0	3" mipt	611.45
GK65	DV6500	65.0	3" mipt	611.45
GK70		70.0	3" mipt	611.45
GK75		75.0	3" mipt	611.45
GK80		80.0	3" mipt	611.45
GK85	DV8500	85.0	3" mipt	611.45
GK90		90.0	3" mipt	611.45
GK95		95.0	3" mipt	611.45
GK100	DV1000	100.0	3" mipt	611.45
GK105		105.0	3" mipt	611.45
GK110		110.0	3" mipt	611.45
GK115		115.0	3" mipt	611.45
GK120	DV1200	120.0	3" mipt	611.45



Pitless Adapters - Bronze



PT300



PT800



PT800T



PT825



PT3000



PT900



PT700 & PT725



BWS75-100

Pitless Adapter Features:

- Cast from **81% COPPER** content alloy bronze to insure long life and durability in the most aggressive well conditions.
- **Extended casing nipple** makes installation easy.
- Rubber inner and outer casing gaskets for certified & approved water tight seal from ground water contamination.
- Built-in lowering eyelet for easier installation (except PT300).
- All PT Series pitless adapters are individually boxed.
- PT300T, PT800T tapped with 1/4" FPT tapping for underground well tank installations.
- PT700, PT725, PT2000 made in US.



Bronze Drain and Wire Fitting Features:

- Cast from bronze to insure long life and durability in the most aggressive well conditions.
- Fastens to well casing to provide tapping for well drain, electrical conduit, bulkhead fittings & other related uses.
- Rubber gasket seals out ground water contamination.

Part Number	Drop Pipe Size	Nominal Well Casing	Casing Hole Opening	Max Load Capacity (lbs.)	Ctn Qty	List Price
PT300	1"	5" through 8"	1 3/4"	800	10	\$ 45.54
PT800	1"	5" through 8"	1 3/4"	900	10	74.82
PT700	1"	5" through 12"	1 3/4"	5,000	10	144.80
PT825	1-1/4"	5" through 8"	2 1/4"	2,000	10	151.29
PT725	1-1/4"	5" through 12"	2 1/8"	5,000	10	222.87
PT3000	2"	5 5/8" through 12"	3 1/8"	5,000	4	461.99
PT2000	2"	5 5/8" through 12"	3 1/8"	5,000	4	552.44
PT900	1" & 1-1/4" (2 Hole)	5" through 8"	1 3/4" & 2 1/4"	2,000	1	427.11
PT300 O-Ring	Fits PT300				1	3.33
PT800 O-Ring	Fits PT800, 825 and 900				1	3.39
TAPPED Pitless Adapters for underground tanks						
PT300T	1"	5" through 8"	1 3/4"	800	1	49.09
PT800T	1"	5" through 8"	1 3/4"	900	1	78.37
BWS75-100	3/4" FPT x 1" MPT	5" through 8"	1 3/8"	-	10/60	27.50



In the United States: Phone (800) 776-2266 Fax (800) 729-3299
 In Canada: Phone (866) 503-5523 Fax (888) 562-2095

www.americangranby.com

6/14/11

1.55

Pitless Adapters - Clear hole, Snap-on



BA Series

Features:

- CLEAR CASING DESIGN - no internal obstructions.
- Self-supporting (750 lbs / 300' of 1" iron pipe).
- 300 series stainless steel spring, pivot pin, pull cable, U-bolt, washers, nuts and extra wide backing strap.
- Built-in safety features should spring or cable fall.
- Available in combination with conduit or watertight caps.
- Quality American made bronze.
- Easy to install.
- **All BA Series pitless adapters and BA-SC combination units are certified and approved watertight to PAS-97 Standards. ☺**



Part Number	Description	Nominal Well Size"	Casing O.D."	Drop Pipe"	Ctn Qty	List Price
BA4-100 ☺	Pitless Adapter Only	4	4 1/2	1	1	\$ 282.28
BA4-100C	With C4 Alum Conduit Cap	4	4 1/2	1	1	323.17
BA4-100SC ☺	With SC4 ABS/Alum Cap	4	4 1/2	1	1	327.90
BA4-100WT	With AWTC4 Alum Cap	4	4 1/2	1	1	264.16
BA4-125 ☺	Pitless Adapter Only	4	4 1/2	1 1/4	1	291.98
BA4-125C	With C4 Alum Conduit Cap	4	4 1/2	1 1/4	1	331.32
BA4-125SC ☺	With SC4 ABS/Alum Cap	4	4 1/2	1 1/4	1	336.85
BA4-125WT	With AWTC4 Alum Cap	4	4 1/2	1 1/4	1	358.12
BA45-100 ☺	Pitless Adapter Only	4 1/2 SDR17	4.95	1	1	285.92
BA45-100SC ☺	With SC45 ABS/Alum Cap	4 1/2 SDR17	4.95	1	1	342.71
BA45-125 ☺	Pitless Adapter Only	4 1/2 SDR17	4.95	1 1/4	1	296.18
BA45-125SC ☺	With SC45 ABS/Alum Cap	4 1/2 SDR17	4.95	1 1/4	1	256.25
BA5-100 ☺	Pitless Adapter Only	5	5 9/16	1	1	288.68
BA5-100SC ☺	With SC5 ABS/Alum Cap	5	5 9/16	1	1	348.11
BA5-125 ☺	Pitless Adapter Only	5	5 9/16	1 1/4	1	298.97
BA5-125SC ☺	With SC5 ABS/Alum Cap	5	5 9/16	1 1/4	1	361.46
BA6-100P	Pitless Adapter Only for Plastic Pipe	6	6 5/8	1	1	302.63
BA6-100PSC	With SC6 ABS/Alum Cap for Plastic Pipe	6	6 5/8	1	1	354.62
BA6-100S	Pitless Adapter Only for Steel Pipe	6	6 5/8	1	1	302.63
BA6-100SSC	With SC6 ABS/Alum Cap for Steel Pipe	6	6 5/8	1	1	354.62

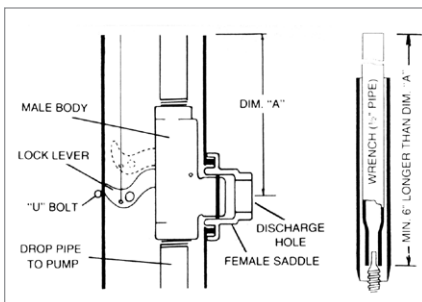

Installation Instructions

Note: Apply lubricant to o-ring on male member of body & female portion of saddle.

1. Cut 2 1/4" diameter discharge hole in casing with a 2 1/4" hole saw. Attach saddle and U-bolt.
2. File notch in top of casing above discharge hole for alignment and for easy reinstallation if pump must be pulled later.
3. Assemble pump and drop pipe to body and lower into casing with 1" support pipe longer than dim A. Note: Make sure male member snaps completely into female portion of saddle.
4. Remove 1" support pipe and attach cap.



Drive Well Points

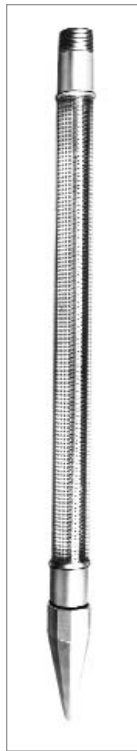

I-Series

Imperial Series Features:

- Designed to be driven into all types of soil.
- Imperial series are wrapped outside with a stainless steel screen
- Stainless steel jacket over gauze construction is permanently fixed to perforated steel pipe.
- Design allows the passage of all the sand free water the pipe can carry.
- Cast iron drive point head can be removed for easy field extension by coupling together with the second well point for added capacity.



Part No.	Simmons	Pipe Size	Length	Gauze	Ctn Qty	List Price
Imperial with Outer Stainless Steel Gauze						
I90-60	1720-1	1 1/4	24"	60	1	\$ 121.81
I94-60	1721-1	1 1/4	30"	60	1	131.88
I98-60	1722-1	1 1/4	36"	60	1	142.11
I100-60	1723-1	1 1/4	42"	60	1	153.44
I102-60	1724-1	1 1/4	48"	60	1	173.75
I136-60	1740-1	1 1/2	24"	60	1	143.98
I138-60	1741-1	1 1/2	30"	60	1	162.35
I144-60	1742-1	1 1/2	36"	60	1	179.33
I168-60	1752-1	2	36"	60	1	216.43
I172-60	1753-1	2	48"	60	1	279.67
I176-60	1754-1	2	60"	60	1	342.83
Imperial with Inner Stainless Steel Gauze						
I90-80	1726-1	1 1/4	24"	80	1	121.81
I94-80	1727-1	1 1/4	30"	80	1	131.88
I98-80	1728-1	1 1/4	36"	80	1	142.11
I102-80	1730-1	1 1/4	48"	80	1	173.75
I138-80	1746-1	1 1/2	30"	80	1	162.35
I144-80	1747-1	1 1/2	36"	80	1	179.33

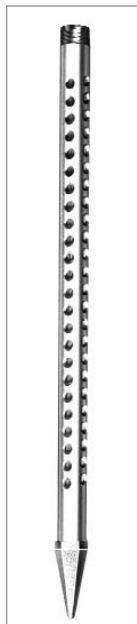
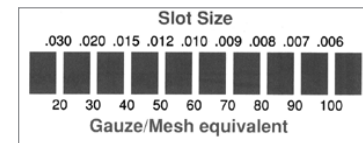

S-Series

Standard Series Features:

- For use in rocky or sandy soil.
- Standard series are wrapped inside with a stainless steel screen.
- Unique corrosion resistant construction features protect stainless steel gauze held in place between galvanized pipe and a stainless steel liner.
- Self flushing chamfered holes in galvanized pipe eliminate clay or sand build-up, giving maximum water yield with minimum development time.



Part No.	Simmons	Pipe Size	Length	Gauze	Ctn Qty	List Price
Standard Series with Inner Stainless Steel Gauze						
S94-60	1721	1 1/4	30"	60	1	\$ 132.01
S98-60	1722	1 1/4	36"	60	1	142.23
S102-60	1724	1 1/4	48"	60	1	173.75
S168-60	1752	2	36"	60	1	216.51
S172-60	1753	2	48"	60	1	279.67
S176-60	1754	2	60"	60	1	342.83
Standard Series with Outer Stainless Steel Gauze						
S94-80	1727	1 1/4	30"	80	1	132.01
S98-80	1728	1 1/4	36"	80	1	142.23

Drive Well Point Supplies



80002C
Sand Shark
Valve

"Sand Shark", Backwash Valves Features:

- Used in soft soil to jet open-end screen to desired depth.
- Thickwalled, cast iron construction with saw teeth to rip through roots and debris.
- Solid ABS ball check keeps sand from entering well when jetting operations are complete.
- Not spring loaded.

Part Number	Valve Size	Pressure Pipe Tap	Ctn Qty	List Price
80002C	2" NPT Male	1" NPS Left Hand Female	Bulk	\$ 75.29



8660B
Backwash
Valve

Part Number	Pipe Size	Description	Ctn Qty	List Price
8660B	2"	No. 19B S/Steel Ball	12	\$ 72.04



434 Series

Turned Coupling Features:

- Used for suspending flush well points or strainers from drive shoes or tubular cylinders.
- Galvanized with standard pipe thread.
- Furnished with right hand pipe threads.
- Thin wall 434J.

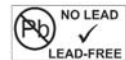

Part Number	Rt. Hand Thread Pipe Size	Well Size	Strainer Size	Coupling O.D.	Coupling Length	Ctn Qty	List Price
Turned Couplings							
434J11/4X11/4	1-1/4 x 1-1/4"	2	1"	1 13/16"	2-1/4"	48	\$ 5.89
434-11/4X11/4	1 1/4 X 1 1/4"	2	1 1/4	1 15/16"	2 1/4	48	6.47



DC

Galvanized Drive Coupling Features:

- Heavy pattern with deep recess for shouldering on imperfect threads of well points.
- Assures proper driving of well points and standard pipe.
- Taper tapped, reamed and drifted.

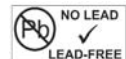

C125

Drive Cap Features:

- Heavy duty forged steel.
- Standard pipe threads.
- Vented on top.

Part Number	Description	Pipe Size	Length (in.)	Ctn Qty	List Price
Galvanized Drive Couplings					
DC125C	1-1/4"	1-1/4"	2.75	40	\$ 8.03
DC150	1-1/2"	1-1/2"	2.75	40	9.93
DC200	2"	2"	2.90	30	13.39
DC200L	2" Long Pattern	2"	3.40	30	17.68
Drive Caps					
C125	Heavy Duty Forged Steel	1-1/4"		32	13.39
C200	Heavy Duty Forged Steel	2"		16	23.21



Pitcher Pump



HPP10

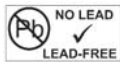

Pitcher Pump Features:

- Recommended for shallow pump applications – depth rating up to 30'.
- Easily installed.
- Made of heavy cast iron.
- Dark green hard enamel paint finish.
- Has open spout.
- 15-3/4" high.
- Tapped for 1-1/4" drop pipe.
- 15 lbs.
- Pumps are individually packaged 4 per master carton.
- Parts are carton qty 1.

Part Number	Description	Master Ctn Qty	List Price
HPP10	Pitcher Pump, Cast Iron, Size #2	4	\$ 118.75

PITCHER PUMP REPLACEMENT PARTS

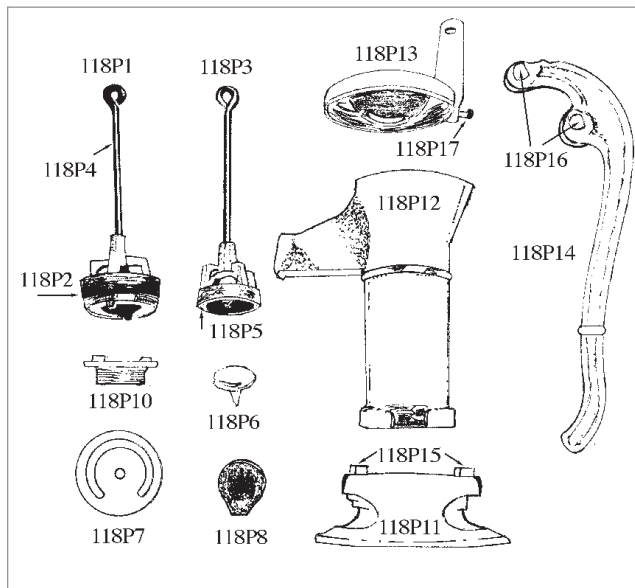

Part Number	Description	List Price
118P1	Complete Plunger Assembly (includes *)	36.98
118P2 *	Cup Leather for Plunger only	13.16
118P3	Plunger Rod and Cage (no cup leather)	14.26
118P4 *	Plunger Rod	7.34
118P5 *	Plunger Cage	9.15
118P6 *	Plunger Weight	5.03
118P7	Flat Leather for Base Valve	9.49
118P8	Weight and Screw for Flat Valve	6.54
118P9	Flat Valve Leather and Weight	15.99
118P10 *	Threaded Nut for Plunger Cage	10.60
118P11	Pump Base with Bolts (118P15)	34.10
118P12	Pump Cylinder	38.79
118P13	Pump Top with Set Screw (118P17)	17.48
118P14	Pump Handle with Two Bolts (118P16)	29.34
118P15	3/8 x1-1/4 Bolts for Pump Base	12.62
118P16	3/8 x 2 bolts for Pump Handle	4.46
118P17	Set Screw for Pump Top	3.81





Cylinder Replacement Parts



CLAYTON MARK®

Product Number	Description	List Price	Page
70039E	A40 2-1/2" x 12" Barrel Only	\$ 264.88	76
70039F	A40 2-1/2" x 16" Barrel Only	285.71	76
70039G	A40 3" x 12" Barrel Only	404.76	76
70039H	A40 3" x 16" Barrel Only	485.12	76
70043C	A40 2-1/2" Cap	54.64	76
70043D	A40 3" Cap	69.82	76
8015C	Top Cap 449B 1-7/8"	46.11	73
8015D	Top Cap 449B 2-1/4"	116.70	73
8015E	Top Cap 449B 2-3/4"	113.04	73
8034D	Cylinder Packer Rubber 450/7039	13.46	75
8036A	Check Packer Rubber 450/7039	8.36	75
8041A	Seating Tool for 450 Cylinders	6.07	75
8042C	Bottom Cap 449B 1-7/8"	53.55	73
8042D	Bottom Cap 449B 2-1/4"	131.32	73
8042E	Bottom Cap 449B 2-3/4"	118.56	73
80723A	Plunger Assembly A40 2"	250.00	76
80723B	Plunger Assembly A40 2 1/4"	276.79	76
80723C	Plunger Assembly A40 2 1/2"	276.79	76
80723D	Plunger Assembly A40 3"	297.62	76
80724A	A40 2" Check Valve	104.17	76
80724B	A40 2-1/4" Check Valve	112.00	76
80724C	A40 2 1/2" Check Valve	130.95	76
80724D	A40 3" Check Valve	142.86	76
8099B	Plunger Poppet 442 1 11/16 & 1 13/16	12.98	74
8099C	Plunger Poppet 442 2"	33.42	74
8099D	Plunger Poppet 442 2-1/4"	34.43	74
8099E	Plunger Poppet 442 2-1/2"	34.53	74
8099G	Plunger Poppet 442 3"	35.56	74
8248B	Top Cap 1" Tap 442 1-11/16"	49.59	74
8248D	Top Cap 1" Tap 442 1-13/16"	36.67	74
8248E	Top Cap 1 1/4" Tap 442 2"	41.37	74
8248G	Top Cap 1 1/4" Tap 442 2-1/4"	26.71	74
8248H	Top Cap 1 1/2" Tap 442 2-1/4"	39.00	74
8248J	Top Cap 1 1/4" Tap 442 2-1/2"	34.78	74
8248R	Top Cap 1 1/4" Tap 442 3"	35.78	74
8248T	Top Cap 2" Tap 442 3"	91.57	74
8281N	Brass Base Ring 450/7039	15.86	75
8333BC	Barrel Only 442 2-1/4" x 18"	127.31	74
8333D	Barrel Only 442 1 11/16" x 18"	108.47	74
8333DB	Barrel Only 442 2" x 16"	82.36	74
8333DC	Barrel Only 442 1 1/4" x 20"	118.28	74
8333FB	Barrel Only 442 2 x 18"	92.04	74



™

In the United States: Phone (800) 776-2266
In Canada: Phone (866) 503-5523

www.americangranby.com

Fax (800) 729-3299
Fax (888) 562-2095

10/12/10

1.77

Cylinder Replacement Parts



Product Number	Description	List Price	Page
8333H	Barrel Only 442 1 11/16" x 16"	105.42	74
8333HB	Barrel Only 442 2 x 20"	94.56	74
8333JA	Barrel Only 442 1 13/16" x 16"	67.66	74
8333LA	Barrel Only 442 1 13/16 x 18"	76.70	74
8333NA	Barrel Only 442 1 13/16 x 20"	85.42	74
8333NC	Barrel Only 442 2 1/2 x 18"	109.31	74
8333ND	Barrel Only 442 3 x 20"	284.39	74
8333PC	Barrel Only 442 2 1/2 x 20"	242.25	74
8333PD	Barrel Only 442 3" x 22"	146.14	74
8333R	Barrel Only 442 1 11/16" x 22"	124.55	74
8333RC	Barrel Only 442 2 1/2" x 22"	112.94	74
8333ZB	Barrel Only 442 2 1/4 x 16"	115.36	74
8334AB	Barrel Only 449 2 1/4 x 30"	279.02	73
8334BB	Barrel Only 449 2 1/4 x 36"	263.24	73
8334N	Barrel Only 449 1 7/8 x 24"	130.49	73
8334P	Barrel Only 449 1 7/8 x 30"	186.76	73
8334R	Barrel Only 449 1 7/8 x 36"	230.86	73
8334XC	Barrel Only 449 2 3/4 x 24"	195.44	73
8334YC	Barrel Only 449 2 3/4 x 30"	241.47	73
8334ZA	Barrel Only 449 2 1/4 x 24"	199.19	73
8334ZC	Barrel Only 449 2 3/4 x 36"	283.03	73
8509B	Cylinder End Base 450 2"	37.47	75
8513C	Spring Dog 4500 for 450 Cylinder	62.61	75
8514B	Plunger Assembly 450/7039 1 13/16	82.75	75
8515AP	Check Assembly 450/7039 2"	58.37	75
8520B	Cylinder Barrel & Base 7039 10ST	93.19	75
8520F	Cylinder Barrel & Base 7039 14ST	104.71	75
8522A	Plunger Assembly w/ leathers 442 1 11/16"	104.58	74
8522B	Plunger Assembly w/ leathers 442 1 13/16"	86.27	74
8522C	Plunger Assembly w/ leathers 442 2"	86.22	74
8522D	Plunger Assembly w/ leathers 442 2 1/4"	107.80	74
8522F	Plunger Assembly w/ leathers 442 2 1/2"	115.77	74
8522J	Plunger Assembly w/ leathers 442 3"	154.51	74
8525C	Check Poppet 450 Cylinder	14.29	75
8525D	Plunger Poppet 450 Cylinder	14.29	75
8533C	Check Assembly w/ leathers 449B 1 7/8"	99.79	73
8533D1	Check Assembly w/ leathers 449B 2 1/4"	135.84	73
8533E1	Check Assembly w/ leathers 449B 2 3/4"	229.76	73
8546B	Bronze Ball 449B 1 1/16"	57.70	73
8546D	Bronze Ball 449B 1 5/16"	71.60	73
8546E	Bronze Ball 449B 1 11/16"	112.87	73
8599A	Plunger Assembly w/ leathers 449B 1 7/8"	138.75	73
8599C	Plunger Assembly w/ leathers 449B 2 1/4"	184.56	73



Cylinder Operating Data



Product Number	Description	List Price	Page
8599E	Plunger Assembly w/ leathers 449B 2 3/4"	259.07	73
8853DA	Bottom Cap Check Assembly 442 3"	173.98	74
8853U	Bottom Cap Check Assembly 442 1 11/16"	95.36	74
8853V	Bottom Cap Check Assembly 442 1 13/16"	65.75	74
8853W	Bottom Cap Check Assembly 442 2"	85.03	74
8853X	Bottom Cap Check Assembly 442 2 1/4"	83.79	74
8853Z	Bottom Cap Check Assembly 442 2 1/2"	117.32	74
8854A	Check Poppet w/ facing 442 1 11/16"	9.69	74
8854B	Check Poppet w/ facing 442 1 13/16"	14.29	74
8854C	Check Poppet w/ facing 442 2"	14.56	74
8854D	Check Poppet w/ facing 442 2 1/4" & 2 1/2"	25.86	74
8854G	Check Poppet w/ facing 442 3"	59.60	74

**Table showing amount of water discharged per stroke by single acting cylinder.
The diameter of cylinder and length of stroke being known.**

Dia. of pump cylinder in inches	Length of stroke in inches with capacity per stroke in gallons												Area of circle cylinder sq in
	1	2	3	4	5	6	7	8	10	12	18	24	
1 3/8	.0064	.0128	.0192	.0256	.0320	.0384	.0448	.0512	.0640	.0768	.1152	.1536	1.4849
1 1/2	.0076	.0153	.0229	.0306	.0382	.0459	.0535	.0612	.0765	.0918	.1375	.1832	1.7671
1 5/8	.0090	.0180	.0270	.0360	.0450	.0540	.0630	.0720	.0900	.1080	.1620	.2140	2.0739
1 3/4	.0104	.0208	.0312	.0416	.0512	.0625	.0729	.0833	.1041	.1249	.1872	.2497	2.4053
1 13/16	.0112	.0224	.0336	.0448	.0560	.0672	.0784	.0896	.1120	.1344	.2016	.2688	2.5802
1 7/8	.0120	.0240	.0360	.0480	.0600	.0720	.0840	.0960	.1200	.1440	.2160	.2280	2.7612
1 31/32	.0132	.0263	.0395	.0527	.0659	.0790	.0922	.1054	.1317	.1580	.2371	.3161	3.0440
2	.0136	.0272	.0408	.0544	.0680	.0816	.0952	.1088	.1360	.1632	.2448	.3264	3.1416
2 3/16	.0163	.0325	.0488	.0650	.0812	.0976	.1137	.1300	.1625	.1952	.2928	.3904	3.7584
2 1/4	.0172	.0344	.0516	.0688	.0860	.1033	.1205	.1377	.1721	.2071	.3104	.4137	3.9760
2 1/2	.0212	.0425	.0637	.0850	.1062	.1275	.1487	.1700	.2125	.2550	.3825	.5100	4.9070
2 3/4	.0257	.0514	.0771	.1028	.1285	.1543	.1800	.2057	.2571	.3085	.4628	.6171	5.9395
3	.0306	.0612	.0918	.1224	.1530	.1836	.2142	.2448	.3060	.3672	.5508	.7344	7.0686

To obtain the capacity of a pump with a diameter of cylinder given in the table, but with a longer stroke than 24 inches (the longest stroke given in the table), add or multiply the capacity to represent the required length of stroke.

For instance: The capacity of a cylinder with a 30 inch stroke would be the same as that (having the same diameter) of an 18 inch stroke cylinder, added to the capacity of a 12 inch stroke cylinder. The same result may be obtained by multiplying the capacity of a cylinder with a 10 inch stroke by 3.

To obtain the amount of water discharged per minute, multiply the capacity per stroke by the number of strokes per minute. To obtain the amount of water discharged per hour, multiply this figure by 60.

Capacities are given in American Gallons. To find English gallons, deduct 1/6; to find liters, multiply by 3.75.



Rod Couplings



720



720 Series Rod Coupling Features:

- Hexagon shaped, galvanized couplings.
- Made from solid bars of cold-rolled steel.
- Use to connect steel pump rods.

720 Rod Couplings

Part Number	Size	Size of Hexagon	Overall Length	Ctn Qty	List Price
8075B1	3/8"x3/8"	5/8"	1-3/4"	25	\$ 1.81
8075C1	7/16"x3/8"	5/8"	1-3/4"	25	1.81
8075D1	7/16"x7/16"	5/8"	1-3/4"	25	1.83
8075E1	1/2"x3/8"	11/16"	1-3/4"	25	3.23
8075F1	1/2"x7/16"	11/16"	1-3/4"	25	3.39
8075G1	1/2"x1/2"	11/16"	1-3/4"	25	2.28
8075J1	5/8"x7/16"	13/16"	2-1/8"	BULK	4.71
8075K1	5/8" x 1/2"	13/16"	2 1/8"	BULK	8.83
8075L1	5/8"x5/8"	13/16"	2-1/8"	BULK	4.65



Add extra years to the life of any drill rig with the products used for years.



ISO 9001

Use Jet-Lube specialty lubricants, thread compounds and sealants on drill rods, pipe, collars, stabs, subs, wire and cable for lower down-time and longer rig life.

Water well drillers use Jet-Lube products on pumps, compressors and potable water connections. You name it, there's a Jet-Lube product for it. There's even environmental safe cleaners and degreasers.

Jet-Lube products are tested tough every day. Every product is the result of more than 50 years of testing and research. Jet-Lube is the only thread compound manufactured with its own downhole simulation, testing and certification equipment. Products are tested on rigs all over the world. Whether drilling in soft rock or harder formations, Jet-Lube delivers ultimate protection.

Where to apply Jet-Lube products:

- ① On tool joints, drill rods and pipe, on threaded connections, flanges and exposed threads. For water wells and monitor wells.
- ② For swivels, crown bearings, travel blocks and open gears; for anti-friction bearings; for all lube points on rigs.
- ③ On cables, ropes, sheave grooves; on cable spool guides and running gears; roller chain.
- ④ For potable water line connections; lines for fuel and gases.
- ⑤ For truck machinery; floors, tanks and trucks.
- ⑥ Jobsite protection.

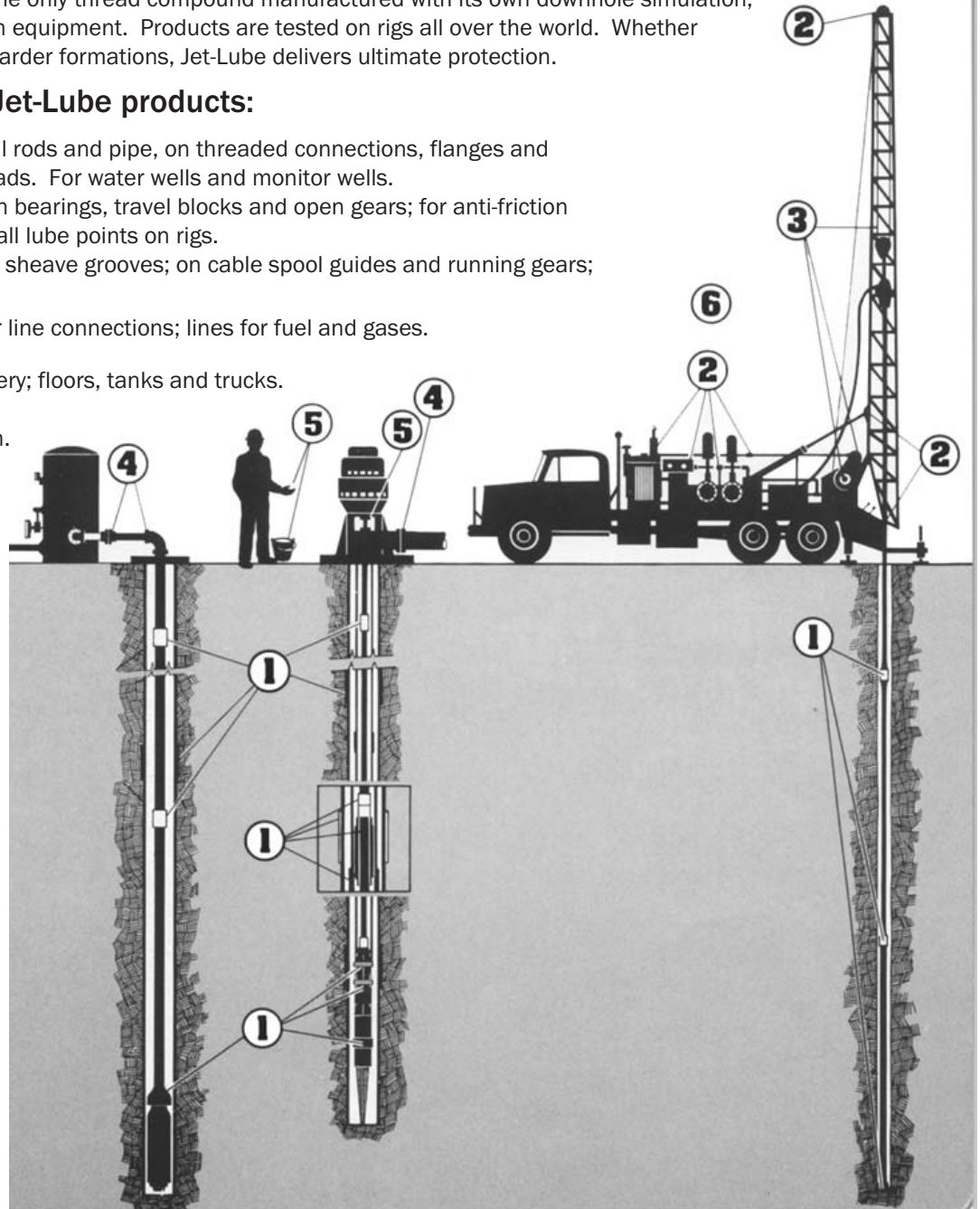



JL100 Series

1

Kopr-Kote® Heavy Duty Drill Pipe Compound (Lead Free)

A high performance, lead free, copper based thread compound for heavy duty drilling. Protects against seizure, galling and downhole makeup.

ARCTIC grade also available. Temp. rating -65 °F to 300 °F.



ISO 9001

Part Number	Net Contents & Container Type	Shipping Weight/Case	Case Equivalents	Case Qty	List Price
JL10050	14 oz. cartridge	36 lbs.	1	30	\$ 35.89
JL10023	1 gal pail	11 lbs.	1	1	164.04
JL10012	2 gal pail	21 lbs.	1	1	309.57
JL10015	5 gal pail	52 lbs.	2	1	614.89
JL10512	ARCTIC GRADE 2 gal pail	21 lbs.	1	1	340.50
JL10515	ARCTIC GRADE 5 gal pail	52 lbs.	2	1	676.36



JL109 Series

1

Jet-Lube 21® Intermediate Grade Drill Pipe Compound (Lead Free)

The lead free professional choice for intermediate drilling applications in softer formations. Environmentally safe.

Part Number	Net Contents & Container Type	Shipping Weight/Case	Case Equivalents	Case Qty	List Price
JL10923	1 gal pail	10 lbs.	1	1	\$ 106.18
JL10912	2 gal pail	20 lbs.	1	1	206.57
JL10915	5 gal pail	49 lbs.	2	1	423.61



JL145 Series

1



Eco-Safe™ Nonmetallic Thread Compound

Premium quality, nonmetallic thread compound containing carbon based fibers and additives and other extreme pressure and anti-wear additives.



Part Number	Net Contents & Container Type	Shipping Weight/Case	Case Equivalents	Case Qty	List Price
JL14523	1 gal pail	12 lbs.	1	1	\$ 152.79
JL14512	2 gal pail	22 lbs.	1	1	308.39
JL14515	5 gal pail	48 lbs.	1	1	504.07



JL668 Series

1

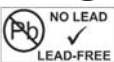

Bullseye™ Water Well and Environmental Compound

High purity thread compound designed for sensitive water well and other environmental drilling applications requiring a petroleum hydrocarbon-free product.



Part Number	Net Contents & Container Type	Shipping Weight/Case	Case Equivalents	Case Qty	List Price
JL66823	1 gal pail	12 lbs.	1	1	\$ 250.68
JL66812	2 gal pail	20 lbs.	1	1	476.75



JL03 Series

1

Jet-Lube Dope Brushes

Thread compound dope brushes, taper or bevel style. 1 1/8" x 16". Can be used in 1, 2 or 5 gallon pails.

Part Number	Net Contents & Container Type	Shipping Weight/Case	Case Equivalents	Case Qty	List Price
JL03000	1 1/8" x 16" Taper	9 lbs.	1	12	\$ 35.29
JL03500	1 1/8" x 16" Bevel	9 lbs.	1	12	33.79



JL119 Series

1

JLS® Economy Grade Drill Pipe Compound (Lead Free)

Economical choice for use only where drilling conditions are least demanding. For use in light to medium drilling in sandy formations. Environmentally safe.



ISO 9001

Part Number	Net Contents & Container Type	Shipping Weight/Case	Case Equivalents	Case Qty	List Price
JL11923	1 gal pail	10 lbs.	1	1	\$ 84.79
JL11912	2 gal pail	20 lbs.	1	1	157.07
JL11915	5 gal pail	50 lbs.	2	1	330.18



JL185 Series

1

NO LEAD
LEAD-FREE

Well-Guard® Monitor Well Drill Thread Compound

A thread compound which provides state-of-the-art protection against galling, seizure and thread damage while being in full compliance with all EPA guidelines. Petroleum hydrocarbon-free and brushable to -10°F. Test results available.

Part Number	Net Contents & Container Type	Shipping Weight/Case	Case Equivalents	Case Qty	List Price
JL18572	1 pint plastic jar	14 lbs.	1	12	\$ 72.96
JL18523	1 gal pail	11 lbs.	1	1	478.96
JL18515	5 gal pail	54 lbs.	2	1	2002.29

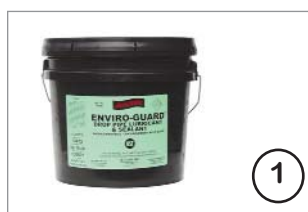

JL184 Series

1

Enviro-Guard™ Drop Pipe Lubricant and Sealant.

Specially formulated to aid in the assembly/disassembly of downhole casing for water wells.



Part Number	Net Contents & Container Type	Shipping Weight/Case	Case Equivalents	Case Qty	List Price
JL18423	1 gal pail	12 lbs.	1	1	\$ 188.54
JL18412	2 gal pail	24 lbs.	1	1	355.32
JL18415	5 gal pail	48 lbs.	1	1	859.82



JL170 Series

1

Run-N-Seal® Tubing and Casing Sealant

An environmentally safe nonmetallic sealant for threaded tubing and casing. Passes California COR Title 22

Part Number	Net Contents & Container Type	Shipping Weight/Case	Case Equivalents	Case Qty	List Price
JL17023	1 gal pail	11 lbs.	1	1	\$ 114.21
JL17012	2 gal pail	22 lbs.	1	1	204.32
JL17015	5 gal pail	54 lbs.	2	1	447.46



JL180 Series

1

RD-N™ Synthetic Rock Drilling Oil for Environmental Drilling

Provides superior lubrication for all makes of pneumatic percussion tools and prevents premature wear of hammer bits. An ISO 100/SAE 30 oil which exceeds all current EPA guidelines. Certified test results available. Can be used as a wire rope lubricant or hydraulic oil on restricted sites where petroleum based products are banned.

Part Number	Net Contents & Container Type	Shipping Weight/Case	Case Equivalents	Case Qty	List Price
JL18033	1 gal jug	36 lbs.	1	4	\$ 187.43
JL18035	5 gal jug	42 lbs.	2	1	844.25



JL369 Series

ALCO-EP™ ECF™ WW Extreme Service Multipurpose Grease.
Premium multipurpose calcium sulfonate complex grease thickening a blend of synthetic oils selected to provide the level of biodegradation required to meet the most safe environmental ratings.



Part Number	Net Contents & Container Type	Shipping Weight/Case	Case Equivalents	Case Qty	List Price
JL36950	14 oz. cartridge	36 lbs.	1	30	\$ 23.00
JL36916	35 lb. pail	39 lbs.	1	1	753.79



JL37050

ALCO-EP™ Premium Grease with Moly-Aluminum Complex (Black)

Water resistant aluminum complex based grease contains graphite, molybdenum disulfide and premium EP additive package for maximum metal protection, water resistance and high temperature (450F) capability in an all-weather formulation. NLGI Grade 2

Part Number	Net Contents & Container Type	Shipping Weight/Case	Case Equivalents	Case Qty	List Price
JL37050	14 oz. cartridge	36 lbs.	1	30	\$ 15.00



JL37341

769 Lubricant® and Penetrant

Heavy duty penetrating lubricant for all environments. When drilling in marshland or near coastlines, protects operating parts against salt corrosion. Frees rusted and frozen parts, displaces moisture, cleans and prevents rust. Non-flammable.

MIL-C-23411A. Federal spec V V-P-216B. USDA-H2

Part Number	Net Contents & Container Type	Shipping Weight/Case	Case Equivalents	Case Qty	List Price
JL37341	12 oz. aerosol	12 lbs.	1	12	\$ 18.96



JL28541

WLD™ Wire Rope, Cable and Roller Chain Dressing and Lubricant

Extend the life of wirelines, ropes, cables, grooves. Specially formulated with molybdenum disulfide and graphite to reduce friction and wear on cable strands. Tacky and adhesive for lasting protection. Penetrates wire strands to lubricate the core, then keeps on working to prevent moisture from corroding the cable. Black

Part Number	Net Contents & Container Type	Shipping Weight/Case	Case Equivalents	Case Qty	List Price
JL28541	12 oz. aerosol	12 lbs.	1	12	\$ 21.75



JL34041

WRL™ Wire Rope and Chain Lubricant/Oil

USDA authorized non-drying film penetrates to the rope core for long-term protection. May be applied by spraying, pouring or with automatic lube system. Pumpable to -25F. Amber

Part Number	Net Contents & Container Type	Shipping Weight/Case	Case Equivalents	Case Qty	List Price
JL34041	12 oz. aerosol	12 lbs.	1	12	\$ 22.64



4

JL355 Series

V-2® Multi Purpose PTFE Thread Sealant

A soft setting, non-petroleum based thread sealant for use where immediate pressurization is desired. Non-staining, low odor, off white in color. Use on all types of metals, reinforced fiberglass and PVC. **MIL-TT-S-1732. USDA H-2 Authorized. IAPMO Approved.**



ISO 9001

Part Number	Net Contents & Container Type	Shipping Weight/Case	Case Equivalents	Case Qty	List Price
JL35502	1/2 pint brush top can	11 lbs.	1	12	\$ 29.32
JL35504	1 pint brush top can	19 lbs.	1	12	43.46



4

JL240 Series

TFW™ Anti-Sieze Thread Sealant with PTFE

Low friction and non-toxic, TFW is used to prevent thread leaks of almost all fluids, gases or steam, even at temperatures up to 500 F. Can be used on metal, PVC, ABS and CPVC fittings and piping. **IAPMO approved.**

Part Number	Net Contents & Container Type	Shipping Weight/Case	Case Equivalents	Case Qty	List Price
JL24002	1/2 pint brush top can	9 lbs.	1	12	\$ 26.82
JL24004	1 pint brush top can	17 lbs.	1	12	38.79



4

JL71741

Pitless Adapter Lube™ Assembly Lubricant

Preservative designed to aid in installation of pitless adapters. **USDA H-1 authorized.** Corrosion preventative contains anti-bacterial/anti-fungal additive.

Part Number	Net Contents & Container Type	Shipping Weight/Case	Case Equivalents	Case Qty	List Price
JL71741	12 oz. aerosol	13 lbs.	1	12	\$ 22.68



4

JL23023

TF-15® Thread Sealant with PTFE for fiberglass pipe

High pressure thread sealant containing PTFE and EP additives that allow for easy breakout without seizing, stripping or galling. Highly recommended for use as a sealant on fiberglass tubing and casing threads. **Passes California COR Title 22**

Part Number	Net Contents & Container Type	Shipping Weight/Case	Case Equivalents	Case Qty	List Price
JL23023	1 gal pail	11 lbs.	1	1	\$ 157.14



5

JL30519

Easy-Clean® Concentrated Rig Wash

A biodegradable detergent to clean oil and grime from equipment or pumping station machinery. Industrial strength concentrated powdered detergent.

Part Number	Net Contents & Container Type	Shipping Weight/Case	Case Equivalents	Case Qty	List Price
JL30519	40 lb. 6 gal pail	43 lbs.	2	1	\$ 345.18



JL710 Series

5

Jet-Lube 5000™ Water Based Cleaner and Degreaser

Emulsifies (lifts and suspends) dirt, carbon, grease, etc., for removal by rinsing or wiping. May be used on surfaces compatible with water. Use full strength or dilute with fresh or salt water. Environmentally safe and **compliant with EPA 624 & 625.**



ISO 9001

Part Number	Net Contents & Container Type	Shipping Weight/Case	Case Equivalents	Case Qty	List Price
JL71043	16 oz. trigger spray	14 lbs.	1	12	\$ 18.75
JL71033	1 gal jug	35 lbs.	1	4	73.68
JL71035	5 gal jug	45 lbs.	2	1	299.89



JL72542

5

Clean-Up Plus™ Organic Solvent Cleaner

Environmentally safe cleaner and degreaser. Blend of organic solvents, safe non-flammable CO2 propellant. Citrus scent. Residue free product is safe on all metals. 29KV dielectric strength. No Tri 1-1-1. **USDA authorized.**

Part Number	Net Contents & Container Type	Shipping Weight/Case	Case Equivalents	Case Qty	List Price
JL72542	15 oz. aerosol	16 lbs.	1	12	\$ 21.82



JL61542

5

Clean-Up™ Industrial Cleaner and Safety Solvent

Heavy duty low foaming cleaner/degreaser. Fast working, non-flammable residue free product formulated with an ozone friendly chlorinated solvent. 29 KV dielectric strength. No Tri 1-1-1.

Part Number	Net Contents & Container Type	Shipping Weight/Case	Case Equivalents	Case Qty	List Price
JL61542	18 oz. aerosol	15 lbs.	1	12	\$ 21.93



JL16041

5

Moly Mist™ Dry Film Lubricant

Use to break in equipment and assemble moving parts. Micro-fine molybdenum disulfide suspended in a quick-drying carrier. Bonds to any surface in seconds to provide low coefficient of friction, extended lubrication and improved operation.

Part Number	Net Contents & Container Type	Shipping Weight/Case	Case Equivalents	Case Qty	List Price
JL16041	12 oz. aerosol	13	1	12	\$ 28.29



JL51541

6

TOP-GUN™ Wasp and Hornet Killer

EPA registered formula kills wasps, hornets, yellow jackets and bees on contact from 15-20 feet. Instant knockdown. Non conductive - 35KV formula for total protection.

Part Number	Net Contents & Container Type	Shipping Weight/Case	Case Equivalents	Case Qty	List Price
JL51541	14 oz. aerosol	15	1	12	\$ 20.96



Check Valves - Brass, Bronze

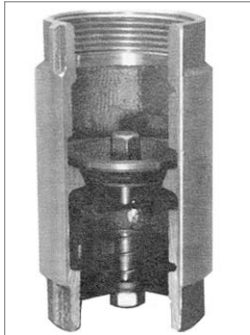

CHECK VALVE Features:

- Cast Brass, bronze, lead free brass or stainless steel body & poppet.
- Buna-N o-ring (Viton on stainless steel).
- Stainless steel springs, washers, locknuts.
- Delrin poppet stem guide.
- 200 psi WOG working pressure.
- 300 lb. max hang weight (down pull) tension.
- Individually cartoned.
- Imported.

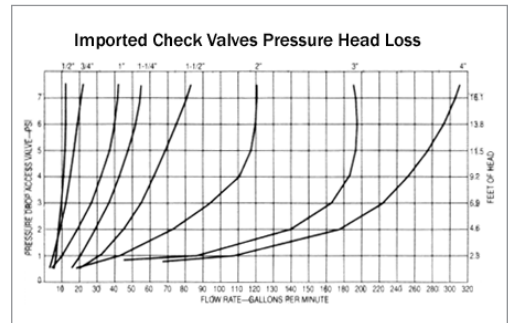

CV-BS Series

CV-BS Series BRASS Check Valves

- Rough body finish.

Part Number	Size	Ctn Qty	List Price
CV50BS	1/2"	100	\$ 10.07
CV75BS	3/4"	80	13.71
CV100BS	1"	60	20.00
CV125BS	1 1/4"	40	33.27
CV150BS	1 1/2"	30	37.38
CV200BS	2"	20	66.72



CVXLD Series

CVXLD Series BRASS Check Valves

- Rough body finish.
- Extra long at discharge end.

Part Number	Size	Ctn Qty	List Price
CVXLD100BS	1" x 1"	60	\$ 38.75
CVXLD125BS	1 1/4" x 1 1/4"	40	45.54



CV-B Series

CV-B Series BRONZE Check Valves

- Machined body finish.

Part Number	Size	Ctn Qty	List Price
CV50B	1/2"	100	\$ 13.25
CV75B	3/4"	80	19.36
CV100B	1"	60	27.32
CV125B	1 1/4"	40	38.39
CV150B	1 1/2"	30	51.96
CV200B	2"	20	89.11
CV300B	3"	6	308.04
CV400B	4"	3	653.04



CVNL-BS Series

CVNL-BS Series LEAD FREE BRASS Check Valves

- Rough body finish.

Part Number	Size	Ctn Qty	List Price
CVNL50BS	1/2"	100	\$ 11.96
CVNL75BS	3/4"	80	17.75
CVNL100BS	1"	60	26.17
CVNL125BS	1 1/4"	40	41.31
CVNL150BS	1 1/2"	30	47.63
CVNL200BS	2"	20	77.48
CVNL300BS	3"	6	273.21
CVNL400BS	4"	3	668.98



Check Valves - Brass, Bronze, Stainless Steel

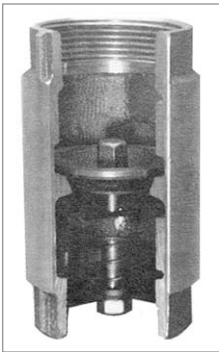

IMPORTED CHECK VALVE Features:

- Cast Brass, bronze, lead free brass or stainless steel body & poppet.
- Buna-N o-ring (Viton on stainless steel).
- Stainless steel springs, washers, locknuts.
- Delrin poppet stem guide.
- 200 psi WOG working pressure.
- 300 lb. maximum hang weight (down pull) tension.
- Individually cartoned.
- Imported.

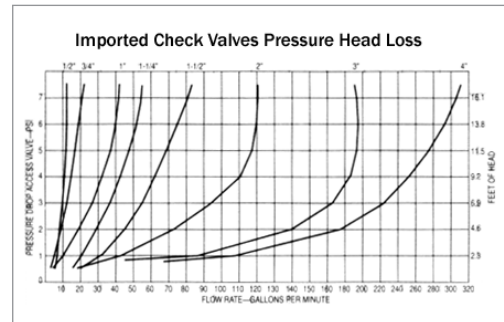

SSCV Series

SSCV Series STAINLESS STEEL Check Valves

- 304 cast stainless steel casting, springs, washers, lock nut.
- Viton o-ring

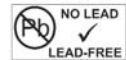

Part Number	Size	Ctn Qty	List Price
SSCV50	1/2"	100	\$ 24.65
SSCV75	3/4"	80	33.55
SSCV100	1"	60	44.23
SSCV125	1 1/4"	40	59.14
SSCV150	1 1/2"	30	77.53
SSCV200	2"	20	128.71
SSCV300	3"	6	545.16
SSCV400	4"	3	1048.57
SSCV1025	1" fpt x 1 1/4" mpt	60	62.50



CVMR-BS Series

CVMR-BS Series BRASS Submersible Check Valves

- Rough body finish.
- FPT x MPT

Part Number	Size (FPT X MPT)	Ctn Qty	List Price
CVMR100BS	1" x 1"	60	\$ 30.89



CVMXL Series

CVMXL Series BRASS Submersible Check Valves

- Rough body finish.
- Extra long body.

Part Number	Size (M X F)	Ctn Qty	List Price
CVMXL100BS	1" x 1"	60	\$ 26.61
CVMXL125BS	1 1/4" x 1 1/4"	40	34.82



CVM-B Series

CVM-B Series BRONZE Submersible Check Valves

- Machined body finish.
- FPT x MPT

Part Number	Size (FPT X MPT)	Ctn Qty	List Price
CVM100B	1" x 1"	60	\$ 35.89
CVM125B	1" x 1 1/4"	60	34.29
CVM1252B	1 1/4" x 1 1/4"	40	51.25



Check Valves - Brass, Bronze

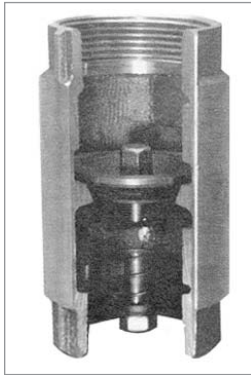

CHECK VALVE Features:

- Cast Brass, bronze, lead free brass or stainless steel body & poppet.
- Buna-N o-ring (Viton on stainless steel).
- Stainless steel springs, washers, locknuts.
- Delrin poppet stem guide.
- 200 psi WOG working pressure.
- 300 lb. maximum hang weight (down pull) tension.
- Individually cartoned.
- Imported

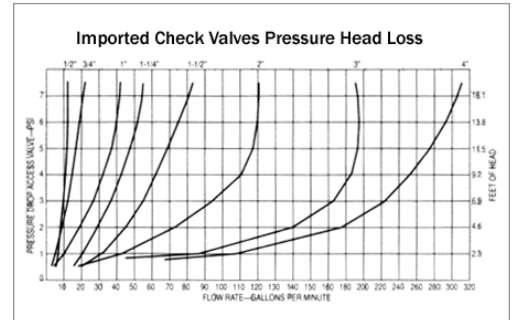

CVMNL-BS Series

CVMNL-BS Series LEAD FREE BRASS Submersible Check Valves

- Rough body finish.
- FPT x MPT

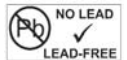

Part Number	Size (FPT X MPT)	Ctn Qty	List Price
CVMNL1252BS	1 1/4" x 1 1/4"	40	\$ 51.61



CVT-1B Series

CVT-1B Series BRONZE Single Tap Check Valves

- Machined body finish.
- 1/8" inlet tap.

Part Number	Size	Ctn Qty	List Price
CVT1001B	1"	60	\$ 35.64
CVT1251B	1 1/4"	40	39.91



CVRT-2BS Series

CVRT-2BS Series BRASS Double Tap Check Valves

- Rough body finish.
- One 1/8" inlet tap.
- One 1/4" outlet tap.

Part Number	Size	Ctn Qty	List Price
CVRT1002BS	1"	60	\$ 31.25
CVRT1252BS	1 1/4"	40	43.96

Check Valves - Brass, Bronze

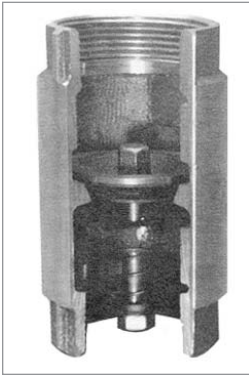

CHECK VALVE Features:

- Cast Brass, bronze, lead free brass or stainless steel body & poppet.
- Buna-N o-ring (Viton on stainless steel).
- Stainless steel springs, washers, locknuts.
- Delrin poppet stem guide.
- 200 psi WOG working pressure.
- 300 lb. maximum hang weight (down pull) tension.
- Individually cartoned.
- Imported.

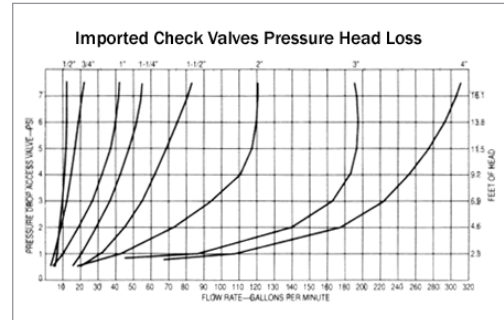

CVT-2B Series

CVT-2B Series BRONZE Double Tap Check Valves

- Machined body finish.
- One 1/8" inlet tap.
- One 1/4" outlet tap.

Part Number	Size	Ctn Qty	List Price
CVT1002B	1"	60	\$ 33.57
CVT1252B	1 1/4"	40	45.00
CVT1502B	1 1/2"	30	56.96
CVT2002B	2"	20	112.50



CVT-3B Series

CVT-3B Series BRONZE Control Center Check Valves

- Machined body finish.
- One 1/8" inlet tap.
- One 1/8" and one 1/4" outlet taps.

Part Number	Size	Ctn Qty	List Price
CVT1003B	1"	60	32.68
CVT1253B	1 1/4"	40	38.04



CVC-B Series

CVC-B Series BRONZE Control Center Check Valves

- Machined body finish.
- One 1/8" inlet tap.
- One 1/8" and two 1/4" outlet taps.

Part Number	Size	Ctn Qty	List Price
CVC100B	1"	60	34.46
CVC125B	1 1/4"	40	40.38



Foot Valves - Brass, Bronze



FOOT VALVE Features:

- Cast Brass, bronze, lead free brass or stainless steel body & poppet.
- Buna-N o-ring (Viton on stainless steel).
- Stainless steel springs, washers, locknuts and strainers.
- 200 psi WOG working pressure.
- Individually cartoned.
- Imported.



FVR-BS Series

FVR-BS Series BRASS Foot Valves

- Rough body finish.

Part Number	Size	Enters Pipe	Ctn Qty	List Price
FVR50BS	1/2"	1 1/4"	100	\$ 10.60
FVR75BS	3/4"	1 1/2"	80	14.11
FVR100BS	1"	2"	60	19.92
FVR125BS	1 1/4"	2 1/2"	40	26.22
FVR150BS	1 1/2"	3"	30	31.25
FVR200BS	2"	3 1/2"	20	52.68



FV-B Series

FV-B Series BRONZE Foot Valves

- Machined body finish.

Part Number	Size	Enters Pipe	Ctn Qty	List Price
FV50B	1/2"	1 1/4"	100	\$ 13.25
FV75B	3/4"	1 1/2"	80	15.38
FV100B	1"	2"	60	23.39
FV125B	1 1/4"	2 1/2"	40	30.89
FV1251B	1 1/4"	2"	50	31.84
FV150B	1 1/2"	3"	30	40.89
FV200B	2"	3 1/2"	20	69.82
FV300B	3"	5"	8	261.61
FV400B	4"	-	4	455.36



FV-BS Series

FV-B Series BRONZE Dual Purpose Foot Valves

- Machined body finish.

Part Number	Size	Enters Pipe	Ctn Qty	List Price
FV100125B	1" FPT x 1 1/4"MPT	2"	60	\$ 28.21

Foot Valves - Brass, Bronze, Stainless Steel



FOOT VALVE Features:

- Cast Brass, bronze, lead free brass or stainless steel body & poppet.
- Buna-N o-ring (Viton on stainless steel).
- Stainless steel springs, washers, locknuts and strainers.
- 200 psi WOG working pressure.
- Individually cartoned.
- Imported.



FVNL-BS Series

FVNL Series LEAD FREE BRASS Foot Valves

- Rough body finish.

Part Number	Size	Enters Pipe	Ctn Qty	List Price
FVNL50BS	1/2"	1 1/4"	100	\$ 10.47
FVNL75BS	3/4"	1 1/2"	80	16.96
FVNL100BS	1"	2"	60	24.61
FVNL125BS	1 1/4"	2 1/2"	40	33.13
FVNL150BS	1 1/2"	3"	30	39.21
FVNL200BS	2"	3 1/2"	20	72.14
FVNL300BS	3"	5"	8	232.50
FVNL400BS	4"	-	4	427.86

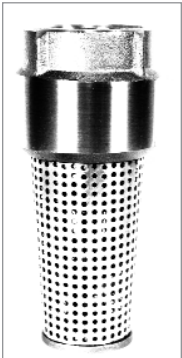

SSFV Series

SSFV Series STAINLESS STEEL Foot Valve Features:

- 304 Stainless steel casting, spring, washer, locknut, strainer
- Viton o-ring

Part Number	Size	Enters Pipe	Ctn Qty	List Price
SSFV50	1/2"	1 1/4"	100	\$ 16.79
SSFV75	3/4"	1 1/2"	80	21.71
SSFV100	1"	2"	60	41.79
SSFV125	1 1/4"	2 1/2"	40	55.34
SSFV150	1 1/2"	3"	30	58.07
SSFV200	2"	3 1/2"	20	124.89
SSFV300	3"	5"	8	464.41
SSFV400	4"	-	4	735.21



FVSC & CVSP Series

FVSC, CVSP Series Stainless Screen, Endcap, Screw, Spring

- Spring replacement for all imported check and foot valves

Screen/Cap/Screw Part Number	Spring Part Number	Size	FVSC List Price	CVSP List Price
FVSC50	CVSP50	1/2"	\$ 6.36	\$ 2.68
FVSC75	CVSP75	3/4"	6.71	2.68
FVSC100	CVSP100	1"	7.36	2.68
FVSC125	CVSP125	1 1/4"	8.86	3.36
FVSC150	CVSP150	1 1/2"	9.11	3.36
FVSC200	CVSP200	2"	9.50	3.75
FVSC300	CVSP300	3"	43.75	4.43
FVSC400	CVSP400	4"	62.50	4.79



Yard Hydrants - Frost Proof



5451 Series

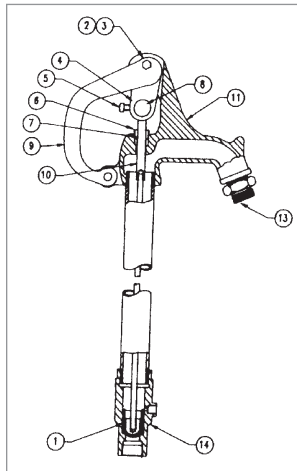

HVB75



RBHE



RBHT

5451 Series Frost Proof Yard Hydrant Features:

- Fully frost proof, shut-off valve below frost line.
- Heavy cast iron head with 3/4" brass discharge connection and bucket hook.
- Heavy, galvanized steel, corrosion resistant, 1" stand-pipe.
- Galvanized carbon steel connecting rod. Brass operating rod.
- Long lasting Buna-N rubber plunger with solid brass core.
- Integral valve seat cast into **BRONZE** valve body. 3/4" FPT connection with double bypass bottom valve for superior flow, less risk of debris blockage.
- 1/8" FPT drain hole.
- Rated to 80 PSI, adjustable. See page 2.18 for adjustment procedure.
- Packed securely in individual heavy weight carton.
- Independent lab tested.
- CE certified.



CLAYTON MARK[®]



Part Number	Bury Depth	Overall Length	Weight (Pounds)	List Price
54511	1	42"	12.4	\$ 117.59
54512	2	54"	15.2	123.98
54513	3	66"	17.8	134.62
54514	4	78"	21.0	143.67
54515	5	90"	22.3	154.31
54516	6	102"	26.2	162.82
54518	8	126"	30.7	184.10

Materials of Construction

#	Item	Material	#	Item	Material
1	Plunger	Buna-N/360 brass	9	Handle	Cast iron
2	Fulcrum Bolt	Steel - Zinc plated	10	Clevis Rod	360 brass
3	Fulcrum Nut	Steel - Zinc plated	11	Head	Cast Iron
4	Links	Steel - Zinc plated	13	Hose Adpt 3/4"	360 brass
5	Set Screw	Steel - Zinc plated	14	Bottom valve	Bronze 81-3-7-9
6	Packing Nut	360 brass		Stand Pipe	Steel - galvanized 1"
7	Packing	Teflon filled graphite			
8	Connector	Brass			

Part Number	Size	# Barbs	Ctn/Case Qty	List Price
Vacuum Breaker				
HVB75	3/4" Meets ASSE 1011 specifications		20/200	\$ 7.54
Cast Bronze Hydrant Elbow (INSxMIP)				
RBHE3/4	3/4" x 3/4"	5	10/100	11.80
RBHE1X3/4	1" x 3/4"	5	10/100	16.39
RBHE1	1" x 1"	5	10/100	16.75
RBHE11/4	1 1/4" x 1 1/4"	5	5/50	30.86
Cast Bronze Extra Long Hydrant Elbow (INS x MIP)				
XLRBHE1	1" x 1"	8	10/100	21.61
XLRBHE1X3/4	1" x 3/4"	10	10/100	18.75
Cast Bronze Hydrant Tee (INS x MIP)				
RBHT3/4	3/4" x 3/4"	4	10/100	16.00
RBHT1x3/4	1" x 3/4"	6	10/100	21.25
RBHT1	1" x 1"	4	10/100	21.61



www.americangranby.com
 In the United States: Phone (800) 776-2266 Fax (800) 729-3299
 In Canada: Phone (866) 503-5523 Fax (888) 562-2095

6/14/11

2.17

Yard Hydrants - Replacement Parts



CLAYTON MARK®

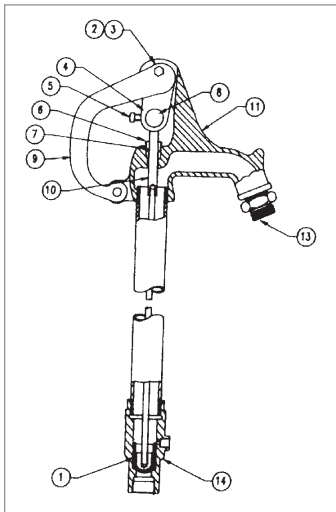

3/4" 5451 Hydrant Flow Rates

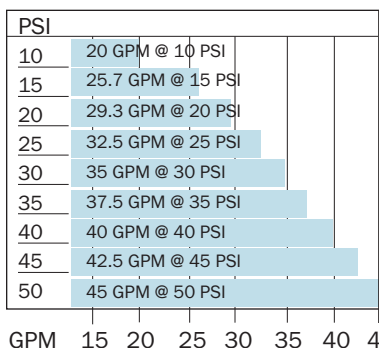

5451 Series Hydrant Replacement Parts

Part Number	Item Number	Description	List Price
YRK1		Repair Kit (Items 1-8)	\$ 17.33
9175B	1	Plunger - rubber	6.37
9023B	2	Fulcrum Bolt - steel	0.36
9023C	3	Nut - steel	0.27
9023D	4	Links (set of 2) - steel	2.38
9023E	5	Set Screw square head - steel	0.47
9023A	6	Packing Nut - brass	2.78
29609G	7	Packing - graphite (2 - 1 old, 1 new style)	3.56
9023G	8	Connector - brass	5.31
2506K	9	Handle - painted cast iron	10.14
2222AHNS	10	Clevis Rod - brass NEW STYLE (double bypass)	11.77
2500K	11	Head only - painted cast iron	34.19
382914	13	Hose Adapter - brass	7.31
381504	14	Valve Body - bronze	45.00
2575K		Complete Head Assembly (Items 2-13)	53.59

STEEL ROD (use with double bypass valve 5451 Series)

TA7100099NS	54511 Rod (32 5/8" old or 32.4" new)	7.49
TA7100100NS	54512 Rod (44 5/8" old or 44.4" new)	10.62
TA7100101NS	54513 Rod (56 5/8" old or 56.4" new)	13.67
TA7100102NS	54514 Rod (68 5/8" old or 68.4" new)	16.51
TA7100103NS	54515 Rod (80 5/8" old or 80.4" new)	19.39
TA7100104NS	54516 Rod (92 5/8" old or 92.4" new)	22.28
TA7100105NS	54518 Rod (116 5/8" old or 116.4" new)	24.45

NOTE: All 5451 Series Hydrants are preset at factory. There should be no need for any adjustment on initial installation. Adjust only if water does not shut off or hydrant does not operate properly.

5451 HYDRANT ADJUSTMENT PROCEDURE

- Turn water supply OFF.
- Open hydrant to relieve pressure.
- Loosen set screw. (Item 1)
- Push brass rod down as far as it will go by hand to be sure the plunger is touching the seat.
- Open handle (Item 2) approximately 30° from closed position.
- Tighten set screw snugly.
- Turn water supply ON.
- Operate hydrant and make sure the hydrant is shutting off properly and flowing properly.
- If hydrant still does not shut off, repeat steps 1 through 8.**
- Flow water through hydrant and then close completely to check for proper drainage by:
 - listening for water draining down pipe or
 - putting your hand over the hose connection to feel for a vacuum.
 If hydrant does not drain, see step 11.
- To clear drain hole blockage, close off hydrant spout by using hose cap or by attaching and kinking a hose. Open and close hydrant to allow water pressure to clear blockage. Repeat step 10 to verify proper drainage. If hydrant still does not drain, repeat steps 1 through 10 to fully uncover drain hole.

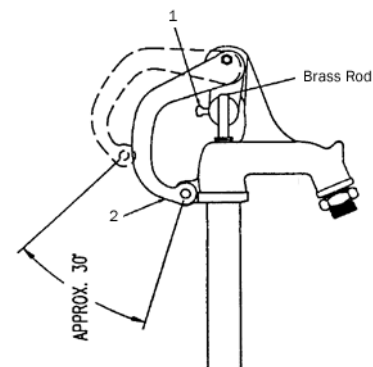

CAUTION: Do not try to make the shutoff adjustment in one attempt or you may overadjust and cause damage to the plunger and



Simmons



Deluxe Frost Proof Yard Hydrant Features:

- FROST-PROOF - Shut-off valve operates below the frost line.
- Pistol type handle eliminates pinching.
- Can be padlocked.
- Wheel handle controls water flow at rate desired.
- Solid brass rod will not rust or cut into packing.
- Water in standpipe drains out when hydrant is off.
- Brass nozzle threaded for standard 3/4" hose coupling.
- Inner parts removable without digging.
- 80 PSI maximum pressure.
- Individually boxed.

CONTAINS LEAD - Not for sale in California. Call for lead free hydrant quote.

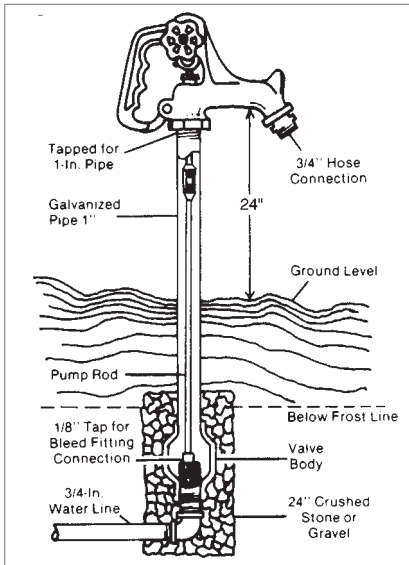
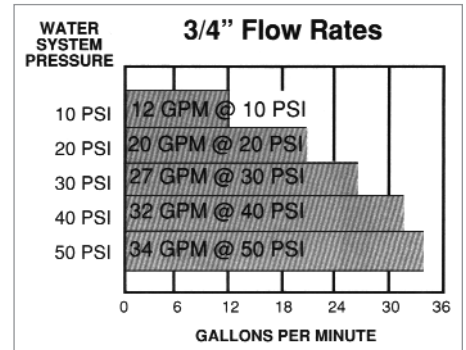

Part Number	Bury Depth	Pipe Length	Overall Length	Ctn Qty	List Price
H800	1 ft	33"	39 1/2"	1	\$ 146.02
H801	1 1/2 ft	41"	47 1/2"	1	150.10
H802	2 ft	47"	53 1/2"	1	154.49
H803	3 ft	59"	65 1/2"	1	163.16
H804	4 ft	71"	77 1/2"	1	174.85
H805	5 ft	83"	89 1/2"	1	186.58
H806	6 ft	95"	101 1/2"	1	201.33
H807	7 ft	107"	113 1/2"	1	213.01
H808	8 ft	119"	125 1/2"	1	228.21



HVB75



RBHE



RBHT

Part Number	Size	# Barbs	Ctn/Case Qty	List Price
Vacuum Breaker				
HVB75	3/4" Meets ASSE 1011 specifications		20/200	\$ 7.54
Cast Bronze Hydrant Elbow (INSxMIP)				
RBHE3/4	3/4" x 3/4"	5	10/100	11.80
RBHE1X3/4	1" x 3/4"	5	10/100	16.39
RBHE1	1" x 1"	5	10/100	16.75
RBHE11/4	1 1/4" x 1 1/4"	5	5/50	30.86
Cast Bronze Extra Long Hydrant Elbow (INS x MIP)				
XLRBHE1	1" x 1"	8	10/100	21.61
XLRBHE1X3/4	1" x 3/4"	10	10/100	18.75
Cast Bronze Hydrant Tee (INS x MIP)				
RBHT3/4	3/4" x 3/4"	4	10/100	16.00
RBHT1x3/4	1" x 3/4"	6	10/100	21.25
RBHT1	1" x 1"	4	10/100	21.61

Yard Hydrants - Replacement Parts



Replacement Parts For H800 Series Hydrants

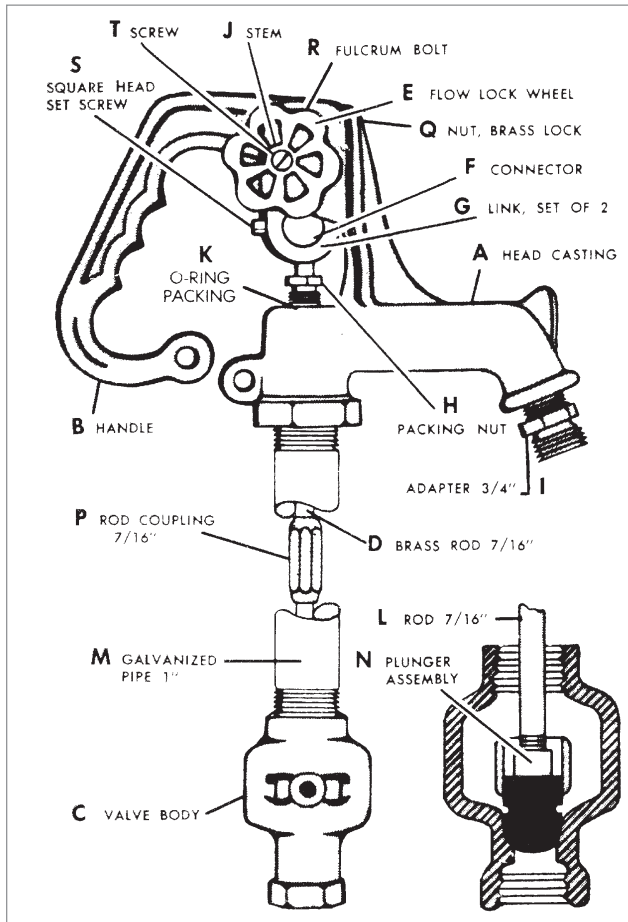

Part Number	Reference Number	Name of Part	List Price
8820	A	Head	\$ 52.74
8821	B	Handle	17.14
8822	C	Valve Body	60.34
8823	D	Brass Extension	11.66
8824	E	Hand Wheel	2.98
8825 *	F	Connector - brass	28.95
8826 *	G	Links(pair) - brass	15.35
8827 *	H	Packing Nut - brass	10.17
8828	I	Brass Hose Adapter	10.94
8829	J	Hydrant Stem	4.16
8839 *	K	O-Ring Packing	2.87
8814-0	L	7/16" Pump Rod for H800	25.07
8814-1		7/16" Pump Rod for H801	31.45
8814-2		7/16" Pump Rod for H802	37.50
8814-3		7/16" Pump Rod for H803	47.89
8814-4		7/16" Pump Rod for H804	58.02
8814-5		7/16" Pump Rod for H805	68.20
8814-6		7/16" Pump Rod for H806	78.21
8814-7		7/16" Pump Rod for H807	88.39
8814-8		7/16" Pump Rod for H808	98.41
8815-0	M	Pipe Casing for H800	28.77
8815-1		Pipe Casing for H801	37.93
8815-2		Pipe Casing for H802	45.16
8815-3		Pipe Casing for H803	57.21
8815-4		Pipe Casing for H804	69.22
8815-5		Pipe Casing for H805	81.22
8833 *	N	Plunger - Buna-N	12.44
8834	P	Rod Coupling	4.70
8301 *	Q	Lock Nut - stainless steel	0.91
8836 *	R	Fulcrum Bolt - stainless steel	3.72
8837 *	S	Set Screw - stainless steel	1.81
8610	T	Screw for Wheel	1.47
840		Head, Complete	85.86
850		*Included in Parts Kit	41.77



Ball Valves - Brass



HFBV6 Series



ISO 9001

MATERIAL SPECIFICATIONS	
Handle nut	Zinc Coated Steel
Handle	Zinc Coated Steel
Gland Follower	Forged Brass
Stem Packing	Teflon®
Ball	Chrome Plated Brass
Seats	Teflon®
Body	Forged Brass
End Adapter	Forged Brass

Teflon® is a Dupont registered trademark

Forged Brass Full Port Ball Valve Features:

- Heavy pattern forged brass construction.
- Full port allows maximum flow & minimum pressure drop or turbulence.
- Teflon® seats, chrome plated brass ball.
- Teflon® stem packing with adjustable gland follower.
- Blow out proof stem design.
- **600 PSI W.O.G. non-shock; 150 PSI S.W.P.** (400 PSI 2 1/2", 3" 4")
- **CSA Certified, UL Listed.**
- Imported, Manufactured for American Granby in an ISO 9001 facility.

DIMENSIONS (IN.)	SIZE	A (S/T)	B (S/T)	C	D (S/T)
	1/4"	1.79/1.76	1.73/1.73	3.54	.32/.39
	3/8"	1.91/1.76	1.73/1.73	3.54	.39/.39
	1/2"	2.05/2.05	1.84/1.92	3.54	.58/.58
	3/4"	2.75/2.36	2.00/2.09	3.78	.75/.75
	1"	3.23/2.76	2.44/2.56	4.53	.95/.95
	1 1/4"	3.82/3.31	2.85/2.95	4.53	1.26/1.26
	1 1/2"	4.43/3.66	3.17/3.35	5.51	1.58/1.58
	2"	5.32/4.18	3.45/3.68	5.51	1.94/1.94
	2 1/2"	6.28/5.36	4.76/4.76	8.66	2.52/2.52
	3"	7.15/6.04	5.08/5.08	8.66	2.95/2.95
	4"	9.28/7.39	5.87/5.87	9.61	3.90/3.90

Part Number	Size	Ctn/Case Qty	List Price Threaded	Part Number	List Price Sweat
HFBV6-25T	1/4"	50/100	\$ 8.46		
HFBV6-38T	3/8"	50/100	8.25		
HFBV6-50T	1/2"	50/100	11.49	HFBV6-50S	\$ 10.16
HFBV6-75T	3/4"	30/60	17.18	HFBV6-75S	16.12
HFBV6-100T	1"	20/40	27.18	HFBV6-100S	25.48
HFBV6-125T	1- 1/4"	12/24	41.23	HFBV6-125S	42.29
HFBV6-150T	1-1/2"	9/18	63.83	HFBV6-150S	60.64
HFBV6-200T	2"	6/12	92.56	HFBV6-200S	82.19
HFBV6-250T	2-1/2"	2/4	214.45		
HFBV6-300T	3"	2/4	279.27		
HFBV6-400T	4"	2	526.62		



HDBV Series

ISO 9001

MATERIAL SPECIFICATIONS and DIMENSIONS
Same as HFBV6 Series above

Forged Brass Full Port Drainable Ball Valve Features:

- Heavy pattern forged brass construction.
- Full port allows maximum flow & minimum pressure drop or turbulence.
- Drain feature allows water line to be drained to prevent freeze-up.
- Teflon® seats, chrome plated brass ball.
- Teflon® stem packing with adjustable gland follower.
- Blow out proof stem design.
- **600 PSI W.O.G. non-shock.**
- Imported, Manufactured for American Granby in an ISO 9001 facility.

Part Number	Size	Ctn/Case Qty	List Price Threaded	Part Number	List Price Sweat
-	1/2"	10/100		HDB50S	\$ 15.57
HDBV75T	3/4"	5/60	22.55	HDBV75S	22.55
HDBV100T	1"	6/36	31.43	HDBV100S	33.20



In the United States: Phone (800) 776-2266 Fax (800) 729-3299
 In Canada: Phone (866) 503-5523 Fax (888) 562-2095

www.americangranby.com

5/3/11

Ball Valves - Brass

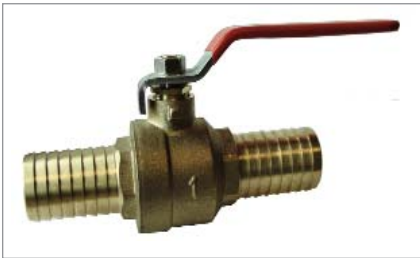

HFBV6-I Series

ISO 9001

Forged Brass FULL Port Ball Valve with Hose Barbs

Features:

- Heavy pattern forged brass construction.
- Full port allows maximum flow and minimum pressure drop or turbulence.
- Teflon® seats, chrome plated brass ball.
- Teflon® stem packing with adjustable gland follower.
- Blow-out proof stem design.
- **600 psi W.O.G.** non-shock; **150 psi S.W.P.**
- Insert hose barb ends for use with polyethylene pipe connections.
- Imported. Manufactured for American Granby in an ISO 9001 facility.



MATERIAL SPECIFICATIONS

Handle nut	Zinc Coated Steel
Handle	Zinc Coated Steel
Gland Follower	Forged Brass
Stem Packing	Teflon®
Ball	Chrome Plated Brass
Seats	Teflon®
Body	Forged Brass
End Adapter	Forged Brass

Teflon® is a Dupont registered trademark

Part Number	Size	Ctn/Case	
		Qty	List Price
HFBV6-50I	1/2"	50/100	\$ 15.61
HFBV6-75I	3/4"	30/60	24.11
HFBV6-100I	1"	20/40	29.82
HFBV6-125I	1-1/4"	12/24	54.47



IBV Series

ISO 9001

Forged Brass Conventional Port Ball Valve Features:

- Regular pattern forged brass construction.
- Conventional port with excellent flow characteristics compared with other valves in its class.
- Teflon® seats, chrome plated brass ball.
- Double o-ring stem seal.
- Blow-out proof stem design.
- **400 PSI W.O.G** non-shock, **125 PSI S.W.P.**
- Imported. Manufactured for American Granby in an ISO 9001 facility.

DIMENSIONS (IN.)	SIZE	A (TxT)	A (SxS)	B	C	D
	1/2"	1.83	1.97	1.54	.39	3.19
	3/4"	2.09	2.44	2.09	.59	3.64
	1"	2.40	2.95	2.20	.79	3.64
	1 1/4"	2.76	3.35	2.36	.98	3.64
	1 1/2"	3.27	4.00	2.64	1.26	4.41
	2"	3.82	4.82	3.15	1.57	5.63

MATERIAL SPECIFICATIONS

Handle Nut	Zinc Coated Steel
Handle	Zinc Coated Steel
Stem O-Rings	NBR
Stem	Forged Brass
Ball	Chrome Plated Brass
Seats	Teflon®
Body	Forged Brass
End Adapter	Forged Brass

Teflon® is a Dupont registered trademark

Threaded	Sweat	Ctn/Case		
Part Number	Part Number	Size	Qty	List Price
IBV50T	IBV50S	1/2"	16/128	\$ 8.64
IBV75T	IBV75S	3/4"	10/100	14.60
IBV100T	IBV100S	1"	12/48	23.61
IBV125T	IBV125S	1-1/4"	8/32	36.39
IBV150T	IBV150S	1-1/2"	6/24	53.71
IBV200T	IBV200S	2"	4/16	81.79



Ball Valves - Gas, Stainless



HGBVL Series



HGBVT Series

Forged Brass Gas Ball Valve Features:

- Heavy duty two piece forged brass body.
- For use with natural, manufactured, mixed, liquified petroleum and LP gas/air mixtures.
- Meets ANSI standard Z21.15 for use as a gas appliance connector valve (1/2 lb. system). CSA, US/AGA B-16.44
- UL Listed 757X for fire protection.
- Pressure rated at 175 psi W.O.G. non-shock.
- Imported, Mfg for American Granby in an ISO 9001 facility.



ISO 9001

MATERIAL SPECIFICATIONS

Handle Screw	Steel
Handle	Aluminum
Stem O-Rings	NBR
Stem	Forged Brass
Ball	Chrome Plated Brass
Seats	Teflon®
Body	Forged Brass
End Adapter	Forged Brass

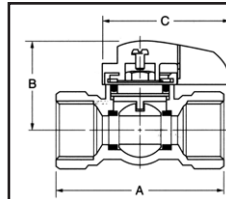

DIMENSIONS (IN.)

SIZE	A	B	C	BTU Capacity/Hr.
1/2"	2.21	1.46	1.81	295,000
3/4"	2.38	1.75	1.81	795,000
1"	2.91	1.89	1.81	1,200,000

Lever Style	Tee Style	Size	Ctn/Case Qty	List Price
Part Number	Part Number	t x t		
HGBVL50T	HGBVT50T	1/2"	12/144	\$ 10.99
HGBVL75T	HGBVT75T	3/4"	12/96	16.59
HGBVL100T	HGBVT100T	1"	6/96	30.46



SSBV Series

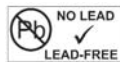

Stainless Steel Full Port Ball Valve Features:

- 316 Stainless steel ball valves
- Full Port, 1000 psi WOG
- Locking Handle (padlock not included)
- Investment castings.
- PTFE seal and packing.
- Blow-out proof stem.
- Mounting pad tapping.
- FPT x FPT



DIMENSIONS (IN.)

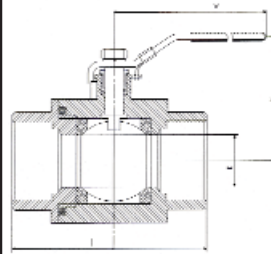

SIZE	D	L	H	W
1/4"	0.394	2.126	1.732	3.701
3/8"	0.472	2.126	1.732	3.701
1/2"	0.591	2.441	2.087	4.134
3/4"	0.787	2.913	2.283	4.528
1"	0.984	3.268	2.480	4.843
1 1/4"	1.260	3.858	2.835	5.354
1 1/2"	1.496	4.173	3.307	6.614
2"	1.969	4.724	3.701	6.772
2 1/2"	2.559	6.299	4.803	9.134
3"	3.150	7.402	5.197	9.370

MATERIAL SPECIFICATIONS

Body	Stainless Steel
Cap	Stainless Steel
Ball	Stainless Steel
Seats	PTFE
Stem	Stainless Steel
Handle	Stainless Steel
Packing	PTFE
Seal Gasket	PTFE
Nut	Stainless Steel
Handle Cover	Plastic
Thrust Washer	Stainless Steel

Part Number	Description	Size T x T	Case Qty	List Price
SSBV25TLH	Stainless 1000#	1/4"	2/80	\$ 28.98
SSBV38TLH	Stainless 1000#	3/8"	2/80	26.39
SSBV50TLH	Stainless 1000#	1/2"	2/80	29.36
SSBV75TLH	Stainless 1000#	3/4"	2/60	40.33
SSBV100TLH	Stainless 1000#	1"	2/40	59.14
SSBV125TLH	Stainless 1000#	1 1/4"	2/30	90.40
SSBV150TLH	Stainless 1000#	1 1/2"	2/16	133.89
SSBV200TLH	Stainless 1000#	2"	2/10	199.85
SSBV250TLH	Stainless 1000#	2 1/2"	2/4	372.17
SSBV300TLH	Stainless 1000#	3"	2/4	604.77



In the United States: Phone (800) 776-2266 Fax (800) 729-3299
In Canada: Phone (866) 503-5523 Fax (888) 562-2095

www.americangranby.com

6/14/11

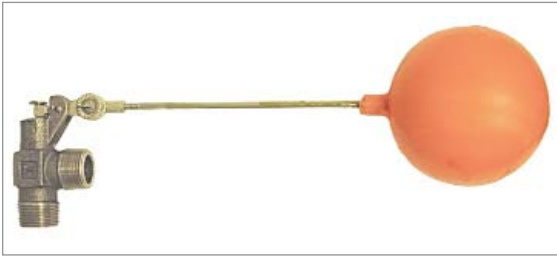

BFV Series

Bronze Float Valve Features:

- Cast bronze body
- Buna-N Disc
- Heavy Duty
- Tapped for 1/4"-20SAE rod
- Threaded outlet
- Rated at 125 psi

Part Number	Size	Inlet	Outlet	Tapped	Ctn Qty	List Price
BFV1/2	1/2"	1/2" mpt	1/2" mpt	1/4"-20SAE	10/100	\$ 29.70
BFV3/4	3/4"	3/4" mpt	3/4" mpt	1/4"-20SAE	10/80	35.83
BFV1	1"	1" mpt	1" mpt	1/4"-20SAE	10/40	47.34



BFVR Series

Brass Rods Features:

- Brass SAE
- Male thread both ends

Part Number	Length	Thread	Fits Valve Size	Ctn Qty	List Price
BFVR8	8"	1/4"-20SAE	1/2" - 1"	50/400	\$ 6.62
BFVR10	10"	1/4"-20SAE	1/2" - 1"	50/300	7.67
BFVR12	12"	1/4"-20SAE	1/2" - 1"	50/300	8.59



BFVFP Series

Plastic Float Features:

- PVC
- Corrosion resistant
- Lightweight
- Up to 175°F
- For open tank service only

Part Number	Float Diam.	Buoyancy	Female Connection	Ctn Qty	List Price
BFVFP5	5"	2.17 lbs.	1/4"-20SAE	100	\$ 21.23
BFVFP6	6"	3.8 lbs.	1/4"-20SAE	100	25.00
BFVFP8	8"	9.87 lbs.	1/4"-20SAE	20	31.08



GV200 Series

GV200 Series Forged Brass Gate Valve Features:

- Constructed of heavy duty forged brass.
- **Die-cast** body, **forged** bonnet are connected with a teflon body to bonnet gasket for a leak proof seat.
- Screwed bonnet, non-rising stem, solid wedge disc and integral seats.
- Teflon® stem seal packing. Teflon® is a registered trademark of Dupont.
- Cast iron hand wheel
- Rated at **200 PSI WOG; 125 PSI SWP** (working pressure, non shock)
- Threaded ends produced to ANSI/ASME B1.20.1 (NPT) standards.
- Sweat ends produced to ANSI B16.18-1984 standards
- Imported

MATERIAL SPECIFICATIONS	
Wheel Nut	Brass
Hand Wheel	Cast Iron
Gland Follower Nut	Brass
Gland Follower	Brass
Stem Seal Packing	Teflon
Bonnet	Brass
Body-Bonnet Gasket	Teflon
Lock Nut	Brass
Stem	Brass
Disc	Brass
Body	Brass

DIMENSIONS (IN.)	SIZE	A (IPS)	A (Cx C)	B (IPS)	B (Cx C)	C
	1/2"	1.68	1.76	2.77	2.79	2.15
	3/4"	1.76	2.34	2.97	3.10	2.15
	1"	2.03	2.69	3.44	3.63	2.34
	1 1/4"	2.30	3.01	4.02	4.37	2.93
	1 1/2"	2.46	3.36	4.45	4.96	2.93
	2"	2.69	3.98	5.23	6.13	3.12
	2 1/2"	3.43		6.36		3.90
	3"	3.71		7.41		4.29
	4"	4.45		9.17		5.07

Threaded Part Number	Sweat Part Number	Size	Ctn/Case Qty	List Price
GV200-50T		1/2"	10 / 100	\$ 12.01
	GV200-50S	1/2"	10 / 100	13.21
GV200-75T		3/4"	10 / 100	14.91
	GV200-75S	3/4"	10 / 100	14.83
GV200-100T		1"	5 / 50	21.64
	GV200-100S	1"	5 / 50	20.32
GV200-125T		1 1/4"	5 / 50	31.40
	GV200-125S	1 1/4"	5 / 50	42.87
GV200-150T		1 1/2"	2 / 30	37.50
	GV200-150S	1 1/2"	2 / 30	45.57
GV200-200T		2"	2 / 20	62.31
	GV200-200S	2"	2 / 20	75.36
GV200-250T		2 1/2"	1 / 10	138.58
GV200-300T		3"	1 / 10	176.96
GV200-400T		4"	1 / 4	319.02

Valves - Brass Swing Check



HSCV Series

ISO 9001

MATERIAL SPECIFICATIONS	
Cap	Brass
Body	Brass
Disc	Brass
Hinge Pin	Brass
Screw	Brass

Brass Swing Check Valve Features:

- Constructed of heavy duty cast brass.
- Screwed cap, swing type disc and integral seat.
- Prevents backflow while offering full flow performance with a minimum of turbulence or pressure loss.
- Rated **200 PSI W.O.G.** (working pressure non-shock)
- Imported.
- Manufactured for American Granby in an ISO 9001 factory.

DIMENSIONS (IN.)	SIZE	A (IPS)	A (CxC)	B (IPS)	B (CxC)
	1/2"	2.05	2.05	1.47	1.49
	3/4"	2.32	2.32	1.58	1.58
	1"	2.56	2.56	1.68	1.68
	1 1/4"	3.12	3.12	1.84	1.84
	1 1/2"	3.45	3.45	2.15	2.15
	2"	4.16	4.16	2.69	2.69
	2 1/2"	5.11		2.93	
	3"	5.74		3.78	
	4"	6.79		3.90	

Threaded Part Number	Sweat Part Number	Size	Ctn/Case Qty	List Price
HSCV50T		1/2"	10/120	\$ 17.66
	HSCV50S	1/2"	10/120	18.26
HSCV75T		3/4"	10/80	21.73
	HSCV75S	3/4"	10/80	22.31
HSCV100T		1"	5/60	28.21
	HSCV100S	1"	5/60	28.75
HSCV125T		1-1/4"	5/40	44.03
	HSCV125S	1-1/4"	5/40	46.33
HSCV150T		1-1/2"	5/30	50.89
	HSCV150S	1-1/2"	5/30	53.26
HSCV200T		2"	2/24	86.26
	HSCV200S	2"	2/24	89.64
HSCV250T		2-1/2"	1/15	162.41
HSCV300T		3"	1/10	228.95
HSCV400T		4"	1/6	364.73



Plumbing Valves - Low Pressure

BOILER DRAINS • HOSE BIBBS

- 125 PSI WOG (working pressure - non-shock), 200 PSI WOG (1/4 turn ball valves hose bibbs)
- All valves shown below are CSA rated except THBB/IHBB Series
- Imported



HBD Series



HBD-SB Series



IBD-SB Series
IBD-SBNL Series



HNKD Series



HHB Series



HHBNHT Series



THBB Series
IHBB Series



IHBBSS Series



IHBBNHT Series



IHBBSSNHT Series

Part Number	Size	Description	Ctn/Case Qty	List Price
Brass Boiler Drains				
HBD50 ☺	1/2"	mip x ght	12/144	\$ 8.66
HBD75	3/4"	mip x ght	12/144	9.91
HBD50SB ☺	1/2"	w/ stuffing box mip x ght	12/144	9.89
HBD75SB	3/4"	w/ stuffing box mip x ght	12/144	11.01
Brass Full Flow Boiler Drains				
IBD50SB ☺	1/2"	w/ stuffing box mip x ght	12/144	12.16
IBD75SB	3/4"	w/ stuffing box mip x ght	12/144	12.46
NO LEAD Brass Full Flow Boiler Drains (CA AB1953 certified)				
IBD50SBNL ☺	1/2"	w/ stuffing box mip x ght	12/144	12.53
IBD75SBNL	3/4"	w/ stuffing box mip x ght	12/144	12.86
Brass No-Kink Boiler Drains				
HNKD50 ☺	1/2"	mip x ght	12/144	8.76
HNKD75	3/4"	mip x ght	12/144	9.66
Brass Hose Bibbs				
HHB50 ☺	1/2"	mip x ght	12/144	9.76
HHB75	3/4"	mip x ght	12/144	11.11
Brass Hose Bibbs - No Garden Hose Thread, Sampling Valve				
HHB50NHT ☺	1/2"	mip x spout	12/144	9.45
HHB75NHT	3/4"	mip x spout	12/144	10.57
1/4 turn Ball Valve Brass Hose Bibbs w/ T Handle - 200 psi WOG non-shock				
IHBB50 ☺	1/2"	mip x ght (blue handle)	12/144	10.13
IHBB75	3/4"	mip x ght (blue handle)	12/144	11.86
THBB50	1/2"	mip x ght ITALY (red handle)	10/100	16.60
THBB75	3/4"	mip x ght ITALY (red handle)	10/100	19.84
1/4 turn Ball Valve 304 Stainless Steel Hose Bibbs w/ T Handle - 200 psi WOG non-shock				
IHBB50SS	1/2"	mip x ght	12/144	22.32
IHBB75SS	3/4"	mip x ght	12/144	22.79
1/4 turn Ball Valve Brass Hose Bibbs w/ T Handle - 200 psi WOG non-shock No garden hose thread - Sampling valve				
IHBB50NHT ☺	1/2"	mip x spout (blue handle)	12/144	10.59
IHBB75NHT	3/4"	mip x spout (blue handle)	12/144	11.47
1/4 turn Ball Valve 304 Stainless Steel Hose Bibbs w/ T Handle - 200 psi WOG non-shock - No garden hose thread - Sampling valve				
IHBB50SSNHT	1/2"	mip x spout	12/144	22.32
IHBB75SSNHT	3/4"	mip x spout	12/144	25.75

☺ Has combination 1/2" mip and 1/2" solder connection



www.americangranby.com
 In the United States: Phone (800) 776-2266 Fax (800) 729-3299
 In Canada: Phone (866) 503-5523 Fax (888) 562-2095

6/14/11

Plumbing Valves - Brass, Low Pressure



BENT NOSE GARDEN • ANGLE SILL COCKS • FROST PROOF SILL COCKS

- 125 PSI WOG (working pressure - non-shock)
- Imported



HBNG Series



HSC Series

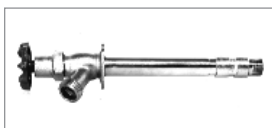

H500 Series



H500AS Series



HVB75

Part Number	Size	Description	Ctn/Case Qty	List Price
Full Flow Bent Nose Garden Valves				
HBNG50	1/2"	fip x ght	12/72	\$ 14.93
HBNG75	3/4"	fip x ght	12/72	14.93
HBNG100	1"	fip x ght	12/72	17.64
Brass Angle Sill Cocks				
HSC50T	1/2"	fip x ght	12/144	10.23
HSC75T	3/4"	fip x ght	12/144	11.86
HSC50C	1/2"	swt x ght	12/144	9.71
HSC75C	3/4"	swt x ght	12/144	10.56
Chrome Plated Brass Frost Proof Sill Cocks, IPS x Sweat Fitting				
H504	1/2 x 4"		2/40	31.04
H506	1/2 x 6"		2/40	32.68
H508	1/2 x 8"		2/40	33.45
H510	1/2 x 10"		2/40	34.98
H512	1/2 x 12"		2/40	35.98
H514	1/2 x 14"		2/40	36.98
Chrome Plated Brass Frost Proof Sill Cocks w/ 3/4" mpt x 1/2" fip connection				
H504-3/4	3/4 x 1/2 x 4"		2/40	31.75
H506-3/4	3/4 x 1/2 x 6"		2/40	33.12
H508-3/4	3/4 x 1/2 x 8"		2/40	34.48
H510-3/4	3/4 x 1/2 x 10"		2/40	35.84
H512-3/4	3/4 x 1/2 x 12"		2/40	36.72
H514-3/4	3/4 x 1/2 x 14"		2/40	38.56
Chrome Plated Brass Anti-Siphon Sill Cocks* w/ 1/2" mip x 1/2" swt connection				
H504AS	1/2 x 4"		2/30	38.32
H506AS	1/2 x 6"		2/30	39.95
H508AS	1/2 x 8"		2/30	41.38
H510AS	1/2 x 10"		2/30	42.77
H512AS	1/2 x 12"		2/30	44.15
H514AS	1/2 x 14"		2/30	45.72
* with integral vacuum breaker				
Vacuum Breaker				
HVB75	3/4"	Meets ASSE 1011 specifications	20/200	\$ 7.54



Butterfly Valves - Cast Iron



HBFV Series
ISO 9002



HBFV GEAR Series



Cast Iron Butterfly Valve Features:

- Designed for swimming pool, irrigation and water systems.
- Wafer body features 4 alignment holes.
- Lever lock handle (spring loaded) provides excellent manual control for balancing or shut off services.
- Notched throttling plate allows balancing in 10° increments in any position desired within 90° arc rotation of the disc.
- Positive bubble-tight shutoff with minimum torque.
- Seat face eliminates need for flange gaskets.
- Phenolic backed seats prevent collapse, are stretch resistant, blowout proof and field replaceable.
- **EPDM seats** temperature rated at -30° F to 275° F.
- 416 stainless steel shaft
- Bidirectional dead-end capability for 250 psi (2" - 12").
- Compatible with ANSI 125/150 flanges.
- Valves meet AWWA C-504-87 section 5 proof of design tests.
- Designed to comply with MSS SP-67 and API 609.
- **Ductile iron, ENP plated disc.**
- Manufactured for AGI in an ISO 9002 facility.
- Imported

Part No.	Size	Weight(lbs)	Ctn Qty	List Price
Ductile Iron ENP Plated Disc*				
HBFV2	2"	7	1	\$ 107.09
HBFV2 1/2	2-1/2"	8	1	126.65
HBFV3	3"	10	1	162.95
HBFV4	4"	12	1	209.38
HBFV5	5"	15.5	1	229.78
HBFV6	6"	17.5	1	273.75
HBFV8	8"	33	1	461.73
HBFV10	10"	50	1	577.31
HBFV12	12"	74	1	917.27
Ductile Iron ENP Plated Disc - GEAR DRIVE *				
HBFV6-GEAR	6"	28.5	1	351.89
HBFV8 GEAR	8"	54	1	573.50
Replacement Handles for HBFV Series				
BFH2	2"		1	17.46
BFH3	3"		1	17.46
BFH4	4"		1	17.46
BFH5	5"		1	20.87
BFH6	6"		1	20.87
BFH8	8"		1	42.94
BFH10	10"		1	42.94
BFH12	12"		1	48.88

Flanges & Bolt kits available,
see page 3.26

Butterfly Valves - Cast Iron

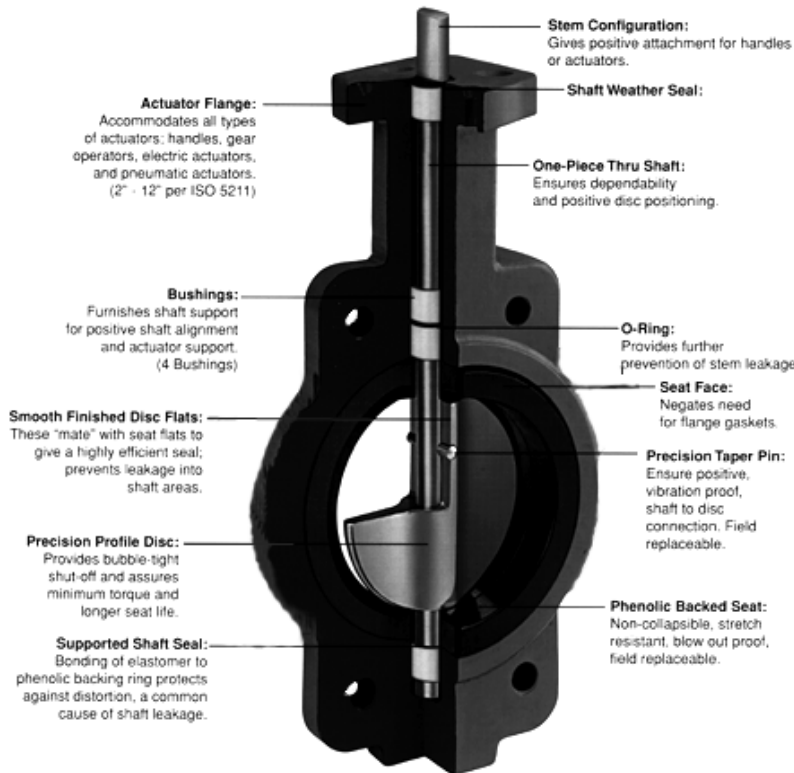

MATERIAL SPECIFICATIONS		
No.	Part	Material
1	Body	Cast Iron
2	Disc	Ductile Iron
3	Seat	EPDM
4	Shaft	416 Stainless Steel
5	Taper Pin	316 Stainless Steel
6	Key	Carbon Steel
7	O-ring	EPDM
8-10	Bushing	PTFE

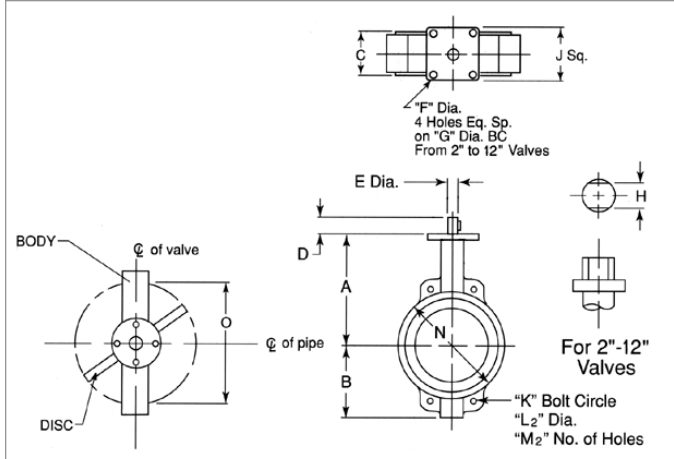
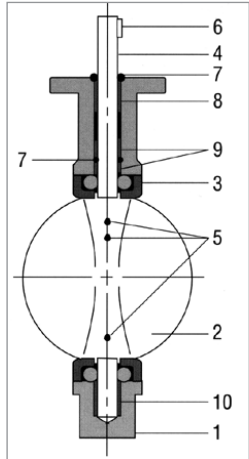

SIZE \ DIMENSION (in) for HBFV Series

	A	B	C	D	E	F	G	H	J	K	L ₂	M ₂	N	O
2"	6 3/8	3 1/4	1 3/4	1 1/4	1/2	3/8	2.76	.39	2 3/4	4 3/4	11/16	4	4	1.26
2 1/2"	6 7/8	3 3/4	1 7/8	1 1/4	1/2	3/8	2.76	.39	2 3/4	5 1/2	11/16	4	4 3/4	1.83
3"	7 1/8	4	1 7/8	1 1/4	1/2	3/8	2.76	.39	2 3/4	6	11/16	4	5 1/8	2.54
4"	7 7/8	4 7/8	2 1/8	1 1/4	5/8	3/8	2.76	.47	2 3/4	7 1/2	11/16	4	6 3/4	3.54
5"	8 3/8	5 3/8	2 1/4	1 3/4	3/4	3/8	2.76	.55	2 3/4	8 1/2	13/16	4	7 3/4	4.36
6"	8 7/8	5 7/8	2 1/4	1 1/4	3/4	3/8	2.76	.55	2 3/4	9 1/2	13/16	4	8 5/8	5.72
8"	10 1/4	7 1/8	2 1/2	1 3/4	7/8	7/16	4.02	.67	3 3/4	11 3/4	13/16	4	10 9/16	7.6
10"	11 1/2	8 1/4	2 3/4	1 3/4	1 1/8	7/16	4.02	.87	3 3/4	14.14	15/16	4	13 1/16	9.5
12"	13 1/4	9 3/4	3 1/8	1 3/4	1 1/4	7/16	4.02	.95	3 3/4	17	15/16	4	16 1/8	11.45





Ultraviolet Disinfection Systems

Ultraviolet disinfection is an effective way to provide bacteria free water for home or industry.



UVSL Series

- Completely automatic.
- Compact and easy to install.
- No chemicals required.
- Low operating costs.
- Low maintenance.
- No taste or odor.



SAFE LITE Economy Series UV Disinfection System

Features:

- Quick installation.
- Economical.
- 304 stainless steel chamber. Electropolished.
- Powered by wall mounted ballast with lamp on indicator.
- 8 gallon complete with flow control.



UV, UV-SE & UV-W Series

Standard Series UV Disinfection System Features:

UV Series:

- Constructed for wall mounting.
- 304 stainless steel chamber. Electropolished.
- Sight port to safely view operation.
- 7 & 15 gallon complete with flow control.
- CSA approved.

UV-W Series:

- Same as UV series with:
- Internal wiper unit for manual cleaning of quartz sleeve.
- 8 & 15 gallon complete with flow control.

UV-SE Series:

- Same as UV series with:
- 7 & 15 gallon complete with flow control. Remote flow control adder for 24 gallon (not included)
- Electronic built-in "lamp-out" circuit/alarm.
- ON/OFF indicator light.
- Standard auxillary output terminal for optional solenoid shut-off (UVS077 not included).
- CSA pending

Ultraviolet Disinfection Systems



Water entering the disinfection unit flows in the space between the quartz sleeve and the chamber wall. Turbulent flow through the unit insures exposure of micro-organisms to lethal dosages of ultraviolet rays. Water exiting the chamber is safe and ready to use.

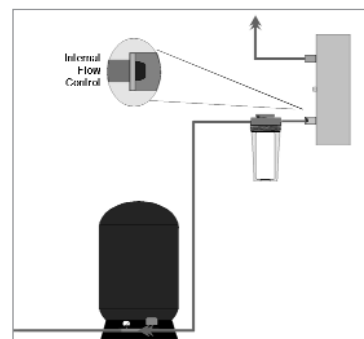
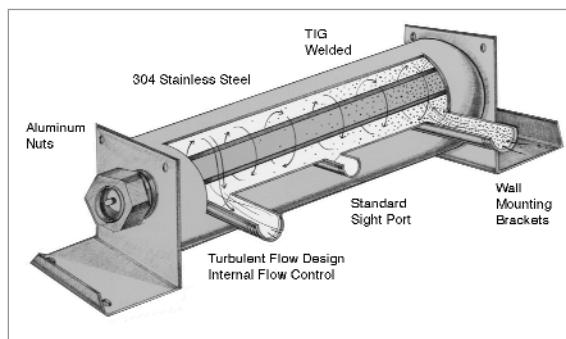

Typical Installation



Part Number	Max GPM	# of Lamps	KW @ 120V	AMPS @ 120V	AMPS @ 220V	Pipe Size	Dimensions LxWxD	Weight	Flow Control	Lamp Out Alarm	List Price
Safe Lite Economy Series											
UVSL8	8	1	0.07	.60	.30	3/4" MIP	18"x4"x7"	28	Yes	No	\$ 858.70
Standard Series											
UV7	7	1	0.07	.60	.30	3/4" MIP	18"x4"x7"	19	Yes	No	1270.91
UV15	15	1	0.07	.60	.30	3/4" MIP	36"x4"x7"	28	Yes	No	1600.46
Standard Series w/ Lamp out alarm											
UV7SE	7	1	0.07	.60	.30	3/4" MIP	18"x4"x7"	19	Yes	Yes	1289.28
UV15SE	15	1	0.07	.60	.30	3/4" MIP	36"x4"x7"	28	Yes	Yes	1621.50
Lamp out circuit board provides a visual and audible alarm when a lamp outage occurs. Solenoid protection can be added via the on-board relay and the purchase of an UVS077 Solenoid. 220V 50Hz less power cord net adder \$ 35.72. Not available on SE series. Non standard porting net adder \$ 75.00											
Standard Series w/ Internal wiper*											
UV8W	8	1	0.07	.60	.30	3/4" MIP	18"x4"x7"	25	Yes	No	1681.10

* Check with AGI for delivery lead time on UV-W series



Ultraviolet Disinfection Parts



UVM254



UVS077

Part Number	Description	For Use With Series	List Price
Accessories			
UVM254	UV Dosage meter w/ alarm	UV, UV-W	\$ 1169.19
UVS079	Shut-Off Solenoid 1" FNPT, use w/ UVM254, or UVM257 Specify when ordering	UV, UV-W, UV-SE, UVC	232.97
Maintenance & Repair Parts			
UVP4025	Brass end nut assembly - complete (new)	All models	68.89
UVP5175	Monitor lens kit		62.77
UVP8544	O-ring - Standard for end nut		3.21
UVP8222	Ballast - (120V, 60 Hz)	7-8 gpm units	81.58
UVP8224	Ballast - (120V, 60Hz)	12-45 gpm units	88.68
UVP8225	Ballast - (120V, 60Hz)	24-120 gpm units	121.93
Service Kits - Include bulb, quartz sleeve, o-rings and small tube of silicone.			
Recommended 1 per year.			
UVK07	Includes (1) UVB1805 bulb, (1) UVQS6211 sleeve, (2) UVP8544 o-rings	UV7, UV7SE	146.49
UVK015	Includes (1) UVB8246 bulb, (1) UVQS6608 sleeve, (2) UVP8544 o-rings	All 15 models	195.48
UVK024	Includes (2) UVB8246 bulb, (2) UVQS6608 sleeve, (4) UVP8544 o-rings	All 24 models	396.89

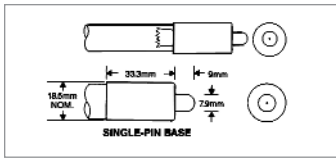

UVB Series - 1 pin each end

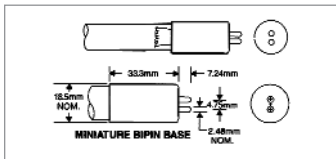

UVB Series - 2 pins each end

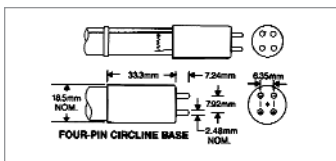

UVB Series - 4 pins one end

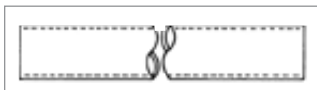

UVQS Series

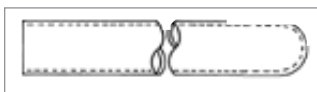

UVQS-D Series

Part Number	Bulb Length	Description	For Use With Series	List Price
UV Bulbs				
UVB1805	14"	1 pin each end	UV7, UV7SE	\$ 112.79
UVB1814	27.3"	1 pin each end		130.82
UVB8246	33.2"	1 pin each end	All 15 UVC80 24 28 60 120	130.82
UVB11149	45.88"	1 pin each end		130.82
UVB11550	61.2"	1 pin each end	UVC130 bulb	191.03
UVB2436	17"	2 pins each end		130.82
UVB2457	18"	2 pins each end	DWSW-8	130.82
UVB2793	31.34"	2 pins each end		130.82
UVB4287	11.3"	4 pins one end		130.82
UVB4330	13"	4 pins one end		130.82
UVB4357	14.5"	4 pins one end		130.82
UVB4409	16"	4 pins one end		130.82
UVB4436	17"	4 pins one end		130.82
UVB4450	17.71"	4 pins one end	DWS-8V, SE8V, SL5, SL8, SL8V	130.82
UVB4739	29"	4 pins one end	DWS-12V, SE12V	130.82
UVB4793	31.34"	4 pins one end		130.82
UVB4810	32"	4 pins one end		130.82
UVB4854	33.2"	4 pins one end		130.82
Bulb length is from end to end excluding pin connection.				
Quartz Sleeves - Open Ends (22 mm ID, 24.5mm OD)				
UVQS6211	14.37"	Quartz Sleeve	UV7, UV7SE	39.67
UVQS1483	19"	Quartz Sleeve	DWSW-8	49.90
UVQS6608	32.62"	Quartz Sleeve	All 12 15 24 48 60 80 120	83.42
UVQS1575	62"	Quartz Sleeve	UVC130	168.40
Quartz Sleeves - Domed Ends (22 mm ID, 24.5mm OD)				
UVQS1435D	17"	Dome End Quartz Sleeve		84.67
UVQS476D	19"	Dome End Quartz Sleeve	SL5, SL8, DWS-8V	83.42
UVQS335D	34"	Dome End Quartz Sleeve		83.42



Compression Couplings-Imported, PVC/CPVC



MATERIAL SPECIFICATIONS

#	Part	Material
1	Body	UPVC, CPVC
2	Compression Nut	UPVC, CPVC
3	Gasket - PVC	NR
	Gasket - CPVC	EPDM

PVC Compressing Coupling Features:

- Iron Pipe Size (PVC), Copper Tube Size (CPVC)
- For use with cold water (PVC) or hot water (CPVC-CTS)
- Natural rubber gasket seals
- Rated at 200 psi at 70 °F
- Imported

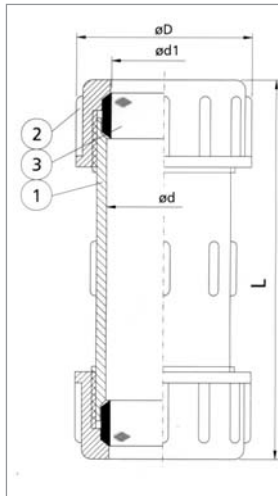

"PC" Series IPS DIMENSIONS (IN.)

SIZE	D	d	d1	L
1/2"	1.85	.91	.83	5.24
3/4"	2.09	1.18	1.04	5.32
1"	2.40	1.42	1.31	5.75
1 1/4"	2.87	1.81	1.65	6.30
1 1/2"	3.15	2.05	1.89	6.89
2"	3.62	2.56	2.37	7.87
2 1/2"	4.53	2.52	2.87	9.92
3"	5.28	3.62	3.49	10.87
4"	6.34	4.65	4.49	11.93
6"	8.78	6.85	6.62	11.22

"HW" Series CTS DIMENSIONS (IN.)

1/2"	1.30	.71	.63	4.49
3/4"	1.85	.95	.88	5.00

Part Number	Material	Size	Case Qty	List Price
PC10-1/2	PVC	1/2" IPS	100	\$ 2.33
PC10-3/4	PVC	3/4" IPS	90	2.70
PC10-1	PVC	1" IPS	60	3.49
PC10-11/4	PVC	1 1/4" IPS	40	4.20
PC10-11/2	PVC	1 1/2" IPS	30	5.79
PC10-2	PVC	2" IPS	20	8.06
PC10-21/2	PVC	2 1/2" IPS	10	18.42
PC10-3	PVC	3" IPS	4	26.06
PC10-4	PVC	4" IPS	2	34.39
PC10-6	PVC	6" IPS	2	82.73
HW10CTS1/2	CPVC	1/2" CTS	20/360	4.07
HW10CTS3/4	CPVC	3/4" CTS	20/240	4.93



SW Series

Part Number	For Use with Coupling Sizes	Ctn Qty	List Price
Adjustable Strap Wrench			
SW400	1/2" through 4"	10/60	\$ 17.68
SW600	1/2" through 6"	10/60	20.18



Compression Fittings, Galvanized



Galvanized Long Pattern Compressing Fitting Features:

- Bodies made of steel tubing. (GC 10), malleable iron (GC10C)
- End nuts made of malleable iron.
- Galvanized finish
- Buna-N gaskets on domestic fittings.
- SBR gaskets on GC10C series.
- Maximum rated service temperature for gaskets: 212 °F (100° C).

WARNING: Designer and/or contractor must provide suitable anchoring of piping to prevent pull-out from fittings when applications subject piping to external forces such as ground shift and temperature variations that cause linear pipe contraction.

Recommended Maximum Pressure (PSI)		
Size	Torque Ft. Lbs	Anchored Piping
1/2"	150	150
3/4"	150	150
1"	225	100
1-1/4"	225	100
1-1/2"	225	100
2"	300	75



GC10C Series

ISO 9002



Coupling GC10C - Long Pattern - Imported - Malleable Iron, 125 PSI, 120° F

Part Number	Size	Pipe O.D.	Ctn/Case Qty	List Price
GC10C1/2	1/2"	.840	30 / 60	\$ 10.20
GC10C3/4	3/4"	1.050	25 / 50	11.44
GC10C1	1"	1.315	15 / 30	13.42
GC10C11/4	1-1/4"	1.660	12 / 24	17.04
GC10C11/2	1-1/2"	1.900	9 / 18	20.19
GC10C2	2"	2.375	14	30.19



GC10 Series

Coupling GC10 - Made in U.S.A. - Steel Tube

Part Number	Size	Pipe O.D.	Ctn Qty	List Price
GC10-1/2	1/2"	.840	12	\$ 25.66
GC10-3/4	3/4"	1.050	12	27.98
GC10-1	1"	1.315	12	33.04
GC10-11/4	1-1/4"	1.660	6	44.12
GC10-11/2	1-1/2"	1.900	6	48.73
GC10-2	2"	2.375	6	61.24



GC12 Series

Adapters GC12 - Made in U.S.A. - Steel Tube

Part Number	Size	Pipe O.D.	Ctn Qty	List Price
GC12-1/2	1/2"	.840	12	\$ 37.50
GC12-3/4	3/4"	1.050	12	36.18
GC12-1	1"	1.315	12	38.31
GC12-11/4	1-1/4"	1.660	6	45.54
GC12-11/2	1-1/2"	1.900	6	63.32
GC12-2	2"	2.375	6	63.44



Pipe Repair Clamps

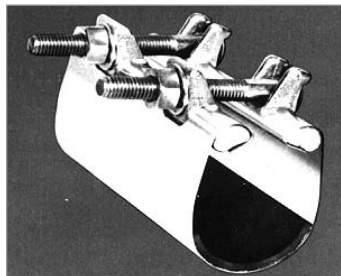

Repair Clamp Features:

- Pipe repair clamps eliminate the need for costly pipe replacement for simple leaks.
- Non-corrosive clamp band is made of annealed stainless steel.
- Nuts and bolts are cadmium plated with a chromate finish; heavy duty hex nut with washer.
- Lugs are made of annealed, malleable iron for maximum strength and permanence; iron phosphate finish.
- Neoprene gasket with maximum rated service temperature of 212° F (100°C).
- Imported

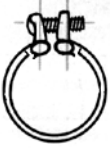

Straight through bolt pull on lugs gives more uniform pressure on the band, more pressure on pipe with less torque on nut.

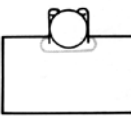

Oval lug opening in band won't tear - no corners to rip out as with square hole.

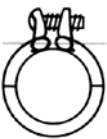

Lugs above pipe level don't pull into pipe. Gives more tension on band - more sealing power yet won't crush pipe.



Band covers lead edge of lug. Equal pressure across entire band. No friction - no cutting into pipe surface by raw edge of band opening.

Part Number	Nominal Pipe Size	IPS Pipe O.D.	CTS Tube O.D.	Ctn Qty	List Price
3" Wide, 1 Bolt					
HRC3-3/8	3/8"	.675	.625	6/72	\$ 5.94
HRC3-1/2	1/2"	.840	.875	6/72	6.98
HRC3-3/4	3/4"	1.050	1.125	6/72	7.13
HRC3-1	1"	1.315	1.375	6/72	7.97
HRC3-1 1/4	1 1/4"	1.660	1.625	6/72	8.79
HRC3-1 1/2	1 1/2"	1.900		6/72	8.90
HRC3-2	2"	2.375		6/72	10.67
HRC3-2 1/2	2 1/2"	2.875		6/48	11.37
HRC3-3	3"	3.50		6/48	12.05
HRC3-4	4"	4.50		6/24	12.35
6" Wide, 2 Bolts					
HRC6-1/2	1/2"	.840	.875	6/56	12.54
HRC6-3/4	3/4"	1.050	1.125	6/56	13.44
HRC6-1	1"	1.315	1.375	6/56	13.60
HRC6-1 1/4	1 1/4"	1.660	1.625	6/56	15.06
HRC6-1 1/2	1 1/2"	1.900		6/56	16.49
HRC6-2	2"	2.375		6/56	19.77
HRC6-2 1/2	2 1/2"	2.875		6/24	21.28
HRC6-3	3"	3.50		6/24	22.44
HRC6-4	4"	4.50		6/24	22.92

Couplings, Caps - Flexible & No-Hub



Coupling, Cap Features:

- Flexible couplings for joining all types of sewer pipe, including transitions from one type to another.
- NO-HUB couplings for joining cast iron pipe sections
- End Caps for capping cast iron, steel, PVC and ABS pipe.
- 300 Series stainless steel clamps
- Meets IAPMO File #0317, BOCA ESI RR#90-68, SBCCI PST&ESI Report #9483B
- CSA Approved



C Series



MR Series



MRTC Series



07 Series

Part Number	Size	Connection	Ctn Qty	List Price
NO HUB COUPLINGS				
C150C	1 1/2 X 1 1/2	CI X CI	100	\$ 9.37
C200C	2 X 2	CI X CI	100	9.37
C215C	2 X 1 1/2	CI X CI	100	10.92
C300C	3 X 3	CI X CI	100	10.92
C400C	4 X 4	CI X CI	100	13.22
FLEXIBLE COUPLINGS				
MR0244	4 X 4	CLAY X CI/PL	18	14.44
MR5615/125	1 1/4 x 1 1/2	CI/PL x TUBE	24	7.60
MR56125	1 1/2" Tubing, Copper or 1 1/4" PL to Same		24	6.89
MR5615	1 1/2 x 1 1/2	CI/PL X CI/PL	24	7.31
MR5622/125	2 x 1 1/4	CI/PL x CI/PL	24	7.66
MR56215	2 X 1 1/2	CI/PL X CI/PL	24	8.33
MR5622	2 X 2	CI/PL X CI/PL	24	7.88
MR56315	3 x 1 1/2	CI/PL x CI/PL	24	13.93
MR5632	3 X 2	CI/PL X CI/PL	24	9.84
MR5633	3 X 3	CI/PL X CI/PL	18	10.64
MR5642	4 x 2	CI/PL x CI/PL	18	17.19
MR5643	4 X 3	CI/PL X CI/PL	18	14.35
MR5644	4 X 4	CI/PL X CI/PL	24	13.33
MR5655	5 X 5	CI/PL X CI/PL	14	20.88
MR5664	6 x 4	CI/PL x CI/PL	10	31.02
MR5666	6 X 6	CI/PL X CI/PL	12	28.51
DRAIN PIPING TO TUBULAR TRAP *				
MRTC150	1 1/4" x 1 1/2"		24	4.19
MRDTC150	1 1/4" or 1 1/2" x 1 1/4" or 1 1/2"		24	5.13
MRDTC215	2" x 1 1/4" or 1 1/2"		24	6.77
* Any combination of 1 1/4" or 1 1/2" tubular drain (plastic, tubular or copper)				
END CAPS				
0701-011	1 1/2"		24	4.08
0702-019	2"		24	4.80
0703-017	3"		24	6.07
0704-015	4"		24	7.76
0705-020	5"		20	15.51
0706-028	6"		12	15.97



Clear Braided PVC Hose



Clear Braided PVC Hose Standard Wall, Class 125 Features:

- Flexible, see through clear hose with braid pattern reinforcement of two polyester spirals.
- Flexible clear PVC NSF 51 certified to 100°F (38°C), USP CLASS V1 rated.
- All hose compound ingredients used are listed in US FDA CFR, Title 21.
- Temperature range + 25° to 150° F / -5° to +65°C.
- Silicone free.
- Food and beverage grade, standard wall.
- Use for air, water lines.



Part Number	Nominal (inches)		Max Working Pressure		Reel Length	Approx Wt per CFT.	List Price Per Reel
	ID	OD	PSI@68°F	PSI@122°F			
CBH316-1	3/16	0.375	250	105	100'	4.5 lbs	\$ 117.06
CBH25-1	1/4	0.438	250	105	100'	5.7 lbs	102.32
CBH516-1	5/16	0.525	250	105	100'	7.5 lbs	150.56
CBH38-1	3/8	0.594	225	97	100'	9.0 lbs	145.37
CBH50-1	1/2	0.750	200	86	100'	13.8 lbs	195.91
CBH50-3	1/2	0.750	200	86	300'	13.8 lbs	587.73
CBH58-1	5/8	0.875	200	86	100'	16.5 lbs	231.09
CBH75-1	3/4	1.030	150	65	100'	21.9 lbs	293.71
CBH75-3	3/4	1.030	150	65	300'	21.9 lbs	881.15
CBH100-1	1	1.300	125	54	100'	31.5 lbs	378.42
CBH100-2	1	1.300	125	54	200'	31.5 lbs	707.34
CBH125-50	1 1/4	1.625	100	43	50'	45.0 lbs	359.08
CBH125-1	1 1/4	1.625	100	43	100'	45.0 lbs	718.17
CBH150-50	1 1/2	1.937	100	43	50'	64.0 lbs	432.96
CBH150-1	1 1/2	1.937	100	43	100'	64.0 lbs	865.91
CBH200-50	2	2.490	75	33	50'	95.0 lbs	739.93
CBH200-1	2	2.490	75	33	100'	95.0 lbs	1479.89

** Temperatures higher than 68° F reduce available working pressure. See next page for temperature, working pressure calculation chart and cautionary note.

Clear Braided PVC Hose



Effects of Elevated Temperatures on Thermoplastic Hose.

The compounds used in clear braided PVC hose are generally referred to as thermoplastics. These materials achieve their optimum physical properties at room temperature, 68°F (20°C). As these materials are exposed to increased ambient temperatures, they will soften and their physical properties will change. This will have the effect of sharply reducing the available working pressure. Coupling retention will also be reduced. The charts below illustrate this effect. In all cases, the product should be tested in a controlled, secure and safe environment, and all operating conditions should be considered prior to use.

All published working pressures of AGI Series CBH hose are based on a room temperature of 68°F (20°C).

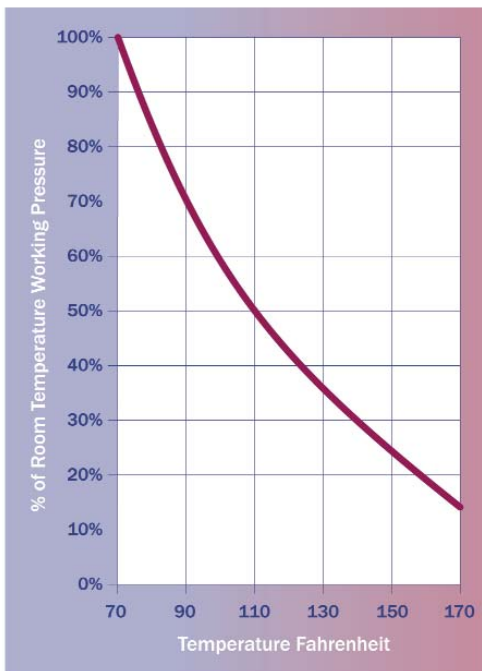

Example from the Fahrenheit Chart

If working pressure at 68°F is 200 psi, then the WP at 110°F is 200 x 50%, or 100 psi

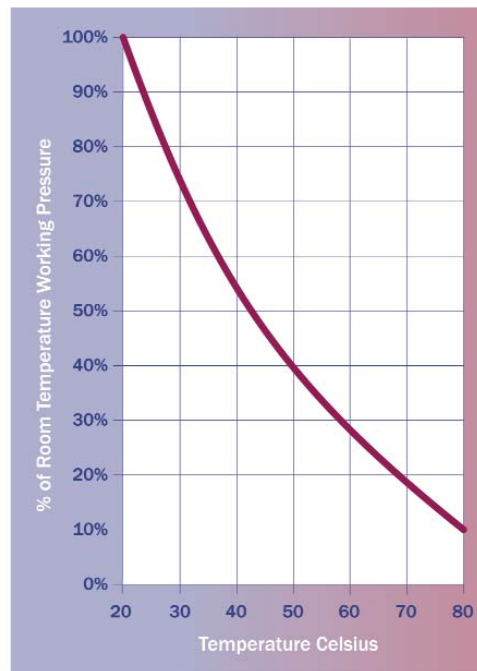

Example from the Celsius Chart

If working pressure at 20° is 14 bar, then the WP at 50°C is 14 x 50%, or 5.6 bar

CAUTIONARY NOTE

The charts are to be used as a guideline only. The information and recommendations contained here are, to the best of our manufacturer's knowledge, accurate and reliable, but no guarantee of their accuracy is made. All products are sold upon the condition that purchasers shall make their own tests to determine the suitability of such products for their particular purposes and uses, and purchasers assume all risks and liability for the results of use of the products, including use in accordance with seller's recommendations. Variability in length of exposure, temperature, pressure, velocity of fluid, and chemical concentration all contribute to reduced working pressure and hose reliability.



Washer & Ice Maker Boxes

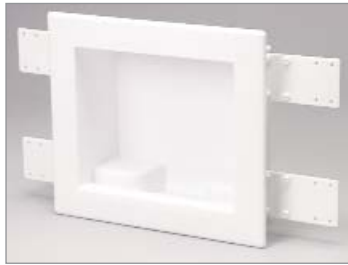

Washer Box

Washer Box Features:

- Center drain or dual drain.
- High impact polystyrene.
- 4 support brackets.
- Easy drain knockout.
- Top mount knockouts
- Box dimensions: 8 3/4" w x 7 1/2" h x 3 5/8" d
- Faceplate dimensions: 11 3/4" w x 10 1/8" h



Ice Maker Box

Ice Maker Box Features:

- 2 support brackets.
- High impact polystyrene.
- Valves comply with requirements of NSF 61, Section 9.
- Available in several box and valve configurations.
- Provides quick, safe water supply and shutoff for refrigerator ice maker and water dispenser.
- Box dimensions: 6" w x 6" h x 3 3/8"D.
- Faceplate dimensions: 8 1/4" w x 8 1/4" H

Part Number	Valve Connection	Valve Type	Drain	Ctn Qty	List Price
Standard Washer Boxes					
38934	1/2" Sweat	1/4 turn brass ball valves	Center	12	\$ 61.12
38937	1/2" CPVC	1/4 turn brass ball valves	Center	12	63.31
38945	1/2" PEX	1/4 turn brass ball valves	Center	12	71.27
Dual Drain Washer Boxes					
38673	1/2" Sweat	1/4 turn brass ball valves	Dual	12	74.76
38670	1/2" CPVC	1/4 turn brass ball valves	Dual	12	74.76
38660	1/2" Sweat	Single Lever ball valves	Dual	12	117.68
Ice Maker Boxes					
38681	1/2" Sweat	1/4 turn brass ball valve		6	46.07
38680	1/2" CPVC	1/4 turn brass ball valve		6	46.05
38684	1/2" PEX	1/4 turn brass ball valve		6	46.53
38805	Box Only	None		6	14.64

Closet Flanges & Gaskets



43503

Level Fit Closet Flange Features:

- 3" or 4" all plastic flange solvent welds inside of 4" or over 3" Sch 40 DWV pipe.
- Four mounting slots.
- Four countersunk holes for secure attachment to the floor.



43513

Level Fit Closet Flange with metal ring Features:

- The metal ring provides added strength and cracking resistance to the flange and can be rotated to allow precise alignment of bolts and screws.
- 3" or 4" flange solvent welds inside of 4" or over 3" Sch 40 DWV pipe.



43500

Level Fit Offset Closet Flange with metal ring Features:

- The metal ring provides added strength and cracking resistance to the flange and can be rotated to allow precise alignment of bolts and screws.
- 3" or 4" flange solvent welds inside of 4" or over 3" Sch 40 DWV pipe.
- 2" offset allows a margin of error for drain pipe/flange alignment.

Part Number	Material	Description	Size	Ctn Qty	List Price
Closet Flanges					
43505	PVC	Plastic ring closet flange w/ KO	3" x 4"	12	\$ 7.23
43503	PVC	Plastic ring closet flange	3" x 4"	12	6.38
43502	ABS	Plastic ring closet flange	3" x 4"	12	6.82
Closet Flanges with Metal Adjustable Ring					
43513	PVC	Metal ring closet flange	3" x 4"	12	10.56
43512	ABS	Metal ring closet flange	3" x 4"	12	12.84
Offset Closet Flanges					
43501	PVC	Offset closet flange	3" x 4"	12	19.18
43500	ABS	Offset closet flange	3" x 4"	12	27.36



Adjustable Urinal Flange Kit Features:

- Horizontal mounting slots accommodate urinals with 3 1/2" to 7" mount centers.
- Kit includes all bolts, nuts, washers and gaskets.
- Flanges solvent weld into any 2" fitting. They do not weld "over".

Part Number	Material	Description	Size	Ctn Qty	List Price
43543	PVC	Urinal flange kit	2"	10	\$ 38.13



Wax Closet Gasket Features:

- Amber-color.
- Meets Federal specifications HH-C-536A.

Part Number	Description & Material	Size	Ctn Qty	List Price
AGWAX	Standard wax gasket	3", 4"	48	\$ 2.50
AGWAXH	Wax gasket w/Horn	3", 4"	24	3.16
AGWAXJ	Jumbo wax gasket 1 1/2"	3", 4"	24	6.09



Perforated Hanger Strapping



101 Series Galvanized Duct Tape

- 24 and 28 gauge
- Alternate 1/4" and 5/16" bolt and nail holes
- 3/4" width

102 Series Plastic Polypropylene Hanger Strapping

- 1/8" dia. holes
- Max working load - 15# @ 85° F
- Breaking Strength - 100# @ 68° F

100G Series Galvanized or Zinc Plated

- Perforated hanger strapping
- 20 to 28 gauge
- 1/4" bolt holes
- 3/4" width

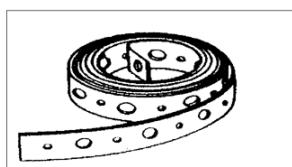

101 Series

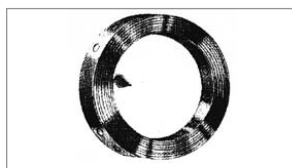

102 Series

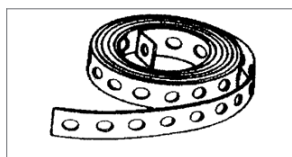

100G and 100S Series

Part Number	Size	Ctn Qty	List Price
101 Series - Galvanized Duct Tape			
101-10	3/4" x 10' x 24 gauge	50	\$ 2.57
101-50	3/4" x 50' x 24 gauge	10	14.78
101-100	3/4" x 100' x 24 gauge	5	28.60
101-10-28	3/4" x 10' x 28 gauge	50	2.28
101-50-28	3/4" x 50' x 28 gauge	10	13.56
101-100-28	3/4" x 100' x 28 gauge	5	24.64
102 Series - Plastic Polypropylene			
102-10	3/4" x 10' x .05 gauge	BULK/100	2.42
102-25	3/4" x 25' x .05 gauge	1/40	4.71
102-50	3/4" x 50' x .05 gauge	1/20	12.59
102-100	3/4" x 100' x .05 gauge	1/10	22.50
100G Series - Galvanized or Zinc Plated			
100G-10-24	3/4" x 10' x 24 gauge	50	2.56
100G-50-24	3/4" x 50' x 24 gauge	10	14.78
100G-100-24	3/4" x 100' x 24 gauge	5	28.60
100G-10-28	3/4" x 10' x 28 gauge	50	2.12
100G-10-22	3/4" x 10' x 22 gauge	50	3.21
100G-50-22	3/4" x 50' x 22 gauge	10	18.48
100G-100-22	3/4" x 100' x 22 gauge	5	34.56
100G-10-20	3/4" x 10' x 20 gauge	50	3.75
100G-50-20	3/4" x 50' x 20 gauge	10	20.19
100G-100-20	3/4" x 100' x 20 gauge	5	23.42
100S Series - Steel Plain			
100S-10-24	3/4" x 10' x 24 gauge	50	2.28



604 Series

604 Series Insulated Glide Clip Features:

- Specially compounded material wrapped around copper clad steel permits smooth, silent pipe movement.
- Prevents electrolysis and corrosion.
- Resists temperature up to 280° F(137° C). Ideal for hot water heating or supply lines -- eliminates creaking noises made by pipe expanding and contracting against wood surfaces.



606 Series

606 Series Van Hanger Features:

- Unique design for applications that require space between pipe and mounting surface.
- Copper clad steel, heavy duty metal construction.



608 Series

608 Series Copper Tube Strap Features:

- Copper clad steel; heavy duty metal construction.

Part Number	Size	Mounting Hardware (incl)	Ctn Qty	List Price
Insulated Glide Clips				
604-1/2	1/2"	Copper Clad Nails	10	\$ 3.44
604-3/4	3/4"	Copper Clad Nails	10	3.70
604-1	1"	Copper Clad Nails	10	4.64
604-11/4	1-1/4"	Copper Clad Nails	10	5.23
Copper Clad Van Hangers				
606-1/2	1/2"	Copper Clad Screw	20	2.64
606-3/4	3/4"	Copper Clad Screw	20	2.86
606-1	1"	Copper Clad Screw	20	3.12
Copper Tube Straps				
608-1/2	1/2"	Copper Clad Nails	100	0.36
608-3/4	3/4"	Copper Clad Nails	50	0.46
608-1	1"	Copper Clad Nails	50	0.57
608-11/4	1-1/4"	Copper Clad Nails	50	0.67



500 Series Copper Clad Tube Straps

- 2 ear and one ear styles

510 Series Copper Clad Tube Straps

- One ear styles

511 Series Plastic Tube Tallon

- Made of polyethylene
- 1/2, 3/4 and 1" sizes available

513 Series Single Shot Hanger

- Plastic with nail

515 Series Suspension Clamp

- Made of polyethylene

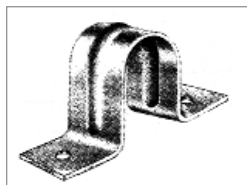

500 Series

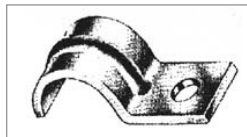

510 Series

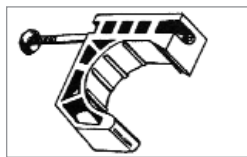

511 Series

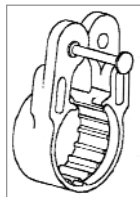

513 Series

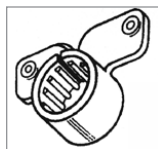

515 Series

Part Number	Size	Ctn Qty	List Price
Copper Clad Tube Straps, TWO HOLE			
500-1/2	1/2"	100	\$ 0.13
500-3/4	3/4"	100	0.16
500-1	1"	100	0.19
500-1 1/4	1 1/4"	100	0.47
Copper Clad Tube Straps, ONE HOLE			
510-1/4	1/4"	100	0.43
510-3/8	3/8"	100	0.43
510-1/2	1/2"	100	0.45
510-3/4	3/4"	100	0.49
510-1	1"	100	0.96
510-1 1/2	1 1/2"	50	2.27
510-2	2"	50	2.65
Tube Tallon Clamp			
511-1/2	1/2"	100	0.23
511-3/4	3/4"	100	0.32
511-1	1"	50	0.86
Suspension Clamp			
513-1/2	1/2"	50	0.65
513-3/4	3/4"	50	0.81
Suspension Clamp			
515-1/2	1/2"	100	0.47
515-3/4	3/4"	100	0.50
515-1	1"	50	1.45

Pipe Straps



600 Series Galvanized Pipe Straps

- 2 ear
- 1/2 - 2" sizes available

603 Series Plastic Coated Pipe Straps

- 2 ear
- 1" - 2" sizes available

610 and 620 Series Galvanized Pipe Straps

- 1 ear
- 1" - 2" sizes available

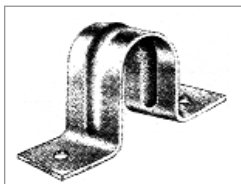

600 Series

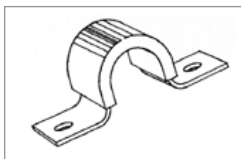

603 Series

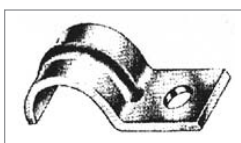

610/620 Series

Part Number	Size	Ctn Qty	List Price
Galvanized Pipe Straps			
600-1/4	1/4"	100	\$ 0.18
600-3/8	3/8"	100	0.18
600-1/2	1/2"	100	0.15
600-3/4	3/4"	100	0.21
600-1	1"	100	0.34
600-1 1/4	1 1/4"	50	0.44
600-1 1/2	1 1/2"	50	0.51
600-2	2"	50	0.79
600-2 1/2	2 1/2"	25	1.28
600-3	3"	25	1.64
600-4	4"	25	2.73
Plastic Coated Pipe Straps			
603-1	1"	50	4.02
603-1 1/4	1 1/4"	50	4.28
603-1 1/2	1 1/2"	50	4.68
603-2	2"	50	4.96
603-3	3"	25	8.57
603-4	4"	25	10.71
603-6	6"	10	28.39
One Hole Pipe Straps			
610-1/4	1/4" Pipe	100	0.25
610-3/8	3/8" Pipe	100	0.32
610-1/2	1/2" Pipe	100	0.37
610-3/4	3/4" Pipe	100	0.61
610-1	1" Pipe	100	0.70
610-1 1/4	1 1/4" Pipe	100	1.13
610-1 1/2	1 1/2" Pipe	50	1.94
610-2	2" Pipe	50	2.27
One Hole EMT Straps			
620-1/2	1/2" EMT	100	0.37
620-3/4	3/4" EMT	100	0.38
620-1	1" EMT	100	0.48
620-1 1/4	1 1/4" EMT	100	0.83
620-1 1/2	1 1/2" EMT	50	1.19
620-2	2" EMT	50	2.27



Tube & Pipe Hooks

200 S Series Bright Steel
200 C Series Copper Clad

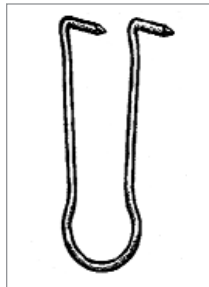

200S and 200C Series

Part Number	Size (pipe x length)	Ctn Qty	List Price
Bright Steel			
200S-1/2X4	1/2" X 4"	50	\$ 0.51
200S-1/2X6	1/2" X 6"	50	0.57
200S-1/2X8	1/2" X 8"	50	0.68
200S-1/2X10	1/2" X 10"	50	1.26
200S-1/2X12	1/2" x 12"	50	1.41
200S-3/4X4	3/4" X 4"	50	0.51
200S-3/4X6	3/4" X 6"	50	0.57
200S-3/4X12	3/4" X 12"	50	1.41
200S-1X4	1" X 4"	50	0.51
200S-1X6	1" X 6"	50	0.57
200S-1X8	1" X 8"	50	0.68
200S-1X10	1" X 10"	50	1.26
200S-1 1/4X6	1 1/4" X 6"	50	0.92
200S-1 1/4X8	1 1/4" X 8"	50	1.11
200S-1 1/4X10	1 1/4" X 10"	50	1.26
200S-1 1/4X12	1 1/4" X 12"	50	1.41
200S-1 1/2X6	1 1/2" X 6"	50	0.92
200S-1 1/2X8	1 1/2" X 8"	50	1.11
200S-1 1/2X10	1 1/2" X 10"	50	1.26
200S-1 1/2X12	1 1/2" X 12"	50	1.41
200S-2X6	2" X 6"	50	0.92
200S-2X8	2" X 8"	50	1.11
200S-2X10	2" X 10"	50	1.26
200S-2X12	2" X 12"	50	1.41
Copper Clad			
200C-1/2X4	1/2" X 4"	50	0.59
200C-1/2X6	1/2" X 6"	50	0.66
200C-1/2X8	1/2" X 8"	50	0.82
200C-1/2X10	1/2" X 10"	50	1.54
200C-1/2X12	1/2" X 12"	50	1.74
200C-3/4X4	3/4" X 4"	50	0.59
200C-3/4X6	3/4" X 6"	50	0.66
200C-3/4X8	3/4" X 8"	50	0.82
200C-3/4X10	3/4" X 10"	50	1.54
200C-3/4X12	3/4" X 12"	50	1.74
200C-1X4	1" X 4"	50	0.59
200C-1X6	1" X 6"	50	0.66
200C-1X8	1" X 8"	50	0.82
200C-1X10	1" X 10"	50	1.54
200C-1X12	1" X 12"	50	1.74

Tube & Pipe Hooks



200 C Series Copper Clad
200 P Series Plastic Coated

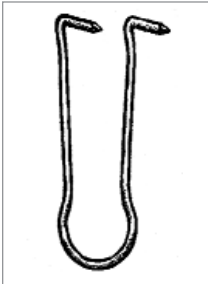

200S and 200C Series

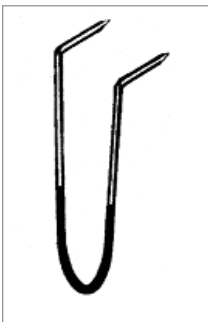

200P Series

Part Number	Size (pipe x length)	Ctn Qty	List Price
200C-11/4X6	1 1/4" X 6"	50	\$ 0.66
200C-11/4X8	1 1/4" X 8"	50	0.82
200C-11/4X10	1 1/4" X 10"	50	1.54
200C-11/4X12	1 1/4" X 12"	50	1.74
200C-11/2X6	1 1/2" X 6"	50	1.08
200C-11/2X8	1 1/2" X 8"	50	1.17
200C-11/2X10	1 1/2" X 10"	50	1.54
200C-11/2X12	1 1/2" X 12"	50	1.74
200C-2X6	2" X 6"	50	1.08
200C-2X8	2" X 8"	50	1.17
200C-2X10	2" X 10"	50	1.54
200C-2X12	2" X 12"	50	1.74
Plastic Coated			
200P-1/2X4	1/2" X 4"	50	1.77
200P-1/2X6	1/2" X 6"	50	1.88
200P-1/2X8	1/2" X 8"	50	2.72
200P-1/2X10	1/2" X 10"	50	4.87
200P-1/2x12	1/2" x 12"	50	6.27
200P-3/4X4	1/2" Pipe* x 4"	50	1.77
200P-3/4X6	1/2" Pipe* x 6"	50	1.88
200P-3/4X8	1/2" Pipe* x 8"	50	2.72
200P-3/4X10	1/2" Pipe* x 10"	50	4.87
200P-3/4X12	1/2" Pipe* x 12"	50	6.27
200P-1x4	3/4" Pipe* x 4"	50	1.77
200P-1X6	3/4" Pipe* x 6"	50	1.88
200P-1X8	3/4" Pipe* x 8"	50	2.72
200P-1X10	3/4" Pipe* x 10"	50	4.87
200P-1X12	3/4" Pipe* x 12"	50	6.27
200P-11/4X6	1" Pipe * x 6"	50	3.44
200P-11/4X8	1" Pipe * x 8"	50	4.53
200P-11/4X10	1" Pipe * x 10"	50	4.87
200P-11/4X12	1" Pipe * x 12"	50	6.27
200P-11/2X6	1 1/4" Pipe * x 6"	50	3.44
200P-11/2X8	1 1/4" Pipe * x 8"	50	4.53
200P-11/2X10	1 1/4" Pipe * x 10"	50	4.87
200P-11/2X12	1 1/4" Pipe * x 12"	50	6.27
200P-2X6	1 1/2" Pipe * x 6"	50	3.44
200P-2X8	1 1/2" Pipe * x 8"	50	4.53
200P-2X10	1 1/2" Pipe * x 10"	50	4.87
200P-2X12	1 1/2" Pipe * x 12"	50	6.27

* For plastic coated steel pipe hooks, order tube hook of next larger size.
Ex: For 3/4" x 6" pipe use 1" x 6" hook.



DWV Hanger - Galvanized

- Not plastic coated

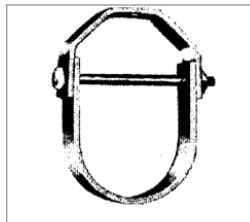

Clevis

Part Number	Size	Ctn Qty	List Price
Light Clevis			
104-1/2	1/2"	100	\$ 1.68
104-3/4	3/4"	100	1.72
104-1	1"	100	1.77
104-1 1/4	1 1/4"	100	1.88
104-1 1/2	1 1/2"	100	2.04
104-2	2"	50	2.17
104-2 1/2	2 1/2"	25	3.80
104-3	3"	25	4.19
104-4	4"	25	5.68
Copperclad Clevis			
406-1/2	1/2"	100	1.93
406-3/4	3/4"	100	1.98
406-1	1"	100	2.31
406-1 1/4	1 1/4"	100	2.47
406-1 1/2	1 1/2"	100	2.73
406-2	2"	50	3.27
Standard Clevis, Black			
204-1/2	1/2"	100	1.93
204-3/4	3/4"	100	1.93
204-1	1"	100	2.04
204-1 1/4	1 1/4"	100	2.33
204-1 1/2	1 1/2"	100	2.52
204-2	2"	50	2.76
204-2 1/2	2 1/2"	25	5.41
204-3	3"	25	5.84
204-4	4"	25	7.23
204-5	5"	15	13.82
204-6	6"	10	15.27
204-8	8"	8	23.90
204-10	10"	BULK	64.28
204-12	12"	BULK	61.69
DWV Hanger - Galvanized			
120-1 1/2	1 1/2"	50	2.35
120-2	2"	50	2.47
120-3	3"	50	2.57
120-4	4"	50	2.95

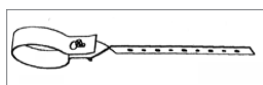

DWV Hanger

Pipe Hangers



Adjustable Swivel Ring

- Galvanized, or copperclad
- 1/2" to 4" - 3/8" rod
- 5" to 8" - 1/2" rod



900 All Thread Rod

- 6' length, plain

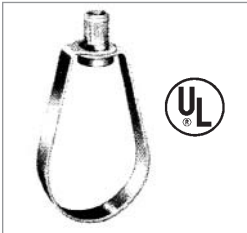

300 Swivel Ring

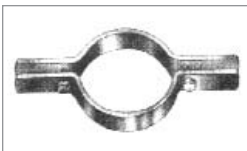

108 Riser Clamp

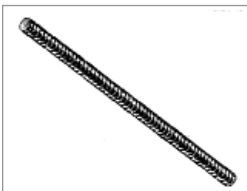

900 Rod

Part Number	Size	Ctn Qty	List Price
Adjustable Swivel Ring, Galvanized			
300-1/2	1/2"	100	\$ 1.55
300-3/4	3/4"	100	1.55
300-1	1"	100	1.64
300-11/4	1 1/4"	100	1.64
300-11/2	1 1/2"	100	1.93
300-2	2"	100	2.09
300-21/2	2 1/2"	50	3.75
300-3	3"	50	4.44
300-4	4"	25	5.68
300-5	5"	20	7.88
300-6	6"	20	8.62
300-8	8"	10	10.61
Adjustable Swivel Ring, Copperclad			
301-1/2	1/2"	100	2.67
301-3/4	3/4"	100	2.72
301-1	1"	100	2.82
301-11/4	1 1/4"	100	2.87
301-11/2	1 1/2"	100	2.92
301-2	2"	100	3.20
Riser Clamp, Black			
108-1	1"	25	5.68
108-11/4	1 1/4"	25	5.89
108-11/2	1 1/2"	25	6.65
108-2	2"	25	7.39
108-21/2	2 1/2"	25	8.15
108-3	3"	25	9.86
108-4	4"	25	12.59
108-5	5"	15	18.48
108-6	6"	10	19.45
108-8	8"	BULK	50.36
108-10	10"	BULK	62.95
All Thread Rod			
900-1/4	1/4"	50	5.20
900-3/8	3/8"	25	9.80
900-1/2	1/2"	15	18.52
900-5/8	5/8"	9	31.12
900-3/4	3/4"	6	47.96
900-1	1"	3	90.87



Split Ring Pipe Hangers

Split Ring Hangers - Malleable Iron

- Galvanized, black or copper clad
- 3/8" to 2" - 3/8" rod
- 2 1/2" to 4" - 1/2" rod

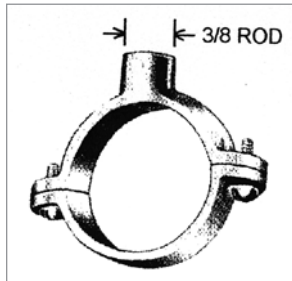

Split Ring Hangers

Part Number	Size	Rod Size	Ctn Qty	List Price
Split Ring Pipe Hanger, Black malleable				
202-3/8	3/8"	3/8"	50	\$ 3.02
202-1/2	1/2"	3/8"	50	3.02
202-3/4	3/4"	3/8"	50	3.14
202-1	1"	3/8"	50	3.49
202-1 1/4	1 1/4"	3/8"	25	4.31
202-1 1/2	1 1/2"	3/8"	25	5.34
202-2	2"	3/8"	25	5.59
Split Ring Pipe Hanger, Galvanized malleable				
385-3/8	3/8"	3/8"	50	3.37
385-1/2	1/2"	3/8"	50	3.37
385-3/4	3/4"	3/8"	50	3.60
385-1	1"	3/8"	50	4.13
385-1 1/4	1 1/4"	3/8"	25	4.94
385-1 1/2	1 1/2"	3/8"	25	6.92
385-2	2"	3/8"	25	6.39
385-2 1/2	2 1/2"	1/2"	25	14.53
385-3	3"	1/2"	25	17.44
385-4	4"	1/2"	25	23.25
Split Ring Pipe Hanger, Copper Clad, Malleable				
485-3/8	3/8"	3/8"	50	2.68
485-1/2	1/2"	3/8"	50	2.68
485-3/4	3/4"	3/8"	50	2.73
485-1	1"	3/8"	50	3.08
485-1 1/4	1 1/4"	3/8"	25	3.66
485-1 1/2	1 1/2"	3/8"	25	3.78
485-2	2"	3/8"	25	4.47
485-2 1/2	2 1/2"	1/2"	25	14.53
485-3	3"	1/2"	25	17.44
485-4	4"	1/2"	25	23.25

Plastic Pipe Hangers & Accessories

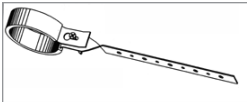

DWV Hanger

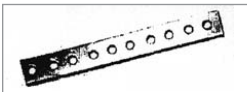

DWV Extension Bar

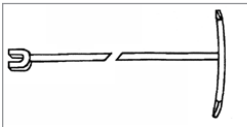

Stop Keys

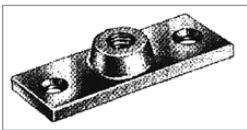

Flanges



C Clamps



Top Beam Clamp

Part Number	Size	Ctn Qty	List Price
DWV Hanger Plastic Coated			
220-11/2	1 1/2"	50	\$ 5.63
220-2	2"	50	5.89
220-3	3"	50	6.56
220-4	4"	50	7.37
220-6	6"	25	19.49
DWV Extension Bar			
221-3	16 gauge x 3'	25	2.59
Stop Keys			
413-6	6'	6	101.79
413-8	8'	6	138.48
413-10	10'	6	158.62
Ceiling Flanges			
208-3/8BT	3/8" bolt thread, malleable iron	100	1.66
389-1/4PT	1/4" pipe thread, galvanized	100	1.74
389-3/8BT	3/8" bolt thread, galvanized	100	1.76
389-1/2BT	1/2" bolt thread, galvanized	100	4.56
489-3/8BT	3/8" bolt thread, copper clad	100	2.04
C Clamps			
122-1/4			
122-3/8	For Pipe Sizes	Fits Rods Size	
122-1/2	1/2" - 2"	1/4" without locknut	50 4.03
123-3/8	2 1/2" - 3 1/2"	3/8" without locknut	100 3.35
123-1/2	1/2" - 2"	1/2" without locknut	100 4.91
123-3/8	1/2" - 2"	3/8" with locknut	100 3.37
123-1/2	2 1/2" - 3 1/2"	1/2" with locknut	100 4.02
123-5/8	4" - 5"	5/8" with locknut	50 14.73
123-3/4	6"	3/4" with locknut	50 18.86
Top Beam Clamp , 3/4" Standard Opening			
125-3/8	3/8" rod	100	2.79
125-1/2	1/2"rod	100	3.49

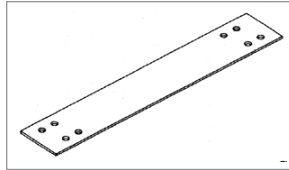

918/916/913 FHA Plates

918, 919, 916 and 913 FHA Plates

- 1 1/2" width and 3" width in 18 gauge
- 18, 16 and 13 gauge

530 Stud Guards

- Triangle points
- 1 1/2" width
- 18 gauge

531 Stud Guards

- Triangle points
- 1 1/2" width
- 20 gauge

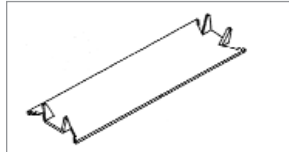

530 & 531 Stud Guards

920 Stud Guards

- Twist points
- 1 1/2" width
- 19 gauge

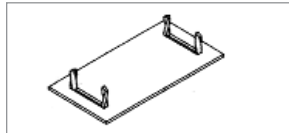

920 Stud Guards

922 Stud Guards

- Interlocking
- 1 1/2" width
- 20 gauge

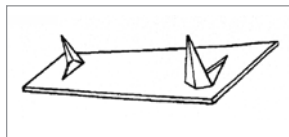

922 Stud Guards

Part Number	Size and Gauge	Ctn Qty	List Price
FHA Plates			
918-11/2X9	1 1/2" X 9", 18 gauge	50	\$ 0.90
918-11/2X12	1 1/2" X 12", 18 gauge	50	1.13
918-11/2X18	1 1/2" X 18", 18 gauge	50	1.71
916-11/2X9	1 1/2" X 9", 16 gauge	50	1.11
916-11/2X12	1 1/2" X 12", 16 gauge	50	1.56
916-11/2X18	1 1/2" X 18", 16 gauge	50	2.32
913-11/2X9	1 1/2" X 9", 13 gauge	50	1.47
913-11/2X12	1 1/2" X 12", 13 gauge	25	2.19
913-11/2X18	1 1/2" X 18", 13 gauge	25	3.28
919-3X9	3" X 9", 18 gauge	50	1.59
919-3X12	3" X 12", 18 gauge	50	2.12
919-3X18	3" X 18", 18 gauge	50	3.21
Stud Guards			
530-11/2X3	1 1/2" X 3", 18 gauge	100	0.28
530-11/2x5	1 1/2" x 5", 18 gauge	100	0.42
530-11/2X6	1 1/2" X 6", 18 gauge	100	0.46
531-11/2X3	1 1/2" X 3", 20 gauge	100	0.23
531-11/2x5	1 1/2" x 5", 20 gauge	100	0.37
531-11/2X6	1 1/2" X 6", 20 gauge	100	0.39
920-11/2X3	1 1/2" x 3", 19 gauge	100	0.24
920-11/2X6	1 1/2" X 6", 19 gauge	100	0.41
922-11/2X3	1 1/2" x 3", 20 gauge	100	0.21
922-11/2X6	1 1/2" X 6", 20 gauge	100	0.42





Hand Cleaner Towels



SCRUBS® WATERLESS HAND CLEANING TOWELS



So unique they needed a patent! Powerful yet safe cleaning agents work together with an absorbent, non scratching abrasive hand cleaning towel. The result is hands that are clean and protected, with a pleasant fragrance...and are residue free. These shop size, durable towels quickly remove tough to clean substances including: Dirt, Heavy Grease, Adhesives, Lubricants, Oils, Ink, Tar, Wax, Caulk, Sealants, Paint and more.

Scrubs® is registered by Dymon Inc.

Features:

- Pre-moistened, heavy duty towel with pumice scrubbing power.
- Works fast to loosen, dissolve and absorb dirt & grease.
- Deep cleaning scrubbers remove embedded grime easily.
- Conditions and softens hands... *No rinsing. No drying. No residue.*

Part Number	Description	Ctn Qty	List Price
SCRB72	Scrubs 72 Count Bucket	6	\$ 35.62
42293	Scrubs Attachable Bracket	1	24.23



PERMATEX FAST ORANGE® HAND CLEANER WIPES



Fast Orange Hand Cleaner Wipes remove the toughest grease, tar, grime, ink, paints, sealants, adhesives and other difficult soils. Each pre-moistened wipe has a textured surface on one side that is ideal for cleaning heavy-duty soils from hands, tools and work areas. The wipes also have a smooth side for general purpose cleaning.

Suggested applications: Fields service trucks, industrial work stations, construction, utility maintenance, transportation, printing, municipal maintenance, marine and warehouse personnel.

Part Number	Description	Ctn Qty	List Price
25072	72 count bucket	6	\$ 47.31

3M™ Spray Adhesive



3M™ BLUE 72 Spray Adhesives

- Pressure sensitive repositionable adhesive
- Aggressive tack and low soak-in.
- Use it for temporarily positioning and holding many fabrics.
- Precise spray control with a wide spray pattern.
- Ideal for pool liner installation
- Manufactured for AGI in an ISO 900 facility.



ISO 9002



3M™ ORANGE FOAM FAST 74 Spray Adhesives

- 74 Foam Fast Adhesive gives fast tack with foam-tearing strength and a soft, non-dimpling glue line.
- Bonds foam to foam, foam to metal.
- Non-misting, precise spray pattern.
- Not for sale in California. Does not meet Aerosol Consumer Products VOC limits.
- Manufactured for AGI in an ISO 900 facility.

Product	Bond Type	Bonding Time	Spray Width	Spray Pattern	Color	Temperature Resistance	Coverage
72	Temp or Permanent	One side-8 hrs Two sides-7 days	3-3.5 in	Controlled Lace	Blue	120°F 48°C	100 sq ft. 9.3 m ²
74	Permanent	One side -not recommended Two sides-15 minutes	1-3 in variable	Lace	Light Orange	120°F 48°C	260 sq ft. 25 m ²

Part Number	Can Size	Ctn/Pallet Qty	List Price
BLUE 72	Blue Spray Adhesive 24 fl oz. can 17.33 oz. net	12/768	\$ 35.70
ORANGE74	Orange spray adhesive 24 fl oz. can 17.33 oz. net	12/768	43.33

Pallet pricing available. Call your Sales Representative.





A simple squeeze to repair horizontal cracks and spalls, and to set anchors

DP600

Horizontal Concrete Repair Features:

Hardens in as little as 5 minutes,

Cracks and spalls in concrete floors are an eyesore as well as a potential safety risk. Fixing them has meant either hiring and waiting for an outside contractor or doing it yourself with a repair method that takes the floor out of service for up to 24 hours. Now with 3M Concrete Repair, you save money and time.

- Self-leveling urethane flows smoothly into cleaned cracks and gaps and hardens in as little as 5 minutes. A fork lift can pass over a repair in as few as 15 minutes.
- Hardens to any depth without cracking or shrinking.
- Flexible urethane expands and contracts for durability that outlasts repairs made with concrete.
- Do it yourself with a common caulking gun and eliminate the cost and wait for an outside contractor.
- *Easy to use - Just clean damaged area and fill. With every squeeze of the caulking gun trigger, cartridge nozzle meters and mixes precise proportions for optimum performance.*



Fill spalls



Custom threading and anchoring

Part Number	Description	Ctn Qty	List Price
DP600	Concrete Repair, 8.4 fl oz cartridge supplied with 2 nozzles	6	\$ 111.72



9" Ratchet Style Caulking Gun

Part Number	Size	Color	Ctn Qty	List Price
CG9	9" Ratchet	Blue	20	4.39



Horizontal Concrete Repair Specifications:

- Gray, self-leveling urethane concrete repair.
- 8.4 fl oz. cartridge of concrete repair and 2 nozzles.
- Work life of 70 sec.
- Handling time of 5 minutes
- Cure time of 60 minutes

Applications:

- Repairing cracks and spalls on concrete floors or horizontal surfaces.
- Setting anchors in concrete floors or horizontal surfaces.
- Light-duty custom threading and anchoring.
- Use outdoors or in highly ventilated area.

Approximate coverage:

Crack Width	Crack Depth	Linear Feet per 8.4 fl. oz.
1/4"	1/4"	19.3
1/2"	1/4"	9.9
3/4"	1/4"	6.4
1"	1/4"	4.9
1/4"	1/2"	9.9
1/2"	1/2"	4.9
3/4"	1/2"	3.0
1"	1/2"	2.0

Bead Size dimension	Linear Feet per 8.4 fl oz.
1/16"	815.0
1/8"	205.0
1/4"	51.9
3/8"	22.2
1/2"	12.4

Quick and Easy Spall Repair



Clean
Remove all loose material from area to be filled. Concrete should be dry and grease-free.



Fill
Dispense product into deepest part of repair areas, slightly overfilling. Product self-levels and is tack-free in as little as one minute.



Finish
In as little as 15 minutes, product can be sanded to remove rough edges. It can be painted within one hour.



Tapes - Teflon® Thread Seal



HTST Series



Imported Teflon® Thread Seal Tape Features:

- Medium density thread seal tape requires fewer wraps.
- Manufactured from 100% virgin PTFE.
- 3.5 mil thick.
- Mil. Spec. T-27730A.
- Meets ASTM D-3308.

• Teflon® is a Dupont registered trademark

Part Number	Width	Length	Color	Ctn/Case Qty	List Price
HTST260-1/2	1/2"	260 inches	White	144/576	\$ 0.86
HTST260-3/4	3/4"	260 inches	White	144/576	1.25
HTST260-1	1"	260 inches	White	144/576	1.44
HTST520-1/2	1/2"	520 inches	White	144/576	1.29
HTST520-3/4	3/4"	520 inches	White	144/576	1.53
HTST520-1	1"	520 inches	White	144/576	1.72



HTT Series

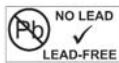

Made in USA Teflon® Thread Seal Tape Features:

- UL Listed.
 - 100% virgin PTFE.
- HTT260/HTT520 Medium Density Teflon® Tape

- White general purpose
- Medium density.

HTT260-1/2SS Gray Stainless Steel Teflon® Tape

- Nickel pigment added for use on all stainless steel threads.
- Prevents galling, seizing and corrosion.
- High density for course SS threads.

HTT260-1/2PP Pink Plumbers Teflon® Tape

- For plumbers and pipe fitters.
- Pink to signify heavier than standard or medium density.

HTT260-1/2GAS Yellow Gas Service Teflon® Tape

- For gas lines of all types- Natural gas, butane, propane.

HTT260-1/2OXY Green Oxygen Teflon® Tape

- Green for oxygen applications. Grease free.
- For all oxygen lines. Will not support combustion.

HTT260-1/2XHD White Extra High Density Teflon® Tape

- For all industrial applications.
- Can be used for water, oil, chemical, medical or food processing.

• Teflon® is a Dupont registered trademark

Part Number	Color	Usage	Thickness	Density	Temp Range	Specs
HTT260	White	General	3.5 mil	.90	-450°F to +550°F	Mil T-27730A
HTT520	White	General	3.5 mil	.90	-450°F to +550°F	Mil T-27730A
HTT260-1/2OXY	Green	Oxygen lines	3.5 mil	1.55	-450°F to +550°F	Mil T-27730A/AA58092
HTT260-1/2PP	Pink	Plumbing	3.5 mil	1.55	-450°F to +550°F	Mil T-27730A/AA
HTT260-1/2XHD	White	Industrial	3.5 mil	1.20	-450°F to +550°F	Mil T-27730A
HTT260-1/2SS	Light Gray	Stainless Steel	3.5 mil	1.55	-450°F to +550°F	Mil T-27730A/AA58092
HTT260-1/2GAS	Yellow	Gas lines	3.5 mil	1.20	-450°F to +550°F	Mil T-27730A

Part Number	Width	Length	Color	Case Qty	List Price
HTT260	1/2"	260 in	White	144	\$ 1.80
HTT520	1/2"	520 in	White	144	2.68
HTT520-3/4	3/4"	520 in	White	144	4.22
HTT520-1	1"	520 in	White	144	5.45
HTT260-1/2OXY	1/2"	260 in	Green	144	4.50
HTT260-1/2PP	1/2"	260 in	Pink	144	4.50
HTT260-1/2XHD	1/2"	260 in	White	144	3.86
HTT260-1/2SS	1/2"	260 in	Light Gray	144	4.50
HTT260-1/2GAS	1/2"	260 in	Yellow	144	3.86



www.americangranby.com
 In the United States: Phone (800) 776-2266 Fax (800) 729-3299
 In Canada: Phone (866) 503-5523 Fax (888) 562-2095

5/3/11



T Series



General Purpose Vinyl Electrical Tape Features:

- Economical, flexible, general purpose electrical tape.
- Use for insulation, protective jacketing and harnessing.
- 7 mil thickness.
- Temperature Range 32°F and 176°F.
- Meets mil spec. MIL-I-7798A.
- Imported

Part Number	Thickness	WidthxLength	Color	Ctn Qty	List Price
T60	7 mil	3/4" x 60 feet	Black	64	\$ 1.97



AWT Series



Premium All Weather Vinyl Electrical and Pipe Wrap Tape Features:

- For use in **all weather** applications.
- Use for insulation, protective jacketing and harnessing and pipe wrap.
- 7 mil thickness, 3/4" or 2" width.
- Temperature range 14°F and 176°F.
- Meets Mil. Spec. MIL-1-7798A.
- Tested to ASTM D-1000
- Imported

Part Number	Thickness	WidthxLength	Color	Ctn Qty	List Price
AWT60	7 mil	3/4" x 60 feet	Black	64	\$ 2.22
AWT60-2	7 mil	2" x 60 feet	Black	48	5.64



1700



3M® 1700 Temflex™ Vinyl Electrical Tape Features:

- Economical, flexible, general purpose electrical tape.
- Use for protective jacketing and harnessing.
- 7 mil thickness.
- Temperature rating to 176°F, 80°C.
- Meets ASTM D-2301 Type 1.
- Imported



Part Number	Thickness	WidthxLength	Color	Ctn Qty	List Price
1700	7 mil	3/4" x 60 feet	Black	100	\$ 3.08

LISTED 539H LR48769
Insulating Tape



TS Series

ISO 900 X



3M® Scotch® Professional Use Premium Vinyl Plastic Tape Features:

- Highly conformable, super stretchy in **all weather** applications.
- Resists UV rays, abrasion, corrosion, alkalis and acids.
- Flame Retardent.
- 7 mil tape thickness Super 33+. 8.5 mil thickness Super 88
- Temperature range 0°F to 220°F.
- Use as a primary insulation for wire cable splices up to 600V.
- Use as protective jacketing.
- Made in USA. Made for AGI in a ISO 900X facility.

Super 33+
ASTM D-3005 Type I
UL273 & CSA LR48769
Super 88
MIL-I-24391C
ASTM D-3005 Type I
UL 539H & CSA LR48769

Part Number	Thickness	WidthxLength	Color	Ctn Qty	List Price
TS33-20	7 mil	3/4" x 20 feet	Black	10/100	\$ 6.18
TS33-44	7 mil	3/4" x 44 feet	Black	10/100	11.20
TS33-66	7 mil	3/4" x 66 feet	Black	10/100	14.18
TS88-66	8.5 mil	3/4" x 66 feet	Black	10/100	17.71

• Scotch® is a 3M registered trademark





Boss® 136 Firestop/Draft Sealant



BOSS® 136 Firestop/Draft Sealant is a single component fire rated sealant and is a noncombustible filler caulking used for firestopping applications in the annular space around wires, pipes, ducts, vents, cable lines and other penetrations to the building envelope. It is a non-slumping sealant that sets to form a hard surface. **BOSS® 136** can be applied to any gap or penetration where the specification is noncombustible and/or ASTM-E136 rated. **BOSS® 136** is to be used for interior applications only.

The noncombustible specification is common to one and two family construction and to non-rated penetrations in multifamily and commercial construction. **BOSS® 136** is colored red for ease of inspection.

In the event of a fire **BOSS® 136** will prevent the spread of fire, smoke and toxic gases through penetration openings.

BOSS® 136 serves to form a “gasket or seal against air infiltration” as required by the Model Energy Code in both performance and prescriptive versions.

REQUIRED AREAS OF USAGE FOR FIRESTOPPING*

Seal ALL areas of penetration as shown in the illustration below.

- ALL - Exterior wall studs (including horizontal penetrations.)
- ALL - Floor penetrations.
- ALL - Ceiling penetrations.
- ALL - Framing around chimneys (at ceiling and floor levels.)

* Always consult local building codes.

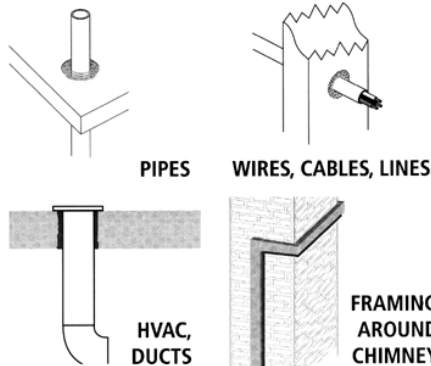

FEATURES:

- Completely non-toxic and contains no asbestos or PCB's.
- Noncombustible.
- Applied with a conventional caulking gun.
- Easily applied sealant with water cleanup capabilities.
- An accredited fire block/smoke seal caulk.
- Single component system, no mixing necessary and no additions required.
- Meets residential construction code approvals including I.R.C.
- For interior applications only.
- Available in traditional cartridge and NEW aerosol can.
- Excellent adhesion to a wide variety of substrate material.

APPLICABLE STANDARDS

- UBC Page 1-378, 1997 edition.
- CABO Section 602.7, Item 4 of the 1995 edition.
- BOCA (NBC) regulation 704.4.1.1 1996.
- ASTM E-136.

Part Number	Description	Ctn Qty	List Price
BOSS136	10.1 oz cartridge	12	\$ 11.28

Boss® 136 Firestop/Draft Sealant



HOW TO USE

- Cut nozzle to desired bead size. Insert cartridge into standard caulking gun.
- For a smooth seal, hold at 45° angle and apply by pushing sealant ahead of nozzle.
- Apply at 40°F or above.
- To ensure good adhesion, all surfaces should be clean and free of dust, oil, loose materials or any other substances.
- Make sure that BOSS® 136 makes complete contact with the entire surface of the opening and also the surface of the penetrating item.

Always follow cartridge directions. Clean the area to be treated so that it is free of all particles and debris. For large openings, mineral wool fibers can be used as a backer to help hold the product in place until cured. Steel screen wire can be stapled in place over the material when a large opening is overhead or configured such that the material will not support its own weight during cure.

TEMPERATURE RANGE

BOSS® 136 freezes in the cartridge at temperatures below 32° F. The product can be warmed and applied at any temperature but will not cure below 40° F. Freeze thaw cycles do not alter the cured product. Cure time may exceed 72 hours at non-freezing temperature.

CAUTION

- Keep from freezing
- Do not take internally
- Keep out of reach of children.

CONTAINS

- Sodium Silicate CAS# 1344-09-8.

COLOR

Boss® 136 Fire/Smoke and Draft Sealant is red in color for ease of inspection.

PACKAGING

Boss® 136 Firestop/Draft Sealant is available in standard 10.1 fl. oz cartridges and 11.0 oz. net wt. aerosol cans.

STORAGE & SHELF LIFE

Boss® 136 should not be stored where the ambient temperatures exceed 120°F or below 35°F. Should freezing occur, insure that product is defrosted fully prior to use. Shelf life is 12 months from the date of shipment. Ensure stock is

SPECIFICATIONS

Meets or exceeds ASTM E-136 for noncombustible building materials. Conforms to BOCA National Building Code (1996), CABO one and two family dwelling code (1995), Uniform Building Code (1997), Section 796, Fire Block and Draft Stop. BOCA-SBCCI-ICBO-NFPA Building Codes. Consult your local code official for the proper use of product.

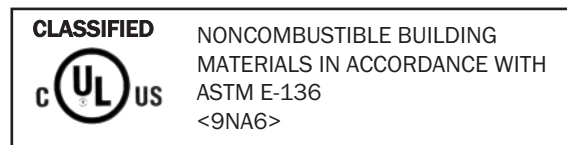

ALSO CLASSIFIED IN ACCORDANCE WITH ASTM E 136-96a, "Standard test method for the behavior of materials in a vertical tube furnace at 750°C."





BOSS® Expanding Foam Sealant



BOSS® 333 Expanding Foam Sealant Features:

- Easy to use, multi-purpose urethane foam.
- Unlike ordinary sealants, it expands **three** times it's original volume.
- Adheres to all building materials except Teflon®, silicone and polyethelene.
- Seals by expanding into gaps, cracks and crevices.
- Uses including insulating, sealing and filling gaps around pipes, plumbing fixtures, ductwork and foundations.
- UL classified.

DIRECTIONS FOR USE:

1. Shake can before and during use.
2. Surface must be clean and free of grease and oil.
3. Can must be held UPSIDE DOWN during application.
4. Insert straw into void and depress the trigger. The use of protective gloves is highly recommended.
5. Fill void 50% full to allow for expansion.
6. Uncured foam can be cleaned with acetone or paint thinner.
7. Cured foam can be trimmed, sanded, painted or stained. Foam MUST be painted or covered if application is exposed to UV light.

	R19028 CAULKING AND SEALANTS SURFACE BURNING CHARACTERISTICS APPLIED TO INORGANIC REINFORCED CEMENT BOARD*
	FLAME SPREAD: 5 SMOKE DEVELOPED: 20 38FN
* Tested as applied in three 3/4" beads 5" on center covering 12.5% of the exposed test sample area.	

Part Number	Description	Ctn Qty	List Price
33316B *	Expanding Foam Sealant, 12 oz can w/ application tip	12	\$ 14.55
33324B *	Expanding Foam Sealant, 24 oz can w/ application tip	12	28.47

* SHIPPING NOTE: Ground shipping only. Can NOT be shipped via air.



BOSS® line of adhesives, grouts and lubricants are specifically formulated for use with pools and whirlpool baths.

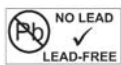

BOSS® 801 Neutral Cure Silicone Adhesive Features:

- A one part, low odor, non-corrosive, oxime cure adhesive and sealant.
- Provides excellent adhesion to ceramic tile, spa jets, skimmers, lighting fixtures, plumbing and fiber optic lighting.
- Adheres well to fiberglass, ABS, acrylic, PVC, wood and masonry.

BOSS® 802 Acetoxy Cure Silicone General Purpose Adhesive Features:

- A one part, acetoxy cure, adhesive/sealant.
- Performs well in jet sealing applications.
- Designed for many other pool and spa maintenance and repair needs.

BOSS® 803 Neutral Cure Silicone Adhesive/Grout Features:

- A one part, low odor, non-corrosive, oxime cure silicone grout.
- Formulated for use in repairing tile installations.
- Adheres well to fiberglass, ABS, acrylic, PVC, wood and masonry.

BOSS® 804 Neutral Cure Silicone Ceramic Tile Grout Features:

- A one part, low odor, non-corrosive, oxime cure silicone grout.
- Spreads easily and provides ample tooling time.
- Excellent adhesion to all ceramic tiles

BOSS® 820 Pool & Spa Silicone Lubricant Features:

- Water washout resistant and non-solidifying compound.
- Provides superb lubricant for rubber o-rings.
- Non-corrosive, silicone lubricant compound.

Part Number	Description	Ctn Qty	List Price
80100B	Silicone Adhesive Clear, 10.3 oz cart	12	\$ 15.31
80101B	Silicone Adhesive White, 10.3 oz cart	12	15.31
80200B	Silicone Adhesive Gen Purpose, Clear 10.3 oz. cart	12	9.37
80201B	Silicone Adhesive Gen Purpose, White 10.3 oz cart	12	9.37
80331B	Silicone Adhesive Grout, Clear 3 oz. tube	12	7.65
80401B	Silicone Ceramic Tile Grout, White 10.3 oz cart	12	15.31
82001B	Pool & Spa Lubricant Clear, 1 oz tube bulk	288	5.18
82002B	Pool & Spa Lubricant Clear, 1 oz tube 36 pc tub	36	249.90
82030B	Pool & Spa Lubricant Clear, 3 oz tube	12	7.88
82000B	Pool & Spa Lubricant Clear, 5.3 oz tube	12	13.21



Dow Corning® General Purpose Silicone Sealant



PLB 90 Series

Dow Corning® General Purpose Silicone Sealant Features:

- Cures to 100% silicone rubber.
- One part, ready to use. Fast cure, high strength.
- Resistant to sunlight & weather extremes.
- Remains flexible; will not become brittle, crack or tear.
- Removable, reusable, resealable nozzle.
- Meets the requirements of FDA Regulation No. 21CFR177.2600.



Dow Corning General Purpose Silicone Sealant is a one-part acetoxy cure silicone sealant for general purpose applications. Provides a flexible bond and will not harden or crack. Trademate General Purpose Silicone Sealant is a high performance sealant, with +/- 25% movement capability when properly applied.

It can be used as a bedding material, formed-in-place gaskets and bumpers. Adhere trim, name plates, signs. Seal around sinks, faucets, showers, tubs, toilets and vents. It can be used for most marine applications. Seal between hull and deck, most boat decks, windows, port lights, windshields and hatches.



Product Properties:

Tooling Time *	.5-10 minutes
Tack Free Time *	.15-20 minutes
Complete Set-up time *	.24 hours (1/8")
Cure System	.Acetoxy
Application Temperature Range-20° F to 122° F-29° C to 50° C
As Cured (after 7 days)	
Durometer hardness Shore A27 points
Tensile Strength350 psi
Elongation600 %
Temperature Range - continuous-40° F to 350° F-40° C to 176° C
Movement capability+/- 25%

* At 77° F (25° C) and 50% relative humidity

Approval/Specifications:

- ASTM C920 Type S, Grade NS, Class 25, Use NT, G and A.
- Federal Specification TT-S-001543A, Type non-sag, Class A,
- Federal Specification TT-S-00230C, Type II, Class A

Storage:

- Store below 90° F (32° C) in a dry place.
- To store short term, replace cap.
- To store long term, unscrew nozzle, screw cap in cartridge and store nozzle in cap.

Limitations:

- Not for structural glazing
- Not paintable
- Not suited for prolonged submersion in water or below-grade applications.
- May not adhere to oily woods or be compatible with substrates made of methylmethacrylate, polycarbonate, polypropylene, polyethylene and polytetrafluoroethylene.
- Not suitable for surfaces that might bleed oils, plasticizers or solvents or porous surfaces such as cement-like materials, stone or surfaces prone to attack by weak acids.
- May not cure properly if used in spaces confined from atmospheric moisture.
- May cause corrosion on some brass, copper, zinc or zinc-alloy containing fixtures (galvanized).
- This product is neither tested nor represented as suitable for medical or pharmaceutical uses.
- Not for use where abrasion and physical abuse are encountered.



9" Ratchet Style Caulking Gun

Part Number	Size	Color	Ctn Qty	List Price
PLB90C	10.3 oz. cartridge	Clear	12	\$ 9.90
PLB90W	10.3 oz. cartridge	White	12	9.90
CG9	9" Ratchet	Blue	20	4.39



In the United States: Phone (800) 776-2266 Fax (800) 729-3299
In Canada: Phone (866) 503-5523 Fax (888) 562-2095

www.americangranby.com

2/15/11

7.13

Dow Corning® Tub, Tile & Ceramic Silicone Sealant



PLB 100 Series

Dow Corning® Tub, Tile & Ceramic Silicone Sealant Features:

- Cures to 100% silicone rubber.
- One part, ready to use. Fast cure, high strength.
- **Cured silicone is mildew resistant**
- Remains flexible; will not become brittle, crack or tear.
- Removable, reusable, resealable nozzle.
- Clear & almond colors meet the requirements of FDA Regulation No. 21CFR177.2600.

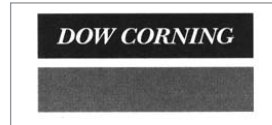

Dow Corning Tub, Tile & Ceramic Silicone Sealant is a one-part acetoxy cure silicone sealant for non-porous surface applications requiring a **mildew-resistant** sealant. This versatile material can be used as an adhesive, sealant, or grout for repairing or replacing ceramic tiles as well as in many other plumbing applications. It can be used for tub and shower enclosures.

It can be used to form watertight seals around bathtubs, shower enclosures, sink vanities, countertops, lavatories, faucets, saunas, hot tubs, plumbing fixtures, drains, piping, shower doors and floor seams.



Product Properties:

Tooling Time *	.5-10 minutes
Tack Free Time *	.15-20 minutes
Complete Set-up time *	.24 hours (1/8")
Cure System	.Acetoxy
Application Temperature Range-20°F to 122°F-29°C to 50°C
As Cured (after 7 days)	
Durometer hardness Shore A27 points
Tensile Strength325 psi
Elongation600 %
Temperature Range - continuous-40°F to 350°F-40°C to 176°C
Movement capability+/- 25%
* At 77°F (25°C) and 50% relative humidity	

Approval/Specifications:

- ASTM C920 Type S, Grade NS, Class 25, Use NT, G and A.
- Federal Specification TT-S-001543A, Type non-sag, Class A,
- Federal Specification TT-S-00230C, Type II, Class A

Storage:

- Store below 90° F (32° C) in a dry place.
- To store short term, replace cap.
- To store long term, unscrew nozzle, screw cap in cartridge and store nozzle in cap.

Limitations:

- Not for structural glazing
- Not paintable
- Not suited for prolonged submersion in water or below-grade applications. Not for aquarium use as product contains a fungicide.
- May not adhere to oily woods or be compatible with substrates made of methylmethacrylate, polycarbonate, polypropylene, polyethylene and polytetrafluoroethylene.
- Not suitable for surfaces that might bleed oils, plasticizers or solvents or porous surfaces such as cement-like materials, stone or surfaces prone to attack by weak acids.
- May not cure properly if used in spaces confined from atmospheric moisture.
- May cause corrosion on some brass, copper, zinc or zinc-alloy, containing fixtures (galvanized).
- This product is neither tested nor represented as suitable for medical or pharmaceutical uses.
- Not for use where abrasion and physical abuse are encountered.



9" Ratchet Style Caulking Gun

Part Number	Size	Color	Ctn Qty	List Price
PLB103C	3 oz tube	Clear	12	\$ 7.17
PLB103W	3 oz tube	White	12	7.17
PLB100C	10.3 oz cartridge	Clear	12	11.00
PLB100W	10.3 oz cartridge	White	12	11.00
CG9	9" Ratchet	Blue	20	4.39



PVC Solvent Cements

United Elchem UNI-WELD

PVC REGULAR CLEAR CEMENTS

LO-VOC



2200 Series
CLEAR

- Regular bodied, clear cement for use on PVC pipe and fittings. Up to 4" for DWV Sch 40 and up to 2" for Sch 80.
- Recommended for ALL grades and types of PVC pipe and fittings, potable water and DWV.
- Sets up quickly.
- Recommended application temperature 40°F to 110°F.
- Meets ASTM D-2564.
- Meets California Air Quality Management District and other environmental district rules.



Part Number	Size	Case Qty	List Price
2266S	4 oz.	24	\$ 7.59
2256S	8 oz.	24	11.48
2246S	16 oz.	24	19.30
2236S	32 oz.	12	33.23
2224	1 gallon	6	118.41

PVC REGULAR CLEAR ADVANCED CEMENTS

LO-VOC



2800 Series
CLEAR

- Regular bodied, clear cement for use on PVC pipe and fittings. Up to 4" for DWV Sch 40 and up to 2" for Sch 80.
- Recommended for ALL grades and types of PVC pipe and fittings, potable water, pressure pipe, gas, conduit and DWV.
- Sets up quickly.
- Recommended application temperature 40°F to 100°F.
- Meets ASTM D-2564.
- Meets California Air Quality Management District and other environmental district rules.



Part Number	Size	Case Qty	List Price
2866S	4 oz.	24	\$ 6.54
2856S	8 oz.	24	10.98
2846S	16 oz.	24	19.15
2836S	32 oz.	12	33.80
2824	1 gallon	6	118.86

PVC MEDIUM CLEAR CEMENTS

LO-VOC



1200 Series
CLEAR

- Medium bodied, clear cement for use on PVC pipe and fittings. Up to 6" for Sch 40 and Sch 80.
- Recommended for ALL grades and types of PVC pipe and fittings, drain, waste and vent pipe, and potable water
- Recommended application temperature 40°F to 110°F.
- Meets ASTM D-2564.
- Meets California Air Quality Management District and other environmental district rules.



Part Number	Size	Case Qty	List Price
1266S	4 oz.	24	\$ 7.97
1256S	8 oz.	24	12.37
1246S	16 oz.	24	21.62
1236S	32 oz.	12	30.13
1224	1 gallon	6	128.18



PVC MEDIUM GRAY CEMENTS

LO-VOC

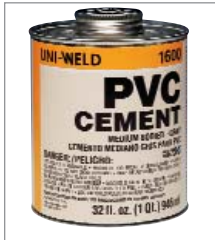

1600 Series
GRAY

- Medium bodied, gray colored cement for use on PVC pipe and fittings. Up to 6" for Sch 40 and Sch 80.
- Recommended for ALL grades and types of PVC pipe and fittings, potable water and DWV.
- Recommended application temperature 40°F to 110°F.
- Meets ASTM D-2564.
- Meets California Air Quality Management District and other environmental district rules.



Part Number	Size	Case Qty	List Price
1666S	4 oz.	24	\$ 8.13
1656S	8 oz.	24	12.46
1646S	16 oz.	24	20.34
1636S	32 oz.	12	36.45
1624	1 gallon	6	131.11

PVC MEDIUM "HOT" BLUE CEMENTS

LO-VOC

PLUMB-TITE™



2000 Series
BLUE

- Medium bodied, blue colored cement for PVC pipe and fittings. Up to 6" for Sch 40 and Sch 80.
- **Very fast setting cement formulated for wet conditions and/or quick pressurization and fast installation.**
- Recommended for ALL grades and types of PVC pipe and fittings, potable water, pressure pipe and DWV.
- Blue color fades to clear in direct sunlight.
- No primer needed on non-pressure DWV, where local codes permit.
- Recommended application temperature 40°F to 110°F.
- Meets ASTM D-2564.
- Meets California Air Quality Management District and other environmental district rules.



Part Number	Size	Case Qty	List Price
2066S	4 oz.	24	\$ 8.89
2056S	8 oz.	24	13.88
2046S	16 oz.	24	24.53
2036S	32 oz.	12	13.88
2024	1 gallon	6	170.33



PVC Solvent Cements

United Elchem
UNI-WELD

PVC ALL WEATHER CEMENTS

LO-VOC

POLAR-WELD



2600 Series
CLEAR

- Medium bodied, clear cement for PVC pipe and fittings. Up to 6" for Sch 40 and Sch 80.
- Recommended for ALL grades and types of PVC pipe and fittings, potable water, pressure pipe and DWV.
- Non-pressure DWV, up through 4" diameter: No primer needed, where local codes permit.
- **Formulated for fast initial set-up at temperatures down to -5°F to 110°F.**
- Meets ASTM D-2564.
- Meets California Air Quality Management District and other environmental district rules.



Part Number	Size	Case Qty	List Price
2666S	4 oz.	24	\$ 10.66
2656S	8 oz.	24	12.81
2646S	16 oz.	24	29.80
2636S	32 oz.	12	48.67
2624	1 gallon	6	174.97

PVC MEDIUM RAIN-R-SHINE® BLUE CEMENTS

LO-VOC



308 Series
BLUE

- Medium bodied, blue colored cement for PVC pipe and fittings. Up to 6" for Sch 40 and Sch 80.
- **Very fast setting cement formulated for wet conditions and/or quick pressurization and fast installation.**
- Recommended for ALL grades and types of PVC pipe and fittings, potable water and DWV.
- Pool/Irrigation installations.
- **No primer needed on non-pressure DWV, where local codes permit.**
- Recommended application temperature 40°F to 110°F.
- Meets ASTM D-2564.
- Meets California Air Quality Management District and other environmental district rules.



Part Number	Size	Case Qty	List Price
30890	4 oz.	24	\$ 7.77
30891	8 oz.	24	12.56
30893	16 oz.	24	18.03
30894	32 oz.	12	36.37
30895	1 gallon	6	120.19



American Granby Inc.™

In the United States: Phone (800) 776-2266 Fax (800) 729-3299
In Canada: Phone (866) 503-5523 Fax (888) 562-2095

www.americangranby.com

6/14/11

7.19

PVC Solvent Cements



United Elchem
UNI-WELD

PVC MEDIUM "HOT" BLUE CEMENTS LO-VOC TURF-TITE



2400 Series BLUE

- Medium bodied, blue colored cement for PVC pipe and fitting. Up to 6" for Sch 40 and Sch 80.
- **Very fast setting cement formulated for wet conditions and/or quick pressurization and fast installation.**
- Recommended for ALL grades and types of PVC pipe and fittings, potable water, pressure pipe and DWV.
- Irrigation installations.
- Fades to clear in sunlight.
- No primer needed on non-pressure DWV, where local codes permit.
- Recommended application temperature 40°F to 110°F.
- Meets ASTM D-2564.
- Meets California Air Quality Management District and other environmental district rules.



Part Number	Size	Case Qty	List Price
2466S	4 oz.	24	\$ 8.61
2456S	8 oz.	24	13.82
2446S	16 oz.	24	24.07
2436S	32 oz.	12	42.28
2424	1 gallon	6	158.20

PVC MEDIUM "HOT" BLUE CEMENTS LO-VOC POOL-TITE

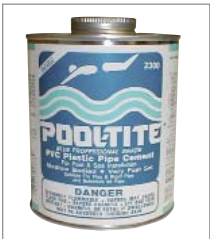

2300 Series
BLUE

- Medium bodied, blue colored cement for PVC pipe and fittings. Up to 6" for Sch 40 and Sch 80.
- **Very fast setting cement formulated for wet conditions.**
- Recommended for ALL grades and types of PVC pipe and fittings, potable water, pressure pipe, gas, conduit, PVC flex pipe and DWV.
- **Color fades to clear in sunlight.**
- **No primer needed on non-pressure DWV, where local codes permit.**
- Recommended application temperature 40°F to 100°F.
- Works on flex to rigid pipe applications.
- Meets ASTM D-2564.
- Meets California Air Quality Management District and other environmental district rules.

Part Number	Size	Case Qty	List Price
2366S	4 oz.	24	\$ 8.33
2356S	8 oz.	24	12.93
2346S	16 oz.	24	19.89
2336S	32 oz.	12	35.53
2324	1 gallon	6	111.77



PVC, CPVC Solvent Cements

United Elchem
UNI-WELD

PVC MEDIUM CLEAR FAST SET CEMENTS LO-VOC POOL-CLEAR



2900 Series
CLEAR

- Medium bodied, clear cement for PVC pipe and fitting. Up to 6"
- Recommended for Sch 40 and Sch 80 pipe and fittings.
- Also recommended for PVC flex pipe.
- Meets ASTM D-2564.
- Meets California Air Quality Management District and other environmental district rules.



Part Number	Size	Case Qty	List Price
30875	4 oz.	24	\$ 7.82
2946S	16 oz.	24	28.53
2936S	32 oz.	12	47.79
2924	1 gallon	6	145.65

CPVC MEDIUM ORANGE CEMENTS LO-VOC

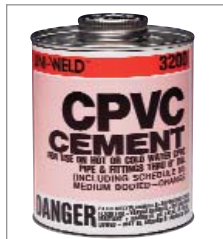

3200 Series
ORANGE

- Medium bodied, orange colored cement for use on CPVC pipe and fittings. Up to 6"
- For copper tube size (CTS) and Sch 80, potable water pressure pipe.
- Recommended application temperatures down to 40°F to 110°F.
- Meets ASTM F-493.
- Meets California Air Quality Management District and other environmental district rules.



Part Number	Size	Case Qty	List Price
3266S	4 oz.	24	\$ 9.76
3256S	8 oz.	24	15.09
3246S	16 oz.	24	29.43
3236S	32 oz.	12	39.82

CPVC FLOWGUARD® GOLD™ LO-VOC 1-STEP YELLOW CEMENTS



319 Series

- Exceeds new environmental requirements and meets various CA district rules.
- For copper tube size (CTS) CPVC hot and cold potable water pipe and fittings up to 2" interference fit only.
- May be used without primer where local codes permit.
- For cold water systems and hot water systems up to 180°F.
- Faster cure time/reduced installation time.
- Meets ASTM F-493.
- Meets California Air Quality Management District and other environmental district rules.



Part Number	Size	Case Qty	List Price
31910	4 oz.	24	\$ 10.56
31911	8 oz.	24	16.88
31912	16 oz.	24	30.44

PVC and Multipurpose Solvent Cements



United Elchem
UNI-WELD

PVC HEAVY DUTY CLEAR CEMENTS

LO-VOC

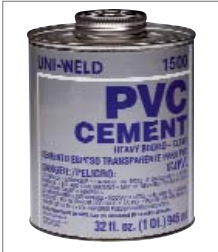

1500 Series
CLEAR

- Heavy bodied, clear cement for PVC pipe and fittings. Up to 18" for Sch 40 and Sch 80.
- Recommended for ALL grades and types of PVC pipe and fittings, potable water and DWV.
- Thick formula fills gaps in large diameter pipe and loose fitting joints.
- Recommended application temperature 40°F to 110°F.
- Meets ASTM D-2564.
- Meets California Air Quality Management District and other environmental district rules.



Part Number	Size	Case Qty	List Price
1566S	4 oz.	24	\$ 6.39
1556S	8 oz.	24	10.04
1546S	16 oz.	24	21.97
1536S	32 oz.	12	35.87
1524	1 gallon	6	111.13

PVC HEAVY DUTY GRAY CEMENTS

LO-VOC

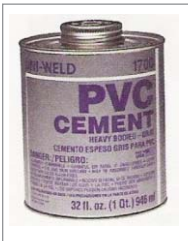

1700 Series
GRAY

- Heavy bodied, gray colored cement for use on PVC pipe and fittings. Up to 18" for Sch 40 and Sch 80.
- Recommended for ALL grades and types of PVC pipe and fittings, potable water and DWV.
- Thick formula fills gaps in large diameter pipe and fitting.
- Recommended application temperature 40°F to 110°F.
- Meets ASTM D-2564.
- Meets California Air Quality Management District and other environmental district rules.



Part Number	Size	Case Qty	List Price
1756S	8 oz.	24	\$ 14.03
1746S	16 oz.	24	25.68
1736S	32 oz.	12	45.12
1724	1 gallon	6	160.50

MULTI PURPOSE REGULAR CLEAR CEMENTS

LO-VOC



6200 Series
CLEAR

- Regular bodied, clear cement for ABS, PVC or CPVC up to 4".
- Recommended for pipe and fittings Sch 40 and Sch 80, potable water, pressure pipe and DWV.
- Recommended application temperature 40°F to 110°F.
- Meets performance requirements of ASTM D-2564, D-2235, F-493.
- Meets California Air Quality Management District and other environmental district rules.

Part Number	Size	Case Qty	List Price
6266S	4 oz.	24	\$ 8.80
6256S	8 oz.	24	14.04
6246S	16 oz.	24	19.24
6236S	32 oz.	12	33.26
30848	1 gallon	6	122.63



ABS Solvent Cements

United Elchem
UNI-WELD

ABS MEDIUM BLACK CEMENTS LO-VOC

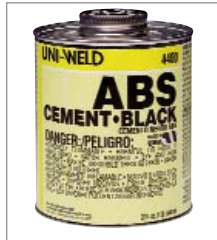

4400 Series BLACK

- Medium bodied, black cement for ABS pipe and fittings. Up to 6".
- For ALL types and grades of ABS pipe and fittings for DWV.
- **For all non-pressure applications.**
- Recommended application temperatures 40°F to 110°F.
- Meets ASTM D-2235.
- Meets California Air Quality Management District and other environmental district rules.



Part Number	Size	Case Qty	List Price
4466S	4 oz.	24	\$ 8.40
4456S	8 oz.	24	11.84
4446S	16 oz.	24	12.12
4436S	32 oz.	12	35.76
4424	1 gallon	6	102.52

ABS TO PVC TRANSITION GREEN CEMENTS LO-VOC



309 Series GREEN

- Medium bodied, green colored cement for use in joining **ABS to PVC in non-pressure transition joints.**
- All schedules up to 6" pipe fittings.
- Recommended application temperature 40°F to 110°F.
- Meets ASTM D-3138.
- Meets California Air Quality Management District and other environmental district rules.



Part Number	Size	Case Qty	List Price
30900	4 oz.	24	\$ 8.73
30925	16 oz.	24	22.40
30926	32 oz.	12	39.70



CLEAR PRIMER - NSF LISTED

LO-VOC



9300 Series
CLEAR

- A clear aggressive primer for use on PVC and CPVC pipe and fittings.
- All schedules and diameters.
- Removes all surface dirt, grease and grime as well as softens pipe to allow a fast, secure solvent weld.
- Meets ASTM F-656.
- Meets California Air Quality Management District and other environmental district rules.



Part Number	Size	Case Qty	List Price
9366S	4 oz.	24	\$ 7.94
9356S	8 oz.	24	11.07
9346S	16 oz.	24	22.75
9336S	32 oz.	12	32.37
9324	1 gallon	6	116.96

PURPLE PRIMER - NSF LISTED

LO-VOC



8700 Series
PURPLE

- A purple tinted aggressive primer for use on PVC and CPVC pipe and fittings.
- **Exceeds new environmental requirements and meets various CA district rules.**
- For use in areas where plumbing code calls for verification that a primer has been used.
- Removes all surface dirt, grease and grime as well as softens pipe to allow a fast, secure solvent weld.



Part Number	Size	Case Qty	List Price
8766S	4 oz.	24	\$ 9.01
8756S	8 oz.	24	12.45
8746S	16 oz.	24	21.93
8736S	32 oz.	12	29.73
8724	1 gallon	6	116.46

BLUE PRIMER - NSF LISTED

LO-VOC

PRIME-TITE™



8000 Series
BLUE

- A blue-tinted aggressive primer for use on PVC and CPVC pipe and fittings.
- **Blue color fades to clear in direct sunlight.**
- Formulated to work with "TITE" products.
- Meets ASTM F-656.
- Meets California Air Quality Management District and other environmental district rules.



Part Number	Size	Case Qty	List Price
8056S	8 oz.	24	\$ 14.17
8046S	16 oz.	24	24.21
8036S	32 oz.	12	43.38





Primers and Cleaners

United Elchem
UNI-WELD

PURPLE PRIMER/CLEANER LO-VOC



8800 Series
PURPLE

- Purple tinted all purpose primer/cleaner for PVC and CPVC pipe and fittings.
- Removes surface dirt, grease and grime as well as softens pipe to allow a fast, secure solvent weld.
- Less aggressive than clear primer and purple primer.
- Purple tint for verification for code.
- **Exceeds new environmental requirements and meets various CA district rules.**

Part Number	Size	Case Qty	List Price
8866S	4 oz.	24	\$ 7.79
8856S	8 oz.	24	11.63
8846S	16 oz.	24	22.75
8836S	32 oz.	12	31.70
8824S	1 gallon	6	108.44

CLEANER LO-VOC



7300 Series
CLEAR

- Clear cleaner for ABS, PVC and CPVC pipe and fittings.
- All schedules and diameters.
- **Exceeds new environmental requirements and meets various CA district rules.**
- Fast-acting cleaner removes surface dirt, grease and grime.
- Flows freely and evaporates quickly.

Part Number	Size	Case Qty	List Price
7366S	4 oz.	24	\$ 6.80
7356S	8 oz.	24	8.99
7346S	16 oz.	24	15.97
7336S	32 oz.	12	21.26
7324	1 gallon	6	89.78

DAUBERS and EMPTY CANS



- Replacement product daubers.
- Reusable cone top metal containers.

Part Number	Size	Case Qty	List Price
DAUBERS			
31312	Fits 32 oz quart can	48	\$ 3.52
31310	Fits 16 oz pint can	48	2.94
31309	Fits 8 oz 1/2 pint can	24	3.32
EMPTY CANS			
30901	Gallon 2 7/8" mouth	6	27.73





Lubricants - Super Lube®



Super Lube® is a patented, multi-purpose synthetic lubricant, containing SYNCOLON® (PTFE) particles held in suspension. Super Lube lasts longer and outperforms conventional petroleum-based greases and oils. Packaging includes tubes, grease cartridges, aerosols, bottles, pails and drums.

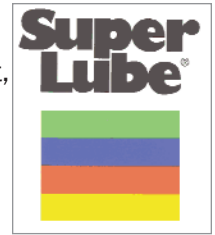

How does the chemistry of SuperLube differ from conventional petroleum-based greases and mineral oils? Super Lube grease and oils are exceptionally pure lubricants because they are synthetic. This gives SuperLube very stable and predictable chemical properties. Petroleum-based machine and gear oils are made from refined crude oil and contain impurities which cannot be removed. These impurities interfere with film strength and wear protection. They also form deposits at high temperatures and solidify at low temperatures. Petroleum-based greases are formulated by adding lithium, calcium or sodium thickeners to petroleum-based oil.



31110

Super Lube Aerosol



A multi-purpose PTFE based synthetic lubricant available in aerosol form. Super Lube aerosol disperses and penetrates while lubricating & loosening rust and dirt. Super Lube aerosol offers continuous protection as it "sets up" and forms a grease film barrier that defends against oxidation. This barrier helps extend the life of equipment and reduces maintenance.

Super Lube Non-Aerosol Pump



Because of environmental concerns, many industrial facilities do not allow the use of aerosol products. Super Lube Oil with PTFE is available in a one quart trigger spray container to address these needs.



51600

Benefits:

- Synthetic with PTFE
- Provides more reliable lubrication and outlasts petroleum based greases & oils
- Non-toxic, odorless
- USDA H-1 for use in federally inspected meat & poultry plants.
- Remains free flowing in freezing temperatures
- High dielectric strength
- Water and saltwater waterproof
- Will not stain or harm wood, rubber, leather, plastics, fabric & paint
- Won't drip, run or evaporate
- 1A copper corrosion
- Excellent salt spray performance
- Repels dirt, dust, grit and grime
- Prevents rust and corrosion while reducing friction
- Reduces maintenance for longer machinery life

Applications:

- Plain & anti-friction bearings
- Ball & roller bearings
- Wheel bearings
- Chassis points
- Fifth wheels
- Electric motor bearings
- Disc brake assemblies
- Pumps
- Blowers
- Cams
- Slides
- Conveyors
- Chains
- Water pumps
- Valves
- Open gears



Super Lube® and SYNCOLON® are trademarks of SYNCO Chemical Corp.

Part Number (old)	Description	Case Qty	List Price
31040 (23755)	6 oz. aerosol	12	\$ 12.04
31110 (20029)	11 oz. aerosol	12	14.87
51600 (24575)	32 oz. non-aerosol trigger spray	12	35.65



American Granby Inc.™

In the United States: Phone (800) 776-2266 Fax (800) 729-3299
In Canada: Phone (866) 503-5523 Fax (888) 562-2095

www.americangranby.com

6/14/11



11016



Super Lube Dri Lube (Dri-Film)

Super Lube Dri-Lube is a self-cleaning lubricant that actually cleans while lubricating. Super Lube Dri-Lube leaves behind a protective shield lubricant that will not attract dust. The dry coating provides a low coefficient of friction which gives excellent lubrication and release properties. Dri-Lube can be used on wood, metal and most plastics not under stress and has excellent thermal and chemical stability, forming a natural insulating barrier when used on electronics.

Benefits:

- Clean, non-staining
- For uses from -40°F to +500°F
- Non-conducting
- Easy to use
- Resists acid attacks
- Dries on contact
- Effective mold release agent
- Not affected by oil, water or solvents
- Long lasting lubrication
- Cleans while lubricating
- Stops squeaking, sticking
- Prevents corrosion

Applications:

- Industrial slides and glides
- High speed machinery
- Precision instruments
- Door and trunk hinges
- Pipe fittings
- Electronic & electrical equipment
- Chains
- Tools
- Zippers
- Lock cylinders
- Rusted nuts and bolts
- Cable pivots

Part Number	Description	Case Qty	List Price
11016	11 oz. aerosol	12	\$ 17.10

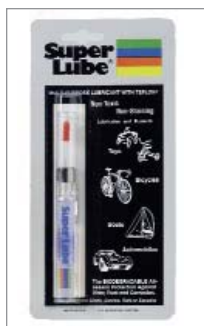
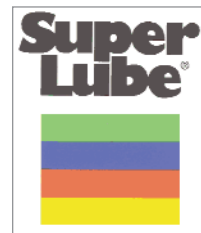

51010

Super Lube Oil with PTFE

Super Lube Oil with PTFE is a premium synthetic oil with suspended PTFE particles that bond to surfaces to add lubricity to moving parts. Super Lube Oil with PTFE is used for applications which allow parts to be confined (ie. gear box). Use it as a general purpose lubricant for industrial machinery and equipment. Super Lube Oil with PTFE provides long life protection against friction, wear, rust and corrosion. Machinery lasts longer, downtime is reduced, and productivity is increased. Super Lube Oil with PTFE is safe on metal, rubber, plastic, wood, leather, fabric & painted surfaces.

Benefits:

- Waterproof
- Non-toxic (USDA rating H1)
- Synthetic with PTFE
- Reduces friction and wear
- Extends machinery & equipment life
- Reduces maintenance
- Viscosity stable
- Long-lasting

Applications:

- Plain, anti-friction & roller bearings
- Enclosed industrial gears
- Enclosed chains
- Gearhead motors
- Paper machines
- Conveyors
- Machine ways
- Reciprocating compressor lubricant additive
- Machine tools
- Centralized systems
- Straight, helical, bevel & spiral gears

Typical Properties:

Color: Translucent white
 Viscosity tested to ASTM D445
 cSt@ 100°F: 14-17
 cSt @ 40°F: 118-122
 ISO grade: 220
 Replaces ISO grade: 150-320
 Replaces SAE grade gear oils: 90
 Viscosity index: 145
 Shelf Life: 24 months

Part Number (old)	Description	Case Qty	List Price
51010SL (82333)	7 ml precision oiler	12	\$ 7.28
51040 (82334)	1 gallon	4	131.60
82337 (52040)	Light Weight Oil 1 gallon	4	114.58



41150

21030

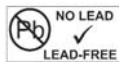

TYPICAL PROPERTIES

Color: Translucent white
 Operating Temperature
 Range: -45° to 450° F
 NLGI Grade (ASTM D1092): 2
 Dropping point (ASTM D566):
 >500° F (260C)
 Four ball test (ASTM D2783):
 Load wear index: 81.73 kg
 Weld point: 400 kg
 Oxidation stability 100 hrs.
 (ASTM D942): 0 psi
 Wheel bearing leakage
 (ASTM D1263): 0.2g
 Copper corrosion 24 hrs @
 100° C (ASTM D4048): 1B,
 shiny
 Shelf life: 24 months

Super Lube Grease

Super Lube is a patented synthetic NLGI grade 2 heavy-duty, multi-purpose lubricant with PTFE. Synthetic base fluids and the addition of PTFE micro powders combine to form a premium lubricant that provides long life protection against friction, wear, rust and corrosion. Machinery lasts longer, downtime is reduced, and productivity is increased.

Super Lube is a USDA listed Food Grade Lubricant, rated H1 for incidental food contact. Super Lube will not run or drip, does not evaporate or form gummy deposits and will not dry out, melt or separate.

Super Lube is a synthetic, heavy duty lubricant that is compatible with most other lubricants. Super Lube Grease outlasts conventional greases 50-100% and has excellent adhesion.

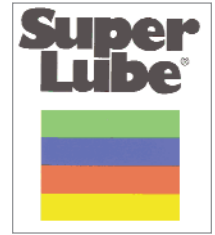

Benefits:

- Clean
- Non-toxic
- Non-staining
- Dielectric
- USDA Rating H1
- Will not drip, run or evaporate
- Impervious to salt water, safe in potable water
- Long lasting
- Prevents rust & corrosion while reducing friction
- Compatible with conventional lubricants
- Repels dirt, dust, grit & grime
- Extends machinery and equipment life
- Reduces maintenance while saving time & money
- Reduces friction and wear
- Will not stain or harm wood, rubber, leather, plastic, fabrics and paint.

Applications:

- Plain and anti-friction bearings
- Ball and roller bearings
- Wheel bearings
- Chassis points
- Fifth wheels
- Electric motor bearings
- Disc brake assemblies
- Pumps
- Blowers
- Cams
- Slides
- Conveyors
- Chains
- Water pumps
- Valves
- Open gears
- Switch assemblies
- Cables
- Fans
- Electronic equipment
- Deep drawing application

Super Lube Grease Replaces

- Lithium, Bentone, Calcium or Aluminum complex grease
- High & low temperature greases
- Electric motor grease
- Food grade grease
- Bearing, wheel bearing grease
- Multi-purpose grease
- Dielectric grease
- Valve sealant
- O-ring lubricant

Part Number (old)	Description	Case Qty	List Price
21010 (82324)	1/2 oz. tube	12	\$ 6.22
21030 (82325)	3 oz. tube	12	10.50
72350 (41150)	400 g cartridge	12	21.97
41160 (82329)	400 g jar	12	22.68
41050 (82330)	5 lb. pail	4	119.27
41030 (82331)	30 lb. pail	1	671.36



11362

Super Lube Product Display

- 36 pc. assortment with counter display
- Contains:
 - 12 #21030 Super Lube Grease w/ PTFE, 3 oz. tubes
 - 12 #31040 Super Lube w/ PTFE 6 oz. aerosol
 - 12 #31110 Super Lube w/ PTFE 11 oz. aerosol

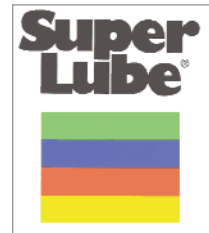

21013 and 51013

Super Lube Grease w/ PTFE Counter display

- Packaged in a cardboard counter display
- Contains 40, 1/2 oz. tubes Super Lube w/ PTFE grease

Super Lube Precision Oiler w/ PTFE Counter display

- Packaged in a cardboard counter display
- Contains 48, 7 ml precision oiler pens of Super Lube w/ PTFE

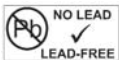

Part Number	Description	Display Qty	List Price
11362	Assorted Counter Display	36	\$ 513.30
21013	Counter display w/ Grease	40	297.55
51013	Counter display w/ Oiler	48	327.70



Super Lube Air Tool Lubricant

Super Lube Air Tool Lubricant is formulated to meet the special requirements for industrial, household and agricultural tools. It absorbs water and eliminates any ice buildup and frost in air tools. Blended rust and corrosion inhibitors and a special base fluid oil minimizes wear and allows operation of air tools at temperatures as low as -40°F.

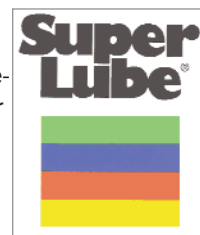

Applications:

- Air impact tools
- Drills
- Grinders
- Screwdrivers
- Sanders
- Percussion tools
- Household shop tools
- All air tool oil lubricated

Benefits:

- Wide temperature range
- Works on types of pneumatic equipment
- Prevents rust and corrosion
- Can be used as a light oil
- Gives worn tools new life
- Less friction and wear
- Protects against corrosives
- Less tendency for bubbles
- Absorbs moisture
- Eliminates ice buildup and frost in air tools.

Part Number	Description	Case Qty	List Price
12004	4 oz. bottle	6	\$ 8.87
12016	16 oz. bottle	12	19.25
12032	32 oz. bottle	12	35.41
12040	1 gallon	4	122.37
12050	5 gallon	1	568.31



Super Lube Syncopen

Super Lube Synthetic Penetrant is a super fast acting, penetrating, synthetic oil that cuts through rust or corrosion. Syncopen penetrates hard to reach areas to allow easy removal of rusted and corroded screws, nuts or bolts. Syncopen penetrates, lubricates and leaves a protective film to help prevent future rusting or corrosion.

Benefits:

- Cleans and Penetrates
- Loosens rusted parts
- Frees sticky mechanisms
- Stops squeaks
- Protects against rust & corrosion
- Drives out moisture
- Leaves a protective lubricating film

Typical Properties:

TEST	METHOD	SYNCOPEN
Color		Translucent Brown
Specific Gravity	ASTM D1298	.85
Pour Point	ASTM D97	-40 °F
Salt Spray Test (500 hrs)	ASTM B117	Pass
Copper Corrosion 24 hrs @ 100 °C	ASTM D130	1A
USDA Rating	NSF	H1
Shelf Life		24 months

Part Number	Description	Case Qty	List Price
85011	11 oz. aerosol	12	\$ 14.08
85032	32 oz. trigger pump spray bottle	12	37.63
85010	1 gallon	4	122.18
85050	5 gallon	1	584.24





Miscellaneous Tools



WCS1022, WCS1022MU

HARVARD CONTRACTOR'S WCS1022 Wire Cutter/Strippers Features:

- Combination wire cutter and stripper.
- Strips wire sizes 22-10 AWG.
- Heavy duty scissor opening spring.
- Cushioned plastic grips.
- Easy locking thumb lock.



HARVARD CONTRACTOR'S WCS1022MU Wire Cutter/Stripper/Crimper Features:

- Compact, high quality multi-use tool designed for perform six most common electrical wiring functions.
- Made of heat-treated carbon steel.
- Handles a variety of terminal and connector styles-insulated and non-insulated.
- Wire range 22-10 AWG.
- Anvil-type wire cutter for clean cuts.
- Crimp dies for 22-10 AWG non-insulated terminals and connectors.
- Wire stripping stations for circumferencial cutless effort.
- Crimp die for 7 and 8 mm ignition parts.
- Cushioned plastic grips.

Part Number	Description	Ctn Qty	List Price
WCS1022	Wire Cutter/Stripper	100	\$ 17.68
WCS1022MU	Wire Cutter/Stripper/Crimper	72	17.68

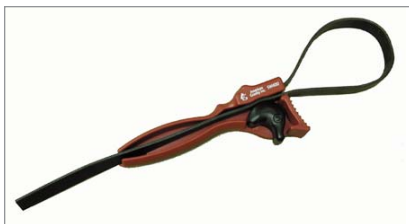

SW Series

Adjustable Strap Wrench:

Part Number	For Use with Coupling Sizes	Ctn Qty	List Price
SW400	1/2" through 4"	60	\$ 17.68
SW600	1/2" through 6"	60	20.18



SW500C

SW500 Nipple Extractor Features:

- For 1/2" or 3/4" plastic nipples.
- Easy to remove broken plastic riser from sprinkler pipe and fittings.
- Insert tip and turn.

Part Number	Description	Ctn Qty	List Price
SW500C	Stub Wrench	25	6.43

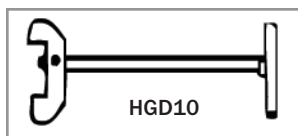

HGD10

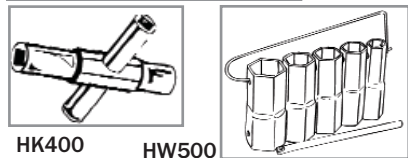

HK400

HW500

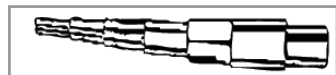

HR

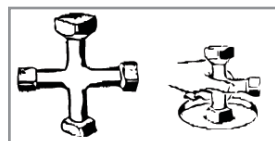

HP400



HI

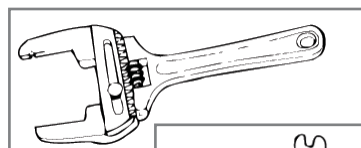

HAS300

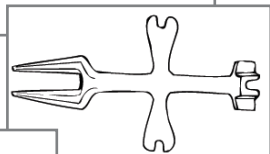

HPO400

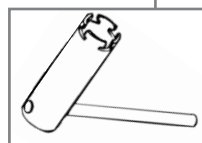

HS200

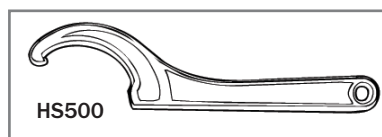

HS500



HK50

Garbage Disposal Wrench Features:

- Fits standard units.

4-Way Key Features:

- For use on square stem 1/4", 9/32", 5/16", 11/32".

Tub and Shower Valve Socket Wrench Set Features:

- Set includes sockets, handle and wire.

Radiator Spud Wrench Features:

- For use when spud wrench or key is required.
- Plated.

4 Way Countersunk Plug Wrench Features:

- Steel construction.

Internal Pipe Wrench Features:

- Available in sizes 3/8", 1/2", 3/4" and 1".

Adjustable Strainer and Spud Wrench Features:

- Use for Basket Strainers and Closet Spud.
- Minimum 1" to Maximum 3".
- Plated.

4-Way P.O. Plug Wrench Features:

- Plated.
- Use when installing or removing tub drains, P.O. plugs & basket strainers.

Strainer Wrench

- Plated steel.
- For use on basket strainers and tub drains with crossbars.
- Long handle for leverage.

Spanner and Strainer Wrench Features:

- Plated, malleable iron.
- For use on basket strainer jam nuts.

Part Number	Description	Ctn Qty	List Price
HGD10	Garbage disposal wrench	1	\$ 7.11
HK400	Four way key	6	5.23
HW500	Complete wrench set	1	16.36
HR	Radiator spud wrench	5	22.37
HP400	4 way plug wrench	1	25.86
HI380	3/8" internal pipe wrench	5	4.40
HI500	1/2" internal pipe wrench	5	5.48
HI750	3/4" internal pipe wrench	5	5.72
HI100	1" internal pipe wrench	5	10.50
HK50	Utility knife w/extra blade	12	7.40
HAS300	Adjustable strainer wrench	10	15.54
HPO400	4-Way plug wrench	10	7.04
HS200	Strainer wrench	10	8.64
HS500	Spanner/strainer wrench	10	8.47



Insert Fittings - Cast Bronze

- For use with flexible plastic pipe
- **Heavy Pattern**, contractor grade cast bronze.
- Imported



RBMA



RRBMA



XLRBMA



RBMUA



RBRA



RBFA



RBC

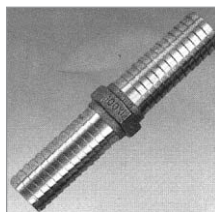

XLRBC

Part Number	Size	Style	Number of Barbs	Ctn/Case Qty	List Price
Cast Bronze Male Insert Adapters (INS x MIP)					
RBMA1/2	1/2" x 1/2"	Hex	5	10/200	\$ 7.04
RBMA3/4	3/4" x 3/4"	Hex	5	10/200	9.00
RBMA1	1" x 1"	Hex	7	10/100	13.41
RRBMA1	1" x 1"	Round	6	10/100	13.79
RBMA1X3/4	1" x 3/4"	Hex	5	10/100	10.79
RBMA1X11/4	1" x 11/4"	Hex	6	10/100	16.75
RBMA11/4	1 1/4" x 1 1/4"	Hex	6	10/100	17.96
RBMA11/4X1	1 1/4" x 1"	Hex	7	10/100	17.32
RBMA11/2	1 1/2" x 1 1/2"	Hex	6	5/50	20.79
RBMA11/2X11/4	1 1/2" x 1 1/4"	Hex	6	10/100	18.89
RBMA2	2" x 2"	Hex	7	5/50	33.71
Cast Bronze Extra Long Male Adapters (INS x MIP)					
XLRBMA1	1" x 1"	Hex	12	10/100	20.18
XLRBMA1x11/4	1" x 1 1/4"	Hex	12	10/100	20.32
XLRBMA11/4	1 1/4" x 1 1/4"	Hex	12	10/100	23.93
XLRBMA2	2" x 2"	Hex	12	5/50	41.64
Cast Bronze Male Union Adapters (INS x MIP)					
RBMUA1	1" x 1"	Hex	6	10/80	22.78
RBMUA11/4	1 1/4" x 1 1/4"	Hex	6	10/40	20.33
Cast Bronze Rope Adapter (INS x MIP)					
RBRA1	1" x 1"	Round w/ rope eye	11	10/100	15.61
RBRA1X11/4	1" x 1 1/4"	Round w/ rope eye	6	10/100	17.51
RBRA11/4	1 1/4" x 1 1/4"	Round w/ rope eye	6	10/100	19.64
Cast Bronze Female Adapters (INS x FIP)					
RBFA1/2	1/2" x 1/2"	Round	5	10/200	9.11
RBFA3/4	3/4" x 3/4"	Round	5	10/100	10.18
RBFA1	1" x 1"	Round	5	10/100	16.61
RBFA11/4	1 1/4" x 1 1/4"	Round	7	10/100	19.54
RBFA11/2	1 1/2" x 1 1/2"	Round	6	5/50	23.68
RBFA2	2" x 2"	Round	7	5/50	36.96
Cast Bronze Couplings (INS x INS)					
RBC1/2	1/2" x 1/2"	Hex	4	10/220	6.30
RBC3/4	3/4" x 3/4"	Hex	4	10/200	9.50
RBC3/4X1	3/4" x 1"	Hex	5 x 6	10/100	12.50
RBC1	1" x 1"	Hex	5	10/100	13.04
RBC1X11/4	1" x 1 1/4"	Hex	6	10/100	20.32
RBC11/4	1 1/4" x 1 1/4"	Hex	6	10/100	19.00
RBC11/2	1 1/2" x 1 1/2"	Hex	4	5/50	19.79
RBC2	2" x 2"	Hex	4	5/50	28.00
Cast Bronze Extra Long Couplings (INS x INS)					
XLRBC1	1" x 1"	Hex	12	10/100	20.71
XLRBC11/4	1 1/4" x 1 1/4"	Hex	12	5/50	29.93
XLRBC2	2" x 2"	Hex	12	5/25	54.68

Insert Fittings - Cast Bronze



- For use with flexible plastic pipe
- **Heavy Pattern**, contractor grade cast bronze.
- Imported

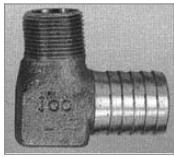

RBHE



RBFE

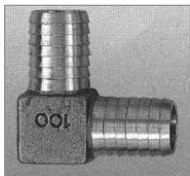

RBE



RBGSE

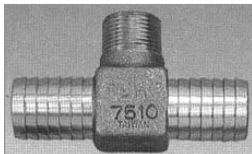

RBHT

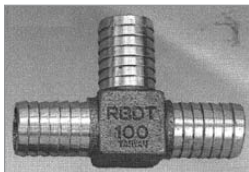

RBT



RBFT

Part Number	Size	Number of Barbs	Ctn/Case Qty	List Price
Cast Bronze Hydrant Elbow (INS x MIP)				
RBHE3/4	3/4" x 3/4"	5	10/100	\$ 11.80
RBHE1x3/4	1" x 3/4"	5	10/100	21.25
RBHE1	1" x 1"	5	10/100	16.75
RBHE11/4	1 1/4" x 1 1/4"	6	5/50	30.86
Cast Bronze Extra Long Hydrant Elbows (INS x MIP)				
XLRBHE1	1" x 1"	8	10/100	21.61
XLRBHE1X3/4	1" x 3/4"	10	10/100	18.75
Cast Bronze Combination Elbows (INS x FIP)				
RBFE1	1" x 1"	8	5/50	21.86
RBFE1x11/4	1" x 1 1/4"	8	5/50	21.86
RBFE11/4	1 1/4" x 1 1/4"	6	5/50	25.79
Cast Bronze Elbows (INS x INS)				
RBE3/4	3/4" x 3/4"	5	10/200	13.68
RBE1	1" x 1"	6	10/100	18.36
RBE11/4	1 1/4" x 1 1/4"	6	10/50	30.32
Cast Bronze Ground Source Elbows (INS x MIP w/ 1/4" tap)				
RBGSE3/4	3/4" x 3/4"		10/100	13.96
RBGSE1X3/4	1" x 3/4"		10/100	13.96
RBGSE1	1" x 1"		10/80	18.04
RBGSE11/4	1 1/4" x 1 1/4"		5/50	28.71
Cast Bronze Hydrant Tees (INS x MIP)				
RBHT3/4	3/4" x 3/4"	4	10/100	16.00
RBHT1X3/4	1" x 3/4"	6	10/100	22.14
RBHT1	1" x 1"	4	10/100	21.61
Cast Bronze Tees (INS x INS)				
RBT3/4	3/4" x 3/4"	5	10/100	15.36
RBT1	1" x 1"	6	10/100	25.79
RBT11/4	1 1/4" x 1 1/4"	6	5/50	39.57
Cast Bronze Combination Tees (INS x FPT)				
RBFT3/4	3/4" x 3/4"	6	10/100	20.83
RBFT1	1" x 1"	6	6/60	37.10
RBFT1X1X3/4	1" x 1" x 3/4"	6	8/80	31.50
RBFT11/4	1 1/4" x 1 1/4"	6	4/40	45.56



Insert Fittings - Steel, Zinc Plated

- For use with flexible poly pipe
- Made in North America.
- IMAS Imported
- Made from Sch 40 C.W. steel pipe, zinc plated.

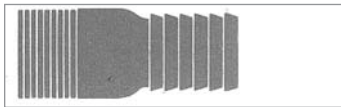

S12, IMAS

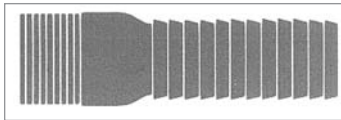

XS12, IMAS-XL

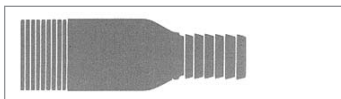

S38

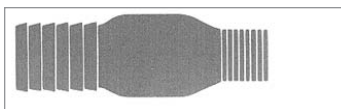

S74, IMAS

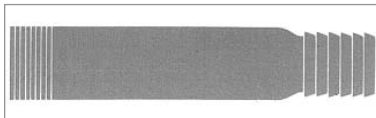

S86

Part Number	Size	Ctn/Case Qty	List Price
Male Adapter, mipt x ins *			
S12-1/2	1/2"	25	\$ 4.63
S12-3/4	3/4"	25	4.95
S12-1	1"	20	6.34
S12-11/4	1-1/4"	20	8.03
S12-11/2	1-1/2"	10	9.95
S12-2	2"	10	14.36
S12-21/2	2-1/2"	BULK	37.66
S12-3	3"	BULK	50.80
S12-4	4"	BULK	82.29
Male Adapter, mipt x ins IMPORTED **			
IMAS50	1/2"	50/300	1.39
IMAS75	3/4"	50/200	1.91
IMAS100	1"	25/200	2.51
IMAS125	1 1/4"	12/108	4.49
IMAS150	1 1/2"	6/90	5.83
IMAS200	2"	5/60	8.55
IMAS250	2 1/2"	2/10	21.95
IMAS300	3"	2/10	24.87
IMAS400	4"	2/10	39.86
Extra Long Male Adapter, mipt x ins *			
XS12-1	1"	25	12.30
XS12-11/4	1-1/4"	25	16.25
XS12-11/2	1-1/2"	25	18.71
Extra Long Male Adapter, mipt x ins IMPORTED **			
IMAS100XL	1"	10/120	4.04
IMAS125XL	1 1/4"	10/80	6.96
Reducing Male Adapter, mipt x ins *			
S38-3/4X1/2	3/4" x 1/2"	25	20.10
S38-1X3/4	1" x 3/4"	25	22.16
S38-11/4X1	1-1/4" x 1"	25	25.29
S38-11/2X11/4	1-1/2" x 1-1/4"	25	31.42
S38-2X11/2	2" x 1-1/2"	25	42.17
Reducing Male Adapter, ins x mipt *			
S74-1X3/4	1" x 3/4"	25	12.44
S74-11/4X1	1-1/4" x 1"	25	17.80
S74-11/2X11/4	1-1/2" x 1-1/4"	25	21.20
Reducing Male Adapter, ins x mipt IMPORTED **			
IMAS7550	3/4" x 1/2"	250	4.47
IMAS1075	1" x 3/4"	250	5.14
Venturi Adapter, mipt x ins *			
S86-3/4X6	3/4" x 6"	25	18.05
S86-3/4X10	3/4" x 10"	25	21.48
S86-3/4X12	3/4" x 12"	25	21.76
S86-1X6	1" x 6"	25	13.71
S86-1X8	1" x 8"	25	16.56
S86-1x10	1" x 10"	25	18.60
S86-1X12	1" x 12"	25	21.24
S86-11/4X6	1-1/4" x 6"	25	18.66
S86-11/4X8	1-1/4" x 8"	25	21.01
S86-11/4X10	1-1/4" x 10"	25	25.34
S86-11/4X12	1-1/4" x 12"	25	32.46

Insert Fittings - Steel, Zinc Plated



- For use with flexible poly pipe
- Made in North America.
- ISVMA, ISWSE, IFAS, ICS - Imported
- Made from Sch 40 C.W. steel pipe, zinc plated.

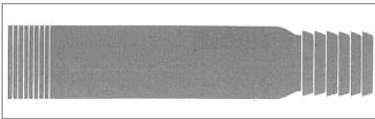

ISVMA

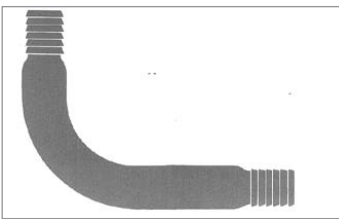

S99, ISWSE



S10, ICS



XS10, ICS-XL

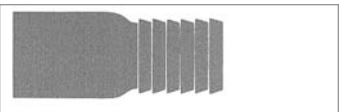

S90, IFAS



Part Number	Size	Ctn/Case Qty	List Price
Venturi Adapter, mipt x ins IMPORTED **			
ISVMA1X6	1" x 6"	60	\$ 5.43
ISVMA1X8	1" x 8"	50	7.95
ISVMA1X10	1" x 10"	40	9.44
ISVMA11/4X6	1-1/4" x 6"	50	7.46
ISVMA11/4X8	1-1/4" x 8"	40	9.27
ISVMA11/4X10	1-1/4" x 10"	30	11.49
Well Seal Elbow, ins x ins *			
S99-1	1"	10	26.66
S99-11/4	1-1/4"	10	36.03
Well Seal Elbow, ins x ins IMPORTED **			
ISWSE100	1"	BULK	13.11
ISWSE125	1-1/4"	BULK	21.54
Coupling, ins x ins *			
S10-1/2	1/2"	25	4.18
S10-3/4	3/4"	25	4.95
S10-1	1"	20	6.70
S10-11/4	1-1/4"	20	9.51
S10-11/2	1-1/2"	10	10.64
S10-2	2"	10	19.60
S10-3	3"	BULK	65.36
S10-4	4"	BULK	104.56
Coupling, ins x ins IMPORTED **			
ICS50	1/2"	50/300	1.35
ICS75	3/4"	50/200	1.91
ICS100	1"	25/200	2.34
ICS125	1 1/4"	20/120	4.38
ICS150	1 1/2"	10/60	5.57
ICS200	2"	10/60	7.40
ICS250	2 1/2"	2/10	21.99
ICS300	3"	2/10	24.46
ICS400	4"	2/10	29.46
Extra Long Coupling, ins x ins *			
XS10-1	1"	25	22.32
XS10-11/4	1-1/4"	25	32.08
Extra Long Coupling, ins x ins IMPORTED **			
ICS100XL	1"	10/120	3.93
ICS125XL	1-1/4"	10/80	6.96
Female Adapter, fipt x ins *			
S90-1/2	1/2"	25/300	12.82
S90-3/4	3/4"	25/200	16.76
S90-1	1"	20/160	21.61
S90-11/4	1-1/4"	20/120	26.93
S90-11/2	1-1/2"	10/60	31.99
S90-2	2"	10/40	38.79
Female Adapter, fipt x ins IMPORTED **			
IFAS100	1"	125	4.82
IFAS125	1 1/4"	100	11.11



Insert Fittings - Stainless Steel



SSMA Series



XLSSMA

Features:

- Imported cast from Grade 304 Stainless Steel.
- Made in U.S.A. from Grade 316 Stainless Steel.
- For use with flexible poly pipe.

Part Number	Size	# Barbs	Ctn/Case Qty	List Price
Grade 304 SS, IMPORTED				
Male Adapters, MIPT X INS, HEX PATTERN				
SSMA1/2	1/2"	6	10/200	\$ 8.18
SSMA3/4	3/4"	6	10/200	10.26
SSMA1	1"	6	10/100	17.00
SSMA11/4	1 1/4"	6	5/100	20.71
SSMA11/4X1	1 1/4" x 1"	6	5/100	18.00
SSMA11/2	1 1/2"	6	5/80	26.89
SSMA2	2"	6	5/40	37.49
Grade 304 SS, HEAVY PATTERN EXTRA LONG, IMPORTED				
Male Adapters, MIPT X INS, HEX PATTERN				
XLSSMA11/4X1	1 1/4" x 1"	13	5/60	46.86



SS12 Series



SS38 Series

Part Number	Size	# Barbs	Ctn/Case Qty	List Price
Grade 316 SS, MADE IN U.S.A.				
Male Adapter, MIPT X INS, ROUND PATTERN				
SS12-1/2	1/2"	6	25/300	\$ 21.17
SS12-3/4	3/4"	7	25/200	19.49
SS12-1	1"	7	20/160	22.08
SS12-11/4	1-1/4"	6	20/120	36.20
SS12-11/2	1-1/2"	6	10/60	49.01
SS12-2	2"	7	10/40	64.41
Male Reducing Adapter mipt x red. ins				
SS38-11/4x1	1-1/4 x 1"	7	25/100	52.13



SS10 Series



Grade 316 SS, EXTRA LONG, MADE IN U.S.A.				
Male Adapter, MIPT X INS, ROUND PATTERN				
XSS12-1	1	14	25	43.07
XSS12-11/4	11/4	14	25	56.11
Grade 316 SS, MADE IN U.S.A.				
Coupling, INS X INS, ROUND PATTERN				
SS10-1	1	7	20	31.50
SS10-11/4	11/4	7	20	41.64
Grade 316 SS, EXTRA LONG, MADE IN U.S.A.				
Coupling, INS X INS, ROUND PATTERN				
XSS10-1	1	14	25	56.98

Insert Fittings - Yellow Brass



- For use with flexible poly pipe
- Imported



YB00



YB10



YB12

Part Number	Size	Ctn/Case Qty	List Price
Yellow Brass Adapters, ins x solder			
YB00-1/2	1/2"	10/200	\$ 4.11
YB00-3/4	3/4"	10/200	5.86
YB00-1	1"	10/200	7.93
YB00-11/4	1-1/4"	10/200	8.39
YB00-11/2	1-1/2"	5/80	29.46
Yellow Brass Couplings, ins x ins			
YB10-1/2	1/2"	10/200	4.82
YB10-3/4	3/4 "	10/200	5.54
YB10-1	1"	10/200	7.50
YB10-11/4	1-1/4"	10/200	9.82
Yellow Brass Adapters, ins x mipt			
YB12-1	1"	10/200	9.25



Compression Couplings-Imported, PVC/CPVC

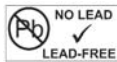

MATERIAL SPECIFICATIONS

#	Part	Material
1	Body	UPVC, CPVC
2	Compression Nut	UPVC, CPVC
3	Gasket - PVC	NR
	Gasket - CPVC	EPDM

PVC Compressing Coupling Features:

- Iron Pipe Size (PVC), Copper Tube Size (CPVC)
- For use with cold water (PVC) or hot water (CPVC-CTS)
- Natural rubber gasket seals
- Rated at 200 psi at 70 °F
- Imported

"PC" Series IPS DIMENSIONS (IN.)				
SIZE	D	d	d1	L
1/2"	1.85	.91	.83	5.24
3/4"	2.09	1.18	1.04	5.32
1"	2.40	1.42	1.31	5.75
1 1/4"	2.87	1.81	1.65	6.30
1 1/2"	3.15	2.05	1.89	6.89
2"	3.62	2.56	2.37	7.87
2 1/2"	4.53	2.52	2.87	9.92
3"	5.28	3.62	3.49	10.87
4"	6.34	4.65	4.49	11.93
6"	8.78	6.85	6.62	11.22

"HW" Series CTS DIMENSIONS (IN.)				
SIZE	D	d	d1	L
1/2"	1.30	.71	.63	4.49
3/4"	1.85	.95	.88	5.00

Part Number	Material	Size	Case Qty	List Price
PC10-1/2	PVC	1/2" IPS	100	\$ 2.33
PC10-3/4	PVC	3/4" IPS	90	2.70
PC10-1	PVC	1" IPS	60	3.49
PC10-11/4	PVC	1 1/4" IPS	40	4.20
PC10-11/2	PVC	1 1/2" IPS	30	5.79
PC10-2	PVC	2" IPS	20	8.06
PC10-21/2	PVC	2 1/2" IPS	10	18.42
PC10-3	PVC	3" IPS	4	26.06
PC10-4	PVC	4" IPS	2	34.39
PC10-6	PVC	6" IPS	2	82.73
HW10CTS1/2	CPVC	1/2" CTS	20/360	4.07
HW10CTS3/4	CPVC	3/4" CTS	20/240	4.93



SW Series

Part Number	For Use with Coupling Sizes	Ctn Qty	List Price
Adjustable Strap Wrench			
SW400	1/2" through 4"	10/60	\$ 17.68
SW600	1/2" through 6"	10/60	20.18



American Granby Inc.™

In the United States: Phone (800) 776-2266 Fax (800) 729-3299
 In Canada: Phone (866) 503-5523 Fax (888) 562-2095

www.americangranby.com

4/2009

12.15

Compression Fittings, Galvanized



Galvanized Long Pattern Compression Fitting Features:

- Bodies made of steel tubing (GC10), malleable iron (GC10C)
- End nuts made of malleable iron.
- Galvanized finish
- Buna-N gaskets on domestic fittings.
- SBR gaskets on GC10C series.
- Maximum rated service temperature for gaskets: 212 °F (100° C).
- GC10C manufactured for AGI in an ISO9002 facility.

WARNING: Designer and/or contractor must provide suitable anchoring of piping to prevent pull-out from fittings when applications subject piping to external forces such as ground shift and temperature variations that cause linear pipe contraction.

Recommended Maximum Pressure(PSI)		
Size	Torque Ft. Lbs	Anchored Piping
1/2"	150	150
3/4"	150	150
1"	225	100
1-1/4"	225	100
1-1/2"	225	100
2"	300	75



GC10C Series



ISO 9002

Coupling GC10C - Long Pattern - Imported - Malleable Iron, 125 PSI, 120° F				
Part Number	Size	Pipe O.D.	Ctn/Case Qty	List Price
GC10C1/2	1/2"	.840	30 / 60	\$ 10.20
GC10C3/4	3/4"	1.050	25 / 50	11.44
GC10C1	1"	1.315	15 / 30	13.42
GC10C11/4	1-1/4"	1.660	12 / 24	17.04
GC10C11/2	1-1/2"	1.900	9 / 18	20.19
GC10C2	2"	2.375	14	30.19



GC10 Series

Coupling GC10 - Made in U.S.A. - Steel Tube				
Part Number	Size	Pipe O.D.	Ctn Qty	List Price
GC10-1/2	1/2"	.840	12	\$ 25.66
GC10-3/4	3/4"	1.050	12	27.98
GC10-1	1"	1.315	12	33.04
GC10-11/4	1-1/4"	1.660	6	44.12
GC10-11/2	1-1/2"	1.900	6	48.73
GC10-2	2"	2.375	6	61.24



GC12 Series

Adapters GC12 - Made in U.S.A. - Steel Tube				
Part Number	Size	Pipe O.D.	Ctn Qty	List Price
GC12-1/2	1/2"	.840	12	\$ 37.50
GC12-3/4	3/4"	1.050	12	36.18
GC12-1	1"	1.315	12	38.31
GC12-11/4	1-1/4"	1.660	6	45.54
GC12-11/2	1-1/2"	1.900	6	63.32
GC12-2	2"	2.375	6	63.44



Pipe Repair Clamps

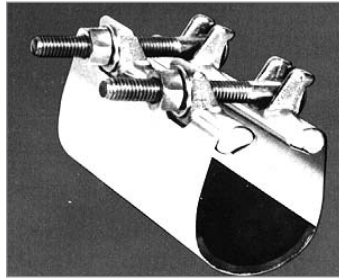

Repair Clamp Features:

- Pipe repair clamps eliminate the need for costly pipe replacement for simple leaks.
- Non-corrosive clamp band is made of annealed stainless steel.
- Nuts and bolts are cadmium plated with a chromate finish; heavy duty hex nut with washer.
- Lugs are made of annealed, malleable iron for maximum strength and permanence; iron phosphate finish.
- Neoprene gasket with maximum rated service temperature of 212° F (100°C).
- Imported

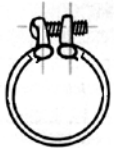

Straight through bolt pull on lugs gives more uniform pressure on the band, more pressure on pipe with less torque on nut.

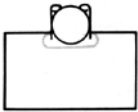

Oval lug opening in band won't tear - no corners to rip out as with square hole.

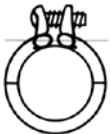

Lugs above pipe level don't pull into pipe. Gives more tension on band - more sealing power yet won't crush pipe.



Band covers lead edge of lug. Equal pressure across entire band. No friction - no cutting into pipe surface by raw edge of band opening.

Part Number	Nominal Pipe Size	IPS Pipe O.D.	CTS Tube O.D.	Ctn Qty	List Price
3" Wide, 1 Bolt					
HRC3-3/8	3/8"	.675	.625	6/72	\$ 5.94
HRC3-1/2	1/2"	.840	.875	6/72	6.98
HRC3-3/4	3/4"	1.050	1.125	6/72	7.13
HRC3-1	1"	1.315	1.375	6/72	7.97
HRC3-1 1/4	1 1/4"	1.660	1.625	6/72	8.79
HRC3-1 1/2	1 1/2"	1.900		6/72	8.90
HRC3-2	2"	2.375		6/72	10.67
HRC3-2 1/2	2 1/2"	2.875		6/48	11.37
HRC3-3	3"	3.50		6/48	12.05
HRC3-4	4"	4.50		6/24	12.35
6" Wide, 2 Bolts					
HRC6-1/2	1/2"	.840	.875	6/56	12.54
HRC6-3/4	3/4"	1.050	1.125	6/56	13.44
HRC6-1	1"	1.315	1.375	6/56	13.60
HRC6-1 1/4	1 1/4"	1.660	1.625	6/56	15.06
HRC6-1 1/2	1 1/2"	1.900		6/56	16.49
HRC6-2	2"	2.375		6/56	19.77
HRC6-2 1/2	2 1/2"	2.875		6/24	21.28
HRC6-3	3"	3.50		6/24	22.44
HRC6-4	4"	4.50		6/24	22.92

Couplings, Caps - Flexible & No-Hub



Coupling, Cap Features:

- Flexible couplings for joining all types of sewer pipe, including transitions from one type to another.
- NO-HUB couplings for joining cast iron pipe sections
- End Caps for capping cast iron, steel, PVC and ABS pipe.
- 300 Series stainless steel clamps
- Meets IAPMO File #0317, BOCA ESI RR#90-68, SBCCI PST&ESI Report #9483B
- CSA Approved



C Series



MR Series



MRTC Series



07 Series

Part Number	Size	Connection	Ctn Qty	List Price
NO HUB COUPLINGS				
C150C	1 1/2 X 1 1/2	CI X CI	100	\$ 9.37
C200C	2 X 2	CI X CI	100	9.37
C215C	2 X 1 1/2	CI X CI	100	10.92
C300C	3 X 3	CI X CI	100	10.92
C400C	4 X 4	CI X CI	100	13.22
FLEXIBLE COUPLINGS				
MR0244	4 X 4	CLAY X CI/PL	18	14.44
MR5615/125	1 1/4 x 1 1/2	CI/PL x TUBE	24	7.60
MR56125	1 1/2" Tubing, Copper or 1 1/4" PL to Same		24	6.89
MR5615	1 1/2 x 1 1/2	CI/PL X CI/PL	24	7.31
MR5622/125	2 x 1 1/4	CI/PL x CI/PL	24	7.66
MR56215	2 X 1 1/2	CI/PL X CI/PL	24	8.33
MR5622	2 X 2	CI/PL X CI/PL	24	7.88
MR56315	3 x 1 1/2	CI/PL x CI/PL	24	13.93
MR5632	3 X 2	CI/PL X CI/PL	24	9.84
MR5633	3 X 3	CI/PL X CI/PL	18	10.64
MR5642	4 x 2	CI/PL x CI/PL	18	17.19
MR5643	4 X 3	CI/PL X CI/PL	18	14.35
MR5644	4 X 4	CI/PL X CI/PL	24	13.33
MR5655	5 X 5	CI/PL X CI/PL	14	20.88
MR5664	6 x 4	CI/PL x CI/PL	10	31.02
MR5666	6 X 6	CI/PL X CI/PL	12	28.51
DRAIN PIPING TO TUBULAR TRAP *				
MRTC150	1 1/4" x 1 1/2"		24	4.19
MRDTC150	1 1/4" or 1 1/2" x 1 1/4" or 1 1/2"		24	5.13
MRDTC215	2" x 1 1/4" or 1 1/2"		24	6.77
* Any combination of 1 1/4" or 1 1/2" tubular drain (plastic, tubular or copper)				
END CAPS				
0701-011	1 1/2"		24	4.08
0702-019	2"		24	4.80
0703-017	3"		24	6.07
0704-015	4"		24	7.76
0705-020	5"		20	15.51
0706-028	6"		12	15.97



Threaded Bronze Fittings

Threaded Bronze 125 lb. SIAM

- Dimension: ANSI B16.15, ASME B16.14, A-A-59617, MSS-SP-106
- Threads: ANSI/ASME B1.20.1
- Material: ASTM B62-93 (C83600)
- Imported. Manufactured for AGI in an ISO 9001 facility.

Threaded Bronze 125 lb. CHINA

- Threads: ANSI B16.15 125S fittings
- Threads: ANSI B16.24 150S flanges
- Material: ASTM B584-C84400

SIAM - THAILAND

ISO 9001

CHINA



B90L Series

Part Number	Size	Ctn Qty	List Price
90 ° Elbow, fipt x fipt			
B90L1/8	1/8"	25	\$ 6.32
B90L1/4	1/4"	25	6.32
B90L3/8	3/8"	25	6.32
B90L1/2	1/2"	25	9.59
B90L3/4	3/4"	25	12.98
B90L1	1"	20	19.96
B90L11/4	1-1/4"	10	31.75
B90L11/2	1-1/2"	5	39.67
B90L2	2"	5	64.50
B90L21/2	2 1/2"	1	126.62
B90L3	3"	1	194.23
B90L4	4"	1	647.40



B90L Reducer Series

90 ° Elbow, Reducer fipt x fipt			
B90L1/2X3/8	1/2" x 3/8"	25	10.42
B90L3/4X1/2	3/4" x 1/2"	25	14.16
B90L1x1/2	1" x 1/2"	25	24.87
B90L1X3/4	1" x 3/4"	25	24.87
B90L11/4X1	1 1/4" x 1"	10	38.84



B45L Series

45° Elbows, fipt x fipt			
B45L1/8	1/8"	25	6.92
B45L1/4	1/4"	25	6.92
B45L3/8	3/8"	25	6.92
B45L1/2	1/2"	25	8.78
B45L3/4	3/4"	25	12.98
B45L1	1"	25	21.85
B45L11/4	1-1/4"	10	34.95
B45L11/2	1-1/2"	10	43.77
B45L2	2"	5	71.03
B45L21/2	2 1/2"	1	192.26
B45L3	3"	1	309.00
B45L4	4"	1	706.36



B90SL Series

90 ° Street Elbow, fipt x mipt			
B90SL1/8	1/8"	25	9.59
B90SL1/4	1/4"	25	9.59
B90SL3/8	3/8"	25	9.59
B90SL1/2	1/2"	25	11.95
B90SL3/4	3/4"	25	16.89
B90SL1	1"	10	27.89
B90SL11/4	1-1/4"	10	42.75
B90SL11/2	1-1/2"	10	55.60
B90SL2	2"	5	94.34
B90SL21/2	2 1/2"	1	206.02
B90SL3	3"	1	309.00
B90SL4	4"	1	927.13

Part Number	Ctn Qty	List Price
90 ° Elbow, fipt x fipt		
TB90L1/8	50/600	\$ 4.01
TB90L1/4	100/400	4.01
TB90L3/8	75/300	4.01
TB90L1/2	50/200	6.08
TB90L3/4	25/100	8.24
TB90L1	20/80	12.70
TB90L11/4	25/50	20.14
TB90L11/2	35	25.19
TB90L2	20	40.98
TB90L21/2	10	80.46
TB90L3	6	123.39

90 ° Elbow, Reducer fipt x fipt		
TB90L1/2X3/8	50/200	6.61
TB90L3/4X1/2	30/120	9.03
TB90L1x1/2	25/100	15.79
TB90L1X3/4	25/50	15.79
TB90L11/4X1	50	24.64

45° Elbows, fipt x fipt		
TB45L1/8	50/600	4.39
TB45L1/4	120/480	4.39
TB45L3/8	50/300	4.39
TB45L1/2	50/200	5.58
TB45L3/4	25/100	8.24
TB45L1	90	13.90
TB45L11/4	50	22.19
TB45L11/2	40	27.81
TB45L2	25	45.10

90 ° Street Elbow, fipt x mipt		
TB90SL1/8	200/800	6.08
TB90SL1/4	100/400	6.08
TB90SL3/8	60/240	6.08
TB90SL1/2	50/200	7.60
TB90SL3/4	25/100	10.71
TB90SL1	20/60	17.69
TB90SL11/4	20/40	27.14
TB90SL11/2	35	35.32
TB90SL2	25	59.92

Threaded Bronze Fittings



Threaded Bronze 125 lb. SIAM

- Dimension: ANSI B16.15, ASME B16.14, A-A-59617, MSS-SP-106
- Threads: ANSI/ASME B1.20.1
- Material: ASTM B62-93 (C83600)
- Imported. Manufactured for AGI in an ISO 9001 facility.

Threaded Bronze 125 lb. CHINA

- Threads: ANSI B16.15 125S fittings
- Threads: ANSI B16.24 150S flanges
- Material: ASTM B584-C84400

SIAM - THAILAND

ISO 9001

CHINA

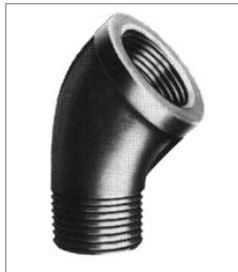

B45SL Series

Part Number	Size	Ctn Qty	List Price
45° Street Elbows, fipt x mipt			
B45SL1/8	1/8"	25	\$ 9.79
B45SL1/4	1/4"	25	9.79
B45SL3/8	3/8"	25	9.79
B45SL1/2	1/2"	25	11.95
B45SL3/4	3/4"	25	16.89
B45SL1	1"	10	27.89
B45SL1 1/4	1 1/4"	10	42.75
B45SL1 1/2	1 1/2"	5	57.28
B45SL2	2"	1	145.04

Tee, fipt x fipt x fipt

BT1/8	1/8"	25	8.78
BT1/4	1/4"	25	8.78
BT3/8	3/8"	25	8.78
BT1/2	1/2"	25	11.12
BT3/4	3/4"	25	15.91
BT1	1"	10	28.26
BT1 1/4	1-1/4"	5	39.67
BT1 1/2	1-1/2"	5	54.52
BT2	2"	5	89.42
BT2 1/2	2 1/2"	1	240.14
BT3	3"	1	265.74
BT4	4"	1	882.76

Tee, Reducer fipt x fipt x fipt

BT3/4X1/2	3/4 x 3/4 x 1/2"	10	19.09
BT3/4X3/4X1/4	3/4 x 3/4 x 1/4"	25	20.97
BT3/4X1	3/4 x 3/4 x 1"	10	37.93
BT1X1/4	1 x 1 x 1/4"	10	37.92
BT1X1/2	1 x 1 x 1/2"	10	37.92
BT1X3/4	1 x 1 x 3/4"	10	34.70
BT1X3/4X3/4	1 x 3/4 x 3/4"	10	37.93
BT1X3/4X1	1 x 3/4 x 1"	10	37.91
BT1 1/4X3/4	1 1/4 x 1 1/4 x 3/4"	10	53.21
BT1 1/4X1	1 1/4 x 1 1/4 x 1"	5	49.04
BT1 1/2X3/4	1 1/2 x 1 1/2 x 3/4"	5	67.57
BT1 1/2X1	1 1/2 x 1 1/2 x 1"	5	67.57
BT1 1/2X1 1/4	1 1/2 x 1 1/2 x 1 1/4"	5	67.57
BT2X3/4	2 x 2 x 3/4"	5	110.41
BT2X1	2 x 2 x 1"	5	110.41
BT2X1 1/2	2 x 2 x 1 1/2"	1	110.41



BT Series

Part Number	Ctn Qty	List Price
45° Street Elbows, fipt x mipt		
TB45SL1/8	50/600	\$ 6.21
TB45SL1/4	35/420	6.21
TB45SL3/8	270	6.21
TB45SL1/2	100/20	7.60
TB45SL3/4	60/120	10.71
TB45SL1	30/60	17.69
TB45SL1 1/4	20/40	27.14
TB45SL1 1/2	15/30	36.41
TB45SL2	18	61.69

Tee, fipt x fipt x fipt

TBT1/8	75/450	5.58
TBT1/4	50/300	5.58
TBT3/8	45/180	5.58
TBT1/2	40/120	7.09
TBT3/4	35/70	10.08
TBT1	20/40	17.96
TBT1 1/4	14/28	25.19
TBT1 1/2	11/22	34.65
TBT2	6/12	56.77
TBT3	1/6	168.79

Tee, Reducer fipt x fipt x fipt

TBT3/4X1/2	45/90	12.12
TBT1X1/4	60	24.11
TBT1X1/2	35/70	24.11
TBT1X3/4	30/60	22.08
TBT1X3/4X3/4	65	24.11
TBT1X3/4X1	50	24.11
TBT1 1/4X3/4	18/36	33.80
TBT1 1/4X1	18/36	31.15
TBT1 1/2X3/4	15/30	42.90
TBT1 1/2X1	13/26	42.90
TBT1 1/2X1 1/4	13/26	42.90
TBT2X3/4	9/18	70.11
TBT2X1	9/18	70.11
TBT2X1 1/2	8/16	70.11



BT Reducer Series



Threaded Bronze Fittings

Threaded Bronze 125 lb. SIAM

- Dimension: ANSI B16.15, ASME B16.14, A-A-59617, MSS-SP-106
- Threads: ANSI/ASME B1.20.1
- Material: ASTM B62-93 (C83600)
- Imported. Manufactured for AGI in an ISO 9001 facility.



BCR Series



BC Series



BC Reducer Series

Case quantities
required
please for fittings
through 2"

SIAM - THAILAND ISO 9001

Part Number	Size	Ctn Qty	List Price
Cross, fipt			
BCR1/8	1/8"	100	\$ 21.93
BCR1/4	1/4"	275	21.93
BCR3/8	3/8"	125	21.93
BCR1/2	1/2"	25	26.64
BCR3/4	3/4"	10	25.81
BCR1	1"	5	40.89
BCR11/4	1 1/4"	1	64.04
BCR11/2	1 1/2"	8	84.96
BCR2	2"	1	170.40

Couplings, fipt x fipt

BC1/8	1/8"	25	6.71
BC1/4	1/4"	25	6.71
BC3/8	3/8"	25	6.71
BC1/2	1/2"	25	8.41
BC3/4	3/4"	25	11.12
BC1	1"	25	16.86
BC11/4	1-1/4"	10	26.30
BC11/2	1-1/2"	10	35.72
BC2	2"	5	58.82
BC21/2	2 1/2"	1	127.30
BC3	3"	1	176.54
BC4	4"	1	338.50

Couplings, Reducing fipt x fipt

BC1/4X1/8	1/4 x 1/8"	25	7.14
BC3/8X1/8	3/8 x 1/8"	25	6.59
BC3/8X1/4	3/8" x 1/4"	25	7.14
BC1/2X1/8	1/2" X 1/8"	100	10.77
BC1/2X1/4	1/2 x 1/4"	25	8.95
BC1/2X3/8	1/2 x 3/8"	25	8.95
BC3/4X1/4	3/4 x 1/4"	25	14.75
BC3/4X3/8	3/4" X 3/8"	50	14.43
BC3/4X1/2	3/4 x 1/2"	25	13.27
BC1X3/8	1" X 3/8"	25	22.11
BC1X1/2	1 x 1/2"	25	22.11
BC1X3/4	1 x 3/4"	25	22.11
BC11/4X1/2	1-1/4 x 1/2"	10	39.44
BC11/4X3/4	1-1/4 x 3/4"	10	35.72
BC11/4X1	1-1/4 x 1"	10	35.72
BC11/2X1/2	1 1/2" X 1/2"	35	64.49
BC11/2X3/4	1 1/2" x 3/4"	10	50.87
BC11/2X1	1-1/2 x 1"	10	45.17
BC11/2X11/4	1-1/2 x 1-1/4"	10	45.17
BC2X1/2	2" X 1/2"	25	96.71
BC2X3/4	2" X 3/4"	15	96.71
BC2X1	2 x 1"	10	75.62
BC2X11/4	2 x 1-1/4"	10	67.19
BC2X11/2	2 x 1-1/2"	5	67.19

Threaded Bronze 125 lb. CHINA

- Threads: ANSI B16.15 125S fittings
- Threads: ANSI B16.24 150S flanges
- Material: ASTM B584-C84400

CHINA

Part Number	Ctn Qty	List Price
Cross, fipt		
TBCR1/8	180	\$ 11.36
TBCR1/4	80	11.36
TBCR3/8	30/60	11.36
TBCR1/2	45	11.36
TBCR3/4	30/60	16.38
TBCR1	40	35.97
TBCR11/4	24	40.67
TBCR2	5/10	108.24

Couplings, fipt x fipt

TBC1/8	60/720	4.26
TBC1/4	150/600	4.26
TBC3/8	100/400	4.26
TBC1/2	50/200	5.37
TBC3/4	25/100	7.09
TBC1	100	10.68
TBC11/4	75	16.70
TBC11/2	50	22.69
TBC2	30	37.37

Couplings, Reducing fipt x fipt

TBC1/4X1/8	35/420	4.58
TBC3/8X1/8	30/360	4.58
TBC3/8X1/4	30/360	4.58
TBC1/2X1/8	70/280	5.67
TBC1/2X1/4	75/300	5.67
TBC1/2X3/8	40/240	5.67
TBC3/4X1/4	50/200	9.35
TBC3/4X3/8	30/180	8.44
TBC3/4X1/2	45/180	8.44
TBC1X1/2	30/120	14.05
TBC1X3/4	25/100	14.05
TBC11/4X1/2	25/75	25.07
TBC11/4X3/4	90	22.69
TBC11/4X1	80	22.69
TBC11/2X1/2	20/60	32.32
TBC11/2X3/4	30/90	32.32
TBC11/2X1	65	28.69
TBC11/2X11/4	60	28.69
TBC2X1/2	40	48.01
TBC2X3/4	40	48.01
TBC2X1	40	48.01
TBC2X11/4	40	42.65
TBC2X11/2	35	42.65

Threaded Bronze Fittings



Threaded Bronze 125 lb. SIAM

- Dimension: ANSI B16.15, ASME B16.14, A-A-59617, MSS-SP-106
- Threads: ANSI/ASME B1.20.1
- Material: ASTM B62-93 (C83600)
- Imported. Manufactured for AGI in an ISO 9001 facility.



BB Series

SIAM - THAILAND

ISO 9001

Part Number	Size	Ctn Qty	List Price
Bushing, mipt x fipt			
BB1/4X1/8	1/4 x 1/8"	25	5.72
BB3/8X1/8	3/8 x 1/8"	25	6.61
BB3/8X1/4	3/8 x 1/4"	25	6.83
BB1/2X1/8	1/2" x 1/8"	25	6.34
BB1/2X1/4	1/2 x 1/4"	25	5.34
BB1/2X3/8	1/2 x 3/8"	25	5.34
BB3/4X1/8	3/4 x 1/8"	25	8.88
BB3/4X1/4	3/4 x 1/4"	25	8.88
BB3/4X3/8	3/4 x 3/8"	25	7.32
BB3/4X1/2	3/4 x 1/2"	25	7.32
BB1X1/4	1 x 1/4"	25	13.51
BB1X3/8	1" X 3/8"	125	13.51
BB1X1/2	1 x 1/2"	25	11.12
BB1X3/4	1 x 3/4"	25	11.12
BB11/4X1/4	1-1/4 x 1/4"	25	22.72
BB11/4X3/8	1 1/4" X 3/8"	25	29.43
BB11/4X1/2	1 1/4" x 1/2"	25	22.72
BB11/4X3/4	1-1/4 x 3/4"	25	18.93
BB11/4X1	1-1/4 x 1"	25	18.93
BB11/2X1/2	1-1/2 x 1/2"	25	29.52
BB11/2X3/4	1-1/2 x 3/4"	25	29.52
BB11/2X1	1-1/2 x 1"	25	24.16
BB11/2X11/4	1-1/2 x 1-1/4"	25	24.16
BB2X1/2	2 X 1/2"	10	43.05
BB2X3/4	2 x 3/4"	10	43.05
BB2X1	2 x 1"	10	43.05
BB2X11/4	2 x 1-1/4"	10	35.72
BB2X11/2	2 x 1-1/2"	10	35.72
BB21/2X1	2 1/2" X 1	5	109.95
BB21/2X11/4	2 1/2" X 1 1/4"	5	109.95
BB21/2X11/2	2 1/2" X 1 1/2"	5	109.94
BB21/2X2	2-1/2 x 2"	5	71.48
BB3X1	3" X 1"	5	321.23
BB3X2	3 x 2"	5	108.10
Caps, fipt			
BCP1/8	1/8"	25	5.02
BCP1/4	1/4"	25	5.02
BCP3/8	3/8"	25	5.02
BCP1/2	1/2"	25	6.71
BCP3/4	3/4"	25	8.88
BCP1	1"	25	13.77
BCP11/4	1-1/4"	25	21.07
BCP11/2	1-1/2"	10	28.43
BCP2	2"	10	48.26
BCP21/2	2 1/2"	5	120.02
BCP3	3"	1	191.41
BCP4	4"	1	281.71



BCP Series

Threaded Bronze 125 lb. CHINA

- Threads: ANSI B16.15 125S fittings
- Threads: ANSI B16.24 150S flanges
- Material: ASTM B584-C84400

CHINA

Part Number	Ctn Qty	List Price
Bushing, mipt x fipt		
TBB1/4X1/8	240/1440	\$ 3.37
TBB3/8X1/8	100/600	3.37
TBB3/8X1/4	100/600	3.37
TBB1/2X1/8	150/600	4.05
TBB1/2X1/4	100/600	3.37
TBB1/2X3/8	100/600	3.37
TBB3/4X1/8	50/300	5.61
TBB3/4X1/4	50/300	5.61
TBB3/4X3/8	50/300	4.67
TBB3/4X1/2	50/300	4.67
TBB1X1/4	50/200	8.55
TBB1X3/8	200	8.55
TBB1X1/2	50/200	7.09
TBB1X3/4	50/200	7.09
TBB11/4X1/4	30/120	14.45
TBB11/4X1/2	30/120	14.45
TBB11/4X3/4	30/120	12.01
TBB11/4X1	30/120	12.01
TBB11/2X1/2	25/75	18.75
TBB11/2X3/4	25/75	18.75
TBB11/2X1	25/75	15.34
TBB11/2X11/4	25/75	15.34
TBB2X1/2	60	27.33
TBB2X3/4	20/60	27.33
TBB2X1	20/60	27.33
TBB2X11/4	20/60	22.69
TBB2X11/2	20/60	22.69
TBB21/2X2	1/32	45.39
TBB3X1	1/20	79.95
TBB3X2	1/20	68.67
Caps, fipt		
TBCP1/8	100/1200	3.17
TBCP1/4	200/800	3.17
TBCP3/8	50/600	3.17
TBCP1/2	50/300	4.26
TBCP3/4	40/240	5.61
TBCP1	35/140	8.77
TBCP11/4	25/100	13.36
TBCP11/2	25/75	18.07
TBCP2	18/54	30.64



Threaded Bronze Fittings

Threaded Bronze 125 lb. SIAM

- Dimension: ANSI B16.15, ASME B16.14, A-A-59617, MSS-SP-106
- Threads: ANSI/ASME B1.20.1
- Material: ASTM B62-93 (C83600)
- Imported. Manufactured for AGI in an ISO 9001 facility.

Threaded Bronze 125 lb. CHINA

- Threads: ANSI B16.15 125S fittings
- Threads: ANSI B16.24 150S flanges
- Material: ASTM B584-C84400

SIAM - THAILAND

ISO 9001

CHINA

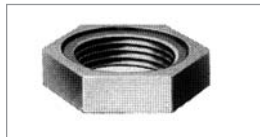

BLN Series

Part Number	Size	Ctn Qty	List Price
Lock Nut			
BLN1/8	1/8"	25	\$ 3.49
BLN1/4	1/4"	25	3.49
BLN3/8	3/8"	25	3.49
BLN1/2	1/2"	25	5.34
BLN3/4	3/4"	25	6.34
BLN1	1"	25	9.43
BLN11/4	1 1/4"	25	15.36
BLN11/2	1 1/2"	25	19.91
BLN2	2"	10	31.65



BP Series

Part Number	Size	Ctn Qty	List Price
Square Head Plug, mipt			
BP1/8	1/8"	25	6.23
BP1/4	1/4"	25	5.77
BP3/8	3/8"	25	7.06
BP1/2	1/2"	25	6.64
BP3/4	3/4"	25	7.56
BP1	1"	25	9.97
BP11/4	1-1/4"	25	14.88
BP11/2	1-1/2"	25	18.97
BP2	2"	10	29.83
BP21/2	2 1/2"	5	70.73
BP3	3"	5	81.82
BP4	4"	1	220.72



BU Series

Part Number	Size	Ctn Qty	List Price
Threaded Union, fipt x fipt			
BU1/8	1/8"	25	26.52
BU1/4	1/4"	25	22.42
BU3/8	3/8"	25	22.42
BU1/2	1/2"	25	24.43
BU3/4	3/4"	25	33.78
BU1	1"	10	44.73
BU11/4	1-1/4"	5	65.49
BU11/2	1-1/2"	5	77.41
BU2	2"	1	119.13
BU21/2	2 1/2"	1	323.78
BU3	3"	1	361.96
BU4	4"	1	1103.60

Part Number	Ctn Qty	List Price
Lock Nut		
TBLN1/8	100/600	\$ 2.18
TBLN1/4	100/400	2.18
TBLN3/8	500/1000	2.18
TBLN1/2	100/600	3.37
TBLN3/4	50/300	4.05
TBLN1	60/240	5.98
TBLN11/4	30/120	9.73
TBLN11/2	25/100	12.65
TBLN2	30/90	20.11

Part Number	Ctn Qty	List Price
Square Head Plug, mipt		
TBP1/8	900/3600	3.68
TBP1/4	500/2000	3.68
TBP3/8	45/540	3.68
TBP1/2	150/600	4.24
TBP3/4	100/400	4.81
TBP1	50/200	6.32
TBP11/4	35/140	9.46
TBP11/2	30/120	12.01
TBP2	100	18.97

TBP3	30	50.19
------	----	--------------

Part Number	Ctn Qty	List Price
Threaded Union, fipt x fipt		
TBU1/8	30/180	14.27
TBU1/4	60/240	14.27
TBU3/8	35/140	14.27
TBU1/2	25/100	15.50
TBU3/4	20/80	21.46
TBU1	35/70	28.42
TBU11/4	35	41.61
TBU11/2	25	49.15
TBU2	18	75.68

TBU3	8	229.91
------	---	---------------

Threaded Bronze Fittings - Chrome Plated



Threaded Bronze 125 lb. SIAM

- Dimension: ANSI B16.15, ASME B16.14, A-A-59617, MSS-SP-106
- Threads: ANSI/ASME B1.20.1
- Material: ASTM B62-93 (C83600)
- Imported. Manufactured for AGI in an ISO 9001 facility.

ISO 9001



CP90L Series



CP45L Series



CP90SL Series



CPT Series



CPC Series

Part Number	Size	Ctn Qty	List Price
90 ° Elbow, fipt x fipt			
CP90L3/8	3/8"	25	\$ 44.93
CP90L1/2	1/2"	25	44.93
CP90L3/4	3/4"	25	60.11
CP90L1	1"	25	97.77
45° Elbows, fipt x fipt			
CP45L3/8	3/8"	25	55.24
CP45L1/2	1/2"	25	55.24
CP45L3/4	3/4"	25	78.43
CP45L1	1"	25	133.81
90 ° Street Elbow, fipt x mipt			
CP90SL3/8	3/8"	25	60.11
CP90SL1/2	1/2"	25	60.11
CP90SL3/4	3/4"	25	82.73
CP90SL1	1"	10	135.35
Tee, fipt x fipt x fipt			
CPT3/8	3/8"	25	52.78
CPT1/2	1/2"	25	52.78
CPT3/4	3/4"	25	75.01
CPT1	1"	10	135.35
Couplings, fipt x fipt			
CPC3/8	3/8"	25	37.59
CPC1/2	1/2"	25	37.59
CPC3/4	3/4"	25	52.78
CPC1	1"	25	90.02



Malleable Iron Fittings - Imported

Imported Malleable Iron Fitting Features:

- Class 150 malleable iron pipe fittings
- Suitable for water, steam, air, gas and oil
- All fittings are air pressure tested
- Working pressure: Max: 300 psi @ -20°F to 150°F., Min 150 psi @ 350°F
- Made in China
- Tensile Strength: Min 48000 psi (330 MPa)
- Elongation: Min 8%

Specifications:

Material: ANSI/ASTM A197
 Dimensions: ANSI B.16.3 fittings
 ASME/ANSI B.16.39 unions
 Threads: ASME/ANSI B.1.20.1

ISO 9002

All class 150 imported malleable iron pipe fittings are manufactured under a quality control program complying with CSA B-51 specifications.
 Canadian Registration Number OA5312.5C
 Galvanized ONLY: NSF 61-4 Listed by IAPMO R&T. Meets CA AB1953



BLACK

GALVANIZED



BIM90L/GIM90L Series



BIM90L/GIM90L Reducer Series

Size	Inner/Master Ctn Qty	List Price
90° ELBOW fipxfipt		
BIM90L1/8	50/600	\$ 2.05
BIM90L1/4	35/420	1.94
BIM90L3/8	45/270	1.94
BIM90L1/2 UF	50/200	1.46
BIM90L3/4 UF	30/90	2.21
BIM90L1 UF	20/60	3.12
BIM90L11/4 UF	20/40	5.07
BIM90L11/2 UF	10/20	6.64
BIM90L2 UF	8/16	11.40
BIM90L21/2 UF	1/15	24.79
BIM90L3 UF	1/10	37.00
BIM90L4 UF	1/5	78.62
90° ELBOW REDUCER fipxfipt		
BIM90L3/8X1/8	60/360	4.06
BIM90L3/8X1/4	60/360	2.56
BIM90L1/4X1/8	60/360	3.50
BIM90L1/2X1/8	40/240	2.51
BIM90L1/2X1/4 UF	40/240	2.51
BIM90L1/2X3/8 UF	50/200	2.40
BIM90L3/4X1/2	40/120	2.52
BIM90L3/4X1/4 UF	50/150	3.34
BIM90L3/4X3/8 UF	50/150	3.34
BIM90L1X1/4 UF	30/90	5.27
BIM90L1X3/8 UF	30/90	5.27
BIM90L1X3/4 UF	30/90	3.23
BIM90L11/4X1/2 UF	30/60	6.97
BIM90L11/4X1 UF	20/40	5.27
BIM90L11/4X3/4 UF	30/60	5.96
BIM90L11/2X1 UF	20/40	8.62
BIM90L11/2X11/4 UF	15/30	8.62
BIM90L2X1 UF	14/28	12.43
BIM90L2X11/4 UF	10/20	12.43
BIM90L2X11/2 UF	10/20	10.92
BIM90L21/2X3/4 F	9/18	30.51
BIM90L21/2X1 F	1/16	30.51
BIM90L21/2X11/4 F	1/15	30.51
BIM90L21/2X11/2 UF	1/15	30.51
BIM90L21/2X2 UF	1/15	30.00
BIM90L3X2 UF	1/10	48.46

Size	Inner/Master Ctn Qty	List Price
90° ELBOW fipxfipt		
GIM90L1/8	50/600	\$ 2.87
GIM90L1/4	35/420	2.73
GIM90L3/8	45/270	2.73
GIM90L1/2 UF	50/200	1.84
GIM90L3/4 UF	30/90	2.24
GIM90L1 UF	20/60	4.07
GIM90L11/4 UF	20/40	6.25
GIM90L11/2 UF	10/20	8.25
GIM90L2 UF	8/16	13.73
GIM90L21/2 UF	1/15	34.18
GIM90L3 UF	1/10	57.43
GIM90L4 UF	1/5	99.47
90° ELBOW REDUCER fipxfipt		
GIM90L3/8X1/8	60/360	5.24
GIM90L3/8X1/4	60/360	3.70
GIM90L1/4X1/8	60/360	4.15
GIM90L1/2X1/8	40/240	3.45
GIM90L1/2X1/4 UF	40/240	3.45
GIM90L1/2 x 3/8 UF	50/200	3.45
GIM90L3/4 x 1/2 UF	40/120	3.34
GIM90L3/4X1/4 UF	50/150	4.40
GIM90L3/4X3/8 UF	50/150	4.40
GIM90L1X1/4 UF	30/90	6.93
GIM90L1X3/8 UF	30/90	6.93
GIM90L1 x 3/4 UF	30/90	4.27
GIM90L11/4 x 1 UF	20/40	7.10
GIM90L11/2 x 1 UF	20/40	10.94
GIM90L11/2 x 11/4 UF	15/30	10.94
GIM90L2 x 1 UF	14/28	15.21
GIM90L2 x 11/4 UF	10/20	15.21
GIM90L2 x 11/2 UF	10/20	13.27
GIM90L21/2X3/4 F	9/18	48.63
GIM90L21/2X1 F	1/16	48.63
GIM90L21/2X11/4 F	1/15	48.63
GIM90L21/2X11/2 UF	1/15	48.63
GIM90L21/2X2 UF	1/15	43.31
GIM90L3X2 UF	1/10	68.40

U - UL Approval
 F - FM Approval



www.americangranby.com
 In the United States: Phone (800) 776-2266 Fax (800) 729-3299
 In Canada: Phone (866) 503-5523 Fax (888) 562-2095

6/14/11

12.33

Malleable Iron Fittings - Imported



BLACK

GALVANIZED



BIM45L/GIM45L Series

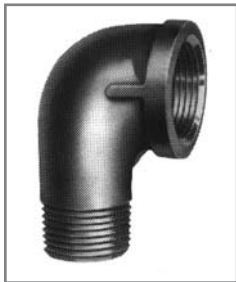

BIM90SL/GIM90SL Series

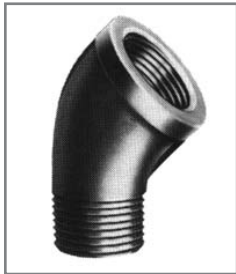

BIM45SL/GIM45SL Series



BIMT/GIMT Series

U - UL Approval
F - FM Approval

Size	Inner/Master Ctn Qty	List Price
45° ELBOW fiptxfipt		
BIM45L1/8	50/600	\$ 2.96
BIM45L1/4	35/420	3.06
BIM45L3/8	50/300	2.79
BIM45L1/2 UF	50/200	2.40
BIM45L3/4 UF	40/120	2.93
BIM45L1 UF	20/60	3.74
BIM45L11/4 UF	20/40	6.52
BIM45L11/2 UF	15/30	8.07
BIM45L2 UF	9/18	12.12
BIM45L21/2 UF	1/15	34.20
BIM45L3 UF	1/10	44.44
BIM45L4 UF	1/6	86.27
90° STREET ELBOW fiptxmpt		
BIM90SL1/8	50/600	2.96
BIM90SL1/4	35/420	2.96
BIM90SL3/8	40/240	2.96
BIM90SL1/2 UF	60/180	3.07
BIM90SL3/4 UF	30/90	2.96
BIM90SL1 UF	30/60	4.29
BIM90SL11/4 UF	20/40	6.52
BIM90SL11/2 UF	13/26	8.73
BIM90SL2 UF	7/14	14.09
BIM90SL21/2 UF	1/13	34.83
BIM90SL3 UF	1/8	53.14
45° STREET ELBOW fiptxmpt		
BIM45SL1/8	50/600	4.62
BIM45SL1/4	35/420	3.45
BIM45SL3/8	45/270	3.91
BIM45SL1/2 UF	100/200	3.12
BIM45SL3/4 UF	60/120	4.85
BIM45SL1 UF	30/60	5.61
BIM45SL11/4 UF	20/40	9.67
BIM45SL11/2 UF	15/30	12.00
TEE fiptxfiptxfipt		
BIMT1/8	75/450	3.12
BIMT1/4	50/300	2.95
BIMT3/8 UF	45/180	2.95
BIMT1/2 UF	40/120	1.93
BIMT3/4 UF	35/70	2.69
BIMT1 UF	20/40	4.80
BIMT11/4 UF	14/28	7.75
BIMT11/2 UF	11/22	9.67
BIMT2 UF	6/12	16.44
BIMT21/2 UF	1/10	33.79
BIMT3 UF	1/6	50.76
BIMT4 UF	1/4	119.12

Size	Inner/Master Ctn Qty	List Price
45° ELBOW fiptxfipt		
GIM45L1/8	50/600	\$ 4.11
GIM45L1/4	35/420	3.65
GIM45L3/8	50/300	3.59
GIM45L1/2 UF	50/200	2.81
GIM45L3/4 UF	40/120	3.93
GIM45L1 UF	20/60	4.49
GIM45L11/4 UF	20/40	8.19
GIM45L11/2 UF	15/30	9.76
GIM45L2 UF	9/18	14.59
GIM45L21/2 UF	1/15	49.37
GIM45L3 UF	1/10	71.74
GIM45L4 UF	1/6	120.29
90° STREET ELBOW fiptxmpt		
GIM90SL1/8	50/600	3.90
GIM90SL1/4	35/420	3.75
GIM90SL3/8	40/240	3.75
GIM90SL1/2 UF	60/180	3.84
GIM90SL3/4 UF	35/90	3.75
GIM90SL1 UF	30/60	5.11
GIM90SL11/4 UF	20/40	8.58
GIM90SL11/2 UF	13/26	10.53
GIM90SL2 UF	7/14	18.26
GIM90SL21/2 UF	1/13	49.53
GIM90SL3 UF	1/8	74.77
45° STREET ELBOW fiptxmpt		
GIM45SL1/8	50/600	5.37
GIM45SL1/4	35/420	4.58
GIM45SL3/8	45/270	5.22
GIM45SL1/2 UF	100/200	4.00
GIM45SL3/4 UF	60/120	6.54
GIM45SL1 UF	30/60	8.07
GIM45SL11/4 UF	20/40	12.15
GIM45SL11/2 UF	15/30	14.67
TEE fiptxfiptxfipt		
GIMT1/8	75/450	4.07
GIMT1/4	50/300	3.54
GIMT3/8	45/180	3.54
GIMT1/2 UF	40/120	2.17
GIMT3/4 UF	35/70	3.67
GIMT1 UF	20/40	5.98
GIMT11/4UF	14/28	9.48
GIMT11/2 UF	11/22	11.84
GIMT2 UF	6/12	19.76
GIMT21/2 UF	1/10	53.03
GIMT3 UF	1/6	62.20
GIMT4 UF	1/4	147.06

Carton Quantities subject to change. Contact Customer Service

6/14/11

12.34



In the United States: Phone (800) 776-2266 Fax (800) 729-3299
In Canada: Phone (866) 503-5523 Fax (888) 562-2095

www.americangranby.com



Malleable Iron Fittings - Imported

BLACK

GALVANIZED



**BIMT/GIMT
Reducer Series**

Size	Inner/Master Ctn Qty	List Price
TEE REDUCER fiptxfiptxfipt		
BIMT1/2X1/2X3/8 UF	45/180	\$ 3.73
BIMT3/4x1/2x1/2 UF	45/90	3.94
BIMT3/4X1/2x3/4 UF	45/90	4.33
BIMT3/4X3/4X1/4 UF	50/100	4.18
BIMT3/4x3/4x1/2 UF	45/90	3.51
BIMT3/4X3/4X1 UF	25/50	3.79
BIMT1X1/2X1/2 UF	30/60	6.43
BIMT1X1/2X3/4 UF	25/50	6.43
BIMT1X1/2X1 UF	30/60	5.52
BIMT1X3/4X1/2 UF	25/50	5.48
BIMT1x3/4x3/4 UF	25/50	5.10
BIMT1x3/4x1 UF	25/50	5.52
BIMT1x1x1/2 UF	35/70	4.85
BIMT1x1x3/4 UF	30/60	4.85
BIMT1X1X11/4 UF	18/36	10.24
BIMT11/4X1/2X11/4 UF	10/40	10.02
BIMT11/4X3/4X3/4 UF	20/40	10.02
BIMT11/4X3/4X1 UF	18/36	9.39
BIMT11/4x3/4x11/4 UF	18/36	9.15
BIMT11/4X1X1/2 UF	18/36	9.74
BIMT11/4X1X3/4 UF	18/36	8.83
BIMT11/4X1X1 UF	20/40	8.83
BIMT11/4X11/4X1/2 UF	20/40	8.77
BIMT11/4x11/4x3/4 UF	18/36	7.69
BIMT11/4x11/4x1 UF	18/36	7.69
BIMT11/4x1x11/4 UF	18/36	10.24
BIMT11/2X1/2X11/2 UF	13/26	11.99
BIMT11/2X3/4X3/4 F	13/26	19.12
BIMT11/2X3/4X11/4 F	11/22	9.13
BIMT11/2X3/4X11/2 UF	13/26	11.99
BIMT11/2X1X3/4 F	18/36	11.97
BIMT11/2X1X1 UF	15/30	11.97
BIMT11/2X1X11/2 UF	13/26	11.99
BIMT11/2X11/4X3/4 UF	11/22	11.99
BIMT11/2X11/4X1 UF	11/22	10.30
BIMT11/2X11/4X11/4 UF	11/22	16.20
BIMT11/2X11/2X1/2 UF	20/40	10.26
BIMT11/2x11/2x3/4 UF	15/30	9.74
BIMT11/2x11/2x1 UF	13/26	9.74
BIMT11/2X11/2X11/4 UF	13/26	11.78
BIMT2X1/2X2 UF	10/20	18.75
BIMT2X3/4X3/4	9/18	18.40
BIMT2X3/4X2 UF	9/18	18.40
BIMT2X1X2 UF	9/18	18.75
BIMT2X11/2X11/4 UF	8/16	18.75
BIMT2X11/2X11/2 UF	8/16	18.40
BIMT2X11/2X2 UF	8/16	18.75
BIMT2X2X1/2 UF	10/20	15.20
BIMT2X2X1 UF	9/18	15.20
BIMT2X2X11/4 UF	9/18	16.07
BIMT2X2X11/2 UF	9/18	16.07

Size	Inner/Master Ctn Qty	List Price
TEE REDUCER fiptxfiptxfipt		
GIMT1/2X1/2X3/8	45/180	\$ 4.50
GIMT3/4x1/2x1/2 UF	45/90	5.24
GIMT3/4X3/4X1/4 UF	45/90	4.77
GIMT3/4x3/4x1/2 UF	50/100	4.62
GIMT3/4x1/2x3/4 UF	45/90	5.24
GIMT3/4X3/4X1 UF	25/50	7.99
GIMT1X1/2X3/4 UF	25/50	7.97
GIMT1X1/2X1 UF	30/60	5.54
GIMT1X3/4X1/2 UF	25/50	5.54
GIMT1x3/4x3/4 UF	25/50	7.78
GIMT1x3/4x1 UF	25/50	7.78
GIMT1x1x1/2 UF	35/70	6.46
GIMT1x1x3/4 UF	30/60	6.46
GIMT1X1X11/4 UF	18/36	12.41
GIMT11/4X1/2X11/4 UF	10/40	8.36
GIMT11/4X3/4X3/4 UF	20/40	8.36
GIMT11/4x3/4x1 UF	18/36	12.72
GIMT11/4x3/4x11/4 UF	18/36	11.48
GIMT11/4X1X1/2 UF	18/36	12.13
GIMT11/4X1X3/4 UF	18/36	12.16
GIMT11/4X1X1 UF	20/40	8.36
GIMT11/4x11/4x3/4 UF	18/36	10.02
GIMT11/4x11/4x1 UF	18/36	10.02
GIMT11/4x1x11/4 UF	18/36	12.41
GIMT11/2X1/2X11/2 UF	13/26	16.82
GIMT11/2X3/4X3/4 F	13/26	22.18
GIMT11/2X3/4X11/4 F	11/22	10.55
GIMT11/2X3/4X11/2 UF	13/26	15.31
GIMT11/2X1X3/4 F	18/36	10.55
GIMT11/2X1X1 UF	15/30	10.55
GIMT11/2X1X11/2 UF	13/26	15.31
GIMT11/2X11/4X3/4 UF	11/22	15.31
GIMT11/2X11/4X1 UF	11/22	15.00
GIMT11/2X11/4X11/4 UF	11/22	21.37
GIMT11/2X11/2X1/2 UF	20/40	10.55
GIMT11/2x11/2x3/4 UF	15/30	12.41
GIMT11/2x11/2x1 UF	13/26	12.41
GIMT11/2X11/2X11/4 UF	13/26	10.55
GIMT2X1/2X2 UF	10/20	21.63
GIMT2X3/4X3/4	9/18	21.22
GIMT2X3/4X2 UF	9/18	21.22
GIMT2X1X2 UF	9/18	21.63
GIMT2X11/2X11/4 UF	8/16	21.63
GIMT2X11/2X11/2 UF	8/16	21.22
GIMT2X11/2X2 UF	8/16	21.63
GIMT2X2X1 UF	9/18	17.96
GIMT2X2X11/4 UF	9/18	21.10
GIMT2X2X11/2 UF	9/18	21.10

U - UL Approval
F - FM Approval



In the United States: Phone (800) 776-2266 Fax (800) 729-3299
In Canada: Phone (866) 503-5523 Fax (888) 562-2095

www.americangranby.com

6/14/11

12.35

Malleable Iron Fittings - Imported



BLACK

GALVANIZED



BIMT/GIMT
Reducer Series



BIMST/GIMST
Reducer Series



BIMCR/GIMCR Series



BIMRHC/GIMRHC
Series

Size	Inner/Master Ctn Qty	List Price
BIMT21/2X21/2X1 UF	1/10	\$39.90
BIMT21/2X21/2X1 1/2 UF	1/10	39.90
BIMT21/2X21/2X2 UF	1/10	39.97
BIMT3X3X3/4 UF	1/12	54.38
BIMT3X3X1 UF	1/12	53.40
BIMT3X3X1 1/4 UF	1/12	54.38
BIMT3X3X1 1/2 UF	1/12	53.40
BIMT3X3X2 UF	1/6	53.40
BIMT3X3X2 1/2 UF	1/6	61.03
street TEE fiptxfiptxmpt		
BIMST1/2 UF	25/150	4.89
BIMST3/4 UF	25/100	6.52
BIMST1 UF	20/60	8.91
BIMST1 1/4 UF	20/40	18.25
CROSS fipt		
BIMCR1/8	60/180	7.10
BIMCR1/4	80/240	6.03
BIMCR3/8	60/120	6.16
BIMCR1/2 UF	45/90	6.97
BIMCR3/4 UF	30/60	8.49
BIMCR1 UF	16/32	10.49
BIMCR1 1/4 UF	9/18	17.02
BIMCR1 1/2 UF	8/16	21.05
BIMCR2 UF	5/10	34.83
BIMCR2 1/2 UF	1/6	61.48
BIMCR3 UF	1/4	91.66
BIMCR4 UF	1/2	187.10
Right Hand Coupling fiptxfipt		
BIMRHC1/4	40/480	2.49
BIMRHC3/8	50/300	2.49
BIMRHC1/2 UF	60/240	1.99
BIMRHC3/4 UF	50/150	2.31
BIMRHC1 UF	25/75	3.52
BIMRHC1 1/4 UF	32/64	4.55
BIMRHC1 1/2 UF	18/36	6.07
BIMRHC2 UF	12/24	8.86
BIMRHC2 1/2 UF	1/16	24.11
BIMRHC3 UF	1/12	32.59
BIMRHC4 UF	1/7	65.01

Size	Inner/Master Ctn Qty	List Price
GIMT21/2X21/2X1 UF	1/10	\$30.78
GIMT21/2X21/2X1 1/2 UF	1/10	30.78
GIMT21/2X21/2X2 UF	1/10	57.56
GIMT3X3X3/4 UF	1/12	81.60
GIMT3X3X1 UF	1/12	78.08
GIMT3X3X1 1/4 UF	1/12	79.61
GIMT3X3X1 1/2 UF	1/12	78.08
GIMT3X3X2 UF	1/6	78.08
GIMT3X3X2 1/2 UF	1/6	87.71
street TEE fiptxfiptxmpt		
GIMST1/2 UF	25/150	6.97
GIMST3/4 UF	25/100	7.62
GIMST1 UF	20/60	12.10
GIMST1 1/4 UF	20/40	25.01
CROSS fipt		
GIMCR1/8	60/180	9.05
GIMCR1/4	80/240	9.05
GIMCR3/8	60/120	9.05
GIMCR1/2 UF	45/90	9.07
GIMCR3/4 UF	30/60	11.07
GIMCR1 UF	16/32	15.25
GIMCR1 1/4 UF	9/18	22.10
GIMCR1 1/2 UF	8/16	26.84
GIMCR2 UF	5/10	51.15
GIMCR2 1/2 UF	1/6	97.60
GIMCR3 UF	1/4	131.48
GIMCR4 UF	1/2	265.63
Right Hand Coupling fiptxfipt		
GIMRHC1/4	40/480	3.18
GIMRHC3/8	50/300	3.18
GIMRHC1/2 UF	60/240	2.56
GIMRHC3/4 UF	50/150	2.94
GIMRHC1 UF	25/75	4.85
GIMRHC1 1/4 UF	32/64	6.60
GIMRHC1 1/2 UF	18/36	7.55
GIMRHC2 UF	12/24	11.07
GIMRHC2 1/2 UF	1/16	33.74
GIMRHC3 UF	1/12	45.10
GIMRHC4 UF	1/7	95.79

U - UL Approval
F - FM Approval

6/14/11

12.36



In the United States: Phone (800) 776-2266 Fax (800) 729-3299
In Canada: Phone (866) 503-5523 Fax (888) 562-2095

www.americangranby.com



Malleable Iron Fittings - Imported

BLACK

GALVANIZED

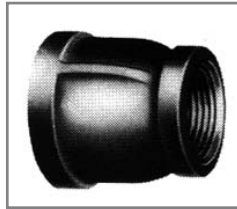

**BIMRC/GIMRC
Reducer Series**

Size	Inner/Master Ctn Qty	List Price
REDUCING COUPLING fiptxfipt		
BIMRC1/4 x 1/8	35/420	\$ 2.18
BIMRC3/8 x 1/4	30/360	2.18
BIMRC1/2 x 1/4 U	50/300	1.94
BIMRC1/2 x 3/8 UF	40/240	1.87
BIMRC3/4X1/4 U	30/180	2.47
BIMRC3/4 x 3/8 UF	30/180	2.47
BIMRC3/4 x 1/2 UF	60/180	2.10
BIMRC1X3/8 UF	40/120	3.88
BIMRC1 x 1/2 UF	25/100	3.30
BIMRC1 x 3/4 UF	25/100	3.30
BIMRC11/4 x 1/2 UF	25/75	4.78
BIMRC11/4 x 3/4 UF	25/75	4.15
BIMRC11/4 x 1 UF	20/60	4.15
BIMRC11/2 x 3/4 UF	30/60	6.85
BIMRC11/2 x 1 UF	25/50	6.07
BIMRC11/2 x 1 1/4 UF	24/48	5.22
BIMRC2 x 1/2 UF	21/42	9.88
BIMRC2 x 3/4 UF	21/42	8.69
BIMRC2 x 1 UF	21/42	8.22
BIMRC2 x 1 1/4 UF	18/36	8.69
BIMRC2 x 1 1/2 UF	18/36	7.58
BIMRC21/2X1 1/2 UF	1/16	22.62
BIMRC21/2X2 UF	1/20	19.38
BIMRC3X1	1/12	30.79
BIMRC3X1 1/4	1/12	30.79
BIMRC3X1 1/2 UF	1/12	30.22
BIMRC3X2 UF	1/12	25.09
BIMRC3X2 1/2 UF	1/12	30.22
BIMRC4X2 UF	1/9	60.57
BIMRC4X3 UF	1/8	60.57
HEX BUSHING miptxfipt		
BIMHB1/4X1/8	100/1200	2.64
BIMHB3/8x1/4	100/600	2.64
BIMHB1/2x1/8 U	150/600	2.64
BIMHB1/2x1/4 UF	100/600	2.64
BIMHB1/2x3/8 UF	100/600	2.64
BIMHB3/4X1/8 U	50/300	2.57
BIMHB3/4x1/4 U	50/300	2.54
BIMHB3/4x3/8 UF	50/300	2.57
BIMHB3/4x1/2 UF	50/300	2.40
BIMHB1X1/8 U	50/200	2.96
BIMHB1X1/4 U	50/200	3.21
BIMHB1X3/8 U	50/200	3.26
BIMHB1x1/2 UF	50/200	2.49
BIMHB1x3/4 UF	50/200	2.49
BIMHB11/4X1/4 U	30/120	4.13
BIMHB11/4X3/8 U	30/120	3.66
BIMHB11/4x1/2 UF	30/120	3.51
BIMHB11/4x3/4 UF	30/120	3.19
BIMHB11/4x1 UF	30/120	3.19



BIMHB/GIMHB Series

Size	Inner/Master Ctn Qty	List Price
REDUCING COUPLING fiptxfipt		
GIMRC1/4 x 1/8	35/240	\$ 2.71
GIMRC3/8 x 1/4	30/360	2.71
GIMRC1/2 x 1/4 U	50/300	2.44
GIMRC1/2 x 3/8 UF	40/240	2.31
GIMRC3/4X1/4 U	30/180	3.06
GIMRC3/4 x 3/8 UF	30/180	3.06
GIMRC3/4 x 1/2 UF	60/180	2.71
GIMRC1X3/8 UF	40/120	5.52
GIMRC1 x 1/2 UF	25/100	4.50
GIMRC1 x 3/4 UF	25/100	4.15
GIMRC11/4 x 1/2 UF	25/75	7.08
GIMRC11/4 x 3/4 UF	25/75	5.73
GIMRC11/4 x 1 UF	20/60	5.73
GIMRC11/2 x 3/4 UF	30/60	7.33
GIMRC11/2 x 1 UF	25/50	7.33
GIMRC11/2 x 1 1/4 UF	24/48	6.97
GIMRC2 x 1/2 UF	21/42	11.99
GIMRC2 x 3/4 UF	21/42	11.99
GIMRC2 x 1 UF	21/42	10.05
GIMRC2 x 1 1/4 UF	18/36	8.68
GIMRC2 x 1 1/2 UF	18/36	8.13
GIMRC21/2X1 1/2 UF	1/16	31.64
GIMRC21/2X2 UF	1/20	31.08
GIMRC3X1	1/12	42.08
GIMRC3X1 1/4	1/12	42.08
GIMRC3X1 1/2 UF	1/12	41.27
GIMRC3X2 UF	1/12	38.98
GIMRC3X2 1/2 UF	1/12	41.34
GIMRC4X2 UF	1/9	89.29
GIMRC4X3 UF	1/8	89.29
HEX BUSHING miptxfipt		
GIMHB1/4X1/8	100/1200	3.83
GIMHB3/8X1/4	100/600	3.83
GIMHB1/2x1/8 U	150/600	3.83
GIMHB1/2x1/4 UF	100/600	3.83
GIMHB1/2x3/8 UF	100/600	3.83
GIMHB3/4X1/8 U	50/300	4.40
GIMHB3/4x1/4 U	50/300	3.95
GIMHB3/4x3/8 UF	50/300	4.40
GIMHB3/4x1/2 UF	50/600	3.54
GIMHB1X1/8 U	50/200	4.14
GIMHB1X1/4 U	50/200	4.70
GIMHB1X3/8 U	50/200	7.32
GIMHB1x1/2 UF	50/200	4.24
GIMHB1x3/4 UF	50/200	3.99
GIMHB11/4X1/4 U	30/120	6.77
GIMHB11/4X3/8 U	30/120	6.77
GIMHB11/4x1/2 UF	30/120	5.93
GIMHB11/4x3/4 UF	30/120	5.40
GIMHB11/4x1 UF	30/120	5.40

U - UL Approval
F - FM Approval



In the United States: Phone (800) 776-2266 Fax (800) 729-3299
In Canada: Phone (866) 503-5523 Fax (888) 562-2095

www.americgranby.com

6/14/11

12.37

Malleable Iron Fittings - Imported



BLACK

GALVANIZED



BIMHB/GIMHB Series

Size	Inner/Master Ctn Qty	List Price
HEX BUSHING Cont. miptxfipt		
BIMHB11/2X1/4 U	25/75	\$ 4.86
BIMHB11/2x1/2 UF	25/75	4.00
BIMHB11/2x3/4 UF	25/75	4.00
BIMHB11/2x1 UF	25/75	3.51
BIMHB11/2x11/4 UF	25/75	4.00
BIMHB2X1/4 U	20/60	6.85
BIMHB2x1/2 UF	20/60	6.07
BIMHB2x3/4 UF	20/60	4.86
BIMHB2x1 UF	20/60	4.55
BIMHB2x11/4 UF	20/60	4.55
BIMHB2x11/2 UF	20/60	5.07
BIMHB21/2X3/4 UF	1/30	8.25
BIMHB21/2X1 UF	1/24	8.25
BIMHB21/2X11/4 UF	1/24	8.25
BIMHB21/2X11/2 UF	1/28	7.68
BIMHB21/2X2 UF	1/32	7.65
BIMHB3X3/4 UF	1/20	11.40
BIMHB3X1 UF	1/20	11.40
BIMHB3X11/4 UF	1/20	11.40
BIMHB3X11/2 UF	1/20	11.63
BIMHB3X2 UF	1/20	13.61
BIMHB3X21/2 UF	1/20	13.61
BIMHB31/2X3 UF	1/10	25.53
BIMHB4X3/4 F	1/10	23.12
BIMHB4X1 F	1/10	23.12
BIMHB4X11/4 UF	1/10	23.12
BIMHB4X11/2 UF	1/10	23.12
BIMHB4X2 F	1/10	20.16
BIMHB4X21/2 F	1/10	22.71
BIMHB4X3 UF	1/10	20.16
CAP fipt		
BIMCA3/8	50/600	1.62
BIMCA1/2 UF	50/300	1.47
BIMCA3/4 UF	40/240	1.99
BIMCA1 UF	35/140	2.40
BIMCA11/4 UF	25/100	3.12
BIMCA11/2 UF	25/75	4.27
BIMCA2 UF	18/54	5.57
BIMCA21/2 UF	1/30	13.86
BIMCA3 UF	1/20	20.60
BIMCA4 UF	1/14	32.16
BIMCA6 UF	1/2	128.50

Size	Inner/Master Ctn Qty	List Price
HEX BUSHING Cont. miptxfipt		
GIMHB11/2X1/4 U	25/75	\$ 8.59
GIMHB11/2x1/2 UF	25/75	7.84
GIMHB11/2x3/4 UF	25/75	7.84
GIMHB11/2x1 UF	25/75	7.06
GIMHB11/2X11/4 UF	25/75	6.52
GIMHB2X1/4 U	20/60	9.85
GIMHB2 x 1/2 UF	20/60	9.85
GIMHB2 x 3/4 UF	20/60	9.09
GIMHB2 x 1 F	20/60	8.64
GIMHB2 x 11/4 UF	20/60	8.64
GIMHB2 x 11/2 UF	20/60	7.55
GIMHB21/2X3/4 UF	1/30	14.19
GIMHB21/2X1 UF	1/24	14.19
GIMHB21/2X11/4 UF	1/24	14.19
GIMHB21/2X11/2 UF	1/28	13.87
GIMHB21/2X2 UF	1/32	12.36
GIMHB3X3/4 UF	1/20	18.72
GIMHB3X1 UF	1/20	18.72
GIMHB3X11/4 UF	1/20	18.72
GIMHB3X11/2 UF	1/20	18.36
GIMHB3X2 UF	1/20	16.64
GIMHB3X21/2 UF	1/20	17.63
GIMHB31/2X3 UF	1/10	41.40
GIMHB4X3/4 F	1/10	39.27
GIMHB4X1 F	1/10	39.27
GIMHB4X11/4 UF	1/10	39.27
GIMHB4X11/2 UF	1/10	39.27
GIMHB4X2 F	1/10	34.65
GIMHB4X21/2 F	1/10	39.27
GIMHB4X3 UF	1/10	36.63
CAP fipt		
GIMCA3/8	50/600	2.44
GIMCA1/2 UF	50/300	1.87
GIMCA3/4 UF	40/240	2.69
GIMCA1 UF	35/140	2.96
GIMCA11/4 UF	25/100	4.38
GIMCA11/2 UF	25/75	5.52
GIMCA2 UF	18/54	6.97
GIMCA21/2 UF	1/30	22.20
GIMCA3 UF	1/20	26.91
GIMCA4 UF	1/14	53.43
GIMCA6 UF	1/2	194.45



BIMCA/GIMCA Series

☺ Steel, Made in USA

Carton Quantities subject to change. Contact Customer Service

U - UL Approval
F - FM Approval

6/14/11

12.38



In the United States: Phone (800) 776-2266 Fax (800) 729-3299
In Canada: Phone (866) 503-5523 Fax (888) 562-2095

www.americangranby.com



Malleable Iron Fittings - Imported

BLACK

GALVANIZED



BIMP/GIMP Series



BIMU/GIMU Series



BIMFF/GIMFF Series



BIMEP/GIMEP Series

Size	Inner/Master Ctn Qty	List Price
Square Head Plug mipt		
BIMP1/8 ☺	100	\$ 0.66
BIMP1/4 ☺	100	0.66
BIMP3/8 ☺	45/540	0.99
BIMP1/2 UF ☺	40/480	1.03
BIMP3/4 UF ☺	25/300	1.11
BIMP1 UF	40/160	1.61
BIMP11/4 UF	25/100	2.39
BIMP11/2 UF	24/72	2.81
BIMP2 UF	15/45	3.97
BIMP21/2 UF	1/40	7.27
BIMP3 UF	1/30	9.96
BIMP4 F	1/8	20.88
BIMP5 UF	1/4	44.95
BIMP6 UF	1/2	55.47

Size	Inner/Master Ctn Qty	List Price
Unions, 150 lbs UL Listed fiptxfipt		
BIMU150-1/8	30 /180	\$ 9.66
BIMU150-1/4	30/180	9.18
BIMU150-3/8	35/140	6.21
BIMU150-1/2 UF	30/120	5.93
BIMU150-3/4 UF	25/75	8.91
BIMU150-1 UF	20/40	8.86
BIMU150-11/4 UF	18/36	11.75
BIMU150-11/2 UF	12/24	18.60
BIMU150-2 UF	8/16	27.87
BIMU150-21/2 UF	1/10	54.25
BIMU150-3 UF	1/5	65.88

Size	Inner/Master Ctn Qty	List Price
FLOOR FLANGE fipt		
BIMFF1/4	30/180	5.36
BIMFF3/8	50/200	5.36
BIMFF1/2 F	25/100	5.36
BIMFF3/4 F	20/80	5.73
BIMFF1 F	20/60	7.43
BIMFF11/4 F	15/45	10.22
BIMFF11/2 F	12/36	11.92
BIMFF2 F	8/24	14.46

Size	Inner/Master Ctn Qty	List Price
EXTENSION PIECE		
BIMEP1/2 F	50/300	4.29
BIMEP3/4 F	60/180	6.31
BIMEP1 F	30/60	8.78
BIMEP11/4 F	30/60	10.98
BIMEP11/2 F	1/35	11.75
BIMEP2 F	15/30	13.77

Size	Inner/Master Ctn Qty	List Price
Square Head Plug mipt		
GIMP1/8 ☺	100	\$ 1.00
GIMP1/4 ☺	100	1.00
GIMP3/8 ☺	45/540	1.31
GIMP1/2 UF ☺	40/480	1.44
GIMP3/4 UF ☺	25/300	1.48
GIMP1 UF	40/160	2.48
GIMP11/4 UF	25/100	4.15
GIMP11/2 UF	24/72	5.63
GIMP2 UF	15/45	7.08
GIMP21/2 UF	1/40	13.91
GIMP3 UF	1/30	19.73
GIMP4 F	1/8	40.89
GIMP5 UF	1/4	78.38
GIMP6 UF	1/2	81.18

Size	Inner/Master Ctn Qty	List Price
Unions, 150 lbs UL Listed fiptxfipt		
GIMU150-1/8	30/180	\$ 11.51
GIMU150-1/4	30/180	11.15
GIMU150-3/8	35/140	9.03
GIMU150-1/2 UF	30/120	7.08
GIMU150-3/4 UF	25/75	9.03
GIMU150-1 UF	20/40	10.65
GIMU150-11/4 UF	18/36	15.00
GIMU150-11/2 UF	12/24	18.50
GIMU150-2 UF	8/16	28.18
GIMU150-21/2 UF	1/10	47.80
GIMU150-3 UF	1/5	101.48

Size	Inner/Master Ctn Qty	List Price
FLOOR FLANGE fipt		
GIMFF1/4	30/180	11.44
GIMFF3/8	50/200	11.44
GIMFF1/2 F	25/100	11.44
GIMFF3/4 F	20/80	12.81
GIMFF1 F	20/60	14.08
GIMFF11/4 F	15/45	16.04
GIMFF11/2 F	12/36	19.99
GIMFF2 F	8/24	26.33

Size	Inner/Master Ctn Qty	List Price
EXTENSION PIECE		
GIMEP1/2 F	50/300	6.07
GIMEP3/4 F	60/180	9.07
GIMEP1 F	30/60	11.35
GIMEP11/4 F	30/60	13.82
GIMEP11/2 F	1/35	16.16
GIMEP2 F	15/30	20.88

U - UL Approval
F - FM Approval

Carton Quantities subject to change. Contact Customer Service



www.americangranby.com
In the United States: Phone (800) 776-2266 Fax (800) 729-3299
In Canada: Phone (866) 503-5523 Fax (888) 562-2095

6/14/11

12.39





Malleable Iron Fittings - Domestic

Domestic Malleable Iron Fitting Features:

- Class 150 malleable iron pipe fittings
- Suitable for water, steam, air, gas and oil
- All fittings are air pressure tested
- Working pressure:
 - Max: 300 psi @ -20°F to 150°F.
 - Min 150 psi @ 366°F
- Made in USA

Malleable Iron Fitting Specifications:

Material: ASTM A197
 Dimensions: ANSI/ASME B16.3
 ANSI/ASME B1.20.1
 Pressure ratings: ANSI/ASME B16.3
 Coatings: ASTM A153, A165



BLACK



BM90L/GM90L Series

Size	Ctn Qty	List Price
90° ELBOW fipxfipt		
BM90L1/8	35/210	\$ 6.00
BM90L1/4	30/180	5.86
BM90L3/8	30/180	5.86
BM90L1/2	50/200	4.06
BM90L3/4	35/140	4.90
BM90L1	20/80	8.51
BM90L11/4	20/40	14.03
BM90L11/2	8/32	18.46
BM90L2	8/16	31.82
BM90L21/2	12	70.88
BM90L3	5	103.72
BM90L4	4	222.79



BM90L/GM90L Reducer Series

Size	Ctn Qty	List Price
90° ELBOW REDUCER fipxfipt		
BM90L3/8 x 1/4	25/150	8.24
BM90L1/2 x 1/4	30/180	7.95
BM90L1/2 x 3/8	50/200	7.74
BM90L3/4 x 3/8	30/180	7.95
BM90L3/4 x 1/2	30/120	7.95
BM90L1 x 1/2	25/100	11.03
BM90L1 x 3/4	20/80	10.23
BM90L11/4 x 3/4	15/60	19.16
BM90L11/4 x 1	10/40	17.18
BM90L11/2 x 1/2	12/48	26.57
BM90L11/2 x 3/4	12/48	27.73
BM90L11/2 x 1	10/40	24.24
BM90L11/2 x 11/4	15/30	24.24
BM90L2 x 1/2	10/40	33.53
BM90L2 x 3/4	15/30	42.30
BM90L2 x 1	12/24	39.90
BM90L2 x 11/4	10/20	39.90
BM90L2 x 11/2	10/20	35.10
BM90L21/2 x 11/2	12	102.02

GALVANIZED

Size	Ctn Qty	List Price
90° ELBOW fipxfipt		
GM90L1/8	35/210	\$ 9.29
GM90L1/4	30/180	8.48
GM90L3/8	30/180	8.48
GM90L1/2	50/200	5.46
GM90L3/4	35/140	6.71
GM90L1	20/80	12.42
GM90L11/4	20/40	19.63
GM90L11/2	8/32	25.62
GM90L2	8/16	41.98
GM90L21/2	12	109.85
GM90L3	5	181.11
GM90L4	4	319.43

Size	Ctn Qty	List Price
90° ELBOW REDUCER fipxfipt		
GM90L3/8 x 1/4	25/150	13.58
GM90L1/2 x 1/4	30/180	11.71
GM90L1/2 x 3/8	50/200	10.05
GM90L3/4 x 3/8	30/180	16.09
GM90L3/4 x 1/2	30/120	11.66
GM90L1 x 1/2	25/100	15.89
GM90L1 x 3/4	20/80	14.97
GM90L11/4 x 3/4	15/60	30.16
GM90L11/4 x 1	10/40	25.10
GM90L11/2 x 1/2	12/48	34.66
GM90L11/2 x 3/4	12/48	40.12
GM90L11/2 x 1	10/40	40.12
GM90L11/2 x 11/4	15/30	40.12
GM90L2 x 1/2	10/40	44.87
GM90L2 x 3/4	15/30	56.88
GM90L2 x 1	12/24	55.75
GM90L2 x 11/4	10/20	53.74
GM90L2 x 11/2	10/20	46.88
GM90L21/2 x 11/2	12	177.02
GM90L3 x 2	8	250.82

Case quantities required please for fittings through 2"

Malleable Iron Fittings - Domestic



BLACK

GALVANIZED



BM45L/GM45L Series



BM90SL/GM90SL Series



BM45SL/GM45SL Series



BMT/GMT Series

Size	Ctn Qty	List Price
45° ELBOW fipxfipt		
BM45L1/4	35/210	\$ 8.83
BM45L3/8	40/240	8.83
BM45L1/2	50/200	6.70
BM45L3/4	40/160	8.29
BM45L1	25/100	10.44
BM45L11/4	10/40	18.47
BM45L11/2	10/40	22.84
BM45L2	8/16	34.54
BM45L21/2	15	99.95
BM45L3	8	129.83
BM45L4	4	254.58
90° STREET ELBOW fipxfipt		
BM90SL1/8	40/240	8.65
BM90SL1/4	30/180	8.65
BM90SL3/8	30/180	8.65
BM90SL1/2	50/200	8.40
BM90SL3/4	35/140	8.40
BM90SL1	20/80	11.89
BM90SL11/4	15/30	18.47
BM90SL11/2	12/24	24.71
BM90SL11/2 x 11/4	16/32	44.87
BM90SL2	8/16	40.15
BM90SL21/2	8	101.77
BM90SL3	8	155.35
45° STREET ELBOW fipxfipt		
BM45SL1/8	30/180	13.60
BM45SL3/8	30/180	11.48
BM45SL1/2	50/200	9.37
BM45SL3/4	40/160	14.15
BM45SL1	25/100	16.48
BM45SL11/4	25/50	28.49
BM45SL11/2	15/30	36.74
BM45SL2	10/20	61.77
TEE fipxfiptxfipt		
BMT1/8	35/210	9.04
BMT1/4	35/210	8.51
BMT3/8	30/180	8.51
BMT1/2	30/120	5.42
BMT3/4	20/80	7.78
BMT1	12/48	13.33
BMT11/4	15/30	21.60
BMT11/2	10/20	26.85
BMT2	15	45.78
BMT21/2	8	98.70
BMT3	6	145.39
BMT4	3	351.40

Size	Ctn Qty	List Price
45° ELBOW fipxfipt		
GM45L1/4	35/210	\$ 11.57
GM45L3/8	40/240	12.92
GM45L1/2	50/200	8.64
GM45L3/4	40/160	12.42
GM45L1	25/100	14.03
GM45L11/4	10/40	26.21
GM45L11/2	10/40	30.78
GM45L2	8/16	45.55
GM45L21/2	15	158.50
GM45L3	8	230.53
GM45L4	4	386.45
90° STREET ELBOW fipxfipt		
GM90SL1/8	40/240	12.14
GM90SL1/4	30/180	11.75
GM90SL3/8	30/180	11.75
GM90SL1/2	50/200	12.01
GM90SL3/4	35/140	12.01
GM90SL1	20/80	16.06
GM90SL11/4	15/30	26.96
GM90SL11/2	12/24	33.84
GM90SL11/2 x 11/4	16/32	55.08
GM90SL2	8/16	57.06
GM90SL21/2	8	165.05
GM90SL3	8	240.20
45° STREET ELBOW fipxfipt		
GM45SL1/8	30/180	17.68
GM45SL3/8	30/180	17.42
GM45SL1/2	50/200	13.20
GM45SL3/4	40/160	20.95
GM45SL1	25/100	26.84
GM45SL11/4	25/50	40.28
GM45SL11/2	15/30	48.78
GM45SL2	10/20	80.34
TEE fipxfiptxfipt		
GMT1/8	35/210	13.14
GMT1/4	35/210	11.08
GMT3/8	30/180	11.08
GMT1/2	30/120	7.08
GMT3/4	20/80	11.66
GMT1	12/48	18.86
GMT11/4	15/30	29.93
GMT11/2	10/20	37.21
GMT2	15	60.47
GMT21/2	8	170.27
GMT3	6	199.68
GMT4	3	472.35



Malleable Iron Fittings - Domestic



BLACK

GALVANIZED



**BMT/GMT
Reducer Series**

Size	Ctn Qty	List Price
TEE Reducing fipxfiptxfipt		
BMT1/2 x 1/2 x 1/4	25/100	\$ 9.24
BMT1/2 x 1/2 x 3/4	30/120	13.91
BMT3/4 x 1/2 x 1/2	30/120	12.37
BMT3/4 x 3/4 x 1/4	30/120	13.39
BMT3/4 x 3/4 x 3/8	30/120	14.79
BMT3/4 x 3/4 x 1/2	25/100	12.05
BMT3/4 x 1/2 x 3/4	20/80	13.91
BMT3/4 x 3/4 x 1	15/60	18.34
BMT1 x 1/2 x 1/2	20/80	17.32
BMT1 x 1/2 x 3/4	20/80	20.66
BMT1 x 1/2 x 1	15/60	17.32
BMT1 x 3/4 x 1/2	20/40	17.41
BMT1 x 3/4 x 3/4	20/40	16.09
BMT1 x 3/4 x 1	20/40	17.65
BMT1 x 1 x 1/4	20/80	19.25
BMT1 x 1 x 1/2	15/60	15.20
BMT1x1x3/4	25/50	15.20
BMT1x 1 x 11/4	15/30	33.66
BMT11/4 x 1/2 x 11/4	10/40	32.27
BMT11/4 x 3/4 x 3/4	10/40	32.27
BMT11/4 x 3/4 x 1	10/40	29.88
BMT11/4 x 3/4 x 11/4	15/30	29.24
BMT11/4 x 1 x 1	15/30	28.38
BMT11/4 x 11/4 x 1/2	15/30	27.71
BMT11/4 x 11/4 x 3/4	12/24	24.29
BMT11/4 x 11/4 x 1	14/28	26.33
BMT11/4 x 1 x 11/4	15/30	34.07
BMT11/2 x 1/2 x 11/2	10/20	38.56
BMT11/2 x 3/4 x 3/4	10/40	64.63
BMT11/2 x 3/4 x 11/2	10/20	38.56
BMT11/2 x 1 x 11/2	10/20	38.56
BMT11/2 x 11/4 x 3/4	10/20	38.56
BMT11/2 x 11/4 x 1	8/16	33.10
BMT11/2 x 11/4 x 11/4	10/20	51.73
BMT11/2 x 11/4 x 11/2	10/20	58.14
BMT11/2 x 11/2 x 1/2	8/32	32.46
BMT11/2 x 11/2 x 3/4	10/20	30.66
BMT11/2 x 11/2 x 1	10/20	30.66
BMT11/2 x 11/2 x 11/4	8/40	37.92
BMT2 x 1/2 x 2	8/16	60.12
BMT2 x 3/4 x 2	8/16	59.08
BMT2 x 1 x 2	8/16	60.12
BMT2 x 2 x 1/2	10/20	48.97
BMT2 x 2 x 3/4	10/20	48.05
BMT2 x 2 x 1	10/20	48.05
BMT2 x 2 x 11/4	8/16	51.73
BMT2 x 2 x 11/2	8/16	51.73
BMT2 x 11/4 x 11/4	8/16	60.12
BMT2 x 11/2x11/4	8/16	60.23
BMT2 x 11/2 x 11/2	8/16	59.08
BMT21/2 x 21/2 x 2	12	128.40

Size	Ctn Qty	List Price
TEE Reducing fipxfiptxfipt		
GMT1/2 x 1/2 x 3/8	35/140	\$ 16.44
GMT3/4 x 1/2 x 1/2	30/120	19.40
GMT3/4 x 3/4 x 1/4	30/120	17.33
GMT3/4 x 3/4 x 1/2	25/100	16.23
GMT3/4 x 1/2 x 3/4	20/80	18.51
GMT3/4 x 3/4 x 1	15/60	27.92
GMT1x1/4x1	15/80	29.48
GMT1 x 1/2 x 1/2	20/80	28.45
GMT1 x 1/2 x 3/8	20/80	29.06
GMT1 x 1/2 x 1	15/60	28.45
GMT1 x 3/4x 1/2	20/40	28.45
GMT1 x 3/4 x 3/4	20/40	27.44
GMT1 x 3/4 x 1	20/40	28.45
GMT1 x 1 x 1/2	15/60	22.78
GMT1x1x3/4	25/50	22.78
GMT1x 1 x 11/4	15/30	46.04
GMT11/4 x 1/2 x 11/4	10/40	44.77
GMT11/4 x 3/4 x 3/4	10/40	48.72
GMT11/4 x 3/4 x 1	10/40	46.31
GMT11/4 x 3/4 x 11/4	15/30	42.00
GMT11/4 x 1 x 1	15/30	42.87
GMT11/4 x 11/4 x 1/2	15/30	37.34
GMT11/4 x 11/4 x 3/4	12/24	35.33
GMT11/4 x 11/4 x 1	14/28	35.33
GMT11/4 x 1 x 11/4	15/30	45.33
GMT11/2 x 1/2 x 11/2	10/20	61.56
GMT11/2 x 3/4 x 3/4	10/40	81.94
GMT11/2 x 3/4 x 11/2	10/20	56.14
GMT11/2 x 1 x 11/2	10/20	56.14
GMT11/2 x 11/4 x 3/4	10/20	56.14
GMT11/2 x 11/4 x 1	8/16	53.06
GMT11/2 x 11/4 x 11/4	10/20	77.82
GMT11/2 x 11/4 x 11/2	10/20	77.82
GMT11/2 x 11/2 x 1/2	8/32	46.12
GMT11/2 x 11/2 x 3/4	10/20	43.64
GMT11/2 x 11/2 x 1	10/20	43.64
GMT11/2 x 11/2 x 11/4	8/40	54.64
GMT2 x 1/2 x 2	8/16	79.37
GMT2 x 3/4 x 2	8/16	77.86
GMT2 x 1 x 2	8/16	79.37
GMT2 x 2 x 1/2	10/20	70.99
GMT2 x 2 x 3/4	10/20	63.72
GMT2 x 2 x 1	10/20	62.53
GMT2 x 2 x 11/4	8/16	75.02
GMT2 x 2 x 11/2	8/16	75.05
GMT2 x 11/4 x 11/4	8/16	79.37
GMT2 x 11/2x11/4	8/16	79.37
GMT2 x 11/2 x 11/2	8/16	77.86
GMT21/2 x 21/2 x 2	12	210.91



Malleable Iron Fittings - Domestic



BLACK

GALVANIZED



**BMT/GMT
Reducer Series**



BMST/GSMT Series



BMCR/GMCR Series



BMRHC/GMRHC Series

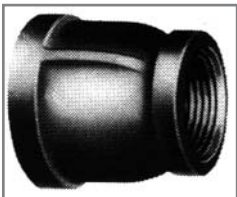

**BMRHC/GMRHC
Reducer Series**

Size	Ctn Qty	List Price
TEE Reducing, Cont. fipxtxfipt		
BMT3 x 3 x 3/4	8	\$ 174.84
BMT3 x 3 x 1	8	172.32
BMT3 x 3 x 1 1/4	8	181.56
BMT3 x 3 x 1 1/2	8	178.28
BMT3 x 3 x 2	8	171.49
BMT3 x 3 x 2 1/2	8	203.72
STREET TEE fipxtmipxtfip		
BMST3/4	20/80	19.85
BMST1	12/24	26.23
BMST1 1/4	10/20	43.14
CROSS fip		
BMCR1/2	30/120	20.52
BMCR3/4	15/60	24.83
BMCR1	15/30	30.59
BMCR1 1/4	12/24	49.65
BMCR1 1/2	8/16	61.54
BMCR2	8	101.17
Right Hand Coupling fipxtfip		
BMRHC1/4	35/210	7.28
BMRHC3/8	40/240	7.28
BMRHC1/2	40/240	5.61
BMRHC3/4	40/160	6.58
BMRHC1	25/100	9.84
BMRHC1 1/4	15/60	15.10
BMRHC1 1/2	10/40	17.22
BMRHC2	8/32	25.52
BMRHC2 1/2	8	70.43
BMRHC3	8	95.21
BMRHC4	4	191.75
REDUCING COUPLING fipxtfip		
BMRC1/4 x 1/8 ☺	25/150	7.67
BMRC3/8 x 1/4	25/150	7.67
BMRC1/2 x 1/4	25/150	6.97
BMRC1/2 x 3/8	30/180	6.59
BMRC3/4 x 1/4	35/210	8.80
BMRC3/4 x 3/8	35/210	8.80
BMRC3/4 x 1/2	50/200	7.37
BMRC1 x 3/8	30/120	14.45
BMRC1 x 1/2	30/120	11.75
BMRC1 x 3/4	25/100	11.48
BMRC1 1/4 x 1/2	15/60	17.32
BMRC1 1/4 x 3/4	15/60	14.76
BMRC1 1/4 x 1	15/60	14.76

Size	Ctn Qty	List Price
TEE Reducing, Cont. fipxtxfipt		
GMT3 x 3 x 3/4	8	\$ 385.03
GMT3 x 3 x 1	8	275.98
GMT3 x 3 x 1 1/4	8	291.88
GMT3 x 3 x 1 1/2	8	286.30
GMT3 x 3 x 2	8	275.98
GMT3 x 3 x 2 1/2	8	321.44
STREET TEE fipxtmipxtfip		
GMST3/4	20/80	25.39
GMST1	12/24	40.14
GMST1 1/4	10/20	66.94
CROSS fip		
GMCR1/2	30/120	29.12
GMCR3/4	15/60	35.48
GMCR1	15/30	48.96
GMCR1 1/4	12/24	73.60
GMCR1 1/2	8/16	86.10
GMCR2	8	163.10
Right Hand Coupling fipxtfip		
GMRHC1/4	35/210	10.13
GMRHC3/8	40/240	10.47
GMRHC1/2	40/240	8.00
GMRHC3/4	40/160	9.22
GMRHC1	25/100	15.11
GMRHC1 1/4	15/60	12.31
GMRHC1 1/2	10/40	24.22
GMRHC2	8/32	35.41
GMRHC2 1/2	8	108.40
GMRHC3	8	144.87
GMRHC4	4	313.93
REDUCING COUPLING fipxtfip		
GMRC1/4 x 1/8 ☺	25/150	10.39
GMRC3/8 x 1/4	25/150	10.39
GMRC1/2 x 1/4	25/150	9.33
GMRC1/2 x 3/8	30/180	9.70
GMRC3/4 x 1/4	35/210	11.78
GMRC3/4 x 3/8	35/210	11.78
GMRC3/4 x 1/2	50/200	10.38
GMRC1 x 3/8	30/120	22.46
GMRC1 x 1/2	30/120	17.29
GMRC1 x 3/4	25/100	16.06
GMRC1 1/4 x 1/2	15/60	28.70
GMRC1 1/4 x 3/4	15/60	22.37
GMRC1 1/4 x 1	15/60	21.93

☺ Steel



Malleable Iron Fittings - Domestic



BLACK

GALVANIZED

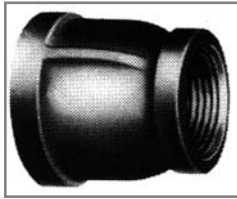

**BMRHC/GMRHC
Reducer Series**

Size	Ctn Qty	List Price
REDUCING COUPLING - con't fiptxfipt		
BMRC11/2 x 1/2	15/60	\$ 22.03
BMRC11/2 x 3/4	10/40	24.83
BMRC11/2 x 1	10/40	21.64
BMRC11/2 x 1 1/4	10/40	18.66
BMRC2 x 1/2	8/32	35.87
BMRC2 x 3/4	8/32	30.97
BMRC2 x 1	15/30	29.26
BMRC2 x 1 1/4	10/20	30.97
BMRC2 x 1 1/2	10/20	27.04
BMRC2 1/2 x 1 1/2	10	73.75
BMRC2 1/2 x 2	10	62.16
BMRC3 x 1	8	98.96
BMRC3x 1 1/4	8	100.80
BMRC3 x 1 1/2	8	97.16
BMRC3 x 2	8	80.46
BMRC3 x 2 1/2	8	93.95
BMRC4 x 2	4	194.75
BMRC4 x 3	4	194.75

Size	Ctn Qty	List Price
REDUCING COUPLING - con't fiptxfipt		
GMRC11/2 x 1/2	15/60	\$ 33.84
GMRC11/2 x 3/4	10/40	28.84
GMRC11/2 x 1	10/40	28.84
GMRC11/2 x 1 1/4	10/40	27.24
GMRC2 x 1/2	8/32	48.86
GMRC2 x 3/4	8/32	43.31
GMRC2 x 1	15/30	39.34
GMRC2 x 1 1/4	10/20	41.59
GMRC2 x 1 1/2	10/20	36.20
GMRC2 1/2 x 1 1/2	10	116.04
GMRC2 1/2 x 2	10	109.76
GMRC3 x 1	8	154.18
GMRC3 x 1 1/4	8	154.18
GMRC3 x 1 1/2	8	145.86
GMRC3 x 2	8	137.85
GMRC3 x 2 1/2	8	140.76
GMRC4 x 2	4	315.60
GMRC4 x 3	4	315.60



BMHB/GMHB Series

Size	Ctn Qty	List Price
HEX BUSHING miptxfipt		
BMHB1/4 x 1/8 ☺	25/150	7.61
BMHB3/8 x 1/8 ☺	25/150	7.61
BMHB3/8 x 1/4 ☺	25/150	7.61
BMHB1/2 x 1/8 ☺	25/150	7.61
BMHB1/2 x 1/4 ☺	25/150	7.61
BMHB1/2 x 3/8 ☺	25/150	7.61
BMHB3/4 x 1/8	25/150	7.52
BMHB3/4 x 1/4	25/150	7.14
BMHB3/4 x 3/8	25/150	7.32
BMHB3/4 x 1/2	25/150	6.59
BMHB1 x 1/8	25/150	10.70
BMHB1 x 1/4	25/150	9.24
BMHB1 x 3/8	25/150	9.50
BMHB1 x 1/2	25/150	7.03
BMHB1 x 3/4	25/150	6.92
BMHB1 1/4 x 1/8	25/150	12.88
BMHB1 1/4 x 1/4	25/150	13.28
BMHB1 1/4 x 1/2	25/150	10.28
BMHB1 1/4 x 3/4	25/150	9.04
BMHB1 1/4 x 1	25/150	9.04
BMHB1 1/2 x 1/4	15/150	15.47
BMHB1 1/2 x 1/2	30/120	11.76
BMHB1 1/2 x 3/4	30/120	11.76
BMHB1 1/2 x 1	30/120	10.32
BMHB1 1/2 x 1 1/4	30/120	11.48
BMHB2x 1/4	20/80	16.68
BMHB2 x 1/2	20/80	18.68
BMHB2 x 3/4	20/80	14.77
BMHB2 x 1	20/80	14.12
BMHB2 x 1 1/4	20/80	14.12
BMHB2 x 1 1/2	20/80	14.44

Size	Ctn Qty	List Price
HEX BUSHING miptxfipt		
GMHB1/4 x 1/8 ☺	25/150	12.14
GMHB3/8 x 1/8 ☺	25/150	12.14
GMHB3/8 x 1/4 ☺	25/150	12.14
GMHB1/2 x 1/8 ☺	25/150	12.14
GMHB1/2 x 1/4 ☺	25/150	12.14
GMHB1/2 x 3/8 ☺	25/150	12.14
GMHB3/4 x 1/8	25/150	13.20
GMHB3/4 x 1/4	25/150	12.84
GMHB3/4 x 3/8	25/150	14.36
GMHB3/4 x 1/2	25/150	10.99
GMHB1 x 1/8	25/150	17.66
GMHB1 x 1/4	25/150	15.00
GMHB1 x 3/8	25/150	15.08
GMHB1 x 1/2	25/150	13.58
GMHB1 x 3/4	25/150	12.63
GMHB1 1/4 x 1/8	25/150	22.09
GMHB1 1/4 x 1/4	25/150	22.63
GMHB1 1/4 x 3/8	25/150	22.63
GMHB1 1/4 x 1/2	25/150	19.28
GMHB1 1/4 x 3/4	25/150	17.02
GMHB1 1/4 x 1	25/150	17.02
GMHB1 1/2 x 1/4	15/120	30.48
GMHB1 1/2 x 1/2	30/120	23.70
GMHB1 1/2 x 3/4	30/120	23.70
GMHB1 1/2 x 1	30/120	21.41
GMHB1 1/2 x 1 1/4	30/120	20.52
GMHB2x 1/4	20/80	34.52
GMHB2 x 1/2	20/80	29.70
GMHB2 x 3/4	20/80	27.60
GMHB2 x 1	20/80	27.60
GMHB2 x 1 1/4	20/80	27.60
GMHB2 x 1 1/2	20/80	23.81

☺ Steel



www.americgranby.com
In the United States: Phone (800) 776-2266 Fax (800) 729-3299
In Canada: Phone (866) 503-5523 Fax (888) 562-2095

6/14/11

12.45

Malleable Iron Fittings - Domestic



BLACK

GALVANIZED



BMHB/GMHB Series

Size	Ctn Qty	List Price
HEX BUSHING CONT. miptxfipt		
BMHB21/2 x 3/4	20	\$ 25.98
BMHB21/2 x 1	20	25.98
BMHB21/2 x 11/4	20	25.98
BMHB21/2 x 11/2	20	22.60
BMHB21/2 x 2	20	22.25
BMHB3x1/2	10/20	39.10
BMHB3 x 3/4	10/20	38.16
BMHB3 x 1	10/20	35.12
BMHB3 x 11/4	10/20	35.12
BMHB3 x 11/2	10/20	35.12
BMHB3 x 2	10/20	26.23
BMHB3 x 2 1/2	10	30.41
BMHB4 x 3/4	10	79.59
BMHB4 x 1	10	79.59
BMHB4 x 1 1/4	10	79.59
BMHB4 x 1 1/2	10	73.29
BMHB4 x 2	10	59.16
BMHB4 x 2 1/2	10	71.59
BMHB4 x 3	10	59.16
FLUSH BUSHING		
BMFB1 x 3/4	25/150	18.28
BMFB1 1/4 x 1	25/150	19.77
DOUBLE TAP BUSHING		
BMDTB2X11/4	20	29.20
CAP fipt		
BMCA1/4 ☺	40	5.40
BMCA3/8 ☺	40	4.53
BMCA1/2	50/300	4.10
BMCA3/4	40/240	5.56
BMCA1	25/150	6.72
BMCA1 1/4	25/100	8.86
BMCA1 1/2	20/80	12.18
BMCA2	10/40	17.76
BMCA2 1/2	6/12	40.46
BMCA3	6/12	60.12
BMCA4	5/10	103.08

Size	Ctn Qty	List Price
HEX BUSHING CONT. miptxfipt		
GMHB21/2 x 3/4	20	\$ 50.27
GMHB21/2 x 1	20	50.27
GMHB21/2 x 1 1/4	20	50.27
GMHB21/2 x 1 1/2	20	45.25
GMHB21/2 x 2	20	39.63
GMHB3x1/2	10/20	66.32
GMHB3 x 3/4	10/20	66.32
GMHB3 x 1	10/20	66.32
GMHB3 x 1 1/4	10/20	64.78
GMHB3 x 1 1/2	10/20	59.69
GMHB3 x 2	10/20	51.58
GMHB3 x 2 1/2	10	55.37
GMHB4 x 1	10	139.00
GMHB4 x 1 1/4	10	139.00
GMHB4 x 1 1/2	10	139.00
GMHB4 x 2	10	108.28
GMHB4 x 2 1/2	10	139.00
GMHB4 x 3	10	108.28
FLUSH BUSHING		
GMFB1 x 3/4	25/150	30.81
GMFB1 1/4 x 1	25/150	38.13
DOUBLE TAP BUSHING		
GMDTB2X1X1	20	48.66
GMDTB2X1 1/4X1 1/4	20	48.66
CAP fipt		
GMCA1/4 ☺	40	7.33
GMCA3/8 ☺	40	7.33
GMCA1/2	50/300	6.06
GMCA3/4	40/240	8.38
GMCA1	25/150	10.39
GMCA1 1/4	25/100	13.67
GMCA1 1/2	20/80	17.52
GMCA2	10/40	24.54
GMCA2 1/2	6/12	71.27
GMCA3	6/12	86.38
GMCA4	5/10	190.81



BMFB/GMFB Series



BMCA/GMCA Series

☺ Steel



Malleable Iron Fittings - Domestic



BLACK

GALVANIZED

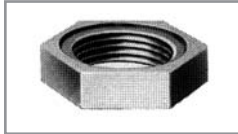

BMLN/GMLN Series

Size	Ctn Qty	List Price
LOCK NUT		
BMLN1/8 ☺	100/600	5.63
BMLN1/4 ☺	100/600	5.18
BMLN3/8	50/300	6.76
BMLN1/2	50/300	5.80
BMLN3/4	50/300	6.33
BMLN1	40/160	12.13
BMLN11/4	40/160	9.97
BMLN11/2	40/160	14.01
BMLN2	25/100	23.23

Size	Ctn Qty	List Price
LOCK NUT		
GMLN1/8 ☺	100/600	6.40
GMLN1/4 ☺	100/600	5.18
GMLN3/8	50/300	8.48
GMLN1/2	50/300	6.86
GMLN3/4	50/300	8.04
GMLN1	40/160	14.62
GMLN11/4	40/160	14.03
GMLN11/2	40/160	18.21
GMLN2	25/100	32.07



BMP/GMP Series

Size	Ctn Qty	List Price
Square Head Plug mipt		
BMP1/8 ☺	100	\$ 1.02
BMP1/4 ☺	100	1.02
BMP3/8 ☺	100	1.02
BMP1/2 ☺	100	1.11
BMP3/4 ☺	100	1.23
BMP1	40/240	3.79
BMP11/4	40/160	6.05
BMP11/2	40/80	8.56
BMP2	25/50	9.98
BMP21/2	20/40	24.31
BMP3	10/20	28.16
BMP4	5/10	58.00
BMP5		109.03

Size	Ctn Qty	List Price
Square Head Plug mipt		
GMP1/8 ☺	100	\$ 1.52
GMP1/4 ☺	100	1.54
GMP3/8 ☺	100	1.54
GMP1/2 ☺	100	1.66
GMP3/4 ☺	100	1.79
GMP1	40/240	8.10
GMP11/4	40/160	13.52
GMP11/2	40/80	18.26
GMP2	40/50	22.68
GMP21/2	20/40	47.92
GMP3	10/20	61.38
GMP4	5/10	119.03
GMP5		236.65

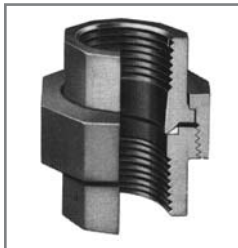

BMU/GMU Series

Size	Ctn Qty	List Price
Unions, 150 lbs UL Listed		
BMU150-1/8	25/150	31.08
BMU150-1/4	35/210	28.75
BMU150-3/8	35/210	19.81
BMU150-1/2	40/160	17.94
BMU150-3/4	30/60	20.62
BMU150-1	25/50	26.87
BMU150-11/4	15/30	38.55
BMU150-11/2	12/24	48.07
BMU150-2	8/16	55.88
BMU150-21/2	8	166.49
BMU150-3	8	200.42
BMU150-4	1	522.70

Size	Ctn Qty	List Price
Unions, 150 lbs UL Listed		
GMU150-1/8	25/150	44.29
GMU150-1/4	35/210	39.00
GMU150-3/8	35/210	26.10
GMU150-1/2	40/160	23.81
GMU150-3/4	30/60	27.37
GMU150-1	25/50	35.83
GMU150-11/4	15/30	51.81
GMU150-11/2	12/24	62.77
GMU150-2	8/16	72.17
GMU150-21/2	8	250.69
GMU150-3	8	350.87
GMU150-4	1	751.10



BMFF/GMFF Series

Size	Ctn Qty	List Price
FLOOR FLANGE (diameter)		
BMFF1/4 2 3/8"	25/150	12.57
BMFF3/8 2 15/16"	25/150	12.57
BMFF1/2 3"	30/120	18.93
BMFF3/4 3 1/4"	30/120	19.93
BMFF1 3 7/8"	30/60	23.78
BMFF11/4 3 7/8"	30/60	23.78
BMFF11/2 4 1/2"	10/40	30.59
BMFF2 5 1/2"	15/30	36.80
BMFF21/2 5 13/16"	10	40.38
BMFF3 6 3/8"	10	50.99

Size	Ctn Qty	List Price
FLOOR FLANGE (diameter)		
GMFF1/4 2 3/8"	25/150	24.43
GMFF3/8 2 15/16"	25/150	24.43
GMFF1/2 3"	30/120	47.30
GMFF3/4 3 1/4"	30/120	47.30
GMFF1 3 7/8"	30/60	43.17
GMFF11/4 3 7/8"	30/60	57.38
GMFF11/2 4 1/2"	10/40	73.52
GMFF2 5 1/2"	15/30	93.37
GMFF21/2 5 13/16"	10	113.51
GMFF3 6 3/8"	10	110.78

☺ Steel



www.americangranby.com
 In the United States: Phone (800) 776-2266 Fax (800) 729-3299
 In Canada: Phone (866) 503-5523 Fax (888) 562-2095

6/14/11

12.47





Nipples - Schedule 80 PVC, CPVC



Schedule 80 PVC and CPVC Nipple Features:

- Sturdy, Sch 80 PVC, CPVC
- Chemical Resistant.
- Gray or white (1/2" thru 2") in Sch 80 PVC.
- Threaded on both ends.
- Standard carton quantity of 50 (1/2" diam) or 25 (3/4" thru 2" diam).
- Threaded one end only (TOE) available upon request.
- Clear available upon request.



ORDER BY SIZE ONLY (DIAMETER X LENGTH)

EXAMPLES: **1/2x3** FOR GRAY PVC

1/2x3W FOR WHITE PVC

CPVC1xCLOSE FOR CPVC

PIPE DIA.	LENGTH CLOSE	SCHEDULE 80 PVC NIPPLE LIST PRICES-GRAY & WHITE (SHADED AREA INDICATES SIZES AVAILABLE IN WHITE PVC)										
		CLOSE	1 1/2"	2"	2 1/2"	3"	4"	5"	6"	8"	10"	12"
1/4"	7/8"	0.91		1.11		1.16	1.36					2.26
3/8"	1"	0.87		1.01						2.02		
1/2"	1 1/8"	0.59	0.68	0.68	0.74	0.77	0.86	1.05	1.12	1.32	1.56	1.68
3/4"	1 3/8"	0.64	0.68	0.74	0.77	0.81	0.99	1.16	1.36	1.58	1.88	2.04
1"	1 1/2"	0.92		1.08	1.19	1.21	1.43	1.76	1.94	2.29	2.73	3.04
1 1/4"	1 5/8"	1.33		1.46	1.57	1.73	1.98	2.34	2.62	3.18	3.72	4.19
1 1/2"	1 3/4"	1.66		1.84	1.94	2.10	2.46	2.77	3.18	3.83	4.39	4.94
2"	2"	2.19			2.46	2.62	3.09	3.61	4.02	4.93	5.81	6.66
3"		7.95				9.57	11.21		15.04	16.97	21.08	25.06
4"		13.01					14.99		18.99	22.52	27.14	31.74

PIPE DIA.	SCHEDULE 80 PVC NIPPLE LIST PRICES PRE-CUT PIPE THREADED BOTH ENDS				
	LENGTH 18"	24"	30"	36"	48"
1/2"	2.30	2.78	3.50	4.21	5.27
3/4"	2.75	3.47	4.36	5.36	7.08
1"	4.36	5.17		7.73	9.87
1 1/4"	6.38				15.98
1 1/2"		10.29		13.83	
2"				18.28	
3"	32.37	41.66			

SCHEDULE 80 CPVC PIPE NIPPLES			
PART NO.	SIZE	CTN QTY	LIST PRICE
CPVC1xCLOSE	1 X CLOSE	25	\$ 2.62
CPVC11/2xCLOSE	1 1/2 x CLOSE	25	3.83
CPVC11/2X6	1 1/2 X 6	25	11.03
CPVC11/2x8	1 1/2 x 8	25	13.41
CPVC11/2X12	1 1/2 X 12	25	20.88
CPVC2xCLOSE	2 X CLOSE	25	6.38
CPVC2X6	2 X 6	25	15.73
CPVC2x8	2 x 8	25	18.62
CPVC2X12	2 X 12	BULK	28.70
CPVC2x24	2 x 24	BULK	57.74



Nipples - Red Brass, Chrome Plated Red Brass



Red Brass Nipple Features:

- Red Brass pipe conforms to ASTM B43-91
- 85% copper, 15% zinc, no lead
- Made in the U.S.A.
- Manufactured for AGI in an ISO 9002 facility.
- Standard carton quantity is 25 pieces through 1" diameter.
- Standard carton quantity is 10 pieces 1 1/4" - 2" diameter.



ORDER BY PART NUMBER **B80** WITH SIZE (DIAMETER X LENGTH)

EXAMPLE: **B80-1/2 x 3**

ISO 9002

		RED BRASS PIPE NIPPLE LIST PRICES											
PIPE DIA.	LENGTH CLOSE	CLOSE	1 1/2"	2"	2 1/2"	3"	3 1/2"	4"	4 1/2"	5"	5 1/2"	6"	
		1/8"	3/4"	\$3.30	3.76	4.01	4.62	4.89	5.29	5.92	6.70	7.26	7.91
1/4"	7/8"	3.76	4.30	4.82	5.33	4.83	6.99	7.89	8.91	9.72	10.54	11.37	
3/8"	1"	4.00	4.78	5.33	6.22	7.16	8.25	9.22	10.45	11.42	12.44	13.42	
1/2"	1 1/8"	4.92	5.67	6.73	7.99	9.36	10.71	12.26	13.59	14.99	16.46	17.79	
3/4"	1 3/8"	7.15	7.54	9.04	10.50	12.09	13.86	15.71	17.50	19.32	21.07	21.85	
1"	1 1/2"	10.51		12.90	15.04	17.18	19.86	22.27	24.82	27.46	30.10	32.69	
1 1/4"	1 5/8"	16.01		17.95	19.24	24.82	27.07	31.25	36.35	38.17	40.60	45.46	
1 1/2"	1 3/4"	20.05		21.49	24.75	29.49	32.61	38.48	41.27	47.93	49.95	54.20	
2"	2"	30.80			33.49	38.04	45.12	47.33	52.85	58.47	64.22	69.74	



Chrome Plated Red Brass Nipple Features:

- Red brass pipe conforms to ASTM B43-91
- 85% copper, 15% zinc, no lead.
- Made in the U.S.A.
- Manufactured for AGI in an ISO 9002 facility.
- Standard carton quantity is 25.



ORDER BY PART NUMBER **CP80** WITH SIZE (DIAMETER X LENGTH)

EXAMPLE: **CP80-1/2 x 3**

ISO 9002

		chrome plated RED BRASS PIPE NIPPLE LIST PRICES											
PIPE DIA.	LENGTH CLOSE	CLOSE	1 1/2"	2"	2 1/2"	3"	3 1/2"	4"	4 1/2"	5"	5 1/2"	6"	
		3/8"	1"	\$ 8.43	9.97	12.12	13.09	16.07	17.34	20.58	21.97	24.06	26.12
1/2"	1 1/8"	11.23	12.98	15.29	18.19	21.31	24.33	27.91	30.26	33.35	36.58	40.60	
3/4"	1 3/8"	18.33		23.06		30.85			43.80				
1"	1 1/2"	27.00		33.31		44.78		58.30		71.88	78.74	85.85	



Nipples - Black Steel

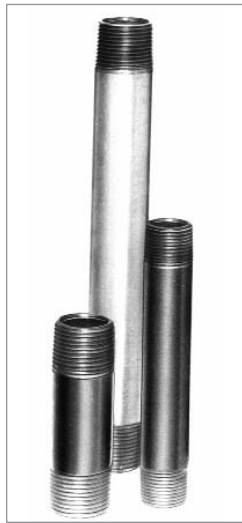

Black Steel Nipple Features:

- Standard carton quantity is 25 pieces for all diameters up to 2" and all lengths up to 6".
- Carton quantities required for nipples through 2" diameter.
- Imported.

ORDER BY PART NUMBER BS80 WITH SIZE (DIAMETER X LENGTH)
EXAMPLE: BS80-1/2 x 3

BLACK STEEL PIPE NIPPLE LIST PRICES STANDARD WELDED																			
PIPE DIA.	LENGTH CLOSE																		
		CLOSE	1 1/2"	2"	2 1/2"	3"	3 1/2"	4"	4 1/2"	5"	5 1/2"	6"	7"	8"	9"	10"	11"	12"	
1/8"	3/4"	0.98	1.18	1.18	1.36	1.36	1.77	1.77	3.15	3.15	3.49	3.49			4.80			5.31	5.59
1/4"	7/8"	1.16	1.23	1.23	1.59	1.59	1.87	1.87	2.81	2.81	3.30	3.03	5.07	5.07				5.98	6.59
3/8"	1"	1.18	1.35	1.35	1.72	1.72	2.04	2.04	2.95	2.95	3.35	3.35	5.78	5.78	6.48	6.48	7.06	7.06	
1/2"	1 1/8"	1.03	1.03	1.03	1.23	1.23	1.50	1.50	1.72	1.72	1.99	1.99	3.49	3.49	4.19	4.19	4.98	4.98	
3/4"	1 3/8"	1.17	1.22	1.22	1.45	1.45	1.80	1.80	2.17	2.17	2.57	2.57	4.29	4.29	4.95	4.95	5.51	5.51	
1"	1 1/2"	1.72		1.89	2.04	2.04	2.64	2.64	3.20	3.20	3.76	3.76	5.70	5.70	6.69	6.69	7.67	7.67	
1 1/4"	1 5/8"	2.20		2.38	2.73	2.73	3.52	3.52	4.33	4.33	5.09	5.09	7.18	7.18	8.63	8.63	9.76	9.76	
1 1/2"	1 3/4"	2.72		2.93	3.29	3.29	4.18	4.18	5.11	5.11	6.02	6.02	8.25	8.25	9.73	9.73	11.58	11.58	
2"	2"	3.73			4.29	4.29	5.52	5.52	6.73	6.73	7.96	7.96	11.71	11.71	13.79	13.79	15.84	15.84	
2 1/2"	2 1/2"	11.22				11.53	13.56	13.56		14.86	16.14	16.14		20.51			23.06	25.62	
3"	2 5/8"	13.85				15.06	17.85	17.85	19.68	19.68	21.42	21.42	28.87	28.87			32.42	35.97	35.97
4"	2 7/8"	20.88						24.16	26.57	26.57	29.49	29.49	34.05	34.05			39.19	46.53	
6"	3 1/8"	37.88											66.13	76.86	86.56		106.27	126.00	

BLACK STEEL PIPE NIPPLE LIST PRICES PRE-CUT PIPE THREADED BOTH ENDS								
PIPE DIA.	PACK QTY							
		18"	24"	30"	36"	48"	60"	72"
3/8"	5	\$ 9.90	12.34					
1/2"	5	7.39	9.72	11.36	13.38	16.92	20.31	24.97
3/4"	5	9.17	11.73	13.71	16.24	21.62	26.47	30.46
1"	3	11.77	15.40	17.77	21.44	47.98	35.24	41.64
1 1/4"	3	14.99	20.21	23.85	28.10	37.53	46.79	
1 1/2"	3	17.12	23.12	28.14	33.72	44.78	55.84	67.10
2"	3	23.85	31.60	37.74	45.24	60.09	74.96	
2 1/2"	3		52.35					
3"	3	51.89	68.50		101.48	134.51		
4"	3	73.38	96.95					

Black Steel Tank Leg Features:

- For use with standard steel tanks
- No cradle required
- Threaded one end x square cut

PART NO.	CTN QTY	LIST PRICE
BS80-11/4X10TOE	5/20	\$ 8.63
BS80-11/4X11TOE	5/20	9.76
BS80-11/4X12TOE	5/20	9.76
BS80-11/4X14TOE	5/20	9.76

Nipples - Galvanized Steel



Galvanized Steel Nipple Features:

- Standard carton quantity is 25 pieces for all diameters up to 2" and all lengths up to 6".
- Carton quantities required for nipples through 2" diameter.
- Imported.

ORDER BY PART NUMBER GS80 WITH SIZE (DIAMETER X LENGTH)
EXAMPLE: GS80-1/2 x 3



GALVANIZED STEEL PIPE NIPPLE LIST PRICES STANDARD WELDED																		
PIPE DIA.	LENGTH CLOSE	CLOSE	1 1/2"	2"	2 1/2"	3"	3 1/2"	4"	4 1/2"	5"	5 1/2"	6"	7"	8"	9"	10"	11"	12"
1/8"	3/4"	1.22	1.70	1.70	2.24	2.22	2.62	2.62	4.46	4.46	4.98	4.98		6.59				
1/4"	7/8"	1.31	1.54	1.54	1.99	1.99	2.38	2.38	3.29	3.29	3.65	3.65	6.27	6.27	7.04	7.04		7.79
3/8"	1"	1.41	1.61	1.61	2.18	2.18	2.58	2.58	3.59	3.59	3.97	3.97		6.35		7.53		8.39
1/2"	1 1/8"	1.17	1.30	1.30	1.50	1.50	1.84	1.84	2.20	2.20	2.49	2.49	4.36	4.36	5.21	5.21	5.95	5.95
3/4"	1 3/8"	1.45	1.58	1.58	1.73	1.73	2.16	2.16	2.71	2.71	3.22	3.22	5.61	5.61	6.24	6.24	6.97	6.97
1"	1 1/2"	2.00		2.35	2.53	2.53	3.07	3.07	3.74	3.74	4.27	4.27	7.10	7.10	8.15	8.15	9.47	9.47
1 1/4"	1 5/8"	2.68		2.91	3.15	3.15	3.90	3.90	4.64	4.64	5.61	5.61	8.76	8.76	10.43	10.43	12.09	12.09
1 1/2"	1 3/4"	3.12		3.36	3.74	3.74	4.76	4.76	5.75	5.75	6.47	6.47	10.00	10.00	11.67	11.67		13.33
2"	2"	4.40			4.95	4.95	6.04	6.04	7.72	7.72	8.94	8.94	14.60	14.60	17.10	17.10	19.60	19.60
2 1/2"	2 1/2"	13.13				13.65	15.85	15.85	17.67	17.67	19.40	19.40	25.01	25.01		28.49	31.90	31.90
3"	2 5/8"	15.77				17.95	21.04	21.04	24.53	24.53	25.94	25.94	34.94	34.94	39.84	39.84	44.81	44.81
4"	2 7/8"	23.63				37.89		28.22	31.67	31.67	35.02	35.02	41.81	41.81	48.42	48.42		55.11
6"	3 1/8"	46.06						56.87				80.40		105.22		129.20		153.15

GALVANIZED STEEL PIPE NIPPLE LIST PRICES PRE-CUT PIPE THREADED BOTH ENDS								
PIPE DIA.	PACK QTY	18"	24"	30"	36"	48"	60"	72"
3/8"	5	11.89						
1/2"	5	9.13	11.73	13.87	16.01	20.54	25.32	29.91
3/4"	5	10.84	13.90	17.10	19.63	25.65	31.40	37.07
1"	3	13.96	18.60	21.70	24.80	32.89	41.39	
1 1/4"	3	18.40	24.67	29.15	33.62	44.58	55.43	
1 1/2"	3	20.91	27.97	33.79	39.60	52.64	66.69	
2"	3	28.51	37.71	44.38	51.05	66.37	82.92	
2 1/2"	3	43.84	57.83	74.51				
3"	3	61.75	81.46	102.07	120.74	160.03		
4"	3	87.31	107.11		171.31	227.21		

GALVANIZED STEEL REDUCING PIPE NIPPLES			
PART NO.	SIZE	CTN QTY	LIST PRICE
GSR80-3/4X1/2X23/4	3/4 X 1/2 X 2 3/4	25	\$ 11.96
GSR80-1 1/4x1x3 1/2	1 1/4 x 1 x 3 1/2	25	14.41
GSR80-1x3/4x3	1 x 3/4 x 3	25	13.45