

Self Diagnosis
Supported model

SERVICE MANUAL

GE-1A CHASSIS

MODEL	COMMANDER	DEST	CHASSIS NO.	MODEL	COMMANDER	DEST	CHASSIS NO.
KV-28DS65U	RM-892	UK	SCC-Q71D-A	KV-32DS65U	RM-892	UK	SCC-Q71C-A

FD Trinitron

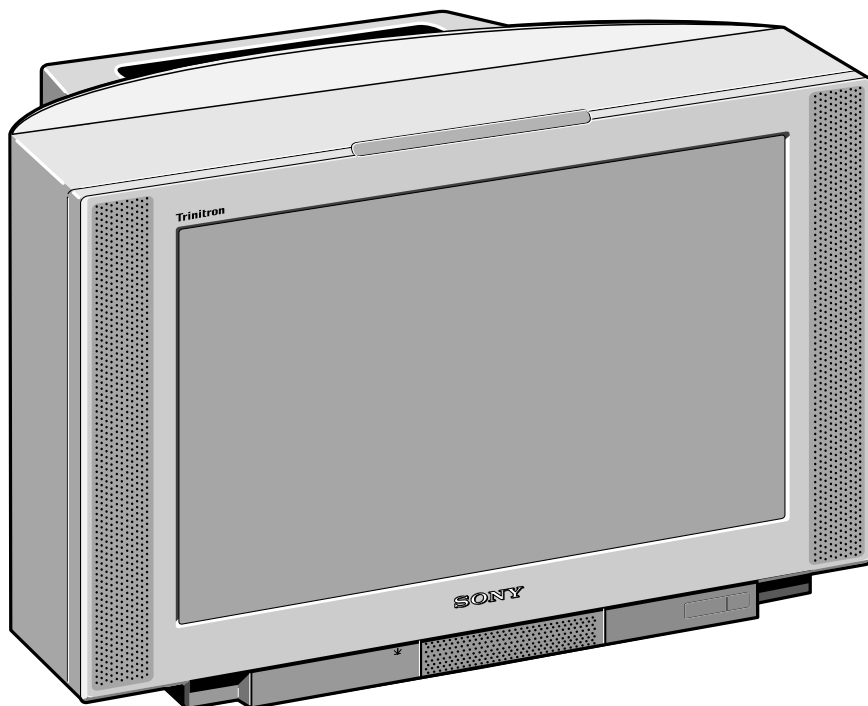

TRINITRON® COLOR TV

SONY®

TABLE OF CONTENTS

<i>Section</i>	<i>Title</i>	<i>Page</i>	<i>Section</i>	<i>Title</i>	<i>Page</i>
	Specifications3	5. DIAGRAMS		
	Warning and Caution4	5-1.	Block Diagram (1)33
	Connectors5		Block Diagram (2)35
	Self-Diagnostic Function6		Block Diagram (3)37
1. GENERAL				Block Diagram (4)39
	Quick Start Guide9		Block Diagram (5)41
	Overview10		Block Diagram (6)43
	Additional TV Features11		Block Diagram (7)45
	Teletext17	5-2.	Circuit Board Location49
	Event Schedule Guide19	5-3.	Schematic Diagrams and	
	Specifications20		Printed Wiring Boards49
	Troubleshooting20		* C Board51
2. DISASSEMBLY				* H Board53
2-1.	Rear Cover Removal21		* D2 Board53
2-2.	Chassis Assy Removal21		* A Board59
2-3.	Service Position21		* B Board68
2-4.	A1 Board Removal21		* A1 Board77
2-5.	J Board Removal22		* D Board83
2-6.	B Board Removal22		* D1 Board86
2-7.	D1 Board Removal22		* N Board93
2-8.	H Bracket Removal22		* F1 Board105
2-9.	Picture Tube Removal23		* VM Board105
3. SET-UP ADJUSTMENTS				* J Board108
3-1.	Beam Landing24	5-4.	Semiconductors111
3-2.	Convergence25	5-5.	IC Blocks114
3-3.	Focus27	6. EXPLODED VIEWS		
3-4.	Screen [G2] White Balance27	6-1.	Chassis116
4. CIRCUIT ADJUSTMENTS			6-2.	Picture Tube117
4-1.	Electrical Adjustments29	7. ELECTRICAL PARTS LIST	118
4-3.	Test Mode 231			

CAUTION

SHORT CIRCUIT THE ANODE OF THE PICTURE TUBE AND THE ANODE CAP TO THE METAL CHASSIS, CRT SHIELD, OR THE CARBON PAINTED ON THE CRT, AFTER REMOVAL OF THE ANODE CAP

WARNING !!

AN ISOLATING TRANSFORMER SHOULD BE USED DURING ANY SERVICE WORK TO AVOID POSSIBLE SHOCK HAZARD DUE TO LIVE CHASSIS. THE CHASSIS OF THIS RECEIVER IS DIRECTLY CONNECTED TO THE POWER LINE.

SAFETY-RELATED COMPONENT WARNING !!

COMPONENTS IDENTIFIED BY SHADING AND MARKED Δ ON THE SCHEMATIC DIAGRAMS, EXPLODED VIEWS AND IN THE PARTS LIST ARE CRITICAL FOR SAFE OPERATION. REPLACE THESE COMPONENTS WITH SONY PARTS WHOSE PART NUMBERS APPEAR AS SHOWN IN THIS MANUAL OR IN SUPPLEMENTS PUBLISHED BY SONY.

ATTENTION

APRES AVOIR DECONNECTE LE CAP DE L'ANODE, COURT-CIRCUITER L'ANODE DU TUBE CATHODIQUE ET CELUI DE L'ANODE DU CAP AU CHASSIS METALLIQUE DE L'APPAREIL, OU AU COUCHE DE CARBONE PEINTE SUR LE TUBE CATHODIQUE OU AU BLINDAGE DU TUBE CATHODIQUE.

ATTENTION !!

AFIN D'EVITER TOUT RISQUE D'ELECTROCUTION PROVENANT D'UN CHÂSSIS SOUS TENTION, UN TRANSFORMATEUR D'ISOLEMENT DOIT ETRE UTILISÉ LORS DE TOUT DÉPANNAGE. LE CHÂSSIS DE CE RÉCEPTEUR EST DIRECTMENT RACCORDÉ À L'ALIMENTATION SECTEUR.

ATTENTION AUX COMPOSANTS RELATIFS À LA SÉCURITÉ !!

LES COMPOSANTS IDENTIFIÉS PAR UNE TRAME ET PAR UNE MARQUE Δ SUR LES SCHÉMAS DE PRINCIPE, LES VUES EXPLOSÉES ET LES LISTES DE PIÈCES SONT D'UNE IMPORTANCE CRITIQUE POUR LA SÉCURITÉ DU FONCTIONNEMENT, NE LES REMPLACER QUE PAR DES COMPOSANTS SONY DONT LE NUMÉRO DE PIÈCE EST INDIQUÉ DANS LE PRÉSENT MANUEL OU DANS DES SUPPLÈMENTS PUBLIÉS PAR SONY.

ITEM MODEL	Television System	Stereo System	Channel Coverage	Color System
UK	I	NICAM Stereo	UHF : B21-B69	PAL NTSC4.43, NTSC3.58 (VIDEO IN)

MODEL	28DS65U	32DS65U
Power Consumption	200W	200W

[PICTURE TUBE]

KV-28DS65

FD Trinitron WIDE
Approx. 71 cm (28 inches)
(Approx. 66cm picture measured diagonally)
102 degree deflection

KV-32DS65

FD Trinitron WIDE
Approx. 82 cm (32 inches)
(Approx. 76 cm picture measured diagonally)
102 degree deflection

Input/Output Terminals

[REAR]

- ① / → ② 21-pin Euro connector (CENELEC standard).
 - Inputs for Audio and Video signals.
 - Inputs for RGB.
 - Outputs of TV Video and Audio signals.
- ② / → ③ 21-pin Euro connector
 - Inputs for Audio and Video signals.
 - Inputs for S video.
 - Outputs for Video and Audio signals (selectable).
- ③ / → ④ 21-pin Euro connector
 - Inputs for Audio and Video signals.
 - Inputs for S video.

[FRONT]

- ③ Video output - phono jack
- ③ Audio inputs - phono jacks
- ③ S Video input - 4 pin DIN
- Headphone jack : stereo minijack

Sound output 2x30W (Music Power)
Power requirements 220 - 240V

Dimensions
KV-28DS65 Approx 773 x 501 x 526 mm (w/h/d)
KV-32DS65 Approx 867 x 564 x 558 mm (w/h/d)

Weight
KV-28DS65 Approx 56.5kg
KV-32DS65 Approx 68.5kg

Supplied accessories RM-892 Remote Commander (1)
IEC designated R6 batteries (2)
Other features NICAM, DNR, Dolby Digital
Surround System, Graphic Equalizer,
TELETEXT, Smartlink

[RM-892]

Remote control system Infrared control
Power requirements 3V dc
2 batteries IEC designation
R6 (size AA)
Dimensions Approx 210x56x24mm (w/h/d)
Weight Approx 110g (Not including battery)

Design and specifications are subject to change without notice.

Model Name		
Item	KV-28DS65U	KV-32DS65U
Pal Comb	ON	ON
PIP	OFF	OFF
RGB Priority	ON	ON
Woofers Box	ON	ON
Scart 1	ON	ON
Scart 2	ON	ON
Front in (3)	ON	ON
Scart 4	ON	ON
Projector	OFF	OFF
AKB in 16:9 mode	ON	ON
Norm B/G	OFF	OFF
Norm I	ON	ON
Norm D/K	OFF	OFF
Norm AUS	OFF	OFF
Norm L	OFF	OFF
Norm SAT	OFF	OFF
Norm M	OFF	OFF
Teletext	ON	ON
Nicam Stereo	ON	ON
Language Preset	English	English

WARNING

The flexible mains lead is supplied connected to a **B.S. 1363** fused plug having a fuse of **5 AMP** capacity. Should the fuse need to be replaced, use a **5 AMP FUSE** approved by **ASTA** to **BS 1362**, ie one that carries the  mark.

IF THE PLUG SUPPLIED WITH THIS APPLIANCE IS NOT SUITABLE FOR THE OUTLET SOCKETS IN YOUR HOME, IT SHOULD BE CUT OFF AND AN APPROPRIATE PLUG FITTED. THE PLUG SEVERED FROM THE MAINS LEAD MUST BE DESTROYED AS A PLUG WITH BARED WIRES IS DANGEROUS IF ENGAGED IN A LIVE OUTLET SOCKET.

When an alternative type of plug is used it should be fitted with a **5 AMP FUSE**, otherwise the circuit should be protected by a **5 AMP FUSE** at the distribution board.

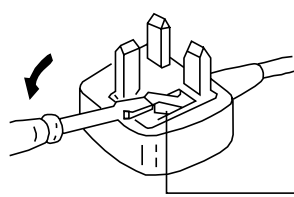

How to replace the fuse.
Open the fuse compartment with a screwdriver blade and replace the fuse.

21 pin connector

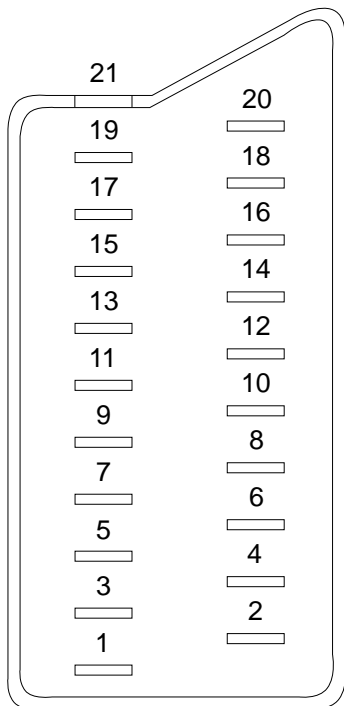
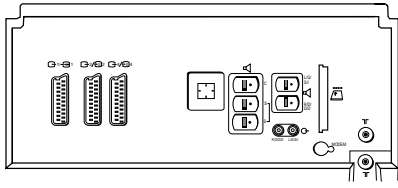

Pin No	1	2	4	Signal	Signal level
1	○	○	○	Audio output B (right)	Standard level : 0.5V rms Output impedance : Less than 1kohm*
2	○	○	○	Audio output B (right)	Standard level : 0.5V rms Output impedance : More than 10kohm*
3	○	○	○	Audio output A (left)	Standard level : 0.5V rms Output impedance : Less than 1kohm*
4	○	○	○	Ground (audio)	
5	○	○	○	Ground (blue)	
6	○	○	○	Audio input A (left)	Standard level : 0.5V rms Output impedance : More than 10kohm*
7	○	●	●	Blue input	0.7 +/- 3dB, 75 ohms positive
8	○	○	○	Function select (AV control)	High state (9.5-12V) : Part mode Low state (0-2V) : TV mode Input impedance : More than 10K ohms Input capacitance : Less than 2nF
9	○	○	○	Ground (green)	
10	○	○	○	Open	
11	○	●	●	Green	Green signal : 0.7 +/- 3dB, 75 ohms, positive
12	○	○	○	Open	
13	○	○	○	Ground (red)	
14	○	○	○	Ground (blanking)	
15	○	-	-	Red input	0.7 +/- 3dB, 75 ohms, positive
	-	○	○	(S signal Chroma input)	0.3 +/- 3dB, 75 ohms, positive
16	○	●	●	Blanking input (Ys signal)	High state (1-3V) Low state (0-0.4V) Input impedance : 75 ohms
17	○	○	○	Ground (video output)	
18	○	○	○	Ground (video input)	
19	○	○	○	Video output	1V +/- 3dB, 75ohms, positive sync 0.3V (-3+10dB)
20	○	-	-	Video input	1V +/- 3dB, 75ohms, positive sync 0.3V (-3+10dB)
	-	○	○	Video input Y (S signal)	1V +/- 3dB, 75ohms, positive sync 0.3V (-3+10dB)
21	○	○	○	Common ground (plug, shield)	

○ Connected ● Not Connected (open) * at 20Hz - 20kHz

Pin No.	Signal	Signal Level
1	Ground	
2	Ground	
3	Y (S signal) input	1V ± 3dB 75 ohm, positive Sync. 0.3V -3 + 10dB
4	C (S signal) input	0.3V ± 3dB 75 ohm, positive Sync.

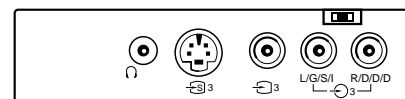

GE-1A SELF DIAGNOSTIC SOFTWARE

The identification of errors within the GE-1A chassis is triggered in one of two ways :- 1: Busy or 2: Device failure to respond to IIC. In the event of one of these situations arising the software will first try to release the bus if busy (Failure to do so will report with continuous flashing LED) and then communicate with each device in turn to establish if a device is faulty. If a device is found to be faulty the relevant device number will be displayed through the LED (Series of flashes which must be counted) See table 1., non fatal errors are reported using this method.

Diagnostic Item Description	No of times Standby LED Flashes	Probable cause Location	Detected Symptoms
Power does not turn on	Does not light	Power cord is not plugged in Fuse is burned out	Power does not come on No power is supplied to the TV AC power supply is faulty
+B Overvoltage(OVP)	2 times	H.OUT (Q502) is shorted. (D Board) IC603 Power IC is shorted. (D Board)	Power does not come on Load on power line has shorted
Vertical Deflection stopped	4 times	+15V is not supplied R519 open (D Board) -15V is not supplied R518 open (D Board) IC502 is shorted (D Board)	Vertical deflection pulse has stopped Power line has shorted

ERROR	LED ERROR COUNT
No error	00
Not allowed (may be confused with Sircs response flash!)	01
Over Current Protection	02
Over Voltage Protection	03
Vertical Protection	04
No function	05
H - Protection	06
Speaker Protection	07
MEGATEXT	08
NVM	09
Main colour decoder	10
Feature Box 1	11
D/A converter	12
Multi Component processor	13
Multi sound processor	14
DMUX	15
Feature Box 2	16

Flash Timing Example : e.g. error number 3

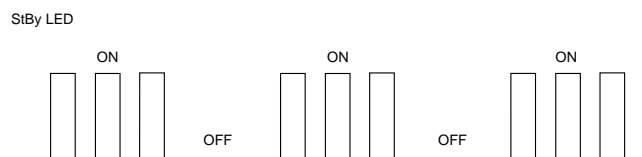

ERROR DETECTION MONITOR

Device acknowledge is used to check IIC errors. Device acknowledge is checked by sending an IIC start sequence during CRT power on. Each device is checked three times, if there is no acknowledge after every attempt, it will be regarded as an error. There are three steps to check errors

1. IIC line 0
If all devices except the NVM are errors, IIC line 0 error is displayed
2. Board check
If all devices mounted on one board have errors, board error is displayed
3. Each device check
If IIC line error and board error are not detected then the device with an error is displayed

The detected errors can be displayed as follows:

1. Error Monitor Menu
2. Error Reader

1. ERROR MONITOR MENU

The error monitor menu is displayed by selecting TT22. The following menu will be displayed:

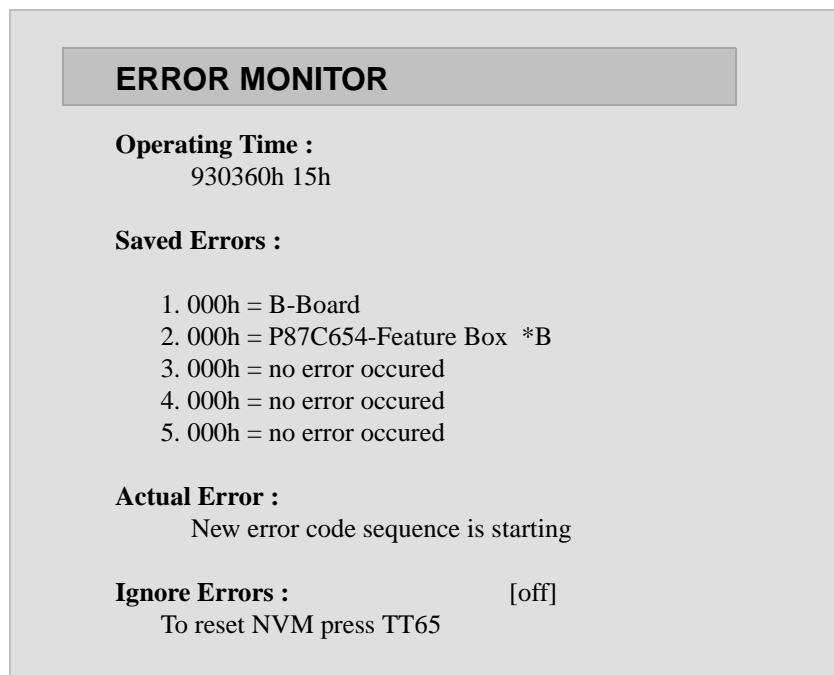

ERROR MONITOR

Operating Time :
930360h 15h

Saved Errors :

1. 000h = B-Board
2. 000h = P87C654-Feature Box *B
3. 000h = no error occurred
4. 000h = no error occurred
5. 000h = no error occurred

Actual Error :
New error code sequence is starting

Ignore Errors : [off]
To reset NVM press TT65

2. ERROR READER DISPLAY

The error reader display is connected to the service connector to read actual error codes. The part number for the error reader display is S-188-900-10. Once an error has been detected it will then be displayed on the two digit error reader. The errors displayed refer to the following table :

Error Code	Send Data to Error Reader		Error type	Function
	Data high	Data Low		
00 00h	-	f0h	no device	
Gen.IIC Error				
00 01h	f0h	01h	IIC 0 line	
00 02h	f0h	02h	IIC 1 line	
Board Error				
01 00h	f1h	00h	A Board	
02 00h	f2h	00h	No function	
03 00h	f3h	00h	B Board	
04 00h	f4h	00h	No function	
05 00h	f5h	00h	D1 Board	
06 00h	f6h	00h	J Board	
07 00h	f7h	00h	Q Board	
Device Error				
A Board				
01 01h	f1h	01h	ST24C64	NVM doesn't respond
01 02h	f1h	02h	SDA5273/75	Megatext doesn't respond
01 03h	f1h	03h	CXA2101	MCP
01 04h	f1h	04h	SDA9361	Deflection doesn't respond
01 05h	f1h	05h	TVF-01-XXX	Tuner doesn't respond
01 06h	f1h	06h	No function	
01 07h	f1h	07h	MSP3410D	Audio processor
01 08h	f1h	08h	CXA1875	Port Expander for SCART doesn't respond
01 09h	f1h	09h	CXA1315	Port Expander for UYV doesn't respond
01 10h	f1h	10h	PCF8574	General Port Expander 1 doesn't respond
01 11h	f1h	11h	No function	
01 12h	f1h	12h	PCF8574	Interrupt Port Expander doesn't respond
01 13h	f1h	13h	PCF8593	Real Time Clock doesn't respond
01 14h	f1h	14h	No function	
02 01h	f2h	01h	TC9337	Audio Effect Processor (DSP) doesn't respond
B Board				
03 01h	f3h	01h	TDA9144	Colour Decoder doesn't respond
03 02h	f3h	02h	No function	
03 03h	f3h	03h	No function	
03 04h	f3h	04h	P87C654	Feature box1 doesn't respond
03 05h	f3h	05h	SDA9280	D/A Converter doesn't respond
03 06h	f3h	06h	P87C654	Feature box doesn't respond
D1 Board				
05 01h	f5h	01h	CXA1875	Port expander for MP, S-Cont doesn't respond
J Board				
06 01h	f6h	01h	CXA1855	AV-Switch Doesn't respond
06 02h	f6h	02h	TDA7309	Headphone processor doesn't respond

SECTION 1 GENERAL

The operating instructions mentioned here are partial abstracts from the Operating Manual. The page numbers of the Operating Instruction Manual remain as in the manual.

Quick Start Guide

6. Automatically Tuning the TV

You need to tune the TV to receive channels. By following the instructions below, this TV will automatically search and store all available channels for you. If at any time when using this menu you want to return to the normal TV picture, press the MENU button.

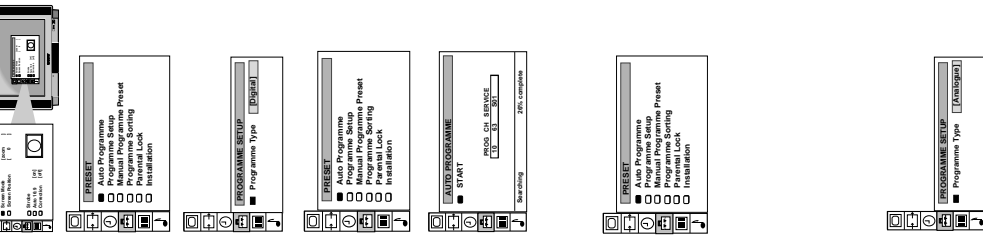
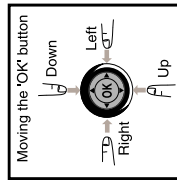

- 1 Press the MENU button on the remote control to display the menu on the TV screen.
- 2 Move the OK button on the remote control DOWN to select the symbol on the menu screen then move RIGHT to enter the 'PRESET' menu.
- 3 Move the OK button DOWN to select "Programme Setup", then move RIGHT to enter the 'PROGRAMME SETUP' menu.
- 4 Move the OK button RIGHT to highlight the brackets then move repeatedly DOWN to select 'Digital' if you wish to view digital channels or 'Analogue' if you wish to view analogue channels.
- 5 Press the OK button to confirm then move LEFT to display the PRESET menu.
- 6 Move the OK button UP to select 'Auto Programme' then move the OK button RIGHT to display the 'AUTO PROGRAMME' menu.
- 7 Press the OK button to start the automatic tuning process. The word 'Searching' now flashes on the menu screen and the TV starts to store all available channels. As the TV is searching, the bottom right corner of the menu screen displays its progress. Please be patient and do not press any buttons.
- 8 When the autotune procedure is complete, the PRESET menu appears on the screen and the channel currently being broadcast on programme 1 is displayed.
- 9 Press the MENU button to remove the 'PRESET' menu from the TV screen. You can now view the channels by pressing the PROG+/- or the numbered buttons on the remote control.

Notes:

- If you wish to stop the "Autotune" procedure, press the OK button then the MENU button on the remote control.

- If, after tuning is complete, no digital programme is displayed on the TV, repeat steps 1-9 but select 'Analogue' in the Programme Setup menu screen. When digital programmes become available in your area, repeat steps 1-9 above and select 'Digital' in the Programme Setup menu screen.

Quick Start Guide

Selecting Analogue or Digital Channels

You have the option to view either digital channels or analogue channels.

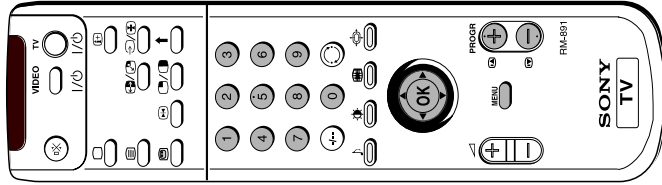
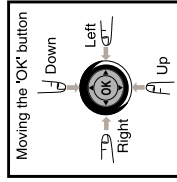

- 1 Press the MENU button on the remote control to display the menu on the TV screen.
- 2 Move the OK button on the remote control DOWN to select the symbol on the menu screen then move RIGHT to enter the 'PRESET' menu.
- 3 Move the OK button DOWN to select "Programme Setup", then move RIGHT to enter the 'PROGRAMME SETUP' menu.
- 4 Move the OK button RIGHT to highlight the brackets then move repeatedly DOWN to select 'Digital' if you wish to view digital channels or 'Analogue' if you wish to view analogue channels.
- 5 Press the OK button to confirm your selection.
- 6 You can now view the channels by pressing the PROG+/- or the numbered buttons on the remote control.

Selecting Digital/Analogue Channels via Remote Control

- 1 Press the OK button on the remote control to display the programme table on the TV screen.
- 2 Push the joystick UP or DOWN to select 'Digital/Analogue' then move RIGHT to enter your option.
- 3 Move the joystick UP or DOWN to select 'Digital' if you wish to view digital channels or 'Analogue' if you wish to view analogue channels.

Note: This model may be supplied with the RM-892 version commander.

Overview of the Remote Control Buttons

To Mute Sound
Press to mute TV sound. Press again to restore the sound.

To Return to TV Mode
Press to return to the normal operation from teletext mode or standby mode. These buttons have no function.

To Select Teletext
Press to select Teletext mode.

To Select ESG
Press to display the Event Schedule Guide. Press again to remove display.

To Freeze the picture
Press to freeze the picture. Press again to cancel freeze.

To Select Channels
Press numbered buttons to select channels. For double-digit programme numbers, e.g. 23, press **2** first, then the buttons **2** and **3**. If you enter an incorrect first digit, this should be corrected by entering another digit (0 - 9) and then selecting **2** button again to enter the programme number of your choice.

To Display Sound Menu
Press to change the sound settings. Press again to remove the display.

To Display Picture Menu
Press to change the picture settings. Press again to remove the display.

To Adjust TV Volume
Press to adjust the volume of the TV.

To Control Other Sony Equipment
With this selector you can control other Sony equipment. Open the remote control lid and set the selector according to the type of equipment you want to control then use the buttons on the remote control to operate the equipment.
VTR1 : Sony Beta VCR
VTR2 : Sony 8mm VCR
VTR3 : Sony VHS VCR
VTR4 : Sony Digital VCR
MDP : Sony Multi Disc Player

To Reset to Factory Settings
Open the remote control lid and press to return picture and sound levels to factory settings.

VCR On/Off Button
Press to temporarily switch off VCR (if Sony VCR connected). Press again to switch on VCR.

To Temporarily Switch Off TV
Press to temporarily switch off TV. Press again to switch on TV from standby mode. To save energy when you temporarily switch off completely when TV is not in use. NOTE: After 15 - 30 minutes without a TV signal and without any button being pressed, the TV switches automatically into standby mode.

To Reveal On Screen Information
Press to reveal all on-screen indications. Press again to cancel.

To select input signal or freeze teletext
Press to select inputs from the TV sockets (see Using Optional Equipment section). In teletext mode, press to freeze the displayed page. Press once again to cancel.

To Return To Previous Channel
Press to return to the previous channel you were watching. Note: This can be done only after watching the present channel for 3 seconds.

To Change Screen Format
Press to change the size of the screen. This button can be used in Teletext mode only. Please see Teletext section of manual for details.

To Select Menu Items
Use this OK button to select options available in the menu system of the TV.

To Select Channels
Press to select channels.

To Display the Menu
Press if you wish to use the TV menu system. Press again to remove the menu from the TV screen.

To Display the Time
Open the remote control lid and press to display the time on screen.

To Operate Video Equipment
Open the remote control lid and press these buttons to operate your video equipment (please refer to your VCR manual).

Overview of the TV Set Functions

Volume control buttons. After pressing the CONTROL button on the top of the TV set, press to increase (+)/decrease (-) volume.

Video input button. After pressing the CONTROL button on the top of the TV set, press to select the input signals from VCR etc.

Programme Up (+) or Down (-) buttons. After pressing the CONTROL button on the top of the TV set, press to select TV channels.

CONTROL button. Press to activate and illuminate the control panel.

On/Off Switch. Press to switch TV on/off.

Adjusting the Picture

Although the picture is adjusted at the factory, you can modify it to suit your own taste.

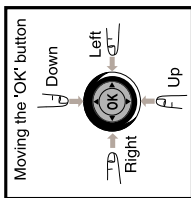

- 1 Press the MENU button on the remote control to display the menu on the TV screen.
- 2 Move the OK button on the remote control DOWN to select the PICTURE CONTROL menu on the TV screen.
- 3 Move the OK button UP or DOWN to select the item on the screen you wish to adjust. For a description of the menu items and their effects, see the following table.
- 4 Move the OK button RIGHT to highlight the settings.
- 5 Adjust the setting by moving the OK button UP, DOWN, LEFT or RIGHT.
- 6 As soon as you have adjusted the item, press the OK button to confirm.
- 7 Repeat steps 3 to 6 to adjust the other items.
- 8 Press the MENU button to remove the display from the TV screen.

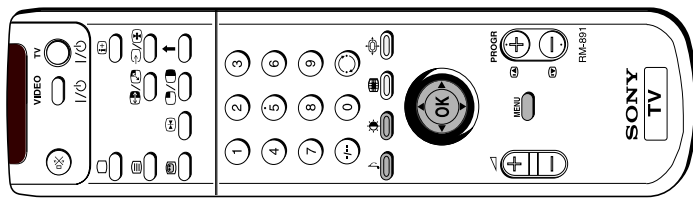
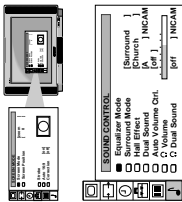

Picture Control	Effect/Operation
Picture Mode	Select between the following sound settings ▼ Personal (for individual settings) Movie (for films) Live (for live broadcasts) ▲ Less ▲ More
Brightness*	► Darker ► Brighter
Colour*	◀ Less ▶ More
Hue**	◀ Greenish ▶ Reddish
Sharpness*	◀ Softer ▶ Sharper
Reset	Resets picture to factory preset levels
AI (Artificial Intelligence)	▼ Off:normal On:automatic optimization of contrast level according to the TV signal.
Noise Reduction	▼ Off:normal On:reduces picture noise in case of a weak broadcast signal.
100Hz Mode	▼ 1:Normal ▲ 2:LFR (Line Flicker Reduction) off

* Only if "Personal" is selected in "Picture Mode".
 ** Available for NTSC colour system only.

Changing Picture and Sound Modes Quickly

You can quickly change the Picture Mode or the Equalizer Mode without entering the 'PICTURE CONTROL' or 'SOUND CONTROL' menu screens.

- 1 Press the * symbol on the remote control for picture modes or the * symbol for equalizer modes.
- 2 Move the OK button on the remote control UP or DOWN to select the desired mode.
- 3 Press * or * again to remove the display from the TV screen.

Adjusting the Sound

Although the sound is adjusted at the factory, you can modify it to suit your own taste.

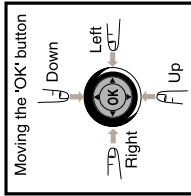

- 1 Press the MENU button on the remote control to display the menu on the TV screen.
- 2 Move the OK button on the remote control DOWN to select the SOUND CONTROL menu on the TV screen.
- 3 Move the OK button UP or DOWN to select the item on the screen you wish to adjust. For a description of the menu items and their effects, see the following table.
- 4 Move the OK button RIGHT to highlight the settings.
- 5 Adjust the setting by moving the OK button UP, DOWN, LEFT or RIGHT.
- 6 As soon as you have adjusted the item, press the OK button to confirm.
- 7 Repeat steps 3 to 6 to adjust the other items.
- 8 Press the MENU button to remove the display from the TV screen.

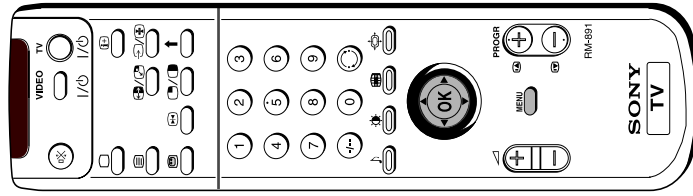
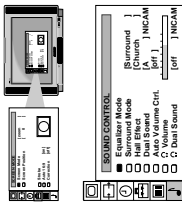

Sound Control	Effect/Operation
Equalizer Mode	Select between the following sound settings ▲ Personal Vocal Jazz Rock Pop ▼ Flat (fixed setting, cannot be adjusted) You can adjust the mode selected in Equaliser mode by cutting and boosting the 5 selected frequency bands. Only the changes made in Personal can be stored, the others return to factory setting. Select the desired bar by moving the OK button UP, DOWN, LEFT or RIGHT then press the OK button to confirm.
Surround Mode	▲ Off Hall ▼ Pro Logic ▲ Stadium Hall Church ▼ Disco
*Hall Effect	• For a bilingual broadcast: A for channel 1 ◀ ▶ B for channel 2 • For a stereo broadcast: Stereo ◀ ▶ Mono
Dual Sound	• For a bilingual broadcast: A for channel 1 ◀ ▶ B for channel 2 • For a stereo broadcast: Stereo ◀ ▶ Mono
**Auto Volume Control	On: volume level of the channels will stay the same independent of the broadcast signal (e.g. in case of advertisements) 4 Off: volume level changes according to the broadcast signal
Headphones	Less ◀ ▶ More
2 Volume	• For a bilingual broadcast: A for channel 1 ◀ ▶ B for channel 2 • For a stereo broadcast: Stereo ◀ ▶ Mono

* Only if "Hall" is selected in Surround Mode.
 ** Only if Surround Mode is switched to "off"

Setting up Dolby ProLogic

Before listening to Dolby Surround sound, you can adapt the Dolby features to suit your own taste. It is normal to set up the levels and modes of the speakers only when installing the TV and the speakers or when changing the position of the speakers.

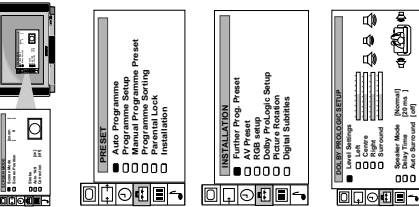
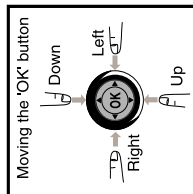

- 1 Press the MENU button on the remote control to display the menu on the TV screen.
- 2 Move the OK button on the remote control DOWN to select the symbol on the TV screen then move to RIGHT to confirm.
- 3 Move the OK button DOWN to select 'Installation' then move the OK button RIGHT to enter.
- 4 Move the OK button DOWN to select 'Dolby ProLogic Setup' then move RIGHT to enter.

- 5 Select 'Level Settings' by moving the OK button UP or DOWN. Move the OK button to RIGHT to enter.

- 6 Select Left (left speaker), Centre (centre speaker), Right (right speaker) or Surround (surround speakers) by moving the OK button DOWN then move the OK button RIGHT to confirm.
- 7 Adjust the level by moving the OK button RIGHT or LEFT.
- 8 After you have adjusted the level, press the OK button to confirm.

- 9 Repeat steps 6 to 8 if you wish to adjust the sound levels of the other speakers (from your sitting position the sound output from all speakers should be balanced).

- 10 Move the OK button LEFT.
- 11 Select 'Speaker mode' by moving the OK button DOWN then move the OK button RIGHT to enter.

- 12 Push the OK button repeatedly DOWN to select:
 - Normal - all speakers are activated
 - 3 Wide - surround speakers are not used, centre speaker carries full frequency response
 - 3 Normal - surround speakers are not used
 - Wide - wider bandwidth for centre speaker
 - Phantom - centre speaker is not used
 - Normal - all speakers are activated

Press the OK button to confirm your choice.

- 13 Select 'Delay Time' by moving the OK button DOWN then move to RIGHT to confirm. Adjust the delay time of the surround speakers by moving the OK button UP or DOWN (e.g. 20 ms or standard room 30 ms for small rooms)
 - 15 ms to 1. 20 ms to 1. 25 ms to 1. 30 ms

Press the OK button to confirm your choice.

- 14 Select 'Auto Surround' by moving the OK button DOWN then move to RIGHT to confirm. Move the OK button DOWN to select:
 - On - When receiving a Dolby Surround encoded programme, the TV switches automatically to Dolby Surround sound (depending on availability of service by broadcaster).
 - Off - normal

Press the OK button to confirm your choice.

- 15 Press the MENU button on the remote control to remove the menu from the TV screen.

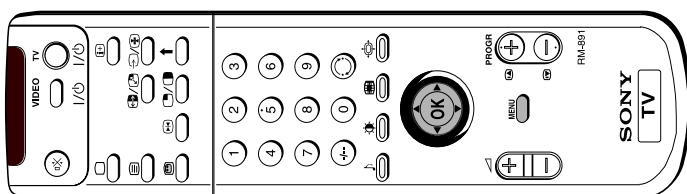

Operating Screen Mode

Using this Screen Mode feature you can change the aspect ratio of the screen or reproduce the main picture image by Image (Strobe function).

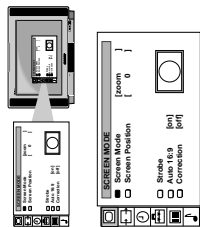

- 1 Press the MENU button on the remote control to display the menu on the TV screen.
- 2 Move the OK button on the remote control RIGHT to select the 'Screen Mode' then move to RIGHT to select the brackets. Move the OK button repeatedly UP or DOWN to select one of the following modes:
 - smart - imitation of wide screen effect (16:9) for 4:3 broadcasts.
 - wide - for 16:9 broadcasts
 - smart - imitation of wide screen effect (16:9) for movies broadcast in cinematic format.

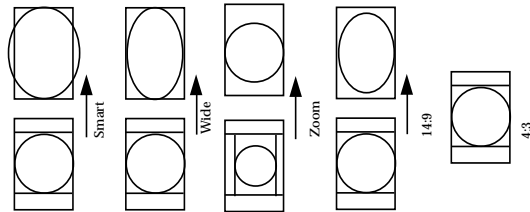

- 3 Press the OK button to confirm the selection.
 - 14:9 - compromise between 4:3 and 16:9 format
 - 4:3 - conventional 4:3 picture

- 4 Strobe Mode

Move the OK button DOWN to select 'Strobe'. Press the OK button to confirm. The TV picture is now displayed image by image, creating a slow motion effect. Move the OK button UP or DOWN to select the speed of the motion. Press the OK button to cancel the strobe mode.

- 5 Auto 16:9

Move the OK button DOWN to select 'Auto 16:9' then move RIGHT to confirm. Move the OK button DOWN to select 'On' for automatic selection of format or 'Off' for normal mode. Press OK button to confirm.

- 6 Correction (only for Auto 16:9)

In case of automatic format detection there are two possibilities for 4:3/14:9 signals: Set Correction to 'on' if you wish Smart mode to appear on the screen or set it to 'off' if you prefer 4:3/14:9 mode. Move the OK button DOWN to select 'Correction' then move RIGHT to confirm. Move the OK button DOWN to select 'On' or 'Off'. Press OK button to confirm.

- 7 Press the MENU button to remove the menu from the TV screen.

Sorting Programme Positions

After tuning you may wish to change the order in which the channels appear on the TV. You may wish for example to move the channel on programme number 8 to a different programme number.

- 1 Press the MENU button on the remote control to display the menu on the TV screen.

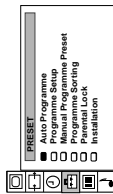
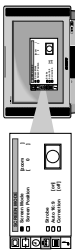
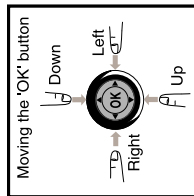

- 2 Move the OK button on the remote control DOWN to select the symbol on the menu screen then move RIGHT to enter.

- 3 Move the OK button DOWN to select 'Programme Sorting', then move RIGHT to confirm.

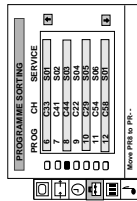

- 4 Move the OK button UP or DOWN to select the programme position of the channel you want to move eg PROG 8). Press the OK button to confirm.

- 5 Move the OK button UP or DOWN to select the new programme position for your selected channel. Press the OK button to confirm. Your selected channel has now moved to its new programme number.

- 6 Repeat steps 4 and 5 to sort other programme positions.

- 7 Press the MENU button to remove the menu from the TV screen.

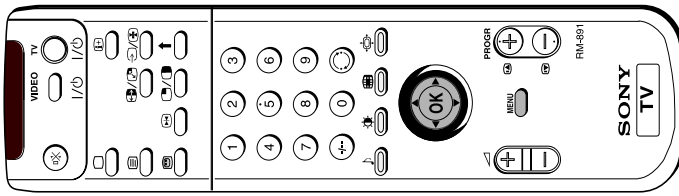

Using Parental Lock

This function enables you to prevent children watching undesirable broadcasts.

- 1 Press the MENU button on the remote control to display the menu on the TV screen.

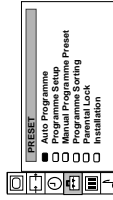
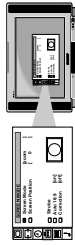

- 2 Move the OK button on the remote control DOWN to select the symbol on the menu screen then move RIGHT to confirm.

- 3 Move the OK button DOWN to select 'Parental Lock' then move RIGHT to confirm.

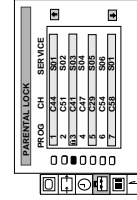

- 4 Move the OK button DOWN to select the channel you want to block. Press the OK button to confirm. The symbol appears before the programme position to indicate that this channel is now blocked. To unblock the channel, press the OK button again. The symbol disappears.

- 5 Repeat step 4 to block other channels.

- 6 Press the MENU button to remove the menu from the TV screen.

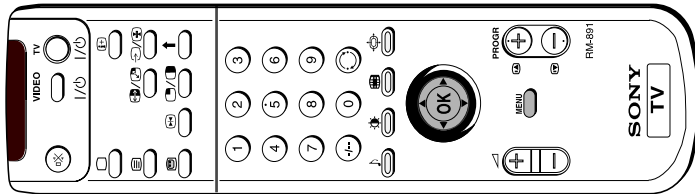
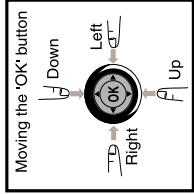

Using Further Programme Preset

With this feature you can

- a) individually adjust and store the volume level of each channel (Volume Offset).
- b) preset the AV output for the programme positions of channels with scrambled signals (e.g. from a Pay TV decoder). In this way a connected VCR records the unscrambled signal.

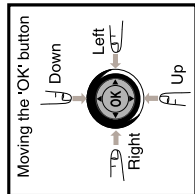

- 1 Press the MENU button on the remote control to display the menu on the TV screen.
- 2 Move the OK button on the remote control DOWN to select the symbol on the menu screen then move RIGHT to confirm.
- 3 Move the OK button DOWN to select 'Installation' then move RIGHT to confirm.
- 4 Move the OK button DOWN to select 'Further Prog. Preset' then move RIGHT to confirm.

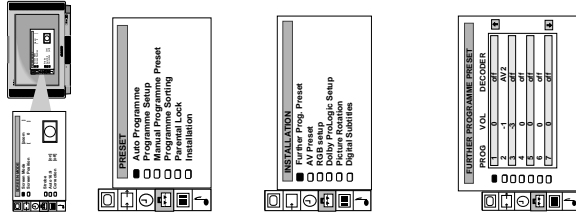

- 5 Move the OK button UP or DOWN to select the programme position you want then move repeatedly RIGHT to select:
 - a) VOL (Volume Offset), b) DECODER. The selected item changes colour.

- 6a) **VOL**
Move the OK button UP or DOWN to adjust the volume for the selected programme position within a range of -7 to +7. Press the OK button to confirm. Repeat steps 5 and 6 to set the volume level for other programme positions.

- 6b) **DECODER**
Move the OK button repeatedly DOWN to select AV1 or AV2 for the programme position and press the OK button to confirm. Repeat steps 5 and 6 to preset the AV output for other programme positions.

- 7 Press the MENU button to remove the menu from the TV screen.

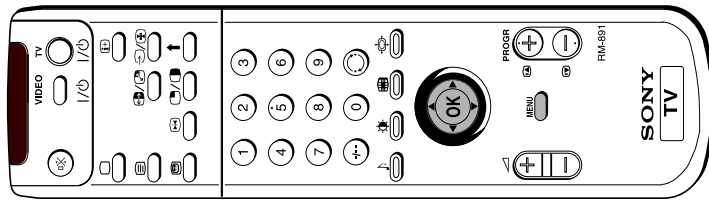

Adjusting the Picture Rotation

If, due to the earth's magnetic field, the picture slants, you can use this function to readjust the picture.

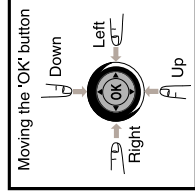

- 1 Press the MENU button on the remote control to display the menu on the TV screen.
- 2 Move the OK button on the remote control DOWN to select the symbol on the menu screen then move to RIGHT to enter.
- 3 Move the OK button DOWN to select 'Installation' then move RIGHT to enter.
- 4 Move the OK button DOWN to select 'Picture Rotation' then move RIGHT to enter.
- 5 Move the OK button RIGHT then move UP or DOWN to adjust the picture rotation. The adjusting range is -4 to +4. Press the OK button to enter.
- 6 Press the MENU button to remove the menu from the TV screen.

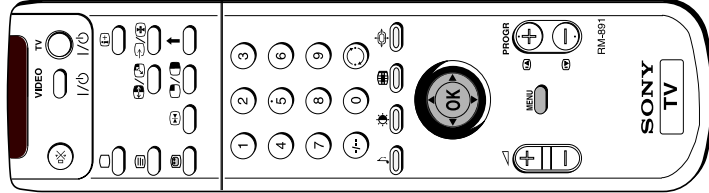

Displaying Subtitles

With this feature you can view subtitles on the TV screen when watching digital channels. When watching analogue channels you can view subtitles via the teletext menu screen (see the Teletext section of this instruction manual).

- 1 Press the MENU button on the remote control to display the menu on the TV screen.
- 2 Move the OK button on the remote control DOWN to select the symbol  on the menu screen then move RIGHT to enter.
- 3 Move the OK button DOWN to select 'Installation' then move RIGHT to enter.

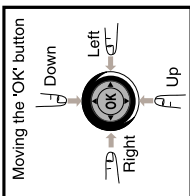
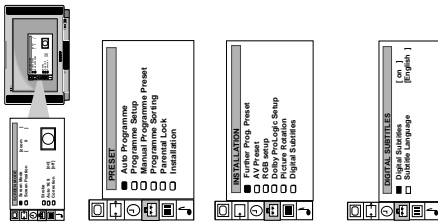

- 4 Move the OK button DOWN to select 'Digital Subtitles' then move RIGHT to enter.
- 5 Move the OK button RIGHT to select 'Digital Subtitles' then move DOWN to switch on/off digital subtitles.
- 6 Press the OK button to enter.

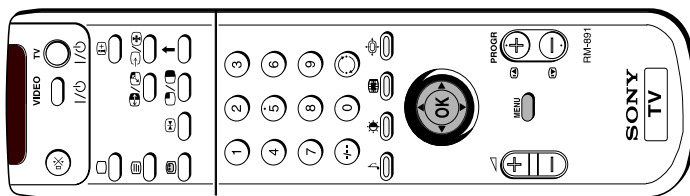

- 7 If you have switched on the subtitles and wish to change the subtitle language, move the OK button DOWN to select 'Subtitle Language' then move RIGHT to highlight the language options.
- 8 Move the OK button repeatedly DOWN to select your chosen language then press the OK button to confirm your choice.

- 9 Press the MENU button to remove the menu from the TV screen.



Using the Sleep Timer

The TV can be set to switch automatically to standby mode after a length of time chosen by you. You may set the time in 15 minute steps up to 4 hours.

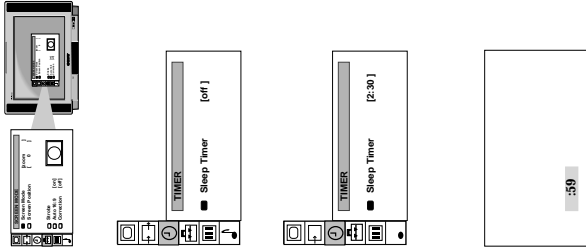
- 1 Press the MENU button on the remote control to display the menu on the TV screen.
- 2 Move the OK button on the remote control DOWN to select the symbol  on the TV screen, then move RIGHT twice.
- 3 Move the OK button UP or DOWN repeatedly until the required amount of time delay appears on the screen.
- 4 Once the time delay has been selected, press the OK button to enter.
- 5 Press the MENU button to remove the menu from the TV screen.



Notes:

- When watching TV, press the  button to display time remaining.
- To return to normal operation from standby mode, press the  button.

Manually Tuning the TV

You have already tuned the TV to receive all available channels using the 'Automatically Tuning the TV' procedure at the start of this manual. You can however carry out this operation manually using the following instructions.

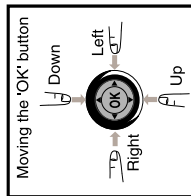

- 1 Press the MENU button on the remote control to display the menu on the TV screen.
- 2 Move the OK button on the remote control DOWN to select the symbol on the menu screen then move RIGHT to enter.
- 3 Move the OK button DOWN to select 'Manual Programme Preset' then move RIGHT to enter.
- 4 Move the OK button UP or DOWN to select a programme number for your channel (eg PROGRAM 1 for BBC1) then move RIGHT to enter.
- 5 Move the OK button repeatedly RIGHT until ↑ appears in the SEARCH column.
- 6 Move the OK button UP or DOWN to search for a channel.

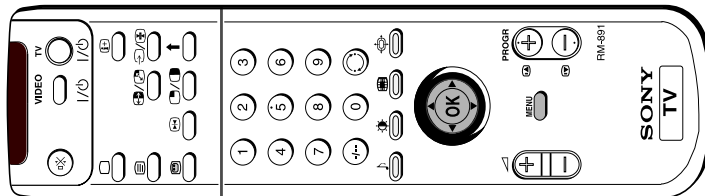

- 7 If you do not wish to store this channel on the programme number you selected, move the OK button UP or DOWN to continue searching for the desired channel.
- 8 If this is the channel you wish to store, press the OK button.
- 9 Repeat steps 4 to 8 if you wish to store more channels then press the MENU button to remove the menu from the TV screen.

Skipping Programme Positions

This function enables you to skip unused programme positions when selecting them with the PROG +/- buttons. However, by using the number buttons you can still select the skipped programme position.

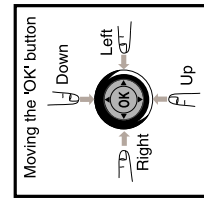

- 1 Press the MENU button on the remote control to display the menu on the TV screen.
- 2 Move the OK button on the remote control DOWN to select the symbol on the menu screen then move RIGHT to enter.
- 3 Move the OK button DOWN to select 'Manual Programme Preset' then move RIGHT to enter.
- 4 Move the OK button UP or DOWN to select the programme position you want to skip then move RIGHT to enter.
- 5 Move the OK button DOWN to select '...' in the position INPUT. Press the OK button to enter.
- 6 Repeat steps 4 and 5 to skip other programme positions.
- 7 Press the MENU button to remove the menu from the TV screen.

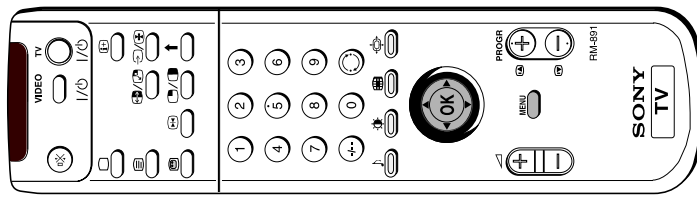

Viewing Standard Teletext

Standard Teletext is an information service transmitted by broadcasters which can be viewed on most of your traditional analogue channels.

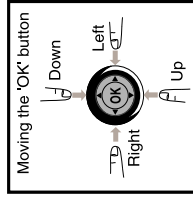

Selecting Teletext

- 1 When viewing analogue channels, press a number button on the remote control to select the channel which carries the teletext service you wish to receive.
- 2 Press the **OK** button on the remote control to switch on teletext. Press the **OK** button again to superimpose teletext on to the TV screen.
- 3 Input three digits for the page number using the numbered buttons on the control. If you make a mistake, type in any three digits then re-enter the correct page number.



Using Other Teletext Functions

Page Catching

Input a teletext page number. Press the **OK** button. 'Page Catching' is displayed at the top of the page. Move the **OK** button UP or DOWN to select the page number you require. Press the **OK** button. The requested page is displayed after some seconds.

To Move to Next or Preceding Page

Press **OK** or **OK** on the control to select the previous or next page.

To Freeze a Teletext Page

Press **OK** on the control to freeze the page. Press **OK** again to cancel the freeze.

Revealing concealed information (eg: answers to a quiz)

Press **OK** to reveal information. Press again to conceal the information.

Using colour buttons to access pages

When the colour coded menu appears at the bottom of a page, press the colour button (green, red, yellow or blue) on the control to access the corresponding page.

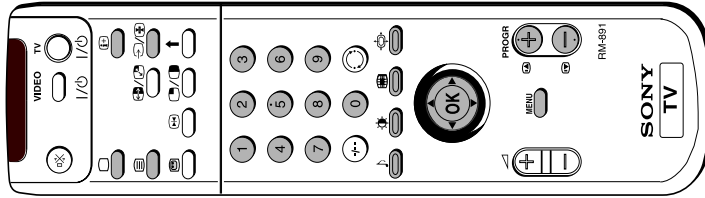

Adjusting the TV Picture for an RGB Source

After connecting an RGB source such as a playstation to the TV, you may need to adjust your TV picture.

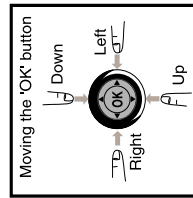

- 1 Press the * button repeatedly on your remote control to display the * symbol on the TV screen.
- 2 Press the MENU button on your remote control to display the menu on the TV screen.
- 3 Move the **OK** button DOWN to select the symbol on the menu screen then move **RIGHT** to enter the 'PRESET' menu.
- 4 Move the **OK** button DOWN to select 'Installation' on the TV screen then move **RIGHT** to enter the 'INSTALLATION' menu.
- 5 Move the **OK** button DOWN to select 'RGB SetUp' on the TV screen then move **RIGHT** to enter the 'RGB SETUP' menu.
- 6 Move the **OK** button **RIGHT** to select 'H Centre' on the screen then move **UP** or **DOWN** to adjust the centre of the picture over a range of -20 to +20.
- 7 Press the **OK** button to confirm the range.
- 8 Move the **OK** button DOWN to select 'H Size' then move **RIGHT** to highlight the range.
- 9 Move the **OK** button **UP** or **DOWN** to adjust the horizontal slant of the picture over a range of -20 to +20.
- 10 Press the **OK** button to confirm the new range.
- 11 Press the MENU button to remove the menu from the TV screen.

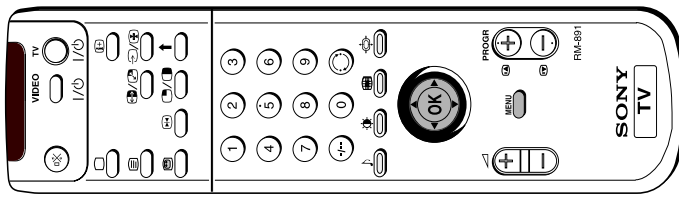

Viewing Standard Teletext

Select further standard teletext functions as follows:

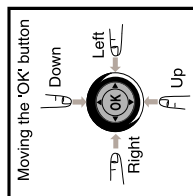

Using the Teletext Menu

- 1 With teletext on the TV screen, press the MENU button on the remote control to display the teletext menu.
- 2 Move the OK button on the remote control DOWN to select the teletext function you want then move RIGHT to confirm your choice.

Preset User Pages...

- For quick access to the pages you frequently use, you can store your favourite teletext pages.
- 1 Push to **▼** to select the bank (from A to E) in which you want to store the pages then push to **▶** to confirm.
 - 2 Push to **▼** to select the three digits of your 6 favourite digits. Press the OK button to confirm or selection.
 - 3 Push to **▼** to select 'Allocate Bank' then push to **▶** to confirm.
 - 4 Push to **▼** to select the programme position which is carrying the teletext service containing your favourite pages, then push to **▶** to confirm.
 - 5 Push to **▼** to select the bank chosen in step 1 then press the OK button to confirm.
 - 6 Repeat steps 1 to 5 if you wish to store pages in the other four available banks.

User Pages...

- 7 Push to **▶** twice to display the Teletext menu screen.
- 8 Push to **▼** to select User Pages then push to **▶** to confirm.
- 9 Push to **▼** to select a favourite page then press the OK button to display the page.

Index

The Index gives you an overview of the teletext contents.

Top/Bottom/Full

For easier reading, you can enlarge the teletext page. Push the OK button to select, to enlarge the upper half, push to **▼** to enlarge the lower half. Press the OK button to resume the normal display.

Text Clear

After selecting this function, you can watch a TV programme while waiting for a requested teletext page to be captured. When the page is available, it will be displayed.

Subtitles

Check with your teletext service for information about subtitled TV programmes. After selecting the function the subtitles are displayed. Press the function again to remove the subtitles.

Time Page

- Check with your teletext service about the availability of time coded pages. If available, you can call up a page at a certain time.
- 1 With this Time Page menu on the TV screen, push to **▶** to enter the three digits of the page you want to call up. Push to **▶** to confirm.
 - 2 Push to **▼** to enter the three digits of the page you want (eg 301) and the four digits of the desired time (eg 18:54). Push to **▶** after each digit. Press the OK button to confirm. At the requested time, the page you selected is displayed.

Subpage

Using this function you can select the subpages, if available, of a particular teletext page. After selecting the function push to **▶** to access the various subpages. Select the function again to cancel the request.

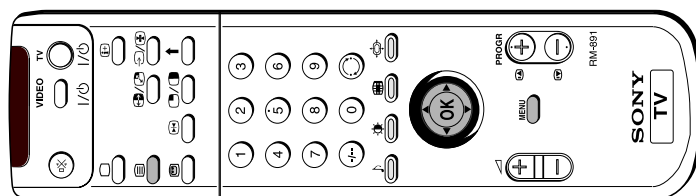

Viewing Digital Teletext

Most of the digital TV channels broadcast information via teletext.

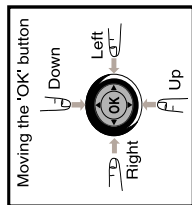

Selecting Teletext

- 1 To view the digital teletext service, firstly select the dedicated teletext channel.
- 2 Individual Teletext pages are then selected by using the UP, DOWN, LEFT or RIGHT buttons to guide the on-screen cursor to the required area of the screen. Pressing the OK button then displays the chosen information.
- 3 Alternatively, use the numeric buttons 0-9 to directly enter the number of the page you require.
- 4 When you have finished viewing Teletext, select an alternative channel in the normal manner.

Normal Teletext services may also be available on other digital channels and are selected using the **TV** button.

- 1 Press a number button on the remote control to select the channel which carries the teletext service you wish to receive.
- 2 Press the **TV** button on the remote control to switch on teletext. Press the **TV** button again to superimpose teletext on to the TV screen.
- 3 Input three digits for the page number using the numbered buttons on the control. If you make a mistake, type in any three digits then reenter the correct page number.
- 4 Press the **OK** button to switch off teletext.

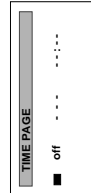
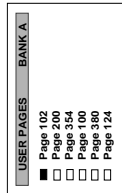
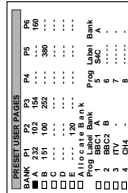
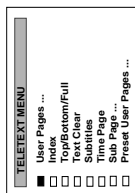

Electronic Programme Guide (EPG)

The Electronic Programme Guide (EPG) is a guide which provides programme information for all digital channels supporting EPG.

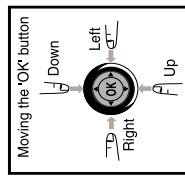

Displaying the EPG

- 1 Press the **OK** button on the remote control to display the programme guide on the TV screen. You may see the message 'EPG INFORMATION IS TEMPORARILY UNAVAILABLE' whilst waiting for the EPG to appear on screen.
- 2 Move the **OK** button on the remote control **UP**, **DOWN**, **LEFT** or **RIGHT** to move the on-screen cursor around the guide.
- 3 Press the **OK** button again to remove the programme guide from the TV screen.

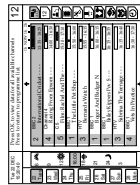

Viewing Information on the EPG

You can alter the type of information presented on the EPG by changing data in each of the EPG columns. You can for example display information for all sports programmes being shown tomorrow from 5.00pm onwards.

- 1 Press the **OK** button on the remote control to display the EPG on the TV screen.
- 2 Move the **OK** button on the remote control **RIGHT** or **LEFT** to highlight the date column then move the **OK** button **UP** or **DOWN** to select your chosen date.
- 3 Move the **OK** button **RIGHT** or **LEFT** to highlight the 'time' column then move the **OK** button **UP** or **DOWN** to select your chosen time.
- 4 Move the **OK** button **RIGHT** or press the **OK** button. The EPG will display programme information according to the date and time you selected.
- 5 Move the **OK** button **RIGHT** to highlight the 'programme type' column then move **UP** or **DOWN** to select **Films**, **News**, **Lifestyle**, **Sport**, **Children's Programmes**, **Entertainment** or **Education**.
- 6 Move the **OK** button **RIGHT** or **LEFT** or press the **OK** button to update the programme information accordingly. If you selected tomorrow's date, 17:00 and **Sport**, you should now be able to view all the sports programmes being shown tomorrow from 5.00 pm onwards.
- 7 Press the **OK** button on the remote control to remove the EPG from the TV screen.

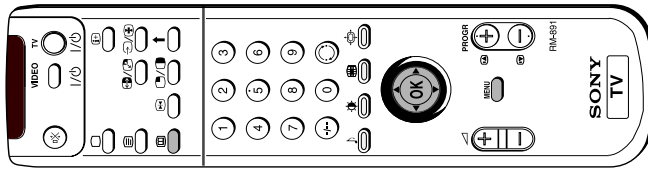

Electronic Programme Guide (EPG)

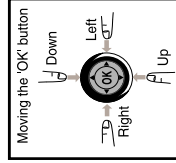

Setting The Manual Timer

- 1 Press the **OK** button on the remote control to display the EPG on the TV screen.
- 2 Move the **OK** button **RIGHT** or **LEFT** to highlight the 'programme type' column then move the **OK** button **DOWN** to select the timer symbol .
- 3 Press the **OK** button to display a screen of 9 programme slots, each one indicating that it is either free for programming, or that it has a programme already stored in it.
- 4 Move the **OK** button **LEFT** to enter the 'programme' column.
- 5 Move the **OK** button **UP** or **DOWN** to select a free row then press the **OK** button to display the 'Set' Timer screen. This screen asks you to confirm the date, programme number, start time and stop time.
- 6 Move the **OK** button **UP** to select the date area then move the **OK** buttons **UP** or **DOWN** to enter the date.
- 7 Move the **OK** button **RIGHT** to confirm the date then press the **OK** button **UP** or **DOWN** to select the month and to select the start time.
- 8 Move the **OK** button **RIGHT** to confirm the month and to select the start time.
- 9 Move the **OK** button **UP** or **DOWN** to enter the time you wish the timer to switch on, preferably several minutes before your video recorder is due to start recording. Move the **OK** button **RIGHT** to confirm after each entry.
- 10 Move the **OK** button **UP** or **DOWN** to enter the time you want the timer to switch off, preferably after your video is due to stop recording.
- 11 Move the **OK** button **RIGHT** to confirm each entry, then move the **OK** button **UP** or **DOWN** to select the programme number.
- 12 Press the **OK** button to save the settings, then follow the on-screen instructions until you finally select **Home** to return to the Manual Timer Setup menu.
- 13 Select another available slot if you wish to record a further programme. Otherwise, move the **OK** button **RIGHT** to enter the 'programme type' column then press the **OK** button to return to the EPG.
- 14 If you have finished viewing programmes on your TV, press the button before the timer recording starts. This will leave your TV in standby mode for the timer settings to be activated. If, however, you wish to continue watching other programmes after setting the timer, you can do so by changing programmes in the normal way. If you are watching another programme when the timer is due to start, the display shown will appear on screen.
- 15 If you do not wish to view the recording, press the **1/0** button whilst the display is still on screen to leave your TV in standby mode. The standby indicator on the front of the TV will flash to show that the timer record operation is active. If, however, you choose to change programmes, you will automatically cancel the recording.

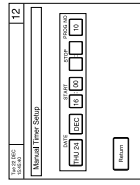
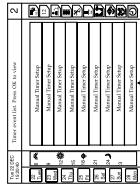
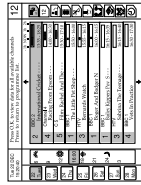

▶ Timer Recording Even will begin soon. During the recording select the channel.

Specifications

TV system

Colour system

PAL
NTSC 3.58, 4.43 (only Video In)

Channel coverage

UHF: B2-L-B69

Picture tube

KV-28DS60U/28DS65U

FD Trinitron WIDE

Approx. 71 cm (28 inches) (Approx. 66 cm picture measured diagonally),

102° deflection

KV-32DS60U/32DS65U

FD Trinitron WIDE

Approx. 82 cm (32 inches) (Approx. 76 cm picture measured diagonally),

102° deflection

Rear Terminals

 21-pin Euro connector (CENELEC standard) including audio/video input, RGB input, TV audio/video output

 21-pin Euro connector (CENELEC standard) including audio/video input, S-video input, Monitor audio/video output

 21-pin Euro connector (CENELEC standard) including audio/video input, S-video input, Monitor audio/video output

 Audio outputs - phono jacks

 Modem Connector

Front Terminals

 video input - phono jack

 audio inputs - phono jacks

 S-video input - 4 pin DIN

 Headphones jack - minijack stereo

Sound output:

Centre

Surround

2 x 30 W (music power) 2 x 15 W (RMS)

1 x 30 W (music power) 1 x 15 W (RMS)

2 x 15 W (music power) 2 x 7.5 (RMS)

Power consumption

KV-28DS60U/28DS65U

KV-32DS60U/32DS65U

200 W

200 W

Dimensions (w x h x d)

KV-28DS60U/28DS65U

KV-32DS60U/32DS65U

Approx. 773 x 501 x 526 mm

Approx. 867 x 564 x 558 mm

Weight

KV-28DS60U/28DS65U

KV-32DS60U/32DS65U

Approx. 53.0 kg

Approx. 71.5 kg

Accessories supplied

RM-891 or RM-892 Remote Control (1)

IEC designated size AA battery (2)

Surround speaker (2)

Other features

TELETEXT

DNR (Digital Noise Reduction)

Dolby ProLogic Surround System







































Graphic Equalizer

NICAM Stereo

Smartlink

Design and specifications are subject to change without notice.

Troubleshooting

Problem	Cause
No picture, no sound.	<ul style="list-style-type: none"> Power off. TV in standby. Aerial disconnected. Picture preset level adjustment. No digital transmissions in your area. No digital transmissions from the transmitter you are currently using. Weak signal. Unsuitable aerial. Scrambled/subscription-only channel. Programme used only for data (no picture or sound). Programme not being transmitted. Digital mode Timer Record active (regular flash). Fault (irregular flash). Volume control.
Poor or no picture (screen is dark), but good sound.	<ul style="list-style-type: none"> Wrong external mode selected on an RGB video source. Colour level setting. Batteries low. Inputs from external equipment not switched off.
No picture on any channel after digital tuning.	<ul style="list-style-type: none"> Inputs from external equipment not switched off.
Some channels are blank.	<ul style="list-style-type: none"> Wrong external mode selected on an RGB video source. Colour level setting. Batteries low. Inputs from external equipment not switched off.
Standby indicator flashing.	<ul style="list-style-type: none"> Wrong external mode selected on an RGB video source. Colour level setting. Batteries low. Inputs from external equipment not switched off.
Good picture, no sound.	<ul style="list-style-type: none"> Wrong external mode selected on an RGB video source. Colour level setting. Batteries low. Inputs from external equipment not switched off.
Poor picture quality.	<ul style="list-style-type: none"> Wrong external mode selected on an RGB video source. Colour level setting. Batteries low. Inputs from external equipment not switched off.
No colour on colour programmes.	<ul style="list-style-type: none"> Wrong external mode selected on an RGB video source. Colour level setting. Batteries low. Inputs from external equipment not switched off.
Remote control does not function.	<ul style="list-style-type: none"> Wrong external mode selected on an RGB video source. Colour level setting. Batteries low. Inputs from external equipment not switched off.
Distorted picture when changing programmes or selecting Teletext.	<ul style="list-style-type: none"> Wrong external mode selected on an RGB video source. Colour level setting. Batteries low. Inputs from external equipment not switched off.
Cause	Solution
Power off.	<ul style="list-style-type: none"> Plug in the TV.
TV in Standby.	<ul style="list-style-type: none"> Press the  button on the front of the TV. If the  button or a programme number on the remote control.
Aerial disconnected.	<ul style="list-style-type: none"> Check the aerial connection.
Picture level adjustment.	<ul style="list-style-type: none"> Select  on the TV menu system then adjust the brightness, picture and colour balance levels. Lift the flap of the remote control and press  to return to the preset factory levels.
No digital transmissions in your area.	<ul style="list-style-type: none"> Switch the TV to analogue mode using the manual then contact a local installer to find out when digital transmissions start in your area. Contact a local installer to find out which transmitter you should be pointing your aerial at. Change your aerial to cover the channels used by digital programmes (Contact a local installer). Ensure aerial is plugged directly into the TV (not through other equipment). Ensure aerial is correctly aligned to transmitter. Upgrade to a higher gain aerial. Subscribe to pay-per-view broadcaster. See "Skipping programme position" section. See "Exchanging programme positions" section. Do not open the cabinet, refer to qualified person. Contact your nearest Sony Service Centre.
No digital transmissions from the transmitter you are currently using	<ul style="list-style-type: none"> Press the  + button on the remote control. If  is displayed on the screen, press the  button on the remote control. Press the  button repeatedly on the remote control until the RGB symbol  is displayed on screen. Select  in the TV menu system then adjust the colour setting. Lift the flap of the remote control and press  to return to the preset factory level.
Weak signal.	<ul style="list-style-type: none"> Change your aerial to cover the channels used by digital programmes (Contact a local installer). Ensure aerial is plugged directly into the TV (not through other equipment). Ensure aerial is correctly aligned to transmitter. Upgrade to a higher gain aerial. Subscribe to pay-per-view broadcaster. See "Skipping programme position" section. See "Exchanging programme positions" section. Do not open the cabinet, refer to qualified person. Contact your nearest Sony Service Centre.
Scrambled/subscription-only channel.	<ul style="list-style-type: none"> Press the  + button on the screen, press the  button on the remote control. Press the  button repeatedly on the remote control until the RGB symbol  is displayed on screen. Select  in the TV menu system then adjust the colour setting. Lift the flap of the remote control and press  to return to the preset factory level.
Programme information without picture or sound.	<ul style="list-style-type: none"> Press the  + button on the screen, press the  button on the remote control. Press the  button repeatedly on the remote control until the RGB symbol  is displayed on screen. Select  in the TV menu system then adjust the colour setting. Lift the flap of the remote control and press  to return to the preset factory level.
Fault.	<ul style="list-style-type: none"> Press the  + button on the screen, press the  button on the remote control. Press the  button repeatedly on the remote control until the RGB symbol  is displayed on screen. Select  in the TV menu system then adjust the colour setting. Lift the flap of the remote control and press  to return to the preset factory level.
Volume control.	<ul style="list-style-type: none"> Press the  + button on the screen, press the  button on the remote control. Press the  button repeatedly on the remote control until the RGB symbol  is displayed on screen. Select  in the TV menu system then adjust the colour setting. Lift the flap of the remote control and press  to return to the preset factory level.
Wrong external mode selected.	<ul style="list-style-type: none"> Press the  + button on the screen, press the  button on the remote control. Press the  button repeatedly on the remote control until the RGB symbol is displayed on screen. Select in the TV menu system then adjust the colour setting. Lift the flap of the remote control and press to return to the preset factory level.
Colour level setting.	<ul style="list-style-type: none"> Press the + button on the screen, press the button on the remote control. Press the button repeatedly on the remote control until the RGB symbol is displayed on screen. Select in the TV menu system then adjust the colour setting. Lift the flap of the remote control and press to return to the preset factory level.

• If you continue to have these problems, have your TV serviced by qualified personnel.

• Never open the casing yourself.

SECTION 2 DISASSEMBLY

2-1. REAR COVER REMOVAL

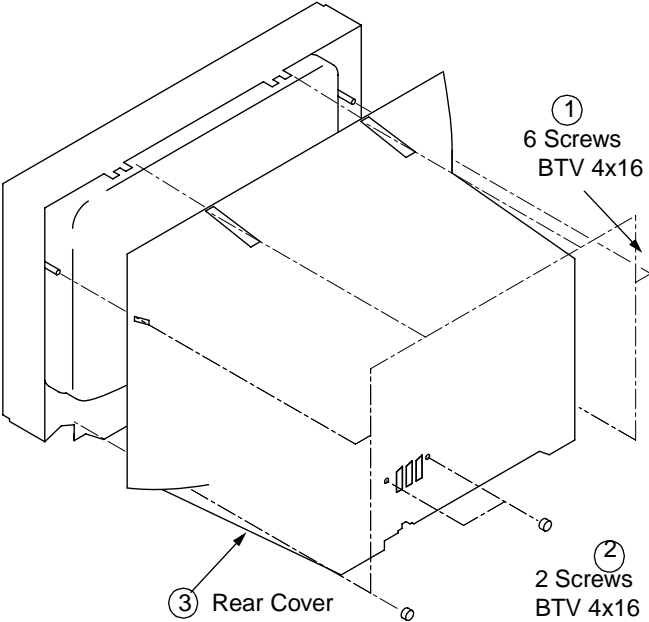

2-2. CHASSIS ASSY REMOVAL

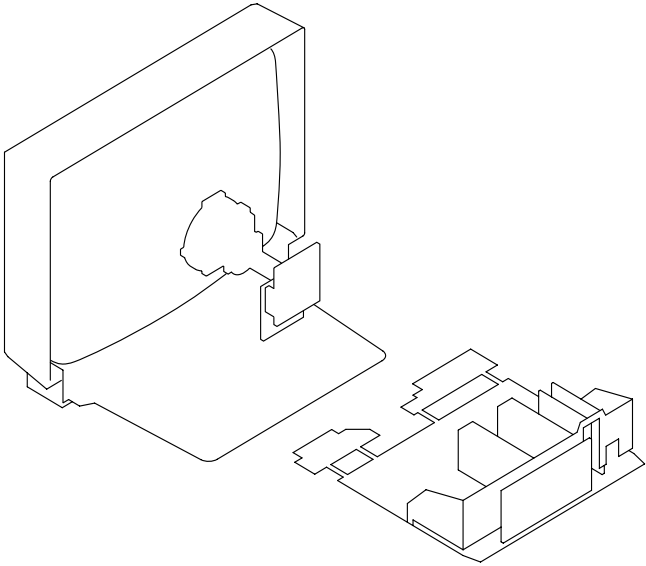

2-3. SERVICE POSITION

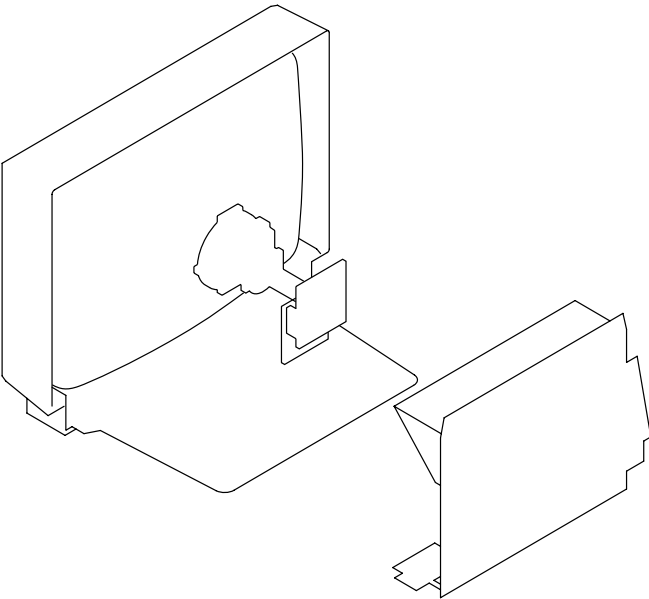

2-4. A1 BOARD REMOVAL

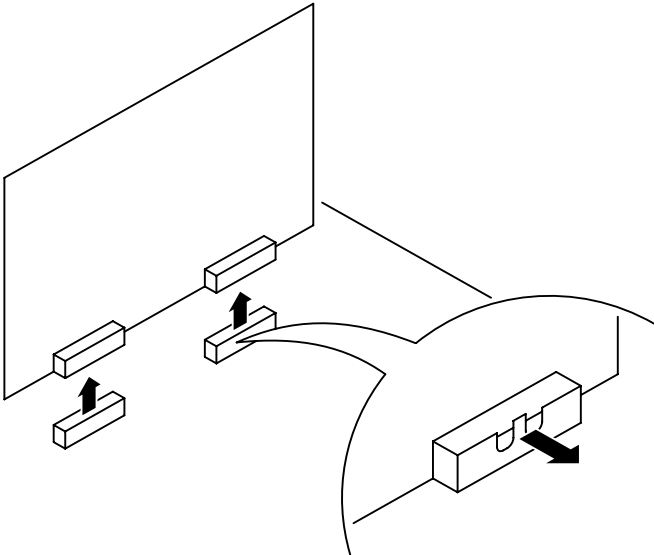

2-5. J BOARD REMOVAL

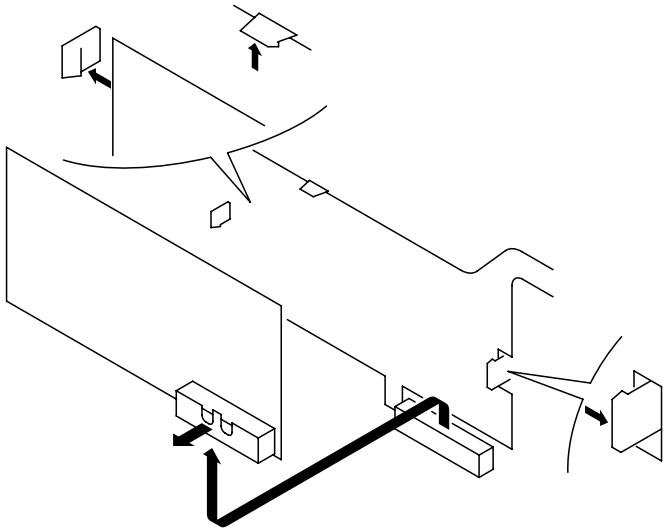

2-6. B BOARD REMOVAL

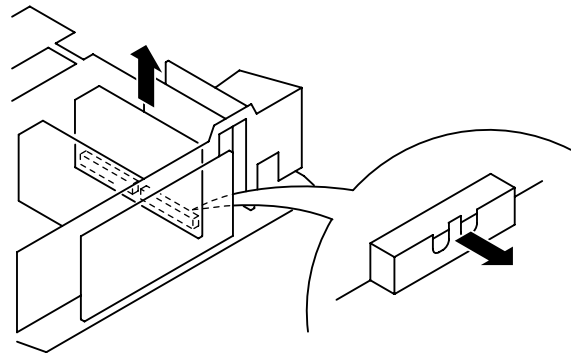

2-7. D1 BOARD REMOVAL

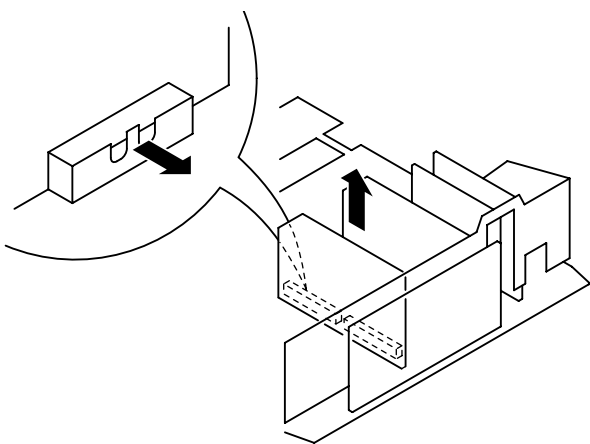

2-8. H BRACKET REMOVAL

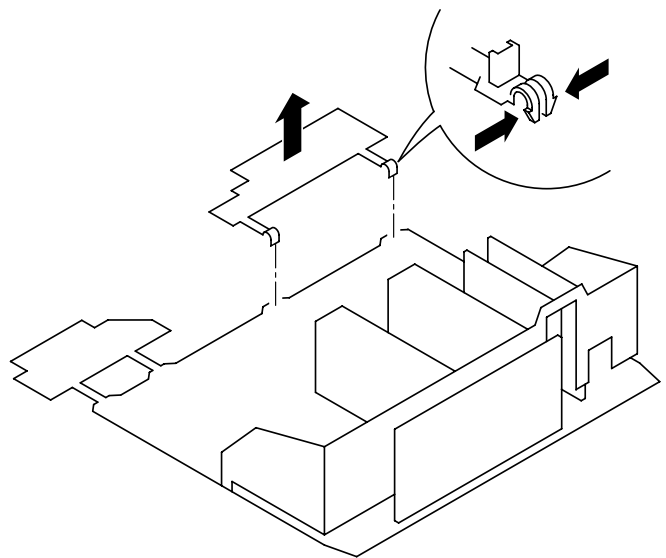

2-9. PICTURE TUBE REMOVAL

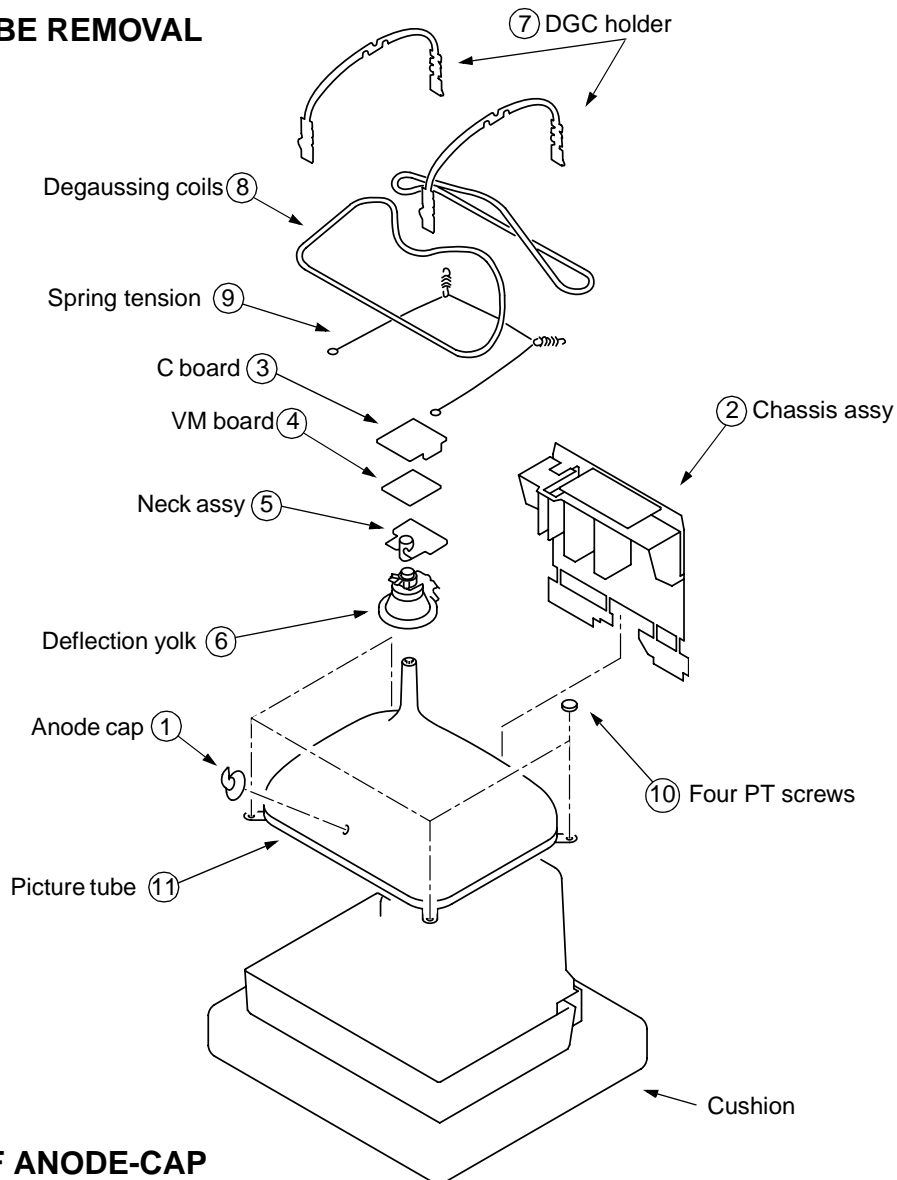

• REMOVAL OF ANODE-CAP

Note : Short circuit the anode of the picture tube and the anode cap to the metal chassis, CRT shield or carbon paint on the CRT, after removing the anode.

* REMOVING PROCEDURES.

-
- ① Turn up one side of the rubber cap in the direction indicated by the arrow (a)
 - ② Using a thumb pull up the rubber cap firmly in the direction indicated by the arrow (b)
 - ③ When one side of the rubber cap is separated from the anode button, the anode-cap can be removed by turning up the rubber cap and pulling it up in the direction of the arrow (c)

• HOW TO HANDLE THE ANODE-CAP

- ① To prevent damaging the surface of the anode-cap do not use sharp materials.
- ② Do not apply too great a pressure on the rubber, as this may cause damage to the anode connector.
- ③ A metal fitting called a shatter hook terminal is fitted inside the rubber cap. Do not turn the rubber foot over excessively this may cause damage if the shatter hook sticks out.

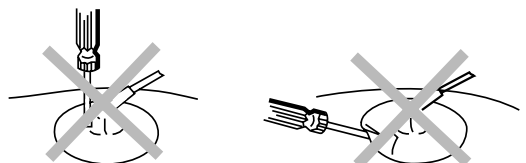

SECTION 3 SET-UP ADJUSTMENTS

- When complete readjustment is necessary or a new picture tube is installed, carry out the following adjustments.
- Unless there are specific instructions to the contrary, carry out these adjustments with the rated power supply.
- Unless there are specific instructions to the contrary, set the controls and switches to the following settings:

Contrast normal
 Brightness normal

Carry out the following adjustments in this order:

- 3-1. Beam Landing
- 3-2. Convergence
- 3-3. Focus
- 3-4. White balance

- Note:** Test equipment required
1. Color bar/pattern generator.
 2. Degausser.
 3. Digital multimeter.
 4. Oscilloscope.

3-1. BEAM LANDING

Preparation:

1. In order to reduce the influence of geomagnetism on the set's picture tube, face it in an easterly or westerly direction.
2. Switch on the set's power and degauss with the degausser.

(1) Adjustment of Correction Magnet for Y-Splitting Axis

1. Input a crosshatch signal from the pattern generator.
2. Set the Picture control to minimum and confirm that the Brightness control is set to normal.
3. Position the neck assembly as indicated in Fig.3-2.
4. Move the deflection yolk as far forward as is possible.
5. Adjust the upper and lower pin symmetrically by opening or closing the Y-splitting axis correction magnets located on the neck assembly.
6. Return the deflection yolk to its original position.

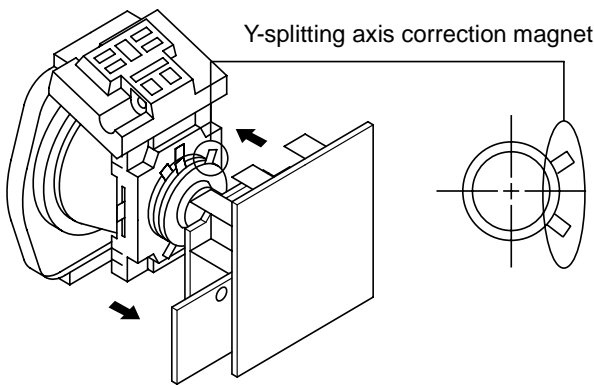

Caution :

High voltages are present on the Deflection yolk terminals - take care when handling the Deflection yolk whilst carrying out adjustments.

(2) Landing

Note : Before carrying out the following adjustments adjust the magnets as indicated below [See Fig.3-3].

1. Input an all-white signal from the pattern generator. Maximize the picture setting and adjust the Brightness setting.
2. Rough-adjust the focus and horizontal convergence.
3. Loosen the deflection yolk screws and align the purity adjustment knob to its central position. [See Fig.3-1].
4. Switch from the all-white pattern to an all-green pattern.
5. Move the deflection yolk backwards and adjust with the purity magnet so that the green is at the centre and it aligns symmetrically. [See Fig.3-4].
6. Move the deflection yolk forward and adjust so that the entire screen becomes green.
7. Switch the raster signal to red, then to blue and verify the landing condition.
8. When the position of the deflection yolk has been determined, fasten the deflection yolk with the screw.
9. If the beam does not land correctly in all the corners of the screen, use magnets to correct it. [See Fig.3-5].

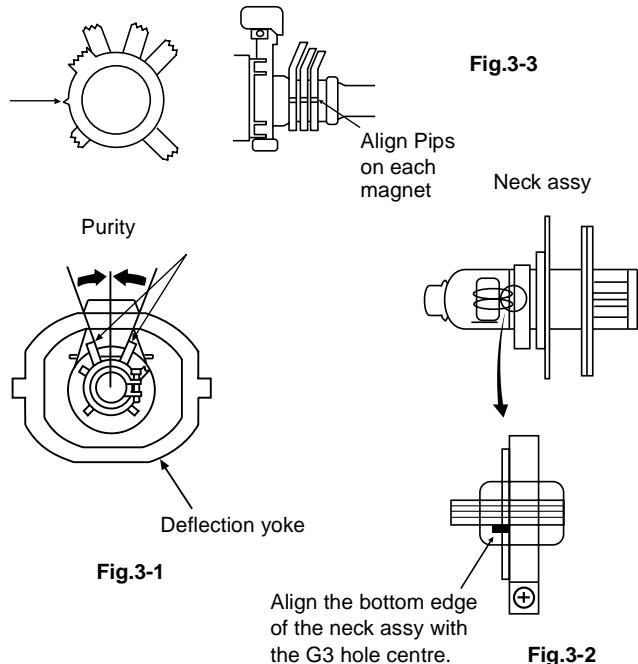

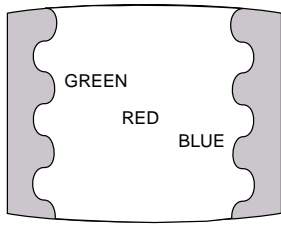

Fig.3-4

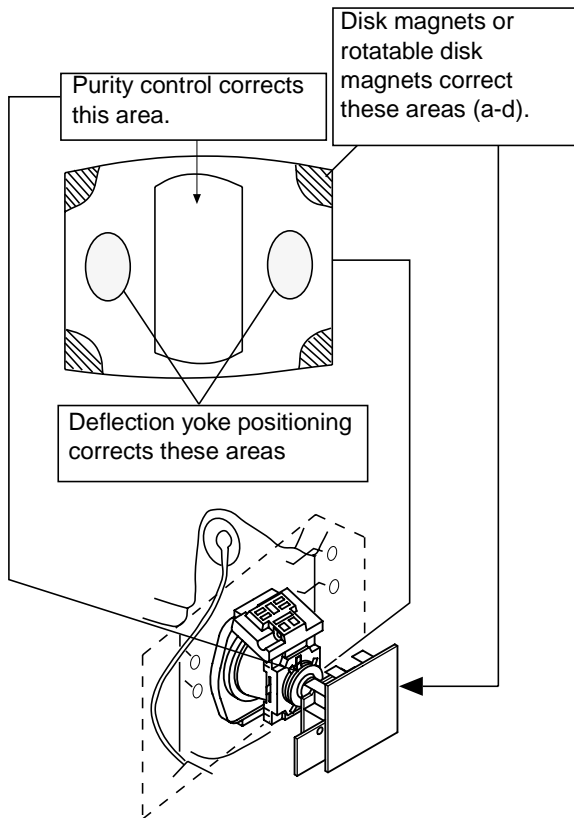
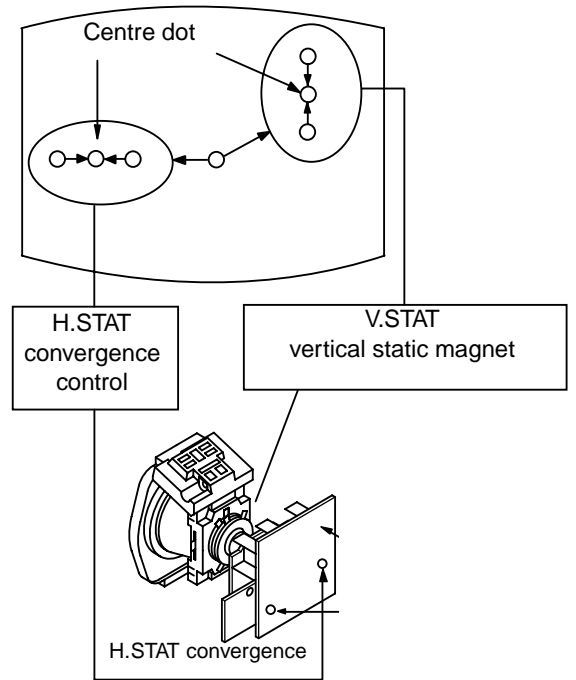

Fig. 3-5

3-2. CONVERGENCE

(1) Screen centre convergence [Static convergence]

1. Input a dot signal from the pattern generator. Normalize the picture setting.
2. [Moving horizontally], adjust the H.STAT control so that the horizontal red, green and blue dots coincide at the centre of the screen.
3. [Moving vertically], adjust the V.STAT magnet so that the vertical red, green and blue dots coincide at the centre of the screen.



- If the horizontal dots are unable to coincide with the variable range of the H.STAT convergence, adjust together with the V.STAT convergence while tracking.
[Adjust the convergence by tilting the V.STAT convergence or by opening and closing the V.STAT convergence.]

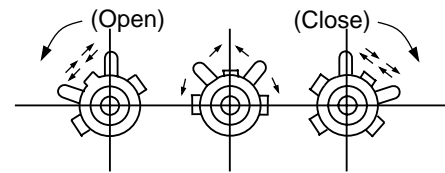

4. Movement of the red, green and blue dots by tilting the V.STAT magnet and by opening or closing the V.STAT magnet.
- a). By opening or closing the V.STAT magnet, the red, green and blue dots move as indicated below.

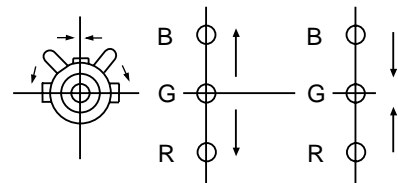

- b). By rotating the V.STAT magnet counter clockwise, the red, green and blue dots move as indicated below.

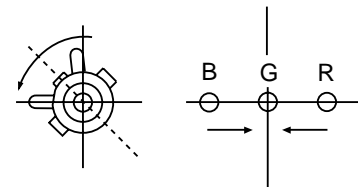

- c). By rotating the V.STAT magnet clockwise, the red, green and blue dots move in the direction indicated below.

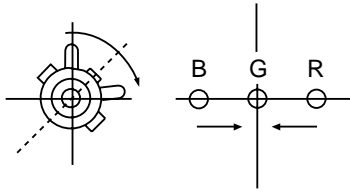

- d). By opening or closing the V.STAT magnet, the red, green and blue dots move in the direction indicated below.

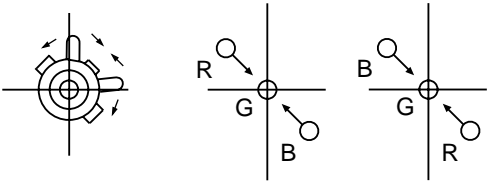

Note : If the blue dot does not coincide with the red and green points correct the points by using the BMC [Hexapole] magnet.

5. Correction for HMC [horizontal mis-convergence] and VMC [vertical mis-convergence] by using the BMC [Hexapole] magnet.

- a). HMC correction by BMC [Hexapole] magnet and movement of the electron beam.

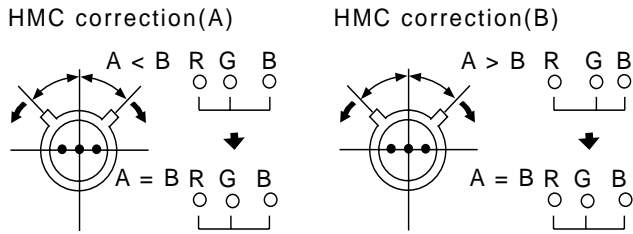

- b). VMC correction by BMC [Hexapole] magnet and movement of the electron beam.

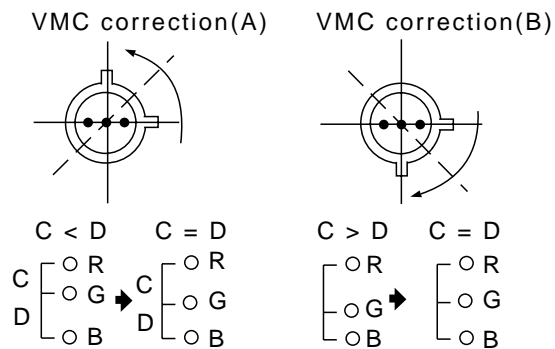

(2) Dynamic convergence

HTIL

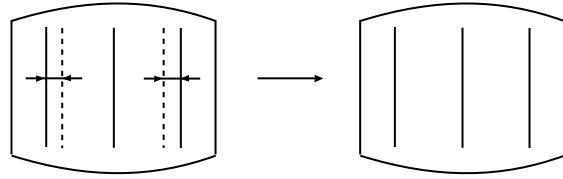

1. HTIL correction can be performed by adjusting RV1502 on the D1 board.

COR.BOW

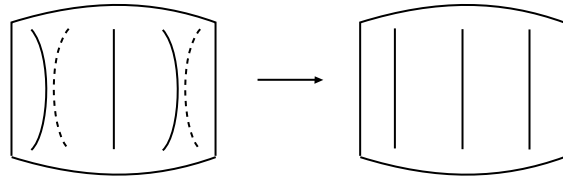

2. COR.BOW correction can be performed by adjusting RV1503 on the D1 board.

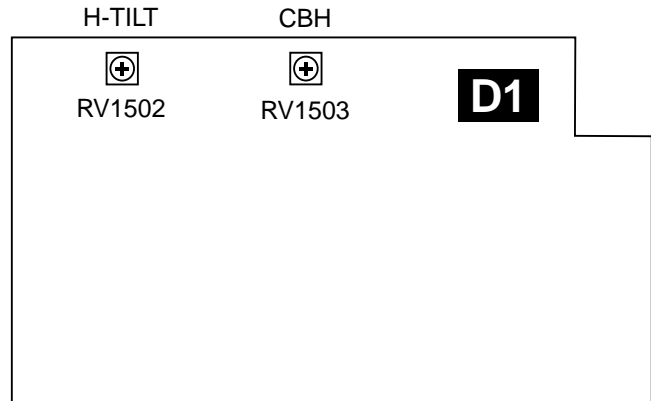

Layout of each control

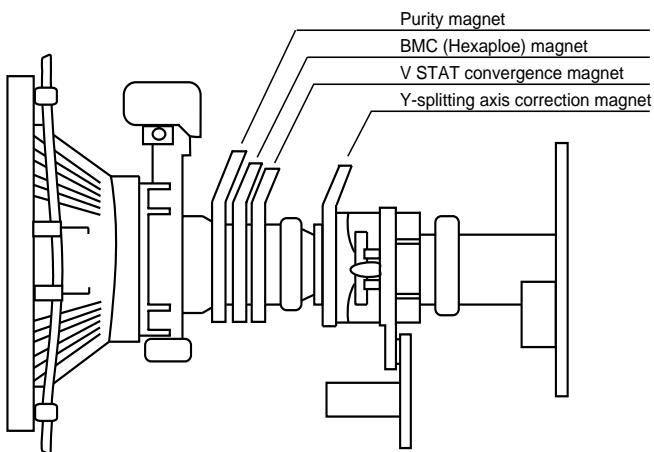

Note : If you are unable to adjust the corner convergence properly, this can be corrected with the use of permalloys.

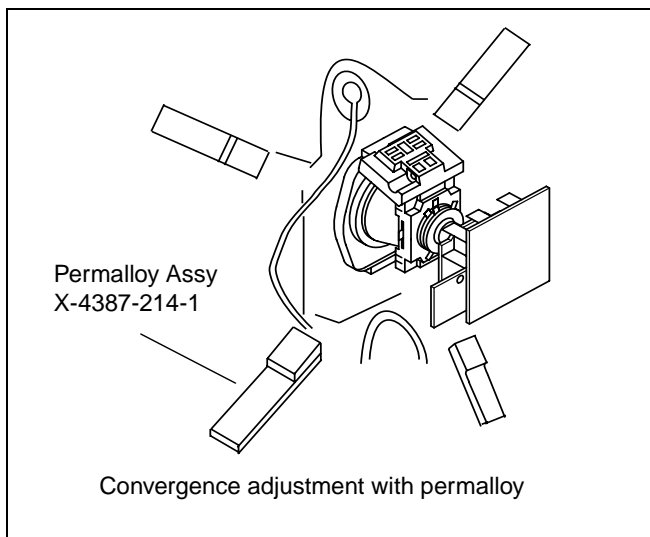
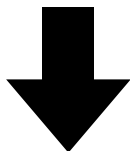
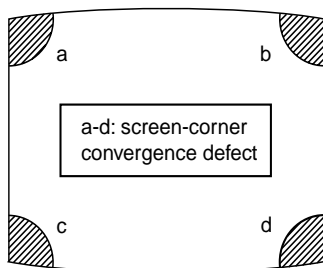

3-3. FOCUS

1. Receive a television broadcast signal.
2. Normalize the picture setting.
3. Adjust the focus control located on the flyback transformer to obtain the best focus at the centre of the screen. Bring only the centre area of the screen into focus, the magenta-ring appears on the screen. In this case, adjust the focus to optimize the screen uniformly.

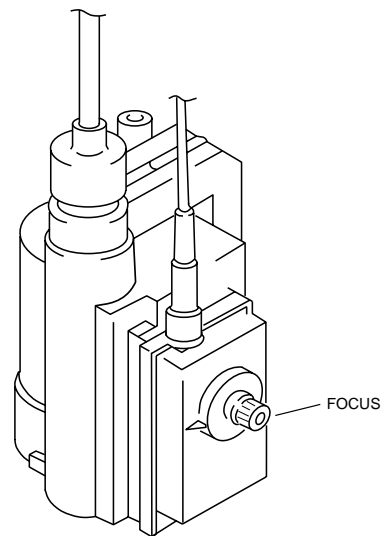

3-4. SCREEN (G2), WHITE BALANCE

[Adjustment in the service mode using the remote commander]

G2 adjustment (RV701)

1. Input a dot signal from the pattern generator.
2. Set the Picture, Brightness and Colour to minimum.
3. Apply 170V DC from an external power supply to the R, G and B cathodes of the CRT.
4. Whilst watching the picture, adjust RV701 [SCREEN] located on the C Board to the point just before the flyback return lines disappear.

White balance adjustment

1. Input an all-white signal.
2. Enter into the Service Mode by pressing 'TEST', 'TEST' and 'MENU' 'MENU' on the Service Commander.
3. Move the OK button down until 'MCP CXA2101' is selected then move the OK button to the right. The 'MCP CXA2101' menu will appear on the screen.
4. Select '19 R DRIVE' by moving the OK button down until '19 R DRIVE' is selected then move the OK button to the right and adjust to 41 by pushing the OK button up or down.
5. Press the OK button to write the data.
6. Adjust the '21 G DRIVE' and '23 B DRIVE' so that the white balance becomes optimum.
7. Press the OK button to write the data.
8. Input a 5 - 10 NIT all-white signal.
9. Select '25 R CUT-OFF' by moving the OK button down until '25 R CUT-OFF' is selected then move the OK button to the right and adjust to 41 by pushing the OK button up or down.
10. Adjust the '27 G CUT-OFF', and '29 B CUT-OFF' so that the white balance becomes optimum.
11. Press the OK button to write the data.

Item No	Adjustment menu	Data Amount
1	RED	ON
2	GREEN	ON
3	BLUE	ON
4	CBLK	OFF
5	AKB T	OFF
6	BLK SW	OFF
7	DA TEST	OFF
8	HY SW	0
9	PICTURE	57
10	LIMIT LEVEL	1
11	HUE	31
12	SYSTEM	1
13	COLOR	31
14	AGE WHT	OFF
15	AGE BLK	OFF
16	BRIGHT	31
17	YS/YM SW	0
18	YM/VM	0
19	SHARPNESS	35
20	D COL	0
21	G DRIVE	ADJ
22	CLP SW	1
23	B DRIVE	ADJ
24	CLP MSK	0
25	R CUT OFF	32
26	ABL MODE	2
27	G CUT OFF	ADJ
28	ABL TH	1
29	B CUT OFF	ADJ
30	SUB BRT	ADJ
31	H SEP SEL	1
32	FIX SEL	0
33	V - TC	2
34	H WIDTH	0
35	HD TC	1
36	HS MASK	1
37	CB OFF SET 1	7
38	CR OFF SET 1	7
39	CB OFF SET 2	7
40	CR OFF SET 2	7

SECTION 4 CIRCUIT ADJUSTMENTS

4-1. ELECTRICAL ADJUSTMENTS

Service adjustments to this model can be performed using the supplied Remote Commander RM-891.

HOW TO ENTER INTO SERVICE MODE

1. Turn on the main power switch of the set while pressing the



PROG + and PROG - buttons on the top panel.

2. 'TT--' will appear in the upper right corner of the screen. Other status information will also be displayed.
3. Press 'MENU' 'MENU' on the remote commander to obtain the following menu on the screen.

DEVICES	
Init TV	
Sound	MSP3410D
Feature Box	S87654
Deflect Cont.	SDA9361
Deflect Cont.Subadjust	
MCP	CXA2101
Col.Dec.Main	TDA9144
DA	SDA9280
Line 23 Detection	
Sub Adjust	
Port Expander	

4. Move to the corresponding adjustment item by pushing the OK button up or down.
5. Push the OK button to the right to enter into the required adjustment.
6. Press the 'Menu' button and '00' on the Remote Commander to quit the Service Mode when all adjustments have been completed.

Defl.Cont. SDA9361		
1	V SIZE	ADJ
2	V POSITION	ADJ
3	V LINEARITY	ADJ
4	S CORRECTION	ADJ
5	H SIZE	ADJ
6	PIN AMP	ADJ
7	UPPER CORNER PIN	ADJ
8	LOWER CORNER PIN	ADJ
9	V BOW	ADJ
10	PIN PHASE	ADJ
11	V ANGLE	ADJ

CENTRE ADJUSTMENT FOR 4:3 MODE

1. Input a Sony special pattern.
2. Switch the TV into Analogue 4:3 mode.
3. Enter into the service menu by pressing 'TEST' 'TEST' and 'MENU' 'MENU' on the remote commander.
4. Select 'DA SDA9280' from the 'Devices' menu.
5. The 'DA SDA9280' menu will appear on screen.
6. Adjust '29 BCKPOS' so that the picture is in the centre of the screen.

CENTRE ADJUSTMENT FOR DIGITAL MODE

1. Input a Digital test pattern.
2. Switch the TV into Digital mode.
3. Enter into the service menu by pressing 'TEST' 'TEST' and 'MENU' 'MENU' on the remote commander.
4. Select 'Deflect.Cont SDA9361' from the 'Devices' menu.
5. The 'Deflect.Cont SDA9361' menu will appear on screen.
6. Adjust '48 INT H PHASE' so that the picture is in the centre of the screen.
7. Adjust item 1 V size and item 2 V position so that the picture is in the centre of the screen.

DA SDA9280		
1	Int 444	ON
2	Int 422	ON
3	Incodc	ON
4	Incodl	OFF
5	Infor	1
6	Insneg	ON
7	Trawid	7
8	Thresh	11
9	VinV	Dependant on analogue or digital
10	UinV	Dependant on analogue or digital
11	Cgrres	0
12	Cgr	OFF
13	Ydel1	Dependant on analogue or digital
14	YinV	OFF
15	Ygrres	0
16	Ygr	OFF
17	Bcof	Dependant on analogue or digital
18	Lcof	Dependant on analogue or digital
19	Hcof	Dependant on analogue or digital
20	Phacom	2
21	Cor	ON
22	Comex	OFF
23	Comp	OFF
24	Readd	0
25	Ovsamp	ON
26	Ovfil	ON
27	Backgr	OFF
28	Hsdel	2
29	Bckpos	191

DEFLECTION ADJUSTMENT FOR WIDE MODE

1. Input an Phillips pattern.
2. Switch the TV into wide mode.
3. Enter into the service menu by pressing 'TEST' 'TEST' and 'MENU' 'MENU' on the remote commander.
4. Select 'Deflect.Cont SDA9361' from the 'Devices' menu.
5. The 'Deflect.Cont SDA9361' menu will appear on screen.
6. Select and adjust each item to obtain optimum image.
7. Return to the 'Devices' menu.
8. Select the 'Sub Adjust' menu.
9. Select and adjust each item to obtain optimum image.
10. Repeat above steps in Digital mode.

Defl.Cont. SDA9361		
1	V SIZE	ADJ
2	V POSITION	ADJ
3	V LINEARITY	ADJ
4	S CORRECTION	ADJ
5	H SIZE	ADJ
6	PIN AMP	ADJ
7	UPPER CORNER PIN	ADJ
8	LOWER CORNER PIN	ADJ
9	V BOW	ADJ
10	PIN PHASE	ADJ
11	V ANGLE	ADJ

DEFLECTION CONTR.SUBADJUST

1	SMART V SIZE	54
2	SMART V POSITION	220
3	SMART V LINEARITY	215
4	SMART S CORRECTION	236
5	SMART H SIZE	80
6	SMART PIN AMP	217
7	SMART UPPER CORNER PIN	17
8	SMART LOWER CORNER PIN	189
9	SMART V BOW	243
10	SMART PIN PHASE	202
11	SMART V ANGLE	5

DEFLECTION ADJUSTMENT FOR SMART MODE

1. Input a Phillips pattern.
2. Switch the TV into smart mode.
3. Enter into the service menu by pressing 'TEST' 'TEST' and 'MENU' 'MENU' on the remote commander.
4. Select 'Deflect.Cont SDA9361' from the 'Devices' menu.
5. The 'Deflect.Cont SDA9361' menu will appear on screen.
6. Select and adjust each item to obtain optimum image.
7. Return to the 'Devices' menu.
8. Select the 'Deflect cont.Subadjust' menu.
9. Select and adjust each item to obtain optimum image.
10. Return to the 'Devices' menu.
11. Select the 'Subadjust' menu.
12. Select and adjust each item to obtain optimum image.
13. Repeat above steps in Digital mode.

SUB ADJUSTMENT		
1	RGB Level	8
2	Menue/Text H-pos	-2
3	Extra Framing Window	255
4	4/3 Center	

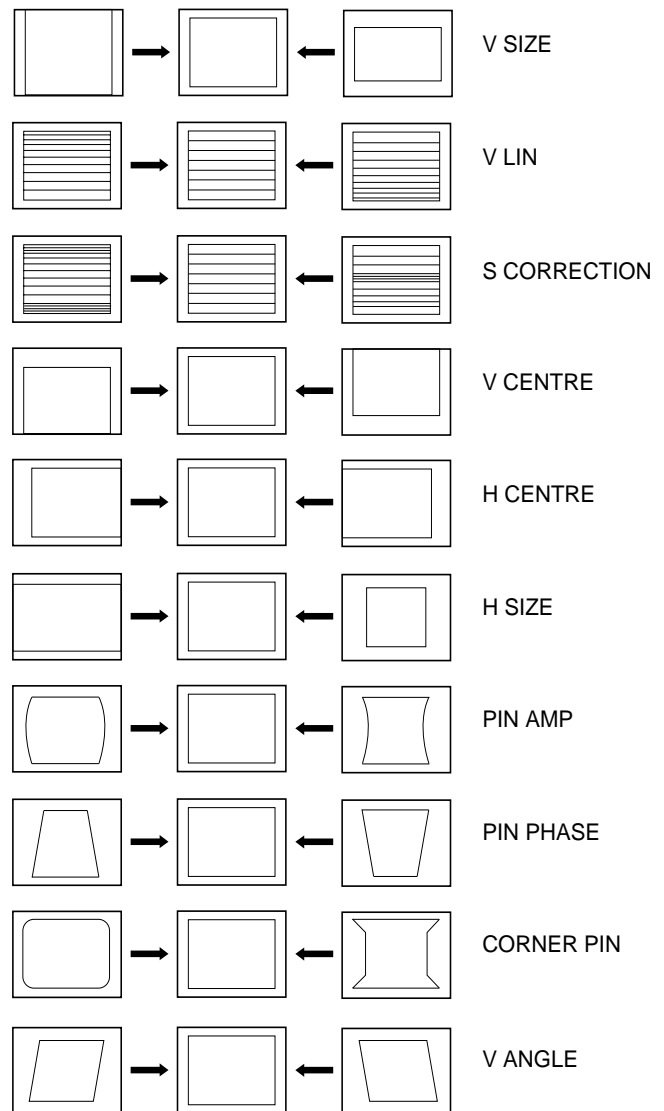

4-2. TEST MODE 2:

Is available by pressing 'TEST' button twice, OSD 'TT' appears. The functions described below are available by pressing the two numbers. To release the Test mode 2, press 0 twice, or switch the TV into stand-by mode, or press the  TV button on the remote commander.

00	Cancel Test mode
01	Picture maximum - Colour Minimum
02	Direct Access to Noise Reduction
03	Volume 35%
04	Display Service Menu in Service mode
05	Display Service Menu in Production mode
06	Volume 80%
07	Ageing mode On/Off
08	Set shipping conditions
09	No function
10	TT number will be deleted
11	No function
12	Sub Colour Adjustment
13	Display software version and TV configuration
14	Production Info Display
15	Read factory setting
16	Save Last Power Memory data
17	Label AV sources
18	Level 2.5 Text Feature on/off
19	Set volume to 50%
20	TT number will be deleted
21	Picture Rotation
22	Operating Timer and Error monitor display
23	Status menu display
24	Direct access to sub colour
25	Status menu display
26	Text character set
27	Text character set
28	Text character set
29	Text character set
30	TT number will be deleted
31	Geometry adjustment 1
32	Geometry adjustment 2
33	No function
34	Reset NVM
35	Disable/Enable picture blanking
36	No function
37	Phillips Bug switch
38	Fast Helper switch
39	Reset Programme Table
40	TT number will be deleted
41	Screen Mode check

42	Auto-shut-off
43	NVM Map
44	Sub-Brightness Adjustment
45	No function
46	IR Channel Presetting Mode
47	Headphone Source Selection
48	Speaker Source Selection
49	EEPROM Testbyte is erased
50	TT number will be deleted
51	Strobe mode test
52	Reserved for uCon internal Test
53	Dynamic picture (AI) check
54	Velocity Modulation (VM) check
55	MTX Slicer Control
56	MTX Slicer Control
57	Megatext Service Menu
58	MTX Small Framing Code Window
59	MTX Wide Framing Code Window
60	TT number will be deleted
61	Sound default
62	No function
63	No function
64	Reset IIC Slave Commands
65	Reset Error Codes
66	No function
67	Headphone Volume
68	Ignore Errors
69	Reset Ignore Errors
70	TT number will be deleted
71	No function
72	NVM Subadjustment default
73	Clear programs
74	NVM Port-Expander default
75	No function
76	NVM default data
77	NVM D/A converter default
78	No function
79	No function
80	TT number will be deleted
81	NVM feature box default
82	No function
83	No function

84	NVM MCP default
85	NVM main colour decoder default
86	Display BER
87	No function
88	Text character set Russian/East
89	Text character set Russian/West with ESC
90	TT number will be deleted
91	Dolby Mode Normal
92	ASIC-Version
93	NVM MCP subadjustment default
94	Noise Sequencer Left
95	Noise Sequencer Center
96	Noise Sequencer Right
97	Noise Sequencer Surround
98	Surround Mode off
99	Dolby Mode Phantom

5-1. BLOCK DIAGRAMS (3)

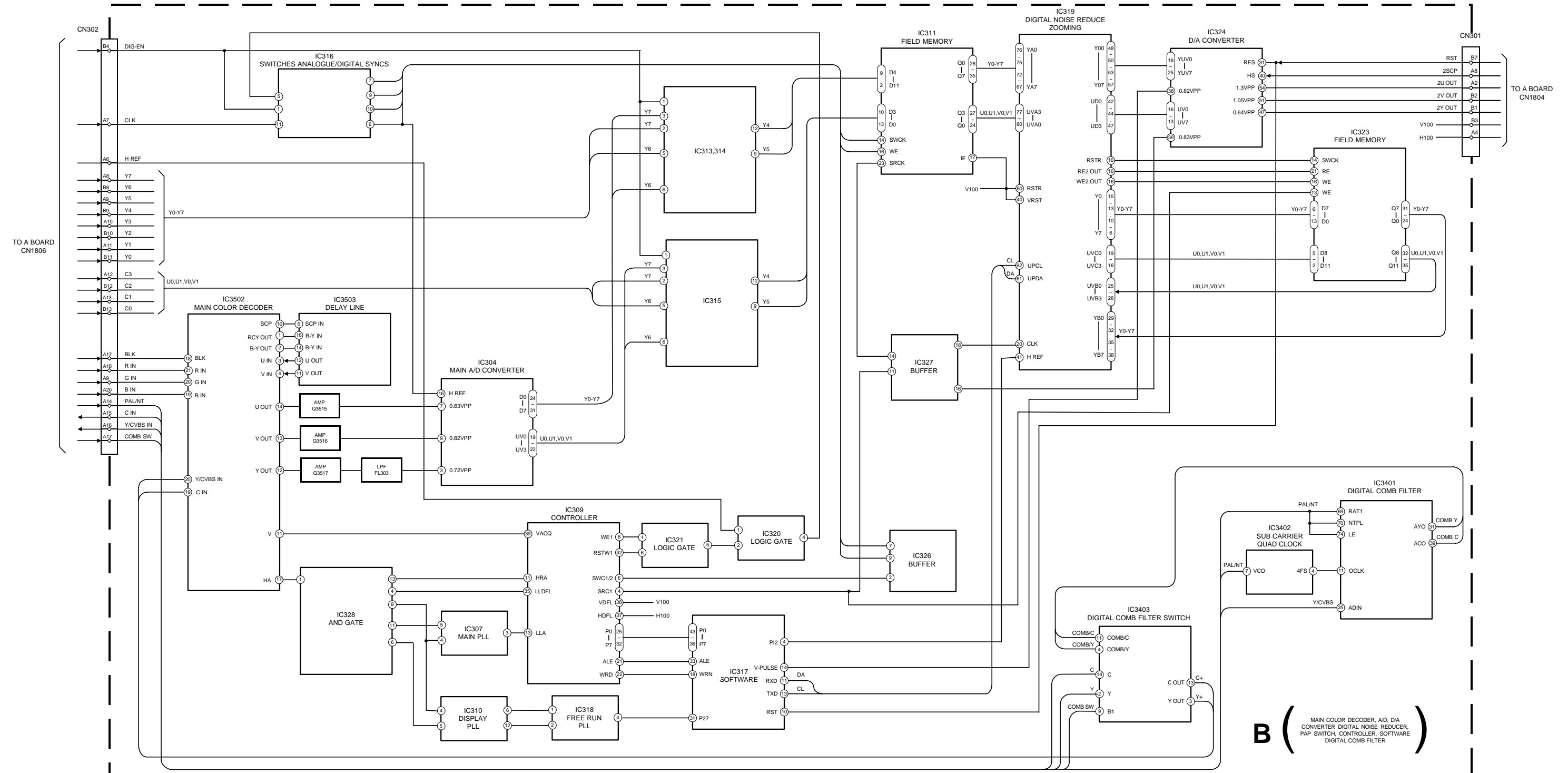

5-1. BLOCK DIAGRAMS (4)

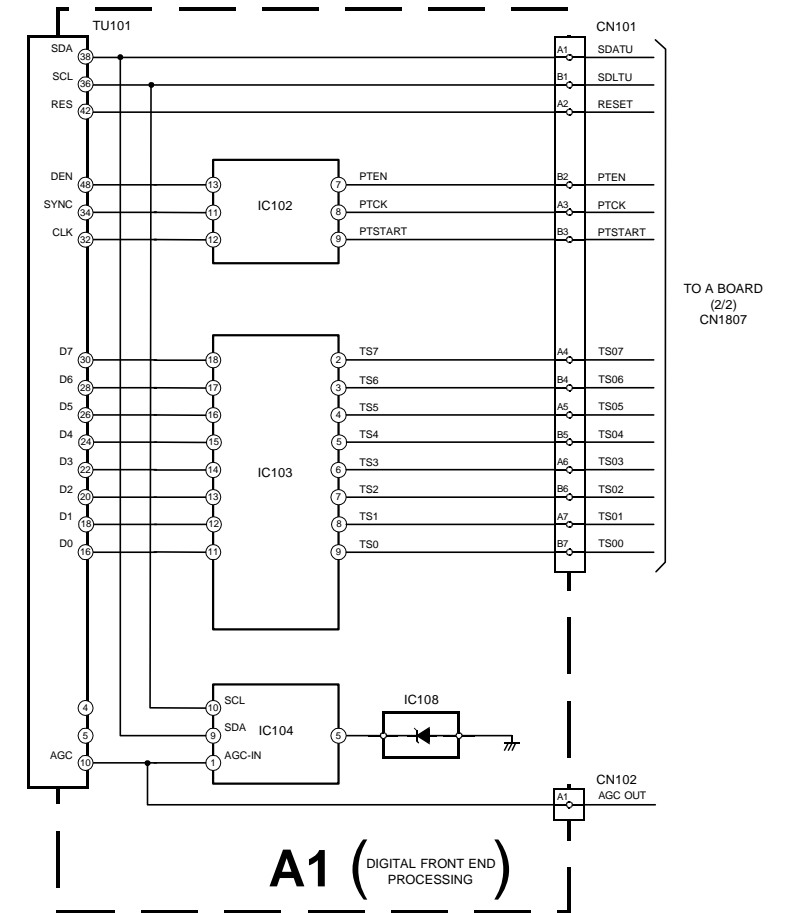
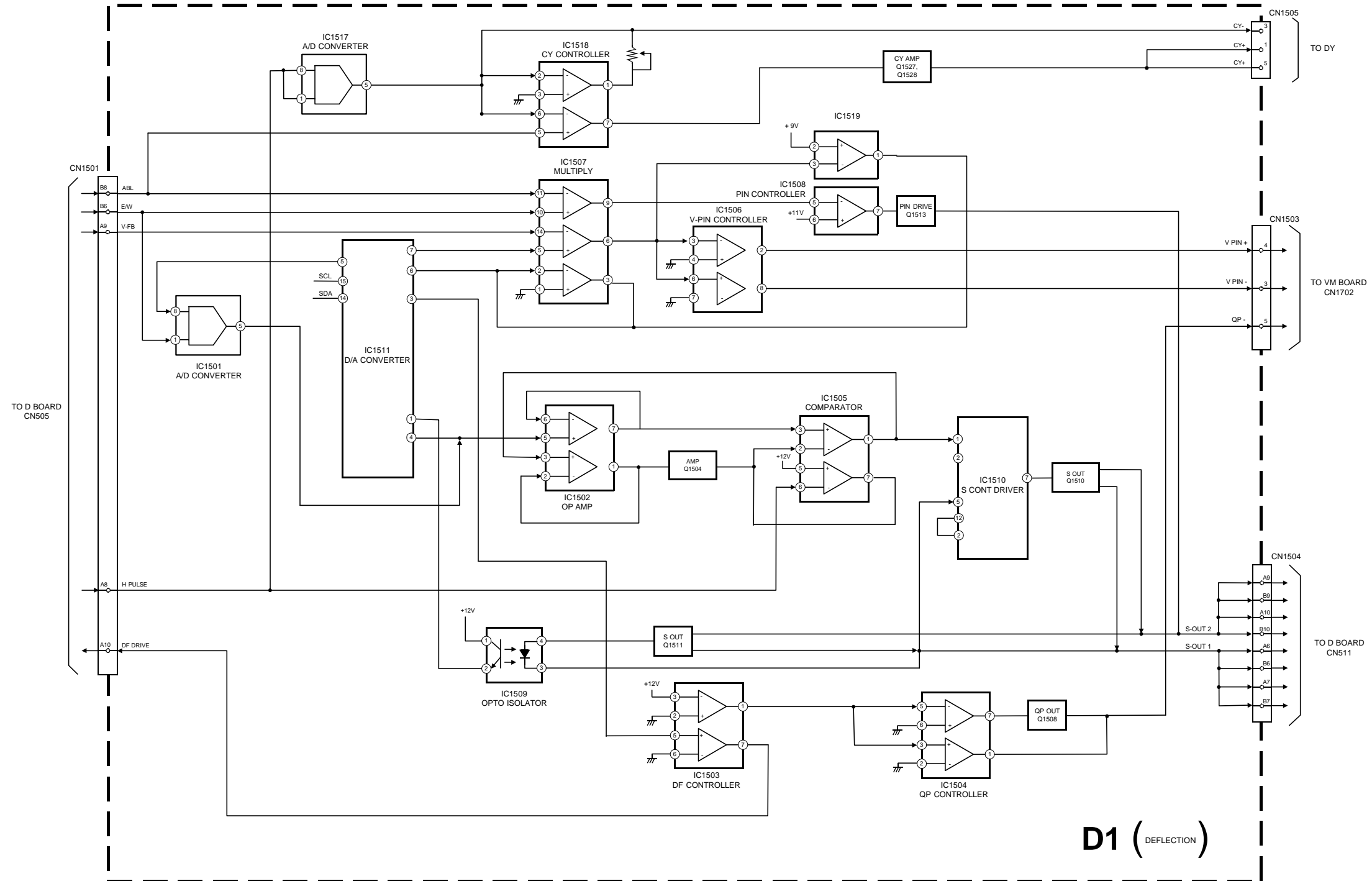

5-1. BLOCK DIAGRAMS (5)

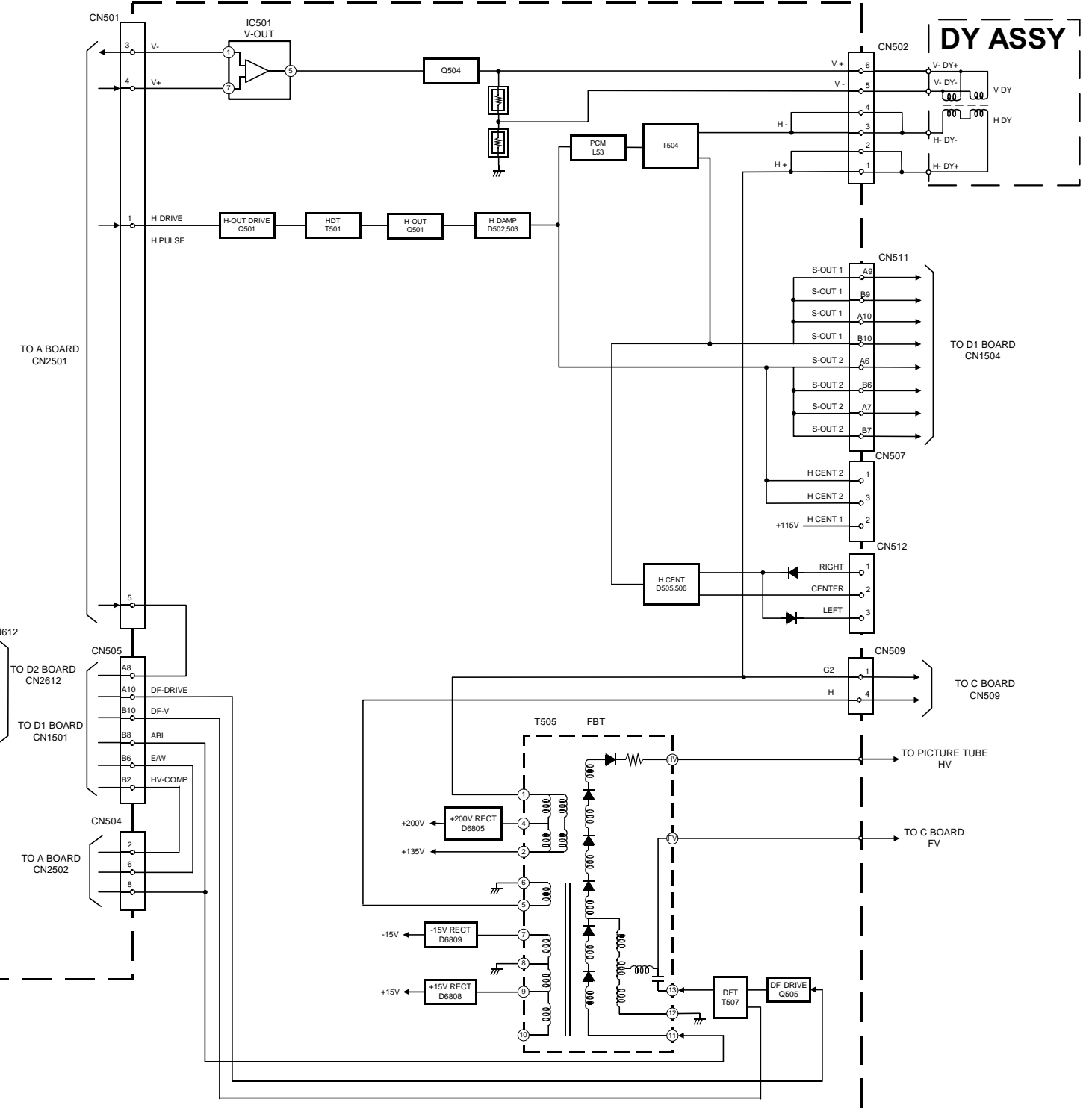
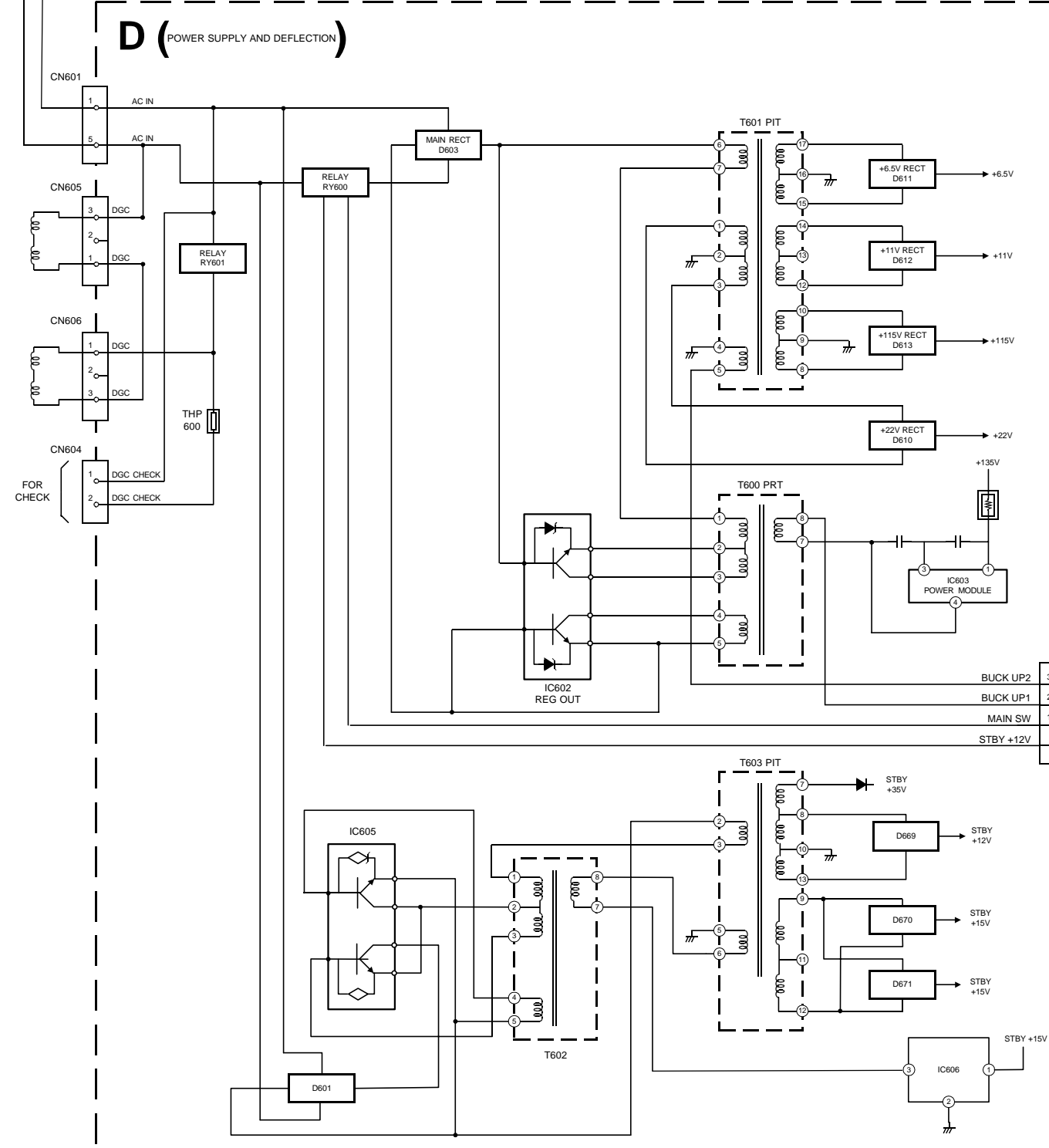
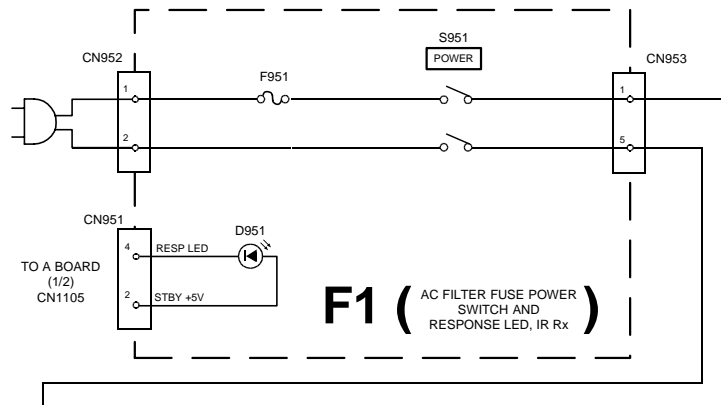

5-1. BLOCK DIAGRAMS (6)

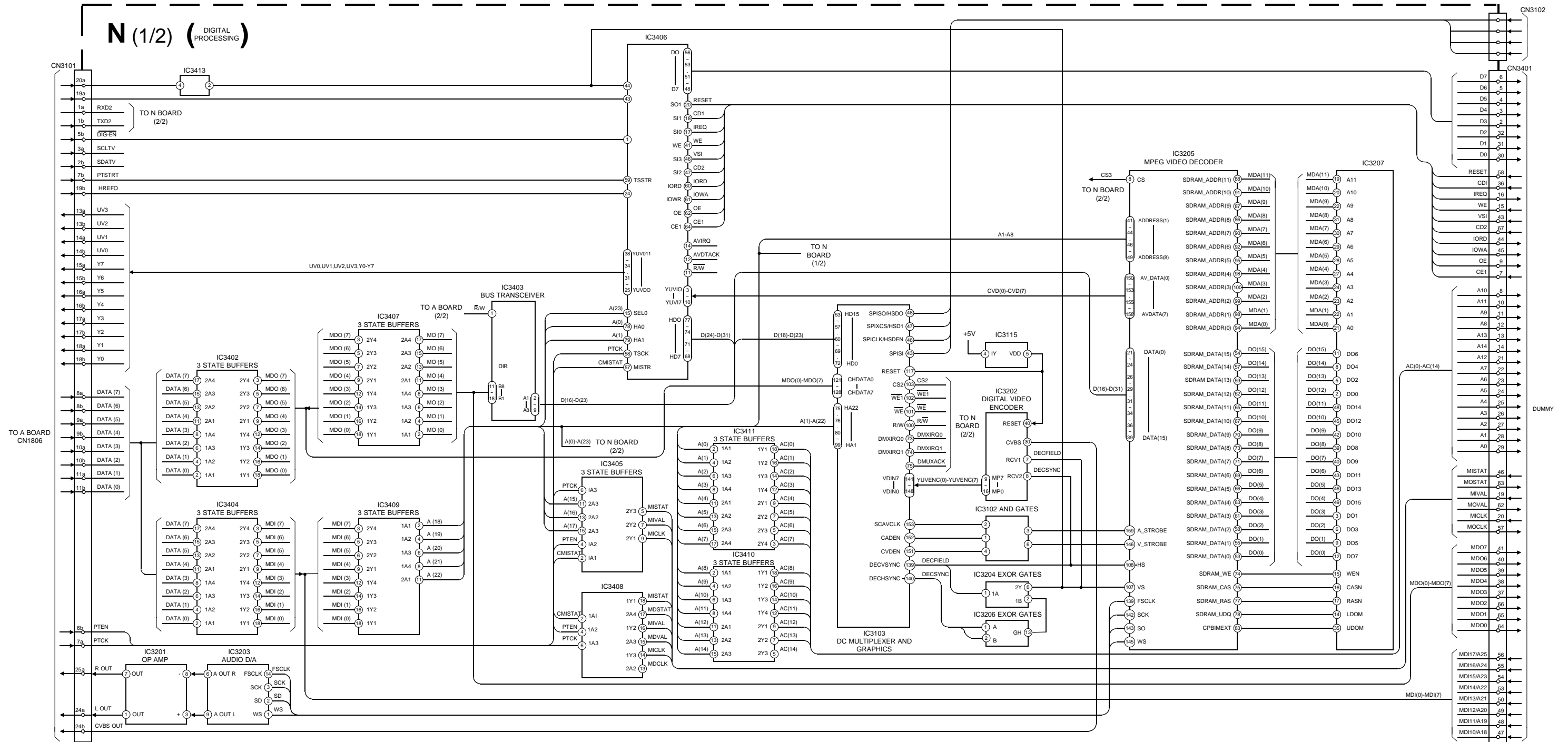

5-1. BLOCK DIAGRAMS (8)

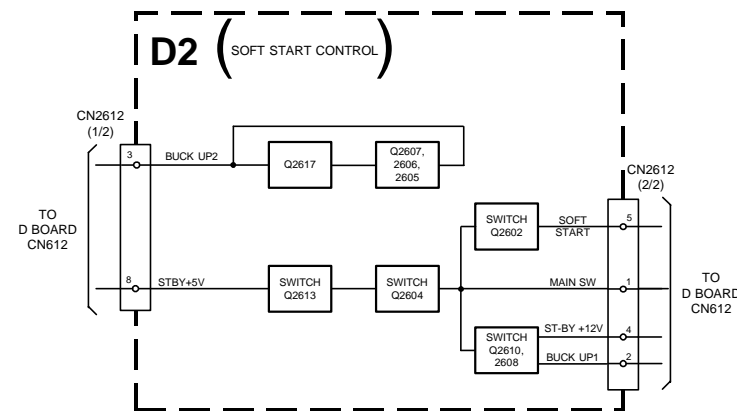
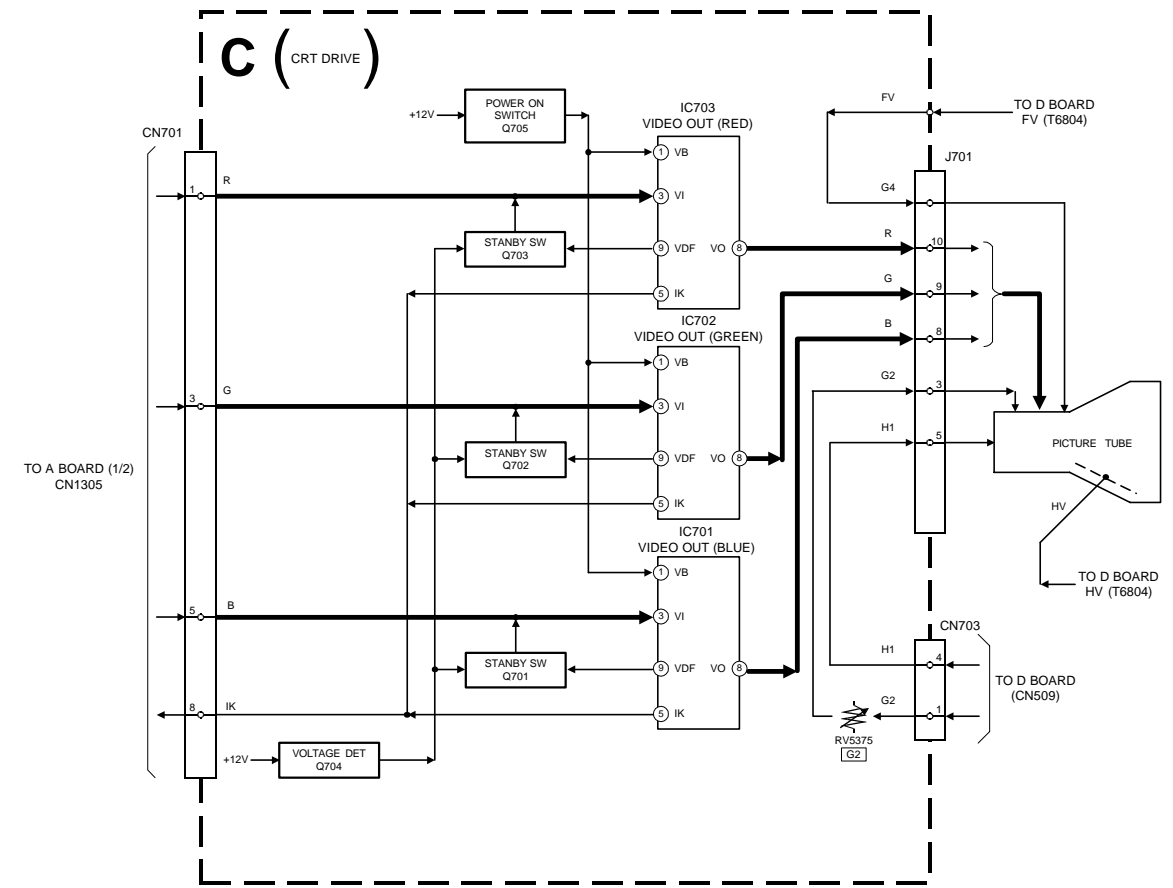
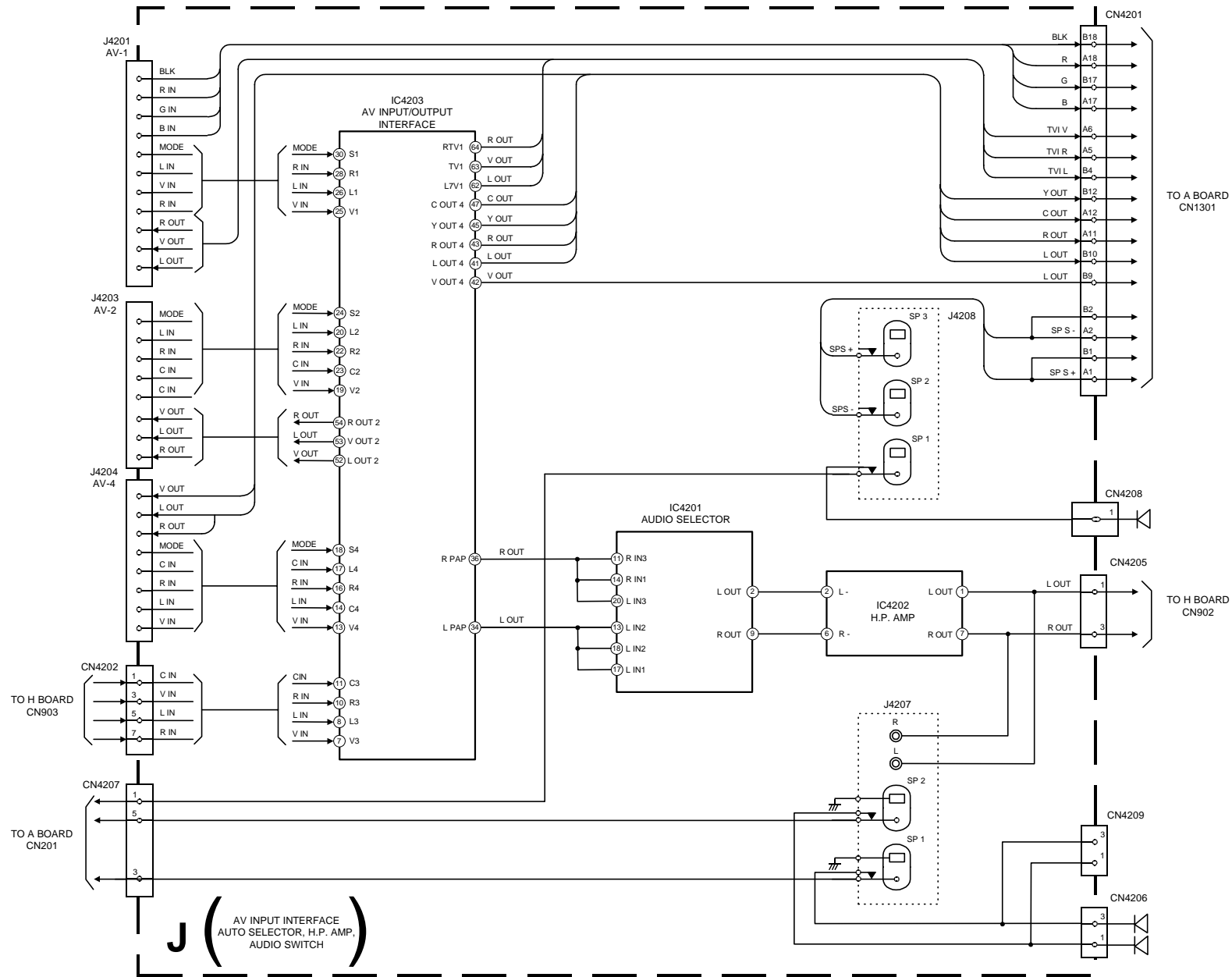

5-2. CIRCUIT BOARD LOCATION

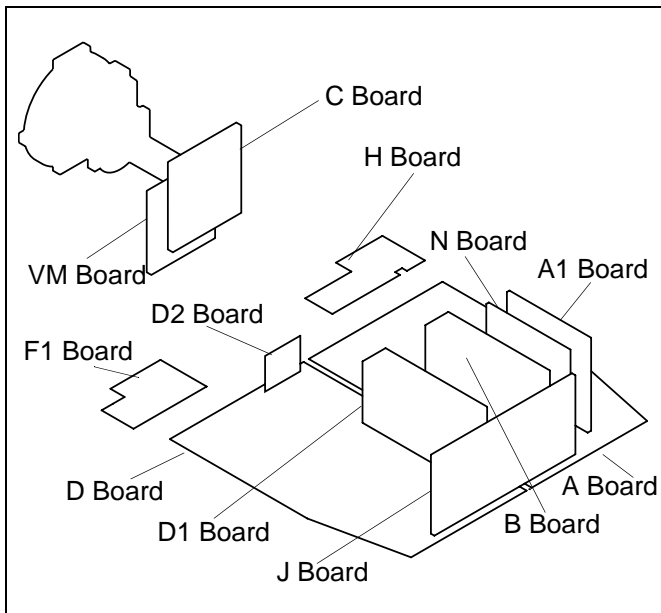

5-3. SCHEMATIC DIAGRAMS AND PRINTED WIRING BOARDS

Note :

- All capacitors are in μF unless otherwise noted.
- pF : $\mu\mu\text{F}$ 50WV or less are not indicated except for electrolytic types.
- Indication of resistance, which does not have one for rating electrical power, is as follows.

Pitch : 5mm
Electrical power rating : 1/4W

- Chip resistors are 1/10W
- All resistors are in ohms.
k = 1000 ohms, M = 1000,000 ohms
- : nonflammable resistor.
- : fusible resistor.
- : internal component.
- : panel designation or adjustment for repair.
- All variable and adjustable resistors have characteristic curve B, unless otherwise noted.
- All voltages are in Volts.
- Readings are taken with a 10Mohm digital mutimeter.
- Readings are taken with a color bar input signal.
- Voltage variations may be noted due to normal production tolerences.
- : B + bus.
- : B - bus.
- : RF signal path.
- : earth - ground.
- : earth - chassis.

Reference Information

RESISTOR	RN	: METAL FILM
	RC	: SOLID
	FPRD	: NON FLAMMABLE CARBON
	FUSE	: NON FLAMMABLE FUSIBLE
	RS	: NON FLAMMABLE METAL OXIDE
	RB	: NON FLAMMABLE CEMENT
	RW	: NON FLAMMABLE WIREWOUND
		: ADJUSTMENT RESISTOR
COIL	LF-8L	: MICRO INDUCTOR
CAPACITOR	TA	: TANTALUM
	PS	: STYROL
	PP	: POLYPROPYLENE
	PT	: MYLAR
	MPS	: METALIZED POLYESTER
	MPP	: METALIZED POLYPROPYLENE
	ALB	: BIPOLAR
	ALT	: HIGH TEMPERATURE
	ALR	: HIGH RIPPLE

Note : The components identified by shading and marked are critical for safety. Replace only with the part numbers specified in the parts list.

Note : Les composants identifiés par une trame et par une marque sont d'une importance critique pour la sécurité. Ne les remplacer que par des pièces de numéro spécifié.

C [PRINTED WIRING BOARD]

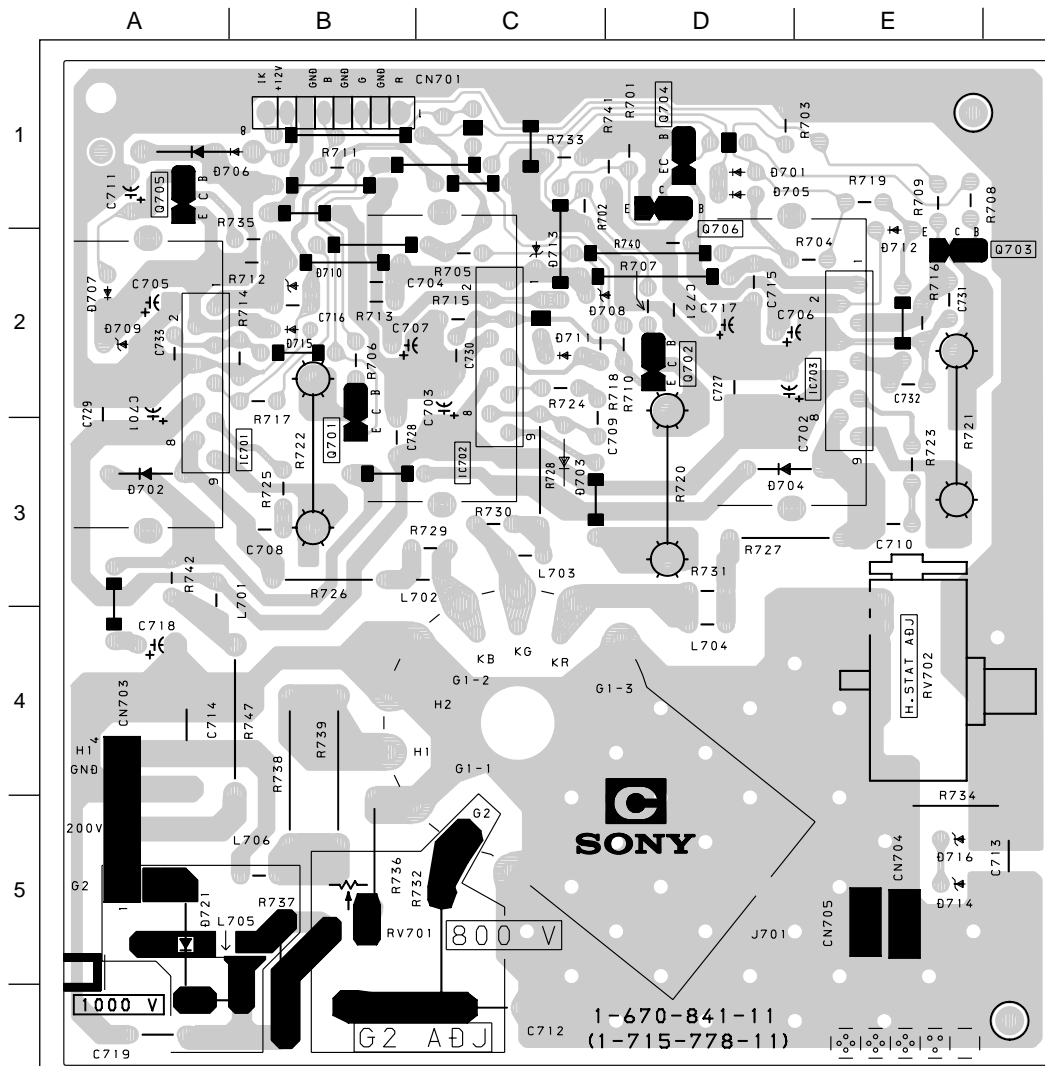

IC		Q704	D - 1	D705	D - 1	D713	C - 2
IC701	B - 3	Q705	A - 1	D706	A - 1	D714	E - 5
IC702	C - 3	Q706	D - 2	D707	A - 2	D715	B - 2
IC703	E - 2	DIODE		D708	C - 2	D716	E - 5
TRANSISTOR		D701	D - 1	D709	A - 2	D721	A - 5
Q701	B - 3	D702	A - 3	D710	B - 2	VR	
Q702	D - 2	D703	C - 3	D711	C - 2	RV701	B - 5
Q703	E - 2	D704	C - 2	D712	E - 2	RV702	E - 4

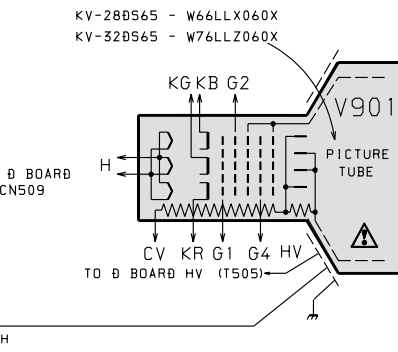
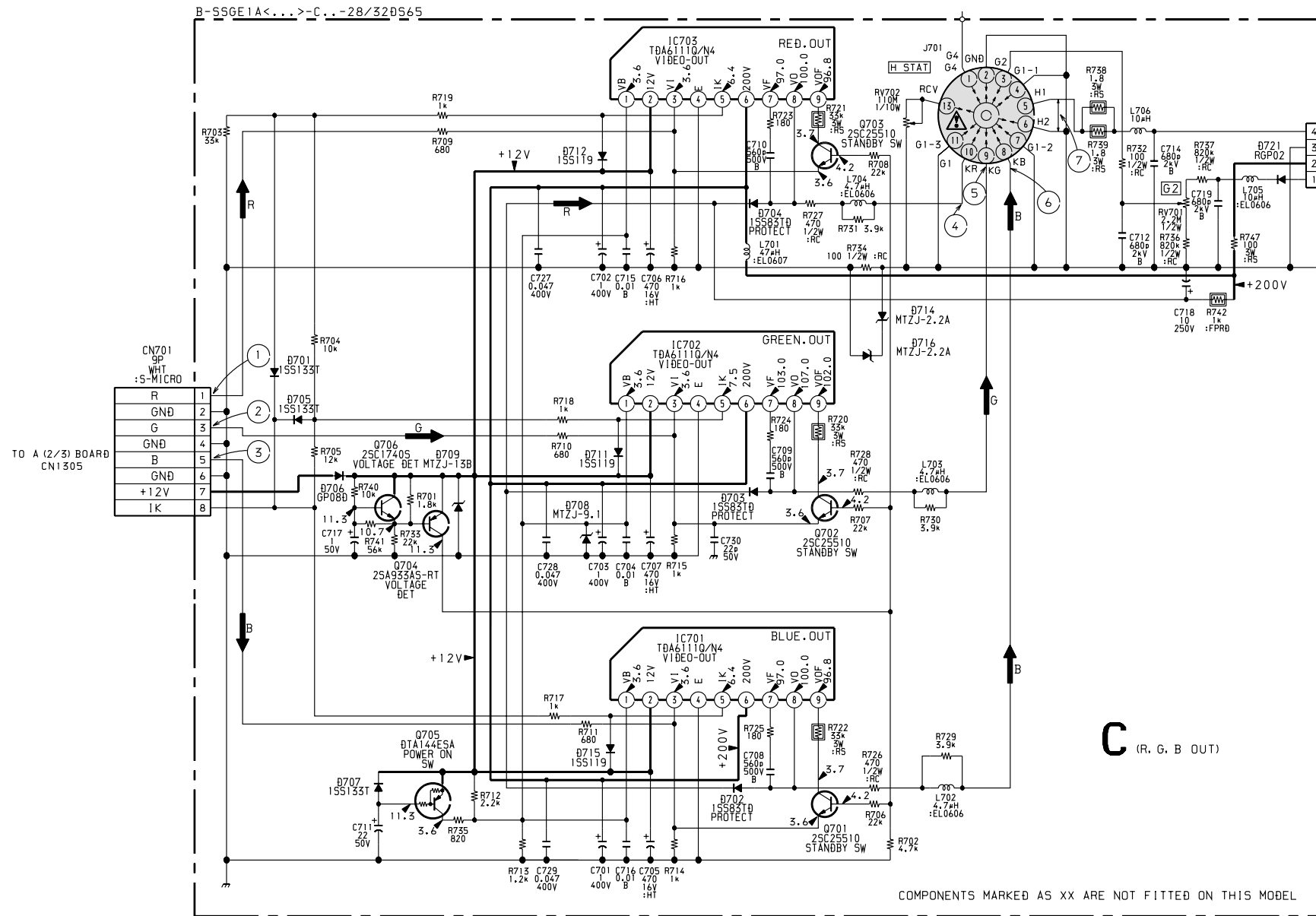

C BOARD WAVEFORMS

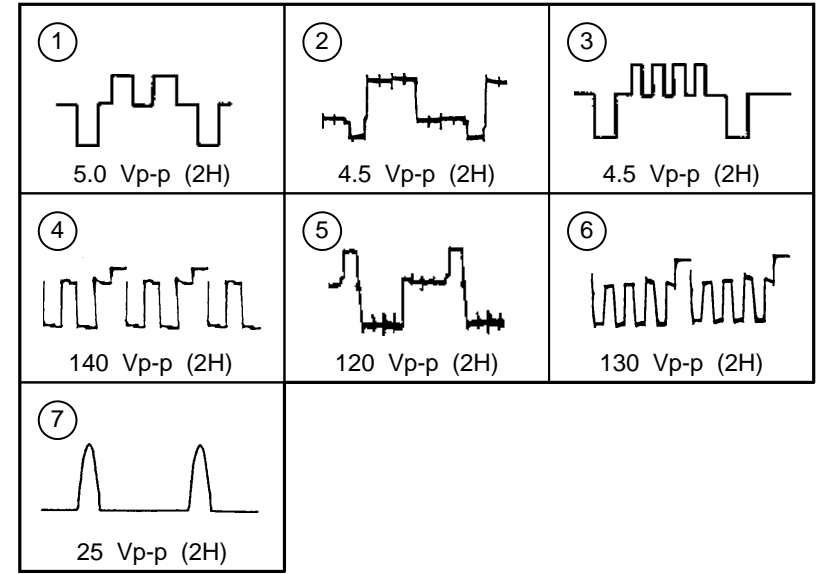

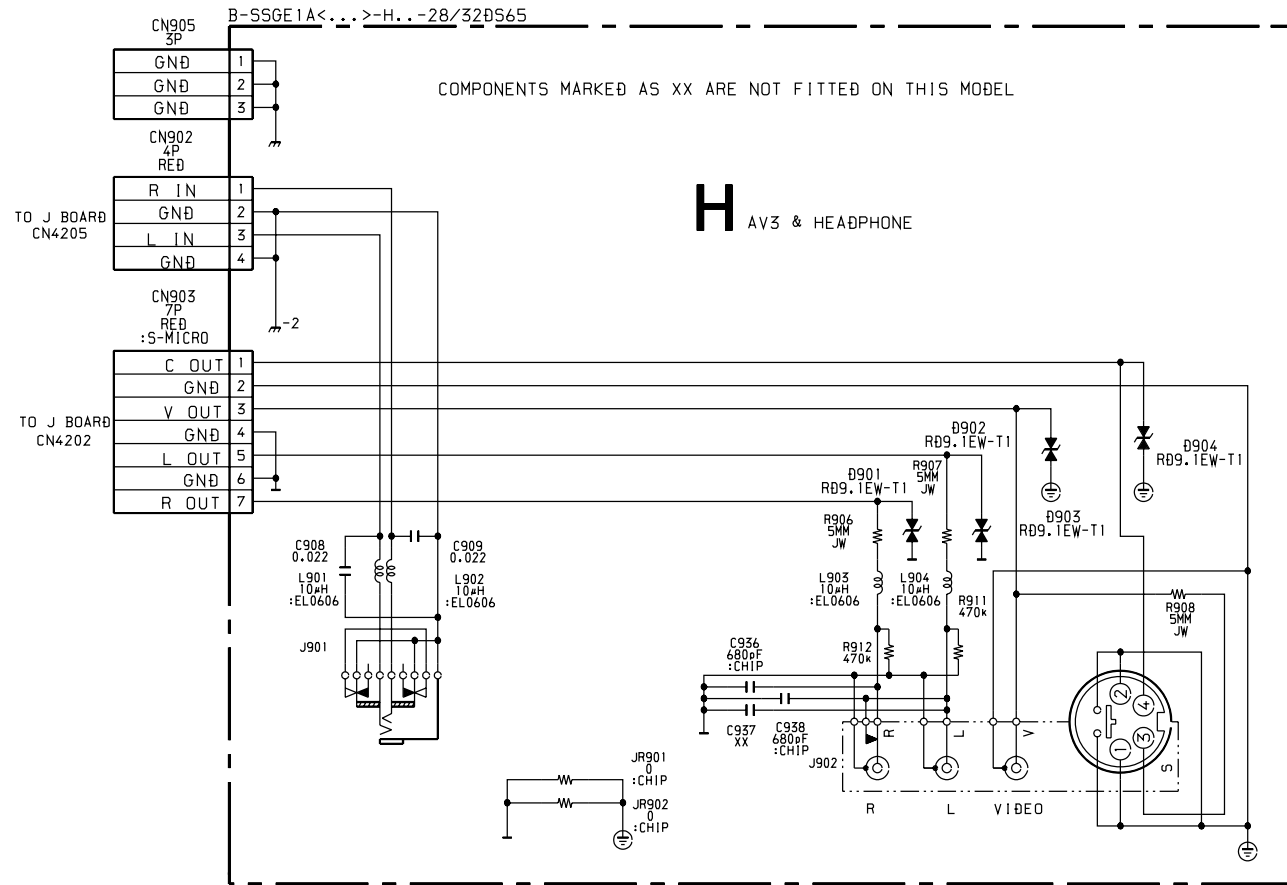

H [AV3 AND HEADPHONE]

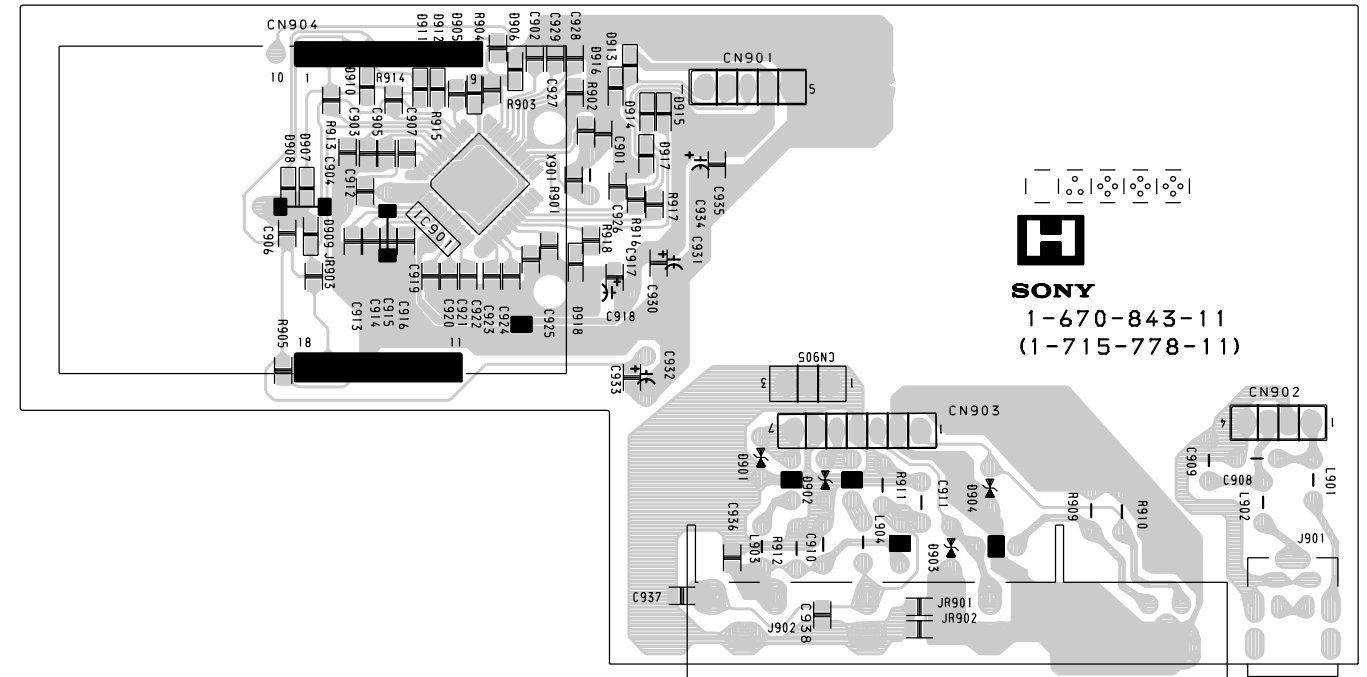

H [PRINTED WIRING BOARD]

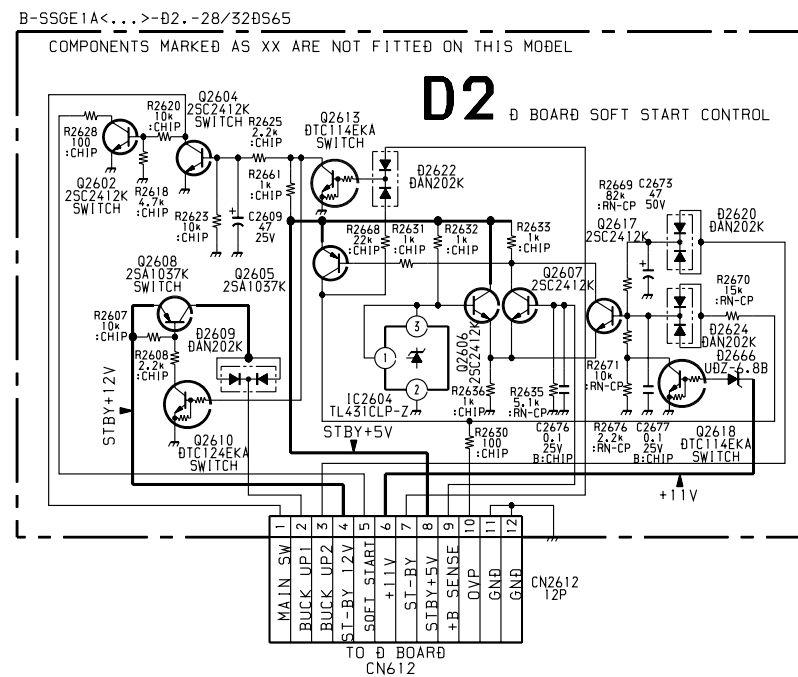

D2 [SOFT START CONTROL]

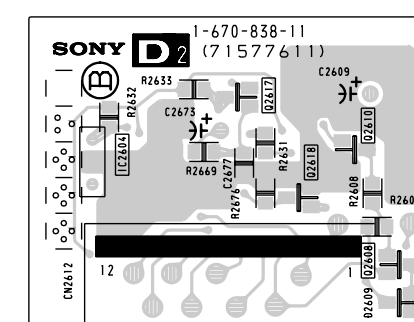
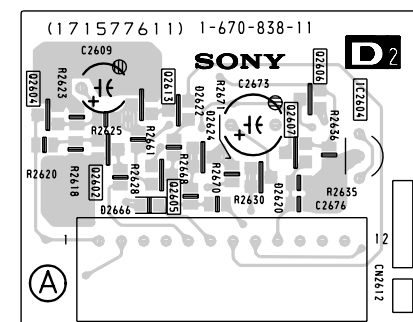

D2 [PRINTED WIRING BOARD]

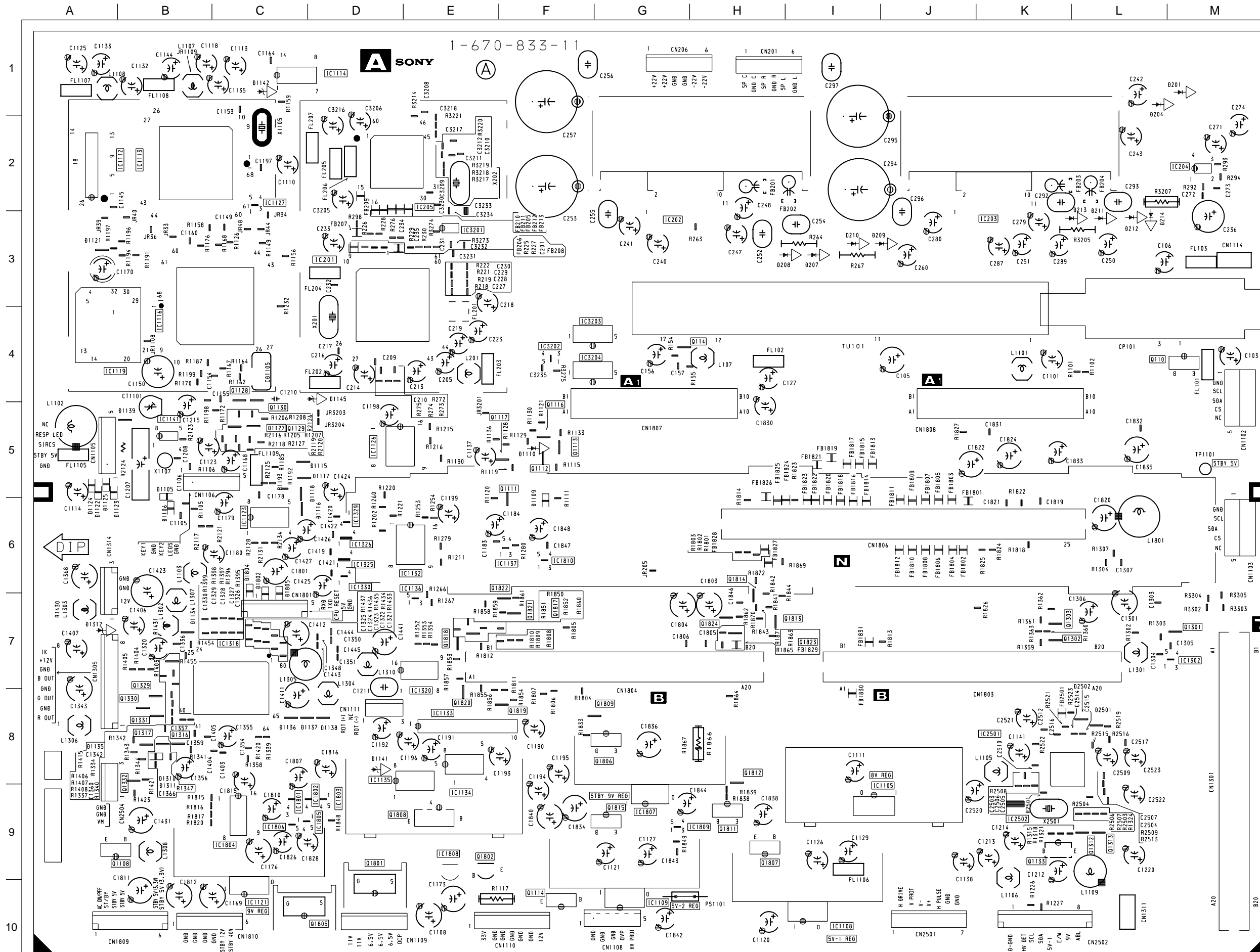

SEMICONDUCTOR LOCATION TABLE

IC		DIODE	
IC103	T - 3	D201	M - 1
IC201	Q - 2	D203	N - 2
IC202	G - 3	D204	L - 2
IC203	B - 22	D207	I - 3
IC204	M - 2	D208	H - 3
IC205	E - 3	D209	I - 3
IC1101	P - 4	D210	I - 3
IC1105	J - 8	D211	L - 3
IC1108	I - 10	D212	L - 3
IC1109	I - 19	D213	L - 3
IC1111	C - 11	D214	L - 3
IC1112	A - 2	D1101	Y - 3
IC1113	B - 14	D1102	Z - 3
IC1114	D - 1	D1103	Y - 3
IC1116	B - 4	D1104	Z - 3
IC1119	A - 4	D1105	B - 6
IC1121	C - 10	D1106	B - 6
IC1123	C - 6	D1107	Y - 3
IC1127	C - 3	D1108	Y - 5
IC1132	E - 6	D1109	F - 5
IC1133	E - 8	D1110	F - 5
IC1134	E - 9	D1117	D - 5
IC1135	D - 9	D1118	C - 6
IC1136	D - 7	D1120	Y - 4
IC1137	F - 6	D1121	A - 3
IC1141	B - 5	D1122	A - 6
IC1140	O - 7	D1123	A - 6
IC1302	M - 7	D1124	A - 6
IC1318	C - 7	D1125	A - 6
IC1320	E - 8	D1126	Y - 5
IC1325	D - 6	D1127	Y - 5
IC1326	D - 6	D1128	Y - 4
IC1330	D - 6	D1129	Y - 5
IC1801	C - 9	D1134	B - 7
IC1802	C - 9	D1135	A - 8
IC1803	C - 9	D1136	C - 8
IC1804	C - 9	D1137	C - 8
IC1805	C - 9	D1138	D - 8
IC1806	C - 9	D1139	B - 5
IC1807	G - 9	D1142	C - 1
IC1808	T - 9	D1145	X - 5
IC1809	G - 9	D1310	B - 8
IC1810	F - 6	D1311	B - 8
IC2501	K - 8	D1312	A - 7
IC2502	K - 9	D1801	X - 7
IC2503	F - 4	D1802	C - 6
IC3301	N - 7	D1803	Y - 7
IC3203	F - 4	D1804	C - 6
IC3204	F - 4	D1805	C - 6
		D1806	X - 7
		D2501	L - 8
		D2502	L - 8
		D3201	V - 3

SEMICONDUCTOR LOCATION TABLE

TRANSISTORS		
Q108	R-4	Q1804 V-9
Q109	S-3	Q1805 C-10
Q110	L-4	Q1807 H-9
Q111	L-4	Q1808 E-9
Q114	H-4	Q1809 H-9
Q202	W-3	Q1810 S-10
Q203	W-4	Q1811 H-9
Q205	N-3	Q1812 H-9
Q206	N-3	Q1813 I-7
Q209	O-2	Q1814 H-6
Q210	O-3	Q1815 G-9
Q211	P-2	Q1817 F-7
Q212	P-2	Q1818 U-7
Q213	P-2	Q1819 F-8
Q215	N-2	Q1820 E-8
Q1108	B-9	Q1821 F-7
Q1110	Z-9	Q1822 F-7
Q1111	F-5	Q1823 I-7
Q1112	F-5	Q1824 I-7
Q1113	F-5	Q3301 M-7
Q1116	F-5	
Q1117	E-5	
Q1120	X-2	
Q1121	X-3	
Q1122	X-2	
Q1123	Y-1	
Q1124	Z-3	
Q1125	X-8	
Q1127	C-5	
Q1128	C-4	
Q1129	C-5	
Q1130	C-5	
Q1133	K-9	
Q1134	Q-10	
Q1301	O-7	
Q1302	L-7	
Q1303	L-7	
Q1312	L-9	
Q1313	L-9	
Q1316	B-8	
Q1317	B-8	
Q1318	Z-7	
Q1329	B-7	
Q1330	B-8	
Q1331	B-8	
Q1332	B-9	
Q1801	D-9	
Q1802	E-9	
Q1803	W-9	

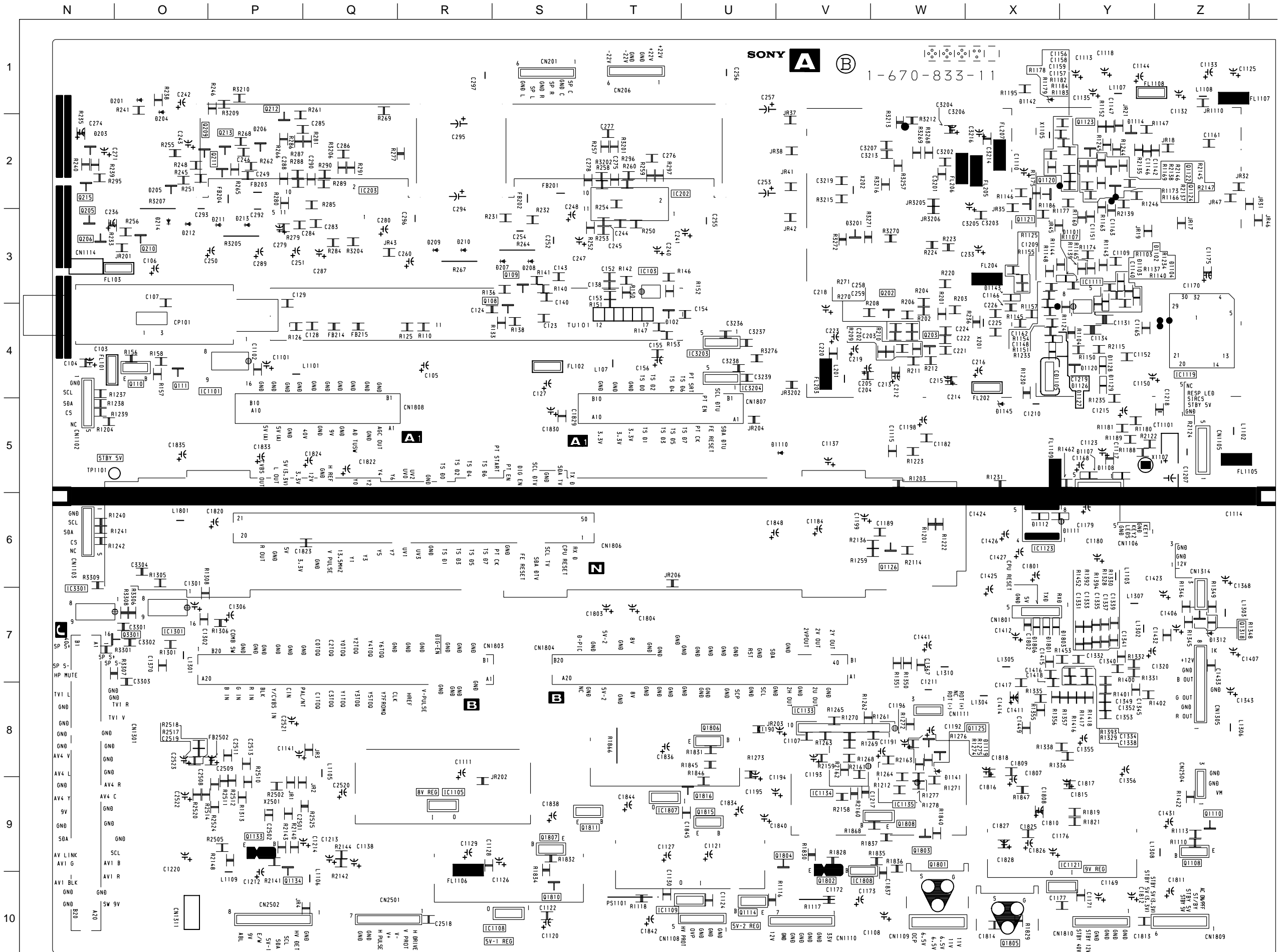

A [PRINTED WIRING BOARD (B SIDE)]

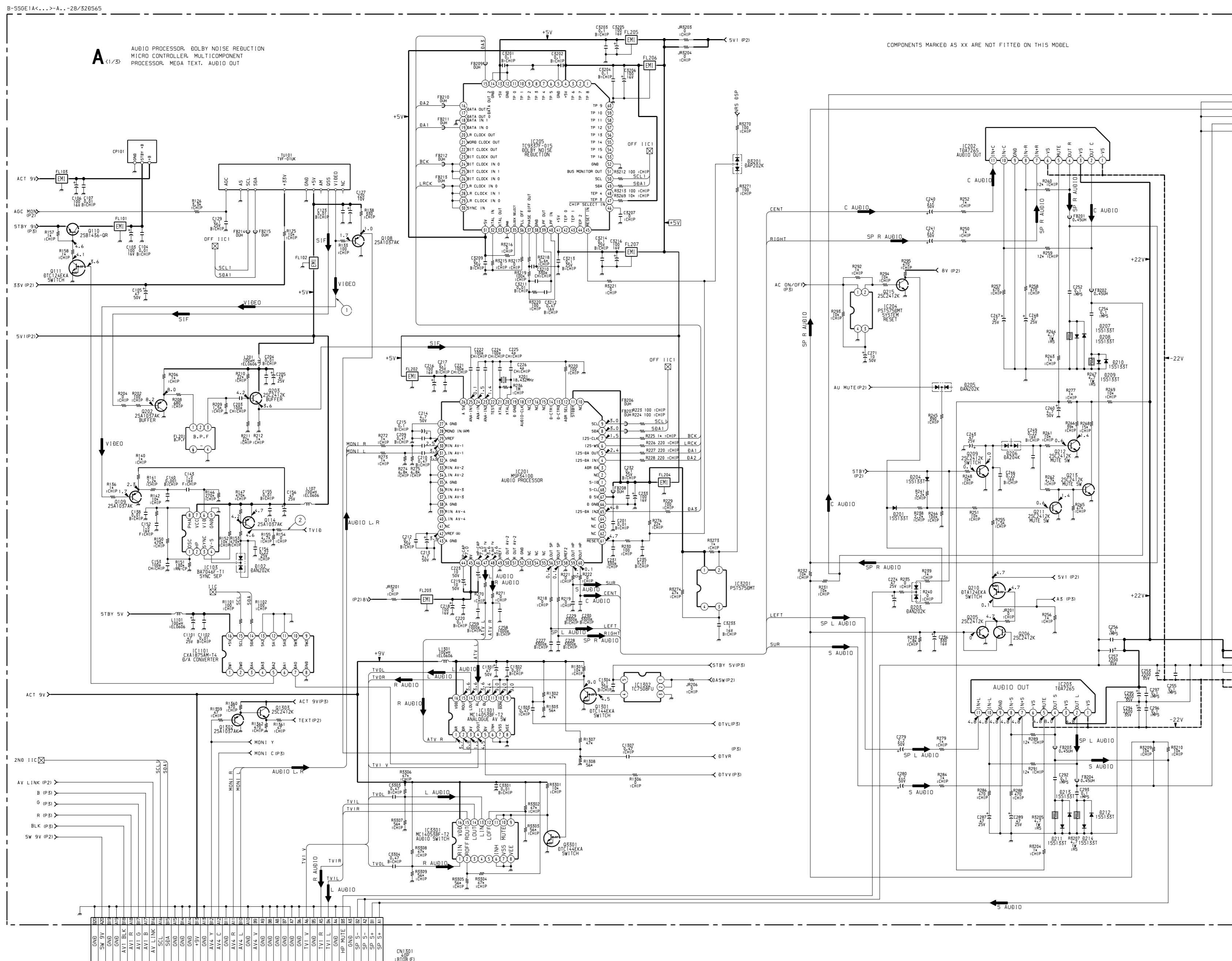

TO J BOARD
CN4207

1	SP_C
2	GND_C
3	SP_R
4	GND_R
5	SP_L
6	GND_L

TO O BOARD
CN407

1	+22V
2	+22V
3	GND
4	GND
5	-22V
6	-22V

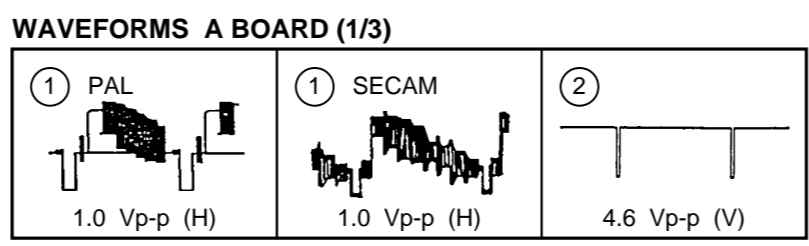

A (1/3)
AUDIO PROCESSOR, BOLDY NOISE REDUCTION
MICRO CONTROLLER, MULTICOMPONENT
PROCESSOR, MEGA TEXT, AUDIO OUT

COMPONENTS MARKED AS XX ARE NOT FITTED ON THIS MODEL

1 2 3 4 5 6 7 8 9 10 11 12 13 14 15 16 17 18 19 20

A B C D E F G H I J K L M N O P Q R S T

B-556E1A...A...-28/320565

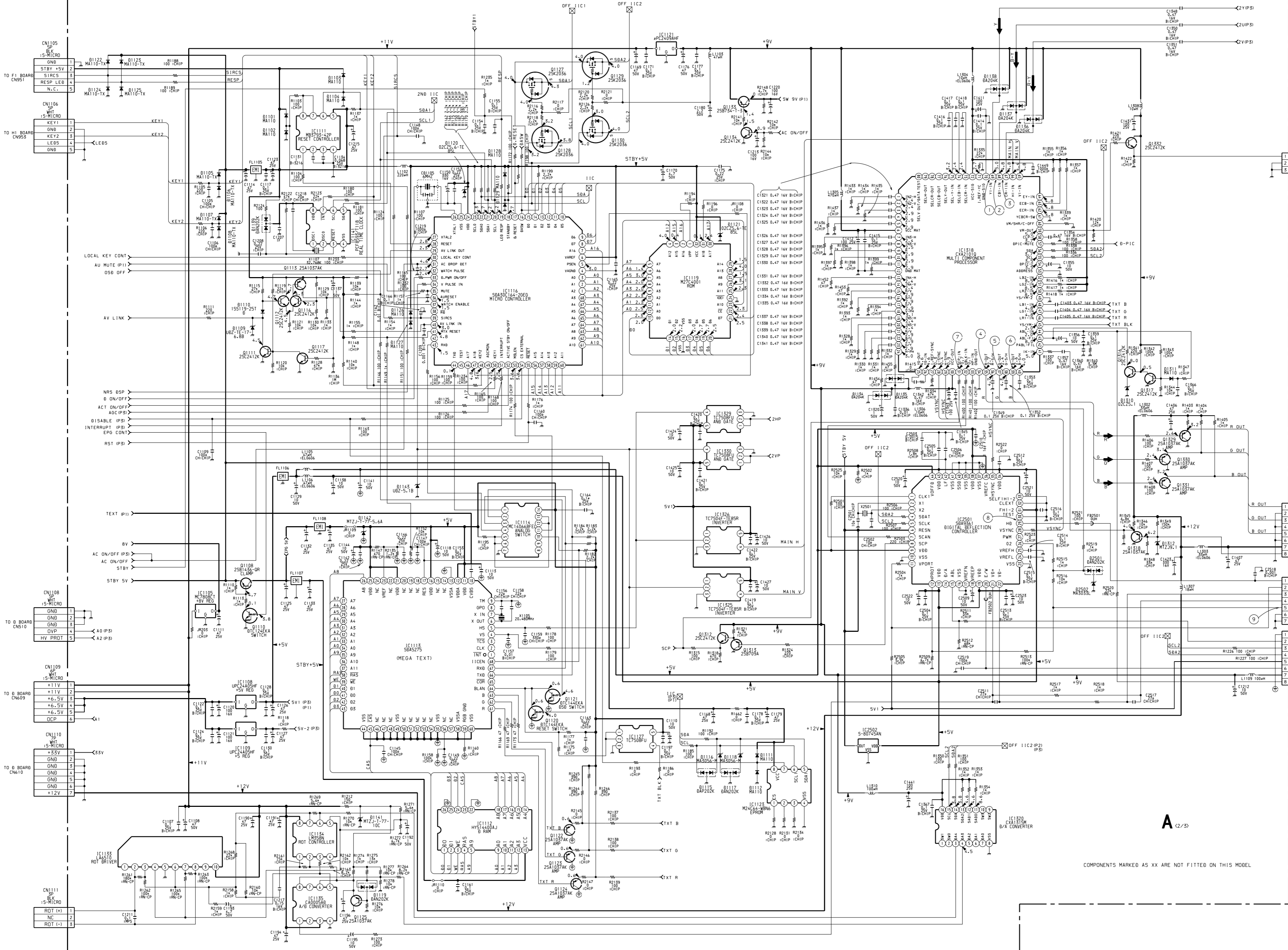

WAVEFORMS A BOARD (2/3)

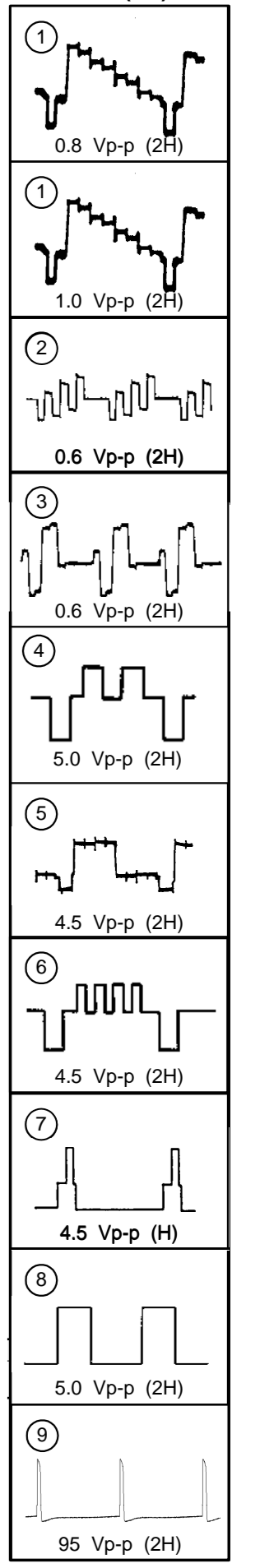

A (2/3)

COMPONENTS MARKED AS XX ARE NOT FITTED ON THIS MODEL

A
B
C
D
E
F
G
H
I
J
K
L
M
N
O
P
Q
R
S

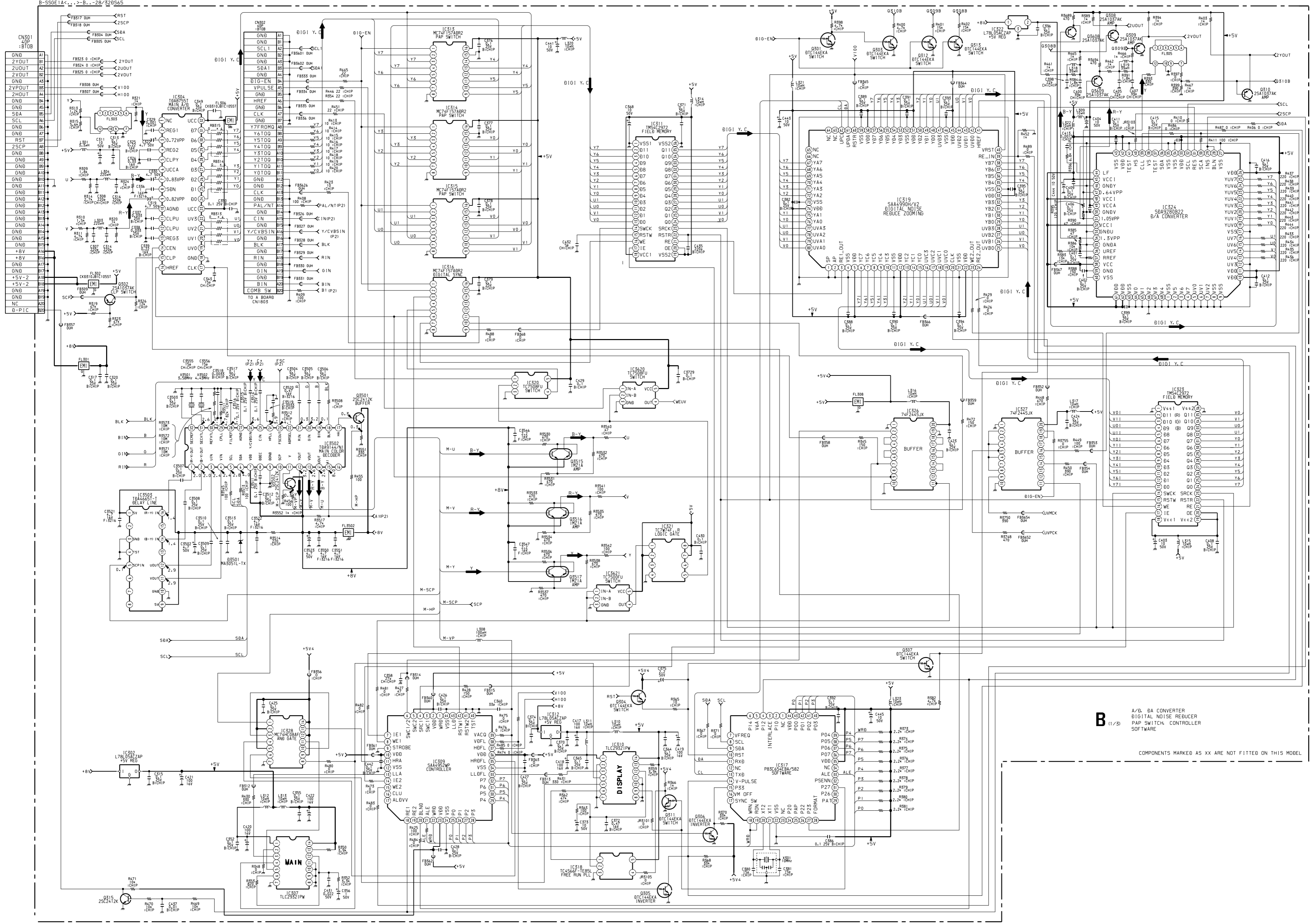

B [A/D, D/A CONVERTOR, DIGITAL NOISE REDUCER, PAP SWITCH, CONTROLLER SOFTWARE(PAGE 1/3)]

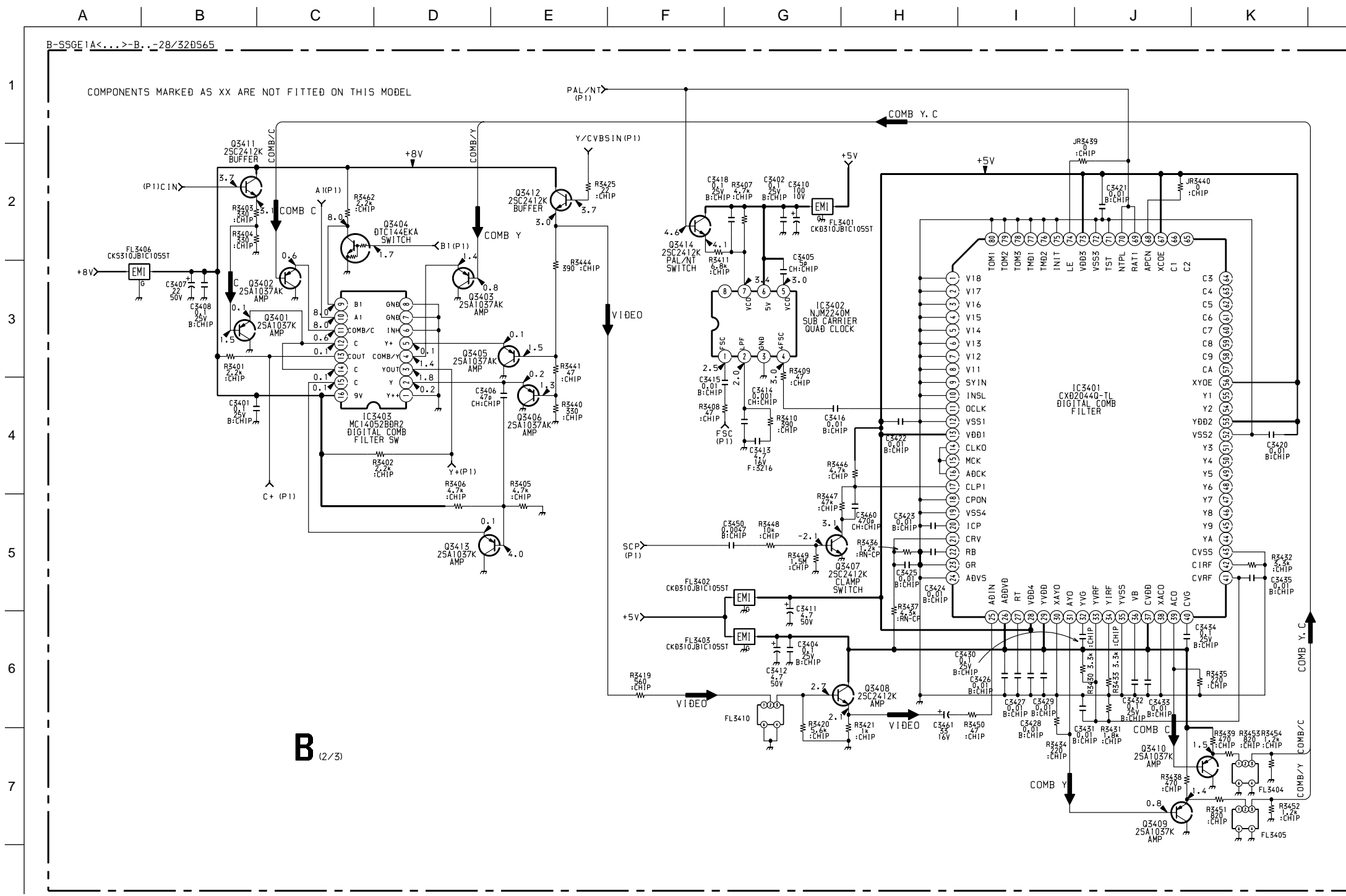

B (2/3)

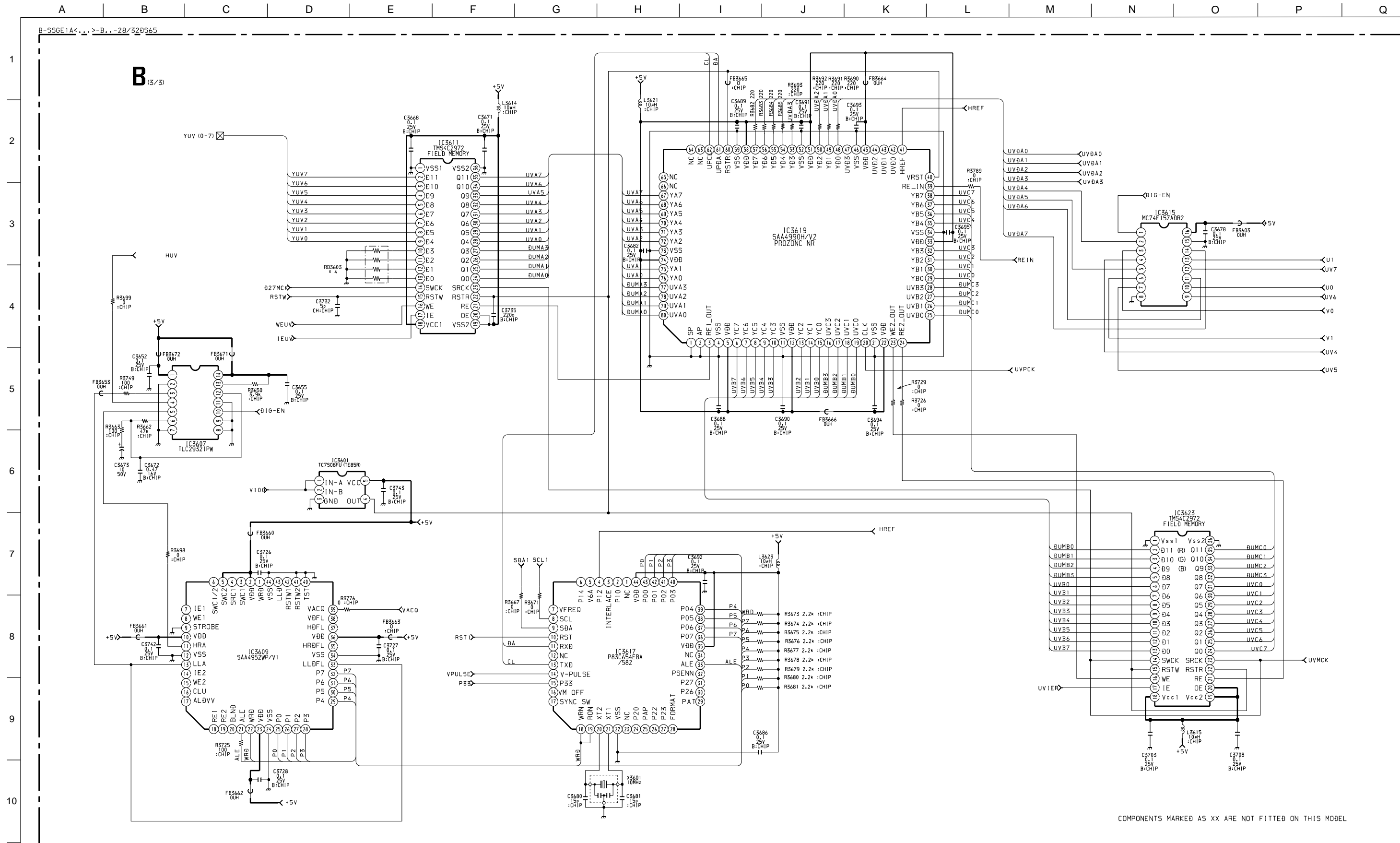

B [A/D D/A CONVERTOR, DIGITAL NOISE REDUCER, PDP SWITCH, CONTROLLER SOFTWARE (Page 3/3)]

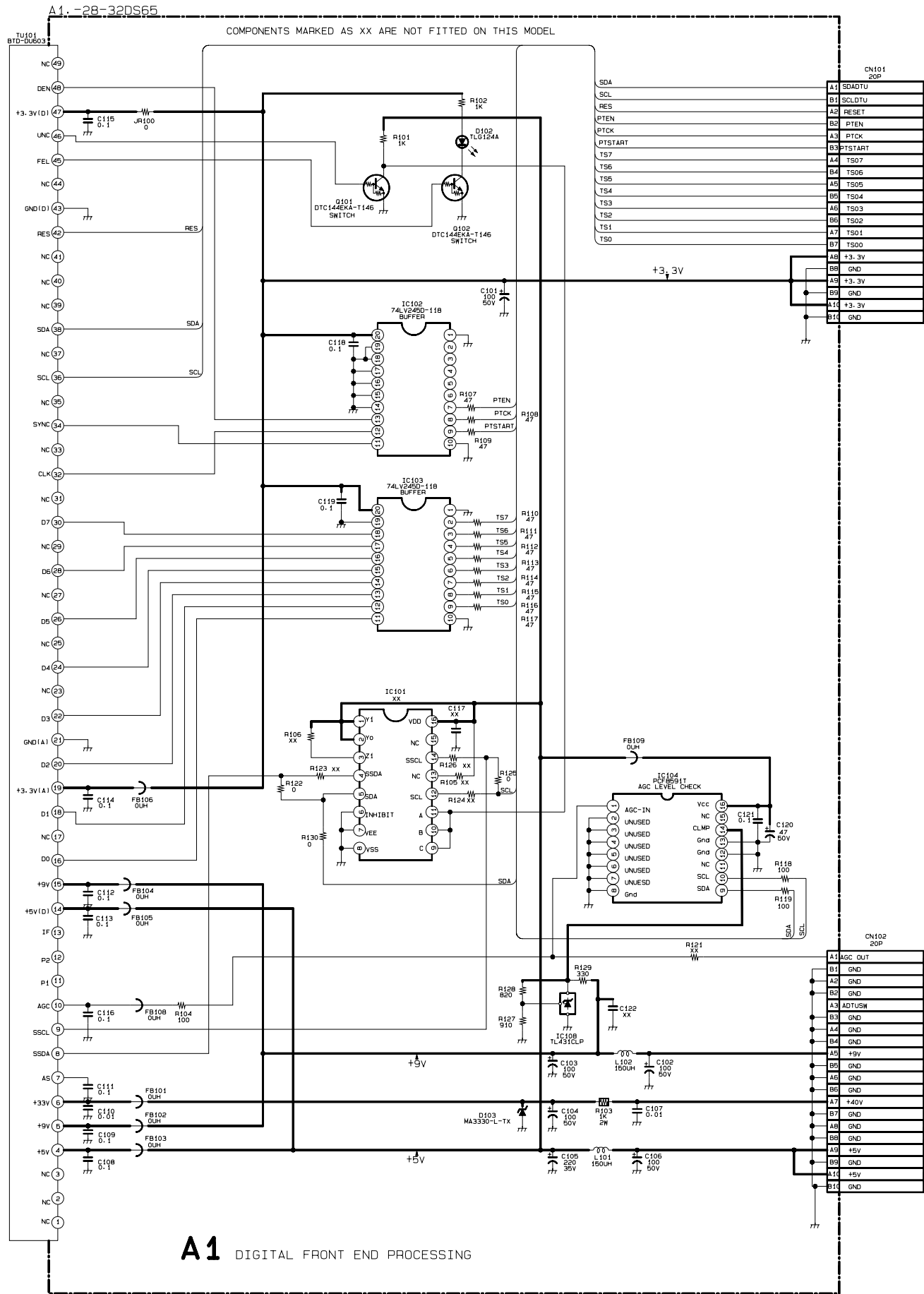

A1 [DIGITAL FRONT END PROCESSING]

A1 [PRINTED WIRING BOARD (A SIDE)]

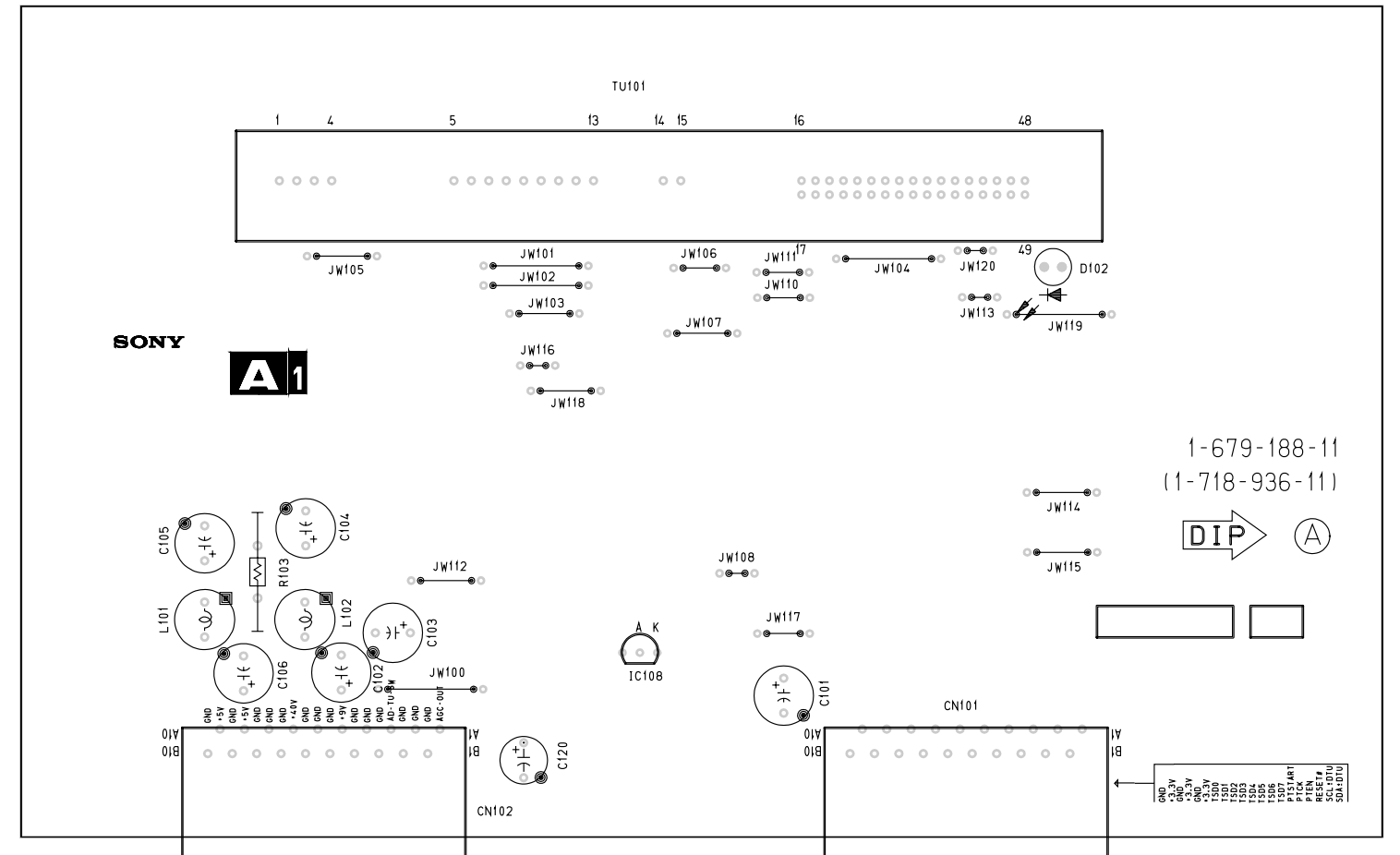

A1 [PRINTED WIRING BOARD (B SIDE)]

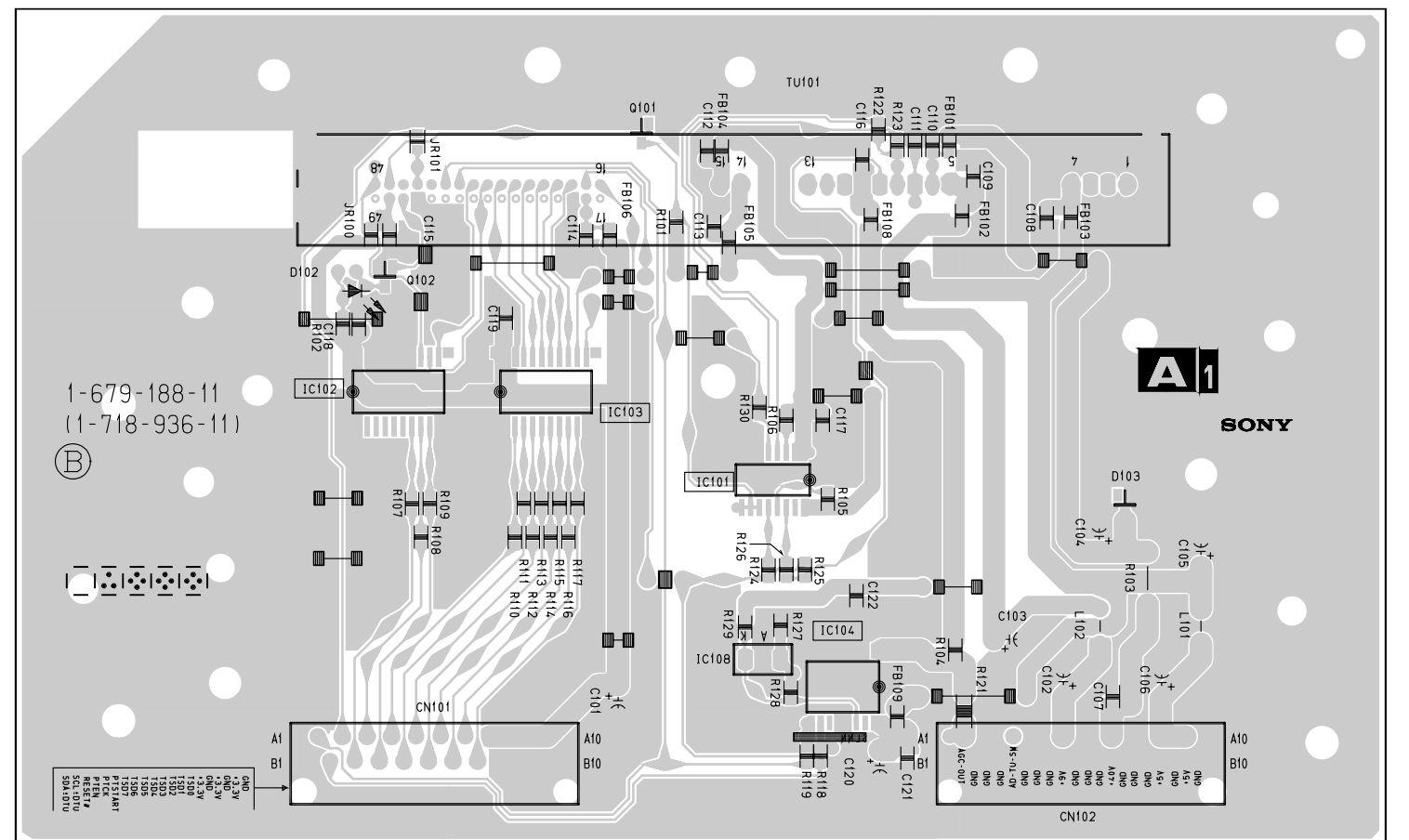

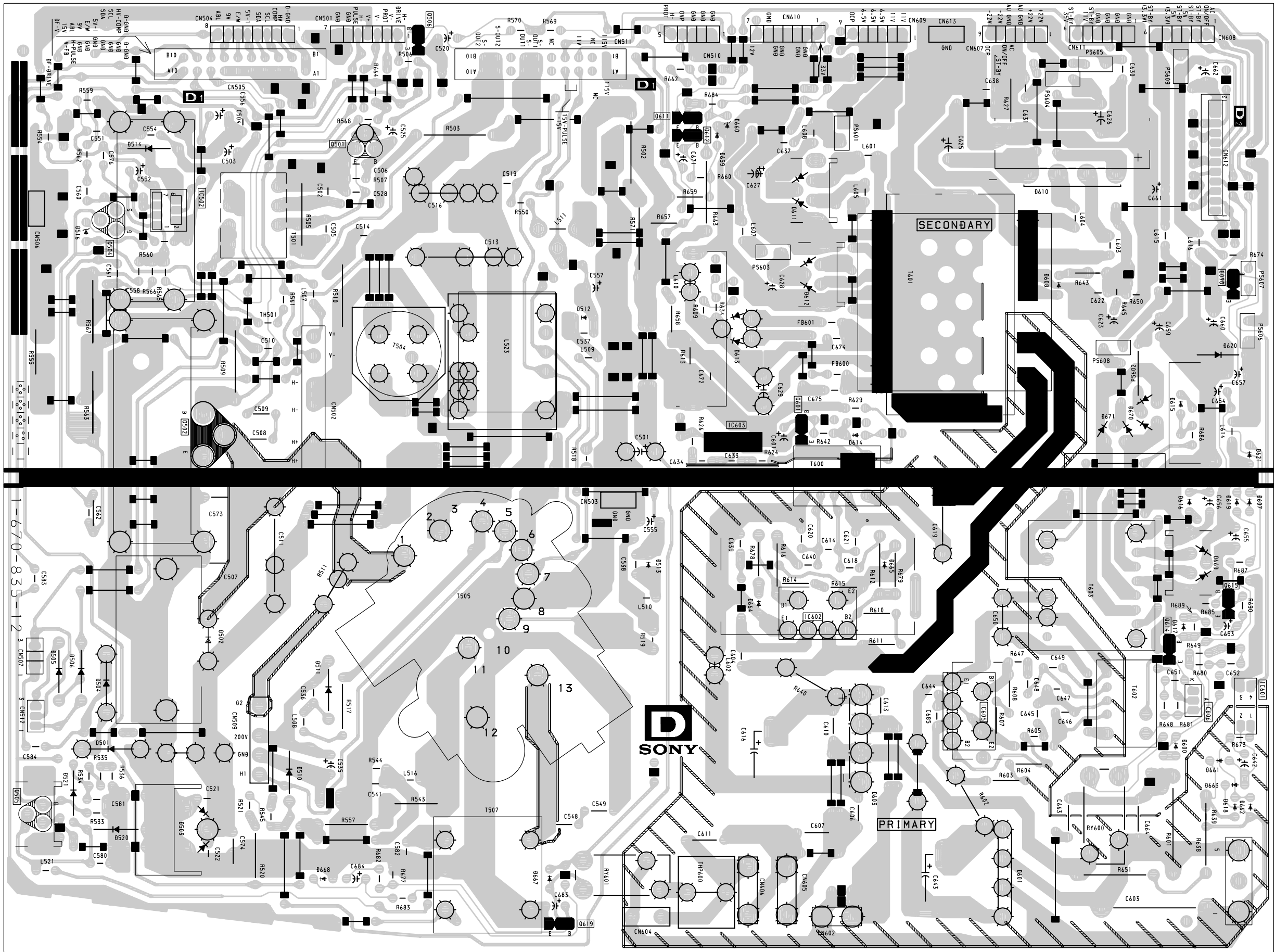

D [PRINTED WIRING BOARD [B] SIDE]

 **NOTE:**
 Portions of the circuit marked as shown are high voltage areas. Use care to prevent electric shock during inspection or repair.

1 2 3 4 5 6 7 8 9 10 11 12 13 14 15 16 17 18 19 20

A
B
C
D
E
F
G
H
I
J
K
L
M
N
O
P
Q
R
S
T

D BOARD * MARK

Ref	28DS65U	32DS65U
C507	-	330PF
C511	18000PF	0.017UF
C516	0.56UF	0.39UF
C607	JW10.0MM	10000PF
CN501	7P	-
CN605	-	3P
CN610	7P	-
L523	1-416-447-11	1-416-448-11
R510	330	100
R571	1K	1.2K
T504	1-431-599-11	1-431-600-11

WAVEFORMS D BOARD

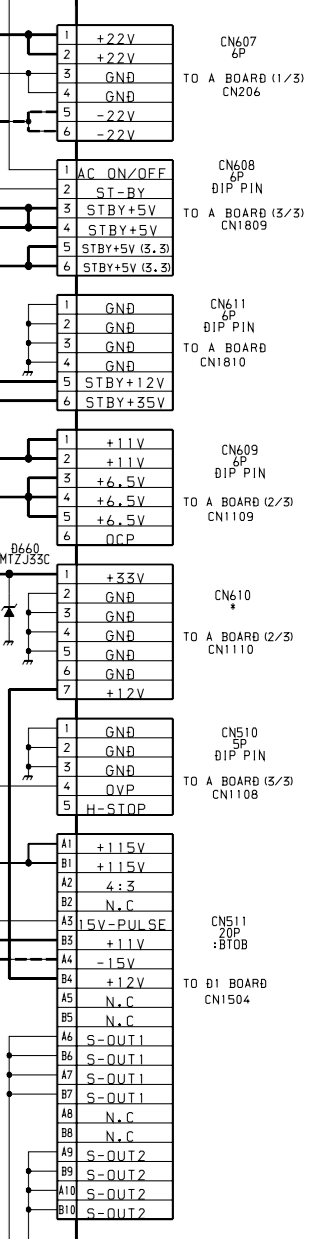
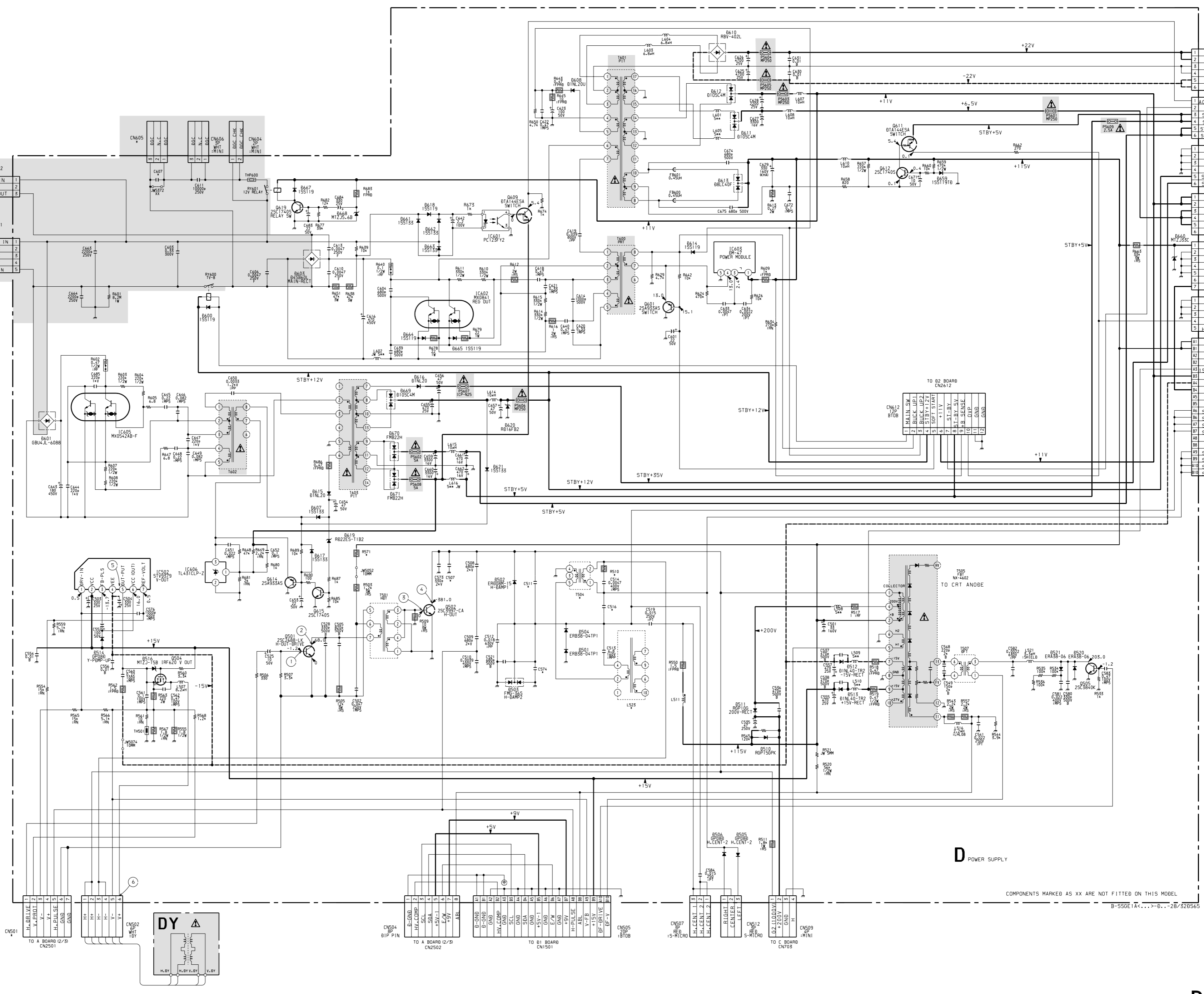
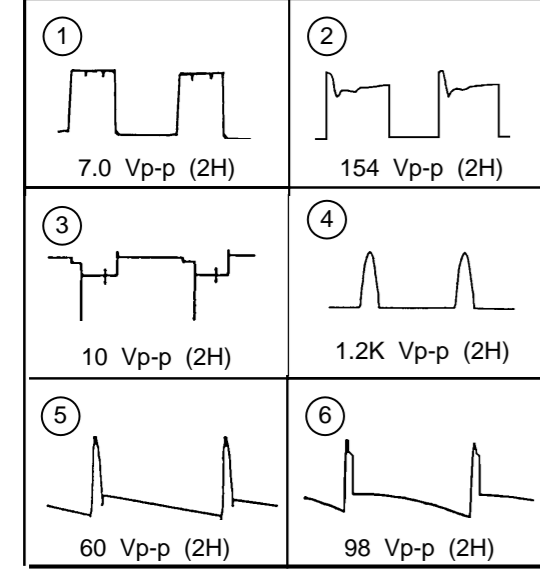

D POWER SUPPLY

COMPONENTS MARKED AS XX ARE NOT FITTED ON THIS MODEL
B-550E1A...S-D...-28/32DS65

B-5961A...-D1.-28/320565

D1 BF AMP S-CONT DRIVER
PIN CONTROLLER, V-PIN CONTROLLER,
A/D CONVERTER, CY CONTROLLER

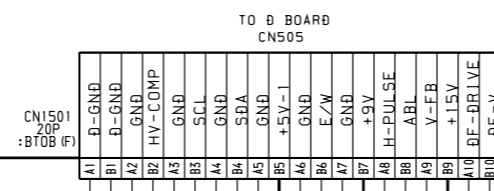

D1 BOARD * MARK

Ref	28DS65U	28DS65U
C1525	0.015UF	0.0047UF
C1551	0.33UF	0.43UF
C1572	1UF	0.1UF
C1576	0.022UF	0.015UF
C1577	-	0.0047UF
PS1502	1-533-593-31	1-532-841-21
Q1502	2SA1037AK	2SA1162G
Q1503	2SA1037AK	2SA1162G
Q1504	2SA1037AK	2SA1162G
Q1509	2SA1037AK	2SA1162G
Q1522	2SA1037AK	2SA1162G
Q1530	2SA1037AK	2SA1162G
Q1531	2SA1037AK	2SA1162G
R1535	15K	12K
R1537	22K	27K
R1614	2.7	3.9
R1615	2.7	3.9
R1630	8.2K	6.8K
R1639	100	82
R1641	12K	10K
R1647	-	220K
R1650	36K	39K
R1664	6.8K	5.6K
R1665	6.8K	5.6K
R1666	-	270K
R1675	2.7	3.9
R1688	2.7	3.9
R1708	220K	150K

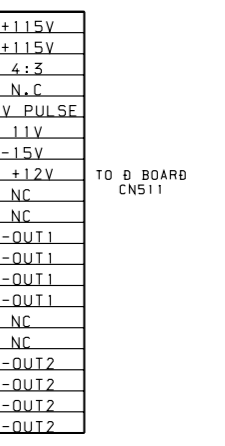
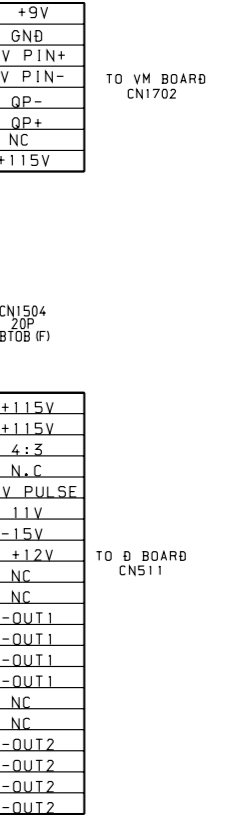
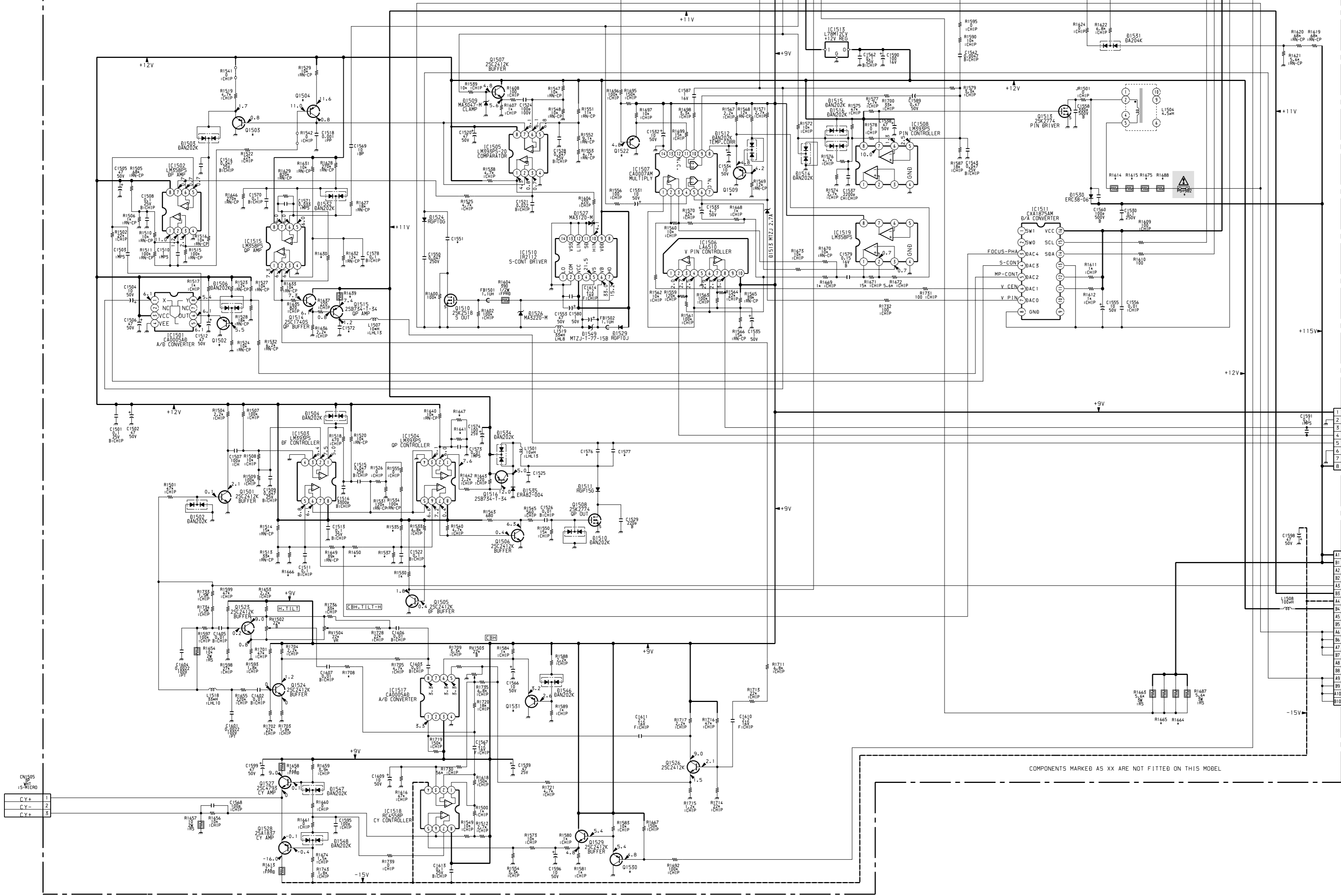

D1 [BF AMP S-CONT DRIVER, PIN CONTROLLER, V-PIN CONTROLLER, A/D CONVERTER, CY CONTROLLER]

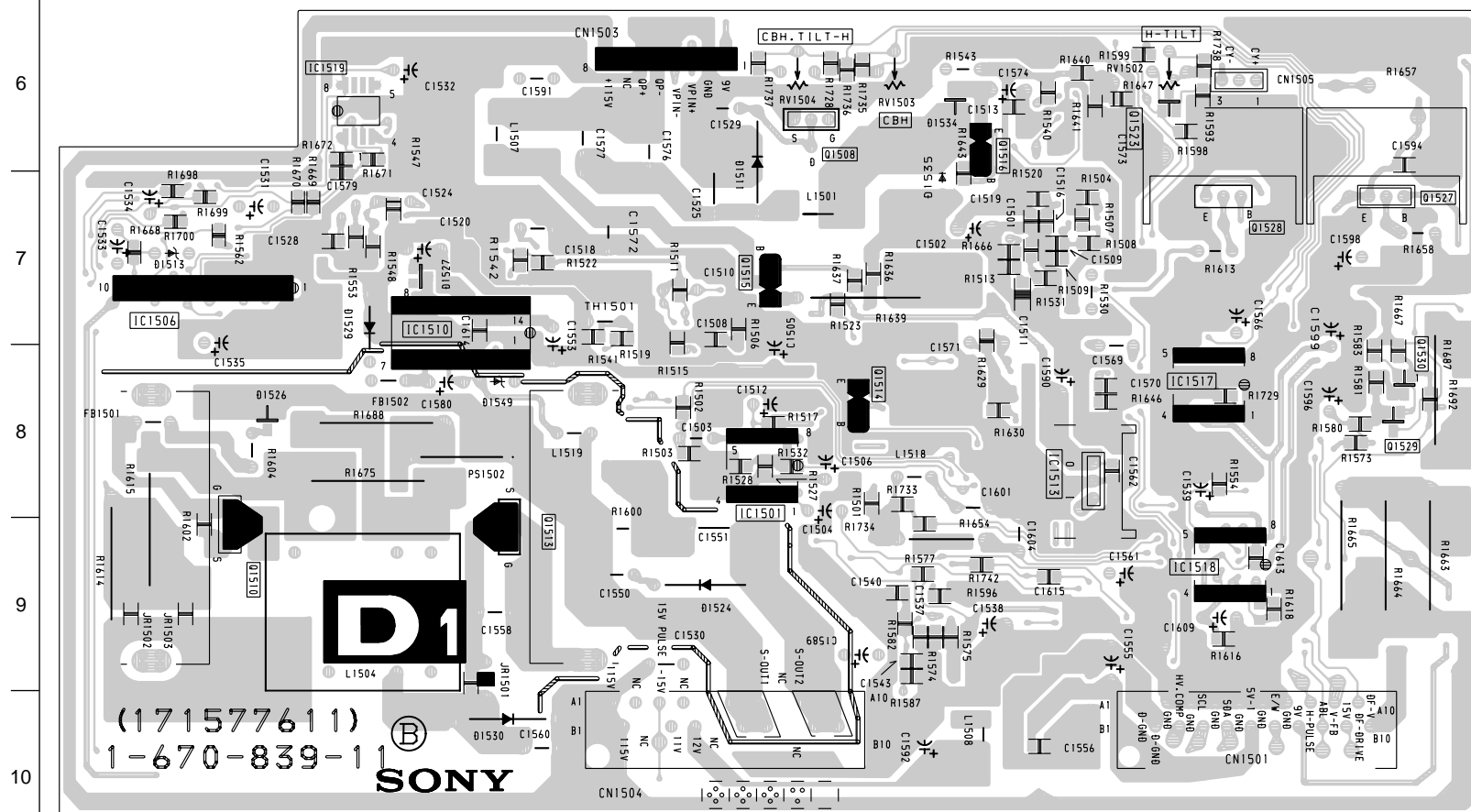
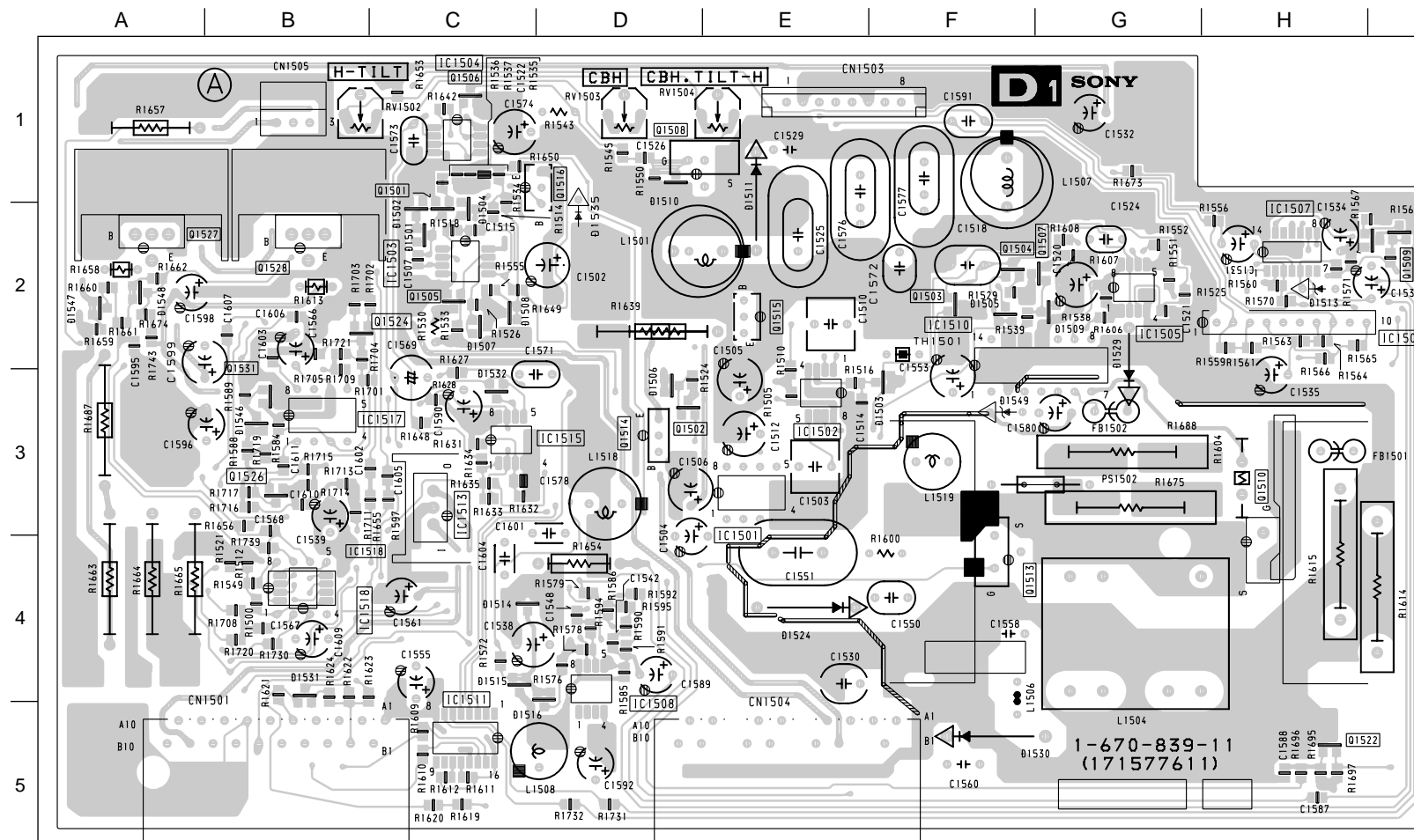

SEMICONDUCTOR LOCATION TABLE

IC	Q1523	G - 6	
IC1501	E - 8	Q1524	C - 2
IC1502	E - 3	Q1526	B - 3
IC1503	C - 2	Q1527	A - 2
IC1504	C - 1	Q1528	B - 2
IC1505	G - 2	Q1529	H - 8
IC1506	A - 7	Q1530	H - 8
IC1507	H - 2	Q1531	B - 3
IC1508	D - 8	DIODE	
IC1510	C - 7	D1502	B - 10
IC1511	C - 4	D1504	B - 12
IC1513	C - 3	D1507	C - 2
IC1515	D - 3	D1508	C - 2
IC1517	C - 3	D1509	G - 2
IC1518	B - 4	D1510	B - 9
IC1519	B - 6	D1511	E - 1
TRANSISTOR		D1512	I - 2
Q1501	C - 2	D1513	H - 2
Q1502	D - 3	D1515	C - 4
Q1503	F - 2	D1516	C - 5
Q1504	F - 2	D1524	E - 4
Q1505	C - 2	D1529	G - 2
Q1506	C - 1	D1530	C - 10
Q1507	F - 2	D1531	B - 4
Q1508	E - 6	D1532	C - 2
Q1510	B - 9	D1534	F - 6
Q1513	C - 9	D1535	F - 6
Q1514	E - 8	D1546	B - 3
Q1515	E - 7	D1547	A - 2
Q1516	D - 1	D1548	A - 2
Q1522	H - 5	D1549	F - 3

SEMICONDUCTOR LOCATION TABLE

IC	IC3402	G - 9	
IC3101	G - 5	IC3403	I - 6
IC3102	F - 3	IC3404	H - 7
IC3103	F - 1	IC3405	I - 7
IC3112	E - 8	IC3407	H - 6
IC3115	G - 5	IC3408	I - 8
IC3116	D - 4	IC3409	E - 2
IC3201	B - 5	IC3410	E - 2
IC3202	C - 4	IC3411	E - 3
IC3203	B - 4	IC3412	D - 3
IC3204	G - 9	IC3413	D - 5
IC3205	F - 3	TRANSISTOR	
IC3206	G - 8	Q3101	G - 5
IC3207	H - 3	Q3201	I - 10
IC3208	B - 4	Q3202	H - 9
IC3301	B - 5	Q3204	B - 5
IC3304	J - 4	Q3301	A - 4
IC3307	I - 4	Q3302	I - 9
IC3308	I - 2	Q3303	J - 9
IC3309	G - 5	Q3401	I - 7
IC3310	H - 5	Q3402	G - 9
IC3312	I - 2	DIODE	
IC3313	I - 3	D3305	I - 10
IC3315	J - 7	D3306	A - 4
IC3316	C - 3	D3307	A - 5
IC3317	B - 4	D3308	A - 5
IC3318	I - 2	D3309	A - 5
IC3320	H - 2		

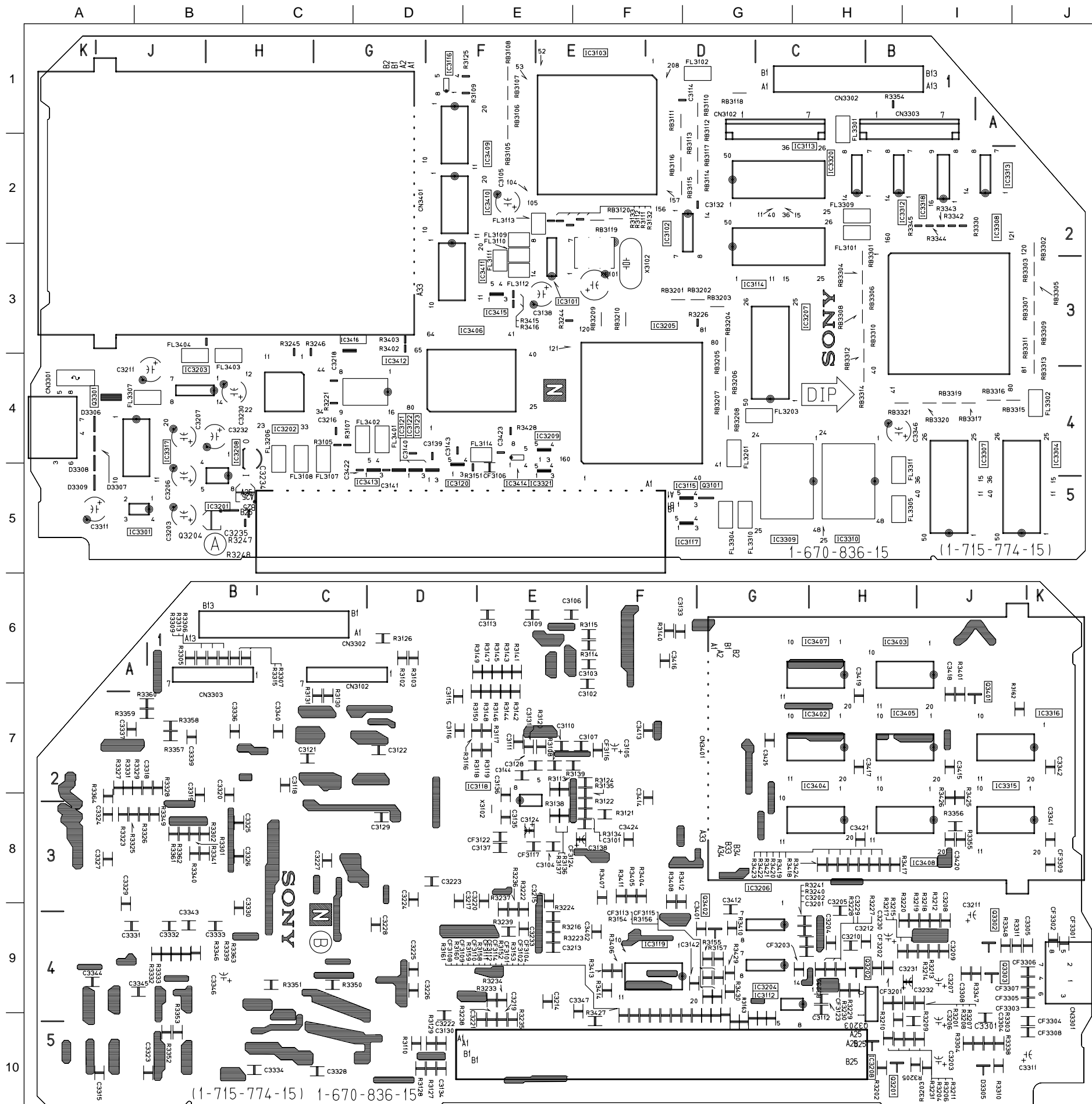

1 2 3 4 5 6 7 8 9 10 11 12 13 14 15 16 17 18 19 20

A B C D E F G H I J K L M N O P Q R S T

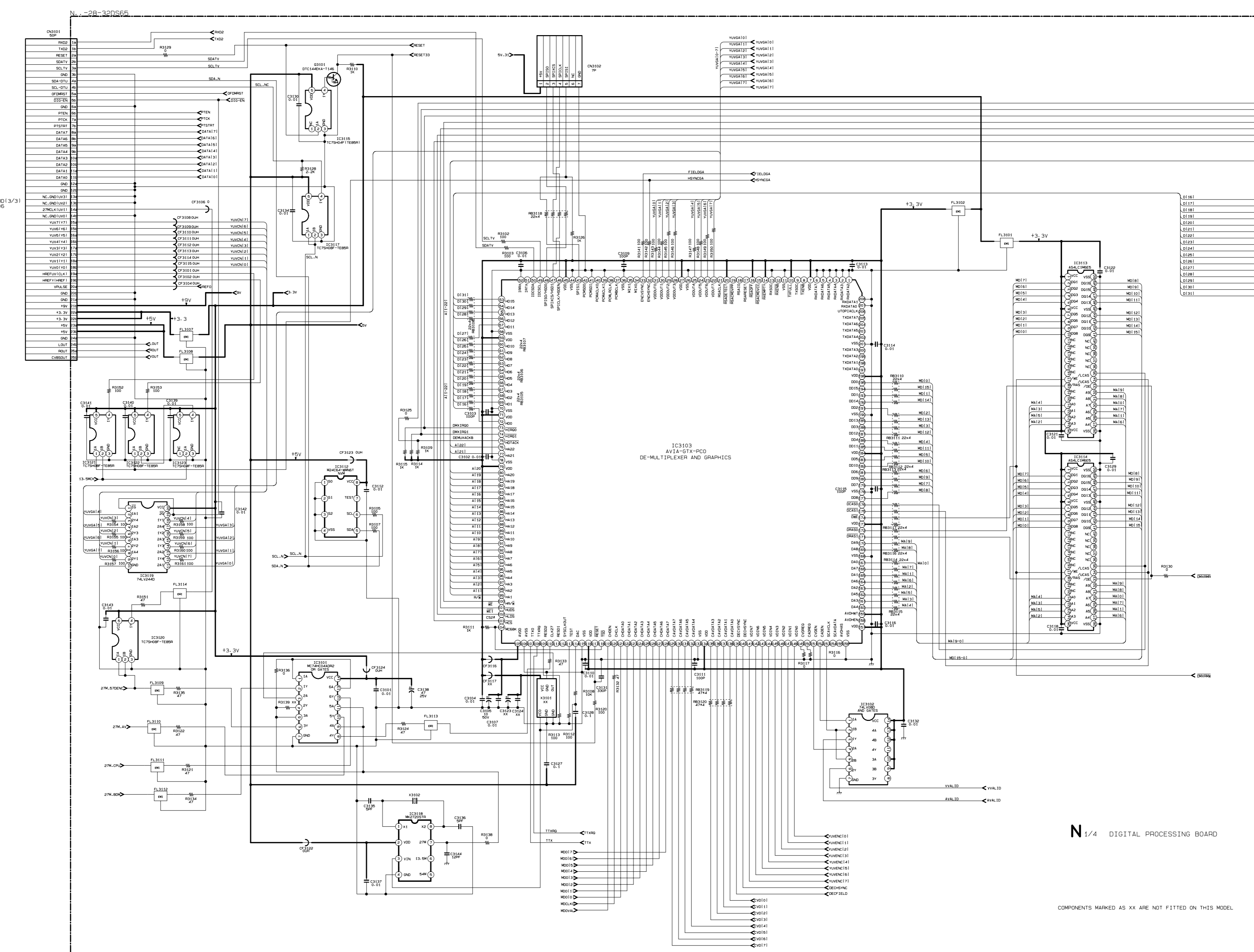

N 1/4 DIGITAL PROCESSING BOARD

COMPONENTS MARKED AS XX ARE NOT FITTED ON THIS MODEL

1 2 3 4 5 6 7 8 9 10 11 12 13 14 15 16 17 18 19 20

A
B
C
D
E
F
G
H
I
J
K
L
M
N
O
P
Q
R
S
T

N_{3/4}

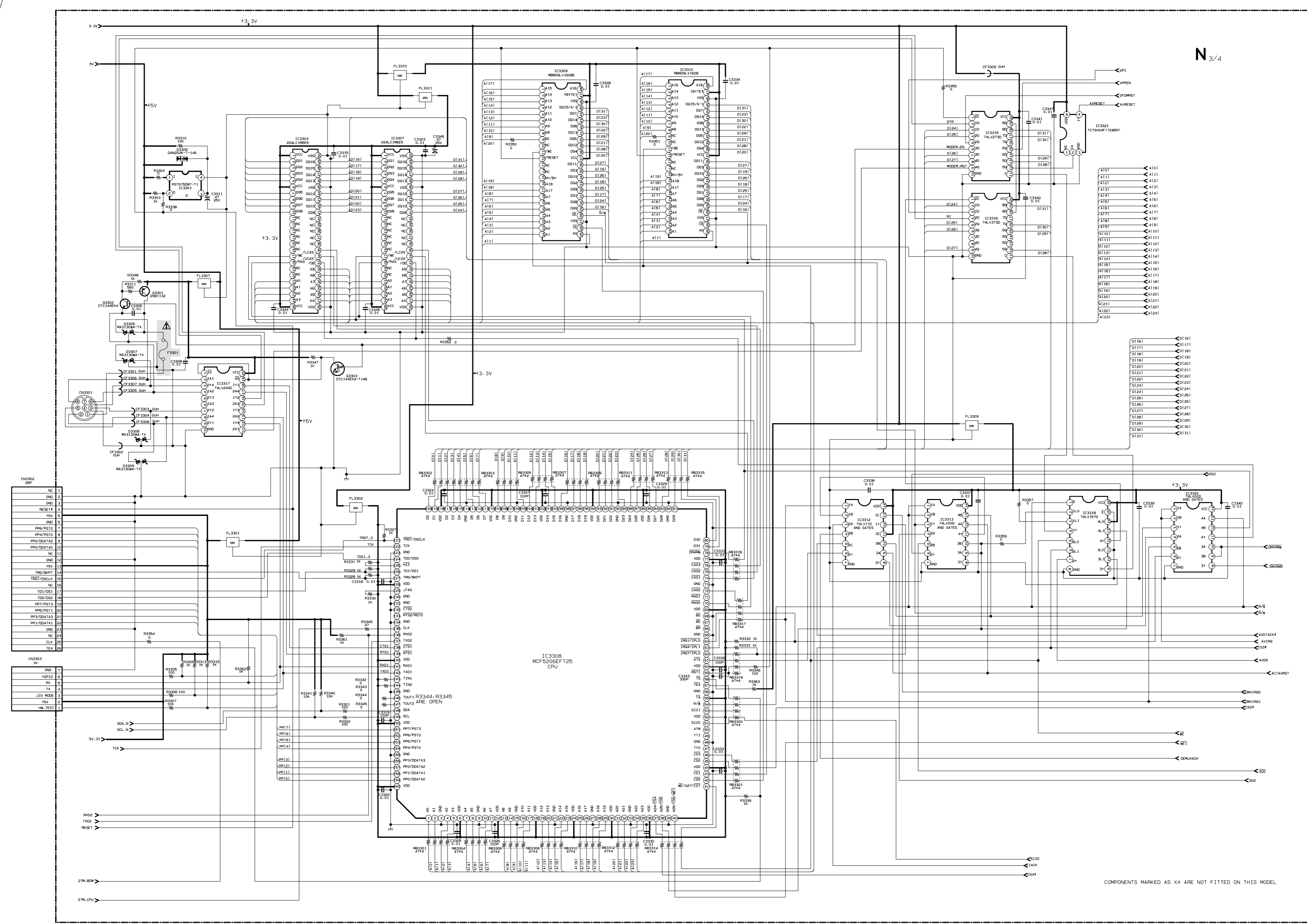

COMPONENTS MARKED AS XX ARE NOT FITTED ON THIS MODEL

N. - 28-32DS65

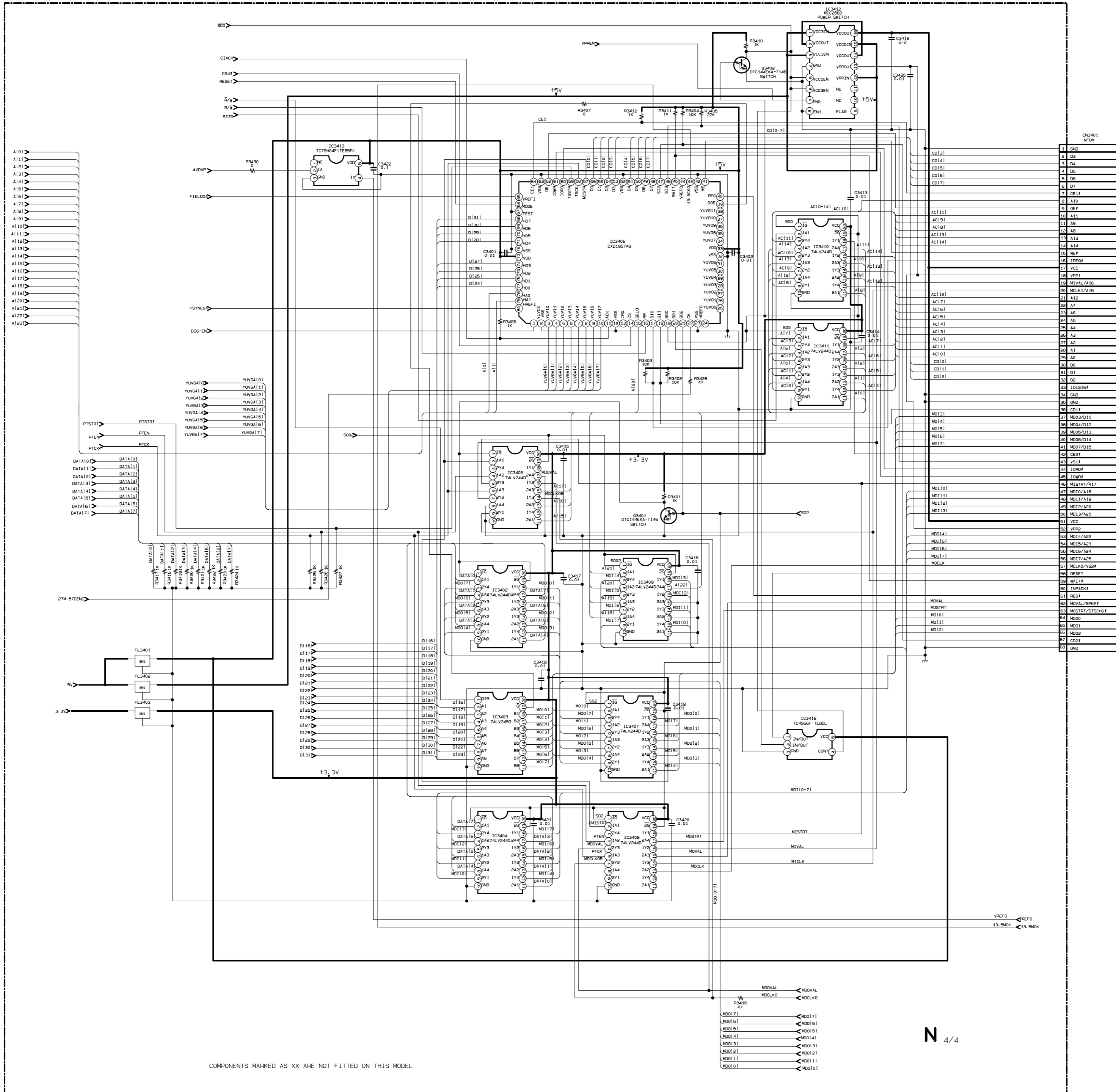

COMPONENTS MARKED AS XX ARE NOT FITTED ON THIS MODEL

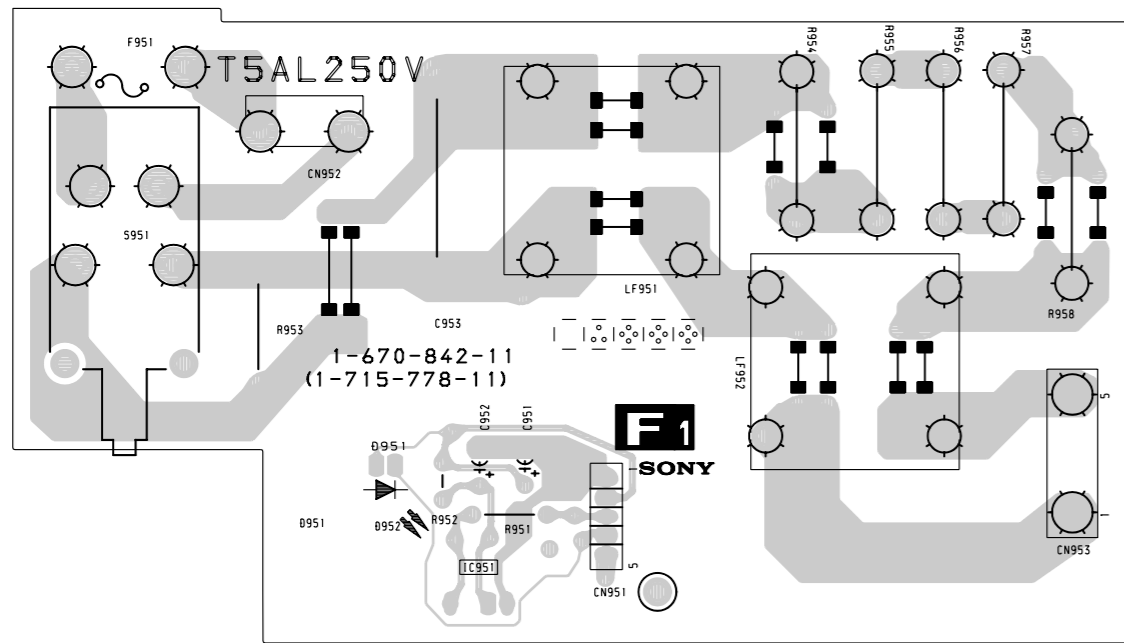
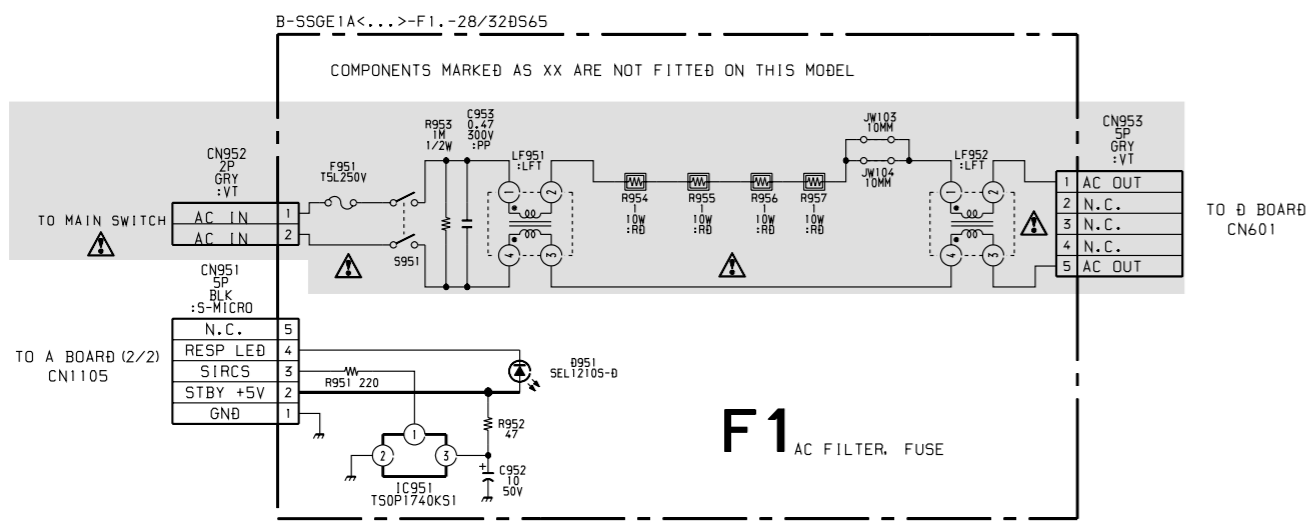

F1 [AC FILTER, FUSE]

SEMICONDUCTOR LOCATION TABLE

IC	D4209	A-4
IC4201	D-5	D4210 B-4
IC4202	C-5	D4211 A-4
IC4203	E-3	D4212 C-3
TRANSISTOR		
Q4204	E-9	D4214 C-1
Q4205	E-3	D4215 C-4
Q4206	D-6	D4216 C-1
Q4207	F-3	D4217 B-1
Q4208	E-8	D4218 C-4
Q4209	D-7	D4220 C-2
Q4210	D-6	D4222 K-2
Q4214	C-6	D4223 D-2
Q4217	C-7	D4224 D-1
Q4218	D-7	D4225 D-4
Q4219	G-3	D4227 D-4
DIODE		
D4201	B-4	D4229 D-2
D4202	B-4	D4230 D-2
D4203	B-2	D4232 E-2
D4204	B-1	D4233 F-2
D4205	A-2	D4234 F-2
D4207	A-2	
D4208	A-3	

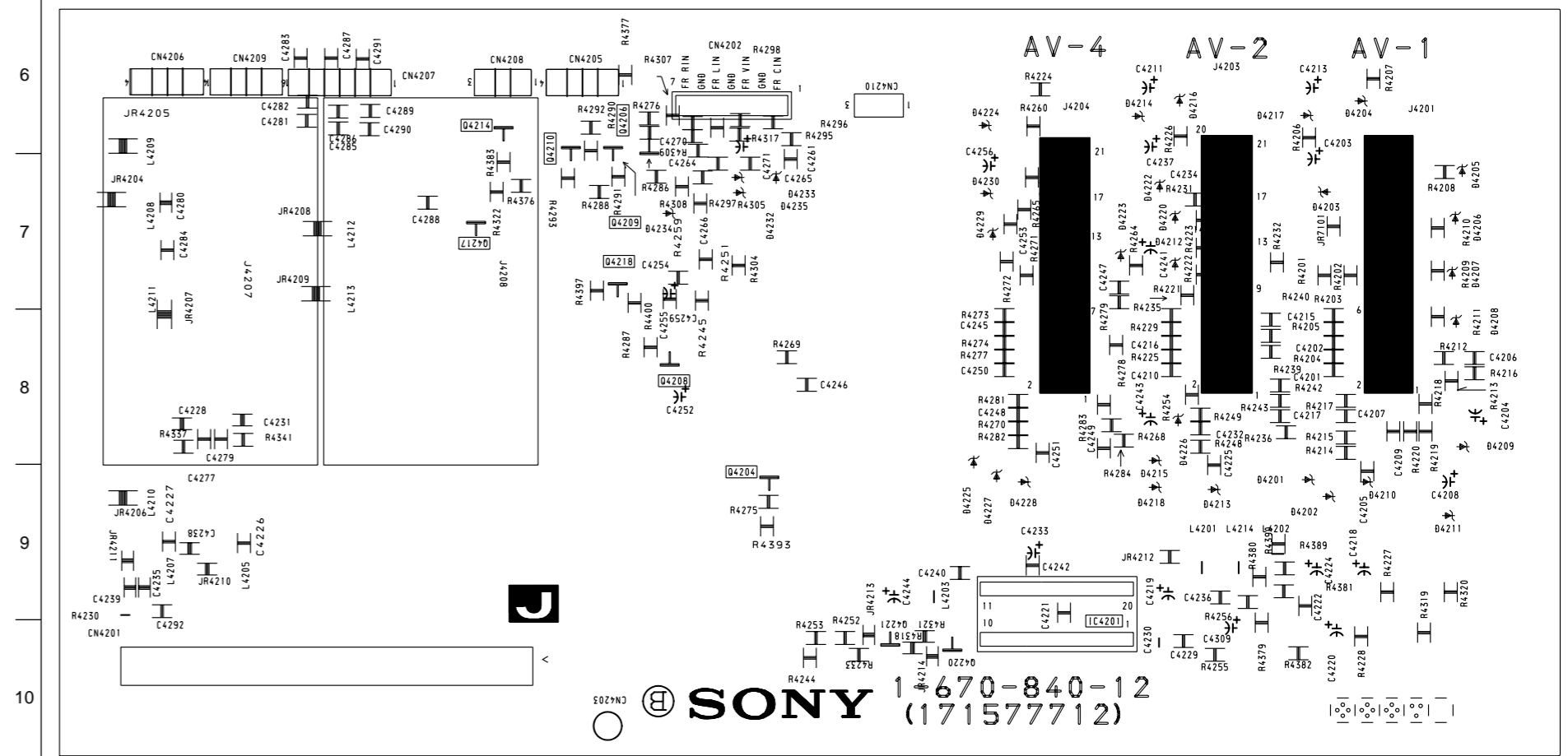
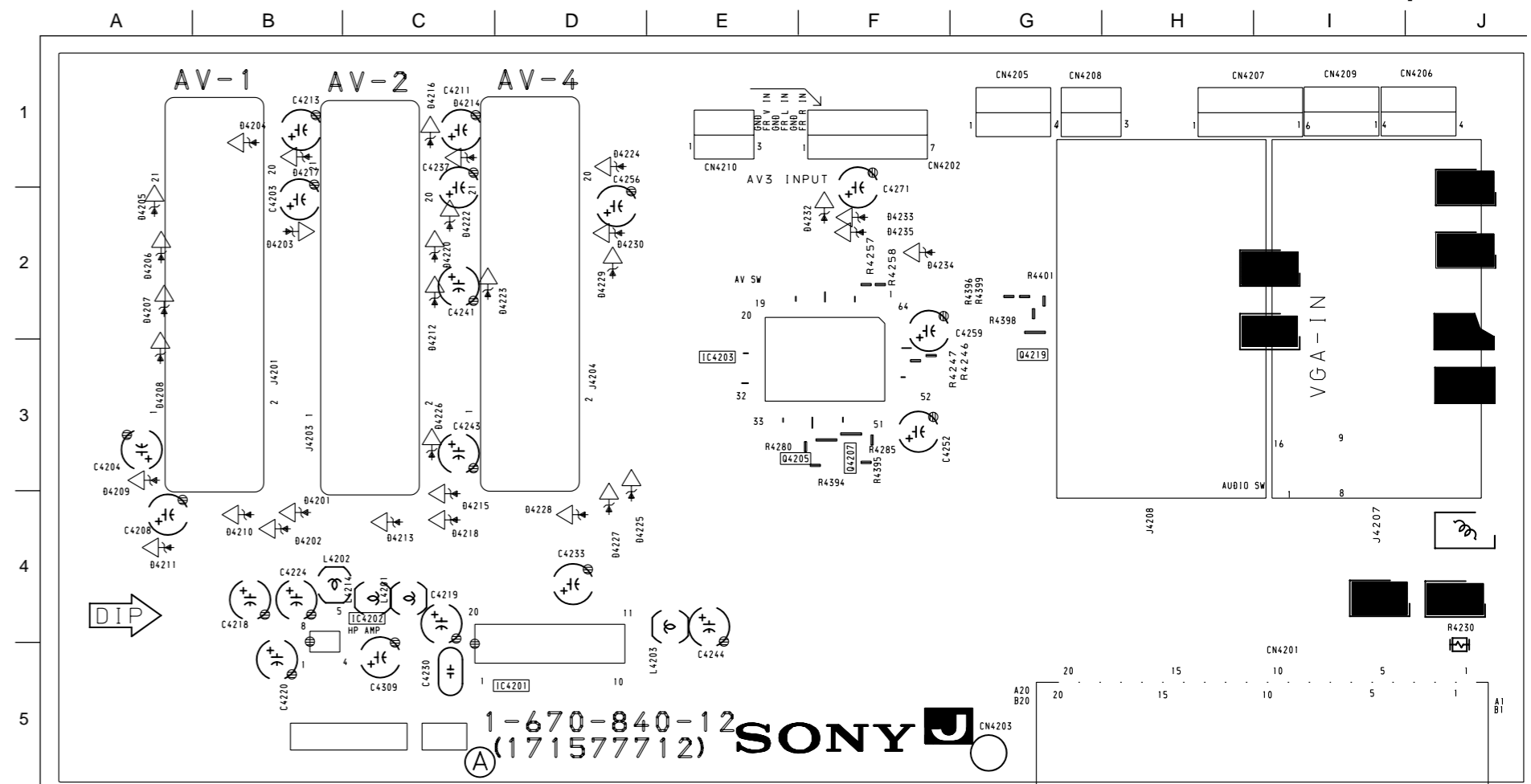

J [PRINTED WIRING BOARD]

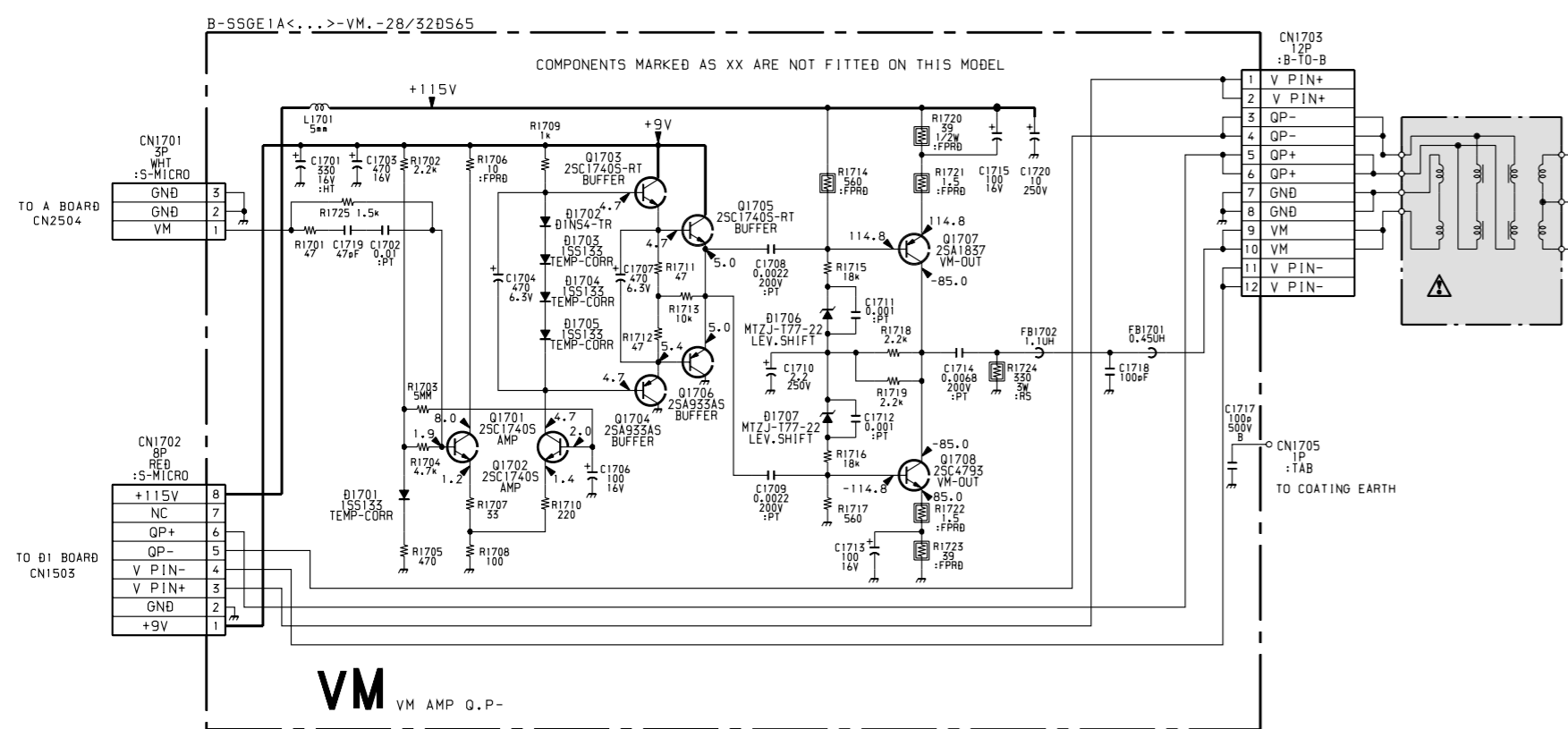

VM [VM AMP Q.P.]

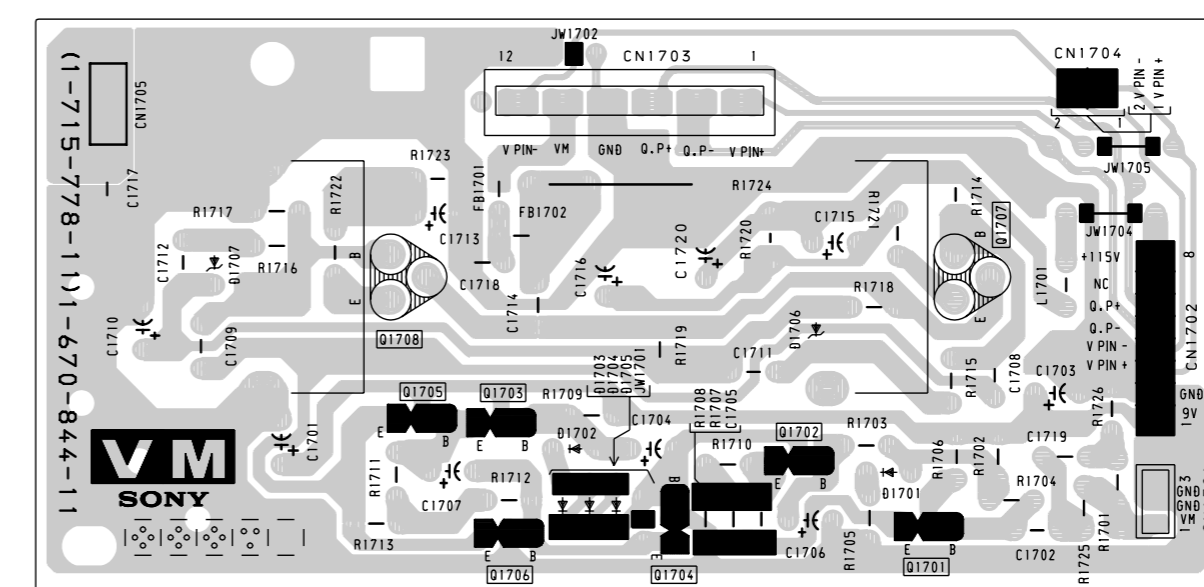

B-SSGE1A<...>-J...-28/32D565

J AV SWITCHING

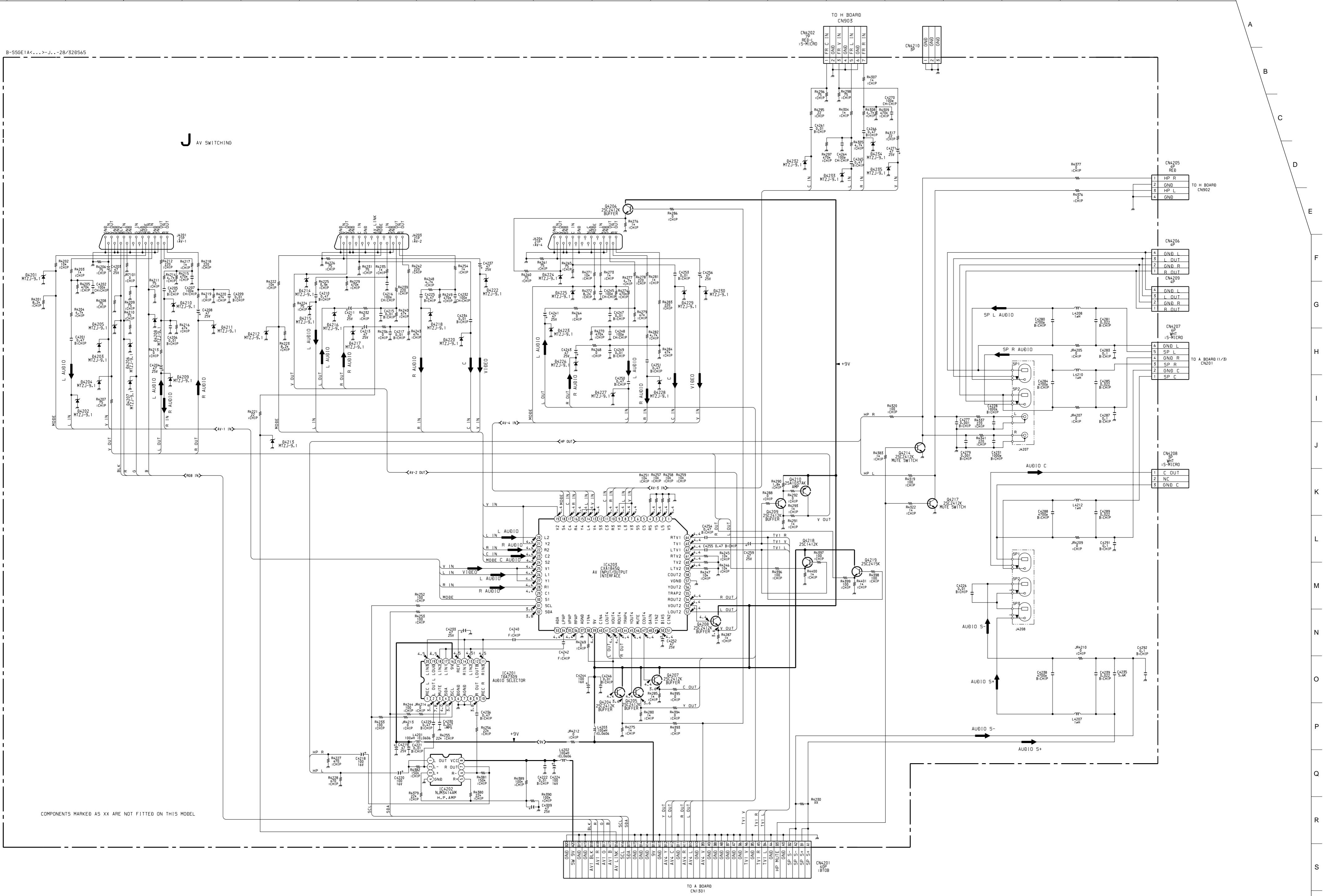

COMPONENTS MARKED AS XX ARE NOT FITTED ON THIS MODEL

5-4 SEMICONDUCTORS

BA7046F
 BA7046F-T1
 MB3793-42NF
 MB3793-42NF-ER
 MC14066BFEL
 NJM2240M
 NJM2240M(TE2)
 NJM3404AM-TE1

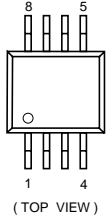

CAD005AD
 LM358N
 LM358PS
 LM393P
 M5216P
 ST24C16FB6
 TDA2822M
 UPC393C

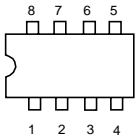

CXA1855Q-T6

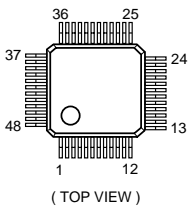

CXA1875AM-T4
 HEF4053BT
 MC14052BDR2
 MC14053BF-T2
 MC74F157ADR2
 SN74LS221D
 74HCT4046AD/S470

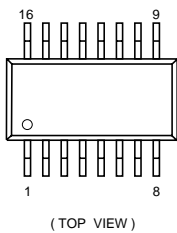

CXD2044Q-TL
 SAA4990H/V2

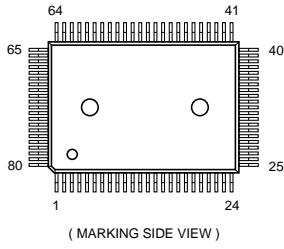

L7805CV
 LM2940CT-9.0
 LM2940T-8.0
 LM2940T-9.0
 L4941BV
 TEA7605
 MC7808CT

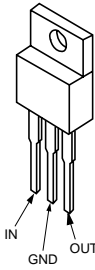

LM78L05ACZ
 LM78L12ACZ
 L78L05ACZ-AP
 L78L12ACZ-AP
 MC78L05AC PRP

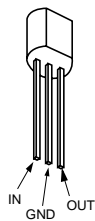

MB814400C-70P-JN-ER

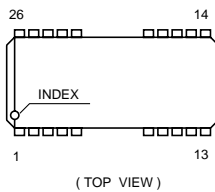

MBM29F04DA-90PFN

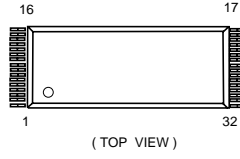

MC74F240DWR2
 MC74F244MEL

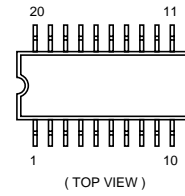

MSP3400C-PS-C6-T
 MSP3410D-PS-B4-T
 SAA7185WP
 SDA30C164-2-GEG
 SDA30C164-2GEG
 SDA5273P-C26-GEG
 SDA5275
 SDA9280B22

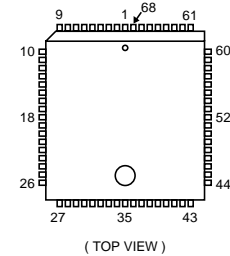

M27C4001-15C1
 M27C4001-15C1-GE101

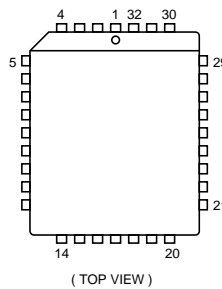

P83C654EBA/582
 SDA9280A41

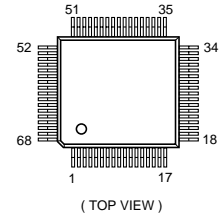

EPM7032LC44-15-AE001
 SAA4952WP/V1
 SAA7165WP

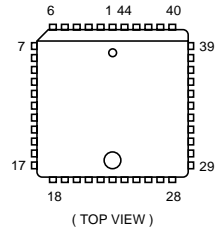

SDA9361

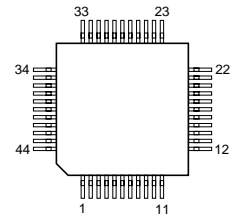

STV9379

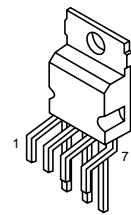

TC4S66F
 TC4S66F-TE85L

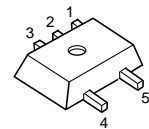

TC552557DFTL-70V-EL

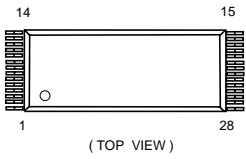

TDA8755T-T

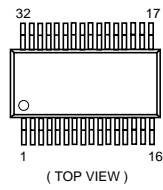

PST575DMT-T1
TLC2932IPW-20
U2860B-BFPG3
74LVC08D

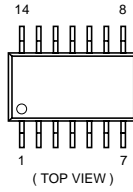

2SA1837

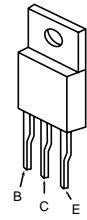

TDA4665T-T

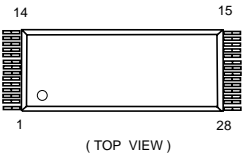

TDA9143/N2
TDA9144/N1
TDA9170T

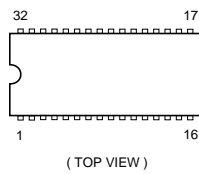

DTA114EK DTC144EK
DTA114EK-T146 DTC144EK-T146
DTA144EK DTC144EKA-T146
DTA144EK-T146 2SA1037K-T-146-R
DTC114EK 2SA1162-G
DTC114EKA-T146 2SC2412K-QR
DTC124EKA-T146 2SC2412K-T-146-R

2SC2500-B
2SC2551-O
2SC2552O-TPE2



TDA6111Q
TDA6111Q/N4

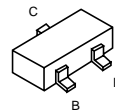
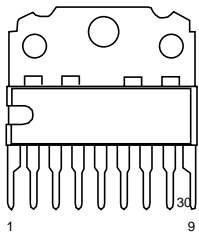

TL431CLP
TL431CLP-Z20
TL431CPS-T1
TL431CZ

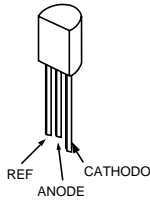

IMZ1A-T109

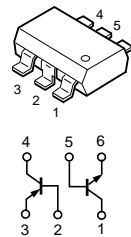

2SC2688-LK

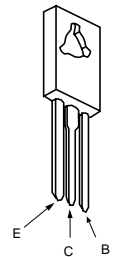

TDA7265

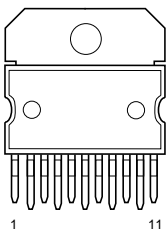

TDA7309

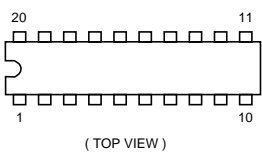

TMS4C2972-26DTR
TMS4C2972-28DTR

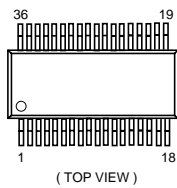

JA101TP-Q 2SA733-K
JC501TP-Q 2SA933AS-RT
DTA144ESA 2SA933AS-RT
DTA144ESA-TP 2SA933S-RT
DTC144ESA-TP 2SC1740S-RT
2SA1175-HFE 2SC2785-HFE

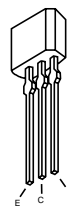

2SC3997CA

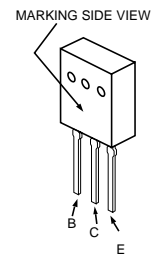

2SC4793

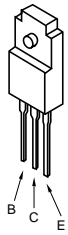

D1NL20

D1NL20-TA

D1NL20-TR

EGP20G

EL1Z

GP08D

GP08DPKG23

MTZJ-T-77-9.1

MTZJ-T-77-9.1A

R2K-V1

RGP02-20EG23

RGP02-20EL-6394

RGP10GPKG23

RGP15GPKG23

S2LA20F

1SS133T-77

1SS83

1SS83TD

ESAD39M-06C

ESAD39M-06CF38

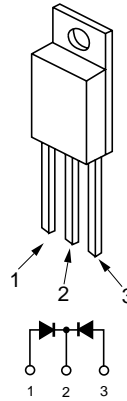

ERA38-06TP1

MTZJ-T-77-10C

MTZJ-T-77-13B

MTZJ-T-77-15B

MTZJ-T-77-2.2A

MTZJ-T-77-33C

MTZJ-T-77-39C

MTZJ-T-77-5.6A

MTZJ-T-77-5.6B

MTJ-T-77-9.1

MTZJ-13B

MTZJ-33C

MTZJ-39C

RD15ES-B2

RD5.6ESB2

RD9.1ESB2

1SS119-25

1SS119-25TD

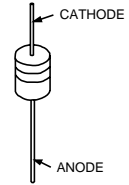

2SD2396H

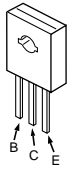

D10SC4M-F

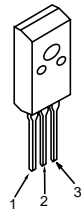

MA3033-L

MA3033L-TX

MA3056M-TX

MA3130WA-TX

O2CZ5.6-TEBSL

O2CZ5.1-TEBSL

MA3062M-TX

MA3030-H(TX)

RD5.6M-B2

MA110-TX

RD22ESB2

UDZ-TE-17-12B

UDZ-TE-17-6.8B

DAN202K

DAN202K-T-146

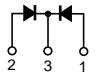
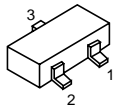

D4SB60L

D4SB60L-F

RBA-402L

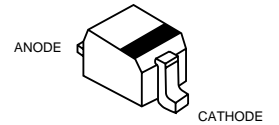
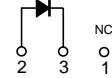
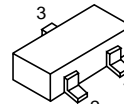
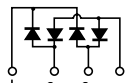
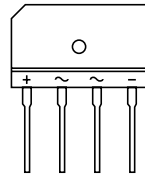

DAP202K

DAP202K-T-146

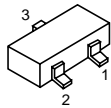

ERC38-06

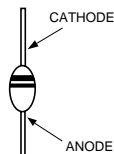

MA3051L-TX

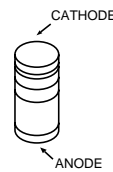

MA73-TX

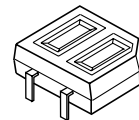

DA204K

DA204K-T-146

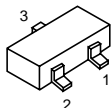

ERD08M-15

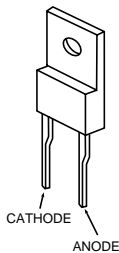

5-5. IC BLOCK DIAGRAMS

D BOARD IC502 STV9379

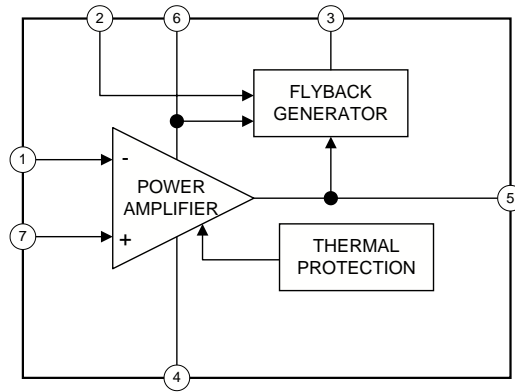

A BOARD IC201 MSP3410B-PS-B4-T

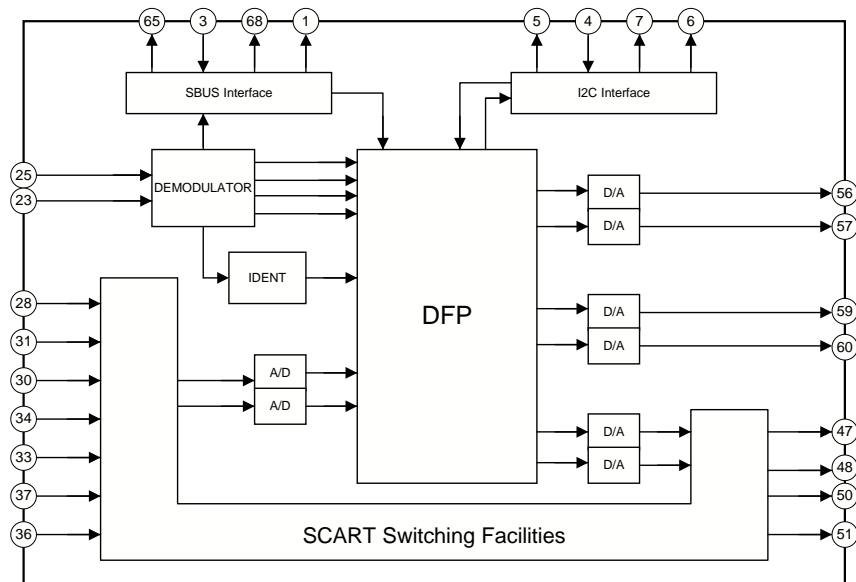

SECTION 6 EXPLODED VIEWS

NOTE :

- Items with no part number and no description are not stocked because they are seldom required for routine service.
- The construction parts of an assembled part are indicated with a collation number in the remarks column.
- Items marked “*” are not stocked since they are seldom required for routine service. Some delay should be anticipated when ordering these items.

Note : Les composants identifiés par une trame et par une marque Δ sont d'une importance critique pour la sécurité. Ne les remplacer que par des pièces du numéro spécifié.

Note : The components identified by shading and marked Δ are critical for safety. Replace only with the part numbers specified in the parts list.

6-1. CHASSIS

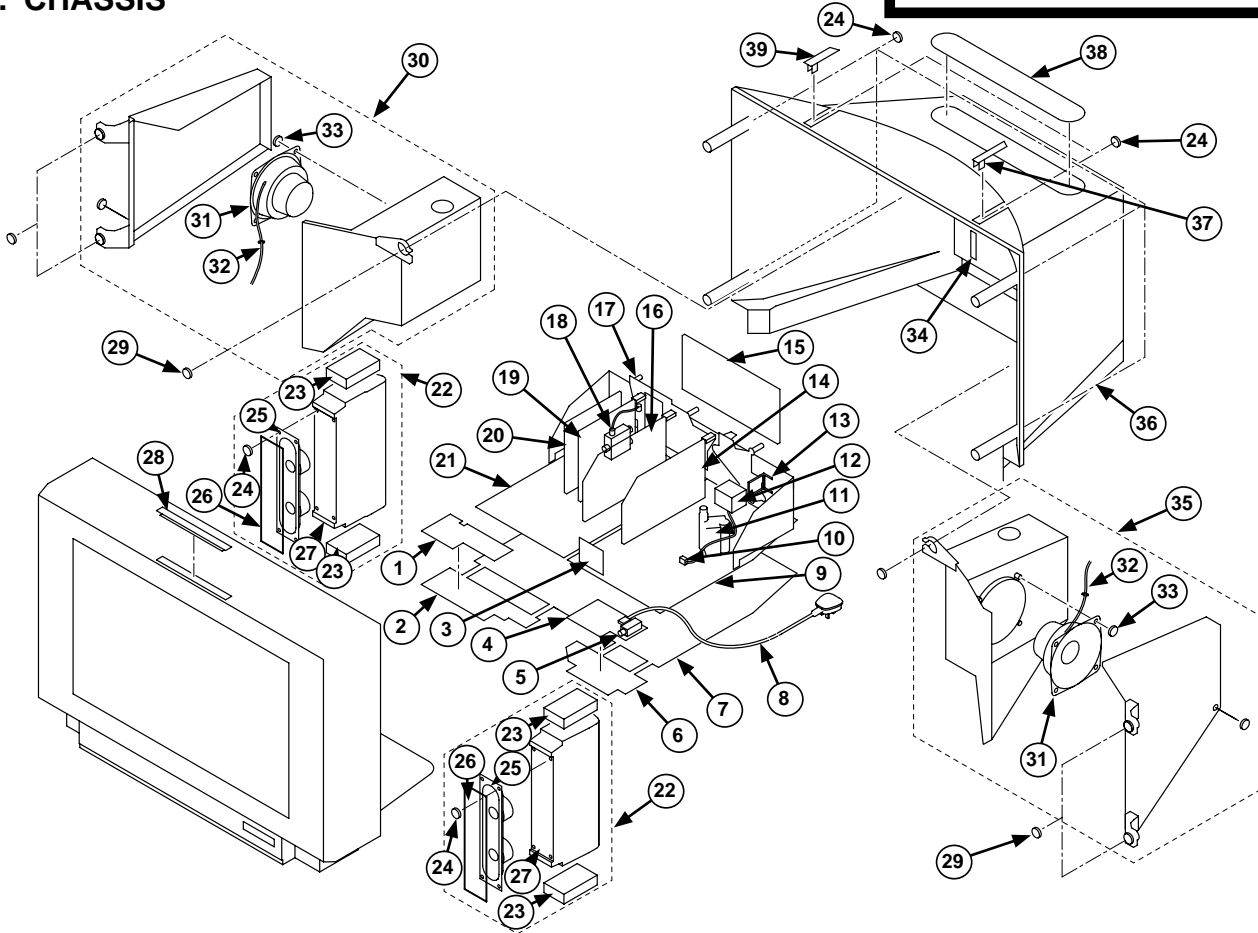

REF.NO.	PART.NO	DESCRIPTION	REMARK	REF.NO.	PART.NO	DESCRIPTION	REMARK
1	*A-1646-163-A	H BOARD, COMPLETE		20	*A-1632-905-A	A1 BOARD, COMPLETE	
2	*4-204-430-01	BRACKET, H (KV-28DS65)		21	*A-1632-770-A	A BOARD, COMPLETE	
	*4-204-430-11	BRACKET, H (KV-32DS65)		22	*A-1678-152-A	SIDE BOX ASSY 23-27	
3	*A-1640-314-A	D2 BOARD, COMPLETE		23	*4-202-988-01	CUSHION, BOX	
4	*A-1624-072-A	F1 BOARD, COMPLETE		24	4-039-358-01	SCREW (4X16), (+) BV TAPPING	
5	Δ *1-571-433-21	SWITCH, PUSH (AC POWER)		25	1-529-153-11	SPEAKER (4.8x20CM)	
6	*4-204-431-01	BRACKET, F (KV-28DS65)		26	*4-204-509-01	BOX, BAFFLE SPEAKER	
	*4-204-431-11	BRACKET, F (KV-32DS65)		27	*4-204-510-01	BOX, REAR SPEAKER	
7	*4-203-784-01	BRACKET, MAIN		28	1-771-778-11	ARRAY, SWITCH	
8	Δ 1-776-204-21	CORD, POWER (FILTER)		29	4-384-096-01	SCREW (4X16), TAPPING	
9	*A-1642-235-A	D BOARD, COMPLETE (KV-28DS65)		30	*A-1678-150-C	WOOFER (L) ASSY SP 31-33	
	*A-1642-238-A	D BOARD, COMPLETE (KV-32DS65)		31	1-529-144-11	SPEAKER (13CM)	
10	1-555-716-51	CABLE PIN		32	1-790-005-21	CABLE SPEAKER (WITH GROMMET)	
11	Δ 1-453-366-11	TRANSFORMER ASSY, FLYBACK (NX-4602//J1I4)		33	4-039-355-11	SCREW (4X12), (+) BV TAPPING	
12	1-419-893-11	COIL CHOKE, 26MMH		34	4-204-656-11	COVER, PCMCIA	
13	4-205-943-01	BRACKET PFC		35	*A-1678-151-C	WOOFER (R) ASSY SP 31-33	
14	*A-1642-236-A	D1 BOARD, COMPLETE (KV-28DS65)		36	4-204-459-21	COVER, REAR (KV-28DS65)	
	*A-1642-237-A	D1 BOARD, COMPLETE (KV-32DS65)			4-204-367-31	COVER, REAR (KV-32DS65)	
15	*A-1651-096-A	J BOARD, COMPLETE		37	4-204-427-11	COVER, SCREW (L) (KV-28DS65)	
16	*A-1620-110-A	B BOARD, COMPLETE			4-204-369-31	COVER, SCREW (L) (KV-32DS65)	
17	*4-204-432-01	BRACKET, J		38	4-204-458-11	COVER, PORT	
18	1-693-339-21	TUNER/VIF (UK)		39	4-204-428-11	COVER, SCREW (R) (KV-28DS65)	
19	*A-1654-030-A	N BOARD, COMPLETE			4-204-370-11	COVER, SCREW (R) (KV-32DS65)	

6-2. PICTURE TUBE

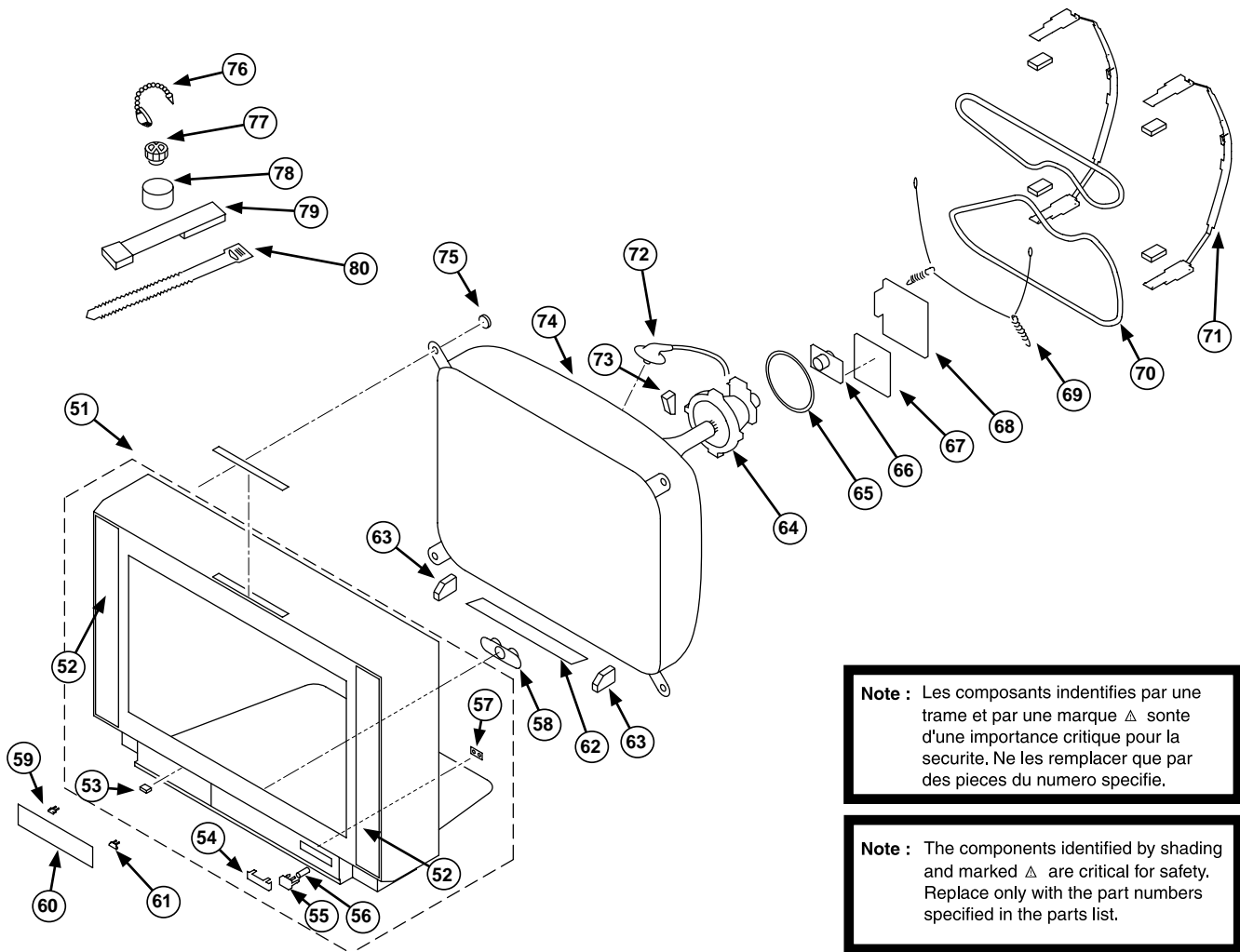

Note : Les composants indentifiés par une trame et par une marque Δ sont d'une importance critique pour la securite. Ne les remplacer que par des pieces du numero specifie.

Note : The components identified by shading and marked Δ are critical for safety. Replace only with the part numbers specified in the parts list.

REF.NO.	PART.NO	DESCRIPTION	REMARK	REF.NO.	PART.NO	DESCRIPTION	REMARK
51	X-4200-417-5	BEZNET ASSY (KV-28DS65)	52-57	66	Δ 8-453-015-11	NECK ASS, (NA2913-M)	
	X-4200-563-4	BEZNET ASSY (KV-32DS65)	52-57	67	*A-1644-092-A	VM BOARD, COMPLETE	
52	4-204-450-11	GRILLE, SPEAKER (KV-28DS65)		68	*A-1638-114-A	C BOARD, COMPLETE	
	4-204-368-11	GRILLE, SPEAKER (KV-32DS65)		69	4-200-433-01	SPRING, EXTENSION (KV-28DS65)	
53	4-042-192-01	CATCHER, PUSH			4-369-318-31	SPRING, TENSION (KV-32DS65)	
54	4-204-492-02	WINDOW, ORNAMENTAL		70	Δ 1-416-466-11	COIL, DEMAGNETIC (KV-28DS65)	
55	4-204-438-11	BUTTON, POWER			Δ 1-416-768-11	COIL, DEMAGNETIC (KV-32DS65)	
56	4-202-964-11	SPRING		71	*4-057-303-01	HOLDER, DGC (KV-28DS65)	
57	4-204-439-02	GUIDE, LIGHT			*4-059-569-01	HOLDER, DGC (KV-32DS65)	
58	1-529-143-11	SPEAKER (4.2X20CM)		72	Δ 1-251-317-63	CAP ASSY, HIGH-VOLTAGE	
59	4-222-555-01	SHAFT, DOOR (KV-28DS65)		73	4-203-658-01	SPACER, DY	
	3-703-035-11	SHAFT, LID (KV-32DS65)		74	Δ 8-737-786-05	PICTURE TUBE (W66LLX060X) (KV-28DS65)	
60	4-205-106-11	DOOR, CONTROL			Δ 8-735-079-01	PICTURE TUBE (W76LLZ060X) (KV-32DS65)	
61	4-045-250-01	DAMPER		75	4-036-188-01	SCREW SELF TAPPING (KV-28DS65)	
62	4-203-128-41	SHEET, BLOTTING (KV-28DS65)			4-204-225-01	PT-SCREW (KV-32DS65)	
	4-203-128-31	SHEET, BLOTTING (KV-32DS65)		76	4-308-870-00	CLIP, LEAD WIRE	
63	*4-203-098-01	SUPPORTER, CRT (KV-32DS65)		77	1-452-094-00	MAGNET, ROTATABLE DISK; 15MM	
64	Δ 1-451-463-21	DEFLECTION YOKE Y28RVC (KV-28DS65)		78	4-452-032-00	MAGNET, DISK; 10MM	
	Δ 1-451-462-21	DEFLECTION YOKE Y32RVC (KV-32DS65)		79	X-4387-214-1	PERMALLOY ASSY, CORRECTION	
65	1-452-896-11	COIL, NA ROTATION (RT200)		80	3-701-007-00	BAND, BINDING	

SECTION 7 ELECTRICAL PARTS LIST

PARTS LISTING TABLE OF CONTENTS

	Page
B BOARD COMPLETE Parts List :	119
F1 BOARD COMPLETE Parts List :	125
A BOARD COMPLETE Parts List :	125
A1 BOARD COMPLETE Parts List :	136
C BOARD COMPLETE Parts List :	137
D2 BOARD COMPLETE Parts List :	138
D1 BOARD COMMON Parts List : Parts common to all models listed in this manual	139
D1 BOARD VARIANT Parts List : Parts that belong only to the model specified	
Model	
<u>KV-28DS65U</u>	142
<u>KV-32DS65U</u>	142
D BOARD COMMON Parts List : Parts common to all models listed in this manual	143
D BOARD VARIANT Parts List : Parts that belong only to the model specified	
Model	
<u>KV-28DS65U</u>	146
<u>KV-32DS65U</u>	146
H BOARD COMPLETE Parts List :	147
J BOARD COMPLETE Parts List :	147
N BOARD COMPLETE Parts List :	150
VM BOARD COMPLETE Parts List :	154
MISCELLANEOUS :	156
ACCESSORIES AND PACKAGING MATERIALS :	156

Note : Refer to the designated variant parts list when seeking a part indicated by an asterisk (*)
Parts indicated (XX) on the Schematic Diagram are not used in this model and therefore do not appear in the Parts List.

REF.NO.	PART.NO	DESCRIPTION	REMARK	REF.NO.	PART.NO	DESCRIPTION	REMARK
*A-1620-110-A B Board, Complete							
< CAPACITOR >							
C307	1-163-125-00	CERAMIC CHIP 220PF	5.00% 50V	C390	1-164-004-11	CERAMIC CHIP 0.1UF	10.00% 25V
C308	1-163-259-91	CERAMIC CHIP 220PF	5.00% 50V	C391	1-164-004-11	CERAMIC CHIP 0.1UF	10.00% 25V
C311	1-126-964-11	ELECT 10UF	20.00% 50V	C392	1-164-004-11	CERAMIC CHIP 0.1UF	10.00% 25V
C313	1-164-004-11	CERAMIC CHIP 0.1UF	10.00% 25V	C393	1-164-004-11	CERAMIC CHIP 0.1UF	10.00% 25V
C314	1-163-125-00	CERAMIC CHIP 220PF	5.00% 50V	C394	1-164-004-11	CERAMIC CHIP 0.1UF	10.00% 25V
C315	1-164-004-11	CERAMIC CHIP 0.1UF	10.00% 25V	C395	1-164-004-11	CERAMIC CHIP 0.1UF	10.00% 25V
C316	1-163-125-00	CERAMIC CHIP 220PF	5.00% 50V	C396	1-164-004-11	CERAMIC CHIP 0.1UF	10.00% 25V
C317	1-164-004-11	CERAMIC CHIP 0.1UF	10.00% 25V	C398	1-163-235-11	CERAMIC CHIP 22PF	5.00% 50V
C319	1-126-963-11	ELECT 4.7UF	20.00% 50V	C399	1-164-004-11	CERAMIC CHIP 0.1UF	10.00% 25V
C320	1-164-004-11	CERAMIC CHIP 0.1UF	10.00% 25V	C400	1-163-241-11	CERAMIC CHIP 39PF	5.00% 50V
C322	1-126-963-11	ELECT 4.7UF	20.00% 50V	C401	1-164-004-11	CERAMIC CHIP 0.1UF	10.00% 25V
C325	1-164-489-11	CERAMIC CHIP 0.22UF	10.00% 16V	C402	1-164-004-11	CERAMIC CHIP 0.1UF	10.00% 25V
C326	1-110-501-11	CERAMIC CHIP 0.33UF	10.00% 16V	C403	1-126-964-11	ELECT 10UF	20.00% 50V
C329	1-163-141-00	CERAMIC CHIP 0.001UF	5.00% 50V	C404	1-126-964-11	ELECT 10UF	20.00% 50V
C330	1-126-963-11	ELECT 4.7UF	20.00% 50V	C405	1-163-235-11	CERAMIC CHIP 22PF	5.00% 50V
C336	1-162-638-11	CERAMIC CHIP 1UF	16V	C406	1-164-004-11	CERAMIC CHIP 0.1UF	10.00% 25V
C337	1-163-989-11	CERAMIC CHIP 0.033UF	10.00% 25V	C407	1-163-241-11	CERAMIC CHIP 39PF	5.00% 50V
C338	1-163-989-11	CERAMIC CHIP 0.033UF	10.00% 25V	C408	1-164-004-11	CERAMIC CHIP 0.1UF	10.00% 25V
C339	1-164-489-11	CERAMIC CHIP 0.22UF	10.00% 16V	C409	1-164-004-11	CERAMIC CHIP 0.1UF	10.00% 25V
C343	1-163-231-11	CERAMIC CHIP 15PF	5.00% 50V	C411	1-164-004-11	CERAMIC CHIP 0.1UF	10.00% 25V
C349	1-164-004-11	CERAMIC CHIP 0.1UF	10.00% 25V	C412	1-164-004-11	CERAMIC CHIP 0.1UF	10.00% 25V
C350	1-164-004-11	CERAMIC CHIP 0.1UF	10.00% 25V	C413	1-163-145-00	CERAMIC CHIP 0.0015UF	5.00% 50V
C352	1-164-004-11	CERAMIC CHIP 0.1UF	10.00% 25V	C415	1-164-004-11	CERAMIC CHIP 0.1UF	10.00% 25V
C355	1-164-004-11	CERAMIC CHIP 0.1UF	10.00% 25V	C416	1-164-004-11	CERAMIC CHIP 0.1UF	10.00% 25V
C356	1-126-960-11	ELECT 1UF	20.00% 50V	C417	1-126-933-11	ELECT 100UF	20.00% 16V
C358	1-163-237-11	CERAMIC CHIP 27PF	5.00% 50V	C418	1-126-933-11	ELECT 100UF	20.00% 16V
C360	1-163-105-00	CERAMIC CHIP 33PF	5.00% 50V	C419	1-126-933-11	ELECT 100UF	20.00% 16V
C364	1-164-004-11	CERAMIC CHIP 0.1UF	10.00% 25V	C420	1-126-933-11	ELECT 100UF	20.00% 16V
C365	1-164-004-11	CERAMIC CHIP 0.1UF	10.00% 25V	C421	1-126-933-11	ELECT 100UF	20.00% 16V
C368	1-126-964-11	ELECT 10UF	20.00% 50V	C422	1-126-933-11	ELECT 100UF	20.00% 16V
C370	1-164-004-11	CERAMIC CHIP 0.1UF	10.00% 25V	C423	1-164-004-11	CERAMIC CHIP 0.1UF	10.00% 25V
C371	1-164-004-11	CERAMIC CHIP 0.1UF	10.00% 25V	C424	1-164-004-11	CERAMIC CHIP 0.1UF	10.00% 25V
C372	1-107-823-11	CERAMIC CHIP 0.47UF	10.00% 16V	C425	1-164-004-11	CERAMIC CHIP 0.1UF	10.00% 25V
C373	1-126-964-11	ELECT 10UF	20.00% 50V	C426	1-164-004-11	CERAMIC CHIP 0.1UF	10.00% 25V
C374	1-164-004-11	CERAMIC CHIP 0.1UF	10.00% 25V	C427	1-164-004-11	CERAMIC CHIP 0.1UF	10.00% 25V
C375	1-126-961-11	ELECT 2.2UF	20.00% 50V	C428	1-164-004-11	CERAMIC CHIP 0.1UF	10.00% 25V
C376	1-164-004-11	CERAMIC CHIP 0.1UF	10.00% 25V	C429	1-164-004-11	CERAMIC CHIP 0.1UF	10.00% 25V
C377	1-164-004-11	CERAMIC CHIP 0.1UF	10.00% 25V	C430	1-164-004-11	CERAMIC CHIP 0.1UF	10.00% 25V
C378	1-164-004-11	CERAMIC CHIP 0.1UF	10.00% 25V	C431	1-163-037-11	CERAMIC CHIP 0.022UF	10.00% 50V
C379	1-164-004-11	CERAMIC CHIP 0.1UF	10.00% 25V	C432	1-163-222-11	CERAMIC CHIP 5PF	0.25PF 50V
C380	1-163-097-00	CERAMIC CHIP 15PF	5.00% 50V	C435	1-163-001-11	CERAMIC CHIP 220PF	10.00% 50V
C381	1-163-097-00	CERAMIC CHIP 15PF	5.00% 50V	C437	1-163-021-91	CERAMIC CHIP 0.01UF	10.00% 50V
C382	1-164-004-11	CERAMIC CHIP 0.1UF	10.00% 25V	C441	1-126-964-11	ELECT 10UF	20.00% 50V
C386	1-164-004-11	CERAMIC CHIP 0.1UF	10.00% 25V	C442	1-164-004-11	CERAMIC CHIP 0.1UF	10.00% 25V
C388	1-164-004-11	CERAMIC CHIP 0.1UF	10.00% 25V	C443	1-126-964-11	ELECT 10UF	20.00% 50V
C389	1-164-004-11	CERAMIC CHIP 0.1UF	10.00% 25V	C444	1-126-964-11	ELECT 10UF	20.00% 50V
				C445	1-126-964-11	ELECT 10UF	20.00% 50V
				C3401	1-164-004-11	CERAMIC CHIP 0.1UF	10.00% 25V
				C3402	1-164-004-11	CERAMIC CHIP 0.1UF	10.00% 25V
				C3404	1-164-004-11	CERAMIC CHIP 0.1UF	10.00% 25V

REF.NO.	PART.NO	DESCRIPTION	REMARK	REF.NO.	PART.NO	DESCRIPTION	REMARK
FB307	1-414-234-22	FERRITE	Ouh	FB3665	1-216-295-11	SHORT	0
FB308	1-414-234-22	FERRITE	Ouh	FB3666	1-500-245-11	FERRITE	Ouh
FB309	1-414-234-22	FERRITE	Ouh	FB3671	1-500-245-11	FERRITE	Ouh
FB312	1-414-553-11	FERRITE	Ouh	FB3672	1-500-245-11	FERRITE	Ouh
FB313	1-414-553-11	FERRITE	Ouh	< FILTER >			
FB314	1-414-553-11	FERRITE	Ouh	FL301	1-233-893-21	FILTER, CHIP EMI	
FB315	1-414-950-21	FERRITE	Ouh	FL302	1-233-893-21	FILTER, CHIP EMI	
FB317	1-414-234-22	FERRITE	Ouh	FL303	1-233-767-21	FILTER	
FB318	1-414-234-22	FERRITE	Ouh	FL305	1-415-940-21	DELAY LINE	
FB323	1-216-295-11	SHORT	0	FL306	1-233-893-21	FILTER, CHIP EMI	
FB324	1-216-295-11	SHORT	0	FL308	1-233-893-21	FILTER, CHIP EMI	
FB325	1-216-295-11	SHORT	0	FL3401	1-233-893-21	FILTER, CHIP EMI	
FB326	1-414-234-22	FERRITE	Ouh	FL3402	1-233-893-21	FILTER, CHIP EMI	
FB327	1-414-234-22	FERRITE	Ouh	FL3403	1-233-893-21	FILTER, CHIP EMI	
FB328	1-414-234-22	FERRITE	Ouh	FL3404	1-233-766-21	FILTER	
FB329	1-414-234-22	FERRITE	Ouh	FL3405	1-233-768-21	FILTER	
FB330	1-414-234-22	FERRITE	Ouh	FL3406	1-233-893-21	FILTER, CHIP EMI	
FB331	1-414-234-22	FERRITE	Ouh	FL3410	1-233-765-21	FILTER	
FB333	1-414-234-22	FERRITE	Ouh	FL3502	1-233-893-21	FILTER, CHIP EMI	
FB334	1-414-234-22	FERRITE	Ouh	< IC >			
FB335	1-414-234-22	FERRITE	Ouh	IC302	8-759-991-41	IC LM78L05ACZ	
FB336	1-414-234-22	FERRITE	Ouh	IC304	8-759-257-59	IC TDA8755T-T	
FB352	1-414-553-11	FERRITE	Ouh	IC307	8-759-669-75	IC TLC2932IPWR	
FB353	1-414-553-11	FERRITE	Ouh	IC309	8-759-438-64	IC SAA4952WP/V1	
FB354	1-414-553-11	FERRITE	Ouh	IC310	8-759-669-75	IC TLC2932IPWR	
FB356	1-216-295-11	SHORT	0	IC311	8-759-439-25	IC TMS4C2972-26DTR	
FB357	1-414-234-22	FERRITE	Ouh	IC312	8-759-991-41	IC LM78L05ACZ	
FB358	1-414-553-11	FERRITE	Ouh	IC313	8-759-432-96	IC MC74F157ADR2	
FB359	1-414-553-11	FERRITE	Ouh	IC314	8-759-432-96	IC MC74F157ADR2	
FB360	1-500-245-11	FERRITE	Ouh	IC315	8-759-432-96	IC MC74F157ADR2	
FB361	1-500-245-11	FERRITE	Ouh	IC316	8-759-432-96	IC MC74F157ADR2	
FB362	1-500-245-11	FERRITE	Ouh	IC317	8-759-561-81	IC P83C654EBA/582	
FB363	1-216-295-11	SHORT	0	IC318	8-759-234-77	IC TC4S66F	
FB364	1-500-245-11	FERRITE	Ouh	IC319	8-759-439-62	IC SAA4990H/V2	
FB365	1-216-295-11	SHORT	0	IC320	8-759-058-62	IC TC7S08FU (TE85R)	
FB366	1-500-245-11	FERRITE	Ouh	IC321	8-759-180-84	IC TC7W74F	
FB367	1-500-245-11	FERRITE	Ouh	IC322	8-759-991-41	IC LM78L05ACZ	
FB368	1-216-295-11	SHORT	0	IC323	8-759-439-25	IC TMS4C2972-26DTR	
FB3601	1-414-234-22	FERRITE	Ouh	IC324	8-759-467-19	IC SDA9280B22	
FB3602	1-414-234-22	FERRITE	Ouh	IC326	8-759-948-58	IC 74F244SJ	
FB3603	1-500-245-11	FERRITE	Ouh	IC327	8-759-948-58	IC 74F244SJ	
FB3626	1-414-950-21	FERRITE	Ouh	IC328	8-759-032-14	IC MC74HC08AF	
FB3652	1-414-553-11	FERRITE	Ouh	IC3401	8-752-379-35	IC CXD2044Q-TL	
FB3653	1-414-553-11	FERRITE	Ouh	IC3402	8-759-711-62	IC NJM2240M	
FB3654	1-414-553-11	FERRITE	Ouh	IC3403	8-759-385-76	IC MC14052BDR2	
FB3660	1-500-245-11	FERRITE	Ouh	IC3502	8-759-447-67	IC TDA9144/N1	
FB3661	1-500-245-11	FERRITE	Ouh	IC3503	8-759-565-20	IC TDA4665T/V5-118	
FB3662	1-500-245-11	FERRITE	Ouh	IC3601	8-759-058-62	IC TC7S08FU (TE85R)	
FB3663	1-216-295-11	SHORT	0				
FB3664	1-500-245-11	FERRITE	Ouh				

B

REF.NO.	PART.NO	DESCRIPTION	REMARK	REF.NO.	PART.NO	DESCRIPTION	REMARK
IC3607	8-759-669-75	IC TLC2932IPWR		Q3401	8-729-026-49	TRANSISTOR 2SA1037AK	
IC3609	8-759-438-64	IC SAA4952WP/V1		Q3402	8-729-026-49	TRANSISTOR 2SA1037AK	
IC3611	8-759-439-25	IC TMS4C2972-26DTR		Q3403	8-729-026-49	TRANSISTOR 2SA1037AK	
IC3615	8-759-432-96	IC MC74F157ADR2		Q3404	1-801-806-11	TRANSISTOR DTC144EKA	
IC3617	8-759-561-81	IC P83C654EBA/582		Q3405	8-729-026-49	TRANSISTOR 2SA1037AK	
IC3619	8-759-439-62	IC SAA4990H/V2		Q3406	8-729-026-49	TRANSISTOR 2SA1037AK	
IC3620	8-759-058-62	IC TC7S08FU (TE85R)		Q3407	8-729-120-28	TRANSISTOR 2SC1623-L5L6	
IC3621	8-759-058-54	IC TC7S00FU (TE85R)		Q3408	8-729-120-28	TRANSISTOR 2SC1623-L5L6	
IC3623	8-759-439-25	IC TMS4C2972-26DTR		Q3409	8-729-026-49	TRANSISTOR 2SA1037AK	
		< COIL >		Q3410	8-729-026-49	TRANSISTOR 2SA1037AK	
L301	1-408-597-31	INDUCTOR	3.30UH	Q3411	8-729-120-28	TRANSISTOR 2SC1623-L5L6	
L303	1-410-435-21	INDUCTOR	220UH	Q3412	8-729-120-28	TRANSISTOR 2SC1623-L5L6	
L304	1-410-435-21	INDUCTOR	220UH	Q3413	8-729-026-49	TRANSISTOR 2SA1037AK	
L308	1-408-789-21	INDUCTOR	100UH	Q3414	8-729-120-28	TRANSISTOR 2SC1623-L5L6	
L309	1-408-603-31	INDUCTOR	10UH	Q3501	8-729-120-28	TRANSISTOR 2SC1623-L5L6	
L310	1-412-029-11	INDUCTOR	10UH	Q3502	8-729-120-28	TRANSISTOR 2SC1623-L5L6	
L311	1-412-029-11	INDUCTOR	10UH	Q3515	8-729-038-96	TRANSISTOR IMZ1A-T109	
L312	1-412-029-11	INDUCTOR	10UH	Q3516	8-729-038-96	TRANSISTOR IMZ1A-T109	
L313	1-412-029-11	INDUCTOR	10UH	Q3517	8-729-038-96	TRANSISTOR IMZ1A-T109	
L314	1-412-029-11	INDUCTOR	10UH	Q3608	8-729-026-49	TRANSISTOR 2SA1037AK	
L315	1-412-029-11	INDUCTOR	10UH	Q3609	8-729-026-49	TRANSISTOR 2SA1037AK	
L316	1-412-029-11	INDUCTOR	10UH			< RESISTOR >	
L317	1-412-029-11	INDUCTOR	10UH	JR3101	1-216-295-11	SHORT	0
L318	1-408-610-31	INDUCTOR	39UH	JR3103	1-216-295-11	SHORT	0
L319	1-408-610-31	INDUCTOR	39UH	JR3105	1-216-295-11	SHORT	0
L320	1-412-029-11	INDUCTOR	10UH	JR3439	1-216-295-11	SHORT	0
L321	1-412-029-11	INDUCTOR	10UH	JR3440	1-216-295-11	SHORT	0
L322	1-412-029-11	INDUCTOR	10UH	R309	1-216-055-00	RES-CHIP	1.8K 5% 1/10W
L323	1-412-029-11	INDUCTOR	10UH	R310	1-216-053-00	RES-CHIP	1.5K 5% 1/10W
L3614	1-412-029-11	INDUCTOR	10UH	R311	1-216-065-91	RES-CHIP	4.7K 5% 1/10W
L3615	1-412-029-11	INDUCTOR	10UH	R313	1-216-051-00	RES-CHIP	1.2K 5% 1/10W
L3621	1-412-029-11	INDUCTOR	10UH	R314	1-216-059-00	RES-CHIP	2.7K 5% 1/10W
L3623	1-412-029-11	INDUCTOR	10UH	R315	1-216-067-00	RES-CHIP	5.6K 5% 1/10W
		< TRANSISTOR >		R319	1-216-089-11	RES-CHIP	47K 5% 1/10W
Q301	1-801-806-11	TRANSISTOR DTC144EKA		R320	1-216-049-11	RES-CHIP	1K 5% 1/10W
Q302	8-729-026-49	TRANSISTOR 2SA1037AK		R321	1-216-049-11	RES-CHIP	1K 5% 1/10W
Q303	1-801-806-11	TRANSISTOR DTC144EKA		R323	1-216-089-11	RES-CHIP	47K 5% 1/10W
Q304	1-801-806-11	TRANSISTOR DTC144EKA		R324	1-216-049-11	RES-CHIP	1K 5% 1/10W
Q305	1-801-806-11	TRANSISTOR DTC144EKA		R326	1-216-075-00	RES-CHIP	12K 5% 1/10W
Q306	1-801-806-11	TRANSISTOR DTC144EKA		R345	1-216-029-00	RES-CHIP	150 5% 1/10W
Q307	1-801-806-11	TRANSISTOR DTC144EKA		R348	1-216-295-11	SHORT	0
Q308	8-729-026-49	TRANSISTOR 2SA1037AK		R350	1-216-063-91	RES-CHIP	3.9K 5% 1/10W
Q309	8-729-026-49	TRANSISTOR 2SA1037AK		R352	1-216-061-00	RES-CHIP	3.3K 5% 1/10W
Q310	8-729-026-49	TRANSISTOR 2SA1037AK		R353	1-216-047-91	RES-CHIP	820 5% 1/10W
Q311	1-801-806-11	TRANSISTOR DTC144EKA		R354	1-216-009-91	RES-CHIP	22 5% 1/10W
Q312	1-801-806-11	TRANSISTOR DTC144EKA		R359	1-216-063-91	RES-CHIP	3.9K 5% 1/10W
Q313	1-801-806-11	TRANSISTOR DTC144EKA		R362	1-216-089-11	RES-CHIP	47K 5% 1/10W
Q315	8-729-120-28	TRANSISTOR 2SC1623-L5L6		R363	1-216-025-11	RES-CHIP	100 5% 1/10W

REF.NO.	PART.NO	DESCRIPTION	REMARK	REF.NO.	PART.NO	DESCRIPTION	REMARK
R365	1-216-001-00	RES-CHIP	10 5% 1/10W	R426	1-216-295-11	SHORT	0
R366	1-216-049-11	RES-CHIP	1K 5% 1/10W	R427	1-216-017-91	RES-CHIP	47 5% 1/10W
R367	1-216-295-11	SHORT	0	R428	1-216-029-00	RES-CHIP	150 5% 1/10W
R368	1-216-085-00	RES-CHIP	33K 5% 1/10W	R429	1-216-295-11	SHORT	0
R370	1-216-085-00	RES-CHIP	33K 5% 1/10W	R430	1-216-037-00	RES-CHIP	330 5% 1/10W
R371	1-216-295-11	SHORT	0	R431	1-216-037-00	RES-CHIP	330 5% 1/10W
R373	1-216-057-00	RES-CHIP	2.2K 5% 1/10W	R433	1-216-033-00	RES-CHIP	220 5% 1/10W
R374	1-216-057-00	RES-CHIP	2.2K 5% 1/10W	R434	1-216-033-00	RES-CHIP	220 5% 1/10W
R375	1-216-057-00	RES-CHIP	2.2K 5% 1/10W	R435	1-216-033-00	RES-CHIP	220 5% 1/10W
R376	1-216-057-00	RES-CHIP	2.2K 5% 1/10W	R436	1-216-033-00	RES-CHIP	220 5% 1/10W
R377	1-216-057-00	RES-CHIP	2.2K 5% 1/10W	R437	1-216-033-00	RES-CHIP	220 5% 1/10W
R378	1-216-057-00	RES-CHIP	2.2K 5% 1/10W	R438	1-216-033-00	RES-CHIP	220 5% 1/10W
R379	1-216-057-00	RES-CHIP	2.2K 5% 1/10W	R439	1-216-033-00	RES-CHIP	220 5% 1/10W
R380	1-216-057-00	RES-CHIP	2.2K 5% 1/10W	R440	1-216-033-00	RES-CHIP	220 5% 1/10W
R381	1-216-057-00	RES-CHIP	2.2K 5% 1/10W	R441	1-216-033-00	RES-CHIP	220 5% 1/10W
R382	1-216-065-91	RES-CHIP	4.7K 5% 1/10W	R442	1-216-033-00	RES-CHIP	220 5% 1/10W
R383	1-216-076-00	RES-CHIP	13K 5% 1/10W	R443	1-216-033-00	RES-CHIP	220 5% 1/10W
R384	1-216-055-00	RES-CHIP	1.8K 5% 1/10W	R444	1-216-033-00	RES-CHIP	220 5% 1/10W
R385	1-216-017-91	RES-CHIP	47 5% 1/10W	R445	1-216-009-91	RES-CHIP	22 5% 1/10W
R386	1-216-073-00	RES-CHIP	10K 5% 1/10W	R446	1-216-009-91	RES-CHIP	22 5% 1/10W
R388	1-216-029-00	RES-CHIP	150 5% 1/10W	R448	1-216-041-00	RES-CHIP	470 5% 1/10W
R389	1-216-049-11	RES-CHIP	1K 5% 1/10W	R449	1-216-025-11	RES-CHIP	100 5% 1/10W
R390	1-216-017-91	RES-CHIP	47 5% 1/10W	R450	1-216-039-00	RES-CHIP	390 5% 1/10W
R391	1-216-055-00	RES-CHIP	1.8K 5% 1/10W	R451	1-216-009-91	RES-CHIP	22 5% 1/10W
R393	1-216-037-00	RES-CHIP	330 5% 1/10W	R452	1-247-831-91	RES-CHIP	1K 5% 1/4W
R394	1-216-049-11	RES-CHIP	1K 5% 1/10W	R455	1-216-025-11	RES-CHIP	100 5% 1/10W
R395	1-216-027-00	RES-CHIP	120 5% 1/10W	R456	1-216-025-11	RES-CHIP	100 5% 1/10W
R396	1-216-069-00	RES-CHIP	6.8K 5% 1/10W	R461	1-216-049-11	RES-CHIP	1K 5% 1/10W
R397	1-216-295-11	SHORT	0	R462	1-216-049-11	RES-CHIP	1K 5% 1/10W
R398	1-216-065-91	RES-CHIP	4.7K 5% 1/10W	R465	1-216-049-11	RES-CHIP	1K 5% 1/10W
R399	1-216-039-00	RES-CHIP	390 5% 1/10W	R466	1-216-049-11	RES-CHIP	1K 5% 1/10W
R400	1-216-065-91	RES-CHIP	4.7K 5% 1/10W	R467	1-216-049-11	RES-CHIP	1K 5% 1/10W
R401	1-216-077-91	RES-CHIP	15K 5% 1/10W	R469	1-216-073-00	RES-CHIP	10K 5% 1/10W
R402	1-216-077-91	RES-CHIP	15K 5% 1/10W	R470	1-216-073-00	RES-CHIP	10K 5% 1/10W
R403	1-216-049-11	RES-CHIP	1K 5% 1/10W	R471	1-216-073-00	RES-CHIP	10K 5% 1/10W
R406	1-216-295-11	SHORT	0	R472	1-216-029-00	RES-CHIP	150 5% 1/10W
R408	1-216-025-11	RES-CHIP	100 5% 1/10W	R473	1-216-295-11	SHORT	0
R409	1-216-025-11	RES-CHIP	100 5% 1/10W	R474	1-216-295-11	SHORT	0
R410	1-216-295-11	SHORT	0	R475	1-216-295-11	SHORT	0
R411	1-216-025-11	RES-CHIP	100 5% 1/10W	R476	1-216-295-11	SHORT	0
R413	1-216-001-00	RES-CHIP	10 5% 1/10W	R480	1-216-295-11	SHORT	0
R414	1-216-001-00	RES-CHIP	10 5% 1/10W	R481	1-216-295-11	SHORT	0
R415	1-216-001-00	RES-CHIP	10 5% 1/10W	R482	1-216-295-11	SHORT	0
R416	1-216-001-00	RES-CHIP	10 5% 1/10W	R483	1-216-295-11	SHORT	0
R417	1-216-001-00	RES-CHIP	10 5% 1/10W	R484	1-216-295-11	SHORT	0
R418	1-216-001-00	RES-CHIP	10 5% 1/10W	R485	1-216-295-11	SHORT	0
R419	1-216-001-00	RES-CHIP	10 5% 1/10W	R486	1-216-295-11	SHORT	0
R420	1-216-001-00	RES-CHIP	10 5% 1/10W	R487	1-216-295-11	SHORT	0
R423	1-216-001-00	RES-CHIP	10 5% 1/10W	R488	1-216-295-11	SHORT	0
R425	1-216-025-11	RES-CHIP	100 5% 1/10W	R489	1-216-295-11	SHORT	0

B

REF.NO.	PART.NO	DESCRIPTION	REMARK	REF.NO.	PART.NO	DESCRIPTION	REMARK
R3401	1-216-057-00	RES-CHIP	2.2K 5% 1/10W	R3536	1-216-041-00	RES-CHIP	470 5% 1/10W
R3402	1-216-057-00	RES-CHIP	2.2K 5% 1/10W	R3537	1-216-041-00	RES-CHIP	470 5% 1/10W
R3403	1-216-037-00	RES-CHIP	330 5% 1/10W	R3538	1-216-041-00	RES-CHIP	470 5% 1/10W
R3404	1-216-037-00	RES-CHIP	330 5% 1/10W	R3540	1-216-017-91	RES-CHIP	47 5% 1/10W
R3405	1-216-065-91	RES-CHIP	4.7K 5% 1/10W	R3541	1-216-025-11	RES-CHIP	100 5% 1/10W
R3406	1-216-065-91	RES-CHIP	4.7K 5% 1/10W	R3542	1-216-025-11	RES-CHIP	100 5% 1/10W
R3407	1-216-065-91	RES-CHIP	4.7K 5% 1/10W	R3545	1-216-025-11	RES-CHIP	100 5% 1/10W
R3408	1-216-017-91	RES-CHIP	47 5% 1/10W	R3551	1-216-037-00	RES-CHIP	330 5% 1/10W
R3409	1-216-017-91	RES-CHIP	47 5% 1/10W	R3552	1-216-049-11	RES-CHIP	1K 5% 1/10W
R3410	1-216-039-00	RES-CHIP	390 5% 1/10W	R3571	1-218-179-11	RES-CHIP	10M 5% 1/10W
R3411	1-216-069-00	RES-CHIP	6.8K 5% 1/10W	R3572	1-218-179-11	RES-CHIP	10M 5% 1/10W
R3419	1-216-043-91	RES-CHIP	560 5% 1/10W	R3573	1-218-179-11	RES-CHIP	10M 5% 1/10W
R3420	1-216-067-00	RES-CHIP	5.6K 5% 1/10W	R3650	1-216-063-91	RES-CHIP	3.9K 5% 1/10W
R3421	1-216-049-11	RES-CHIP	1K 5% 1/10W	R3662	1-216-089-11	RES-CHIP	47K 5% 1/10W
R3425	1-216-009-91	RES-CHIP	22 5% 1/10W	R3663	1-216-025-11	RES-CHIP	100 5% 1/10W
R3430	1-216-061-00	RES-CHIP	3.3K 5% 1/10W	R3667	1-216-295-11	SHORT	0
R3431	1-216-055-00	RES-CHIP	1.8K 5% 1/10W	R3671	1-216-295-11	SHORT	0
R3432	1-216-061-00	RES-CHIP	3.3K 5% 1/10W	R3673	1-216-057-00	RES-CHIP	2.2K 5% 1/10W
R3433	1-216-061-00	RES-CHIP	3.3K 5% 1/10W	R3674	1-216-057-00	RES-CHIP	2.2K 5% 1/10W
R3434	1-216-033-00	RES-CHIP	220 5% 1/10W	R3675	1-216-057-00	RES-CHIP	2.2K 5% 1/10W
R3435	1-216-033-00	RES-CHIP	220 5% 1/10W	R3676	1-216-057-00	RES-CHIP	2.2K 5% 1/10W
R3436	1-216-653-11	METAL CHIP	1.2K 0.5% 1/10W	R3677	1-216-057-00	RES-CHIP	2.2K 5% 1/10W
R3437	1-216-666-11	METAL CHIP	4.3K 0.5% 1/10W	R3678	1-216-057-00	RES-CHIP	2.2K 5% 1/10W
R3438	1-216-041-00	RES-CHIP	470 5% 1/10W	R3679	1-216-057-00	RES-CHIP	2.2K 5% 1/10W
R3439	1-216-041-00	RES-CHIP	470 5% 1/10W	R3680	1-216-057-00	RES-CHIP	2.2K 5% 1/10W
R3440	1-216-037-00	RES-CHIP	330 5% 1/10W	R3681	1-216-057-00	RES-CHIP	2.2K 5% 1/10W
R3441	1-216-017-91	RES-CHIP	47 5% 1/10W	R3682	1-216-033-00	RES-CHIP	220 5% 1/10W
R3444	1-216-039-00	RES-CHIP	390 5% 1/10W	R3683	1-216-033-00	RES-CHIP	220 5% 1/10W
R3446	1-216-065-91	RES-CHIP	4.7K 5% 1/10W	R3684	1-216-033-00	RES-CHIP	220 5% 1/10W
R3447	1-216-089-11	RES-CHIP	47K 5% 1/10W	R3685	1-216-033-00	RES-CHIP	220 5% 1/10W
R3448	1-216-073-00	RES-CHIP	10K 5% 1/10W	R3689	1-216-041-00	RES-CHIP	470 5% 1/10W
R3449	1-216-125-00	RES-CHIP	1.5M 5% 1/10W	R3690	1-216-033-00	RES-CHIP	220 5% 1/10W
R3450	1-216-017-91	RES-CHIP	47 5% 1/10W	R3691	1-216-033-00	RES-CHIP	220 5% 1/10W
R3451	1-216-047-91	RES-CHIP	820 5% 1/10W	R3692	1-216-033-00	RES-CHIP	220 5% 1/10W
R3452	1-216-051-00	RES-CHIP	1.2K 5% 1/10W	R3693	1-216-033-00	RES-CHIP	220 5% 1/10W
R3453	1-216-047-91	RES-CHIP	820 5% 1/10W	R3694	1-216-041-00	RES-CHIP	470 5% 1/10W
R3454	1-216-051-00	RES-CHIP	1.2K 5% 1/10W	R3698	1-216-295-11	SHORT	0
R3462	1-216-057-00	RES-CHIP	2.2K 5% 1/10W	R3699	1-216-295-11	SHORT	0
R3508	1-216-049-11	RES-CHIP	1K 5% 1/10W	R3725	1-216-025-11	RES-CHIP	100 5% 1/10W
R3511	1-216-095-00	RES-CHIP	82K 5% 1/10W	R3726	1-216-295-11	SHORT	0
R3512	1-216-077-91	RES-CHIP	15K 5% 1/10W	R3729	1-216-295-11	SHORT	0
R3513	1-216-025-11	RES-CHIP	100 5% 1/10W	R3748	1-216-041-00	RES-CHIP	470 5% 1/10W
R3514	1-216-033-00	RES-CHIP	220 5% 1/10W	R3749	1-216-025-11	RES-CHIP	100 5% 1/10W
R3517	1-216-065-91	RES-CHIP	4.7K 5% 1/10W	R3750	1-216-039-00	RES-CHIP	390 5% 1/10W
R3530	1-216-041-00	RES-CHIP	470 5% 1/10W	R3755	1-216-295-11	SHORT	0
R3531	1-216-041-00	RES-CHIP	470 5% 1/10W	R3776	1-216-295-11	SHORT	0
R3532	1-216-041-00	RES-CHIP	470 5% 1/10W	R3789	1-216-295-11	SHORT	0
R3533	1-216-041-00	RES-CHIP	470 5% 1/10W				
R3534	1-216-041-00	RES-CHIP	470 5% 1/10W				
R3535	1-216-041-00	RES-CHIP	470 5% 1/10W				

Note : The components identified by shading and marked Δ are critical for safety. Replace only with the part numbers specified in the parts list.

B **F1** **A**

REF.NO.	PART.NO	DESCRIPTION	REMARK	REF.NO.	PART.NO	DESCRIPTION	REMARK
< RESISTOR CHIP NETWORK >				< SWITCH >			
RB313	1-239-711-91	NETWORK RESISTOR (CHIP) 0		5951	Δ 1-571-433-21	SWITCH, PUSH (AC POWER)	
RB314	1-239-711-91	NETWORK RESISTOR (CHIP) 0		*A-1632-770-A A Board, Complete			
RB315	1-239-711-91	NETWORK RESISTOR (CHIP) 0		1-750-797-12		SOCKET, PLCC	
RB3603	1-233-576-11	RES, CHIP NETWORK 100		4-202-373-01		SPRING, IC	
< CRYSTAL >				4-382-854-11		SCREW (M3X10), P, SW (+)	
X301	1-579-175-11	VIBRATOR, CERAMIC		< CAPACITOR >			
X3501	1-567-505-11	OSCILLATOR, CRYSTAL		C103	1-126-933-11	ELECT 100UF	20.00% 16V
X3502	1-567-504-11	OSCILLATOR, CRYSTAL		C104	1-163-021-91	CERAMIC CHIP 0.01UF	10.00% 50V
X3601	1-579-175-11	VIBRATOR, CERAMIC		C105	1-126-967-11	ELECT 47UF	20.00% 50V
*A-1624-072-A F1 Board, Complete				C106	1-126-933-11	ELECT 100UF	20.00% 16V
< CAPACITOR >				C107	1-163-021-91	CERAMIC CHIP 0.01UF	10.00% 50V
C952	1-126-964-11	ELECT 10UF	20.00% 50V	C123	1-163-021-91	CERAMIC CHIP 0.01UF	10.00% 50V
C953	Δ 1-136-527-12	FILM 0.47UF	20.00% 300V	C127	1-126-934-11	ELECT 220UF	20.00% 10V
< CONNECTOR >				C129	1-164-004-11	CERAMIC CHIP 0.1UF	10.00% 25V
CN951	*1-568-880-51	PIN, CONNECTOR 5P		C138	1-163-021-91	CERAMIC CHIP 0.01UF	10.00% 50V
CN952	Δ 1-580-843-11	PIN, CONNECTOR (POWER)		C140	1-163-009-11	CERAMIC CHIP 0.001UF	10.00% 50V
CN953	Δ *1-691-291-11	PIN, CONNECTOR (PC BOARD) 5P		C143	1-164-346-11	CERAMIC CHIP 1UF	16V
< DIODE >				C152	1-164-346-11	CERAMIC CHIP 1UF	16V
D951	8-719-080-92	DIODE SLA-570LT3F		C153	1-163-251-11	CERAMIC CHIP 100PF	5.00% 50V
	*4-203-258-11	HOLDER, LED (D951)		C154	1-115-340-11	CERAMIC CHIP 0.22UF	10.00% 25V
< FUSE >				C155	1-163-021-91	CERAMIC CHIP 0.01UF	10.00% 50V
F951	Δ 1-532-299-00	FUSE 5A 250V		C156	1-104-664-11	ELECT 47UF	20.00% 25V
	Δ *1-533-725-11	HOLDER, FUSE (F951)		C201	1-163-021-91	CERAMIC CHIP 0.01UF	10.00% 50V
< IC >				C203	1-163-251-11	CERAMIC CHIP 100PF	5.00% 50V
IC951	8-749-014-59	IC TSOP1740KS1		C204	1-163-021-91	CERAMIC CHIP 0.01UF	10.00% 50V
< FILTER >				C205	1-104-664-11	ELECT 47UF	20.00% 25V
LF951	Δ 1-431-402-11	TRANSFORMER, LINE FILTER		C209	1-107-823-11	CERAMIC CHIP 0.47UF	10.00% 16V
LF952	Δ 1-431-402-11	TRANSFORMER, LINE FILTER		C210	1-107-823-11	CERAMIC CHIP 0.47UF	10.00% 16V
< RESISTOR >				C212	1-164-004-11	CERAMIC CHIP 0.1UF	10.00% 25V
R951	1-249-409-11	CARBON 220 5% 1/4W		C213	1-126-963-11	ELECT 4.7UF	20.00% 50V
R952	1-249-401-11	CARBON 47 5% 1/4W		C214	1-126-963-11	ELECT 4.7UF	20.00% 50V
R953	Δ 1-214-937-00	CARBON 1M 5% 1/2W		C215	1-164-004-11	CERAMIC CHIP 0.1UF	10.00% 25V
R954	Δ 1-205-998-11	CEMENTED 1 5% 10W		C216	1-126-933-11	ELECT 100UF	20.00% 16V
R955	Δ 1-205-998-11	CEMENTED 1 5% 10W		C217	1-164-004-11	CERAMIC CHIP 0.1UF	10.00% 25V
R956	Δ 1-205-998-11	CEMENTED 1 5% 10W		C218	1-126-933-11	ELECT 100UF	20.00% 16V
R957	Δ 1-205-998-11	CEMENTED 1 5% 10W		C219	1-126-964-11	ELECT 10UF	20.00% 50V
				C220	1-164-004-11	CERAMIC CHIP 0.1UF	10.00% 25V
				C221	1-163-251-11	CERAMIC CHIP 100PF	5.00% 50V
				C222	1-163-251-11	CERAMIC CHIP 100PF	5.00% 50V
				C223	1-126-964-11	ELECT 10UF	20.00% 50V
				C224	1-163-251-11	CERAMIC CHIP 100PF	5.00% 50V
				C225	1-163-087-00	CERAMIC CHIP 4PF	0.25PF 50V
				C226	1-163-087-00	CERAMIC CHIP 4PF	0.25PF 50V
				C227	1-164-182-11	CERAMIC CHIP 0.0033UF	10.00% 50V
				C228	1-164-182-11	CERAMIC CHIP 0.0033UF	10.00% 50V
				C229	1-164-182-11	CERAMIC CHIP 0.0033UF	10.00% 50V



REF.NO.	PART.NO	DESCRIPTION	REMARK	REF.NO.	PART.NO	DESCRIPTION	REMARK
C230	1-164-182-11	CERAMIC CHIP 0.0033UF	10.00% 50V	C1123	1-104-664-11	ELECT 47UF	20.00% 25V
C231	1-163-129-00	CERAMIC CHIP 330PF	5.00% 50V	C1124	1-164-004-11	CERAMIC CHIP 0.1UF	10.00% 25V
C232	1-164-004-11	CERAMIC CHIP 0.1UF	10.00% 25V	C1125	1-104-664-11	ELECT 47UF	20.00% 25V
C233	1-126-933-11	ELECT 100UF	20.00% 16V	C1126	1-107-888-11	ELECT 47UF	20.00% 25V
C235	1-163-021-91	CERAMIC CHIP 0.01UF	10.00% 50V	C1127	1-107-888-11	ELECT 47UF	20.00% 25V
C236	1-104-661-91	ELECT 330UF	20.00% 16V	C1128	1-164-004-11	CERAMIC CHIP 0.1UF	10.00% 25V
C240	1-126-961-11	ELECT 2.2UF	20.00% 50V	C1129	1-107-906-11	ELECT 10UF	20.00% 50V
C241	1-126-961-11	ELECT 2.2UF	20.00% 50V	C1130	1-164-004-11	CERAMIC CHIP 0.1UF	10.00% 25V
C243	1-104-664-11	ELECT 47UF	20.00% 25V	C1131	1-107-682-11	CERAMIC CHIP 1UF	10.00% 16V
C246	1-164-489-11	CERAMIC CHIP 0.22UF	10.00% 16V	C1132	1-104-664-11	ELECT 47UF	20.00% 25V
C247	1-104-664-11	ELECT 47UF	20.00% 25V	C1133	1-104-664-11	ELECT 47UF	20.00% 25V
C248	1-104-664-11	ELECT 47UF	20.00% 25V	C1134	1-164-157-11	CERAMIC CHIP 0.068UF	10.00% 25V
C249	1-164-489-11	CERAMIC CHIP 0.22UF	10.00% 16V	C1135	1-104-664-11	ELECT 47UF	20.00% 25V
C252	1-136-165-00	FILM 0.1UF	5.00% 50V	C1137	1-126-960-11	ELECT 1UF	20.00% 50V
C253	1-126-953-11	ELECT 2200UF	20.00% 35V	C1138	1-126-964-11	ELECT 10UF	20.00% 50V
C254	1-136-165-00	FILM 0.1UF	5.00% 50V	C1141	1-126-964-11	ELECT 10UF	20.00% 50V
C255	1-136-165-00	FILM 0.1UF	5.00% 50V	C1142	1-115-340-11	CERAMIC CHIP 0.22UF	10.00% 25V
C256	1-136-165-00	FILM 0.1UF	5.00% 50V	C1144	1-126-964-11	ELECT 10UF	20.00% 50V
C257	1-126-953-11	ELECT 2200UF	20.00% 35V	C1145	1-163-251-11	CERAMIC CHIP 100PF	5.00% 50V
C258	1-163-009-11	CERAMIC CHIP 0.001UF	10.00% 50V	C1146	1-115-340-11	CERAMIC CHIP 0.22UF	10.00% 25V
C259	1-163-009-11	CERAMIC CHIP 0.001UF	10.00% 50V	C1147	1-163-251-11	CERAMIC CHIP 100PF	5.00% 50V
C260	1-126-963-11	ELECT 4.7UF	20.00% 50V	C1148	1-163-251-11	CERAMIC CHIP 100PF	5.00% 50V
C271	1-126-964-11	ELECT 10UF	20.00% 50V	C1149	1-115-340-11	CERAMIC CHIP 0.22UF	10.00% 25V
C274	1-104-664-11	ELECT 47UF	20.00% 25V	C1150	1-104-661-91	ELECT 330UF	20.00% 16V
C279	1-126-961-11	ELECT 2.2UF	20.00% 50V	C1152	1-115-340-11	CERAMIC CHIP 0.22UF	10.00% 25V
C280	1-126-961-11	ELECT 2.2UF	20.00% 50V	C1153	1-164-004-11	CERAMIC CHIP 0.1UF	10.00% 25V
C287	1-104-664-11	ELECT 47UF	20.00% 25V	C1154	1-164-004-11	CERAMIC CHIP 0.1UF	10.00% 25V
C289	1-104-664-11	ELECT 47UF	20.00% 25V	C1155	1-164-004-11	CERAMIC CHIP 0.1UF	10.00% 25V
C292	1-136-165-00	FILM 0.1UF	5.00% 50V	C1156	1-163-235-11	CERAMIC CHIP 22PF	5.00% 50V
C293	1-136-165-00	FILM 0.1UF	5.00% 50V	C1157	1-163-021-91	CERAMIC CHIP 0.01UF	10.00% 50V
C294	1-126-953-11	ELECT 2200UF	20.00% 35V	C1158	1-163-235-11	CERAMIC CHIP 22PF	5.00% 50V
C295	1-126-953-11	ELECT 2200UF	20.00% 35V	C1159	1-163-263-11	CERAMIC CHIP 330PF	5.00% 50V
C296	1-136-165-00	FILM 0.1UF	5.00% 50V	C1160	1-163-251-11	CERAMIC CHIP 100PF	5.00% 50V
C297	1-136-165-00	FILM 0.1UF	5.00% 50V	C1161	1-164-004-11	CERAMIC CHIP 0.1UF	10.00% 25V
C1101	1-104-664-11	ELECT 47UF	20.00% 25V	C1162	1-163-021-91	CERAMIC CHIP 0.01UF	10.00% 50V
C1102	1-163-021-91	CERAMIC CHIP 0.01UF	10.00% 50V	C1163	1-115-340-11	CERAMIC CHIP 0.22UF	10.00% 25V
C1105	1-163-251-11	CERAMIC CHIP 100PF	5.00% 50V	C1164	1-164-004-11	CERAMIC CHIP 0.1UF	10.00% 25V
C1106	1-163-251-11	CERAMIC CHIP 100PF	5.00% 50V	C1165	1-115-340-11	CERAMIC CHIP 0.22UF	10.00% 25V
C1107	1-164-004-11	CERAMIC CHIP 0.1UF	10.00% 25V	C1166	1-164-004-11	CERAMIC CHIP 0.1UF	10.00% 25V
C1108	1-126-967-11	ELECT 47UF	20.00% 50V	C1168	1-104-664-11	ELECT 47UF	20.00% 25V
C1109	1-163-251-11	CERAMIC CHIP 100PF	5.00% 50V	C1169	1-107-909-11	ELECT 47UF	20.00% 50V
C1110	1-126-964-11	ELECT 10UF	20.00% 50V	C1170	1-126-963-11	ELECT 4.7UF	20.00% 50V
C1111	1-107-888-11	ELECT 47UF	20.00% 25V	C1171	1-164-004-11	CERAMIC CHIP 0.1UF	10.00% 25V
C1113	1-126-964-11	ELECT 10UF	20.00% 50V	C1175	1-115-340-11	CERAMIC CHIP 0.22UF	10.00% 25V
C1114	1-104-664-11	ELECT 47UF	20.00% 25V	C1176	1-126-967-11	ELECT 47UF	20.00% 50V
C1117	1-164-004-11	CERAMIC CHIP 0.1UF	10.00% 25V	C1177	1-164-004-11	CERAMIC CHIP 0.1UF	10.00% 25V
C1118	1-126-964-11	ELECT 10UF	20.00% 50V	C1178	1-164-004-11	CERAMIC CHIP 0.1UF	10.00% 25V
C1120	1-107-882-91	ELECT 100UF	20.00% 16V	C1179	1-104-664-11	ELECT 47UF	20.00% 25V
C1121	1-107-882-91	ELECT 100UF	20.00% 16V	C1180	1-126-961-11	ELECT 2.2UF	20.00% 50V
C1122	1-164-004-11	CERAMIC CHIP 0.1UF	10.00% 25V	C1182	1-164-004-11	CERAMIC CHIP 0.1UF	10.00% 25V

REF.NO.	PART.NO	DESCRIPTION	REMARK	REF.NO.	PART.NO	DESCRIPTION	REMARK
C1183	1-164-004-11	CERAMIC CHIP 0.1UF	10.00% 25V	C1341	1-107-823-11	CERAMIC CHIP 0.47UF	10.00% 16V
C1184	1-126-964-11	ELECT 10UF	20.00% 50V	C1342	1-107-823-11	CERAMIC CHIP 0.47UF	10.00% 16V
C1189	1-164-004-11	CERAMIC CHIP 0.1UF	10.00% 25V	C1343	1-104-665-11	ELECT 100UF	20.00% 25V
C1190	1-107-888-11	ELECT 47UF	20.00% 25V	C1345	1-164-004-11	CERAMIC CHIP 0.1UF	10.00% 25V
C1191	1-107-888-11	ELECT 47UF	20.00% 25V	C1348	1-107-823-11	CERAMIC CHIP 0.47UF	10.00% 16V
C1192	1-126-960-11	ELECT 1UF	20.00% 50V	C1349	1-164-004-11	CERAMIC CHIP 0.1UF	10.00% 25V
C1193	1-107-905-11	ELECT 4.7UF	20.00% 50V	C1350	1-107-823-11	CERAMIC CHIP 0.47UF	10.00% 16V
C1194	1-107-888-11	ELECT 47UF	20.00% 25V	C1351	1-107-823-11	CERAMIC CHIP 0.47UF	10.00% 16V
C1195	1-107-906-11	ELECT 10UF	20.00% 50V	C1352	1-164-004-11	CERAMIC CHIP 0.1UF	10.00% 25V
C1196	1-104-664-11	ELECT 47UF	20.00% 25V	C1353	1-164-004-11	CERAMIC CHIP 0.1UF	10.00% 25V
C1197	1-164-004-11	CERAMIC CHIP 0.1UF	10.00% 25V	C1354	1-107-823-11	CERAMIC CHIP 0.47UF	10.00% 16V
C1198	1-126-964-11	ELECT 10UF	20.00% 50V	C1355	1-126-964-11	ELECT 10UF	20.00% 50V
C1199	1-126-964-11	ELECT 10UF	20.00% 50V	C1356	1-126-964-11	ELECT 10UF	20.00% 50V
C1207	1-110-489-11	CAPACITOR 1F	5.5V	C1357	1-107-823-11	CERAMIC CHIP 0.47UF	10.00% 16V
C1208	1-115-340-11	CERAMIC CHIP 0.22UF	10.00% 25V	C1359	1-164-004-11	CERAMIC CHIP 0.1UF	10.00% 25V
C1209	1-163-009-11	CERAMIC CHIP 0.001UF	10.00% 50V	C1360	1-107-823-11	CERAMIC CHIP 0.47UF	10.00% 16V
C1211	1-136-165-00	FILM 0.1UF	5.00% 50V	C1366	1-164-004-11	CERAMIC CHIP 0.1UF	10.00% 25V
C1212	1-126-964-11	ELECT 10UF	20.00% 50V	C1367	1-164-004-11	CERAMIC CHIP 0.1UF	10.00% 25V
C1213	1-126-933-11	ELECT 100UF	20.00% 16V	C1403	1-107-823-11	CERAMIC CHIP 0.47UF	10.00% 16V
C1215	1-104-664-11	ELECT 47UF	20.00% 25V	C1404	1-107-823-11	CERAMIC CHIP 0.47UF	10.00% 16V
C1217	1-164-492-11	CERAMIC CHIP 0.15UF	10.00% 16V	C1405	1-107-823-11	CERAMIC CHIP 0.47UF	10.00% 16V
C1218	1-163-234-11	CERAMIC CHIP 20PF	5.00% 50V	C1406	1-104-664-11	ELECT 47UF	20.00% 25V
C1219	1-163-009-11	CERAMIC CHIP 0.001UF	10.00% 50V	C1407	1-104-664-11	ELECT 47UF	20.00% 25V
C1220	1-126-933-11	ELECT 100UF	20.00% 16V	C1411	1-104-665-11	ELECT 100UF	20.00% 25V
C1301	1-126-967-11	ELECT 47UF	20.00% 50V	C1412	1-104-665-11	ELECT 100UF	20.00% 25V
C1302	1-163-021-91	CERAMIC CHIP 0.01UF	10.00% 50V	C1414	1-164-004-11	CERAMIC CHIP 0.1UF	10.00% 25V
C1303	1-107-823-11	CERAMIC CHIP 0.47UF	10.00% 16V	C1415	1-164-004-11	CERAMIC CHIP 0.1UF	10.00% 25V
C1304	1-164-004-11	CERAMIC CHIP 0.1UF	10.00% 25V	C1416	1-164-004-11	CERAMIC CHIP 0.1UF	10.00% 25V
C1307	1-107-823-11	CERAMIC CHIP 0.47UF	10.00% 16V	C1417	1-164-004-11	CERAMIC CHIP 0.1UF	10.00% 25V
C1320	1-126-960-11	ELECT 1UF	20.00% 50V	C1418	1-164-004-11	CERAMIC CHIP 0.1UF	10.00% 25V
C1321	1-107-823-11	CERAMIC CHIP 0.47UF	10.00% 16V	C1419	1-164-004-11	CERAMIC CHIP 0.1UF	10.00% 25V
C1322	1-107-823-11	CERAMIC CHIP 0.47UF	10.00% 16V	C1420	1-164-004-11	CERAMIC CHIP 0.1UF	10.00% 25V
C1323	1-107-823-11	CERAMIC CHIP 0.47UF	10.00% 16V	C1421	1-164-004-11	CERAMIC CHIP 0.1UF	10.00% 25V
C1324	1-107-823-11	CERAMIC CHIP 0.47UF	10.00% 16V	C1422	1-164-004-11	CERAMIC CHIP 0.1UF	10.00% 25V
C1325	1-107-823-11	CERAMIC CHIP 0.47UF	10.00% 16V	C1423	1-104-661-91	ELECT 330UF	20.00% 16V
C1326	1-107-823-11	CERAMIC CHIP 0.47UF	10.00% 16V	C1424	1-126-964-11	ELECT 10UF	20.00% 50V
C1327	1-107-823-11	CERAMIC CHIP 0.47UF	10.00% 16V	C1425	1-126-964-11	ELECT 10UF	20.00% 50V
C1328	1-107-823-11	CERAMIC CHIP 0.47UF	10.00% 16V	C1426	1-126-964-11	ELECT 10UF	20.00% 50V
C1329	1-107-823-11	CERAMIC CHIP 0.47UF	10.00% 16V	C1427	1-126-964-11	ELECT 10UF	20.00% 50V
C1330	1-107-823-11	CERAMIC CHIP 0.47UF	10.00% 16V	C1431	1-104-665-11	ELECT 100UF	20.00% 25V
C1331	1-107-823-11	CERAMIC CHIP 0.47UF	10.00% 16V	C1441	1-104-665-11	ELECT 100UF	20.00% 25V
C1332	1-107-823-11	CERAMIC CHIP 0.47UF	10.00% 16V	C1449	1-163-009-11	CERAMIC CHIP 0.001UF	10.00% 50V
C1333	1-107-823-11	CERAMIC CHIP 0.47UF	10.00% 16V	C1803	1-126-967-11	ELECT 47UF	20.00% 50V
C1334	1-107-823-11	CERAMIC CHIP 0.47UF	10.00% 16V	C1804	1-126-967-11	ELECT 47UF	20.00% 50V
C1335	1-107-823-11	CERAMIC CHIP 0.47UF	10.00% 16V	C1805	1-164-004-11	CERAMIC CHIP 0.1UF	10.00% 25V
C1336	1-163-021-91	CERAMIC CHIP 0.01UF	10.00% 50V	C1806	1-164-004-11	CERAMIC CHIP 0.1UF	10.00% 25V
C1337	1-107-823-11	CERAMIC CHIP 0.47UF	10.00% 16V	C1807	1-126-964-11	ELECT 10UF	20.00% 50V
C1338	1-107-823-11	CERAMIC CHIP 0.47UF	10.00% 16V	C1808	1-164-004-11	CERAMIC CHIP 0.1UF	10.00% 25V
C1339	1-107-823-11	CERAMIC CHIP 0.47UF	10.00% 16V	C1809	1-164-004-11	CERAMIC CHIP 0.1UF	10.00% 25V
C1340	1-107-823-11	CERAMIC CHIP 0.47UF	10.00% 16V	C1810	1-126-964-11	ELECT 10UF	20.00% 50V



REF.NO.	PART.NO	DESCRIPTION	REMARK	REF.NO.	PART.NO	DESCRIPTION	REMARK
C1811	1-107-909-11	ELECT 47UF	20.00% 50V	C2519	1-163-251-11	CERAMIC CHIP 100PF	5.00% 50V
C1812	1-107-909-11	ELECT 47UF	20.00% 50V	C2520	1-126-964-11	ELECT 10UF	20.00% 50V
C1813	1-164-004-11	CERAMIC CHIP 0.1UF	10.00% 25V	C2521	1-126-964-11	ELECT 10UF	20.00% 50V
C1814	1-164-004-11	CERAMIC CHIP 0.1UF	10.00% 25V	C2522	1-126-964-11	ELECT 10UF	20.00% 50V
C1815	1-126-964-11	ELECT 10UF	20.00% 50V	C2523	1-126-964-11	ELECT 10UF	20.00% 50V
C1816	1-126-964-11	ELECT 10UF	20.00% 50V	C3201	1-164-004-11	CERAMIC CHIP 0.1UF	10.00% 25V
C1817	1-164-004-11	CERAMIC CHIP 0.1UF	10.00% 25V	C3202	1-164-004-11	CERAMIC CHIP 0.1UF	10.00% 25V
C1818	1-164-004-11	CERAMIC CHIP 0.1UF	10.00% 25V	C3203	1-164-004-11	CERAMIC CHIP 0.1UF	10.00% 25V
C1819	1-164-004-11	CERAMIC CHIP 0.1UF	10.00% 25V	C3204	1-164-004-11	CERAMIC CHIP 0.1UF	10.00% 25V
C1820	1-126-967-11	ELECT 47UF	20.00% 50V	C3205	1-126-933-11	ELECT 100UF	20.00% 16V
C1821	1-164-004-11	CERAMIC CHIP 0.1UF	10.00% 25V	C3206	1-126-933-11	ELECT 100UF	20.00% 16V
C1822	1-107-905-11	ELECT 4.7UF	20.00% 50V	C3207	1-216-295-11	SHORT 0	
C1823	1-164-004-11	CERAMIC CHIP 0.1UF	10.00% 25V	C3209	1-164-004-11	CERAMIC CHIP 0.1UF	10.00% 25V
C1824	1-107-905-11	ELECT 4.7UF	20.00% 50V	C3210	1-163-263-11	CERAMIC CHIP 330PF	5.00% 50V
C1825	1-164-004-11	CERAMIC CHIP 0.1UF	10.00% 25V	C3211	1-163-021-91	CERAMIC CHIP 0.01UF	10.00% 50V
C1826	1-107-906-11	ELECT 10UF	20.00% 50V	C3212	1-107-823-11	CERAMIC CHIP 0.47UF	10.00% 16V
C1827	1-164-004-11	CERAMIC CHIP 0.1UF	10.00% 25V	C3213	1-164-004-11	CERAMIC CHIP 0.1UF	10.00% 25V
C1828	1-107-906-11	ELECT 10UF	20.00% 50V	C3214	1-164-004-11	CERAMIC CHIP 0.1UF	10.00% 25V
C1829	1-164-004-11	CERAMIC CHIP 0.1UF	10.00% 25V	C3216	1-126-933-11	ELECT 100UF	20.00% 16V
C1830	1-107-905-11	ELECT 4.7UF	20.00% 50V	C3233	1-107-682-11	CERAMIC CHIP 1UF	10.00% 16V
C1831	1-164-004-11	CERAMIC CHIP 0.1UF	10.00% 25V	C3301	1-163-021-91	CERAMIC CHIP 0.01UF	10.00% 50V
C1832	1-164-004-11	CERAMIC CHIP 0.1UF	10.00% 25V	C3303	1-107-823-11	CERAMIC CHIP 0.47UF	10.00% 16V
C1833	1-107-905-11	ELECT 4.7UF	20.00% 50V	C3304	1-107-823-11	CERAMIC CHIP 0.47UF	10.00% 16V
C1834	1-107-909-11	ELECT 47UF	20.00% 50V			< FILTER >	
C1835	1-126-967-11	ELECT 47UF	20.00% 50V	CD1105	1-527-992-31	OSCILLATOR, CERAMIC	
C1836	1-107-928-11	ELECT 4.7UF	20.00% 100V			< CONNECTOR >	
C1837	1-163-021-91	CERAMIC CHIP 0.01UF	10.00% 50V	CN201	*1-568-881-51	PIN, CONNECTOR 6P	
C1842	1-107-906-11	ELECT 10UF	20.00% 50V	CN206	*1-568-881-51	PIN, CONNECTOR 6P	
C1843	1-164-004-11	CERAMIC CHIP 0.1UF	10.00% 25V	CN1102	*1-564-520-11	PLUG, CONNECTOR 5P	
C1844	1-107-906-11	ELECT 10UF	20.00% 50V	CN1103	*1-564-520-11	PLUG, CONNECTOR 5P	
C1845	1-164-004-11	CERAMIC CHIP 0.1UF	10.00% 25V	CN1105	*1-568-880-51	PIN, CONNECTOR 5P	
C1846	1-163-021-91	CERAMIC CHIP 0.01UF	10.00% 50V	CN1106	*1-568-880-51	PIN, CONNECTOR 5P	
C1847	1-164-004-11	CERAMIC CHIP 0.1UF	10.00% 25V	CN1108	*1-568-880-51	PIN, CONNECTOR 5P	
C1848	1-126-964-11	ELECT 10UF	20.00% 50V	CN1109	*1-568-881-51	PIN, CONNECTOR 6P	
C2501	1-163-227-11	CERAMIC CHIP 10PF	0.50PF 50V	CN1110	*1-568-882-51	PIN, CONNECTOR 7P	
C2502	1-163-227-11	CERAMIC CHIP 10PF	0.50PF 50V	CN1111	*1-568-878-51	PIN, CONNECTOR 3P	
C2503	1-163-011-11	CERAMIC CHIP 0.0015UF	10.00% 50V	CN1301	1-695-298-11	CONNECTOR, BOARD TO BOARD 40P	
C2504	1-164-004-11	CERAMIC CHIP 0.1UF	10.00% 25V	CN1305	*1-564-511-11	PLUG, CONNECTOR 8P	
C2505	1-164-004-11	CERAMIC CHIP 0.1UF	10.00% 25V	CN1803	1-695-298-11	CONNECTOR, BOARD TO BOARD 40P	
C2506	1-163-251-11	CERAMIC CHIP 100PF	5.00% 50V	CN1804	1-695-298-11	CONNECTOR, BOARD TO BOARD 40P	
C2509	1-126-964-11	ELECT 10UF	20.00% 50V	CN1806	1-695-299-11	CONNECTOR, BOARD TO BOARD 50P	
C2510	1-164-346-11	CERAMIC CHIP 1UF	16V	CN1807	1-695-297-11	CONNECTOR, BOARD TO BOARD 20P	
C2511	1-163-237-11	CERAMIC CHIP 27PF	5.00% 50V	CN1808	1-695-297-11	CONNECTOR, BOARD TO BOARD 20P	
C2512	1-164-004-11	CERAMIC CHIP 0.1UF	10.00% 25V	CN1809	*1-564-509-11	PLUG, CONNECTOR 6P	
C2513	1-164-004-11	CERAMIC CHIP 0.1UF	10.00% 25V	CN1810	*1-564-509-11	PLUG, CONNECTOR 6P	
C2514	1-164-004-11	CERAMIC CHIP 0.1UF	10.00% 25V	CN2501	*1-568-882-51	PIN, CONNECTOR 7P	
C2515	1-164-004-11	CERAMIC CHIP 0.1UF	10.00% 25V	CN2502	*1-564-511-11	PLUG, CONNECTOR 8P	
C2516	1-164-004-11	CERAMIC CHIP 0.1UF	10.00% 25V				
C2517	1-163-237-11	CERAMIC CHIP 27PF	5.00% 50V				
C2518	1-163-009-11	CERAMIC CHIP 0.001UF	10.00% 50V				

REF.NO.	PART.NO	DESCRIPTION	REMARK	REF.NO.	PART.NO	DESCRIPTION	REMARK
CN2504	*1-568-878-51	PIN, CONNECTOR 3P		D1136	8-719-914-42	DIODE DA204K	
		< COMPOSITION CIRCUIT BLOCK >		D1137	8-719-914-42	DIODE DA204K	
				D1138	8-719-914-42	DIODE DA204K	
				D1139	8-719-914-43	DIODE DAN202K-T-146	
CP101	8-598-468-00	RF SPLITTER RFD-AU601		D1141	8-719-048-55	DIODE RD5.6ES-B1	
		< DIODE >					
D102	8-719-914-43	DIODE DAN202K		D1142	8-719-109-88	DIODE MTZJ-T-77-5.6A	
D201	8-719-991-33	DIODE 1SS133T-77		D1143	8-719-069-54	DIODE UDZS-TE17-5.1B	
D203	8-719-914-43	DIODE DAN202K		D1310	8-719-025-29	DIODE 02CZ5.1-TE85L	
D204	8-719-991-33	DIODE 1SS133T-77		D1311	8-719-404-46	DIODE MA110	
D205	8-719-914-43	DIODE DAN202K		D1312	8-719-923-60	DIODE MTZJ-T-77-9.1A	
				D1801	8-719-404-46	DIODE MA110	
D206	8-719-914-42	DIODE DA204K		D1802	8-719-404-46	DIODE MA110	
D207	8-719-991-33	DIODE 1SS133T-77		D1803	8-719-404-46	DIODE MA110	
D208	8-719-991-33	DIODE 1SS133T-77		D1804	8-719-404-46	DIODE MA110	
D209	8-719-991-33	DIODE 1SS133T-77		D1805	8-719-404-46	DIODE MA110	
D210	8-719-991-33	DIODE 1SS133T-77					
				D1806	8-719-404-46	DIODE MA110	
D211	8-719-991-33	DIODE 1SS133T-77		D2501	8-719-914-43	DIODE DAN202K	
D212	8-719-991-33	DIODE 1SS133T-77		D2502	8-719-028-00	DIODE MA3033L	
D213	8-719-991-33	DIODE 1SS133T-77		D3201	8-719-914-44	DIODE DAP202K	
D214	8-719-991-33	DIODE 1SS133T-77				< FERRITE BEAD >	
D1101	8-719-404-46	DIODE MA110		FB201	1-410-396-41	FERRITE	0.45UH
				FB202	1-410-396-41	FERRITE	0.45UH
D1102	8-719-404-46	DIODE MA110		FB203	1-410-396-41	FERRITE	0.45UH
D1103	8-719-404-46	DIODE MA110		FB204	1-410-396-41	FERRITE	0.45UH
D1104	8-719-404-46	DIODE MA110		FB206	1-414-553-11	FERRITE	0UH
D1105	8-719-404-46	DIODE MA110					
D1106	8-719-404-46	DIODE MA110		FB207	1-414-553-11	FERRITE	0UH
				FB208	1-500-245-11	FERRITE	0UH
D1107	8-719-404-46	DIODE MA110		FB209	1-414-553-11	FERRITE	0UH
D1108	8-719-404-46	DIODE MA110		FB210	1-414-553-11	FERRITE	0UH
D1109	8-719-978-33	DIODE DTZ-TT11-6.8B		FB211	1-414-553-11	FERRITE	0UH
D1110	8-719-911-19	DIODE 1SS119-25					
D1111	8-719-404-46	DIODE MA110		FB212	1-414-553-11	FERRITE	0UH
				FB213	1-414-553-11	FERRITE	0UH
D1112	8-719-404-46	DIODE MA110		FB214	1-414-553-11	FERRITE	0UH
D1115	8-719-914-44	DIODE DAP202K		FB215	1-414-553-11	FERRITE	0UH
D1116	8-719-105-91	DIODE RD5.6M-B2		FB1801	1-414-234-22	FERRITE	0UH
D1117	8-719-914-43	DIODE DAN202K					
D1118	8-719-105-91	DIODE RD5.6M-B2		FB1802	1-414-234-22	FERRITE	0UH
				FB1803	1-414-234-22	FERRITE	0UH
D1119	8-719-914-43	DIODE DAN202K		FB1804	1-414-234-22	FERRITE	0UH
D1120	8-719-025-31	DIODE 02CZ5.6-TE85L		FB1805	1-414-234-22	FERRITE	0UH
D1121	8-719-025-31	DIODE 02CZ5.6-TE85L		FB1806	1-414-234-22	FERRITE	0UH
D1122	8-719-404-46	DIODE MA110					
D1123	8-719-404-46	DIODE MA110		FB1807	1-414-234-22	FERRITE	0UH
				FB1808	1-414-234-22	FERRITE	0UH
D1124	8-719-404-46	DIODE MA110		FB1809	1-216-295-11	SHORT	0
D1125	8-719-404-46	DIODE MA110		FB1810	1-216-017-91	RES-CHIP	47 5% 1/10W
D1126	8-719-404-46	DIODE MA110		FB1811	1-216-295-11	SHORT	0
D1127	8-719-404-46	DIODE MA110					
D1128	8-719-404-46	DIODE MA110		FB1812	1-216-295-11	SHORT	0
				FB1813	1-414-234-22	FERRITE	0UH
D1129	8-719-404-46	DIODE MA110		FB1814	1-414-234-22	FERRITE	0UH
D1134	8-719-914-42	DIODE DA204K		FB1815	1-414-234-22	FERRITE	0UH
D1135	8-719-914-42	DIODE DA204K					



REF.NO.	PART.NO	DESCRIPTION	REMARK	REF.NO.	PART.NO	DESCRIPTION	REMARK
FB1816	1-414-234-22	FERRITE	OUH	IC1116	8-759-442-44	IC SDA30C164-2-GEG	
FB1817	1-414-234-22	FERRITE	OUH	IC1119	8-759-651-98	IC M27C4001-15C1-GA144	
FB1818	1-414-234-22	FERRITE	OUH	IC1121	8-759-390-51	IC UPC2409AHF	
FB1819	1-414-234-22	FERRITE	OUH	IC1123	8-759-560-25	IC M24C64-WBN6	
FB1820	1-414-234-22	FERRITE	OUH	IC1126	8-759-990-63	IC PCF8574AT	
FB1821	1-414-234-22	FERRITE	OUH	IC1127	8-759-058-62	IC TC7S08FU(TE85R)	
FB1822	1-414-234-22	FERRITE	OUH	IC1132	8-759-990-63	IC PCF8574AT	
FB1823	1-414-234-22	FERRITE	OUH	IC1133	8-759-822-38	IC LA6510	
FB1824	1-414-234-22	FERRITE	OUH	IC1134	8-759-008-70	IC LM358N	
FB1825	1-414-234-22	FERRITE	OUH	IC1135	8-759-325-48	IC CA0005AD	
FB1826	1-414-234-22	FERRITE	OUH	IC1136	8-759-058-62	IC TC7S08FU(TE85R)	
FB1827	1-414-234-22	FERRITE	OUH	IC1137	8-759-058-54	IC TC7S00FU(TE85R)	
FB1828	1-414-234-22	FERRITE	OUH	IC1141	8-759-478-44	IC PCF8593/T118	
FB1829	1-414-234-22	FERRITE	OUH	IC1301	8-759-300-71	IC HD14053BFP	
FB1830	1-414-234-11	FERRITE	OUH	IC1302	8-759-058-62	IC TC7S08FU(TE85R)	
FB1831	1-414-234-11	FERRITE	OUH	IC1318	8-752-082-92	IC CXA2101Q-TL	
FB2501	1-414-553-11	FERRITE	OUH	IC1320	8-752-058-68	IC CXA1315M	
FB2502	1-414-553-11	FERRITE	OUH	IC1325	8-759-031-84	IC SC7S04F	
	< FILTER >			IC1326	8-759-031-84	IC SC7S04F	
FL101	1-236-071-11	ENCAPSULATED COMPONENT		IC1329	8-759-058-62	IC TC7S08FU(TE85R)	
FL102	1-236-071-11	ENCAPSULATED COMPONENT		IC1330	8-759-058-62	IC TC7S08FU(TE85R)	
FL103	1-236-071-11	ENCAPSULATED COMPONENT		IC1801	8-759-058-54	IC TC7S00FU(TE85R)	
FL201	1-233-764-21	FILTER		IC1802	8-759-058-54	IC TC7S00FU(TE85R)	
FL202	1-236-071-11	ENCAPSULATED COMPONENT		IC1803	8-759-058-54	IC TC7S00FU(TE85R)	
FL203	1-236-071-11	ENCAPSULATED COMPONENT		IC1804	8-759-300-71	IC HD14053BFP	
FL204	1-236-071-11	ENCAPSULATED COMPONENT		IC1805	8-759-058-62	IC TC7S08FU(TE85R)	
FL205	1-236-071-11	ENCAPSULATED COMPONENT		IC1806	8-759-058-62	IC TC7S08FU(TE85R)	
FL206	1-236-071-11	ENCAPSULATED COMPONENT		IC1807	8-759-701-59	IC NJM78M09FA	
FL207	1-236-071-11	ENCAPSULATED COMPONENT		IC1808	8-759-908-15	IC TL431CLP	
FL1105	1-236-071-11	ENCAPSULATED COMPONENT		IC1809	8-759-058-62	IC TC7S08FU(TE85R)	
FL1106	1-236-071-11	ENCAPSULATED COMPONENT		IC1810	8-759-058-54	IC TC7S00FU(TE85R)	
FL1107	1-236-071-11	ENCAPSULATED COMPONENT		IC2501	8-759-421-42	IC SDA9361	
FL1108	1-236-071-11	ENCAPSULATED COMPONENT		IC2502	8-759-087-73	IC S-80745AN-D9-S	
	< IC >			IC3201	8-759-342-60	IC PST575DMT-T1	
IC103	8-759-514-57	IC BA7046F		IC3301	8-759-300-71	IC HD14053BFP	
IC201	8-759-654-15	IC MSP3410D-C5-PS			< COIL >		
IC202	8-759-190-89	IC TDA7265		L107	1-408-615-31	INDUCTOR	100UH
IC203	8-759-190-89	IC TDA7265		L201	1-408-615-31	INDUCTOR	100UH
IC204	8-759-342-60	IC PST575DMT-T1		L1101	1-408-615-31	INDUCTOR	100UH
IC205	8-759-439-65	IC TC9337F-015		L1102	1-412-541-41	INDUCTOR	220UH
IC1101	8-752-072-94	IC CXA1875AM-T4		L1103	1-408-611-31	INDUCTOR	47UH
IC1105	8-759-507-29	IC LM7808CT		L1105	1-408-611-31	INDUCTOR	47UH
IC1108	8-759-593-62	IC UPC24A05AHF		L1106	1-408-611-31	INDUCTOR	47UH
IC1109	8-759-593-62	IC UPC24A05AHF		L1109	1-412-537-31	INDUCTOR	100UH
IC1111	8-759-259-18	IC MB3793-42PNF		L1301	1-408-615-31	INDUCTOR	100UH
IC1112	8-759-688-37	IC HY514400AJ		L1302	1-408-609-41	INDUCTOR	33UH
IC1113	8-759-665-84	IC SDA5275-3PC02-2		L1303	1-408-609-41	INDUCTOR	33UH
IC1114	8-759-008-67	IC MC14066BF		L1304	1-408-603-31	INDUCTOR	10UH
				L1305	1-412-545-11	INDUCTOR	470UH

REF.NO.	PART.NO	DESCRIPTION	REMARK	REF.NO.	PART.NO	DESCRIPTION	REMARK
L1306	1-408-603-31	INDUCTOR	10UH	Q1329	8-729-026-49	TRANSISTOR 2SA1037AK	
L1307	1-408-412-00	INDUCTOR	18UH	Q1330	8-729-026-49	TRANSISTOR 2SA1037AK	
L1308	1-408-603-31	INDUCTOR	10UH	Q1331	8-729-026-49	TRANSISTOR 2SA1037AK	
L1310	1-408-615-31	INDUCTOR	100UH	Q1332	8-729-120-28	TRANSISTOR 2SC1623-L5L6	
L1801	1-406-664-21	INDUCTOR	68UH	Q1801	8-729-034-57	TRANSISTOR IRFI244G	
< TRANSISTOR >				Q1802	8-729-140-04	TRANSISTOR 2SB1116A-L	
Q108	8-729-026-49	TRANSISTOR 2SA1037AK		Q1803	8-729-901-00	TRANSISTOR DTC124EK	
Q109	8-729-026-49	TRANSISTOR 2SA1037AK		Q1804	8-729-900-53	TRANSISTOR DTC114EK	
Q110	8-729-035-81	TRANSISTOR 2SB1436-QR		Q1805	8-729-034-57	TRANSISTOR IRFI244G	
Q111	8-729-901-00	TRANSISTOR DTC124EKA		Q1806	8-729-035-81	TRANSISTOR 2SB1436-QR	
Q114	8-729-026-49	TRANSISTOR 2SA1037AK		Q1807	8-729-035-81	TRANSISTOR 2SB1436-QR	
Q202	8-729-026-49	TRANSISTOR 2SA1037AK		Q1808	8-729-021-82	TRANSISTOR 2SD2396K	
Q203	8-729-120-28	TRANSISTOR 2SC1623-L5L6		Q1809	8-729-901-00	TRANSISTOR DTC124EK	
Q205	8-729-120-28	TRANSISTOR 2SC1623-L5L6		Q1810	8-729-901-00	TRANSISTOR DTC124EK	
Q206	8-729-120-28	TRANSISTOR 2SC1623-L5L6		Q1811	8-729-035-81	TRANSISTOR 2SB1436-QR	
Q209	8-729-120-28	TRANSISTOR 2SC1623-L5L6		Q1812	8-729-901-00	TRANSISTOR DTC124EK	
Q210	8-729-027-31	TRANSISTOR DTA124EKA		Q1813	8-729-028-28	TRANSISTOR 2SK2036 (TE85L)	
Q211	8-729-120-28	TRANSISTOR 2SC1623-L5L6		Q1814	8-729-028-28	TRANSISTOR 2SK2036 (TE85L)	
Q212	8-729-120-28	TRANSISTOR 2SC1623-L5L6		Q1815	8-729-035-81	TRANSISTOR 2SB1436-QR	
Q213	8-729-120-28	TRANSISTOR 2SC1623-L5L6		Q1816	8-729-901-00	TRANSISTOR DTC124EK	
Q215	8-729-120-28	TRANSISTOR 2SC1623-L5L6		Q1817	8-729-026-49	TRANSISTOR 2SA1037AK	
Q1108	8-729-035-81	TRANSISTOR 2SB1436-QR		Q1818	8-729-120-28	TRANSISTOR 2SC1623-L5L6	
Q1110	8-729-901-00	TRANSISTOR DTC124EK		Q1819	8-729-026-49	TRANSISTOR 2SA1037AK	
Q1111	8-729-120-28	TRANSISTOR 2SC1623-L5L6		Q1820	8-729-120-28	TRANSISTOR 2SC1623-L5L6	
Q1112	8-729-120-28	TRANSISTOR 2SC1623-L5L6		Q1821	8-729-026-49	TRANSISTOR 2SA1037AK	
Q1113	8-729-026-49	TRANSISTOR 2SA1037AK		Q1822	8-729-120-28	TRANSISTOR 2SC1623-L5L6	
Q1116	8-729-120-28	TRANSISTOR 2SC1623-L5L6		Q1823	8-729-026-49	TRANSISTOR 2SA1037AK	
Q1117	8-729-120-28	TRANSISTOR 2SC1623-L5L6		Q1824	8-729-120-28	TRANSISTOR 2SC1623-L5L6	
Q1120	1-801-806-11	TRANSISTOR DTC144EKA		Q3301	1-801-806-11	TRANSISTOR DTC144EKA	
Q1121	1-801-806-11	TRANSISTOR DTC144EKA		< RESISTOR >			
Q1122	8-729-026-49	TRANSISTOR 2SA1037AK		JR201	1-216-295-11	SHORT	0
Q1123	8-729-026-49	TRANSISTOR 2SA1037AK		JR203	1-216-295-11	SHORT	0
Q1124	8-729-026-49	TRANSISTOR 2SA1037AK		JR206	1-216-295-11	SHORT	0
Q1125	8-729-026-49	TRANSISTOR 2SA1037AK		JR1108	1-216-295-11	SHORT	0
Q1126	8-729-120-28	TRANSISTOR 2SC1623-L5L6		JR1109	1-216-295-11	SHORT	0
Q1127	8-729-028-28	TRANSISTOR 2SK2036 (TE85L)		JR1110	1-216-295-11	SHORT	0
Q1128	8-729-028-28	TRANSISTOR 2SK2036 (TE85L)		JR3201	1-216-295-11	SHORT	0
Q1129	8-729-028-28	TRANSISTOR 2SK2036 (TE85L)		JR3203	1-216-295-11	SHORT	0
Q1130	8-729-028-28	TRANSISTOR 2SK2036 (TE85L)		JR3204	1-216-295-11	SHORT	0
Q1133	8-729-140-97	TRANSISTOR 2SB734-34		R125	1-216-073-00	RES-CHIP	10K 5% 1/10W
Q1134	8-729-120-28	TRANSISTOR 2SC1623-L5L6		R126	1-216-061-00	RES-CHIP	3.3K 5% 1/10W
Q1301	1-801-806-11	TRANSISTOR DTC144EKA		R133	1-216-025-11	RES-CHIP	100 5% 1/10W
Q1302	8-729-026-49	TRANSISTOR 2SA1037AK		R136	1-216-049-11	RES-CHIP	1K 5% 1/10W
Q1303	8-729-120-28	TRANSISTOR 2SC1623-L5L6		R138	1-216-037-00	RES-CHIP	330 5% 1/10W
Q1312	8-729-120-28	TRANSISTOR 2SC1623-L5L6		R140	1-216-049-11	RES-CHIP	1K 5% 1/10W
Q1313	8-729-216-22	TRANSISTOR 2SA1162G		R141	1-216-057-00	RES-CHIP	2.2K 5% 1/10W
Q1316	8-729-120-28	TRANSISTOR 2SC1623-L5L6		R142	1-216-073-00	RES-CHIP	10K 5% 1/10W
Q1317	8-729-120-28	TRANSISTOR 2SC1623-L5L6		R146	1-216-107-00	RES-CHIP	270K 5% 1/10W
Q1318	8-729-026-49	TRANSISTOR 2SA1037AK		R147	1-216-113-00	RES-CHIP	470K 5% 1/10W

A

REF.NO.	PART.NO	DESCRIPTION	REMARK	REF.NO.	PART.NO	DESCRIPTION	REMARK
R150	1-216-113-00	RES-CHIP	470K 5% 1/10W	R261	1-216-073-00	RES-CHIP	10K 5% 1/10W
R151	1-218-755-11	METAL CHIP	130K 0.5% 1/10W	R262	1-216-065-91	RES-CHIP	4.7K 5% 1/10W
R152	1-216-073-00	RES-CHIP	10K 5% 1/10W	R263	1-216-049-11	RES-CHIP	1K 5% 1/10W
R153	1-216-113-00	RES-CHIP	470K 5% 1/10W	R264	1-216-357-00	METAL OXIDE	4.7 5% 1W
R154	1-216-295-11	SHORT	0	R265	1-216-089-11	RES-CHIP	47K 5% 1/10W
R155	1-216-065-91	RES-CHIP	4.7K 5% 1/10W	R266	1-216-236-11	RES-CHIP	39K 5% 1/8W
R157	1-216-049-11	RES-CHIP	1K 5% 1/10W	R267	1-216-357-00	METAL OXIDE	4.7 5% 1W
R158	1-216-049-11	RES-CHIP	1K 5% 1/10W	R268	1-216-077-91	RES-CHIP	15K 5% 1/10W
R202	1-216-025-11	RES-CHIP	100 5% 1/10W	R269	1-216-073-00	RES-CHIP	10K 5% 1/10W
R204	1-216-295-11	SHORT	0	R270	1-216-295-11	SHORT	0
R206	1-216-049-11	RES-CHIP	1K 5% 1/10W	R271	1-216-295-11	SHORT	0
R208	1-216-045-00	RES-CHIP	680 5% 1/10W	R272	1-216-049-11	RES-CHIP	1K 5% 1/10W
R209	1-216-053-00	RES-CHIP	1.5K 5% 1/10W	R273	1-216-049-11	RES-CHIP	1K 5% 1/10W
R210	1-216-081-00	RES-CHIP	22K 5% 1/10W	R274	1-216-069-00	RES-CHIP	6.8K 5% 1/10W
R211	1-216-081-00	RES-CHIP	22K 5% 1/10W	R275	1-216-069-00	RES-CHIP	6.8K 5% 1/10W
R212	1-216-049-11	RES-CHIP	1K 5% 1/10W	R276	1-216-081-00	RES-CHIP	22K 5% 1/10W
R218	1-216-295-11	SHORT	0	R277	1-216-049-11	RES-CHIP	1K 5% 1/10W
R219	1-216-295-11	SHORT	0	R279	1-216-049-11	RES-CHIP	1K 5% 1/10W
R220	1-216-025-11	RES-CHIP	100 5% 1/10W	R284	1-216-049-11	RES-CHIP	1K 5% 1/10W
R221	1-216-295-11	SHORT	0	R286	1-216-041-00	RES-CHIP	470 5% 1/10W
R222	1-216-295-11	SHORT	0	R288	1-216-041-00	RES-CHIP	470 5% 1/10W
R223	1-216-025-11	RES-CHIP	100 5% 1/10W	R289	1-216-075-00	RES-CHIP	12K 5% 1/10W
R224	1-216-025-11	RES-CHIP	100 5% 1/10W	R291	1-216-075-00	RES-CHIP	12K 5% 1/10W
R225	1-216-049-11	RES-CHIP	1K 5% 1/10W	R292	1-216-049-11	RES-CHIP	1K 5% 1/10W
R226	1-216-033-00	RES-CHIP	220 5% 1/10W	R293	1-216-073-00	RES-CHIP	10K 5% 1/10W
R227	1-216-033-00	RES-CHIP	220 5% 1/10W	R294	1-216-073-00	RES-CHIP	10K 5% 1/10W
R228	1-216-033-00	RES-CHIP	220 5% 1/10W	R295	1-216-041-00	RES-CHIP	470 5% 1/10W
R229	1-216-025-11	RES-CHIP	100 5% 1/10W	R1101	1-216-025-11	RES-CHIP	100 5% 1/10W
R230	1-216-025-11	RES-CHIP	100 5% 1/10W	R1102	1-216-025-11	RES-CHIP	100 5% 1/10W
R231	1-216-073-00	RES-CHIP	10K 5% 1/10W	R1103	1-216-025-11	RES-CHIP	100 5% 1/10W
R232	1-216-073-00	RES-CHIP	10K 5% 1/10W	R1104	1-216-025-11	RES-CHIP	100 5% 1/10W
R233	1-216-055-00	RES-CHIP	1.8K 5% 1/10W	R1105	1-216-033-00	RES-CHIP	220 5% 1/10W
R235	1-216-295-11	SHORT	0	R1106	1-216-033-00	RES-CHIP	220 5% 1/10W
R236	1-216-121-11	RES-CHIP	1M 5% 1/10W	R1107	1-216-025-11	RES-CHIP	100 5% 1/10W
R238	1-216-057-00	RES-CHIP	2.2K 5% 1/10W	R1110	1-216-049-11	RES-CHIP	1K 5% 1/10W
R239	1-216-049-11	RES-CHIP	1K 5% 1/10W	R1111	1-216-033-00	RES-CHIP	220 5% 1/10W
R240	1-216-295-11	SHORT	0	R1113	1-216-049-11	RES-CHIP	1K 5% 1/10W
R241	1-216-057-00	RES-CHIP	2.2K 5% 1/10W	R1115	1-216-083-00	RES-CHIP	27K 5% 1/10W
R245	1-216-039-00	RES-CHIP	390 5% 1/10W	R1118	1-216-295-11	SHORT	0
R246	1-216-097-11	RES-CHIP	100K 5% 1/10W	R1119	1-216-081-00	RES-CHIP	22K 5% 1/10W
R248	1-216-073-00	RES-CHIP	10K 5% 1/10W	R1120	1-216-073-00	RES-CHIP	10K 5% 1/10W
R250	1-216-049-11	RES-CHIP	1K 5% 1/10W	R1121	1-216-073-00	RES-CHIP	10K 5% 1/10W
R251	1-216-073-00	RES-CHIP	10K 5% 1/10W	R1124	1-216-025-11	RES-CHIP	100 5% 1/10W
R252	1-216-049-11	RES-CHIP	1K 5% 1/10W	R1125	1-216-025-11	RES-CHIP	100 5% 1/10W
R255	1-216-053-00	RES-CHIP	1.5K 5% 1/10W	R1126	1-216-025-11	RES-CHIP	100 5% 1/10W
R256	1-216-049-11	RES-CHIP	1K 5% 1/10W	R1128	1-216-089-11	RES-CHIP	47K 5% 1/10W
R257	1-216-041-00	RES-CHIP	470 5% 1/10W	R1129	1-216-073-00	RES-CHIP	10K 5% 1/10W
R258	1-216-041-00	RES-CHIP	470 5% 1/10W	R1130	1-216-073-00	RES-CHIP	10K 5% 1/10W
R259	1-216-075-00	RES-CHIP	12K 5% 1/10W	R1133	1-216-049-11	RES-CHIP	1K 5% 1/10W
R260	1-216-075-00	RES-CHIP	12K 5% 1/10W	R1136	1-216-121-11	RES-CHIP	1M 5% 1/10W

REF.NO.	PART.NO	DESCRIPTION	REMARK	REF.NO.	PART.NO	DESCRIPTION	REMARK
R1137	1-216-049-11	RES-CHIP	1K 5% 1/10W	R1195	1-216-001-00	RES-CHIP	10 5% 1/10W
R1139	1-216-073-00	RES-CHIP	10K 5% 1/10W	R1196	1-216-295-11	SHORT	0
R1140	1-216-073-00	RES-CHIP	10K 5% 1/10W	R1198	1-216-025-11	RES-CHIP	100 5% 1/10W
R1143	1-216-025-11	RES-CHIP	100 5% 1/10W	R1199	1-216-057-00	RES-CHIP	2.2K 5% 1/10W
R1144	1-216-049-11	RES-CHIP	1K 5% 1/10W	R1201	1-216-049-11	RES-CHIP	1K 5% 1/10W
R1145	1-216-025-11	RES-CHIP	100 5% 1/10W	R1202	1-216-049-11	RES-CHIP	1K 5% 1/10W
R1146	1-216-025-11	RES-CHIP	100 5% 1/10W	R1203	1-216-049-11	RES-CHIP	1K 5% 1/10W
R1147	1-216-041-00	RES-CHIP	470 5% 1/10W	R1204	1-216-073-00	RES-CHIP	10K 5% 1/10W
R1148	1-216-049-11	RES-CHIP	1K 5% 1/10W	R1211	1-216-025-11	RES-CHIP	100 5% 1/10W
R1149	1-216-049-11	RES-CHIP	1K 5% 1/10W	R1212	1-216-029-00	RES-CHIP	150 5% 1/10W
R1150	1-216-057-00	RES-CHIP	2.2K 5% 1/10W	R1215	1-216-025-11	RES-CHIP	100 5% 1/10W
R1151	1-216-025-11	RES-CHIP	100 5% 1/10W	R1216	1-216-025-11	RES-CHIP	100 5% 1/10W
R1152	1-216-073-00	RES-CHIP	10K 5% 1/10W	R1220	1-216-025-11	RES-CHIP	100 5% 1/10W
R1154	1-216-049-11	RES-CHIP	1K 5% 1/10W	R1221	1-216-025-11	RES-CHIP	100 5% 1/10W
R1155	1-216-049-11	RES-CHIP	1K 5% 1/10W	R1222	1-216-025-11	RES-CHIP	100 5% 1/10W
R1156	1-216-025-11	RES-CHIP	100 5% 1/10W	R1223	1-216-049-11	RES-CHIP	1K 5% 1/10W
R1157	1-216-049-11	RES-CHIP	1K 5% 1/10W	R1226	1-216-025-11	RES-CHIP	100 5% 1/10W
R1158	1-216-097-11	RES-CHIP	100K 5% 1/10W	R1227	1-216-025-11	RES-CHIP	100 5% 1/10W
R1159	1-216-025-11	RES-CHIP	100 5% 1/10W	R1231	1-216-295-11	SHORT	0
R1160	1-216-295-11	SHORT	0	R1232	1-216-025-11	RES-CHIP	100 5% 1/10W
R1162	1-216-057-00	RES-CHIP	2.2K 5% 1/10W	R1233	1-216-025-11	RES-CHIP	100 5% 1/10W
R1164	1-216-057-00	RES-CHIP	2.2K 5% 1/10W	R1234	1-216-025-11	RES-CHIP	100 5% 1/10W
R1165	1-216-025-11	RES-CHIP	100 5% 1/10W	R1235	1-216-049-11	RES-CHIP	1K 5% 1/10W
R1166	1-216-017-91	RES-CHIP	47 5% 1/10W	R1237	1-216-025-11	RES-CHIP	100 5% 1/10W
R1167	1-216-037-00	RES-CHIP	330 5% 1/10W	R1238	1-216-025-11	RES-CHIP	100 5% 1/10W
R1168	1-216-025-11	RES-CHIP	100 5% 1/10W	R1239	1-216-295-11	SHORT	0
R1169	1-216-017-91	RES-CHIP	47 5% 1/10W	R1240	1-216-025-11	RES-CHIP	100 5% 1/10W
R1170	1-216-057-00	RES-CHIP	2.2K 5% 1/10W	R1241	1-216-025-11	RES-CHIP	100 5% 1/10W
R1172	1-216-025-11	RES-CHIP	100 5% 1/10W	R1242	1-216-025-11	RES-CHIP	100 5% 1/10W
R1173	1-216-017-91	RES-CHIP	47 5% 1/10W	R1244	1-216-039-00	RES-CHIP	390 5% 1/10W
R1174	1-216-025-11	RES-CHIP	100 5% 1/10W	R1245	1-216-039-00	RES-CHIP	390 5% 1/10W
R1175	1-216-017-91	RES-CHIP	47 5% 1/10W	R1246	1-216-039-00	RES-CHIP	390 5% 1/10W
R1176	1-216-049-11	RES-CHIP	1K 5% 1/10W	R1253	1-216-025-11	RES-CHIP	100 5% 1/10W
R1177	1-216-049-11	RES-CHIP	1K 5% 1/10W	R1254	1-216-025-11	RES-CHIP	100 5% 1/10W
R1178	1-216-025-11	RES-CHIP	100 5% 1/10W	R1259	1-216-025-11	RES-CHIP	100 5% 1/10W
R1179	1-216-025-11	RES-CHIP	100 5% 1/10W	R1260	1-216-025-11	RES-CHIP	100 5% 1/10W
R1180	1-216-025-11	RES-CHIP	100 5% 1/10W	R1261	1-218-758-11	METAL CHIP	180K 0.5% 1/10W
R1181	1-216-025-11	RES-CHIP	100 5% 1/10W	R1262	1-216-699-91	METAL CHIP	100K 0.5% 1/10W
R1182	1-216-057-00	RES-CHIP	2.2K 5% 1/10W	R1263	1-216-699-91	METAL CHIP	100K 0.5% 1/10W
R1183	1-216-057-00	RES-CHIP	2.2K 5% 1/10W	R1264	1-216-673-11	METAL CHIP	8.2K 0.5% 1/10W
R1184	1-216-057-00	RES-CHIP	2.2K 5% 1/10W	R1265	1-216-699-91	METAL CHIP	100K 0.5% 1/10W
R1185	1-216-025-11	RES-CHIP	100 5% 1/10W	R1266	1-216-025-11	RES-CHIP	100 5% 1/10W
R1186	1-216-295-11	SHORT	0	R1267	1-216-025-11	RES-CHIP	100 5% 1/10W
R1187	1-216-057-00	RES-CHIP	2.2K 5% 1/10W	R1268	1-216-081-00	RES-CHIP	22K 5% 1/10W
R1188	1-216-025-11	RES-CHIP	100 5% 1/10W	R1269	1-216-669-11	METAL CHIP	5.6K 0.5% 1/10W
R1189	1-216-025-11	RES-CHIP	100 5% 1/10W	R1270	1-216-675-91	METAL CHIP	10K 0.5% 1/10W
R1190	1-216-025-11	RES-CHIP	100 5% 1/10W	R1271	1-216-669-11	METAL CHIP	5.6K 0.5% 1/10W
R1192	1-216-025-11	RES-CHIP	100 5% 1/10W	R1272	1-216-667-11	METAL CHIP	4.7K 0.5% 1/10W
R1193	1-216-295-11	SHORT	0	R1273	1-216-025-11	RES-CHIP	100 5% 1/10W
R1194	1-216-295-11	SHORT	0	R1274	1-216-049-11	RES-CHIP	1K 5% 1/10W

A

REF.NO.	PART.NO	DESCRIPTION	REMARK	REF.NO.	PART.NO	DESCRIPTION	REMARK
R1275	1-216-678-11	METAL CHIP	13K 0.5% 1/10W	R1392	1-216-049-11	RES-CHIP	1K 5% 1/10W
R1276	1-216-073-00	RES-CHIP	10K 5% 1/10W	R1393	1-216-049-11	RES-CHIP	1K 5% 1/10W
R1277	1-216-675-91	METAL CHIP	10K 0.5% 1/10W	R1394	1-216-049-11	RES-CHIP	1K 5% 1/10W
R1278	1-216-675-91	METAL CHIP	10K 0.5% 1/10W	R1395	1-216-049-11	RES-CHIP	1K 5% 1/10W
R1279	1-216-025-11	RES-CHIP	100 5% 1/10W	R1396	1-216-049-11	RES-CHIP	1K 5% 1/10W
R1280	1-216-025-11	RES-CHIP	100 5% 1/10W	R1397	1-216-049-11	RES-CHIP	1K 5% 1/10W
R1301	1-216-073-00	RES-CHIP	10K 5% 1/10W	R1398	1-216-049-11	RES-CHIP	1K 5% 1/10W
R1302	1-216-089-11	RES-CHIP	47K 5% 1/10W	R1399	1-216-049-11	RES-CHIP	1K 5% 1/10W
R1303	1-216-091-00	RES-CHIP	56K 5% 1/10W	R1400	1-216-025-11	RES-CHIP	100 5% 1/10W
R1306	1-216-295-11	SHORT	0	R1401	1-216-025-11	RES-CHIP	100 5% 1/10W
R1307	1-216-089-11	RES-CHIP	47K 5% 1/10W	R1402	1-216-025-11	RES-CHIP	100 5% 1/10W
R1308	1-216-091-00	RES-CHIP	56K 5% 1/10W	R1403	1-216-049-11	RES-CHIP	1K 5% 1/10W
R1315	1-216-025-11	RES-CHIP	100 5% 1/10W	R1404	1-216-049-11	RES-CHIP	1K 5% 1/10W
R1318	1-216-041-00	RES-CHIP	470 5% 1/10W	R1405	1-216-049-11	RES-CHIP	1K 5% 1/10W
R1321	1-216-065-91	RES-CHIP	4.7K 5% 1/10W	R1406	1-216-025-11	RES-CHIP	100 5% 1/10W
R1324	1-216-033-00	RES-CHIP	220 5% 1/10W	R1407	1-216-025-11	RES-CHIP	100 5% 1/10W
R1328	1-216-049-11	RES-CHIP	1K 5% 1/10W	R1408	1-216-025-11	RES-CHIP	100 5% 1/10W
R1329	1-216-049-11	RES-CHIP	1K 5% 1/10W	R1415	1-216-295-11	SHORT	0
R1330	1-216-049-11	RES-CHIP	1K 5% 1/10W	R1416	1-216-049-11	RES-CHIP	1K 5% 1/10W
R1331	1-216-049-11	RES-CHIP	1K 5% 1/10W	R1417	1-216-049-11	RES-CHIP	1K 5% 1/10W
R1332	1-216-049-11	RES-CHIP	1K 5% 1/10W	R1418	1-216-049-11	RES-CHIP	1K 5% 1/10W
R1334	1-216-089-11	RES-CHIP	47K 5% 1/10W	R1420	1-216-075-00	RES-CHIP	12K 5% 1/10W
R1335	1-216-081-00	RES-CHIP	22K 5% 1/10W	R1421	1-216-033-00	RES-CHIP	220 5% 1/10W
R1336	1-216-025-11	RES-CHIP	100 5% 1/10W	R1422	1-216-049-11	RES-CHIP	1K 5% 1/10W
R1337	1-216-025-11	RES-CHIP	100 5% 1/10W	R1433	1-216-049-11	RES-CHIP	1K 5% 1/10W
R1338	1-216-025-11	RES-CHIP	100 5% 1/10W	R1434	1-216-049-11	RES-CHIP	1K 5% 1/10W
R1339	1-216-049-11	RES-CHIP	1K 5% 1/10W	R1435	1-216-049-11	RES-CHIP	1K 5% 1/10W
R1340	1-216-133-00	RES-CHIP	3.3M 5% 1/10W	R1436	1-216-049-11	RES-CHIP	1K 5% 1/10W
R1341	1-216-033-00	RES-CHIP	220 5% 1/10W	R1437	1-216-049-11	RES-CHIP	1K 5% 1/10W
R1342	1-216-097-11	RES-CHIP	100K 5% 1/10W	R1452	1-216-017-91	RES-CHIP	47 5% 1/10W
R1343	1-216-097-11	RES-CHIP	100K 5% 1/10W	R1453	1-216-017-91	RES-CHIP	47 5% 1/10W
R1344	1-216-073-00	RES-CHIP	10K 5% 1/10W	R1454	1-216-017-91	RES-CHIP	47 5% 1/10W
R1345	1-216-069-00	RES-CHIP	6.8K 5% 1/10W	R1455	1-216-017-91	RES-CHIP	47 5% 1/10W
R1346	1-216-073-00	RES-CHIP	10K 5% 1/10W	R1462	1-216-295-11	SHORT	0
R1347	1-216-295-11	SHORT	0	R1801	1-216-025-11	RES-CHIP	100 5% 1/10W
R1348	1-216-085-00	RES-CHIP	33K 5% 1/10W	R1802	1-216-025-11	RES-CHIP	100 5% 1/10W
R1349	1-216-101-00	RES-CHIP	150K 5% 1/10W	R1803	1-216-025-11	RES-CHIP	100 5% 1/10W
R1350	1-216-025-11	RES-CHIP	100 5% 1/10W	R1804	1-216-025-11	RES-CHIP	100 5% 1/10W
R1351	1-216-025-11	RES-CHIP	100 5% 1/10W	R1805	1-216-025-11	RES-CHIP	100 5% 1/10W
R1352	1-216-049-11	RES-CHIP	1K 5% 1/10W	R1806	1-216-025-11	RES-CHIP	100 5% 1/10W
R1353	1-216-049-11	RES-CHIP	1K 5% 1/10W	R1807	1-216-025-11	RES-CHIP	100 5% 1/10W
R1354	1-216-049-11	RES-CHIP	1K 5% 1/10W	R1808	1-216-025-11	RES-CHIP	100 5% 1/10W
R1355	1-216-049-11	RES-CHIP	1K 5% 1/10W	R1809	1-216-025-11	RES-CHIP	100 5% 1/10W
R1356	1-216-049-11	RES-CHIP	1K 5% 1/10W	R1810	1-216-025-11	RES-CHIP	100 5% 1/10W
R1357	1-216-049-11	RES-CHIP	1K 5% 1/10W	R1811	1-216-025-11	RES-CHIP	100 5% 1/10W
R1358	1-216-025-11	RES-CHIP	100 5% 1/10W	R1812	1-216-025-11	RES-CHIP	100 5% 1/10W
R1359	1-216-017-91	RES-CHIP	47 5% 1/10W	R1813	1-216-025-11	RES-CHIP	100 5% 1/10W
R1360	1-216-041-00	RES-CHIP	470 5% 1/10W	R1814	1-216-025-11	RES-CHIP	100 5% 1/10W
R1361	1-216-017-91	RES-CHIP	47 5% 1/10W	R1815	1-216-049-11	RES-CHIP	1K 5% 1/10W
R1362	1-216-041-00	RES-CHIP	470 5% 1/10W	R1816	1-216-049-11	RES-CHIP	1K 5% 1/10W

REF.NO.	PART.NO	DESCRIPTION	REMARK	REF.NO.	PART.NO	DESCRIPTION	REMARK
R1817	1-216-049-11	RES-CHIP	1K 5% 1/10W	R2118	1-216-057-00	RES-CHIP	2.2K 5% 1/10W
R1818	1-216-295-11	SHORT	0	R2120	1-216-057-00	RES-CHIP	2.2K 5% 1/10W
R1819	1-216-025-11	RES-CHIP	100 5% 1/10W	R2121	1-216-295-11	SHORT	0
R1820	1-216-049-11	RES-CHIP	1K 5% 1/10W	R2122	1-216-089-11	RES-CHIP	47K 5% 1/10W
R1821	1-216-025-11	RES-CHIP	100 5% 1/10W	R2123	1-216-081-00	RES-CHIP	22K 5% 1/10W
R1823	1-216-025-11	RES-CHIP	100 5% 1/10W	R2124	1-247-807-31	CARBON	100 5% 1/4W
R1824	1-216-025-11	RES-CHIP	100 5% 1/10W	R2126	1-216-057-00	RES-CHIP	2.2K 5% 1/10W
R1825	1-216-017-91	RES-CHIP	47 5% 1/10W	R2128	1-216-295-11	SHORT	0
R1826	1-216-017-91	RES-CHIP	47 5% 1/10W	R2131	1-216-295-11	SHORT	0
R1827	1-216-025-11	RES-CHIP	100 5% 1/10W	R2134	1-216-295-11	SHORT	0
R1828	1-216-081-00	RES-CHIP	22K 5% 1/10W	R2135	1-216-653-11	METAL CHIP	1.2K 0.5% 1/10W
R1829	1-216-073-00	RES-CHIP	10K 5% 1/10W	R2136	1-216-049-11	RES-CHIP	1K 5% 1/10W
R1830	1-216-081-00	RES-CHIP	22K 5% 1/10W	R2137	1-216-025-11	RES-CHIP	100 5% 1/10W
R1831	1-216-049-11	RES-CHIP	1K 5% 1/10W	R2138	1-216-025-11	RES-CHIP	100 5% 1/10W
R1832	1-216-049-11	RES-CHIP	1K 5% 1/10W	R2139	1-216-025-11	RES-CHIP	100 5% 1/10W
R1833	1-216-049-11	RES-CHIP	1K 5% 1/10W	R2141	1-216-073-00	RES-CHIP	10K 5% 1/10W
R1834	1-216-049-11	RES-CHIP	1K 5% 1/10W	R2142	1-216-073-00	RES-CHIP	10K 5% 1/10W
R1835	1-216-025-11	RES-CHIP	100 5% 1/10W	R2144	1-216-073-00	RES-CHIP	10K 5% 1/10W
R1836	1-216-643-11	METAL CHIP	470 0.5% 1/10W	R2145	1-216-295-11	SHORT	0
R1837	1-216-633-11	METAL CHIP	180 0.5% 1/10W	R2146	1-216-295-11	SHORT	0
R1838	1-216-049-11	RES-CHIP	1K 5% 1/10W	R2147	1-216-295-11	SHORT	0
R1839	1-216-049-11	RES-CHIP	1K 5% 1/10W	R2148	1-216-065-91	RES-CHIP	4.7K 5% 1/10W
R1840	1-216-295-11	SHORT	0	R2158	1-216-049-11	RES-CHIP	1K 5% 1/10W
R1841	1-216-025-11	RES-CHIP	100 5% 1/10W	R2159	1-216-049-11	RES-CHIP	1K 5% 1/10W
R1842	1-216-025-11	RES-CHIP	100 5% 1/10W	R2160	1-216-675-91	METAL CHIP	10K 0.5% 1/10W
R1843	1-216-057-00	RES-CHIP	2.2K 5% 1/10W	R2161	1-216-077-91	RES-CHIP	15K 5% 1/10W
R1844	1-216-057-00	RES-CHIP	2.2K 5% 1/10W	R2162	1-216-073-00	RES-CHIP	10K 5% 1/10W
R1845	1-216-073-00	RES-CHIP	10K 5% 1/10W	R2163	1-216-071-00	RES-CHIP	8.2K 5% 1/10W
R1846	1-216-041-00	RES-CHIP	470 5% 1/10W	R2501	1-216-025-11	RES-CHIP	100 5% 1/10W
R1850	1-216-049-11	RES-CHIP	1K 5% 1/10W	R2502	1-216-049-11	RES-CHIP	1K 5% 1/10W
R1851	1-216-025-11	RES-CHIP	100 5% 1/10W	R2503	1-216-033-00	RES-CHIP	220 5% 1/10W
R1853	1-216-049-11	RES-CHIP	1K 5% 1/10W	R2504	1-216-049-11	RES-CHIP	1K 5% 1/10W
R1854	1-216-049-11	RES-CHIP	1K 5% 1/10W	R2505	1-216-063-91	RES-CHIP	3.9K 5% 1/10W
R1855	1-216-025-11	RES-CHIP	100 5% 1/10W	R2506	1-216-025-11	RES-CHIP	100 5% 1/10W
R1857	1-216-049-11	RES-CHIP	1K 5% 1/10W	R2507	1-216-025-11	RES-CHIP	100 5% 1/10W
R1858	1-216-049-11	RES-CHIP	1K 5% 1/10W	R2508	1-216-055-00	RES-CHIP	1.8K 5% 1/10W
R1859	1-216-025-11	RES-CHIP	100 5% 1/10W	R2509	1-216-667-11	METAL CHIP	4.7K 0.5% 1/10W
R1861	1-216-049-11	RES-CHIP	1K 5% 1/10W	R2511	1-216-085-00	RES-CHIP	33K 5% 1/10W
R1862	1-216-049-11	RES-CHIP	1K 5% 1/10W	R2512	1-216-695-11	METAL CHIP	68K 0.5% 1/10W
R1863	1-216-025-11	RES-CHIP	100 5% 1/10W	R2513	1-216-699-91	METAL CHIP	100K 0.5% 1/10W
R1865	1-216-049-11	RES-CHIP	1K 5% 1/10W	R2515	1-216-049-11	RES-CHIP	1K 5% 1/10W
R1866	1-215-863-11	METAL OXIDE	100 5% 1W	R2516	1-216-073-00	RES-CHIP	10K 5% 1/10W
R1868	1-216-021-00	RES-CHIP	68 5% 1/10W	R2517	1-216-049-11	RES-CHIP	1K 5% 1/10W
R1870	1-216-295-11	SHORT	0	R2518	1-216-049-11	RES-CHIP	1K 5% 1/10W
R1871	1-216-025-11	RES-CHIP	100 5% 1/10W	R2519	1-216-049-11	RES-CHIP	1K 5% 1/10W
R1872	1-216-025-11	RES-CHIP	100 5% 1/10W	R2520	1-216-683-11	METAL CHIP	22K 0.5% 1/10W
R2114	1-216-073-00	RES-CHIP	10K 5% 1/10W	R2521	1-216-025-11	RES-CHIP	100 5% 1/10W
R2115	1-216-057-00	RES-CHIP	2.2K 5% 1/10W	R2522	1-216-295-11	SHORT	0
R2116	1-216-057-00	RES-CHIP	2.2K 5% 1/10W	R2523	1-216-295-11	SHORT	0
R2117	1-216-295-11	SHORT	0	R2525	1-216-073-00	RES-CHIP	10K 5% 1/10W



REF.NO.	PART.NO	DESCRIPTION	REMARK
R3204	1-216-049-11	RES-CHIP 1K 5%	1/10W
R3205	1-216-357-00	METAL OXIDE 4.7 5%	1W
R3207	1-216-357-00	METAL OXIDE 4.7 5%	1W
R3209	1-216-073-00	RES-CHIP 10K 5%	1/10W
R3210	1-216-073-00	RES-CHIP 10K 5%	1/10W
R3212	1-216-025-11	RES-CHIP 100 5%	1/10W
R3213	1-216-025-11	RES-CHIP 100 5%	1/10W
R3215	1-216-295-11	SHORT 0	
R3216	1-216-295-11	SHORT 0	
R3217	1-216-295-11	SHORT 0	
R3218	1-216-067-00	RES-CHIP 5.6K 5%	1/10W
R3219	1-216-097-11	RES-CHIP 100K 5%	1/10W
R3220	1-216-025-11	RES-CHIP 100 5%	1/10W
R3221	1-216-295-11	SHORT 0	
R3269	1-216-073-00	RES-CHIP 10K 5%	1/10W
R3270	1-216-025-11	RES-CHIP 100 5%	1/10W
R3271	1-216-025-11	RES-CHIP 100 5%	1/10W
R3273	1-216-049-11	RES-CHIP 1K 5%	1/10W
R3274	1-216-089-11	RES-CHIP 47K 5%	1/10W
R3301	1-216-073-00	RES-CHIP 10K 5%	1/10W
R3302	1-216-089-11	RES-CHIP 47K 5%	1/10W
R3303	1-216-091-00	RES-CHIP 56K 5%	1/10W
R3304	1-216-089-11	RES-CHIP 47K 5%	1/10W
R3305	1-216-091-00	RES-CHIP 56K 5%	1/10W
R3306	1-216-089-11	RES-CHIP 47K 5%	1/10W
R3307	1-216-091-00	RES-CHIP 56K 5%	1/10W
R3308	1-216-089-11	RES-CHIP 47K 5%	1/10W
R3309	1-216-091-00	RES-CHIP 56K 5%	1/10W
< TUNER >			
TU101	1-693-339-21	TUNER/VIF	
< CRYSTAL >			
X201	1-760-628-11	VIBRATOR, CRYSTAL	
X1105	1-760-551-21	VIBRATOR, CERAMIC	
X1107	1-760-105-11	VIBRATOR, CRYSTAL	
X2501	1-567-970-31	VIBRATOR, CRYSTAL	

***A-1632-905-A A1 Board, Complete**

< CAPACITOR >			
C101	1-126-968-11	ELECT 100UF	20.00% 50V
C102	1-126-968-11	ELECT 100UF	20.00% 50V
C103	1-126-968-11	ELECT 100UF	20.00% 50V
C104	1-126-968-11	ELECT 100UF	20.00% 50V
C105	1-126-949-11	ELECT 220UF	20.00% 35V
C106	1-126-968-11	ELECT 100UF	20.00% 50V
C107	1-163-021-91	CERAMIC CHIP 0.01UF	10.00% 50V
C108	1-163-038-11	CERAMIC CHIP 0.1UF	25V
C109	1-163-038-11	CERAMIC CHIP 0.1UF	25V

REF.NO.	PART.NO	DESCRIPTION	REMARK
C110	1-163-021-91	CERAMIC CHIP 0.01UF	10.00% 50V
C111	1-163-038-11	CERAMIC CHIP 0.1UF	25V
C112	1-163-038-11	CERAMIC CHIP 0.1UF	25V
C113	1-163-038-11	CERAMIC CHIP 0.1UF	25V
C114	1-163-038-11	CERAMIC CHIP 0.1UF	25V
C115	1-163-038-11	CERAMIC CHIP 0.1UF	25V
C116	1-163-038-11	CERAMIC CHIP 0.1UF	25V
C118	1-163-038-11	CERAMIC CHIP 0.1UF	25V
C119	1-163-038-11	CERAMIC CHIP 0.1UF	25V
C120	1-126-967-11	ELECT 47UF	20.00% 50V
C121	1-163-038-11	CERAMIC CHIP 0.1UF	25V
< CONNECTOR >			
CN101	1-695-300-11	CONNECTOR, BOARD TO BOARD 20P	
CN102	1-695-300-11	CONNECTOR, BOARD TO BOARD 20P	
< DIODE >			
D102	8-719-812-43	DIODE TLG124A	
D103	8-719-043-11	DIODE MA3330-L-TX	
< FERRITE BEAD >			
FB101	1-414-232-11	FERRITE	0UH
FB102	1-414-232-11	FERRITE	0UH
FB103	1-414-232-11	FERRITE	0UH
FB104	1-414-232-11	FERRITE	0UH
FB105	1-414-232-11	FERRITE	0UH
FB106	1-414-232-11	FERRITE	0UH
FB108	1-414-232-11	FERRITE	0UH
FB109	1-414-232-11	FERRITE	0UH
< IC >			
IC102	8-759-542-06	IC 74LV245D-118	
IC103	8-759-542-06	IC 74LV245D-118	
IC104	8-759-669-71	IC PCF8591T	
IC108	8-759-007-33	TL431CLP	
< COIL >			
L101	1-412-539-11	INDUCTOR	150UH
L102	1-412-539-11	INDUCTOR	150UH
< TRANSISTOR >			
Q101	1-801-806-11	TRANSISTOR DTC144EKA	
Q102	1-801-806-11	TRANSISTOR DTC144EKA	
< RESISTOR >			
JR100	1-216-295-11	SHORT	0
R101	1-216-049-11	RES-CHIP 1K 5%	1/10W
R102	1-216-049-11	RES-CHIP 1K 5%	1/10W

Note : The components identified by shading and marked Δ are critical for safety. Replace only with the part numbers specified in the parts list.

A1 **C**

REF.NO.	PART.NO	DESCRIPTION	REMARK	REF.NO.	PART.NO	DESCRIPTION	REMARK
R103	1-215-892-11	METAL OXIDE	1K 5% 2W	C729	1-136-207-11	MYLAR	0.047UF 10.00% 400V
R104	1-216-025-11	RES-CHIP	100 5% 1/10W	C730	1-102-959-91	CERAMIC	22PF 5.00% 50V
R107	1-216-017-91	RES-CHIP	47 5% 1/10W	< CONNECTOR >			
R108	1-216-017-91	RES-CHIP	47 5% 1/10W	CN701	*1-564-511-11	PLUG, CONNECTOR	8P
R109	1-216-017-91	RES-CHIP	47 5% 1/10W	CN703	1-508-766-00	PIN, CONNECTOR	(5MM PITCH) 4P
R110	1-216-017-91	RES-CHIP	47 5% 1/10W	CN704	1-695-915-11	TAB (CONTACT)	
R111	1-216-017-91	RES-CHIP	47 5% 1/10W	< DIODE >			
R112	1-216-017-91	RES-CHIP	47 5% 1/10W	D701	8-719-991-33	DIODE	1SS133T-77
R113	1-216-017-91	RES-CHIP	47 5% 1/10W	D702	8-719-901-83	DIODE	1SS83
R114	1-216-017-91	RES-CHIP	47 5% 1/10W	D703	8-719-901-83	DIODE	1SS83
R115	1-216-017-91	RES-CHIP	47 5% 1/10W	D704	8-719-901-83	DIODE	1SS83
R116	1-216-017-91	RES-CHIP	47 5% 1/10W	D705	8-719-991-33	DIODE	1SS133T-77
R117	1-216-017-91	RES-CHIP	47 5% 1/10W	D706	8-719-908-03	DIODE	GP08
R118	1-216-025-11	RES-CHIP	100 5% 1/10W	D707	8-719-991-33	DIODE	1SS133T-77
R119	1-216-025-11	RES-CHIP	100 5% 1/10W	D708	8-719-923-60	DIODE	MTZJ-T-77-9.1A
R122	1-216-295-11	SHORT	0	D709	8-719-921-88	DIODE	MTZJ-13B
R125	1-216-295-11	SHORT	0	D711	8-719-911-19	DIODE	1SS119-25
R127	1-216-650-11	METAL CHIP	910 0.5% 1/10W	D712	8-719-911-19	DIODE	1SS119-25
R128	1-216-649-11	METAL CHIP	820 0.5% 1/10W	D714	8-719-982-96	DIODE	MTZJ-T-77-2.2A
R129	1-216-639-11	METAL CHIP	330 0.5% 1/10W	D715	8-719-911-19	DIODE	1SS119-25
R130	1-216-295-11	SHORT	0	D716	8-719-982-96	DIODE	MTZJ-T-77-2.2A
< TUNER >				D721	8-719-031-34	DIODE	RGF02-20EG23
TU101	8-598-572-00	FRONT END BTD-DU603		< IC >			
*A-1638-114-A C Board, Complete							
	4-382-854-11	SCREW (M3X10), P, SW (+)		IC701	8-759-360-83	IC	TDA6111Q/N4
< CAPACITOR >				IC702	8-759-360-83	IC	TDA6111Q/N4
C701	1-107-967-11	ELECT	1UF 20.00% 400V	IC703	8-759-360-83	IC	TDA6111Q/N4
C702	1-107-967-11	ELECT	1UF 20.00% 400V	< SOCKET >			
C703	1-107-967-11	ELECT	1UF 20.00% 400V	J701	Δ 1-540-071-22	SOCKET, CRT	
C704	1-102-129-00	CERAMIC	0.01UF 10.00% 50V	< COIL >			
C705	1-128-528-11	ELECT	470UF 20.00% 16V	L701	1-410-671-31	INDUCTOR	47UH
C706	1-128-528-11	ELECT	470UF 20.00% 16V	L702	1-408-599-31	INDUCTOR	4.7UH
C707	1-128-528-11	ELECT	470UF 20.00% 16V	L703	1-408-599-31	INDUCTOR	4.7UH
C708	1-102-157-00	CERAMIC	560PF 10.00% 500V	L704	1-408-599-31	INDUCTOR	4.7UH
C709	1-102-157-00	CERAMIC	560PF 10.00% 500V	L705	1-408-603-31	INDUCTOR	10UH
C710	1-102-157-00	CERAMIC	560PF 10.00% 500V	L706	1-412-525-31	INDUCTOR	10UH
C711	1-107-907-11	ELECT	22UF 20.00% 50V	< TRANSISTOR >			
C712	1-162-116-00	CERAMIC	680PF 10.00% 2KV	Q701	8-729-255-12	TRANSISTOR	2SC2551-0
C714	1-162-116-00	CERAMIC	680PF 10.00% 2KV	Q702	8-729-255-12	TRANSISTOR	2SC2551-0
C715	1-102-129-00	CERAMIC	0.01UF 10.00% 50V	Q703	8-729-255-12	TRANSISTOR	2SC2551-0
C716	1-102-129-00	CERAMIC	0.01UF 10.00% 50V	Q704	8-729-026-39	TRANSISTOR	2SA933AS-QT
C717	1-107-902-11	ELECT	1UF 20.00% 50V	Q705	8-729-029-56	TRANSISTOR	DTA144ESA
C718	1-107-652-11	ELECT	10UF 20.00% 250V	Q706	8-729-119-78	TRANSISTOR	2SC2785-HFE
C719	1-162-116-00	CERAMIC	680PF 10.00% 2KV				
C727	1-136-207-11	MYLAR	0.047UF 10.00% 400V				
C728	1-136-207-11	MYLAR	0.047UF 10.00% 400V				



REF.NO.	PART.NO	DESCRIPTION	REMARK
< RESISTOR >			
R701	1-249-420-11	CARBON	1.8K 5% 1/4W
R702	1-249-425-11	CARBON	4.7K 5% 1/4W
R703	1-249-435-11	CARBON	33K 5% 1/4W
R704	1-249-429-11	CARBON	10K 5% 1/4W
R705	1-249-430-11	CARBON	12K 5% 1/4W
R706	1-249-433-11	CARBON	22K 5% 1/4W
R707	1-249-433-11	CARBON	22K 5% 1/4W
R708	1-249-433-11	CARBON	22K 5% 1/4W
R709	1-249-415-11	CARBON	680 5% 1/4W
R710	1-249-415-11	CARBON	680 5% 1/4W
R711	1-249-415-11	CARBON	680 5% 1/4W
R712	1-249-421-11	CARBON	2.2K 5% 1/4W
R713	1-249-418-11	CARBON	1.2K 5% 1/4W
R714	1-249-417-11	CARBON	1K 5% 1/4W
R715	1-249-417-11	CARBON	1K 5% 1/4W
R716	1-249-417-11	CARBON	1K 5% 1/4W
R717	1-249-417-11	CARBON	1K 5% 1/4W
R718	1-249-417-11	CARBON	1K 5% 1/4W
R719	1-249-417-11	CARBON	1K 5% 1/4W
R720	1-215-926-00	METAL OXIDE	33K 5% 3W
R721	1-215-926-00	METAL OXIDE	33K 5% 3W
R722	1-215-926-00	METAL OXIDE	33K 5% 3W
R723	1-249-408-11	CARBON	180 5% 1/4W
R724	1-249-408-11	CARBON	180 5% 1/4W
R725	1-249-408-11	CARBON	180 5% 1/4W
R726	1-202-565-00	SOLID	470 20% 1/2W
R727	1-202-565-00	SOLID	470 20% 1/2W
R728	1-202-565-00	SOLID	470 20% 1/2W
R729	1-249-424-11	CARBON	3.9K 5% 1/4W
R730	1-249-424-11	CARBON	3.9K 5% 1/4W
R731	1-249-424-11	CARBON	3.9K 5% 1/4W
R732	1-202-549-00	SOLID	100 20% 1/2W
R733	1-249-433-11	CARBON	22K 5% 1/4W
R734	1-202-549-00	SOLID	100 20% 1/2W
R735	1-249-416-11	CARBON	820 5% 1/4W
R736	1-202-884-11	SOLID	820K 20% 1/2W
R737	1-202-884-11	SOLID	820K 20% 1/2W
R738	1-216-392-11	METAL OXIDE	1.8 5% 3W
R739	1-216-392-11	METAL OXIDE	1.8 5% 3W
R740	1-249-429-11	CARBON	10K 5% 1/4W
R741	1-249-438-11	CARBON	56K 5% 1/4W
R742	1-249-417-11	CARBON	1K 5% 1/4W
R747	1-215-911-11	METAL OXIDE	100 5% 3W
< VARIABLE RESISTOR >			
RV701	1-230-641-11	RES, ADJ, METAL GLAZE 2.2M	
RV702	1-241-656-21	RES, ADJ, METAL FILM 110M	

REF.NO.	PART.NO	DESCRIPTION	REMARK
*A-1640-314-A D2 Board, Complete			
< CAPACITOR >			
C2609	1-104-664-11	ELECT 47UF	20.00% 25V
C2673	1-126-967-11	ELECT 47UF	20.00% 50V
C2676	1-164-004-11	CERAMIC CHIP 0.1UF	10.00% 25V
C2677	1-164-004-11	CERAMIC CHIP 0.1UF	10.00% 25V
< CONNECTOR >			
CN2612	*1-770-748-11	CONNECTOR, BOARD TO BOARD 12P	
< DIODE >			
D2609	8-719-914-43	DIODE DAN202K	
D2620	8-719-914-43	DIODE DAN202K	
D2622	8-719-914-43	DIODE DAN202K	
D2624	8-719-914-43	DIODE DAN202K	
D2666	8-719-978-33	DIODE DTZ-T111-6.8B	
< IC >			
IC2604	8-759-908-15	IC TL431CLP-Z20	
< TRANSISTOR >			
Q2602	8-729-120-28	TRANSISTOR 2SC1623-L5L6	
Q2604	8-729-120-28	TRANSISTOR 2SC1623-L5L6	
Q2605	8-729-026-49	TRANSISTOR 2SA1037AK	
Q2606	8-729-120-28	TRANSISTOR 2SC1623-L5L6	
Q2607	8-729-120-28	TRANSISTOR 2SC1623-L5L6	
Q2608	8-729-026-49	TRANSISTOR 2SA1037AK	
Q2610	8-729-901-00	TRANSISTOR DTC124EK	
Q2613	8-729-900-53	TRANSISTOR DTC114EK	
Q2617	8-729-120-28	TRANSISTOR 2SC1623-L5L6	
Q2618	8-729-900-53	TRANSISTOR DTC114EK	
< RESISTOR >			
R2607	1-216-073-00	RES-CHIP 10K 5%	1/10W
R2608	1-216-057-00	RES-CHIP 2.2K 5%	1/10W
R2618	1-216-065-91	RES-CHIP 4.7K 5%	1/10W
R2620	1-216-073-00	RES-CHIP 10K 5%	1/10W
R2623	1-216-073-00	RES-CHIP 10K 5%	1/10W
R2625	1-216-057-00	RES-CHIP 2.2K 5%	1/10W
R2628	1-216-025-11	RES-CHIP 100 5%	1/10W
R2630	1-216-025-11	RES-CHIP 100 5%	1/10W
R2631	1-216-049-11	RES-CHIP 1K 5%	1/10W
R2632	1-216-049-11	RES-CHIP 1K 5%	1/10W
R2633	1-216-049-11	RES-CHIP 1K 5%	1/10W
R2635	1-216-668-11	METAL CHIP 5.1K 0.5%	1/10W
R2636	1-216-049-11	RES-CHIP 1K 5%	1/10W
R2661	1-216-049-11	RES-CHIP 1K 5%	1/10W
R2668	1-216-081-00	RES-CHIP 22K 5%	1/10W

REF.NO.	PART.NO	DESCRIPTION	REMARK	REF.NO.	PART.NO	DESCRIPTION	REMARK
R2669	1-216-697-91	METAL CHIP 82K 0.5% 1/10W		C1556	1-163-021-91	CERAMIC CHIP 0.01UF	10.00% 50V
R2670	1-216-679-11	METAL CHIP 15K 0.5% 1/10W		C1558	1-102-030-00	CERAMIC 330PF	10.00% 500V
R2671	1-216-675-91	METAL CHIP 10K 0.5% 1/10W		C1560	1-162-117-00	CERAMIC 100PF	10.00% 500V
R2676	1-216-659-11	METAL CHIP 2.2K 0.5% 1/10W		C1562	1-164-004-11	CERAMIC CHIP 0.1UF	10.00% 25V
*A-1642-236-A D1 Board, Complete (KV-28DS65U) *A-1642-237-A D1 Board, Complete (KV-32DS65U)				C1566	1-107-906-11	ELECT 10UF	20.00% 50V
D1 Board Common Parts				C1567	1-164-505-11	CERAMIC CHIP 2.2UF	16V
	4-382-854-11	SCREW (M3X10), P, SW (+)		C1568	1-163-117-00	CERAMIC CHIP 100PF	5.00% 50V
		< CAPACITOR >		C1569	1-107-714-11	ELECT 10UF	20.00% 50V
C1501	1-164-004-11	CERAMIC CHIP 0.1UF	10.00% 25V	C1570	1-115-339-11	CERAMIC CHIP 0.1UF	10.00% 50V
C1502	1-107-909-11	ELECT 47UF	20.00% 50V	C1571	1-136-159-00	FILM 0.033UF	5.00% 50V
C1503	1-136-177-00	FILM 1UF	5.00% 50V	C1573	1-136-153-00	FILM 0.01UF	5.00% 50V
C1504	1-126-964-11	ELECT 10UF	20.00% 50V	C1574	1-104-665-11	ELECT 100UF	20.00% 25V
C1505	1-126-967-11	ELECT 47UF	20.00% 50V	C1578	1-104-329-11	CERAMIC CHIP 0.1UF	10.00% 50V
C1506	1-126-967-11	ELECT 47UF	20.00% 50V	C1579	1-164-492-11	CERAMIC CHIP 0.15UF	10.00% 16V
C1507	1-163-251-11	CERAMIC CHIP 100PF	5.00% 50V	C1580	1-107-902-11	ELECT 1UF	20.00% 50V
C1508	1-164-004-11	CERAMIC CHIP 0.1UF	10.00% 25V	C1587	1-164-346-11	CERAMIC CHIP 1UF	16V
C1509	1-163-809-11	CERAMIC CHIP 0.047UF	10.00% 25V	C1589	1-126-959-11	ELECT 0.47UF	20.00% 50V
C1510	1-136-177-00	FILM 1UF	5.00% 50V	C1590	1-107-882-91	ELECT 100UF	20.00% 16V
C1511	1-104-329-11	CERAMIC CHIP 0.1UF	10.00% 50V	C1591	1-136-165-00	FILM 0.1UF	5.00% 50V
C1512	1-126-967-11	ELECT 47UF	20.00% 50V	C1595	1-163-117-00	CERAMIC CHIP 100PF	5.00% 50V
C1513	1-164-004-11	CERAMIC CHIP 0.1UF	10.00% 25V	C1596	1-107-906-11	ELECT 10UF	20.00% 50V
C1514	1-163-809-11	CERAMIC CHIP 0.047UF	10.00% 25V	C1598	1-107-909-11	ELECT 47UF	20.00% 50V
C1515	1-163-809-11	CERAMIC CHIP 0.047UF	10.00% 25V	C1599	1-107-909-11	ELECT 47UF	20.00% 50V
C1516	1-164-182-11	CERAMIC CHIP 0.0033UF	10.00% 50V	C1601	1-137-389-11	MYLAR 0.0022UF	5.00% 100V
C1518	1-136-479-11	FILM 0.001UF	2.00% 50V	C1602	1-163-021-91	CERAMIC CHIP 0.01UF	10.00% 50V
C1520	1-107-909-11	ELECT 47UF	20.00% 50V	C1603	1-163-021-91	CERAMIC CHIP 0.01UF	10.00% 50V
C1521	1-163-037-11	CERAMIC CHIP 0.022UF	10.00% 50V	C1604	1-137-389-11	MYLAR 0.0022UF	5.00% 100V
C1522	1-104-329-11	CERAMIC CHIP 0.1UF	10.00% 50V	C1605	1-163-021-91	CERAMIC CHIP 0.01UF	10.00% 50V
C1524	1-137-503-11	FILM 100PF	5.00% 100V	C1606	1-163-021-91	CERAMIC CHIP 0.01UF	10.00% 50V
C1526	1-163-021-91	CERAMIC CHIP 0.01UF	10.00% 50V	C1607	1-163-021-91	CERAMIC CHIP 0.01UF	10.00% 50V
C1528	1-163-809-11	CERAMIC CHIP 0.047UF	10.00% 25V	C1609	1-126-964-11	ELECT 10UF	20.00% 50V
C1529	1-102-110-00	CERAMIC 220PF	10.00% 50V	C1610	1-164-505-11	CERAMIC CHIP 2.2UF	16V
C1530	1-136-189-00	MYLAR 0.1UF	10.00% 250V	C1611	1-164-505-11	CERAMIC CHIP 2.2UF	16V
C1531	1-107-906-11	ELECT 10UF	20.00% 50V	C1613	1-164-004-11	CERAMIC CHIP 0.1UF	10.00% 25V
C1532	1-107-906-11	ELECT 10UF	20.00% 50V	C1614	1-164-505-11	CERAMIC CHIP 2.2UF	16V
C1533	1-126-963-11	ELECT 4.7UF	20.00% 50V	< CONNECTOR >			
C1534	1-107-906-11	ELECT 10UF	20.00% 50V	CN1501	1-695-300-11	CONNECTOR, BOARD TO BOARD 20P	
C1535	1-107-902-11	ELECT 1UF	20.00% 50V	CN1503	*1-564-511-61	PLUG, CONNECTOR 8P	
C1537	1-164-690-91	CERAMIC CHIP 0.0022UF	5.00% 50V	CN1504	1-695-300-11	CONNECTOR, BOARD TO BOARD 20P	
C1538	1-126-967-11	ELECT 47UF	20.00% 50V	CN1505	*1-568-878-51	PIN, CONNECTOR 3P	
C1539	1-104-664-11	ELECT 47UF	20.00% 25V	< DIODE >			
C1542	1-163-017-00	CERAMIC CHIP 0.0047UF	10.00% 50V	D1502	8-719-914-43	DIODE DAN202K	
C1543	1-163-809-11	CERAMIC CHIP 0.047UF	10.00% 25V	D1503	8-719-914-43	DIODE DAN202K	
C1550	1-136-207-11	MYLAR 0.047UF	10.00% 250V	D1504	8-719-914-43	DIODE DAN202K	
C1553	1-107-909-11	ELECT 47UF	20.00% 50V	D1506	8-719-914-43	DIODE DAN202K	
C1555	1-126-964-11	ELECT 10UF	20.00% 50V	D1509	8-719-401-32	DIODE MA3047M-TX	
				D1510	8-719-914-43	DIODE DAN202K	
				D1511	8-719-979-85	DIODE EGP20G	

REF.NO.	PART.NO	DESCRIPTION	REMARK	REF.NO.	PART.NO	DESCRIPTION	REMARK
D1512	8-719-914-43	DIODE DAN202K				< TRANSISTOR >	
D1513	8-719-981-94	DIODE MTZJ-2.7A					
D1514	8-719-914-43	DIODE DAN202K		Q1501	8-729-120-28	TRANSISTOR 2SC1623-L5L6	
D1515	8-719-914-43	DIODE DAN202K		Q1505	8-729-120-28	TRANSISTOR 2SC1623-L5L6	
D1516	8-719-914-43	DIODE DAN202K		Q1506	8-729-120-28	TRANSISTOR 2SC1623-L5L6	
				Q1507	8-729-120-28	TRANSISTOR 2SC1623-L5L6	
D1524	8-719-302-43	DIODE EL1Z		Q1508	8-729-045-54	TRANSISTOR 2SK2774-01MR-F1	
D1526	8-719-402-92	DIODE MA3220M-TX					
D1527	8-719-106-71	DIODE RD12M-B2		Q1510	8-729-034-09	TRANSISTOR 2SK2518-01MR	
D1529	8-719-947-06	DIODE RGP10JPKG23		Q1513	8-729-045-54	TRANSISTOR 2SK2774-01MR-F1	
D1530	8-719-971-20	DIODE ERC38-06		Q1514	8-729-119-78	TRANSISTOR 2SC2785-HFE	
				Q1515	8-729-140-97	TRANSISTOR 2SB734-34	
D1531	8-719-914-42	DIODE DA204K		Q1516	8-729-140-97	TRANSISTOR 2SB734-34	
D1532	8-719-914-43	DIODE DAN202K					
D1534	8-719-914-43	DIODE DAN202K		Q1523	8-729-120-28	TRANSISTOR 2SC1623-L5L6	
D1535	8-719-987-87	DIODE ERA85-009		Q1524	8-729-120-28	TRANSISTOR 2SC1623-L5L6	
D1546	8-719-914-43	DIODE DAN202K		Q1526	8-729-120-28	TRANSISTOR 2SC1623-L5L6	
				Q1527	8-729-017-06	TRANSISTOR 2SC4793	
D1547	8-719-914-43	DIODE DAN202K		Q1528	8-729-017-05	TRANSISTOR 2SA1837	
D1548	8-719-914-43	DIODE DAN202K					
D1549	8-719-110-41	DIODE RD15ES-B2		Q1529	8-729-120-28	TRANSISTOR 2SC1623-L5L6	
		< FERRITE BEAD >				< RESISTOR >	
FB1501	1-410-397-21	FERRITE	1.1UH	JR1501	1-216-295-11	SHORT	0
FB1502	1-410-397-21	FERRITE	1.1UH				
				R1500	1-216-049-11	RES-CHIP	1K 5% 1/10W
		< IC >		R1501	1-216-089-11	RES-CHIP	47K 5% 1/10W
IC1501	8-759-325-48	IC CA0005AD		R1502	1-216-081-00	RES-CHIP	22K 5% 1/10W
IC1502	8-759-983-69	IC LM358PS		R1504	1-216-057-00	RES-CHIP	2.2K 5% 1/10W
IC1503	8-759-988-13	IC LM393PS		R1505	1-216-695-11	METAL CHIP	68K 0.5% 1/10W
IC1504	8-759-988-13	IC LM393PS					
IC1505	8-759-988-13	IC LM393PS		R1506	1-216-651-11	METAL CHIP	1K 0.5% 1/10W
				R1507	1-216-097-11	RES-CHIP	100K 5% 1/10W
IC1506	8-759-822-38	IC LA6510		R1508	1-216-073-00	RES-CHIP	10K 5% 1/10W
IC1507	8-759-251-31	IC CA0007AM		R1509	1-216-097-11	RES-CHIP	100K 5% 1/10W
IC1508	8-759-988-13	IC LM393PS		R1510	1-216-675-91	METAL CHIP	10K 0.5% 1/10W
IC1510	8-759-185-47	IC IR2112					
IC1511	8-752-072-94	IC CXA1875AM-T4		R1511	1-216-699-91	METAL CHIP	100K 0.5% 1/10W
				R1512	1-216-059-00	RES-CHIP	2.7K 5% 1/10W
IC1513	8-759-604-39	IC M5F78M12L		R1513	1-216-687-11	METAL CHIP	33K 0.5% 1/10W
IC1515	8-759-983-69	IC LM358PS		R1514	1-216-679-11	METAL CHIP	15K 0.5% 1/10W
IC1517	8-759-325-48	IC CA0005AD		R1515	1-216-699-91	METAL CHIP	100K 0.5% 1/10W
IC1518	8-759-145-58	IC UPC4558C					
IC1519	8-759-983-69	IC LM358PS		R1516	1-216-675-91	METAL CHIP	10K 0.5% 1/10W
				R1517	1-216-049-11	RES-CHIP	1K 5% 1/10W
		< COIL >		R1518	1-216-041-00	RES-CHIP	470 5% 1/10W
L1501	1-406-989-21	INDUCTOR	10MH	R1519	1-216-065-91	RES-CHIP	4.7K 5% 1/10W
L1504	1-411-557-11	INDUCTOR	4.5UH	R1520	1-216-675-91	METAL CHIP	10K 0.5% 1/10W
L1507	1-406-989-21	INDUCTOR	10MH				
L1508	1-412-537-31	INDUCTOR	100UH	R1522	1-216-081-00	RES-CHIP	22K 5% 1/10W
L1518	1-406-680-11	INDUCTOR	33MH	R1523	1-216-677-11	METAL CHIP	12K 0.5% 1/10W
				R1524	1-216-675-91	METAL CHIP	10K 0.5% 1/10W
L1519	1-412-531-31	INDUCTOR	33UH	R1525	1-216-065-91	RES-CHIP	4.7K 5% 1/10W
				R1526	1-216-295-11	SHORT	0
				R1527	1-216-675-91	METAL CHIP	10K 0.5% 1/10W
				R1528	1-216-681-11	METAL CHIP	18K 0.5% 1/10W
				R1529	1-216-675-91	METAL CHIP	10K 0.5% 1/10W

REF.NO.	PART.NO	DESCRIPTION	REMARK	REF.NO.	PART.NO	DESCRIPTION	REMARK
R1530	1-249-417-11	CARBON	1K 5% 1/4W	R1590	1-216-073-00	RES-CHIP	10K 5% 1/10W
R1531	1-218-754-11	METAL CHIP	120K 0.5% 1/10W	R1593	1-216-055-00	RES-CHIP	1.8K 5% 1/10W
R1532	1-216-670-11	METAL CHIP	6.2K 0.5% 1/10W	R1595	1-216-295-11	SHORT	0
R1533	1-216-069-00	RES-CHIP	6.8K 5% 1/10W	R1597	1-216-097-11	RES-CHIP	100K 5% 1/10W
R1534	1-216-699-91	METAL CHIP	100K 0.5% 1/10W	R1598	1-216-083-00	RES-CHIP	27K 5% 1/10W
R1538	1-216-065-91	RES-CHIP	4.7K 5% 1/10W	R1599	1-216-089-11	RES-CHIP	47K 5% 1/10W
R1539	1-216-073-00	RES-CHIP	10K 5% 1/10W	R1600	1-249-441-11	CARBON	100K 5% 1/4W
R1540	1-216-065-91	RES-CHIP	4.7K 5% 1/10W	R1602	1-216-097-11	RES-CHIP	100K 5% 1/10W
R1541	1-216-295-11	SHORT	0	R1604	1-260-323-71	CARBON	390 5% 1/2W
R1542	1-216-295-11	SHORT	0	R1606	1-216-033-00	RES-CHIP	220 5% 1/10W
R1543	1-249-415-11	CARBON	680 5% 1/4W	R1607	1-216-049-11	RES-CHIP	1K 5% 1/10W
R1545	1-216-043-91	RES-CHIP	560 5% 1/10W	R1608	1-216-025-11	RES-CHIP	100 5% 1/10W
R1547	1-216-675-91	METAL CHIP	10K 0.5% 1/10W	R1609	1-216-025-11	RES-CHIP	100 5% 1/10W
R1548	1-216-675-91	METAL CHIP	10K 0.5% 1/10W	R1610	1-216-025-11	RES-CHIP	100 5% 1/10W
R1549	1-216-073-00	RES-CHIP	10K 5% 1/10W	R1611	1-216-049-11	RES-CHIP	1K 5% 1/10W
R1550	1-216-077-91	RES-CHIP	15K 5% 1/10W	R1612	1-216-049-11	RES-CHIP	1K 5% 1/10W
R1551	1-216-676-11	METAL CHIP	11K 0.5% 1/10W	R1613	1-249-385-11	CARBON	2.2 5% 1/4W
R1552	1-216-674-11	METAL CHIP	9.1K 0.5% 1/10W	R1616	1-216-089-11	RES-CHIP	47K 5% 1/10W
R1553	1-216-667-11	METAL CHIP	4.7K 0.5% 1/10W	R1618	1-216-101-00	RES-CHIP	150K 5% 1/10W
R1554	1-216-061-00	RES-CHIP	3.3K 5% 1/10W	R1619	1-216-695-11	METAL CHIP	68K 0.5% 1/10W
R1555	1-216-295-11	SHORT	0	R1620	1-216-695-11	METAL CHIP	68K 0.5% 1/10W
R1556	1-216-025-11	RES-CHIP	100 5% 1/10W	R1621	1-216-669-11	METAL CHIP	5.6K 0.5% 1/10W
R1559	1-216-099-00	RES-CHIP	120K 5% 1/10W	R1622	1-216-069-00	RES-CHIP	6.8K 5% 1/10W
R1560	1-216-073-00	RES-CHIP	10K 5% 1/10W	R1623	1-216-085-00	RES-CHIP	33K 5% 1/10W
R1561	1-216-097-11	RES-CHIP	100K 5% 1/10W	R1624	1-216-295-11	SHORT	0
R1562	1-216-073-00	RES-CHIP	10K 5% 1/10W	R1627	1-216-681-11	METAL CHIP	18K 0.5% 1/10W
R1563	1-216-097-11	RES-CHIP	100K 5% 1/10W	R1628	1-218-762-11	METAL CHIP	270K 0.5% 1/10W
R1564	1-216-081-00	RES-CHIP	22K 5% 1/10W	R1629	1-218-774-11	METAL CHIP	820K 0.5% 1/10W
R1565	1-216-689-11	METAL CHIP	39K 0.5% 1/10W	R1631	1-216-675-91	METAL CHIP	10K 0.5% 1/10W
R1566	1-216-679-11	METAL CHIP	15K 0.5% 1/10W	R1632	1-216-677-11	METAL CHIP	12K 0.5% 1/10W
R1567	1-216-057-00	RES-CHIP	2.2K 5% 1/10W	R1633	1-216-675-91	METAL CHIP	10K 0.5% 1/10W
R1568	1-216-677-11	METAL CHIP	12K 0.5% 1/10W	R1635	1-216-047-91	RES-CHIP	820 5% 1/10W
R1569	1-216-677-11	METAL CHIP	12K 0.5% 1/10W	R1636	1-216-057-00	RES-CHIP	2.2K 5% 1/10W
R1570	1-216-081-00	RES-CHIP	22K 5% 1/10W	R1637	1-216-033-00	RES-CHIP	220 5% 1/10W
R1571	1-216-059-00	RES-CHIP	2.7K 5% 1/10W	R1640	1-216-675-91	METAL CHIP	10K 0.5% 1/10W
R1572	1-216-073-00	RES-CHIP	10K 5% 1/10W	R1642	1-216-057-00	RES-CHIP	2.2K 5% 1/10W
R1573	1-216-073-00	RES-CHIP	10K 5% 1/10W	R1643	1-216-033-00	RES-CHIP	220 5% 1/10W
R1574	1-216-059-00	RES-CHIP	2.7K 5% 1/10W	R1646	1-218-762-11	METAL CHIP	270K 0.5% 1/10W
R1575	1-216-089-11	RES-CHIP	47K 5% 1/10W	R1649	1-216-689-11	METAL CHIP	39K 0.5% 1/10W
R1576	1-216-065-91	RES-CHIP	4.7K 5% 1/10W	R1653	1-216-057-00	RES-CHIP	2.2K 5% 1/10W
R1577	1-216-059-00	RES-CHIP	2.7K 5% 1/10W	R1654	1-215-898-11	METAL OXIDE	10K 5% 2W
R1578	1-216-295-11	SHORT	0	R1655	1-216-105-91	RES-CHIP	220K 5% 1/10W
R1579	1-216-061-00	RES-CHIP	3.3K 5% 1/10W	R1656	1-216-073-00	RES-CHIP	10K 5% 1/10W
R1580	1-216-049-11	RES-CHIP	1K 5% 1/10W	R1657	1-215-880-00	METAL OXIDE	10 5% 2W
R1581	1-216-049-11	RES-CHIP	1K 5% 1/10W	R1658	1-249-385-11	CARBON	2.2 5% 1/4W
R1583	1-216-073-00	RES-CHIP	10K 5% 1/10W	R1659	1-216-063-91	RES-CHIP	3.9K 5% 1/10W
R1584	1-216-049-11	RES-CHIP	1K 5% 1/10W	R1660	1-216-295-11	SHORT	0
R1587	1-216-079-00	RES-CHIP	18K 5% 1/10W	R1661	1-216-295-11	SHORT	0
R1588	1-216-057-00	RES-CHIP	2.2K 5% 1/10W	R1663	1-216-485-11	METAL OXIDE	5.6K 5% 3W
R1589	1-216-049-11	RES-CHIP	1K 5% 1/10W	R1667	1-216-101-00	RES-CHIP	150K 5% 1/10W

D1

Note : The components identified by shading and marked Δ are critical for safety. Replace only with the part numbers specified in the parts list.

REF.NO.	PART.NO	DESCRIPTION	REMARK
R1668	1-216-049-11	RES-CHIP 1K 5%	1/10W
R1669	1-216-049-11	RES-CHIP 1K 5%	1/10W
R1670	1-216-675-91	METAL CHIP 10K 0.5%	1/10W
R1671	1-216-077-91	RES-CHIP 15K 5%	1/10W
R1672	1-216-067-00	RES-CHIP 5.6K 5%	1/10W
R1673	1-216-073-00	RES-CHIP 10K 5%	1/10W
R1674	1-216-053-00	RES-CHIP 1.5K 5%	1/10W
R1687	1-216-485-11	METAL OXIDE 5.6K 5%	3W
R1692	1-216-097-11	RES-CHIP 100K 5%	1/10W
R1695	1-216-101-00	RES-CHIP 150K 5%	1/10W
R1696	1-216-097-11	RES-CHIP 100K 5%	1/10W
R1697	1-216-073-00	RES-CHIP 10K 5%	1/10W
R1698	1-216-061-00	RES-CHIP 3.3K 5%	1/10W
R1699	1-216-077-91	RES-CHIP 15K 5%	1/10W
R1700	1-216-085-00	RES-CHIP 33K 5%	1/10W
R1701	1-216-089-11	RES-CHIP 47K 5%	1/10W
R1702	1-216-081-00	RES-CHIP 22K 5%	1/10W
R1703	1-216-055-00	RES-CHIP 1.8K 5%	1/10W
R1704	1-216-057-00	RES-CHIP 2.2K 5%	1/10W
R1705	1-216-065-91	RES-CHIP 4.7K 5%	1/10W
R1709	1-216-061-00	RES-CHIP 3.3K 5%	1/10W
R1711	1-216-069-00	RES-CHIP 6.8K 5%	1/10W
R1713	1-216-081-00	RES-CHIP 22K 5%	1/10W
R1714	1-216-081-00	RES-CHIP 22K 5%	1/10W
R1715	1-216-051-00	RES-CHIP 1.2K 5%	1/10W
R1716	1-216-089-11	RES-CHIP 47K 5%	1/10W
R1717	1-216-057-00	RES-CHIP 2.2K 5%	1/10W
R1719	1-216-101-00	RES-CHIP 150K 5%	1/10W
R1720	1-216-079-00	RES-CHIP 18K 5%	1/10W
R1721	1-216-065-91	RES-CHIP 4.7K 5%	1/10W
R1728	1-216-081-00	RES-CHIP 22K 5%	1/10W
R1730	1-216-091-00	RES-CHIP 56K 5%	1/10W
R1731	1-216-025-11	RES-CHIP 100 5%	1/10W
R1732	1-216-025-11	RES-CHIP 100 5%	1/10W
R1733	1-216-125-00	RES-CHIP 1.5M 5%	1/10W
R1734	1-216-125-00	RES-CHIP 1.5M 5%	1/10W
R1735	1-216-069-00	RES-CHIP 6.8K 5%	1/10W
R1736	1-216-085-00	RES-CHIP 33K 5%	1/10W
R1739	1-216-295-11	SHORT 0	
R1743	1-216-055-00	RES-CHIP 1.8K 5%	1/10W
< VARIABLE RESISTOR >			
RV1502	1-241-765-11	RES, ADJ, CARBON 22K	
RV1503	1-241-765-11	RES, ADJ, CARBON 22K	
RV1504	1-241-765-11	RES, ADJ, CARBON 22K	

REF.NO.	PART.NO	DESCRIPTION	REMARK
---------	---------	-------------	--------

D1 Board Variant Parts KV-28DS65U

< CAPACITOR >

C1525	1-129-716-00	FILM 0.015UF 5.00%	630V
C1551	1-115-516-11	FILM 0.33UF 5.00%	250V
C1572	1-130-834-00	MYLAR 1UF 20.00%	63V
C1576	1-129-718-00	FILM 0.022UF 5.00%	630V

< IC LINK >

PS1502 Δ 1-533-593-31 LINK, IC

< TRANSISTOR >

Q1502	8-729-026-49	TRANSISTOR 2SA1037AK	
Q1503	8-729-026-49	TRANSISTOR 2SA1037AK	
Q1504	8-729-026-49	TRANSISTOR 2SA1037AK	
Q1509	8-729-026-49	TRANSISTOR 2SA1037AK	
Q1522	8-729-026-49	TRANSISTOR 2SA1037AK	
Q1530	8-729-026-49	TRANSISTOR 2SA1037AK	
Q1531	8-729-026-49	TRANSISTOR 2SA1037AK	

< RESISTOR >

R1535	1-216-679-11	METAL CHIP 15K 0.5%	1/10W
R1537	1-216-683-11	METAL CHIP 22K 0.5%	1/10W
R1614	1-240-265-11	CMT-MELF 2.7 5%	10W
R1615	1-240-265-11	CMT-MELF 2.7 5%	10W
R1630	1-216-673-11	METAL CHIP 8.2K 0.5%	1/10W
R1639	1-215-911-11	METAL OXIDE 100 5%	3W
R1641	1-216-677-11	METAL CHIP 12K 0.5%	1/10W
R1650	1-216-688-11	METAL CHIP 36K 0.5%	1/10W
R1664	1-215-922-11	METAL OXIDE 6.8K 5%	3W
R1665	1-215-922-11	METAL OXIDE 6.8K 5%	3W
R1675	1-240-265-11	CMT-MELF 2.7 5%	1/10W
R1688	1-240-265-11	CMT-MELF 2.7 5%	1/10W
R1708	1-216-101-00	RES-CHIP 150K 5%	1/10W

D1 Board Variant Parts KV-32DS65U

< CAPACITOR >

C1525	1-136-347-11	FILM 0.0047UF 5.00%	630V
C1551	1-117-451-11	FILM 0.43UF 5.00%	250V
C1572	1-136-165-00	FILM 0.1UF 5.00%	50V
C1576	1-129-716-00	FILM 0.015UF 5.00%	630V
C1577	1-136-347-11	FILM 0.0047UF 5.00%	630V

< IC LINK >

PS1502 Δ 1-532-841-21 LINK, IC

Note : The components identified by shading and marked Δ are critical for safety. Replace only with the part numbers specified in the parts list.

D1 D

REF.NO.	PART.NO	DESCRIPTION	REMARK	REF.NO.	PART.NO	DESCRIPTION	REMARK
< TRANSISTOR >				C525	1-107-906-11	ELECT 10UF	20.00% 50V
Q1502	8-729-216-22	TRANSISTOR 2SA1162G		C528	1-102-030-00	CERAMIC 330PF	10.00% 500V
Q1503	8-729-216-22	TRANSISTOR 2SA1162G		C535	1-107-655-11	ELECT 47UF	20.00% 250V
Q1504	8-729-216-22	TRANSISTOR 2SA1162G		C536	1-102-228-00	CERAMIC 470PF	10.00% 500V
Q1509	8-729-216-22	TRANSISTOR 2SA1162G		C537	1-102-228-00	CERAMIC 470PF	10.00% 500V
Q1522	8-729-216-22	TRANSISTOR 2SA1162G		C538	1-102-228-00	CERAMIC 470PF	10.00% 500V
Q1530	8-729-216-22	TRANSISTOR 2SA1162G		C541	1-106-375-12	MYLAR 0.022UF	10.00% 250V
Q1531	8-729-216-22	TRANSISTOR 2SA1162G		C548	1-162-131-11	CERAMIC 220PF	10.00% 2KV
< RESISTOR >				C549	1-162-129-00	CERAMIC 150PF	10.00% 2KV
R1535	1-216-677-11	METAL CHIP 12K 0.5% 1/10W		C552	1-126-968-11	ELECT 100UF	20.00% 50V
R1537	1-216-685-11	METAL CHIP 27K 0.5% 1/10W		C554	1-102-129-00	CERAMIC 0.01UF	10.00% 50V
R1614	1-240-581-11	CEMENTED 3.9 5% 10W		C555	1-126-941-11	ELECT 470UF	20.00% 25V
R1615	1-240-581-11	CEMENTED 3.9 5% 10W		C556	1-102-129-00	CERAMIC 0.01UF	10.00% 50V
R1630	1-216-671-11	METAL CHIP 6.8K 0.5% 1/10W		C557	1-126-941-11	ELECT 470UF	20.00% 25V
R1639	1-216-474-11	METAL OXIDE 82 5% 3W		C560	1-137-401-11	MYLAR 0.22UF	10.00% 100V
R1641	1-216-675-91	METAL CHIP 10K 0.5% 1/10W		C561	1-106-220-00	MYLAR 0.1UF	10.00% 100V
R1647	1-218-760-11	METAL CHIP 220K 0.5% 1/10W		C562	1-130-785-11	MYLAR 0.47UF	10.00% 100V
R1650	1-216-689-11	METAL CHIP 39K 0.5% 1/10W		C573	1-162-115-00	CERAMIC 330PF	10.00% 2KV
R1664	1-216-485-11	METAL OXIDE 5.6K 5% 3W		C576	1-129-702-00	MYLAR 0.001UF	10.00% 400V
R1665	1-216-485-11	METAL OXIDE 5.6K 5% 3W		C580	1-102-030-00	CERAMIC 330PF	10.00% 500V
R1666	1-218-762-11	METAL CHIP 270K 0.5% 1/10W		C581	1-136-205-11	MYLAR 0.022UF	10.00% 400V
R1675	1-240-581-11	CEMENTED 3.9 5% 10W		C582	1-129-898-00	FILM 0.0022UF	5.00% 630V
R1688	1-240-581-11	CEMENTED 3.9 5% 10W		C583	1-130-785-11	MYLAR 0.47UF	10.00% 100V
R1708	1-216-105-91	RES-CHIP 220K 5% 1/10W		C584	1-104-696-11	MYLAR 0.015UF	10.00% 250V
< CAPACITOR >				C601	1-126-965-11	ELECT 22UF	20.00% 50V
C501	1-123-024-21	ELECT 33UF 160V		C603	Δ 1-136-415-51	FILM 0.33UF	20.00% 300V
C502	1-136-207-11	MYLAR 0.047UF 10.00% 250V		C604	1-164-625-11	CERAMIC 680PF	10.00% 500V
C503	1-128-527-11	ELECT 330UF 20.00% 25V		C606	Δ 1-161-964-51	CERAMIC 0.0047UF	250V
C504	1-128-527-11	ELECT 330UF 20.00% 25V		C610	1-161-964-51	CERAMIC 0.0047UF	250V
C505	1-102-212-00	CERAMIC 820PF 10.00% 500V		C611	Δ 1-113-927-11	CERAMIC 10000PF	20.00% 250V
C508	1-162-116-00	CERAMIC 680PF 10.00% 2KV		C613	1-161-964-51	CERAMIC 0.0047UF	250V
C509	1-162-116-00	CERAMIC 680PF 10.00% 2KV		C614	1-164-645-11	CERAMIC 1000PF	10.00% 500V
C510	1-136-558-11	MYLAR 0.0039UF 10.00% 400V		C616	1-117-753-11	ELECT (BLOCK) 470UF	20.00% 450V
C512	1-129-717-00	FILM 0.018UF 5.00% 630V		C618	1-137-194-81	FILM 0.47UF	5.00% 50V
C513	1-115-177-11	FILM 6.8UF 5.00% 160V		C619	1-117-976-11	FILM 0.039UF	5.00% 800V
C514	1-137-043-11	MYLAR 0.0047UF 10.00% 400V		C620	1-136-171-00	FILM 0.33UF	5.00% 50V
C519	1-104-696-11	MYLAR 0.015UF 10.00% 250V		C621	1-136-171-00	FILM 0.33UF	5.00% 50V
C521	1-102-002-00	CERAMIC 680PF 10.00% 500V		C622	1-137-194-81	FILM 0.47UF	5.00% 50V
				C623	1-126-968-11	ELECT 100UF	20.00% 50V
				C625	1-128-548-11	ELECT 4700UF	20.00% 25V
				C626	1-128-548-11	ELECT 4700UF	20.00% 25V
				C627	1-126-936-11	ELECT 3300UF	20.00% 16V
				C628	1-126-943-11	ELECT 2200UF	20.00% 25V
				C629	1-110-626-11	ELECT 330UF	20.00% 160V
				C630	1-102-129-00	CERAMIC 0.01UF	10.00% 50V
				C631	1-102-129-00	CERAMIC 0.01UF	10.00% 50V
				C633	1-137-368-11	MYLAR 0.0047UF	5.00% 50V
				C634	1-106-351-00	MYLAR 0.0022UF	99% 200V
				C639	1-164-625-11	CERAMIC 680PF	10.00% 500V
				C640	1-137-194-81	FILM 0.47UF	5.00% 50V

***A-1642-235-A D Board, Complete (KV-28DS65U)**
***A-1642-238-A D Board, Complete (KV-32DS65U)**

D Board Common Parts

- 4-200-399-01 SPACER, IC
- 4-201-023-01 SPACER, INSULATING
- 4-202-373-01 SPRING, IC
- 4-309-378-00 WASHER
- 4-382-854-11 SCREW (M3X10), P, SW (+)

D

Note : The components identified by shading and marked Δ are critical for safety. Replace only with the part numbers specified in the parts list.

REF.NO.	PART.NO	DESCRIPTION	REMARK
C642	1-128-579-11	ELECT	2.2UF 20.00% 100V
C643	1-125-991-11	ELECT	180UF 20% 450V
C644	1-107-824-11	CERAMIC	220PF 5.00% 1KV
C645	1-136-169-00	FILM	0.22UF 5.00% 50V
C646	1-136-164-00	FILM	0.082UF 5.00% 50V
C647	1-107-824-11	CERAMIC	220PF 5.00% 1KV
C648	1-136-169-00	FILM	0.22UF 5.00% 50V
C649	1-136-164-00	FILM	0.082UF 5.00% 50V
C650	1-117-631-21	FILM	3300PF 3.00% 1.2KV
C651	1-136-157-00	FILM	0.022UF 5.00% 50V
C652	1-136-165-00	FILM	0.1UF 5.00% 50V
C653	1-126-965-11	ELECT	22UF 20.00% 50V
C654	1-126-967-11	ELECT	47UF 20.00% 50V
C655	1-126-941-11	ELECT	470UF 20.00% 25V
C656	1-126-967-11	ELECT	47UF 20.00% 50V
C657	1-126-967-11	ELECT	47UF 20.00% 50V
C659	1-126-936-11	ELECT	3300UF 20.00% 16V
C660	1-126-936-11	ELECT	3300UF 20.00% 16V
C661	1-126-935-11	ELECT	470UF 20.00% 16V
C662	1-126-935-11	ELECT	470UF 20.00% 16V
C663	Δ 1-113-920-11	CERAMIC	0.0022UF 20.00% 250V
C664	Δ 1-113-920-11	CERAMIC	0.0022UF 20.00% 250V
C671	1-107-906-11	ELECT	10UF 20.00% 50V
C672	1-136-165-00	FILM	0.1UF 5.00% 50V
C674	1-164-625-11	CERAMIC	680PF 10.00% 500V
C675	1-164-625-11	CERAMIC	680PF 10.00% 500V
C683	1-126-965-11	ELECT	22UF 20.00% 50V
C684	1-126-940-11	ELECT	330UF 20.00% 25V
C685	1-107-824-11	CERAMIC	220PF 5.00% 1KV
< CONNECTOR >			
CN502	*1-580-798-11	CONNECTOR PIN (DY) 6P	
CN504	1-900-902-85	CONNECTOR ASSY, MICRO 8P	
CN505	1-695-297-11	CONNECTOR, BOARD TO BOARD 20P	
CN507	1-568-878-51	PIN, CONNECTOR 3P	
CN509	1-508-766-00	PIN, CONNECTOR (5MM PITCH) 4P	
CN510	1-900-902-82	CONNECTOR ASSY, MICRO 5P	
CN511	1-695-297-11	CONNECTOR, BOARD TO BOARD 20P	
CN512	1-568-878-51	PIN, CONNECTOR 3P	
CN601	Δ *1-691-291-11	PIN, CONNECTOR (PC BOARD) 5P	
CN602	Δ *1-691-960-11	PIN, CONNECTOR (PC BOARD) 3P	
CN604	Δ *1-508-786-00	PIN, CONNECTOR (5MM PITCH) 2P	
CN606	Δ 1-508-765-00	PIN, CONNECTOR (5MM PITCH) 3P	
CN607	*1-568-881-51	PIN, CONNECTOR 6P	
CN608	1-900-902-83	CONNECTOR ASSY, MICRO 6P	
CN609	1-900-902-83	CONNECTOR ASSY, MICRO 6P	
CN611	1-900-902-83	CONNECTOR ASSY, MICRO 6P	
CN612	*1-770-747-11	CONNECTOR, BOARD TO BOARD 12P	

REF.NO.	PART.NO	DESCRIPTION	REMARK
< DIODE >			
D501	8-719-987-84	DIODE ERB38-04	
D502	8-719-979-99	DIODE ERD08M-15	
D503	8-719-052-09	DIODE FMG-36S-LF024	
D504	8-719-987-84	DIODE ERB38-04	
D505	8-719-908-03	DIODE GP08D	
D506	8-719-908-03	DIODE GP08D	
D510	8-719-979-85	DIODE EGP20G	
D511	8-719-302-43	DIODE EL1Z	
D512	8-719-052-90	DIODE D1NL40-TA2	
D513	8-719-052-90	DIODE D1NL40-TA2	
D514	8-719-908-03	DIODE GP08D	
D516	8-719-110-41	DIODE RD15ES-B2	
D520	8-719-970-87	DIODE ERA38-06	
D521	8-719-970-87	DIODE ERA38-06	
D600	8-719-911-19	DIODE 1SS119-25	
D601	8-719-025-88	DIODE GBU4JL-6088	
D603	8-719-510-53	DIODE D4SB60L	
D607	8-719-991-33	DIODE 1SS133T-77	
D608	8-719-063-73	DIODE D1NL20U-TR	
D610	8-719-079-50	DIODE RBV-402L	
D611	8-719-510-12	DIODE D10SC4M	
D612	8-719-510-12	DIODE D10SC4M	
D613	8-719-500-71	DIODE D8LC40	
D614	8-719-911-19	DIODE 1SS119-25	
D615	8-719-063-73	DIODE D1NL20U-TR	
D616	8-719-063-73	DIODE D1NL20U-TR	
D617	8-719-991-33	DIODE 1SS133T-77	
D618	8-719-911-19	DIODE 1SS119-25	
D619	8-719-110-57	DIODE RD22ES-B2	
D620	8-719-160-65	DIODE RD16FB2	
D621	8-719-991-33	DIODE 1SS133T-77	
D659	8-719-911-19	DIODE 1SS119-25	
D660	8-719-982-27	DIODE MT2J-33C	
D661	8-719-991-33	DIODE 1SS133T-77	
D662	8-719-991-33	DIODE 1SS133T-77	
D663	8-719-991-33	DIODE 1SS133T-77	
D664	8-719-911-19	DIODE 1SS119-25	
D665	8-719-911-19	DIODE 1SS119-25	
D667	8-719-911-19	DIODE 1SS119-25	
D668	8-719-109-89	DIODE RD5.6ESB2	
D669	8-719-510-12	DIODE D10SC4M	
D670	8-719-040-01	DIODE FMB-22H	
D671	8-719-040-01	DIODE FMB-22H	
< FERRITE BEAD >			
FB600	1-410-396-41	FERRITE	0.45UH
FB601	1-410-396-41	FERRITE	0.45UH

Note : The components identified by shading and marked Δ are critical for safety. Replace only with the part numbers specified in the parts list.

D

REF.NO.	PART.NO	DESCRIPTION	REMARK	REF.NO.	PART.NO	DESCRIPTION	REMARK
	< IC >						
IC502	8-759-192-71	IC STV9379		Q615	8-729-119-78	TRANSISTOR 2SC2785-HFE	
IC601	8-749-010-64	PHOTO COUPLER PC123F2		Q619	8-729-119-78	TRANSISTOR 2SC2785-HFE	
IC602	8-729-043-26	TRANSISTOR MX0841T-F			< RESISTOR >		
IC603	1-810-050-11	POWER MODULE DM-47		R503	1-216-481-11	METAL OXIDE 1.2K 5%	3W
IC605	8-729-045-61	TRANSISTOR MX0542AB-F		R505	1-216-487-11	METAL OXIDE 12K 5%	3W
				R506	1-249-411-11	CARBON 330 5%	1/4W
IC606	8-759-908-15	IC TL431CLP		R507	1-247-843-11	CARBON 3.3K 5%	1/4W
				R509	1-215-905-11	METAL OXIDE 10 5%	3W
	< COIL >						
L507	1-412-524-11	INDUCTOR 8.2UH		R511	1-216-434-11	METAL OXIDE 1.8K 5%	1W
L508	1-535-303-00	LEAD, JUMPER (5.0MM)		R517	1-202-972-61	FUSIBLE 1 5%	1/4W
L509	1-535-303-00	LEAD, JUMPER (5.0MM)		R518	1-249-377-11	CARBON 0.47 5%	1/4W
L510	1-535-303-00	LEAD, JUMPER (5.0MM)		R519	1-260-288-11	CARBON 0.47 5%	1/2W
L511	1-459-104-00	COIL, WITH CORE		R520	1-214-907-00	METAL 56K 1%	1/2W
L516	1-408-947-00	INDUCTOR 2.2MH		R521	1-535-303-00	LEAD, JUMPER (5.0MM)	
L521	1-416-675-21	INDUCTOR 3.3UH		R533	1-249-417-11	CARBON 1K 5%	1/4W
L601	1-535-303-00	LEAD, JUMPER (5.0MM)		R534	1-249-441-11	CARBON 100K 5%	1/4W
L602	1-535-303-00	LEAD, JUMPER (5.0MM)		R535	1-249-441-11	CARBON 100K 5%	1/4W
L603	1-406-658-21	INDUCTOR 6.8UH		R536	1-249-441-11	CARBON 100K 5%	1/4W
L604	1-406-658-21	INDUCTOR 6.8UH		R543	1-215-894-11	METAL OXIDE 2.2K 5%	2W
L605	1-535-303-00	LEAD, JUMPER (5.0MM)		R544	1-249-424-11	CARBON 3.9K 5%	1/4W
L607	1-412-525-31	INDUCTOR 10UH		R545	1-247-881-00	CARBON 120K 5%	1/4W
L608	1-412-525-31	INDUCTOR 10UH		R550	1-249-383-11	CARBON 1.5 5%	1/4W
L610	1-412-525-31	INDUCTOR 10UH		R554	1-215-449-00	METAL 15K 1%	1/4W
L614	1-412-525-31	INDUCTOR 10UH		R555	1-214-798-21	METAL 1.8 1%	1/2W
L615	1-412-525-31	INDUCTOR 10UH		R557	1-215-894-11	METAL OXIDE 2.2K 5%	2W
L616	1-535-303-00	LEAD, JUMPER (5.0MM)		R559	1-215-438-00	METAL 5.1K 1%	1/4W
				R560	1-247-843-11	CARBON 3.3K 5%	1/4W
				R561	1-215-373-31	METAL 10 1%	1/4W
	< IC LINK >						
PS601	Δ 1-801-550-21	PROTECTOR, MODULE 2.5A MP250		R562	1-249-383-11	CARBON 1.5 5%	1/4W
PS602	Δ 1-533-597-31	LINK, IC		R563	1-215-888-00	METAL OXIDE 220 5%	2W
PS603	Δ 1-801-550-21	PROTECTOR, MODULE 2.5A MP250		R565	1-215-449-00	METAL 15K 1%	1/4W
PS604	Δ 1-801-550-21	PROTECTOR, MODULE 2.5A MP250		R566	1-215-438-00	METAL 5.1K 1%	1/4W
PS605	Δ 1-801-550-21	PROTECTOR, MODULE 2.5A MP250		R567	1-214-798-21	METAL 1.8 1%	1/2W
PS606	Δ 1-801-550-21	PROTECTOR, MODULE 2.5A MP250		R568	1-249-418-11	CARBON 1.2K 5%	1/4W
PS607	Δ 1-532-637-00	LINK, IC 1A ICP-F25		R601	Δ 1-218-265-11	METAL 8.2M 5%	1W
PS608	Δ 1-801-549-21	PROTECTOR, MODULE		R602	1-217-418-61	FUSIBLE 0.47 10%	1/2W
PS609	Δ 1-801-550-21	PROTECTOR, MODULE 2.5A MP250		R603	1-260-127-11	CARBON 220K 5%	1/2W
				R604	1-260-127-11	CARBON 220K 5%	1/2W
	< TRANSISTOR >						
Q501	8-729-119-80	TRANSISTOR 2SC2688-LK		R605	1-249-391-11	CARBON 6.8 5%	1/4W
Q502	8-729-821-07	TRANSISTOR 2SC3997CA		R607	1-260-127-11	CARBON 220K 5%	1/2W
Q504	8-729-039-68	TRANSISTOR IRF620		R608	1-260-127-11	CARBON 220K 5%	1/2W
Q505	8-729-043-95	TRANSISTOR 2SC3840 (3)		R609	1-249-417-11	CARBON 1K 5%	1/4W
Q601	8-729-026-39	TRANSISTOR 2SA933AS-QT		R610	1-260-129-11	CARBON 330K 5%	1/2W
Q609	8-729-029-56	TRANSISTOR DTA144ESA		R611	1-260-129-11	CARBON 330K 5%	1/2W
Q611	8-729-029-56	TRANSISTOR DTA144ESA		R612	1-216-369-00	METAL OXIDE 1 5%	2W
Q612	8-729-119-78	TRANSISTOR 2SC2785-HFE		R613	1-207-905-00	WIREWOUND 0.27 10%	2W
Q614	8-729-026-39	TRANSISTOR 2SA933AS-QT		R614	1-260-129-11	CARBON 330K 5%	1/2W
				R615	1-260-129-11	CARBON 330K 5%	1/2W

D

Note : The components identified by shading and marked Δ are critical for safety. Replace only with the part numbers specified in the parts list.

REF.NO.	PART.NO	DESCRIPTION	REMARK
R616	1-216-369-00	METAL OXIDE 1 5% 2W	
R624	1-247-895-91	CARBON 470K 5% 1/4W	
R626	1-249-429-11	CARBON 10K 5% 1/4W	
R629	1-249-425-11	CARBON 4.7K 5% 1/4W	
R634	1-215-479-00	METAL 270K 1% 1/4W	
R638	1-215-927-00	METAL OXIDE 47K 5% 3W	
R639	1-249-429-11	CARBON 10K 5% 1/4W	
R640	1-202-933-61	FUSIBLE 0.1 10% 1/2W	
R642	1-249-429-11	CARBON 10K 5% 1/4W	
R643	1-249-443-11	CARBON 0.47 5% 1/4W	
R645	1-249-393-11	CARBON 10 5% 1/4W	
R647	1-249-391-11	CARBON 6.8 5% 1/4W	
R648	1-249-437-11	CARBON 47K 5% 1/4W	
R649	1-215-429-00	METAL 2.2K 1% 1/4W	
R650	1-249-425-11	CARBON 4.7K 5% 1/4W	
R651	1-215-927-00	METAL OXIDE 47K 5% 3W	
R657	1-260-127-11	CARBON 220K 5% 1/2W	
R658	1-249-416-11	CARBON 820 5% 1/4W	
R659	1-260-131-11	CARBON 470K 5% 1/2W	
R660	1-249-429-11	CARBON 10K 5% 1/4W	
R662	1-249-410-11	CARBON 270 5% 1/4W	
R663	1-215-926-00	METAL OXIDE 33K 5% 3W	
R673	1-249-417-11	CARBON 1K 5% 1/4W	
R674	1-249-417-11	CARBON 1K 5% 1/4W	
R677	1-249-436-11	CARBON 39K 5% 1/4W	
R678	1-215-859-00	METAL OXIDE 22 5% 1W	
R679	1-215-859-00	METAL OXIDE 22 5% 1W	
R680	1-249-417-11	CARBON 1K 5% 1/4W	
R681	1-215-428-00	METAL 2K 1% 1/4W	
R682	1-249-430-11	CARBON 12K 5% 1/4W	
R683	1-249-417-11	CARBON 1K 5% 1/4W	
R685	1-249-429-11	CARBON 10K 5% 1/4W	
R686	1-249-377-11	CARBON 0.47 5% 1/4W	
R687	1-249-417-11	CARBON 1K 5% 1/4W	
R689	1-249-429-11	CARBON 10K 5% 1/4W	
R690	1-247-807-31	CARBON 100 5% 1/4W	
< RELAY >			
RY600	Δ 1-755-178-11	RELAY, AC POWER	
RY601	Δ 1-755-198-11	RELAY	
< TRANSFORMER >			
T501	1-427-762-11	TRANSFORMER, FERRITE (HDT)	
T505	Δ 1-453-366-11	TRANSFORMER ASSY, FLYBACK (NX-4602//J114)	
T507	1-433-487-11	TRANSFORMER, FERRITE (DFT)	
T600	Δ 1-431-616-11	TRANSFORMER, CONVERTER	
T601	Δ 1-433-491-11	TRANSFORMER, CONVERTER (PIT)	
T602	Δ 1-431-616-11	TRANSFORMER, CONVERTER	
T603	Δ 1-433-490-11	TRANSFORMER, CONVERTER (PIT)	

REF.NO.	PART.NO	DESCRIPTION	REMARK
---------	---------	-------------	--------

< THERMISTOR >

TH501 1-800-193-00 THERMISTOR

THP600 Δ 1-809-827-11 THERMISTOR, POSITIVE**D Board Variant Parts KV-28DS65U**

< CAPACITOR >

C511 1-117-846-11 FILM 18000PF 3.00% 1.5KV

C516 1-109-837-11 FILM 0.56UF 5.00% 400V

C574 1-136-347-11 FILM 0.0047UF 5.00% 630V

C607 1-535-303-00 LEAD, JUMPER (10.0MM)

< CONNECTOR >

CN501 1-900-902-84 CONNECTOR ASSY, MICRO 7P

CN610 1-900-902-84 CONNECTOR ASSY, MICRO 7P

< COIL >

L523 1-416-447-11 COIL (WITH CORE) (PMC)

< RESISTOR >

R510 1-215-914-11 METAL OXIDE 330 5% 3W

R571 1-215-917-11 METAL OXIDE 1K 5% 3W

< TRANSFORMER >

T504 1-431-599-11 TRANSFORMER, HORIZONTAL LINEAR

D Board Variant Parts KV-32DS65U

< CAPACITOR >

C507 1-162-115-00 CERAMIC 820PF 10.00% 500V

C511 1-113-582-11 FILM 0.017UF 3.00% 2KV

C516 1-115-517-11 FILM 0.39UF 5.00% 250V

C574 1-129-708-91 FILM 0.0033UF 5.00% 630V

C607 1-113-927-11 CERAMIC 10000PF 20.00% 250V

< CONNECTOR >

CN605 1-508-765-00 PIN, CONNECTOR (5MM PITCH) 3P

< COIL >

L523 1-416-448-11 COIL (WITH CORE) (PMC)

< RESISTOR >

R510 1-215-911-11 METAL OXIDE 100 5% 3W

R571 1-216-481-11 METAL OXIDE 1.2K 5% 3W

REF.NO.	PART.NO	DESCRIPTION	REMARK	REF.NO.	PART.NO	DESCRIPTION	REMARK
< TRANSFORMER >							
T504	1-431-600-11	TRANSFORMER, HORIZONTAL LINEAR		C4206	1-163-021-91	CERAMIC CHIP 0.01UF	10.00% 50V
*A-1646-163-A H Board, Complete							
< CAPACITOR >							
C908	1-137-372-11	MYLAR 0.022UF	5.00% 50V	C4207	1-163-251-11	CERAMIC CHIP 100PF	5.00% 50V
C909	1-137-372-11	MYLAR 0.022UF	5.00% 50V	C4208	1-104-664-11	ELECT 47UF	20.00% 25V
C936	1-163-007-11	CERAMIC CHIP 680PF	10.00% 50V	C4209	1-163-021-91	CERAMIC CHIP 0.01UF	10.00% 50V
C938	1-163-007-11	CERAMIC CHIP 680PF	10.00% 50V	C4210	1-107-823-11	CERAMIC CHIP 0.47UF	10.00% 16V
< CONNECTOR >							
CN902	*1-564-507-11	PLUG, CONNECTOR 4P		C4211	1-104-664-11	ELECT 47UF	20.00% 25V
CN903	*1-568-882-51	PIN, CONNECTOR 7P		C4213	1-104-664-11	ELECT 47UF	20.00% 25V
CN905	*1-564-518-11	PLUG, CONNECTOR 3P		C4215	1-163-021-91	CERAMIC CHIP 0.01UF	10.00% 50V
< DIODE >							
D901	8-719-108-12	DIODE RD9.1EW		C4216	1-163-251-11	CERAMIC CHIP 100PF	5.00% 50V
D902	8-719-108-12	DIODE RD9.1EW		C4217	1-163-021-91	CERAMIC CHIP 0.01UF	10.00% 50V
D903	8-719-108-12	DIODE RD9.1EW		C4218	1-126-933-11	ELECT 100UF	20.00% 16V
D904	8-719-108-12	DIODE RD9.1EW		C4219	1-104-664-11	ELECT 47UF	20.00% 25V
< JACK >							
J901	1-764-606-11	JACK		C4220	1-126-933-11	ELECT 100UF	20.00% 16V
J902	1-779-947-11	TERMINAL BLOCK, S		C4221	1-163-021-91	CERAMIC CHIP 0.01UF	10.00% 50V
< COIL >							
L901	1-408-603-31	INDUCTOR 10UH		C4222	1-163-021-91	CERAMIC CHIP 0.01UF	10.00% 50V
L902	1-408-603-31	INDUCTOR 10UH		C4224	1-126-933-11	ELECT 100UF	20.00% 16V
L903	1-408-603-31	INDUCTOR 10UH		C4225	1-107-823-11	CERAMIC CHIP 0.47UF	10.00% 16V
L904	1-408-603-31	INDUCTOR 10UH		C4226	1-163-021-91	CERAMIC CHIP 0.01UF	10.00% 50V
< RESISTOR >							
JR901	1-216-295-11	SHORT 0		C4228	1-163-009-11	CERAMIC CHIP 0.001UF	10.00% 50V
JR902	1-216-295-11	SHORT 0		C4229	1-107-823-11	CERAMIC CHIP 0.47UF	10.00% 16V
R906	1-535-465-11	LEAD, JUMPER (5.0MM)		C4230	1-136-161-00	FILM 0.047UF	5.00% 50V
R907	1-535-465-11	LEAD, JUMPER (5.0MM)		C4231	1-163-009-11	CERAMIC CHIP 0.001UF	10.00% 50V
R908	1-535-465-11	LEAD, JUMPER (5.0MM)		C4232	1-163-251-11	CERAMIC CHIP 100PF	5.00% 50V
R911	1-247-895-91	CARBON 470K 5% 1/4W		C4233	1-104-664-11	ELECT 47UF	20.00% 25V
R912	1-247-895-91	CARBON 470K 5% 1/4W		C4234	1-163-021-91	CERAMIC CHIP 0.01UF	10.00% 50V
*A-1651-096-A J Board, Complete							
< CAPACITOR >							
C4201	1-107-823-11	CERAMIC CHIP 0.47UF	10.00% 16V	C4235	1-216-067-00	RES-CHIP 5.6K 5% 1/10W	
C4202	1-163-251-11	CERAMIC CHIP 100PF	5.00% 50V	C4236	1-107-823-11	CERAMIC CHIP 0.47UF	10.00% 16V
C4203	1-104-664-11	ELECT 47UF	20.00% 25V	C4237	1-104-664-11	ELECT 47UF	20.00% 25V
C4204	1-104-664-11	ELECT 47UF	20.00% 25V	C4238	1-163-017-00	CERAMIC CHIP 0.0047UF	10.00% 50V
C4205	1-107-823-11	CERAMIC CHIP 0.47UF	10.00% 16V	C4239	1-163-037-11	CERAMIC CHIP 0.022UF	10.00% 50V
				C4240	1-164-346-11	CERAMIC CHIP 1UF	16V
				C4241	1-104-664-11	ELECT 47UF	20.00% 25V
				C4242	1-164-346-11	CERAMIC CHIP 1UF	16V
				C4243	1-104-664-11	ELECT 47UF	20.00% 25V
				C4244	1-126-767-11	ELECT 1000UF	20.00% 16V
				C4245	1-163-251-11	CERAMIC CHIP 100PF	5.00% 50V
				C4246	1-163-021-91	CERAMIC CHIP 0.01UF	10.00% 50V
				C4247	1-163-021-91	CERAMIC CHIP 0.01UF	10.00% 50V
				C4248	1-163-251-11	CERAMIC CHIP 100PF	5.00% 50V
				C4249	1-163-021-91	CERAMIC CHIP 0.01UF	10.00% 50V
				C4250	1-107-823-11	CERAMIC CHIP 0.47UF	10.00% 16V
				C4251	1-107-823-11	CERAMIC CHIP 0.47UF	10.00% 16V
				C4252	1-104-664-11	ELECT 47UF	20.00% 25V
				C4253	1-163-021-91	CERAMIC CHIP 0.01UF	10.00% 50V
				C4254	1-107-823-11	CERAMIC CHIP 0.47UF	10.00% 16V
				C4255	1-107-823-11	CERAMIC CHIP 0.47UF	10.00% 16V
				C4256	1-104-664-11	ELECT 47UF	20.00% 25V
				C4259	1-104-664-11	ELECT 47UF	20.00% 25V
				C4261	1-163-021-91	CERAMIC CHIP 0.01UF	10.00% 50V
				C4264	1-163-251-11	CERAMIC CHIP 100PF	5.00% 50V

J

REF.NO.	PART.NO	DESCRIPTION	REMARK	REF.NO.	PART.NO	DESCRIPTION	REMARK
C4265	1-107-823-11	CERAMIC CHIP 0.47UF	10.00% 16V	D4223	8-719-923-60	DIODE MTZJ-T-77-9.1A	
C4266	1-107-823-11	CERAMIC CHIP 0.47UF	10.00% 16V	D4224	8-719-923-60	DIODE MTZJ-T-77-9.1A	
C4270	1-163-251-11	CERAMIC CHIP 100PF	5.00% 50V	D4225	8-719-923-60	DIODE MTZJ-T-77-9.1A	
C4271	1-104-664-11	ELECT 47UF	20.00% 25V	D4226	8-719-923-60	DIODE MTZJ-T-77-9.1A	
C4277	1-163-009-11	CERAMIC CHIP 0.001UF	10.00% 50V	D4227	8-719-923-60	DIODE MTZJ-T-77-9.1A	
C4279	1-163-009-11	CERAMIC CHIP 0.001UF	10.00% 50V	D4228	8-719-923-60	DIODE MTZJ-T-77-9.1A	
C4280	1-163-017-00	CERAMIC CHIP 0.0047UF	10.00% 50V	D4229	8-719-923-60	DIODE MTZJ-T-77-9.1A	
C4281	1-163-037-11	CERAMIC CHIP 0.022UF	10.00% 50V	D4230	8-719-923-60	DIODE MTZJ-T-77-9.1A	
C4283	1-164-004-11	CERAMIC CHIP 0.1UF	10.00% 25V	D4232	8-719-923-60	DIODE MTZJ-T-77-9.1A	
C4284	1-163-017-00	CERAMIC CHIP 0.0047UF	10.00% 50V	D4233	8-719-923-60	DIODE MTZJ-T-77-9.1A	
C4285	1-163-037-11	CERAMIC CHIP 0.022UF	10.00% 50V	D4234	8-719-923-60	DIODE MTZJ-T-77-9.1A	
C4287	1-164-004-11	CERAMIC CHIP 0.1UF	10.00% 25V	D4235	8-719-923-60	DIODE MTZJ-T-77-9.1A	
C4288	1-163-017-00	CERAMIC CHIP 0.0047UF	10.00% 50V			< IC >	
C4289	1-163-037-11	CERAMIC CHIP 0.022UF	10.00% 50V	IC4201	8-759-330-93	IC TDA7309	
C4291	1-164-004-11	CERAMIC CHIP 0.1UF	10.00% 25V	IC4202	8-759-545-66	IC NJM3414AMP(TE2)	
C4292	1-164-004-11	CERAMIC CHIP 0.1UF	10.00% 25V	IC4203	8-752-082-87	IC CXA1845Q-TL	
C4309	1-104-664-11	ELECT 47UF	20.00% 25V			< JACK >	
		< CONNECTOR >		J4201	1-561-534-41	SOCKET, PIN 21P	
CN4201	1-695-301-11	CONNECTOR, BOARD TO BOARD 40P		J4203	1-695-293-11	SOCKET 21P	
CN4202	*1-564-522-11	PLUG, CONNECTOR 7P		J4204	1-695-293-11	SOCKET 21P	
CN4205	*1-564-519-11	PLUG, CONNECTOR 4P		J4207	1-537-979-11	TERMINAL BOARD	
CN4206	*1-564-507-11	PLUG, CONNECTOR 4P		J4208	1-537-978-11	TERMINAL BOARD	
CN4207	1-564-521-11	PLUG, CONNECTOR 6P				< COIL >	
CN4208	*1-564-518-11	PLUG, CONNECTOR 3P		L4201	1-408-615-31	INDUCTOR 100UH	
CN4209	*1-564-507-11	PLUG, CONNECTOR 4P		L4202	1-408-615-31	INDUCTOR 100UH	
CN4210	*1-564-518-11	PLUG, CONNECTOR 3P		L4203	1-408-615-31	INDUCTOR 100UH	
		< DIODE >		L4207	1-402-711-11	INDUCTOR 1UH	
D4201	8-719-923-60	DIODE MTZJ-T-77-9.1A		L4208	1-402-711-11	INDUCTOR 1UH	
D4202	8-719-923-60	DIODE MTZJ-T-77-9.1A		L4210	1-402-711-11	INDUCTOR 1UH	
D4203	8-719-923-60	DIODE MTZJ-T-77-9.1A		L4212	1-402-711-11	INDUCTOR 1UH	
D4204	8-719-923-60	DIODE MTZJ-T-77-9.1A				< TRANSISTOR >	
D4205	8-719-923-60	DIODE MTZJ-T-77-9.1A		Q4204	8-729-120-28	TRANSISTOR 2SC1623-L5L6	
D4206	8-719-923-60	DIODE MTZJ-T-77-9.1A		Q4205	8-729-120-28	TRANSISTOR 2SC1623-L5L6	
D4207	8-719-923-60	DIODE MTZJ-T-77-9.1A		Q4206	8-729-120-28	TRANSISTOR 2SC1623-L5L6	
D4208	8-719-923-60	DIODE MTZJ-T-77-9.1A		Q4207	8-729-120-28	TRANSISTOR 2SC1623-L5L6	
D4209	8-719-923-60	DIODE MTZJ-T-77-9.1A		Q4208	8-729-120-28	TRANSISTOR 2SC1623-L5L6	
D4210	8-719-923-60	DIODE MTZJ-T-77-9.1A		Q4209	8-729-120-28	TRANSISTOR 2SC1623-L5L6	
D4211	8-719-923-60	DIODE MTZJ-T-77-9.1A		Q4210	8-729-026-49	TRANSISTOR 2SA1037AK	
D4212	8-719-923-60	DIODE MTZJ-T-77-9.1A		Q4214	8-729-120-28	TRANSISTOR 2SC1623-L5L6	
D4213	8-719-923-60	DIODE MTZJ-T-77-9.1A		Q4217	8-729-120-28	TRANSISTOR 2SC1623-L5L6	
D4214	8-719-923-60	DIODE MTZJ-T-77-9.1A		Q4218	8-729-120-28	TRANSISTOR 2SC1623-L5L6	
D4215	8-719-923-60	DIODE MTZJ-T-77-9.1A		Q4219	8-729-120-28	TRANSISTOR 2SC1623-L5L6	
D4216	8-719-923-60	DIODE MTZJ-T-77-9.1A				< RESISTOR >	
D4217	8-719-923-60	DIODE MTZJ-T-77-9.1A		JR4205	1-216-296-11	SHORT 0	
D4218	8-719-923-60	DIODE MTZJ-T-77-9.1A					
D4220	8-719-923-60	DIODE MTZJ-T-77-9.1A					
D4222	8-719-923-60	DIODE MTZJ-T-77-9.1A					

REF.NO.	PART.NO	DESCRIPTION	REMARK	REF.NO.	PART.NO	DESCRIPTION	REMARK
JR4207	1-216-296-11	SHORT	0	R4248	1-216-065-91	RES-CHIP	4.7K 5% 1/10W
JR4209	1-216-296-11	SHORT	0	R4249	1-216-113-00	RES-CHIP	470K 5% 1/10W
JR4210	1-216-295-11	SHORT	0	R4251	1-216-073-00	RES-CHIP	10K 5% 1/10W
JR4212	1-216-295-11	SHORT	0	R4252	1-216-025-11	RES-CHIP	100 5% 1/10W
JR4213	1-216-295-11	SHORT	0	R4253	1-216-025-11	RES-CHIP	100 5% 1/10W
JR4214	1-216-295-11	SHORT	0	R4254	1-216-049-11	RES-CHIP	1K 5% 1/10W
JR7101	1-216-295-11	SHORT	0	R4255	1-216-081-00	RES-CHIP	22K 5% 1/10W
R4201	1-216-071-00	RES-CHIP	8.2K 5% 1/10W	R4256	1-216-081-00	RES-CHIP	22K 5% 1/10W
R4202	1-216-073-00	RES-CHIP	10K 5% 1/10W	R4257	1-216-073-00	RES-CHIP	10K 5% 1/10W
R4203	1-216-049-11	RES-CHIP	1K 5% 1/10W	R4258	1-216-073-00	RES-CHIP	10K 5% 1/10W
R4204	1-216-065-91	RES-CHIP	4.7K 5% 1/10W	R4259	1-216-073-00	RES-CHIP	10K 5% 1/10W
R4205	1-216-113-00	RES-CHIP	470K 5% 1/10W	R4260	1-216-022-00	RES-CHIP	75 5% 1/10W
R4206	1-216-022-00	RES-CHIP	75 5% 1/10W	R4261	1-216-022-00	RES-CHIP	75 5% 1/10W
R4207	1-216-022-00	RES-CHIP	75 5% 1/10W	R4264	1-216-295-11	SHORT	0
R4208	1-216-022-00	RES-CHIP	75 5% 1/10W	R4265	1-216-022-00	RES-CHIP	75 5% 1/10W
R4209	1-216-022-00	RES-CHIP	75 5% 1/10W	R4268	1-216-295-11	SHORT	0
R4210	1-216-022-00	RES-CHIP	75 5% 1/10W	R4269	1-216-295-11	SHORT	0
R4211	1-216-022-00	RES-CHIP	75 5% 1/10W	R4270	1-216-113-00	RES-CHIP	470K 5% 1/10W
R4212	1-216-033-00	RES-CHIP	220 5% 1/10W	R4271	1-216-073-00	RES-CHIP	10K 5% 1/10W
R4213	1-216-295-11	SHORT	0	R4272	1-216-071-00	RES-CHIP	8.2K 5% 1/10W
R4214	1-216-065-91	RES-CHIP	4.7K 5% 1/10W	R4273	1-216-049-11	RES-CHIP	1K 5% 1/10W
R4215	1-216-113-00	RES-CHIP	470K 5% 1/10W	R4274	1-216-113-00	RES-CHIP	470K 5% 1/10W
R4216	1-216-089-11	RES-CHIP	47K 5% 1/10W	R4275	1-216-049-11	RES-CHIP	1K 5% 1/10W
R4217	1-216-049-11	RES-CHIP	1K 5% 1/10W	R4276	1-216-049-11	RES-CHIP	1K 5% 1/10W
R4218	1-216-033-00	RES-CHIP	220 5% 1/10W	R4277	1-216-065-91	RES-CHIP	4.7K 5% 1/10W
R4219	1-216-295-11	SHORT	0	R4278	1-216-033-00	RES-CHIP	220 5% 1/10W
R4220	1-216-089-11	RES-CHIP	47K 5% 1/10W	R4279	1-216-089-11	RES-CHIP	47K 5% 1/10W
R4221	1-216-009-91	RES-CHIP	22 5% 1/10W	R4280	1-216-049-11	RES-CHIP	1K 5% 1/10W
R4222	1-216-073-00	RES-CHIP	10K 5% 1/10W	R4281	1-216-049-11	RES-CHIP	1K 5% 1/10W
R4223	1-216-071-00	RES-CHIP	8.2K 5% 1/10W	R4282	1-216-065-91	RES-CHIP	4.7K 5% 1/10W
R4224	1-216-022-00	RES-CHIP	75 5% 1/10W	R4283	1-216-033-00	RES-CHIP	220 5% 1/10W
R4225	1-216-063-91	RES-CHIP	3.9K 5% 1/10W	R4284	1-216-089-11	RES-CHIP	47K 5% 1/10W
R4226	1-216-022-00	RES-CHIP	75 5% 1/10W	R4285	1-216-049-11	RES-CHIP	1K 5% 1/10W
R4227	1-216-041-00	RES-CHIP	470 5% 1/10W	R4286	1-216-295-11	SHORT	0
R4228	1-216-041-00	RES-CHIP	470 5% 1/10W	R4287	1-216-049-11	RES-CHIP	1K 5% 1/10W
R4229	1-216-113-00	RES-CHIP	470K 5% 1/10W	R4288	1-216-295-11	SHORT	0
R4231	1-216-022-00	RES-CHIP	75 5% 1/10W	R4290	1-216-055-00	RES-CHIP	1.8K 5% 1/10W
R4232	1-216-295-11	SHORT	0	R4291	1-216-049-11	RES-CHIP	1K 5% 1/10W
R4233	1-216-025-11	RES-CHIP	100 5% 1/10W	R4292	1-216-295-11	SHORT	0
R4235	1-216-049-11	RES-CHIP	1K 5% 1/10W	R4293	1-216-049-11	RES-CHIP	1K 5% 1/10W
R4236	1-216-295-11	SHORT	0	R4295	1-216-009-91	RES-CHIP	22 5% 1/10W
R4239	1-216-033-00	RES-CHIP	220 5% 1/10W	R4296	1-216-022-00	RES-CHIP	75 5% 1/10W
R4240	1-216-089-11	RES-CHIP	47K 5% 1/10W	R4297	1-216-113-00	RES-CHIP	470K 5% 1/10W
R4242	1-216-033-00	RES-CHIP	220 5% 1/10W	R4298	1-216-022-00	RES-CHIP	75 5% 1/10W
R4243	1-216-089-11	RES-CHIP	47K 5% 1/10W	R4304	1-216-049-11	RES-CHIP	1K 5% 1/10W
R4244	1-216-025-11	RES-CHIP	100 5% 1/10W	R4305	1-216-065-91	RES-CHIP	4.7K 5% 1/10W
R4245	1-216-073-00	RES-CHIP	10K 5% 1/10W	R4307	1-216-049-11	RES-CHIP	1K 5% 1/10W
R4246	1-216-073-00	RES-CHIP	10K 5% 1/10W	R4308	1-216-065-91	RES-CHIP	4.7K 5% 1/10W
R4247	1-216-073-00	RES-CHIP	10K 5% 1/10W	R4309	1-216-113-00	RES-CHIP	470K 5% 1/10W
				R4317	1-216-009-91	RES-CHIP	22 5% 1/10W



REF.NO.	PART.NO	DESCRIPTION	REMARK
R4319	1-216-025-11	RES-CHIP 100 5%	1/10W
R4320	1-216-025-11	RES-CHIP 100 5%	1/10W
R4322	1-216-049-11	RES-CHIP 1K 5%	1/10W
R4337	1-216-033-00	RES-CHIP 220 5%	1/10W
R4341	1-216-033-00	RES-CHIP 220 5%	1/10W
R4376	1-216-295-11	SHORT 0	
R4377	1-216-295-11	SHORT 0	
R4379	1-216-081-00	RES-CHIP 22K 5%	1/10W
R4380	1-216-081-00	RES-CHIP 22K 5%	1/10W
R4381	1-216-101-00	RES-CHIP 150K 5%	1/10W
R4382	1-216-101-00	RES-CHIP 150K 5%	1/10W
R4383	1-216-049-11	RES-CHIP 1K 5%	1/10W
R4389	1-216-097-11	RES-CHIP 100K 5%	1/10W
R4390	1-216-097-11	RES-CHIP 100K 5%	1/10W
R4393	1-216-295-11	SHORT 0	
R4394	1-216-295-11	SHORT 0	
R4395	1-216-295-11	SHORT 0	
R4396	1-216-025-11	RES-CHIP 100 5%	1/10W
R4397	1-216-025-11	RES-CHIP 100 5%	1/10W
R4398	1-216-025-11	RES-CHIP 100 5%	1/10W
R4399	1-216-025-11	RES-CHIP 100 5%	1/10W
R4400	1-216-049-11	RES-CHIP 1K 5%	1/10W
R4401	1-216-049-11	RES-CHIP 1K 5%	1/10W

***A-1654-030-A N Board, Complete**

4-204-791-01 SCREW + B, 2X8

< CAPACITOR >

C3101	1-163-021-91	CERAMIC CHIP 0.01UF	10.00% 50V
C3102	1-163-021-91	CERAMIC CHIP 0.01UF	10.00% 50V
C3103	1-163-251-11	CERAMIC CHIP 100PF	5.00% 50V
C3104	1-163-021-91	CERAMIC CHIP 0.01UF	10.00% 50V
C3105	1-126-964-11	ELECT 10UF	20.00% 50V
C3106	1-163-021-91	CERAMIC CHIP 0.01UF	10.00% 50V
C3107	1-163-021-91	CERAMIC CHIP 0.01UF	10.00% 50V
C3109	1-163-251-11	CERAMIC CHIP 100PF	5.00% 50V
C3110	1-163-021-91	CERAMIC CHIP 0.01UF	10.00% 50V
C3111	1-163-251-11	CERAMIC CHIP 100PF	5.00% 50V
C3112	1-163-021-91	CERAMIC CHIP 0.01UF	10.00% 50V
C3113	1-163-021-91	CERAMIC CHIP 0.01UF	10.00% 50V
C3114	1-163-021-91	CERAMIC CHIP 0.01UF	10.00% 50V
C3115	1-163-251-11	CERAMIC CHIP 100PF	5.00% 50V
C3116	1-163-021-91	CERAMIC CHIP 0.01UF	10.00% 50V
C3118	1-163-021-91	CERAMIC CHIP 0.01UF	10.00% 50V
C3121	1-163-021-91	CERAMIC CHIP 0.01UF	10.00% 50V
C3122	1-163-021-91	CERAMIC CHIP 0.01UF	10.00% 50V
C3127	1-163-038-11	CERAMIC CHIP 0.1UF	25V
C3128	1-163-038-11	CERAMIC CHIP 0.1UF	25V
C3129	1-163-021-91	CERAMIC CHIP 0.01UF	10.00% 50V

REF.NO.	PART.NO	DESCRIPTION	REMARK
C3130	1-163-021-91	CERAMIC CHIP 0.01UF	10.00% 50V
C3131	1-163-263-11	CERAMIC CHIP 330PF	5.00% 50V
C3132	1-163-021-91	CERAMIC CHIP 0.01UF	10.00% 50V
C3134	1-163-021-91	CERAMIC CHIP 0.01UF	10.00% 50V
C3135	1-163-222-11	CERAMIC CHIP 5PF	0.25PF 50V
C3136	1-163-222-11	CERAMIC CHIP 5PF	0.25PF 50V
C3137	1-163-021-91	CERAMIC CHIP 0.01UF	10.00% 50V
C3138	1-107-888-11	ELECT 47UF	20.00% 25V
C3139	1-163-021-91	CERAMIC CHIP 0.01UF	10.00% 50V
C3140	1-163-021-91	CERAMIC CHIP 0.01UF	10.00% 50V
C3141	1-163-021-91	CERAMIC CHIP 0.01UF	10.00% 50V
C3142	1-163-021-91	CERAMIC CHIP 0.01UF	10.00% 50V
C3143	1-163-021-91	CERAMIC CHIP 0.01UF	10.00% 50V
C3144	1-163-159-00	CERAMIC CHIP 12PF	2.00% 50V
C3201	1-163-021-91	CERAMIC CHIP 0.01UF	10.00% 50V
C3202	1-163-021-91	CERAMIC CHIP 0.01UF	10.00% 50V
C3203	1-126-964-11	ELECT 10UF	20.00% 50V
C3204	1-163-021-91	CERAMIC CHIP 0.01UF	10.00% 50V
C3205	1-163-021-91	CERAMIC CHIP 0.01UF	10.00% 50V
C3206	1-126-964-11	ELECT 10UF	20.00% 50V
C3207	1-126-964-11	ELECT 10UF	20.00% 50V
C3208	1-163-009-11	CERAMIC CHIP 0.001UF	10.00% 50V
C3209	1-163-009-11	CERAMIC CHIP 0.001UF	10.00% 50V
C3210	1-163-021-91	CERAMIC CHIP 0.01UF	10.00% 50V
C3211	1-126-964-11	ELECT 10UF	20.00% 50V
C3212	1-163-021-91	CERAMIC CHIP 0.01UF	10.00% 50V
C3213	1-163-251-11	CERAMIC CHIP 100PF	5.00% 50V
C3214	1-163-021-91	CERAMIC CHIP 0.01UF	10.00% 50V
C3215	1-163-021-91	CERAMIC CHIP 0.01UF	10.00% 50V
C3216	1-163-021-91	CERAMIC CHIP 0.01UF	10.00% 50V
C3217	1-163-021-91	CERAMIC CHIP 0.01UF	10.00% 50V
C3218	1-163-021-91	CERAMIC CHIP 0.01UF	10.00% 50V
C3219	1-163-021-91	CERAMIC CHIP 0.01UF	10.00% 50V
C3220	1-163-251-11	CERAMIC CHIP 100PF	5.00% 50V
C3221	1-163-251-11	CERAMIC CHIP 100PF	5.00% 50V
C3222	1-163-021-91	CERAMIC CHIP 0.01UF	10.00% 50V
C3223	1-163-021-91	CERAMIC CHIP 0.01UF	10.00% 50V
C3224	1-163-021-91	CERAMIC CHIP 0.01UF	10.00% 50V
C3225	1-163-251-11	CERAMIC CHIP 100PF	5.00% 50V
C3226	1-163-021-91	CERAMIC CHIP 0.01UF	10.00% 50V
C3227	1-163-021-91	CERAMIC CHIP 0.01UF	10.00% 50V
C3228	1-163-021-91	CERAMIC CHIP 0.01UF	10.00% 50V
C3229	1-163-227-11	CERAMIC CHIP 10PF	0.50PF 50V
C3230	1-107-888-11	ELECT 47UF	20.00% 25V
C3231	1-163-021-91	CERAMIC CHIP 0.01UF	10.00% 50V
C3232	1-107-888-11	ELECT 47UF	20.00% 25V
C3233	1-163-263-11	CERAMIC CHIP 330PF	5.00% 50V
C3234	1-124-779-00	ELECT CHIP 10UF	20.00% 16V
C3235	1-124-779-00	ELECT CHIP 10UF	20.00% 16V
C3305	1-163-021-91	CERAMIC CHIP 0.01UF	10.00% 50V

Note : The components identified by shading and marked Δ are critical for safety. Replace only with the part numbers specified in the parts list.

N

REF.NO.	PART.NO	DESCRIPTION	REMARK	REF.NO.	PART.NO	DESCRIPTION	REMARK
C3308	1-163-021-91	CERAMIC CHIP 0.01UF	10.00% 50V	CF3109	1-543-948-22	FERRITE	0UH
C3311	1-107-888-11	ELECT 47UF	20.00% 25V	CF3110	1-543-948-22	FERRITE	0UH
C3315	1-163-021-91	CERAMIC CHIP 0.01UF	10.00% 50V	CF3111	1-543-948-22	FERRITE	0UH
C3318	1-163-021-91	CERAMIC CHIP 0.01UF	10.00% 50V	CF3112	1-543-948-22	FERRITE	0UH
C3319	1-163-251-11	CERAMIC CHIP 100PF	5.00% 50V	CF3113	1-543-948-22	FERRITE	0UH
C3320	1-163-021-91	CERAMIC CHIP 0.01UF	10.00% 50V	CF3114	1-543-948-22	FERRITE	0UH
C3323	1-163-021-91	CERAMIC CHIP 0.01UF	10.00% 50V	CF3115	1-543-948-22	FERRITE	0UH
C3324	1-163-021-91	CERAMIC CHIP 0.01UF	10.00% 50V	CF3116	1-500-245-11	FERRITE	0UH
C3325	1-163-021-91	CERAMIC CHIP 0.01UF	10.00% 50V	CF3122	1-500-245-11	FERRITE	0UH
C3326	1-163-251-11	CERAMIC CHIP 100PF	5.00% 50V	CF3123	1-500-245-11	FERRITE	0UH
C3327	1-163-251-11	CERAMIC CHIP 100PF	5.00% 50V	CF3124	1-500-245-11	FERRITE	0UH
C3328	1-163-021-91	CERAMIC CHIP 0.01UF	10.00% 50V	CF3201	1-500-245-11	FERRITE	0UH
C3329	1-163-021-91	CERAMIC CHIP 0.01UF	10.00% 50V	CF3202	1-500-245-11	FERRITE	0UH
C3330	1-163-021-91	CERAMIC CHIP 0.01UF	10.00% 50V	CF3203	1-500-245-11	FERRITE	0UH
C3331	1-163-021-91	CERAMIC CHIP 0.01UF	10.00% 50V	CF3301	1-414-232-22	FERRITE	0UH
C3332	1-163-251-11	CERAMIC CHIP 100PF	5.00% 50V	CF3302	1-414-232-22	FERRITE	0UH
C3333	1-163-021-91	CERAMIC CHIP 0.01UF	10.00% 50V	CF3303	1-414-232-22	FERRITE	0UH
C3334	1-163-021-91	CERAMIC CHIP 0.01UF	10.00% 50V	CF3304	1-414-232-22	FERRITE	0UH
C3336	1-163-021-91	CERAMIC CHIP 0.01UF	10.00% 50V	CF3305	1-414-232-22	FERRITE	0UH
C3337	1-163-021-91	CERAMIC CHIP 0.01UF	10.00% 50V	CF3306	1-414-232-22	FERRITE	0UH
C3339	1-163-021-91	CERAMIC CHIP 0.01UF	10.00% 50V	CF3307	1-414-232-22	FERRITE	0UH
C3340	1-163-021-91	CERAMIC CHIP 0.01UF	10.00% 50V	CF3308	1-414-232-22	FERRITE	0UH
C3341	1-163-021-91	CERAMIC CHIP 0.01UF	10.00% 50V	CF3309	1-500-245-11	FERRITE	0UH
C3342	1-163-021-91	CERAMIC CHIP 0.01UF	10.00% 50V				
C3343	1-163-263-11	CERAMIC CHIP 330PF	5.00% 50V			< CONNECTOR >	
C3344	1-163-021-91	CERAMIC CHIP 0.01UF	10.00% 50V	CN3101	1-695-302-11	CONNECTOR, BOARD TO BOARD 50P	
C3345	1-163-021-91	CERAMIC CHIP 0.01UF	10.00% 50V	CN3102	*1-564-510-11	PLUG, CONNECTOR 7P	
C3346	1-107-888-11	ELECT 47UF	20.00% 25V	CN3301	1-563-486-11	SOCKET, CONNECTOR	
C3347	1-163-021-91	CERAMIC CHIP 0.01UF	10.00% 50V	CN3302	*1-785-719-11	PIN, CONNECTOR (PWB) 26P	
C3401	1-163-021-91	CERAMIC CHIP 0.01UF	10.00% 50V	CN3303	*1-564-510-11	PLUG, CONNECTOR 7P	
C3402	1-163-021-91	CERAMIC CHIP 0.01UF	10.00% 50V	CN3401	1-785-770-11	CONNECTOR, CARD (PCMCIA CARD)	
C3412	1-164-505-11	CERAMIC CHIP 2.2UF	16V			< DIODE >	
C3413	1-163-021-91	CERAMIC CHIP 0.01UF	10.00% 50V	D3305	8-719-914-43	DIODE DAN202K	
C3414	1-163-021-91	CERAMIC CHIP 0.01UF	10.00% 50V	D3306	8-719-421-59	DIODE MA3130WA-TX	
C3415	1-163-021-91	CERAMIC CHIP 0.01UF	10.00% 50V	D3307	8-719-421-59	DIODE MA3130WA-TX	
C3416	1-163-021-91	CERAMIC CHIP 0.01UF	10.00% 50V	D3308	8-719-421-59	DIODE MA3130WA-TX	
C3417	1-163-021-91	CERAMIC CHIP 0.01UF	10.00% 50V	D3309	8-719-421-59	DIODE MA3130WA-TX	
C3418	1-163-021-91	CERAMIC CHIP 0.01UF	10.00% 50V			< FUSE >	
C3419	1-163-021-91	CERAMIC CHIP 0.01UF	10.00% 50V	F3301	Δ 1-533-900-21	FUSE	
C3420	1-163-021-91	CERAMIC CHIP 0.01UF	10.00% 50V			< FILTER >	
C3421	1-163-021-91	CERAMIC CHIP 0.01UF	10.00% 50V	FL3101	1-239-899-21	FILTER, CHIP EMI	
C3422	1-163-038-11	CERAMIC CHIP 0.1UF	25V	FL3102	1-239-899-21	FILTER, CHIP EMI	
C3425	1-163-021-91	CERAMIC CHIP 0.01UF	10.00% 50V	FL3107	1-239-899-21	FILTER, CHIP EMI	
		< FILTER >		FL3108	1-239-899-21	FILTER, CHIP EMI	
CF3101	1-543-948-22	FERRITE	0UH	FL3109	1-239-558-11	FILTER, CHIP EMI	
CF3102	1-543-948-22	FERRITE	0UH	FL3110	1-239-558-11	FILTER, CHIP EMI	
CF3104	1-543-948-22	FERRITE	0UH				
CF3106	1-216-295-11	SHORT	0				
CF3108	1-543-948-22	FERRITE	0UH				



REF.NO.	PART.NO	DESCRIPTION	REMARK	REF.NO.	PART.NO	DESCRIPTION	REMARK
FL3111	1-239-558-11	FILTER, CHIP EMI		IC3315	8-759-577-89	IC 74LV273D-118	
FL3112	1-239-558-11	FILTER, CHIP EMI		IC3316	8-759-542-08	IC 74LV373D-118	
FL3113	1-239-558-11	FILTER, CHIP EMI		IC3317	8-759-542-07	IC 74LV244D-118	
FL3114	1-239-558-11	FILTER, CHIP EMI		IC3318	8-759-560-75	IC 74LV157D-118	
FL3201	1-239-899-21	FILTER, CHIP EMI		IC3320	8-759-492-09	IC 74LV00D-118	
FL3203	1-239-899-21	FILTER, CHIP EMI		IC3321	8-759-325-67	IC TC7SH04F(TE85R)	
FL3206	1-239-899-21	FILTER, CHIP EMI		IC3402	8-759-542-07	IC 74LV244D-118	
FL3301	1-239-899-21	FILTER, CHIP EMI		IC3403	8-759-542-06	IC 74LV245D-118	
FL3302	1-239-899-21	FILTER, CHIP EMI		IC3404	8-759-542-07	IC 74LV244D-118	
FL3307	1-239-899-21	FILTER, CHIP EMI		IC3405	8-759-542-07	IC 74LV244D-118	
FL3309	1-239-899-21	FILTER, CHIP EMI		IC3406	8-752-397-41	IC CXD1957AQ-TL	
FL3310	1-239-899-21	FILTER, CHIP EMI		IC3407	8-759-542-07	IC 74LV244D-118	
FL3311	1-239-899-21	FILTER, CHIP EMI		IC3408	8-759-542-07	IC 74LV244D-118	
FL3401	1-239-899-21	FILTER, CHIP EMI		IC3409	8-759-542-07	IC 74LV244D-118	
FL3402	1-239-899-21	FILTER, CHIP EMI		IC3410	8-759-542-07	IC 74LV244D-118	
FL3403	1-239-899-21	FILTER, CHIP EMI		IC3411	8-759-542-07	IC 74LV244D-118	
	< IC >			IC3412	*8-759-346-63	IC MIC2560-OBWM-T&R	
IC3101	8-759-398-17	IC MC74HC04ADR2		IC3413	8-759-325-67	IC TC7SH04F(TE85R)	
IC3102	8-759-560-76	IC 74LV08D-118		IC3416	8-759-234-77	IC TC4S66F	
IC3103	8-759-590-03	IC AVIA-GTX-PCO			< TRANSISTOR >		
IC3112	8-759-492-55	IC M24C64-WMM6T		Q3101	1-801-806-11	TRANSISTOR DTC144EKA	
IC3113	8-759-638-52	IC AS4LC1M16ES-60TCTR		Q3201	8-729-120-28	TRANSISTOR 2SC1623-L5L6	
IC3114	8-759-638-52	IC AS4LC1M16ES-60TCTR		Q3202	8-729-026-49	TRANSISTOR 2SA1037AK	
IC3115	8-759-325-67	IC TC7SH04F(TE85R)		Q3203	8-729-900-53	TRANSISTOR DTC114EK	
IC3117	8-759-394-05	IC TC7SH08F-TE85R		Q3204	8-729-900-53	TRANSISTOR DTC114EK	
IC3118	8-759-544-28	IC MK2720STR		Q3301	8-729-106-60	TRANSISTOR 2SB1115A	
IC3119	8-759-542-07	IC 74LV244D-118		Q3302	1-801-806-11	TRANSISTOR DTC144EKA	
IC3120	8-759-394-05	IC TC7SH08F-TE85R		Q3303	1-801-806-11	TRANSISTOR DTC144EKA	
IC3121	8-759-394-05	IC TC7SH08F-TE85R		Q3401	1-801-806-11	TRANSISTOR DTC144EKA	
IC3122	8-759-394-05	IC TC7SH08F-TE85R		Q3402	1-801-806-11	TRANSISTOR DTC144EKA	
IC3123	8-759-325-67	IC TC7SH04F(TE85R)			< RESISTOR >		
IC3201	8-759-701-40	IC NJM3404AM-T1		R3102	1-216-025-11	RES-CHIP 100 5%	1/10W
IC3202	8-759-485-02	IC SAA7120H/V1		R3103	1-216-025-11	RES-CHIP 100 5%	1/10W
IC3203	6-700-116-01	IC WM8725ED/R		R3105	1-216-025-11	RES-CHIP 100 5%	1/10W
IC3204	8-759-492-07	IC 74LV86D-118		R3107	1-216-025-11	RES-CHIP 100 5%	1/10W
IC3205	8-759-587-87	IC SAA7201-H/C3		R3108	1-216-073-00	RES-CHIP 10K 5%	1/10W
IC3206	8-759-492-08	IC 74LV164D-118		R3109	1-216-049-11	RES-CHIP 1K 5%	1/10W
IC3207	8-259-641-84	IC HY57V1616ODTC-8		R3110	1-216-049-11	RES-CHIP 1K 5%	1/10W
IC3208	8-759-991-41	IC L78L05ACZ		R3111	1-216-049-11	RES-CHIP 1K 5%	1/10W
IC3209	8-759-394-05	IC TC7SH08F-TE85R		R3112	1-216-025-11	RES-CHIP 100 5%	1/10W
IC3301	8-759-342-60	IC PST575DMT-T1		R3113	1-216-025-11	RES-CHIP 100 5%	1/10W
IC3304	8-759-638-52	IC AS4LC1M16ES-60TCTR		R3114	1-216-049-11	RES-CHIP 1K 5%	1/10W
IC3307	8-759-638-52	IC AS4LC1M16ES-60TCTR		R3115	1-216-049-11	RES-CHIP 1K 5%	1/10W
IC3308	8-759-539-09	IC MCF5206EFT25		R3116	1-216-295-11	SHORT 0	
IC3309	8-759-584-50	IC MBM29LV160BE-90TN-BLO4		R3117	1-216-295-11	SHORT 0	
IC3310	8-759-561-67	IC MBM29LV160B-90PFTN		R3120	1-216-025-11	RES-CHIP 100 5%	1/10W
IC3312	8-759-542-03	IC 74LV11D-118		R3121	1-216-017-91	RES-CHIP 47 5%	1/10W
IC3313	8-759-492-09	IC 74LV00D-118		R3122	1-216-017-91	RES-CHIP 47 5%	1/10W

REF.NO.	PART.NO	DESCRIPTION	REMARK	REF.NO.	PART.NO	DESCRIPTION	REMARK
R3124	1-216-017-91	RES-CHIP	47 5% 1/10W	R3218	1-216-025-11	RES-CHIP	100 5% 1/10W
R3125	1-216-295-11	SHORT	0	R3219	1-216-025-11	RES-CHIP	100 5% 1/10W
R3126	1-216-049-11	RES-CHIP	1K 5% 1/10W	R3220	1-216-025-11	RES-CHIP	100 5% 1/10W
R3128	1-216-057-00	RES-CHIP	2.2K 5% 1/10W	R3222	1-216-049-11	RES-CHIP	1K 5% 1/10W
R3129	1-216-295-11	SHORT	0	R3223	1-216-049-11	RES-CHIP	1K 5% 1/10W
R3130	1-216-295-11	SHORT	0	R3224	1-216-061-00	RES-CHIP	3.3K 5% 1/10W
R3132	1-216-017-91	RES-CHIP	47 5% 1/10W	R3226	1-216-017-91	RES-CHIP	47 5% 1/10W
R3133	1-216-017-91	RES-CHIP	47 5% 1/10W	R3227	1-216-295-11	SHORT	0
R3134	1-216-017-91	RES-CHIP	47 5% 1/10W	R3228	1-216-022-00	RES-CHIP	75 5% 1/10W
R3135	1-216-017-91	RES-CHIP	47 5% 1/10W	R3229	1-216-049-11	RES-CHIP	1K 5% 1/10W
R3136	1-216-295-11	SHORT	0	R3230	1-216-025-11	RES-CHIP	100 5% 1/10W
R3138	1-216-295-11	SHORT	0	R3231	1-216-049-11	RES-CHIP	1K 5% 1/10W
R3141	1-216-025-11	RES-CHIP	100 5% 1/10W	R3232	1-216-049-11	RES-CHIP	1K 5% 1/10W
R3142	1-216-025-11	RES-CHIP	100 5% 1/10W	R3233	1-216-049-11	RES-CHIP	1K 5% 1/10W
R3143	1-216-025-11	RES-CHIP	100 5% 1/10W	R3234	1-216-049-11	RES-CHIP	1K 5% 1/10W
R3144	1-216-025-11	RES-CHIP	100 5% 1/10W	R3235	1-216-049-11	RES-CHIP	1K 5% 1/10W
R3145	1-216-025-11	RES-CHIP	100 5% 1/10W	R3237	1-216-049-11	RES-CHIP	1K 5% 1/10W
R3146	1-216-025-11	RES-CHIP	100 5% 1/10W	R3238	1-216-049-11	RES-CHIP	1K 5% 1/10W
R3147	1-216-025-11	RES-CHIP	100 5% 1/10W	R3239	1-216-025-11	RES-CHIP	100 5% 1/10W
R3148	1-216-025-11	RES-CHIP	100 5% 1/10W	R3240	1-216-025-11	RES-CHIP	100 5% 1/10W
R3149	1-216-025-11	RES-CHIP	100 5% 1/10W	R3241	1-216-025-11	RES-CHIP	100 5% 1/10W
R3150	1-216-025-11	RES-CHIP	100 5% 1/10W	R3244	1-216-017-91	RES-CHIP	47 5% 1/10W
R3151	1-216-017-91	RES-CHIP	47 5% 1/10W	R3245	1-216-017-91	RES-CHIP	47 5% 1/10W
R3152	1-216-025-11	RES-CHIP	100 5% 1/10W	R3246	1-216-017-91	RES-CHIP	47 5% 1/10W
R3153	1-216-025-11	RES-CHIP	100 5% 1/10W	R3247	1-216-097-11	RES-CHIP	100K 5% 1/10W
R3154	1-216-025-11	RES-CHIP	100 5% 1/10W	R3248	1-216-097-11	RES-CHIP	100K 5% 1/10W
R3155	1-216-025-11	RES-CHIP	100 5% 1/10W	R3301	1-216-025-11	RES-CHIP	100 5% 1/10W
R3156	1-216-025-11	RES-CHIP	100 5% 1/10W	R3302	1-216-025-11	RES-CHIP	100 5% 1/10W
R3157	1-216-025-11	RES-CHIP	100 5% 1/10W	R3303	1-216-049-11	RES-CHIP	1K 5% 1/10W
R3158	1-216-025-11	RES-CHIP	100 5% 1/10W	R3304	1-216-295-11	SHORT	0
R3159	1-216-025-11	RES-CHIP	100 5% 1/10W	R3305	1-216-025-11	RES-CHIP	100 5% 1/10W
R3160	1-216-025-11	RES-CHIP	100 5% 1/10W	R3306	1-216-025-11	RES-CHIP	100 5% 1/10W
R3161	1-216-025-11	RES-CHIP	100 5% 1/10W	R3307	1-216-025-11	RES-CHIP	100 5% 1/10W
R3201	1-216-683-11	METAL CHIP	22K 0.5% 1/10W	R3309	1-216-049-11	RES-CHIP	1K 5% 1/10W
R3202	1-216-065-00	RES-CHIP	4.7K 5% 1/10W	R3310	1-216-073-00	RES-CHIP	10K 5% 1/10W
R3203	1-216-065-00	RES-CHIP	4.7K 5% 1/10W	R3311	1-216-043-91	RES-CHIP	560 5% 1/10W
R3204	1-216-683-11	METAL CHIP	22K 0.5% 1/10W	R3313	1-216-049-11	RES-CHIP	1K 5% 1/10W
R3205	1-216-043-91	RES-CHIP	560 5% 1/10W	R3315	1-216-049-11	RES-CHIP	1K 5% 1/10W
R3206	1-216-675-91	METAL CHIP	10K 0.5% 1/10W	R3327	1-216-049-11	RES-CHIP	1K 5% 1/10W
R3207	1-216-073-00	RES-CHIP	10K 5% 1/10W	R3328	1-216-049-11	RES-CHIP	1K 5% 1/10W
R3208	1-216-689-11	RES-CHIP	39K 5% 1/10W	R3329	1-216-049-11	RES-CHIP	1K 5% 1/10W
R3209	1-216-689-11	RES-CHIP	39K 5% 1/10W	R3330	1-216-049-11	RES-CHIP	1K 5% 1/10W
R3210	1-216-675-91	METAL CHIP	10K 0.5% 1/10W	R3331	1-216-049-11	RES-CHIP	1K 5% 1/10W
R3211	1-216-073-00	RES-CHIP	10K 5% 1/10W	R3332	1-216-049-11	RES-CHIP	1K 5% 1/10W
R3212	1-216-057-00	RES-CHIP	2.2K 5% 1/10W	R3333	1-216-049-11	RES-CHIP	1K 5% 1/10W
R3213	1-216-057-00	RES-CHIP	2.2K 5% 1/10W	R3338	1-216-295-11	SHORT	0
R3214	1-216-295-11	SHORT	0	R3339	1-216-049-11	RES-CHIP	1K 5% 1/10W
R3215	1-216-073-00	RES-CHIP	10K 5% 1/10W	R3340	1-216-073-00	RES-CHIP	10K 5% 1/10W
R3216	1-216-061-00	RES-CHIP	3.3K 5% 1/10W	R3341	1-216-073-00	RES-CHIP	10K 5% 1/10W
R3217	1-216-025-11	RES-CHIP	100 5% 1/10W	R3342	1-216-295-11	SHORT	0

REF.NO.	PART.NO	DESCRIPTION	REMARK	REF.NO.	PART.NO	DESCRIPTION	REMARK
C1703	1-126-935-11	ELECT	470UF	20.00%	16V		
C1704	1-126-935-11	ELECT	470UF	20.00%	6.3V		
C1706	1-126-933-11	ELECT	100UF	20.00%	16V		
C1707	1-126-935-11	ELECT	470UF	20.00%	6.3V		
C1708	1-104-989-91	MYLAR	0.0022UF	5.00%	200V		
C1709	1-104-989-91	MYLAR	0.0022UF	5.00%	200V		
C1710	1-107-649-11	ELECT	2.2UF	20.00%	250V		
C1711	1-130-471-00	MYLAR	0.001UF	5.00%	50V		
C1712	1-130-471-00	MYLAR	0.001UF	5.00%	50V		
C1713	1-126-933-11	ELECT	100UF	20.00%	16V		
C1714	1-107-363-91	MYLAR	0.0068UF	10.00%	200V		
C1715	1-126-933-11	ELECT	100UF	20.00%	16V		
C1717	1-162-117-00	CERAMIC	100PF	10.00%	500V		
C1718	1-102-106-00	CERAMIC	100PF	10.00%	50V		
C1719	1-101-880-00	CERAMIC	47PF	5.00%	50V		
C1720	1-107-652-11	ELECT	10UF	20.00%	250V		
< CONNECTOR >							
CN1701	*1-568-878-51	PIN, CONNECTOR 3P					
CN1702	*1-564-511-11	PLUG, CONNECTOR 8P					
CN1703	*1-770-747-11	CONNECTOR, BOARD TO BOARD 12P					
CN1705	1-695-915-11	TAB (CONTACT)					
< DIODE >							
D1701	8-719-991-33	DIODE 1SS133T-77					
D1702	8-719-510-02	DIODE D1NS4					
D1703	8-719-991-33	DIODE 1SS133T-77					
D1704	8-719-991-33	DIODE 1SS133T-77					
D1705	8-719-991-33	DIODE 1SS133T-77					
D1706	8-719-924-11	DIODE MTZJ-T-77-22					
D1707	8-719-924-11	DIODE MTZJ-T-77-22					
< FERRITE BEAD >							
FB1701	1-410-396-41	FERRITE	0.45UH				
FB1702	1-410-397-21	FERRITE	1.1UH				
< COIL >							
L1701	1-535-303-00	LEAD, JUMPER (5.0MM)					
< TRANSISTOR >							
Q1701	8-729-119-78	TRANSISTOR 2SC2785-HFE					
Q1702	8-729-119-78	TRANSISTOR 2SC2785-HFE					
Q1703	8-729-119-78	TRANSISTOR 2SC2785-HFE					
Q1704	8-729-026-39	TRANSISTOR 2SA933AS-QT					
Q1705	8-729-119-78	TRANSISTOR 2SC2785-HFE					
Q1706	8-729-026-39	TRANSISTOR 2SA933AS-QT					
Q1707	8-729-017-05	TRANSISTOR 2SA1837					
Q1708	8-729-017-06	TRANSISTOR 2SC4793					
< RESISTOR >							
R1701	1-249-401-11	CARBON	47	5%	1/4W		
R1702	1-249-421-11	CARBON	2.2K	5%	1/4W		
R1703	1-535-303-00	LEAD, JUMPER (5.0MM)					
R1704	1-249-425-11	CARBON	4.7K	5%	1/4W		
R1705	1-249-413-11	CARBON	470	5%	1/4W		
R1706	1-249-393-11	CARBON	10	5%	1/4W		
R1707	1-249-399-11	CARBON	33	5%	1/4W		
R1708	1-247-807-31	CARBON	100	5%	1/4W		
R1709	1-249-417-11	CARBON	1K	5%	1/4W		
R1710	1-249-409-11	CARBON	220	5%	1/4W		
R1711	1-249-401-11	CARBON	47	5%	1/4W		
R1712	1-249-401-11	CARBON	47	5%	1/4W		
R1713	1-249-429-11	CARBON	10K	5%	1/4W		
R1714	1-249-414-11	CARBON	560	5%	1/4W		
R1715	1-249-432-11	CARBON	18K	5%	1/4W		
R1716	1-249-432-11	CARBON	18K	5%	1/4W		
R1717	1-249-414-11	CARBON	560	5%	1/4W		
R1718	1-249-421-11	CARBON	2.2K	5%	1/4W		
R1719	1-249-421-11	CARBON	2.2K	5%	1/4W		
R1720	1-260-311-11	CARBON	39	5%	1/2W		
R1721	1-249-383-11	CARBON	1.5	5%	1/4W		
R1722	1-249-383-11	CARBON	1.5	5%	1/4W		
R1723	1-249-400-11	CARBON	39	5%	1/4W		
R1724	1-215-914-11	METAL OXIDE	330	5%	3W		
R1725	1-249-419-11	CARBON	1.5K	5%	1/4W		

Note : The components identified by shading and marked Δ are critical for safety. Replace only with the part numbers specified in the parts list.

REF.NO. PART.NO DESCRIPTION REMARK

MISCELLANEOUS

Δ 1-416-466-11 COIL DEMAGNETIC (KV-28DS65)
 Δ 1-416-768-11 COIL DEMAGNETIC (KV-32DS65)
 4-452-032-00 MAGNETIC, DISK; 10MM
 1-452-094-00 MAGNET, ROTATABLE DISK; 15MM
 1-529-153-11 SPEAKER (4.8X20CM)

 1-529-144-11 SPEAKER (13CM)
 1-452-896-11 COIL, NA ROTATION (RT200)
 Δ 1-571-433-21 SWITCH, PUSH (AC POWER)
 Δ 1-776-204-21 CORD, POWER (FILTER)
 1-693-339-11 TUNER/VIF (UK)

Δ 8-737-786-05 PICTURE TUBE (W66LLX060X) (KV-28DS65)
 Δ 8-735-079-01 PICTURE TUBE (W76LLZ-060X) (KV-32DS65)
 Δ 1-451-463-21 DEFLECTION YOKE (Y28RVC2) (KV-28DS65)
 Δ 1-451-462-21 DEFLECTION YOKE (Y32RVC2) (KV-32DS65)
 Δ 8-453-015-11 NECK ASSY, NA2913-M

Δ 1-251-317-63 CAP ASSY, HIGH VOLTAGE

ACCESSORIES AND PACKAGING MATERIALS

4-204-616-65 MANUAL INSTRUCTION
 1-765-654-21 CABLE, SPEAKER
 4-205-059-01 REGISTRATION CARD (DIGITAL)
 *4-395-957-01 BAG, PROTECTION (KV-28DS65)
 *4-029-168-01 BAG, PROTECTION (KV-32DS65)

 *4-204-457-05 INDIVIDUAL CARTON (KV-28DS65)
 *4-204-378-05 INDIVIDUAL CARTON (KV-32DS65)
 *4-204-451-01 CUSHION (UPPER) (ASSY) (KV-28FX65)
 *4-204-387-01 CUSHION (UPPER) (ASSY) (KV-32DS65)
 *4-204-454-01 CUSHION (LOWER) (ASSY) (KV-28DS65)

 *4-204-388-01 CUSHION (LOWER) (ASSY) (KV-32DS65)

REMOTE COMMANDER

1-418-572-11 REMOTE COMMANDER (RM-892)

REF.NO. PART.NO DESCRIPTION REMARK

TRACE

A new TV Repair Assistance Tool that combines ease of use and powerful PC software tools to allow you to save valuable time during many TV repairs.



The TRACE interface connects to the PC's serial port. It provides connection to the TV's I²C bus and can be provided with an InfraRed transmitter (optional).

The interface is powered by a standard 9 V PP3 battery for portable use, and can also be powered by an external 9V/25mA DC power supply.

The TRACE software that is supplied with the interface allows you to:

- Read, restore and compare NVM contents via the I²C bus
- Acknowledge check of all I²C devices in the TV set
- Read Error Codes (emulation of the Error Reader tool)

With the optional IR Add-on kit, the following features can be added:

- Remote Commander emulation
- User programmable Functional Check through Infrared
- Fast and documented Test Mode setting of all Sony TV chassis

Additional features such as Adjustments and Troubleshooting are available in chassis-dependent software modules. Please contact your local Sony Service organisation for the latest information.

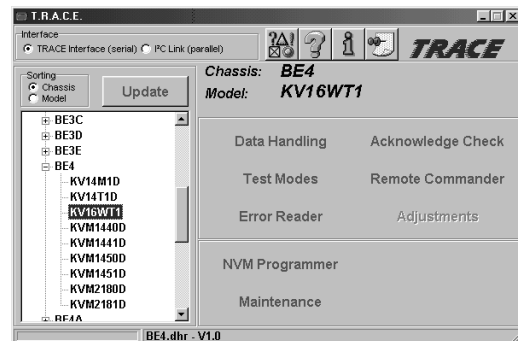

Note: For workshops already using the existing I²C Link parallel port interface (9-948-320-30), this software can be used as well, replacing the TV Data Handling software (9-948-340-50), but Error Reader and IR functions can only be accessed with the TRACE interface.

Partnumbers: TRACE Starter Kit (TRACE interface + software): 9-948-320-70
TRACE Software (for users of the I²C Link interface): 9-948-340-80
TRACE IR Add-on (IR interface + Remote Commander software): 9-948-320-80

PC requirements: IBM-compatible PC with operating system Windows95, Windows98, or WindowsNT*.

* WindowsNT only supported with TRACE interface

Sony Corporation
Sony UK
Service Promotions Dept.

English
00AP7105-1
Printed in U.K.
© 2001.1