

SHARP SERVICE MANUAL

No. SX8S6LC32D653



LCD COLOUR TELEVISION

LC-32D653E
LC-32D654E
LC-37D653E
LC-37D654E
LC-46D653E
LC-46D654E

MODELS

In the interests of user-safety (Required by safety regulations in some countries) the set should be restored to its original condition and only parts identical to those specified should be used.

OUTLINE

This Service Manual covers the differences from LC-32D65E/RU, LC-37D65E/RU and LC-46D65E/RU. For other technical information, refer to the LC-32D65E/RU, LC-37D65E/RU (No. S88N7LC32D65E) or LC-46D65E/RU (S08R9LC46D65E) Service Manual.

CONTENTS

OUTLINE AND MODIFIED PARTS LIST

OUTLINE.....	i
MODIFIED PARTS LIST (LC-32/37D653E/D654E).....	i
MODIFIED PARTS LIST (LC-46D653E/D654E).....	ii

SAFETY PRECAUTION

IMPORTANT SERVICE SAFETY PRE- CAUTION.....	iii
Precautions for using lead-free solder	iv

CHAPTER 1. ADJUSTMENT PROCEDURE

[1] ADJUSTMENT PROCEDURE	1-1
--------------------------------	-----

CHAPTER 2. SCHEMATIC DIAGRAM

[1] DESCRIPTION OF SCHEMATIC DIA- GRAM.....	2-1
[2] SCHEMATIC DIAGRAM (LC-32/37D653E/D654E)	2-2
[3] SCHEMATIC DIAGRAM (LC-46D653E/D654E)	2-18

Parts Guide

Parts marked with "⚠" are important for maintaining the safety of the set. Be sure to replace these parts with specified ones for maintaining the safety and performance of the set.

OUTLINE AND MODIFIED PARTS LIST**OUTLINE**

This Service Manual covers the differences from LC-32D65E/RU, LC-37D65E/RU and LC-46D65E/RU. For other technical information, refer to the LC-32D65E/RU, LC-37D65E/RU (No. S88N7LC32D65E) or LC-46D65E/RU (No. S08R9LC46D65E) Service Manual.

MODIFIED PARTS LIST (LC-32/37D653E/D654E)

Ref.No.	Description	No. S88N7LC32D65E (Base Models)	No. SX8S6LC32D653 (This Model)	Remarks
PRINTED WIRING BOARD ASSEMBLIES (LC-32D653E)				
N	MAIN Unit	DUNTKE685FM01	DUNTKE685FM31	Changes
N	R/C LED Unit	DUNTKE687FM01	DUNTKE687FM31	Only unit code changes
N	POWER/INVERTER Unit	RUNTKA456WJQZ	RUNTKA456WJQZ	No changes
PRINTED WIRING BOARD ASSEMBLIES (LC-32D654E)				
N	MAIN Unit	DUNTKE685FM01	DUNTKE685FM33	Changes
N	R/C LED Unit	DUNTKE687FM01	DUNTKE687FM33	Only unit code changes
N	POWER/INVERTER Unit	RUNTKA456WJQZ	RUNTKA456WJQZ	No changes
PRINTED WIRING BOARD ASSEMBLIES (LC-37D653E)				
N	MAIN Unit	DUNTKE685FM03	DUNTKE685FM32	Changes
N	R/C LED Unit	DUNTKE687FM03	DUNTKE687FM32	Only unit code changes
N	POWER Unit	RDENCA267WJQZ	RDENCA267WJQZ	No changes
N	INVERTER Unit	RUNTKA457WJQZ	RUNTKA457WJQZ	No changes
PRINTED WIRING BOARD ASSEMBLIES (LC-37D654E)				
N	MAIN Unit	DUNTKE685FM03	DUNTKE685FM34	Changes
N	R/C LED Unit	DUNTKE687FM03	DUNTKE687FM34	Only unit code changes
N	POWER Unit	RDENCA267WJQZ	RDENCA267WJQZ	No changes
N	INVERTER Unit	RUNTKA457WJQZ	RUNTKA457WJQZ	No changes
LCD PANEL				
N	32" LCD Panel Module	R1LK315D3LW1AY	R1LK315D3LW1AS	Changes
N	37" LCD Panel Module	R1LK370D3LW1AY	R1LK370D3LW10Y	Changes
CABINET PARTS				
Refer to Parts List.				
SUPPLIED ACCESSORIES				
Refer to Parts List.				
PACKING PARTS				
Refer to Parts List.				
Service Jigs				
Refer to Parts List.				

MODIFIED PARTS LIST (LC-46D653E/D654E)

Ref.No.	Description	No. S08R9LC46D65E (Base Models)	No. SX8S6LC32D653 (This Model)	Remarks
PRINTED WIRING BOARD ASSEMBLIES (LC-46D653E)				
N	KEY Unit	DUNTKE266FM01	DUNTKE266FM01	No Changes
N	MAIN Unit	DUNTKE685FM05	DUNTKE685FM36	Changes
N	LED Unit	DUNTKE687FM05	DUNTKE687FM36	Only unit code changes
N	POWER Unit (Unit Replacement Item)	RDENCA308WJQZ	RDENCA308WJQZ	No Changes
PRINTED WIRING BOARD ASSEMBLIES (LC-46D654E)				
N	KEY Unit	DUNTKE266FM01	DUNTKE266FM01	No Changes
N	MAIN Unit	DUNTKE685FM05	DUNTKE685FM37	Changes
N	LED Unit	DUNTKE687FM05	DUNTKE687FM37	Only unit code changes
N	POWER Unit (Unit Replacement Item)	RDENCA308WJQZ	RDENCA308WJQZ	No Changes
LCD PANEL				
N	46" LCD Panel Module	R1LK460D3LW6AY	R1LK460D3LW6AY	No Changes
CABINET PARTS				
Refer to Parts List.				
SUPPLIED ACCESSORIES				
Refer to Parts List.				
PACKING PARTS				
Refer to Parts List.				
Service Jigs				
Refer to Parts List.				

SAFETY PRECAUTION

IMPORTANT SERVICE SAFETY PRECAUTION

- Service work should be performed only by qualified service technicians who are thoroughly familiar with all safety checks and the servicing guidelines which follow:

WARNING

- For continued safety, no modification of any circuit should be attempted.
- Disconnect AC power before servicing.

CAUTION:
 FOR CONTINUED PROTECTION AGAINST A RISK OF FIRE REPLACE ONLY WITH SAME TYPE FUSE.
 F7101 (3.15A/250V), F7102 (1A/250V),
 F7103 (3.15A/250V) (LC-32/37D653E/D654E)
 F7000 (4A/250V), F7001 (4A/250V)
 (LC-46D653E/D654E)

BEFORE RETURNING THE RECEIVER (Fire & Shock Hazard)

Before returning the receiver to the user, perform the following safety checks:

- Inspect all lead dress to make certain that leads are not pinched, and check that hardware is not lodged between the chassis and other metal parts in the receiver.
- Inspect all protective devices such as non-metallic control knobs, insulation materials, cabinet backs, adjustment and compartment covers or shields, isolation resistor-capacitor networks, mechanical insulators, etc.
- To be sure that no shock hazard exists, check for leakage current in the following manner:
 - Plug the AC cord directly into a 220~240 volt AC outlet.
 - Using two clip leads, connect a 1.5k ohm, 10 watt resistor paralleled by a 0.15µF capacitor in series with all exposed metal cabinet parts and a known earth ground, such as electrical conduit or electrical ground connected to an earth ground.

- Use an AC voltmeter having with 5000 ohm per volt, or higher, sensitivity or measure the AC voltage drop across the resistor.
 - Connect the resistor connection to all exposed metal parts having a return to the chassis (antenna, metal cabinet, screw heads, knobs and control shafts, escutcheon, etc.) and measure the AC voltage drop across the resistor.
- All checks must be repeated with the AC cord plug connection reversed. (If necessary, a nonpolarized adaptor plug must be used only for the purpose of completing these checks.) Any reading of 1.05 V peak (this corresponds to 0.7 mA peak AC.) or more is excessive and indicates a potential shock hazard which must be corrected before returning the monitor to the owner.

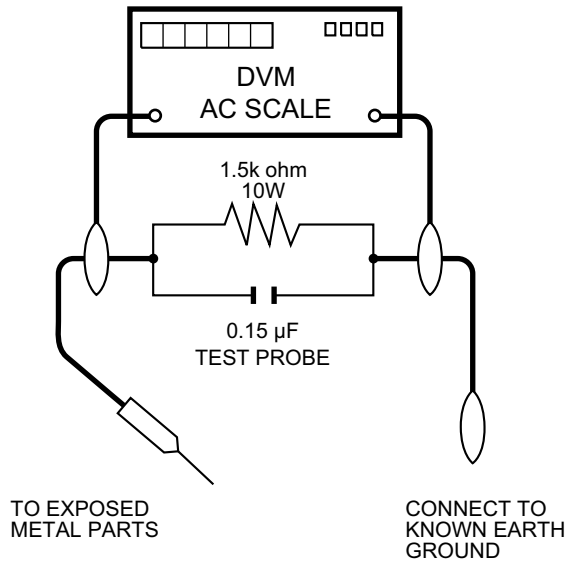

SAFETY NOTICE

Many electrical and mechanical parts in LCD color television have special safety-related characteristics.

These characteristics are often not evident from visual inspection, nor can protection afforded by them be necessarily increased by using replacement components rated for higher voltage, wattage, etc.

Replacement parts which have these special safety characteristics are identified in this manual; electrical components having such features are identified by “” and shaded areas in the Replacement Parts List and Schematic Diagrams.

For continued protection, replacement parts must be identical to those used in the original circuit.

The use of a substitute replacement parts which do not have the same safety characteristics as the factory recommended replacement parts shown in this service manual, may create shock, fire or other hazards.

Precautions for using lead-free solder

■Employing lead-free solder

- “PWBs” of this model employs lead-free solder. The LF symbol indicates lead-free solder, and is attached on the PWBs and service manuals. The alphabetical character following LF shows the type of lead-free solder.

Example:

LFa
Sn-Ag-Cu

Indicates lead-free solder of tin, silver and copper.

LFa/a
Sn-Ag-Cu

Indicates lead-free solder of tin, silver and copper.

■Using lead-free wire solder

- When fixing the PWB soldered with the lead-free solder, apply lead-free wire solder. Repairing with conventional lead wire solder may cause damage or accident due to cracks.

As the melting point of lead-free solder (Sn-Ag-Cu) is higher than the lead wire solder by 40 °C, we recommend you to use a dedicated soldering bit, if you are not familiar with how to obtain lead-free wire solder or soldering bit, contact our service station or service branch in your area.

■Soldering

- As the melting point of lead-free solder (Sn-Ag-Cu) is about 220 °C which is higher than the conventional lead solder by 40 °C, and as it has poor solder wettability, you may be apt to keep the soldering bit in contact with the PWB for extended period of time. However, Since the land may be peeled off or the maximum heat-resistance temperature of parts may be exceeded, remove the bit from the PWB as soon as you confirm the steady soldering condition.

Lead-free solder contains more tin, and the end of the soldering bit may be easily corroded. Make sure to turn on and off the power of the bit as required.

If a different type of solder stays on the tip of the soldering bit, it is alloyed with lead-free solder. Clean the bit after every use of it.

When the tip of the soldering bit is blackened during use, file it with steel wool or fine sandpaper.

- Be careful when replacing parts with polarity indication on the PWB silk.

Lead-free wire solder for servicing

Part No.	★	Description	Code
ZHNDai123250E	J	φ0.3mm 250g (1roll)	BL
ZHNDai126500E	J	φ0.6mm 500g (1roll)	BK
ZHNDai12801KE	J	φ1.0mm 1kg (1roll)	BM

CHAPTER 1. ADJUSTMENT PROCEDURE

[1] ADJUSTMENT PROCEDURE

1. Adjustment method after PWB and/or IC replacement due to repair

The unit is set to the optimum at the time of shipment from the factory. If any value should become improper or any adjustment is necessary due to the part replacement, make an adjustment according to the following procedure.

1. Procure the following units in order to replace the main unit, IC8101.

MAIN UNIT: DUNTKE685FM31 (LC-32D653E)
DUNTKE685FM33 (LC-32D654E)
DUNTKE685FM32 (LC-37D653E)
DUNTKE685FM34 (LC-37D654E)
DUNTKE685FM36 (LC-46D653E)
DUNTKE685FM37 (LC-46D654E)

NOTE: [Caution when replacing ICs in the main unit (IC1504)]

The above ICs are EEPROMs storing the EDID data of HDMI. Before replacing the relevant part, procure the following parts in which the data have been rewritten.

IC1504	RH-iXC442WJN1S	EDID (HDMI)
IC1503	RH-iXC697WJQZS	EDID (PC)
IC2003	RH-iXC331WJNNQ	UCON (LC-46D653E/D654E)

CHAPTER 2. SCHEMATIC DIAGRAM

[1] DESCRIPTION OF SCHEMATIC DIAGRAM

VOLTAGE MEASUREMENT CONDITION:

1. The voltages at test points are measured on exclusive AC adaptor and the stable supply voltage of AC 230V.
Signals are fed by a colour bar signal generator for servicing purpose and the above voltages are measured with a 20k ohm/V tester.

INDICATION OF RESISTOR & CAPACITOR:

RESISTOR

1. The unit of resistance "Ω" is omitted.
(K=kΩ=1000 Ω, M=MΩ).
2. All resistors are ± 5%, unless otherwise noted.
(K= ± 10%, F= ± 1%, D= ± 0.5%)
3. All resistors are 1/16W, unless otherwise noted.

CAPACITOR

1. All capacitors are μF, unless otherwise noted.
(P=pF=μμF).
2. All capacitors are 50V, unless otherwise noted.

CAUTION:

This circuit diagram is original one, therefore there may be a slight difference from yours.

SAFETY NOTES:

1. DISCONNECT THE AC PLUG FROM THE AC OUTLET BEFORE REPLACING PARTS.
2. SEMICONDUCTOR HEAT SINKS SHOULD BE REGARDED AS POTENTIAL SHOCK HAZARDS WHEN THE CHASSIS IS OPERATING.

IMPORTANT SAFETY NOTICE:

PARTS MARKED WITH "△" () ARE IMPORTANT FOR MAINTAINING THE SAFETY OF THE SET. BE SURE TO REPLACE THESE PARTS WITH SPECIFIED ONES FOR MAINTAINING THE SAFETY AND PERFORMANCE OF THE SET.

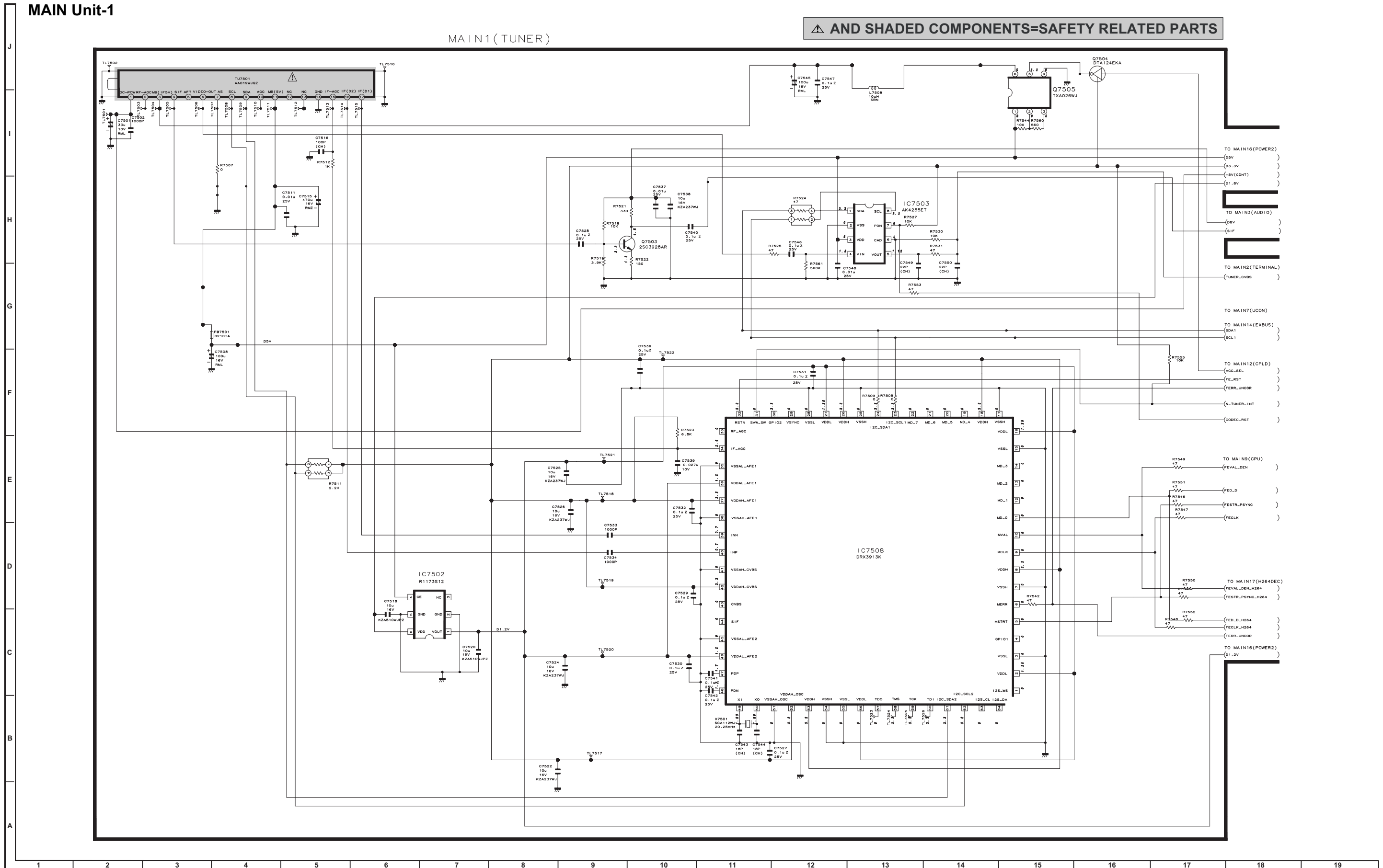

MAIN Unit-2

MAIN2(TERMINAL)

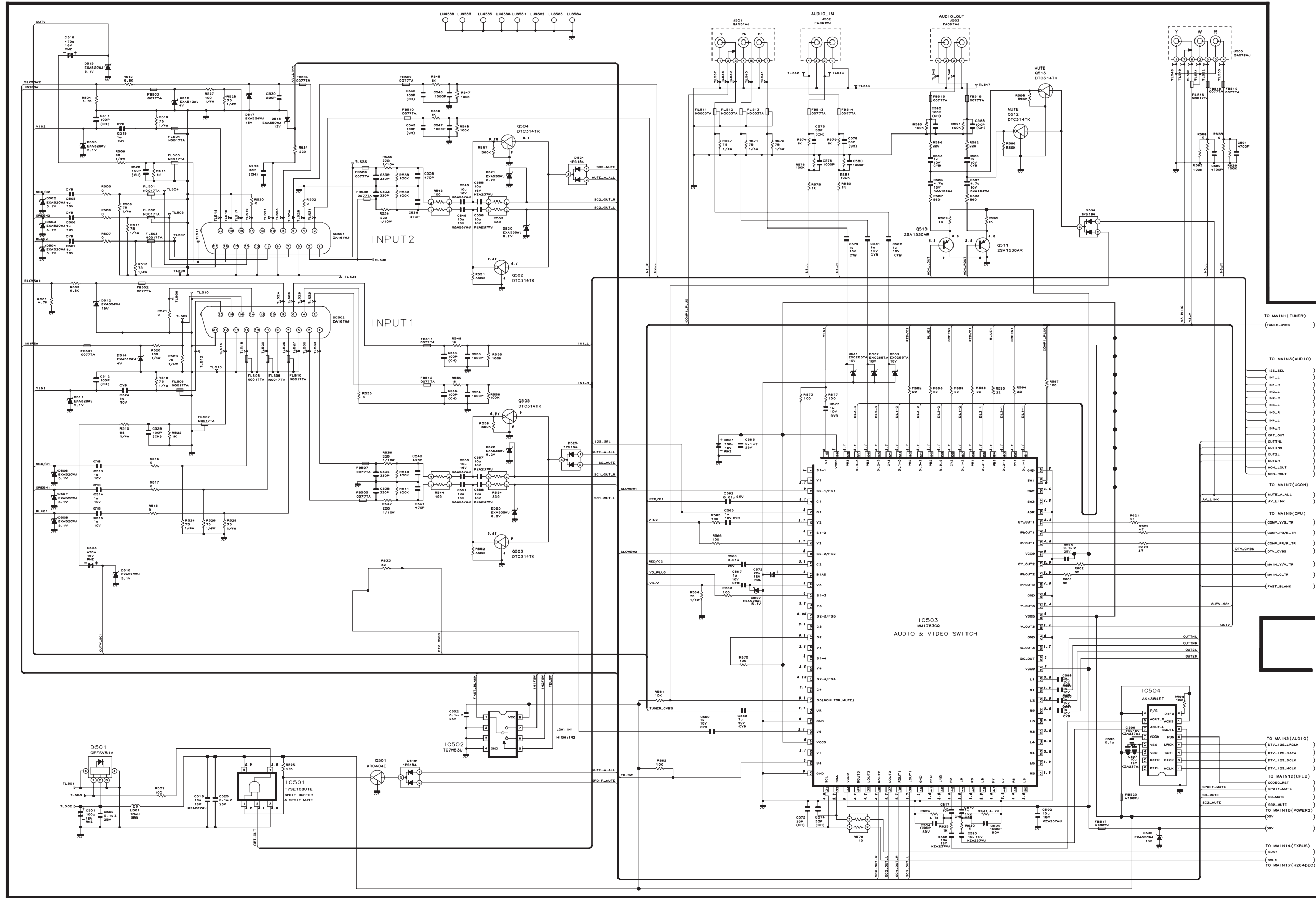

J
I
H
G
F
E
D
C
B
A

1 2 3 4 5 6 7 8 9 10 11 12 13 14 15 16 17 18 19

MAIN Unit-3

MAIN3 (AUDIO)

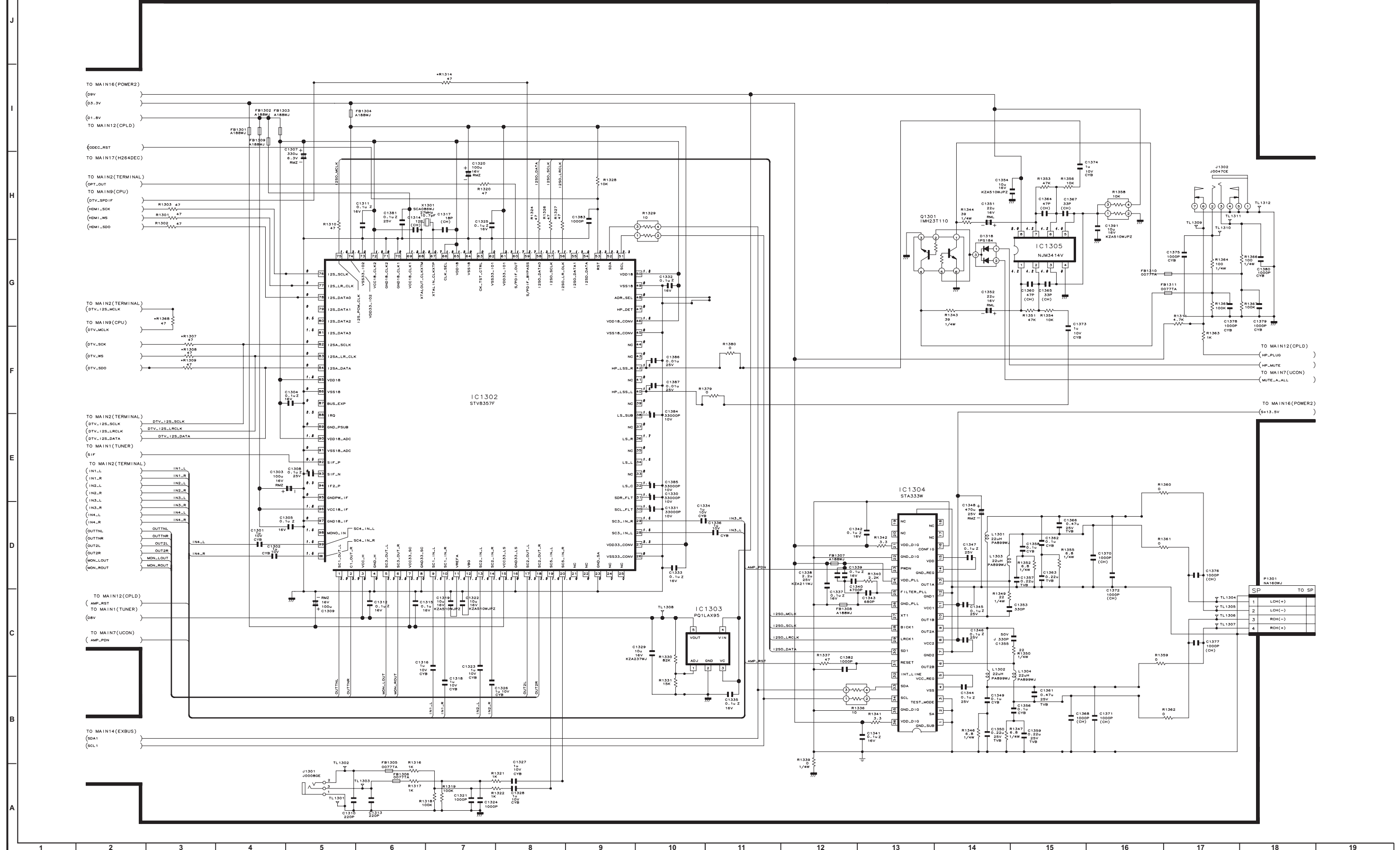

MAIN Unit-4

MAIN4 (HDMI)

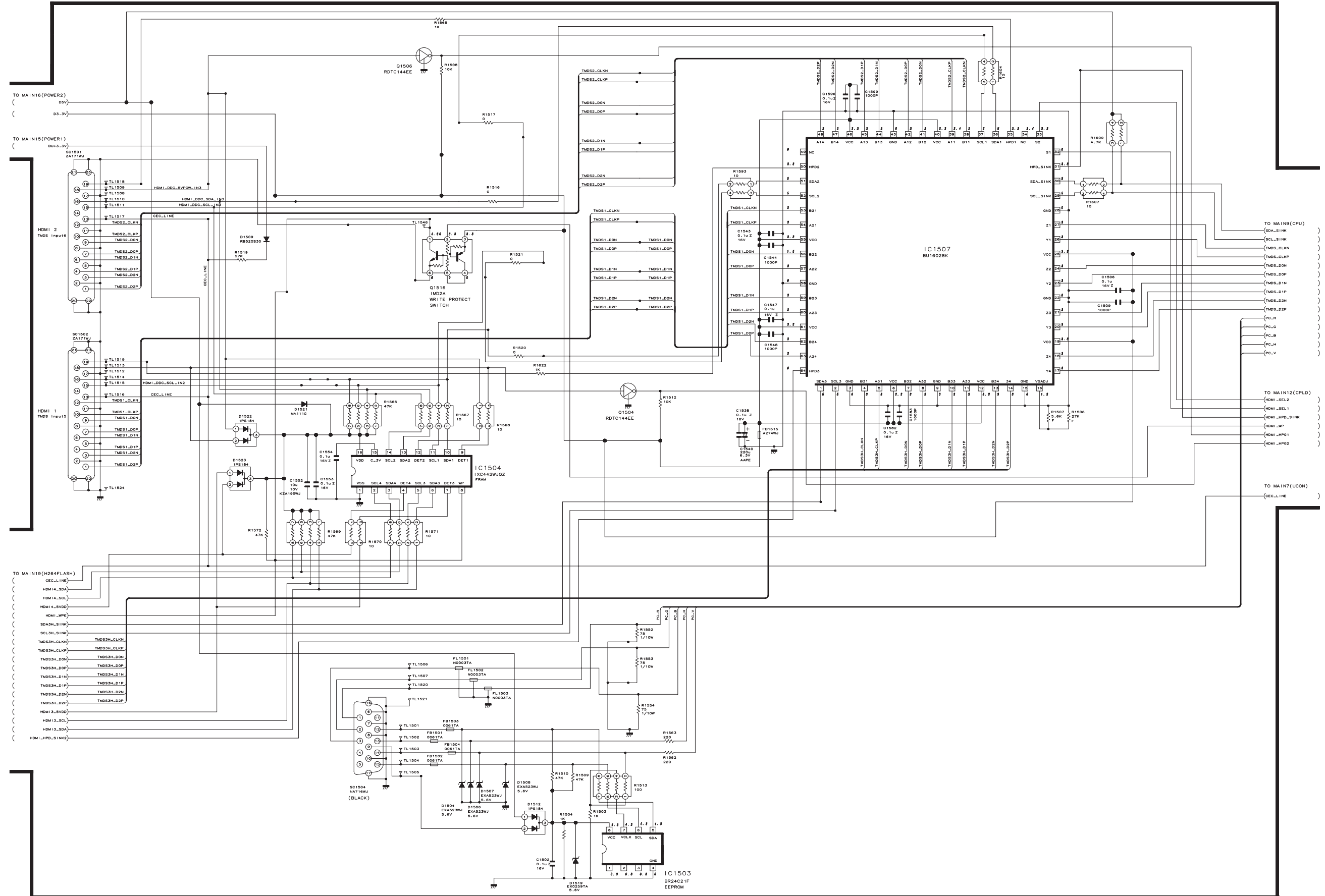

MAIN Unit-5

MAIN6 (DSW)

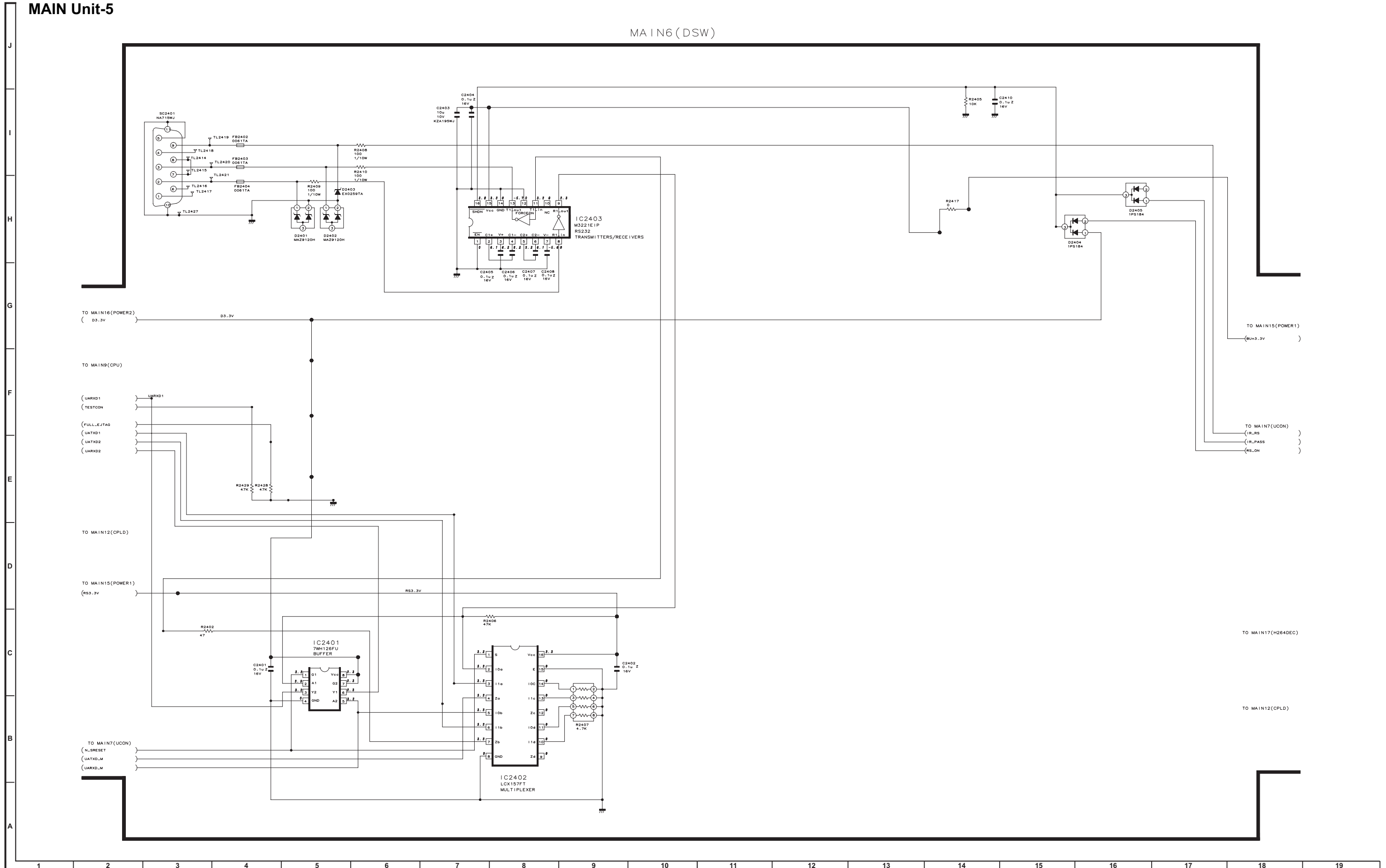

MAIN Unit-6

MAIN7(UCON)

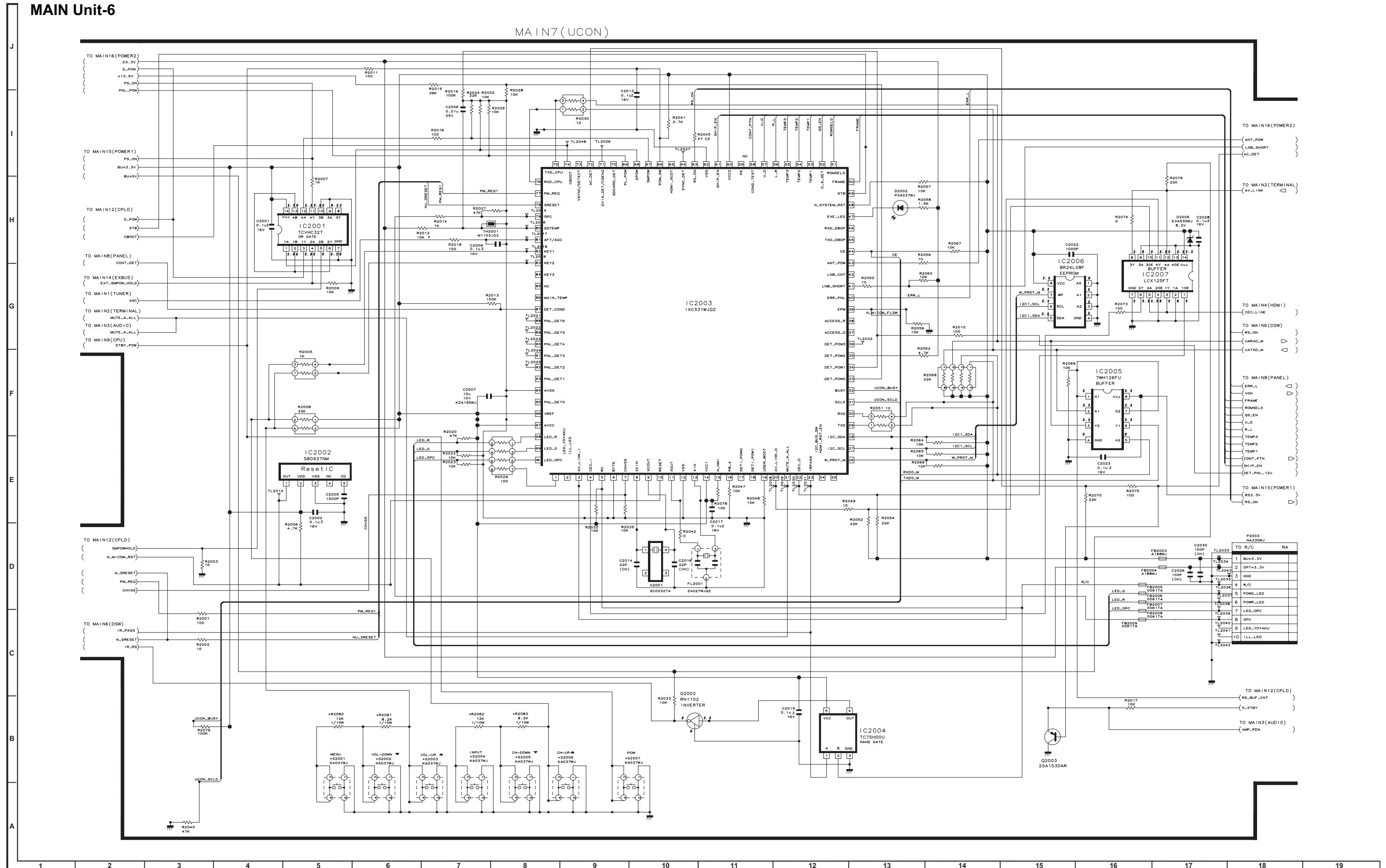

MAIN Unit-7

MAIN8 (PANEL)

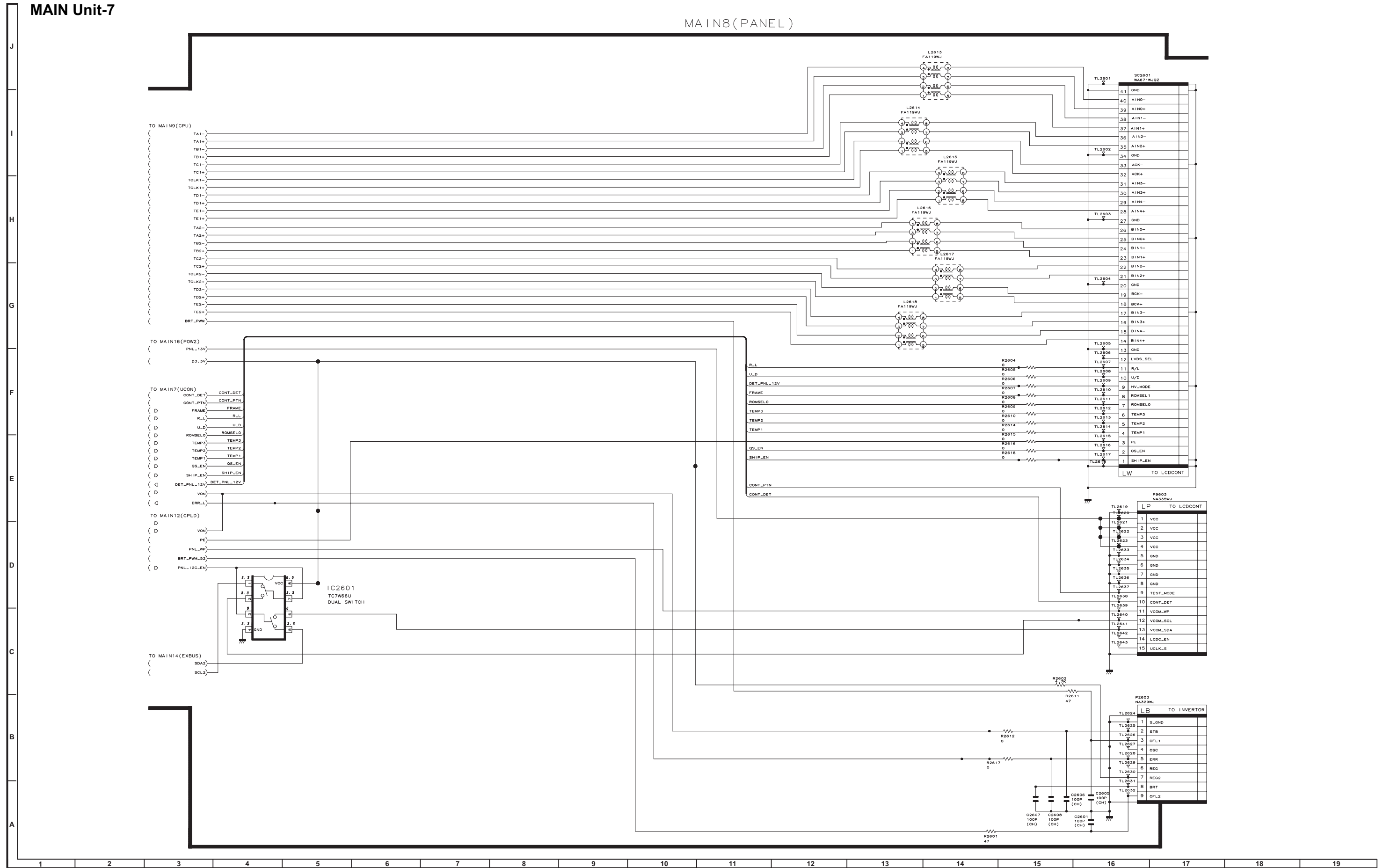

MAIN Unit-8

MAIN9 (CPU)

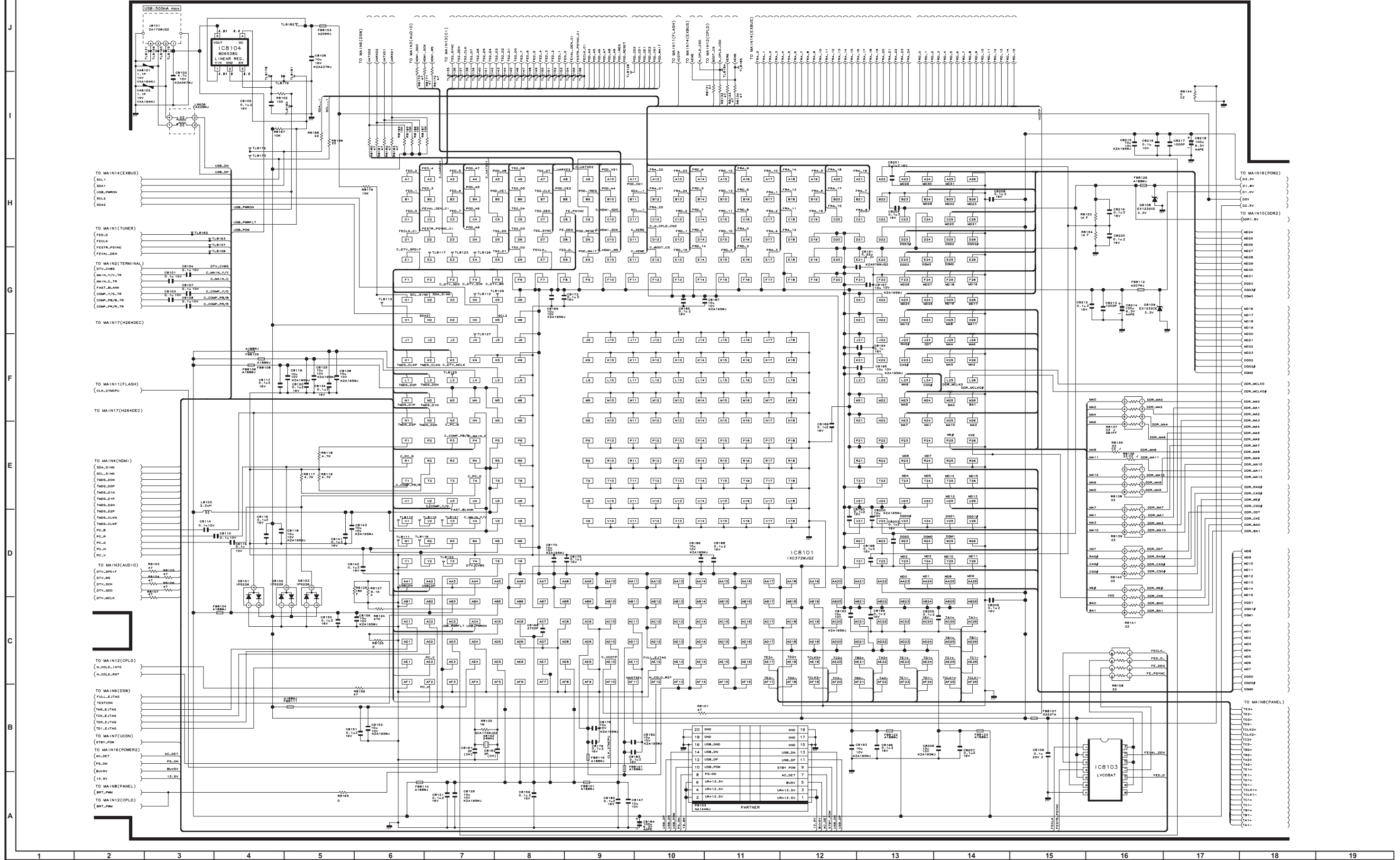

MAIN Unit-9

MAIN10(DDR2)

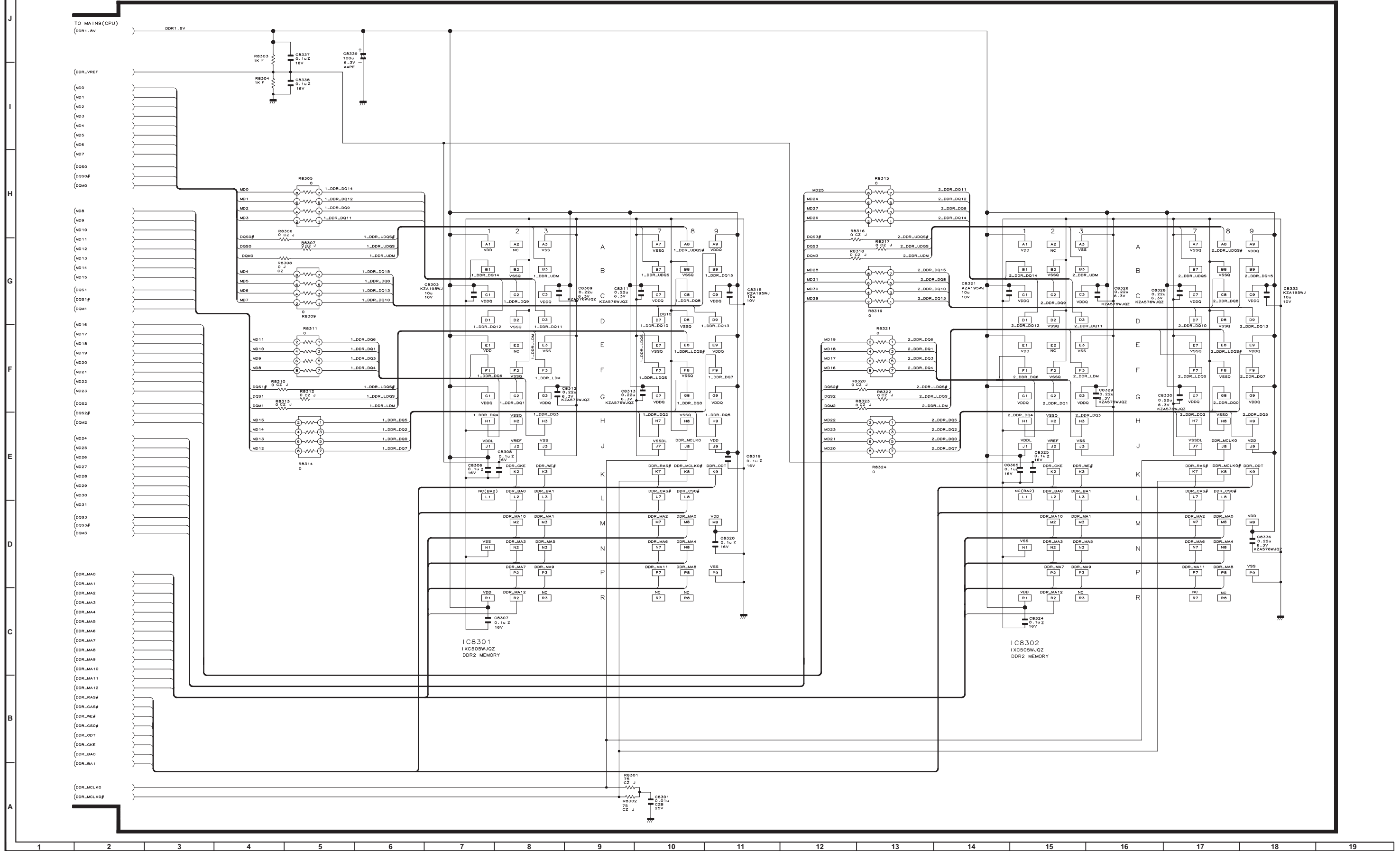

MAIN Unit-10

MAIN11(FLASH)

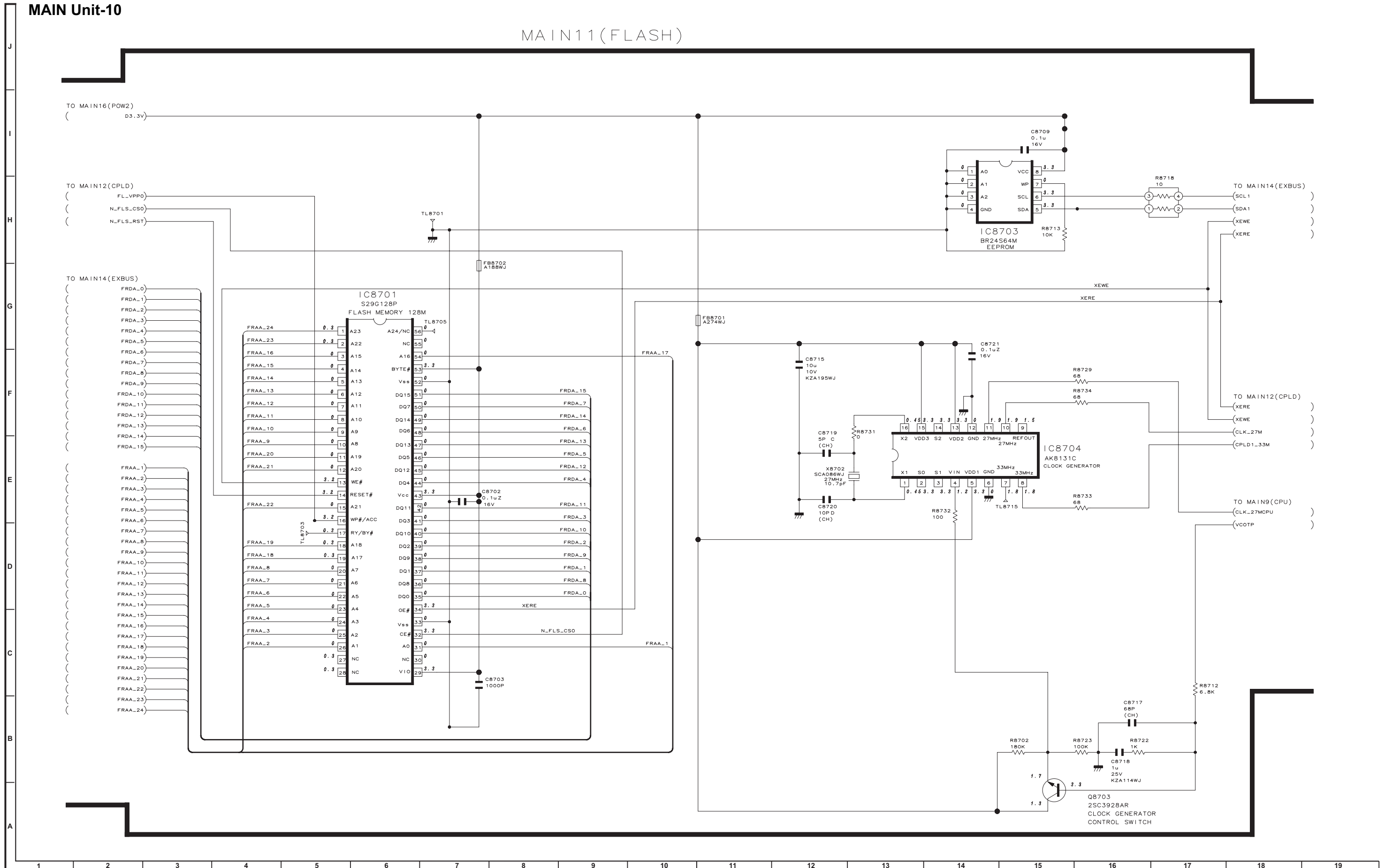

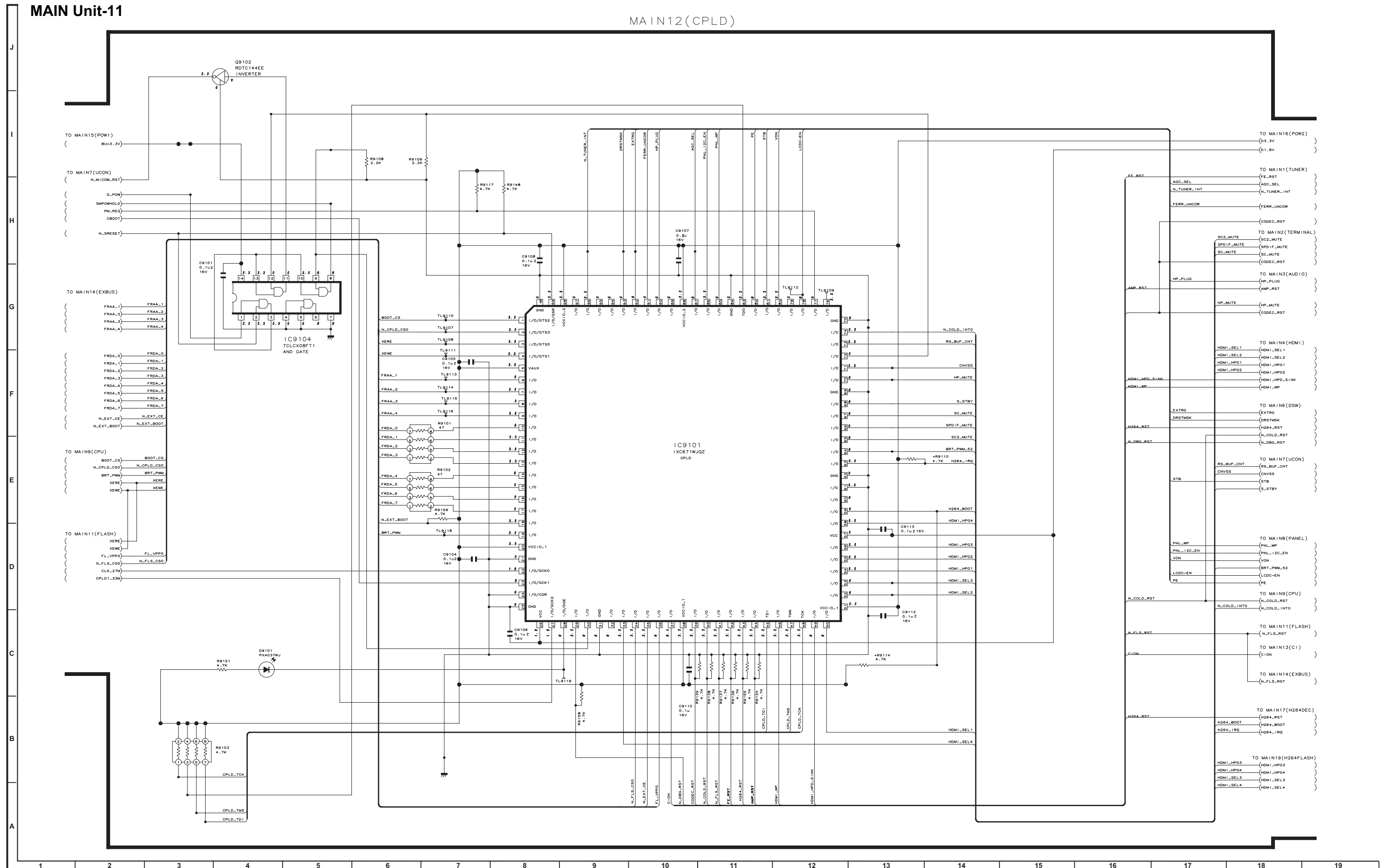

MAIN Unit-12

MAIN13(C1)

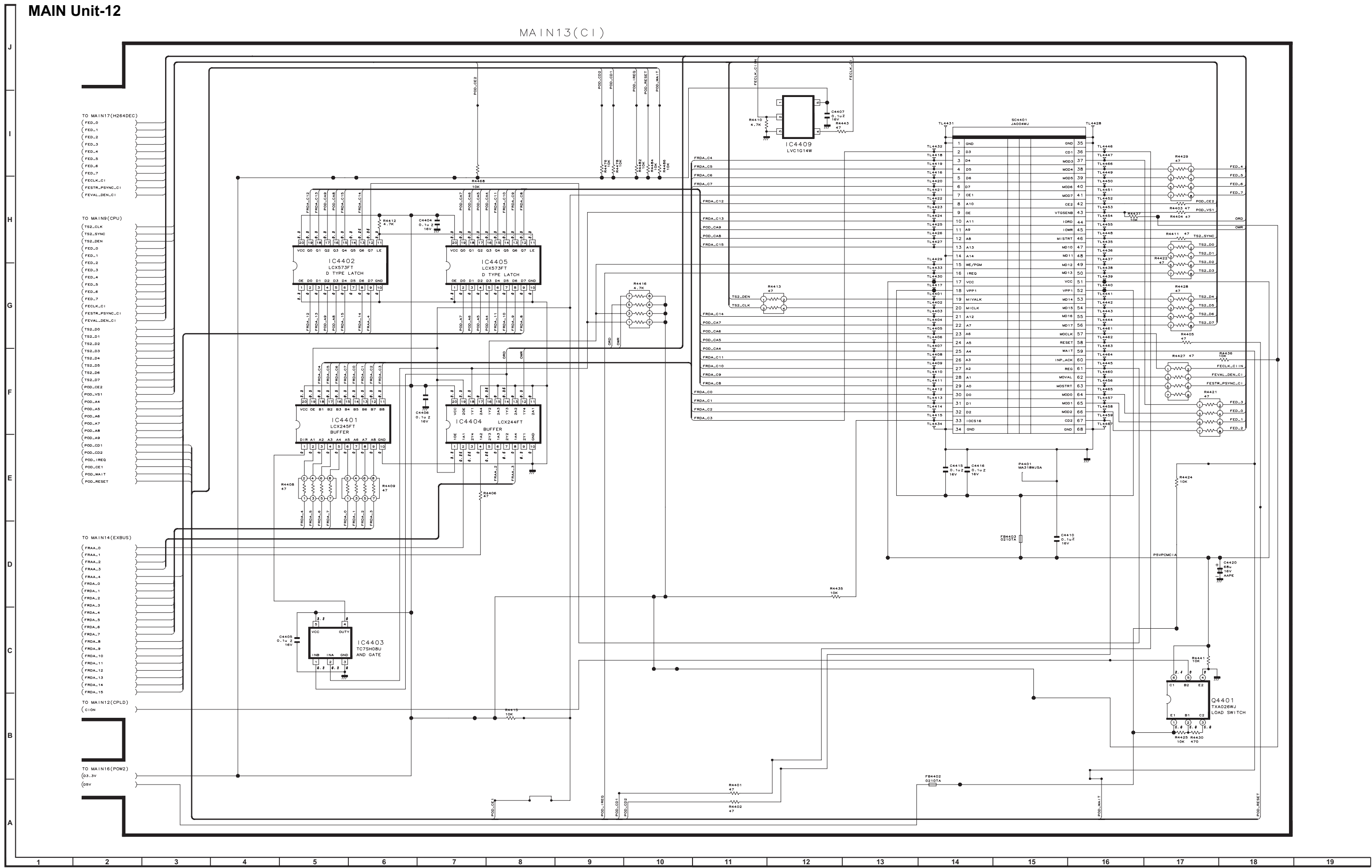

MAIN Unit-13

MAIN14 (EXBUS)

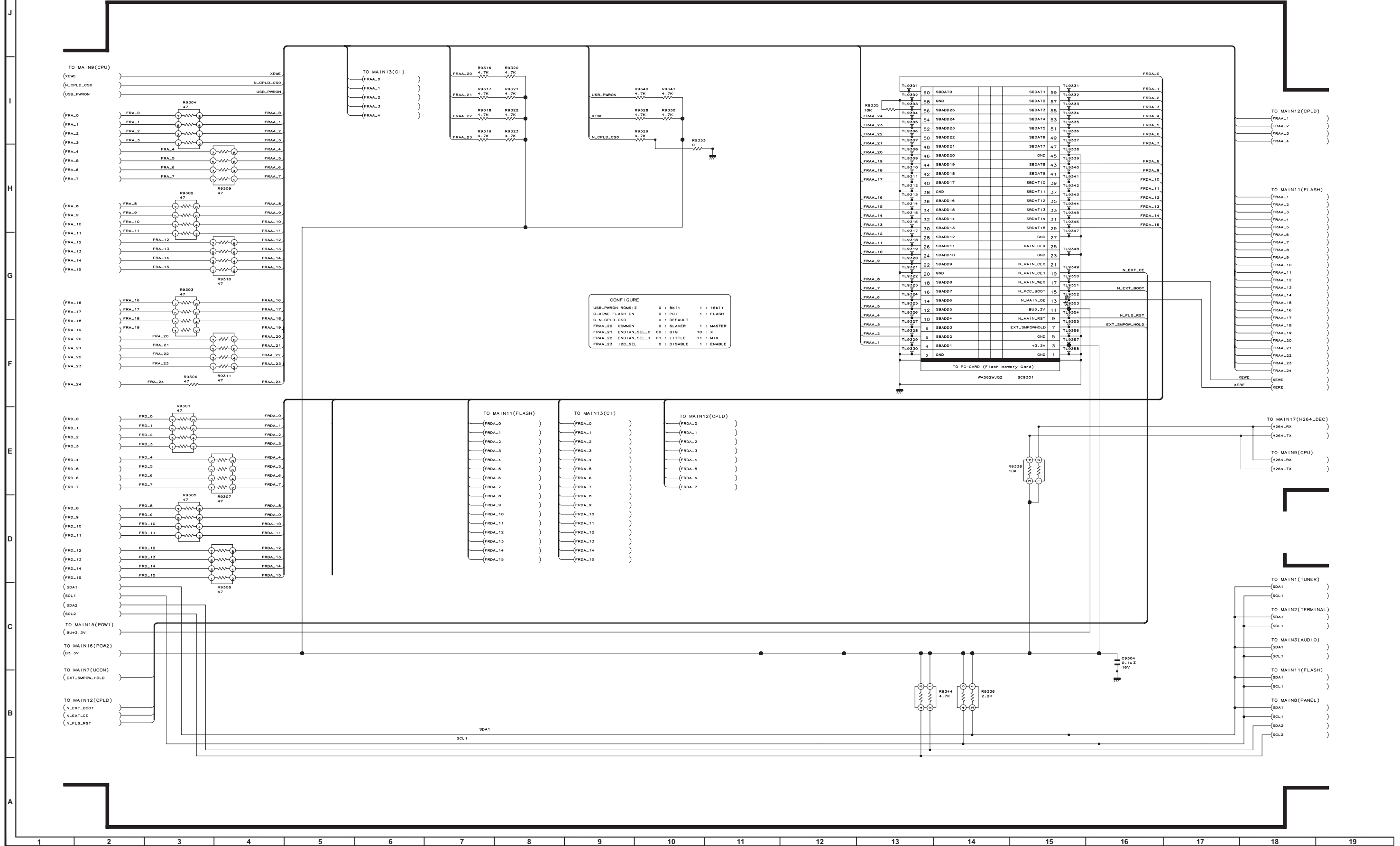

MAIN Unit-14

MAIN15 (POWER 1)

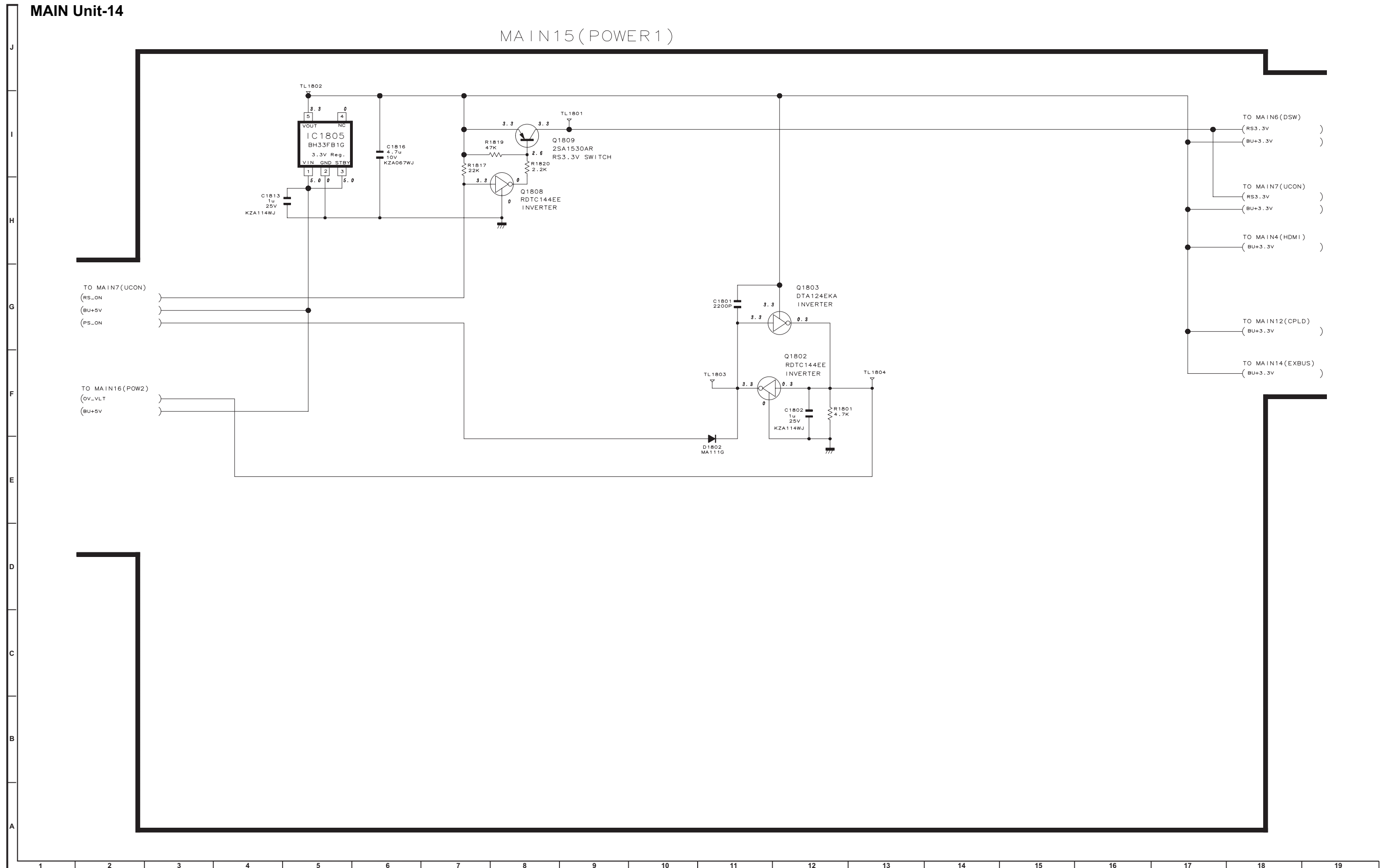

MAIN Unit-15

MAIN16 (POWER2)

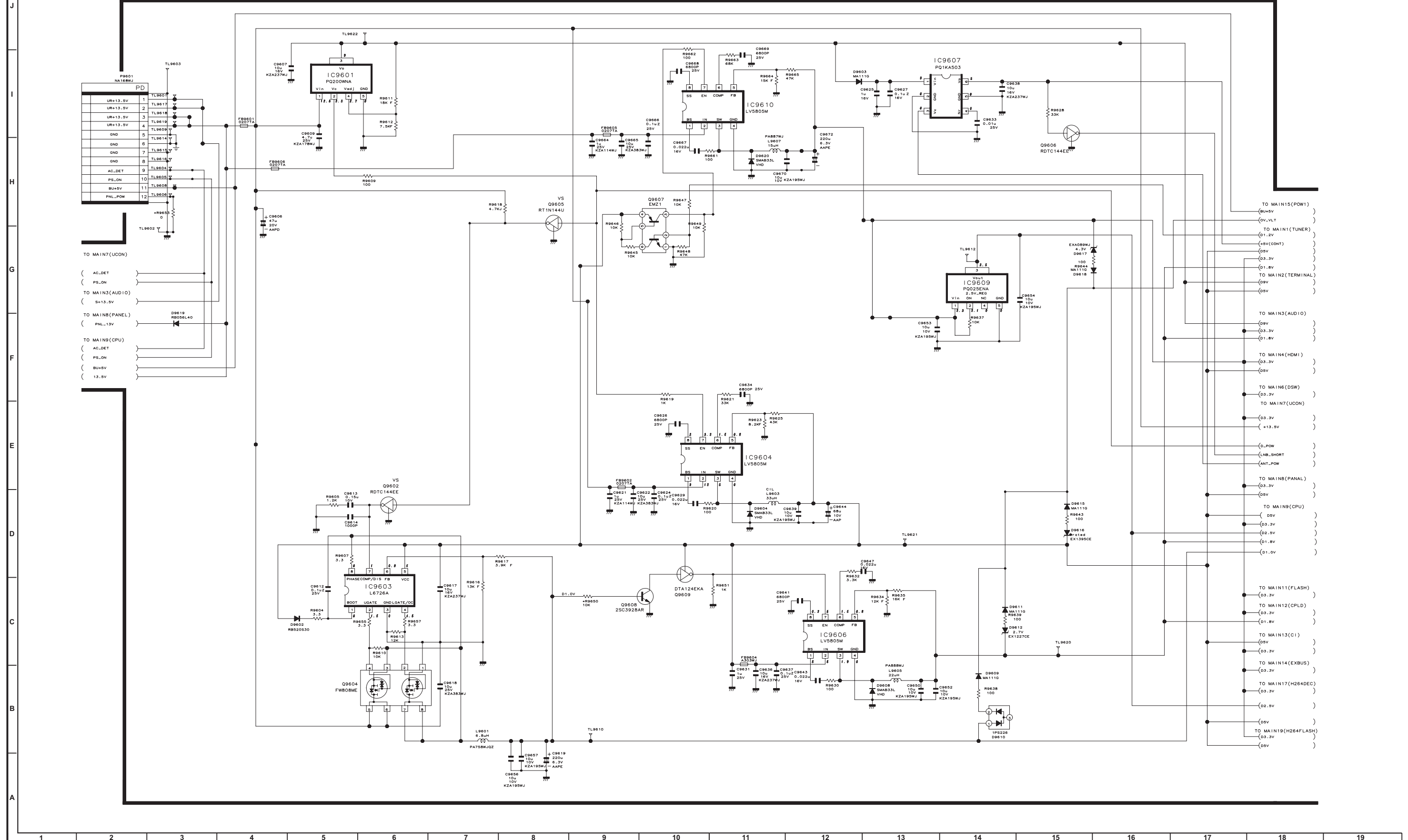

MAIN Unit-16

MAIN19(H.264_FLASH)

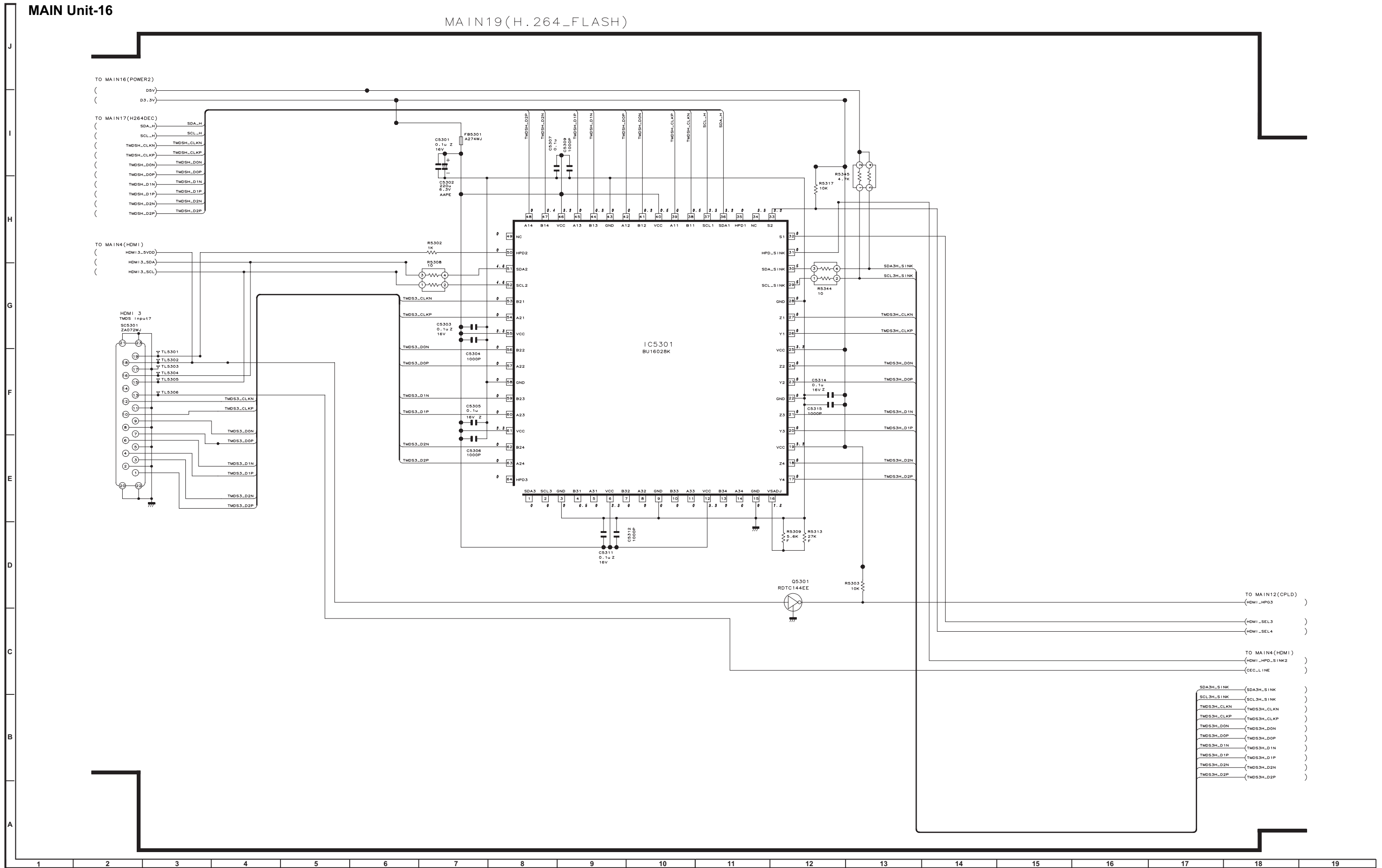

MAIN Unit-1

MAIN1(TUNER)

▲ AND SHADED COMPONENTS=SAFETY RELATED PARTS

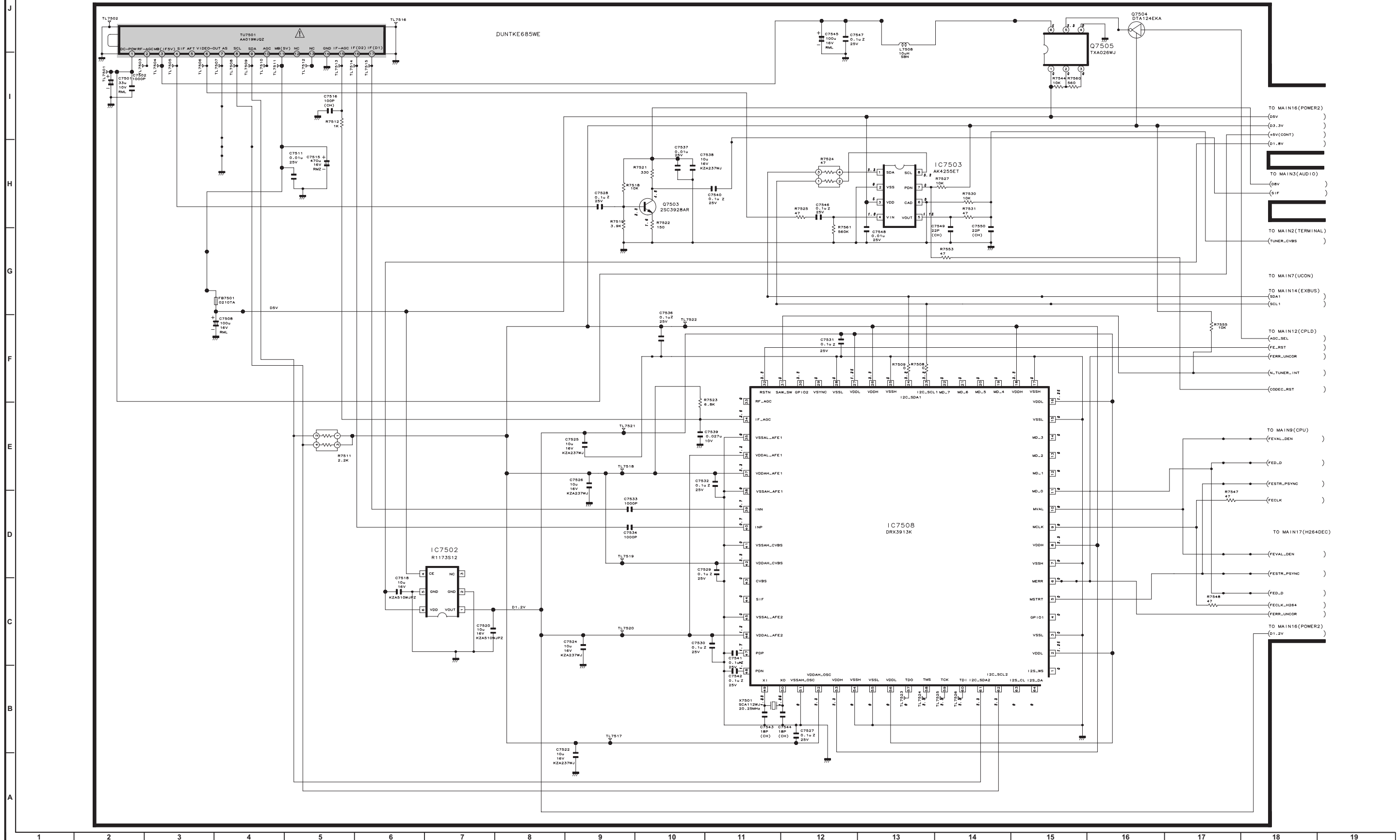

MAIN Unit-2

MAIN2(TERMINAL)

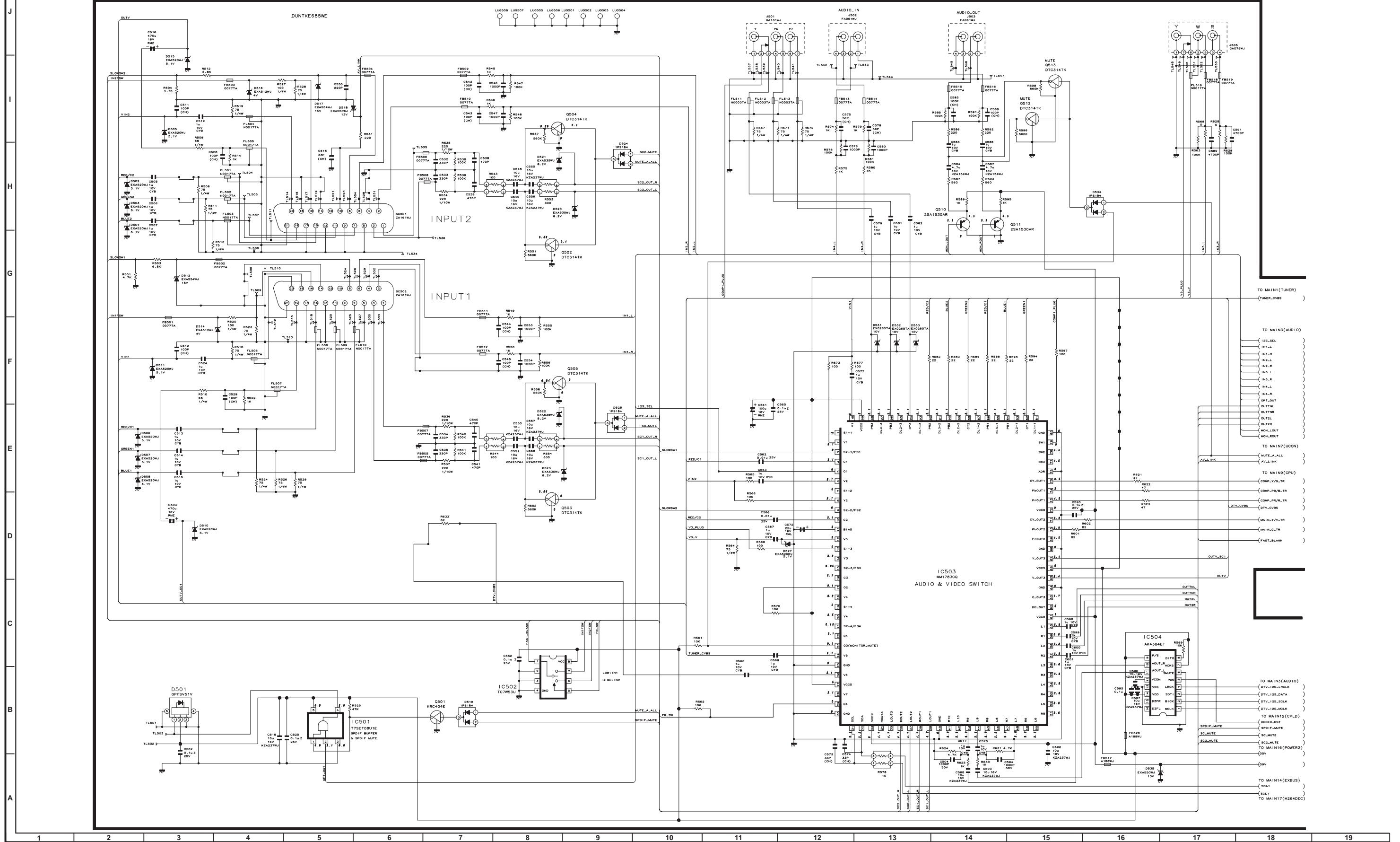

MAIN Unit-3

MAIN3 (AUDIO)

DUNTKE685WE

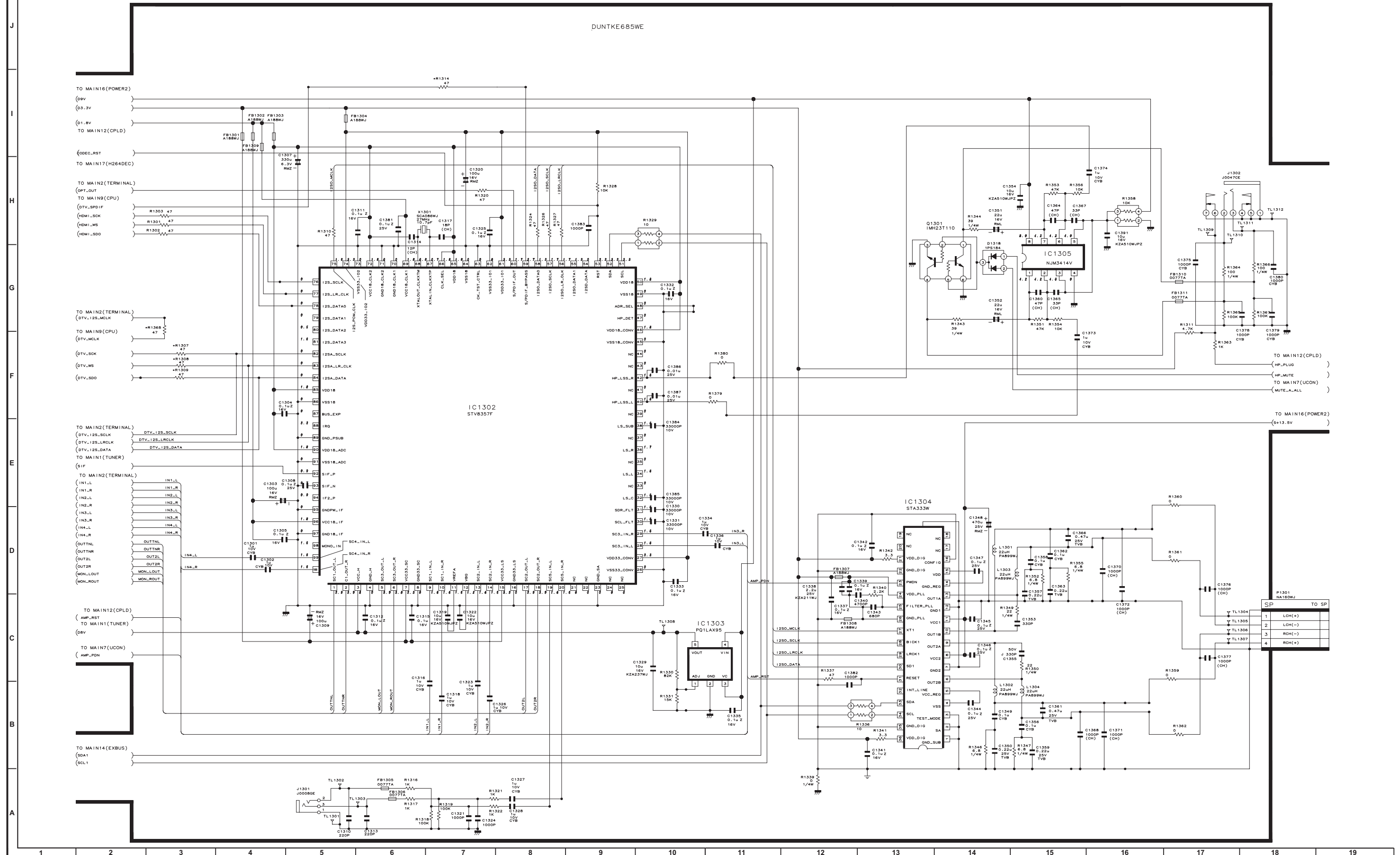

MAIN Unit-4

MAIN4 (HDMI)

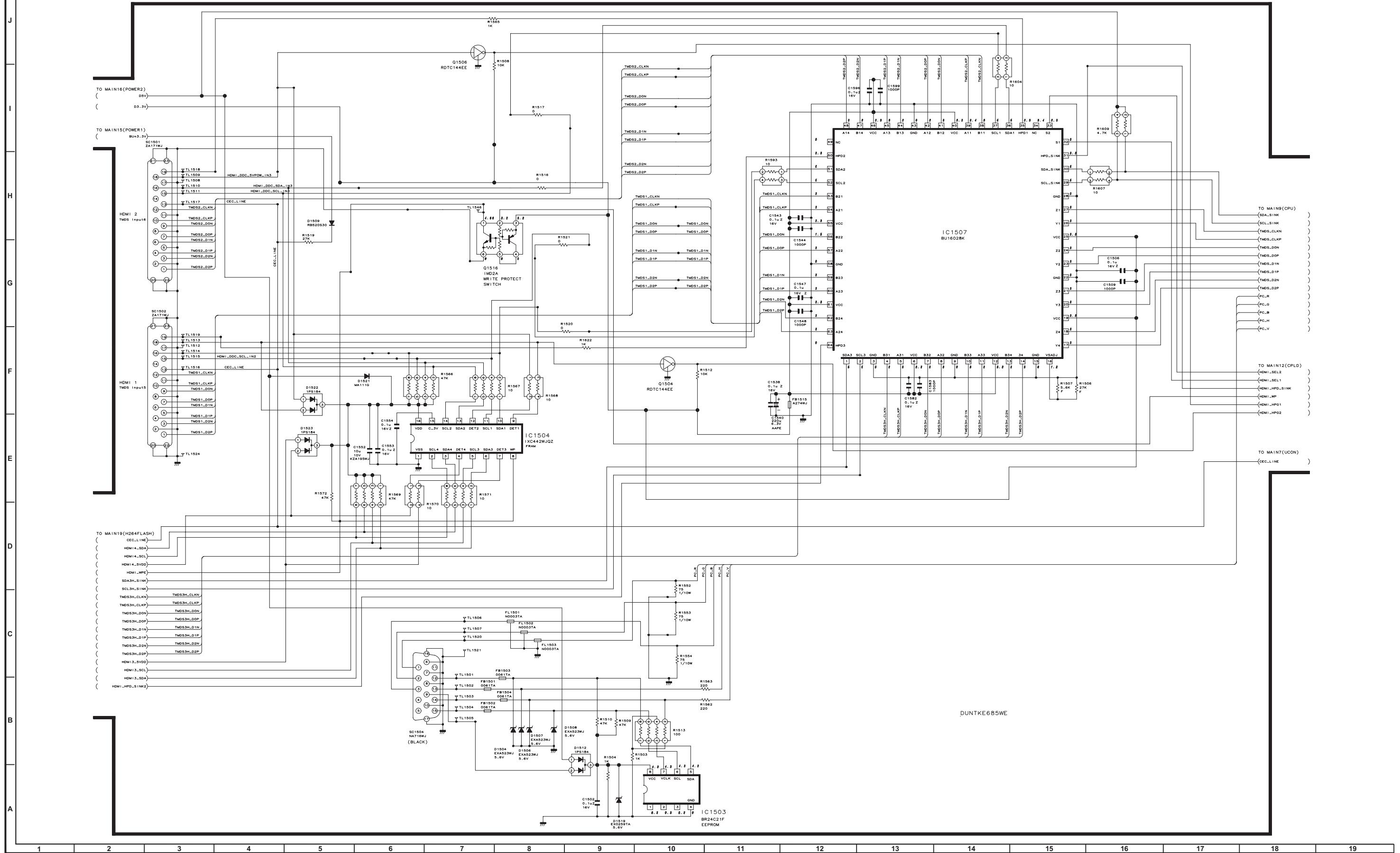

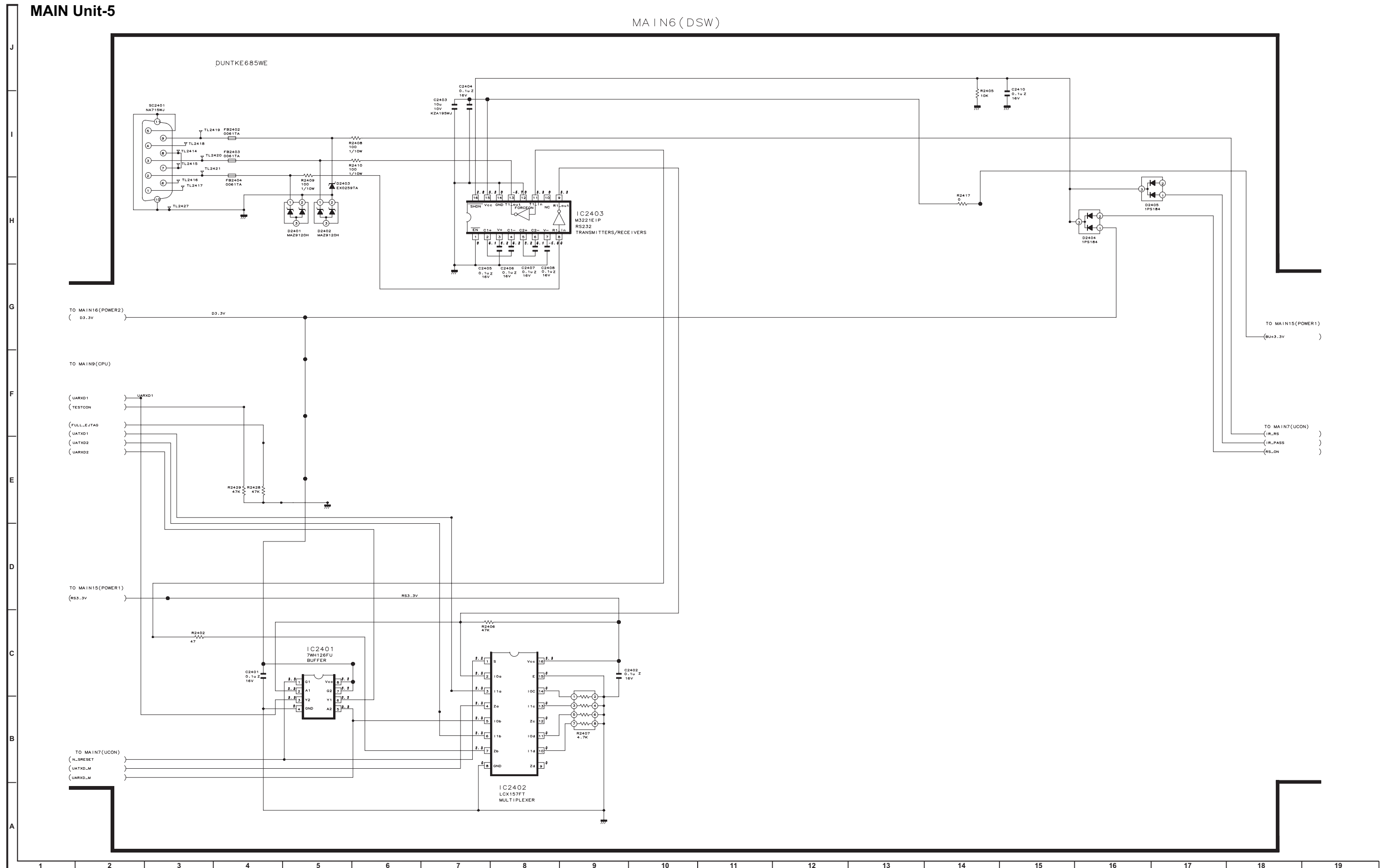

MAIN Unit-6

MAIN7 (UCON)

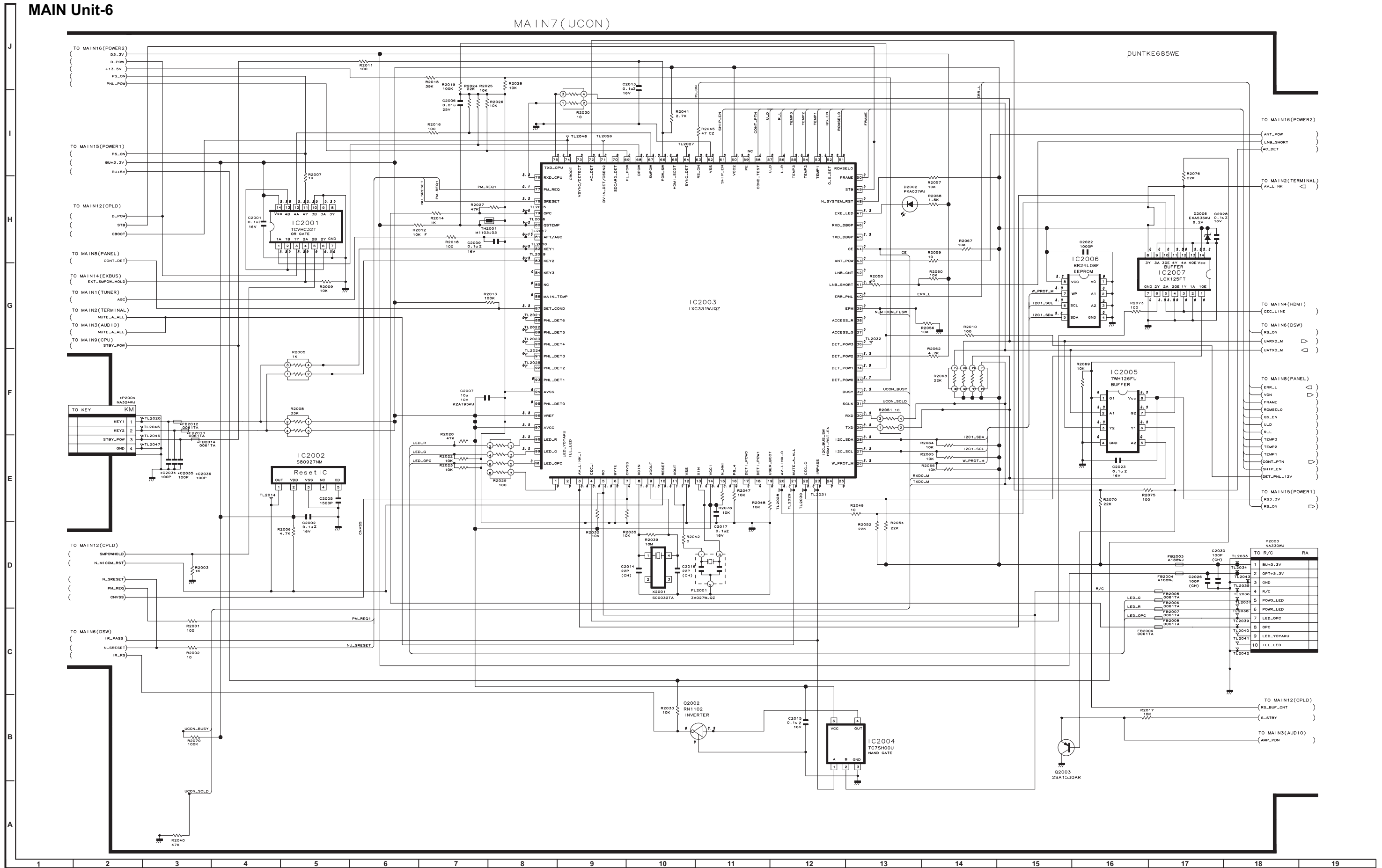

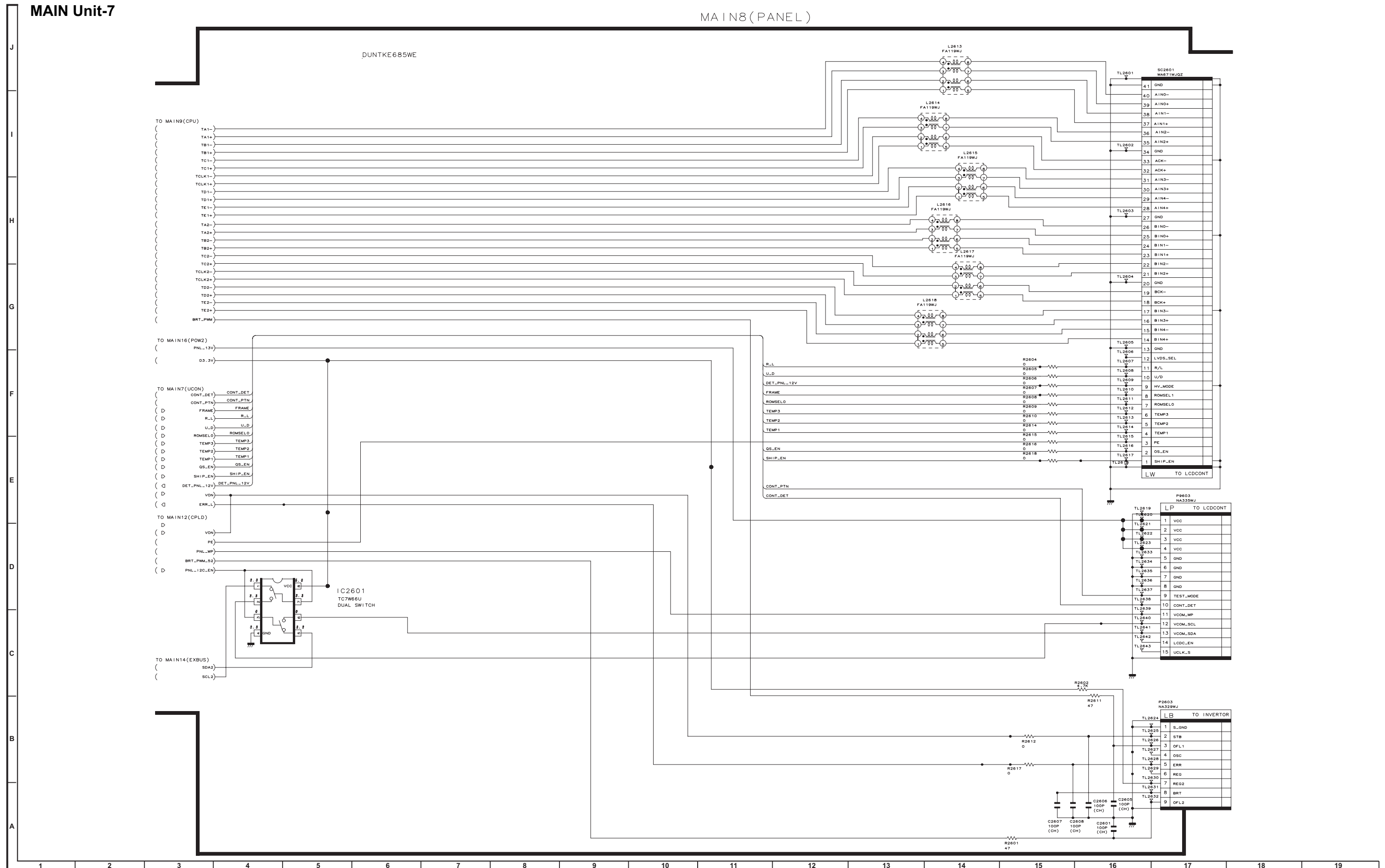

MAIN Unit-8

MAIN9 (CPU)

DUNTKE685WE

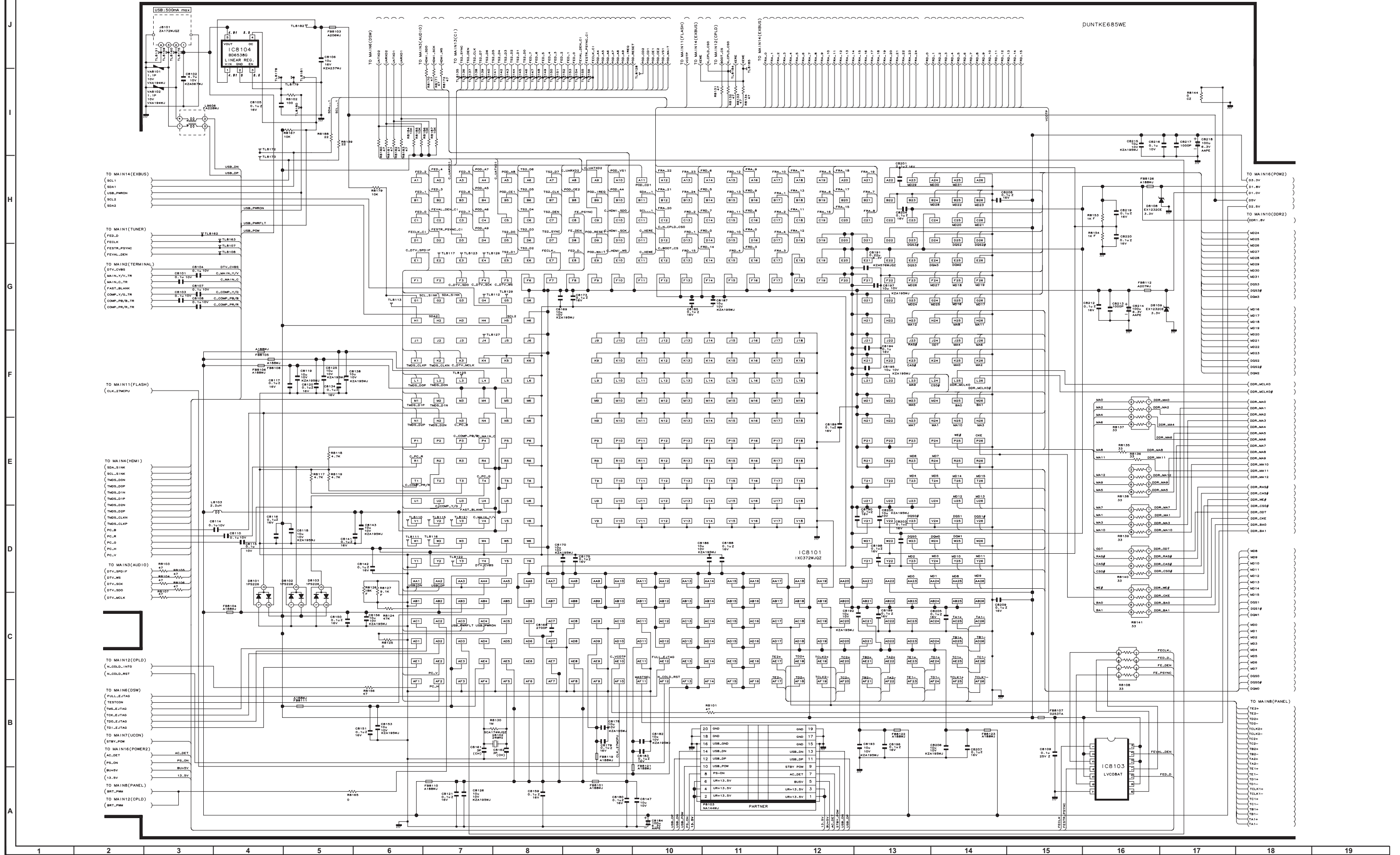

MAIN Unit-9

MAIN10(DDR2)

DUNTKE685WE

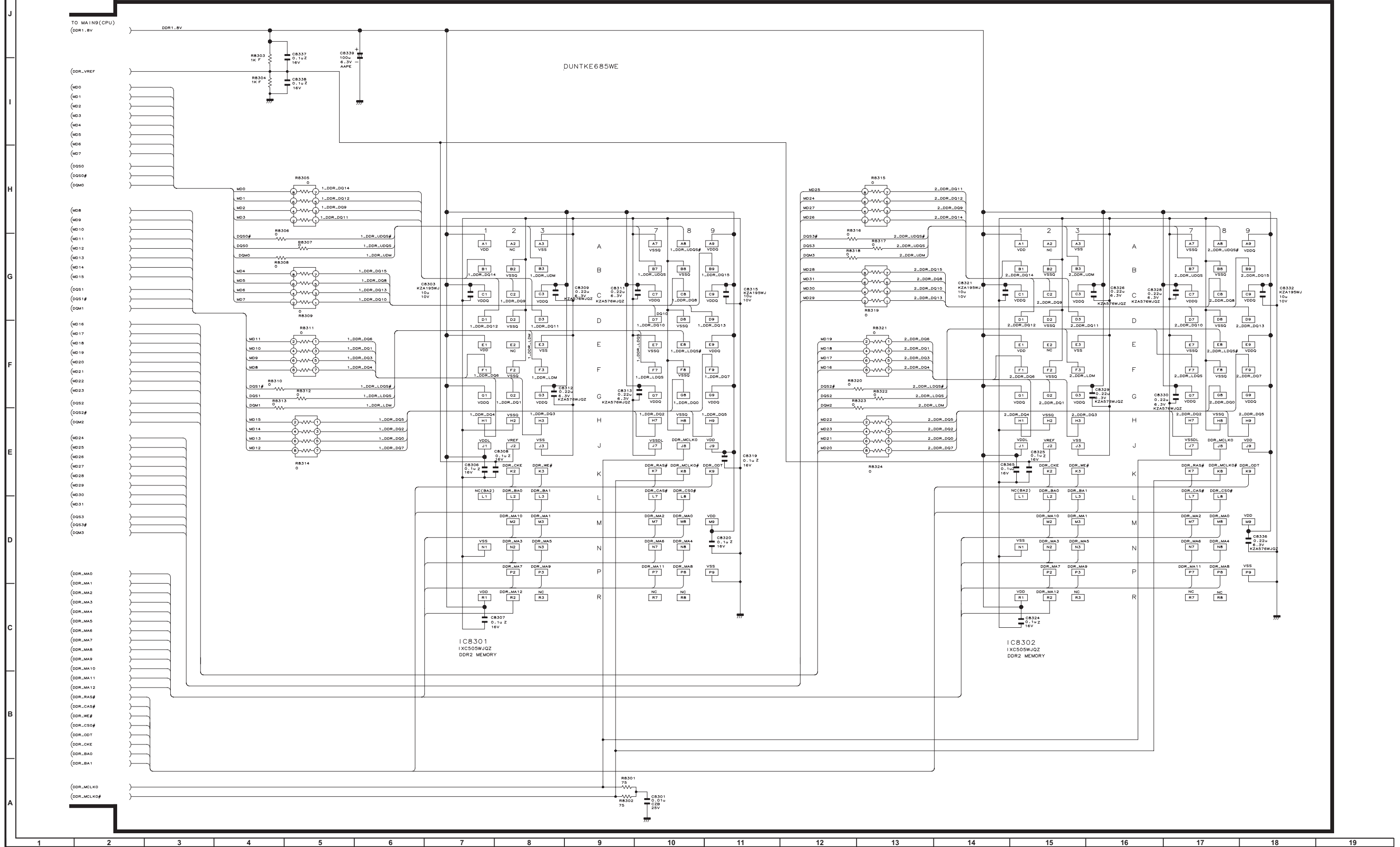

MAIN Unit-10

MAIN11(FLASH)

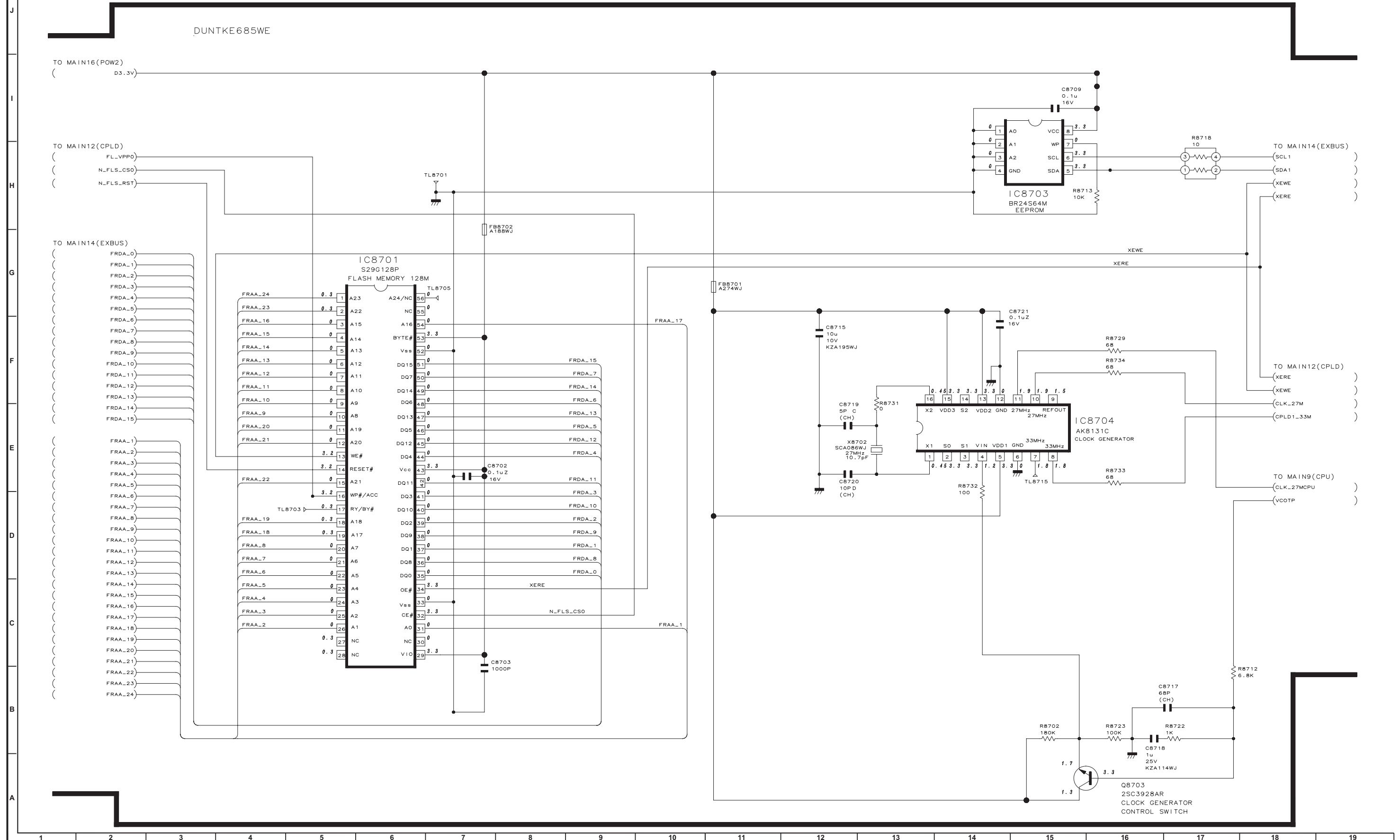

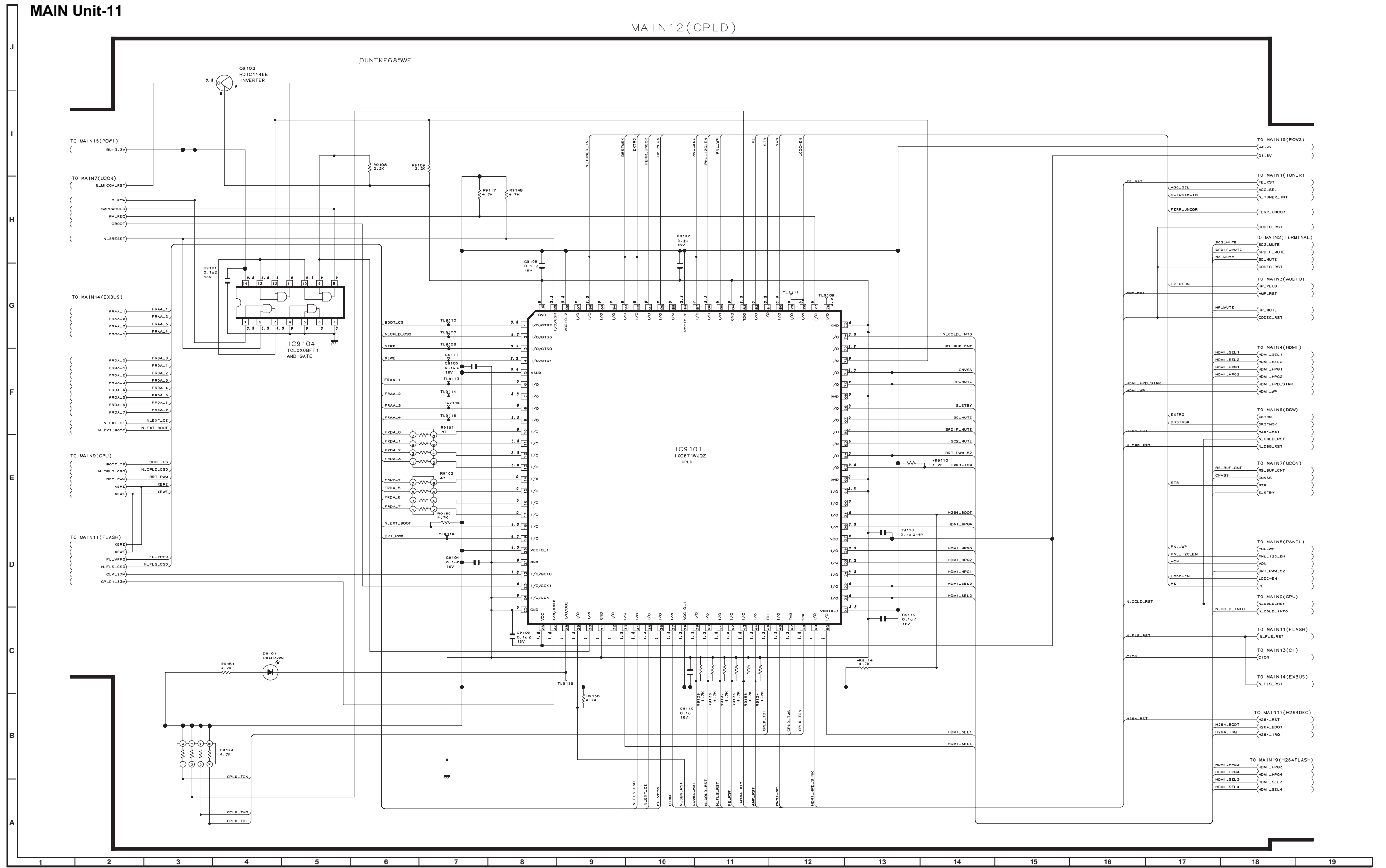

MAIN Unit-12

MAIN13(C1)

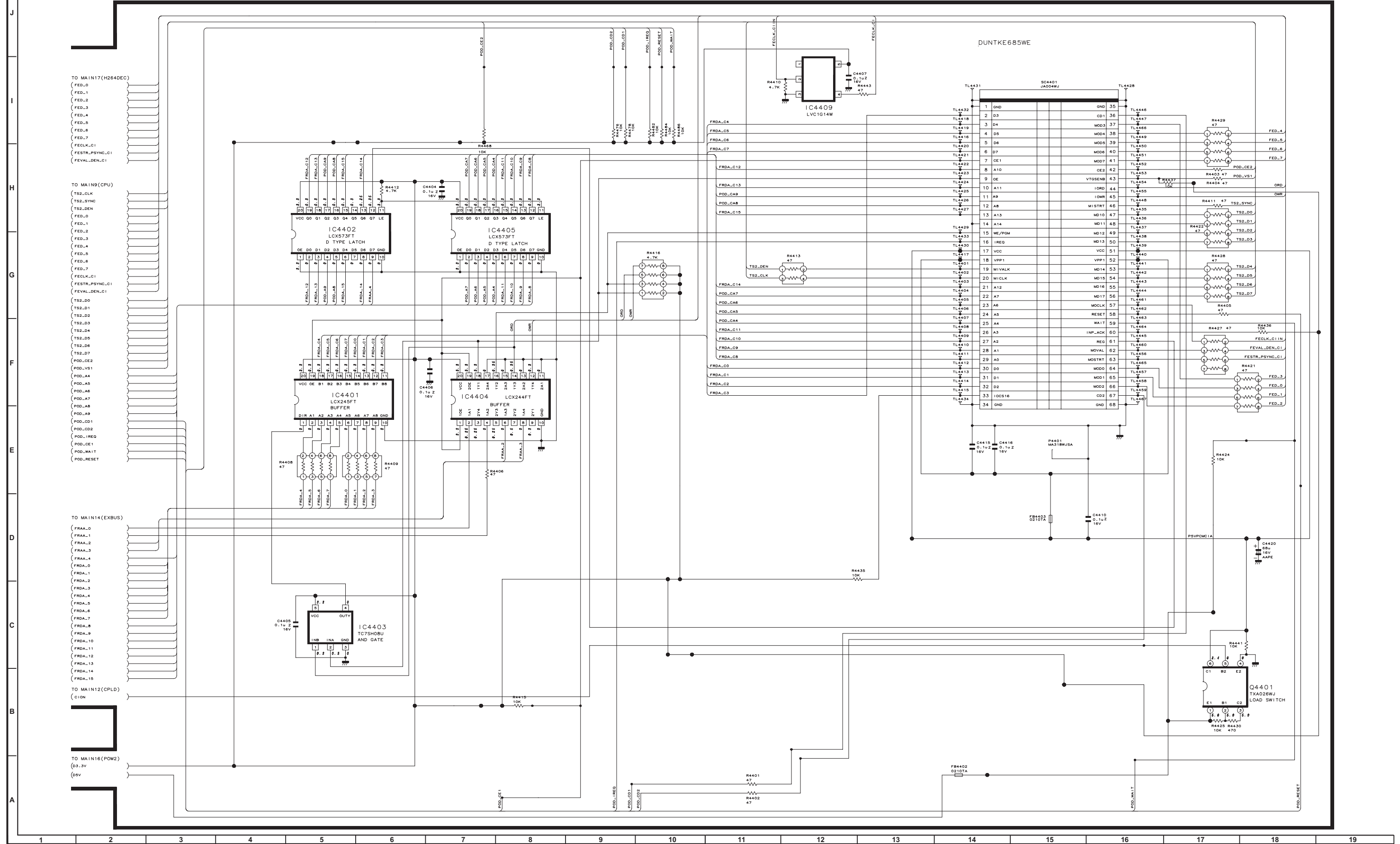

MAIN Unit-13

MAIN14 (EXBUS)

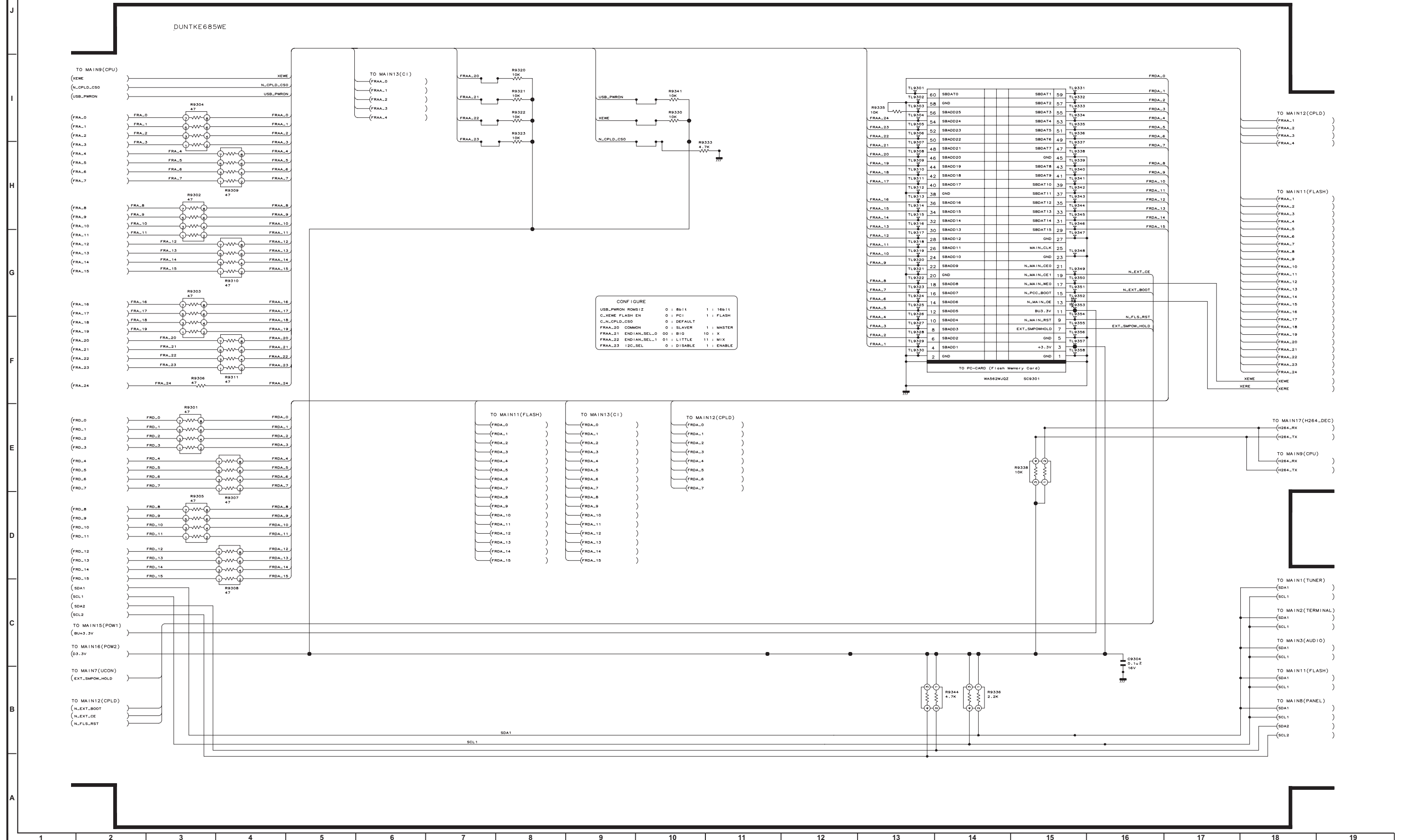

CONFIGURE

USB_PWRON	ROMSIZ	0 : 8b11	1 : 16b11
C_XEWE_FLASH_EN	0 : PCI	1 : FLASH	
C_N_CPLD_CS0	0 : DEFAULT		
FRAA_20_COMMON	0 : SLAVER	1 : MASTER	
FRAA_21_ENDIAN_SEL_0	00 : BIG	10 : X	
FRAA_22_ENDIAN_SEL_1	01 : LITTLE	11 : MIX	
FRAA_23_I2C_SEL	0 : DISABLE	1 : ENABLE	

MAIN Unit-14

MAIN15 (POWER1)

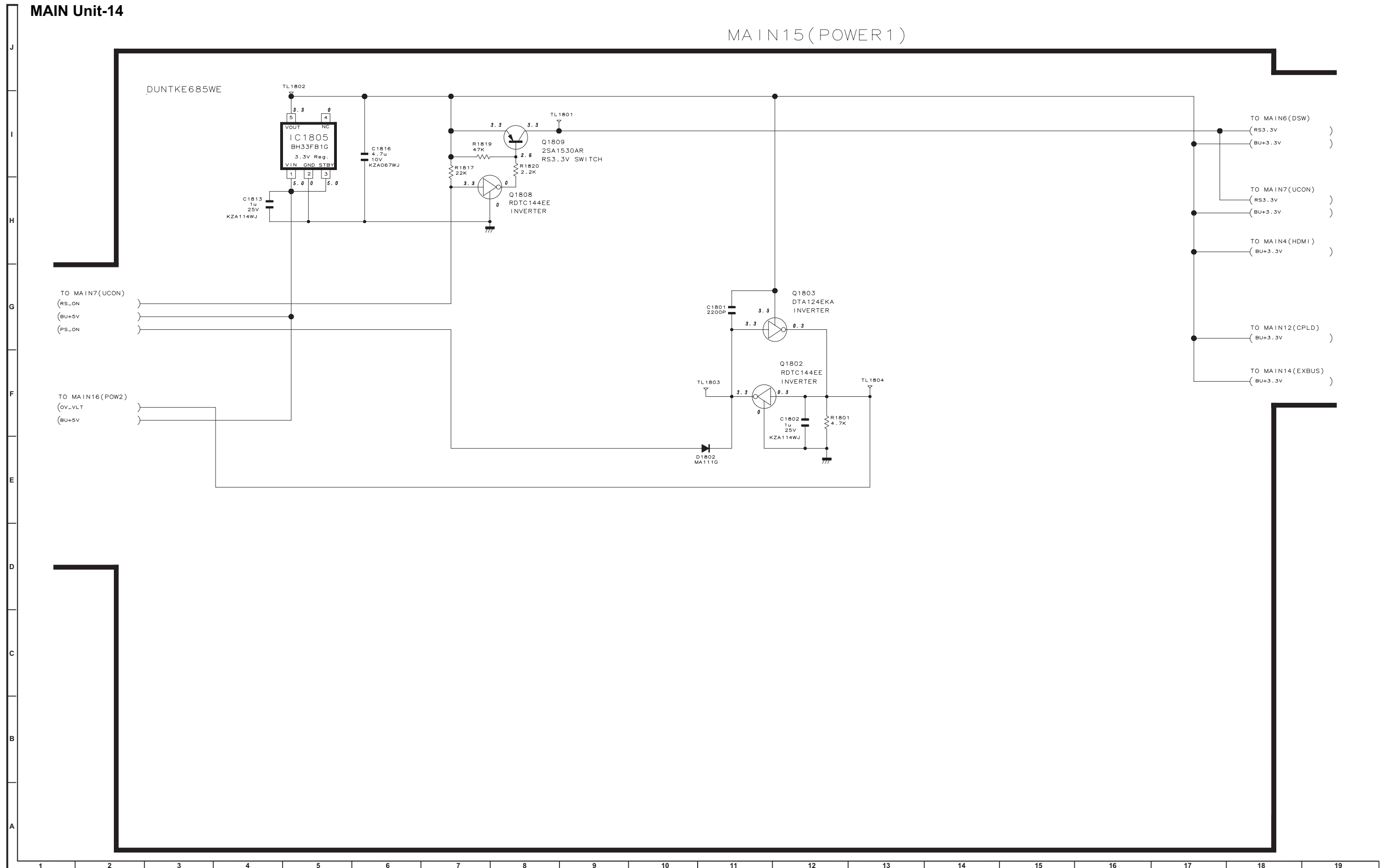

MAIN Unit-15

MAIN16 (POWER2)

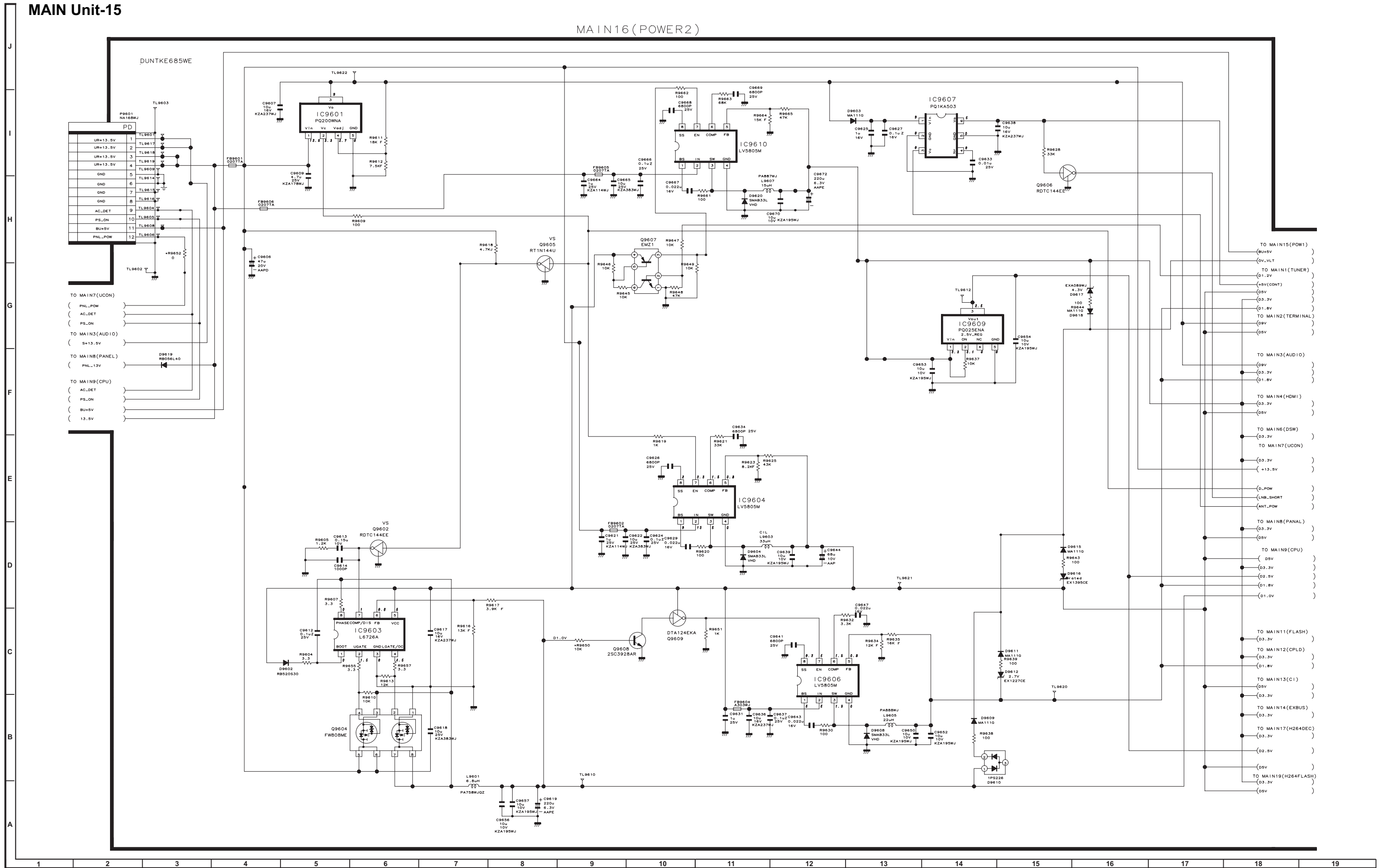

MAIN Unit-16

MAIN19(H.264_FLASH)

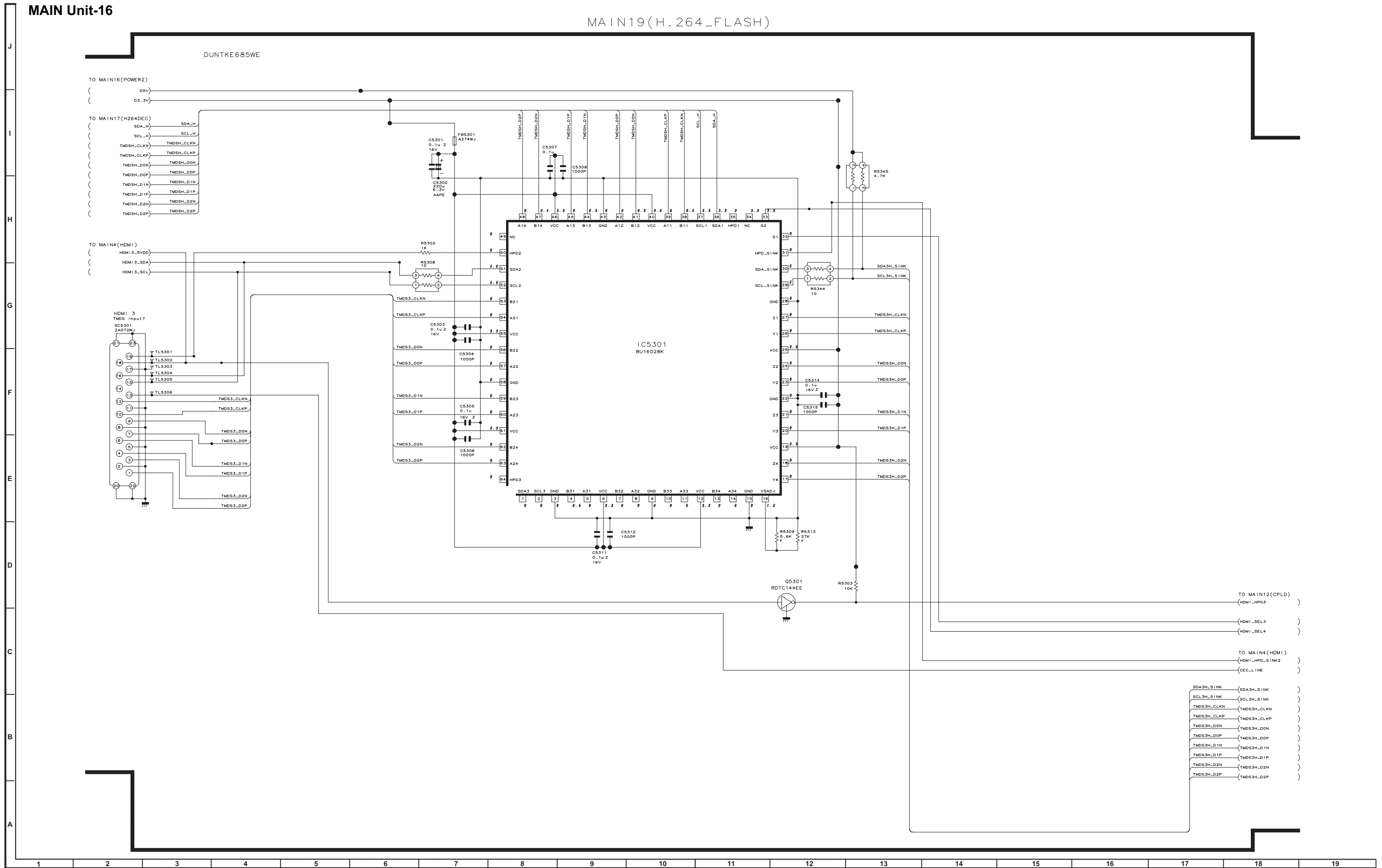

SHARP PARTS GUIDE

No. SX8S6LC32D653



LCD COLOUR TELEVISION

LC-32D653E

LC-32D654E

LC-37D653E

LC-37D654E

LC-46D653E

MODELS LC-46D654E

CONTENTS

- | | |
|---|---|
| [1] PRINTED WIRING BOARD ASSEMBLIES (LC-32D653E) | [11] CABINET PARTS (LC-37D653E/D654E) |
| [2] PRINTED WIRING BOARD ASSEMBLIES (LC-32D654E) | [12] LCD PANEL MODULE ASSEMBLY (LC-37D653E/D654E) |
| [3] PRINTED WIRING BOARD ASSEMBLIES (LC-37D653E) | [13] CABINET PARTS (LC-46D653E/D654E) |
| [4] PRINTED WIRING BOARD ASSEMBLIES (LC-37D654E) | [14] LCD MODULE Assembly (LC-46D653E/D654E) |
| [5] PRINTED WIRING BOARD ASSEMBLIES (LC-46D653E) | [15] SUPPLIED ACCESSORIES |
| [6] PRINTED WIRING BOARD ASSEMBLIES (LC-46D654E) | [16] PACKING PARTS (LC-32D653E/D654E) |
| [7] LCD PANEL | [17] PACKING PARTS (LC-37D653E/D654E) |
| [8] DUNTKE685FM31/FM33/FM32/ FM34/FM36/FM37 (MAIN Unit) | [18] PACKING PARTS (LC-46D653E/D654E) |
| [9] CABINET PARTS (LC-32D653E/D654E) | [19] SERVICE JIGS |
| [10] LCD PANEL MODULE ASSEMBLY (LC-32D653E/D654E) | |

Parts marked with "△" are important for maintaining the safety of the set. Be sure to replace these parts with specified ones for maintaining the safety and performance of the set.

NO.	PARTS CODE	PRICE RANK	NEW MARK	PART DELIVERY	DESCRIPTION
[1] PRINTED WIRING BOARD ASSEMBLIES (LC-32D653E)					
N	DUNTKE685FM31	CM	N	R	MAIN Unit
N	DUNTKE687FM31	AZ	N	R	R/C LED Unit
N	RUNTKA456WJQZ	BS	N	S	POWER/INVERTER Unit (Not Replacement Item)
[2] PRINTED WIRING BOARD ASSEMBLIES (LC-32D654E)					
N	DUNTKE685FM33	CM	N	R	MAIN Unit
N	DUNTKE687FM33	AZ	N	R	R/C LED Unit
N	RUNTKA456WJQZ	BS	N	S	POWER/INVERTER Unit (Not Replacement Item)
[3] PRINTED WIRING BOARD ASSEMBLIES (LC-37D653E)					
N	DUNTKE685FM32	CM	N	R	MAIN Unit
N	DUNTKE687FM32	AZ	N	R	R/C LED Unit
N	RDENCA267WJQZ	BL	N	S	POWER Unit (Not Replacement Item)
N	RUNTKA457WJQZ	BK	N	S	INVERTER Unit (Not Replacement Item)
[4] PRINTED WIRING BOARD ASSEMBLIES (LC-37D654E)					
N	DUNTKE685FM34	CM	N	R	MAIN Unit
N	DUNTKE687FM34	AZ	N	R	R/C LED Unit
N	RDENCA267WJQZ	BL	N	S	POWER Unit (Not Replacement Item)
N	RUNTKA457WJQZ	BK	N	S	INVERTER Unit (Not Replacement Item)
[5] PRINTED WIRING BOARD ASSEMBLIES (LC-46D653E)					
N	DUNTKE266FM01	AR	N	R	KEY Unit
N	DUNTKE685FM36	CL	N	R	MAIN Unit
N	DUNTKE687FM36	AZ	N	R	LED Unit
N	RDENCA308WJQZ	BP	N	S	POWER Unit (Unit Replacement Item)
[6] PRINTED WIRING BOARD ASSEMBLIES (LC-46D654E)					
N	DUNTKE266FM01	AR	N	R	KEY Unit
N	DUNTKE685FM37	CV	N	R	MAIN Unit
N	DUNTKE687FM37	BD	N	R	LED Unit
N	RDENCA308WJQZ	BP	N	S	POWER Unit (Unit Replacement Item)
[7] LCD PANEL					
N	R1LK315D3LW1AS	DG	N	J	32" LCD Panel Module (LC-32D653E/D654E)
N	R1LK370D3LW10Y	DE	N	J	37" LCD Panel Module (LC-37D653E/D654E)
N	R1LK460D3LW6AY	EC	N	J	46" LCD Panel Module (LC-46D653E/D654E)
[8] DUNTKE685FM31/FM33/FM32/FM34/FM36/FM37 (MAIN Unit)					
C502	VCKYCZ1EF104ZY	AA		J	Capacitor 0.1 25V Ceramic
C503	VCEASY1CN477MY	AD		J	Capacitor 470 16V Electrolytic
C504	VCKYCZ1HB102KY	AB		J	Capacitor 1000p 50V Ceramic
C505	VCKYCY1AB105KY	AB		J	Capacitor 1 10V Ceramic
C506	VCKYCY1AB105KY	AB		J	Capacitor 1 10V Ceramic
C507	VCKYCY1AB105KY	AB		J	Capacitor 1 10V Ceramic
C511	VCCCCZ1HH101JY	AB		J	Capacitor 100p 50V Ceramic
C512	VCCCCZ1HH101JY	AB		J	Capacitor 100p 50V Ceramic
C513	VCKYCY1AB105KY	AB		J	Capacitor 1 10V Ceramic
C514	VCKYCY1AB105KY	AB		J	Capacitor 1 10V Ceramic
C515	VCKYCY1AB105KY	AB		J	Capacitor 1 10V Ceramic
C516	VCEASY1CN477MY	AD		J	Capacitor 470 16V Electrolytic
C517	VCKYCY1AB105KY	AB		J	Capacitor 1 10V Ceramic
C518	RC-KZA237WJZZY	AB		J	Capacitor 10 16V Ceramic
C519	VCKYCY1AB105KY	AB		J	Capacitor 1 10V Ceramic
C524	VCKYCY1AB105KY	AB		J	Capacitor 1 10V Ceramic
C525	VCKYCZ1EF104ZY	AA		J	Capacitor 0.1 25V Ceramic
C528	VCCCCZ1HH101JY	AB		J	Capacitor 100p 50V Ceramic
C529	VCCCCZ1HH101JY	AB		J	Capacitor 100p 50V Ceramic
C530	VCKYCZ1HB221KY	AA		J	Capacitor 220p 50V Ceramic
C532	VCKYCZ1HB331KY	AA		J	Capacitor 330p 50V Ceramic
C533	VCKYCZ1HB331KY	AA		J	Capacitor 330p 50V Ceramic
C534	VCKYCZ1HB331KY	AA		J	Capacitor 330p 50V Ceramic
C535	VCKYCZ1HB331KY	AA		J	Capacitor 330p 50V Ceramic
C538	VCKYCZ1HB471KY	AB		J	Capacitor 470p 50V Ceramic
C539	VCKYCZ1HB471KY	AB		J	Capacitor 470p 50V Ceramic
C540	VCKYCZ1HB471KY	AB		J	Capacitor 470p 50V Ceramic
C541	VCKYCZ1HB471KY	AB		J	Capacitor 470p 50V Ceramic
C542	VCCCCZ1HH101JY	AB		J	Capacitor 100p 50V Ceramic
C543	VCCCCZ1HH101JY	AB		J	Capacitor 100p 50V Ceramic
C544	VCCCCZ1HH101JY	AB		J	Capacitor 100p 50V Ceramic
C545	VCCCCZ1HH101JY	AB		J	Capacitor 100p 50V Ceramic
C546	VCKYCZ1HB102KY	AB		J	Capacitor 1000p 50V Ceramic
C547	VCKYCZ1HB102KY	AB		J	Capacitor 1000p 50V Ceramic
C548	RC-KZA237WJZZY	AB		J	Capacitor 10 16V Ceramic
C549	RC-KZA237WJZZY	AB		J	Capacitor 10 16V Ceramic
C550	RC-KZA237WJZZY	AB		J	Capacitor 10 16V Ceramic
C551	RC-KZA237WJZZY	AB		J	Capacitor 10 16V Ceramic
C552	VCKYCZ1EF104ZY	AA		J	Capacitor 0.1 25V Ceramic
C553	VCKYCZ1HB102KY	AB		J	Capacitor 1000p 50V Ceramic
C554	VCKYCZ1HB102KY	AB		J	Capacitor 1000p 50V Ceramic
C555	RC-KZA237WJZZY	AB		J	Capacitor 10 16V Ceramic
C556	RC-KZA237WJZZY	AB		J	Capacitor 10 16V Ceramic
C557	RC-KZA237WJZZY	AB		J	Capacitor 10 16V Ceramic
C558	RC-KZA237WJZZY	AB		J	Capacitor 10 16V Ceramic

NO.	PARTS CODE	PRICE RANK	NEW MARK	PART DELIVERY	DESCRIPTION
[8] DUNTKE685FM31/FM33/FM32/FM34/FM36/FM37 (MAIN Unit)					
C560	VCKYCY1AB105KY	AB		J	Capacitor 1 10V Ceramic
C561	VCERMZ1CN107MY	AD		J	Capacitor 100 16V Electrolytic
C562	VCKYCY1EB103KY	AA		J	Capacitor 0.01 25V Ceramic
C563	VCKYCY1AB105KY	AB		J	Capacitor 1 10V Ceramic
C565	VCKYCY1EF104ZY	AA		J	Capacitor 0.1 25V Ceramic
C566	VCKYCY1EB103KY	AA		J	Capacitor 0.01 25V Ceramic
C567	VCKYCY1AB105KY	AB		J	Capacitor 1 10V Ceramic
C568	RC-KZA237WJZZY	AB		J	Capacitor 10 16V Ceramic
C569	VCKYCY1AB105KY	AB		J	Capacitor 1 10V Ceramic
C570	VCKYCY1AB105KY	AB		J	Capacitor 1 10V Ceramic
C572	VCERML1CN226MY	AC		J	Capacitor 22 16V Electrolytic (LC-32/37D653E/D654E)
C572	VCEASX1CN226MY	AC		J	Capacitor 22 16V Electrolytic (LC-42D653E/D654E)
C573	VCCCCZ1HH330JY	AB		J	Capacitor 33p 50V Ceramic
C574	VCCCCZ1HH330JY	AB		J	Capacitor 33p 50V Ceramic
C575	VCCCCZ1HH560JY	AB		J	Capacitor 56p 50V Ceramic
C576	VCKYCY1HB102KY	AB		J	Capacitor 1000p 50V Ceramic
C577	VCKYCY1AB105KY	AB		J	Capacitor 1 10V Ceramic
C578	VCCCCZ1HH560JY	AB		J	Capacitor 56p 50V Ceramic
C579	VCKYCY1AB105KY	AB		J	Capacitor 1 10V Ceramic
C580	VCKYCY1HB102KY	AB		J	Capacitor 1000p 50V Ceramic
C581	VCKYCY1AB105KY	AB		J	Capacitor 1 10V Ceramic
C582	VCKYCY1AB105KY	AB		J	Capacitor 1 10V Ceramic
C583	VCKYCY1AB105KY	AB		J	Capacitor 1 10V Ceramic
C584	RC-KZA154WJZZY	AB		J	Capacitor 4.7 16V Ceramic
C585	VCCCCZ1HH101JY	AB		J	Capacitor 100p 50V Ceramic
C586	VCKYCY1AB105KY	AB		J	Capacitor 1 10V Ceramic
C587	RC-KZA154WJZZY	AB		J	Capacitor 4.7 16V Ceramic
C588	VCCCCZ1HH101JY	AB		J	Capacitor 100p 50V Ceramic
C589	VCKYCY1HB472KY	AA		J	Capacitor 4700p 50V Ceramic
C590	VCKYCY1EF104ZY	AA		J	Capacitor 0.1 25V Ceramic
C591	VCKYCY1HB472KY	AA		J	Capacitor 4700p 50V Ceramic
C592	RC-KZA237WJZZY	AB		J	Capacitor 10 16V Ceramic
C593	RC-KZA237WJZZY	AB		J	Capacitor 10 16V Ceramic
C594	VCKYCY1HB102KY	AB		J	Capacitor 1000p 50V Ceramic
C595	VCKYCY1EF104ZY	AA		J	Capacitor 0.1 25V Ceramic
C596	RC-KZA237WJZZY	AB		J	Capacitor 10 16V Ceramic
C597	RC-KZA237WJZZY	AB		J	Capacitor 10 16V Ceramic
C598	VCKYCY1AB105KY	AB		J	Capacitor 1 10V Ceramic
C599	VCKYCY1AB105KY	AB		J	Capacitor 1 10V Ceramic
C600	VCKYCY1AB105KY	AB		J	Capacitor 1 10V Ceramic
C601	VCKYCY1AB105KY	AB		J	Capacitor 1 10V Ceramic
C615	VCCCCZ1HH330JY	AB		J	Capacitor 33p 50V Ceramic
C1301	VCKYCY1AB105KY	AB		J	Capacitor 1 10V Ceramic
C1302	VCKYCY1AB105KY	AB		J	Capacitor 1 10V Ceramic
C1303	VCEASY1CN107MY	AC		J	Capacitor 100 16V Electrolytic
C1304	VCKYCY1CF104ZY	AA		J	Capacitor 0.1 16V Ceramic
C1305	VCKYCY1CF104ZY	AA		J	Capacitor 0.1 16V Ceramic
C1307	VCEASY0JN337MY	AC		J	Capacitor 370 6.3V Electrolytic
C1308	VCKYCY1EF104ZY	AA		J	Capacitor 0.1 25V Ceramic
C1309	VCEASY1CN107MY	AC		J	Capacitor 100 16V Electrolytic
C1310	VCKYCY1HB221KY	AA		J	Capacitor 220p 50V Ceramic
C1311	VCKYCY1CF104ZY	AA		J	Capacitor 0.1 16V Ceramic
C1312	VCKYCY1CF104ZY	AA		J	Capacitor 0.1 16V Ceramic
C1313	VCKYCY1HB221KY	AA		J	Capacitor 220p 50V Ceramic
C1314	VCCCCZ1HH120JY	AB		J	Capacitor 12p 50V Ceramic
C1315	VCKYCY1CF104ZY	AA		J	Capacitor 0.1 16V Ceramic
C1316	VCKYCY1AB105KY	AB		J	Capacitor 1 10V Ceramic
C1317	VCCCCZ1HH180JY	AB		J	Capacitor 18p 50V Ceramic
C1318	VCKYCY1AB105KY	AB		J	Capacitor 1 10V Ceramic
C1319	RC-KZA510WJJPZY	AB		J	Capacitor 10 16V Ceramic
C1320	VCEASY1CN107MY	AC		J	Capacitor 100 16V Electrolytic
C1321	VCKYCY1HB102KY	AB		J	Capacitor 1000p 50V Ceramic
C1322	RC-KZA510WJJPZY	AB		J	Capacitor 10 16V Ceramic
C1323	VCKYCY1AB105KY	AB		J	Capacitor 1 10V Ceramic
C1324	VCKYCY1HB102KY	AB		J	Capacitor 1000p 50V Ceramic
C1325	VCKYCY1CF104ZY	AA		J	Capacitor 0.1 16V Ceramic
C1326	VCKYCY1AB105KY	AB		J	Capacitor 1 10V Ceramic
C1327	VCKYCY1AB105KY	AB		J	Capacitor 1 10V Ceramic
C1328	VCKYCY1AB105KY	AB		J	Capacitor 1 10V Ceramic
C1329	RC-KZA237WJZZY	AB		J	Capacitor 10 16V Ceramic
C1330	VCKYCY1AB333KY	AB		J	Capacitor 0.033 10V Ceramic
C1331	VCKYCY1AB333KY	AB		J	Capacitor 0.033 10V Ceramic
C1332	VCKYCY1CF104ZY	AA		J	Capacitor 0.1 16V Ceramic
C1333	VCKYCY1CF104ZY	AA		J	Capacitor 0.1 16V Ceramic
C1334	VCKYCY1AB105KY	AB		J	Capacitor 1 10V Ceramic
C1335	VCKYCY1CF104ZY	AA		J	Capacitor 0.1 16V Ceramic
C1336	VCKYCY1AB105KY	AB		J	Capacitor 1 10V Ceramic
C1337	VCKYCY1CF104ZY	AA		J	Capacitor 0.1 16V Ceramic
C1338	RC-KZA211WJZZY	AB		J	Capacitor 2.2 25V Ceramic
C1339	VCKYCY1CF104ZY	AA		J	Capacitor 0.1 16V Ceramic
C1340	VCKYCY1HB472KY	AA		J	Capacitor 4700p 50V Ceramic
C1341	VCKYCY1CF104ZY	AA		J	Capacitor 0.1 16V Ceramic
C1342	VCKYCY1CF104ZY	AA		J	Capacitor 0.1 16V Ceramic
C1343	VCKYCY1HB681KY	AB		J	Capacitor 680p 50V Ceramic
C1344	VCKYCY1EF104ZY	AA		J	Capacitor 0.1 25V Ceramic

NO.	PARTS CODE	PRICE RANK	NEW MARK	PART DELIVERY	DESCRIPTION
[8] DUNTKE685FM31/FM33/FM32/FM34/FM36/FM37 (MAIN Unit)					
C1345	VCKY CZ1EF104ZY	AA		J	Capacitor 0.1 25V Ceramic
C1346	VCKY CZ1EF104ZY	AA		J	Capacitor 0.1 25V Ceramic
C1347	VCKY CZ1EF104ZY	AA		J	Capacitor 0.1 25V Ceramic
C1348	VGEASY1EN477MY	AE		J	Capacitor 470 25V Electrolytic
C1349	VCKYCY1HB104KY	AA		J	Capacitor 0.1 50V Ceramic
C1350	VCKYTV1EB224KY	AA		J	Capacitor 0.22 25V Ceramic
C1351	VGEASX1CN226MY	AC		J	Capacitor 22 16V Electrolytic
C1352	VGEASX1CN226MY	AC		J	Capacitor 22 16V Electrolytic
C1353	VCCCCZ1HH331JY	AA		J	Capacitor 330p 50V Ceramic
C1354	RC-KZA510WJ PZY	AB		J	Capacitor 10 16V Ceramic
C1355	VCCCCZ1HH331JY	AA		J	Capacitor 330p 50V Ceramic
C1356	VCKYCY1HB104KY	AA		J	Capacitor 0.1 50V Ceramic
C1357	VCKYTV1EB224KY	AA		J	Capacitor 0.22 25V Ceramic
C1358	VCKYCY1HB104KY	AA		J	Capacitor 0.1 50V Ceramic
C1359	VCKYTV1EB224KY	AA		J	Capacitor 0.22 25V Ceramic
C1360	VCCCCZ1HH470JY	AB		J	Capacitor 47p 50V Ceramic
C1361	VCKYTV1EB474KY	AC		J	Capacitor 0.47 25V Ceramic
C1362	VCKYCY1HB104KY	AA		J	Capacitor 0.1 50V Ceramic
C1363	VCKYTV1EB224KY	AA		J	Capacitor 0.22 25V Ceramic
C1364	VCCCCZ1HH470JY	AB		J	Capacitor 47p 50V Ceramic
C1365	VCCCCZ1HH330JY	AB		J	Capacitor 33p 50V Ceramic
C1366	VCKYTV1EB474KY	AC		J	Capacitor 0.47 25V Ceramic
C1367	VCCCCZ1HH330JY	AB		J	Capacitor 33p 50V Ceramic
C1368	VCCCCZ1HH102JY	AA		J	Capacitor 1000p 50V Ceramic
C1370	VCCCCZ1HH102JY	AA		J	Capacitor 1000p 50V Ceramic
C1371	VCCCCZ1HH102JY	AA		J	Capacitor 1000p 50V Ceramic
C1372	VCCCCZ1HH102JY	AA		J	Capacitor 1000p 50V Ceramic
C1373	VCKYCY1AB105KY	AB		J	Capacitor 1 10V Ceramic
C1374	VCKYCY1AB105KY	AB		J	Capacitor 1 10V Ceramic
C1375	VCKYCY1HB102KY	AA		J	Capacitor 1000p 50V Ceramic
C1376	VCCCCZ1HH102JY	AA		J	Capacitor 1000p 50V Ceramic
C1377	VCCCCZ1HH102JY	AA		J	Capacitor 1000p 50V Ceramic
C1378	VCKYCY1HB102KY	AA		J	Capacitor 1000p 50V Ceramic
C1379	VCKYCY1HB102KY	AA		J	Capacitor 1000p 50V Ceramic
C1380	VCKYCY1HB102KY	AA		J	Capacitor 1000p 50V Ceramic
C1381	VCKY CZ1EF104ZY	AA		J	Capacitor 0.1 25V Ceramic
C1382	VCCCCZ1HH102JY	AA		J	Capacitor 1000p 50V Ceramic
C1383	VCCCCZ1HH102JY	AA		J	Capacitor 1000p 50V Ceramic
C1384	VCKY CZ1AB333KY	AB		J	Capacitor 0.033 10V Ceramic
C1385	VCKY CZ1AB333KY	AB		J	Capacitor 0.033 10V Ceramic
C1386	VCKY CZ1EB103KY	AA		J	Capacitor 0.01 25V Ceramic
C1387	VCKY CZ1EB103KY	AA		J	Capacitor 0.01 25V Ceramic
C1391	RC-KZA510WJ PZY	AB		J	Capacitor 10 16V Ceramic
C1502	VCKY CZ1CF104ZY	AA		J	Capacitor 0.1 16V Ceramic
C1506	VCKY CZ1CF104ZY	AA		J	Capacitor 0.1 16V Ceramic
C1509	VCKY CZ1HB102KY	AB		J	Capacitor 1000p 50V Ceramic
C1538	VCKY CZ1CF104ZY	AA		J	Capacitor 0.1 16V Ceramic
C1540	VCAAPE0JJ227MY	AE		J	Capacitor 220 6.3V Electrolytic
C1543	VCKY CZ1CF104ZY	AA		J	Capacitor 0.1 16V Ceramic
C1544	VCKY CZ1HB102KY	AB		J	Capacitor 1000p 50V Ceramic
C1547	VCKY CZ1CF104ZY	AA		J	Capacitor 0.1 16V Ceramic
C1548	VCKY CZ1HB102KY	AB		J	Capacitor 1000p 50V Ceramic
C1552	RC-KZA195WJ ZZY	AB		J	Capacitor 10 10V Ceramic
C1553	VCKY CZ1CF104ZY	AA		J	Capacitor 0.1 16V Ceramic
C1554	VCKY CZ1CF104ZY	AA		J	Capacitor 0.1 16V Ceramic
C1582	VCKY CZ1CF104ZY	AA		J	Capacitor 0.1 16V Ceramic
C1583	VCKY CZ1HB102KY	AB		J	Capacitor 1000p 50V Ceramic
C1596	VCKY CZ1CF104ZY	AA		J	Capacitor 0.1 16V Ceramic
C1599	VCKY CZ1HB102KY	AB		J	Capacitor 1000p 50V Ceramic
C1801	VCKY CZ1HB222KY	AB		J	Capacitor 2200p 50V Ceramic
C1802	RC-KZA114WJ ZZY	AB		J	Capacitor 1 25V Ceramic
C1813	RC-KZA114WJ ZZY	AB		J	Capacitor 1 25V Ceramic
C1816	RC-KZA067WJ ZZY	AB		J	Capacitor 4.7 10V Ceramic
C2001	VCKY CZ1CF104ZY	AA		J	Capacitor 0.1 16V Ceramic
C2002	VCKY CZ1CF104ZY	AA		J	Capacitor 0.1 16V Ceramic
C2005	VCKY CZ1HB152KY	AB		J	Capacitor 1500p 50V Ceramic
C2006	VCKY CZ1EB103KY	AA		J	Capacitor 0.01 25V Ceramic
C2007	RC-KZA195WJ ZZY	AB		J	Capacitor 10 10V Ceramic
C2009	VCKY CZ1CF104ZY	AA		J	Capacitor 0.1 16V Ceramic
C2013	VCKY CZ1CF104ZY	AA		J	Capacitor 0.1 16V Ceramic
C2014	VCCCCZ1HH220JY	AB		J	Capacitor 22p 50V Ceramic
C2015	VCKY CZ1CF104ZY	AA		J	Capacitor 0.1 16V Ceramic
C2016	VCCCCZ1HH220JY	AB		J	Capacitor 22p 50V Ceramic
C2017	VCKY CZ1CF104ZY	AA		J	Capacitor 0.1 16V Ceramic
C2022	VCKY CZ1HB102KY	AB		J	Capacitor 1000p 50V Ceramic
C2023	VCKY CZ1CF104ZY	AA		J	Capacitor 0.1 16V Ceramic
C2026	VCCCCZ1HH101JY	AB		J	Capacitor 100p 50V Ceramic
C2028	VCKY CZ1CF104ZY	AA		J	Capacitor 0.1 16V Ceramic
C2030	VCCCCZ1HH101JY	AB		J	Capacitor 100p 50V Ceramic
C2034	VCCCCZ1HH101JY	AB		J	Capacitor 100p 50V Ceramic (LC-46D653E/D654E)
C2035	VCCCCZ1HH101JY	AB		J	Capacitor 100p 50V Ceramic (LC-46D653E/D654E)
C2036	VCCCCZ1HH101JY	AB		J	Capacitor 100p 50V Ceramic (LC-46D653E/D654E)
C2401	VCKY CZ1CF104ZY	AA		J	Capacitor 0.1 16V Ceramic
C2402	VCKY CZ1CF104ZY	AA		J	Capacitor 0.1 16V Ceramic
C2403	RC-KZA195WJ ZZY	AB		J	Capacitor 10 10V Ceramic

NO.	PARTS CODE	PRICE RANK	NEW MARK	PART DELIVERY	DESCRIPTION
[8] DUNTKE685FM31/FM33/FM32/FM34/FM36/FM37 (MAIN Unit)					
C2404	VCKYCZ1CF104ZY	AA		J	Capacitor 0.1 16V Ceramic
C2405	VCKYCZ1CF104ZY	AA		J	Capacitor 0.1 16V Ceramic
C2406	VCKYCZ1CF104ZY	AA		J	Capacitor 0.1 16V Ceramic
C2407	VCKYCZ1CF104ZY	AA		J	Capacitor 0.1 16V Ceramic
C2408	VCKYCZ1CF104ZY	AA		J	Capacitor 0.1 16V Ceramic
C2410	VCKYCZ1CF104ZY	AA		J	Capacitor 0.1 16V Ceramic
C2601	VCCCCZ1HH101JY	AB		J	Capacitor 100p 50V Ceramic
C2605	VCCCCZ1HH101JY	AB		J	Capacitor 100p 50V Ceramic
C2606	VCCCCZ1HH101JY	AB		J	Capacitor 100p 50V Ceramic
C2607	VCCCCZ1HH101JY	AB		J	Capacitor 100p 50V Ceramic
C2608	VCCCCZ1HH101JY	AB		J	Capacitor 100p 50V Ceramic
C4404	VCKYCZ1CF104ZY	AA		J	Capacitor 0.1 16V Ceramic
C4405	VCKYCZ1CF104ZY	AA		J	Capacitor 0.1 16V Ceramic
C4406	VCKYCZ1CF104ZY	AA		J	Capacitor 0.1 16V Ceramic
C4407	VCKYCZ1CF104ZY	AA		J	Capacitor 0.1 16V Ceramic
C4410	VCKYCZ1CF104ZY	AA		J	Capacitor 0.1 16V Ceramic
C4415	VCKYCZ1CF104ZY	AA		J	Capacitor 0.1 16V Ceramic
C4416	VCKYCZ1CF104ZY	AA		J	Capacitor 0.1 16V Ceramic
C4420	VCAAPE1CJ686MY	AE		J	Capacitor 68 16V Electrolytic
C5301	VCKYCZ1CF104ZY	AA		J	Capacitor 0.1 16V Ceramic
C5302	VCAAPE0JJ227MY	AE		J	Capacitor 220 6.3V Electrolytic
C5303	VCKYCZ1CF104ZY	AA		J	Capacitor 0.1 16V Ceramic
C5304	VCKYCZ1HB102KY	AB		J	Capacitor 1000p 50V Ceramic
C5305	VCKYCZ1CF104ZY	AA		J	Capacitor 0.1 16V Ceramic
C5306	VCKYCZ1HB102KY	AB		J	Capacitor 1000p 50V Ceramic
C5307	VCKYCZ1CF104ZY	AA		J	Capacitor 0.1 16V Ceramic
C5309	VCKYCZ1HB102KY	AB		J	Capacitor 1000p 50V Ceramic
C5311	VCKYCZ1CF104ZY	AA		J	Capacitor 0.1 16V Ceramic
C5312	VCKYCZ1HB102KY	AB		J	Capacitor 1000p 50V Ceramic
C5314	VCKYCZ1CF104ZY	AA		J	Capacitor 0.1 16V Ceramic
C5315	VCKYCZ1HB102KY	AB		J	Capacitor 1000p 50V Ceramic
C7501	VCEASX1AN336MY	AC		J	Capacitor 33 10V Electrolytic
C7502	VCKYCZ1HB102KY	AB		J	Capacitor 1000p 50V Ceramic
C7508	VCEASX1CN107MY	AC		J	Capacitor 100 16V Electrolytic
C7511	VCKYCZ1EB103KY	AA		J	Capacitor 0.01 25V Ceramic
C7515	VCEASY1CN477MY	AD		J	Capacitor 470 16V Electrolytic
C7516	VCCCCZ1HH101JY	AB		J	Capacitor 100p 50V Ceramic
C7518	RC-KZA510WJPZY	AB		J	Capacitor 10 16V Ceramic
C7520	RC-KZA510WJPZY	AB		J	Capacitor 10 16V Ceramic
C7522	RC-KZA237WJZZY	AB		J	Capacitor 10 16V Ceramic
C7524	RC-KZA237WJZZY	AB		J	Capacitor 10 16V Ceramic
C7525	RC-KZA237WJZZY	AB		J	Capacitor 10 16V Ceramic
C7526	RC-KZA237WJZZY	AB		J	Capacitor 10 16V Ceramic
C7527	VCKYCZ1EF104ZY	AA		J	Capacitor 0.1 25V Ceramic
C7528	VCKYCZ1EF104ZY	AA		J	Capacitor 0.1 25V Ceramic
C7529	VCKYCZ1EF104ZY	AA		J	Capacitor 0.1 25V Ceramic
C7530	VCKYCZ1EF104ZY	AA		J	Capacitor 0.1 25V Ceramic
C7531	VCKYCZ1EF104ZY	AA		J	Capacitor 0.1 25V Ceramic
C7532	VCKYCZ1EF104ZY	AA		J	Capacitor 0.1 25V Ceramic
C7533	VCKYCZ1HB102KY	AB		J	Capacitor 1000p 50V Ceramic
C7534	VCKYCZ1HB102KY	AB		J	Capacitor 1000p 50V Ceramic
C7536	VCKYCZ1EF104ZY	AA		J	Capacitor 0.1 25V Ceramic
C7537	VCKYCZ1EB103KY	AA		J	Capacitor 0.01 25V Ceramic
C7538	RC-KZA237WJZZY	AB		J	Capacitor 10 16V Ceramic
C7539	VCKYCZ1AB273KY	AB		J	Capacitor 0.027 10V Ceramic
C7540	VCKYCZ1EF104ZY	AA		J	Capacitor 0.1 25V Ceramic
C7541	VCKYCZ1EF104ZY	AA		J	Capacitor 0.1 25V Ceramic
C7542	VCKYCZ1EF104ZY	AA		J	Capacitor 0.1 25V Ceramic
C7543	VCCCCZ1HH180JY	AB		J	Capacitor 18p 50V Ceramic
C7544	VCCCCZ1HH180JY	AB		J	Capacitor 18p 50V Ceramic
C7545	VCEASX1CN107MY	AC		J	Capacitor 100 16V Electrolytic
C7546	VCKYCZ1EF104ZY	AA		J	Capacitor 0.1 25V Ceramic
C7547	VCKYCZ1EF104ZY	AA		J	Capacitor 0.1 25V Ceramic
C7548	VCKYCZ1EB103KY	AA		J	Capacitor 0.01 25V Ceramic
C7549	VCCCCZ1HH220JY	AB		J	Capacitor 22p 50V Ceramic
C7550	VCCCCZ1HH220JY	AB		J	Capacitor 22p 50V Ceramic
C8101	VCKYCZ1AB104KY	AB		J	Capacitor 0.1 10V Ceramic
C8102	RC-KZA067WJZZY	AB		J	Capacitor 4.7 10V Ceramic
C8103	VCKYCZ1AB104KY	AB		J	Capacitor 0.1 10V Ceramic
C8104	VCKYCZ1AB104KY	AB		J	Capacitor 0.1 10V Ceramic
C8105	VCKYCZ1CF104ZY	AA		J	Capacitor 0.1 16V Ceramic
C8106	RC-KZA237WJZZY	AB		J	Capacitor 10 16V Ceramic
C8107	VCKYCZ1AB104KY	AB		J	Capacitor 0.1 10V Ceramic
C8108	VCKYCZ1AB104KY	AB		J	Capacitor 0.1 10V Ceramic
C8109	VCKYCZ1EF104ZY	AA		J	Capacitor 0.1 25V Ceramic
C8110	VCKYCZ1AB104KY	AB		J	Capacitor 0.1 10V Ceramic
C8114	VCKYCZ1AB104KY	AB		J	Capacitor 0.1 10V Ceramic
C8115	VCKYCZ1AB104KY	AB		J	Capacitor 0.1 10V Ceramic
C8116	VCKYCZ1CF104ZY	AA		J	Capacitor 0.1 16V Ceramic
C8117	VCKYCZ1CF104ZY	AA		J	Capacitor 0.1 16V Ceramic
C8118	RC-KZA195WJZZY	AB		J	Capacitor 10 10V Ceramic
C8119	RC-KZA195WJZZY	AB		J	Capacitor 10 10V Ceramic
C8120	VCKYCZ1CF104ZY	AA		J	Capacitor 0.1 16V Ceramic
C8121	VCKYCZ1CF104ZY	AA		J	Capacitor 0.1 16V Ceramic
C8125	RC-KZA195WJZZY	AB		J	Capacitor 10 10V Ceramic

NO.	PARTS CODE	PRICE RANK	NEW MARK	PART DELIVERY	DESCRIPTION
[8] DUNTKE685FM31/FM33/FM32/FM34/FM36/FM37 (MAIN Unit)					
C8126	RC-KZA195WJZZY	AB		J	Capacitor 10 10V Ceramic
C8134	VCKYCZ1CF104ZY	AA		J	Capacitor 0.1 16V Ceramic
C8138	RC-KZA195WJZZY	AB		J	Capacitor 10 10V Ceramic
C8141	VCKYCZ1CF104ZY	AA		J	Capacitor 0.1 16V Ceramic
C8142	VCKYCZ1CF104ZY	AA		J	Capacitor 0.1 16V Ceramic
C8143	RC-KZA195WJZZY	AB		J	Capacitor 10 10V Ceramic
C8147	RC-KZA195WJZZY	AB		J	Capacitor 10 10V Ceramic
C8150	VCKYCZ1CF104ZY	AA		J	Capacitor 0.1 16V Ceramic
C8151	VCKYCZ1CF104ZY	AA		J	Capacitor 0.1 16V Ceramic
C8153	RC-KZA195WJZZY	AB		J	Capacitor 10 10V Ceramic
C8156	RC-KZA195WJZZY	AB		J	Capacitor 10 10V Ceramic
C8159	VCKYCZ1CF104ZY	AA		J	Capacitor 0.1 16V Ceramic
C8161	VCCCCZ1HH3R0CY	AA		J	Capacitor 3p 50V Ceramic
C8162	VCCCCZ1HH3R0CY	AA		J	Capacitor 3p 50V Ceramic
C8168	VCKYCZ1HB272KY	AA		J	Capacitor 2700p 50V Ceramic
C8169	RC-KZA195WJZZY	AB		J	Capacitor 10 10V Ceramic
C8170	RC-KZA195WJZZY	AB		J	Capacitor 10 10V Ceramic
C8173	VCKYCZ1CF104ZY	AA		J	Capacitor 0.1 16V Ceramic
C8175	VCKYCZ1CF104ZY	AA		J	Capacitor 0.1 16V Ceramic
C8178	RC-KZA195WJZZY	AB		J	Capacitor 10 10V Ceramic
C8179	VCKYCZ1CF104ZY	AA		J	Capacitor 0.1 16V Ceramic
C8180	VCKYCZ1CF104ZY	AA		J	Capacitor 0.1 16V Ceramic
C8182	RC-KZA195WJZZY	AB		J	Capacitor 10 10V Ceramic
C8183	VCKYCZ1CF104ZY	AA		J	Capacitor 0.1 16V Ceramic
C8184	VCAAPE0JJ107MY	AE		J	Capacitor 100 6.3V Electrolytic
C8185	VCKYCZ1CF104ZY	AA		J	Capacitor 0.1 16V Ceramic
C8186	RC-KZA195WJZZY	AB		J	Capacitor 10 10V Ceramic
C8187	RC-KZA195WJZZY	AB		J	Capacitor 10 10V Ceramic
C8188	VCKYCZ1CF104ZY	AA		J	Capacitor 0.1 16V Ceramic
C8189	VCKYCZ1CF104ZY	AA		J	Capacitor 0.1 16V Ceramic
C8190	VCKYCZ1CF104ZY	AA		J	Capacitor 0.1 16V Ceramic
C8191	RC-KZA576WJQZY	AB		R	Capacitor 0.22 6.3V Ceramic
C8192	RC-KZA195WJZZY	AB		J	Capacitor 10 10V Ceramic
C8193	RC-KZA195WJZZY	AB		J	Capacitor 10 10V Ceramic
C8194	VCKYCZ1CF104ZY	AA		J	Capacitor 0.1 16V Ceramic
C8195	RC-KZA195WJZZY	AB		J	Capacitor 10 10V Ceramic
C8196	VCKYCZ1CF104ZY	AA		J	Capacitor 0.1 16V Ceramic
C8197	RC-KZA195WJZZY	AB		J	Capacitor 10 10V Ceramic
C8198	VCKYCZ1CF104ZY	AA		J	Capacitor 0.1 16V Ceramic
C8199	VCKYCZ1CF104ZY	AA		J	Capacitor 0.1 16V Ceramic
C8200	RC-KZA195WJZZY	AB		J	Capacitor 10 10V Ceramic
C8201	VCKYCZ1CF104ZY	AA		J	Capacitor 0.1 16V Ceramic
C8203	VCKYCZ1CF104ZY	AA		J	Capacitor 0.1 16V Ceramic
C8204	VCKYCZ1CF104ZY	AA		J	Capacitor 0.1 16V Ceramic
C8205	VCKYCZ1CF104ZY	AA		J	Capacitor 0.1 16V Ceramic
C8206	RC-KZA195WJZZY	AB		J	Capacitor 10 10V Ceramic
C8207	VCKYCZ1CF104ZY	AA		J	Capacitor 0.1 16V Ceramic
C8208	VCKYCZ1CF104ZY	AA		J	Capacitor 0.1 16V Ceramic
C8209	VCKYCZ1CF104ZY	AA		J	Capacitor 0.1 16V Ceramic
C8212	VCKYCZ1CF104ZY	AA		J	Capacitor 0.1 16V Ceramic
C8213	VCKYCZ1HB102KY	AB		J	Capacitor 1000p 50V Ceramic
C8214	VCAAPE0JJ107MY	AE		J	Capacitor 100 6.3V Electrolytic
C8215	RC-KZA195WJZZY	AB		J	Capacitor 10 10V Ceramic
C8216	VCKYCZ1AB104KY	AB		J	Capacitor 0.1 10V Ceramic
C8217	VCKYCZ1HB102KY	AB		J	Capacitor 1000p 50V Ceramic
C8218	VCAAPE0JJ107MY	AE		J	Capacitor 100 6.3V Electrolytic
C8219	VCKYCZ1CF104ZY	AA		J	Capacitor 0.1 16V Ceramic
C8220	VCKYCZ1CF104ZY	AA		J	Capacitor 0.1 16V Ceramic
C8301	VCKYCZ1EB103KY	AA		J	Capacitor 0.01 25V Ceramic
C8303	RC-KZA195WJZZY	AB		J	Capacitor 10 10V Ceramic
C8306	VCKYCZ1CF104ZY	AA		J	Capacitor 0.1 16V Ceramic
C8307	VCKYCZ1CF104ZY	AA		J	Capacitor 0.1 16V Ceramic
C8308	VCKYCZ1CF104ZY	AA		J	Capacitor 0.1 16V Ceramic
C8309	RC-KZA576WJQZY	AB		R	Capacitor 0.22 6.3V Ceramic
C8311	RC-KZA576WJQZY	AB		R	Capacitor 0.22 6.3V Ceramic
C8312	RC-KZA576WJQZY	AB		R	Capacitor 0.22 6.3V Ceramic
C8313	RC-KZA576WJQZY	AB		R	Capacitor 0.22 6.3V Ceramic
C8315	RC-KZA195WJZZY	AB		J	Capacitor 10 10V Ceramic
C8319	VCKYCZ1CF104ZY	AA		J	Capacitor 0.1 16V Ceramic
C8320	VCKYCZ1CF104ZY	AA		J	Capacitor 0.1 16V Ceramic
C8321	RC-KZA195WJZZY	AB		J	Capacitor 10 10V Ceramic
C8324	VCKYCZ1CF104ZY	AA		J	Capacitor 0.1 16V Ceramic
C8325	VCKYCZ1CF104ZY	AA		J	Capacitor 0.1 16V Ceramic
C8326	RC-KZA576WJQZY	AB		R	Capacitor 0.22 6.3V Ceramic
C8328	RC-KZA576WJQZY	AB		R	Capacitor 0.22 6.3V Ceramic
C8329	RC-KZA576WJQZY	AB		R	Capacitor 0.22 6.3V Ceramic
C8330	RC-KZA576WJQZY	AB		R	Capacitor 0.22 6.3V Ceramic
C8332	RC-KZA195WJZZY	AB		J	Capacitor 10 10V Ceramic
C8336	RC-KZA576WJQZY	AB		R	Capacitor 0.22 6.3V Ceramic
C8337	VCKYCZ1CF104ZY	AA		J	Capacitor 0.1 16V Ceramic
C8338	VCKYCZ1CF104ZY	AA		J	Capacitor 0.1 16V Ceramic
C8339	VCAAPE0JJ107MY	AE		J	Capacitor 100 6.3V Electrolytic
C8365	VCKYCZ1CF104ZY	AA		J	Capacitor 0.1 16V Ceramic
C8702	VCKYCZ1CF104ZY	AA		J	Capacitor 0.1 16V Ceramic
C8703	VCCCCZ1HH102JY	AA		J	Capacitor 1000p 50V Ceramic

NO.	PARTS CODE	PRICE RANK	NEW MARK	PART DELIVERY	DESCRIPTION
[8] DUNTKE685FM31/FM33/FM32/FM34/FM36/FM37 (MAIN Unit)					
C8709	VCKYCZ1CF104ZY	AA		J	Capacitor 0.1 16V Ceramic
C8715	RC-KZA195WJZZY	AB		J	Capacitor 10 10V Ceramic
C8717	VCCCCZ1HH680JY	AB		J	Capacitor 68p 50V Ceramic
C8718	RC-KZA114WJZZY	AB		J	Capacitor 1 25V Ceramic
C8719	VCCCCZ1HH5R0CY	AA		J	Capacitor 5p 50V Ceramic
C8720	VCCCCZ1HH100DY	AB		J	Capacitor 10p 50V Ceramic
C8721	VCKYCZ1CF104ZY	AA		J	Capacitor 0.1 16V Ceramic
C9101	VCKYCZ1CF104ZY	AA		J	Capacitor 0.1 16V Ceramic
C9104	VCKYCZ1CF104ZY	AA		J	Capacitor 0.1 16V Ceramic
C9105	VCKYCZ1CF104ZY	AA		J	Capacitor 0.1 16V Ceramic
C9106	VCKYCZ1CF104ZY	AA		J	Capacitor 0.1 16V Ceramic
C9107	VCKYCZ1CF104ZY	AA		J	Capacitor 0.1 16V Ceramic
C9108	VCKYCZ1CF104ZY	AA		J	Capacitor 0.1 16V Ceramic
C9110	VCKYCZ1CF104ZY	AA		J	Capacitor 0.1 16V Ceramic
C9112	VCKYCZ1CF104ZY	AA		J	Capacitor 0.1 16V Ceramic
C9113	VCKYCZ1CF104ZY	AA		J	Capacitor 0.1 16V Ceramic
C9304	VCKYCZ1CF104ZY	AA		J	Capacitor 0.1 16V Ceramic
C9606	VCAAPD1DJ476MY	AF		J	Capacitor 47 20V Electrolytic
C9607	RC-KZA237WJZZY	AB		J	Capacitor 10 16V Ceramic
C9609	RC-KZA178WJZZY	AC		J	Capacitor 4.7 25V Ceramic
C9612	VCKYCZ1EF104ZY	AA		J	Capacitor 0.1 25V Ceramic
C9613	VCKYCY1AB154KY	AB		J	Capacitor 0.15 10V Ceramic
C9614	VCCCCZ1HH102JY	AA		J	Capacitor 1000p 50V Ceramic
C9617	RC-KZA237WJZZY	AB		J	Capacitor 10 16V Ceramic
C9618	RC-KZA383WJZZY	AC		J	Capacitor 10 25V Ceramic
C9619	VCAAPE0JJ227MY	AE		J	Capacitor 220 6.3V Electrolytic
C9621	RC-KZA114WJZZY	AB		J	Capacitor 1 25V Ceramic
C9622	RC-KZA383WJZZY	AC		J	Capacitor 10 25V Ceramic
C9624	VCKYCZ1EF104ZY	AA		J	Capacitor 0.1 25V Ceramic
C9625	VCKYTV1CB105KY	AC		J	Capacitor 1 16V Ceramic
C9626	VCKYCZ1EB682KY	AB		J	Capacitor 6800p 25V Ceramic
C9627	VCKYCZ1CF104ZY	AA		J	Capacitor 0.1 16V Ceramic
C9629	VCKYCZ1CB223KY	AC		J	Capacitor 0.022 16V Ceramic
C9631	RC-KZA114WJZZY	AB		J	Capacitor 1 25V Ceramic
C9633	VCKYCZ1EB103KY	AA		J	Capacitor 0.01 25V Ceramic
C9634	VCKYCZ1EB682KY	AB		J	Capacitor 6800p 25V Ceramic
C9636	RC-KZA237WJZZY	AB		J	Capacitor 10 16V Ceramic
C9637	VCKYCZ1EF104ZY	AA		J	Capacitor 0.1 25V Ceramic
C9638	RC-KZA237WJZZY	AB		J	Capacitor 10 16V Ceramic
C9639	RC-KZA195WJZZY	AB		J	Capacitor 10 10V Ceramic
C9641	VCKYCZ1EB682KY	AB		J	Capacitor 6800p 25V Ceramic
C9643	VCKYCZ1CB223KY	AC		J	Capacitor 0.022 16V Ceramic
C9644	VCAAPG1AJ686MY	AE		R	Capacitor 68 10V Electrolytic
C9647	VCKYCZ1CB223KY	AC		J	Capacitor 0.022 16V Ceramic
C9650	RC-KZA195WJZZY	AB		J	Capacitor 10 10V Ceramic
C9652	RC-KZA195WJZZY	AB		J	Capacitor 10 10V Ceramic
C9653	RC-KZA195WJZZY	AB		J	Capacitor 10 10V Ceramic
C9654	RC-KZA195WJZZY	AB		J	Capacitor 10 10V Ceramic
C9656	RC-KZA195WJZZY	AB		J	Capacitor 10 10V Ceramic
C9657	RC-KZA195WJZZY	AB		J	Capacitor 10 10V Ceramic
C9664	RC-KZA114WJZZY	AB		J	Capacitor 1 25V Ceramic
C9665	RC-KZA383WJZZY	AC		J	Capacitor 10 25V Ceramic
C9666	VCKYCZ1EF104ZY	AA		J	Capacitor 0.1 25V Ceramic
C9667	VCKYCZ1CB223KY	AC		J	Capacitor 0.022 16V Ceramic
C9668	VCKYCZ1EB682KY	AB		J	Capacitor 6800p 25V Ceramic
C9669	VCKYCZ1EB682KY	AB		J	Capacitor 6800p 25V Ceramic
C9670	RC-KZA195WJZZY	AB		J	Capacitor 10 10V Ceramic
C9672	VCAAPE0JJ227MY	AE		J	Capacitor 220 6.3V Electrolytic
D501	VHPGPF5V51V-1	AG	N	J	Diode GPFSV51V
D502	RH-EXA520WJZZY	AB		J	Zener Diode MAZ8051GML
D503	RH-EXA520WJZZY	AB		J	Zener Diode MAZ8051GML
D504	RH-EXA520WJZZY	AB		J	Zener Diode MAZ8051GML
D505	RH-EXA520WJZZY	AB		J	Zener Diode MAZ8051GML
D506	RH-EXA520WJZZY	AB		J	Zener Diode MAZ8051GML
D507	RH-EXA520WJZZY	AB		J	Zener Diode MAZ8051GML
D508	RH-EXA520WJZZY	AB		J	Zener Diode MAZ8051GML
D510	RH-EXA520WJZZY	AB		J	Zener Diode MAZ8051GML
D511	RH-EXA520WJZZY	AB		J	Zener Diode MAZ8051GML
D512	RH-EXA554WJZZY	AB		J	Zener Diode MAZ8150GML
D514	RH-EXA512WJZZY	AB		J	Zener Diode MAZ8039GHL
D515	RH-EXA520WJZZY	AB		J	Zener Diode MAZ8051GML
D516	RH-EXA512WJZZY	AB		J	Zener Diode MAZ8039GHL
D517	RH-EXA554WJZZY	AB		J	Zener Diode MAZ8150GML
D518	RH-EXA550WJZZY	AB		J	Zener Diode MAZ8130GML
D519	VHD1PS184+-1Y	AB		J	Diode 1PS184,115
D520	RH-EXA535WJZZY	AM		J	Zener Diode MAZ8082GML
D521	RH-EXA535WJZZY	AM		J	Zener Diode MAZ8082GML
D522	RH-EXA535WJZZY	AM		J	Zener Diode MAZ8082GML
D523	RH-EXA535WJZZY	AM		J	Zener Diode MAZ8082GML
D524	VHD1PS184+-1Y	AB		J	Diode 1PS184,115
D525	VHD1PS184+-1Y	AB		J	Diode 1PS184,115
D527	RH-EXA520WJZZY	AB		J	Zener Diode MAZ8051GML
D531	RH-EX0265TAZZY	AB		J	Zener Diode PDZ10B,115
D532	RH-EX0265TAZZY	AB		J	Zener Diode PDZ10B,115
D533	RH-EX0265TAZZY	AB		J	Zener Diode PDZ10B,115

NO.	PARTS CODE	PRICE RANK	NEW MARK	PART DELIVERY	DESCRIPTION
[8] DUNTKE685FM31/FM33/FM32/FM34/FM36/FM37 (MAIN Unit)					
D534	VHD1PS184++-1Y	AB		J	Diode 1PS184,115
D535	RH-EXA550WJZZY	AB		J	Zener Diode MAZ8130GML
D1318	VHD1PS184++-1Y	AB		J	Diode 1PS184,115
D1504	RH-EXA523WJZZY	AB		J	Zener Diode MAZ8056GML
D1506	RH-EXA523WJZZY	AB		J	Zener Diode MAZ8056GML
D1507	RH-EXA523WJZZY	AB		J	Zener Diode MAZ8056GML
D1508	RH-EXA523WJZZY	AB		J	Zener Diode MAZ8056GML
D1509	VHDRB520S30-1Y	AC		J	Diode RB520S-30TE61
D1512	VHD1PS184++-1Y	AB		J	Diode 1PS184,115
D1519	RH-EX0259TAZZY	AB		J	Zener Diode PDZ5.6B,115
D1521	VHDM111G++-1Y	AA		J	Diode MA2J1110GL
D1522	VHD1PS184++-1Y	AB		J	Diode 1PS184,115
D1523	VHD1PS184++-1Y	AB		J	Diode 1PS184,115
D1802	VHDM111G++-1Y	AA		J	Diode MA2J1110GL
D2002	RH-PXA037WJZZY	AB		J	Diode SML-310MTT86
D2006	RH-EXA535WJZZY	AM		J	Zener Diode MAZ8082GML
D2401	VHDMAZ9120H-1Y	AC		J	Diode MAZ9120H
D2402	VHDMAZ9120H-1Y	AC		J	Diode MAZ9120H
D2403	RH-EX0259TAZZY	AB		J	Zener Diode PDZ5.6B,115
D2404	VHD1PS184++-1Y	AB		J	Diode 1PS184,115
D2405	VHD1PS184++-1Y	AB		J	Diode 1PS184,115
D8101	VHD1PS226++-1Y	AB		J	Diode 1PS226,115
D8102	VHD1PS226++-1Y	AB		J	Diode 1PS226,115
D8103	VHD1PS226++-1Y	AB		J	Diode 1PS226,115
D8108	RH-EX1232CEZZY	AB		J	Zener Diode EX1232CE, 3.3V
D8109	RH-EX1232CEZZY	AB		J	Zener Diode EX1232CE, 3.3V
D9101	RH-PXA037WJZZY	AB		J	Diode SML-310MTT86
D9602	VHDRB520S30-1Y	AC		J	Diode RB520S-30TE61
D9603	VHDM111G++-1Y	AA		J	Diode MA2J1110GL
D9604	VHDSMAB33L+-1Y	AC		J	Diode SMAB33L-RTK/P
D9608	VHDSMAB33L+-1Y	AC		J	Diode SMAB33L-RTK/P
D9609	VHDM111G++-1Y	AA		J	Diode MA2J1110GL
D9610	VHD1PS226++-1Y	AB		J	Diode 1PS226,115
D9611	VHDM111G++-1Y	AA		J	Diode MA2J1110GL
D9612	RH-EX1227CEZZY	AB		J	Zener Diode HZU2.7B1TRF-E
D9615	VHDM111G++-1Y	AA		J	Diode MA2J1110GL
D9616	RH-EX1395CEZZY	AC		J	Zener Diode UDZSNPTE-176.2B
D9617	RH-EXA089WJZZY	AB		J	Zener Diode UDZSNPTE-174.3B
D9618	VHDM111G++-1Y	AA		J	Diode MA2J1110GL
D9619	VHDRB056L40-1Y	AC		J	Diode RB056L40
D9620	VHDSMAB33L+-1Y	AC		J	Diode SMAB33L-RTK/P
FB501	RBLN-0077TAZZY	AB		J	Balun BLN-0077TA
FB502	RBLN-0077TAZZY	AB		J	Balun BLN-0077TA
FB503	RBLN-0077TAZZY	AB		J	Balun BLN-0077TA
FB504	RBLN-0077TAZZY	AB		J	Balun BLN-0077TA
FB505	RBLN-0077TAZZY	AB		J	Balun BLN-0077TA
FB506	RBLN-0077TAZZY	AB		J	Balun BLN-0077TA
FB507	RBLN-0077TAZZY	AB		J	Balun BLN-0077TA
FB508	RBLN-0077TAZZY	AB		J	Balun BLN-0077TA
FB509	RBLN-0077TAZZY	AB		J	Balun BLN-0077TA
FB510	RBLN-0077TAZZY	AB		J	Balun BLN-0077TA
FB511	RBLN-0077TAZZY	AB		J	Balun BLN-0077TA
FB512	RBLN-0077TAZZY	AB		J	Balun BLN-0077TA
FB513	RBLN-0077TAZZY	AB		J	Balun BLN-0077TA
FB514	RBLN-0077TAZZY	AB		J	Balun BLN-0077TA
FB515	RBLN-0077TAZZY	AB		J	Balun BLN-0077TA
FB516	RBLN-0077TAZZY	AB		J	Balun BLN-0077TA
FB517	RBLN-A188WJZZY	AA		J	Balun BLN-A188WJ
FB518	RBLN-0077TAZZY	AB		J	Balun BLN-0077TA
FB519	RBLN-0077TAZZY	AB		J	Balun BLN-0077TA
FB520	RBLN-A188WJZZY	AA		J	Balun BLN-A188WJ
FB1301	RBLN-A188WJZZY	AA		J	Balun BLN-A188WJ
FB1302	RBLN-A188WJZZY	AA		J	Balun BLN-A188WJ
FB1303	RBLN-A188WJZZY	AA		J	Balun BLN-A188WJ
FB1304	RBLN-A188WJZZY	AA		J	Balun BLN-A188WJ
FB1305	RBLN-0077TAZZY	AB		J	Balun BLN-0077TA
FB1306	RBLN-0077TAZZY	AB		J	Balun BLN-0077TA
FB1307	RBLN-A188WJZZY	AA		J	Balun BLN-A188WJ
FB1308	RBLN-A188WJZZY	AA		J	Balun BLN-A188WJ
FB1309	RBLN-A188WJZZY	AA		J	Balun BLN-A188WJ
FB1310	RBLN-0077TAZZY	AB		J	Balun BLN-0077TA
FB1311	RBLN-0077TAZZY	AB		J	Balun BLN-0077TA
FB1501	RBLN-0061TAZZY	AD		J	Balun BLN-0061TA
FB1502	RBLN-0061TAZZY	AD		J	Balun BLN-0061TA
FB1503	RBLN-0061TAZZY	AD		J	Balun BLN-0061TA
FB1504	RBLN-0061TAZZY	AD		J	Balun BLN-0061TA
FB1515	RBLN-A274WJZZY	AB		J	Balun BLN-A274WJ
FB2003	RBLN-A188WJZZY	AA		J	Balun BLN-A188WJ
FB2004	RBLN-A188WJZZY	AA		J	Balun BLN-A188WJ
FB2005	RBLN-0061TAZZY	AD		J	Balun BLN-0061TA
FB2006	RBLN-0061TAZZY	AD		J	Balun BLN-0061TA
FB2007	RBLN-0061TAZZY	AD		J	Balun BLN-0061TA
FB2008	RBLN-0061TAZZY	AD		J	Balun BLN-0061TA
FB2009	RBLN-0061TAZZY	AD		J	Balun BLN-0061TA
FB2012	RBLN-0061TAZZY	AD		J	Balun BLN-0061TA (LC-46D653E/D654E)

NO.	PARTS CODE	PRICE RANK	NEW MARK	PART DELIVERY	DESCRIPTION
[8] DUNTKE685FM31/FM33/FM32/FM34/FM36/FM37 (MAIN Unit)					
FB2013	RBLN-0061TAZZY	AD		J	Balun BLN-0061TA (LC-46D653E/D654E)
FB2014	RBLN-0061TAZZY	AD		J	Balun BLN-0061TA (LC-46D653E/D654E)
FB2402	RBLN-0061TAZZY	AD		J	Balun BLN-0061TA
FB2403	RBLN-0061TAZZY	AD		J	Balun BLN-0061TA
FB2404	RBLN-0061TAZZY	AD		J	Balun BLN-0061TA
FB4402	RBLN-0210TAZZY	AB		J	Balun BLN-0210TA
FB4403	RBLN-0210TAZZY	AB		J	Balun BLN-0210TA
FB5301	RBLN-A274WJZZY	AB		J	Balun BLN-A274WJ
FB7501	RBLN-0210TAZZY	AB		J	Balun BLN-0210TA
FB8101	RBLN-A188WJZZY	AA		J	Balun BLN-A188WJ
FB8103	RBLN-A206WJZZY	AA		J	Balun BLN-A206WJ
FB8104	RBLN-A188WJZZY	AA		J	Balun BLN-A188WJ
FB8105	RBLN-A188WJZZY	AA		J	Balun BLN-A188WJ
FB8106	RBLN-A188WJZZY	AA		J	Balun BLN-A188WJ
FB8107	RBLN-0253TAZZY	AA		J	Balun BLN-0253TA
FB8108	RBLN-A188WJZZY	AA		J	Balun BLN-A188WJ
FB8110	RBLN-A188WJZZY	AA		J	Balun BLN-A188WJ
FB8111	RBLN-A188WJZZY	AA		J	Balun BLN-A188WJ
FB8112	RBLN-A207WJZZY	AB		J	Balun BLN-A207WJ
FB8119	RBLN-A188WJZZY	AA		J	Balun BLN-A188WJ
FB8121	RBLN-A188WJZZY	AA		J	Balun BLN-A188WJ
FB8122	RBLN-A188WJZZY	AA		J	Balun BLN-A188WJ
FB8123	RBLN-A188WJZZY	AA		J	Balun BLN-A188WJ
FB8126	RBLN-A188WJZZY	AA		J	Balun BLN-A188WJ
FB8701	RBLN-A274WJZZY	AB		J	Balun BLN-A274WJ
FB8702	RBLN-A188WJZZY	AA		J	Balun BLN-A188WJ
FB9601	RBLN-0207TAZZY	AB		J	Balun BLN-0207TA
FB9602	RBLN-0207TAZZY	AB		J	Balun BLN-0207TA
FB9604	RBLN-A303WJZZY	AB		J	Balun BLN-A303WJ
FB9605	RBLN-0207TAZZY	AB		J	Balun BLN-0207TA
FB9606	RBLN-0207TAZZY	AB		J	Balun BLN-0207TA
FL501	FiLN0017TAZZY	AC		J	Filter FiLN0017TA
FL502	FiLN0017TAZZY	AC		J	Filter FiLN0017TA
FL503	FiLN0017TAZZY	AC		J	Filter FiLN0017TA
FL504	FiLN0017TAZZY	AC		J	Filter FiLN0017TA
FL505	FiLN0017TAZZY	AC		J	Filter FiLN0017TA
FL506	FiLN0017TAZZY	AC		J	Filter FiLN0017TA
FL507	FiLN0017TAZZY	AC		J	Filter FiLN0017TA
FL508	FiLN0017TAZZY	AC		J	Filter FiLN0017TA
FL509	FiLN0017TAZZY	AC		J	Filter FiLN0017TA
FL510	FiLN0017TAZZY	AC		J	Filter FiLN0017TA
FL511	FiLN0003TAZZY	AD		J	Filter FiLN0003TA
FL512	FiLN0003TAZZY	AD		J	Filter FiLN0003TA
FL513	FiLN0003TAZZY	AD		J	Filter FiLN0003TA
FL516	FiLN0017TAZZY	AC		J	Filter FiLN0017TA
FL1501	FiLN0003TAZZY	AD		J	Filter FiLN0003TA
FL1502	FiLN0003TAZZY	AD		J	Filter FiLN0003TA
FL1503	FiLN0003TAZZY	AD		J	Filter FiLN0003TA
FL2001	FiLZA027WJQZY	AD		J	Filter
IC501	VHiT7SET08U1EY	AC		J	IC TC7SET08FU(5L,JF,T
IC502	VHiTC7W53U/-1Y	AF		J	IC TC7W53FU(TE12L,F)
IC503	VHiMM1783CQ-1Q	AS	N	J	IC MM1783CQ
IC504	VHiAK4384ET-1Y	AG		J	IC AK4384ET
IC1302	VHiSTV8357F-1Q	AY	N	J	IC STV8357FD
IC1303	VHiPQ1LAX95-1Y	AD		J	IC PQ1LAX95MSPQ
IC1304	VHiSTA333W+-1Y	AQ	N	J	IC STA333W13TR
IC1305	VHiNJM3414V-1Y	AF		J	IC NJM3414AV-TE1
IC1503	RH-iXC697WJQZS	AH		J	IC EDID (PC)
IC1504	RH-iXC442WJN1S	AK		J	IC EDID (HDMI)
IC1507	VHiBU16028K-1Q	AP	N	J	IC BU16028KV
IC1805	VHiBH33FB1G-1Y	AD		J	IC BH33FB1WG-TR
IC2001	VHiTCVHC32T-1Y	AE		J	IC TC74VHC32FT(EL)
IC2002	VHiS80927NM-1Y	AC		J	IC S-80927CNMC-G8XT2G
IC2003	RH-iXC331WJQZQ	AQ		J	IC R5F364V6NFB#U0 (LC-32/37D653E/D654E)
IC2003	RH-iXC331WJNNQ			J	IC R5F364V6NFB#U0 (LC-46D653E/D654E)
IC2004	VHiTC7SH00U-1Y	AC		J	IC TC7SH00FU(T5L,JF,T
IC2005	VHi7WH126FU-1Y	AE		J	IC TC7WH126FU(TE12L,F)
IC2006	VHiBR24L08F-1Y	AE		J	IC BR24L08F-WE2
IC2007	VHiLCX125FT-1Y	AD		J	IC TC74LCX125FT(EL,K)
IC2401	VHi7WH126FU-1Y	AE		J	IC TC7WH126FU(TE12L,F)
IC2402	VHiLCX157FT-1Y	AD		J	IC TC74LCX157FT(EKJ)
IC2403	VHiM3221EiP-1Y	AK	N	J	IC MAX3221EIPWR
IC2601	VHiTC7W66U/-1Y	AE		J	IC TC7W66FU(TE12L,F)
IC4401	VHiLCX245FT-1Y	AD		J	IC TC74LCX245FT(EKJ)
IC4402	VHiLCX573FT-1Y	AF		J	IC TC74LCX573FT(EKJ)
IC4403	VHiTC7SH08U-1Y	AF		J	IC TC7SH08FU(TE85L,JF)
IC4404	VHiLCX244FT-1Y	AE		J	IC TC74LCX244FT(EL,K)
IC4405	VHiLCX573FT-1Y	AF		J	IC TC74LCX573FT(EKJ)
IC4409	VHiLVC1G14W-1Y	AC	N	J	IC 74LVC1G14GW,125
IC5301	VHiBU16028K-1Q	AP	N	J	IC BU16028KV
IC7502	VHiR1173S12-1Y	AE		J	IC R1173S121B-E2-F
IC7503	VHiAK4255ET-1Y	AK	N	J	IC AK4255ET
IC7508	VHiDRX3913K-1Q	AX	N	J	IC DRX3913K-XK-A2
IC8101	Not Available	-	-	-	IC HiDTV Pro WX(8568W-LF) (Please replace the MAIN PWB when it is necessary to replace this IC.)

NO.	PARTS CODE	PRICE RANK	NEW MARK	PART DELIVERY	DESCRIPTION
[8] DUNTKE685FM31/FM33/FM32/FM34/FM36/FM37 (MAIN Unit)					
IC8103	VHILVC08AT+-1Y	AF		J	IC SN74LVC08APWR
IC8104	VHIBD6538G+-1Y	AD		J	IC BD6538G-TR
IC8301	RH-iXC505WJQZQ	AY	N	J	IC K4T51163QG-HCF7
IC8302	RH-iXC505WJQZQ	AY	N	J	IC K4T51163QG-HCF7
IC8701	VHIS29G128P-1Q	AU		J	IC S29GL128P90TFCR20#
IC8703	VHIBR24S64M-1Y	AF		J	IC BR24S64FVM-WTR
IC8704	VHIAK8131C+-1Y	AK		J	IC AK8131C
IC9101	RH-iXC671WJQZQ	AS	N	R	IC XC2C128-7VQG100C
IC9104	VHITCLCX08FT1Y	AD		J	IC TC74LCX08FT(EL,K)
IC9601	VHIPQ200WNA-1Y	AG		J	IC PQ200WNA1ZPH
IC9603	VHIL6726A+-1Y	AH	N	J	IC L6726ATR
IC9604	VHILV5805M+-1Y	AG		J	IC LV5805M-TE-L-E
IC9606	VHILV5805M+-1Y	AG		J	IC LV5805M-TE-L-E
IC9607	VHIPQ1KA503-1Y	AD		R	IC PQ1KA503MZPH
IC9609	VHIPQ025ENA-1Y	AE		J	IC PQ025ENA1ZPH
IC9610	VHILV5805M+-1Y	AG		J	IC LV5805M-TE-L-E
J501	QJAKGA131WJZZ	AG		J	Jack
J502	QJAKFA061WJZZ	AE		J	Jack AUDIO_IN
J503	QJAKFA061WJZZ	AE		J	Jack AUDIO_OUT
J505	QJAKGA079WJZZ	AD		J	Jack
J1301	QJAKJ0008GEZZ	AD		J	Jack
J1302	QJAKJ0047CEZZ	AD		J	Jack Headphone
J8101	QSOCZA172WJQZ	AD		J	Socket 4Pin(USB)
L1301	RCILPA899WJZZY	AC		J	Coil Peaking 22uH
L1302	RCILPA899WJZZY	AC		J	Coil Peaking 22uH
L1303	RCILPA899WJZZY	AC		J	Coil Peaking 22uH
L1304	RCILPA899WJZZY	AC		J	Coil Peaking 22uH
L2613	RCILFA119WJZZY	AE		J	Coil CILFA119WJ
L2614	RCILFA119WJZZY	AE		J	Coil CILFA119WJ
L2615	RCILFA119WJZZY	AE		J	Coil CILFA119WJ
L2616	RCILFA119WJZZY	AE		J	Coil CILFA119WJ
L2617	RCILFA119WJZZY	AE		J	Coil CILFA119WJ
L2618	RCILFA119WJZZY	AE		J	Coil CILFA119WJ
L7508	VPSBN100J1R2NY	AB		J	Coil Peaking 10uH
L8103	VPCWM2R2MR10NY	AC		J	Coil Peaking 2.2uH
L9601	RCILPA758WJQZY	AC		R	Coil CILPA758WJ
L9603	RCILPA762WJQZY	AE		J	Coil CILPA762WJ
L9605	RCILPA888WJQZY	AG		J	Coil CILPA888WJ
L9606	RCILFA228WJZZY	AD		J	Coil CILFA228WJ
L9607	RCILPA887WJZZY	AG		J	Coil CILPA887WJ
LUG501	QLUGHA009WJZZY	AC		J	Lug
LUG502	QLUGHA009WJZZY	AC		J	Lug
LUG503	QLUGHA009WJZZY	AC		J	Lug
LUG504	QLUGHA009WJZZY	AC		J	Lug
LUG505	QLUGHA009WJZZY	AC		J	Lug
LUG506	QLUGHA009WJZZY	AC		J	Lug
LUG507	QLUGHA009WJZZY	AC		J	Lug
LUG508	QLUGHA009WJZZY	AC		J	Lug
P1301	QPLGNA160WJZZY	AD		J	Plug 4Pin(SP)
P2003	QPLGNA330WJZZY	AD		J	Plug 10Pin(RA)
P2004	QPLGNA324WJZZY	AC		J	Plug
P2603	QPLGNA329WJZZY	AD		J	Plug 9Pin(LB)
P4401	QCNCMA318WJSA	AN	N	R	Plug
P8103	QPLGNA144WJZZY	AF		J	Plug 20Pin(PARTNER)
P9601	QPLGNA168WJZZY	AF		J	Plug 12Pin(PD)
P9603	QPLGNA335WJZZY	AD		J	Plug 15pin(LP)
Q501	VSKRC404E+-1Y	AB		J	Transistor KRC404E
Q502	VSDTC314TK/-1Y	AC		J	Transistor DTC314TKT146
Q503	VSDTC314TK/-1Y	AC		J	Transistor DTC314TKT146
Q504	VSDTC314TK/-1Y	AC		J	Transistor DTC314TKT146
Q505	VSDTC314TK/-1Y	AC		J	Transistor DTC314TKT146
Q510	VS2SA1530AR-1Y	AB		J	Transistor 2SA1530A-T112-1R
Q511	VS2SA1530AR-1Y	AB		J	Transistor 2SA1530A-T112-1R
Q512	VSDTC314TK/-1Y	AC		J	Transistor DTC314TKT146
Q513	VSDTC314TK/-1Y	AC		J	Transistor DTC314TKT146
Q1301	VSiMH23T110-1Y	AC		J	Transistor IMH23T110
Q1504	VSRDTC144EE-1Y	AA		J	Transistor PDC144EE,115
Q1506	VSRDTC144EE-1Y	AA		J	Transistor PDC144EE,115
Q1516	VSiMD2A///-1Y	AC		J	Transistor IMD2AT108
Q1802	VSRDTC144EE-1Y	AA		J	Transistor PDC144EE,115
Q1803	VSDTA124EKA-1Y	AB		J	Transistor DTA124EKAT146
Q1808	VSRDTC144EE-1Y	AA		J	Transistor PDC144EE,115
Q1809	VS2SA1530AR-1Y	AB		J	Transistor 2SA1530A-T112-1R
Q2002	VSRN1102///-1Y	AB		J	Transistor RN1102(TE85L,F)
Q2003	VS2SA1530AR-1Y	AB		J	Transistor 2SA1530A-T112-1R
Q4401	RH-TXA026WJZZY	AD		J	Transistor PBL2001D,115
Q5301	VSRDTC144EE-1Y	AA		J	Transistor PDC144EE,115
Q7503	VS2SC3928AR-1Y	AB		J	Transistor 2SC3928A-T112-1R
Q7504	VSDTA124EKA-1Y	AB		J	Transistor DTA124EKAT146
Q7505	RH-TXA026WJZZY	AD		J	Transistor PBL2001D,115
Q8703	VS2SC3928AR-1Y	AB		J	Transistor 2SC3928A-T112-1R
Q9102	VSRDTC144EE-1Y	AA		J	Transistor PDC144EE,115
Q9602	VSRDTC144EE-1Y	AA		J	Transistor PDC144EE,115
Q9604	VSFW808ME+-1Y	AE		J	Transistor FW808-M-TL-E
Q9605	VSRT1N144U/-1Y	AB		J	Transistor RT1N144U-T111-1

NO.	PARTS CODE	PRICE RANK	NEW MARK	PART DELIVERY	DESCRIPTION
[8] DUNTKE685FM31/FM33/FM32/FM34/FM36/FM37 (MAIN Unit)					
Q9606	VSRDTC144EE-1Y	AA		J	Transistor PDTC144EE,115
Q9607	VSEMZ1++++-1Y	AC		J	Transistor EMZ1T2R
Q9608	VS2SC3928AR-1Y	AB		J	Transistor 2SC3928A-T112-1R
Q9609	VSDTA124EKA-1Y	AB		J	Transistor DTA124EKAT146
R501	VRS-CZ1JF472JY	AA		J	Resistor 4.7k 1/16W Metal Oxide
R503	VRS-CZ1JF682JY	AA		J	Resistor 6.8k 1/16W Metal Oxide
R504	VRS-CZ1JF472JY	AA		J	Resistor 4.7k 1/16W Metal Oxide
R508	VRS-TQ2EF750JY	AA		J	Resistor 75 1/4W Metal Oxide
R509	VRS-TQ2EF680JY	AA		J	Resistor 68 1/4W Metal Oxide
R510	VRS-TQ2EF680JY	AA		J	Resistor 68 1/4W Metal Oxide
R511	VRS-TQ2EF750JY	AA		J	Resistor 75 1/4W Metal Oxide
R512	VRS-CZ1JF682JY	AA		J	Resistor 6.8k 1/16W Metal Oxide
R513	VRS-TQ2EF750JY	AA		J	Resistor 75 1/4W Metal Oxide
R514	VRS-CZ1JF102JY	AA		J	Resistor 1k 1/16W Metal Oxide
R518	VRS-TQ2EF750JY	AA		J	Resistor 75 1/4W Metal Oxide
R519	VRS-TQ2EF750JY	AA		J	Resistor 75 1/4W Metal Oxide
R520	VRS-TQ2EF101JY	AA		J	Resistor 100 1/4W Metal Oxide
R522	VRS-CZ1JF102JY	AA		J	Resistor 1k 1/16W Metal Oxide
R523	VRS-TQ2EF750JY	AA		J	Resistor 75 1/4W Metal Oxide
R524	VRS-TQ2EF750JY	AA		J	Resistor 75 1/4W Metal Oxide
R525	VRS-CZ1JF473JY	AA		J	Resistor 47k 1/16W Metal Oxide
R526	VRS-TQ2EF750JY	AA		J	Resistor 75 1/4W Metal Oxide
R527	VRS-TQ2EF101JY	AA		J	Resistor 100 1/4W Metal Oxide
R528	VRS-TQ2EF750JY	AA		J	Resistor 75 1/4W Metal Oxide
R529	VRS-TQ2EF750JY	AA		J	Resistor 75 1/4W Metal Oxide
R531	VRS-CZ1JF221JY	AA		J	Resistor 220 1/16W Metal Oxide
R534	VRS-TV1JD221JY	AA		J	Resistor 220 1/16W Metal Oxide
R535	VRS-TV1JD221JY	AA		J	Resistor 220 1/16W Metal Oxide
R536	VRS-TV1JD221JY	AA		J	Resistor 220 1/16W Metal Oxide
R537	VRS-TV1JD221JY	AA		J	Resistor 220 1/16W Metal Oxide
R538	VRS-CZ1JF104JY	AA		J	Resistor 100k 1/16W Metal Oxide
R539	VRS-CZ1JF104JY	AA		J	Resistor 100k 1/16W Metal Oxide
R540	VRS-CZ1JF104JY	AA		J	Resistor 100k 1/16W Metal Oxide
R541	VRS-CZ1JF104JY	AA		J	Resistor 100k 1/16W Metal Oxide
R543	VRK-SA1JF101JY	AC		J	Resistor 100 1/16W Metal Composition
R544	VRK-SA1JF101JY	AC		J	Resistor 100 1/16W Metal Composition
R545	VRS-CZ1JF102JY	AA		J	Resistor 1k 1/16W Metal Oxide
R546	VRS-CZ1JF102JY	AA		J	Resistor 1k 1/16W Metal Oxide
R547	VRS-CZ1JF104JY	AA		J	Resistor 100k 1/16W Metal Oxide
R548	VRS-CZ1JF104JY	AA		J	Resistor 100k 1/16W Metal Oxide
R549	VRS-CZ1JF102JY	AA		J	Resistor 1k 1/16W Metal Oxide
R550	VRS-CZ1JF102JY	AA		J	Resistor 1k 1/16W Metal Oxide
R551	VRS-CZ1JF564JY	AB		J	Resistor 560k 1/16W Metal Oxide
R552	VRS-CZ1JF564JY	AB		J	Resistor 560k 1/16W Metal Oxide
R553	VRK-SA1JF331JY	AA		J	Resistor 330 1/16W Metal Composition
R554	VRK-SA1JF331JY	AA		J	Resistor 330 1/16W Metal Composition
R555	VRS-CZ1JF104JY	AA		J	Resistor 100k 1/16W Metal Oxide
R556	VRS-CZ1JF104JY	AA		J	Resistor 100k 1/16W Metal Oxide
R557	VRS-CZ1JF564JY	AB		J	Resistor 560k 1/16W Metal Oxide
R558	VRS-CZ1JF564JY	AB		J	Resistor 560k 1/16W Metal Oxide
R561	VRS-CZ1JF103JY	AA		J	Resistor 10k 1/16W Metal Oxide
R562	VRS-CZ1JF103JY	AA		J	Resistor 10k 1/16W Metal Oxide
R563	VRS-CY1JF104JY	AA		J	Resistor 100k 1/16W Metal Oxide
R564	VRS-TQ2EF750JY	AA		J	Resistor 75 1/4W Metal Oxide
R565	VRS-CZ1JF101JY	AA		J	Resistor 100 1/16W Metal Oxide
R566	VRS-CZ1JF101JY	AA		J	Resistor 100 1/16W Metal Oxide
R567	VRS-TQ2EF750JY	AA		J	Resistor 75 1/4W Metal Oxide
R568	VRS-CY1JF000JY	AA		J	Resistor 0 1/16W Metal Oxide
R569	VRS-CZ1JF101JY	AA		J	Resistor 100 1/16W Metal Oxide
R570	VRS-CZ1JF103JY	AA		J	Resistor 10k 1/16W Metal Oxide
R571	VRS-TQ2EF750JY	AA		J	Resistor 75 1/4W Metal Oxide
R572	VRS-TQ2EF750JY	AA		J	Resistor 75 1/4W Metal Oxide
R573	VRS-CZ1JF101JY	AA		J	Resistor 100 1/16W Metal Oxide
R574	VRS-CZ1JF102JY	AA		J	Resistor 1k 1/16W Metal Oxide
R575	VRS-CZ1JF102JY	AA		J	Resistor 1k 1/16W Metal Oxide
R576	VRS-CZ1JF104JY	AA		J	Resistor 100k 1/16W Metal Oxide
R577	VRS-CZ1JF101JY	AA		J	Resistor 100 1/16W Metal Oxide
R578	VRK-SA1JF100JY	AB		J	Resistor 10 1/16W Metal Composition
R579	VRS-CZ1JF102JY	AA		J	Resistor 1k 1/16W Metal Oxide
R580	VRS-CZ1JF102JY	AA		J	Resistor 1k 1/16W Metal Oxide
R581	VRS-CZ1JF104JY	AA		J	Resistor 100k 1/16W Metal Oxide
R582	VRS-CZ1JF220JY	AA		J	Resistor 22 1/16W Metal Oxide
R583	VRS-CZ1JF220JY	AA		J	Resistor 22 1/16W Metal Oxide
R584	VRS-CZ1JF220JY	AA		J	Resistor 22 1/16W Metal Oxide
R585	VRS-CZ1JF104JY	AA		J	Resistor 100k 1/16W Metal Oxide
R586	VRS-CZ1JF221JY	AA		J	Resistor 220 1/16W Metal Oxide
R587	VRS-CZ1JF561JY	AA		J	Resistor 560 1/16W Metal Oxide
R588	VRS-CZ1JF220JY	AA		J	Resistor 22 1/16W Metal Oxide
R589	VRS-CZ1JF102JY	AA		J	Resistor 1k 1/16W Metal Oxide
R590	VRS-CZ1JF220JY	AA		J	Resistor 22 1/16W Metal Oxide
R591	VRS-CZ1JF104JY	AA		J	Resistor 100k 1/16W Metal Oxide
R592	VRS-CZ1JF221JY	AA		J	Resistor 220 1/16W Metal Oxide
R593	VRS-CZ1JF561JY	AA		J	Resistor 560 1/16W Metal Oxide
R594	VRS-CZ1JF220JY	AA		J	Resistor 22 1/16W Metal Oxide
R595	VRS-CZ1JF102JY	AA		J	Resistor 1k 1/16W Metal Oxide

NO.	PARTS CODE	PRICE RANK	NEW MARK	PART DELIVERY	DESCRIPTION
[8] DUNTKE685FM31/FM33/FM32/FM34/FM36/FM37 (MAIN Unit)					
R596	VRS-CZ1JF564JY	AB		J	Resistor 560k 1/16W Metal Oxide
R597	VRS-CZ1JF101JY	AA		J	Resistor 100 1/16W Metal Oxide
R598	VRS-CZ1JF564JY	AB		J	Resistor 560k 1/16W Metal Oxide
R599	VRS-CZ1JF103JY	AA		J	Resistor 10k 1/16W Metal Oxide
R601	VRS-CZ1JF820JY	AA		J	Resistor 82 1/16W Metal Oxide
R602	VRS-CZ1JF820JY	AA		J	Resistor 82 1/16W Metal Oxide
R621	VRS-CZ1JF470JY	AA		J	Resistor 47 1/16W Metal Oxide
R622	VRS-CZ1JF470JY	AA		J	Resistor 47 1/16W Metal Oxide
R623	VRS-CZ1JF470JY	AA		J	Resistor 47 1/16W Metal Oxide
R624	VRS-CZ1JF472JY	AA		J	Resistor 4.7k 1/16W Metal Oxide
R625	VRS-CZ1JF102JY	AA		J	Resistor 1k 1/16W Metal Oxide
R628	VRS-CY1JF000JY	AA		J	Resistor 0 1/16W Metal Oxide
R629	VRS-CY1JF104JY	AA		J	Resistor 100k 1/16W Metal Oxide
R630	VRS-CZ1JF102JY	AA		J	Resistor 1k 1/16W Metal Oxide
R631	VRS-CZ1JF472JY	AA		J	Resistor 4.7k 1/16W Metal Oxide
R633	VRS-CZ1JF820JY	AA		J	Resistor 82 1/16W Metal Oxide
R1301	VRS-CZ1JF470JY	AA		J	Resistor 47 1/16W Metal Oxide
R1302	VRS-CZ1JF470JY	AA		J	Resistor 47 1/16W Metal Oxide
R1303	VRS-CZ1JF470JY	AA		J	Resistor 47 1/16W Metal Oxide
R1307	VRS-CZ1JF470JY	AA		J	Resistor 47 1/16W Metal Oxide
R1308	VRS-CZ1JF470JY	AA		J	Resistor 47 1/16W Metal Oxide
R1309	VRS-CZ1JF470JY	AA		J	Resistor 47 1/16W Metal Oxide
R1310	VRS-CZ1JF470JY	AA		J	Resistor 47 1/16W Metal Oxide
R1311	VRS-CZ1JF472JY	AA		J	Resistor 4.7k 1/16W Metal Oxide
R1314	VRS-CZ1JF470JY	AA		J	Resistor 47 1/16W Metal Oxide
R1316	VRS-CZ1JF102JY	AA		J	Resistor 1k 1/16W Metal Oxide
R1317	VRS-CZ1JF102JY	AA		J	Resistor 1k 1/16W Metal Oxide
R1318	VRS-CZ1JF104JY	AA		J	Resistor 100k 1/16W Metal Oxide
R1319	VRS-CZ1JF104JY	AA		J	Resistor 100k 1/16W Metal Oxide
R1320	VRS-CZ1JF470JY	AA		J	Resistor 47 1/16W Metal Oxide
R1321	VRS-CZ1JF102JY	AA		J	Resistor 1k 1/16W Metal Oxide
R1322	VRS-CZ1JF102JY	AA		J	Resistor 1k 1/16W Metal Oxide
R1324	VRS-CZ1JF470JY	AA		J	Resistor 47 1/16W Metal Oxide
R1326	VRS-CZ1JF470JY	AA		J	Resistor 47 1/16W Metal Oxide
R1327	VRS-CZ1JF470JY	AA		J	Resistor 47 1/16W Metal Oxide
R1328	VRS-CZ1JF103JY	AA		J	Resistor 10k 1/16W Metal Oxide
R1329	VRK-SA1JF100JY	AB		J	Resistor 10 1/16W Metal Composition
R1330	VRS-CZ1JF823FY	AA		J	Resistor 82k 1/16W Metal Oxide
R1331	VRS-CZ1JF153FY	AA		J	Resistor 15k 1/16W Metal Oxide
R1336	VRK-SA1JF100JY	AB		J	Resistor 10 1/16W Metal Composition
R1337	VRS-CZ1JF470JY	AA		J	Resistor 47 1/16W Metal Oxide
R1339	VRS-TQ2EF000JY	AB		J	Resistor 0 1/4W Metal Oxide
R1340	VRS-CZ1JF222JY	AA		J	Resistor 2.2k 1/16W Metal Oxide
R1341	VRS-CZ1JF3R3JY	AA		J	Resistor 3.3 1/16W Metal Oxide
R1342	VRS-CZ1JF3R3JY	AA		J	Resistor 3.3 1/16W Metal Oxide
R1343	VRS-TQ2EF390JY	AA		R	Resistor 39 1/4W Metal Oxide
R1344	VRS-TQ2EF390JY	AA		R	Resistor 39 1/4W Metal Oxide
R1346	VRS-TQ2EF6R8JY	AA		R	Resistor 6.8 1/4W Metal Oxide
R1347	VRS-TQ2EF6R8JY	AA		R	Resistor 6.8 1/4W Metal Oxide
R1349	VRS-TQ2EF220JY	AA		J	Resistor 22 1/4W Metal Oxide
R1350	VRS-TQ2EF220JY	AA		J	Resistor 22 1/4W Metal Oxide
R1351	VRS-CZ1JF473JY	AA		J	Resistor 47k 1/16W Metal Oxide
R1352	VRS-TQ2EF6R8JY	AA		R	Resistor 6.8 1/4W Metal Oxide
R1353	VRS-CZ1JF473JY	AA		J	Resistor 47k 1/16W Metal Oxide
R1354	VRS-CZ1JF103JY	AA		J	Resistor 10k 1/16W Metal Oxide
R1355	VRS-TQ2EF6R8JY	AA		R	Resistor 6.8 1/4W Metal Oxide
R1356	VRS-CZ1JF103JY	AA		J	Resistor 10k 1/16W Metal Oxide
R1358	VRK-SA1JF103JY	AB		J	Resistor 10k 1/16W Metal Composition
R1359	VRS-TV1JD000JY	AA		J	Resistor 0 1/10W Metal Oxide
R1360	VRS-TV1JD000JY	AA		J	Resistor 0 1/10W Metal Oxide
R1361	VRS-TV1JD000JY	AA		J	Resistor 0 1/10W Metal Oxide
R1362	VRS-TV1JD000JY	AA		J	Resistor 0 1/10W Metal Oxide
R1363	VRS-CY1JF102JY	AA		J	Resistor 1k 1/16W Metal Oxide
R1364	VRS-TW2ED101JY	AA		J	Resistor 100 1/4W Metal Oxide
R1365	VRS-CY1JF104JY	AA		J	Resistor 100k 1/16W Metal Oxide
R1366	VRS-TW2ED101JY	AA		J	Resistor 100 1/4W Metal Oxide
R1367	VRS-CY1JF104JY	AA		J	Resistor 100k 1/16W Metal Oxide
R1368	VRS-CZ1JF470JY	AA		J	Resistor 47 1/16W Metal Oxide
R1379	VRS-CZ1JF000JY	AA		J	Resistor 0 1/16W Metal Oxide
R1380	VRS-CZ1JF000JY	AA		J	Resistor 0 1/16W Metal Oxide
R1503	VRS-CZ1JF102JY	AA		J	Resistor 1k 1/16W Metal Oxide
R1504	VRS-CZ1JF102JY	AA		J	Resistor 1k 1/16W Metal Oxide
R1506	VRS-CZ1JF273FY	AA		J	Resistor 27k 1/16W Metal Oxide
R1507	VRS-CZ1JF562FY	AA		J	Resistor 5.6k 1/16W Metal Oxide
R1508	VRS-CZ1JF103JY	AA		J	Resistor 10k 1/16W Metal Oxide
R1509	VRS-CZ1JF473JY	AA		J	Resistor 47k 1/16W Metal Oxide
R1510	VRS-CZ1JF473JY	AA		J	Resistor 47k 1/16W Metal Oxide
R1512	VRS-CZ1JF103JY	AA		J	Resistor 10k 1/16W Metal Oxide
R1513	VRK-SB1FF101JY	AA		J	Resistor 100 1/32W Metal Composition
R1516	VRS-CZ1JF000JY	AA		J	Resistor 0 1/16W Metal Oxide
R1517	VRS-CZ1JF000JY	AA		J	Resistor 0 1/16W Metal Oxide
R1519	VRS-CZ1JF273JY	AA		J	Resistor 27k 1/16W Metal Oxide
R1520	VRS-CZ1JF000JY	AA		J	Resistor 0 1/16W Metal Oxide
R1521	VRS-CZ1JF000JY	AA		J	Resistor 0 1/16W Metal Oxide
R1552	VRS-TV1JD750JY	AA		J	Resistor 75 1/16W Metal Oxide

NO.	PARTS CODE	PRICE RANK	NEW MARK	PART DELIVERY	DESCRIPTION
[8] DUNTKE685FM31/FM33/FM32/FM34/FM36/FM37 (MAIN Unit)					
R1553	VRS-TV1JD750JY	AA		J	Resistor 75 1/16W Metal Oxide
R1554	VRS-TV1JD750JY	AA		J	Resistor 75 1/16W Metal Oxide
R1562	VRS-CZ1JF221JY	AA		J	Resistor 220 1/16W Metal Oxide
R1563	VRS-CZ1JF221JY	AA		J	Resistor 220 1/16W Metal Oxide
R1565	VRS-CZ1JF102JY	AA		J	Resistor 1k 1/16W Metal Oxide
R1566	VRK-SB1FF473JY	AB		J	Resistor 47k 1/32W Metal Composition
R1567	VRK-SB1FF100JY	AA		J	Resistor 10 1/32W Metal Composition
R1568	VRK-SA1JF100JY	AB		J	Resistor 10 1/16W Metal Composition
R1569	VRK-SB1FF473JY	AB		J	Resistor 47k 1/32W Metal Composition
R1570	VRK-SA1JF100JY	AB		J	Resistor 10 1/16W Metal Composition
R1571	VRK-SB1FF100JY	AA		J	Resistor 10 1/32W Metal Composition
R1572	VRS-CZ1JF473JY	AA		J	Resistor 47k 1/16W Metal Oxide
R1593	VRK-SA1JF100JY	AB		J	Resistor 10 1/16W Metal Composition
R1604	VRK-SA1JF100JY	AB		J	Resistor 10 1/16W Metal Composition
R1607	VRK-SA1JF100JY	AB		J	Resistor 10 1/16W Metal Composition
R1609	VRK-SA1JF472JY	AA		J	Resistor 4.7k 1/16W Metal Composition
R1622	VRS-CZ1JF102JY	AA		J	Resistor 1k 1/16W Metal Oxide
R1801	VRS-CZ1JF472JY	AA		J	Resistor 4.7k 1/16W Metal Oxide
R1817	VRS-CZ1JF223JY	AA		J	Resistor 22k 1/16W Metal Oxide
R1819	VRS-CZ1JF473JY	AA		J	Resistor 47k 1/16W Metal Oxide
R1820	VRS-CZ1JF222JY	AA		J	Resistor 2.2k 1/16W Metal Oxide
R2001	VRS-CZ1JF101JY	AA		J	Resistor 100 1/16W Metal Oxide
R2002	VRS-CZ1JF100JY	AA		J	Resistor 10 1/16W Metal Oxide
R2003	VRS-CZ1JF102JY	AA		J	Resistor 1k 1/16W Metal Oxide
R2005	VRS-CJ1JF102JY	AA		J	Resistor 1k 1/16W Metal Oxide
R2006	VRS-CZ1JF472JY	AA		J	Resistor 4.7k 1/16W Metal Oxide
R2007	VRS-CZ1JF102JY	AA		J	Resistor 1k 1/16W Metal Oxide
R2008	VRS-CJ1JF333JY	AA		J	Resistor 33k 1/16W Metal Oxide
R2009	VRS-CZ1JF103JY	AA		J	Resistor 10k 1/16W Metal Oxide
R2010	VRS-CZ1JF101JY	AA		J	Resistor 100 1/16W Metal Oxide
R2011	VRS-CZ1JF101JY	AA		J	Resistor 100 1/16W Metal Oxide
R2012	VRS-CZ1JF103FY	AB		J	Resistor 10k 1/16W Metal Oxide
R2013	VRS-CZ1JF104JY	AA		J	Resistor 100k 1/16W Metal Oxide
R2014	VRS-CZ1JF102JY	AA		J	Resistor 1k 1/16W Metal Oxide
R2015	VRS-CZ1JF393JY	AA		J	Resistor 39k 1/16W Metal Oxide
R2016	VRS-CZ1JF101JY	AA		J	Resistor 100 1/16W Metal Oxide
R2017	VRS-CZ1JF103JY	AA		J	Resistor 10k 1/16W Metal Oxide
R2018	VRS-CZ1JF101JY	AA		J	Resistor 100 1/16W Metal Oxide
R2019	VRS-CZ1JF104JY	AA		J	Resistor 100k 1/16W Metal Oxide
R2020	VRS-CZ1JF473JY	AA		J	Resistor 47k 1/16W Metal Oxide
R2022	VRS-CZ1JF103JY	AA		J	Resistor 10k 1/16W Metal Oxide
R2023	VRS-CZ1JF103JY	AA		J	Resistor 10k 1/16W Metal Oxide
R2024	VRS-CZ1JF223JY	AA		J	Resistor 22k 1/16W Metal Oxide
R2025	VRS-CZ1JF103JY	AA		J	Resistor 10k 1/16W Metal Oxide
R2026	VRS-CZ1JF103JY	AA		J	Resistor 10k 1/16W Metal Oxide
R2027	VRS-CZ1JF473JY	AA		J	Resistor 47k 1/16W Metal Oxide
R2028	VRS-CZ1JF103JY	AA		J	Resistor 10k 1/16W Metal Oxide
R2029	VRK-SB1FF101JY	AA		J	Resistor 100 1/32W Metal Composition
R2030	VRK-SA1JF100JY	AB		J	Resistor 10 1/16W Metal Composition
R2032	VRS-CZ1JF103JY	AA		J	Resistor 10k 1/16W Metal Oxide
R2033	VRS-CZ1JF103JY	AA		J	Resistor 10k 1/16W Metal Oxide
R2035	VRS-CZ1JF103JY	AA		J	Resistor 10k 1/16W Metal Oxide
R2039	VRS-CZ1JF106JY	AA		J	Resistor 10M 1/16W Metal Oxide
R2040	VRS-CZ1JF473JY	AA		J	Resistor 47k 1/16W Metal Oxide
R2041	VRS-CZ1JF272JY	AA		J	Resistor 2.7k 1/16W Metal Oxide
R2042	VRS-CZ1JF000JY	AA		J	Resistor 0 1/16W Metal Oxide
R2045	VRS-CZ1JF470JY	AA		J	Resistor 47 1/16W Metal Oxide
R2047	VRS-CZ1JF103JY	AA		J	Resistor 10k 1/16W Metal Oxide
R2048	VRS-CZ1JF103JY	AA		J	Resistor 10k 1/16W Metal Oxide
R2049	VRS-CZ1JF100JY	AA		J	Resistor 10 1/16W Metal Oxide
R2050	VRS-CZ1JF100JY	AA		J	Resistor 10 1/16W Metal Oxide
R2051	VRK-SA1JF100JY	AB		J	Resistor 10 1/16W Metal Composition
R2052	VRS-CZ1JF223JY	AA		J	Resistor 22k 1/16W Metal Oxide
R2054	VRS-CZ1JF223JY	AA		J	Resistor 22k 1/16W Metal Oxide
R2056	VRS-CZ1JF103JY	AA		J	Resistor 10k 1/16W Metal Oxide
R2057	VRS-CZ1JF103JY	AA		J	Resistor 10k 1/16W Metal Oxide
R2058	VRS-CZ1JF152JY	AA		J	Resistor 1.5k 1/16W Metal Oxide
R2059	VRS-CZ1JF100JY	AA		J	Resistor 10 1/16W Metal Oxide
R2060	VRS-CZ1JF103JY	AA		J	Resistor 10k 1/16W Metal Oxide
R2062	VRS-CZ1JF472JY	AA		J	Resistor 4.7k 1/16W Metal Oxide
R2064	VRS-CZ1JF103JY	AA		J	Resistor 10k 1/16W Metal Oxide
R2065	VRS-CZ1JF103JY	AA		J	Resistor 10k 1/16W Metal Oxide
R2066	VRS-CZ1JF103JY	AA		J	Resistor 10k 1/16W Metal Oxide
R2067	VRS-CZ1JF103JY	AA		J	Resistor 10k 1/16W Metal Oxide
R2068	VRK-SB1FF223JY	AA		J	Resistor 22k 1/32W Metal Composition
R2069	VRS-CZ1JF103JY	AA		J	Resistor 10k 1/16W Metal Oxide
R2070	VRS-CZ1JF223JY	AA		J	Resistor 22k 1/16W Metal Oxide
R2073	VRS-CZ1JF101JY	AA		J	Resistor 100 1/16W Metal Oxide
R2075	VRS-CZ1JF101JY	AA		J	Resistor 100 1/16W Metal Oxide
R2076	VRS-CZ1JF223JY	AA		J	Resistor 22k 1/16W Metal Oxide
R2078	VRS-CZ1JF103JY	AA		J	Resistor 10k 1/16W Metal Oxide
R2079	VRS-CZ1JF104JY	AA		J	Resistor 100k 1/16W Metal Oxide
R2080	VRS-TV1JD123JY	AA		R	Resistor 12k 1/16W Metal Oxide (LC-32/37D653E/D654E)
R2081	VRS-TV1JD822JY	AA		R	Resistor 8.2k 1/16W Metal Oxide (LC-32/37D653E/D654E)
R2082	VRS-TV1JD123JY	AA		R	Resistor 12k 1/16W Metal Oxide (LC-32/37D653E/D654E)

NO.	PARTS CODE	PRICE RANK	NEW MARK	PART DELIVERY	DESCRIPTION
[8] DUNTKE685FM31/FM33/FM32/FM34/FM36/FM37 (MAIN Unit)					
R2083	VRS-TV1JD822JY	AA		R	Resistor 8.2k 1/16W Metal Oxide (LC-32/37D653E/D654E)
R2402	VRS-CZ1JF470JY	AA		J	Resistor 47 1/16W Metal Oxide
R2405	VRS-CZ1JF103JY	AA		J	Resistor 10k 1/16W Metal Oxide
R2406	VRS-CZ1JF473JY	AA		J	Resistor 47k 1/16W Metal Oxide
R2407	VRK-SB1FF472JY	AA		J	Resistor 4.7k 1/32W Metal Composition
R2408	VRS-TV1JD101JY	AA		J	Resistor 100 1/10W Metal Oxide
R2409	VRS-TV1JD101JY	AA		J	Resistor 100 1/10W Metal Oxide
R2410	VRS-TV1JD101JY	AA		J	Resistor 100 1/10W Metal Oxide
R2417	VRS-CZ1JF000JY	AA		J	Resistor 0 1/16W Metal Oxide
R2428	VRS-CZ1JF473JY	AA		J	Resistor 47k 1/16W Metal Oxide
R2429	VRS-CZ1JF473JY	AA		J	Resistor 47k 1/16W Metal Oxide
R2601	VRS-CZ1JF470JY	AA		J	Resistor 47 1/16W Metal Oxide
R2602	VRS-CZ1JF472JY	AA		J	Resistor 4.7k 1/16W Metal Oxide
R2604	VRS-CZ1JF000JY	AA		J	Resistor 0 1/16W Metal Oxide
R2605	VRS-CZ1JF000JY	AA		J	Resistor 0 1/16W Metal Oxide
R2606	VRS-CZ1JF000JY	AA		J	Resistor 0 1/16W Metal Oxide
R2607	VRS-CZ1JF000JY	AA		J	Resistor 0 1/16W Metal Oxide
R2608	VRS-CZ1JF000JY	AA		J	Resistor 0 1/16W Metal Oxide
R2609	VRS-CZ1JF000JY	AA		J	Resistor 0 1/16W Metal Oxide
R2610	VRS-CZ1JF000JY	AA		J	Resistor 0 1/16W Metal Oxide
R2611	VRS-CZ1JF470JY	AA		J	Resistor 47 1/16W Metal Oxide
R2612	VRS-CZ1JF000JY	AA		J	Resistor 0 1/16W Metal Oxide
R2614	VRS-CZ1JF000JY	AA		J	Resistor 0 1/16W Metal Oxide
R2615	VRS-CZ1JF000JY	AA		J	Resistor 0 1/16W Metal Oxide
R2616	VRS-CZ1JF000JY	AA		J	Resistor 0 1/16W Metal Oxide
R2617	VRS-CZ1JF000JY	AA		J	Resistor 0 1/16W Metal Oxide
R2618	VRS-CZ1JF000JY	AA		J	Resistor 0 1/16W Metal Oxide
R4401	VRS-CZ1JF470JY	AA		J	Resistor 47 1/16W Metal Oxide
R4402	VRS-CZ1JF470JY	AA		J	Resistor 47 1/16W Metal Oxide
R4403	VRS-CZ1JF470JY	AA		J	Resistor 47 1/16W Metal Oxide
R4404	VRS-CZ1JF470JY	AA		J	Resistor 47 1/16W Metal Oxide
R4405	VRS-CZ1JF470JY	AA		J	Resistor 47 1/16W Metal Oxide
R4406	VRS-CZ1JF470JY	AA		J	Resistor 47 1/16W Metal Oxide
R4408	VRK-SB1FF470JY	AA		J	Resistor 47 1/32W Metal Composition
R4409	VRK-SB1FF470JY	AA		J	Resistor 47 1/32W Metal Composition
R4410	VRS-CZ1JF472JY	AA		J	Resistor 4.7k 1/16W Metal Oxide
R4411	VRS-CZ1JF470JY	AA		J	Resistor 47 1/16W Metal Oxide
R4412	VRS-CZ1JF472JY	AA		J	Resistor 4.7k 1/16W Metal Oxide
R4413	VRS-CJ1JF470JY	AA		J	Resistor 47 1/16W Metal Oxide
R4415	VRS-CZ1JF103JY	AA		J	Resistor 10k 1/16W Metal Oxide
R4416	VRK-SB1FF472JY	AA		J	Resistor 4.7k 1/32W Metal Composition
R4421	VRK-SB1FF470JY	AA		J	Resistor 47 1/32W Metal Composition
R4422	VRK-SB1FF470JY	AA		J	Resistor 47 1/32W Metal Composition
R4424	VRS-CZ1JF103JY	AA		J	Resistor 10k 1/16W Metal Oxide
R4425	VRS-CZ1JF103JY	AA		J	Resistor 10k 1/16W Metal Oxide
R4427	VRK-SB1FF470JY	AA		J	Resistor 47 1/32W Metal Composition
R4428	VRK-SB1FF470JY	AA		J	Resistor 47 1/32W Metal Composition
R4429	VRK-SB1FF470JY	AA		J	Resistor 47 1/32W Metal Composition
R4430	VRS-CZ1JF471JY	AA		J	Resistor 470 1/16W Metal Oxide
R4435	VRS-CZ1JF103JY	AA		J	Resistor 10k 1/16W Metal Oxide
R4436	VRS-CZ1JF103JY	AA		J	Resistor 10k 1/16W Metal Oxide
R4437	VRS-CZ1JF103JY	AA		J	Resistor 10k 1/16W Metal Oxide
R4441	VRS-CZ1JF103JY	AA		J	Resistor 10k 1/16W Metal Oxide
R4443	VRS-CZ1JF470JY	AA		J	Resistor 47 1/16W Metal Oxide
R4468	VRS-CZ1JF103JY	AA		J	Resistor 10k 1/16W Metal Oxide
R4476	VRS-CZ1JF103JY	AA		J	Resistor 10k 1/16W Metal Oxide
R4478	VRS-CZ1JF103JY	AA		J	Resistor 10k 1/16W Metal Oxide
R4482	VRS-CZ1JF103JY	AA		J	Resistor 10k 1/16W Metal Oxide
R4484	VRS-CZ1JF103JY	AA		J	Resistor 10k 1/16W Metal Oxide
R4486	VRS-CZ1JF103JY	AA		J	Resistor 10k 1/16W Metal Oxide
R5302	VRS-CZ1JF102JY	AA		J	Resistor 1k 1/16W Metal Oxide
R5303	VRS-CZ1JF103JY	AA		J	Resistor 10k 1/16W Metal Oxide
R5308	VRK-SA1JF100JY	AB		J	Resistor 10 1/16W Metal Composition
R5309	VRS-CZ1JF562FY	AA		J	Resistor 5.6k 1/16W Metal Oxide
R5313	VRS-CZ1JF273FY	AA		J	Resistor 27k 1/16W Metal Oxide
R5344	VRK-SA1JF100JY	AB		J	Resistor 10 1/16W Metal Composition
R5345	VRK-SA1JF472JY	AA		J	Resistor 4.7k 1/16W Metal Composition
R7508	VRS-CZ1JF000JY	AA		J	Resistor 0 1/16W Metal Oxide
R7509	VRS-CZ1JF000JY	AA		J	Resistor 0 1/16W Metal Oxide
R7511	VRK-SA1JF222JY	AB		J	Resistor 2.2k 1/16W Metal Composition
R7512	VRS-CZ1JF102JY	AA		J	Resistor 1k 1/16W Metal Oxide
R7518	VRS-CZ1JF103JY	AA		J	Resistor 10k 1/16W Metal Oxide
R7519	VRS-CZ1JF392JY	AA		J	Resistor 3.9k 1/16W Metal Oxide
R7521	VRS-CZ1JF331JY	AA		J	Resistor 330 1/16W Metal Oxide
R7522	VRS-CZ1JF151JY	AA		J	Resistor 150 1/16W Metal Oxide
R7523	VRS-CZ1JF682JY	AA		J	Resistor 6.8k 1/16W Metal Oxide
R7524	VRS-CJ1JF470JY	AA		J	Resistor 47 1/16W Metal Oxide
R7525	VRS-CZ1JF470JY	AA		J	Resistor 47 1/16W Metal Oxide
R7527	VRS-CZ1JF103JY	AA		J	Resistor 10k 1/16W Metal Oxide
R7530	VRS-CZ1JF103JY	AA		J	Resistor 10k 1/16W Metal Oxide
R7531	VRS-CZ1JF470JY	AA		J	Resistor 47 1/16W Metal Oxide
R7544	VRS-CZ1JF103JY	AA		J	Resistor 10k 1/16W Metal Oxide
R7547	VRS-CZ1JF470JY	AA		J	Resistor 47 1/16W Metal Oxide
R7548	VRS-CZ1JF470JY	AA		J	Resistor 47 1/16W Metal Oxide
R7553	VRS-CZ1JF470JY	AA		J	Resistor 47 1/16W Metal Oxide

NO.	PARTS CODE	PRICE RANK	NEW MARK	PART DELIVERY	DESCRIPTION
[8] DUNTKE685FM31/FM33/FM32/FM34/FM36/FM37 (MAIN Unit)					
R7555	VRS-CZ1JF103JY	AA		J	Resistor 10k 1/16W Metal Oxide
R7560	VRS-CZ1JF561JY	AA		J	Resistor 560 1/16W Metal Oxide
R7561	VRS-CZ1JF564JY	AB		J	Resistor 560k 1/16W Metal Oxide
R8101	VRS-CZ1JF470JY	AA		J	Resistor 47 1/16W Metal Oxide
R8102	VRS-CZ1JF101JY	AA		J	Resistor 100 1/16W Metal Oxide
R8103	VRS-CZ1JF470JY	AA		J	Resistor 47 1/16W Metal Oxide
R8104	VRS-CZ1JF470JY	AA		J	Resistor 47 1/16W Metal Oxide
R8105	VRS-CZ1JF470JY	AA		J	Resistor 47 1/16W Metal Oxide
R8106	VRS-CZ1JF470JY	AA		J	Resistor 47 1/16W Metal Oxide
R8107	VRS-CZ1JF470JY	AA		J	Resistor 47 1/16W Metal Oxide
R8108	VRK-SB1FF330JY	AA		J	Resistor 33 1/32W Metal Composition
R8117	VRS-CZ1JF472JY	AA		J	Resistor 4.7k 1/16W Metal Oxide
R8118	VRS-CZ1JF472JY	AA		J	Resistor 4.7k 1/16W Metal Oxide
R8119	VRS-CZ1JF472JY	AA		J	Resistor 4.7k 1/16W Metal Oxide
R8124	VRS-CZ1JF473JY	AA		J	Resistor 47k 1/16W Metal Oxide
R8125	VRS-CZ1JF000JY	AA		J	Resistor 0 1/16W Metal Oxide
R8126	VRS-CZ1JF183FY	AA		J	Resistor 18k 1/16W Metal Oxide
R8127	VRS-CZ1JF912FY	AA		J	Resistor 9.1k 1/16W Metal Oxide
R8130	VRS-CZ1JF105JY	AA		J	Resistor 1M 1/16W Metal Oxide
R8131	VRS-CZ1JF470JY	AA		J	Resistor 47 1/16W Metal Oxide
R8132	VRS-CZ1JF470JY	AA		J	Resistor 47 1/16W Metal Oxide
R8133	VRS-CZ1JF470JY	AA		J	Resistor 47 1/16W Metal Oxide
R8134	VRS-CZ1JF470JY	AA		J	Resistor 47 1/16W Metal Oxide
R8135	VRS-CZ1JF330JY	AA		J	Resistor 33 1/16W Metal Oxide
R8136	VRS-CZ1JF330JY	AA		J	Resistor 33 1/16W Metal Oxide
R8137	VRK-SB1FF330JY	AA		J	Resistor 33 1/32W Metal Composition
R8138	VRK-SB1FF330JY	AA		J	Resistor 33 1/32W Metal Composition
R8139	VRK-SB1FF330JY	AA		J	Resistor 33 1/32W Metal Composition
R8140	VRK-SB1FF330JY	AA		J	Resistor 33 1/32W Metal Composition
R8141	VRK-SB1FF330JY	AA		J	Resistor 33 1/32W Metal Composition
R8144	VRS-CZ1JF000JY	AA		J	Resistor 0 1/16W Metal Oxide
R8153	VRS-CZ1JF102FY	AA		J	Resistor 1k 1/16W Metal Oxide
R8154	VRS-CZ1JF102FY	AA		J	Resistor 1k 1/16W Metal Oxide
R8156	VRS-CZ1JF470JY	AA		J	Resistor 47 1/16W Metal Oxide
R8165	VRS-CZ1JF000JY	AA		J	Resistor 0 1/16W Metal Oxide
R8167	VRS-CZ1JF103JY	AA		J	Resistor 10k 1/16W Metal Oxide
R8170	VRS-CZ1JF470JY	AA		J	Resistor 47 1/16W Metal Oxide
R8171	VRS-CZ1JF470JY	AA		J	Resistor 47 1/16W Metal Oxide
R8172	VRS-CZ1JF470JY	AA		J	Resistor 47 1/16W Metal Oxide
R8179	VRS-CZ1JF103JY	AA		J	Resistor 10k 1/16W Metal Oxide
R8180	VRS-CZ1JF470JY	AA		J	Resistor 47 1/16W Metal Oxide
R8181	VRS-CZ1JF470JY	AA		J	Resistor 47 1/16W Metal Oxide
R8182	VRS-CZ1JF470JY	AA		J	Resistor 47 1/16W Metal Oxide
R8183	VRS-CZ1JF470JY	AA		J	Resistor 47 1/16W Metal Oxide
R8184	VRS-CZ1JF103JY	AA		J	Resistor 10k 1/16W Metal Oxide
R8185	VRS-CZ1JF103JY	AA		J	Resistor 10k 1/16W Metal Oxide
R8186	VRS-CZ1JF103JY	AA		J	Resistor 10k 1/16W Metal Oxide
R8187	VRS-CZ1JF103JY	AA		J	Resistor 10k 1/16W Metal Oxide
R8188	VRS-CZ1JF220JY	AA		J	Resistor 22 1/16W Metal Oxide
R8189	VRS-CZ1JF220JY	AA		J	Resistor 22 1/16W Metal Oxide
R8301	VRS-CZ1JF750JY	AA		J	Resistor 75 1/16W Metal Oxide
R8302	VRS-CZ1JF750JY	AA		J	Resistor 75 1/16W Metal Oxide
R8303	VRS-CZ1JF102FY	AA		J	Resistor 1k 1/16W Metal Oxide
R8304	VRS-CZ1JF102FY	AA		J	Resistor 1k 1/16W Metal Oxide
R8305	VRK-SB1FF000JY	AA		J	Resistor 0 1/32W Metal Composition
R8306	VRS-CZ1JF000JY	AA		J	Resistor 0 1/16W Metal Oxide
R8307	VRS-CZ1JF000JY	AA		J	Resistor 0 1/16W Metal Oxide
R8308	VRS-CZ1JF000JY	AA		J	Resistor 0 1/16W Metal Oxide
R8309	VRK-SB1FF000JY	AA		J	Resistor 0 1/32W Metal Composition
R8310	VRS-CZ1JF000JY	AA		J	Resistor 0 1/16W Metal Oxide
R8311	VRK-SB1FF000JY	AA		J	Resistor 0 1/32W Metal Composition
R8312	VRS-CZ1JF000JY	AA		J	Resistor 0 1/16W Metal Oxide
R8313	VRS-CZ1JF000JY	AA		J	Resistor 0 1/16W Metal Oxide
R8314	VRK-SB1FF000JY	AA		J	Resistor 0 1/32W Metal Composition
R8315	VRK-SB1FF000JY	AA		J	Resistor 0 1/32W Metal Composition
R8316	VRS-CZ1JF000JY	AA		J	Resistor 0 1/16W Metal Oxide
R8317	VRS-CZ1JF000JY	AA		J	Resistor 0 1/16W Metal Oxide
R8318	VRS-CZ1JF000JY	AA		J	Resistor 0 1/16W Metal Oxide
R8319	VRK-SB1FF000JY	AA		J	Resistor 0 1/32W Metal Composition
R8320	VRS-CZ1JF000JY	AA		J	Resistor 0 1/16W Metal Oxide
R8321	VRK-SB1FF000JY	AA		J	Resistor 0 1/32W Metal Composition
R8322	VRS-CZ1JF000JY	AA		J	Resistor 0 1/16W Metal Oxide
R8323	VRS-CZ1JF000JY	AA		J	Resistor 0 1/16W Metal Oxide
R8324	VRK-SB1FF000JY	AA		J	Resistor 0 1/32W Metal Composition
R8702	VRS-CZ1JF184JY	AA		J	Resistor 180k 1/16W Metal Oxide
R8712	VRS-CZ1JF682JY	AA		J	Resistor 6.8k 1/16W Metal Oxide
R8713	VRS-CZ1JF103JY	AA		J	Resistor 10k 1/16W Metal Oxide
R8718	VRK-SA1JF100JY	AB		J	Resistor 10 1/16W Metal Composition
R8722	VRS-CZ1JF102JY	AA		J	Resistor 1k 1/16W Metal Oxide
R8723	VRS-CZ1JF104JY	AA		J	Resistor 100k 1/16W Metal Oxide
R8729	VRS-CZ1JF680JY	AB		J	Resistor 68 1/16W Metal Oxide
R8731	VRS-CZ1JF000JY	AA		J	Resistor 0 1/16W Metal Oxide
R8732	VRS-CZ1JF101JY	AA		J	Resistor 100 1/16W Metal Oxide
R8733	VRS-CZ1JF680JY	AB		J	Resistor 68 1/16W Metal Oxide
R8734	VRS-CZ1JF680JY	AB		J	Resistor 68 1/16W Metal Oxide

NO.	PARTS CODE	PRICE RANK	NEW MARK	PART DELIVERY	DESCRIPTION
[8] DUNTKE685FM31/FM33/FM32/FM34/FM36/FM37 (MAIN Unit)					
R9101	VRK-SB1FF470JY	AA		J	Resistor 47 1/32W Metal Composition
R9102	VRK-SB1FF470JY	AA		J	Resistor 47 1/32W Metal Composition
R9103	VRK-SB1FF472JY	AA		J	Resistor 4.7k 1/32W Metal Composition
R9108	VRS-CZ1JF222JY	AA		J	Resistor 2.2k 1/16W Metal Oxide
R9109	VRS-CZ1JF222JY	AA		J	Resistor 2.2k 1/16W Metal Oxide
R9110	VRS-CZ1JF472JY	AA		J	Resistor 4.7k 1/16W Metal Oxide
R9114	VRS-CZ1JF472JY	AA		J	Resistor 4.7k 1/16W Metal Oxide
R9117	VRS-CZ1JF472JY	AA		J	Resistor 4.7k 1/16W Metal Oxide
R9134	VRS-CZ1JF472JY	AA		J	Resistor 4.7k 1/16W Metal Oxide
R9136	VRS-CZ1JF472JY	AA		J	Resistor 4.7k 1/16W Metal Oxide
R9137	VRS-CZ1JF472JY	AA		J	Resistor 4.7k 1/16W Metal Oxide
R9138	VRS-CZ1JF472JY	AA		J	Resistor 4.7k 1/16W Metal Oxide
R9139	VRS-CZ1JF472JY	AA		J	Resistor 4.7k 1/16W Metal Oxide
R9148	VRS-CZ1JF472JY	AA		J	Resistor 4.7k 1/16W Metal Oxide
R9151	VRS-CZ1JF472JY	AA		J	Resistor 4.7k 1/16W Metal Oxide
R9155	VRS-CZ1JF472JY	AA		J	Resistor 4.7k 1/16W Metal Oxide
R9158	VRS-CZ1JF472JY	AA		J	Resistor 4.7k 1/16W Metal Oxide
R9159	VRS-CZ1JF472JY	AA		J	Resistor 4.7k 1/16W Metal Oxide
R9301	VRK-SB1FF470JY	AA		J	Resistor 47 1/32W Metal Composition
R9302	VRK-SB1FF470JY	AA		J	Resistor 47 1/32W Metal Composition
R9303	VRK-SB1FF470JY	AA		J	Resistor 47 1/32W Metal Composition
R9304	VRK-SB1FF470JY	AA		J	Resistor 47 1/32W Metal Composition
R9305	VRK-SB1FF470JY	AA		J	Resistor 47 1/32W Metal Composition
R9306	VRS-CZ1JF470JY	AA		J	Resistor 47 1/16W Metal Oxide
R9307	VRK-SB1FF470JY	AA		J	Resistor 47 1/32W Metal Composition
R9308	VRK-SB1FF470JY	AA		J	Resistor 47 1/32W Metal Composition
R9309	VRK-SB1FF470JY	AA		J	Resistor 47 1/32W Metal Composition
R9310	VRK-SB1FF470JY	AA		J	Resistor 47 1/32W Metal Composition
R9311	VRK-SB1FF470JY	AA		J	Resistor 47 1/32W Metal Composition
R9320	VRS-CZ1JF103JY	AA		J	Resistor 10k 1/16W Metal Oxide
R9321	VRS-CZ1JF103JY	AA		J	Resistor 10k 1/16W Metal Oxide
R9322	VRS-CZ1JF103JY	AA		J	Resistor 10k 1/16W Metal Oxide
R9323	VRS-CZ1JF103JY	AA		J	Resistor 10k 1/16W Metal Oxide
R9330	VRS-CZ1JF103JY	AA		J	Resistor 10k 1/16W Metal Oxide
R9333	VRS-CZ1JF472JY	AA		J	Resistor 4.7k 1/16W Metal Oxide
R9335	VRS-CZ1JF103JY	AA		J	Resistor 10k 1/16W Metal Oxide
R9336	VRK-SA1JF222JY	AB		J	Resistor 2.2k 1/16W Metal Composition
R9338	VRK-SA1JF103JY	AB		J	Resistor 10k 1/16W Metal Composition
R9339	VRK-SA1JF000JY	AB		J	Resistor 0 1/16W Metal Composition
R9341	VRS-CZ1JF103JY	AA		J	Resistor 10k 1/16W Metal Oxide
R9344	VRK-SA1JF472JY	AA		J	Resistor 4.7k 1/16W Metal Composition
R9604	VRS-CZ1JF3R3JY	AA		J	Resistor 3.3 1/16W Metal Oxide
R9605	VRS-CZ1JF122JY	AA		J	Resistor 1.2k 1/16W Metal Oxide
R9607	VRS-CZ1JF3R3JY	AA		J	Resistor 3.3 1/16W Metal Oxide
R9609	VRS-CZ1JF101JY	AA		J	Resistor 100 1/16W Metal Oxide
R9610	VRS-CZ1JF103JY	AA		J	Resistor 10k 1/16W Metal Oxide
R9611	VRS-CZ1JF183FY	AA		J	Resistor 18k 1/16W Metal Oxide
R9612	VRS-CZ1JF752FY	AA		J	Resistor 7.5k 1/16W Metal Oxide
R9613	VRS-CZ1JF123JY	AA		J	Resistor 12k 1/16W Metal Oxide
R9616	VRS-CZ1JF133FY	AA		J	Resistor 13k 1/16W Metal Oxide
R9617	VRS-CZ1JF392FY	AA		J	Resistor 3.9k 1/16W Metal Oxide
R9618	VRS-CZ1JF472JY	AA		J	Resistor 4.7k 1/16W Metal Oxide
R9619	VRS-CZ1JF102JY	AA		J	Resistor 1k 1/16W Metal Oxide
R9620	VRS-CZ1JF101JY	AA		J	Resistor 100 1/16W Metal Oxide
R9621	VRS-CZ1JF333JY	AA		J	Resistor 33k 1/16W Metal Oxide
R9623	VRS-CZ1JF822FY	AA		J	Resistor 8.2k 1/16W Metal Oxide
R9625	VRS-CZ1JF433FY	AA		J	Resistor 43k 1/16W Metal Oxide
R9628	VRS-CZ1JF333JY	AA		J	Resistor 33k 1/16W Metal Oxide
R9630	VRS-CZ1JF101JY	AA		J	Resistor 100 1/16W Metal Oxide
R9632	VRS-CZ1JF332JY	AA		J	Resistor 3.3k 1/16W Metal Oxide
R9634	VRS-CZ1JF123FY	AA		J	Resistor 12k 1/16W Metal Oxide
R9635	VRS-CZ1JF163FY	AB		J	Resistor 16k 1/16W Metal Oxide
R9637	VRS-CZ1JF103JY	AA		J	Resistor 10k 1/16W Metal Oxide
R9638	VRS-CZ1JF101JY	AA		J	Resistor 100 1/16W Metal Oxide
R9639	VRS-CZ1JF101JY	AA		J	Resistor 100 1/16W Metal Oxide
R9643	VRS-CZ1JF101JY	AA		J	Resistor 100 1/16W Metal Oxide
R9644	VRS-CZ1JF101JY	AA		J	Resistor 100 1/16W Metal Oxide
R9645	VRS-CZ1JF103JY	AA		J	Resistor 10k 1/16W Metal Oxide
R9646	VRS-CZ1JF103JY	AA		J	Resistor 10k 1/16W Metal Oxide
R9647	VRS-CZ1JF103JY	AA		J	Resistor 10k 1/16W Metal Oxide
R9648	VRS-CZ1JF473JY	AA		J	Resistor 47k 1/16W Metal Oxide
R9649	VRS-CZ1JF103JY	AA		J	Resistor 10k 1/16W Metal Oxide
R9650	VRS-CZ1JF103JY	AA		J	Resistor 10k 1/16W Metal Oxide
R9651	VRS-CZ1JF102JY	AA		J	Resistor 1k 1/16W Metal Oxide
R9652	VRS-CZ1JF000JY	AA		J	Resistor 0 1/16W Metal Oxide (LC-46D653E/D654E)
R9653	VRS-CZ1JF000JY	AA		J	Resistor 0 1/16W Metal Oxide (LC-32/37D653E/D654E)
R9655	VRS-CZ1JF3R3JY	AA		J	Resistor 3.3 1/16W Metal Oxide
R9657	VRS-CZ1JF3R3JY	AA		J	Resistor 3.3 1/16W Metal Oxide
R9661	VRS-CZ1JF101JY	AA		J	Resistor 100 1/16W Metal Oxide
R9662	VRS-CZ1JF101JY	AA		J	Resistor 100 1/16W Metal Oxide
R9663	VRS-CZ1JF683JY	AA		J	Resistor 68k 1/16W Metal Oxide
R9664	VRS-CZ1JF153FY	AA		J	Resistor 15k 1/16W Metal Oxide
R9665	VRS-CZ1JF473FY	AA		J	Resistor 47k 1/16W Metal Oxide
RDA8101	PRDARA607WJFW	AL	N	R	Heat Sink
S2001	QSW-KA037WJZZY	AC	N	J	Switch MENU (LC-32/37D653E/D654E)

NO.	PARTS CODE	PRICE RANK	NEW MARK	PART DELIVERY	DESCRIPTION
[8] DUNTKE685FM31/FM33/FM32/FM34/FM36/FM37 (MAIN Unit)					
S2002	QSW-KA037WJZZY	AC	N	J	Switch VOL DOWN (LC-32/37D653E/D654E)
S2003	QSW-KA037WJZZY	AC	N	J	Switch VOL UP (LC-32/37D653E/D654E)
S2004	QSW-KA037WJZZY	AC	N	J	Switch INPUT (LC-32/37D653E/D654E)
S2005	QSW-KA037WJZZY	AC	N	J	Switch CH DOWN (LC-32/37D653E/D654E)
S2006	QSW-KA037WJZZY	AC	N	J	Switch CH UP (LC-32/37D653E/D654E)
S2007	QSW-KA037WJZZY	AC	N	J	Switch POWER (LC-32/37D653E/D654E)
SC501	QSOCZA161WJZZ	AG		J	Socket 21Pin (INPUT 2)
SC502	QSOCZA161WJZZ	AG		J	Socket 21Pin (INPUT 1)
SC1501	QSOCZA171WJZZY	AF		J	Socket 23Pin (HDMI 2/TMDS Input6)
△ SC1502	QSOCZA171WJZZY	AF		J	Socket 23Pin (HDMI 1/TMDS Input5)
SC1504	QSOCNA716WJZZ	AM		J	Socket 17Pin(Black)
SC2401	QSOCNA715WJZZ	AL		J	Socket 11Pin
SC2601	QCNCWA671WJQZY	AH		J	Plug 41Pin(LW)
SC4401	QSOCJA004WJZZQ	AV	N	J	Socket 68Pin
SC5301	QSOCZA072WJZZQ	AH		J	Socket 23Pin (HDMI 3/TMDS Input 7)
SC9301	QCNCWA562WJQZY	AF		J	Connector 60Pin(To PC Card)
TH2001	VHHM1103J03-1Y	AC		J	Thermistor
TU7501	RTUDAA019WJQZ	AZ		S	Tuner
VA8101	RH-VXA194WJZZY	AC		J	Varistor AVRL161A1R1NTB
VA8102	RH-VXA194WJZZY	AC		J	Varistor AVRL161A1R1NTB
X1301	RCRSCA086WJZZY	AG		J	Crystal 27MHz
X2001	RCRSC0032TAZZY	AG		J	Crystal, 32.768kHz
X7501	RCRSCA112WJZZY	AE		R	Crystal
X8102	RCRSCA174WJQZY	AG		J	Crystal
X8702	RCRSCA086WJZZY	AG		J	Crystal 27MHz
N	GCOVAC895WJ1A	AF	N	R	CI Coin Cover
N	PSPA3B313WJKZ	AC		J	Spacer (IC8101)
N	QEARPA318WJFW	AK	N	R	Earth Plate N (LC-32/37D653E/D654E)
N	XBPSN20P14JS0	AB		J	Screw, x2 (CARD SLOT)

[9] CABINET PARTS (LC-32D653E/D654E)

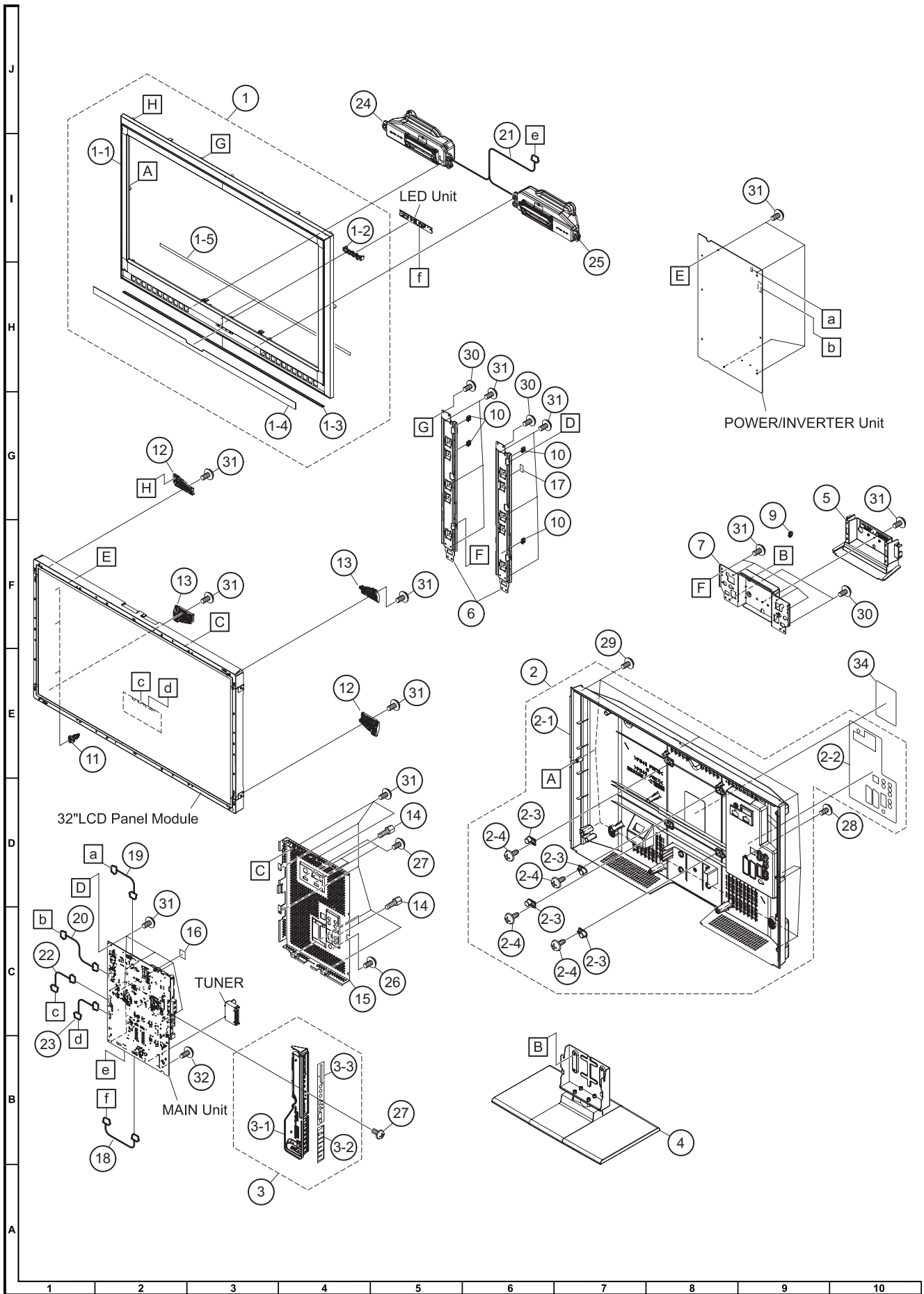

NO.	PARTS CODE	PRICE RANK	NEW MARK	PART DELIVERY	DESCRIPTION
[9] CABINET PARTS (LC-32D653E/D654E)					
1	CCABAC094WJ03		N	S	Front Cabinet Ass'y (LC-32D653E)
1	CCABAC094WJ01	BE	N	S	Front Cabinet Ass'y (LC-32D654E)
1-1	Not Available	-	N	-	Front Cabinet
1-2	HDECQA992WJ1A	AE	N	S	LED Decoration
1-3	HDECSA038WJ1A	AH	N	S	Shine Trim
1-4	HPNLSA195WJ1C		N	S	SP Sheet (LC-32D653E)
1-4	HPNLSA195WJ1A	AM	N	S	SP Sheet (LC-32D654E)
1-5	PSPAHB358WJZZ	AC		S	Mask Himelon (Bottom)
2	CCABBB333WJ01	BE	N	S	Rear Cabinet Ass'y
2-1	Not Available	-	N	-	Rear Cabinet
2-2	HINDPC866WJSA	AN	N	S	Terminal Label
2-3	LHLDZA929WJZZ	AD	N	S	VESA Holder, x4
2-4	XEBS930P08000	AA		J	Screw, x4 (VESA Holder)
3	CCOVAC892WJ01	AN	N	S	Control Cover Ass'y
3-1	Not Available	-	N	-	Control Cover
3-2	HINDPC867WJSA	AE	N	S	Control Label
3-3	HINDPC919WJSA	AE	N	S	SIDE AV Label
4	CDAI-A505WJ02		N	S	Stand Unit
5	GCOVAC893WJ1A	AM	N	S	Bottom Cover
6	LANGKB597WJFW	AM	N	S	Panel Support Angle, x2
7	LANGKB598WJFW	AN	N	S	Stand Angle
9	LHLDWA048WJKZ	AB		J	Wire Holder (SP Wire)
10	LHLDWA143WJKZ	AC		J	Wire Holder (Cable), x4
11	LHLDZA934WJKZ	AB	N	J	POWER PWB Holder, x3
12	LHLDZB147WJKZ	AD	N	S	LCD Holder A, x2
13	LHLDZB148WJKZ	AD	N	S	LCD Holder B, x2
14	NSFTZA237WJFN	AC		J	Screw, x4 (D-SUB)
15	PSLDMB475WJFW	AP	N	S	Full Shield
16	PSPAZB745WJKZ	AF		J	Spacer (30*25*t2.5)
17	PSPAZB864WJKZ	AG		J	Spacer (24*12*t5.0)
18	QCNW-H326WJQZ	AG	N	S	Connecting Cord (RA)
19	QCNW-H330WJQZ	AG	N	S	Connecting Cord (LB)
20	QCNW-H334WJQZ	AH		S	Connecting Cord (PD)
21	QCNW-H343WJQZ	AF	N	S	Connecting Cord (SP)
22	QCNW-H588WJQZ	AX	N	S	Connecting Cord (LW)
23	QCNW-H589WJQZ	AG	N	S	Connecting Cord (LP)
24	RSP-ZA351WJZZ	AR	N	S	Speaker (L)
25	RSP-ZA352WJZZ	AR	N	S	Speaker (R)
26	XBBS730P04000	AA		J	Screw (TUNER/SHIELD)
27	XBPS830P06000	AA		J	Screw, x3 (HDMI)
28	XEBS930P08000	AA		J	Screw (21pin)
29	XEBS940P16000	AB		J	Screw, x10 (CAB-B FIX)
30	XEBSN40P10000	AB		J	Screw, x4 (LCD-HOLDER FIX)
31	XHPS730P06WS0	AA		J	Screw, x33 (ANG/PWB)
32	XHPS730P10WS0	AA	N	S	Screw (MAIN PWB)
34	TLABNC117WJZZ	AC		S	Model Label

[10] LCD PANEL MODULE ASSEMBLY (LC-32D653E/D654E)

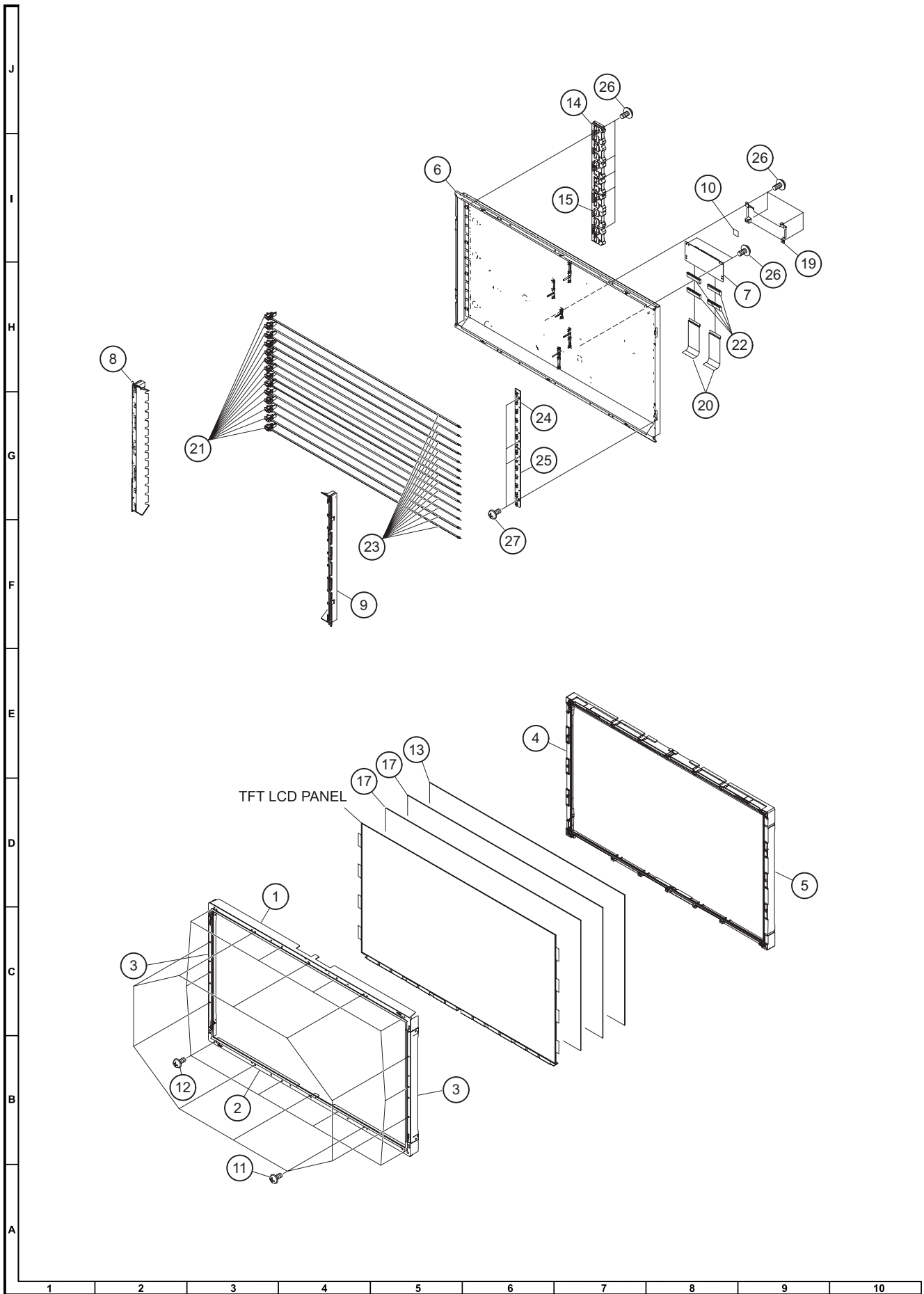

NO.	PARTS CODE	PRICE RANK	NEW MARK	PART DELIVERY	DESCRIPTION
[10] LCD PANEL MODULE ASSEMBLY (LC-32D653E/D654E)					
1	CANGK4055TP0E	AT		J	Bezel Ass'y (Top)
2	CANGK4055TP0D	AP		J	Bezel Ass'y (Bottom)
3	CANGK4054TP0A	AL		J	Bezel Ass'y, x2 (Left/Right)
4	CHLDZ3824TP04	AR		J	Panel Chassis Ass'y (Left)
5	CHLDZ3825TP04	AS		J	Panel Chassis Ass'y (Right)
6	CCHSMA477WJ01	BD		J	Back Light Chassis Ass'y
7	CPWBX4010TPZK			J	LCD Control PWB Unit
8	LHLDZB161WJKZ	AL		J	Lamp Holder (L)
9	LHLDZB162WJKZ	AL		J	Lamp Holder (R)
10	PSHEG0104TPZZ	AD		J	Cooling Sheet
11	LX-EZA028WJF9	AB		J	Screw, x6 (Panel Chassis)
12	LX-HZA039WJF7	AB		J	Screw, x10 (M3X18BL-Bezel)
13	PCOVUA132WJZZ	AX		J	Diffusion Plate
14	PCOVWA017WJKZ	AK		J	SJ Connector Cover
15	PCOVWA023WJKZ	AK		J	SJ Connector Cover 2
17	PSHEPA667WJZZ	AU		J	Lens Sheet, x2
19	PSLDMB419WJFW	AE		J	LCD Control PWB Cover
20	QPWBM0575TPZZ	AN		J	CS-FPC 80pin, x2
21	QSOCFA003WJZZ	AD		J	Lamp Socket, x14
22	RCORFA061WJZZ	AG		J	Ferrite Core, x4
23	RLMP-0663TPZZ	AS		J	Lamp Unit, x14
24	RUNTK3839TPZZ	AM		J	GND-PWB
25	RUNTK3840TPZZ	AM		J	GND-PWB
26	XHPS730P04WS0	AA		J	Screw, x11 (SJ COVER/CONT PWB)
27	XHPS730P08KS0	AB		J	Screw, x4 (M3X8 GND PWB)

[11] CABINET PARTS (LC-37D653E/D654E)

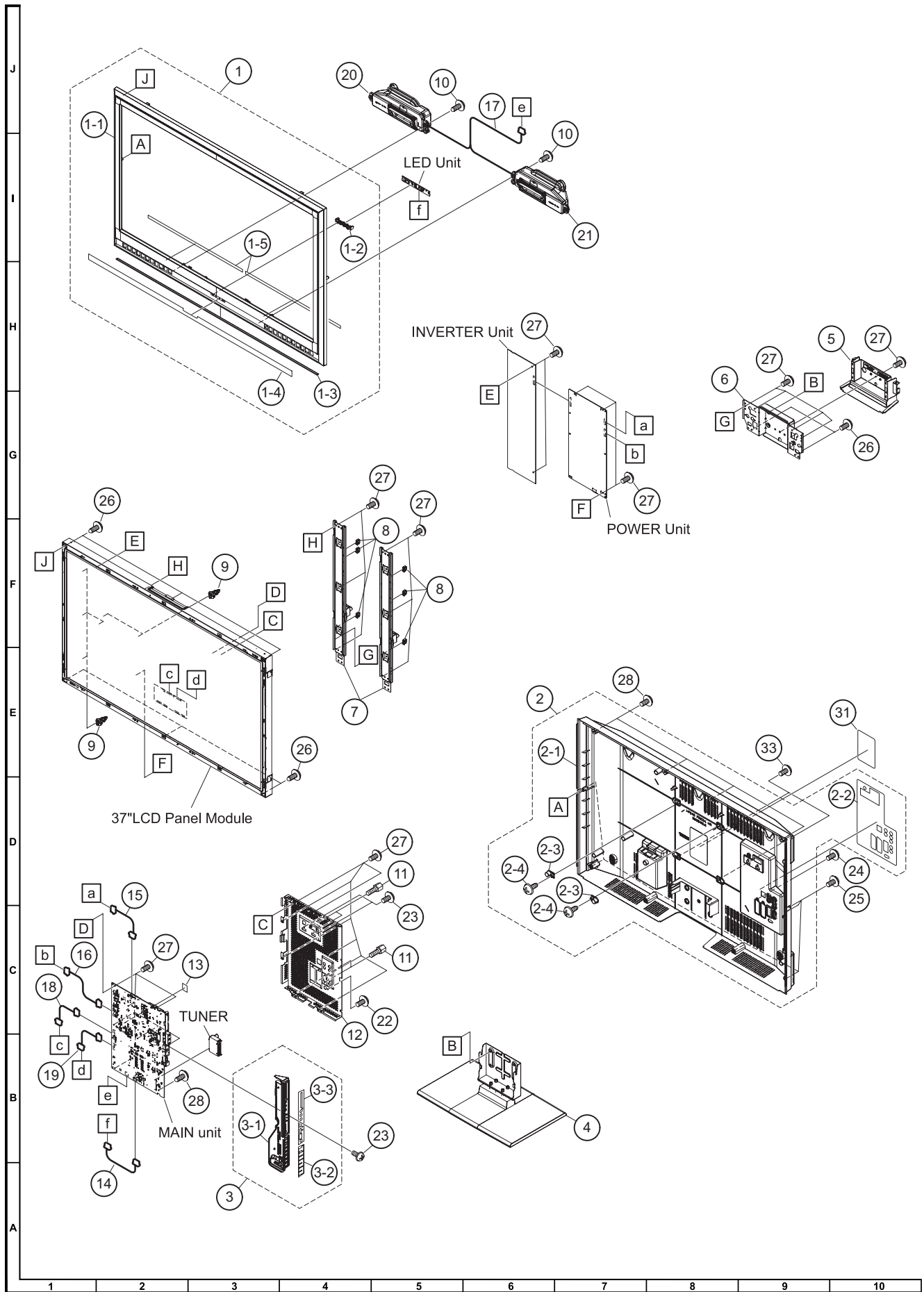

NO.	PARTS CODE	PRICE RANK	NEW MARK	PART DELIVERY	DESCRIPTION
[11] CABINET PARTS (LC-37D653E/D654E)					
1	CCABAC095WJ06		N	S	Front Cabinet Ass'y (LC-37D653E)
1	CCABAC095WJ04		N	S	Front Cabinet Ass'y (LC-37D654E)
1-1	Not Available	-	N	-	Front Cabinet
1-2	HDECQA992WJ1A	AE	N	S	LED Decoration
1-3	HDECSA039WJ1A	AK	N	S	Shine Trim
1-4	HPNLSA196WJ1C		N	S	SP Sheet (LC-37D653E)
1-4	HPNLSA196WJ1A	AN	N	S	SP Sheet (LC-37D654E)
1-5	PSPAHB408WJZZ	AB		S	Mask Himelon, x2
2	CCABBB334WJ02		N	S	Rear Cabinet Ass'y
2-1	Not Available	-	N	-	Rear Cabinet
2-2	HINDPC866WJSA	AN	N	S	Terminal Label
2-3	LHLDZA929WJZZ	AD	N	S	VESA Holder, x2
2-4	XEBS930P08000	AA		J	Screw, x2 (VESA Holder)
3	CCOVAC892WJ02		N	S	Control Cover Ass'y
3-1	Not Available	-	N	-	Control Cover
3-2	HINDPC867WJSA	AE	N	S	Control Label
3-3	HINDPC919WJSA	AE	N	S	SIDE AV Label
4	CDAI-A506WJ02		N	S	Stand Unit
5	GCOVAC893WJ1A	AM	N	S	Bottom Cover
6	LANGKB598WJFW	AN	N	S	Stand Angle
7	LANGKB599WJN0	AR	N	S	Panel Support Angle, x2
8	LHLDWA143WJKZ	AC		J	Wire Holder (Cable), x6
9	LHLDZA934WJKZ	AB	N	J	POWER PWB Holder, x6
10	LX-HZA003WJFN	AC		J	Screw, x2 (Speaker)
11	NSFTZA237WJFN	AC		J	Screw, x4 (D-SUB)
12	PSLDMB475WJFW	AP	N	S	Full Shield
13	PSPAZB745WJKZ	AF		J	Spacer (30*25*t2.5)
14	QCNW-H327WJQZ	AG	N	S	Connecting Cord (RA)
15	QCNW-H331WJQZ	AH	N	S	Connecting Cord (LB)
16	QCNW-H335WJQZ	AK		S	Connecting Cord (PD)
17	QCNW-H344WJQZ	AG	N	S	Connecting Cord (SP)
18	QCNW-H590WJQZ	AY	N	S	Connecting Cord (LW)
19	QCNW-H591WJQZ	AH	N	S	Connecting Cord (LP)
20	RSP-ZA351WJZZ	AR	N	S	Speaker (L)
21	RSP-ZA352WJZZ	AR	N	S	Speaker (R)
22	XBBS730P04000	AA		J	Screw (TUNER/SHIELD)
23	XBBS830P06000	AA		J	Screw, x3 (HDMI)
24	XEBS930P08000	AA		J	Screw, x1 (21 PIN)
25	XEBS940P16000	AB		J	Screw, x7 (CAB-B FIX)
26	XEBSN40P10000	AB		J	Screw, x9 (LCD-HOLDER FIX)
27	XHPS730P06WS0	AA		J	Screw, x29 (ANG/PWB FIX)
28	XHPS730P10WS0	AA	N	S	Screw, x5 (MAIN PWB1/CAB B4)
31	TLABNC117WJZZ	AC		S	Model Label
33	LX-BZA170WJF9	AB		S	Screw, x2 (CAB-B)

[12] LCD PANEL MODULE ASSEMBLY (LC-37D653E/D654E)

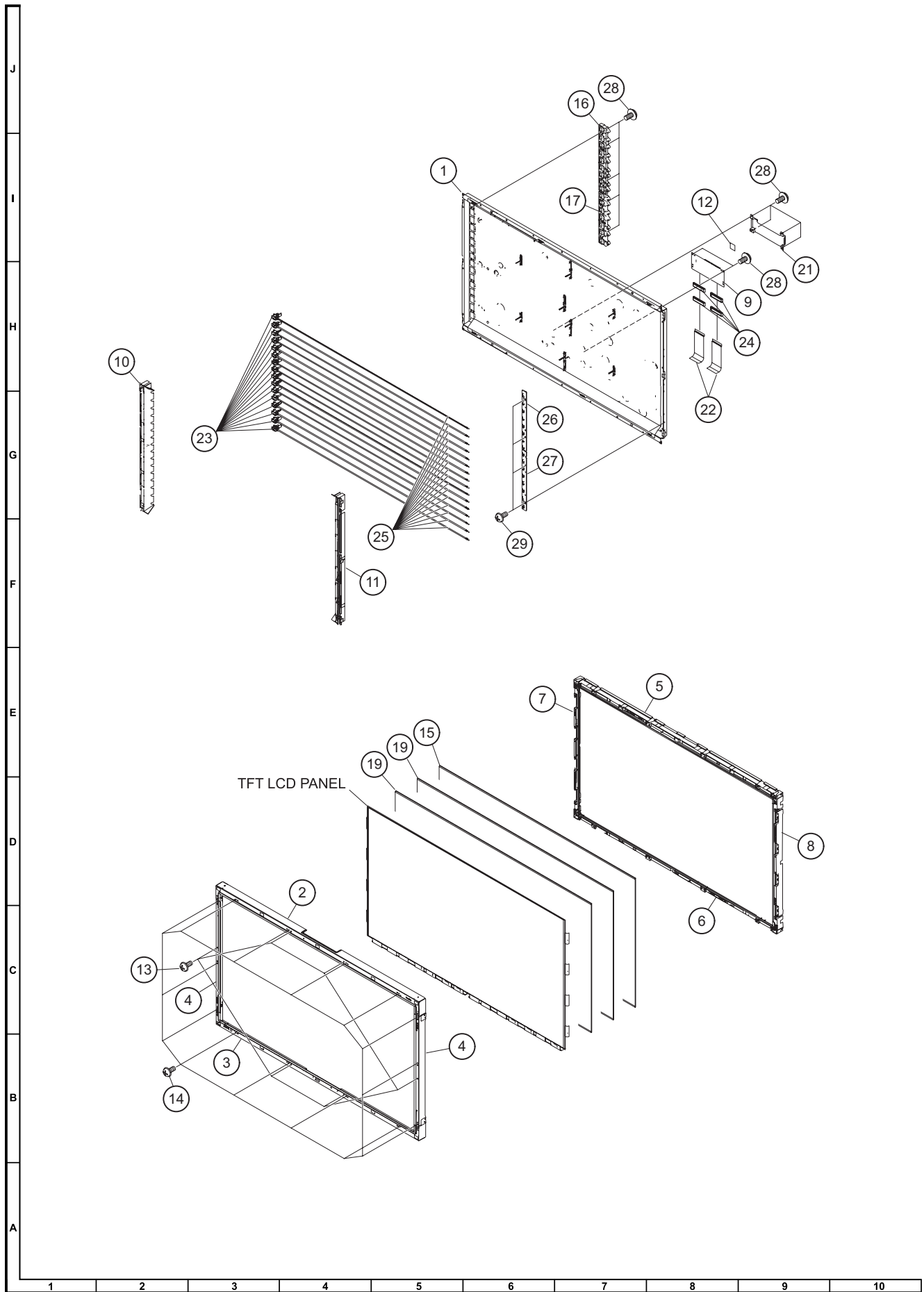

NO.	PARTS CODE	PRICE RANK	NEW MARK	PART DELIVERY	DESCRIPTION
[12] LCD PANEL MODULE ASSEMBLY (LC-37D653E/D654E)					
1	CCHSMA478WJ01	BG		J	Back Light Chassis Ass'y
2	CANGK4053TP02	AX		J	Bezel Ass'y (Top)
3	CANGK4053TP01	AS		J	Bezel Ass'y (Bottom)
4	CANGK4052TP01	AL		J	Bezel Ass'y, x2 (Left/Right)
5	CHLDZ3805TP03	AV		J	Panel Chassis Ass'y (Top)
6	CHLDZ3806TP03	AU		J	Panel Chassis Ass'y (Bottom)
7	CHLDZ3807TP03	AS		J	Panel Chassis Ass'y (Left)
8	CHLDZ3808TP03	AS		J	Panel Chassis Ass'y (Right)
9	CPWBX4010TPZB			J	LCD Control PWB Unit
10	LHLDZB166WJKZ	AL		J	Lamp Holder (L)
11	LHLDZB167WJKZ	AM		J	Lamp Holder (R)
12	PSHEG0104TPZZ	AD		J	Cooling Sheet
13	LX-EZA028WJF9	AB		J	Screw, x6 (Panel Chassis)
14	LX-HZA042WJF8	AB		J	Screw, x12 (M3X18BL-Bezel)
15	PCOVUA122WJZZ	BD		J	Diffusion Plate
16	PCOVWA018WJKZ	AM		J	SJ Connector Cover
17	PCOVWA024WJKZ	AK		J	SJ Connector Cover 2
19	PSHEPA691WJZZ	BC		J	Lens Sheet, x2
21	PSLDMB419WJFW	AE		J	LCD Control PWB Cover
22	QPWBM0575TPZZ	AN		J	CS-FPC 80pin, x2
23	QSOCFA003WJZZ	AD		J	Lamp Socket, x16
24	RCORFA061WJZZ	AG		J	Ferrite Core, x4
25	RLMP-0664TPZZ	AQ		J	Lamp Unit, x16
26	RUNTK3841TPZZ	AN		J	GND-PWB1
27	RUNTK3842TPZZ	AN		J	GND-PWB2
28	XHPS730P04WS0	AA		J	Screw, x11 (SJ COVER/CONT PWB)
29	XHPS730P08KS0	AB		J	Screw, x4 (M3X8 GND PWB)

[13] CABINET PARTS (LC-46D653E/D654E)

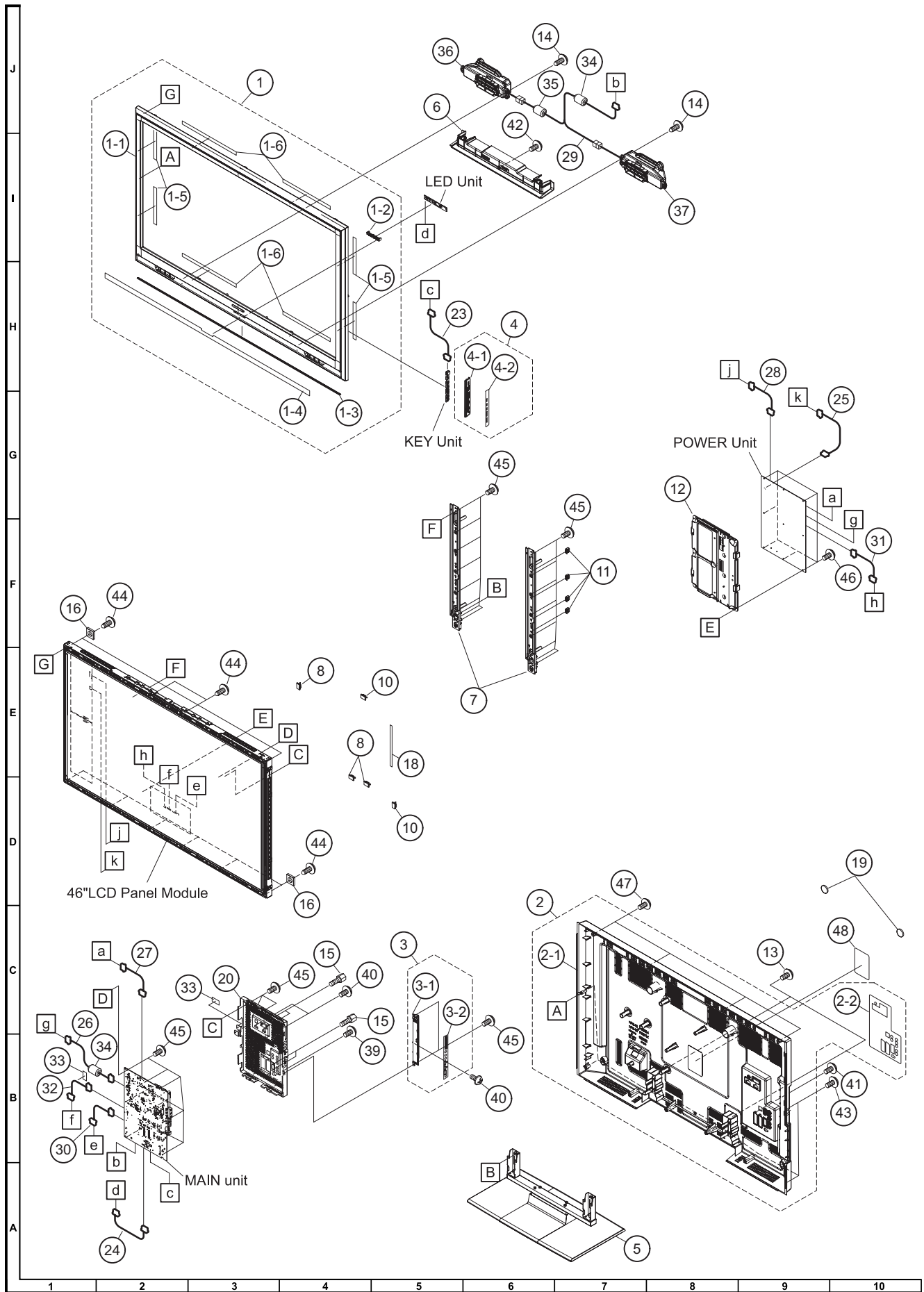



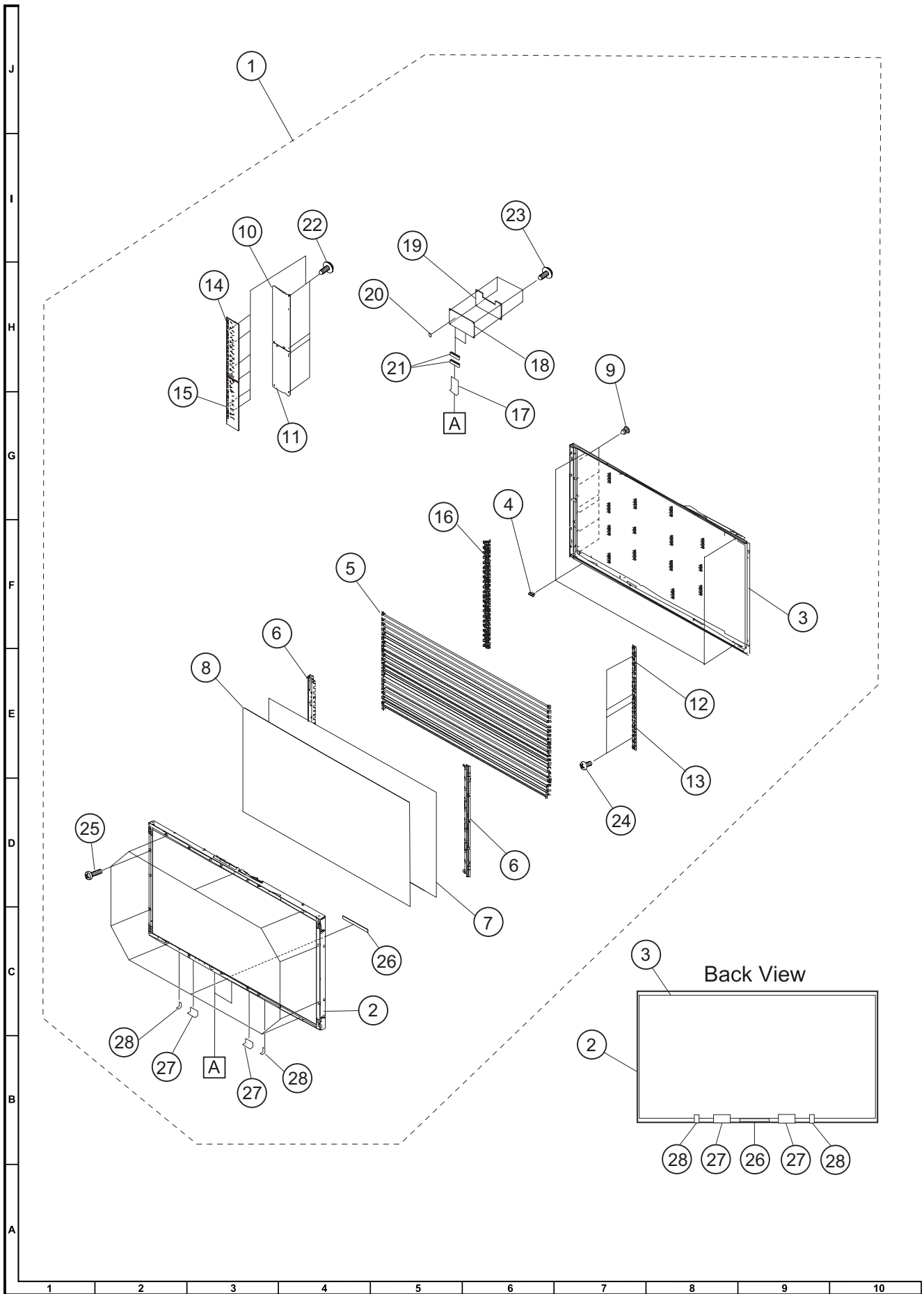

NO.	PARTS CODE	PRICE RANK	NEW MARK	PART DELIVERY	DESCRIPTION
[13] CABINET PARTS (LC-46D653E/D654E)					
1	CCABAC105WJ03		N	S	Front Cabinet Ass'y (LC-46D653E)
1	CCABAC105WJ01		N	S	Front Cabinet Ass'y (LC-46D654E)
1-1	Not Available	-	N	-	Front Cabinet
1-2	HDECQA992WJ1A	AE		S	LED Decoration
1-3	HDECSA040WJ1A	AK	N	S	Shine Trim
1-4	HPNLSA199WJ1C		N	S	SP Sheet (LC-46D653E)
1-4	HPNLSA199WJ1A	AQ	N	S	SP Sheet (LC-46D654E)
1-5	PSPAHB756WJZZ	AA		S	Spacer, x4
1-6	PSPAHB856WJZZ	AB	N	S	Spacer, x4
2	CCABBB343WJ02	BP	N	S	Rear Cabinet Ass'y
2-1	Not Available	-	N	-	Rear Cabinet
2-2	HINDPC866WJSA	AN		S	Terminal Label
3	CCOVAC891WJ03		N	S	Side AV Cover Ass'y
3-1	Not Available	-	N	-	Side AV Cover
3-2	HINDPD186WJSA		N	S	Side AV Label
4	CCOVAC952WJ02	AH	N	S	Control Cover Ass'y
4-1	Not Available	-	N	-	Control Cover
4-2	HINDPC965WJSA	AD	N	S	Control Label
5	CDAI-A507WJ02		N	S	Stand Unit
6	GCOVAC954WJ1A	AK	N	S	Bottom Cover
7	LANGKB776WJFW	AT	N	S	Panel Support Angle, x2
8	LHLDWA133WJKZ	AC		J	Wire Holder, x3
10	LHLDWA175WJUJZ	AC		J	Wire Holder, x2
11	LHLDWA255WJKZ	AF	N	S	Wire Holder, x3
12	LHLDZB230WJ1A	AM	N	S	POWER PWB Holder
13	LX-BZA170WJF9	AB		S	Screw, x2 (Rear Cabinet)
14	LX-HZA003WJFN	AC		J	Screw, x2 (Speaker)
15	NSFTZA237WJFN	AC		J	Screw, x4 (D-Sub)
16	PCUSGA079WJZZ	AB		S	Corner Lug, x6
18	PMLT-A578WJZZ	AE	N	S	10*1.0*185 RT
19	PSHEPA543WJZZ	AA		S	Diffusion Sheet, x2
20	PSLDMB480WJFW	AN	N	S	Full Shield
23	QCNW-H324WJQZ	AF	N	S	Connecting Cord (KM)
24	QCNW-H328WJQZ	AG	N	S	Connecting Cord (RA)
25	QCNW-H339WJQZ	AF	N	S	Connecting Cord (LA)
26	QCNW-H336WJQZ	AL	N	S	Connecting Cord (PD)
27	QCNW-H332WJQZ	AG	N	S	Connecting Cord (LB)
28	QCNW-H764WJQZ	AE	N	S	Connecting Cord (LB2)
29	QCNW-H345WJQZ	AH	N	S	Connecting Cord (SP)
30	QCNW-H753WJQZ	AF	N	S	Connecting Cord (LP)
31	QCNW-H697WJQZ	AE	N	S	Connecting Cord (PL)
32	QCNW-H755WJQZ	BA	N	S	Connecting Cord (LW)
33	QEARZA146WJZZ	AC	N	S	Electro conductive Tape, x2 (50*20 E05R)
34	RCORFA012WJZZ	AG		J	Core, x2 (PD, SP/RA)
35	RCORFA023WJZZ	AK		J	Core (LB, Lch)
36	RSP-ZA381WJZZ	AT	N	S	Speaker Lch
37	RSP-ZA382WJZZ	AT	N	S	Speaker Rch
39	XBBS730P04000	AA		J	Screw (TUNER/SHIELD)
40	XBBS830P06000	AA		J	Screw, x3 (HDMI SIDE)
41	XEBS930P08000	AA		J	Screw (21PIN)
42	XEBS930P10000	AA		J	Screw (Bottom Cover)
43	XEBS940P16000	AB		J	Screw, x8 (Rear Cabinet)
44	XEBSN40P10000	AB		J	Screw, x12 (LCD Holder)
45	XHPS730P06WS0	AA		J	Screw, x31 (PWB Etc)
46	XHPS730P10WS0	AA		S	Screw, 6
47	XHPS830P10WS0	AB		J	Screw, x4 (B-CAB up SI)
48	TLABNC117WJZZ	AC		S	Model Label

[14] LCD MODULE Assembly (LC-46D653E/D654E)

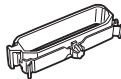

NO.	PARTS CODE	PRICE RANK	NEW MARK	PART DELIVERY	DESCRIPTION
[14] LCD MODULE Assembly (LC-46D653E/D654E)					
1	R1LK460D3LW6AY	EC	N	J	LCD Module Ass'y
2	Not Available	-	-	-	Bezel Ass'y
3	CCHSMA492WJ01	BP		J	BL Chassis Ass'y
4	LHLDZA963WJKZ	AB		J	Sheet Holder, x4
5	RLMPLA038WJN1	AR		J	Lamp, x20
6	LHLDZB235WJKZ	AK		J	Lamp Holder, x2
7	PCOVUA113WJZZ	BA		J	Diffusion Plate
8	PSHEPA811WJZZ	AY		J	Diffusion Sheet
9	LHLDZA979WJKZ	AC		J	Interver Spacer, x6
10	RUNTKA501WJZZ	BL		J	Inverter Unit
11	RUNTKA502WJZZ	BL		J	Inverter Unit
12	RUNTKA503WJZZ	AQ		J	GND-PWB
13	RUNTKA504WJZZ	AQ		J	GND-PWB
14	PCOVWA025WJKZ	AM		J	Cover
15	PCOVWA026WJKZ	AM		J	Cover
16	QSOCFA002WJZZ	AD		J	Socket, x20
17	QPWBM0584TPZZ	AH		J	CS-FPC, x2
18	CPWBX4010TPXC	BN		J	C-PWB (LCD Control Unit)
19	PCOVV2639TPZZ	AF		J	C-PWB Cover
20	PSHEG0104TPZZ	AD		J	Heat Radiation Sheet
21	RCORFA061WJZZ	AG		J	Ferrite Core, x4
22	XHPS830P06WS0	AA		J	Screw, x10 (for Inverter Unit x4, for Cover x6)
23	LX-HZA045WJF7	AB		J	Screw, x4 (for C-PWB)
24	LX-HZA046WJF7	AB		J	Screw, x4 (for GND-PWB)
25	LX-EZA028WJF9	AB		J	Screw, x16 (for fixing Bezel Ass'y and BL Chassis Ass'y)
26	PMLT-A579WJZZ	AN		J	Gasket
27	QEARZA148WJZZ	AG		J	Conductivity Cloth A, x2
28	QEARZA149WJZZ	AE		J	Conductivity Cloth B, x2

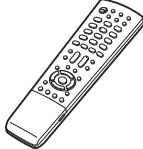
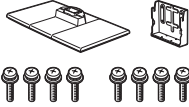
[15] SUPPLIED ACCESSORIES

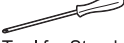
X1 Cable clamp 	X2 AC cord  PrStand unit oduct shape varies in some countries.	X3 Remote control unit 	X12 Stand Ass'y   Tool for Stand X12-1 
X4, X6 Operation manual			
X8 Warranty Card (U.K. and Ireland)			
X9 AQUOS Care Plan (U.K. and Ireland)		X13 CAUTION_CLASS_A	
X11 "AAA" size alkaline battery		X14 Errata Sheet	

NO.	PARTS CODE	PRICE RANK	NEW MARK	PART DELIVERY	DESCRIPTION
[15] SUPPLIED ACCESSORIES					
X1	LHLDWA173WJKZ	AE		J	Cable Clamp
X2	QACCKA004WJPZ	AM		J	AC Cord 2Pin (for EUROPE without U.K. and Ireland)
X2	QACCBAA054WJPZ	AN		S	AC Cord 3Pin (for U.K. and Ireland)
X3	RRMCGA586WJSA	AS		S	Remote Control unit
X4	TINS-D852WJZZ		N	S	Operation Manual (ENGLISH...) (LC-32/46D653E)
X4	TINS-D856WJZZ		N	S	Operation Manual (ENGLISH...) (LC-32/46D654E)
X4	TINS-D890WJZZ		N	P	Operation Manual (ENGLISH...) (LC-37D653E)
X4	TINS-D892WJZZ		N	P	Operation Manual (ENGLISH...) (LC-37D654E)
X6	TINS-D853WJZZ		N	S	Operation Manual (POLISH...) (LC-32/46D653E except for U.K. and Ireland)
X6	TINS-D857WJZZ		N	S	Operation Manual (POLISH...) (LC-32/46D654E except for U.K. and Ireland)
X6	TINS-D891WJZZ		N	P	Operation Manual (POLISH...) (LC-37D653E except for U.K. and Ireland)
X6	TINS-D893WJZZ		N	P	Operation Manual (POLISH...) (LC-37D654E except for U.K. and Ireland)
X8	TGAN-A801WJZZ	AD		S	Warranty Card (for U.K. and Ireland)
X9	TGAN-A802WJZZ	AD		S	AQUOS Care Plan (for U.K. and Ireland)
X11	Not Available	-		-	"AAA" size battery
X12	CDAi-A505WJ02		N	S	Stand Unit (LC-32D653E/D654E)
X12	CDAi-A506WJ02		N	P	Stand Ass'y (LC-37D653E/D654E)
X12	CDAi-A507WJ02		N	S	Stand Ass'y (LC-46D653E/D654E)
X12-1	Not Available	-		-	Tool for Stand
X13	TCAUZA354WJZZ	AB	N	S	CAUTION_CLASS_A (LC-32/46D653E/D654E)
X13	TCAUZA356WJN1		N	P	CAUTION_CLASS_A (LC-37D653E/D654E)
X14	TCAUHA441WJZZ		N	S	Errata Sheet

△
△

[16] PACKING PARTS (LC-32D653E/D654E)

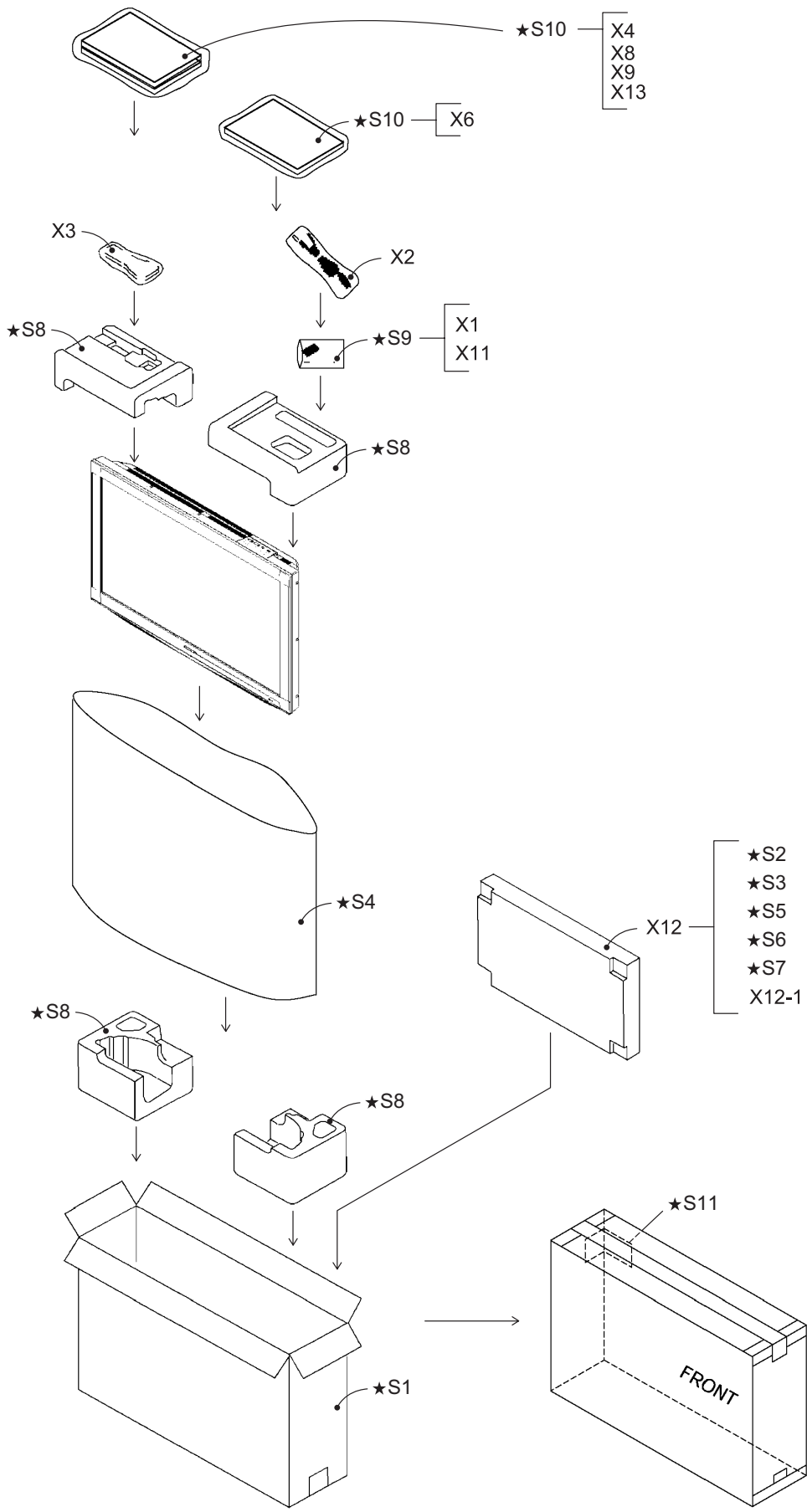

NO.	PARTS CODE	PRICE RANK	NEW MARK	PART DELIVERY	DESCRIPTION
[16] PACKING PARTS (LC-32D653E/D654E)					
S1	SPAKCE271WJZZ	-	N	-	Packing Case
S2	SPAKFB578WJZZ	-		-	Stand Case
S3	SPAKFB662WJZZ	-	N	-	Stand Pad
S4	SPAKPB238WJZZ	-		-	Wrapping Paper
S5	SPAKPB192WJZZ	-		-	Mirror Mat (Stand Base)
S6	SPAKPB053WJZZ	-		-	Mirror Mat (Stand Support)
S7	SPAKAA373WJZZ	-		-	Cover Sheet
S8	SPAKXC058WJZZ	-	N	-	Buffer Material (Top/Bottom)
S9	SSAKAA009WJZZ	-		-	Polyethylene bag
S10	SSAKAA111WJZZ	-		-	Polyethylene bag
S11	TLABM5584BMZZ	-		-	Case No. Label

[17] PACKING PARTS (LC-37D653E/D654E)

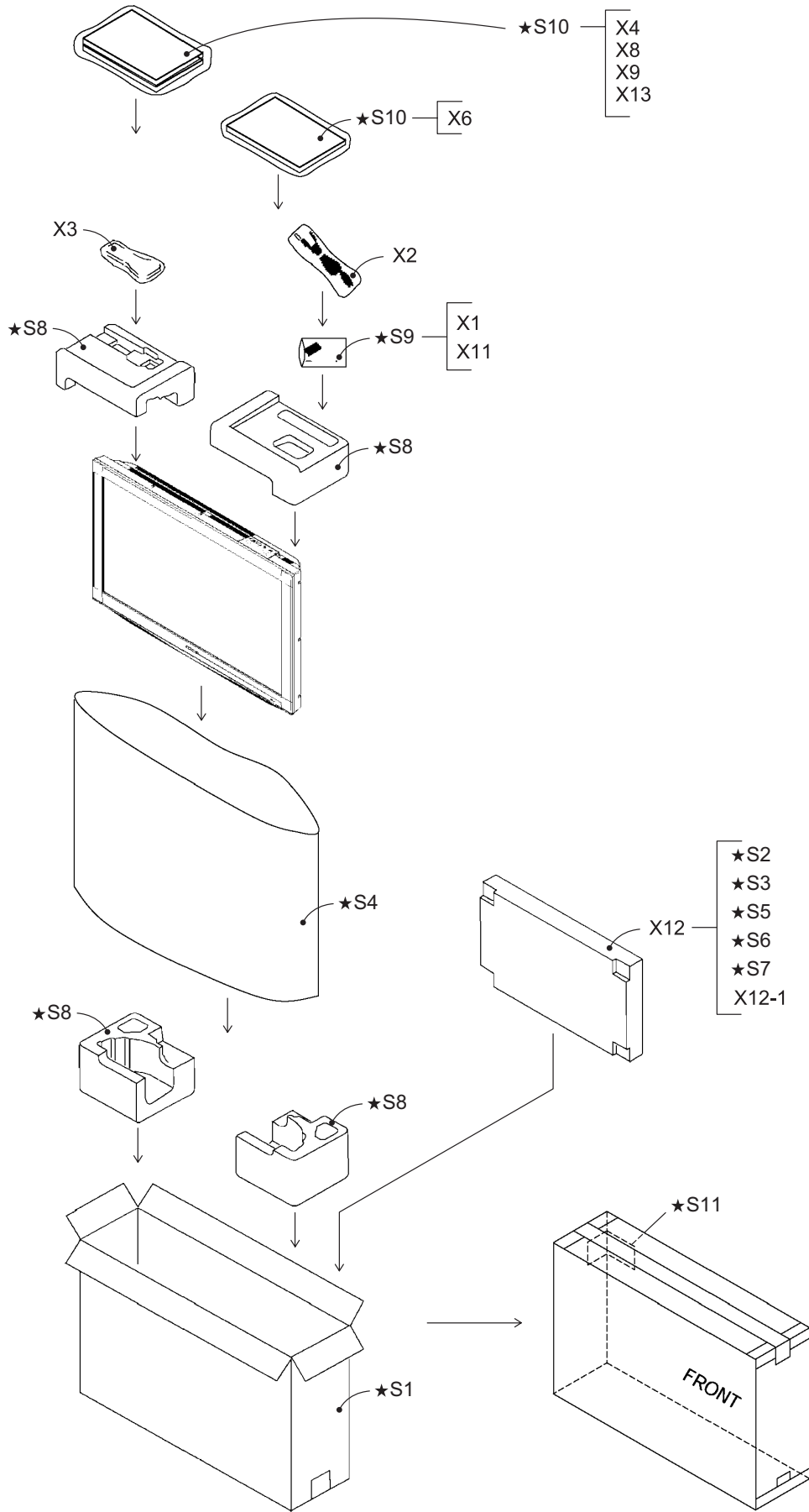

★ Not Replacement item

NO.	PARTS CODE	PRICE RANK	NEW MARK	PART DELIVERY	DESCRIPTION
[17] PACKING PARTS (LC-37D653E/D654E)					
S1	SPAKCE523WJZZ	-	N	-	Packing Case
S2	SPAKFB580WJZZ	-		-	Stand Case
S3	SPAKFB663WJZZ	-	N	-	Stand Pad
S4	SPAKPA338WJZZ	-		-	Wrapping Paper
S5	SPAKPB192WJZZ	-		-	Mirror Mat (Stand Base)
S6	SPAKPB053WJZZ	-		-	Mirror Mat (Stand Support)
S7	SPAKAA373WJZZ	-		-	Cover Sheet
S8	SPAKXC192WJZZ	-	N	-	Buffer Material (Top/Bottom)
S9	SSAKAA009WJZZ	-		-	Polyethylene bag
S10	SSAKAA111WJZZ	-		-	Polyethylene bag
S11	TLABM5584BMZZ	-		-	Case No. Label

NO.	PARTS CODE	PRICE RANK	NEW MARK	PART DELIVERY	DESCRIPTION
[18] PACKING PARTS (LC-46D653E/D654E)					
S1	SPAKCE399WJZZ	-	N	-	Packing Case (Main)
S2	SPAKCE382WJZZ	-	N	-	Packing Case (Bottom)
S3	SPAKFB583WJZZ	-	N	-	Stand Case
S4	SPAKFB666WJZZ	-	N	-	Stand Pad
S5	SPAKPA711WJZZ	-	-	-	Wrapping Paper
S6	SPAKPA780WJZZ	-	N	-	Mirror Mat Base
S7	SPAKPA904WJZZ	-	-	-	Mirror Mat Support
S8	SPAKXC149WJZZ	-	N	-	Buffer Material (Top/Bottom)
S9	SPAKXC150WJZZ	-	N	-	Buffer Material (Top Center)
S10	SPAKXC151WJZZ	-	N	-	Buffer Material (Bottom Center)
S11	SSAKAA009WJZZ	-	-	-	Polyethylene Bag
S12	SSAKAA111WJZZ	-	-	-	Polyethylene Bag
S13	TLABM5584BMZZ	-	-	-	Case Label
[19] SERVICE JIGS					
N	QCNW-G616WJQZ	BK		J	Main-LCD Control (LW)
N	QCNW-H347WJQZ	AY		J	Main-LCD Control (LP)
N	QCNW-H348WJQZ	AW		J	MAIN-LED (RA)
N	QCNW-H185WJQZ	AV		J	MAIN-POWER (LB)
N	QCNW-H184WJQZ	AX		J	Main-Power (PD)
N	QCNW-G445WJQZ	AP		J	Main-Speaker (SP)
N	QCNW-H542WJZZ				POWER-INVERTER (B to B) (LC-37D653E/D654E)
N	QCNW-G440WJQZ	AP		J	Main-Key (KM) (LC-46D653E/D654E)
N	QCNW-G625WJQZ	AP		J	Main-Power (PL) (LC-46D653E/D654E)
N	QCNW-J014WJQZ				MAIN-POWER (LB1) (LC-46D653E/D654E)
N	QCNW-J015WJQZ				POWER-INVERTER (LB2) (LC-46D653E/D654E)
N	QCNW-J016WJQZ				POWER-INVERTER (LA) (LC-46D653E/D654E)

SHARP

COPYRIGHT © 2008 BY SHARP CORPORATION

ALL RIGHTS RESERVED.

No Part of this publication may be reproduced, stored in a retrieval system, or transmitted in any form or by any means, electronic, mechanical, photocopying, recording, or otherwise, without prior written permission of the publisher.