

LCD COLOUR TELEVISION

PAL_{B/G, I} / SECAM_{B/G, D/K, L/L'} SYSTEM COLOUR TELEVISION

MODELS



LC-32GD8_{EE/EF/EI/EK/RU}

LC-32BT8_{EE/EF/EI/EK/RU}

LC-37GD8_{EE/EF/EI/EK/RU}

LC-37BT8_{EE/EF/EI/EK/RU}

In the interests of user safety (required by safety regulations in some countries) the set should be restored to its original condition and only parts identical to those specified should be used.

CONTENTS

ELECTRICAL SPECIFICATIONS	3
IMPORTANT SERVICE SAFETY PRECAUTIONS.....	4
OPERATION MANUAL	6
DIMENSIONS	10
REMOVING OF MAJOR PARTS	11
SERVICE ADJUSTMENTS	15
SOFTWARE UPDATING	23
TROUBLESHOOTING TABLE	41
MAJOR ICs INFORMATION	58
SOURCE OF DOCUMENTATION	98
CHASSIS LAYOUT	99
OVERALL WIRING DIAGRAMS	105
BLOCK DIAGRAM	106
SCHEMATIC DIAGRAMS	108
PRINTED WIRING BOARDS	130
REPLACEMENT PARTS LIST	149
PACKING OF THE SET	168

ELECTRICAL SPECIFICATIONS

Item		32" LCD COLOUR TV, Model: LC-32GD8, LC-32BT8		37" LCD COLOUR TV, Model: LC-37GD8, LC-37BT8	
LCD panel		32" Advanced Super View & BLACK TFT LCD		37" Advanced Super View & BLACK TFT LCD	
Number of dots		3,147,264 dots (1366 × 768 × 3 dots)			
Video Colour System		PAL/SECAM/NTSC 3.58/NTSC 4.43/PAL 60			
TV Function	TV-Standard	Analogue	CCIR (B/G, I, D/K, L, L')		
		Digital	DVB-T (2K/8K OFDM)		
	Receiving Channel	VHF/UHF	E2-E69ch, F2-F10ch, I21-I69ch, IR A-IR Jch, (Digital: E5-E69ch)		
		CATV	Hyper-band, S1-S41ch		
	TV-Tuning System	Auto Preset 99 ch, Auto Label, Auto Sort			
STEREO/BILINGUAL		NICAM/A2			
Brightness		450 cd/m ²			
Backlight life		60,000 hours (at Backlight Standard position)			
Viewing angles		H : 176° V : 176°			
Audio amplifier		10W × 2			
Speaker		130 mm × 60 mm			
Terminals	Rear	Antenna input	UHF/VHF 75Ω Din type (Analogue & Digital)		
		RS-232C	9 pin MINI-DIN male connector		
		EXT 1	SCART (AV input, Y/C input, RGB input, TV output)		
		EXT 2	SCART (AV input/output, Y/C input, RGB input, AV Link)		
		EXT 3	S-VIDEO (Y/C input), RCA pin (AV input)		
		EXT 4	Ø 3.5 mm jack (Audio input), 15 pin mini D-sub (PC/Component)		
		EXT 5	HDMI, Ø 3.5 mm jack (Audio input)		
		C. I. (Common Interface)	EN50221, R206001		
		OUTPUT	RCA pin (Audio)		
		Headphones	Ø 3.5 mm jack (Audio output)		
OSD language		English/German/French/Italian/Spanish/Dutch/Swedish/Portuguese/Finnish/Turkish/Greek/Russian/Polish			
Power Requirement		AC 220-240 V, 50 Hz			
Power Consumption		136 W (0.9 W Standby) (Method IEC60107)		168 W (0.9 W Standby) (Method IEC60107)	
Weight		17 kg (Display only), 19 kg (Display with stand)		20.5 kg (Display only), 23 kg (Display with stand)	
Operating temperature		0°C to +40°C			

- As a part of policy of continuous improvement, SHARP reserves the right to make design and specification changes for product improvement without prior notice. The performance specification figures indicated are nominal values of production units. There may be some deviations from these values in individual units.

Cautions regarding use in high and low temperature environments

- When the unit is used in a low temperature space (e.g. room, office), the picture may leave trails or appear slightly delayed. This is not a malfunction, and the unit will recover when the temperature returns to normal.
 - Do not leave the unit in a hot or cold location. Also, do not leave the unit in a location exposed to direct sunlight or near a heater, as this may cause the cabinet to deform and the LCD panel to malfunction.
- Storage temperature: -20°C to +60°C.

IMPORTANT SERVICE SAFETY PRECAUTION

Service work should be performed only by qualified service technicians who are thoroughly familiar with all safety checks and the servicing guidelines which follow:

WARNING

1. For continued safety, no modification of any circuit should be attempted.
2. Disconnect AC power before servicing.

CAUTION: FOR CONTINUED PROTECTION AGAINST A RISK OF FIRE REPLACE ONLY WITH SAME TYPE
F701 (4A / 250 V)

BEFORE RETURNING THE RECEIVER (Fire & Shock Hazard)

Before returning the receiver to the user, perform the following safety checks:

1. Inspect all lead dress to make certain that leads are not pinched, and check that hardware is not lodged between the chassis and other metal parts in the receiver.
2. Inspect all protective devices such as non-metallic control knobs, insulation materials, cabinet backs, adjustment and compartment covers or shields, isolation resistor-capacitor networks, mechanical insulators, etc.
3. To be sure that no shock hazard exists, check for leakage current in the following manner.

- Plug the AC cord directly into a 220~240 volt AC outlet. (Do not use an isolation transformer for this test).
- Using two clip leads, connect a 1.5k ohm, 10 watt resistor paralleled by a 0.15 μ F capacitor in series with all exposed metal cabinet parts and a known earth ground, such as electrical conduit or electrical ground connected to an earth ground.
 - A true RMS reading multimeter should be used for this test, especially where the equipment uses a switch mode power supply which may result in very non-sinusoidal leakage current.
 - Connect the resistor connection to all exposed metal parts having a return to the chassis (antenna, metal cabinet, screw heads, knobs and control shafts, escutcheon, etc.) and measure the AC voltage drop across the resistor.

All checks must be repeated with the AC cord plug connection reversed. (If necessary, a nonpolarized adaptor plug must be used only for the purpose of completing these checks.)

Any reading of 1.05V peak (this corresponds to 0.7 mA. peak AC.) or more is excessive and indicates a potential shock hazard which must be corrected before returning the monitor to the owner.

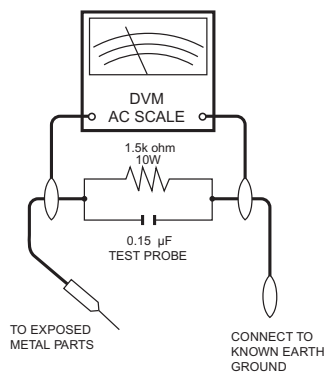

SAFETY NOTICE

Many electrical and mechanical parts in LCD television have special safety-related characteristics.

These characteristics are often not evident from visual inspection, nor can protection afforded by them be necessarily increased by using replacement components rated for higher voltage, wattage, etc.

Replacement parts which have these special safety characteristics are identified in this manual; electrical components having such features are identified by “ \triangle ”.

For continued protection, replacement parts must be identical to those used in the original circuit.

The use of a substitute replacement parts which do not have the same safety characteristics as the factory recommended replacement parts shown in this service manual, may create shock, fire or other hazards.

PRECAUTIONS FOR USING LEAD-FREE SOLDER

1 Employing lead-free solder

“ALL PWB” of this model employs lead-free solder. The LF symbol indicates lead-free solder, and is attached on the PWBs and service manuals. The alphabetical character following LF shows the type of lead-free solder.

Example:

LFa
Sn-Ag-Cu Indicates lead-free solder of tin, silver and copper.

In the case of LC-37GD8 and LC-37BT8, for the Inverter PWB Units the type used is nickel, so they are marked as LFn:

LFn
Sn-Ag-Ni Indicates lead-free solder of tin, silver and nickel.

2 Using lead-free wire solder

When fixing the PWB soldered with the lead-free solder, apply lead-free wire solder. Repairing with conventional lead wire solder may cause damage or accident due to cracks.

As the melting point of lead-free solder (Sn-Ag-Cu) is higher than the lead wire solder by 40°C, we recommend you to use a dedicated soldering bit, if you are not familiar with how to obtain lead-free wire solder or soldering bit, contact our service station or service branch in your area.

3 Soldering

As the melting point of lead-free solder (Sn-Ag-Cu) is about 220°C which is higher than the conventional lead solder by 40°C, and as it has poor solder wettability, you may be apt to keep the soldering bit in contact with the PWB for extended period of time. However, Since the land may be peeled off or the maximum heat-resistance temperature of parts may be exceeded, remove the bit from the PWB as soon as you confirm the steady soldering condition.

Lead-free solder contains more tin, and the end of the soldering bit may be easily corroded. Make sure to turn on and off the power of the bit as required.

If a different type of solder stays on the tip of the soldering bit, it is alloyed with lead-free solder. Clean the bit after every use of it.

When the tip of the soldering bit is blackened during use, file it with steel wool or fine sandpaper.

Be careful when replacing parts with polarity indication on the PWB silk.

Lead-free wire solder for servicing.

Part No.	★	Description	Code
ZHNDai123250E	J	φ0.3mm 250g(1roll)	BL
ZHNDai126500E	J	φ0.6mm 500g(1roll)	BK
ZHNDai12801KE	J	φ1.0mm 1kg(1roll)	BM

OPERATION MANUAL

Quick guide

Remote control unit

- 1 **(Standby/On)**
Enter standby mode or turn on the power. (See page 8.)
- 2 **(Teletext)**
Select the TELETEXT mode, (all TV image, DTV/DATA image, all TEXT image, TV/TEXT image) (See pages 21 and 31.)
- 3 **(Reveal hidden Teletext)**
Select DTV data broadcasting and TELETEXT.
- 4 **(Subtitle for Teletext)**
External: To turn the subtitles on and off. (See page 21.)
DTV: Display the subtitle selection screen. (See page 31.)
- 5 **(Freeze/Hold)**
(See page 21.)
- 6 **(Subpage)**
(See page 21.)
- 7 **0-9**
Set the channel in TV and DTV mode. Set the page in Teletext mode.
- 8 **(Flashback)**
Press to return to the previous image in normal viewing mode. (Will not work while operating in EPG/ESG screen.)
- 9 **DTV**
Press to access DTV mode while watching other input sources, and vice versa.
(This button will not work if you were watching DTV immediately before turning off the TV. In this case first select any other input source except DTV using the **(Input)** button.)
- 10 **(Sound mode)**
Select the sound multiplex mode. (See below.)
- 11 **(Mute)**
Switch the sound on and off.
- 12 **(+/-) (Volume)**
(+) Increase the volume.
(-) Decrease the volume.
- 13 **LIST**
Display the programme list.
- 14 **DTV MENU**
Display DTV Menu screen.
- 15 **END**
Exit the menu screen.

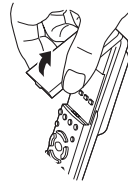
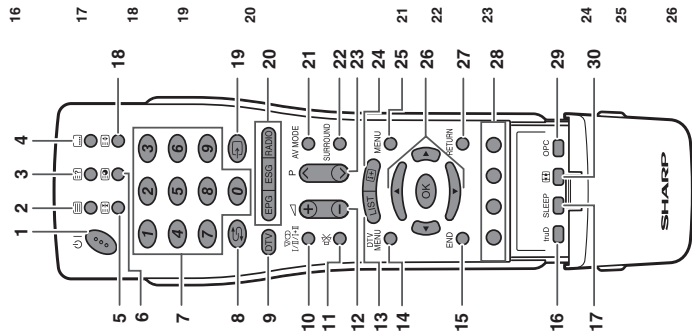

Using on the remote control unit

DTV mode:
Press **DTV** to open the multi audio screen. (See page 31.)

Analogue TV mode:
Each time you press **DTV**, the mode switches as illustrated in the following tables.

NICAM TV broadcasts selection

Signal	Selectable items
Stereo	NICAM STEREO, MONO
Bilingual	NICAM CH A, NICAM CH B, NICAM CH AB, MONO
Monaural	NICAM MONO, MONO

A2 TV broadcasts selection

Signal	Selectable items
Stereo	STEREO, MONO
Bilingual	CH A, CH B, CH AB
Monaural	MONO

NOTE

- When no signal is input, the sound mode will display "MONO".

Quick guide

TV (Front view)

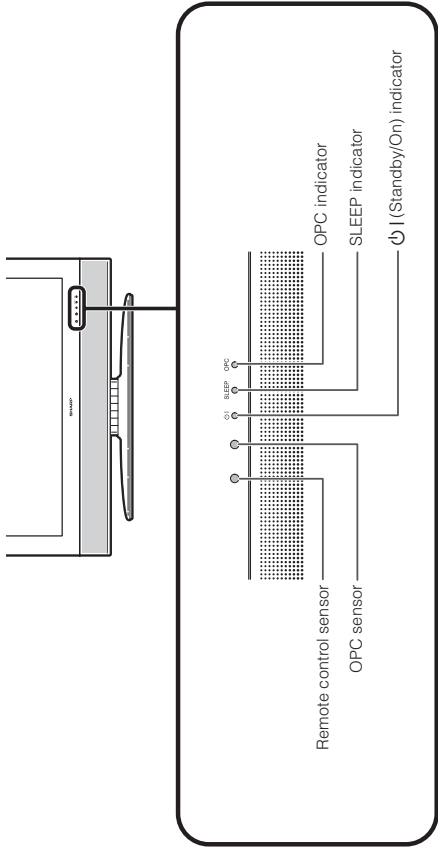

TV (Rear view)

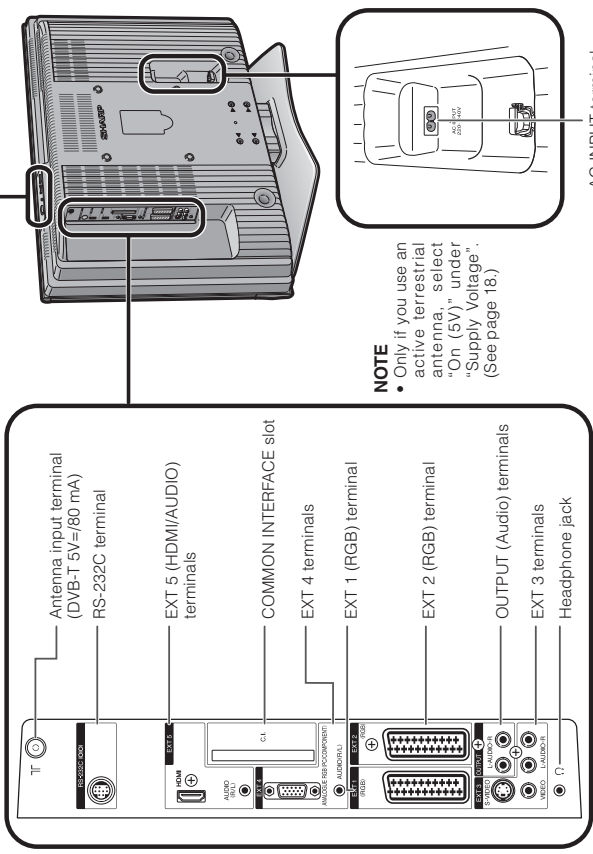
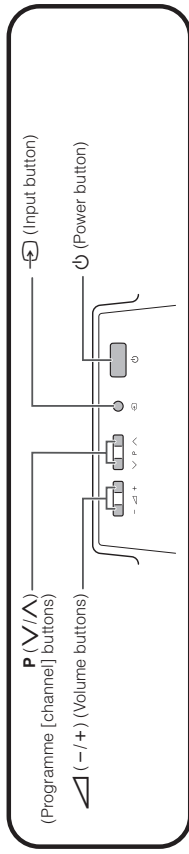

- 16 **truD**
This button is not available in case of using LC-32/37GD8E/BT8E models.
- 17 **SLEEP**
Set the sleep timer in units of 30 min. up to max. 2hr. 30min.
- 18 **(Top/Bottom/Full)**
Set the area of magnification in Teletext mode. (See page 21.)
- 19 **(INPUT SOURCE)**
Select an input source. (TV, DTV, EXT1, EXT2, EXT3, EXT4, EXT5) (See page 9.)
- 20 **EPG**
DTV: To display EPG. (Electronic Programme Guide) screen.
- 21 **ESG**
DTV: To display ESG. (Electronic Service Guide) screen.
- 22 **RADIO**
DTV: Switch between RADIO and DTV mode.
- 23 **AV MODE**
Select a video setting. (See page 13.)
- 24 **SURROUND**
Switch the surround effects on and off.
- 25 **P (V/A)**
TV/DTV: Select the channel. External: Switch to TV or DTV input mode.
Teletext: Move to the next/previous page.
- 26 **(Display information)**
(See pages 21, 29 and 30.)
- 27 **MENU**
Display the MENU screen. (See page 11.)
- 28 **(Cursor)**
Select a desired item on the setting screen.
- 29 **OK**
Execute a command within the menu screen. Display the programme list.
- 30 **RETURN**
Return to the previous menu screen.
- 31 **Colour (Red/Green/Yellow/Blue)**
TELETEXT: Select a page. (See page 21.)
DTV: The coloured buttons are used to select correspondingly to the coloured items in the menu screen.
- 32 **OPC**
To switch the Optical Picture Control on and off. (See page 13.)
- 33 **(WIDE MODE)**
Select the wide mode. (See page 20.)

NOTE
• Only if you use an active terrestrial antenna, select "On (5V)" under "Supply Voltage". (See page 18.)

Operation Manual (Continued)

Using external equipment

Setting the input source

To view external source images, select the input source using  on the remote control unit or TV.

NOTE

- The cables marked with * are commercially available items.

Connecting a VCR

You can use the EXT 1 or 2 terminals when connecting a VCR and other audiovisual equipment. If your VCR supports TV-VCR advanced AV Link systems, you can connect the VCR to the EXT 2 terminal of the TV using the fully-wired SCART cable.

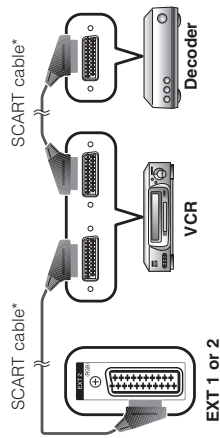

EXT 1 or 2

NOTE

- TV-VCR advanced AV Link systems may not be compatible with some external sources.
- TV-OUT from EXT 1 is not outputted when EXT 5 (HDMI) or DTV is selected as the input.

Connecting a game console or camcorder

A game console, camcorder and some other audiovisual equipment are conveniently connected using the EXT 3 terminals.

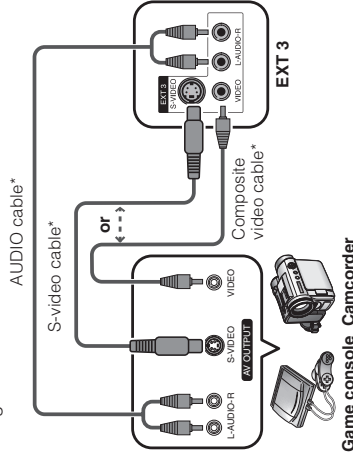

Game console Camcorder

NOTE

- EXT 3: The S-VIDEO terminal has priority over the VIDEO terminals.

Connecting a DVD player

You can use the EXT 2, 3, 4 or 5 (HDMI) terminals when connecting to a DVD player and other audiovisual equipment.

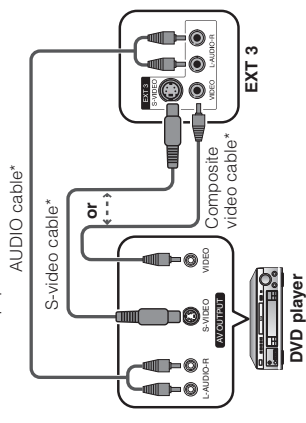

DVD player

NOTE

- EXT 3: The S-VIDEO terminal has priority over the VIDEO terminals.

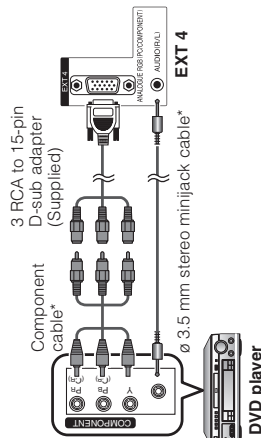

DVD player

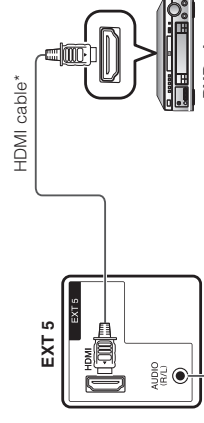

DVD player

When using an HDMI-DVI conversion adapter/cable, input the Audio signal here.

NOTE

- When connecting an HDMI-DVI conversion adapter/cable to the HDMI terminal, the image may not come in clearly.

Using external equipment

Connecting a decoder

You can use the EXT 1 terminal when connecting a decoder and other audiovisual equipment.

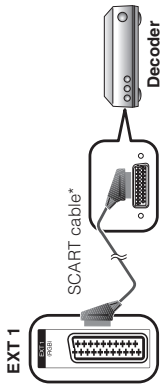

NOTE

- In cases when the decoder needs to receive signal from the TV, make sure to set "Decoder" to "EXT1" in the Programme Setup "Manual Adjust" menu. (See page 16.)
- Do not connect the decoder to the EXT 2 terminal.

Connecting a PC

Use the EXT 4 terminals to connect a PC.

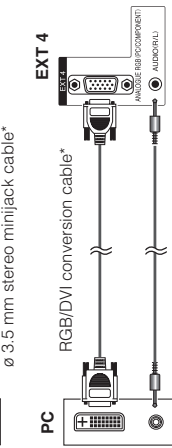
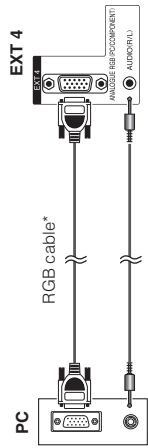

NOTE

- The cables marked with * are commercially available items.
- The PC input terminals are DDC1/2B-compatible.
- Refer to page 33 for a list of PC signals compatible with the TV.
- Macintosh adapters may be required for use for some Macintosh computers.
- When connecting to a PC, the correct input signal type is automatically detected.

Using AV Link function

This TV incorporates three typical AV Link functions for smooth connections between the TV and other audiovisual equipment.

One Touch Play

While the TV is in standby mode, it automatically turns on and plays back the image from the audiovisual source (e.g. VCR, DVD).

WYSIWYR (What You See Is What You Record)

When the remote control unit of the connected VCR has the WYSIWYR button, you can automatically start recording by pressing the WYSIWYR button.

Preset Download

Automatically transfers the channel preset information from the tuner on the TV to the one on the connected audiovisual equipment (e.g. VCR) via the EXT 2 terminal.

NOTE

- Refer to operation manuals of each external equipment for the details.
- Only works when the audiovisual equipment is connected to the EXT 2 terminal on the TV with AV Link via a fully wired SCART.
- The use of the AV Link function is only possible if the TV set has enforced a complete auto-installation with the connected audiovisual equipment (page 8, Initial auto installation).
- The availability of the AV Link function depends on the audiovisual equipment used. Depending on the manufacturer and type of equipment used, it is possible that the described functions may be completely or partially unusable.

Operation Manual (Continued)

Appendix

Troubleshooting

Problem	Possible Solution
• No power.	<ul style="list-style-type: none"> • Check if you pressed on the remote control unit. (See page 8.) • Is the indicator on the TV lights up red, press . • Is the AC cord disconnected? (See page 4.) • Check if you pressed on the TV. (See page 8.)
• Unit cannot be operated.	<ul style="list-style-type: none"> • External influences such as lightning, static electricity etc. may cause improper operation. In this case, operate the unit after first turning the power off, or unplugging the AC cord and re-plugging it in after 1 or 2 minutes.
• Remote control unit does not operate.	<ul style="list-style-type: none"> • Are batteries inserted with polarity (+, -) aligned? (See page 5.) • Are batteries worn out? (Replace with new batteries.) • Are you using it under strong or fluorescent lighting? • Is a fluorescent light illuminated to remote control sensor?
• Picture is cut off.	<ul style="list-style-type: none"> • Is the image position correct? (See page 18.) • Are screen mode adjustments (4:3 Mode/WSS) such as picture size made correctly? (See pages 18 and 20.)
• Strange colour, light colour, or dark, or colour misalignment.	<ul style="list-style-type: none"> • Adjust the picture tone. (See pages 13 and 14.) • Is the room too bright? The picture may look dark in a room that is too bright. • Check the colour system setting. (See pages 16 and 19.) • Check the HDMI Setup setting. (See page 19.)
• Power is suddenly turned off.	<ul style="list-style-type: none"> • The unit's internal temperature has increased. Remove any objects blocking vent or clean. • Check the power control setting. (See page 15.) • Is sleep timer set? Press SLEEP on the remote control unit until it sets to Off.
• No picture.	<ul style="list-style-type: none"> • Is connection to other components correct? (See pages 9 and 10.) • Is input signal type selected correctly after connection? (See page 19.) • Is the correct input source selected? (See page 9.) • Is non-compatible signal being input? (See page 33.) • Is picture adjustment correct? (See pages 13 and 14.) • Is the antenna connected properly? (See page 4.) • Is "On" selected in "Audio Only"? (See page 18.)
• No sound.	<ul style="list-style-type: none"> • Is the volume too low? (See pages 6 and 7.) • Make sure that headphones are not connected. (See page 7.) • Check if you pressed on the remote control unit. (See page 6.)
• The DTV menu screen is displayed in monochrome and hard to select the item.	<ul style="list-style-type: none"> • Check if "Monochrome" is set to "On". If so, set it to "Off". (See page 14.)

Cautions regarding use in high and low temperature environments

- When the unit is used in a low temperature space (e.g. room, office), the picture may leave trails or appear slightly delayed. This is not a malfunction, and the unit will recover when the temperature returns to normal.
- Do not leave the unit in a hot or cold location. Also, do not leave the unit in a location exposed to direct sunlight or near a heater, as this may cause the cabinet to deform and the LCD panel to malfunction. Storage temperature: -20°C to +60°C.

Quick guide

Attaching the stand

Before performing work spread cushioning over the base area to lay the TV on, making sure the area is completely flat. This will prevent it from being damaged.

- 1 Confirm the 8 screws supplied with the TV.
Before attaching (or detaching) stand, unplug the AC cord from the AC INPUT terminal.
- 2 Attach the two parts of the stand unit to each other using the 4 short screws as shown.

Short screws (x4)
(used in step 2)

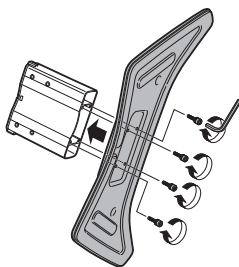

- 3 Insert the stand into the opening on the bottom of the TV.

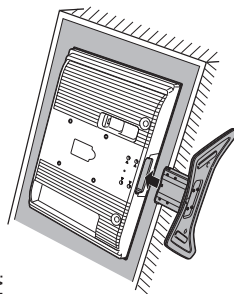

- 4 Insert and tighten the 4 long screws on the rear of the TV as shown.

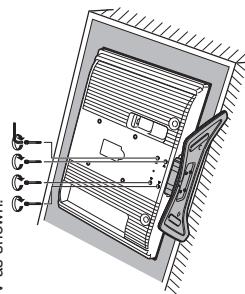

Setting the TV

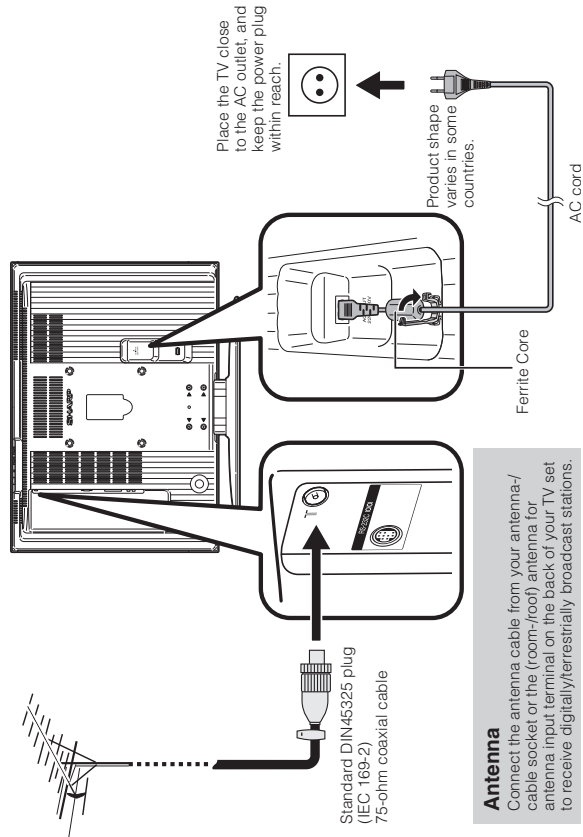

Antenna

Connect the antenna cable from your antenna-/cable socket or the (room-/roof) antenna for antenna input terminal on the back of your TV set to receive digitally/terrestrially broadcast stations.

Operation Manual (Continued)

Appendix

PC compatibility chart

Resolution	Horizontal Frequency	Vertical Frequency	VESA Standard
VGA	640 × 480	31.5 kHz 60 Hz	✓
SVGA	800 × 600	37.9 kHz 60 Hz	✓
XGA	1024 × 768	48.4 kHz 60 Hz	✓

VGA, SVGA and XGA are registered trademarks of International Business Machines Co., Inc.

NOTE

- This TV has only limited PC compatibility, correct operation can only be guaranteed if the video card conforms exactly to the VESA 60Hz standard. Any variations from this standard will result in picture distortions.

RS-232C port specifications

PC Control of the TV

- When a program is set, the TV can be controlled from the PC using the RS-232C terminal. The input signal (PC/video) can be selected, the volume can be adjusted and various other adjustments and settings can be made, enabling automatic programmed playing.
- Attach an RS-232C cable cross-type (commercially available) to a 9 pin D-sub/mini-DIN (optional: AN-A1RS) for the connections.

NOTE

- This operation system should be used by a person who is accustomed to using PCs.

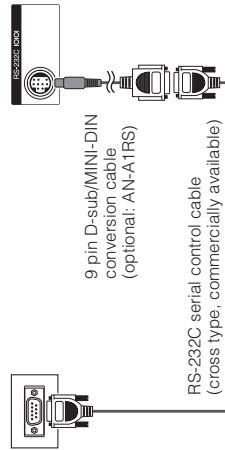

Communication conditions

Set the RS-232C communications settings on the PC to match the TV's communications conditions. The TV's communications settings are as follows:

Baud rate:	9,600 bps
Data length:	8 bits
Parity bit:	None
Stop bit:	1 bit
Flow control:	None

Communication procedure

Send the control commands from the PC via the RS-232C connector.

The TV operates according to the received command and sends a response message to the PC.

Do not send multiple commands at the same time. Wait until the PC receives the OK response before sending the next command.

Command format

Eight ASCII codes + CR



Command 4-digits: Parameter 4-digits Return code
Command 4-digits: Command. The text of four characters.
Parameter 4-digits: parameter 0 - 9, X, blank, ?

Parameter

Input the parameter values, aligning left, and fill with blank(s) for the remainder. (Be sure that four values are input for the parameter.)

When the input parameter is not within an adjustable range, "ERR" returns. (Refer to "Response code format".)

0			
0	0	0	9
-	3	0	
1	0	0	
0	0	5	5

When "?" is input for some commands, the present setting value responds.

?			
?	?	?	?

Response code format

Normal response

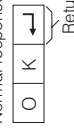

Return code (0DH)

Problem response (communication error or incorrect command)

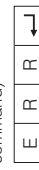

Return code (0DH)

Appendix

Commands

CONTROL ITEM	COMMAND	PARAMETER	CONTROL CONTENTS
POWER SETTING INPUT SELECTION A	P O W R 0	-	POWER OFF
	I N P 0	-	INPUT SWITCHING (Toggle)
	I N P 1	-	TV (CHANNEL FIXED)
	I N P 2	-	DTV (CHANNEL FIXED)
	I N P 3	-	EXT1 (1-5)
	I N P 4	-	1 to 5, ERR (TV/DTV)
	D C C H 1	-	TV DIRECT CHANNEL (1-99)
	C H U P	-	CHANNEL UP
	C H D W	-	CHANNEL DOWN
	D T V D I 1	-	DTV DIRECT CHANNEL (1 to 999)
INPUT SELECTION B	D T V D I 2	-	DTV CHANNEL UP
	D T V D I 3	-	DTV CHANNEL DOWN
	I N P 1 0	-	EXT1 (YC)
	I N P 1 1	-	EXT1 (CVBS)
	I N P 1 2	-	EXT1 (RGB)
	I N P 2 0	-	EXT2 (YC)
	I N P 2 1	-	EXT2 (CVBS)
	I N P 2 2	-	EXT2 (RGB)
	I N P 3 0	-	EXT3
	I N P 4 0	-	EXT4 (RGB)
AV MODE SELECTION	I N P 4 1	-	EXT4 (COMPONENT)
	I N P 4 2	-	0 to 1
	I N P 4 3	-	EXT5 (HDMI)
	A V M D 0	-	AV MODE SELECTION (Toggle)
	A V M D 1	-	STANDARD
	A V M D 2	-	SOFT
	A V M D 3	-	ECO
	A V M D 4	-	USER
	A V M D 5	-	DYNAMIC
	A V M D 7	-	1 to 5
VOLUME	V O L M 1	-	VOLUME (0-80)
	V O L M 2	-	0 to 60
	V O L M 3	-	0 to 60
	V O L M 4	-	0 to 60
	V O L M 5	-	0 to 60
	V O L M 6	-	0 to 60
	V O L M 7	-	0 to 60
	V O L M 8	-	0 to 60
	V O L M 9	-	0 to 60
	V O L M 10	-	0 to 60
CONTROL ITEM POSITION	H P O S 1	-	H-POSITION AV (-10 - +10)
	H P O S 2	-	AV (-10 - +10)
	V P O S 1	-	V-POSITION AV (-20 - +20)
	V P O S 2	-	AV (-20 - +20)
	C L C K 1	-	CLOCK (0-180)
	C L C K 2	-	0 to 180
	P H S E 1	-	PHASE (0-40)
	P H S E 2	-	0 to 40
	W I D E 0	-	WIDE MODE (Toggle)
	W I D E 1	-	NORMAL (AV)
W I D E 2	-	ZOOM 14.9 (AV)	
W I D E 3	-	PANORAMA (AV)	
W I D E 4	-	FULL (AV)	
W I D E 5	-	CINEMA 16.9 (AV)	
W I D E 6	-	CINEMA 14.9 (AV)	
W I D E 9	-	NORMAL (PC)	
W I D E 1 0	-	FULL (PC)	
W I D E 7	-	1 to 10	
M U T E 0	-	MUTE (Toggle)	
M U T E 1	-	MUTE ON	
M U T E 2	-	MUTE OFF	
M U T E 7	-	1 to 2	
A C D V 0	-	SURROUND (Toggle)	
A C D V 1	-	SURROUND ON	
A C D V 2	-	SURROUND OFF	
A C D V 7	-	1 to 2	
A C H A	-	SOUND SELECT (STB/Lingual/mono)	
O F T M 0	-	OFF	
O F T M 1	-	30m	
O F T M 2	-	1h,00m	
O F T M 3	-	1h,30m	
O F T M 4	-	2h,00m	
O F T M 5	-	2h,30m	
O F T M 7	-	0 to 150	
T E X T 0	-	TEXT OFF	
T E X T 1	-	TEXT CHANGE (Toggle)	
T E X T 7	-	0 to 1	
D C P G 1	-	DIRECT PAGE JUMP (100-899)	
D C P G 7	-	100 to 899	

NOTE

- If an underbar (_) appears in the parameter column, enter a space.
- If an asterisk (*) appears, enter a value in the range indicated in brackets under CONTROL CONTENTS.

DIMENSIONS

- () : LC-32GD8
LC-32BT8
- [] : LC-37GD8
LC-37BT8
- : LC-32GD8
LC-32BT8
LC-37GD8
LC-37BT8

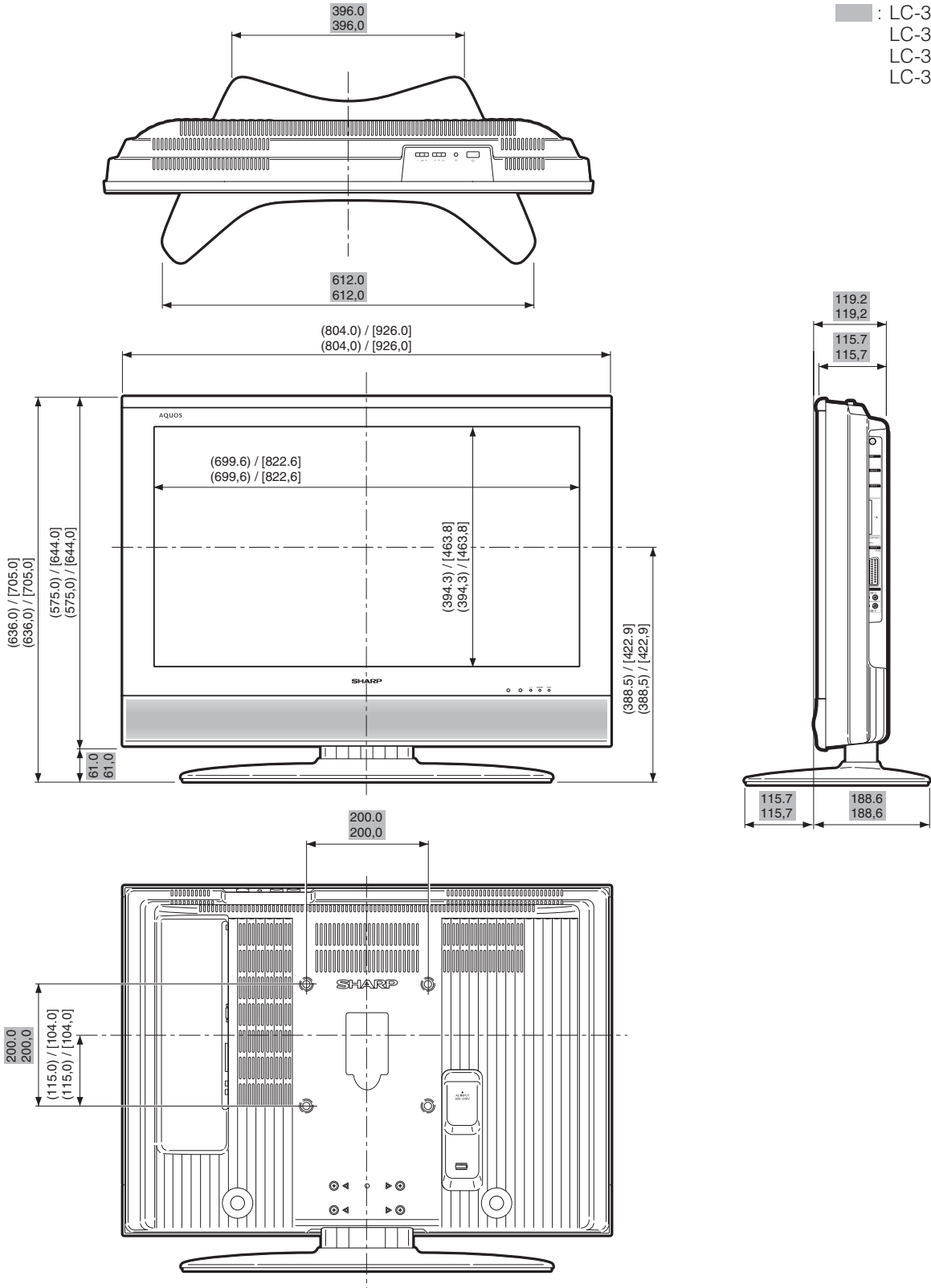

REMOVING OF MAJOR PARTS

1. Remove the stand fixing screws (4 pcs.).
2. Remove the terminal screws (6 pcs.).
3. Remove the cabinet B fixing screws (9 pcs.).
4. Remove the cabinet B after opening from the direction of an arrow.
5. Remove the top cover ass'y.
6. Remove the operation PWB fixing screws (3 pcs.).
7. Remove the stand cover fixing screws (2 pcs.).
8. Remove the stand assist angle fixing screws (2 pcs.).
9. Remove the 6 lock screws from the right and left center angles and take out both center angles.
10. Remove the Shield screws (2 pcs.).

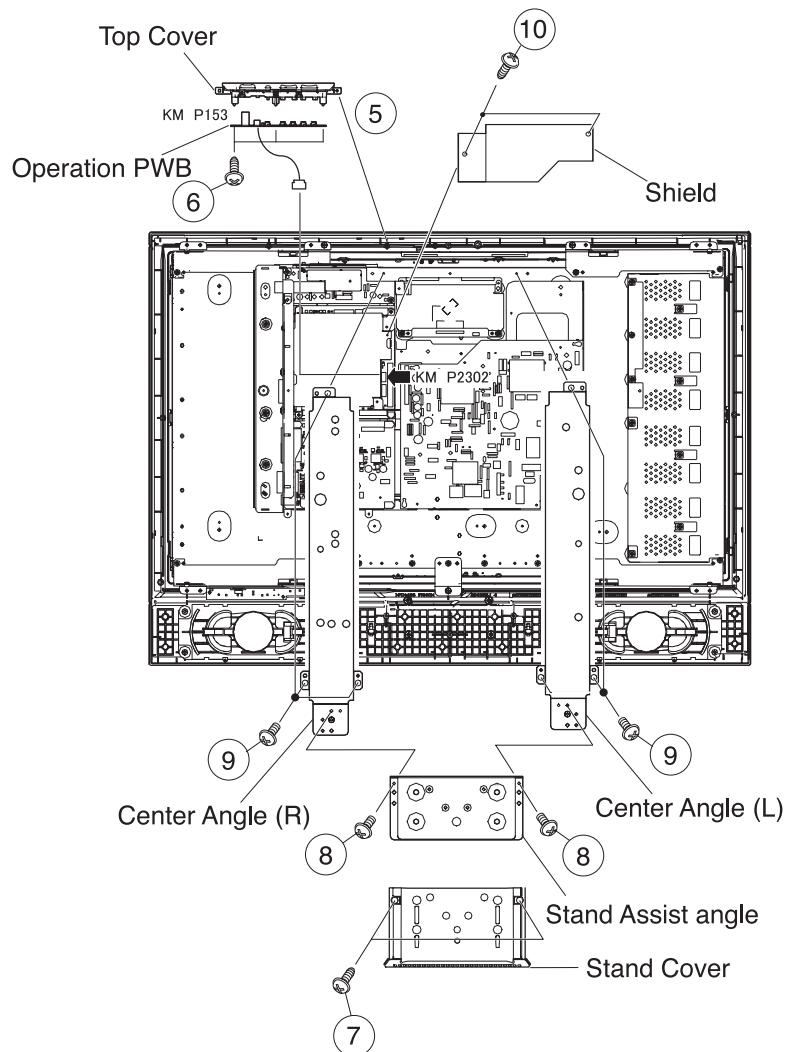
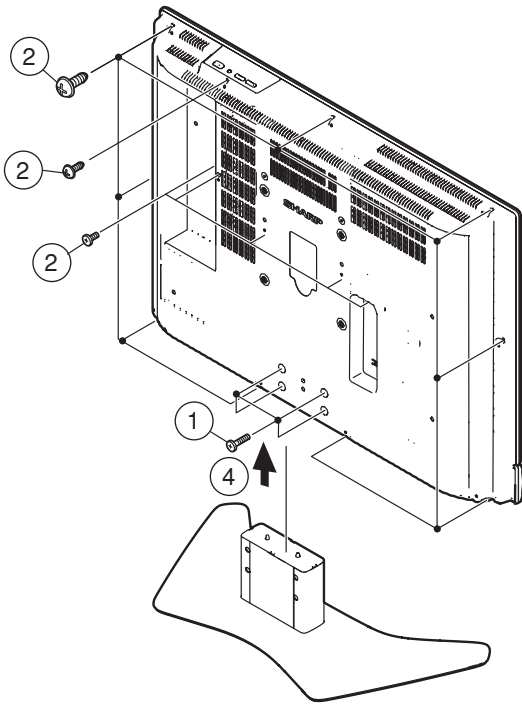

Removing of Major Parts (Continued)

11. Disconnect all the connectors from all the PWBs.

LC-32GD8E/RU,LC-32BT8E/RU

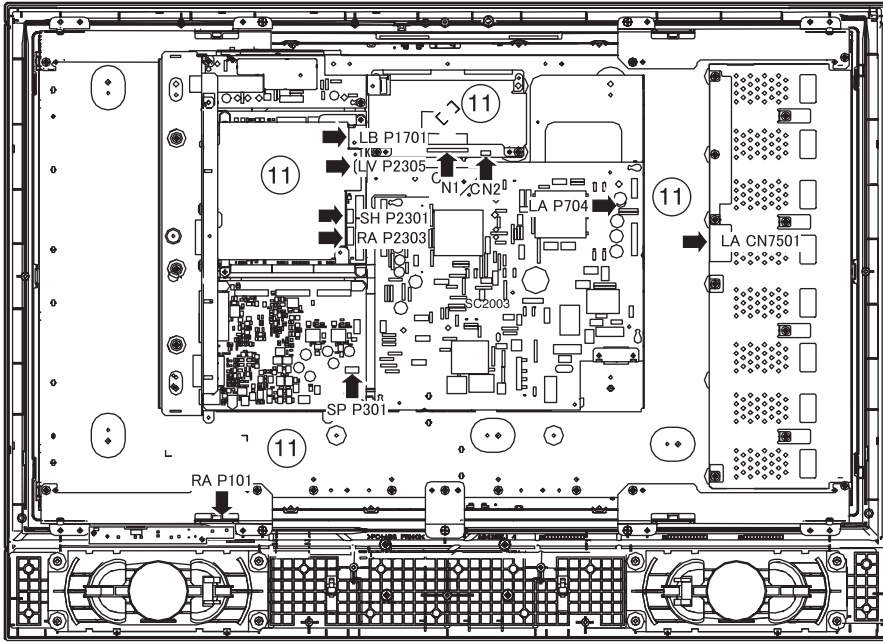

LC-37GD8E/RU,LC-32BT8E/RU

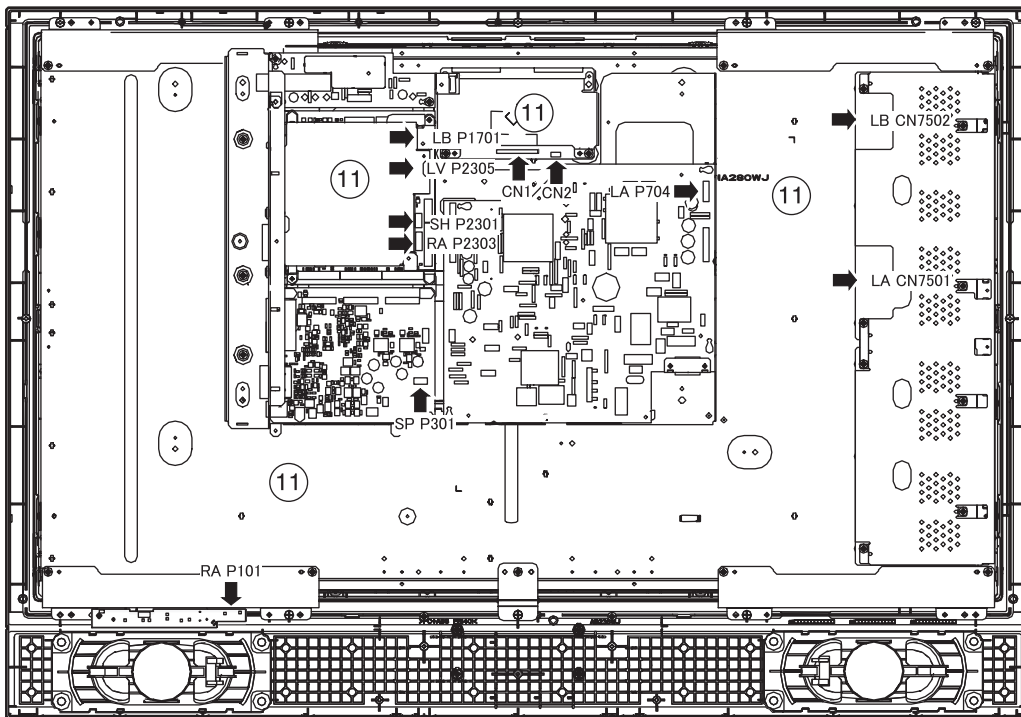

Removing of Major Parts (Continued)

12. Remove the chassis frame fixing screws (5 pcs.).
13. Remove the Digital PWB with Digital PWB Shield fixing screws (4 pcs.).
14. Remove the Digital PWB from Digital PWB Shield (4 pcs.).
15. Remove the D-tuner PWB fixing angle fixing screws (2 pcs.).
16. Remove the power PWB fixing screws (4 pcs.).
17. Remove the AV PWB fixing screws (5 pcs.).
18. Remove the R/C,LED PWB fixing screws (3 pcs.).
19. Remove the 2 lock screws from the right and left speakers and take out both speakers.

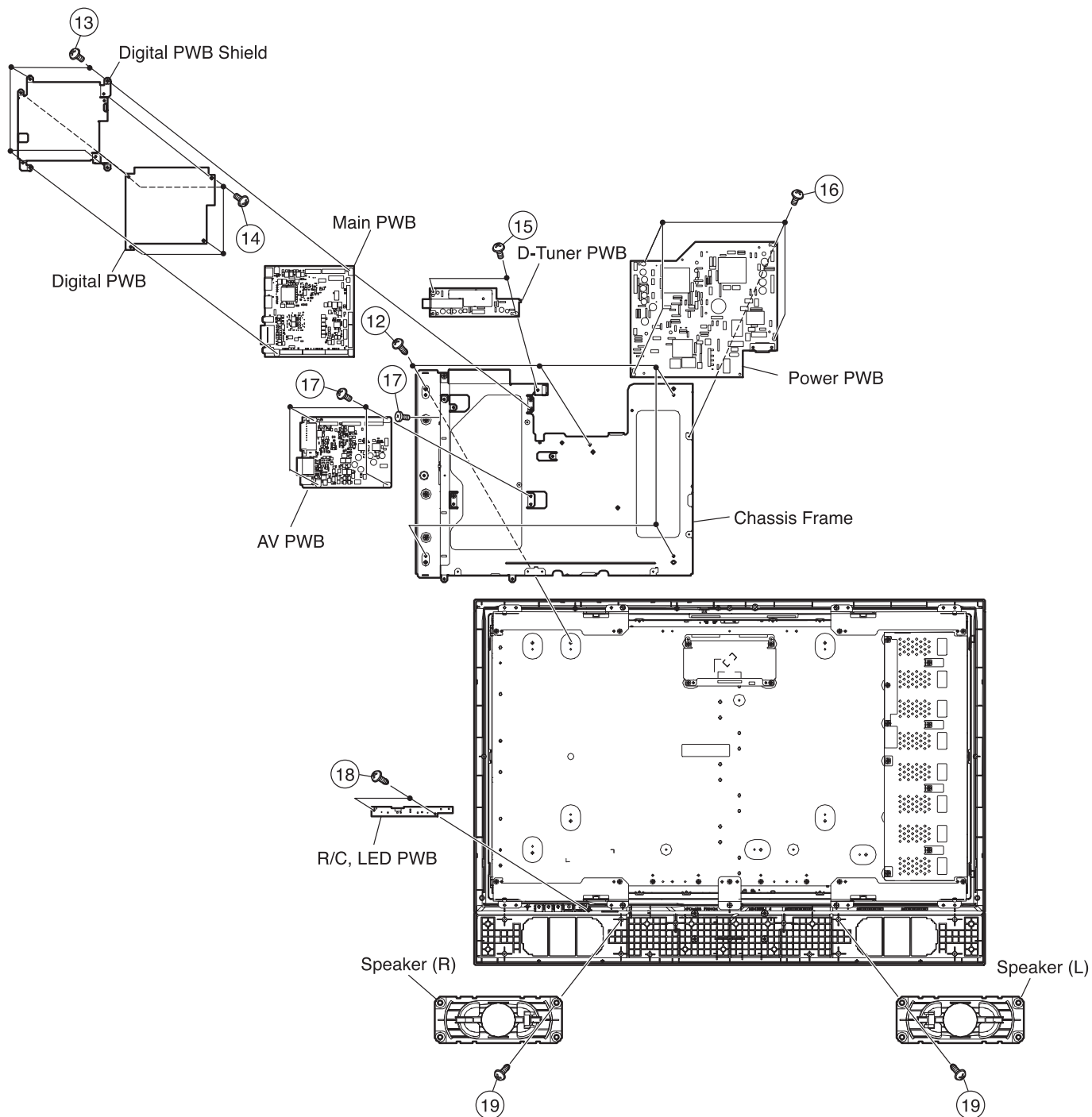

Removing of Major Parts (Continued)

- 20. Remove the LCD angle to LCD Panel fixing screws (9 pcs.).
- 21. Remove the LCD angle to Cabinet-A fixing screws (5 pcs.).

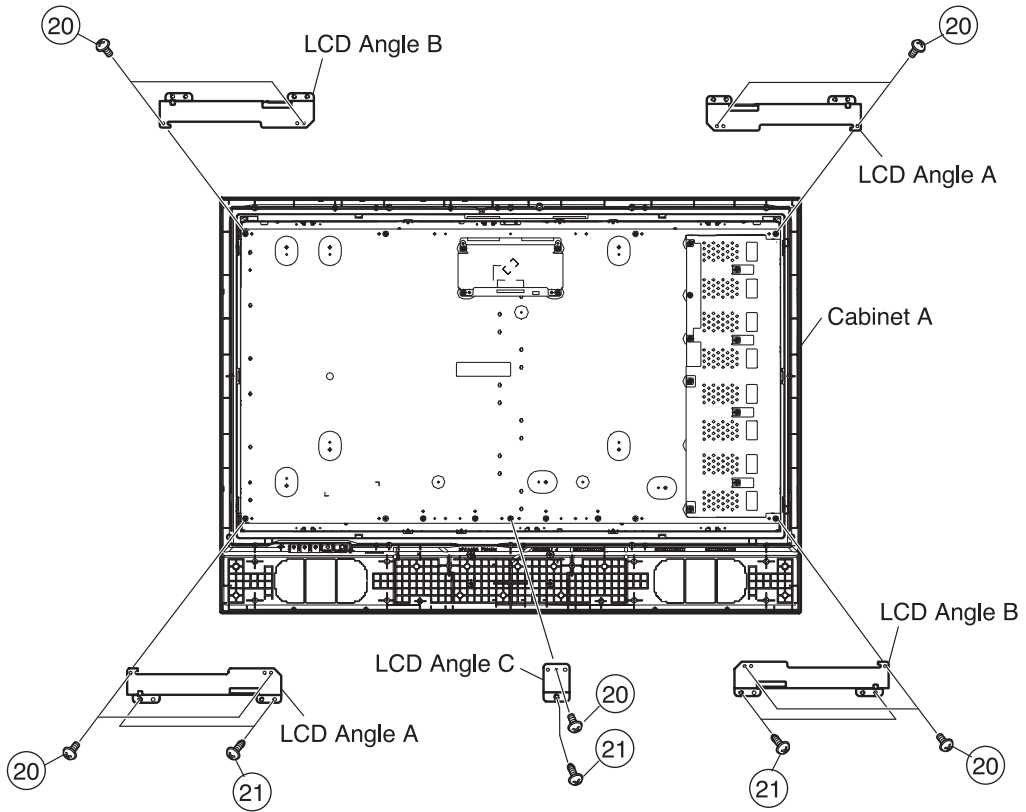

SERVICE ADJUSTMENTS

The adjustment values are set to their optimum at the factory before shipping. If by any chance a value should become improper or a readjustment is required due to part replacement, make an adjustment according to the following procedure.

1. Entering and exiting the adjustment process mode

- 1- Unplug the AC power cord of TV set to force power off.
- 2- While holding down the "VOL (-)" and "INPUT" keys on the set at once, plug in the AC power cord to turn on the set. The letter K appears on the screen. (Factory mode)
- 3- Next, hold down the "VOL (-)" and "P (V)" keys on the set at once. Multiple lines of orange characters appearing on the screen indicate that the set is now in the adjustment process mode. If you fail to enter the adjustment process mode (the display is the same as normal start up), retry the procedure.
- 4- To exit the adjustment process mode after the adjustment is done, unplug the AC power cord to force off the power. (When the power is turned off by the remote controller, unplug also the AC power cord and wait for 10 seconds before plug it in again.)
- 5- To remove "K" mode, just repeat steps 1 and 2. This time the letter K disappears from screen.

Caution: Use due care in handling the information described here lest the users should know how to enter the adjustment process mode. If the settings tampered with in this mode, unrecoverable system damage may result.

2. Remote Controller Key Operation and Description of Display in Adjustment Process Mode

2.1 Key operation

Remote controller key	Main unit key	Function
P (Λ / V)	P (Λ / V)	Moving an item (line) by one (UP/DOWN)
VOL (+/-)	VOL (+/-)	Changing a selected item setting (+1/-1)
Cursor (UP / DOWN)	—————	Turning a page (PREVIOUS / NEXT)
Cursor (LEFT / RIGHT)	—————	Changing a selected line setting (+10/-10)
INPUT SOURCE on remote controller	INPUT button	Input source switching (toggle switching) (TV→DTV→EXT1→EXT2→EXT3→EXT4→EXT5) (Not Operative)
OK	—————	Executing a function

Input mode is switched automatically when relevant adjustment is started so far as the necessary input signal available.

2.2 Description of display

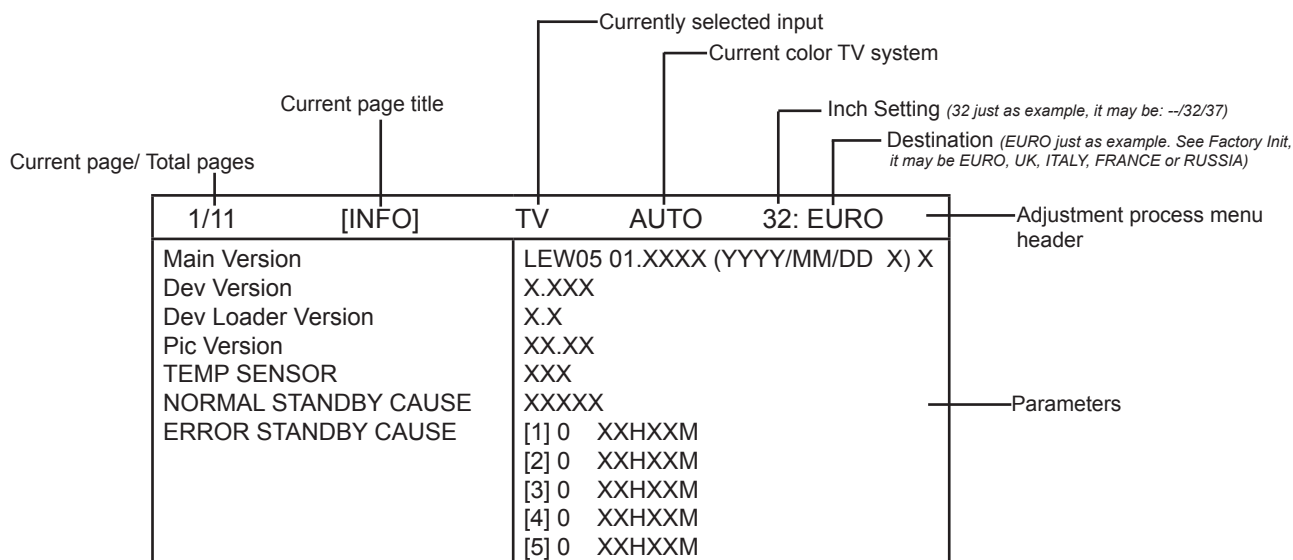

3. Adjustment process mode menu

The character string in brackets [] will appear as a page title in the adjustment process menu header.

Page	Line	Item	Description	Remarks (Adjustment detail, etc.)
1/11		[INFO]		
	1	Main Version	1.xxx (xx/xx/xxxx) x	Main microprocessor version (VCTP)
	2	Dev Version	x.xxx	Digital Module version
	3	Dev Loader Version	x.x	Digital Module loader version
	4	PIC Version	xx.xx	PIC version
	5	TEMP SENSOR	xxx	Temp inside cabinet (near panel)
	6	NORMAL STANDBY CAUSE	[X]0	Last status which cause standby
	7	ERROR STANDBY CAUSE	xxHxxM (X5)	Error standby cause Total operating time before error
2/11		[INIT]		
	1	Factory Init	(--EURO/UK/ITALY/France/RUSSIA)ENTER	Initialization to factory settings
	2	Inch Setting	(--/26/32/37/45)	Initialization data for different panel sizes
	3	PUBLIC MODE	OFF/ON	PUBLIC MODE flag setting
	4	Center Acutime	XxH xxM	Main operating hours (Not Operative)
	5	RESET	OFF/ON	Main operating hours reset
	6	Backlight Acutime	XxH xxM	Backlight operating hours
	7	RESET	OFF/ON	Backlight operating hours reset
	8	Picture Read Pos X	0	x-axis setting of picture data
	9	Picture Read Pos Y	0	y-axis setting of picture data
	10	Picture Read	ON/OFF	Start/stop of picture data
3/11		[PAL. SECAM. N358]		
	1	RF-AGC ADJ	ENTER	RF AGC auto adjustment
	2	PAL+TUNER ADJ	ENTER	PALTUNER auto adjustment
	3	PAL ADJ	ENTER	PAL auto adjustment
	4	TUNER ADJ	ENTER	TUNER auto adjustment
	5	CONTRAST SD	32	SD contrast adjustment
	6	SECAM CB OFFSET	1	SECAM contrast adjustment
	7	SECAM CR OFFSET	1	SECAM contrast adjustment
	8	TUNER A DAC	32	TUNER DAC adjustment
	9	RF AGC	20	RF AGC adjustment
4/11		[COMP 15K]		
	1	COMP 15K ADJ	ENTER	COMP 15K auto adjustment
	2	COMP 15K CONTRAST	32	Contrast adjustment
5/11		[HDTV]		
	1	HDTV CONTRAST	32	Contrast adjustment
6/11		[SMPTE]		
	1	RF-AGC ADJ	ENTER	RF AGC auto adjustment
	2	PAL+TUNER ADJ	ENTER	PALTUNER auto adjustment
	3	PAL ADJ	ENTER	PAL auto adjustment
	4	TUNER ADJ	ENTER	TUNER auto adjustment
	5	CONTRAST SD	32	SD contrast adjustment
	6	SECAM CB OFFSET	1	SECAM contrast adjustment
	7	SECAM CR OFFSET	1	SECAM contrast adjustment
	8	TUNER A DAC	34	TUNER DAC adjustment
	9	RF AGC	25	RF AGC adjustment
7/11		[M GAMMA INFO]		
	1	MGAMMA IN 1	160	W/B adjustment, gradation 1 input setting
	2	MGAMMA IN 2	320	W/B adjustment, gradation 2 input setting
	3	MGAMMA IN 3	480	W/B adjustment, gradation 3 input setting
	4	MGAMMA IN 4	640	W/B adjustment, gradation 4 input setting
	5	MGAMMA IN 5	800	W/B adjustment, gradation 5 input setting
	6	MGAMMA IN 6	960	W/B adjustment, gradation 6 input setting
	7	MGAMMA WRITE	OFF/ON	EEP writing of adjustment values
	8	MGAMMA RESET	OFF/ON	Initialization of adjustment values
8/11		[M GAMMA 1-3]		
	1	MGAMMA R 1	0	W/B adjustment, gradation 1R adjustment value
	2	MGAMMA G 1	0	W/B adjustment, gradation 1G adjustment value
	3	MGAMMA B 1	0	W/B adjustment, gradation 1B adjustment value
	4	MGAMMA R 2	0	W/B adjustment, gradation 2R adjustment value
	5	MGAMMA G 2	0	W/B adjustment, gradation 2G adjustment value
	6	MGAMMA B 2	0	W/B adjustment, gradation 2B adjustment value
	7	MGAMMA R 3	0	W/B adjustment, gradation 3R adjustment value
	8	MGAMMA G 3	0	W/B adjustment, gradation 3G adjustment value
	9	MGAMMA B 3	0	W/B adjustment, gradation 3B adjustment value
	10	MGAMMA WRITE	OFF/ON	EEP writing of adjustment values
9/11		[M GAMMA 4-6]		
	1	MGAMMA R 4	0	W/B adjustment, gradation 4R adjustment value
	2	MGAMMA G 4	0	W/B adjustment, gradation 4G adjustment value
	3	MGAMMA B 4	0	W/B adjustment, gradation 4B adjustment value
	4	MGAMMA R 5	0	W/B adjustment, gradation 5R adjustment value
	5	MGAMMA G 5	0	W/B adjustment, gradation 5G adjustment value

Page	Line	Item	Description	Remarks (Adjustment detail, etc.)
9/11 (Continued)		[M GAMMA 4-6]		
	6	MGAMMA B 5	0	W/B adjustment, gradation 5B adjustment value
	7	MGAMMA R 6	0	W/B adjustment, gradation 6R adjustment value
	8	MGAMMA G 6	0	W/B adjustment, gradation 6G adjustment value
	9	MGAMMA B 6	0	W/B adjustment, gradation 6B adjustment value
	10	MGAMMA WRITE	OFF/ON	EEP writing of adjustment values
10/11		[ETC]		
	1	EEP CLEAR	OFF/ON	Restore NVM data to default values
	2	EEP CLEAR B	OFF/ON	Restore NVM data to default values except adjustment data
	3	STAND BY CAUSE RESET	OFF/ON	Clearing of standby cause error list
	4	AUTO INSTALLATION SW	0/1	0: unfinished 1:finish (The setting takes effect the next time the power is turned on.)
	5	OPTION	0	
	6	COUNTRY	(-/EURO/UK/ITALY/France/RUSSIA)	Selected country
	7	L ERR RESET	0	Lamp error counter
	8	L ERR STOP	0/1	Stops Lamp Error feature
	9	DTV CLR	0/1	Restore Digital Module NVM to default values
	10	I2C-OFF	ENTER	BUS STOP
11/11		LCD		
	1	OSC FREQ 50	144	
	2	OSC FREQ 60	144	
	3	PWM FREQ 50	1	
	4	PWM FREQ 60	1	
	5	PWM FREQ	424	
	6	PWM DUTY	227	
	7	PWM CTRL	0	

4. Special Features

- ERROR STAND-BY CAUSE (Page 1/11)

When the unit enters standby due to operational error, total time before the error and the cause of error is recorded on EEPROM, if possible. The values can be used to locate the fault for repair.

- EEP CLEAR (Page 10/11)

Restore NVM data to default values.

- EEP CLEAR B (Page 10/11)

Restore NVM data to default values except adjustment data.

5. Video Signal Adjustment Procedure

The adjustment process mode menu is listed in Section 3.

5.1. Signal check

Signal generator level adjustment check (Adjustment to the specified level).

- Composite signal PAL : 0.7Vp-p ± 0.02Vp-p (Pedestal to white level)
- 15K Component signal : Y level 0.7Vp-p ± 0.02Vp-p (Pedestal to white level)
(50Hz) (576i/50Hz) PB, PR level 0.7Vp-p ± 0.02Vp-p

5.2. Entering the adjustment process mode

Enter the adjustment process mode according to Section 1.

5.3. RF AGC Adjustment

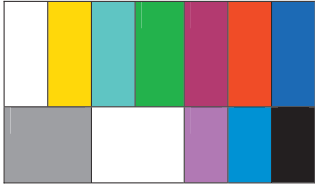
	Adjustment Point	Adjustment conditions	Adjustment procedure
1	Setting	[Signal] PAL Field Color Bar RF signal [Terminal] TUNER	<p>• Feed the PAL color bar signal (E-12ch) to TUNER. Signal level: 50 ±1dB μV (75Ω LOAD)</p> <p>[TUNER]</p> 
2	Auto adjustment performance	Adjustment process page 3.	Bring the cursor on [+RF AGC ADJ] and press [OK]. [+RF AGC ADJ OK] appears when finished.

5.7. ADC Adjustment (Component 15K)

	Adjustment Point	Adjustment conditions	Adjustment procedure
1	Setting	[Signal] (576i/50) COMP 15K, 50Hz 100% Full Field Color Bar [Terminal] EXT4 [COMPONENT]	<ul style="list-style-type: none"> • Feed the COMPONENT 15K 100% full field color bar signal (100% color saturation) to EXT4 COMPONENT IN. <div style="text-align: center;"> <p>[EXT 4]</p> </div>
2	Auto adjustment performance	Adjustment process page 4.	Bring the cursor on [•COMP15K ADJ] and press [OK]. [•COMP15 ADJ OK] appears when finished.

6. White Balance Adjustment

Adjustment procedure Page 7/11 shows the value of adjustment gradation (IN value) and Adjustment procedure Page 8/11 & 9/11 show adj. offset value (initial value : 0). White balance adjustment is executed adjusting the adj. offset value, indicated on Page 8/11 & 9/11.

Condition of the inspection:

- Backlight: MAX (+8) [DYNAMIC]
- Colorimeter at screen centre

Adjustment reference device: Minolta CA-210

Tolerance adjustment spec. ±0.004, Inspection spec. : ±0.006 (GAMMA 1)

Tolerance adjustment spec. ±0.002, Inspection spec. : ±0.004 (GAMMA 2...6)

Adjustment: Check that the values on page 7/11 of process adjustment are set as below. If not, change them accordingly.

M GAMMA IN 1	160	M GAMMA IN 2	320
M GAMMA IN 3	480	M GAMMA IN 4	640
M GAMMA IN 5	800	M GAMMA IN 6	960

1- Display the current adjustment status at point 6. (Page 9/11 of process adjustment)

The pattern for checking the adjustment status is toggled by pressing the “6” button on the remote control. (Normal OSD display -> “6” -> pattern for check (OSD disappears) -> “6” -> normal OSD display -> ...)

2- Read the value of the luminance meter.

3- Change M GAMMA R6/M GAMMA B6 (adjustment offset value) on page 9/11 of process adjustment so that the values of the luminance meter approach **x = 0.272** and **y = 0.277**.

(Basically, G is not changed. If adjustment fails only with R and B, then G should be reduced. In this case, the weaker of R and B must be fixed.)

4- If G is changed in step “3”, change the values of M GAMMA G1 - M GAMMA G5 on pages 8/11 and 9/11 of process adjustment as follows. When not changed, go to step “5”.

Offset value of M GAMMA G1 = (Offset value of M GAMMA G6)*(160/960)

Offset value of M GAMMA G2 = (Offset value of M GAMMA G6)*(320/960)

Offset value of M GAMMA G3 = (Offset value of M GAMMA G6)*(480/960)

Offset value of M GAMMA G4 = (Offset value of M GAMMA G6)*(640/960)

Offset value of M GAMMA G5 = (Offset value of M GAMMA G6)*(800/960)

5- Display the adjustment status of the current point 5. (Each time the “5” button on the remote control is pressed, the adjustment status check pattern is toggled.)
(Normal OSD display -> “5” -> Pattern display (OSD disappears) -> “5” -> Normal OSD display ->...)

Change M GAMMA R5/M GAMMA B5 (adjustment offset value) on page 9/11 of process adjustment so that the values of the luminance meter approach $x = 0.272$ and $y = 0.277$.

6- Repeat step “5” for GAMMA points 4, 3, 2, and 1.

7. QS Temperature NVM Data Confirmation

During servicing of the LCD TV set, by software upgrading or by any cleaning NVM, it's mandatory select the “Inch Setting” in Service Mode, Page 2, according to the size of the TV set.

02/11	[INIT]	INPUT 4	PAL	--:--
	Factory Init	--		
	Inch Setting	--		
	Public Mode	OFF		
	Center Acutime	00H		
	RESET	OFF		
	Backlight Acutime	00H		
	RESET	OFF		
	Picture Read Pos X	0		
	Picture Read Pos Y	0		
	Picture Read	OFF		

Default picture after cleaning NVM.

02/11	[INIT]	INPUT 4	PAL	32:--
	Factory Init	--		
	Inch Setting	32		
	Public Mode	OFF		
	Center Acutime	00H		
	RESET	OFF		
	Backlight Acutime	00H		
	RESET	OFF		
	Picture Read Pos X	0		
	Picture Read Pos Y	0		
	Picture Read	OFF		

Picture with [Inch Setting] to 32.

8. Initialization to factory settings

Caution: When the factory settings have been made, all user setting data, including the channel settings, are initialized. (The adjustments done in the adjustment process mode are not initialized.) Keep this in mind when initializing these settings.

	Adjustment item	Adjustment conditions	Adjustment procedure
1	Factory settings	See to below caution	<ul style="list-style-type: none"> Enter the adjustment process mode. Bring the cursor on to [FACTORY INIT] on page 2/11. Use the [Volume +/-] key to select a region from [EURO/UK/ITALY/France/RUSSIA] and press [ENTER]. “EXECUTING” appears and initialization starts. After a while, “***OK***” appears and the setting is complete. <p>Note: Never turn the power off during initialization.</p> <hr/> <p>The following settings will be back to their factory ones.</p> <ol style="list-style-type: none"> User settings Channel data (e.g. broadcast frequencies) Password data

After adjustments, exit the adjustment process mode.
To exit the adjustment process mode, unplug the AC power cord from the outlet to forcibly turn off the power. When the power is turned off with the remote control, unplug the AC power cord and plug it back in (wait approximately 10 seconds before plugging in the AC power cord).

9. Lamp error detection

9.1. For 37" LCD TV

9.1.1. Functional description

This LCD colour television has a function (lamp error detection) to be turned OFF automatically for safety when the lamp or lamp circuit is abnormal.

If the lamp or lamp circuit is abnormal, or some other errors happen, and the lamp error detection is executed, the following occur.

1- The main unit of television is turned OFF 5 seconds after it is turned ON. (The power LED on the front side of TV

turns from green to red.)

2 - If the situation "1" happens 5 times sequentially, television can not be turned ON. (The power LED remains red.)

9.1.2. Countermeasures

When television is turned OFF by the lamp error detection mentioned above, it enters the adjustment process with the power LED red. Entering the adjustment process turns OFF the error detection and turns ON TV. This enables the operation check to detect errors in the lamp or lamp circuit.

Check whether "L ERROR RESET" on point 7, page 10/11 of the adjustment process is 1 or more. If it is 1 or more, it indicates the lamp error detection was executed. After confirming that the lamp or lamp circuit is normal, reset the lamp error counter pushing "OK" in the R/C. After resetting counter the label "***OK***" appears on Screen.

9.1.3. Reset standby cause error list

After confirming that the lamp error counter has been erased, select "STAND BY CAUSE RESET" on point 3, page 10/11 of the adjustment process and select ON using the right cursor. For execute press "OK" in the R/C and the label "***OK***" appears on Screen.

9.2 For 32" LCD TV

9.2.1. Functional description

This LCD colour television has a function (lamp error detection) to be turned OFF automatically (Inverter unit) for safety when the lamp or lamp circuit is abnormal.

If the lamp or lamp circuit is abnormal, or some other errors happen, and the lamp error detection is executed, the following occur. The Inverter circuit stops but the rest of TV continues working. The power led is green.

9.2.2 Countermeasures

Proceed to repair the inverter unit to solve the problem that produces the lamp error.

9.2.3. Reset standby cause error list

For 32" this is not necessary because the lamp error detection is not operative by software.

10. Public Mode (Hotel Mode)

10.1 How to Enter in the Public Mode (Hotel Mode).

Turn on the power and enter in the Adjustment Process mode (ADJ1 or Service Mode) as usual.

In the [INIT], Page 2/11 of Service, turns ON the Public Mode option.

Turn off TV by pressing Main Power switch.

While pressing "VOL+" and "P^" keys at the same time, press Main Power switch for more than 2 seconds.

After this sequence the TV will turn on showing the Public Mode setting screen as follows:

Public Mode	
POWER ON FIXED	[VARIABLE]
MAXIMUM VOLUME	[60]
VOLUME FIXED	[VARIABLE]
VOLUME FIXED LEVEL	[0]
RC BUTTON	[RESPOND]
PANEL BUTTON	[RESPOND]
MENU BUTTON	[RESPOND]
ON SCREEN DISPLAY	[YES]
INPUT MODE START	[NORMAL]
INPUT MODE FIXED	[VARIABLE]
RESET	
EXECUTE	

Is possible to select each item of function by pressing cursor UP/DOWN keys on the remote control or CH(^)(v) keys on the LCD TV.

The setting position of each item of functions is made by pressing cursor RIGHT/LEFT keys on the remote control or VOL(+)(-) keys on the LCD TV.

Select ENTER position after you set all function, and press cursor RIGHT/LEFT keys on the remote control or VOL(+)(-) keys on the LCD TC for confirmation.

10.2. Public Mode Settings.

1. POWER ON FIXED [VARIABLE ⇔ FIXED]

When it is set to "FIXED" the TV is impossible to be switch off by Main Switch or Remote Control.

2. MAXIMUM VOLUME [0 ⇔ 60]

Is possible to set the maximum volume at limited level.

3. VOLUME FIXED [VARIABLE ⇔ FIXED]

Is possible to fix the sound volume at limited level.

When "FIXED" is selected the sound volume before limited is fixed.

4. VOLUME FIXED LEVEL [0 ⇔ 60]

If "FIXED" has been selected, is possible to set a fixed volume at the level that is choosen.

5. RC BUTTON [RESPOND ⇔ NO RESPOND]

If "NO RESPOND" is selected, the remote control keys are inoperative.

6. PANEL BUTTON [RESPOND ⇔ NO RESPOND]

If "NO RESPOND" has been selected, the set's keys remain deactivated (Except POWER key).

7. MENU BUTTON [RESPOND ⇔ NO RESPOND]

If "NO RESPOND" has been selected, "MENU" keys on the remote control, is inoperative.

8. ON SCREEN DISPLAY [YES ⇔ NO]

If "NO" has been selected, the On Screen Display does not appear.

9. INPUT MODE START [NORMAL ⇨ TV (X) ⇨ DTV ⇨ INPUT1 ⇨ INPUT2 ⇨ INPUT3 ⇨ INPUT4 ⇨ INPUT5 ⇨]

When any other item than "NORMAL" has been selected, the sets will start in a selected input mode at the next power-on.

10. INPUT MODE FIXED [VARIABLE ⇔ FIXED]

If "FIXED" has been selected, any channels and input modes other than those selected at the start mode cannot be picked up.

11. RESET

Cancel all Public Mode settings. (It returns to the factory settings)

12. EXECUTE

After select this item, all positions that has been selected will be set.

SOFTWARE UPDATING

There are 3 methods to update software in the VCTp: I2C method, RS-232C HyperTerminal and RS-232C Tera Term method.

- RS-232C method is allowed when the TV is working properly and the action should be only software upgrade.
- I2C method is required when the VCTp flash is empty or corrupted (it means, any software inside IC running).

1. RS-232C Method Description (HyperTerminal).

The hardware tools requirement are:

1. A Modem-null (Cross type) DB9 female to DB9 female cable.
2. An adaptor DB9 male to mini-Din 9 pin male cable (Sharp Code: QCNWGA015WJPZ)
3. Make the connections as indicated in the figure:

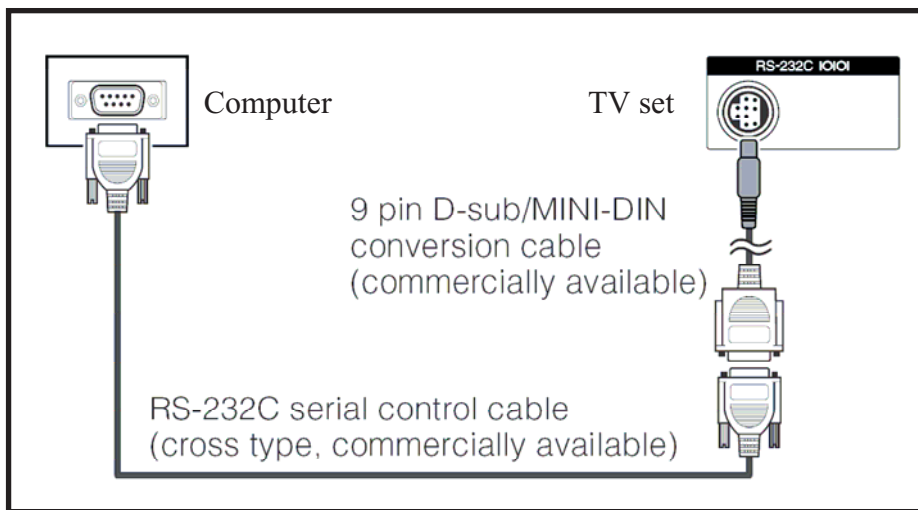

Before using RS-232C updating method is necessary to configure a Terminal PC software. HyperTerminal has been selected as a Terminal software because it's include in all Windows versions as an accessory, and you can find it inside "Accessories\Communications" folder. For this reason, please follow carefully the next steps:

1. First time HyperTerminal is used, it's necessary to configure some settings. Follows next action to configure two connection: low speed (9600bps) and high speed (115200bps).
2. Create a New Connection file with name "P55_9600bps".
3. Select a free COM port and select the Port Settings properties as follows:

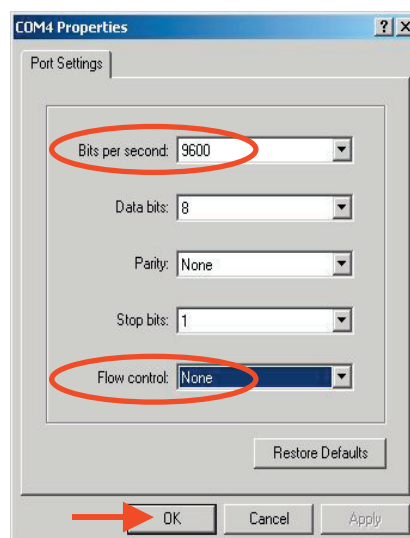

VCTp Software Updating, HyperTerminal (continued)

4. Click on “File\Properties” menu for selecting the General and ASCII properties as follows:

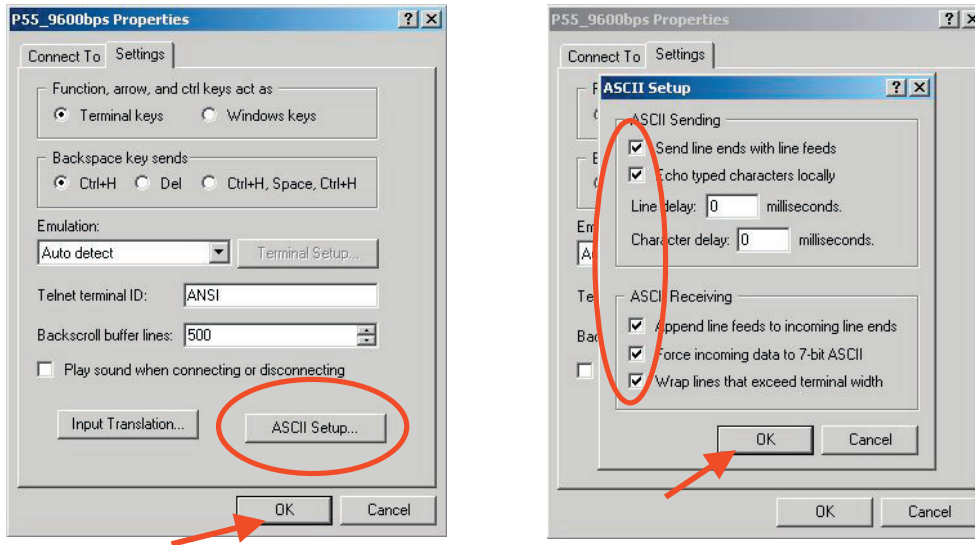

5. Select “New Connection” in the File Menu.

6. Answer “Yes” to close current connection and “Yes” to save session “P55_9600bps”.(*)

7. Create a new connection with the name “P55_115200bps”.(*)

8. Select a the same COM port used in item 2 and select the Port Settings properties as follows:

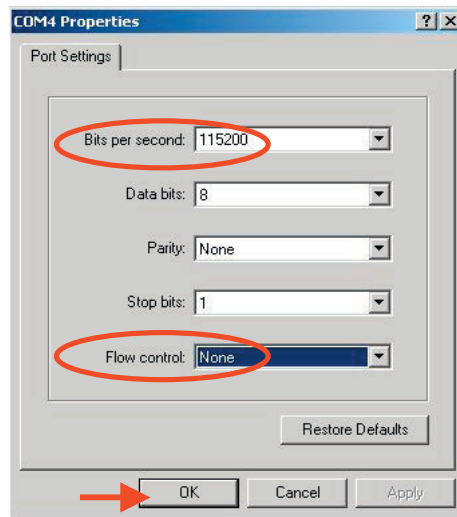

9. Select the same General and ASCII properties as item 3.

10. Close HyperTerminal session, answering “Yes” to close current connection and “Yes” to save session “P55_115200bps”.(*)

To start updating session, click over “P55_9600bps”.(*) icon that you can find in the “START\All programs\Accessories\Communications\HyperTerminal\HyperTerminal” folder and follow next procedure:

1. Check the connection between TV set and PC, sending a wrong command, as for example: “aaa”. TV set returns an “ERR” label as an syntax ERROR (Not correct order or sequence).

VCTp Software Updating, HyperTerminal (continued)

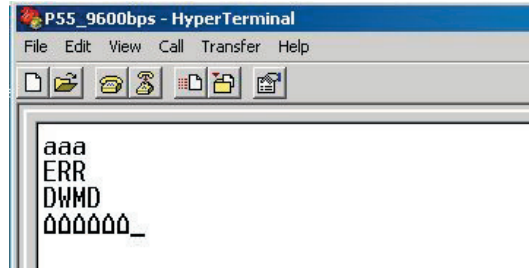

2. Send the command “DWMD” to enter TV set in Download Mode. The TV set answer sending same symbol continuously. If this symbol character doesn’t appear, please don’t worry and pass to next step.
3. Close this connection and open “P55_115200bps” (*) connection clicking over the “P55_115200bps” (*) that you can find in “START\All programs\Accessories\ Communications\HyperTerminal\HyperTerminal” folder.
4. Using “Transfer\Send file...” menu, select desired file (.bin format) and the transmission protocol (Xmodem) as show below.

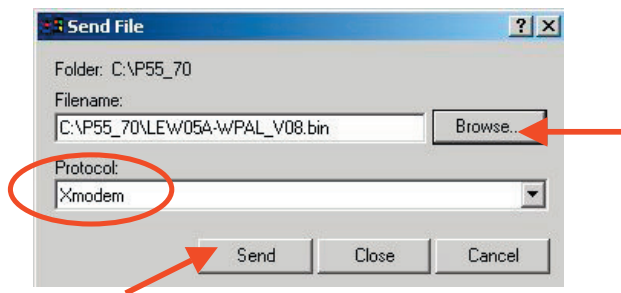

5. After press “Send” button the updating process starts as follows:

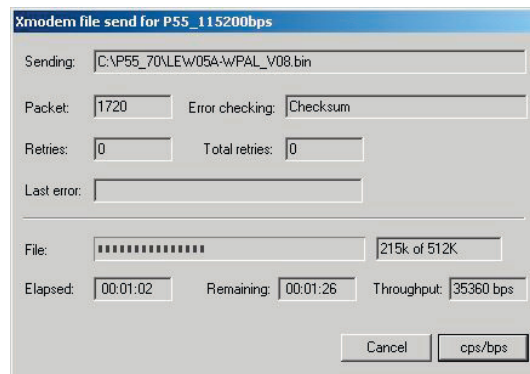

6. When flash update process finishes, the ” Flash programming complete “ label appear in the screen , the device automatically go to switch off, and in a few seconds go to switch on again.

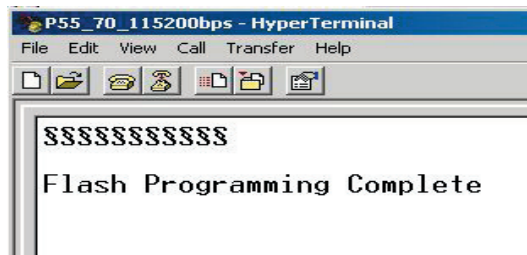

VERY IMPORTANT NOTE:

During the updating time, please don’t use the PC for other purposes, in order to abolish communication problems between TV set and PC. If TV set was not updated properly, the TV won’t have the software to startup again, and you must follow the “I2C method” to update another time the TV set.

1.2. RS-232C Method Description (Tera Term)

The hardware tools requirement are:

1. A Modem-null (Cross type) DB9 female to DB9 female cable.
2. An adaptor DB9 male to mini-Din 9 pin male cable (Sharp Code: QCNWGA015WJPZ)
3. Make the connections as indicated in the figure:

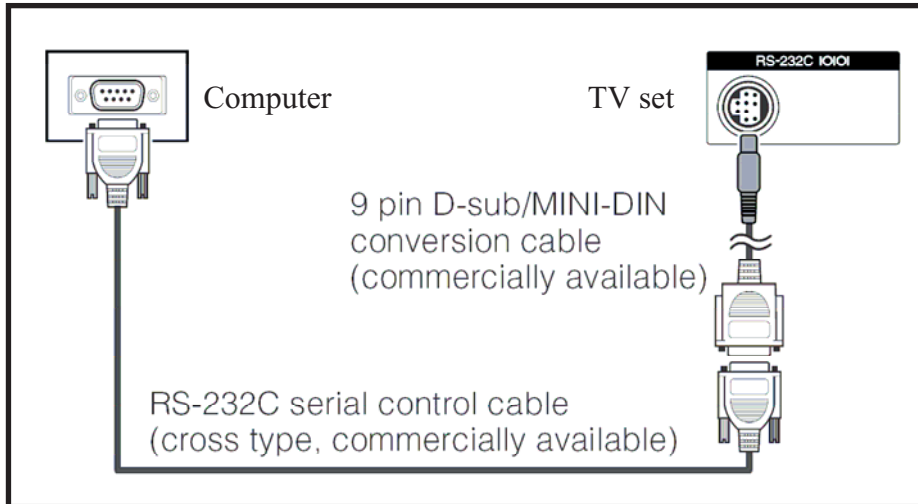

Software requirements :

To upgrade VCTp software from RS-232C external connector is necessary to use a Tera Term (Pro) free software.

The URL of Tera Term home page is:

<http://hp.vector.co.jp/authors/VA002416/teraterm.html>

(The address may be changed in future)

Tera Term (Pro) supported operating systems:

MS-Windows 95 or upper

MS-Windows NT 3.5 and 4.0 or upper

Note.- For Windows 3.1 use Tera Term version 1.X.

Copy all the distribution files to an empty floppy disk or temporary directory (for example C:\TEMP).

Run SETUP.EXE and follow the instruction given by it.

After the installation, the distribution files are no longer needed, you can delete them or may keep them in the floppy disk.

How to use Tera Term Pro :

When the Tera Term (Pro) program is used, it's necessary to shape some settings. Follows next action to configure the connection:

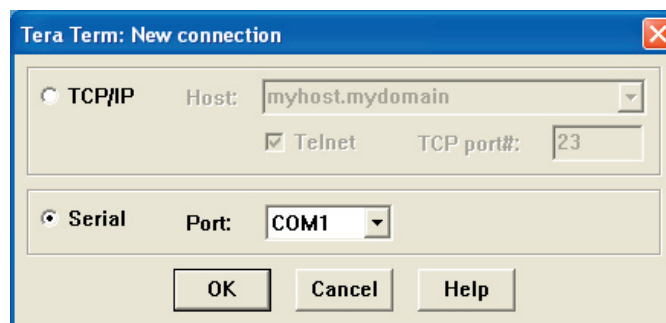

1. Select: **Serial** ⇒ **COM X** ⇒ **O.K.**

VCTp Software Updating, Tera Term (continued)

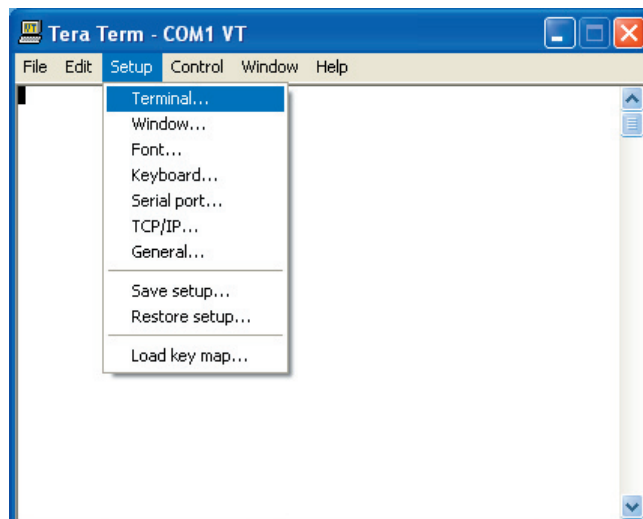

2. Select: **Terminal**

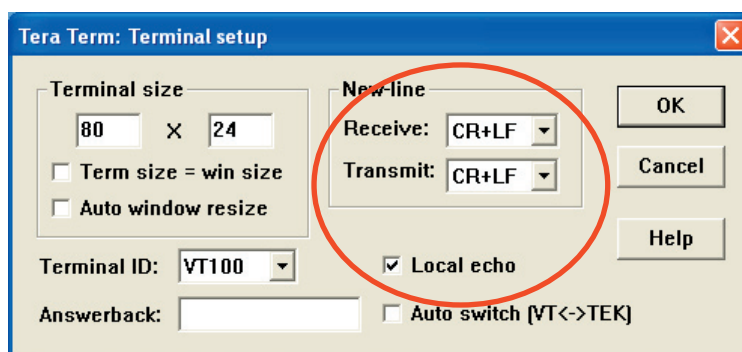

3. Choose the same options as the above picture.

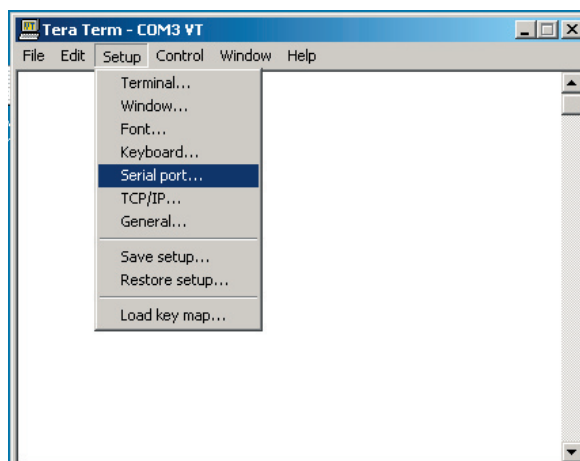

4. Select **Setup** ⇒ **Serial port** ⇒ **O.K.** Appear the follow screen:

VCTp Software Updating, Tera Term (continued)

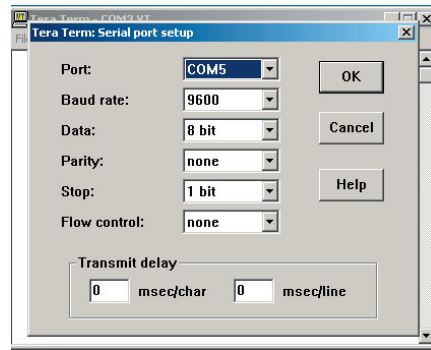

5. Select follows settings:
 Serial port to use: COM x
 Baud rate: 9600
 Data: 8 bits
 Parity: none
 Stop: 1 bit
 Flow control: none
 Enter O.K.

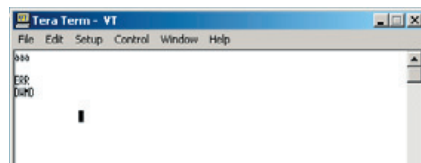

6. Check the connection between TV set and PC, sending a wrong command, as for example: "aaa". TV set returns an "err" label as an syntaxes ERROR (Not correct order or sequence).
 Send a "DWMD" (capital letters) command to enter TV set in Download Mode.
 Change a baud rate to 115200.
 Select: **Setup** ⇒ **Baud rate** ⇒ **115200** ⇒ **O.K.**

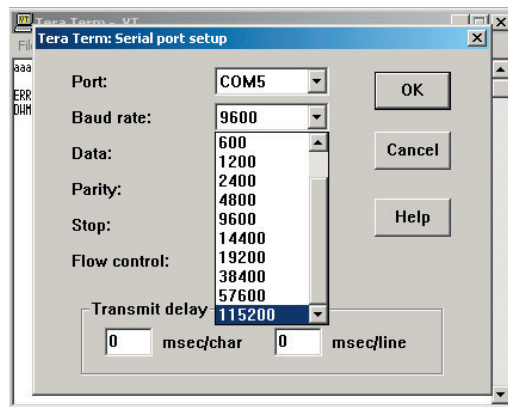

7. Select: **File** ⇒ **Transfer** ⇒ **XMODEM** ⇒ **Sent**

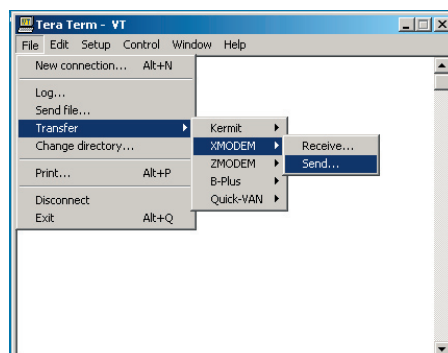

VCTp Software Updating, Tera Term (continued)

8. Choose the file for upgrade and click “Open”.

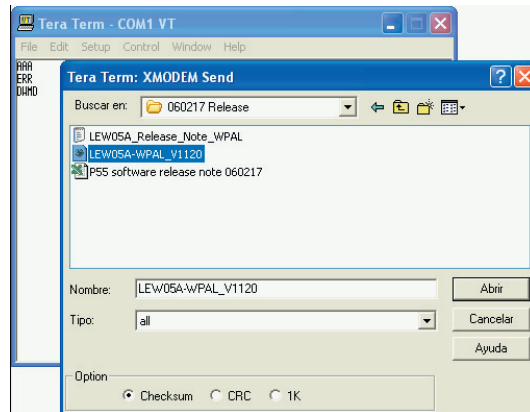

9. After select “Open” the upgrade process starts as follows:

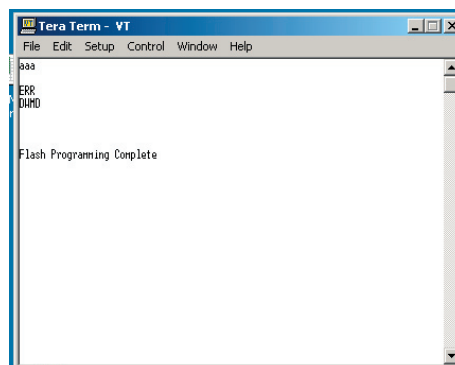
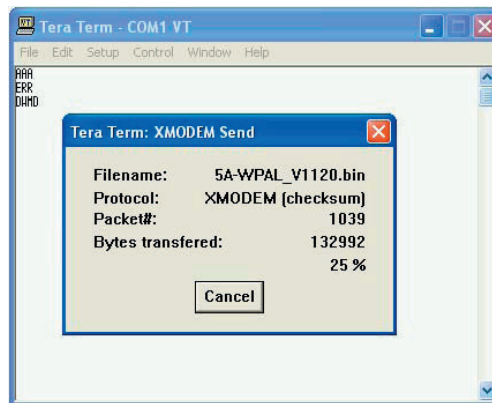

VERY IMPORTANT NOTE:

During the updating time, please don't use the PC for other purposes, in order to abolish communication problems between TV set and PC. If TV set was not updated properly, the TV won't have the software to startup again, and you must follow the "I2C method" to update another time the TV set.

1.3. I2C Method Description

The hardware tools requirement are:

1. A Parallel port I2C interface with 20 pin to 3 pin cable (Sharp Code: CKIT-0004WJV0).
- 2 . Make the connections as indicated below:
 - a. Connect Parallel port I2C interface to LPT port of the computer.
 - b. Connect the 20 to 3 pin cable from the I2C interface to the P2306 socket in the main board (XD603).

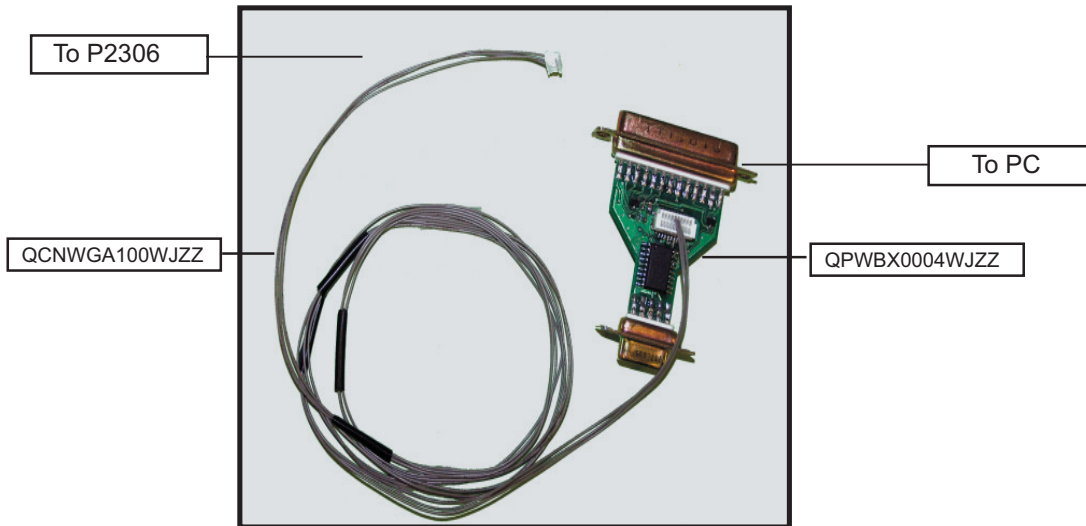

I2C Interface (CKIT-0004WJV0)

Before using I2C method is necessary to install Visual I2C software following next procedure.

1. Install Visual I2C release V3.2.3b from file ("Setup_Visual_I2C_v3-2-3b8h.exe").
 - It's strongly recommended to accept the suggested default folder ("C:\Program Files\Micronas\Visual I2C").
2. Install Visual I2C VCTp extension from file ("Setup_VI2C_for_VCT6wxyP_v0111.exe").
 - It's interesting to change default folder to same as Visual I2C ("C:\Program Files\Micronas\Visual I2C").
 - During this installation process is possible to install also a complementary software to manage NVM memories . This installation is not needed, for this reason uncheck the option when the setup program ask to you. In case of installation it's interesting to change default folder to same as Visual I2C ("C:\Program Files\Micronas\Visual I2C").
3. Install Parallel driver depending of your Windows version from existing files inside the Visual I2C installation folder "C:\Program Files\Micronas\Visual I2C\Port_Driver", following next criteria:
 - a. Windows 98/Me ("Setup_LptDrv_v0104_9x.exe").
 - b. Windows NT ("Setup_LptDrv_v0104_NT_2000.exe").
 - c. Windows Xp/2000 ("Setup_LptDrv_v020201_XP_2000.exe").

After installing Visual I2C, the new generated file structure should look like this:



VCTp Software Updating, I2C (continued)

4. Check installation LPT driver using “C:\Program Files\Micronas\LptDrv\LptDrvTest.exe”. After run this software, if LPT driver is installed properly must appear this screen:

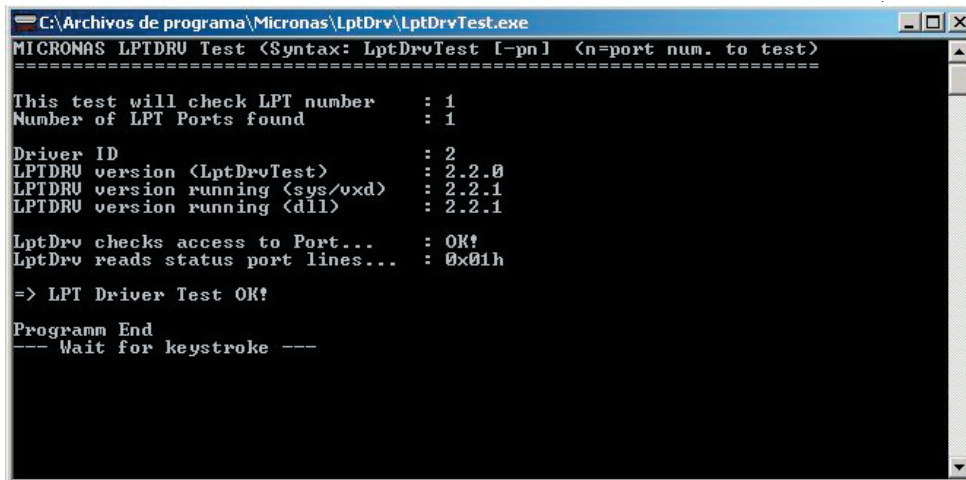

•If the result is not OK, check inside PC bios: Parallel Port Mode=EPP

To run VCTp software update program, please click over “VCTP” icon from “START\All programs\Micronas\Visual I2C\I2C\VCTP” and after Visual I2C finish their starting process click on “TVT” module. As additional method, it’s possible to create a direct access to “C:\Program Files\Micronas\Visual I2C\I2C\vct6wxyP\vctq_tvt.vi2c” and launch it from Windows Desktop.

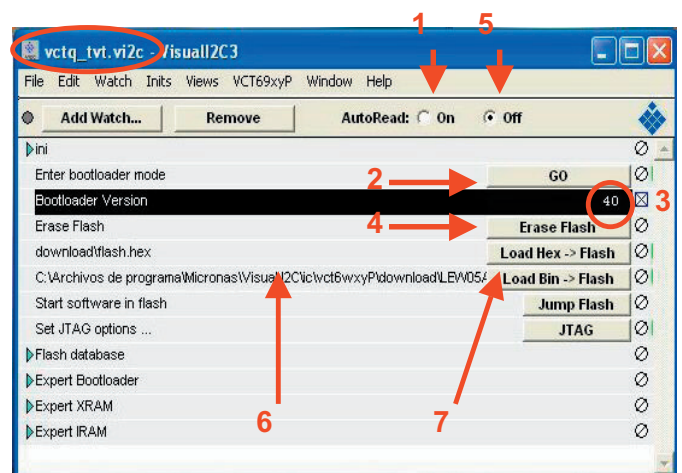
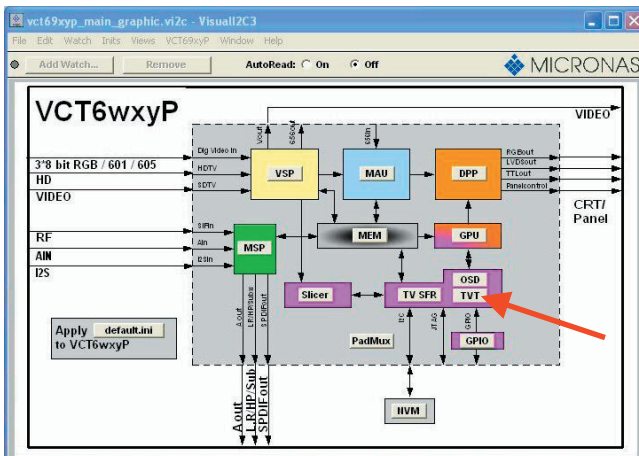

To start updating process follow next instructions:

1. Set Autoread in ON option.
2. Click on “GO” button.
3. Wait until “40” appears in Bootloader Version field.
4. Close DOS pop up windows pressing any key (“Press any key to continue...”).
5. Click on the “Erase flash” button and wait for a seconds and set the AutoRead to OFF.
6. Check in the desired software version is selected in the “Load BinàFlash” option. If it’s not the correct one, please double click on the file name and select it. The first time this software is use it’s necessary to confirm write Addressing margin as from 0x0 to 0x7ffff.

VCTp Software Updating, I2C (continued)

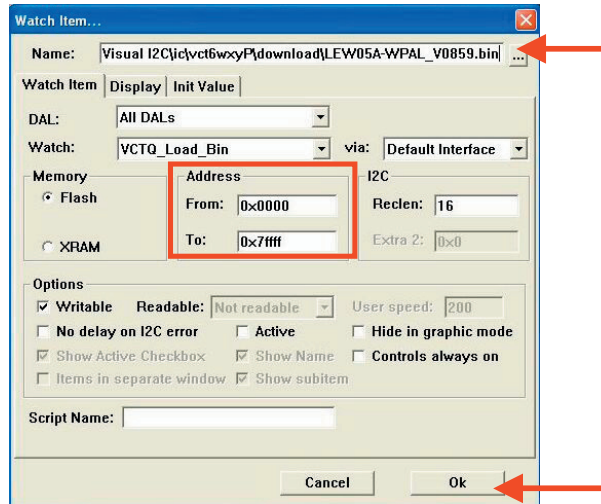

7. Click on the “Load Bin à Flash” to start updating process.

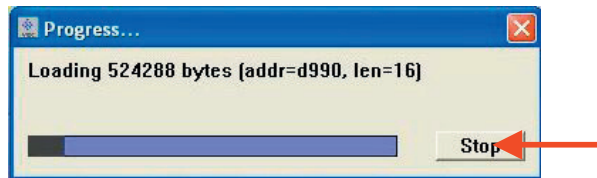

8. When the updating process finishes, the “Progress” pop up window automatically closes. If appears some problem during the updating process a error label appears in the filename information line.

If the TV has problem to enters in the “Bootloader mode”, it’s possible to force it by hardware method. This alternative method is described below:

1. Switch off TV set or hold VCTp RESET line to GND.
2. Pull down SCL line (pin 1) to GND (pin 3) in P2306 connector.
3. Switch on TV set or release VCTp RESET line.
4. Release SCL pull down after minimum of 2 seconds.
5. Check if VCTp is in bootloader mode with Autoread setting in ON.
6. Wait until “40” appears in Bootloader Version field.
7. Follow instruction from item 5 on software method.

Sometimes, depending on the PC hardware, the progress bar runs very fast (Normal time: 1 minute) or some error message appears in the filename information line. This means it’s necessary to modify some parameter of LPT port, for this reason select “LPT Preferences” on the “File\Preferences...” menu and increase Delay from “0” to “1” or “2” (normally, these values are the best choice).

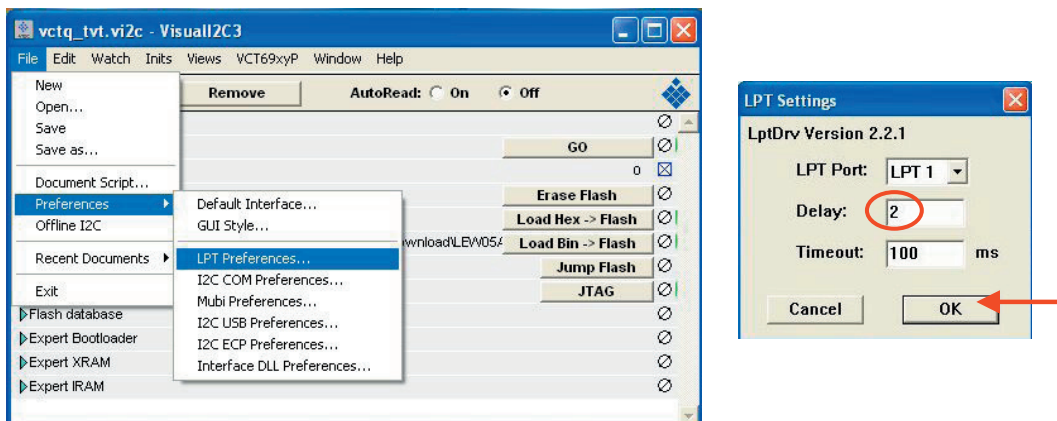

2. How to update the Digital Board Software.

There are 2 methods to update the Digital Board Software on Flash Memory (IC4203) through the Digital Processor (IC4001).

- Jig RS-232 Method (From PC through RS-232C COM port).
- PCMCIA CARD (Compact Flash Memory) Method.

Note: The PCMCIA method is only compatible with those PCs running XP Windows Version.

2.1. Jig RS-232 Method Description

• **Hardware requirements:**

1. A modem null (Cross type) DB9 female to DB9 female cable.
2. The Jig Kit (Sharp Code: QCNWKA012WJZZ)
3. Make the connections as in the below figure.

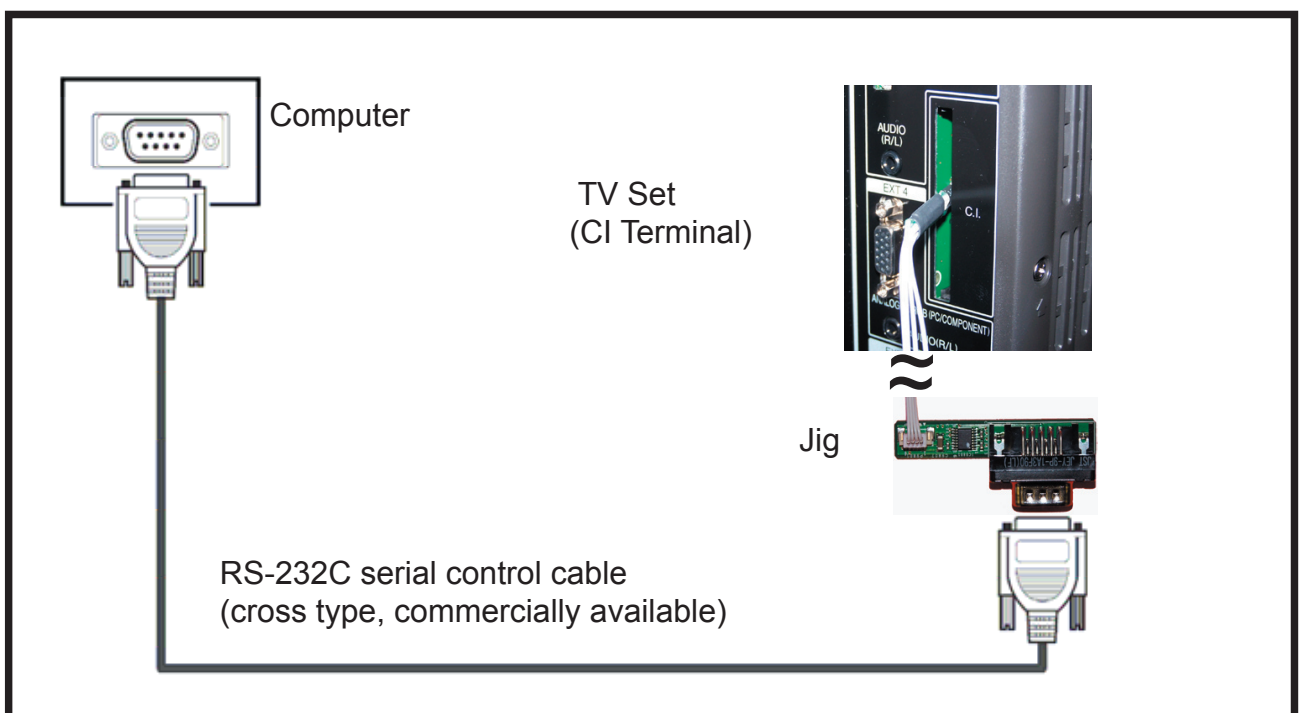

• **Software requirements:**

1. "Winupload" application software on PC.

• **How to setup the "Winupload" software for the first time:**

1. Start "Winupload". It will appear the following picture.

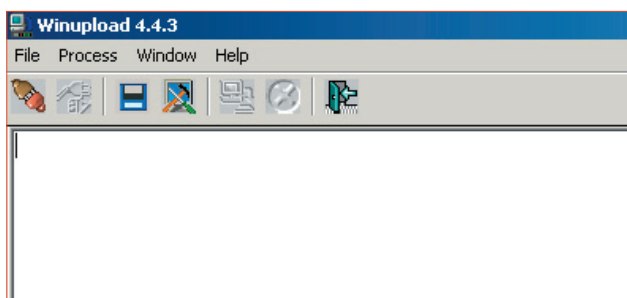

Digital Board Software Updating , Jig RS-232 (continued)

2. Select the most suitable RS232 Serial Port from “Port Setting” - “Process” Menu.

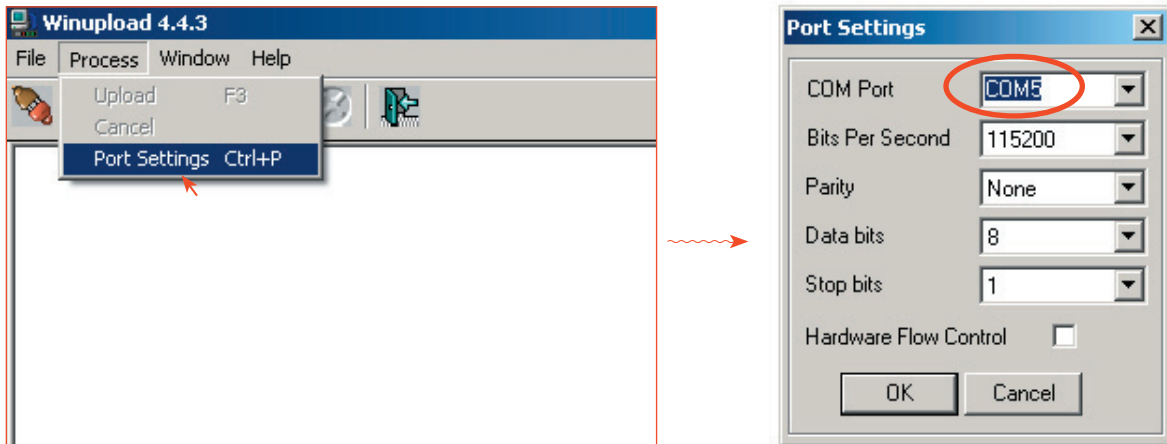

3. Select the following settings from “Port Settings” Menu.

- Bits Per Second: 115200
- Parity: None
- Data bits: 8
- Stop bits: 1
- Hardware Flow Control: OFF

• Procedure for updating the TV set.

1. Switch off the TV set to be updated, in DTV mode.
2. Start “Winupload”. It will appear the following picture on PC.

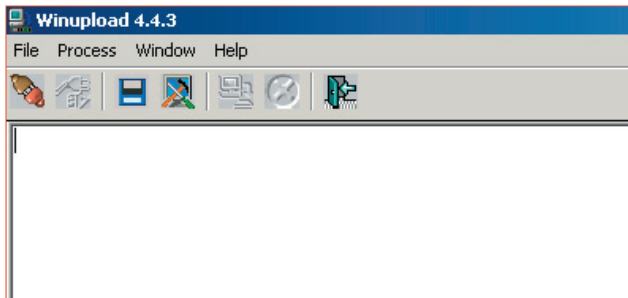

3. Establish connection on Winupload Software.

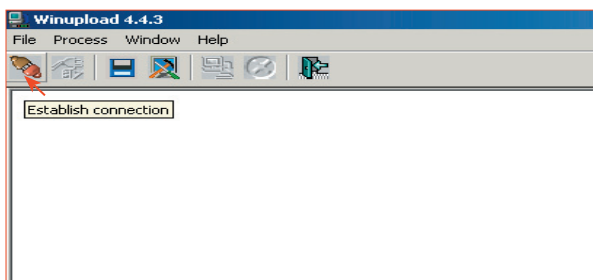

Digital Board Software Updating , Jig RS-232 (continued)

4. Select "Upload URT file"

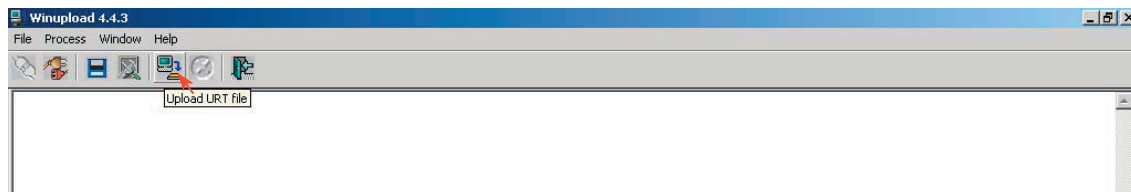

5. Select and open the ".urt" data file from data directory

Note: Consider the version shown below just an example, may be is not the latest one, and could be different depending on the TV set destination (market/Country) or model.

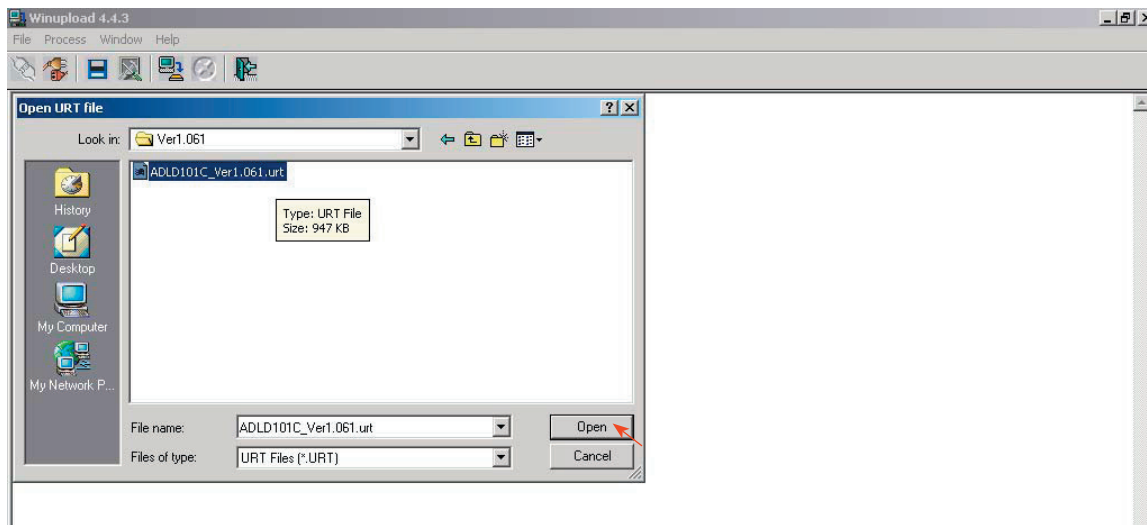

6. Switch On the TV Set (previously in DTV Mode). The Uploading Process starts automatically.

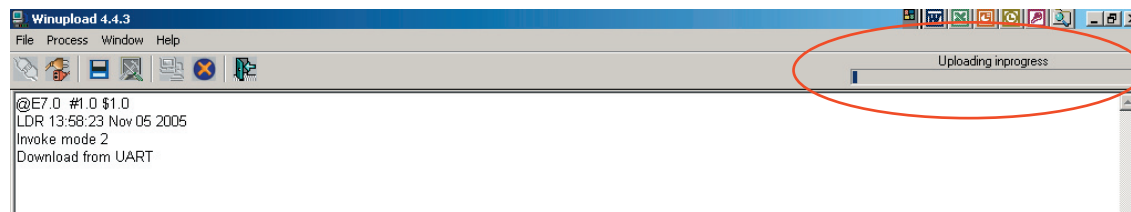

While the TV set is uploading the software, the following information is shown on the TV set screen.

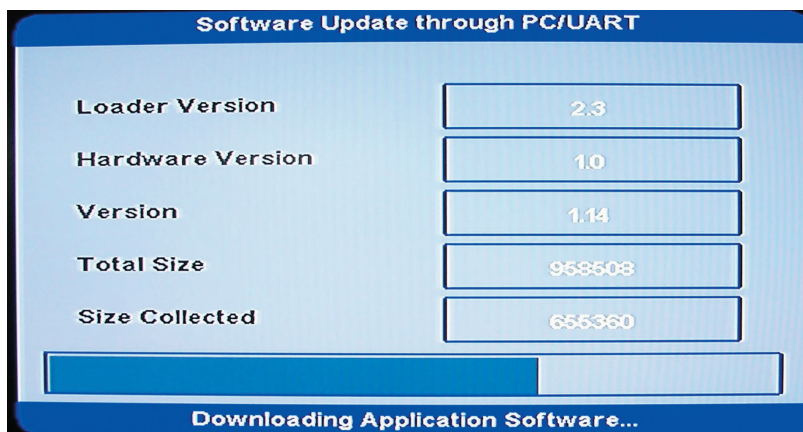

Digital Board Software Updating , Jig RS-232 (continued)

Then, data transfer from PC to TV set finishes when the "Upload progress completed" label appears in the "Winupload" screen. Now, the TV set made some additional verification (Items #2 to #7). When the full uploading process is finished, in the "Winupload" window appears the label "Preparing to start application" for a new TV Set, and just now, in the TV screen of the updated set, appears a congratulations label (Item #8).

PC SCREEN PROGRESS

TV SCREEN PROGRESS

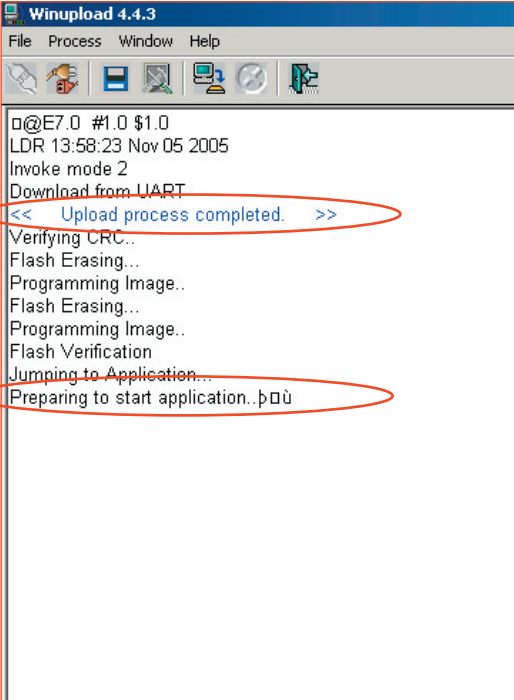
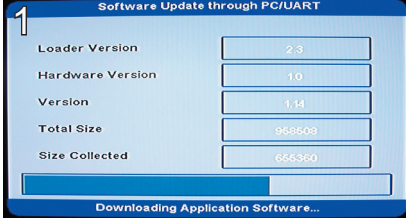
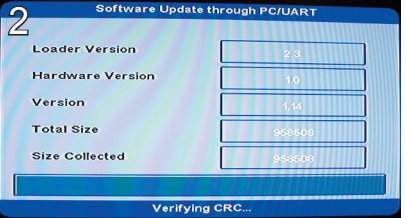
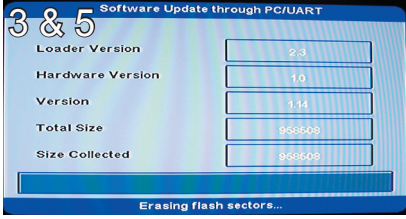
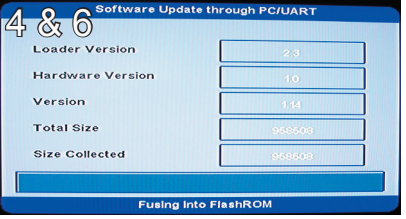
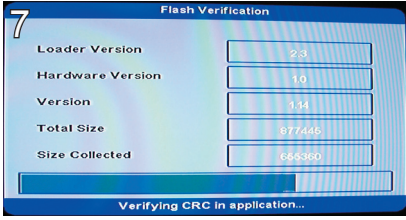
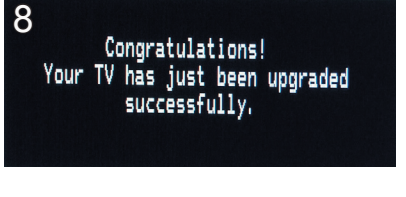
TV INDICATION	1	 <p>Winupload 4.4.3 File Process Window Help @@E7.0 #1.0 \$1.0 LDR 13:58:23 Nov 05 2005 Invoke mode 2 Download from UART 1 << Upload process completed. >> 2 Verifying CRC.. 3 Flash Erasing.. 4 Programming Image.. 5 Flash Erasing.. 6 Programming Image.. 7 Flash Verification 8 Jumping to Application.. 9 Preparing to start application..b00</p>	1	 <p>Software Update through PC/UART Loader Version 2.3 Hardware Version 1.0 Version 1.14 Total Size 958508 Size Collected 655360 Downloading Application Software...</p>	2	 <p>Software Update through PC/UART Loader Version 2.3 Hardware Version 1.0 Version 1.14 Total Size 958508 Size Collected 958508 Verifying CRC...</p>				
	3		3 & 5		 <p>Software Update through PC/UART Loader Version 2.3 Hardware Version 1.0 Version 1.14 Total Size 958508 Size Collected 958508 Erasing flash sectors...</p>		4 & 6	 <p>Software Update through PC/UART Loader Version 2.3 Hardware Version 1.0 Version 1.14 Total Size 958508 Size Collected 958508 Fusing into FlashROM</p>		
	7		7				 <p>Flash Verification Loader Version 2.3 Hardware Version 1.0 Version 1.14 Total Size 977448 Size Collected 655360 Verifying CRC in application...</p>		8	 <p>8 Congratulations! Your TV has just been upgraded successfully.</p>

Note: Do not turn off the TV set while the software updating was in progress.

7. Unplug the AC cord.

8. Disconnect the Jig from TV Set.

• Software Version verification procedure.

1. Connect the AC cord and Switch On the TV Set.
2. Select DTV Menu on TV Set. The following On Screen Display will appear.

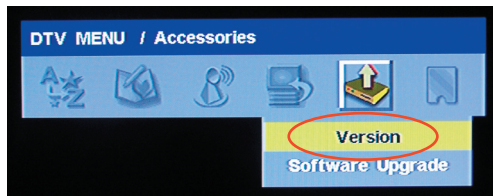

3. Select "Version". The updated version can be verified.

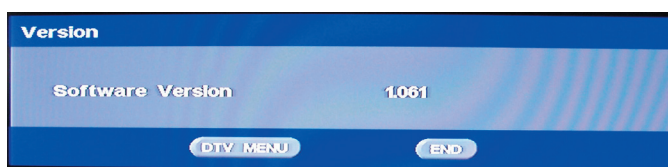

Note: Consider the version shown above just as example, may be is not the latest one, and could be different depending on the TV set destination (market/Country) or model.

2.2. PCMCIA Card (Compact Flash) Method.

• Hardware requirements:

1. Compact Flash Memory Card.
2. PCMCIA Compact Flash Adapter or USB Multi Card Reader.

• Software requirements:

1. "StorageMediaManager1.0.1" application software, installed on PC.
2. "Loader 2.2" or higher application software, installed on DTV Set.

Note: *Storage Media Manager only for Windows XP.*

• How to prepare the CF Card using the "Storage Media Manager 1.0.1" (SMM):

1. Insert PCMCIA (Compact Flash(CF) + CF-Adapter)

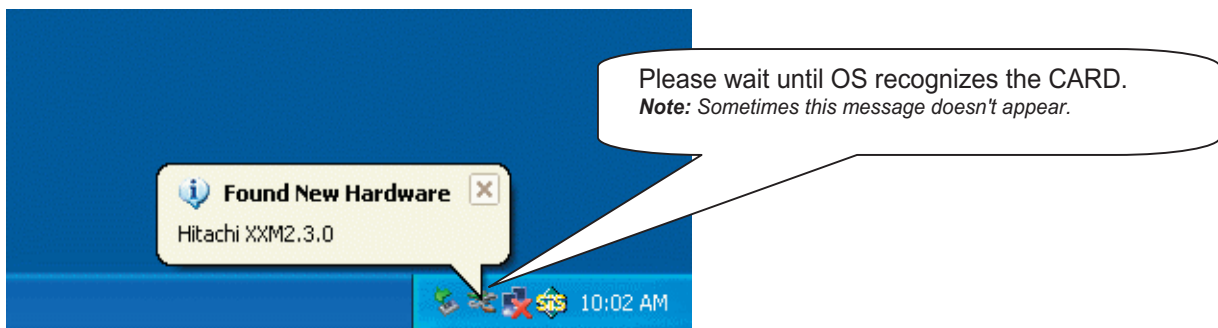

2. Execute SMM. If SMM does not appear or a Windows Error Box appears, please verify there are no USB media drives connected to the PC.

Note: *Consider that it's recommended remove unnecessary media during SMM execution. Probably, If you try to use an USB Multi Card Reader with SMM doesn't work fine.*

3. If the CF card has never been formatted for the SMM (is not same format type used in Windows), the SMM will show you the PCMCIA-CF drive as a Windows Media Drives, hanged of the "My Computer" tree ("J" Drive in the picture showed below).

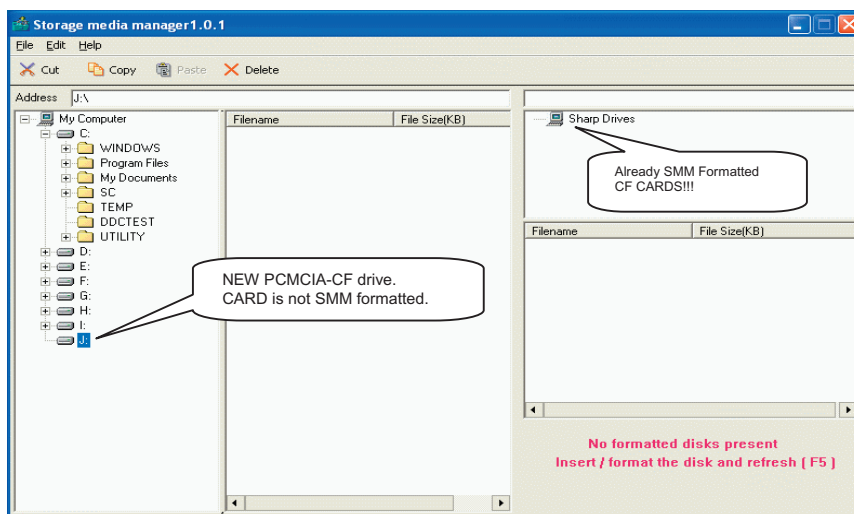

But, if the PCMCIA-CF card had been formatted previously by SMM, directly the PCMCIA-CF drive will appear in the SMM formatted Drives box (**Sharp Drives**). Please go to Item #6.

Digital Board Software Updating , PCMCIA (continued)

4. In case of not SMM formatted card, select PCMCIA-CD Drive and using the Right-Click Pop up Menu please format the Drive.

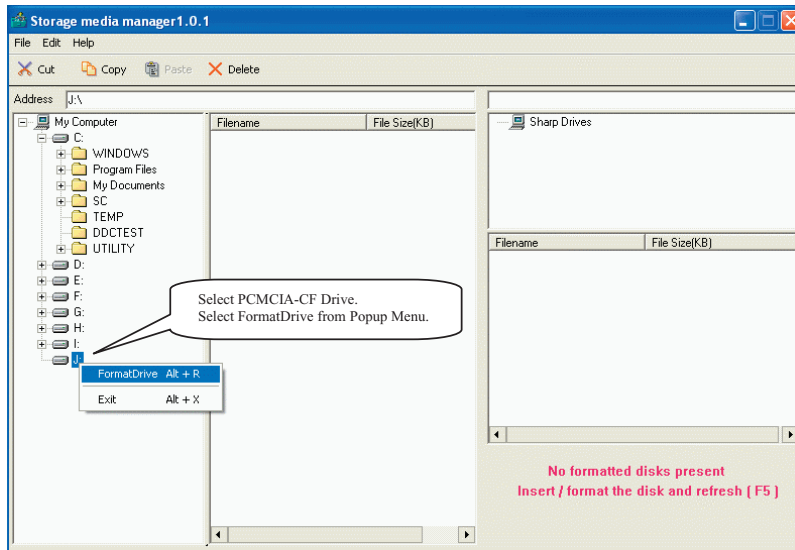

5. Formatting the CF card. Select "Yes" to confirm the action.

NOTICE: All FC's data of the inside are erased.

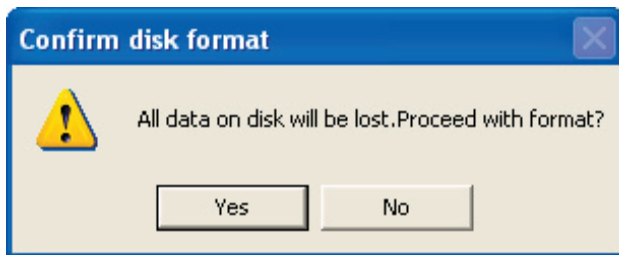

6. If SMM formatted card already appears under SHARP DRIVES box please continue, if not try to repeat from item #1. Select origin folder and ".img" data file to be written in the CF card.

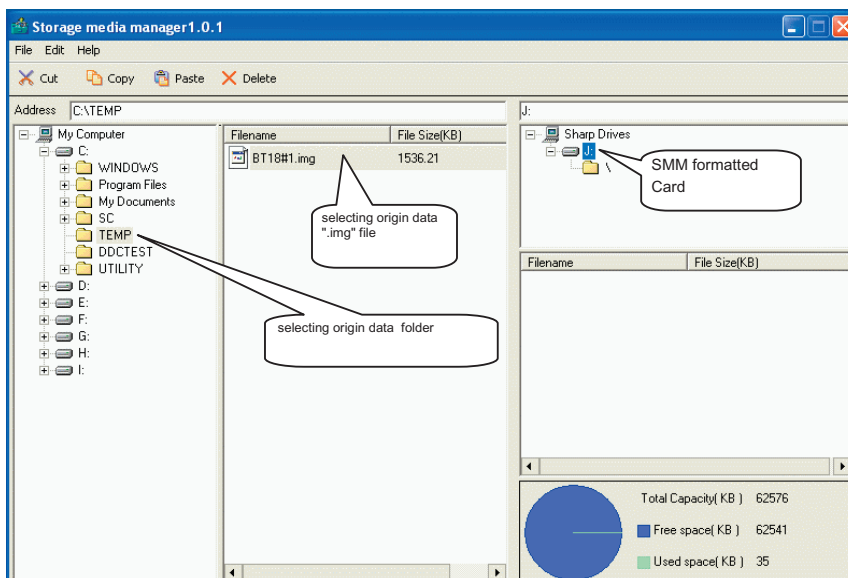

Digital Board Software Updating , PCMCIA (continued)

7. First of all, select copy target drive and then use Drag & drop for the “.img” file.

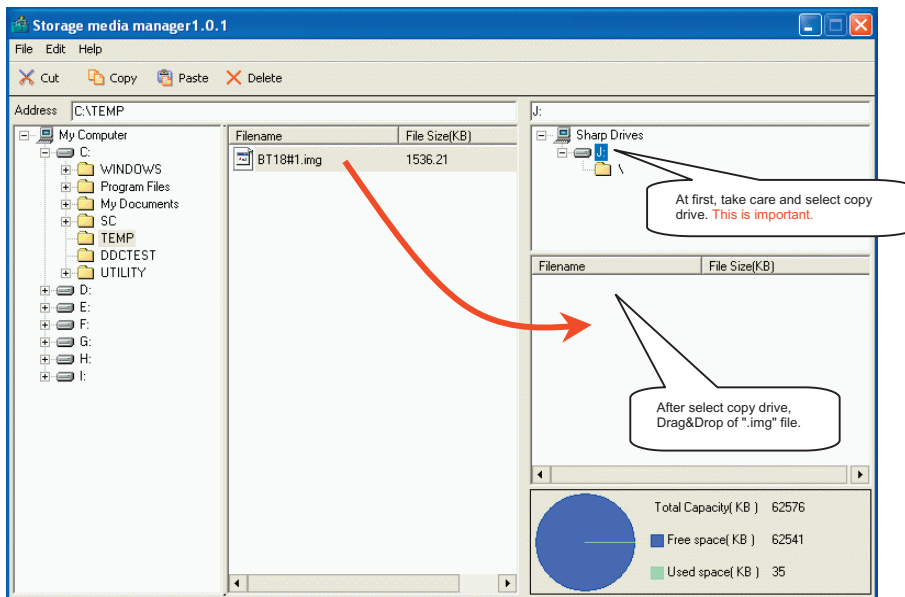

8. Wait, copy is in process.

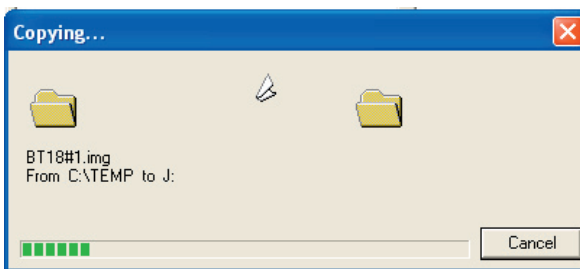

9. Copy is finished, when the Copying progress bar disappears and the name of data file appears in the File Box.

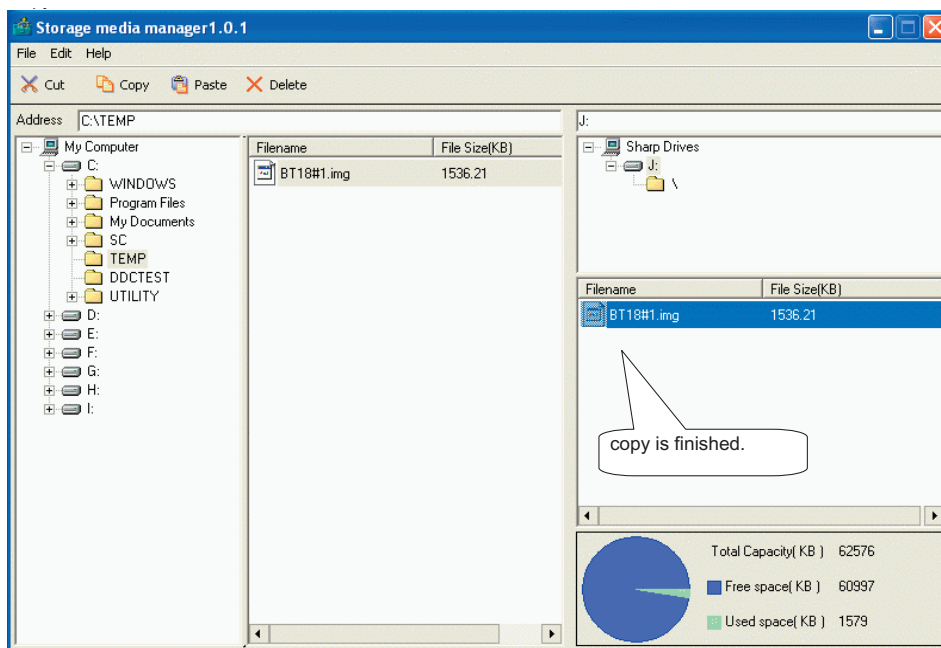

Digital Board Software Updating , PCMCIA (continued)

10. Close SMM application.
11. Remove PCMCIA safely using the Windows Task bar pop up menu (Right-click over the Tray Icon).



12. Now, the PCMCIA-CF card is prepared to update the TV set.

• Procedure to update the TV Set using PCMCIA-CF Card:

1. Switch Off the LCD TV Set.
2. Insert PCMCIA Card (already prepared according the details before given at “How to prepare the CF Card using the “Storage Media Manager 1.0.1” (SMM)”).
3. Switch On the LCD TV Set (it starts automatically the updating, Items #1 to #4).

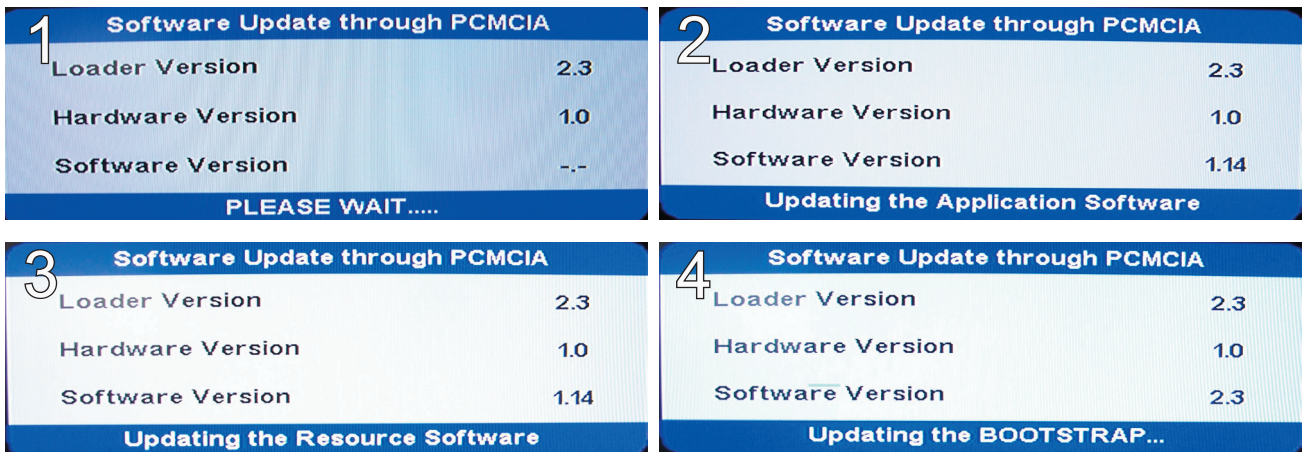

4. Wait till the finishing indication is shown.

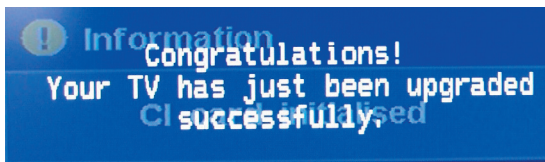

5. For checking the correct update, please Select DTV Menu on TV Set. The following On Screen Display will appear.



6. Select “Version”. The updated version can be verified.

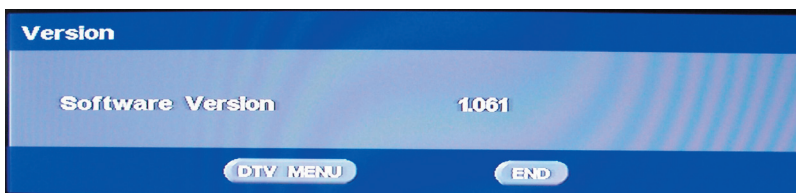

TROUBLESHOOTING TABLE

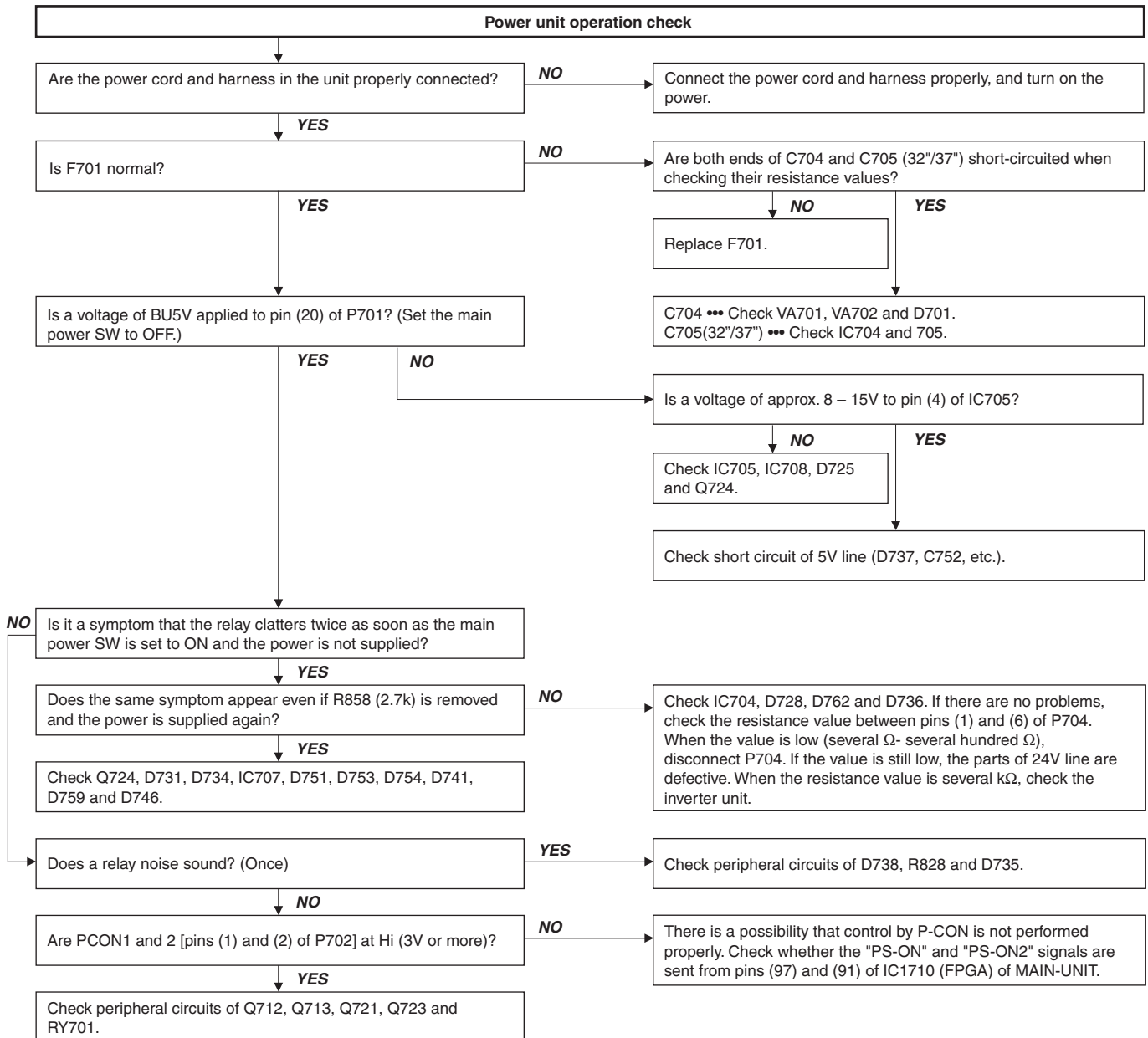

Troubleshooting Table (continued)

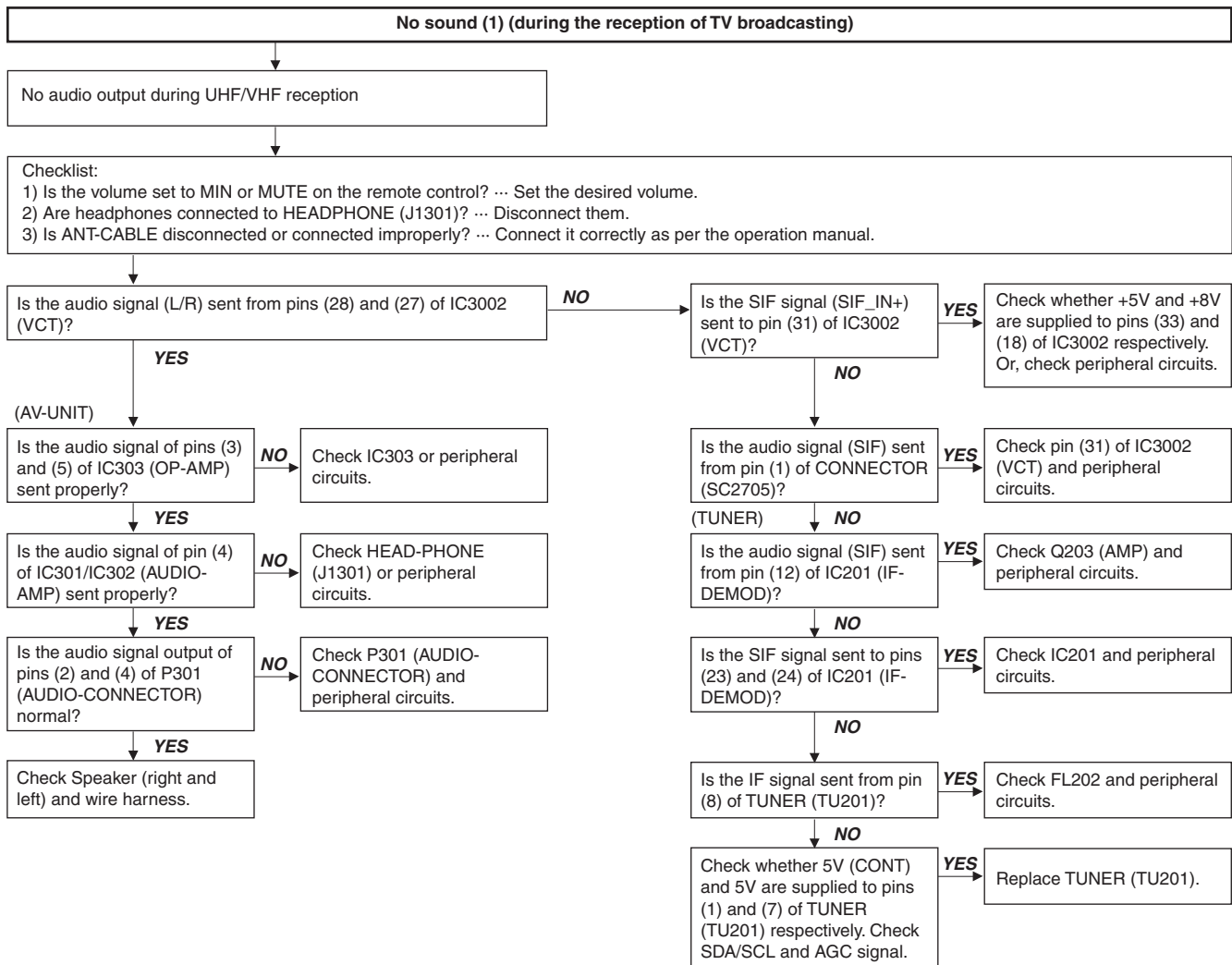

Troubleshooting Table (continued)

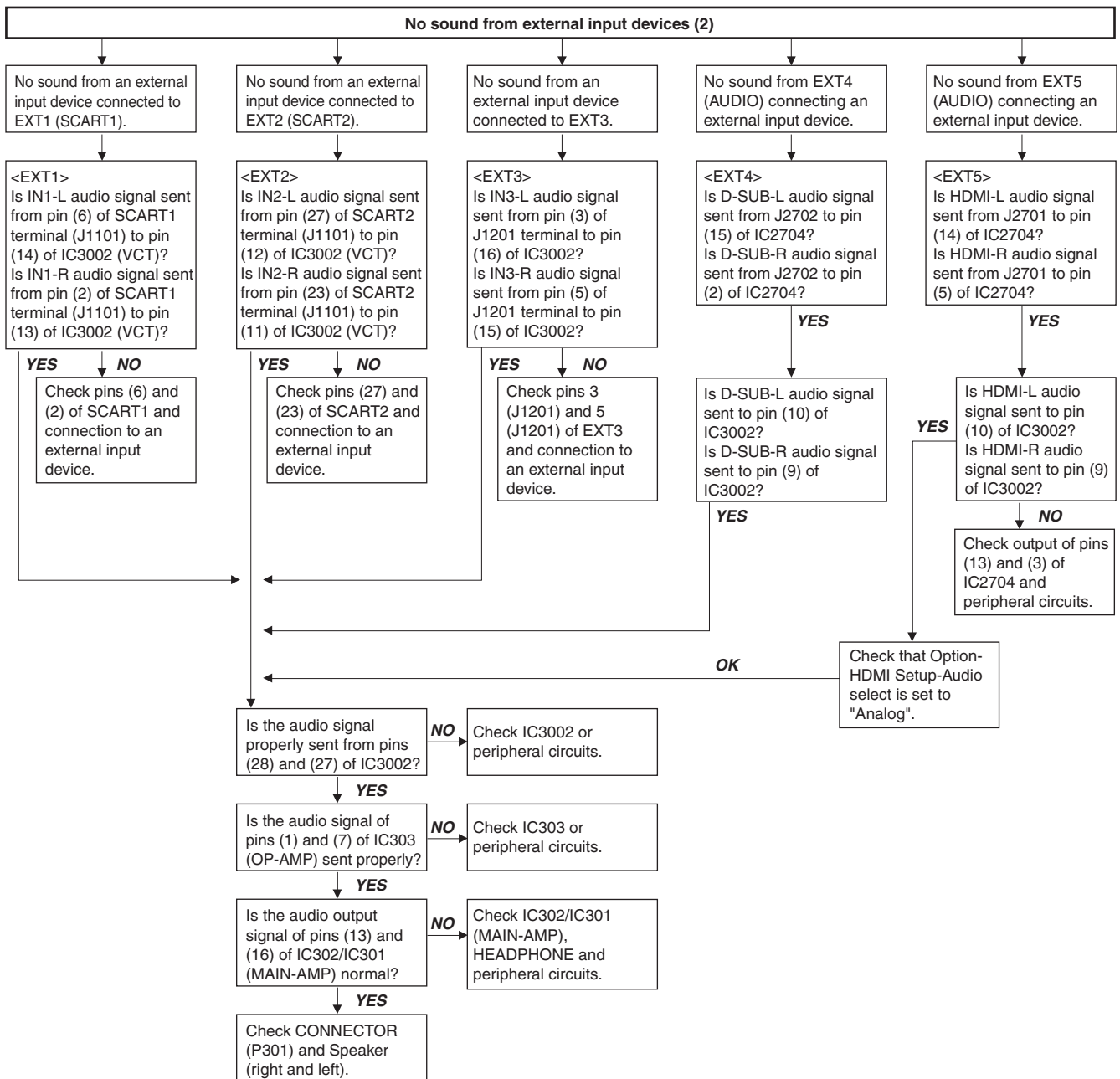

Troubleshooting Table (continued)

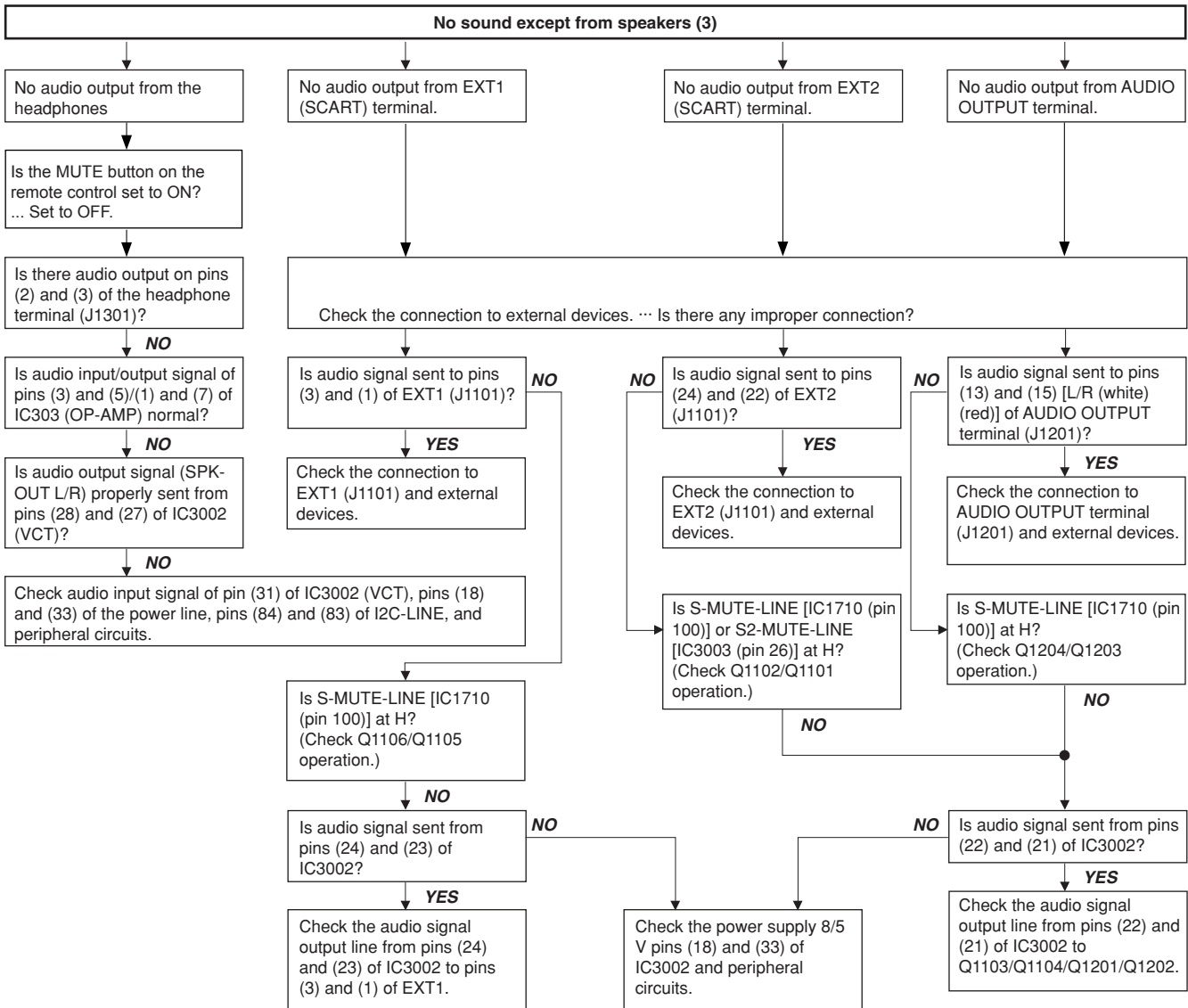

Troubleshooting Table (continued)

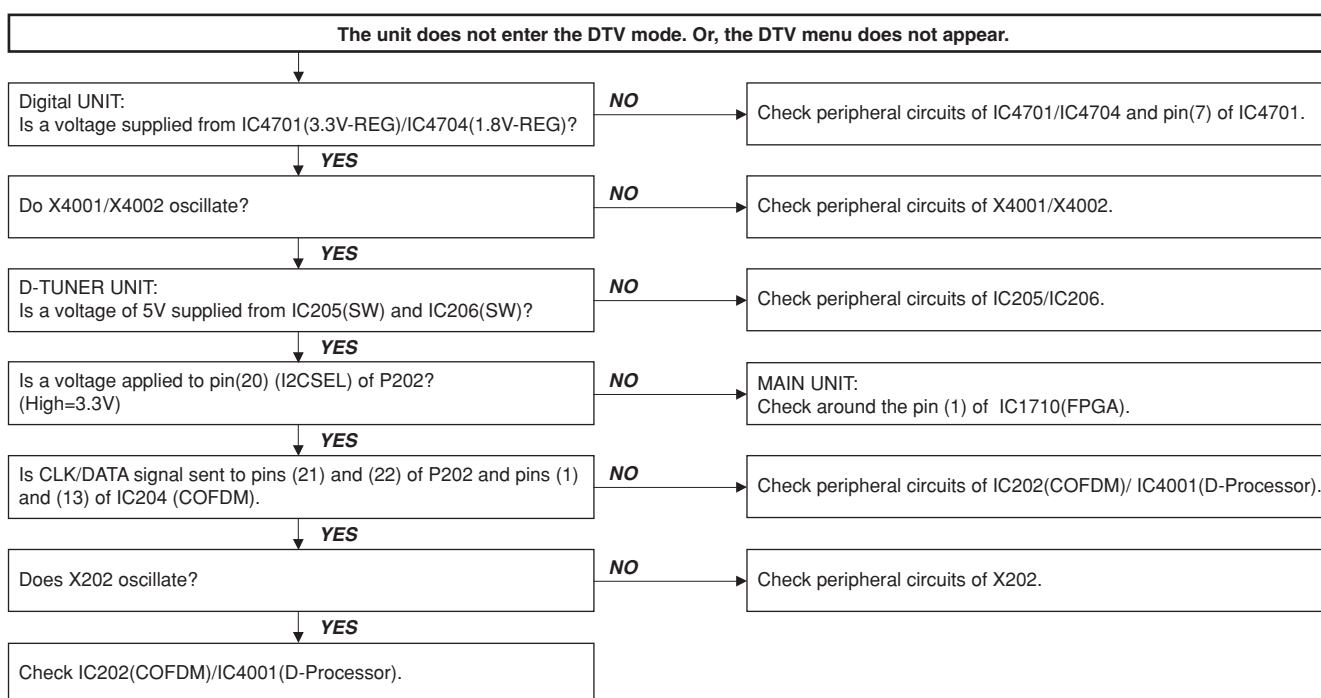
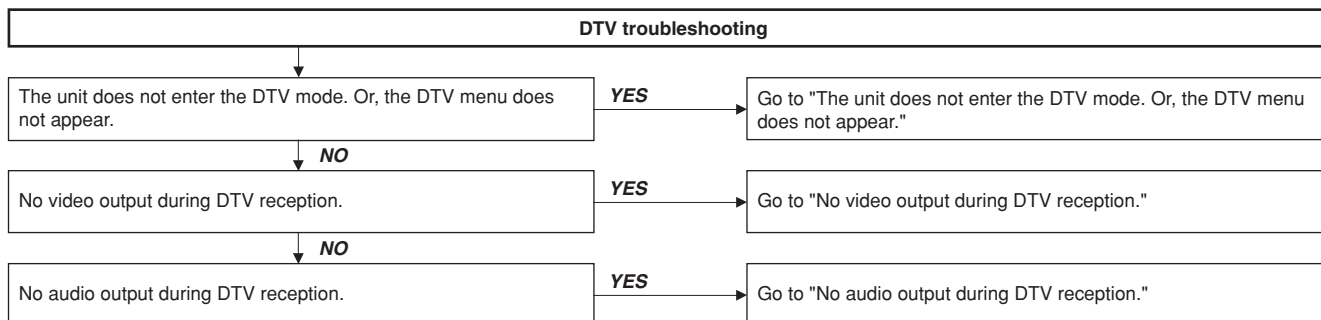

Troubleshooting Table (continued)

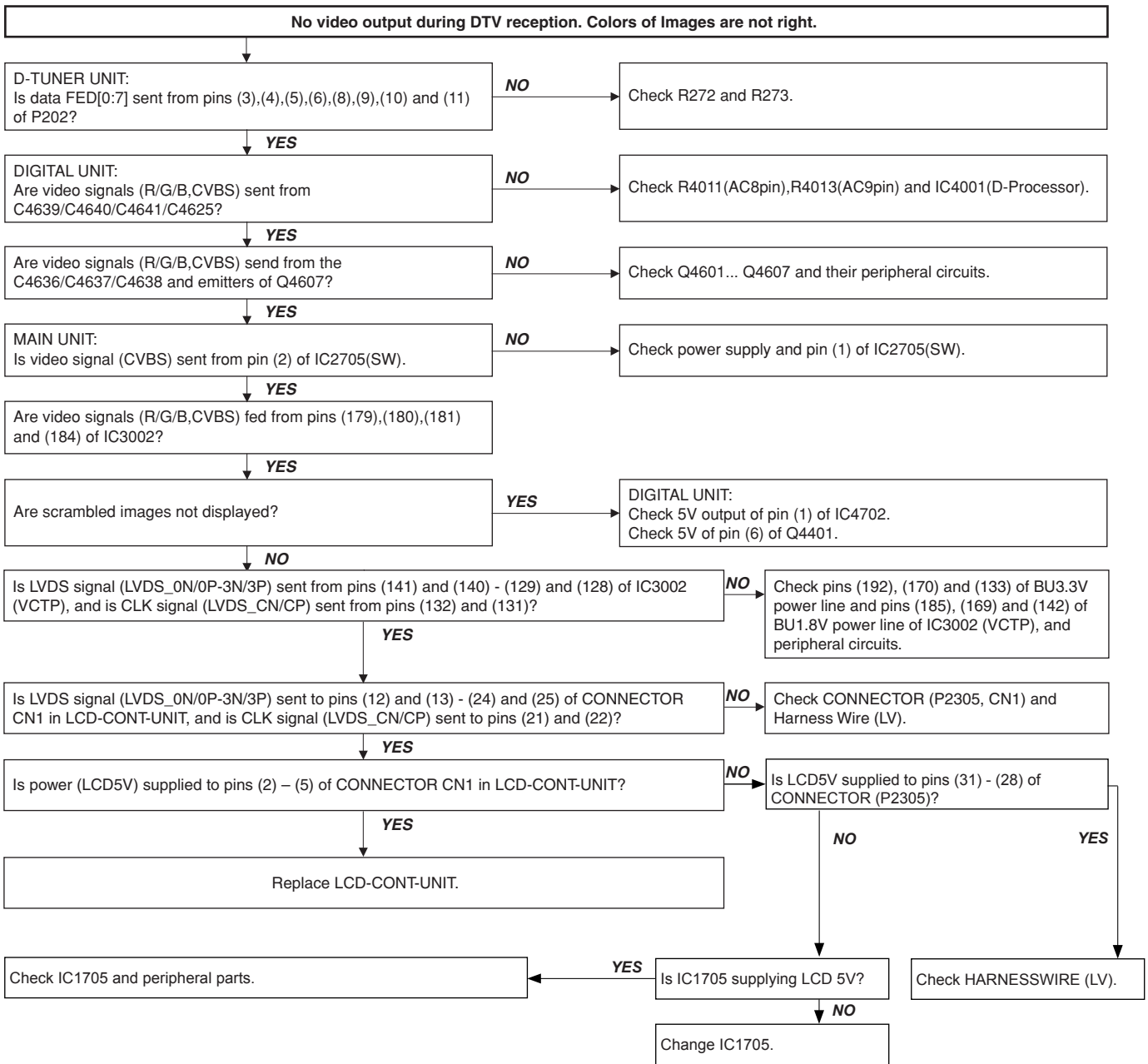

Troubleshooting Table (continued)

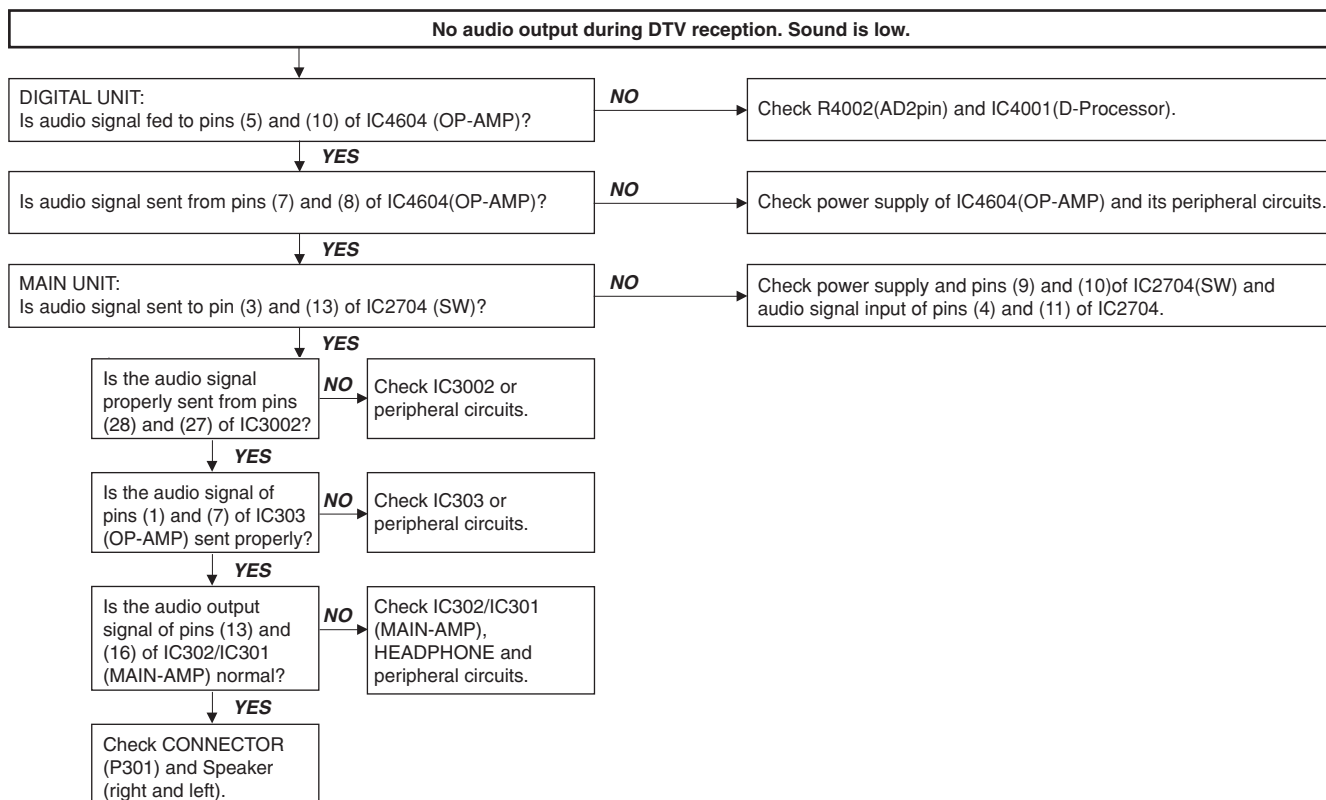

Troubleshooting Table (continued)

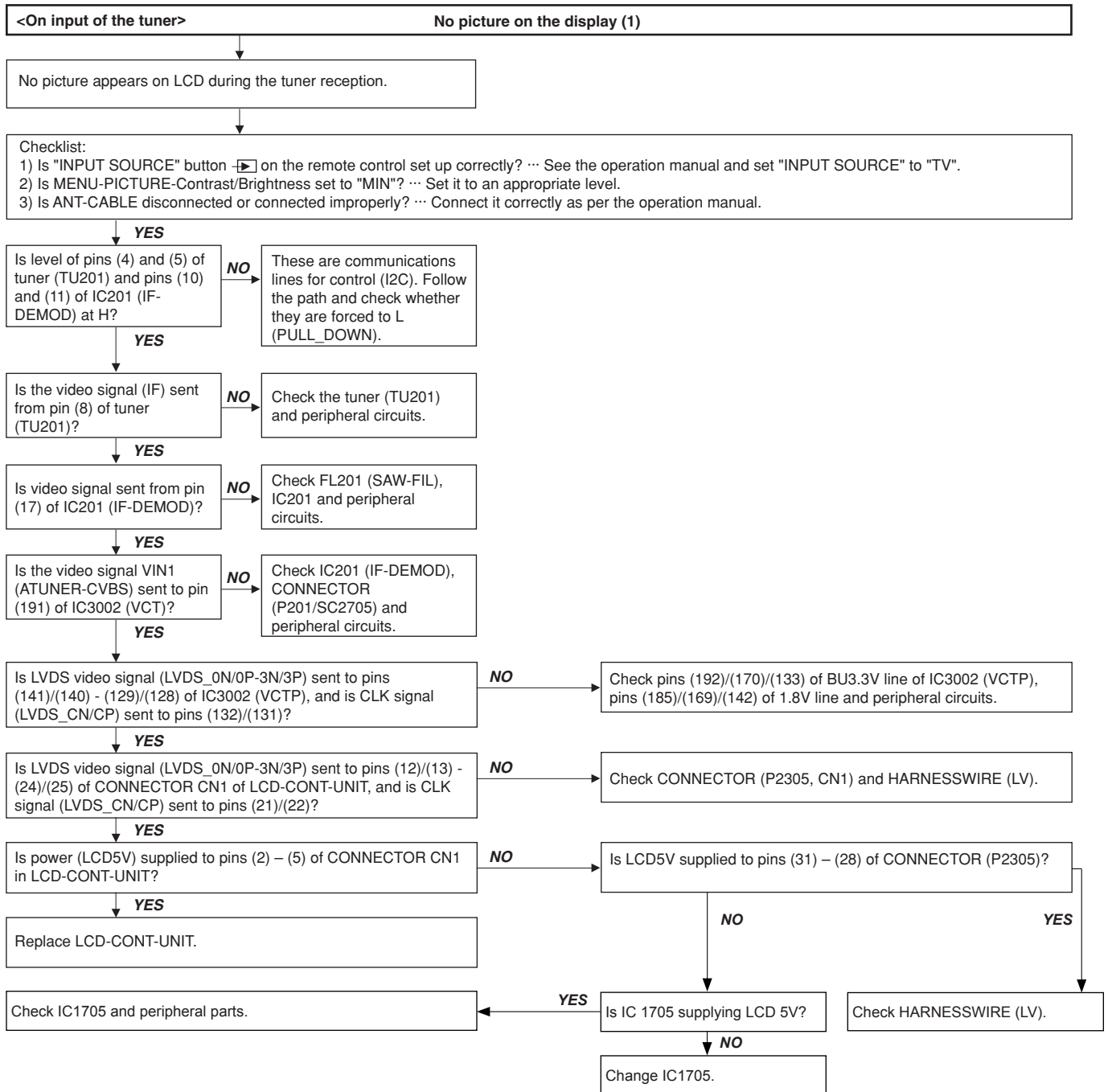

Troubleshooting Table (continued)

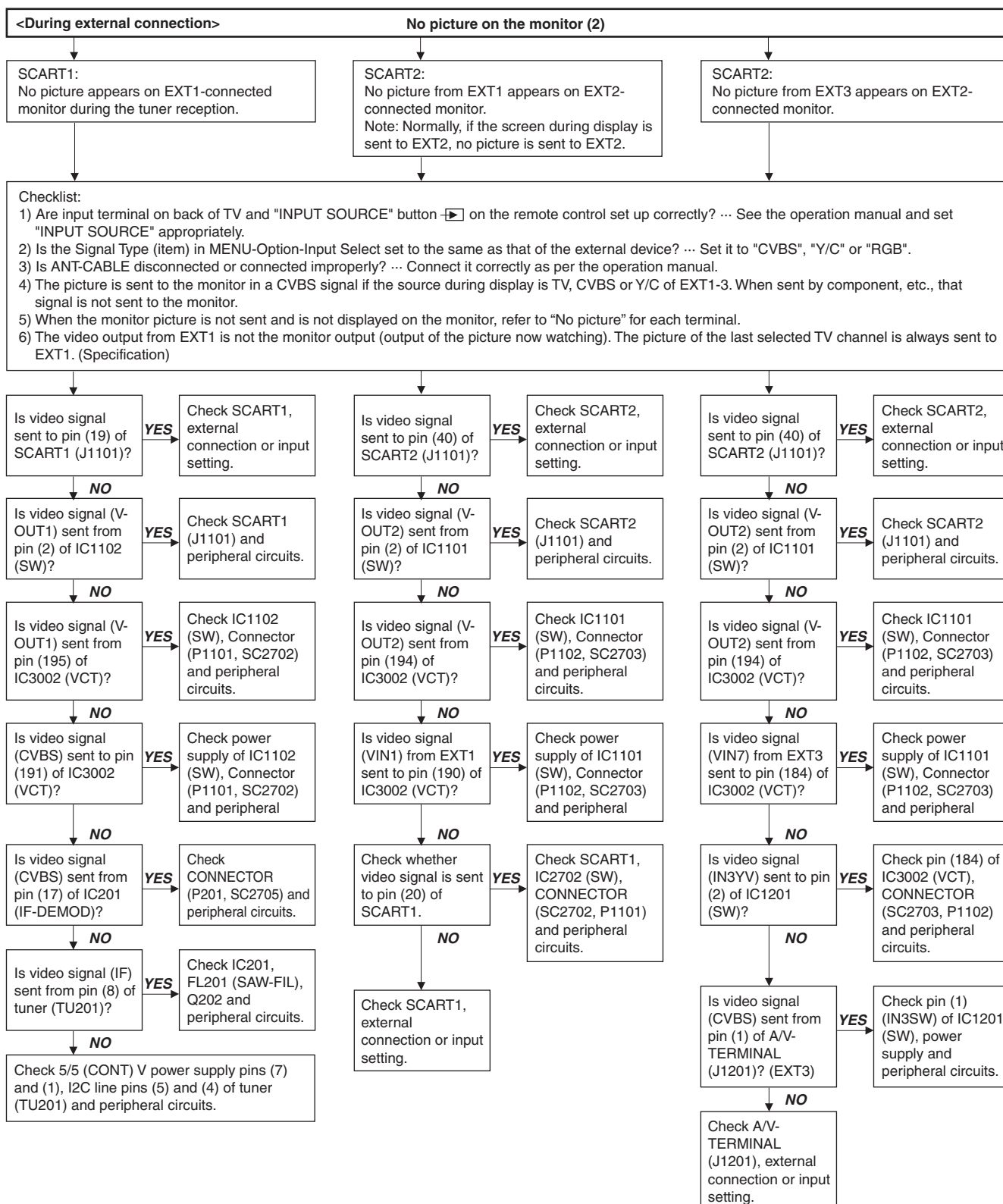

Troubleshooting Table (continued)

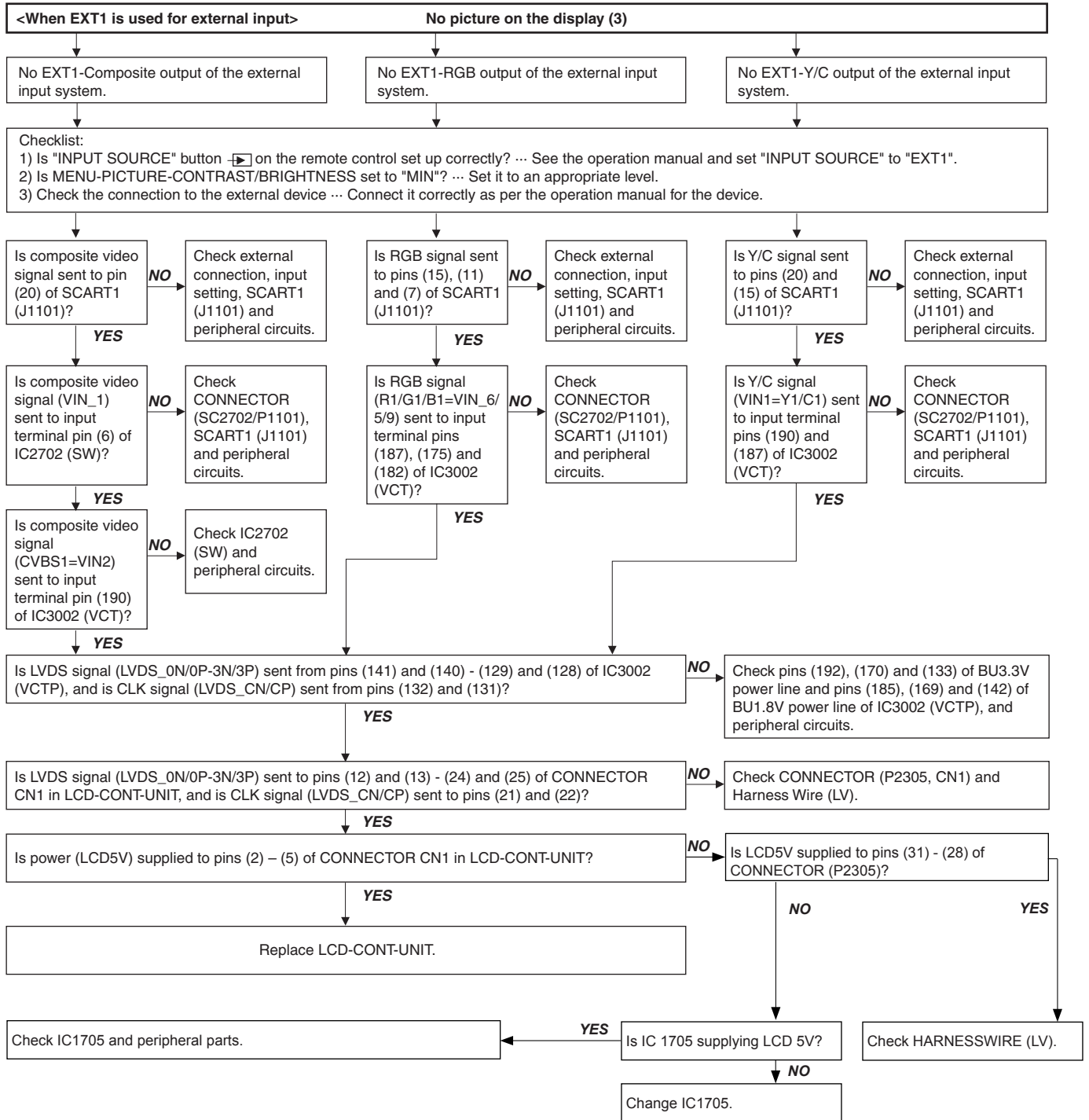

Troubleshooting Table (continued)

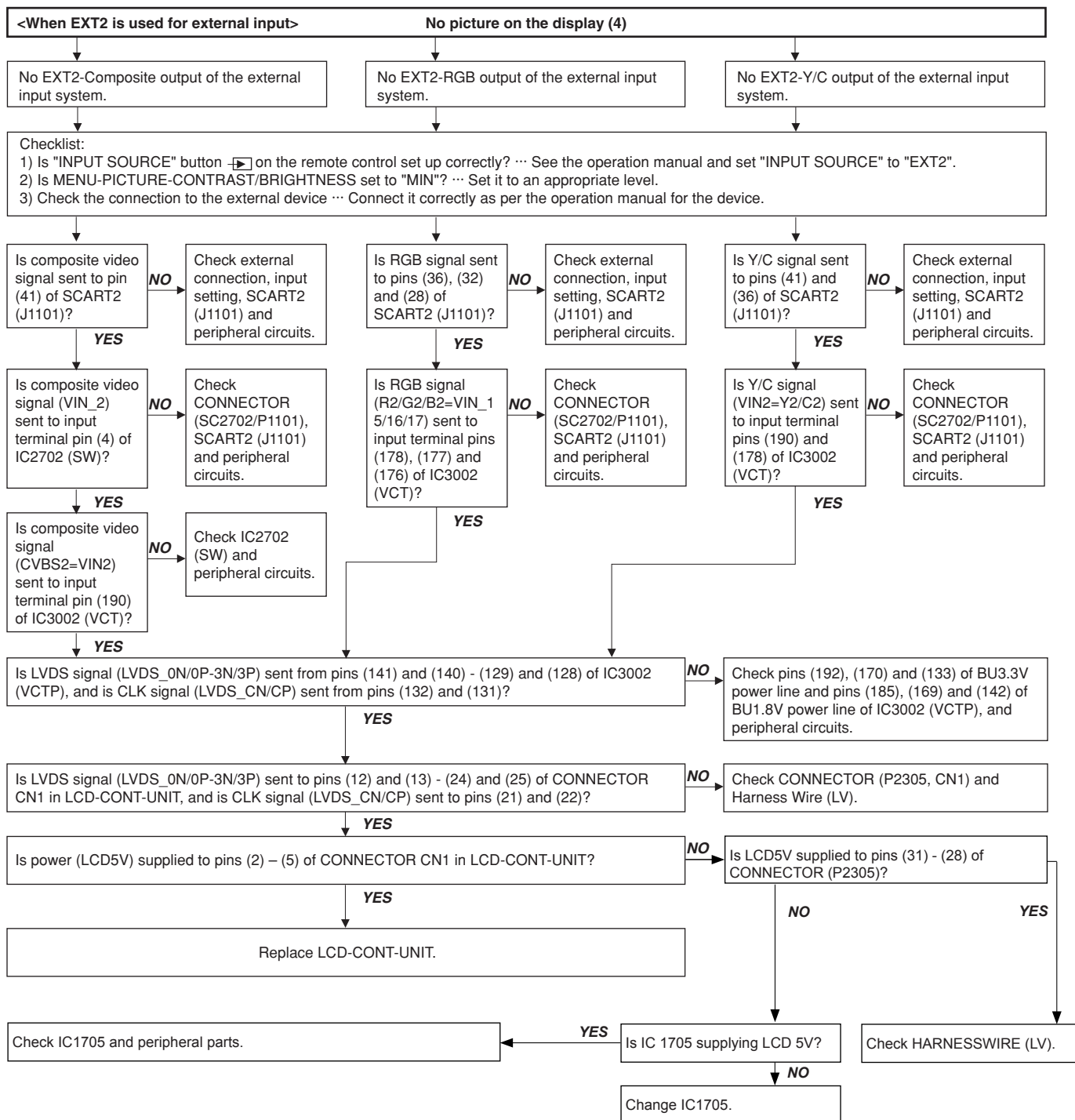

Troubleshooting Table (continued)

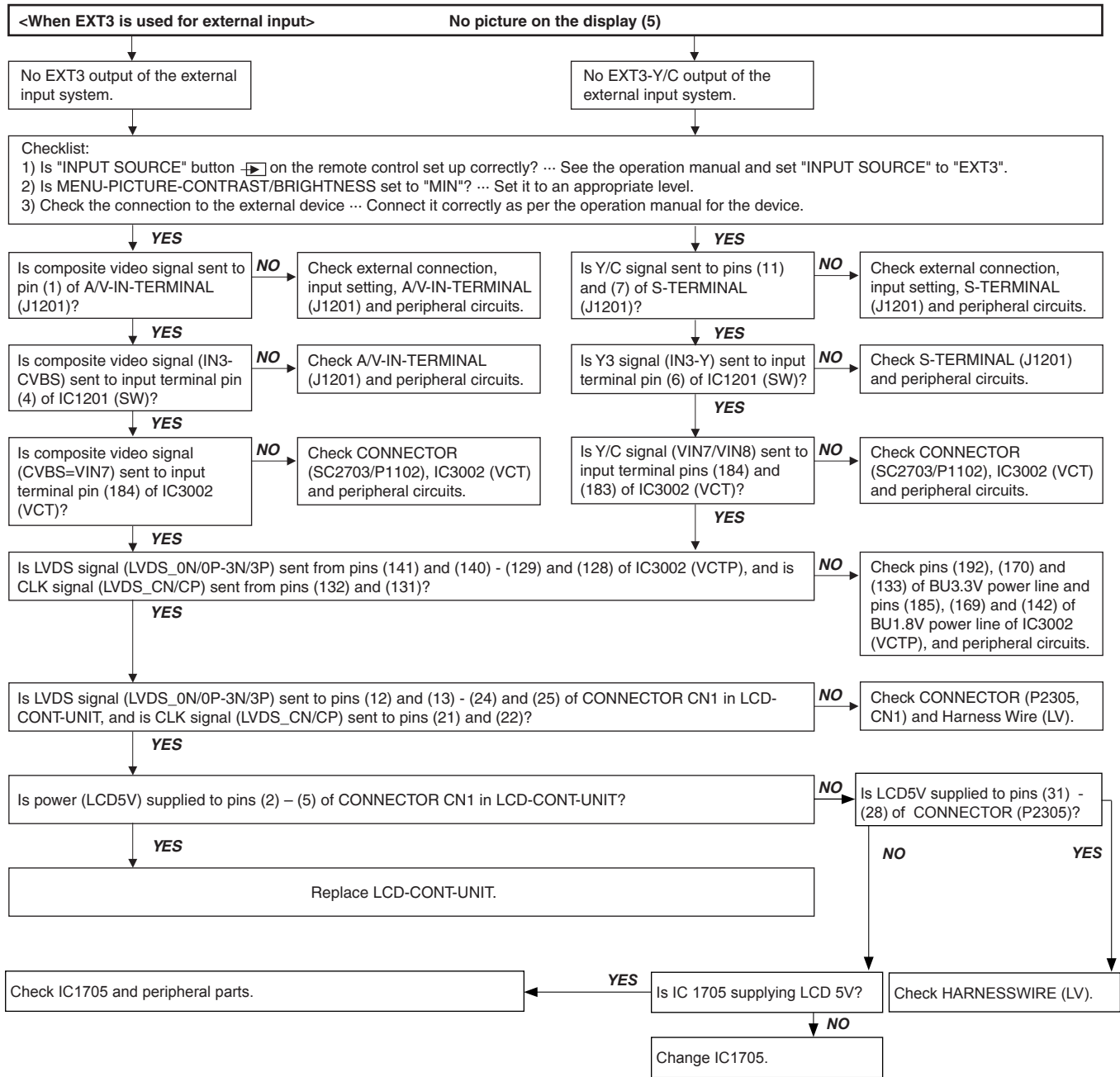

Troubleshooting Table (continued)

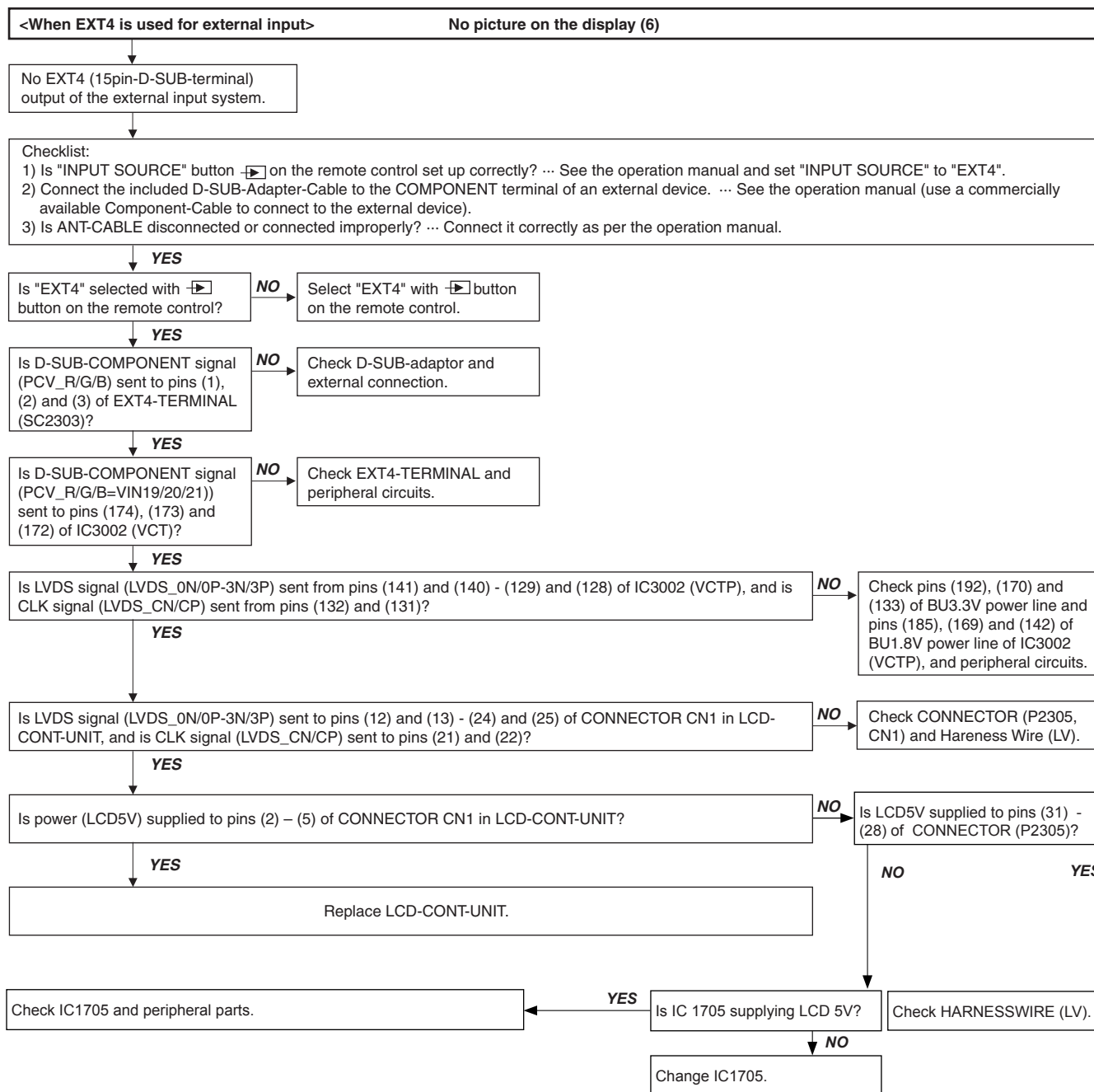

Troubleshooting Table (continued)

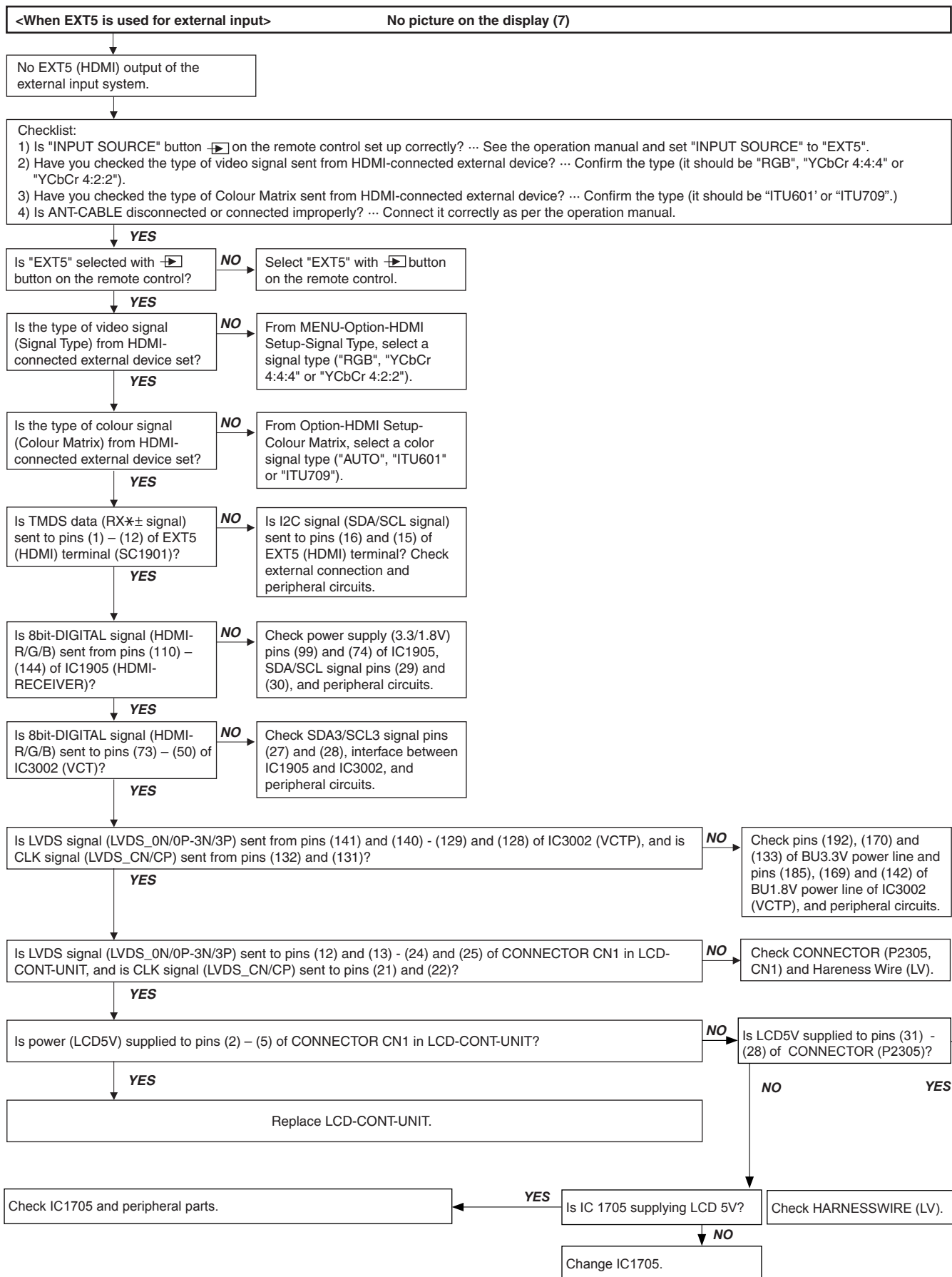

Troubleshooting Table (continued)

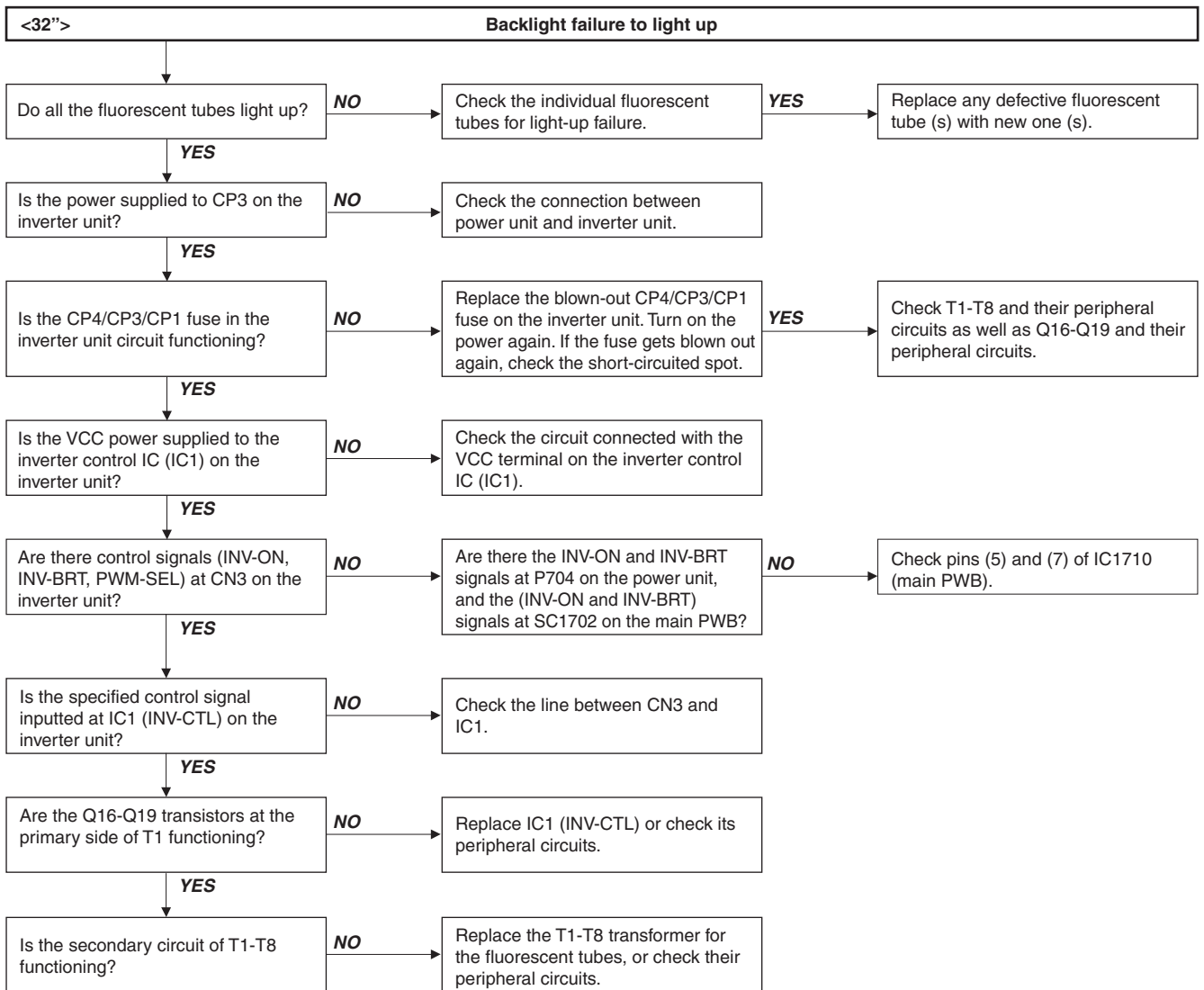

Troubleshooting Table (continued)

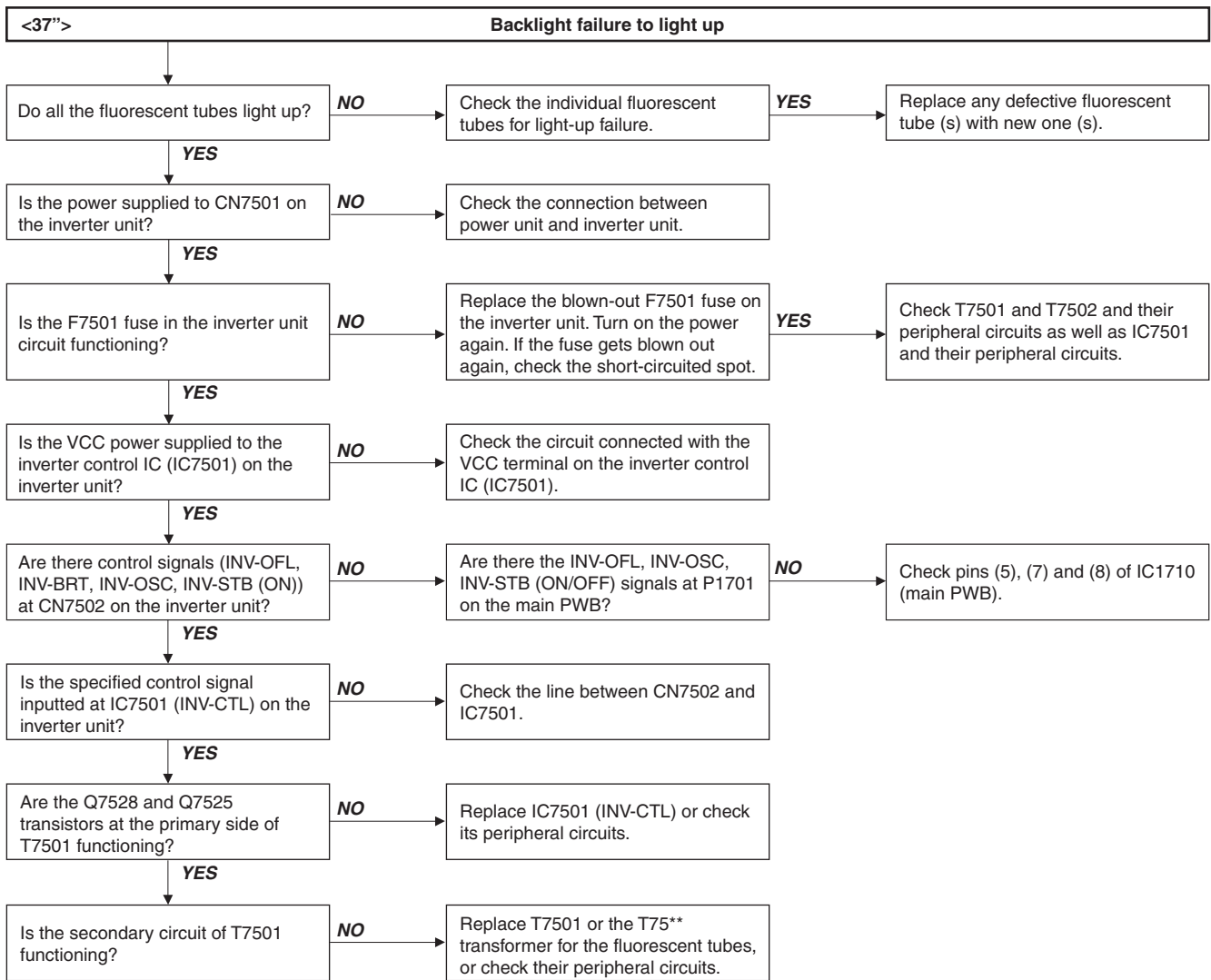

Troubleshooting Table (continued)

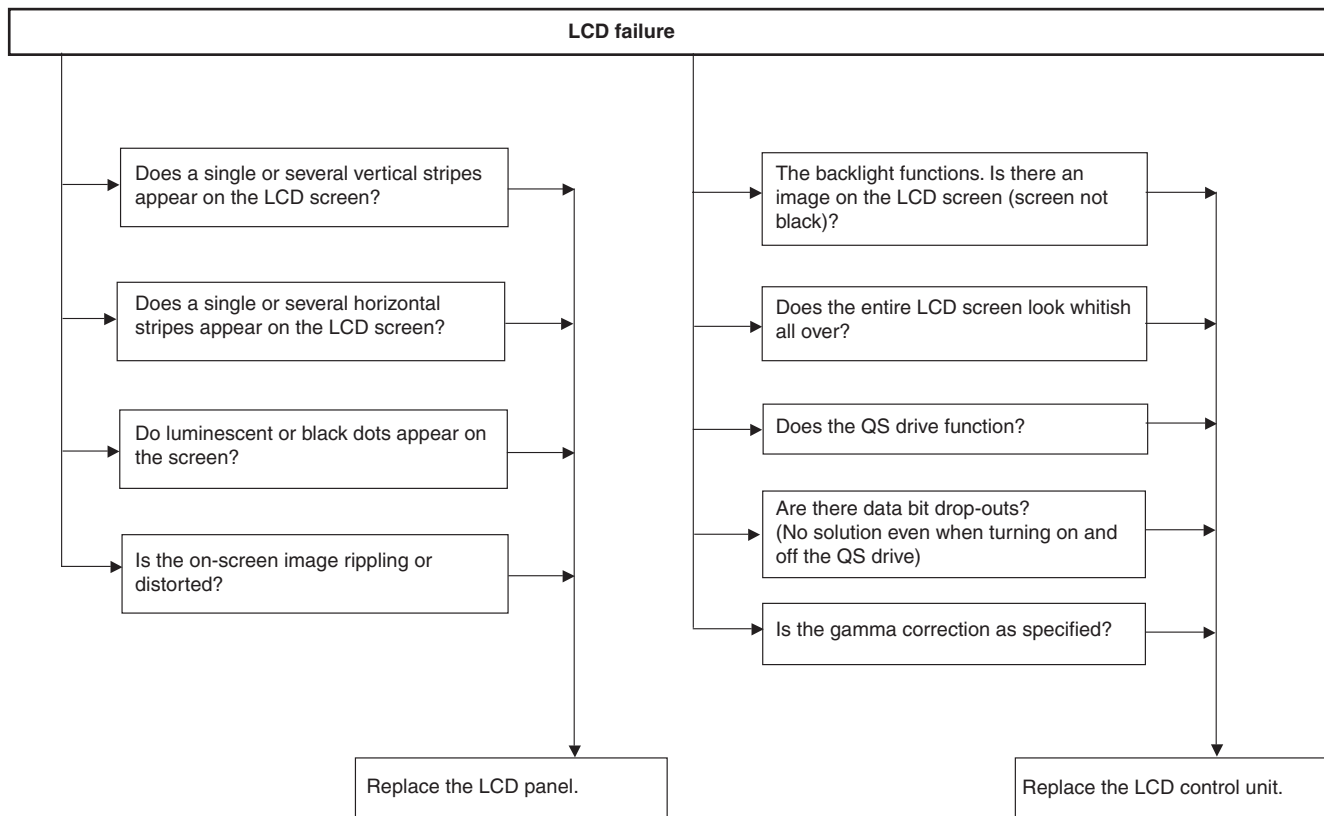

MAJOR ICs INFORMATION

1. General ICs Information

XD890WJ (MAIN UNIT):

· **IC1905** : HDMI RECEIVER

Part number: Sii9021

Sharp code: VHISII9021+-1Q

The Sii9021 is a second generation panel link cinema receiver that is compatible with the HDMI 1.1 (High Definition Multimedia Interface) specification. The Sii9021 is capable of receiving and outputting two channel digital audio signals at up to 192 kHz— an excellent solution for digital TVs.

This IC features the following.

- 1) Digital video interface supports video processors.
- 2) Analog RGB and YPbPr output: 10-bit DAC.
- 3) Digital audio interface supports high-end audio systems.

· **IC1901**: NVM OF HDMI (E-EDID)

Part number: 24LC2BIN

Sharp code: VHI24LC2BIN-1Y

This IC is a 2-wire (I2C bus type) serial EEPROM this is electrically programmable. This EEPROM chip stores the data structure used to carry configuration information for optimal use of a display (EDID data).

· **IC2701** : SYNC SELECT

Part number: TVHC153T

Sharp code: VHITVHC153T-1Y

This VHC153 is a high-speed Dual 4-input multiplexer with common select inputs and individual enable inputs for each section.

· **IC2704** : HDMI & RGB SOUND MULTIPLEXER

Part number: CD4052BP

Sharp code: VHICD4052BP-1Y

The TC74HC4052A is a high-speed CMOS analog multiplexer/demultiplexer backed by silicon gate CMOS technology. The multiplexer function includes the selection and mixing of analog and digital signals. The chip consists of 4 channels (x 2). A digital signal through the control terminal turns on the switch of a corresponding channel.

· **IC3002** : VIDEO PROCESSOR

Part number: VCTP

Sharp code: RH-IXB624WJN1Q

The VCT 6wxyP family is dedicated to high-quality FPD and double-scan TV sets. The memory and program ROM are integrated in the IC. Modular design and deep submicron technology allow the integration of audio, video, teletext, OSD, and controller-related functionalities. They cover the whole range of flat-panel display TVs. The IC is based on proven functional blocks of existing products like VCT 49xxI, VSP 94x5B, and DPS 94xxB.

Each member of the IC family contains the entire audio, video, upconversion processing for 4:3 and 16:9 50/60 Hz progressive or 100/120 Hz interlaced stereo TV sets plus the control/data interface for flat-panel displays. The integrated microcontroller is supported by a powerful OSD and graphics generator with integrated teletext acquisition.

The VCT 6wxyP family provides a front-end video processing unit with 4 CVBS-Y/C or component inputs for HDTV, EDTV, and SDTV. A VBI slicer, support of 1000 pages of teletext, and a 3-D comb filter for PAL and NTSC (in certain versions) are also available. The front-end unit further allows to process an SD and an HD source in parallel, thus enabling PiP and PaP functionality. Motion-adaptive de-interlacing, temporal noise reduction, and film mode detection are based on a unified memory technology.

Post-scaling in the display processing block ensures the desired output format. Display processing is supported by an 8-bit 8051-compatible controller. By means of powerful alpha-blending, the graphics mixer composes the output image from following image layers: the video layer, the OSD layer and the pixel graphics layer.

The audio part consists of a multistandard sound IF demodulator and a baseband processor supporting all desired sound features in this range.

A connection for additional features, such as advanced motion compensation via -Micronas' FRC 94xyA, is also provided.

· **IC2702 & IC2705:** VIDEO INPUT SELECTOR.

Part number: MM1507XN
Sharp code: VHIMM1507XN-1Y

This IC extends the series of ICs for video/audio signal switching, with a 2-input 1-output single video switch with 75Ω driver and input clamp.

· **IC3001 :** NVM 64Kb-E2PROM

Part number: BR24L64F
Sharp code: VHIBR24L64F-1Y

The BR24L64F is a 2-wire (I2C bus type) serial EEPROM that is electrically programmable. This IC stores the control data of system contents (last memory, for example) for the main microprocessor's AV PWB and main PWB. The data is given out by commands from the main microprocessor.

· **IC3003 :** PIC MICROCONTROLLER

Part number: PIC16F913
Sharp code: RH-IXB664WJZZY

28 Pin Flash-Based, 8 bit CMOS Microcontrollers with LCD Driver and nanoWatt Technology.

This IC is controlled via I2C and works how expander of ports. This IC has led control and include A/D converter.

· **IC3005:** RESET IC FOR VCTP (IC3002)

Part number: BU4215G
Sharp code: VHIBU4215G+-1Y

Low voltage detector IC with adjustable output delay. Standard detection voltage = 1.5V

· **IC2301 :** RS-232 TRANSMITTERS/RECEIVERS

Part number: ISL83220
Sharp code: VHIISL83220-1Y

The ISL83220E is a 3.0V to 5.5V powered RS-232 transmitter/receiver, +/-15kV ESD protected, minimum data rate 250 kpbs.

· **IC2303 :** NVM OF PC MODE (EDID)

Part number: BR24C21F
Sharp code: VHIBR24C21F-1Y

This IC is a 2-wire (I2C bus type) serial EEPROM this is electrically programmable. This EEPROM chip stores the data structure used to carry configuration information for optimal use of a display (EDID data).

· **IC1701:** POWER RESET OF +BU1.8V

Part number: BU4239G
Sharp code: VHIBU4239G+-1Y

Low voltage detector IC with adjustable output delay. Standard Detection Voltage = 3.9V

· **IC1702:** BU+3.3V (VOLTAGE INPUT: BU+5V)

Part number: PQ20WZ11
Sharp code: VHIPQ20WZ11-1Y

Low power-loss voltage regulators. Variable Output. Output current 1A. Built-in overcurrent, overheat protection functions, ASO protection circuit.

• **IC1703:** S+8V (VOLTAGE INPUT: POW+12V)

Part number: PQ20WZ11

Sharp code: VHIPQ20WZ11-1Y

Low power-loss voltage regulators. Variable Output. Output current 1A. Built-in overcurrent, overheat protection functions, ASO protection circuit.

• **IC1707:** +3.3V (VOLTAGE INPUT: POW+5V)

Part number: PQ20WZ11

Sharp code: VHIPQ20WZ11-1Y

Low power-loss voltage regulators. Variable Output. Output current 1A. Built-in overcurrent, overheat protection functions, ASO protection circuit.

• **IC1708:** +1.8V (VOLTAGE INPUT: POW+5V)

Part number: MP1410

Sharp code: VHIMP1410ES-1Y

DC to DC Converter. 2A Step down switch mode regulator with a built in internal Power Mosfet. Fault condition protection includes cycle-by-cycle current limiting and thermal shutdown.

• **IC1706:** BU+1.8V (VOLTAGE INPUT: BU+5V)

Part number: MP1410

Sharp code: VHIMP1410ES-1Y

DC to DC Converter. 2A Step down switch mode regulator with a built in internal Power Mosfet. Fault condition protection includes cycle-by-cycle current limiting and thermal shutdown.

• **IC1710:** CPLD

Part number: EPM240T

Sharp code: RH-IXB823WJZZQ

This IC is a CPLD of Altera MAXII family and use 240 logic elements (LEs) (192 equivalent macrocells) MAX II devices offer high I/O counts, fast performance. MAX II devices are designed to reduce cost and power while providing programmable solutions for applications such as bus bridging, I/O expansion, power-on reset (POR) and sequencing control, and device configuration control.

This device controls ON/OFF power supply, signals for inverter unit and etc.

FD604WJ (AV UNIT):

• **IC301 & IC302 :** AUDIO AMPLIFIER

Part number: TDA8931T

Sharp code: VHITDA893T-1Y

The TDA8931 is a switching power stage for high efficiency class-D audio power amplifier systems. The IC has a high efficiency so that a heat sink is not required up to 20W (RMS).

• **IC303 :** HEADPHONE AMPLIFIER

Part number: NJM4558M

Sharp code: VHINJM4558M-1Y

The NJM4558 is a dual high-gain operational amplifier internally compensated and constructed on a single silicon chip using an advanced epitaxial process.

IC1101 & IC1102: SCART VIDEO OUTPUT DRIVER.

Part number: MM1506XN

Sharp code: VHIMM1506XN-1Y

This IC extends the series of ICs for video/audio signal switching, with a 2-input 1-output single video switch with 75Ω driver and input bias (6dB gain).

IC1201: VIDEO INPUT SELECTOR.

Part number: MM1507XN

Sharp code: VHIMM1507XN-1Y

This IC extends the series of ICs for video/audio signal switching, with a 2-input 1-output single video switch with 75Ω driver and input clamp.

FD605WJ (POWER SUPPLY UNIT):· **IC704:** POWER SUPPLY CONTROLLER FOR SIGNAL BOARD

Part number: MR4030
Sharp code: VHIMR4030+-1

A high speed 900V IGBT makes ideal partial resonance operation which ensures high efficiency and low noise. Very low power consumption at micro-loads (burst mode).

Start-up circuit eliminates the need for start-up resistor.

Excess current protection (ON period limitation, primary current limitation), excess voltage protection, and thermal shut-down function are incorporated.

· **IC705:** POWER SUPPLY CONTROLLER FOR INVERTER

Part number: MR4020
Sharp code: VHIMR4020+-1

A high speed 900V IGBT makes ideal partial resonance operation which ensures high efficiency and low noise. Very low power consumption at micro-loads (burst mode).

Start-up circuit eliminates the need for start-up resistor.

Excess current protection (ON period limitation, primary current limitation), excess voltage protection, and thermal shut-down function are incorporated.

· **IC706 & IC707:** FEEDBACK CONTROL

Part number: TA76431R
Sharp code: VHITA76431R-1Y

Adjustable precision shunt regulator for feedback control for driving an optocoupler in power supplies

IC708: LOW AC MAINS VOLTAGE DETECTOR.

Part number: NJM2904M
Sharp code: VHINJM2904M-1Y

The IC consists of two independent, high gain internally frequency compensated operation amplifiers which were designed specifically to operate from single power supply.

IC709: +24V/+5V VOLTAGE SUPERVISOR.

Part number: NJM2903M
Sharp code: VHINJM2903M-1Y

The IC consist of two independent precision voltage comparator, high gain internally frequency compensated operation amplifiers which were designed specifically to operate from single power supply.

FD607WJ (RC/LED UNIT):· **IC101 :** OPC

Part number: TPS850
Sharp code: VHITPS850+-1Y

The TPS850 is a linear-output photo-IC which incorporates a photodiode and current amp circuit in a single chip. This photo-IC is current output type, so can set up output voltage freely by arbitrary load resistance.

FD609WJ (TUNER UNIT):· **IC201 :** IF-Demodulator/PLL

Part number: TDA9886
Sharp code: VHITDA9886+-1Y

The TDA9886 is an alignment-free multi-standard (PAL, SECAM and NTSC) vision and sound IF signal PLL demodulator for positive and negative modulation including sound AM and FM processing.

This IC features the following.

* Gain controlled wide-band vision intermediate frequency (VIF) amplifier (AC-coupled).

* Multi-standard true synchronous demodulation with active carrier regeneration (very linear demodulation, good intermodulation figures reduced harmonics, excellent pulse response).

* Gate phase detector for L/L accent standard.

* Fully integrated VIF Voltage Controlled Oscillator (VCO), alignment-free; frequencies switchable for all negative modulated standards via I2C bus.

* 4MHz reference frequency input [signal from phase-locked loop (PLL) tuning system] or operating as crystal oscillator.

* VIF Automatic Gain Control (AGC) detector for gain control operating as a peak sync detector for negative modulated signals and as a peak white detector for positive modulated signals.

IC 202: COFDM DECODER.

Part number: STV0360C

Sharp code: RH-IXB682WJZZQ

The STV0360C is a COFDM (codec orthogonal frequency division multiplex) demodulator that performs IF to MPEG-2 block processing of OFDM carriers. It is intended for digital terrestrial receivers for compressed video, sound and data services. It implements all the functions from the tuner IF output to the MPEG-2 transport stream input. The STV0360C integrates an A/D converter that delivers the required performance to handle up to 64 QAM carriers in a direct IF sampling architecture.

IC204: I2C BUS SELECTOR (TUNER CONTROLLED FROM VCTP OR COFDM DECODER).

Part number: SN74LV4053APWR

Sharp code: VHILV4053AT-1Y

The SN74LV4053APWR is a high-speed CMOS analog multiplexer/demultiplexer backed by silicon gate CMOS technology. The multiplexer function includes the selection and mixing of analog and digital signals. The chip include two independent 3 channels selectors. A digital signal through the control terminal turns on the switch of a corresponding channel.

KD628WJ (DIGITAL UNIT):

IC4001: DIGITAL PROCESSOR MPEG 1/2 DECODER (Audio/Video).

Part number: STI5516AUCL

Sharp code: RH-IXB680WJZZQ

The STI5516 is a device that integrates all of the back-end functions required for mainstream set-top boxes . These include:

An enhanced ST20 32-bit RISC CPU with a 166MHz clock, 8Kbytes of instruction cache, 8Kbytes of data cache and 8Kbytes of embedded SRAM.

A 16-bit, 133MHz Shared Memory Interface, with support for 64- and 128-bit configurations.

A programmable External Memory Interface supporting six separately configurable banks of SRAM, Flash and DRAM.

An MPEG-2 (MP@ML) decoder, including trick modes such as smooth fast-forward and rewind.

A Graphics/Display unit with five display panes, alpha blending, antialiasing and antialiasing filters, subpicture decoder, and display compositor with separate OSD (On-Screen Display) controls for TV and VCR outputs.

PAL/NTSC/SECAM encoder.

Audio subsystem with embedded DSP for all popular audio formats.

A full range of on-chip peripherals, including five UARTs, six parallel I/O banks, two smart card interfaces, four PWM channels, teletext serializer, multi-channel IR transmitter/receiver, and a modem analog front-end interface.

IC 4203: 16 Mbit Flash Memory (Program Memory).

Part number: MBM29LV160BE70TN

Sharp code: RH-IXA964WJN1

IC 4201 & IC 4202: 64Mbit SDRAM (Temporary Data).

Part number: KAS641632H-UC75

Sharp code: RH-IXB076WJZZQ

IC4204: NVM 64Kb-E2PROM FOR DIGITAL PROCESSOR (IC4001).

Part number: BR24L64F

Sharp code: VHIBR24L64F-1Y

The BR24L64F is a 2-wire (I2C bus type) serial EEPROM that is electrically programmable. This IC stores all data related to the Digital Module (Channels, User settings, etc.).

IC4003: RESET ICs FOR DIGITAL PROCESSOR (IC4001).

Part number: BU4228G

Sharp code: VHIBU4228G+-1Y

Low voltage detector IC with adjustable output delay. Standard detection voltage = 2.8V.

IC4402 & IC4405: OCTAL TRANSPARENT D-TYPE LATCHES WITH 3-STATE OUTPUTS.

Part number: SN74LVC573APWR

Sharp code: VHILVC573AP-1Y

These devices feature 3-state outputs designed specifically for driving highly capacitive or relatively low-impedance loads. They are particularly suitable for implementing buffer registers, input/output (I/O) ports, bidirectional bus drivers, and working registers. In this design additionally are isolating digital processor (IC4001) from PCMCIA connector.

IC4401: LOW VOLTAGE OCTAL BUS TRANSCEIVER WITH 5V TOLERANT INPUTS AND OUTPUTS.

Part number: TC74LCX245FS

Sharp code: VHICLCX245-2Y

The device is designed for working in 3.3V systems but could be used to interface to 5V supply environment for both inputs and outputs. The direction of the data transmission is controlled by the level of the DIR input. The OE input could be used to isolate the device of the busses (PCMCIA and Digital Processor).

IC4404: LOW VOLTAGE BUFFER / LINE DRIVER WITH 5V TOLERANT INPUTS AND OUTPUTS.

Part number: 74LCX244AE

Sharp code: VHILCX244MT-1Y

The LCX244 contains eight non-inverting buffers with 3-STATE outputs. The device may be employed as a memory address driver, clock driver and bus-oriented transmitter/receiver. The LCX244 is designed for low voltage (2.5V or 3.3V) VCC applications with capability of interfacing to a 5V signal environment.

2. Detailed ICs Information

2.1. IC1905 (VHISII9021+-1Q)

2.1.1. Pinning

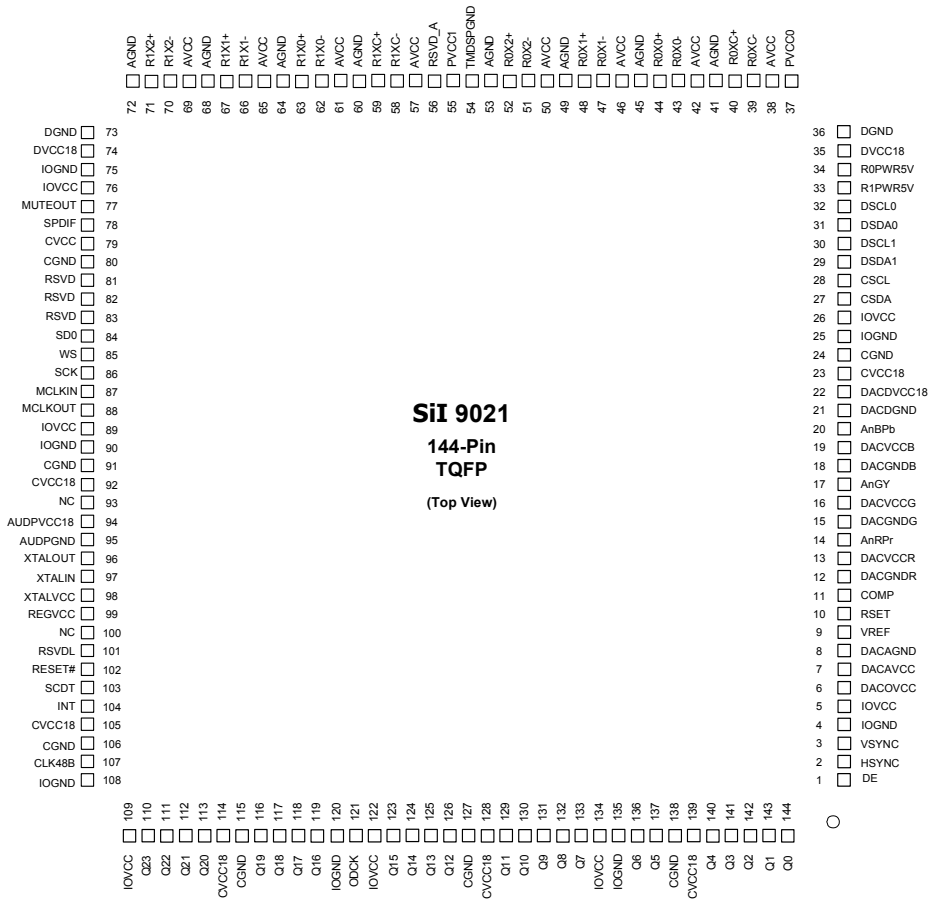

2.1.2. Block Diagram

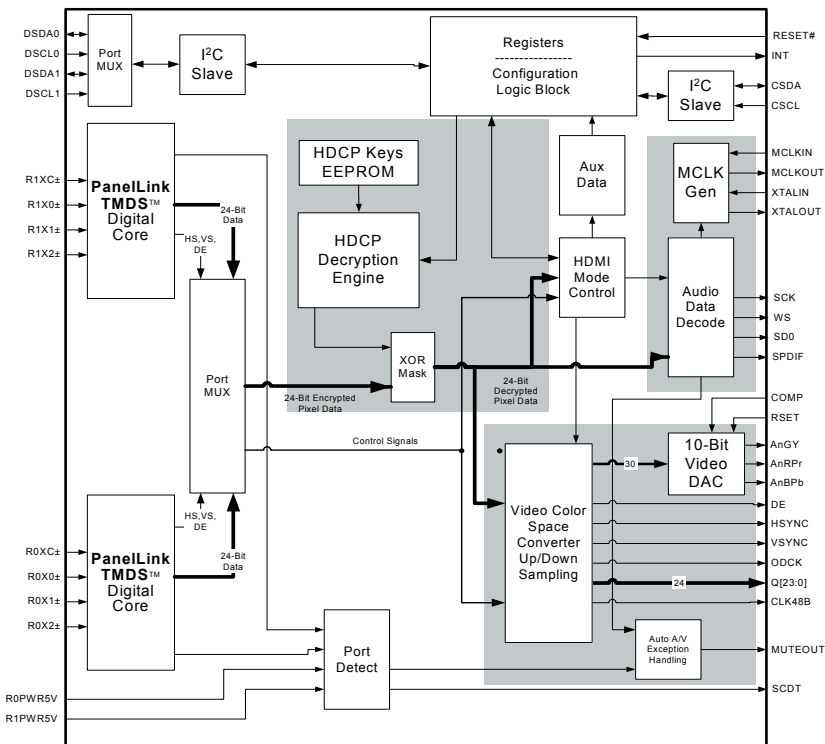

The SiI 9021 supports two HDMI input ports. Only one port may be active at any time.

2.2. IC3002 (RH-IXD624WJN1Q)

2.2.1. Pin Connections and Short Description

NC = not connected
LV = if not used, leave vacant
OBL = obligatory; connect as described in circuit diagram

IN = Input Pin
ANA = Analog Pin
OUT = Output Pin
SUPPLY = Supply Pin

VCTP Pin No. PLQFP 208-1	Pin Name	Type	Connection (If not used)	Short Description
1	656O6 P4_6 TDOFW	IN/OUT	LV	Digital 656 Bit 6 Output Port 4, Bit 6 Input/Output JTAG Interface Data Output (firmw. Controller)
2	656O5 P4_5 TDIFW	IN/OUT	LV	Digital 656 Bit 5 Output Port 4, Bit 5 Input/Output JTAG Interface Data Input (firmw. Controller)
3	656O4 P4_4 TMSFW	IN/OUT	LV	Digital 656 Bit 4 Output Port 4, Bit 4 Input/Output JTAG Interface Mode Select Input (fw. Contr.)
4	656O3 P4_3 TCLK	IN/OUT	LV	Digital 656 Bit 3 Output Port 4, Bit 3 Input/Output JTAG Interface Clock Input (TV Controller)
5	656O2 P4_2 TDO	IN/OUT	LV	Digital 656 Bit 2 Output Port 4, Bit 2 Input/Output JTAG Interface Data Output (TV Controller)
6	656O1 P4_1 TDI	IN/OUT	LV	Digital 656 Bit 1 Output Port 4, Bit 1 Input/Output JTAG Interface Data Input (TV Controller)
7	656O0 P4_0 TMS	IN/OUT	LV	Digital 656 Bit 0 Output (LSB) Port 4, Bit 0 Input/Output JTAG Interface Mode Select Input (TV Contr.)
8	RESETQ	IN/OUT	OBL	Reset Input/Output
9	AIN1R	IN	GND	Analog Audio 1 Input, Right
10	AIN1L	IN	GND	Analog Audio 1 Input, Left
11	AIN2R	IN	GND	Analog Audio 2 Input, Right
12	AIN2L	IN	GND	Analog Audio 2 Input, Left
13	AIN3R	IN	GND	Analog Audio 3 Input, Right
14	AIN3L	IN	GND	Analog Audio 3 Input, Left
15	AIN4R	IN	GND	Analog Audio 4 Input, Right
16	AIN4L	IN	GND	Analog Audio 4 Input, Left
17	VREFAU	ANA	OBL	Reference Voltage, Audio
18	VSUP8.0AU	SUPPLY	OBL	Supply Voltage Analog Audio, 8.0 V
19	GND A	SUPPLY	OBL	Ground Analog Audio, Platform Ground
20	SGND	ANA	OBL	Analog Signal GND

2.2.1. Pin Connections and Short Description (Continued)

VCTP Pin No. PLQFP 208-1	Pin Name	Type	Connection (If not used)	Short Description
21	AOUT2R AIN5R	IN/OUT	LV	Analog Audio 2 Output, Right Analog Audio 5 Input, Right
22	AOUT2L AIN5L	IN/OUT	LV	Analog Audio 2 Output, Left Analog Audio 5 Input, Left
23	AOUT1R	OUT	LV	Analog Audio 1 Output, Right
24	AOUT1L	OUT	LV	Analog Audio 1 Output, Left
25	HEADPHONER	OUT	LV	Analog Headphone Output, Right
26	HEADPHONEL	OUT	LV	Analog Headphone Output, Left
27	SPEAKERR	OUT	LV	Analog Loudspeaker Output, Right
28	SPEAKERL	OUT	LV	Analog Loudspeaker Output, Left
29	SUBWOOFER TEST	IN/OUT	LV	Analog SUBWOOFER Output Test Input
30	VREFSIF	ANA	OBL	Reference Voltage, Audio SIF
31	SIFIN+	IN	VREF _{IF}	Differential IF Input
32	SIFIN-	IN	VREF _{IF}	Differential IF Input
33	VSUP5.0SIF	SUPPLY	OBL	Supply Voltage Analog SIF, 5.0 V
34	GND A	SUPPLY	OBL	Ground Analog SIF, Platform Ground
35	GND3.3DIG	SUPPLY	OBL	Ground Digital Audio Core
36	VSUP3.3DIG	SUPPLY	OBL	Supply Voltage Digital Audio Core, 3.3 V
37	SPDIF_OUT	OUT	LV	SPDIF Output
38	I2S_DA_IN	IN	LV	Audio Bus Data Input
39	I2S_CL	IN	LV	Audio Bus Clock Input
40	I2S_WS	IN	LV	Audio Bus Word Strobe Input
41	I2S_DEL_OUT	OUT	LV	Audio Delay Line Bus Data Output
42	I2S_DEL_IN	IN	LV	Audio Delay Line Bus Data Input
43	I2S_DEL_CL	OUT	LV	Audio Delay Line Bus Clock Output
44	I2S_DEL_WS	OUT	LV	Audio Delay Line Bus Word Strobe Output
45	VSUP3.3RAM	SUPPLY	OBL	Supply Voltage Ram, 3.3 V
46	GND3.3RAM	SUPPLY	OBL	Ground Ram
47	DVS	IN	LV	Digital or Analog Video VSYNC HD Input
48	DEN	IN	LV	Digital Video Enable Input
49	DCLK	IN	LV	Digital Video Clock Input
50	DRI7	IN	LV	Digital Video Red 7 Input

2.2.1. Pin Connections and Short Description (Continued)

VCTP Pin No. PLQFP 208-1	Pin Name	Type	Connection (If not used)	Short Description
51	DRI6	IN	LV	Digital Video Red 6 Input
52	DRI5	IN	LV	Digital Video Red 5 Input
53	DRI4	IN	LV	Digital Video Red 4 Input
54	DRI3	IN	LV	Digital Video Red 3 Input
55	DRI2	IN	LV	Digital Video Red 2 Input
56	DRI1	IN	LV	Digital Video Red 1 Input
57	DRI0	IN	LV	Digital Video Red 0 Input (LSB)
58	DGI7	IN	LV	Digital Video Green 7 Input
59	DGI6	IN	LV	Digital Video Green 6 Input
60	DGI5	IN	LV	Digital Video Green 5 Input
61	DGI4	IN	LV	Digital Video Green 4 Input
62	DGI3	IN	LV	Digital Video Green 3 Input
63	DGI2	IN	LV	Digital Video Green 2 Input
64	DGI1	IN	LV	Digital Video Green 1 Input
65	DGI0	IN	LV	Digital Video Green 0 Input (LSB)
66	DBI7	IN	LV	Digital Video Blue 7 Input
67	DBI6	IN	LV	Digital Video Blue 6 Input
68	DBI5	IN	LV	Digital Video Blue 5 Input
69	DBI4	IN	LV	Digital Video Blue 4 Input
70	DBI3	IN	LV	Digital Video Blue 3 Input
71	DBI2	IN	LV	Digital Video Blue 2 Input
72	DBI1	IN	LV	Digital Video Blue 1 Input
73	DBI0	IN	LV	Digital Video Blue 0 Input (LSB)
74	GND3.3DRI	SUPPLY	OBL	Ground Digital Ram Interface
75	VSUP3.3DRI	SUPPLY	OBL	Supply Voltage Digital Ram Interface, 3.3 V
76	GND3.3COM	SUPPLY	OBL	Ground Common
77	VSUP3.3COM	SUPPLY	OBL	Supply Voltage Common, 3.3V
78	XTALIN	IN	OBL	Analog Crystal Input
79	XTALOUT	OUT	OBL	Analog Crystal Output
80	CLKOUT	OUT	LV	Digital 20MHz Clock Output
81	VSO	OUT	LV	Vertical Sync Output, Frontend

2.2.1. Pin Connections and Short Description (Continued)

VCTP Pin No. PLQFP 208-1	Pin Name	Type	Connection (If not used)	Short Description
82	HSO	OUT	LV	Horizontal Sync Output, Frontend
83	SCL	IN/OUT	OBL	I ² C Bus Clock Input/Output
84	SDA	IN/OUT	OBL	I ² C Bus Data Input/Output
85	GND3.3FL	SUPPLY	OBL	Ground Flash
86	VSUP3.3FL	SUPPLY	OBL	Supply Voltage Flash, 3.3 V
87	P2_0	IN/OUT	LV	Port 2, Bit 0 Input/Output
88	P2_1	IN/OUT	LV	Port 2, Bit 1 Input/Output
89	P2_2	IN/OUT	LV	Port 2, Bit 2 Input/Output
90	P2_3	IN/OUT	LV	Port 2, Bit 3 Input/Output
91	P2_4 TDI	IN/OUT	LV	Port 2, Bit 4 Input/Output JTAG Interface Data Input
92	P2_5 TMS	IN/OUT	LV	Port 2, Bit 5 Input/Output JTAG Interface Mode Select Input
93	OSDV DBO2_0	IN/OUT	LV	Graphic Vertical Sync Input/Output Channel 2 Digital 0 Blue Output (LSB)
94	OSDH DBO2_1	IN/OUT	LV	Graphic Horizontal Sync Input/Output Channel 2 Digital 1 Blue Output
95	GND3.3IO1	SUPPLY	OBL	Ground Digital Input/Output Port 1
96	VSUP3.3IO1	SUPPLY	OBL	Supply Voltage Input/Output Port 1, 3.3 V
97	OSDCLK DBO2_2	IN/OUT	LV	Graphic Clock Input/Output Channel 2 Digital 2 Blue Output
98	OSDFSW DBO2_3	IN/OUT	LV	Graphic Fast Switch Input/Output Channel 2 Digital 3 Blue Output
99	OSDHCS1 P3_7 DBO2_4	IN/OUT	LV	Graphic Half Contrast 1 Input/Output Port 3, Bit 7 Input/Output Channel 2 Digital 4 Blue Output
100	OSDHCS0 P3_6 DBO2_5	IN/OUT	LV	Graphic Half Contrast 0 Input/Output (LSB) Port 3, Bit 6 Input/Output Channel 2 Digital 5 Blue Output
101	OSDB3 P3_5 DBO2_6	IN/OUT	LV	Graphic Blue 3 Input/Output (MSB) Port 3, Bit 5 Input/Output Channel 2 Digital 6 Blue Output
102	OSDB2 P3_4 DBO2_7	IN/OUT	LV	Graphic Blue 2 Input/Output Port 3, Bit 4 Input/Output Channel 2 Digital 7 Blue Output (MSB)
103	OSDB1 DGO2_0	IN/OUT	LV	Graphic Blue 1 Input/Output Channel 2 Digital 0 Green Output (LSB)
104	OSDB0 DGO2_1	IN/OUT	LV	Graphic Blue 0 Input/Output Channel 2 Digital 1 Green Output

2.2.1. Pin Connections and Short Description (Continued)

VCTP Pin No. PLQFP 208-1	Pin Name	Type	Connection (If not used)	Short Description
105	OSDG3 P3_3 DGO2_2	IN/OUT	LV	Graphic Green 3 Input/Output (MSB) Port 3, Bit 3 Input/Output Channel 2 Digital 2 Green Output
106	OSDG2 P3_2 DGO2_3	IN/OUT	LV	Graphic Green 2 Input/Output Port 3, Bit 2 Input/Output Channel 2 Digital 3 Green Output
107	OSDG1 DGO2_4	IN/OUT	LV	Graphic Green 1 Input/Output Channel 2 Digital 4 Green Output
108	OSDG0 DGO2_5	IN/OUT	LV	Graphic Green 0 Input/Output Channel 2 Digital 5 Green Output
109	OSDR3 P3_1 DGO2_6	IN/OUT	LV	Graphic Red 3 Input/Output (MSB) Port 3, Bit 1 Input/Output Channel 2 Digital 6 Green Output
110	OSDR2 P3_0 DGO2_7	IN/OUT	LV	Graphic Red 2 Input/Output Port 3, Bit 0 Input/Output Channel 2 Digital 7 Green Output (MSB)
111	OSDR1 DRO2_0	IN/OUT	LV	Graphic Red 1 Input/Output Channel 2 Digital 0 Red Output (LSB)
112	OSDR0 DRO2_1	IN/OUT	LV	Graphic Red 0 Input/Output (LSB) Channel 2 Digital 1 Red Output
113	GND3.3IO1	SUPPLY	OBL	Ground Digital Input/Output Port 1
114	VSUP3.3IO1	SUPPLY	OBL	Supply Voltage Input/Output Port 1, 3.3 V
115	PCS5 P2_6	IN/OUT	LV	Flat Panel Control Select 5 PWM Output Port 2, Bit 6 Input/Output
116	PCS4 P2_7	IN/OUT	LV	Flat Panel Control Select 4 REV Output Port 2, Bit 7 Input/Output
117	PCS3 P4_0	IN/OUT	LV	Flat Panel Control Select 3 DE2 Output Port 4, Bit 0 Input/Output
118	PCS2 P4_1	IN/OUT	LV	Flat Panel Control Select 2 DE1 Output Port 4, Bit 1 Input/Output
119	PCS1 P4_2	IN/OUT	LV	Flat Panel Control Select 1 V Output Port 4, Bit 2 Input/Output
120	PCS0 P4_3	IN/OUT	LV	Flat Panel Control Select 0 H Output Port 4, Bit 3 Input/Output
121	PCLK2	OUT	LV	Flat Panel Control Clock 2 Output
122	PCLK1	OUT	LV	Flat Panel Control Clock 1 Output
123	GND1.8DIG	SUPPLY	OBL	Ground Digital Core
124	VSUP1.8DIG	SUPPLY	OBL	Supply Voltage Digital Core, 1.8 V
125	DBO1_0 DRO2_2 LVDSA_4P	OUT	LV	Channel 1 Digital 0 Blue Output ¹⁾ (LSB) Channel 2 Digital 2 Red Output ¹⁾ LVDS Channel 1 bit 4 Positive Output ²⁾

2.2.1. Pin Connections and Short Description (Continued)

VCTP Pin No. PLQFP 208-1	Pin Name	Type	Connection (If not used)	Short Description
126	DBO1_1 DRO2_3 LVDSA_4N	OUT	LV	Channel 1 Digital 1 Blue Output ¹⁾ Channel 2 Digital 3 Red Output ¹⁾ LVDS Channel 1 bit 4 Negative Output ²⁾
127	DBO1_2 DRO2_4 VSUP3.3LVDS	OUT SUPPLY	LV OBL	Channel 1 Digital 2 Blue Output ¹⁾ Channel 2 Digital 4 Red Output ¹⁾ Supply Digital Voltage LVDS ²⁾ Port, 3.3 V
128	DBO1_3 DRO2_5 LVDSA_3P	OUT	LV	Channel 1 Digital 3 Blue Output ¹⁾ Channel 2 Digital 5 Red Output ¹⁾ LVDS Channel 1 bit 3 Positive Output ²⁾
129	DBO1_4 DRO2_6 LVDSA_3N	OUT	LV	Channel 1 Digital 4 Blue Output ¹⁾ Channel 2 Digital 6 Red Output ¹⁾ LVDS Channel 1 bit 3 Negative Output ²⁾
130	DBO1_5 DRO2_7 GND3.3LVDS	OUT SUPPLY	LV OBL	Channel 1 Digital 5 Blue Output ¹⁾ Channel 2 Digital 7 Red Output ¹⁾ (MSB) Ground Digital LVDS ²⁾ , 3.3 V
131	DBO1_6 DBO1_0 LVDSA_CLKP	OUT	LV	Channel 1 Digital 6 Blue Output ¹⁾ Channel 1 Digital 0 Blue Output ¹⁾ (LSB) LVDS Channel 1 Clock Positive Output ²⁾
132	DBO1_7 DBO1_1 LVDSA_CLKN	OUT	LV	Channel 1 Digital 7 Blue Output ¹⁾ Channel 1 Digital 1 Blue Output ¹⁾ LVDS Channel 1 Clock Negative Output ²⁾
133	VSUP3.3IO2 VSUP3.3LVDS	SUPPLY	OBL	Supply Digital Output ¹⁾ Port 2 Supply Digital Voltage LVDS ²⁾ , 3.3 V
134	GND3.3IO2 LVDSA_2P	SUPPLY OUT	OBL LV	Ground Voltage Output ¹⁾ Port 2, 3.3 V LVDS Channel 1 bit 2 Positive Output ²⁾
135	DBO1_8 DBO1_2 LVDSA_2N	OUT	LV	Channel 1 Digital 8 Blue Output ¹⁾ Channel 1 Digital 2 Blue Output ¹⁾ LVDS Channel 1 bit 2 Negative Output ²⁾
136	DBO1_9 DBO1_3 GND3.3LVDS	OUT SUPPLY	LV OBL	Channel 1 Digital 9 Blue Output ¹⁾ (MSB) Channel 1 Digital 3 Blue Output ¹⁾ Ground Digital LVDS ²⁾ , 3.3 V
137	DGO1_0 DBO1_4 LVDSA_1P	OUT	LV	Channel 1 Digital 0 Green Output ¹⁾ (LSB) Channel 1 Digital 4 Blue Output ¹⁾ LVDS Channel 1 bit 1 Positive Output ²⁾
138	DGO1_1 DBO1_5 LVDSA_1N	OUT	LV	Channel 1 Digital 1 Green Output ¹⁾ Channel 1 Digital 5 Blue Output ¹⁾ LVDS Channel 1 bit 1 Negative Output ²⁾
139	DGO1_2 DBO1_6 VSUP3.3LVDS	OUT SUPPLY	LV OBL	Channel 1 Digital 2 Green Output ¹⁾ Channel 1 Digital 6 Blue Output ¹⁾ Supply Digital Voltage LVDS ²⁾ , 3.3 V
140	DGO1_3 DBO1_7 LVDSA_0P	OUT	LV	Channel 1 Digital 3 Green Output ¹⁾ Channel 1 Digital 7 Blue Output ¹⁾ (MSB) LVDS Channel 1 bit 0 Positive Output ²⁾

2.2.1. Pin Connections and Short Description (Continued)

VCTP Pin No. PLQFP 208-1	Pin Name	Type	Connection (If not used)	Short Description
141	DGO1_4 DGO1_0 LVDSA_ON	OUT	LV	Channel 1 Digital 4 Green Output ¹⁾ Channel 1 Digital 0 Green Output ¹⁾ (LSB) LVDS Channel 1 bit 0 Negative Output ²⁾
142	DGO1_5 DGO1_1 VSUP1.8LVDS	OUT SUPPLY	LV OBL	Channel 1 Digital 5 Green Output ¹⁾ Channel 1 Digital 1 Green Output ¹⁾ Supply Analog Voltage LVDS ²⁾ , 1.8 V
143	DGO1_6 DGO1_2 REXT	OUT ANA	LV OBL	Channel 1 Digital 6 Green Output ¹⁾ Channel 1 Digital 2 Green Output ¹⁾ LVDS External Resistor ²⁾
144	DGO1_7 DGO1_3 GND1.8LVDS	OUT SUPPLY	LV OBL	Channel 1 Digital 7 Green Output ¹⁾ Channel 1 Digital 3 Green Output ¹⁾ Ground Analog LVDS ²⁾ , 1.8 V
145	DGO1_8 DGO1_4 LVDSB_3P	OUT	LV	Channel 1 Digital 8 Green Output ¹⁾ Channel 1 Digital 4 Green Output ¹⁾ Dual-LVDS Channel 2 bit 3 Positive Output ²⁾
146	DGO1_9 DGO1_5 LVDSB_3N	OUT	LV	Channel 1 Digital 9 Green Output ¹⁾ (MSB) Channel 1 Digital 5 Green Output ¹⁾ Dual-LVDS Channel 2 bit 3 Negative Output ²⁾
147	DRO1_0 DGO1_6 GND3.3LVDS	OUT SUPPLY	LV OBL	Channel 1 Digital 0 Red Output ¹⁾ (LSB) Channel 1 Digital 6 Green Output ¹⁾ Ground Digital LVDS ²⁾ , 3.3 V
148	DRO1_1 DGO1_7 LVDSBCLKP	OUT	LV	Channel 1 Digital 1 Red Output ¹⁾ Channel 1 Digital 7 Green Output ¹⁾ (MSB) Dual-LVDS Channel 2 Clock Positive Output ²⁾
149	GND3.3IO2 LVDSBCLKN	SUPPLY OUT	OBL LV	Ground Digital Output ¹⁾ Port 2 Dual-LVDS Channel 2 Clock Negative Output ²⁾
150	VSUP3.3IO2 VSUP3.3LVDS	SUPPLY	OBL	Supply Voltage Output ¹⁾ Port 2, 3.3 V Supply Digital Voltage LVDS ²⁾ , 3.3 V
151	DRO1_2 DRO1_0 LVDSB_2P	OUT	LV	Channel 1 Digital 2 Red Output ¹⁾ Channel 1 Digital 0 Red Output ¹⁾ (LSB) Dual-LVDS Channel 2 bit 2 Positive Output ²⁾
152	DRO1_3 DRO1_1 LVDSB_2N	OUT	LV	Channel 1 Digital 3 Red Output ¹⁾ Channel 1 Digital 1 Red Output ¹⁾ Dual-LVDS Channel 2 bit 2 Negative Output ²⁾
153	DRO1_4 DRO1_2 GND3.3LVDS	OUT SUPPLY	LV OBL	Channel 1 Digital 4 Red Output ¹⁾ Channel 1 Digital 2 Red Output ¹⁾ Ground Digital LVDS ²⁾ , 3.3 V
154	DRO1_5 DRO1_3 LVDSB_1P	OUT	LV	Channel 1 Digital 5 Red Output ¹⁾ Channel 1 Digital 3 Red Output ¹⁾ Dual-LVDS Channel 2 bit 1 Positive Output ²⁾
155	DRO1_6 DRO1_4 LVDSB_1N	OUT	LV	Channel 1 Digital 6 Red Output ¹⁾ Channel 1 Digital 4 Red Output ¹⁾ Dual-LVDS Channel 2 bit 1 Negative Output ²⁾

2.2.1. Pin Connections and Short Description (Continued)

VCTP Pin No. PLQFP 208-1	Pin Name	Type	Connection (If not used)	Short Description
156	DRO1_7 DRO1_5 VSUP3.3LVDS	OUT SUPPLY	LV OBL	Channel 1 Digital 7 Red Output ¹⁾ Channel 1 Digital 5 Red Output ¹⁾ Supply Digital Voltage LVDS ²⁾ , 3.3 V
157	DRO1_8 DRO1_6 LVDSB_0P	OUT	LV	Channel 1 Digital 8 Red Output ¹⁾ Channel 1 Digital 6 Red Output ¹⁾ Dual-LVDS Channel 2 bit 0 Positive Output ²⁾
158	DRO1_9 DRO1_7 LVDSB_0N	OUT	LV	Channel 1 Digital 9 Red Output ¹⁾ (MSB) Channel 1 Digital 7 Red Output ¹⁾ (MSB) Dual-LVDS Channel 2 bit 0 Negative Output ²⁾
159	P1_7 TDO	IN/OUT	OBL	Port 1, Bit 7 Input/Output JTAG Interface Data Output
160	P1_6 TCLK	IN/OUT	OBL	Port 1, Bit 6 Input/Output JTAG Interface Clock Input
161	P1_5	IN/OUT	LV	Port 1, Bit 5 Input/Output
162	P1_4	IN/OUT	LV	Port 1, Bit 4 Input/Output
163	GND3.3DAC	SUPPLY	OBL	Ground DAC
164	VSUP3.3DAC	SUPPLY	OBL	Supply Voltage DAC, 3.3V
165	P1_3 ROUT	IN/OUT	LV	Port 1, Bit 3 Input/Output Analog Red Output
166	P1_2 GOUT	IN/OUT	LV	Port 1, Bit 2 Input/Output Analog Green Output
167	P1_1 BOUT	IN/OUT	LV	Port 1, Bit 1 Input/Output Analog Blue Output
168	P1_0 SVMOUT	IN/OUT	LV	Port 1, Bit 0 Input/Output Scan Velocity Modulation Output
169	VSUP1.8FE	SUPPLY	OBL	Supply Voltage Analog Video Frontend, 1.8 V
170	VSUP3.3FE	SUPPLY	OBL	Supply Voltage Analog Video Frontend, 3.3 V
171	VIN22 DHS	IN	GND	Analog Video 22 H-Sync Input Digital Video H-Sync Input
172	VIN21	IN	GND	Analog Video 21 B HD Input
173	VIN20	IN	GND	Analog Video 20 G HD Input
174	VIN19	IN	GND	Analog Video 19 R HD Input
175	VIN18	IN	GND	Analog Video 18 Fast Blank 2 Input
176	VIN17	IN	GND	Analog Video 17 B HD Input
177	VIN16	IN	GND	Analog Video 16 G HD Input
178	VIN15	IN	GND	Analog Video 15 R HD Input
179	VIN13	IN	GND	Analog Video 13 B HD Input

2.2.1. Pin Connections and Short Description (Continued)

VCTP Pin No.		Pin Name	Type	Connection (If not used)	Short Description
PLQFP 208-1					
	180	VIN12	IN	GND	Analog Video 12 G HD Input
	181	VIN11	IN	GND	Analog Video 11 R HD Input
	182	VIN9	IN	GND	Analog Video 9 Y or B SD Input
	183	VIN8	IN	GND	Analog Video 8 C or Fast Blank 1 Input
	184	VIN7	IN	GND	Analog Video 7 Y or G SD Input
	185	VSUP1.8FE	SUPPLY	OBL	Supply Voltage Analog Video Frontend, 1.8 V
	186	GND A	SUPPLY	OBL	Analog Video Frontend, Platform Ground
	187	VIN6	IN	GND	Analog Video 6 C or R SD Input
	188	VIN5	IN	GND	Analog Video 5 Y/CVBS Input
	189	VIN3	IN	GND	Analog Video 3 CVBS Input
	190	VIN2	IN	GND	Analog Video 2 CVBS Input
	191	VIN1	IN	GND	Analog Video 1 CVBS Input
	192	VSUP3.3VO	SUPPLY	OBL	Supply Voltage Analog Video Output, 3.3 V
	193	VOUT3	OUT	LV	Analog cvbs Video 3 Output
	194	VOUT2	OUT	OBL	Analog cvbs Video 2 Output
	195	VOUT1	OUT	OBL	Analog cvbs Video 1 Output
	196	GND3.3IO3	SUPPLY	OBL	Ground Digital Input/Output Port 1
	197	VSUP3.3IO3	SUPPLY	OBL	Supply Voltage Input/Output Port 1, 3.3 V
	198	65610 P3_0	IN/OUT	LV	Digital 656 Bit 0 Input (LSB) Port 3, Bit 0 Input/Output
	199	65611 P3_1	IN/OUT	LV	Digital 656 Bit 1 Input Port 3, Bit 1 Input/Output
	200	65612 P3_2	IN/OUT	LV	Digital 656 Bit 2 Input Port 3, Bit 2 Input/Output
	201	65613 P3_3	IN/OUT	LV	Digital 656 Bit 3 Input Port 3, Bit 3 Input/Output
	202	65614 P3_4	IN/OUT	LV	Digital 656 Bit 4 Input Port 3, Bit 4 Input/Output
	203	65615 P3_5	IN/OUT	LV	Digital 656 Bit 5 Input Port 3, Bit 5 Input/Output
	204	65616 P3_6	IN/OUT	LV	Digital 656 Bit 6 Input Port 3, Bit 6 Input/Output
	205	65617 P3_7	IN/OUT	LV	Digital 656 Bit 7 Input Port 3, Bit 7 Input/Output
	206	656CLKI	IN/OUT	GND	Digital 656 Clock Input

2.2.1. Pin Connections and Short Description (Continued)

VCTP Pin No. PLQFP 208-1	Pin Name	Type	Connection (If not used)	Short Description
207	656CLKO	OUT	LV	Digital 656 Clock Output
208	656O7 P4_7 TCLKFW	IN/OUT	LV	Digital 656 Bit 7 Output Port 4, Bit 7 Input/Output JTAG Interface Clock Input (firmw. Controller)
1) only in RGB output version 2) only in LVDS output version				

Display	CRT								FPD													
Application	Analog RGB + SVMOUT + H + V								TTL (Single RGB), LVDS (Dual or Single)						TTL (Dual RGB)							
Panel control									X	X	X	X	X	X	X	X	X	X	X	X	X	X
656IN	X	X	X		X	X			X	X	X		X	X			X		X			
656OUT	X	X	X	X					X	X	X	X					X	X				
OSD444	X			X	X		X		X			X	X		X							
OSD222		X				X				X					X							
Port 1	4	4	4	4	4	4	4	4	8	8	8	8	8	8	8	8	8	8	8	8	8	8
Port 2	8	8	8	8	8	8	8	8	6	6	6	6	6	6	6	6	6	6	6	6	6	6
Port 3		6	8	8		6	8	8		6	6	8		6	8	8		8			8	8
Port 4	2	2	2	2	8	8	8	8						8	8	8	8			8	8	8
Max Number of Ports	14	20	22	22	20	26	28	28	14	20	20	22	22	28	30	30	14	22	22	22	30	30
Note: 24bit RGB input is always available																						

Maximum Number of Ports

2.2.2. Pin Descriptions

2.2.2.1. Supply Pins

VSUP1.8DIG – Supply Voltage 1.8 V

This pin is main and standby supply for the digital core logic of controller, video and display processing.

VSUP1.8FE – Supply Voltage 1.8 V

This pin is main and standby supply for the analog video frontend.

VSUP3.3FE – Supply Voltage 3.3 V

This pin is main and standby supply for the analog video frontend.

VSUP3.3VO – Supply Voltage 3.3 V

This pin is main and standby supply for the analog video outputs.

VSUP1.8LVDS – Supply Voltage 1.8 V

This pin is main and standby supply for the analog LVDS core.

VSUP3.3LVDS – Supply Voltage 3.3 V

This pin is main and standby supply for the Digital LVDS port.

VSUP3.3FL – Supply Voltage 3.3 V

This pin is main and standby supply for the Flash device.

VSUP3.3DRI – Supply Voltage 3.3 V

This pin is main supply for the digital RAM interface.

VSUP3.3RAM – Supply Voltage 3.3 V

This pin is main supply for the RAM device

VSUP3.3IO 1-3 – Supply Voltage 3.3 V

This 3 pins are main and standby supply for the digital I/O-ports.

VSUP3.3COM – Supply Voltage 3.3 V

This pin is main and standby supply for the digital Input ports and common digital logic.

VSUP3.3DIG – Supply Voltage 3.3 V

This pin is main supply for the digital core logic of IF and audio processing and digital video backend.

VSUP8.0AU – Supply Voltage 8.0 V

This pin is main supply for the analog audio processing.

VSUP5.0SIF – Supply Voltage 5.0 V

This pin is main supply for the SIF processing.

VSUP3.3DAC – Supply Voltage 3.3 V

This pin is main and standby supply for the Analog DAC.

GND* – Ground

This pin are main ground for all digital analog and port supplies.

Application Note:

All GND pins must be connected to a low-resistive ground plane underneath the IC. All supply pins must be connected separately with short and low-resistive lines to the power supply. Decoupling capacitors from VSUPxx to GND have to be placed as closely as possible to these pins. It is recommended to use more than one capacitor. By choosing different values, the frequency range of active decoupling can be extended.

2.2.2.2 Audio Pins

VREFAU – Reference Voltage for Analog Audio

This pin serves as the internal ground connection for the analog audio circuitry. It must be connected to the **GND** pin with a 3.3 μ F and a 100 nF capacitor in parallel.

SGND – Analog Reference Input

This is the reference ground Analog Audio part.

AIN1 R/L – Audio 1 Inputs

The analog input signal for audio 1 is fed to this pin. Analog input connection must be AC coupled.

AIN2 R/L – Audio 2 Inputs

The analog input signal for audio 2 is fed to this pin. Analog input connection must be AC coupled.

AIN3 R/L – Audio 3 Inputs

The analog input signal for audio 3 is fed to this pin. Analog input connection must be AC coupled.

AIN4 R/L – Audio 4 Inputs

The analog input signal for audio 4 is fed to this pin. Analog input connection must be AC coupled.

AIN5 R/L – Audio 5 Inputs

The analog input signal for audio 5 is fed to this pin. Analog input connection must be AC coupled.

AOUT1 R/L – Audio 1 Outputs

Output of the analog audio 1 signal. Connections to these pins are intended to be AC coupled.

AOUT2 R/L – Audio 2 Outputs

Output of the analog audio 2 signal. Connections to these pins are intended to be AC coupled.

SPEAKER R/L – Loudspeaker Outputs

Output of the loudspeaker signal.

HEADPHONES R/L – Headphones Outputs

Output of the headphones signal.

2.2.2. Pin Descriptions (Continued)

SUBWOOFER – Subwoofer Outputs
Output of the subwoofer signal

I2S_DEL_WS - Delay Line Bus Word Strobe
This is the word strobe signal of the delay line bus.

I2S_DEL_CL - Delay Line Bus Clock
This is the Clock signal of the delay line bus.

I2S_DEL_IN - Delay Line Bus Data Input
This is the data input signal of the delay line bus.

I2S_DEL_OUT - Delay Line Bus Data Output
This is the data output signal of the delay line bus.

I2S_WS - I2S Word Strobe
This is the word strobe signal of I2S bus.

I2S_DA_IN - I2S Data Input
This is the data input signal of I2S bus.

I2S_CL - I2S Clock
This is the Clock signal of I2S bus.

SPDIF_OUT -
This is an SPDIF output signal to connect to an A/V receiver.

SIF -/+ – Sound IF Input
This is the SIF input to connect to an external DRX.

VREFSIF – Reference Voltage for SIF
This pin serves as the internal ground connection for the analog audio circuitry.

2.2.2.3 Video Pins

656I 0-7 – Digital 656 Data Input
These are the 8 bits digital 656 video inputs.

656CLKI – Digital 656 Input clock
This is the clock for the digital 656 video inputs.

656O 0-7 – Digital 656 Data Output
These are the 8 bits digital 656 video outputs.

656CLKO– Digital 656 output clock
This is the clock for the digital 656 video outputs.

OSDR 0-3 – Graphic Data input/output
These are the 2 or 4 bit graphic input/output

OSDG 0-3 – Graphic Data input/output
These are the 2 or 4 bit graphic input/output

OSDB 0-3 – Graphic Data input/output
These are the 2 or 4 bit graphic input/output

OSDHCS 0-1 – Graphic Half Contrast Input/Output
This is the half contrast for the graphic input/output

OSDFSW – Graphic Fast Switch Input/Output
This is the fast switch for the graphic input/output

OSDCLK – Graphic clock Input/Output
This is the clock for the graphic video input/output

OSDV – Graphic vertical sync Input/Output
This is the vertical sync for the graphic input/output

OSDH – Graphic horizontal sync Input/Output
This is the horizontal sync signal for the graphic I/O

DRO1_ 0-9 - Digital Red Outputs
This are 10 bits digital signals for red outputs, for dual RGB use bits (0-7).

DGO1_ 0-9 - Digital Green Output
This are 10 bits digital signals for green outputs, for dual RGB use bits (0-7).

DBO1_ 0-9 - Digital Blue Outputs
This are 10 bits digital signals for blue outputs, for dual RGB use bits (0-7).

DRO2_ 0-7 - Digital dual Red Outputs
This are 8 bits digital signals for red outputs.

DGO2_ 0-7 - Digital dual Green Output
This are 8 bits digital signals for green outputs.

DBO2_ 0-7 - Digital dual Blue Outputs
This are 8 bits digital signals for blue outputs.

PCS 0-5 - LCD Panel Control Select Outputs
This are 6 control select signals for LCD outputs. For CRT application use PCS_0 as H sync and PCS_1 as V sync Back End.

PCLK1,2 - LCD Panel Clock Outputs
This are the clock signals for LCD/RGB outputs.

LVDSA_* - LCD Panel LVDS Outputs
This are 12 signals and clocks for LVDS single or dual output.

LVDSB_* - LCD Panel LVDS Outputs
This are 10 signals and clocks for LVDS dual output.

REXT - LVDS External Resistor
This pin is connected to the external LVDS resistor. (6.2 kOhm to gnd)

DRI 0-7 - Digital video inputs for Red
This are 8 bits digital inputs for red signal

DGI 0-7- Digital video inputs for Green
This are 8 bits digital inputs for green signal

DBI 0-7- Digital video inputs for Blue
This are 8 bits digital inputs for blue signal.

DEN - Digital video inputs Enable

This is the enable signal for the Digital Video Inputs.

DHS - Digital video inputs Horizontal Sync

This is the H Sync signal for the Digital RGB input bus or for the VGA Video Inputs.

DVS - Digital video inputs Vertical Sync

This is the V Sync signal for the Digital RGB input bus or for the VGA Video Inputs.

DCLK - Digital video inputs Clock

This is the Clock signal for the Digital Video Inputs.

CLKOUT – Digital Output clock

This is a 20MHz clock for the external video ICs.

VIN 1–22 – Analog Video Input

These are the 19 analog video inputs.

(Vin 4, 10 and 14 are missing)

A CVBS, S-VHS, YCrCb or RGB signal is converted using the luma, chroma and component AD converter.

Vin 8, 18 are fast blank inputs. Vin22 is an Hsync input.

The input signals must be AC-coupled.

VOUT 1-3 – Analog Video Output

The analog video inputs that are selected by the video matrix are output at these pins.

ROUT, GOUT, BOUT – Analog RGB Output

These pins are the analog Red/Green/Blue outputs of the back-end.

SVMOUT – Scan Velocity Modulation Output

This output delivers the analog SVM signal. The D/A converter is a current sink like the RGB D/A converters. At zero signal the output current is 50% of the maximum output current.

2.2.2.4 Controller Pins**XTALIN** Crystal Input and **XTALOUT** Crystal Output

These pins are connected to an 20.25 MHz crystal oscillator. An external clock can be fed into XTALIN.

RESETQ – Reset Input/Output

A low level on this pin resets the VCT 69xyP. The internal CPU can pull down this pin to reset external devices connected to this pin.

TEST – Test Input

This pin enables factory test modes. For normal operation, it must be connected to ground.

SCL – I²C Bus Clock

This pin delivers the I²C bus clock line. The signal can be pulled down by external slave ICs to slow down data transfer.

SDA – I²C Bus Data

This pin delivers the I²C bus data line.

P1_0–P1_3 – I/O Port

These pins provide CPU controlled I/O ports.

P1_4–P1_7 – I/O Port

These pins provide CPU controlled I/O ports.

Also used as **CADC1–4** – Controller A/D inputs 1 to 4. This 4 pins are analog/digital converters from the controller

P2_0–P2_7 – I/O Port

These pins provide CPU controlled I/O ports.

P3_0–P3_7 – I/O Port

These pins provide CPU controlled I/O ports.

P4_0–P4_7 – I/O Port

These pins provide CPU controlled I/O ports.

TDO-TCLK-TDI-TMS -JTAG Interface Pins for TV controller.

TCLK at pin 4 (656O3) has during reset an internal pull up: (TCLK=0) at end of reset enables the JTAG mode at 656 LSB's, this can also be done via I2C.

This JTAG is also available at Port(1 and 2) but only via I2C.

TDOFW-TCLKFW-TDIFW-TMSFW -JTAG Interface Pins for firmware controller.

TCLKFW at pin 208 (656O7) has during reset an internal pull up: (TCLKFW=0) at end of reset enables the JTAG mode, this can also be done via I2C.

2.2.3. Pinning

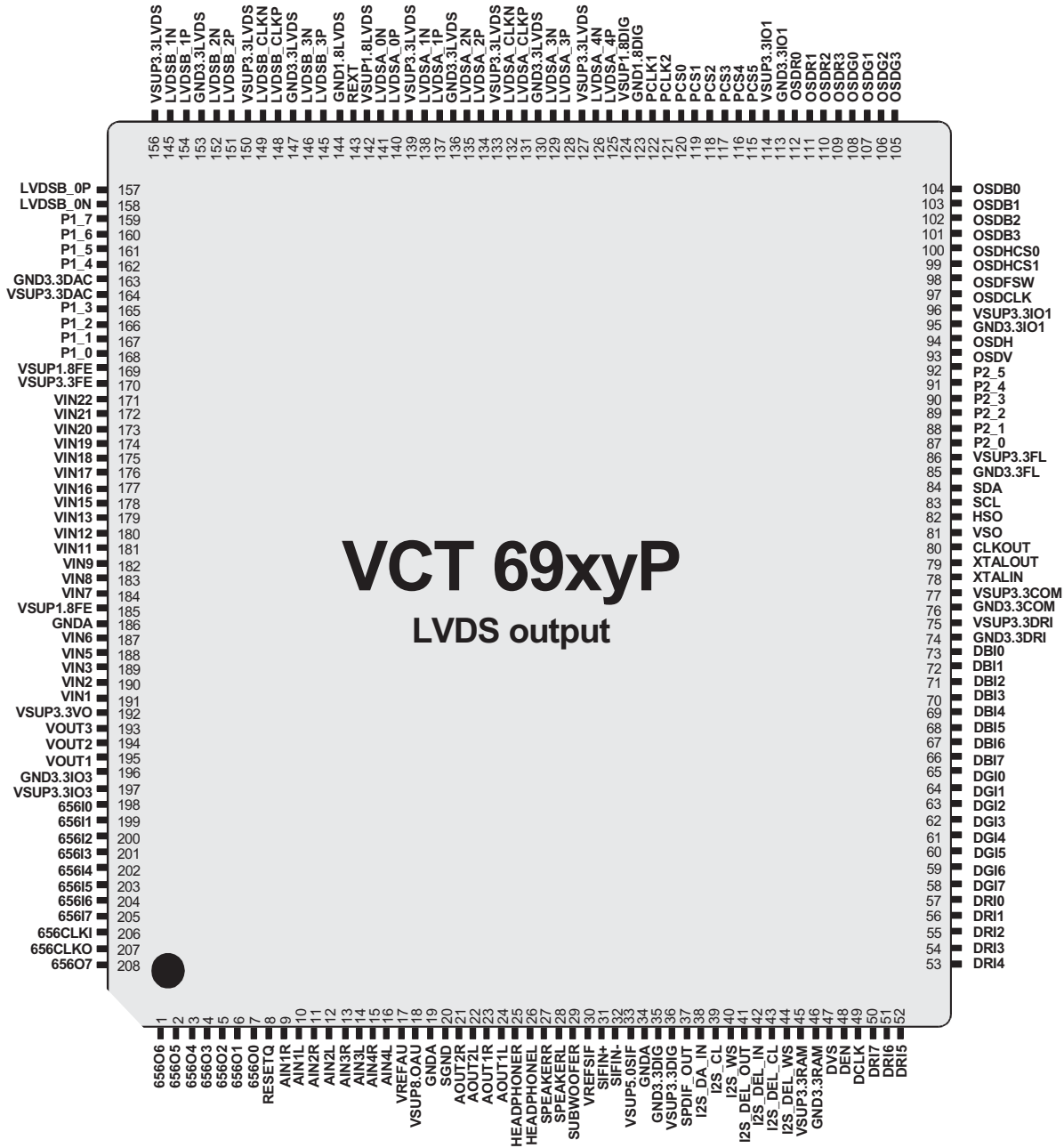

Important Note from MICRONAS:

All information and data contained in the data sheet are without any commitment, are not to be considered as an offer for conclusion of a contract, not shall they be construed as to create any liability. Any new issue of this data sheet invalidates previous issues. Product availability and delivery are exclusively subject to our respective order confirmation form; the same applies to orders based on development samples delivered.

By this publication, Micronas GmbH does not assume responsibility for patent infringements or other rights of third parties which may result from its use.

Further, Micronas GmbH reserves the right to revise this publication and to make changes to its content, at any time, without obligation to notify any person or entity of such revisions or changes.

2.3. IC301, IC302 (VHITDA8931T-1Y)

2.3.1. Block Diagram

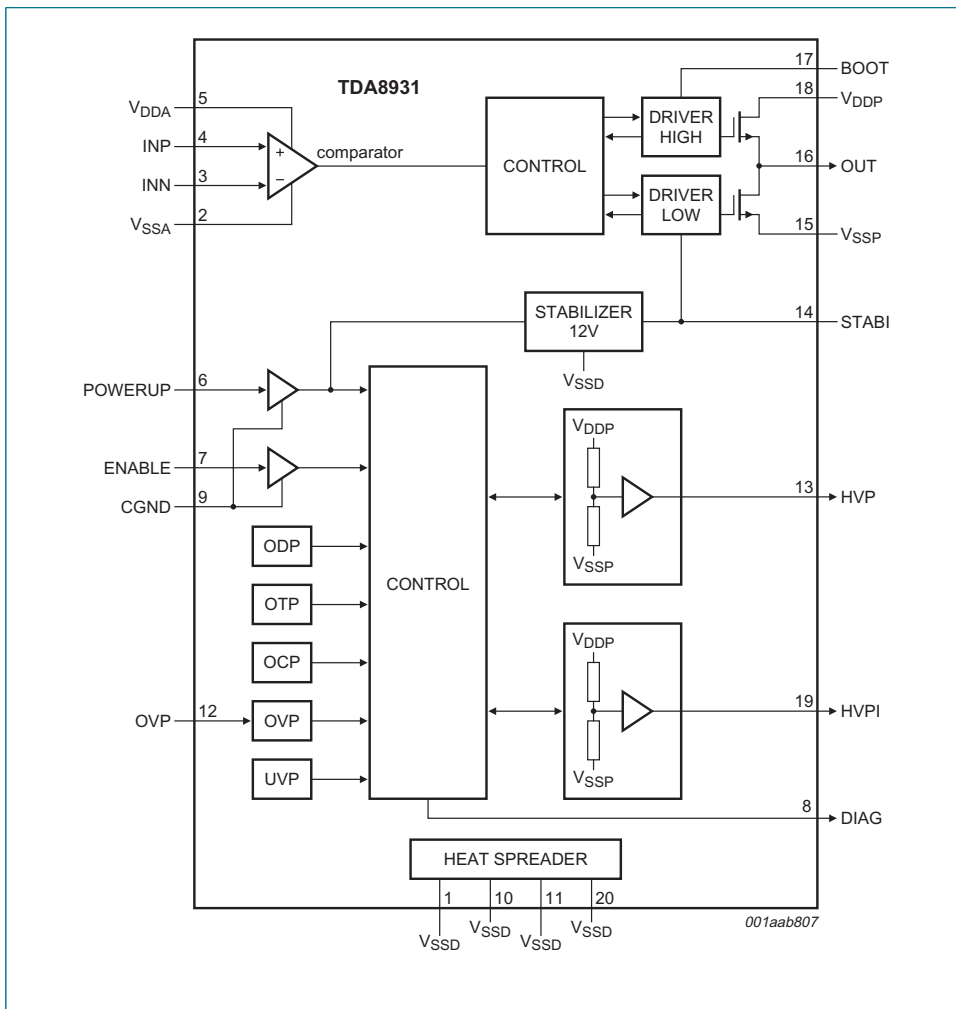

2.3.2. Pinning

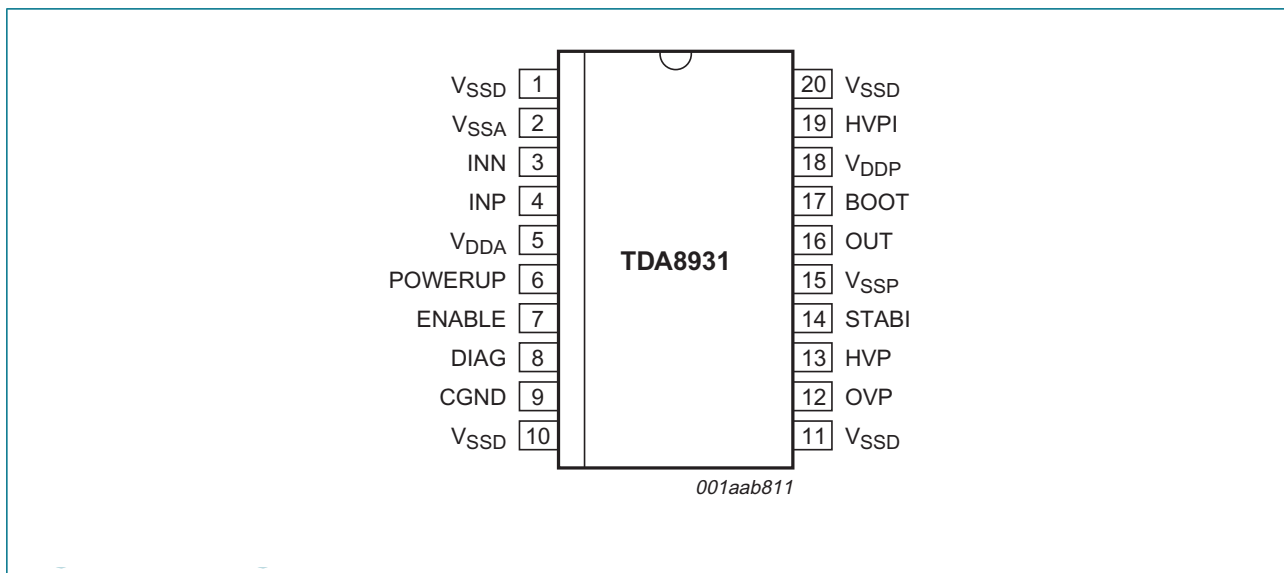

2.4. IC201 (VHITDA9886+-1Y)

2.4.1. Block Diagram

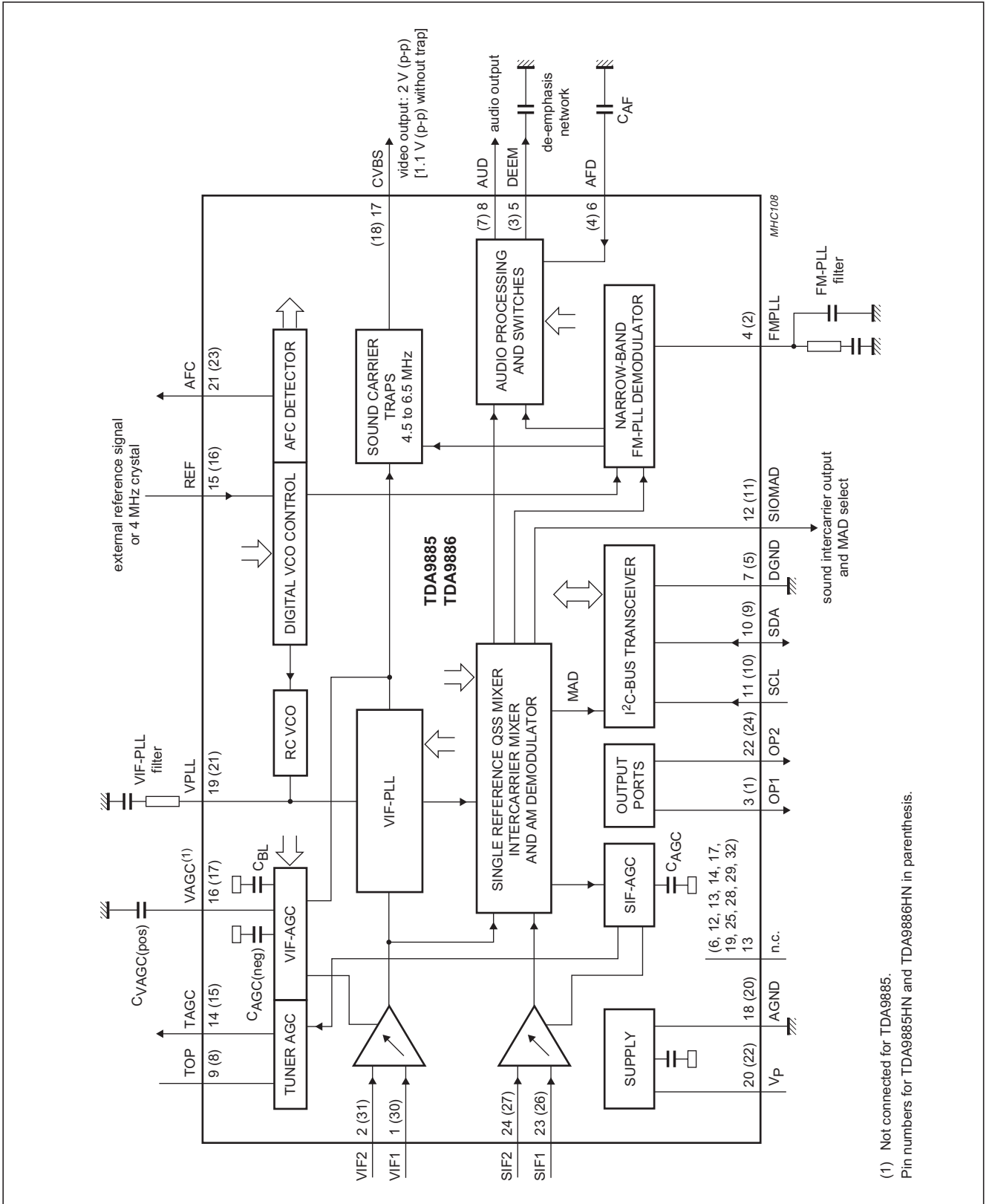

(1) Not connected for TDA9885.
Pin numbers for TDA9885HN and TDA9886HN in parenthesis.

2.4.2. Pinning

SYMBOL	PIN				DESCRIPTION
	TDA9885T TDA9885TS	TDA9886T TDA9886TS	TDA9885HN	TDA9886HN	
VIF1	1	1	30	30	VIF differential input 1
VIF2	2	2	31	31	VIF differential input 2
n.c.	–	–	32	32	not connected
OP1	3	3	1	1	output port 1; open-collector
FMPLL	4	4	2	2	FM-PLL for loop filter
DEEM	5	5	3	3	de-emphasis output for capacitor
AFD	6	6	4	4	AF decoupling input for capacitor
DGND	7	7	5	5	digital ground
n.c.	–	–	6	6	not connected
AUD	8	8	7	7	audio output
TOP	9	9	8	8	tuner AGC TakeOver Point (TOP) for resistor adjustment
SDA	10	10	9	9	I ² C-bus data input and output
SCL	11	11	10	10	I ² C-bus clock input
SIOMAD	12	12	11	11	sound intercarrier output and MAD select with resistor
n.c.	–	–	12	12	not connected
n.c.	13	13	13	13	not connected
n.c.	–	–	14	14	not connected
TAGC	14	14	15	15	tuner AGC output
REF	15	15	16	16	4 MHz crystal or reference signal input
VAGC	–	16	–	17	VIF-AGC for capacitor
n.c.	16	–	17	–	not connected
CVBS	17	17	18	18	composite video output
n.c.	–	–	19	19	not connected
AGND	18	18	20	20	analog ground
VPLL	19	19	21	21	VIF-PLL for loop filter
V _P	20	20	22	22	supply voltage
AFC	21	21	23	23	AFC output
OP2	22	22	24	24	output port 2; open-collector
n.c.	–	–	25	25	not connected
SIF1	23	23	26	26	SIF differential input 1 and MAD select with resistor
SIF2	24	24	27	27	SIF differential input 2 and MAD select with resistor
n.c.	–	–	28	28	not connected
n.c.	–	–	29	29	not connected

2.4.2. Pinning (Continued)

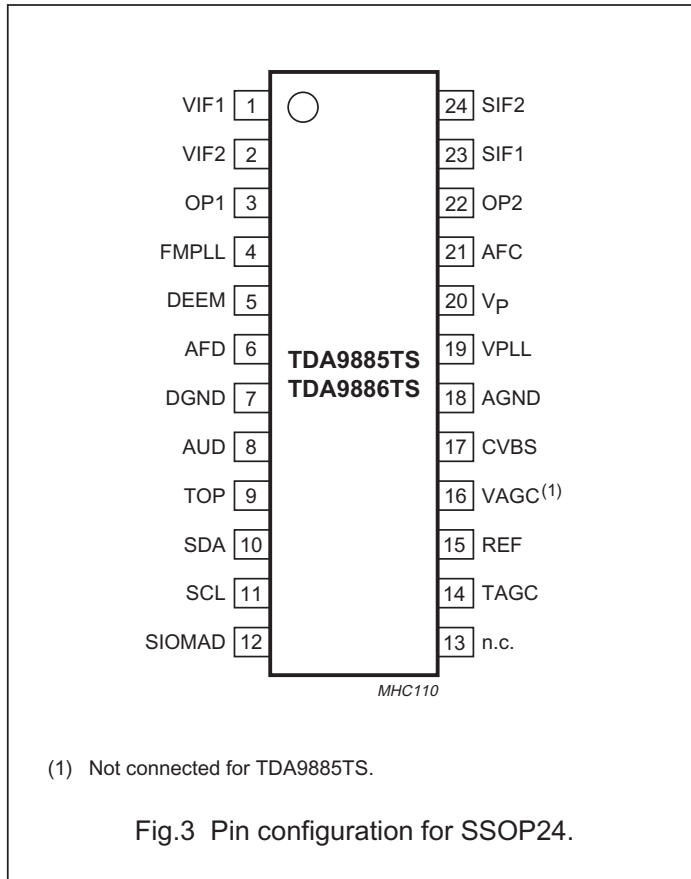

2.5. IC202 (STV0360)
2.5.1. Pinning

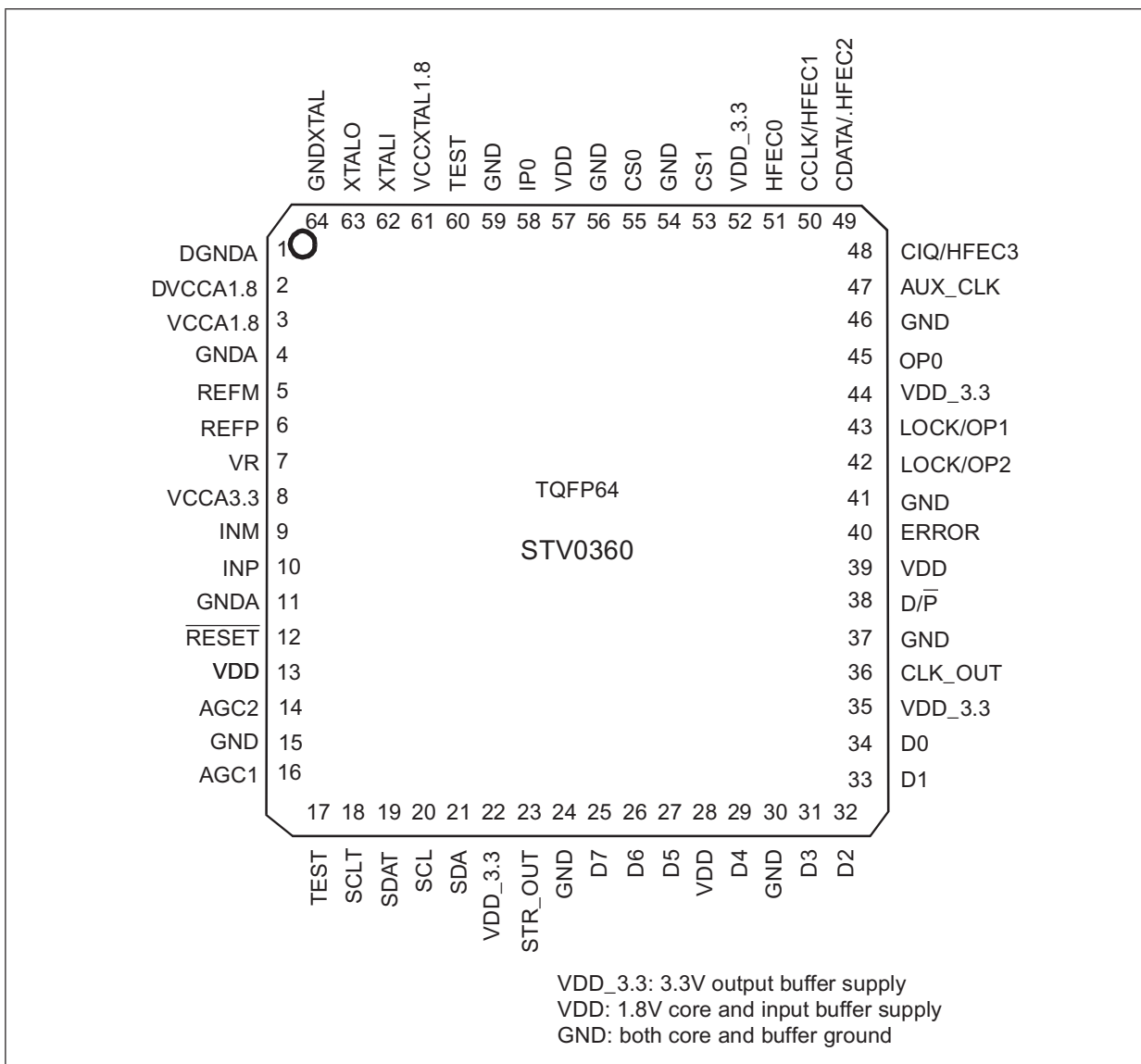

2.5.2. Pin Description

Pin number	Name	Type	Description	Drive (mA)
Clock and resets				
12	$\overline{\text{RESET}}$	I ¹	Hardware reset, active low	-
62	XTALI	Analog	Crystal oscillator input/external clock (1.8 V)	-
63	XTALO	Analog	Crystal oscillator output	-
61	VCCXTAL1.8	Supply	Analog oscillator supply (1.8 V)	-
64	GNDXTAL	Ground	Analog oscillator ground	-
Analog interface				
2	DVCCA1.8	Supply	Analog part digital supply (1.8 V)	-
5	REFM	Analog	Internal negative reference	-
6	REFP	Analog	Internal positive reference	-
3	VCCA1.8	Supply	Analog supply (1.8 V)	-
9	INM	Analog	Negative analog input	-
10	INP	Analog	Positive analog input	-
4, 11	GNDA	Supply	Analog ground	-
1	DGNDA	Ground	Analog ground	-
7	VR	Analog	Reference	-
8	VCCA3.3	Supply	Analog supply (3.3 V)	-
I²C interface				
21	SDA	IO ²	Serial data (open drain)	8
20	SCL	I	Serial clock (open drain)	-
19	SDAT	IO	SDA tuner (open drain)	4
18	SCLT	I	SCL tuner	-
MPEG interface				
25, 26, 27, 29, 31, 32, 33, 34	D7/0	O ³	Serial D7, MPEG data	8/4
36	CLK_OUT	O	MPEG byte or bit clock	4
23	STR_OUT	O	MPEG first byte sync	2
38	D/\overline{P}	O	MPEG data valid/parity	4
40	ERROR	O	MPEG packet error	2
51	HFEC0	O	Hierarchical FEC output bit 0	2
50	CCLK/HFEC1	O	Hierarchical FEC output bit 1 or clock for constellation display	2
49	CDATA/HFEC2	O	Hierarchical FEC output bit 2 or data for constellation display	2
48	CIQ/HFEC3	O	Hierarchical FEC output bit 3 or IQ validation for constellation display	2

2.5.2. Pin Description (Continued)

Pin number	Name	Type	Description	Drive (mA)
Front end controls				
16	AGC1	IO	RF AGC control $\Sigma\Delta$	4
14	AGC2	IO	IF AGC control $\Sigma\Delta$	4
17, 60	TEST		Reserved test mode, must be grounded	
58	IP0	I	General-purpose input port 0 and ADC input for RF level monitoring	-
45	OP0	IO	General-purpose output port 0	4
43	LOCK/OP1	IO	General-purpose output port 1 or lock indicator	4
42	LOCK/OP2	O	General-purpose output port 2 or lock indicator	4
47	AUX_CLK	IO	Auxiliary clock	8
55	CS0	I	Chip select LSB	-
53	CS1	I	Chip select MSB	-
Power supply				
13, 28, 39, 57	VDD	Supply	Digital core supply	
22, 35, 44, 52	VDD_3.3	Supply	Digital IO supply	
15, 24, 30, 37, 41, 46, 54, 56, 59	GND	Ground		

1. All inputs are 3.3 V compatible
2. All bidirectional pads are 3.3 V capable
3. All outputs are 3.3 V capable

2.6.2. Pin Description

STi5516 pin list

Signal names are prefixed by NOT_ if they are active low; otherwise they are active high. All signals are only 3.3 V capable unless otherwise indicated as 1.8 V or 5 V tolerant.

Table 2: I/O load capacitance and DC loading

Pad type	Functional pin group	Maximum load capacitance (pF)	Drive (mA)	Notes
C4	Others	75	4	
S8	SDRAM/EMI	75	8	
S8b	SDRAM/EMI	75	8	
E8	EMI (programmable)	35	8	a
		25	6	a
		15	4	a
		5	2	a
P4	PIO	400	4	

a. Typical load, but the maximum is 75 pF

Table 3: Analog power supply pins

Pin	Location	Number	Function
VDDVDACRGB	AE12	1	3.3 V power supply for RGB video DAC
VDDVDACYCC	AF10	1	3.3 V power supply for YCC video DAC
GNDVDACRGB	AC12	1	Ground for RGB video DAC
GNDVDACYCC	AC10	1	Ground for YCC video DAC
SHIELDVDAC	AC9	1	Shield ground for 2 x video DACs
IREFDACRGB	AD11	1	RGB video DAC current reference
IREFDACYCC	AE9	1	YCC video DAC current reference
VREFDACRGB	AC11	1	RGB video DAC voltage reference
VREFDACYCC	AD9	1	YCC video DAC voltage reference
VDDVPLL	C15	1	3.3 V power for video PLL
VDDAUDIOFSYN	B17	1	1.8 V dedicated power for low jitter audio clock frequency synthesizer
GNDAUDIOFSYN	C17	1	Dedicated ground for low jitter audio clock frequency synthesizer
VDDGENFSYN	A16	1	1.8 V dedicated power for nonaudio clock frequency synthesizer
GNDGENFSYN	B16	1	Dedicated ground for nonaudio clock frequency synthesizer
VDDAADAC	AA2	1	3.3 V power for audio DAC
VSSAADAC	AA1	1	Ground for audio DAC command switches

2.6.2. Pin Description (Continued)

Table 3: Analog power supply pins

Pin	Location	Number	Function
VDDASADAC	AA3	1	3.3 V power for audio DAC substrate
VCCAADAC	AB2	1	3.3 V power for audio DAC command switches
GNDAADAC	AB3	1	Ground for audio DAC
VCCASADAC	AC1	1	3.3 V power for audio DAC command switches substrate
IREF	AC2	1	Audio DAC output reference current
VBGFIL	AD1	1	Audio DAC filtered output reference voltage

Table 4: Digital power supply pins

Pin	Location	Number	Function
VDD18	a	24	1.8 V power supply
VDD33	b	35	3.3 V power supply
RTCVDD	AE8	1	Low power controller 1.8 V power supply
GND	c	76	Ground for power supplies

- a. A19, B18, B22, C18, D10, D18, G1 to G3, H4, L23, P2 to P4, R1, R2, R4, R23 to R26, AC13, AC16 and AC21.
- b. A20, B1, B2, B19, C1 to C3, C19, D1 to D5, D8, D11, D19, E4, E23, F4, J4, J23, M2 to M4, N1, U4, V23, Y23, AB23, AC6, AC18, AC22, AD22, AE22 and AF22.
- c. A15, A21, A23 to A26, B15, B20, B21, B23 to B25, C20 to C24, D7, D15, D16, D20 to D23, E1 to E3, F1 to F3, G4, G23, K23, L11 to L16, M11 to M16, N11 to N16, P11 to P16, R11 to R16, T11 to T16, Y4, AA23, AC5, AC14, AC20, AD21, AE21 and AF21.

Table 5: RTC pins

Pin	Location	I/O	Function
LPCLKIN ^a	AC8	I	Low power clock input
LPCLKOSC ^A	AD8	I/O	Low power clock oscillator

- a. 1.8 V tolerant

2.6.2. Pin Description (Continued)

Table 6: System pins

Pin	Location	I/O	Function	Pad type
CLK27MA ^A	A18	I	Selectable input clock to PLL or for x1 mode	C4
CLKSPEEDSEL ^a	C16	I	PLL speed select	C4
AUXCLKOUT ^a	D17	O	Auxiliary clock for general use	C4
NOT_RESET ^B	AE7	I	System reset	-
NOT_WDOGRSTOUT ^a	AF8	O	Internal watchdog timer reset.	C4

- a. 5 V tolerant
- b. 1.8 V tolerant

Table 7: JTAG pins

Pin	Location	I/O	Function	Pad type
TDI ^A	AC7	I	Boundary scan test data input	C4
TMS ^a	AD7	I	Boundary scan test mode select	C4
TCK ^a	AF7	I	Boundary scan test clock	-
NOT_TRST ^a	AE6	I	Boundary scan test logic reset	C4
TDO ^a	AF6	O	Boundary scan test data output	C4

- a. 5 V tolerant

Table 8: DCU pins

Pin	Location	I/O	Function	Pad type
DCUTRIGGERIN ^a	P1	I	External trigger input to DCU	C4
DCUTRIGGEROUT ^A	R3	O	Signal to trigger external debug circuitry	C4

- a. 5 V tolerant

2.6.2. Pin Description (Continued)

Table 9: EMI pins

Pin	Location	I/O	Function	Pad type
NOT_EMIRAS or NOT_CI_IORD ^a	J2	O	Row address strobe for SDRAM	C4
NOT_EMICAS or NOT_CI_IOW ^a	J1	O	Column address strobe for SDRAM	E8
NOT_EMICSA	K4	O	Peripheral chip select A	E8
NOT_EMICSB	K3	O	Peripheral chip select B	E8
NOT_EMICSC	K2	O	Peripheral chip select C	E8
NOT_EMICSD	K1	O	Peripheral chip select D	E8
NOT_EMICSE	L4	O	Peripheral chip select E	E8
NOT_EMICSF	L3	O	Peripheral chip select F	E8
NOT_EMIBE[1:0]	L1, L2	O	External device data bus byte enable. 1 bit per byte of the data bus.	E8
NOT_EMIOE or NOT_CI_OE	M1	O	External device output enable.	E8
NOT_EMILBA or NOT_CI_WEA	N3	O	Flash device load burst address.	E8
EMWAITNOTTREADY ^b	N4	I	External memory device target ready indicator	C4
EMIRDNOTWR	N2	O	External read/write access indicator. Common to all devices.	E8
EMIDATA[15:0]	c	I/O	External common data bus.	E8
EMIADDR[25:2] ^d	e	O	External common address bus	E8
NOT_EMIREQGNT	J3	O	Bus request/grant indicator	E8
NOT_EMIAKREQ ^b	H1	I	Bus grant/request indicator	C4
EMIBOOTMODE0 ^b	H3	I	External power-up port size indicator	C4
EMISDRAMCLK	A1	O	SDRAM clock	E8
EMIFLASHCLK	A2	O	Peripheral clock	E8

a. Or equivalent ATA HDD interface signal.

b. 5 V tolerant

c. B3, A3, A4, B4, C4, A5, B5, C5, A6, B6, C6, D6, A7, B7, C7 and A8.

d. EMIADDR[19:20] are used as ATA HDD interface function: ATA CS0 and CS1. There is no interconnect configuration control register bit to select this function. The addresses are just reused as chip selects.

e. B8, C8, A9, B9, C9, D9, A10, B10, C10, A11, B11, C11, A12, B12, C12, D12, A13, B13, C13, D13, A14, B14, C14 and D14.

2.6.2. Pin Description (Continued)

Table 10: Transport stream 2 pins

Pin	Location	I/O	Function	Pad type
TSIN2LBYTECLK ^a	L24	I/O	Transport stream bit clock	C4
TSIN2LBYTECLKVALID ^a	L26	I/O	Transport stream bit clock valid edge	C4
TSIN2LERROR ^a	L25	I/O	Transport stream packet error	C4
TSIN2LPACKETCLK ^a	J25	I/O	Transport stream packet strobe	C4
TSIN2LDATA[7:0] ^a	b c	I/O	Transport stream data	C4

a. 5 V tolerant

b. H25, H24, H23, J26, J24, K26, K25 and K24

c. TSIN2LDATA7 is used for data input in serial mode.

Table 11: Transport stream 1 pins

Pin	Location	I/O	Function	Pad type
TSIN1BYTECLK ^a	P23	I	Transport stream bit/byte clock	C4
TSIN1BYTECLKVALID ^a	P26	I	Transport stream bit/byte clock valid edge	C4
TSIN1ERROR ^a	P25	I	Transport stream packet error	C4
TSIN1PACKETCLK ^a	P24	I	Transport stream packet strobe	C4
TSIN1DATA[7:0] ^a	b, c	I	Transport stream data in	C4

a. 5 V tolerant

b. M26, M25, M24, M23, N26, N25, N24 and N23.

c. TSIN1DATA7 is used for data input in serial mode.

2.6.2. Pin Description (Continued)

Table 12: Programmable I/O pins

Pin	Location	I/O	Function	Pad type
PIO0[0:7] ^A	b	I/O	Parallel input/output pin or alternative function	P4
PIO1[0:7] ^a	c	I/O		P4
PIO2[0:7] ^a	d	I/O		P4
PIO3[0:7] ^a	e	I/O		P4
PIO4[0:7] ^a	f	I/O		P4
PIO5[0:7] ^a	g	I/O		P4

- a. 5 V tolerant
- b. U2, U1, U3, V4, V3, V2, V1 and W4
- c. W3, W2, W1, Y3, Y2, Y1, AA4 and AE1
- d. AF1, AD2, AE2, AF2, AF3, AD3, AE3 and AD4
- e. AE5, AE4, AF5, AF4, AD6, AD15, AD5 and AE15
- f. AF15, AD16, AE16, AF16, AC17, AD17, AF18 and AE17
- g. AF17, AD18, AE18, AC19, AD19, AE19, AF19 and AD20

Table 13: Digital audio pins^a

Pin	Location	I/O	Function	Pad type
SCLK ^B	AD13	O	Serial clock	C4
PCMDATA[1] ^b	AE14	O	PCM data out	C4
PCMCLK ^b	AE13	I/O	External PCM clock input or internal PCM clock output	C4
LRCLK ^b	AF13	O	Left/right clock	C4
SPDIF ^b	AC15	O	Digital audio output	C4

- a. Note: Digital audio input pins PCMI_SCLK, PCMI_DATA and PCMI_LRCLK are alternate functions for NOT_CD_REQ[1], I1284HOSTLOGICHIGH, and NOT_CD_REQ[0], on PIO port 3 bits [6:4]
- b. 5 V tolerant

2.6.2. Pin Description (Continued)

Table 14: AVSDRAM pins (SMI)

Pin	Location	I/O	Function	Pad type
SMIADDR[13:0]	a	O	Audio/video core SDRAM address bus	S8
SMIDATA[15:0]	b	I/O	Audio/video core SDRAM data bus	S8
NOT_SMICS0	V25	O	Audio/video core SDRAM chip select for 1st SDRAM	S8
NOT_SMICS1	V26	O	Audio/video core SDRAM chip select for 2nd 16 Mbit SDRAM	S8
NOT_SMICAS	U23	O	Audio/video core SDRAM column address strobe	S8
NOT_SMIRAS	U24	O	Audio/video core SDRAM row address strobe	S8
NOT_SMIWE	U25	O	Audio/video core SDRAM write enable	S8
SMIMEMCLKIN	T23	I	Audio/video core SDRAM memory clock input	S8b
SMIMEMCLKOUT	U26	O	Audio/video core SDRAM memory clock output	S8
SMIDATAML	T24	O	Audio/video core SDRAM data bus lower byte enable	S8
SMIDATAMU	T25	O	Audio/video core SDRAM data bus upper byte enable	S8

- a. AC24, AC23, AD26, AD25, AD24, AD23, AE26, AE25, AE24, AE23, AF26, AF25, AF24 and AF23.
b. V24, W26, W25, W24, W23, Y26, Y25, Y24, AA26, AA25, AA24, AB26, AB25, AB24, AC26 and AC25.

Table 15: IEEE 1284/1394 pins

Pin	Location	I/O	Function	Pad type
P1284DATA[7:0] ^A	b	I/O	1284 data or 1394 AV data	I14
NOT_P1284SELECTIN ^a	E24	I/O	1284 or 1394 AV control signals	I14
NOT_P1284INIT ^a	E25	I/O		I14
NOT_P1284FAULT ^a	E26	I/O		I14
NOT_P1284AUTOFD ^a	D24	I/O		I14
P1284SELECT ^a	D25	I/O		I14
P1284PERROR ^a	D26	I/O		I14
P1284BUSY ^a	C25	I/O		I14
NOT_P1284ACK ^a	C26	I/O		I14
NOT_P1284STROBE ^a	B26	I/O		I14

- a. 5 V tolerant
b. F26, F25, F24, F23, G26, G25, G24 and H26.

2.6.3. Pin Description (Continued)

Table 16: Interrupt pins

Pin	Location	I/O	Function	Pad type
INTERRUPT[3:0] ^A	b	I/O	External interrupts	C4

- a. 5 V tolerant
- b. T1, T2, T3 and T4.

Table 17: Analog audio DAC (digital-to-analog converter) pins

Pin	Location	I/O	Function
OUTPLEFT	AC3	O	Left channel, differential positive current output
OUTMLEFT	AB1	O	Left channel, differential negative current output
OUTPRIGHT	AC4	O	Right channel, differential positive current output
OUTMRIGHT	AB4	O	Right channel, differential negative current output

Table 18: Analog video DAC pins

Pin	Location	I/O	Function
ROUT	AF11	O	Red output
GOUT	AE11	O	Green output
BOUT	AD12	O	Blue output
COUT	AF9	O	Chroma output
CVOUT	AD10	O	Composite video output
YOUT	AE10	O	Luma output

Table 19: Digital video pins

Pin	Location	I/O	Function	Pad type
NOT_HSYNC ^A	AE20	I/O	Horizontal sync	C4
EVENNOTODD ^a	AF20	I/O	Vertical sync	C4

- a. 5 V tolerant

2.6.3. Pin Description (Continued)

Table 20: Port 0 PIO signal assignments

Port 0 bit	Input	Output
Bit 0		SC0_DATAOUT or ASC0_TXD ^a
Bit 1	SC0_DATAIN or ASC0_RXD ^a	
Bit 2	SC0_CG_EXTCLK	
Bit 3		SC0CG_CLK or SMCDSS_CLK ^b
Bit 4		(SCO_RESET)
Bit 5		(SCO_NOT_SETVCC)
Bit 6		SC0_DIR or ASC0_NOTOE ^c , (SCO_NOT_SETVPP)
Bit 7	(SC0_DETECT)	

- a. ASC0 TX/RX data becomes smartcard TX/RX data when the ASC module is used in smartcard mode.
- b. Output function between PIO or smartcard module clock generator alternate function and clock generator module frequency synthesizer clock is selected by bit 28 in the interconnect register CONFIG_CONTROL_A (SMCARDA_DSSSMCLK_NOT_PIOBIT3). If the DSS smartcard mode is selected (bit 28 = 1), this overrides the normal PIO or PIO alternate function output.
- c. When ASC0 is used in nonsmartcard mode, the smartcard direction signal becomes an active low ASC TX output enable signal. The signals are in fact the same, that is, SC0_DIR = 0 means smartcard TX is active.

Table 21: Port 1 PIO signal assignments

Port 1 bit	Input	Output
Bit 0		SC1_DATAOUT or ASC1_TXD ^a
Bit 1	SC1_DATAIN or ASC1_RXD ^a	
Bit 2	SC1_CG_EXTCLK	
Bit 3		SC1CG_CLK or SMCDSS_CLK ^b
Bit 4		(SC1_RESET)
Bit 5	YC[1]	YC[1], (SC1_NOT_SETVCC)
Bit 6		SC1_DIR or ASC1_NOTOE ^c , (SC1_NOT_SETVPP)
Bit 7	YC[0] (SC1_DETECT)	YC[0]

- a. ASC1 TX/RX data becomes smartcard TX/RX data when the ASC module is used in smartcard mode.
- b. Output function between PIO or smartcard module clock generator alternate function and clock generator module frequency synthesizer clock is selected by bit 29 in the interconnect register CONFIG_CONTROL_A (SMCARDB_DSSSMCLK_NOT_PIOBIT3). If the DSS smartcard mode is selected (bit 29 = 1) this overrides the normal PIO or PIO alternate function output.
- c. When ASC1 is used in nonsmartcard mode the smartcard direction signal becomes an active low ASC TX output enable signal. The signals are in fact the same, that is, SC1 DIR = 0

2.6.3. Pin Description (Continued)

Table 22: Port 2 PIO signal assignments

Port 2 bit	Input	Output
Bit 0		MAFE_HC1 or NOT_ASC4_RTS ^a
Bit 1		MAFE_DOUT or ASC4_TXD ^a
Bit 2	MAFE_DIN or ASC4_RXD ^a	
Bit 3	MAFE_FS or NOT_ASC4_CTS ^a	
Bit 4	MAFE_SCLK	
Bit 5	PWM_CAPTURE0	
Bit 6		PWM_COMPARE0
Bit 7		PWM_OUT0

a. Controlled by bit MAFE_OR_UART4_SEL in interconnect register CONFIG_CONTROL_D (bit 20).

Table 23: Port 3 PIO signal assignments

Port 3 bit	Input	Output
Bit 0	SSC0_MTSR_DIN or SSC0_MRST_DIN	SSC0_MTSR_DOUT or SSC0_MRST_DOUT ^a
Bit 1	SSC0_SCLKIN	SSC0_SCLKOUT
Bit 2	SSC1_MTSR_DIN or SSC1_MRST_DIN	SSC1_MTSR_DOUT or SSC1_MRST_DOUT ^b
Bit 3	SSC1_SCLK	SSC1_SCLK
Bit 4	NOT_CD_REQ[0] or PCMI_LRCLK	I1284PERILOGICHIGH
Bit 5	Slave mode I1284HOSTLOGICHIGH or PCMI_DATA	Master mode I1284HOSTLOGICHIGH
Bit 6	NOT_CD_REQ[1] or PCMI_SCLK	I1284INNOTOUT
Bit 7		PWM_OUT1

a. Output function selected by bit 24 in interconnect configuration register CONFIG_CONTROL_B (COMMS_SSC0_DOUT_MRST_NOTMTSR_MUXSEL)

b. Output function selected by bit 25 in interconnect configuration register CONFIG_CONTROL_B (COMMS_SSC1_DOUT_MRST_NOTMTSR_MUXSEL)

2.6.3. Pin Description (Continued)

Table 24: Port 4 PIO signal assignments

Port 4 bit	Input	Output
Bit 0	TTXTREQUEST or OSDENABLE	OSDENABLE ^a
Bit 1	CFC	TXTDATAOUT ^b
Bit 2	YC[7]	YC[7]
Bit 3	ASC2_RXD	
Bit 4		ASC2_TXD ^c
Bit 5	PWM_CAPTURE2 or YC[6]	YC[6]
Bit 6	SCCG_EXTCLK	PWM_COMPARE2
Bit 7		PWM_OUT2

- a. OSDENABLE output function is selected rather than PIO by interconnect configuration register CONFIG_CONTROL_C, bit 2 (CONFIG_OTHER_ALT_PIOPORT4[0]). The output can then be turned off by the MPEG video decoder to use OSDENABLE as an input.
- b. TXTDATAOUT function selected by interconnect configuration register CONFIG_CONTROL_C, bit 3 (CONFIG_OTHER_ALT_PIOPORT4[1])
- c. After reset, register CONFIG_CONTROL_C bit 4 must be set to 1 to pass PIO data or to use ASC2_TXD in alternate output PIO mode.

Table 25: Port 5 PIO signal assignments

Port 5 bit	Input	Output
Bit 0	IRB_IR_IN ^a	
Bit 1	IRB_UHF_IN ^b	
Bit 2		Infrared transmitter/receiver drive PPM
Bit 3		Infrared transmitter/receiver drive jack (0 or z) open drain jack output ^{c, d}
Bit 4	YC[5]	ASC3_TXD or YC[5] ^e
Bit 5	ASC3_RXD or YC[4]	YC[4]
Bit 6	NOT_ASC3_CTS or YC[3]	YC[3]
Bit 7	YC[2]	NOT_ASC3RTS or YC[2] ^e

- a. The wake-up from low power mode function is enabled by interconnect configuration register CONFIG_CONTROL_D, bit 21 (RC_IRDA_DATA_IN_EN).
- b. The wake-up from low power mode function is enabled by interconnect configuration register CONFIG_CONTROL_D, bit 22 (UHF_IN_EN).
- c. PIO needs to be configured as open drain in alternate output mode to use infrared transmitter/receiver drive jack.
- d. After reset, bit 5 in CONFIG_CONTROL_C must be set to 1 to pass PIO data or use infrared transmitter/receiver drive jack in alternate function mode.
- e. Output function selected by bit 11 in CONFIG_CONTROL_E (CONFIG_OTHER_ALT_PIO_YC)

SOURCE OF DOCUMENTATION

IC1905 SiI9021.

SILICON IMAGE Data Sheet:
SiI9021 HDMI PanelLink Cinema Receiver
Doc: SiL-DS-0117-A . August 2004.

IC201 TDA9886.

PHILIPS Semiconductors Product Specification:
TDA9885;TDA9886 I2C-bus controlled single and multistandard alignment-free IF-PLL demodulators. 2003 Oct 02
http://www.semiconductors.philips.com/acrobat_download/datasheets/TDA9885_TDA9886_2.pdf

IC301, IC302 TDA8931.

PHILIPS Semiconductors Preliminary Data Sheet:
TDA8931 Power Comparator 1x20W
Doc: 9397 750 13847 Rev.01. 14 January 2004
http://www.semiconductors.philips.com/acrobat_download/datasheets/TDA8931_1.pdf

IC3002 VCT69xyP.

MICRONAS Avance Information:
VCT69xyP Video-Controller-Text-Audio IC Family for DoubleScan and FPD TV
Doc: 6251-644-1-1AI. November 3, 2004

IC202 STV0360.

STMicroelectronics Data Sheet:
STV0360 COFDM demodulator IC with A/D converter.
Doc: 7283434C. January 2003.

IC4001 STi5516.

STMicroelectronics Data Sheet:
STi5516. Decoder.
Doc: 73688668. Oct 2003.

CHASSIS LAYOUT

Power Supply Unit Layout QPWBF605WJN5

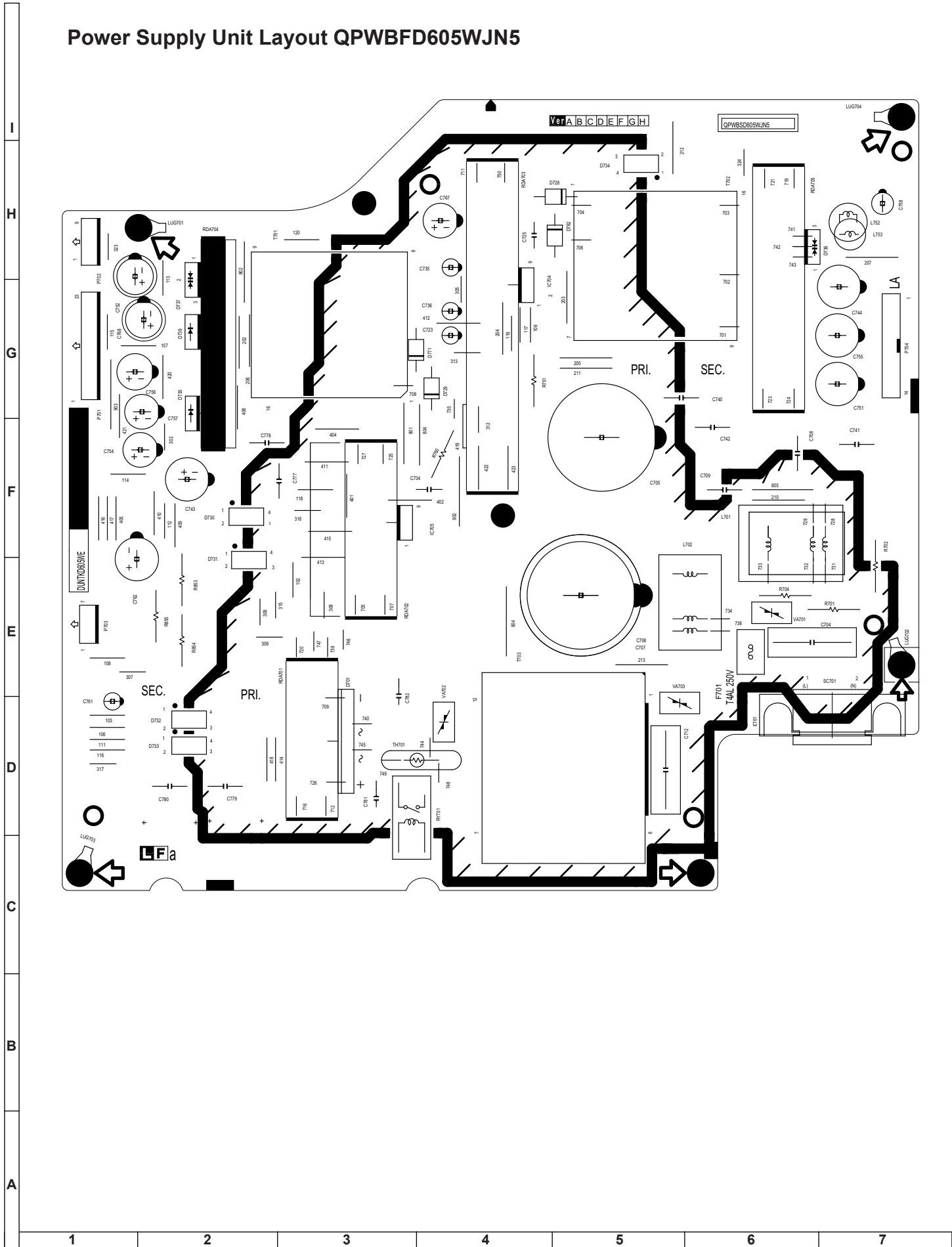

Inverter Unit Layout RDENC2267TPZC

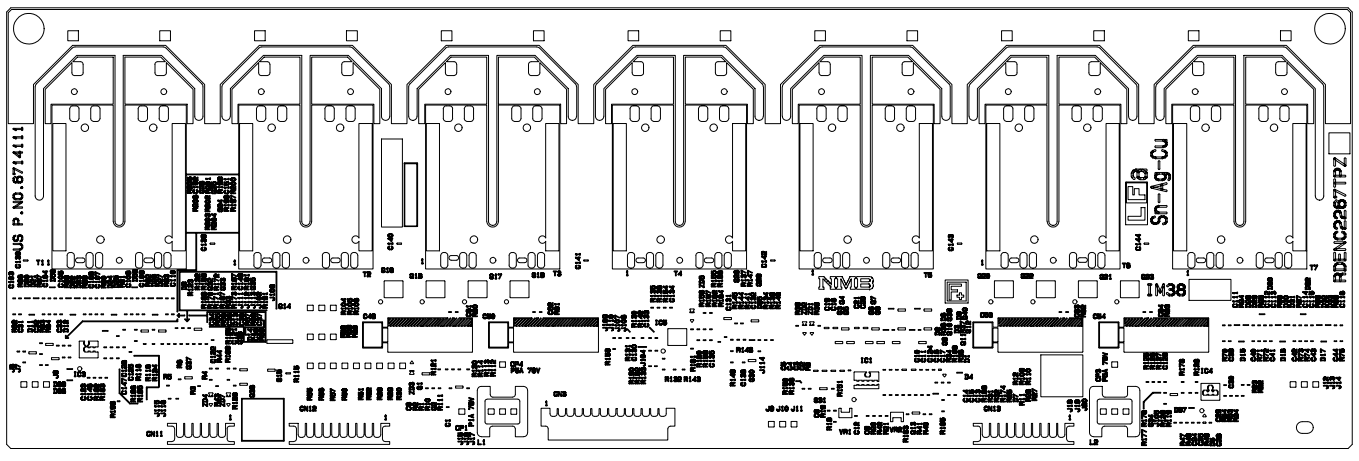

Inverter Unit Layout RUNTKA216WJZZ

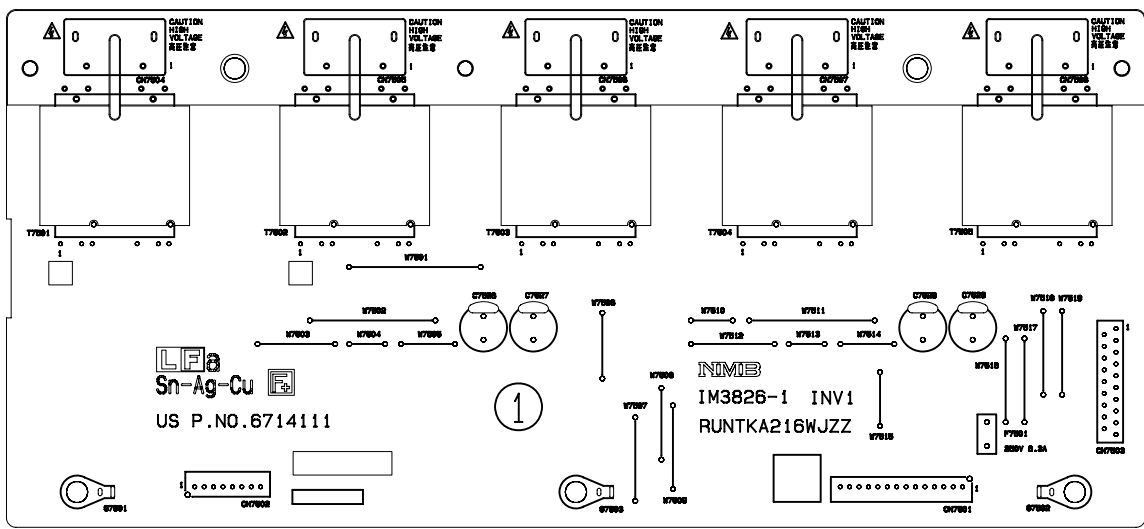

Inverter Unit Layout RUNTKA217WJZZ

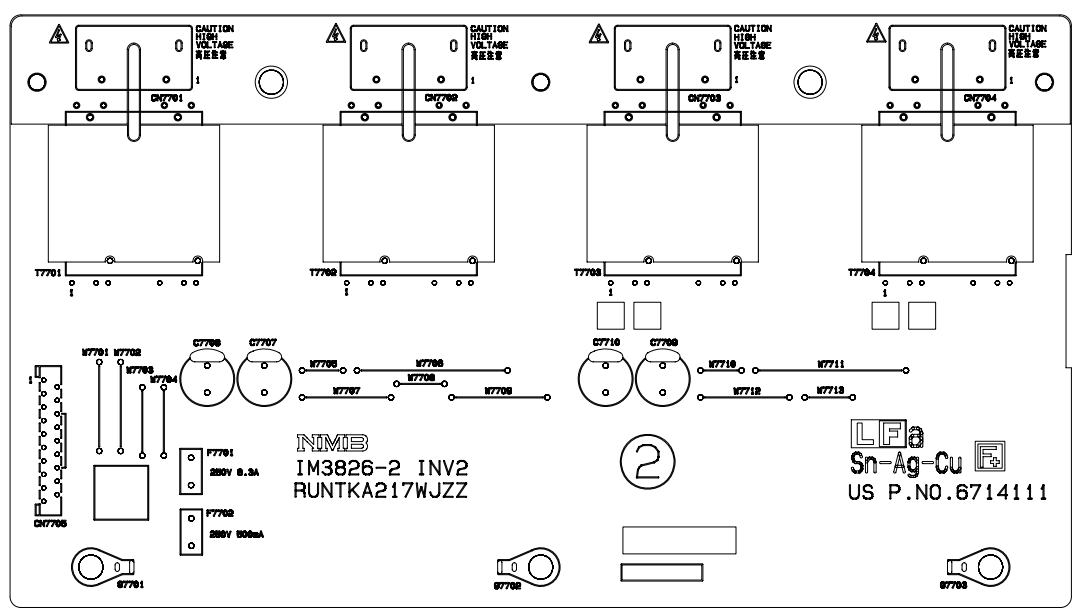

1	2	3	4	5	6	7
---	---	---	---	---	---	---

AV Unit Layout QPWBX604WJN3

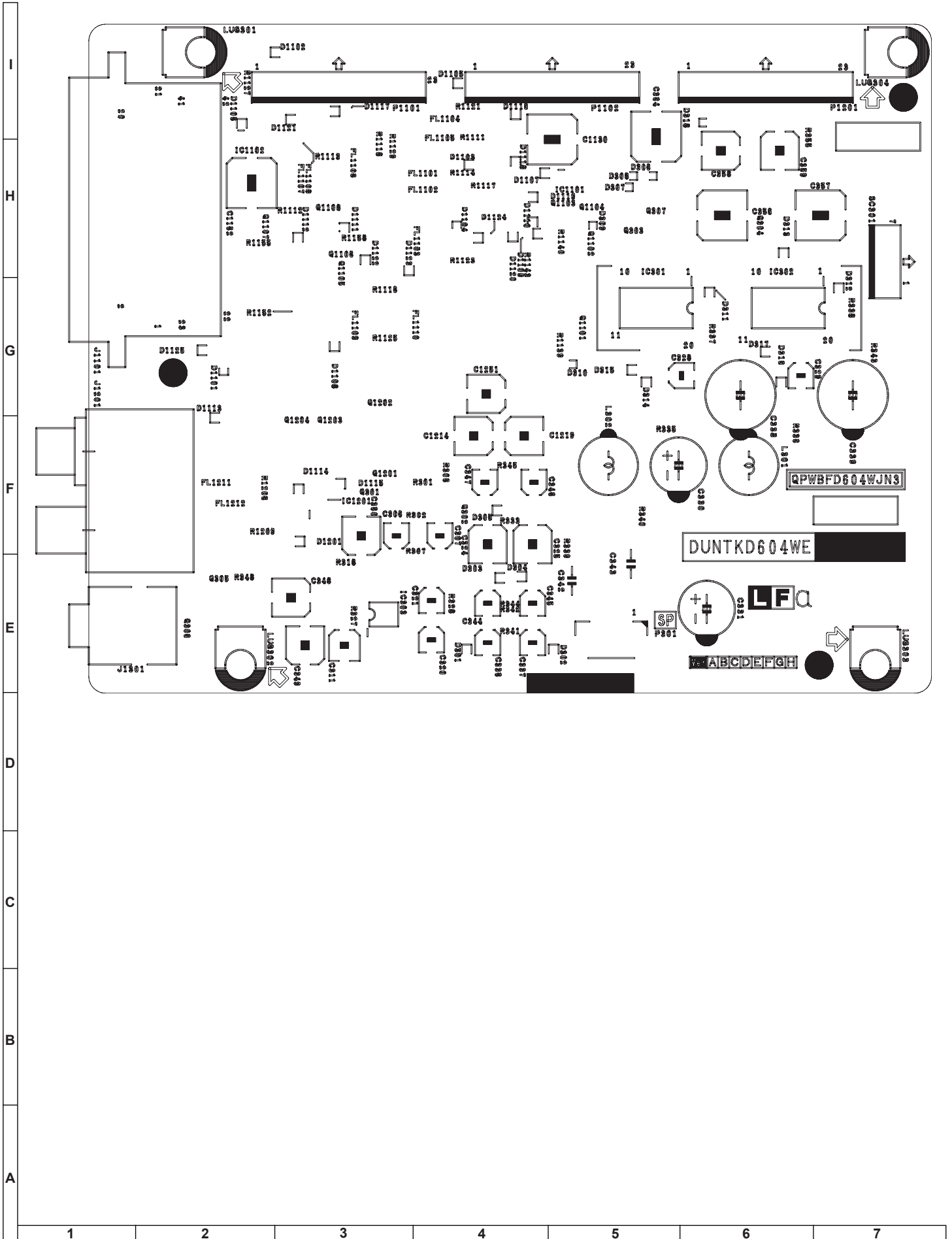

Digital Unit Layout QPWBX628WJN2

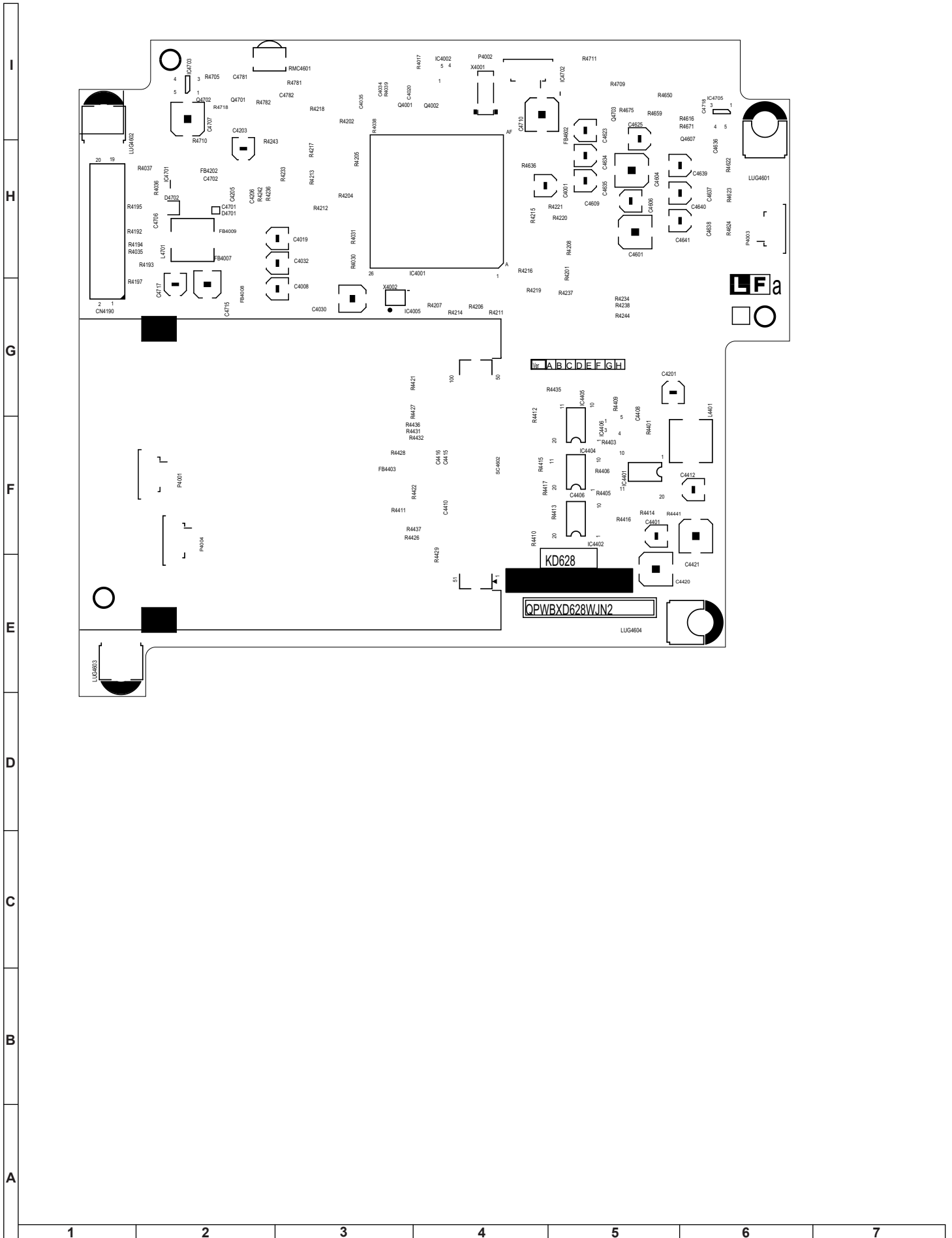

OVERALL WIRING DIAGRAM

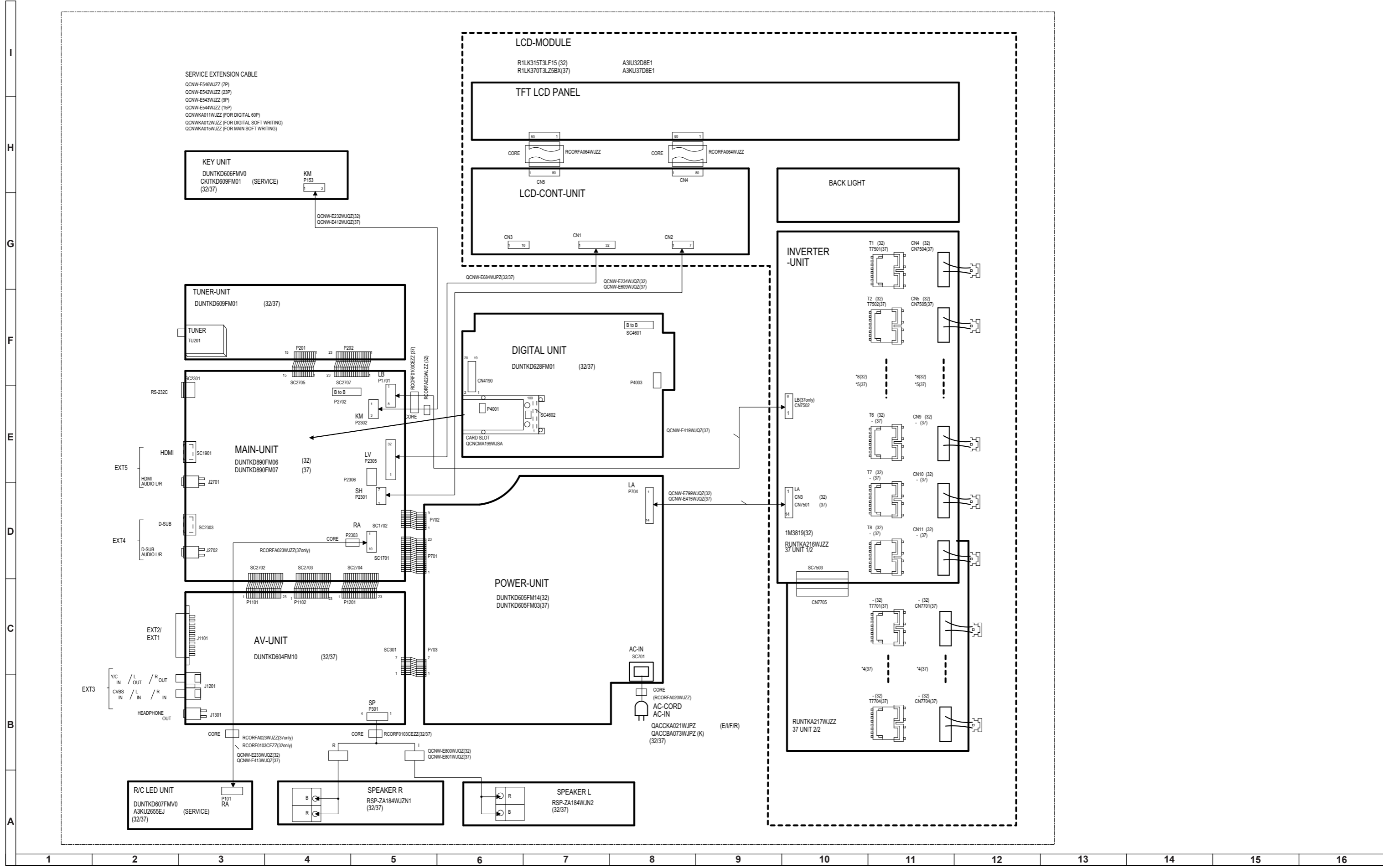

BLOCK DIAGRAM

System Block Diagram

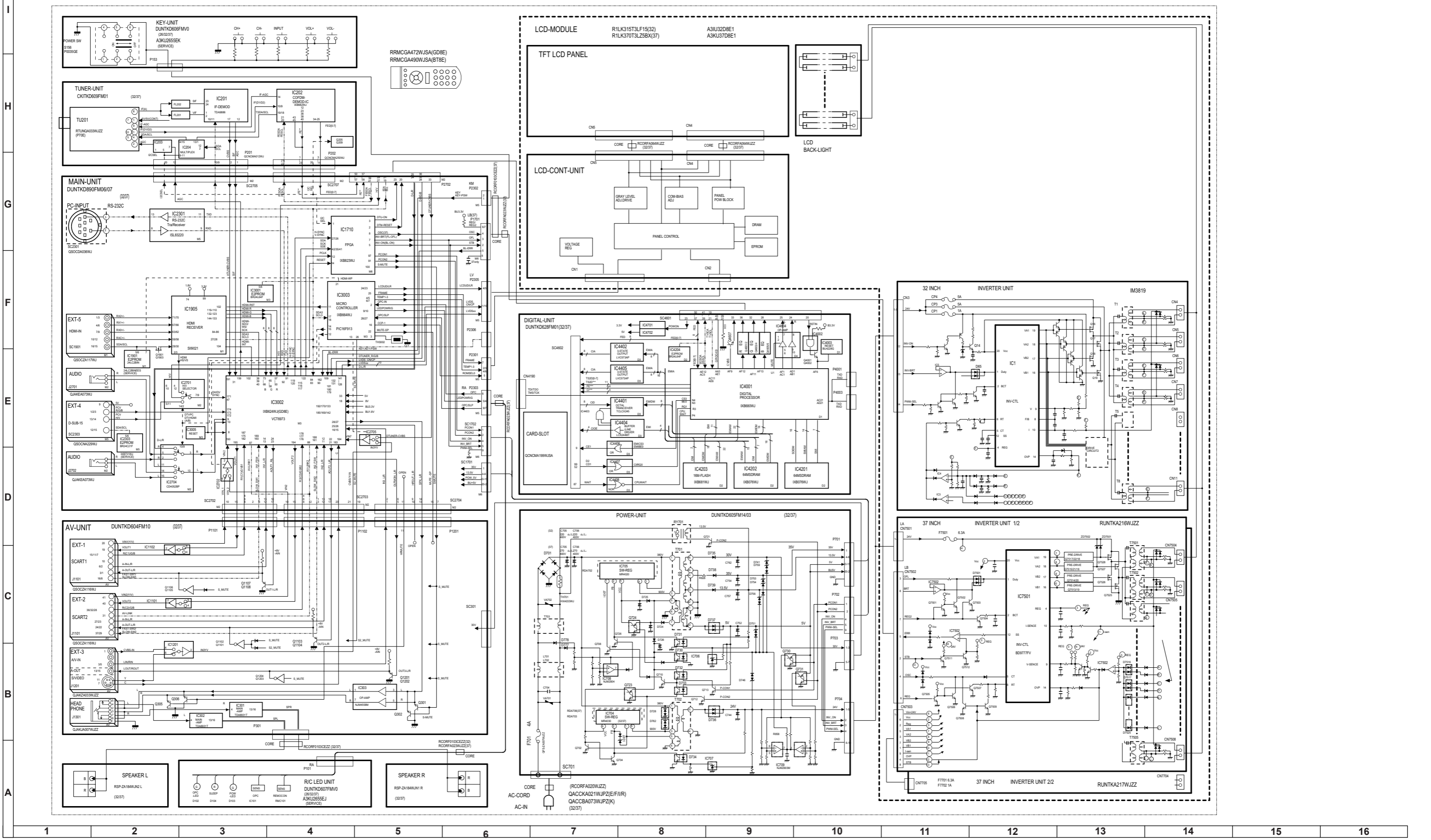

Power-Source Block Diagram

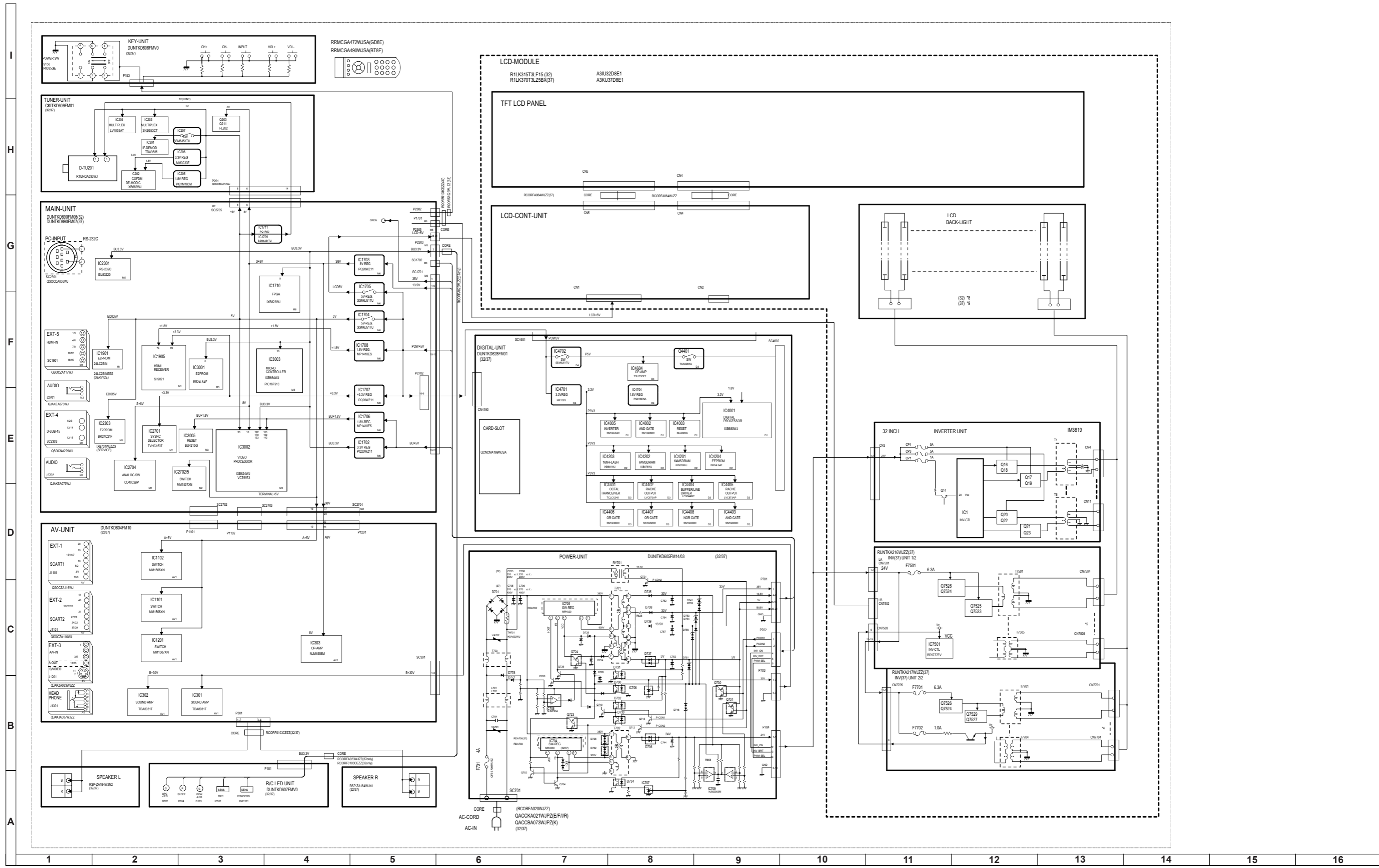

SCHEMATIC DIAGRAMS

Description:

VOLTAGE MEASUREMENT CONDITION:

1. The voltages at test points are measured on exclusive AC adaptor and the stable supply voltage of AC 230V. Signals are fed by a color bar signal generator for servicing purpose and the above voltages are measured with a 20k ohm/V tester.

INDICATION OF RESISTOR & CAPACITOR:

RESISTOR

1. The unit of resistance "Ω" is omitted. (K=kΩ=1000 Ω, M=MΩ).
2. All resistors are ± 5%, unless otherwise noted. (J= ± 5%, F= ± 1%, D= ± 0.5%)
3. All resistors are 1/16W, unless otherwise noted.
4. All resistors are Carbon type, unless otherwise noted.

- (C): Solid (W): Cement
(S): Oxide Film (T): Special
(N): Metal Coating

CAPACITOR

1. All capacitors are μF, unless otherwise noted. (P=pF=μμ F).
2. All capacitors are 50V, unless otherwise noted.
3. All capacitors are Ceramic type, unless otherwise noted.

- (ML): Mylar (TA): Tantalum
(PF): Polypro Film (ST): Styrol

CAUTION:

This circuit diagram is original one, therefore there may be a slight difference from yours.

IMPORTANT SAFETY NOTICE:

PARTS MARKED WITH "⚠" () ARE IMPORTANT FOR MAINTAINING THE SAFETY OF THE SET. BE SURE TO REPLACE THESE PARTS WITH SPECIFIED ONES FOR MAINTAINING THE SAFETY AND PERFORMANCE OF THE SET.

LC-32/37GD8, LC-32/37BT8 RC/LED Unit Diagram

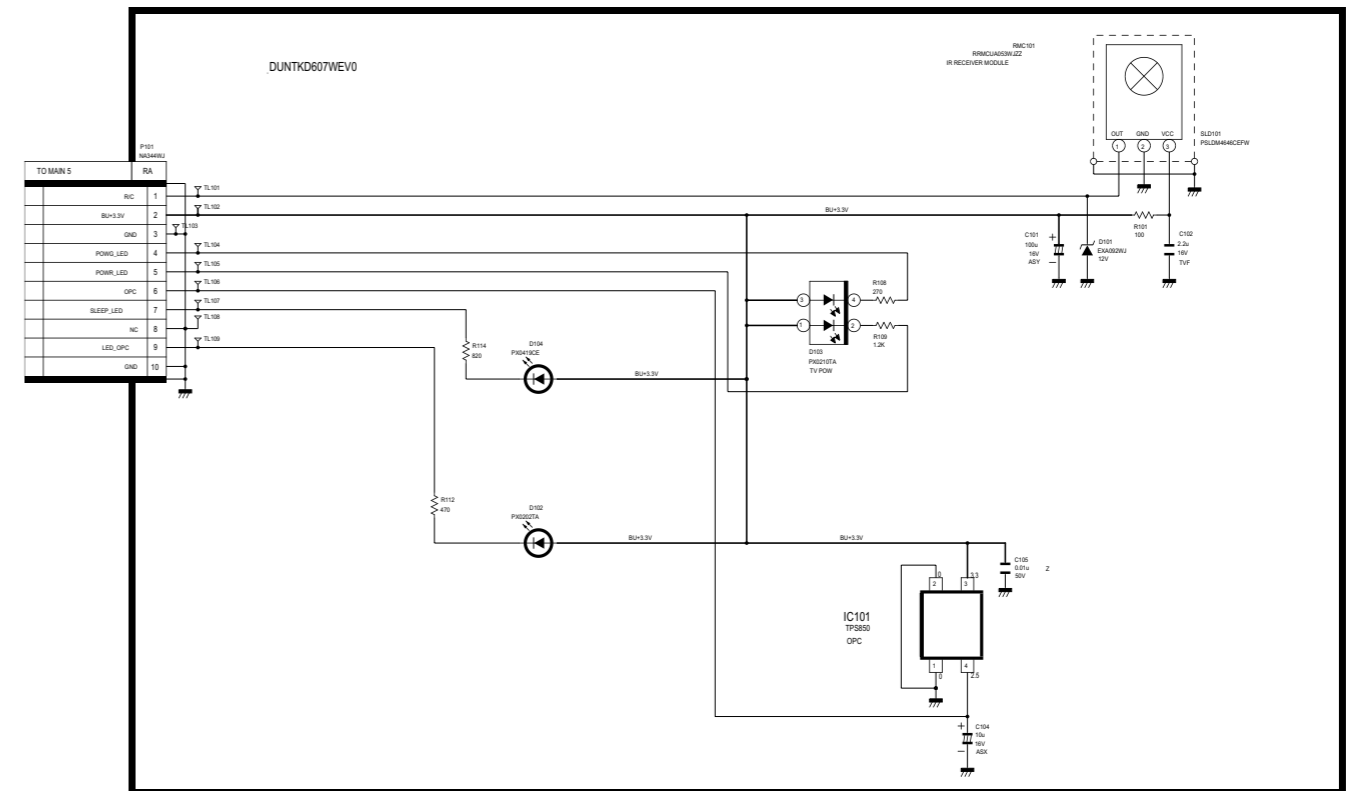

LC-32/37GD8, LC-32/37BT8 KEY Unit Diagram

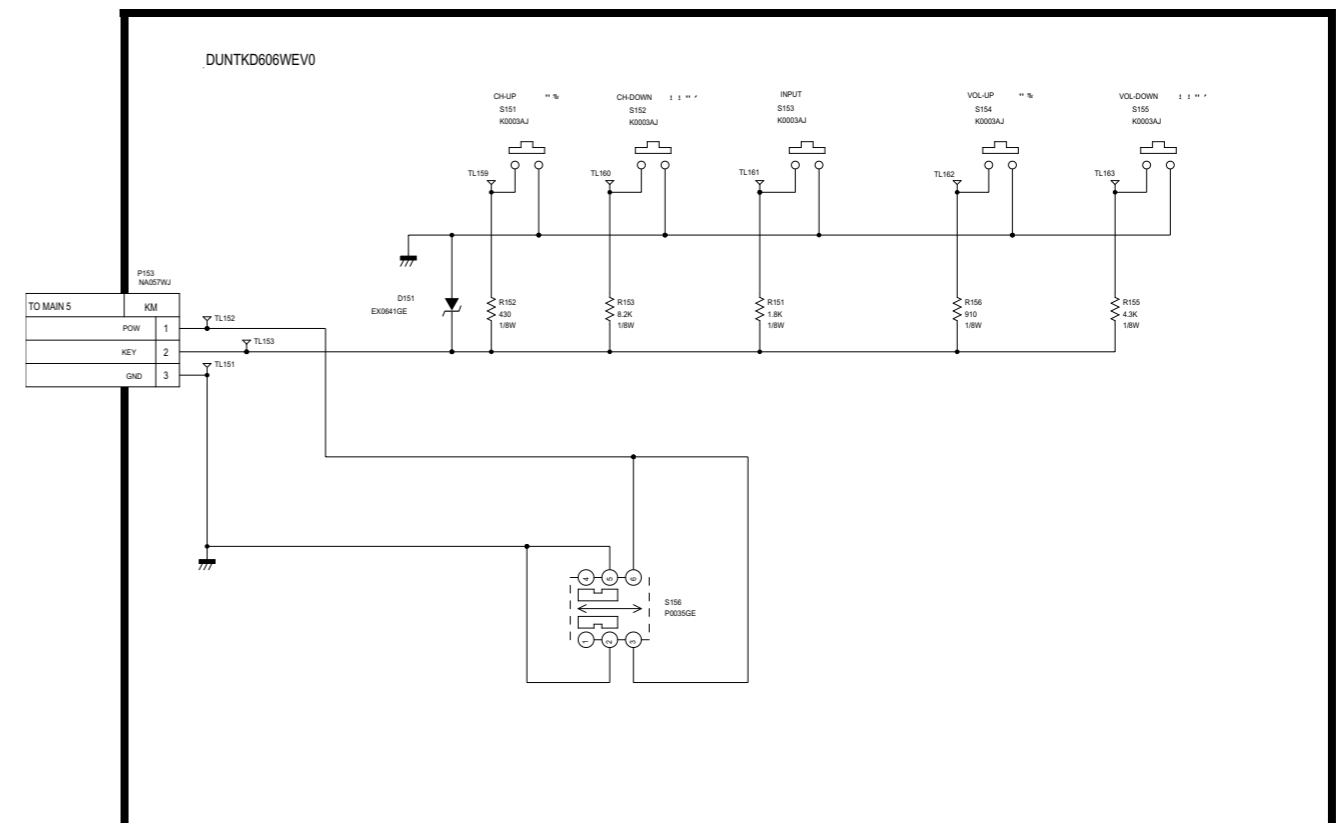

LC-32GD8, LC-32BT8 Main Unit Diagram 1/6 (HDMI)

Ver.N2 (2006.05.16)

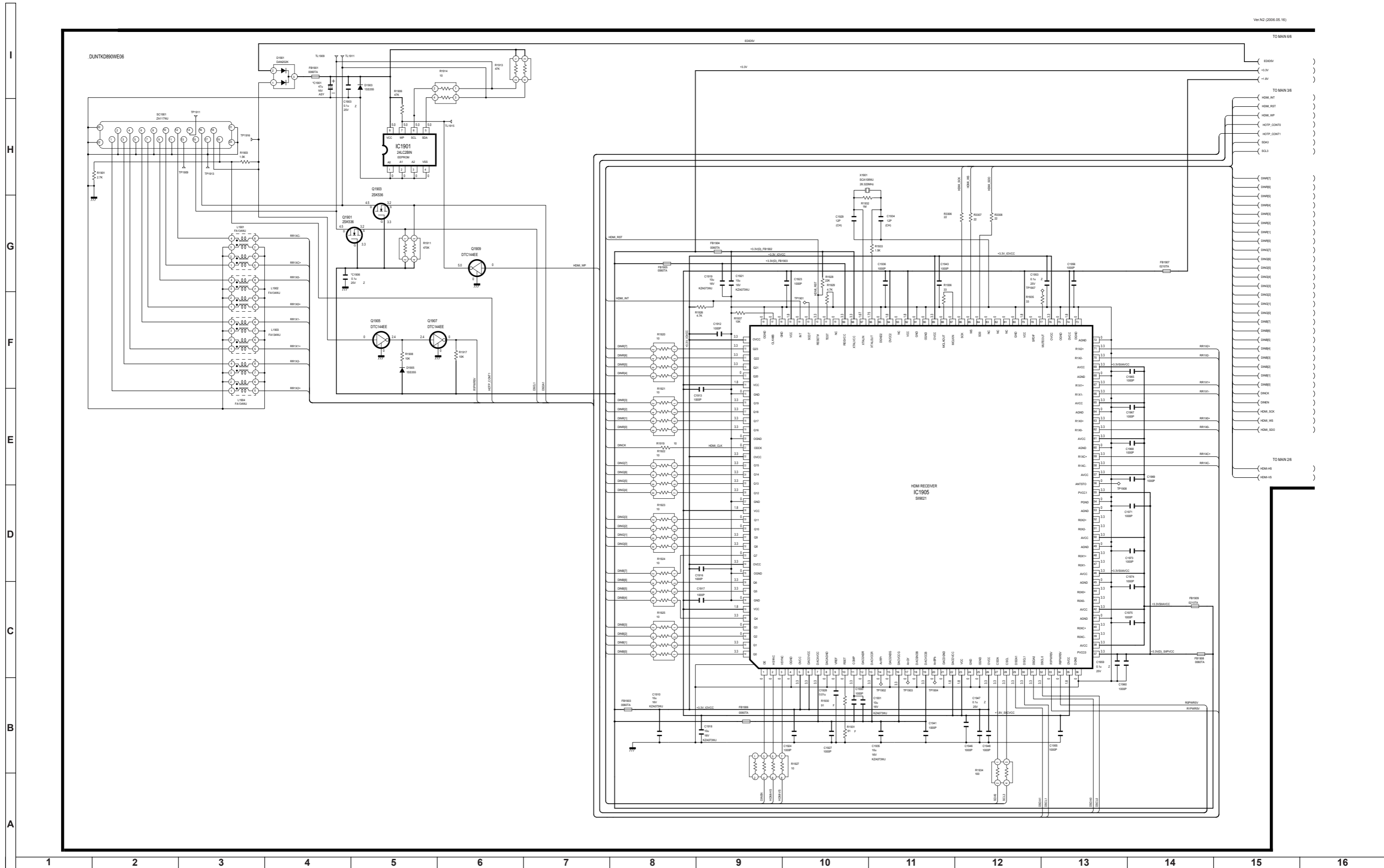

LC-32GD8, LC-32BT8 Main Unit Diagram 2/6 (Signal IN OUT)

Ver N2 (2006.05.16)

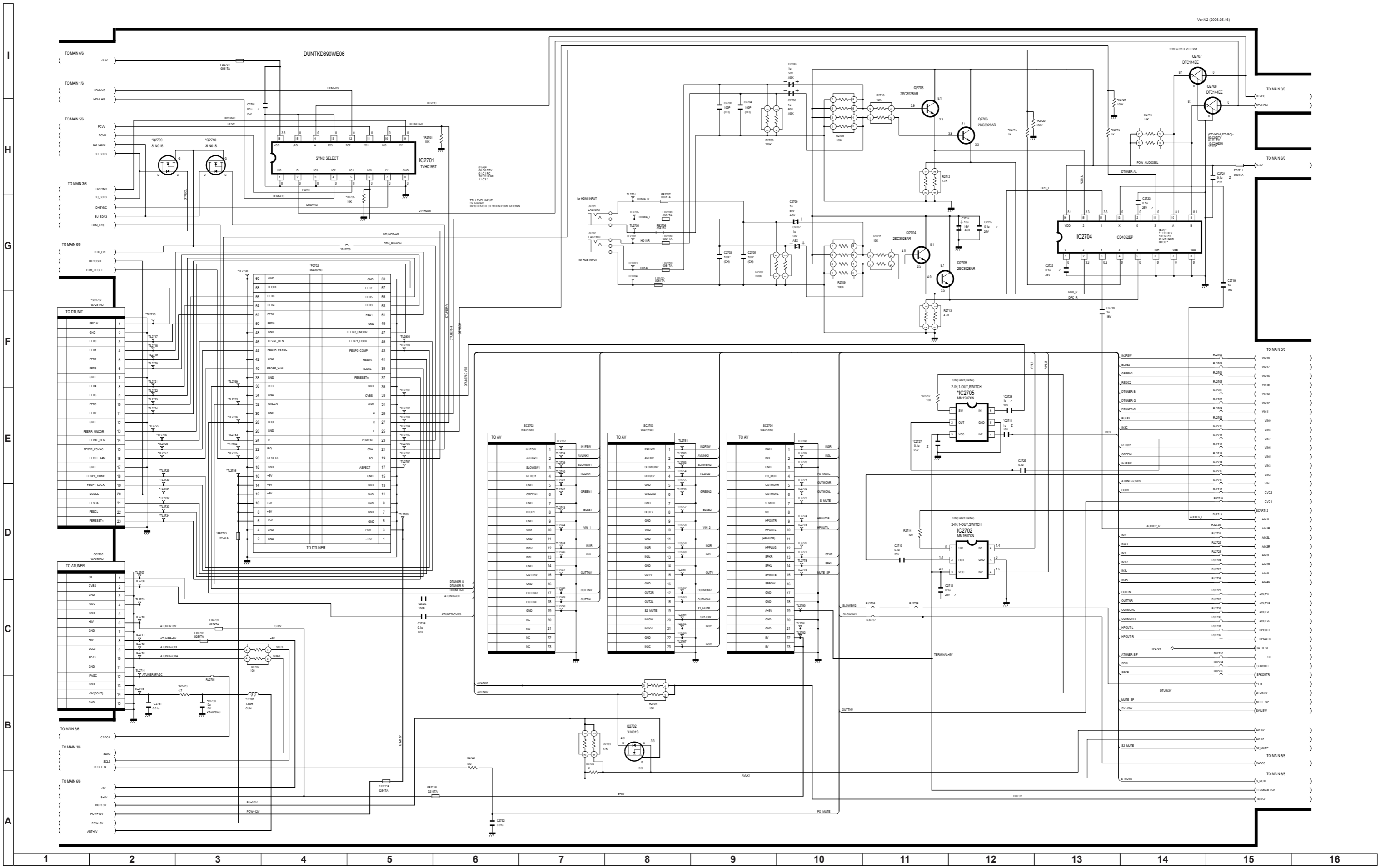

LC-32GD8, LC-32BT8 Main Unit Diagram 3/6 (VCTP)

Ver NZ (2006.05.16)

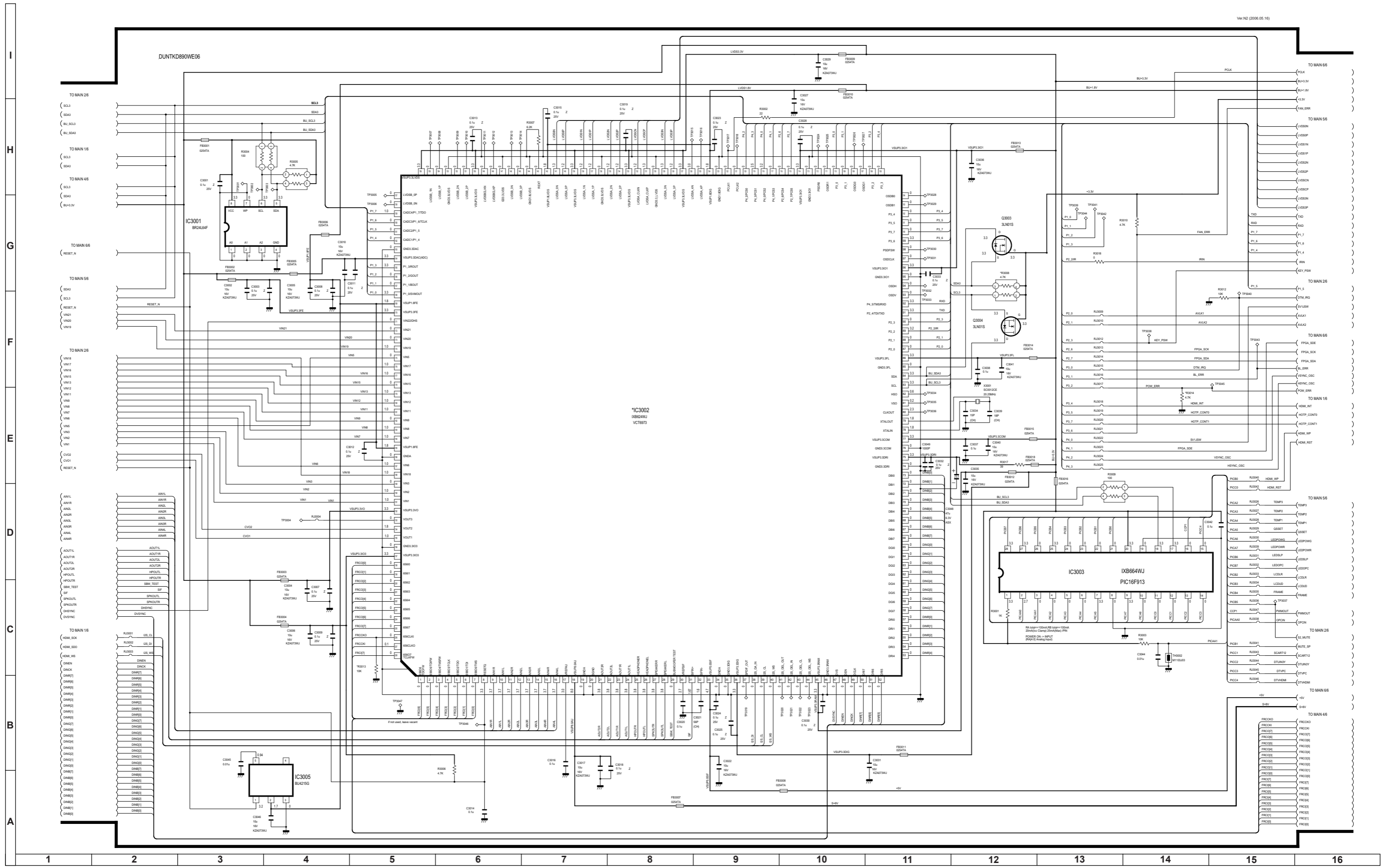

LC-32GD8, LC-32BT8 Main Unit Diagram 4/6 (FRC)
LC-32GD8, LC-32BT8 Main Unit Diagram 5/6 (MISC)

Not used for these models

Ver.02 (2006.05.16)

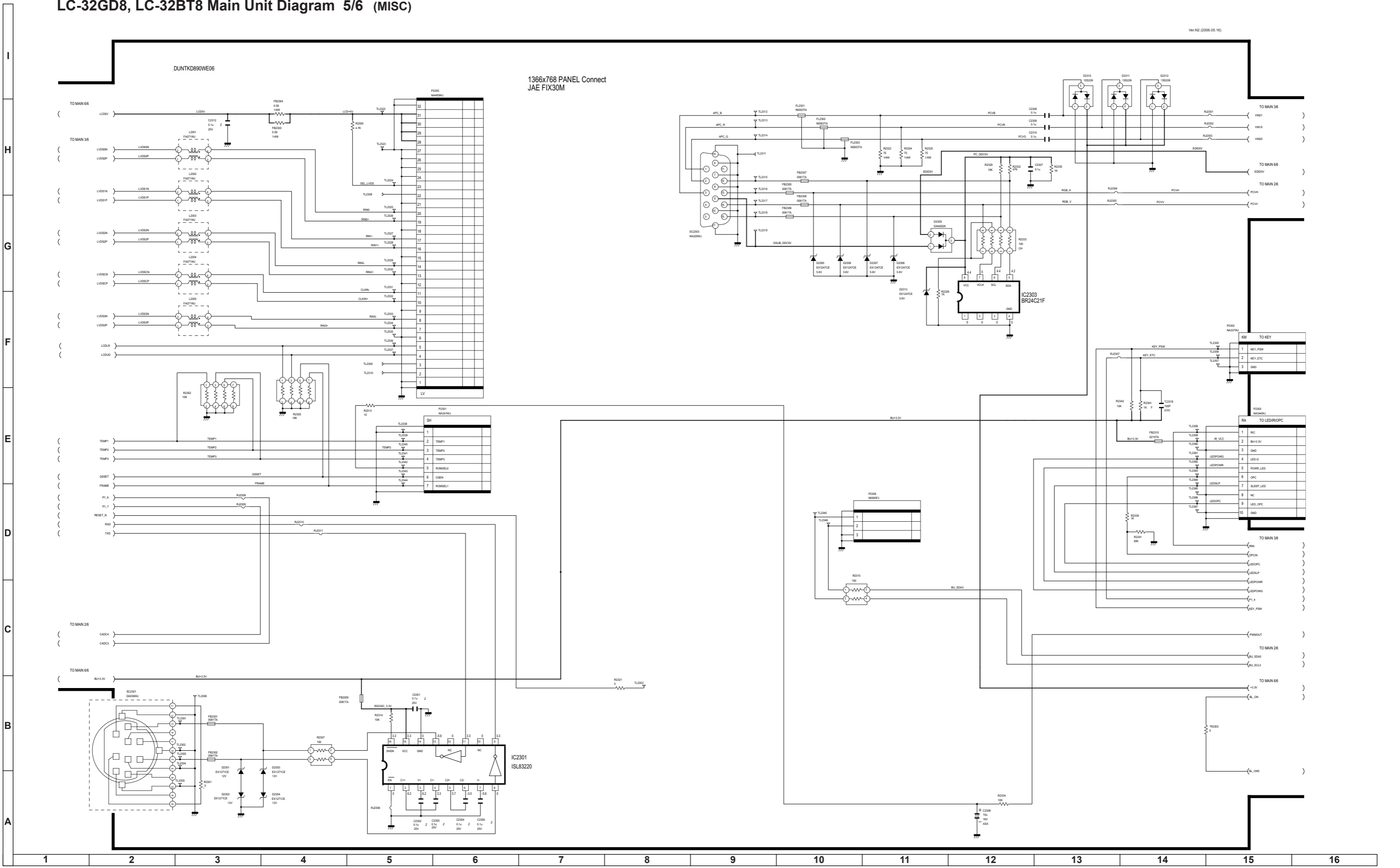

LC-37GD8, LC-37BT8 Main Unit Diagram 1/6 (HDMI)

Ver.N2 (2006.05.16)

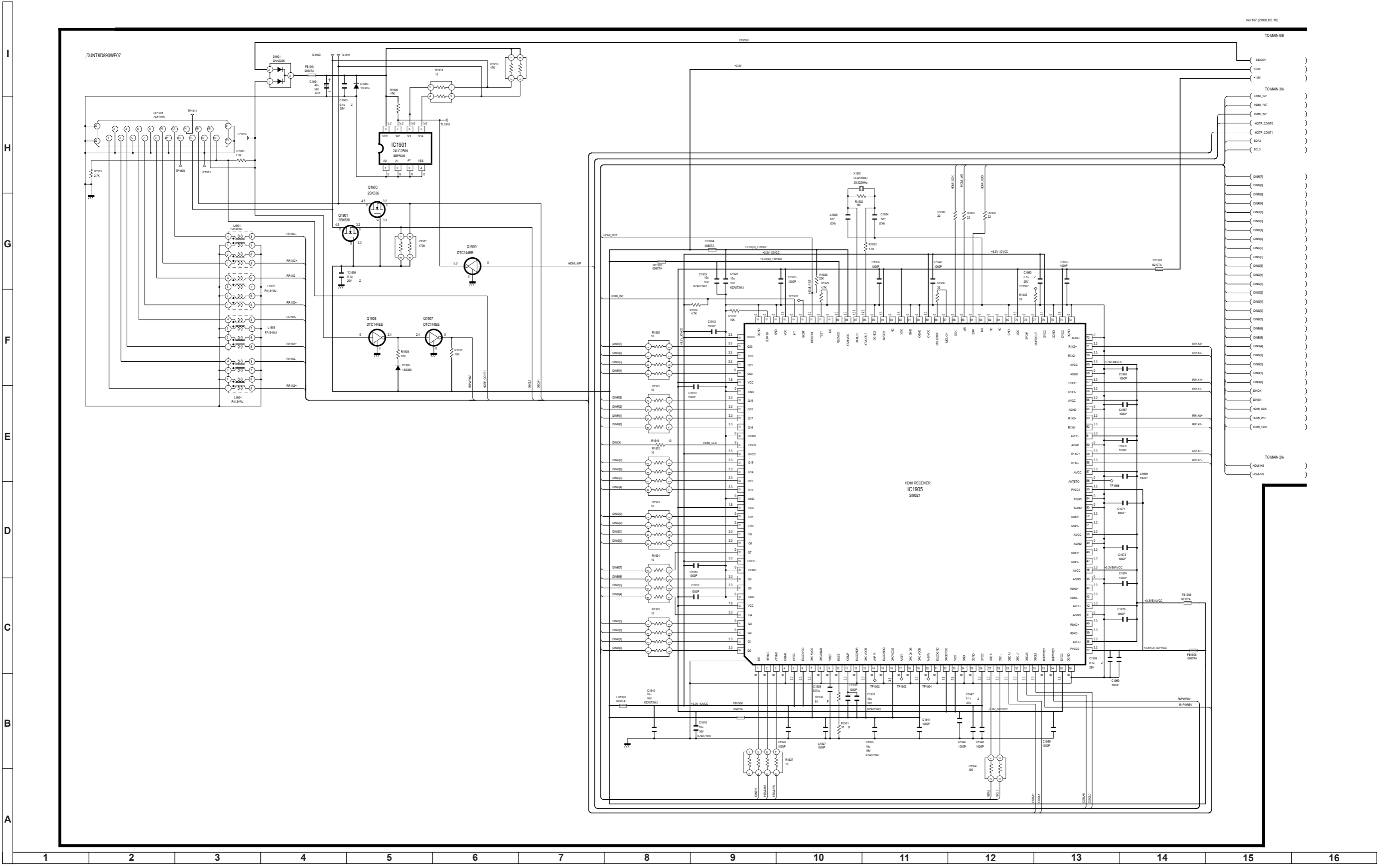

LC-37GD8, LC-37BT8 Main Unit Diagram 2/6 (Signal IN OUT)

Ver.NZ (2006.05.16)

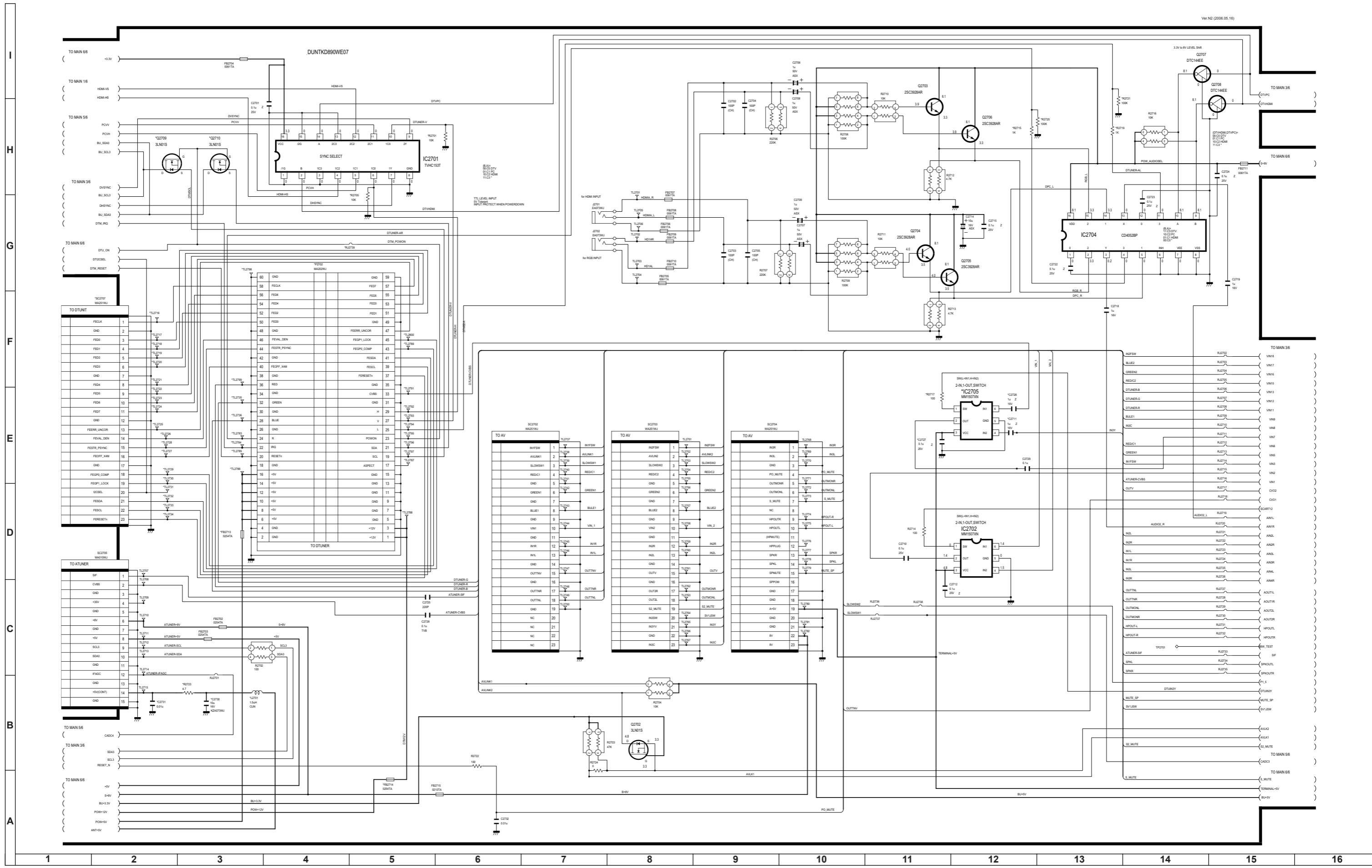

LC-37GD8, LC-37BT8 Main Unit Diagram 3/6 (VCTP)

Ver.N2 (2006.05.18)

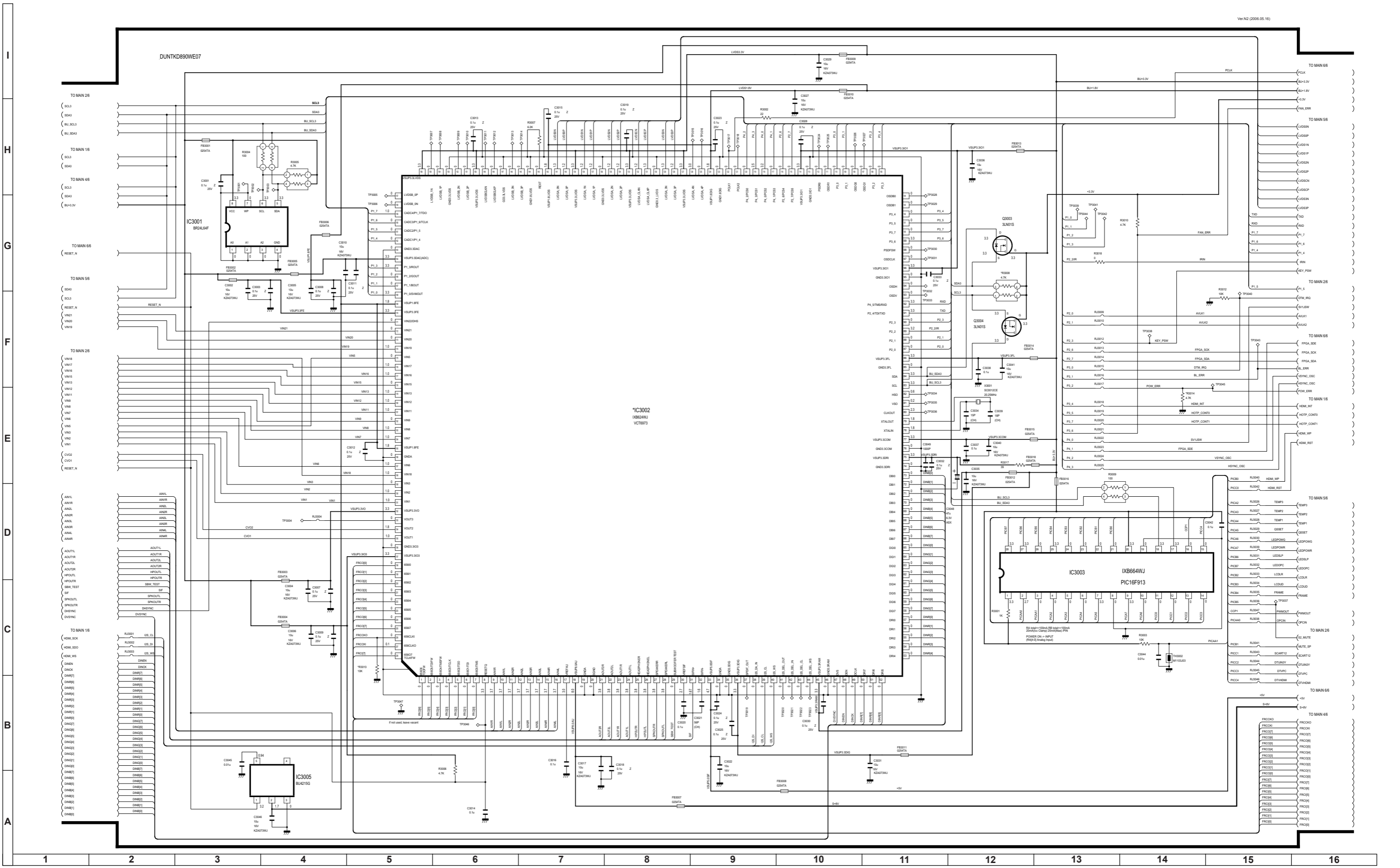

LC-37GD8, LC-37BT8 Main Unit Diagram 4/6 (FRC) Not used for these models
LC-37GD8, LC-37BT8 Main Unit Diagram 5/6 (MISC)

Ver.02 (2006.05.16)

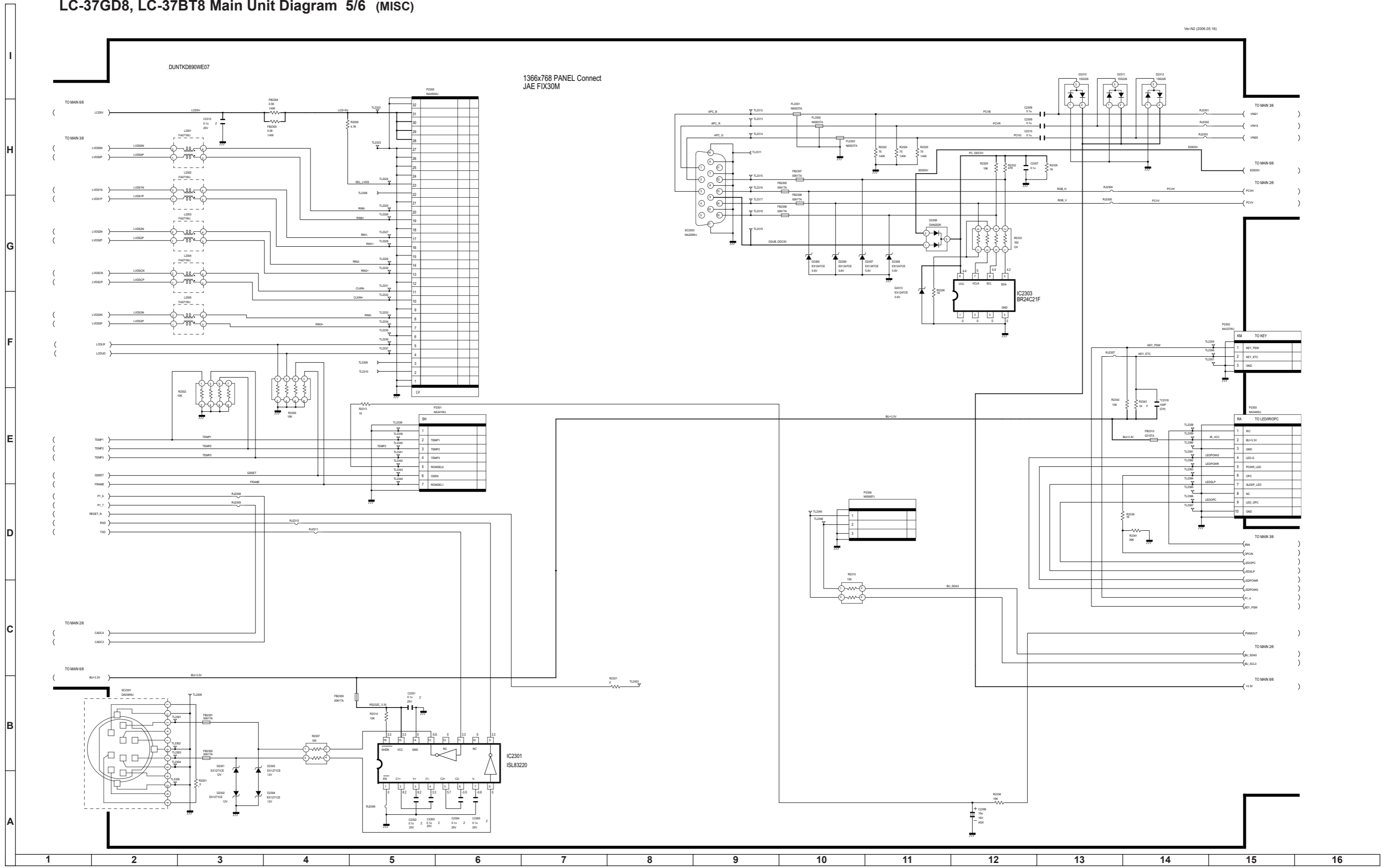

LC-37GD8, LC-37BT8 Main Unit Diagram 6/6 (POWER DC-DC)

Ver.NZ (2008.05.16)

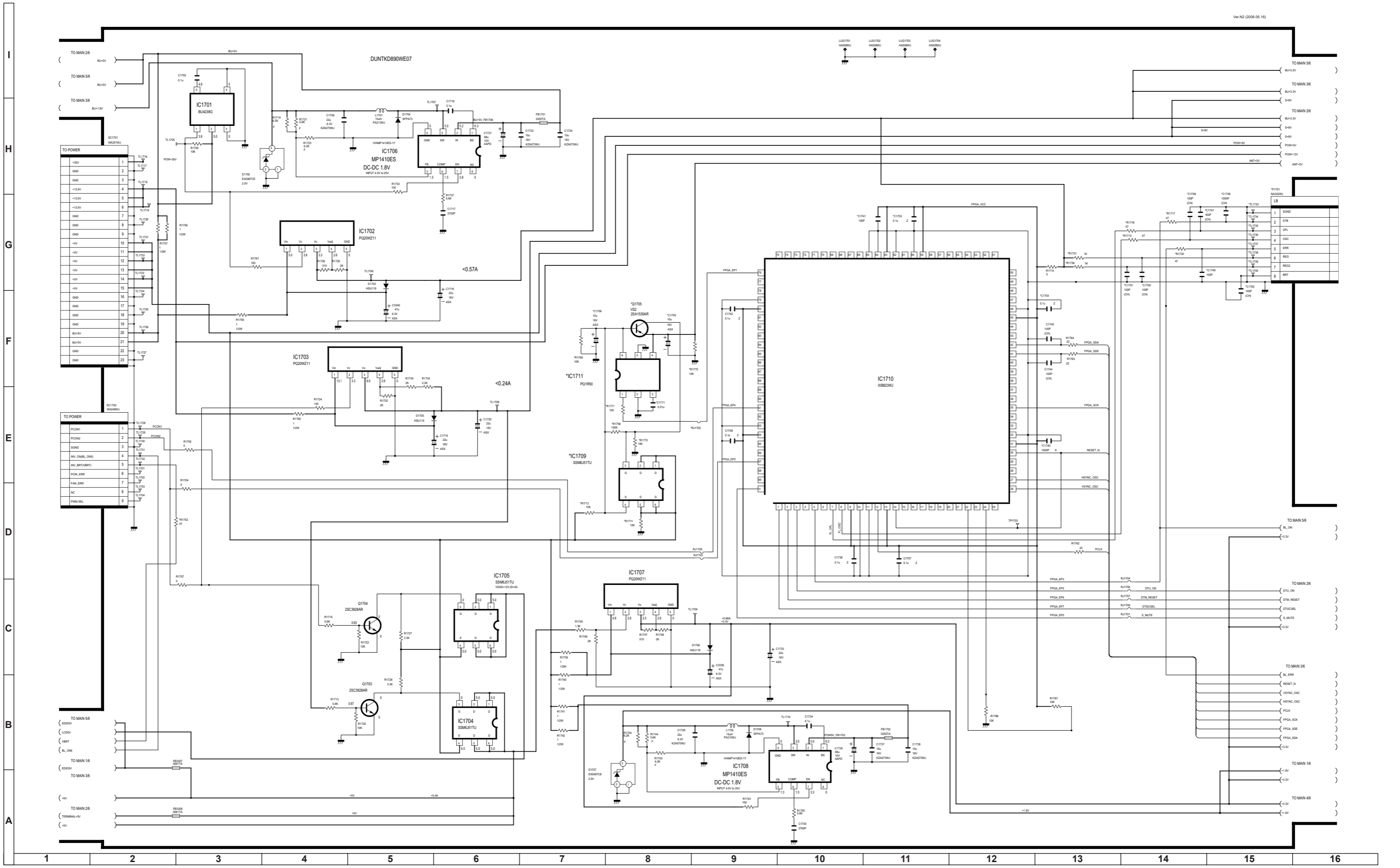

LC-32/37GD8, LC-32/37BT8 AV Unit Diagram

Ver. N3 (2006.05.16)

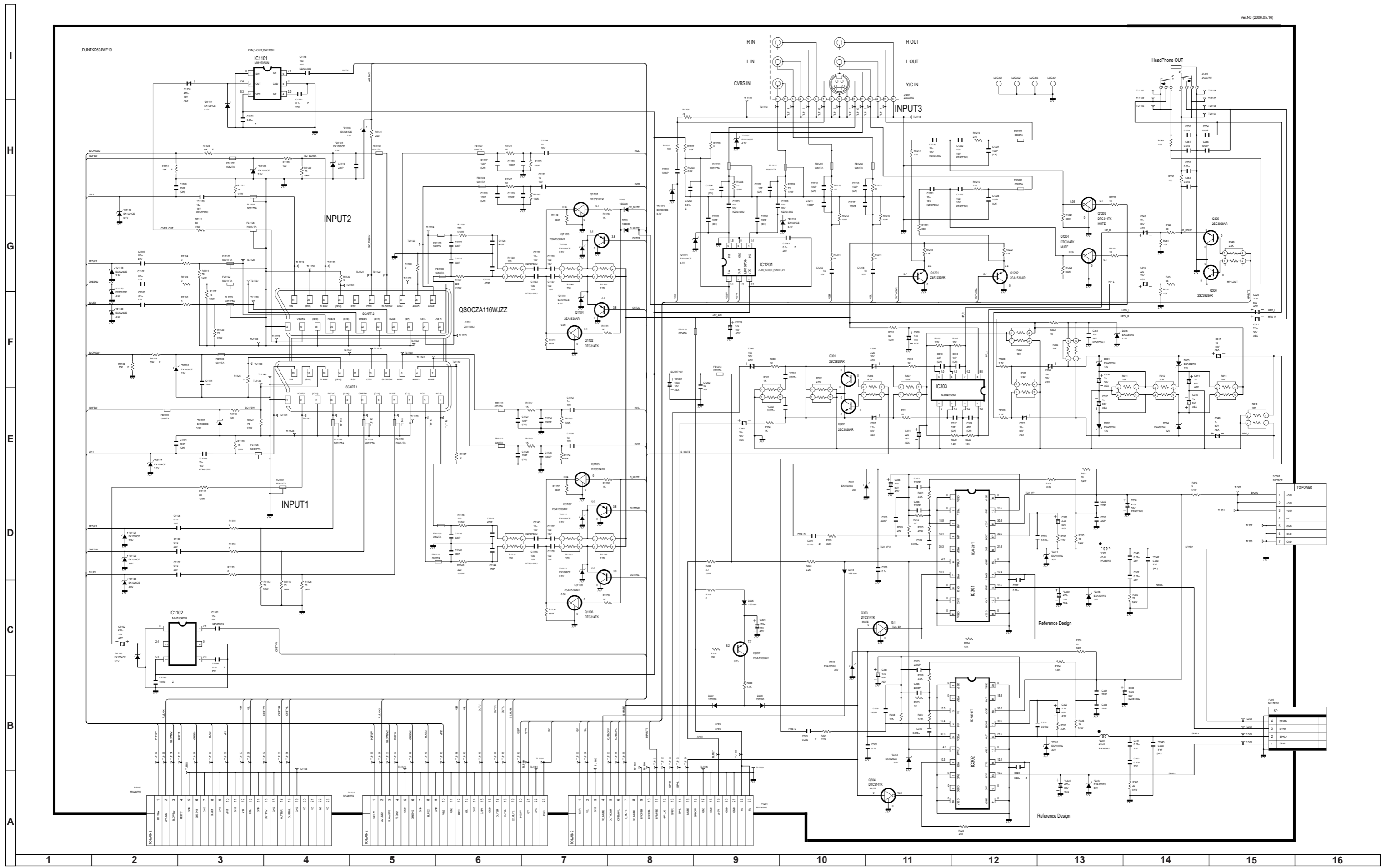

LC-32/37GD8, LC-32/37BT8 TUNER Unit Diagram

VOLTAGE () = DTV-MODE

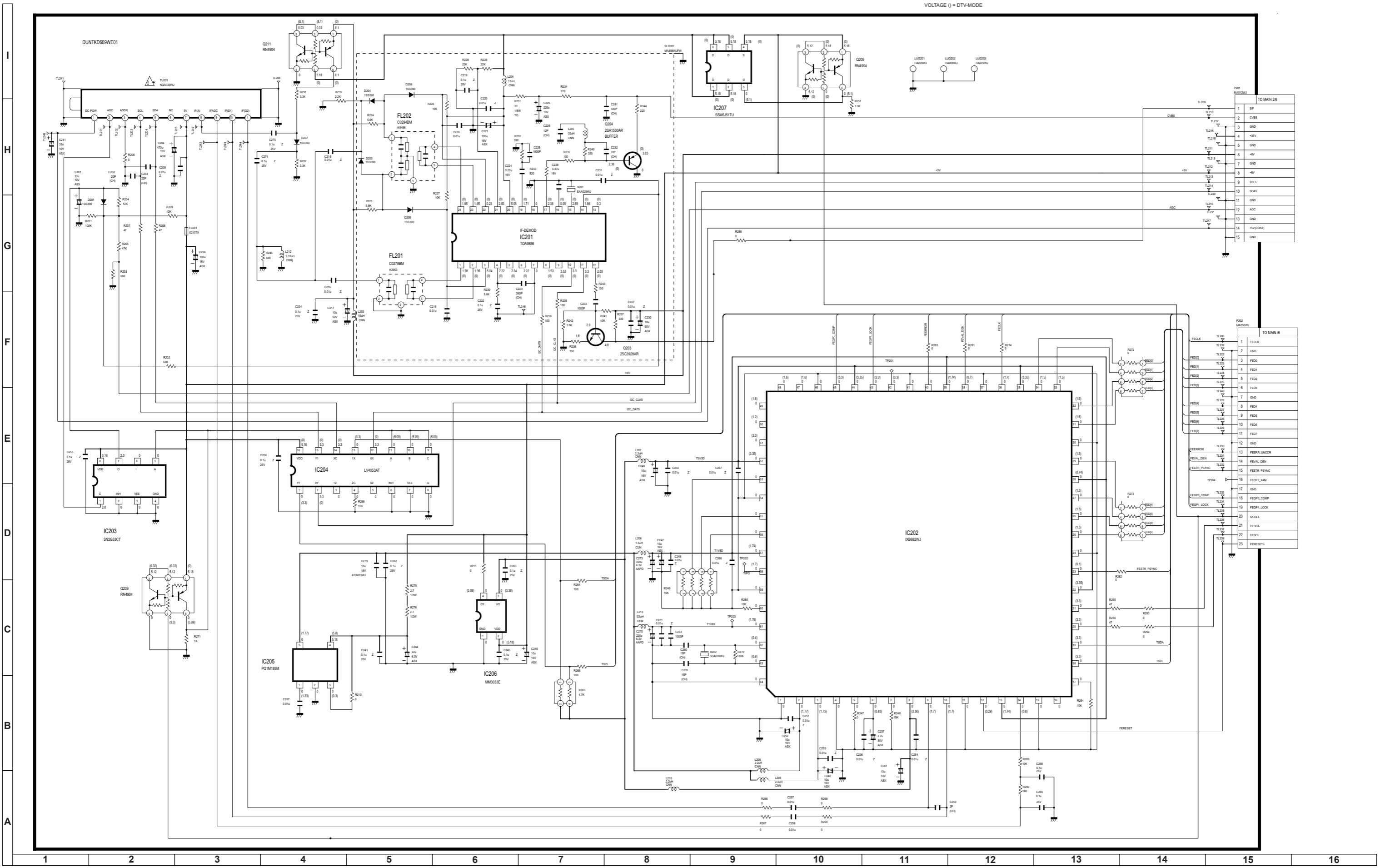

TO MAIN 28

1	SP
2	CVBS
3	GN
4	+5V
5	GN
6	+5V
7	GN
8	+5V
9	GN
10	SCAS
11	GN
12	AOC
13	GN
14	+5V(CONT)
15	GN

TO MAIN 6

1	FECLK
2	GN
3	FED0
4	FED1
5	FED2
6	FED3
7	GN
8	FED4
9	FED5
10	FED6
11	FED7
12	GN
13	FEFRL_LINCR
14	FEVAL_DEN
15	FEFTR_PSYNC
16	FEFTR_PSYNC
17	GN
18	FEFPL_COMP
19	FEFPL_LOCK
20	GN
21	FEFSA
22	FEFSL
23	FEFSEB7H

LC-32GD8, LC-32BT8 POWER SUPPLY Unit Diagram

Ver NS (2006.04.20)

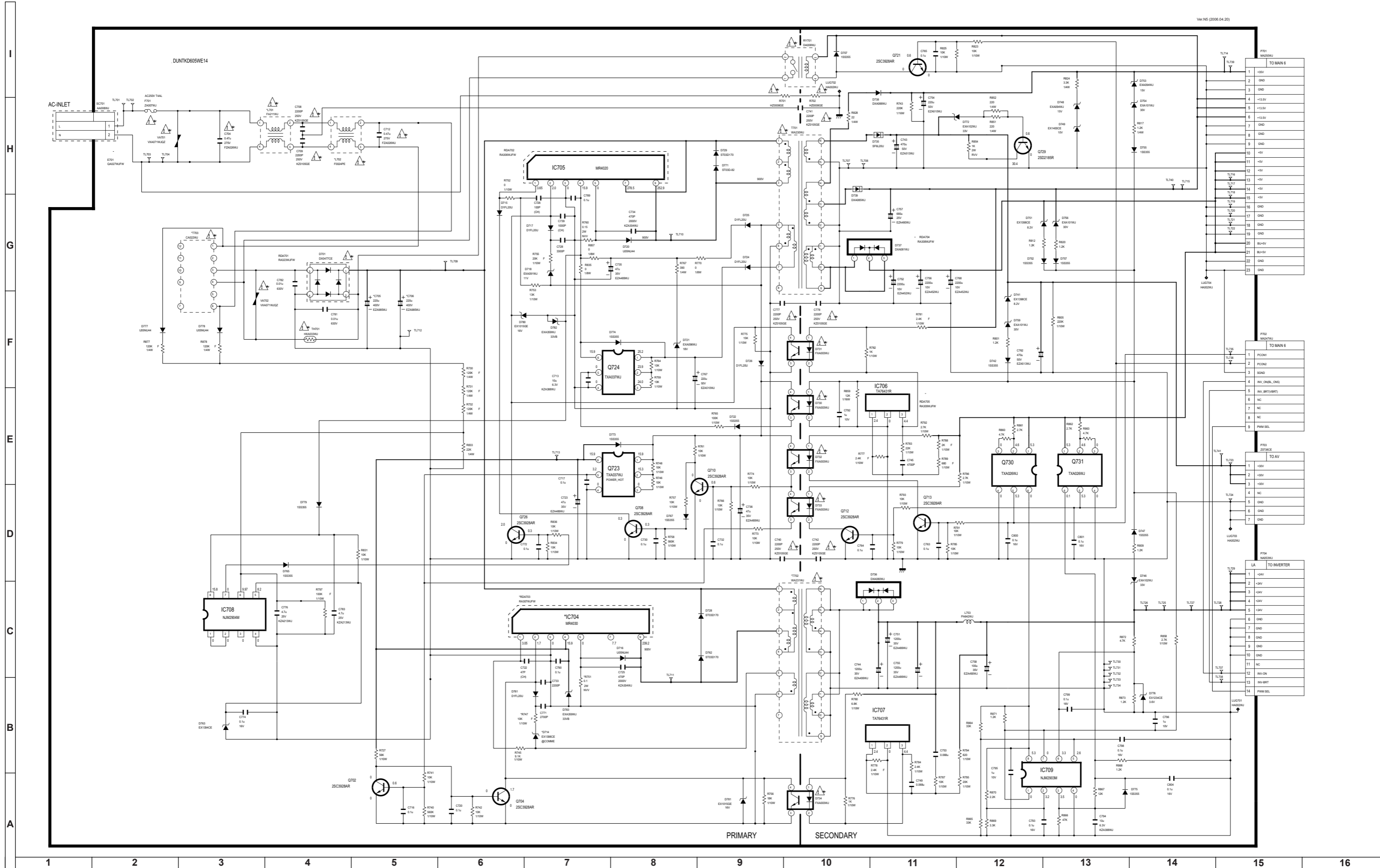

LC-37GD8, LC-37BT8 POWER SUPPLY Unit Diagram

Ver N5 (2006.04.20)

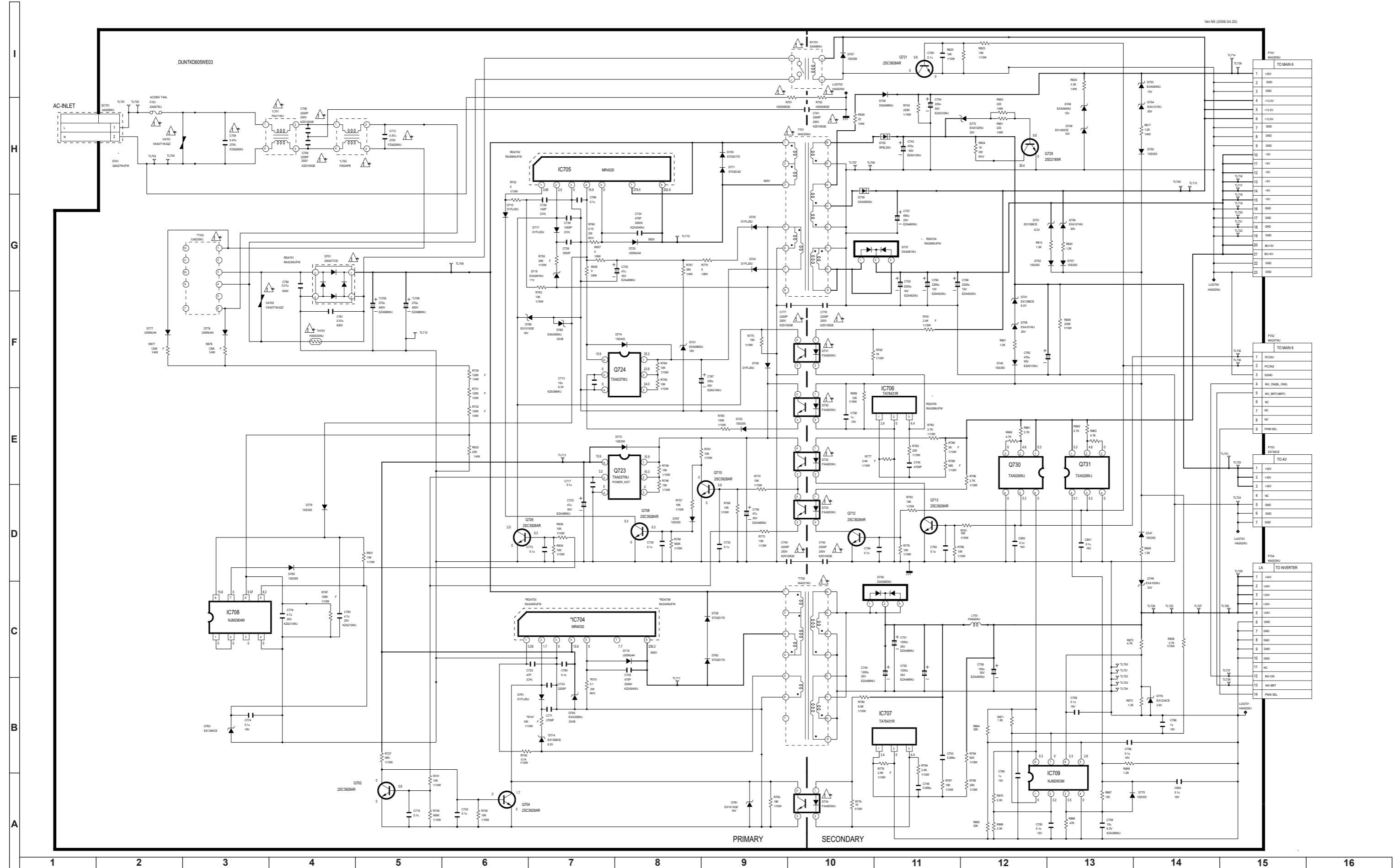

LC-32GD8, LC-32BT8 INVERTER Unit Diagram (RDENC2266TPZC)

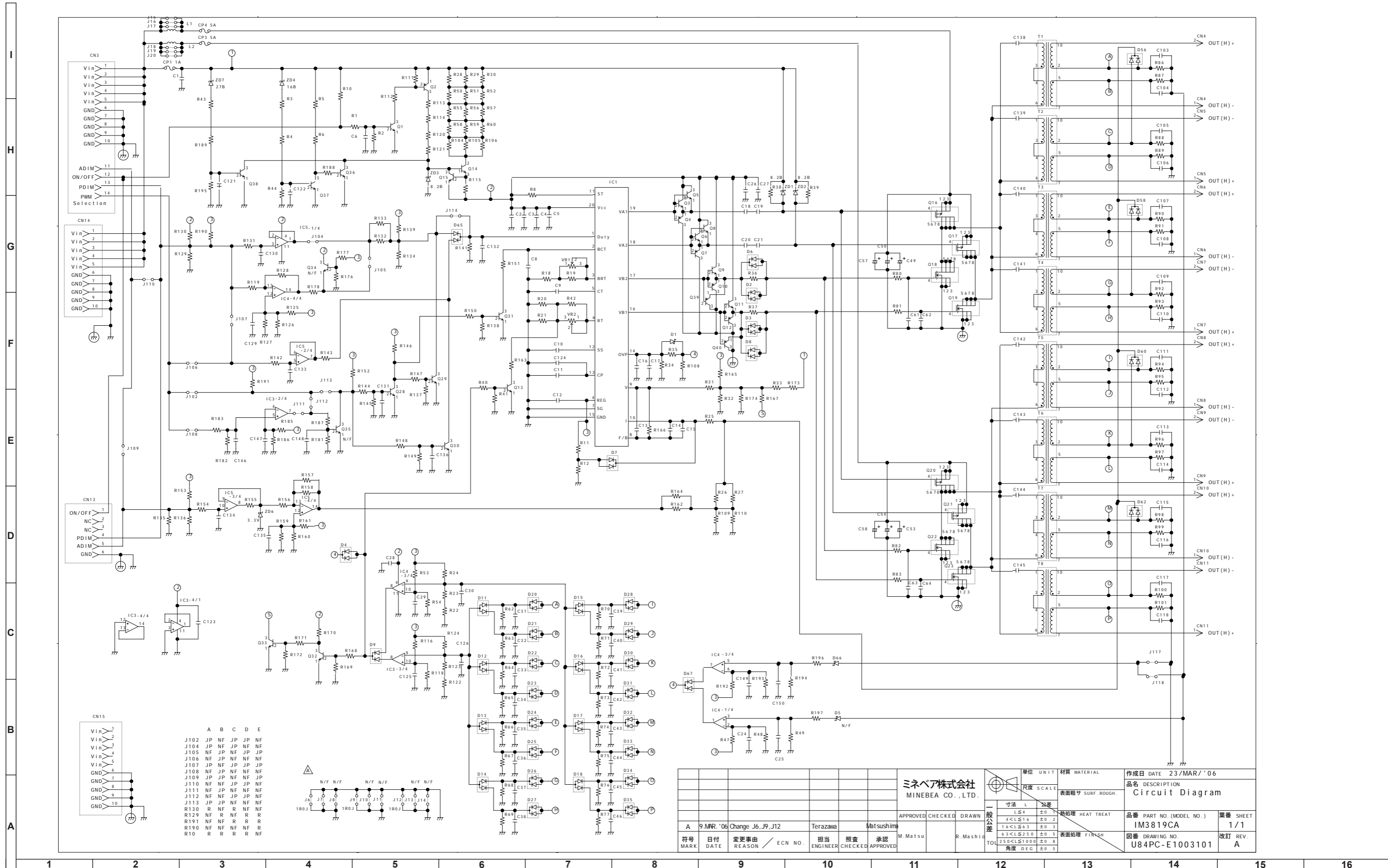

<p>ミネベア株式会社 MINEBEA CO., LTD.</p>				<p>単位 UNIT 材料 MATERIAL 尺度 SCALE 表面粗サ SURF. ROUGH.</p>	<p>作成日 DATE 23/MAR/'06 品名 DESCRIPTION Circuit Diagram</p>
<p>寸法 L 公差 L ≤ 4 ± 0.1 4 < L ≤ 16 ± 0.2 16 < L ≤ 63 ± 0.3 63 < L ≤ 250 ± 0.5 250 < L ≤ 1000 ± 0.8 角度 DEG ± 0.5</p>	<p>熱処理 HEAT TREAT 表面処理 FINISH</p>	<p>品番 PART NO. (MODEL NO.) IM3819CA</p>	<p>葉番 SHEET 1/1</p>	<p>図番 DRAWING NO. U84PC-E1003101</p>	<p>改訂 REV. A</p>
<p>符号 MARK 日付 DATE 変更事由 REASON / ECN NO. 担当 ENGINEER 照査 CHECKED 承認 APPROVED</p>	<p>APPROVED M. Matsu CHECKED R. Mashid DRAWN</p>				

LC-37GD8, LC-37BT8 INVERTER Unit Diagram (RUNTKA216WJZZ)

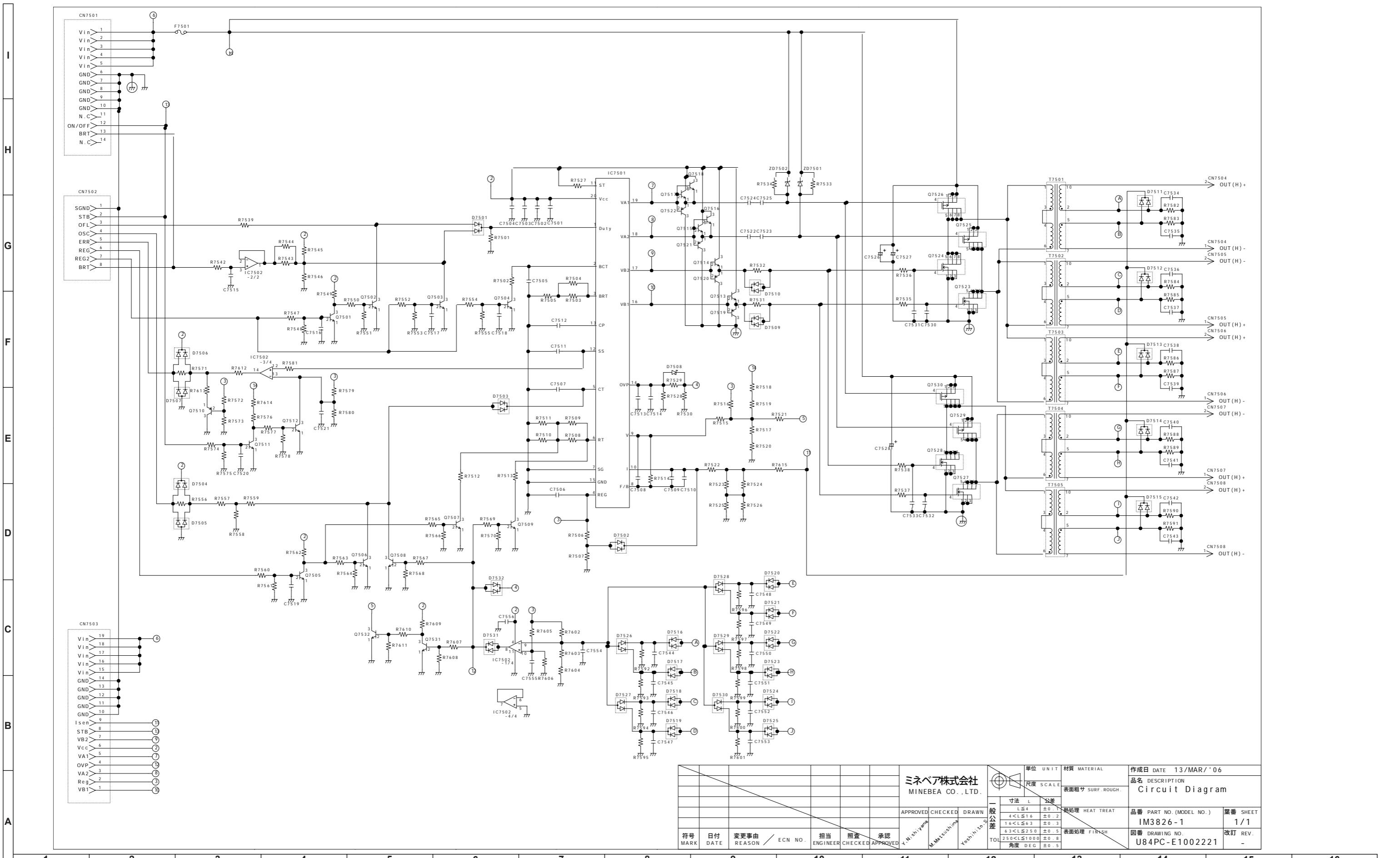

<p>ミネベア株式会社 MINEBEA CO., LTD.</p>				単位 UNIT	材質 MATERIAL	作成日 DATE 13/MAR/'06
				尺度 SCALE	表面粗サ SURF. ROUGH.	品名 DESCRIPTION Circuit Diagram
APPROVED	CHECKED	DRAWN	一般公差	熱処理 HEAT TREAT	品番 PART NO. (MODEL NO.)	葉番 SHEET
符号 MARK	日付 DATE	変更事由 REASON	ECN NO.	表面処理 FINISH	IM3826-1	1/1
担当 ENGINEER	照査 CHECKED	承認 APPROVED	Yoshihiko Sato	図番 DRAWING NO.	U84PC-E100221	改訂 REV.
				寸法 L 公差		
				L ≤ 4 ±0.1		
				4 < L ≤ 16 ±0.2		
				16 < L ≤ 63 ±0.3		
				63 < L ≤ 250 ±0.5		
				250 < L ≤ 1000 ±0.8		
				角度 DEC ±0.5		

LC-37GD8, LC-37BT8 INVERTER Unit Diagram (RUNTKA217WJZZ)

I
H
G
F
E
D
C
B
A

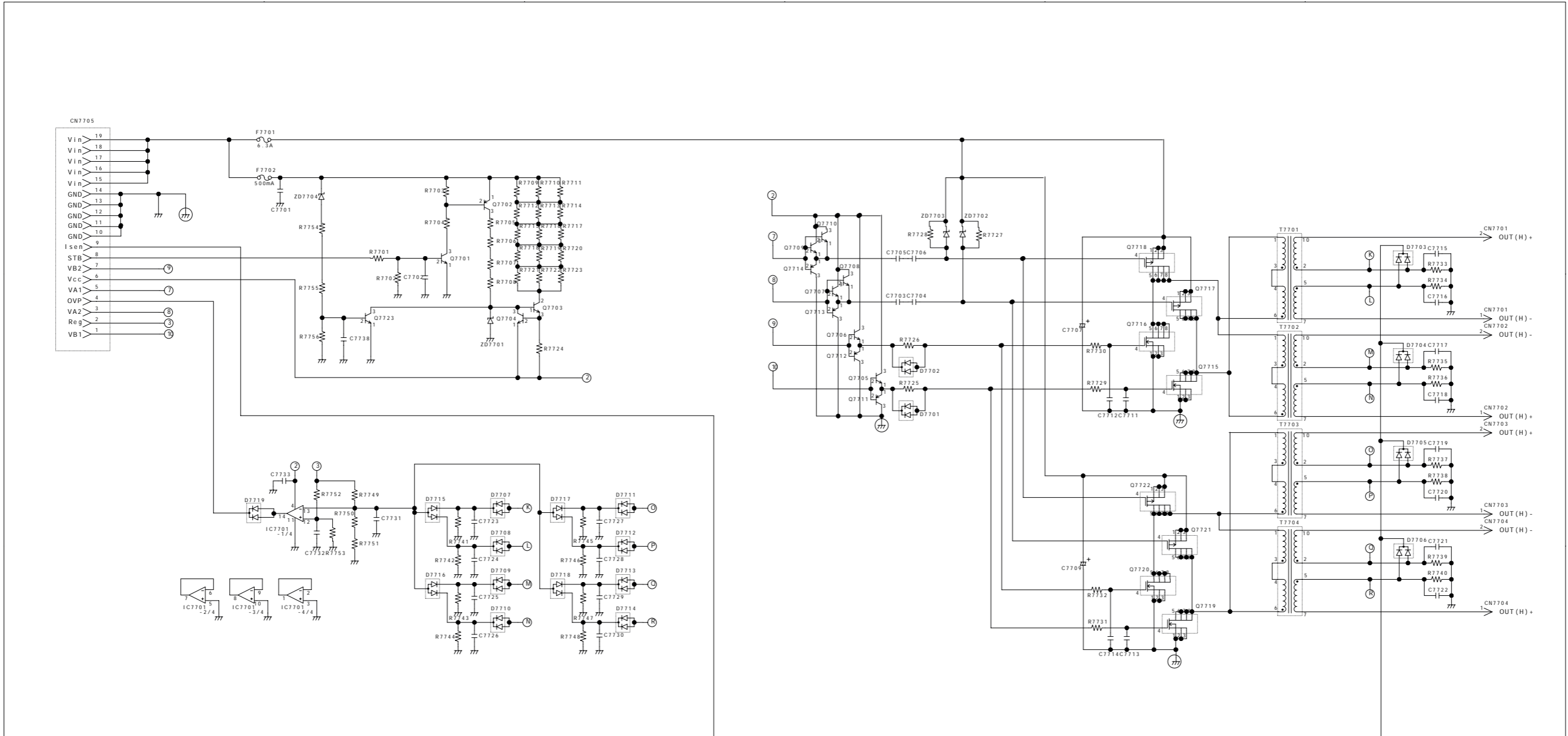

<p>ミネベア株式会社 MINEBEA CO., LTD.</p>				<p>単位 UNIT 材料 MATERIAL</p> <p>尺度 SCALE 表面粗さ SURF.ROUGH.</p>	<p>作成日 DATE 13/MAR/'06</p> <p>品名 DESCRIPTION Circuit Diagram</p>	
				<p>寸法 L 公差</p> <p>1.6<L≤4 ±0.2</p> <p>4<L≤16 ±0.2</p> <p>16<L≤43 ±0.3</p> <p>43<L≤250 ±0.5</p> <p>250<L≤1000 ±0.8</p> <p>角度 DEG ±0.5</p>	<p>表面处理 HEAT TREAT</p> <p>表面处理 FINISH</p>	<p>品番 PART NO. (MODEL NO.)</p> <p>IM3826-2</p> <p>图番 DRAWING NO.</p> <p>U84PC-E1003119</p>
<p>符号 MARK</p> <p>日付 DATE</p> <p>变更事由 REASON</p> <p>ECN NO.</p>	<p>担当 ENGINEER</p> <p>照査 CHECKED</p> <p>承認 APPROVED</p>	<p>Y. Niishi ynm</p> <p>M. Maeda mma</p> <p>Yoshihiko S.</p>	<p>APPROVED</p> <p>CHECKED</p> <p>DRAWN</p>	<p>一般公差</p>		

LC-32/37GD8, LC-32/37BT8 Digital Unit Diagram 1/4 (STI5516)

Ver NZ (2006.05.16)

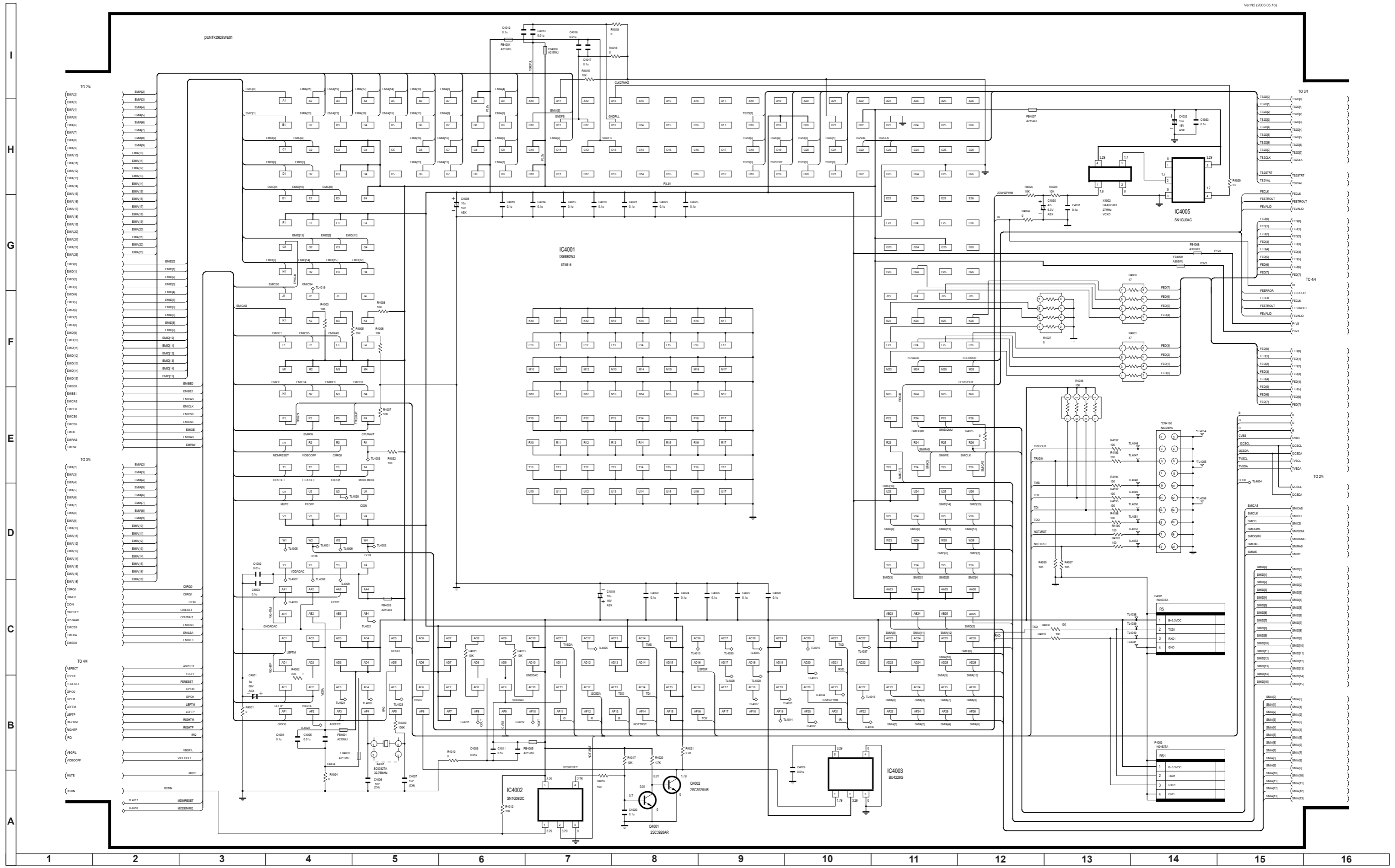

LC-32/37GD8, LC-32/37BT8 Digital Unit Diagram 2/4 (MEMORIES)

Ver.N2 (2008.03.31)

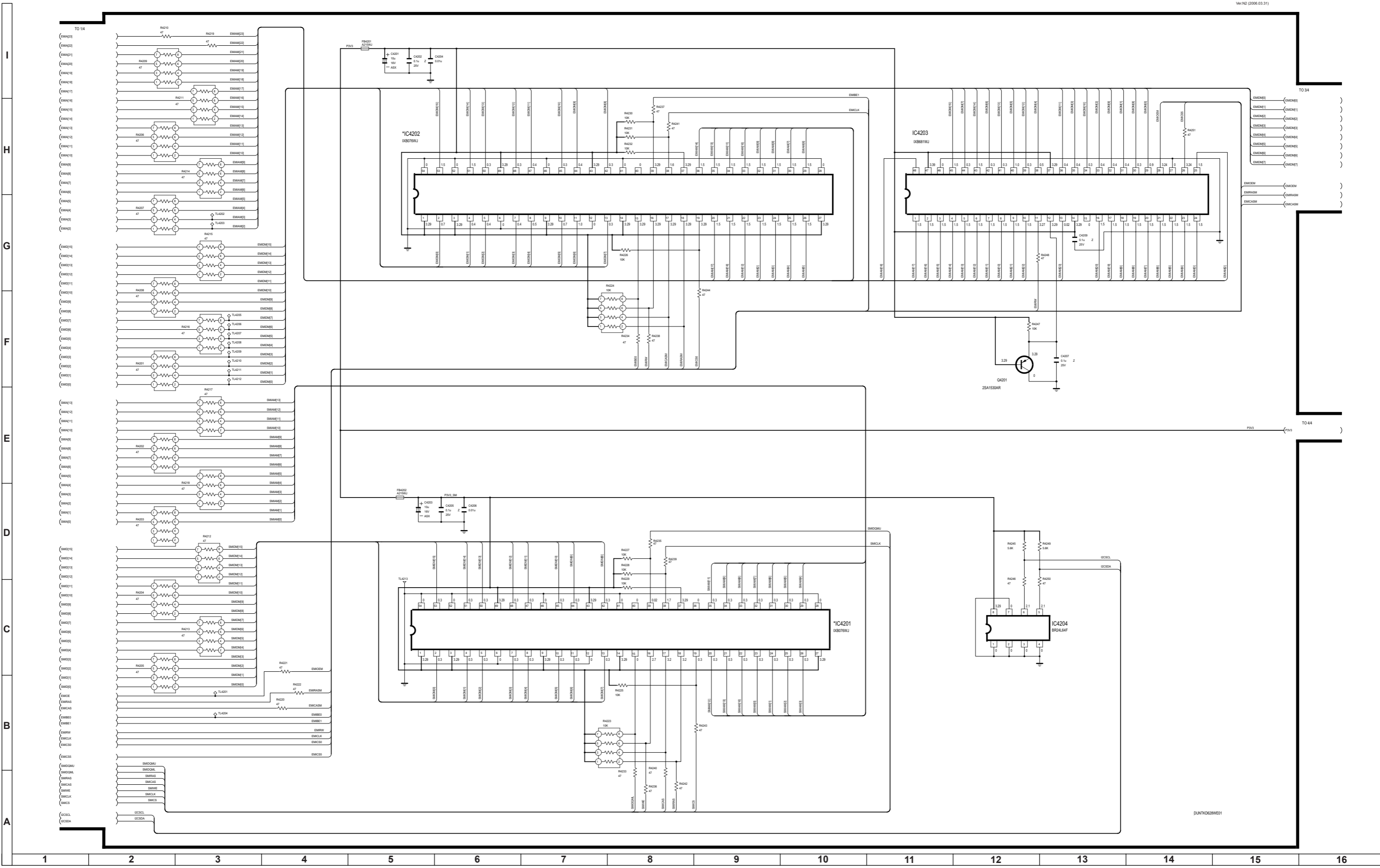

LC-32/37GD8, LC-32/37BT8 Digital Unit Diagram 4/4 (AUDIO / VIDEO OUT / REG)

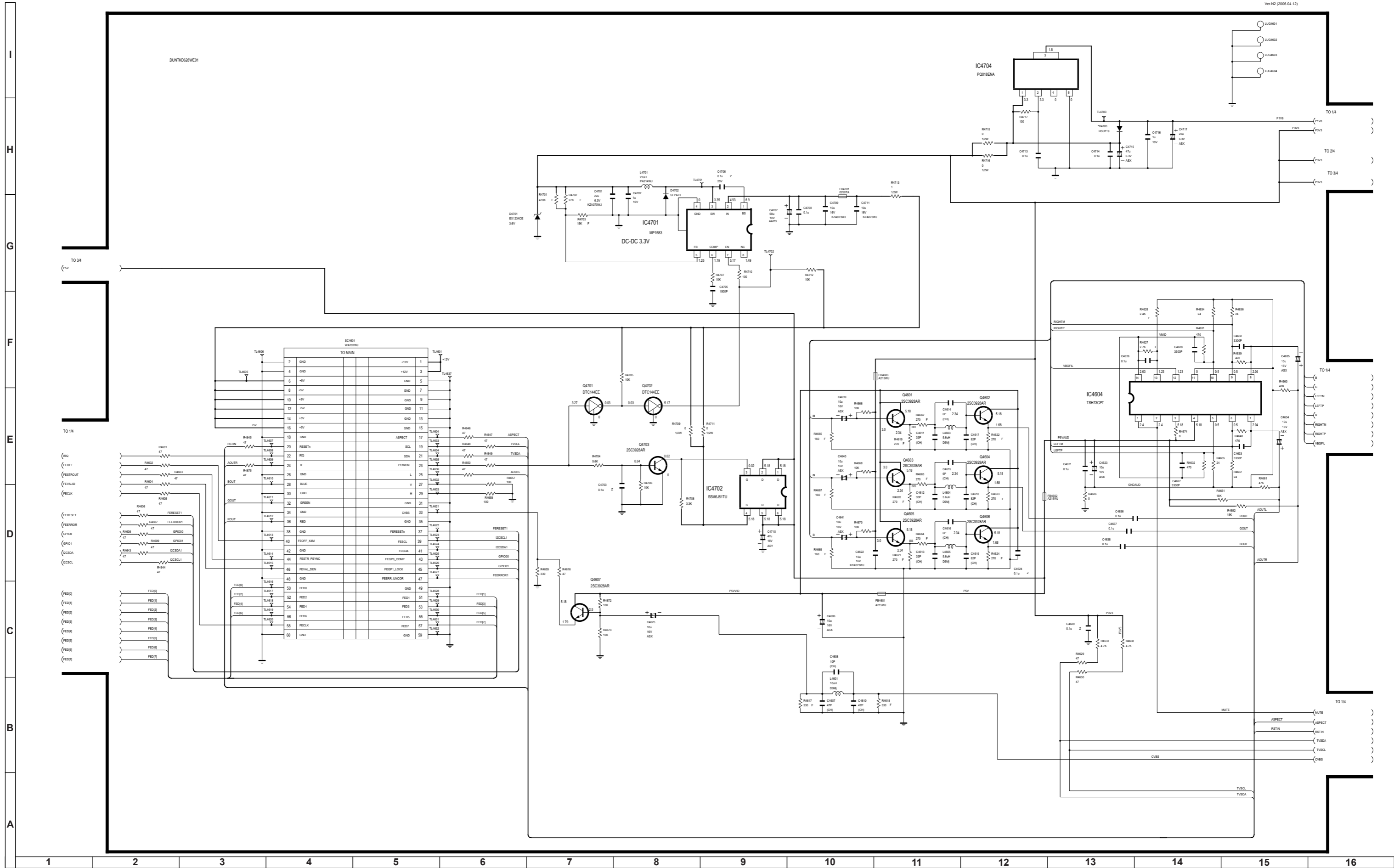

AV Unit PWB (FD604WJN3)

AV Unit, Side A Chip Parts

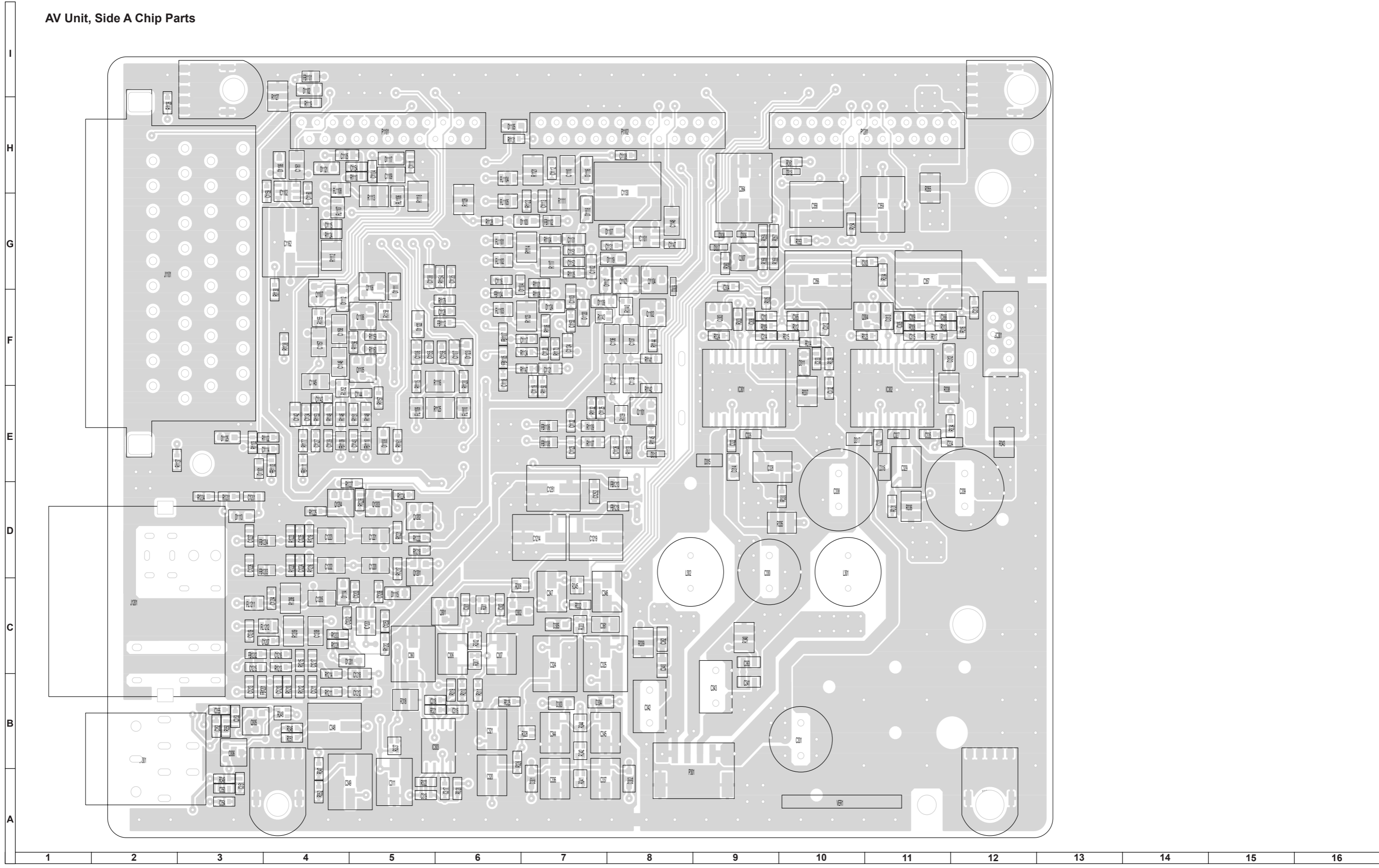

AV Unit PWB (FD604WJN3)

AV Unit, Side B

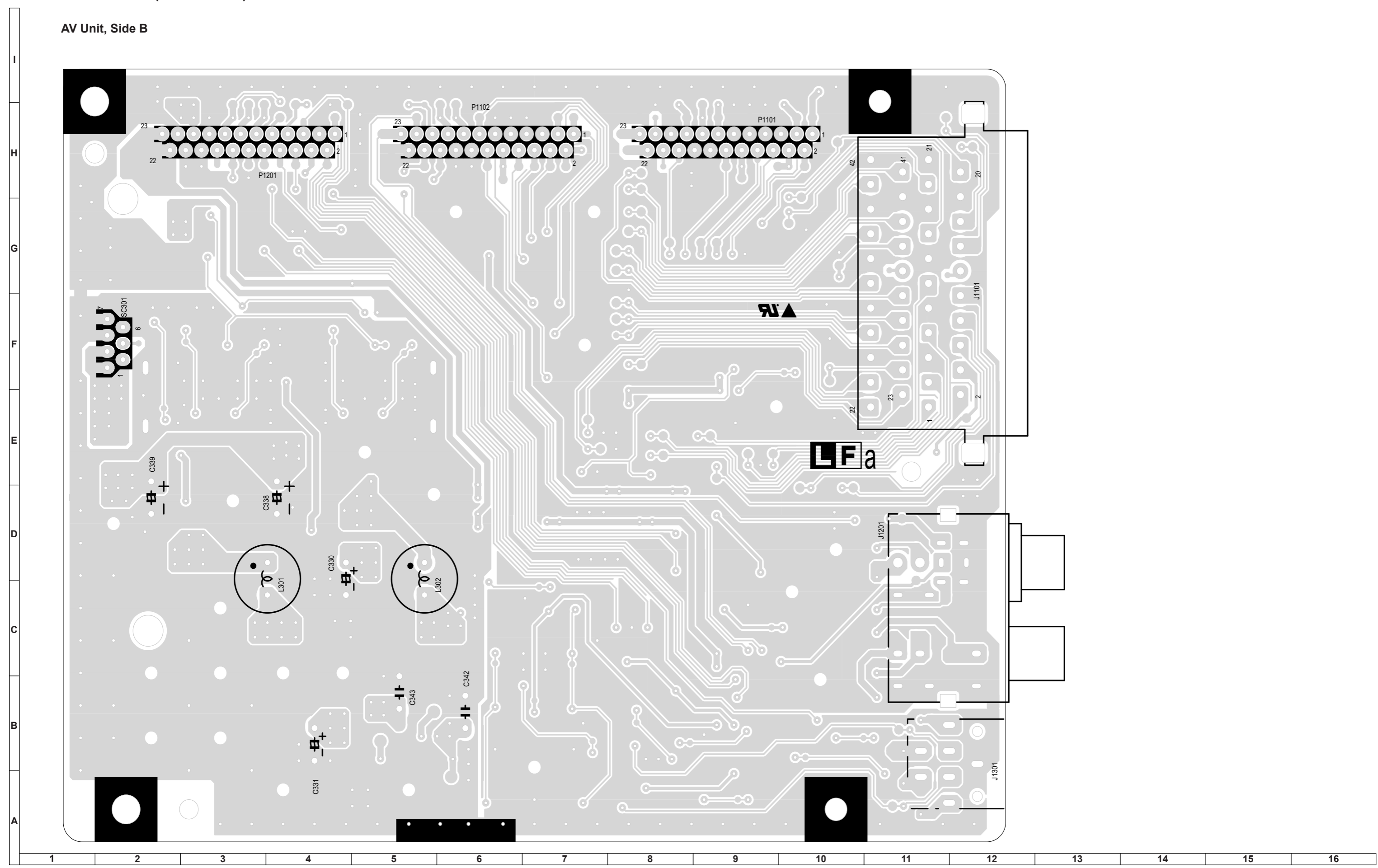

MAIN Unit PWB (XD890WJN2)

MAIN Unit, Side A

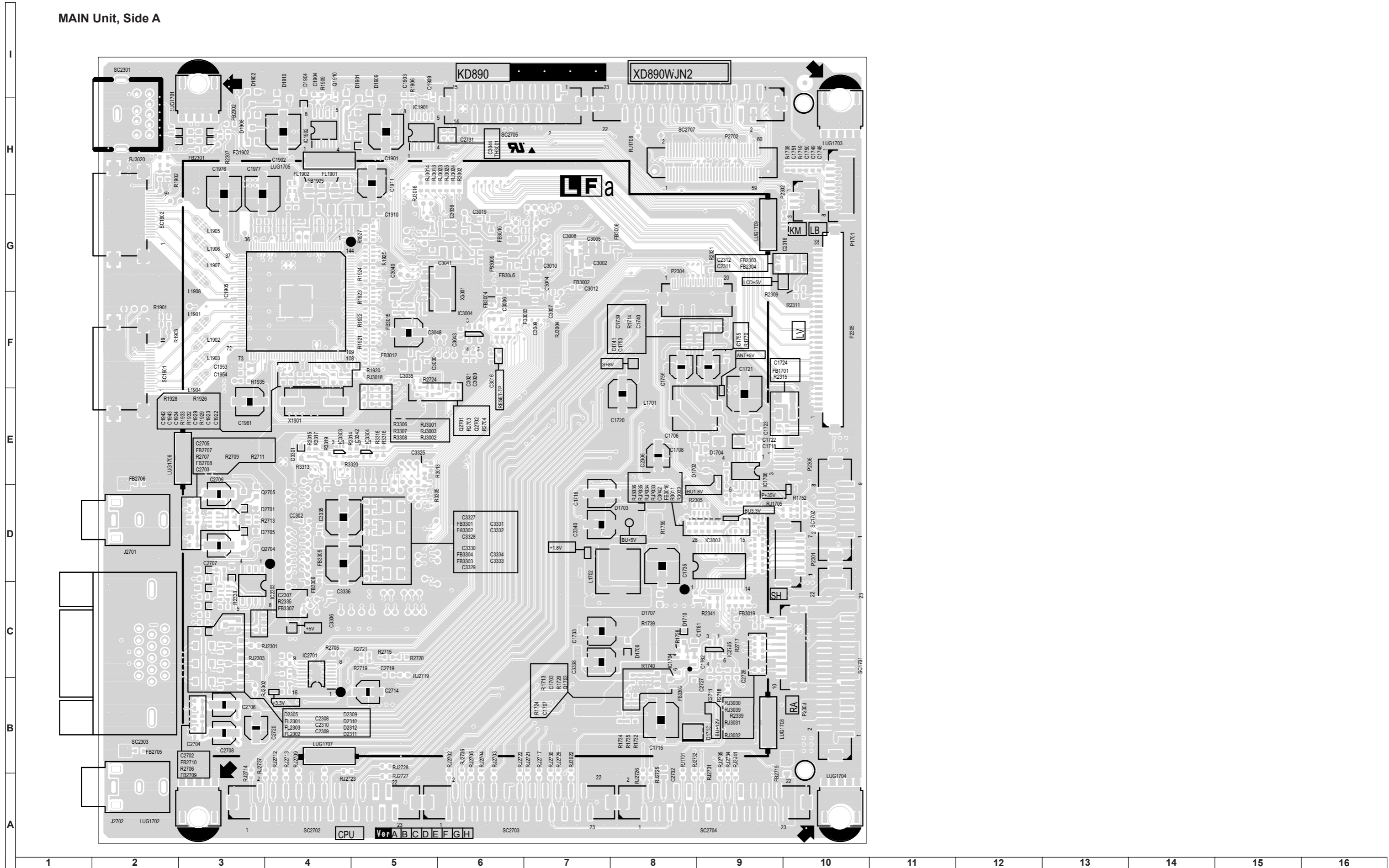

MAIN Unit PWB (XD890WJN2)

MAIN Unit, Side A Chip Parts

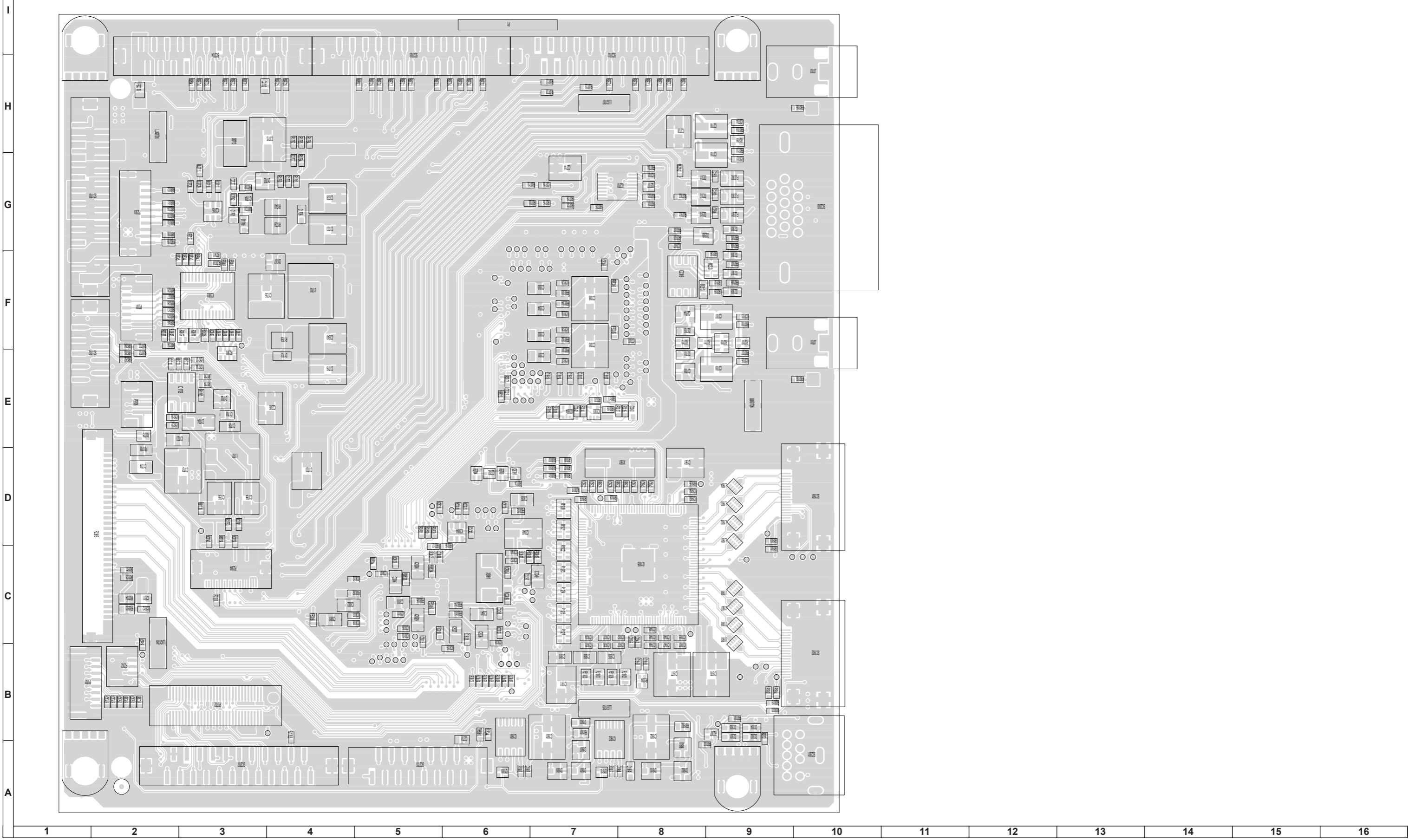

MAIN Unit PWB (XD890WJN2)

MAIN Unit, Side B Chip Parts

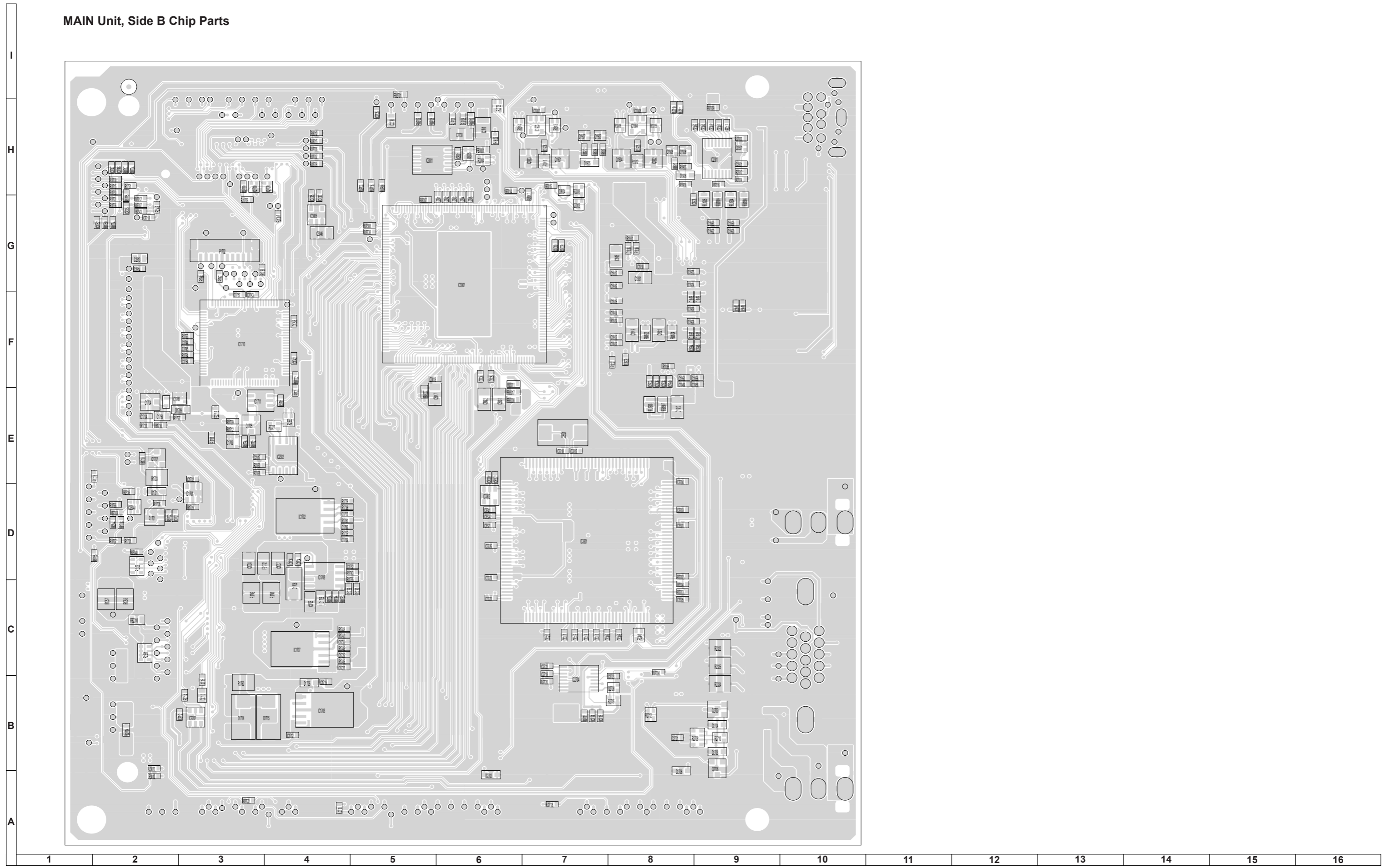

POWER SUPPLY Unit PWB (FD605WJN5)

POWER SUPPLY Unit, Side A

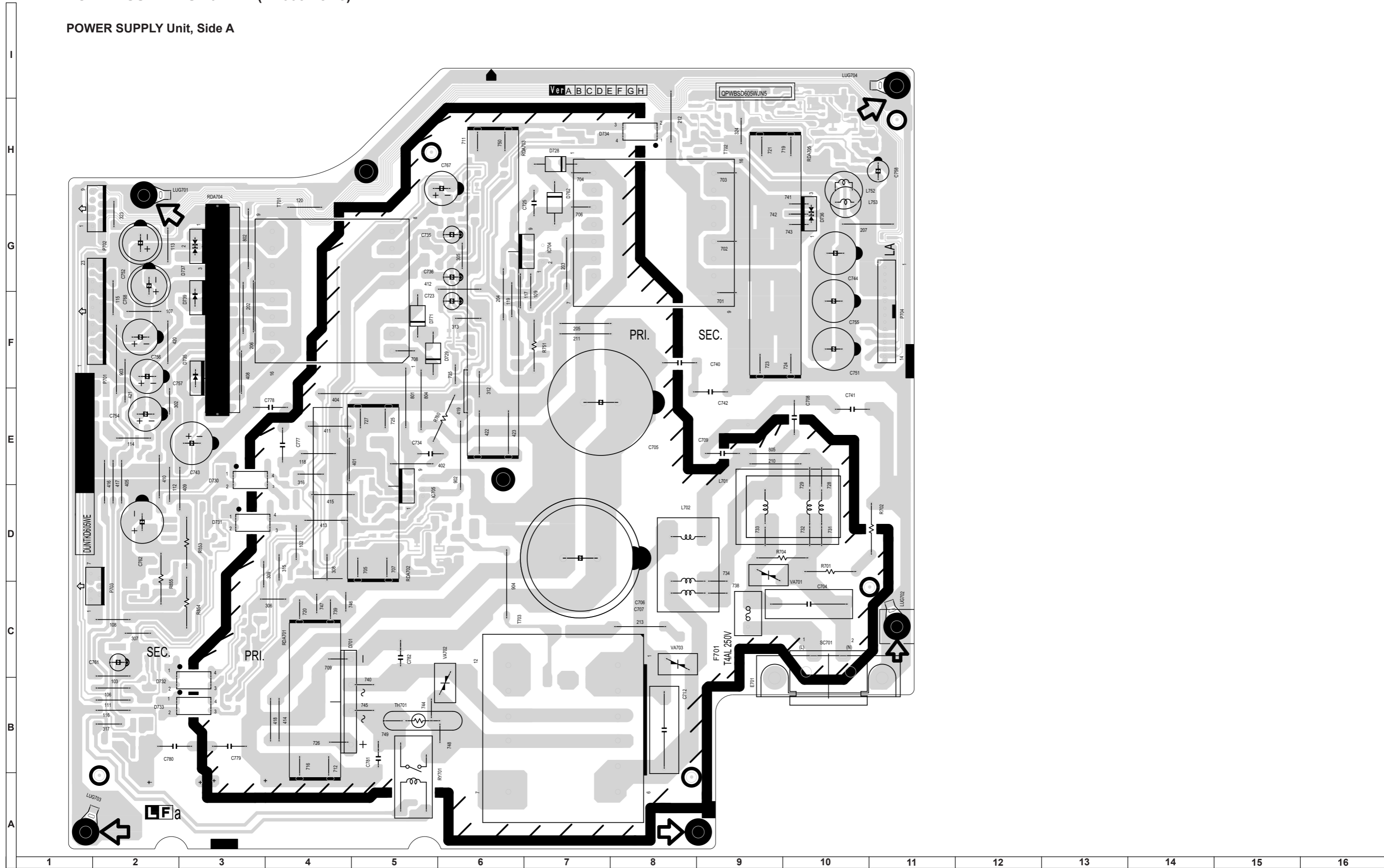

POWER SUPPLY Unit PWB (FD605WJN5)

POWER SUPPLY Unit, Side B

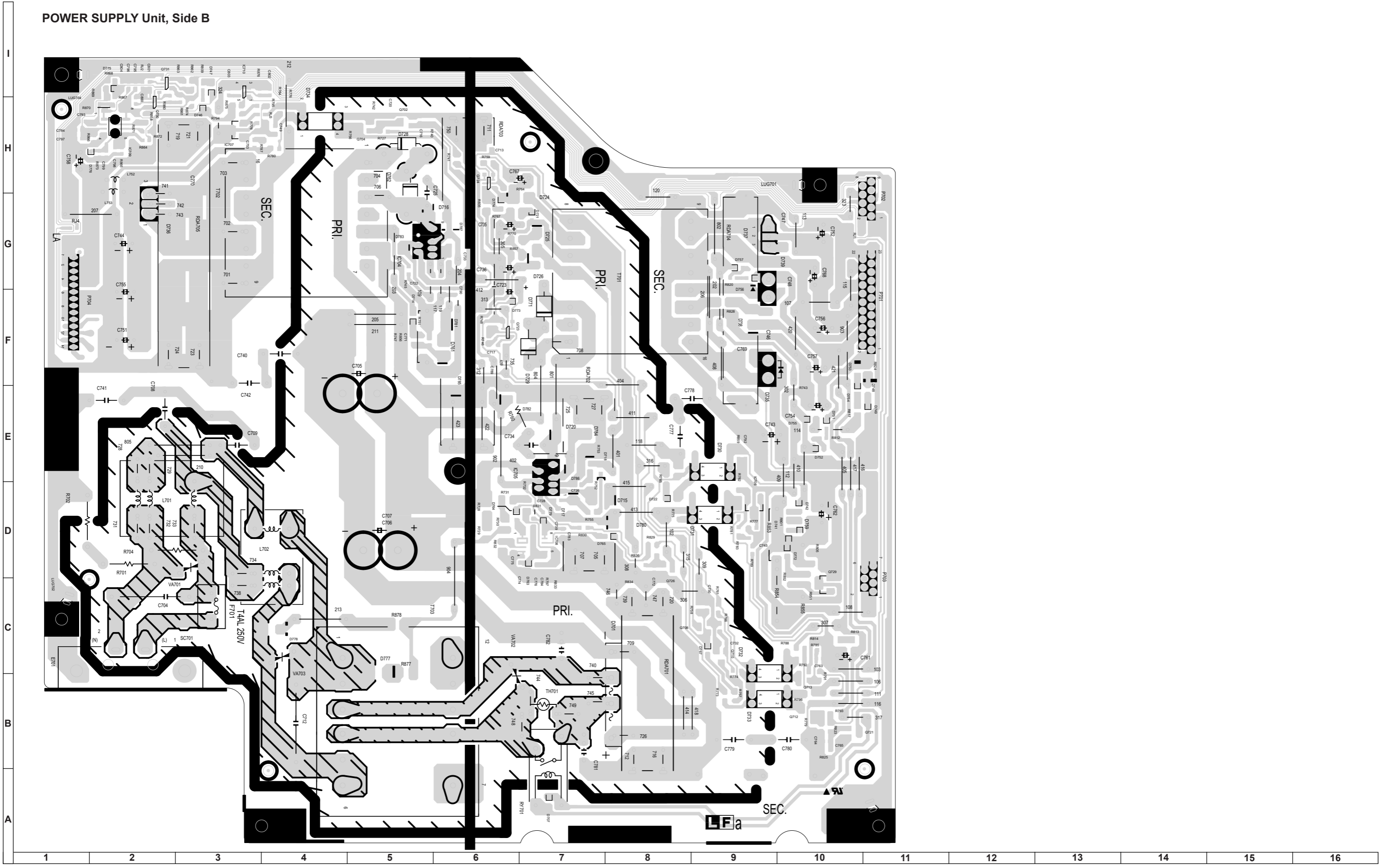

POWER SUPPLY Unit PWB (FD605WJN5)

POWER SUPPLY Unit, Side B Chip Parts

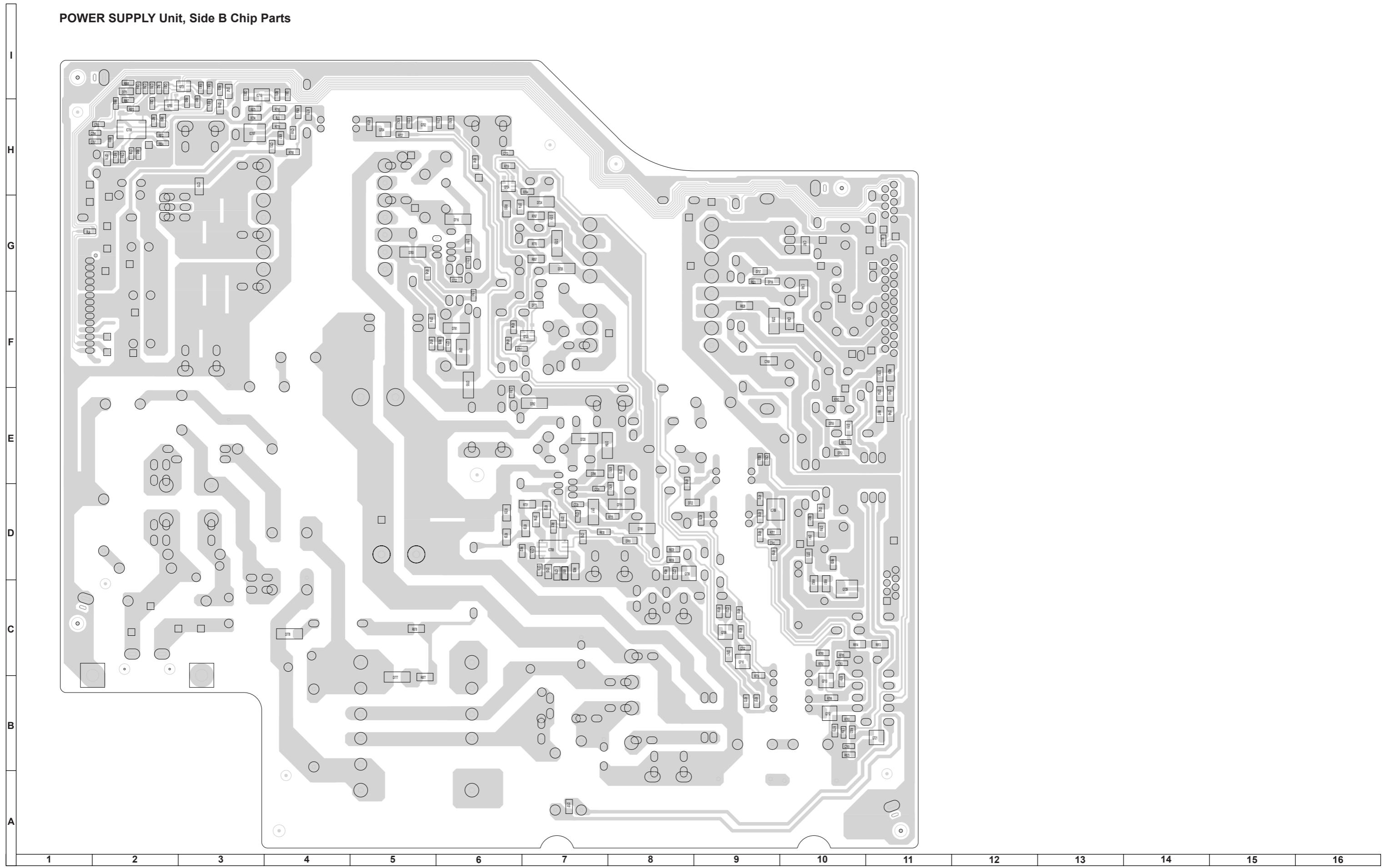

TUNER Unit PWB (KD609WJN3)

TUNER Unit, Side A

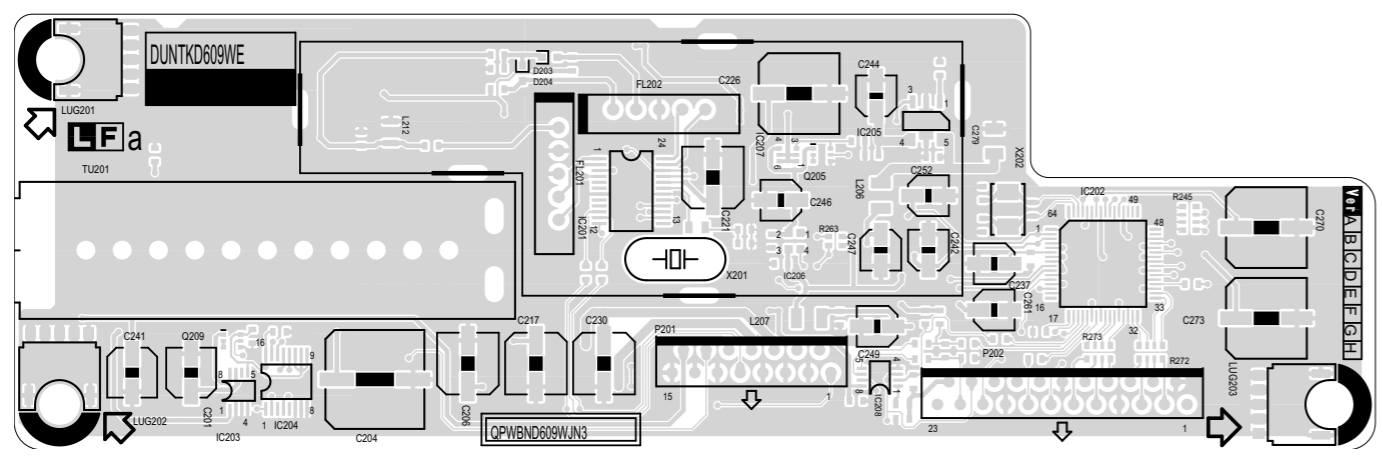

TUNER Unit, Side A Chip Parts

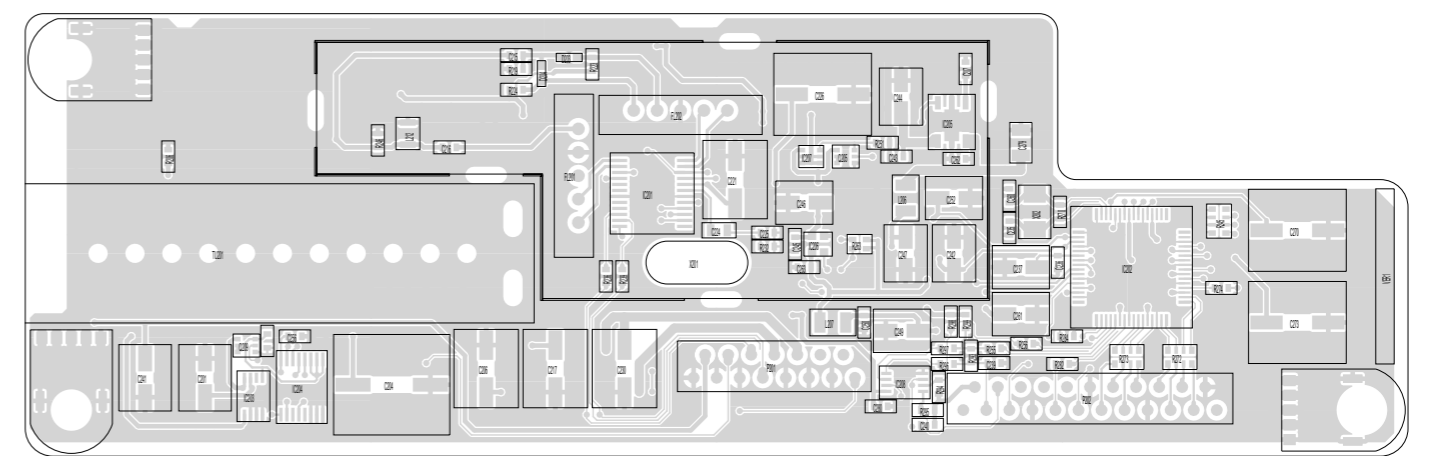

TUNER Unit, Side B

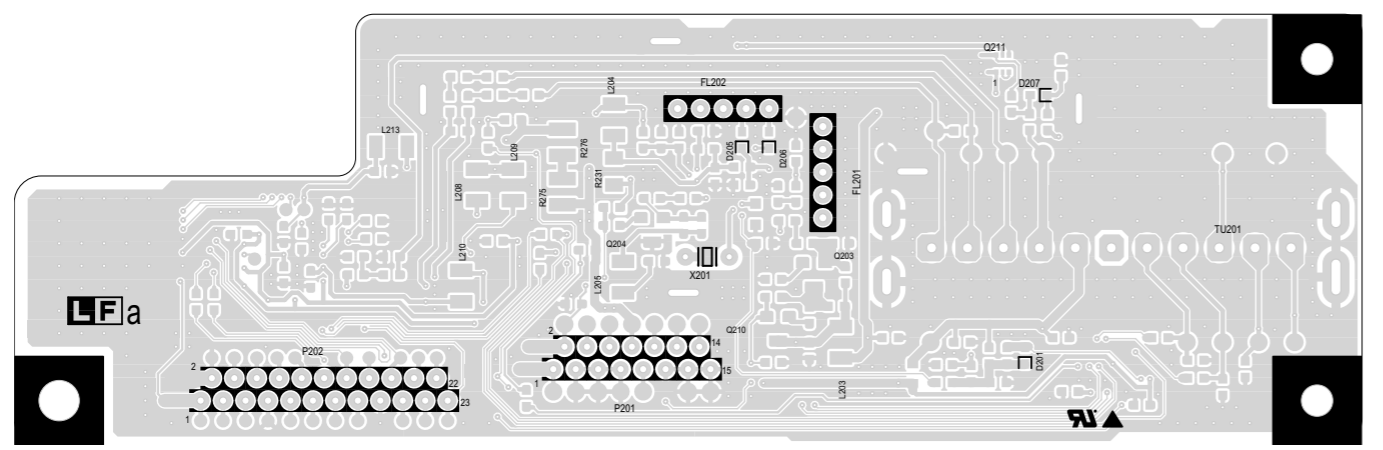

TUNER Unit, Side B Chip Parts

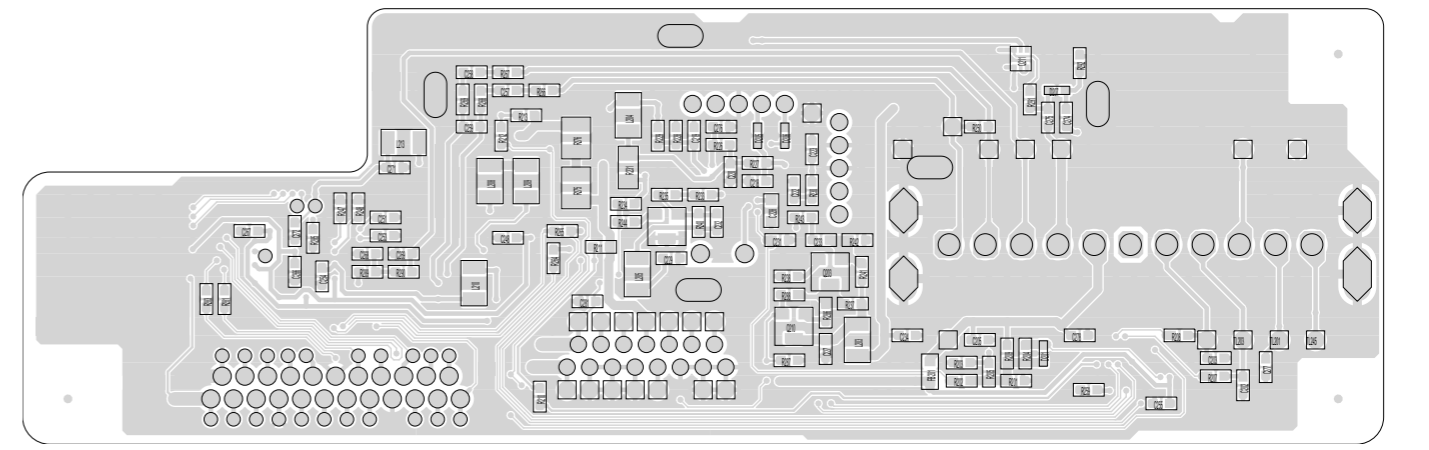

I
H
G
F
E
D
C
B
A

1 2 3 4 5 6 7 8 9 10 11 12 13 14 15 16

RC / LED Unit PWB (FD607WJN1)

RC/LED Unit, Side A

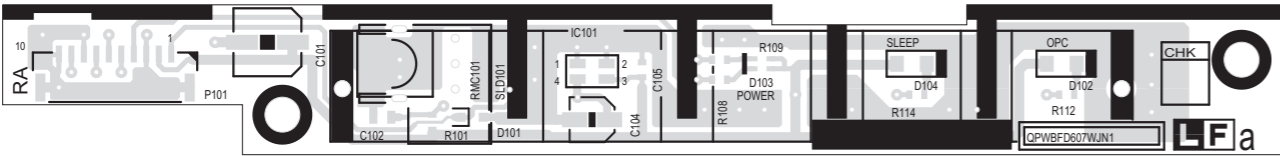

RC / LED Unit, Side A Chip Parts

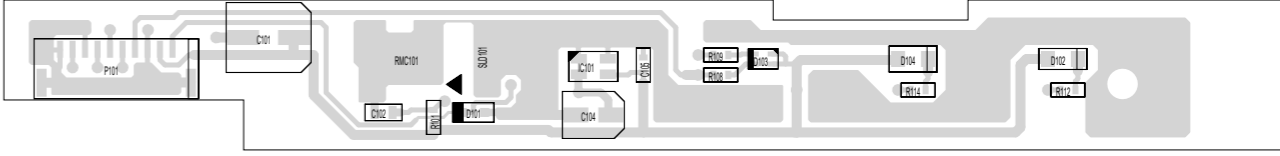

RC/LED Unit, Side B



KEY Unit PWB (FD606WJZZ)

KEY Unit, Side A

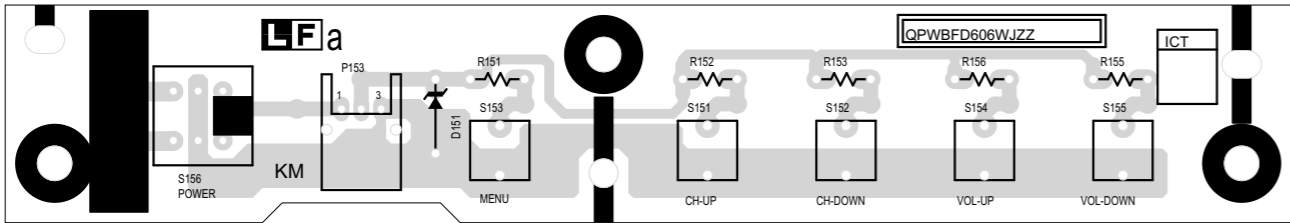

KEY Unit, Side B

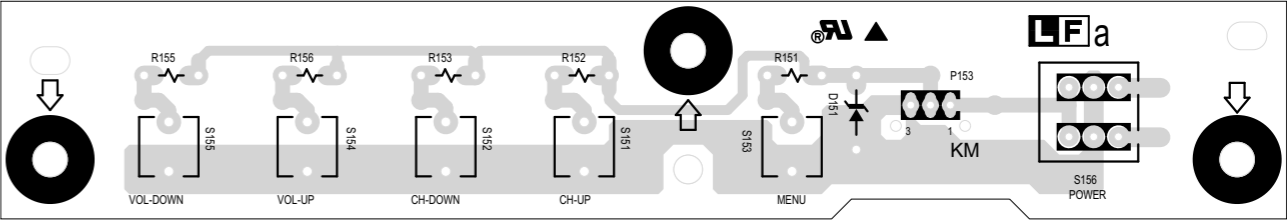

I
H
G
F
E
D
C
B
A

1 2 3 4 5 6 7 8 9 10 11 12 13 14 15 16

INVERTER Unit PWB

LC32GD8, LC32BT8 INVERTER Unit, Side A (RDENC2267TPZ)

I
H
G
T
E
D
C
B
A
1 2 3 4 5 6 7 8 9 10 11 12 13 14 15 16

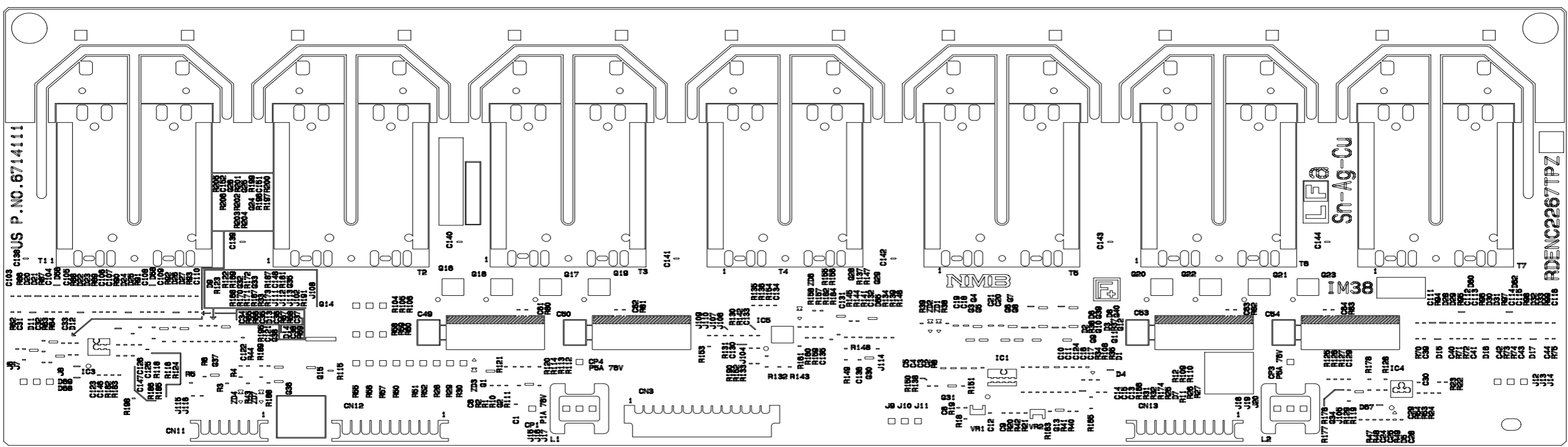

LC32GD8, LC32BT8 INVERTER Unit, Side A Chip Parts

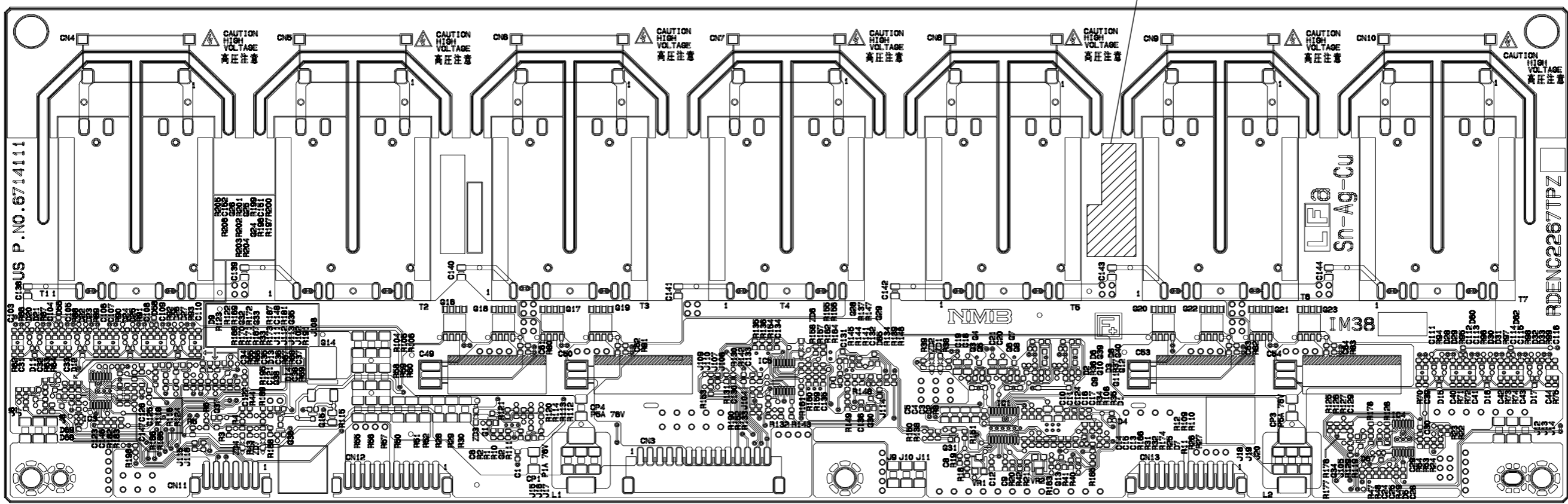

INVERTER Unit PWB (Continued)

LC-37GD8, LC-37BT8 INVERTER Unit, Side A (RUNTKA216WJZZ)

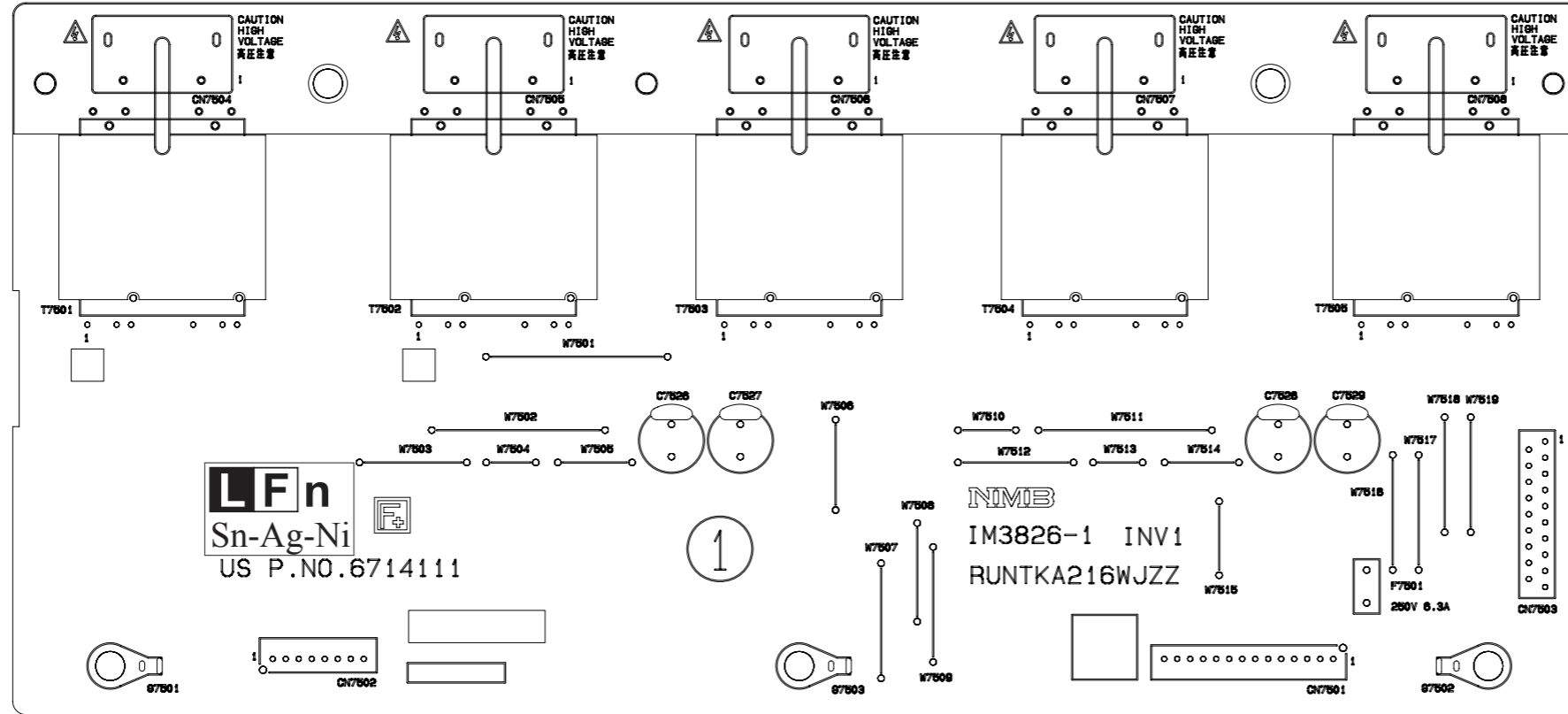

LC-37GD8, LC-37BT8 INVERTER Unit, Side B (RUNTKA216WJZZ)

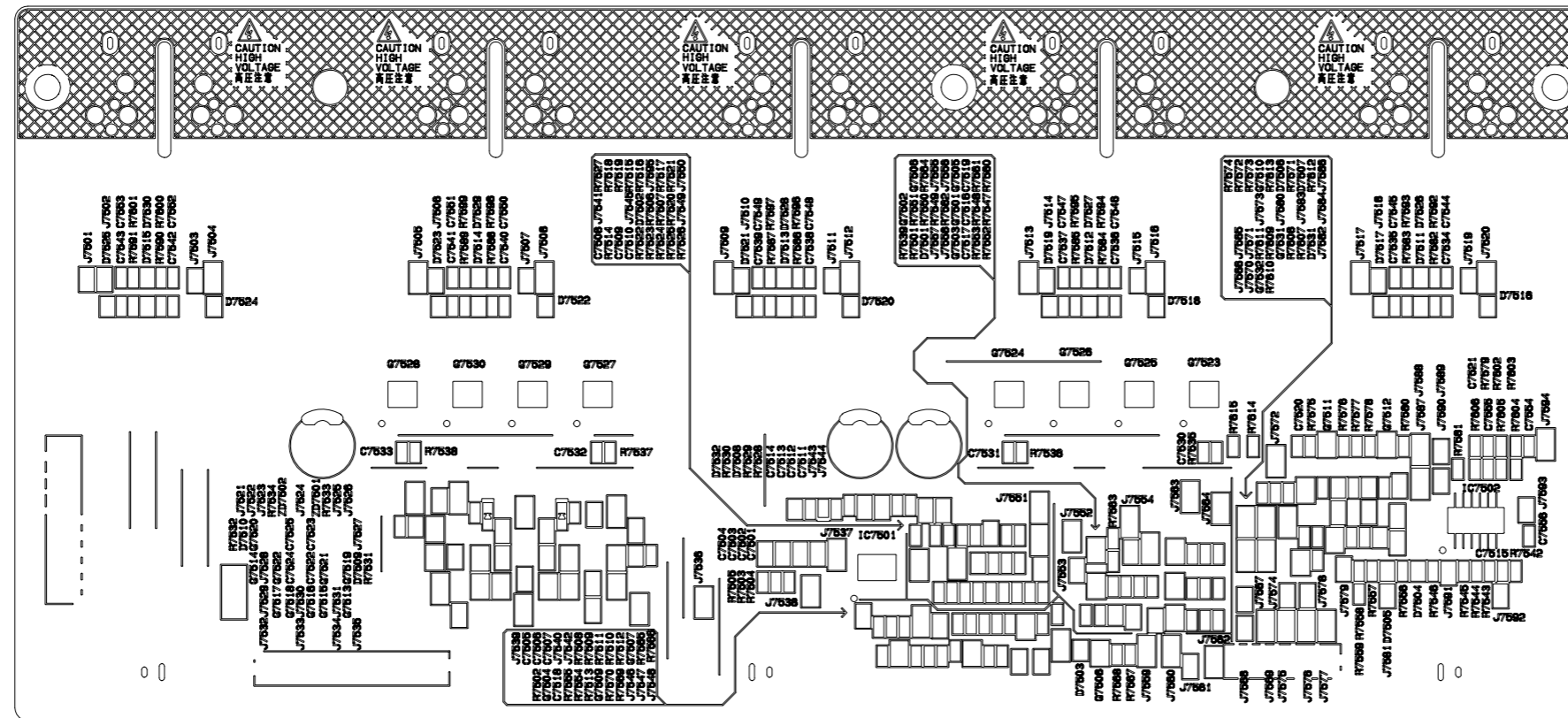

DIGITAL Unit PWB (KD628WJN2)

DIGITAL Unit, Side A

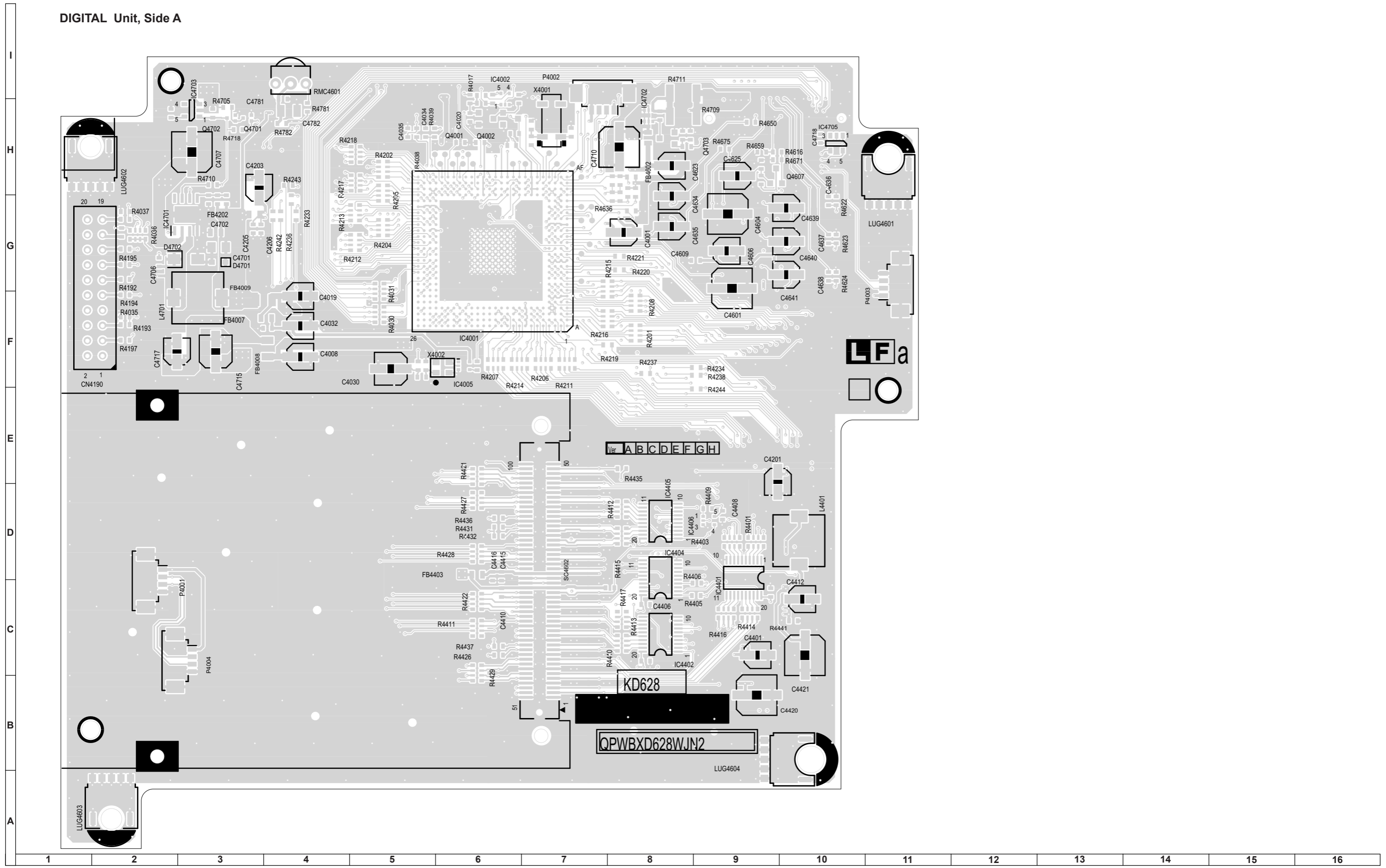

DIGITAL Unit PWB (KD628WJN2)

DIGITAL Unit, Side A Chip Parts

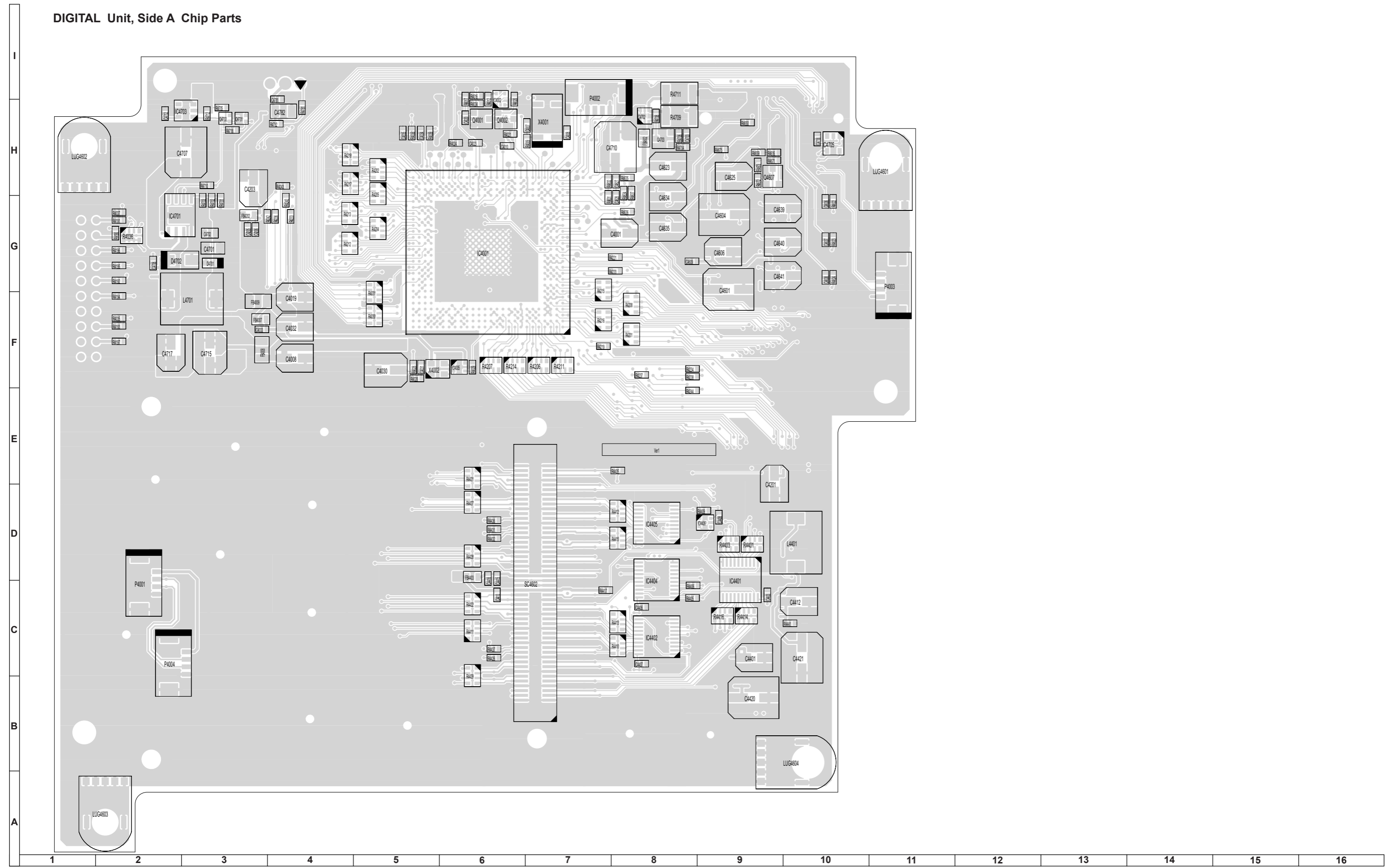

DIGITAL Unit PWB (KD628WJN2)

DIGITAL Unit, Side B Chip Parts

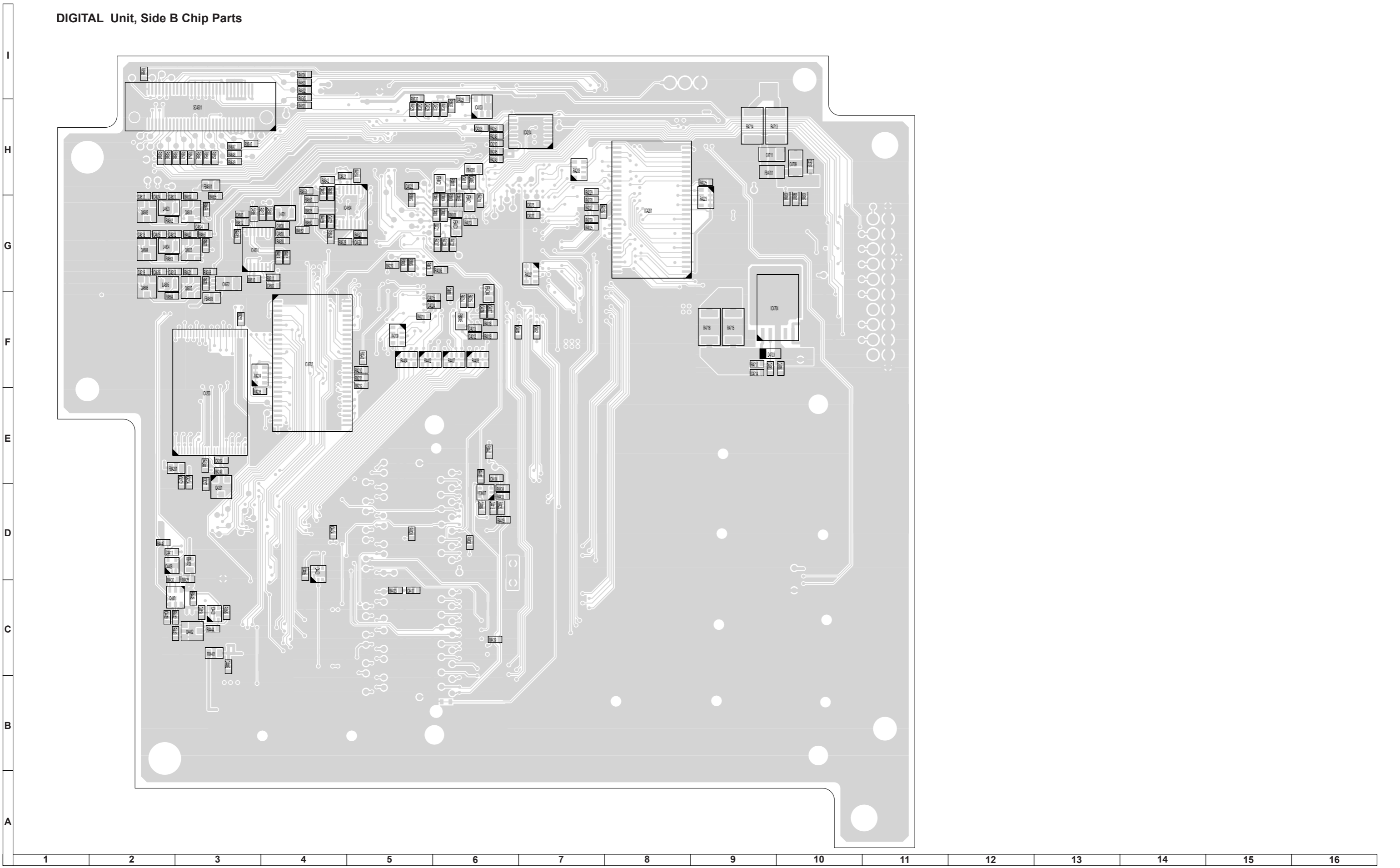

PARTS LISTING

REPLACEMENT PARTS

Replacement parts which have special safety characteristics are identified in this manual. Electrical components having such features are identified by Δ in the Replacement Parts Listing.

The use of a substitute replacement part which does not have the same safety characteristics as the factory recommended is not permitted.

Replacement parts not shown in this service manual may create shock fire, or other hazards.

HOW TO ORDER REPLACEMENT PARTS

To have your order completed promptly and correctly please supply the following information.

- | | |
|-----------------|----------------|
| 1. MODEL NUMBER | 2. REF. NO. |
| 3. PART NO. | 4. DESCRIPTION |
| 5. CODE | 6. QUANTITY |

MARK *: SPARE PARTS DELIVERY SECTION

REF No.	PARTS	DESCRIPTION	*	SN CODE	EX CODE
LCD PANEL					
NOTE : THE PARTS HERE SHOWN ARE SUPPLIED AS AN ASSEMBLY BUT NOT INDEPENDENTLY					
	R1LK315T3LF15	32" LCD Panel Module Unit	R		
	R1LK370T3LZ5BX	37" LCD Panel Module Unit	R	EZ	EZ
PRINTED WIRING BOARDS					
	DUNTKD890FM06	MAIN Unit (LC-32GD8E/RU, LC-32BT8E/RU)	R		
	DUNTKD890FM07	MAIN Unit (LC-37GD8E/RU, LC-37BT8E/RU)	R		
	DUNTKD604FM10	AV Unit	R		
	DUNTKD605FM14	POWER Unit (LC-32GD8E/RU, LC-32BT8E/RU)	R		
	DUNTKD605FM03	POWER Unit (LC-37GD8E/RU, LC-37BT8E/RU)	R		
	DUNTKD606FMV0	KEY Unit	R		
	DUNTKD607FMV0	R/C,LED Unit	R		
	CKITKD609FM01	DIGITAL TUNER Unit	S	AY	BN
	DUNTKD628FM01	DIGITAL Unit	R		
DUNTKD890FM06 (LC-32GD8E/RU,LC-32BT8E/RU) DUNTKD890FM07 (LC-37GD8E/RU,LC-37BT8E/RU) MAIN Unit					
INTEGRATED CIRCUITS					
IC1701	VHIBU4239G+1Y	BU4239G-TR	D	AE	AE
IC1702	VHIPQ20WZ11-1Y	PQ20WZ1UJ00H	D	AF	AF
IC1703	VHIPQ20WZ11-1Y	PQ20WZ1UJ00H	D	AF	AF
IC1704	VSSSM6J51TU-1Y	SSM6J51TU(TE85L,F)	D	AF	AF
IC1705	VSSSM6J51TU-1Y	SSM6J51TU(TE85L,F)	D	AF	AF
IC1706	VHIMP1410ES-1Y	MP1410ES-LF-Z	D	AP	AP
IC1707	VHIPQ20WZ11-1Y	PQ20WZ1UJ00H	D	AF	AF
IC1708	VHIMP1410ES-1Y	MP1410ES-LF-Z	D	AP	AP
IC1709	VSSSM6J51TU-1Y	SSM6J51TU(TE85L,F)	D	AF	AF
IC1710	RH-IXB823WJZZQ	EPM240T100C5N	D	AR	AR
IC1711	VHIPQ1R50/-1Y	PQ1R50J0000H	D	AF	AF
IC1901	VHI24LC2BIN-1Y	24LC02BT-I/SN	D	AF	AF
IC1905	VHISI9021+-1Q	SI9021CTU	D	BC	BC
IC2301	VHISL83220-1Y	ISL83220ECVZ-T	D	AQ	AQ
IC2303	VHIBR24C21F-1Y	BR24C21F-E2	D	AG	AG
IC2701	VHITVHC153T-1Y	TC74VHC153FT(EL,M)	D	AE	AE
IC2702	VHIMM1507XN-1Y	MM1507XNRE	D	AD	AD
IC2704	VHICD4052BP-1Y	CD4052BPWR	D	AD	AD
IC2705	VHIMM1507XN-1Y	MM1507XNRE	D	AD	AD
IC3001	VHIBR24L64F-1Y	BR24L64F-WE2	D	AK	AK
IC3002	RH-IXB624WJN1Q	VT6973	D		
IC3003	RH-IXB64WJZZY	PIC16F913-I/SS-G-GW902T	D	AY	AY
IC3005	VHIBU4215G+1Y	BU4215G-TR	D	AE	AE
TRANSISTORS					
Q1703	VS2SC3928AR-1Y	2SC3928AR	D	AB	AB
Q1704	VS2SC3928AR-1Y	2SC3928AR	D	AB	AB
Q1705	VS2SA1530AR-1Y	2SA1530AR	D	AB	AB

REF No.	PARTS	DESCRIPTION	*	SN CODE	EX CODE
Q1901	VS2SK536///-1Y	2SK536	D	AE	AE
Q1903	VS2SK536///-1Y	2SK536	D	AE	AE
Q1905	VSDTC144EE/-1Y	DTC144EE	D	AA	AA
Q1907	VSDTC144EE/-1Y	DTC144EE	D	AA	AA
Q1909	VSDTC144EE/-1Y	DTC144EE	D	AA	AA
Q2702	VS3LN01S///-1Y	3LN01S	D	AC	AC
Q2703	VS2SC3928AR-1Y	2SC3928AR	D	AB	AB
Q2704	VS2SC3928AR-1Y	2SC3928AR	D	AB	AB
Q2705	VS2SC3928AR-1Y	2SC3928AR	D	AB	AB
Q2706	VS2SC3928AR-1Y	2SC3928AR	D	AB	AB
Q2707	VSDTC144EE/-1Y	DTC144EE	D	AA	AA
Q2708	VSDTC144EE/-1Y	DTC144EE	D	AA	AA
Q2709	VS3LN01S///-1Y	3LN01S	D	AC	AC
Q2710	VS3LN01S///-1Y	3LN01S	D	AC	AC
Q3003	VS3LN01S///-1Y	3LN01S	D	AC	AC
Q3004	VS3LN01S///-1Y	3LN01S	D	AC	AC
DIODES					
D1702	RH-EX0487CEZZY	HZM2.ONBTL-E	D	AC	AC
D1703	VHDHSU119//1-1Y	HSU119TRF-E	D	AB	AB
D1704	VHDSFPA73/2EY	SFPA-73VL	D	AD	AD
D1705	VHDHSU119//1-1Y	HSU119TRF-E	D	AB	AB
D1706	VHDHSU119//1-1Y	HSU119TRF-E	D	AB	AB
D1707	RH-EX0487CEZZY	HZM2.ONBTL-E	D	AC	AC
D1708	VHDSFPA73/2EY	SFPA-73VL	D	AD	AD
D1901	VHDDAN202K/-1Y	DAN202KT146	D	AB	AB
D1903	VHD1SS355//1-1Y	1SS355TE-17	D	AB	AB
D1905	VHD1SS355//1-1Y	1SS355TE-17	D	AB	AB
D2301	RH-EX1271CEZZY	Zener Diode, 12V	D	AB	AB
D2302	RH-EX1271CEZZY	Zener Diode, 12V	D	AB	AB
D2303	RH-EX1271CEZZY	Zener Diode, 12V	D	AB	AB
D2304	RH-EX1271CEZZY	Zener Diode, 12V	D	AB	AB
D2305	RH-EX1247CEZZY	Zener Diode, 5.6V	D	AB	AB
D2306	RH-EX1247CEZZY	Zener Diode, 5.6V	D	AB	AB
D2307	RH-EX1247CEZZY	Zener Diode, 5.6V	D	AB	AB
D2308	RH-EX1247CEZZY	Zener Diode, 5.6V	D	AB	AB
D2309	VHDDAN202K/-1Y	DAN202KT146	D	AB	AB
D2310	VHD1SS226//1-1Y	1SS226(T5L,F,T)	D	AC	AC
D2311	VHD1SS226//1-1Y	1SS226(T5L,F,T)	D	AC	AC
D2312	VHD1SS226//1-1Y	1SS226(T5L,F,T)	D	AC	AC
D2313	RH-EX1247CEZZY	ZENER DIODE, 5.6V	D	AB	AB
PACKAGED CIRCUITS					
TH3002	VHMM1103J03-1Y	Thermistor	D	AC	AC
X1901	RCRSCA108WJZZY	Crystal	D	AF	AF
X3001	RCRSC0012CEZZY	Crystal	D	AH	AH
COILS AND FILTERS					
FL2301	RFILN0003TAZZY	Filter	D	AD	AD
FL2302	RFILN0003TAZZY	Filter	D	AD	AD
FL2303	RFILN0003TAZZY	Filter	D	AD	AD
L1701	RCILPA213WJZZY	Coil	D	AG	AG
L1702	RCILPA213WJZZY	Coil	D	AG	AG
L1901	RCILFA134WJZZY	Coil	D	AF	AF
L1902	RCILFA134WJZZY	Coil	D	AF	AF
L1903	RCILFA134WJZZY	Coil	D	AF	AF
L1904	RCILFA134WJZZY	Coil	D	AF	AF
L2301	RCILFA071WJZZY	Coil	D	AD	AD
L2302	RCILFA071WJZZY	Coil	D	AD	AD
L2303	RCILFA071WJZZY	Coil	D	AD	AD
L2304	RCILFA071WJZZY	Coil	D	AD	AD
L2305	RCILFA071WJZZY	Coil	D	AD	AD
L2701	VPCUN1R5MR12NY	Peaking 1.5uH	D		
CAPACITORS					
C1702	VCKYCY1EF104ZY	0.1 25V Ceramic	D	AA	AA
C1706	RC-KZA070WJZZY	22 6.3V Ceramic	D	AD	AD
C1711	VCKYCY1HB103KY	0.01 50V Ceramic	D	AA	AA
C1715	VCEASX1VN226MY	22 35V Electrolytic	D	AC	AC

REF No.	PARTS	DESCRIPTION	* SN CODE	EX CODE
DUNTKD890F06/07 (LC-32GD8, LC-32BT8 / (LC-37GD8, LC-37BT8)				
MAIN Unit (Continued)				
C1716	VCEASX1CN226MY	22 16V Electrolytic	D AC	AC
C1717	VCKYCY1HB272KY	2700p 50V Ceramic	D AA	AA
C1718	VCKYCY1EF104ZY	0.1 25V Ceramic	D AA	AA
C1720	VCEASX1CN226MY	22 16V Electrolytic	D AC	AC
C1721	VCAAPD1AJ686MY	68 10V Electrolytic	D AE	AE
C1723	RC-KZA073WJZZY	10 16V Ceramic	D AD	AD
C1724	RC-KZA073WJZZY	10 16V Ceramic	D AD	AD
C1726	RC-KZA070WJZZY	22 6.3V Ceramic	D AD	AD
C1730	VCKYCY1HB272KY	2700p 50V Ceramic	D AA	AA
C1733	VCEASX1CN226MY	22 16V Electrolytic	D AC	AC
C1734	VCKYCY1EF104ZY	0.1 25V Ceramic	D AA	AA
C1735	VCAAPD1AJ686MY	68 10V Electrolytic	D AE	AE
C1737	RC-KZA073WJZZY	10 16V Ceramic	D AD	AD
C1738	RC-KZA073WJZZY	10 16V Ceramic	D AD	AD
C1739	VCKYCY1EF104ZY	0.1 25V Ceramic	D AA	AA
C1740	VCCCCY1HH101JY	100p 50V Ceramic	D AA	AA
C1741	VCKYCY1HB102KY	1000p 50V Ceramic	D AA	AA
C1742	VCKYCY1EF104ZY	0.1 25V Ceramic	D AA	AA
C1744	VCCCCY1HH101JY	100p 50V Ceramic	D AA	AA
C1745	VCCCCY1HH101JY	100p 50V Ceramic	D AA	AA
C1746	VCCCCY1HH101JY	1000p 50V Ceramic	D AB	AB
C1747	VCCCCY1HH101JY	1SS390TE61	D AA	AA
		(LC-37GD8E/RU, LC-37BT8E/RU)		
C1748	VCCCCY1HH101JY	1SS390TE61	D AA	AA
		(LC-37GD8E/RU, LC-37BT8E/RU)		
C1749	VCKYCY1HB221KY	1SS390TE61	D AA	AA
		(LC-37GD8E/RU, LC-37BT8E/RU)		
C1750	VCCCCY1HH101JY	1SS390TE61	D AA	AA
		(LC-37GD8E/RU, LC-37BT8E/RU)		
C1751	VCCCCY1HH101JY	1SS390TE61	D AA	AA
		(LC-37GD8E/RU, LC-37BT8E/RU)		
C1752	VCCCCY1HH101JY	1SS390TE61	D AA	AA
		(LC-37GD8E/RU, LC-37BT8E/RU)		
C1753	VCKYCY1EF104ZY	0.1 25V Ceramic	D AA	AA
C1754	VCKYCY1EF104ZY	0.1 25V Ceramic	D AA	AA
C1755	VCEASX1CN106MY	10 16V Electrolytic	D AC	AC
C1756	VCEASX1CN106MY	10 16V Electrolytic	D AC	AC
C1757	VCKYCY1EF104ZY	0.1 25V Ceramic	D AA	AA
C1758	VCKYCY1EF104ZY	0.1 25V Ceramic	D AA	AA
C1901	VCEASY1CN476MY	47 16V Electrolytic	D AC	AC
C1903	VCKYCY1EF104ZY	0.1 25V Ceramic	D AA	AA
C1906	VCKYCY1EF104ZY	0.1 25V Ceramic	D AA	AA
C1910	RC-KZA073WJZZY	10 16V Ceramic	D AD	AD
C1912	VCKYCY1HB102KY	1000p 50V Ceramic	D AA	AA
C1913	VCKYCY1HB102KY	1000p 50V Ceramic	D AA	AA
C1916	VCKYCY1HB102KY	1000p 50V Ceramic	D AA	AA
C1917	VCKYCY1HB102KY	1000p 50V Ceramic	D AA	AA
C1918	RC-KZA073WJZZY	10 16V Ceramic	D AD	AD
C1919	RC-KZA073WJZZY	10 16V Ceramic	D AD	AD
C1921	RC-KZA073WJZZY	10 16V Ceramic	D AD	AD
C1923	VCKYCY1HB102KY	1000p 50V Ceramic	D AA	AA
C1924	VCKYCY1HB102KY	1000p 50V Ceramic	D AA	AA
C1927	VCKYCY1HB102KY	1000p 50V Ceramic	D AA	AA
C1928	VCKYCY1HB103KY	0.01 50V Ceramic	D AA	AA
C1929	VCCCCY1HH120JY	12p 50V Ceramic	D AA	AA
C1930	VCKYCY1HB102KY	1000p 50V Ceramic	D AA	AA
C1931	RC-KZA073WJZZY	10 16V Ceramic	D AD	AD
C1934	VCCCCY1HH120JY	12p 50V Ceramic	D AA	AA
C1935	RC-KZA073WJZZY	10 16V Ceramic	D AD	AD
C1936	VCKYCY1HB102KY	1000p 50V Ceramic	D AA	AA
C1941	VCKYCY1HB102KY	1000p 50V Ceramic	D AA	AA
C1943	VCKYCY1HB102KY	1000p 50V Ceramic	D AA	AA

REF No.	PARTS	DESCRIPTION	* SN CODE	EX CODE
C1946	VCKYCY1HB102KY	1000p 50V Ceramic	D AA	AA
C1947	VCKYCY1EF104ZY	0.1 25V Ceramic	D AA	AA
C1948	VCKYCY1HB102KY	1000p 50V Ceramic	D AA	AA
C1953	VCKYCY1EF104ZY	0.1 25V Ceramic	D AA	AA
C1955	VCKYCY1HB102KY	1000p 50V Ceramic	D AA	AA
C1956	VCKYCY1HB102KY	1000p 50V Ceramic	D AA	AA
C1959	VCKYCY1EF104ZY	0.1 25V Ceramic	D AA	AA
C1960	VCKYCY1HB102KY	1000p 50V Ceramic	D AA	AA
C1965	VCKYCY1HB102KY	1000p 50V Ceramic	D AA	AA
C1967	VCKYCY1HB102KY	1000p 50V Ceramic	D AA	AA
C1968	VCKYCY1HB102KY	1000p 50V Ceramic	D AA	AA
C1969	VCKYCY1HB102KY	1000p 50V Ceramic	D AA	AA
C1971	VCKYCY1HB102KY	1000p 50V Ceramic	D AA	AA
C1973	VCKYCY1HB102KY	1000p 50V Ceramic	D AA	AA
C1974	VCKYCY1HB102KY	1000p 50V Ceramic	D AA	AA
C1975	VCKYCY1HB102KY	1000p 50V Ceramic	D AA	AA
C2301	VCKYCY1EF104ZY	0.1 25V Ceramic	D AA	AA
C2302	VCKYCY1EF104ZY	0.1 25V Ceramic	D AA	AA
C2303	VCKYCY1EF104ZY	0.1 25V Ceramic	D AA	AA
C2304	VCKYCY1EF104ZY	0.1 25V Ceramic	D AA	AA
C2305	VCKYCY1EF104ZY	0.1 25V Ceramic	D AA	AA
C2306	VCEASX1CN106MY	10 16V Electrolytic	D AC	AC
C2307	VCKYCY1EF104ZY	0.1 25V Ceramic	D AA	AA
C2308	VCKYCY1HB104KY	0.1 50V Ceramic	D AA	AA
C2309	VCKYCY1HB104KY	0.1 50V Ceramic	D AA	AA
C2310	VCKYCY1HB104KY	0.1 50V Ceramic	D AA	AA
C2312	VCKYCY1EF104ZY	0.1 25V Ceramic	D AA	AA
C2318	VCCCCY1HH101JY	100p 50V Ceramic	D AA	AA
C2701	VCKYCY1EF104ZY	0.1 25V Ceramic	D AA	AA
C2702	VCCCCY1HH101JY	100p 50V Ceramic	D AA	AA
C2703	VCCCCY1HH101JY	100p 50V Ceramic	D AA	AA
C2704	VCCCCY1HH101JY	100p 50V Ceramic	D AA	AA
C2705	VCCCCY1HH101JY	100p 50V Ceramic	D AA	AA
C2706	VCEASX1HN105MY	1 50V Electrolytic	D AB	AB
C2707	VCEASX1HN105MY	1 50V Electrolytic	D AB	AB
C2708	VCEASX1HN105MY	1 50V Electrolytic	D AB	AB
C2709	VCEASX1HN105MY	1 50V Electrolytic	D AB	AB
C2710	VCKYTV1EB104KY	0.1 25V Ceramic	D AB	AB
C2711	VCKYCY1CF105ZY	1 16V Ceramic	D AA	AA
C2712	VCKYCY1EF104ZY	0.1 25V Ceramic	D AA	AA
C2714	VCEASX1CN106MY	10 16V Electrolytic	D AC	AC
C2715	VCKYCY1EF104ZY	0.1 25V Ceramic	D AA	AA
C2718	VCKYCY1CF105ZY	1 16V Ceramic	D AA	AA
C2719	VCKYCY1CF105ZY	1 16V Ceramic	D AA	AA
C2722	VCKYCY1EF104ZY	0.1 25V Ceramic	D AA	AA
C2723	VCKYCY1EF104ZY	0.1 25V Ceramic	D AA	AA
C2724	VCKYCY1EF104ZY	0.1 25V Ceramic	D AA	AA
C2725	VCKYCY1HB221KY	220p 50V Ceramic	D AA	AA
C2726	VCKYTV1EB104KY	0.1 25V Ceramic	D AB	AB
C2727	VCKYCY1EF104ZY	0.1 25V Ceramic	D AA	AA
C2728	VCKYCY1CF105ZY	1 16V Ceramic	D AA	AA
C2729	VCKYCY1HB104KY	0.1 50V Ceramic	D AA	AA
C2730	RC-KZA073WJZZY	10 16V Ceramic	D AD	AD
C2731	VCKYTV1HB103KY	0.01 50V Ceramic	D AA	AA
C2732	VCKYTV1HB103KY	0.01 50V Ceramic	D AA	AA
C3001	VCKYCY1EF104ZY	0.1 25V Ceramic	D AA	AA
C3002	RC-KZA073WJZZY	10 16V Ceramic	D AD	AD
C3003	VCKYCY1EF104ZY	0.1 25V Ceramic	D AA	AA
C3004	RC-KZA073WJZZY	10 16V Ceramic	D AD	AD
C3005	RC-KZA073WJZZY	10 16V Ceramic	D AD	AD
C3006	RC-KZA073WJZZY	10 16V Ceramic	D AD	AD
C3007	VCKYCY1EF104ZY	0.1 25V Ceramic	D AA	AA
C3008	VCKYCY1EF104ZY	0.1 25V Ceramic	D AA	AA
C3009	VCKYCY1EF104ZY	0.1 25V Ceramic	D AA	AA

REF No.	PARTS	DESCRIPTION	* SN CODE	EX CODE
C3010	RC-KZA073WJZZY	10 16V Ceramic	D AD	AD
C3011	VCKYCY1EF104ZY	0.1 25V Ceramic	D AA	AA
C3012	VCKYCY1EF104ZY	0.1 25V Ceramic	D AA	AA
C3013	VCKYCY1EF104ZY	0.1 25V Ceramic	D AA	AA
C3014	VCKYCY1HB104KY	0.1 50V Ceramic	D AA	AA
C3015	VCKYCY1EF104ZY	0.1 25V Ceramic	D AA	AA
C3016	VCKYCY1HB104KY	0.1 50V Ceramic	D AA	AA
C3017	RC-KZA073WJZZY	10 16V Ceramic	D AD	AD
C3018	VCKYCY1EF104ZY	0.1 25V Ceramic	D AA	AA
C3019	VCKYCY1EF104ZY	0.1 25V Ceramic	D AA	AA
C3020	VCKYCY1HB104KY	0.1 50V Ceramic	D AA	AA
C3021	VCCCCY1HH560JY	56p 50V Ceramic	D AB	AB
C3022	RC-KZA073WJZZY	10 16V Ceramic	D AD	AD
C3023	VCKYCY1EF104ZY	0.1 25V Ceramic	D AA	AA
C3024	VCKYCY1EF104ZY	0.1 25V Ceramic	D AA	AA
C3025	VCKYCY1EF104ZY	0.1 25V Ceramic	D AA	AA
C3027	RC-KZA073WJZZY	10 16V Ceramic	D AD	AD
C3028	VCKYCY1EF104ZY	0.1 25V Ceramic	D AA	AA
C3029	RC-KZA073WJZZY	10 16V Ceramic	D AD	AD
C3030	VCKYCY1EF104ZY	0.1 25V Ceramic	D AA	AA
C3031	RC-KZA073WJZZY	10 16V Ceramic	D AD	AD
C3032	VCKYCY1EF104ZY	0.1 25V Ceramic	D AA	AA
C3033	VCKYCY1EF104ZY	0.1 25V Ceramic	D AA	AA
C3034	VCCCCY1HH150JY	15p 50V Ceramic	D AA	AA
C3035	RC-KZA073WJZZY	10 16V Ceramic	D AD	AD
C3036	RC-KZA073WJZZY	10 16V Ceramic	D AD	AD
C3037	VCKYCY1EF104ZY	0.1 25V Ceramic	D AA	AA
C3038	VCKYCY1EF104ZY	0.1 25V Ceramic	D AA	AA
C3039	VCCCCY1HH180JY	18p 50V Ceramic	D AA	AA
C3040	RC-KZA073WJZZY	10 16V Ceramic	D AD	AD
C3041	RC-KZA073WJZZY	10 16V Ceramic	D AD	AD
C3042	VCKYCY1EF104ZY	0.1 25V Ceramic	D AA	AA
C3044	VCKYCY1HB103KY	0.01 50V Ceramic	D AA	AA
C3045	VCKYCY1HB103KY	0.01 50V Ceramic	D AA	AA
C3046	RC-KZA073WJZZY	10 16V Ceramic	D AD	AD
C3048	VCEASX0JN476MY	47 6.3V Electrolytic	D AC	AC
C3049	VCKYCY1HB102KY	1000p 50V Ceramic	D AA	AA
C3338	VCEASX0JN476MY	47 6.3V Electrolytic	D AC	AC
C3340	VCEASX0JN476MY	47 6.3V Electrolytic	D AC	AC
RESISTORS				
R1704	VRS-CY1JF000JY	0 1/16W Metal Oxide	D AA	AA
R1705	VRS-CY1JF000JY	0 1/16W Metal Oxide	D AA	AA
R1707	VRS-CY1JF000JY	0 1/16W Metal Oxide	D AA	AA
R1709	VRS-CY1JF103JY	10k 1/16W Metal Oxide	D AA	AA
R1711	VRS-CY1JF103JY	10k 1/16W Metal Oxide	D AA	AA
R1712	VRS-CY1JF103JY	10k 1/16W Metal Oxide	D AA	AA
R1713	VRS-CY1JF562JY	5.6k 1/16W Metal Oxide	D AA	AA
R1714	VRS-CY1JF000JY	0 1/16W Metal Oxide	D AA	AA
R1715	VRS-CY1JF470JY	1SS390TE61 (LC-37GD8E/RU, LC-37BT8E/RU)	D AA	AA
R1716	VRS-CY1JF562JY	5.6k 1/16W Metal Oxide	D AA	AA
R1717	VRS-CY1JF000JY	0 1/16W Metal Oxide (LC-32GD8E/RU, LC-32BT8E/RU)	D AA	AA
R1717	VRS-CY1JF470JY	1SS390TE61 (LC-37GD8E/RU, LC-37BT8E/RU)	D AA	AA
R1718	VRS-CY1JF470JY	1SS390TE61 (LC-37GD8E/RU, LC-37BT8E/RU)	D AA	AA
R1719	VRS-CY1JF622FY	6.2k 1/16W Metal Oxide	D AA	AA
R1720	VRS-CY1JF103JY	10k 1/16W Metal Oxide	D AA	AA
R1721	VRS-CY1JF562FY	5.6k 1/16W Metal Oxide	D AA	AA
R1722	VRS-CY1JF103JY	10k 1/16W Metal Oxide	D AA	AA
R1723	VRS-CY1JF622FY	6.2k 1/16W Metal Oxide	D AA	AA
R1724	VRS-CY1JF101JY	100 1/16W Metal Oxide	D AA	AA
R1726	VRS-CY1JF511FY	510 1/16W Metal Oxide	D AA	AA
R1727	VRS-CY1JF332JY	3.3k 1/16W Metal Oxide	D AA	AA

REF No.	PARTS	DESCRIPTION	* SN CODE	EX CODE
R1728	VRS-CY1JF332JY	3.3k 1/16W Metal Oxide	D AA	AA
R1729	VRS-CY1JF202FY	2.0k 1/16W Metal Oxide	D AA	AA
R1730	VRS-CY1JF470JY	1SS390TE61 (LC-37GD8E/RU, LC-37BT8E/RU)	D AA	AA
R1731	VRS-CY1JF102JY	1SS390TE61 (LC-37GD8E/RU, LC-37BT8E/RU)	D AA	AA
R1732	VRS-CY1JF202FY	2.0k 1/16W Metal Oxide	D AA	AA
R1733	VRS-CY1JF101JY	100 1/16W Metal Oxide	D AA	AA
R1734	VRS-CY1JF222FY	2.2k 1/16W Metal Oxide	D AA	AA
R1735	VRS-CY1JF202FY	2.0k 1/16W Metal Oxide	D AA	AA
R1736	VRS-CY1JF102JY	1SS390TE61 (LC-37GD8E/RU, LC-37BT8E/RU)	D AA	AA
R1737	VRS-CY1JF562JY	5.6k 1/16W Metal Oxide	D AA	AA
R1739	VRS-TW2HF1R0JY	1 1/2W Metal Oxide	D AA	AA
R1740	VRS-TW2HF1R0JY	1 1/2W Metal Oxide	D AA	AA
R1741	VRS-TW2HF1R0JY	1 1/2W Metal Oxide	D AA	AA
R1742	VRS-TW2HF1R0JY	1 1/2W Metal Oxide	D AA	AA
R1743	VRS-CY1JF101JY	100 1/16W Metal Oxide	D AA	AA
R1744	VRS-CY1JF562FY	5.6k 1/16W Metal Oxide	D AA	AA
R1745	VRS-CY1JF132JY	1.3k 1/16W Metal Oxide	D AG	AG
R1746	VRS-CY1JF202JY	2.0k 1/16W Metal Oxide	D AA	AA
R1747	VRS-CY1JF511FY	510 1/16W Metal Oxide	D AA	AA
R1748	VRS-CY1JF202FY	2.0k 1/16W Metal Oxide	D AA	AA
R1752	VRS-CY1JF470JY	47 1/16W Metal Oxide	D AA	AA
R1753	VRS-CY1JF622FY	6.2k 1/16W Metal Oxide	D AA	AA
R1754	VRS-CY1JF622FY	6.2k 1/16W Metal Oxide	D AA	AA
R1755	VRS-CY1JF562JY	5.6k 1/16W Metal Oxide	D AA	AA
R1756	VRS-CY1JF104JY	100k 1/16W Metal Oxide	D AA	AA
R1757	VRS-TW2HF1R0JY	1 1/2W Metal Oxide	D AA	AA
R1758	VRS-TW2HF1R0JY	1 1/2W Metal Oxide	D AA	AA
R1759	VRS-TW2HF1R0JY	1 1/2W Metal Oxide	D AA	AA
R1760	VRS-TW2HF1R0JY	1 1/2W Metal Oxide	D AA	AA
R1761	VRS-CY1JF101JY	100 1/16W Metal Oxide	D AA	AA
R1762	VRS-CY1JF220JY	22 1/16W Metal Oxide	D AA	AA
R1763	VRS-CY1JF220JY	22 1/16W Metal Oxide	D AA	AA
R1764	VRS-CY1JF220JY	22 1/16W Metal Oxide	D AA	AA
R1767	VRS-CY1JF103JY	10k 1/16W Metal Oxide	D AA	AA
R1768	VRS-CY1JF103JY	10k 1/16W Metal Oxide	D AA	AA
R1769	VRS-CY1JF103JY	10k 1/16W Metal Oxide	D AA	AA
R1770	VRS-CY1JF103JY	10k 1/16W Metal Oxide	D AA	AA
R1771	VRS-CY1JF101JY	100 1/16W Metal Oxide	D AA	AA
R1772	VRS-CY1JF103JY	10k 1/16W Metal Oxide	D AA	AA
R1773	VRS-CY1JF000JY	0 1/16W Metal Oxide (LC-32GD8E/RU, LC-32BT8E/RU)	D AA	AA
R1774	VRS-CY1JF470JY	47 1/16W Metal Oxide (LC-32GD8E/RU, LC-32BT8E/RU)	D AA	AA
R1775	VRS-CY1JF103JY	10k 1/16W Metal Oxide (LC-32GD8E/RU, LC-32BT8E/RU)	D AA	AA
R1901	VRS-CY1JF272JY	2.7k 1/16W Metal Oxide	D AA	AA
R1903	VRS-CY1JF152JY	1.5k 1/16W Metal Oxide	D AA	AA
R1906	VRS-CY1JF473JY	47k 1/16W Metal Oxide	D AA	AA
R1908	VRS-CY1JF103JY	10k 1/16W Metal Oxide	D AA	AA
R1911	VRS-CJ1JF474JY	470k 1/16W Metal Oxide	D AA	AA
R1913	VRS-CJ1JF473JY	47k 1/16W Metal Oxide	D AB	AB
R1914	VRS-CJ1JF100JY	10 1/16W Metal Oxide	D AA	AA
R1917	VRS-CY1JF103JY	10k 1/16W Metal Oxide	D AA	AA
R1919	VRS-CY1JF100JY	10 1/16W Metal Oxide	D AA	AA
R1920	VRS-CH1JF100JY	10 1/16W Metal Oxide	D AA	AA
R1921	VRS-CH1JF100JY	10 1/16W Metal Oxide	D AA	AA
R1922	VRS-CH1JF100JY	10 1/16W Metal Oxide	D AA	AA
R1923	VRS-CH1JF100JY	10 1/16W Metal Oxide	D AA	AA
R1924	VRS-CH1JF100JY	10 1/16W Metal Oxide	D AA	AA
R1925	VRS-CH1JF100JY	10 1/16W Metal Oxide	D AA	AA
R1926	VRS-CY1JF472JY	4.7k 1/16W Metal Oxide	D AA	AA
R1927	VRS-CH1JF100JY	10 1/16W Metal Oxide	D AA	AA
R1928	VRS-CY1JF223JY	22k 1/16W Metal Oxide	D AA	AA
R1929	VRS-CY1JF472JY	4.7k 1/16W Metal Oxide	D AA	AA
R1930	VRS-CY1JF910FY	91 1/16W Metal Oxide	D AA	AA

REF No.	PARTS	DESCRIPTION	* SN CODE	EX CODE
DUNTKD890FM06/07 (LC-32GD8, LC-32BT8 / (LC-37GD8, LC-37BT8)				
MAIN Unit (Continued)				
R1931	VRS-CY1JF910FY	91 1/16W Metal Oxide	D AA	AA
R1932	VRS-CY1JF105JY	1M 1/16W Metal Oxide	D AA	AA
R1933	VRS-CY1JF152JY	1.5k 1/16W Metal Oxide	D AA	AA
R1934	VRS-CJ1JF101JY	100 1/16W Metal Oxide	D AA	AA
R1935	VRS-CY1JF330JY	33 1/16W Metal Oxide	D AA	AA
R1936	VRS-CY1JF330JY	33 1/16W Metal Oxide	D AA	AA
R1937	VRS-CY1JF103JY	10k 1/16W Metal Oxide	D AA	AA
R2301	VRS-CY1JF000JY	0 1/16W Metal Oxide	D AA	AA
R2302	VRS-CH1JF103JY	10k 1/16W Metal Oxide	D AA	AA
R2303	VRS-CY1JF000JY	0 1/16W Metal Oxide	D AA	AA
		(LC-32GD8E/RU, LC-32BT8E/RU)		
R2305	VRS-CH1JF103JY	10k 1/16W Metal Oxide	D AA	AA
R2307	VRS-CJ1JF101JY	100 1/16W Metal Oxide	D AA	AA
R2309	VRS-CY1JF472JY	4.7k 1/16W Metal Oxide	D AA	AA
R2313	VRS-CY1JF100JY	10 1/16W Metal Oxide	D AA	AA
R2314	VRS-CY1JF103JY	10k 1/16W Metal Oxide	D AA	AA
R2315	VRS-CJ1JF101JY	100 1/16W Metal Oxide	D AA	AA
R2321	VRS-CY1JF000JY	0 1/16W Metal Oxide	D AA	AA
R2322	VRS-TW2ED750JY	75 1/4W Metal Oxide	D AA	AA
R2324	VRS-TW2ED750JY	75 1/4W Metal Oxide	D AA	AA
R2325	VRS-TW2ED750JY	75 1/4W Metal Oxide	D AA	AA
R2326	VRS-CY1JF102JY	1k 1/16W Metal Oxide	D AA	AA
R2329	VRS-CY1JF103JY	10k 1/16W Metal Oxide	D AA	AA
R2332	VRS-CY1JF473JY	47k 1/16W Metal Oxide	D AA	AA
R2333	VRS-CH1JF101JY	100 1/16W Metal Oxide	D AA	AA
R2334	VRS-CY1JF103FY	10k 1/16W Metal Oxide	D AA	AA
R2335	VRS-CY1JF102JY	1k 1/16W Metal Oxide	D AA	AA
R2339	VRS-CY1JF102FY	1k 1/16W Metal Oxide	D AA	AA
R2341	VRS-CY1JF393FY	39k 1/16W Metal Oxide	D AA	AA
R2342	VRS-CY1JF103JY	10k 1/16W Metal Oxide	D AA	AA
R2343	VRS-CY1JF102FY	1k 1/16W Metal Oxide	D AA	AA
R2701	VRS-CY1JF103JY	10k 1/16W Metal Oxide	D AA	AA
R2702	VRS-CJ1JF101JY	100 1/16W Metal Oxide	D AA	AA
R2703	VRS-CJ1JF473JY	47k 1/16W Metal Oxide	D AB	AB
R2704	VRS-CJ1JF103JY	10k 1/16W Metal Oxide	D AA	AA
R2705	VRS-CY1JF103JY	10k 1/16W Metal Oxide	D AA	AA
R2706	VRS-CJ1JF224JY	220k 1/16W Metal Oxide	D AA	AA
R2707	VRS-CJ1JF224JY	220k 1/16W Metal Oxide	D AA	AA
R2708	VRS-CH1JF104JY	100k 1/16W Metal Oxide	D AA	AA
R2709	VRS-CH1JF104JY	100k 1/16W Metal Oxide	D AA	AA
R2710	VRS-CJ1JF103JY	10k 1/16W Metal Oxide	D AA	AA
R2711	VRS-CJ1JF103JY	10k 1/16W Metal Oxide	D AA	AA
R2712	VRS-CJ1JF472JY	4.7k 1/16W Metal Oxide	D AA	AA
R2713	VRS-CJ1JF472JY	4.7k 1/16W Metal Oxide	D AA	AA
R2714	VRS-CY1JF101JY	100 1/16W Metal Oxide	D AA	AA
R2715	VRS-CY1JF102JY	1k 1/16W Metal Oxide	D AA	AA
R2716	VRS-CJ1JF103JY	10k 1/16W Metal Oxide	D AA	AA
R2717	VRS-CY1JF101JY	100 1/16W Metal Oxide	D AA	AA
R2719	VRS-CY1JF102JY	1k 1/16W Metal Oxide	D AA	AA
R2720	VRS-CY1JF104JY	100k 1/16W Metal Oxide	D AA	AA
R2721	VRS-CY1JF104JY	100k 1/16W Metal Oxide	D AA	AA
R2722	VRS-CY1JF101JY	100 1/16W Metal Oxide	D AA	AA
R2723	VRS-CY1JF472JY	4.7 1/16W Metal Oxide	D AA	AA
R2724	VRS-CY1JF000JY	0 1/16W Metal Oxide	D AA	AA
R3001	VRS-CY1JF102JY	1k 1/16W Metal Oxide	D AA	AA
R3002	VRS-CY1JF220JY	22 1/16W Metal Oxide	D AA	AA
R3003	VRS-CY1JF103JY	10k 1/16W Metal Oxide	D AA	AA
R3004	VRS-CJ1JF101JY	100 1/16W Metal Oxide	D AA	AA
R3005	VRS-CJ1JF472JY	4.7k 1/16W Metal Oxide	D AA	AA
R3006	VRS-CY1JF472JY	4.7k 1/16W Metal Oxide	D AA	AA
R3007	VRS-CY1JF622JY	6.2k 1/16W Metal Oxide	D AA	AA
R3008	VRS-CJ1JF472JY	4.7k 1/16W Metal Oxide	D AA	AA
R3009	VRS-CJ1JF101JY	100 1/16W Metal Oxide	D AA	AA
R3010	VRS-CY1JF472JY	4.7k 1/16W Metal Oxide	D AA	AA
R3012	VRS-CY1JF103JY	10k 1/16W Metal Oxide	D AA	AA
R3013	VRS-CY1JF103JY	10k 1/16W Metal Oxide	D AA	AA

REF No.	PARTS	DESCRIPTION	* SN CODE	EX CODE
R3014	VRS-CY1JF472JY	4.7k 1/16W Metal Oxide	D AA	AA
R3017	VRS-CY1JF390JY	39 1/16W Metal Oxide	D AA	AA
R3018	VRS-CY1JF000JY	0 1/16W Metal Oxide	D AA	AA
R3306	VRS-CY1JF220JY	22 1/16W Metal Oxide	D AA	AA
R3307	VRS-CY1JF220JY	22 1/16W Metal Oxide	D AA	AA
R3308	VRS-CY1JF220JY	22 1/16W Metal Oxide	D AA	AA
FERRITE BEAD				
FB1701	RBLN-0250TAZZY	1SS390TE61	D AC	AC
FB1702	RBLN-0250TAZZY	1SS390TE61	D AC	AC
FB1901	RBLN-0060TAZZY	1SS390TE61	D AB	AB
FB1903	RBLN-0060TAZZY	1SS390TE61	D AB	AB
FB1904	RBLN-0060TAZZY	1SS390TE61	D AB	AB
FB1905	RBLN-0060TAZZY	1SS390TE61	D AB	AB
FB1906	RBLN-0060TAZZY	Ferrite Bead	D AB	AB
FB1907	RBLN-0210TAZZY	Ferrite Bead	D AB	AB
FB1908	RBLN-0060TAZZY	Ferrite Bead	D AB	AB
FB1909	RBLN-0210TAZZY	Ferrite Bead	D AB	AB
FB2301	RBLN-0061TAZZY	Ferrite Bead	D AD	AD
FB2302	RBLN-0061TAZZY	Ferrite Bead	D AD	AD
FB2303	VRS-TV2BDR56JY	0.56 1/8W Metal Oxide	D	
FB2304	VRS-TV2BDR56JY	0.56 1/8W Metal Oxide	D	
FB2305	RBLN-0061TAZZY	Ferrite Bead	D AD	AD
FB2306	RBLN-0061TAZZY	Ferrite Bead	D AD	AD
FB2307	RBLN-0061TAZZY	Ferrite Bead	D AD	AD
FB2308	RBLN-0061TAZZY	Ferrite Bead	D AD	AD
FB2309	RBLN-0061TAZZY	Ferrite Bead	D AD	AD
FB2310	RBLN-0210TAZZY	Ferrite Bead	D AB	AB
FB2702	RBLN-0254TAZZY	Ferrite Bead	D AB	AB
FB2703	RBLN-0254TAZZY	Ferrite Bead	D AB	AB
FB2704	RBLN-0061TAZZY	Ferrite Bead	D AD	AD
FB2705	RBLN-0061TAZZY	Ferrite Bead	D AD	AD
FB2706	RBLN-0061TAZZY	Ferrite Bead	D AD	AD
FB2707	RBLN-0061TAZZY	Ferrite Bead	D AD	AD
FB2708	RBLN-0061TAZZY	Ferrite Bead	D AD	AD
FB2709	RBLN-0061TAZZY	Ferrite Bead	D AD	AD
FB2710	RBLN-0061TAZZY	Ferrite Bead	D AD	AD
FB2711	RBLN-0061TAZZY	Ferrite Bead	D AD	AD
FB2713	RBLN-0254TAZZY	Ferrite Bead	D AB	AB
FB2714	RBLN-0254TAZZY	Ferrite Bead	D AB	AB
FB2715	RBLN-0210TAZZY	Ferrite Bead	D AB	AB
FB3001	RBLN-0254TAZZY	Ferrite Bead	D AB	AB
FB3002	RBLN-0254TAZZY	Ferrite Bead	D AB	AB
FB3003	RBLN-0254TAZZY	Ferrite Bead	D AB	AB
FB3004	RBLN-0254TAZZY	Ferrite Bead	D AB	AB
FB3005	RBLN-0254TAZZY	Ferrite Bead	D AB	AB
FB3006	RBLN-0254TAZZY	Ferrite Bead	D AB	AB
FB3007	RBLN-0254TAZZY	Ferrite Bead	D AB	AB
FB3008	RBLN-0254TAZZY	Ferrite Bead	D AB	AB
FB3009	RBLN-0254TAZZY	Ferrite Bead	D AB	AB
FB3010	RBLN-0254TAZZY	Ferrite Bead	D AB	AB
FB3011	RBLN-0254TAZZY	Ferrite Bead	D AB	AB
FB3012	RBLN-0254TAZZY	Ferrite Bead	D AB	AB
FB3013	RBLN-0254TAZZY	Ferrite Bead	D AB	AB
FB3014	RBLN-0254TAZZY	Ferrite Bead	D AB	AB
FB3015	RBLN-0254TAZZY	Ferrite Bead	D AB	AB
FB3016	RBLN-0254TAZZY	Ferrite Bead	D AB	AB
FB3018	RBLN-0254TAZZY	Ferrite Bead	D AB	AB
FB3307	RBLN-0061TAZZY	Ferrite Bead	D AD	AD
FB3308	RBLN-0061TAZZY	Ferrite Bead	D AD	AD
MISCELLANEOUS PARTS				
J2701	QJAKEA073WJZZ	Audio Terminal	D AD	AD
J2702	QJAKEA073WJZZ	Audio Terminal	D AD	AD
LUG1701	QLUGHA009WJZZY	Lug	D AC	AC

REF No.	PARTS	DESCRIPTION	* SN CODE	EX CODE
LUG1702	QLUGH006WJZZY	Lug	D AC	AC
LUG1703	QLUGH006WJZZY	Lug	D AC	AC
LUG1704	QLUGH006WJZZY	Lug	D AC	AC
P1701	QPLGNA342WJZZY	Plug, 8-pin(LB)	D AD	AD
		(LC-37GD8E/RU, LC-37BT8E/RU)		
P1702	QPLGN1075TAZZY	Plug, 10-pin	D AD	AD
P2301	QPLGNA341WJZZY	Plug, 7-pin(SH)	D AD	AD
P2302	QPLGNA337WJZZY	Plug, 3-pin(KM)	D AC	AC
P2303	QPLGNA344WJZZY	Plug, 10-pin(RA)	D AD	AD
P2305	QPLGNA493WJZZY	Plug, 32-pin(LV)	D AM	AM
P2306	QPLGN0565FJZZY	Plug, 3-pin	D AE	AE
P2702	QCNCMA202WJZZY	Connector, 60-pin	D AK	AK
SC1701	QCNCWA251WJZZY	Connector, 23-pin	D AH	AH
SC1702	QCNCWA248WJZZY	Connector, 9-pin	D AD	AD
SC1901	QSOCZA117WJZZQ	EXT5/HDMI Terminal	D AK	AK
SC2301	QSOCDA036WJZZ	PC-INPUT(RS-232C) Terminal	D AF	AF
SC2303	QSOCNA229WJZZ	EXT4/D-SUB-15 Terminal	D AH	AH
SC2702	QCNCWA251WJZZY	Connector, 23-pin	D AH	AH
SC2703	QCNCWA251WJZZY	Connector, 23-pin	D AH	AH
SC2704	QCNCWA251WJZZY	Connector, 23-pin	D AH	AH
SC2705	QCNCWA010WJZZY	Connector, 15-pin	D AE	AE
SC2707	QCNCWA251WJZZY	Connector, 23-pin	D AH	AH
DUNTKD604FM10				
AV Unit				
INTEGRATED CIRCUITS				
IC704	VHIMR4030+-+1	MR4030-7101	R AR	AR
IC705	VHIMR4020+-+1	MR4020-7101	R AQ	AQ
IC706	VHITA76431R-1Y	TA76431FR(TE12L,F)	R AE	AE
IC707	VHITA76431R-1Y	TA76431FR(TE12L,F)	R AE	AE
IC708	VHINJM2904M-1Y	NJM2904M-TE1	R AE	AE
IC709	VHINJM2903M-1Y	NJM2903M-TE1	R AE	AE
TRANSISTORS				
Q301	VS2SC3928AR-1Y	2SC3928AR	R AB	AB
Q302	VS2SC3928AR-1Y	2SC3928AR	R AB	AB
Q303	VSDTC314TKJ-1Y	DTC314TK	R AC	AC
Q304	VSDTC314TKJ-1Y	DTC314TK	R AC	AC
Q305	VS2SC3928AR-1Y	2SC3928AR	R AB	AB
Q306	VS2SC3928AR-1Y	2SC3928AR	R AB	AB
Q307	VS2SA1530AR-1Y	2SA1530AR	R AB	AB
Q1101	VSDTC314TKJ-1Y	DTC314TK	R AC	AC
Q1102	VSDTC314TKJ-1Y	DTC314TK	R AC	AC
Q1103	VS2SA1530AR-1Y	2SA1530AR	R AB	AB
Q1104	VS2SA1530AR-1Y	2SA1530AR	R AB	AB
Q1105	VSDTC314TKJ-1Y	DTC314TK	R AC	AC
Q1106	VSDTC314TKJ-1Y	DTC314TK	R AC	AC
Q1107	VS2SA1530AR-1Y	2SA1530AR	R AB	AB
Q1108	VS2SA1530AR-1Y	2SA1530AR	R AB	AB
Q1201	VS2SA1530AR-1Y	2SA1530AR	R AB	AB
Q1202	VS2SA1530AR-1Y	2SA1530AR	R AB	AB
Q1203	VSDTC314TKJ-1Y	DTC314TK	R AC	AC
Q1204	VSDTC314TKJ-1Y	DTC314TK	R AC	AC
DIODES				
D301	RH-EXA092WJZZY	Zener Diode, 12V	R AB	AB
D302	RH-EXA092WJZZY	Zener Diode, 12V	R AB	AB
D303	RH-EXA092WJZZY	Zener Diode, 12V	R AB	AB
D304	RH-EXA092WJZZY	Zener Diode, 12V	R AB	AB
D305	RH-EXA089WJZZY	Zener Diode, 4.3V	R AB	AB
D306	VHD1SS390+-+1Y	1SS390	R AB	AB
D307	VHD1SS390+-+1Y	1SS390	R AB	AB
D308	VHD1SS390+-+1Y	1SS390	R AB	AB
D309	VHD1SS390+-+1Y	1SS390	R AB	AB
D310	VHD1SS390+-+1Y	1SS390	R AB	AB

REF No.	PARTS	DESCRIPTION	* SN CODE	EX CODE
D311	RH-EXA103WJZZY	Zener Diode	R	
D312	RH-EXA103WJZZY	Zener Diode	R	
D313	RH-EX1393CEZZY	Zener Diode	R AB	AB
D314	RH-EXA101WJZZY	Zener Diode	R AB	AB
D315	RH-EXA101WJZZY	Zener Diode	R AB	AB
D316	RH-EXA101WJZZY	Zener Diode	R AB	AB
D317	RH-EXA101WJZZY	Zener Diode	R AB	AB
D1101	RH-EXA094WJZZY	Zener Diode	R AB	AB
D1102	RH-EXA088WJZZY	Zener Diode, 10V	R	
D1103	RH-EXA088WJZZY	Zener Diode, 10V	R	
D1104	RH-EXA094WJZZY	Zener Diode	R AB	AB
D1105	RH-EXA093WJZZY	Zener Diode, 13V	R AB	AB
D1106	RH-EX1393CEZZY	Zener Diode	R AB	AB
D1107	RH-EX1393CEZZY	Zener Diode	R AB	AB
D1108	RH-EXA093WJZZY	Zener Diode, 13V	R AB	AB
D1109	RH-EX1398CEZZY	Zener Diode	R AB	AB
D1110	RH-EX1398CEZZY	Zener Diode	R AB	AB
D1111	RH-EX1398CEZZY	Zener Diode	R AB	AB
D1112	RH-EX1398CEZZY	Zener Diode	R AB	AB
D1113	RH-EX1393CEZZY	Zener Diode	R AB	AB
D1114	RH-EX1393CEZZY	Zener Diode	R AB	AB
D1115	RH-EX1393CEZZY	Zener Diode	R AB	AB
D1116	RH-EX1393CEZZY	Zener Diode	R AB	AB
D1117	RH-EX1393CEZZY	Zener Diode	R AB	AB
D1118	RH-EXA088WJZZY	Zener Diode	R	
D1119	RH-EXA088WJZZY	Zener Diode	R	
D1120	RH-EXA088WJZZY	Zener Diode	R	
D1121	RH-EXA088WJZZY	Zener Diode	R	
D1122	RH-EXA088WJZZY	Zener Diode	R	
D1123	RH-EXA088WJZZY	Zener Diode	R	
D1201	RH-EX1239CEZZY	Zener Diode	R AB	AB
COILS AND FILTERS				
FL1101	RFILN0017TAZZY	Filter	R AC	AC
FL1102	RFILN0017TAZZY	Filter	R AC	AC
FL1103	RFILN0017TAZZY	Filter	R AC	AC
FL1104	RFILN0017TAZZY	Filter	R AC	AC
FL1105	RFILN0017TAZZY	Filter	R AC	AC
FL1106	RFILN0017TAZZY	Filter	R AC	AC
FL1107	RFILN0017TAZZY	Filter	R AC	AC
FL1108	RFILN0017TAZZY	Filter	R AC	AC
FL1109	RFILN0017TAZZY	Filter	R AC	AC
FL1110	RFILN0017TAZZY	Filter	R AC	AC
FL1111	RFILN0017TAZZY	Filter	R AC	AC
FL1212	RFILN0017TAZZY	Filter	R AC	AC
L301	RCILPA386WJZZ	Coil, 47uH	R	
L302	RCILPA386WJZZ	Coil, 47uH	R	
CAPACITORS				
C301	VCKYCY1CB273KY	Ceramic 0.027 16V	R AB	AB
C302	VCKYCY1CB273KY	Ceramic 0.027 16V	R AB	AB
C303	VCKYCY1HF224ZY	Ceramic 0.22 50V	R AA	AA
C304	VCKYCY1HF224ZY	Ceramic 0.22 50V	R AA	AA
C305	VCKYCY1HB104KY	Ceramic 0.1 50V	R AA	AA
C306	VCEASX1HN225MY	Electrolytic 2.2 50V	R AB	AB
C307	VCEASX1HN225MY	Electrolytic 2.2 50V	R AB	AB
C308	VCKYCY1HB104KY	Ceramic 0.1 50V	R AA	AA
C309	VCKYCY1HB222KY	Ceramic 2200p 50V	R AA	AA
C310	VCKYCY1HB222KY	Ceramic 2200p 50V	R AA	AA
C311	VCEASX1CN226MY	Electrolytic 22 16V	R AC	AC
C312	VCKYCY1HB222KY	Ceramic 2200p 50V	R AA	AA
C313	VCKYCY1HB222KY	Ceramic 2200p 50V	R AA	AA
C314	VCKYCY1HB153KY	Ceramic 0.015 50V	R AA	AA
C315	VCKYCY1HB153KY	Ceramic 0.015 50V	R AA	AA
C316	VCCCCY1HH330JY	Ceramic 33p 50V	R AA	AA

REF No.	PARTS	DESCRIPTION	* SN CODE	EX CODE
DUNTKD604FM10 AV Unit (Continued)				
C317	VCCCCY1HH330JY	Ceramic 33p 50V	R AA	AA
C318	VCCCCY1HH470JY	Ceramic 47p 50V	R AA	AA
C319	VCCCCY1HH470JY	Ceramic 47p 50V	R AA	AA
C320	VCEASX1HN225MY	Electrolytic 2.2 50V	R AB	AB
C321	VCEASX1HN225MY	Electrolytic 2.2 50V	R AB	AB
C322	VCKYCY1HF224ZY	Ceramic 0.22 50V	R AA	AA
C323	VCKYCY1HF224ZY	Ceramic 0.22 50V	R AA	AA
C324	VCEASX1HN106MY	Electrolytic 10 50V	R AC	AC
C325	VCEASX1HN106MY	Electrolytic 10 50V	R AC	AC
C326	VCKYCY1HB153KY	Ceramic 0.015 50V	R AA	AA
C327	VCKYCY1HB153KY	Ceramic 0.015 50V	R AA	AA
C328	VCEASX1HN225MY	Electrolytic 2.2 50V	R AB	AB
C329	VCEASX1HN225MY	Electrolytic 2.2 50V	R AB	AB
C330	VCEAOA1VW477M+	Electrolytic 470 35V	R AB	AB
C331	VCEAOA1VW477M+	Electrolytic 470 35V	R AB	AB
C332	VCKYCY1HB221KY	Ceramic 220p 50V	R AA	AA
C333	VCKYCY1HB221KY	Ceramic 220p 50V	R AA	AA
C334	VCKYCY1HB221KY	Ceramic 220p 50V	R AA	AA
C335	VCKYCY1HB221KY	Ceramic 220p 50V	R AA	AA
C336	VCEASX1HN105MY	Electrolytic 1 50V	R AB	AB
C337	VCEASX1HN105MY	Electrolytic 1 50V	R AB	AB
C338	RC-EZA513WJZZ	470 50V	R	
C339	RC-EZA513WJZZ	470 50V	R	
C340	VCKYTV1EB224KY	Ceramic 0.22 25V	R AA	AA
C341	VCKYTV1EB224KY	Ceramic 0.22 25V	R AA	AA
C342	VCFFYA1HA334J+	0.33 50V	R AB	AB
C343	VCFFYA1HA334J+	0.33 50V	R AB	AB
C344	VCEASX1HN105MY	Electrolytic 1 50V	R AB	AB
C345	VCEASX1HN105MY	Electrolytic 1 50V	R AB	AB
C346	VCEASX1HN105MY	Electrolytic 1 50V	R AB	AB
C347	VCEASX1HN105MY	Electrolytic 1 50V	R AB	AB
C348	VCEASX1VN226MY	Electrolytic 22 35V	R AC	AC
C349	VCEASX1VN226MY	Electrolytic 22 35V	R AC	AC
C350	VCKYCY1HB102KY	Ceramic 1000p 50V	R AA	AA
C351	VCKYCY1HB102KY	Ceramic 1000p 50V	R AA	AA
C352	VCKYCY1HB102KY	Ceramic 1000p 50V	R AA	AA
C353	VCKYCY1HB102KY	Ceramic 1000p 50V	R AA	AA
C354	VCKYCY1HB102KY	Ceramic 1000p 50V	R AA	AA
C355	VCKYCY1HB102KY	Ceramic 1000p 50V	R AA	AA
C356	VCEASY1HN476MY	Electrolytic 47 50V	R AD	AD
C357	VCEASY1HN476MY	Electrolytic 47 50V	R AD	AD
C358	VCEASX1HN106MY	Electrolytic 10 50V	R AC	AC
C359	VCEASX1HN106MY	Electrolytic 10 50V	R AC	AC
C360	VCEASY1CN476MY	Electrolytic 47 16V	R AC	AC
C361	RC-KZA073WJZZY	Ceramic 10 16V	R AD	AD
C362	VCKYTV1EB224KY	Ceramic 0.22 25V	R AA	AA
C363	VCKYTV1EB224KY	Ceramic 0.22 25V	R AA	AA
C364	VCEASY1CN477MY	Electrolytic 470 16V	R AD	AD
C365	VCKYCY1HB222KY	Ceramic 2200p 50V	R AA	AA
C366	VCKYCY1HB222KY	Ceramic 2200p 50V	R AA	AA
C1101	VCKYTV1EB104KY	Ceramic 0.1 25V	R AB	AB
C1102	VCKYTV1EB104KY	Ceramic 0.1 25V	R AB	AB
C1103	VCKYTV1EB104KY	Ceramic 0.1 25V	R AB	AB
C1104	VCCCCY1HH101JY	Ceramic 100p 50V	R AA	AA
C1105	VCKYTV1EB104KY	Ceramic 0.1 25V	R AB	AB
C1106	VCKYTV1EB104KY	Ceramic 0.1 25V	R AB	AB
C1107	VCKYTV1EB104KY	Ceramic 0.1 25V	R AB	AB
C1108	VCCCCY1HH101JY	Ceramic 100p 50V	R AA	AA
C1109	RC-KZA073WJZZY	Ceramic 10 16V	R AD	AD
C1110	RC-KZA073WJZZY	Ceramic 10 16V	R AD	AD
C1114	VCKYCY1HB221KY	Ceramic 220p 50V	R AA	AA
C1116	VCKYCY1HB221KY	Ceramic 220p 50V	R AA	AA

REF No.	PARTS	DESCRIPTION	* SN CODE	EX CODE
C1119	VCKYCY1HB102KY	Ceramic 1000p 50V	R AA	AA
C1120	VCKYCY1HB102KY	Ceramic 1000p 50V	R AA	AA
C1121	VCKYTV1CB105KY	Ceramic 1 16V	R AC	AC
C1122	VCKYCY1HB331KY	Ceramic 330p 50V	R AA	AA
C1123	VCKYCY1HB331KY	Ceramic 330p 50V	R AA	AA
C1124	VCKYTV1CB105KY	Ceramic 1 16V	R AC	AC
C1125	VCKYCY1HB471KY	Ceramic 470p 50V	R AA	AA
C1126	VCKYCY1HB471KY	Ceramic 470p 50V	R AA	AA
C1130	VCEASY1CN477MY	Electrolytic 470 16V	R AD	AD
C1131	VCKYCY1HF103ZY	Ceramic 0.01 50V	R AA	AA
C1132	RC-KZA073WJZZY	Ceramic 10 16V	R AD	AD
C1133	RC-KZA073WJZZY	Ceramic 10 16V	R AD	AD
C1134	VCKYCY1HB102KY	Ceramic 1000p 50V	R AA	AA
C1135	VCKYCY1HB102KY	Ceramic 1000p 50V	R AA	AA
C1136	RC-KZA073WJZZY	Ceramic 10 16V	R AD	AD
C1137	RC-KZA073WJZZY	Ceramic 10 16V	R AD	AD
C1138	VCKYTV1CB105KY	Ceramic 1 16V	R AC	AC
C1139	VCKYCY1HB331KY	Ceramic 330p 50V	R AA	AA
C1140	VCKYCY1HB331KY	Ceramic 330p 50V	R AA	AA
C1142	VCKYTV1CB105KY	Ceramic 1 16V	R AC	AC
C1143	VCKYCY1HB471KY	Ceramic 470p 50V	R AA	AA
C1144	VCKYCY1HB471KY	Ceramic 470p 50V	R AA	AA
C1145	RC-KZA073WJZZY	Ceramic 10 16V	R AD	AD
C1146	RC-KZA073WJZZY	Ceramic 10 16V	R AD	AD
C1147	VCKYCY1EF104ZY	Ceramic 0.1 25V	R AA	AA
C1148	RC-KZA073WJZZY	Ceramic 10 16V	R AD	AD
C1157	RC-KZA073WJZZY	Ceramic 10 16V	R AD	AD
C1158	RC-KZA073WJZZY	Ceramic 10 16V	R AD	AD
C1159	VCKYCY1HF103ZY	Ceramic 0.01 50V	R AA	AA
C1160	VCKYCY1EF104ZY	Ceramic 0.1 25V	R AA	AA
C1161	RC-KZA073WJZZY	Ceramic 10 16V	R AD	AD
C1162	VCEASY1CN477MY	Electrolytic 470 16V	R AD	AD
C1201	VCKYCY1HB102KY	Ceramic 1000p 50V	R AA	AA
C1202	VCKYCY1HF103ZY	Ceramic 0.01 50V	R AA	AA
C1203	VCCCCY1HH101JY	Ceramic 100p 50V	R AA	AA
C1204	VCCCCY1HH100DY	Ceramic 10p 50V	R AA	AA
C1205	RC-KZA073WJZZY	Ceramic 10 16V	R AD	AD
C1206	VCCCCY1HH101JY	Ceramic 100p 50V	R AA	AA
C1207	VCCCCY1HH100DY	Ceramic 10p 50V	R AA	AA
C1208	RC-KZA073WJZZY	Ceramic 10 16V	R AD	AD
C1210	VCCCCY1HH101JY	Ceramic 100p 50V	R AA	AA
C1211	VCKYCY1HB102KY	Ceramic 1000p 50V	R AA	AA
C1212	VCKYTV1CB105KY	Ceramic 1 16V	R AC	AC
C1216	VCCCCY1HH101JY	Ceramic 100p 50V	R AA	AA
C1217	VCKYCY1HB102KY	Ceramic 1000p 50V	R AA	AA
C1218	VCKYTV1CB105KY	Ceramic 1 16V	R AC	AC
C1219	VCEASY1CN476MY	Electrolytic 47 16V	R AC	AC
C1220	RC-KZA073WJZZY	Ceramic 10 16V	R AD	AD
C1221	RC-KZA073WJZZY	Ceramic 10 16V	R AD	AD
C1222	RC-KZA073WJZZY	Ceramic 10 16V	R AD	AD
C1223	RC-KZA073WJZZY	Ceramic 10 16V	R AD	AD
C1224	VCCCCY1HH101JY	Ceramic 100p 50V	R AA	AA
C1225	VCCCCY1HH101JY	Ceramic 100p 50V	R AA	AA
C1252	VCKYTV1CB105KY	Ceramic 1 16V	R AC	AC
C1253	VCKYCY1EF104ZY	Ceramic 0.1 25V	R AA	AA
RESISTORS				
R301	VRS-CJ1JF102JY	Metal Oxide 1k 1/16W	R AA	AA
R302	VRS-CJ1JF472JY	Metal Oxide 4.7k 1/16W	R AA	AA
R304	VRS-CY1JF222JY	Metal Oxide 2.2k 1/16W	R AA	AA
R305	VRS-CY1JF222JY	Metal Oxide 2.2k 1/16W	R AA	AA
R306	VRS-CJ1JF472JY	Metal Oxide 4.7k 1/16W	R AA	AA
R307	VRS-CJ1JF104JY	Metal Oxide 100k 1/16W	R AA	AA
R308	VRS-CY1JF473JY	Metal Oxide 47k 1/16W	R AA	AA

REF No.	PARTS	DESCRIPTION	* SN CODE	EX CODE
R309	VRS-CY1JF473JY	Metal Oxide 47k 1/16W	R AA	AA
R310	VRS-CY1JF102JY	Metal Oxide 1k 1/16W	R AA	AA
R311	VRS-CY1JF102JY	Metal Oxide 1k 1/16W	R AA	AA
R312	VRS-CY1JF102JY	Metal Oxide 1k 1/16W	R AA	AA
R313	VRS-CY1JF102JY	Metal Oxide 1k 1/16W	R AA	AA
R314	VRS-CY1JF392JY	Metal Oxide 3.9k 1/16W	R AA	AA
R315	VRS-CY1JF474JY	Metal Oxide 470k 1/16W	R AA	AA
R316	VRS-CY1JF392JY	Metal Oxide 3.9k 1/16W	R AA	AA
R317	VRS-CY1JF474JY	Metal Oxide 470k 1/16W	R AA	AA
R318	VRS-TW2HF820JY	Metal Oxide 82 1/2W	R	
R319	VRS-CY1JF122JY	Metal Oxide 1.2k 1/16W	R AA	AA
R320	VRS-CY1JF122JY	Metal Oxide 1.2k 1/16W	R AA	AA
R321	VRS-CY1JF103JY	Metal Oxide 10k 1/16W	R AA	AA
R322	VRS-CY1JF103JY	Metal Oxide 10k 1/16W	R AA	AA
R323	VRS-CY1JF473JY	Metal Oxide 47k 1/16W	R AA	AA
R324	VRS-CY1JF473JY	Metal Oxide 47k 1/16W	R AA	AA
R325	VRS-CY1JF332JY	Metal Oxide 3.3k 1/16W	R AA	AA
R326	VRS-CY1JF332JY	Metal Oxide 3.3k 1/16W	R AA	AA
R327	VRS-CJ1JF103JY	Metal Oxide 10k 1/16W	R AA	AA
R328	VRS-CJ1JF392JY	Metal Oxide 3.9k 1/16W	R AA	AA
R329	VRS-CY1JF682JY	Metal Oxide 6.8k 1/16W	R AA	AA
R330	VRS-CY1JF222JY	Metal Oxide 2.2k 1/16W	R AA	AA
R331	VRS-CY1JF222JY	Metal Oxide 2.2k 1/16W	R AA	AA
R332	VRS-CY1JF102JY	Metal Oxide 1k 1/16W	R AA	AA
R333	VRS-CJ1JF103JY	Metal Oxide 10k 1/16W	R AA	AA
R334	VRS-CY1JF682JY	Metal Oxide 6.8k 1/16W	R AA	AA
R335	VRS-TW2ED100JY	Metal Oxide 10 1/4W	R AA	AA
R336	VRS-TW2ED100JY	Metal Oxide 10 1/4W	R AA	AA
R337	VRS-TW2ED100JY	Metal Oxide 10 1/4W	R AA	AA
R338	VRS-TW2ED100JY	Metal Oxide 10 1/4W	R AA	AA
R339	VRS-TW2ED220JY	Metal Oxide 22 1/4W	R AB	AB
R340	VRS-TW2ED220JY	Metal Oxide 22 1/4W	R AB	AB
R341	VRS-CJ1JF103JY	Metal Oxide 10k 1/16W	R AA	AA
R342	VRS-CJ1JF332JY	Metal Oxide 3.3k 1/16W	R AA	AA
R343	VRS-TW2ED000JY	Metal Oxide 0 1/4W	R AB	AB
R344	VRS-CJ1JF103JY	Metal Oxide 10k 1/16W	R AA	AA
R345	VRS-CJ1JF103JY	Metal Oxide 10k 1/16W	R AA	AA
R346	VRS-CY1JF560JY	Metal Oxide 56 1/16W	R AA	AA
R347	VRS-CY1JF560JY	Metal Oxide 56 1/16W	R AA	AA
R348	VRS-CJ1JF222JY	Metal Oxide 2.2k 1/16W	R AA	AA
R349	VRS-CY1JF101JY	Metal Oxide 100 1/16W	R AA	AA
R350	VRS-CY1JF101JY	Metal Oxide 100 1/16W	R AA	AA
R351	VRS-CY1JF103JY	Metal Oxide 10k 1/16W	R AA	AA
R352	VRS-CY1JF103JY	Metal Oxide 10k 1/16W	R AA	AA
R353	VRS-CY1JF102JY	Metal Oxide 1k 1/16W	R AA	AA
R354	VRS-CY1JF102JY	Metal Oxide 1k 1/16W	R AA	AA
R355	VRS-TW2ED2R7JY	Metal Oxide 2.7 1/4W	R	
R356	VRS-CY1JF103JY	Metal Oxide 10k 1/16W	R AA	AA
R358	VRS-CY1JF000JY	Metal Oxide 0 1/16W	R AA	AA
R360	VRS-CY1JF472JY	Metal Oxide 4.7k 1/16W	R AA	AA
R361	VRS-CY1JF101JY	Metal Oxide 100 1/16W	R AA	AA
R1101	VRS-CY1JF153FY	Metal Oxide 15k 1/16W	R AA	AA
R1102	VRS-CY1JF153FY	Metal Oxide 15k 1/16W	R AA	AA
R1103	VRS-CY1JF393FY	Metal Oxide 39k 1/16W	R AA	AA
R1104	VRS-CY1JF000JY	Metal Oxide 0 1/16W	R AA	AA
R1105	VRS-CY1JF000JY	Metal Oxide 0 1/16W	R AA	AA
R1106	VRS-CY1JF000JY	Metal Oxide 0 1/16W	R AA	AA
R1107	VRS-TV1JD221JY	Metal Oxide 220 1/16W	R AA	AA
R1108	VRS-CY1JF393FY	Metal Oxide 39k 1/16W	R AA	AA
R1109	VRS-TV1JD221JY	Metal Oxide 220 1/16W	R AA	AA
R1110	VRS-CY1JF000JY	Metal Oxide 0 1/16W	R AA	AA
R1111	VRS-TW2ED680JY	Metal Oxide 68 1/4W	R AA	AA
R1112	VRS-TW2ED680JY	Metal Oxide 68 1/4W	R AA	AA
R1113	VRS-TW2ED750JY	Metal Oxide 75 1/4W	R AA	AA

REF No.	PARTS	DESCRIPTION	* SN CODE	EX CODE
R1114	VRS-TW2ED750JY	Metal Oxide 75 1/4W	R AA	AA
R1115	VRS-CY1JF000JY	Metal Oxide 0 1/16W	R AA	AA
R1116	VRS-TW2ED750JY	Metal Oxide 75 1/4W	R AA	AA
R1117	VRS-TW2ED750JY	Metal Oxide 75 1/4W	R AA	AA
R1118	VRS-TW2ED750JY	Metal Oxide 75 1/4W	R AA	AA
R1119	VRS-CY1JF101JY	Metal Oxide 100 1/16W	R AA	AA
R1120	VRS-CY1JF000JY	Metal Oxide 0 1/16W	R AA	AA
R1121	VRS-TW2ED750JY	Metal Oxide 75 1/4W	R AA	AA
R1123	VRS-TW2ED750JY	Metal Oxide 75 1/4W	R AA	AA
R1125	VRS-TW2ED750JY	Metal Oxide 75 1/4W	R AA	AA
R1126	VRS-CY1JF000JY	Metal Oxide 0 1/16W	R AA	AA
R1127	VRS-TW2ED750JY	Metal Oxide 75 1/4W	R AA	AA
R1128	VRS-CY1JF101JY	Metal Oxide 100 1/16W	R AA	AA
R1129	VRS-TW2ED750JY	Metal Oxide 75 1/4W	R AA	AA
R1130	VRS-CY1JF000JY	Metal Oxide 0 1/16W	R AA	AA
R1131	VRS-CY1JF221JY	Metal Oxide 220 1/16W	R AA	AA
R1134	VRS-CY1JF102JY	Metal Oxide 1k 1/16W	R AA	AA
R1137	VRS-CY1JF000JY	Metal Oxide 0 1/16W	R AA	AA
R1138	VRS-CY1JF000JY	Metal Oxide 0 1/16W	R AA	AA
R1139	VRS-CJ1JF101JY	Metal Oxide 100 1/16W	R AA	AA
R1140	VRS-CJ1JF331JY	Metal Oxide 330 1/16W	R AA	AA
R1141	VRS-CY1JF564JY	Metal Oxide 560k 1/16W	R AA	AA
R1142	VRS-CY1JF564JY	Metal Oxide 560k 1/16W	R AA	AA
R1143	VRS-CJ1JF272JY	Metal Oxide 2.7k 1/16W	R AA	AA
R1144	VRS-CY1JF102JY	Metal Oxide 1k 1/16W	R AA	AA
R1145	VRS-CY1JF102JY	Metal Oxide 1k 1/16W	R AA	AA
R1146	VRS-TV1JD221JY	Metal Oxide 220 1/16W	R AA	AA
R1147	VRS-CY1JF102JY	Metal Oxide 1k 1/16W	R AA	AA
R1148	VRS-TV1JD221JY	Metal Oxide 220 1/16W	R AA	AA
R1152	VRS-CJ1JF101JY	Metal Oxide 100 1/16W	R AA	AA
R1155	VRS-CJ1JF331JY	Metal Oxide 330 1/16W	R AA	AA
R1156	VRS-CY1JF564JY	Metal Oxide 560k 1/16W	R AA	AA
R1157	VRS-CY1JF564JY	Metal Oxide 560k 1/16W	R AA	AA
R1158	VRS-CJ1JF272JY	Metal Oxide 2.7k 1/16W	R AA	AA
R1159	VRS-CY1JF102JY	Metal Oxide 1k 1/16W	R AA	AA
R1160	VRS-CY1JF102JY	Metal Oxide 1k 1/16W	R AA	AA
R1161	VRS-CY1JF221JY	Metal Oxide 220 1/16W	R AA	AA
R1177	VRS-CY1JF102JY	Metal Oxide 1k 1/16W	R AA	AA
R1179	VRS-CY1JF102JY	Metal Oxide 1k 1/16W	R AA	AA
R1201	VRS-CY1JF101JY	Metal Oxide 100 1/16W	R AA	AA
R1202	VRS-CY1JF392JY	Metal Oxide 3.9k 1/16W	R AA	AA
R1203	VRS-CY1JF682JY	Metal Oxide 6.8k 1/16W	R AA	AA
R1204	VRS-CY1JF750JY	Metal Oxide 75 1/16W	R AA	AA
R1206	VRS-TW2ED750JY	Metal Oxide 75 1/4W	R AA	AA
R1209	VRS-TW2ED750JY	Metal Oxide 75 1/4W	R AA	AA
R1210	VRS-CY1JF102JY	Metal Oxide 1k 1/16W	R AA	AA
R1211	VRS-CY1JF102JY	Metal Oxide 1k 1/16W	R AA	AA
R1212	VRS-CY1JF104JY	Metal Oxide 100k 1/16W	R AA	AA
R1213	VRS-CY1JF102JY	Metal Oxide 1k 1/16W	R AA	AA
R1214	VRS-CY1JF102JY	Metal Oxide 1k 1/16W	R AA	AA
R1215	VRS-CY1JF104JY	Metal Oxide 100k 1/16W	R AA	AA
R1216	VRS-CY1JF271JY	Metal Oxide 270 1/16W	R AA	AA
R1217	VRS-CY1JF331JY	Metal Oxide 330 1/16W	R AA	AA
R1218	VRS-CY1JF272JY	Metal Oxide 2.7k 1/16W	R AA	AA
R1219	VRS-CY1JF271JY	Metal Oxide 270 1/16W	R AA	AA
R1221	VRS-CY1JF331JY	Metal Oxide 330 1/16W	R AA	AA
R1222	VRS-CY1JF272JY	Metal Oxide 2.7k 1/16W	R AA	AA
R1224	VRS-CY1JF564JY	Metal Oxide 560k 1/16W	R AA	AA
R1225	VRS-CY1JF564JY	Metal Oxide 560k 1/16W	R AA	AA
R1226	VRS-CY1JF102JY	Metal Oxide 1k 1/16W	R AA	AA
R1227	VRS-CY1JF102JY	Metal Oxide 1k 1/16W	R AA	AA
R1228	VRS-CY1JF000JY	Metal Oxide 0 1/16W	R AA	AA

REF No.	PARTS	DESCRIPTION	* SN CODE	EX CODE
DUNTKD604FM10				
AV Unit (Continued)				
MISCELLANEOUS PARTS				
FB1101	RBLN-0062TAZZY	Ferrite Beads	R AB	AB
FB1102	RBLN-0062TAZZY	Ferrite Beads	R AB	AB
FB1103	RBLN-0077TAZZY	Ferrite Beads	R AB	AB
FB1104	RBLN-0077TAZZY	Ferrite Beads	R AB	AB
FB1105	RBLN-0051TAZZY	Ferrite Beads	R AC	AC
FB1106	RBLN-0062TAZZY	Ferrite Beads	R AB	AB
FB1107	RBLN-0051TAZZY	Ferrite Beads	R AC	AC
FB1108	RBLN-0062TAZZY	Ferrite Beads	R AB	AB
FB1109	RBLN-0062TAZZY	Ferrite Beads	R AB	AB
FB1110	RBLN-0062TAZZY	Ferrite Beads	R AB	AB
FB1111	RBLN-0051TAZZY	Ferrite Beads	R AC	AC
FB1112	RBLN-0051TAZZY	Ferrite Beads	R AC	AC
FB1201	RBLN-0051TAZZY	Ferrite Beads	R AC	AC
FB1202	RBLN-0051TAZZY	Ferrite Beads	R AC	AC
FB1203	RBLN-0062TAZZY	Ferrite Beads	R AB	AB
FB1204	RBLN-0062TAZZY	Ferrite Beads	R AB	AB
FB1213	RBLN-0210TAZZY	Ferrite Beads	R AB	AB
FB1218	RBLN-0254TAZZY	Ferrite Beads	R AB	AB
J1101	QSOCZA116WJZZ	Socket, 42pin	R	
J1201	QJAKZA033WJZZ	Jack, 16pin (INPUT3)	R	
J1301	QJAKJA007WJZZ	Jack 7pin (HEAD PHONE OUT)	R AD	AD
LUG301	QLUGHA009WJZZY	Lug	R AC	AC
LUG302	QLUGHA009WJZZY	Lug	R AC	AC
LUG303	QLUGHA009WJZZY	Lug	R AC	AC
LUG304	QLUGHA009WJZZY	Lug	R AC	AC
P301	QPLGNA173WJZZY	Plug, 4pin (SP)	R AD	AD
P1101	QCNCMA250WJZZ	Connector, 23pin (to MAIN2)	R AE	AE
P1102	QCNCMA250WJZZ	Connector, 23pin (to MAIN2)	R AE	AE
P1201	QCNCMA250WJZZ	Connector, 23pin (to MAIN2)	R AE	AE
SC301	QSOCZ0738CEZZ	Socket, 7pin (to POWER)	R AE	AE
DUNTKD605FM14/03 (LC-32GD8, LC-32BT8 / (LC-37GD8, LC-37BT8)				
POWER Unit				
INTEGRATED CIRCUITS				
IC704	VHIMR4030++-1	MR4030-7101	R	
IC705	VHIMR4020++-1	MR4020-7101	R	
IC706	VHITA76431R-1Y	TA76431FR(TE12)	R	
IC707	VHITA76431R-1Y	TA76431FR(TE12)	R	
IC708	VHINJM2904M-1Y	NJM2904M	R AE	AE
IC709	VHINJM2903M-1Y	NJM2903M	R	
TRANSISTORS				
Q702	VS2SC3928AR-1Y	2SC3928AR	R AB	AB
Q704	VS2SC3928AR-1Y	2SC3928AR	R AB	AB
Q708	VS2SC3928AR-1Y	2SC3928AR	R AB	AB
Q710	VS2SC3928AR-1Y	2SC3928AR	R AB	AB
Q712	VS2SC3928AR-1Y	2SC3928AR	R AB	AB
Q713	VS2SC3928AR-1Y	2SC3928AR	R AB	AB
Q721	VS2SC3928AR-1Y	2SC3928AR	R AB	AB
Q723	RH-TXA037WJZZY	TXA037WJ	R AE	AE
Q724	RH-TXA037WJZZY	TXA038WJ	R AE	AE
Q726	VS2SC3928AR-1Y	2SC3928AR	R AB	AB
Q729	VS2SD2185R+-1Y	2SD2185R	R AF	AF
Q730	RH-TXA026WJZZY	TXA026WJ	R AD	AD
Q731	RH-TXA026WJZZY	TXA027WJ	R AD	AD
DIODES				
△ D701	RH-DX0477CEZZ	D5SB60	R AF	AF
D707	VHD1SS355/-1Y	1SS355TE-17	R AB	AB
D714	RH-EX1398CEZZY	UDZSTE-178.2B	R AB	AB

REF No.	PARTS	DESCRIPTION	* SN CODE	EX CODE
D715	VHDD1FL20UJ-1Y	D1FL20U	R AC	AC
D716	VHDU05NU44+-1Y	U05NU44(TE12L,Q)	R AE	AE
D717	VHDD1FL20UJ-1Y	D1FL20U	R AC	AC
D718	RH-EXA091WJZZY	UDZSTE-1711B	R AB	AB
D720	VHDU05NU44+-1Y	U05NU44(TE12L,Q)	R AE	AE
D721	RH-EXA096WJZZY	UDZSTE-1718B	R AB	AB
D722	VHD1SS355/-1Y	1SS355TE-17	R AB	AB
D724	VHDD1FL20UJ-1Y	D1FL20U	R AC	AC
D725	VHDD1FL20UJ-1Y	D1FL20U	R AC	AC
D726	VHDD1FL20UJ-1Y	D1FL20U	R AC	AC
D728	VHEST03D170-1	ZENER DIODE	R AG	AG
D729	VHEST03D170-1	ZENER DIODE	R AG	AG
△ D730	RH-FXA003WJZZ	PC123Y82	R AD	AD
△ D731	RH-FXA003WJZZ	PC123Y82	R AD	AD
△ D732	RH-FXA003WJZZ	PC123Y82	R AD	AD
△ D733	RH-FXA003WJZZ	PC123Y82	R AD	AD
△ D734	RH-FXA003WJZZ	PC123Y82	R AD	AD
D735	VHDSF6L20U+-1	SF6L20U	R AG	AG
D736	RH-DXA080WJZZ	SF20JC10-7100	R AK	AK
D737	RH-DXA081WJZZ	D15SCA4M-7000	R AH	AH
D738	RH-DXA088WJZZY	D1FL40-5063	R AD	AD
D739	RH-DXA085WJZZ	D5S9M-7000	R AK	AK
D741	RH-EX1398CEZZY	UDZSTE-178.2B	R AB	AB
D742	VHD1SS355/-1Y	1SS355TE-17	R AB	AB
D746	RH-EXA102WJZZY	UDZSTE-1733B	R AB	AB
D747	VHD1SS355/-1Y	1SS355TE-17	R AB	AB
D748	RH-EXA094WJZZY	UDZSTE-1715B	R AB	AB
D749	RH-EX1400CEZZY	UDZSTE-1710B	R AB	AB
D751	RH-EX1398CEZZY	UDZSTE-178.2B	R AB	AB
D752	VHD1SS355/-1Y	1SS355TE-17	R AB	AB
D753	RH-EXA094WJZZY	UDZSTE-1715B	R AB	AB
D754	RH-EXA101WJZZY	UDZSTE-1730B	R AB	AB
D755	VHD1SS355/-1Y	1SS355TE-17	R AB	AB
D756	RH-EXA101WJZZY	UDZSTE-1730B	R AB	AB
D757	VHD1SS355/-1Y	1SS355TE-17	R AB	AB
D759	RH-EXA101WJZZY	UDZSTE-1730B	R AB	AB
D761	VHDD1FL20UJ-1Y	D1FL20U	R AC	AC
D762	VHEST03D170-1	ZENER DIODE	R AG	AG
D763	RH-EX1394CEZZY	ZENER DIODE, 5.6V	R AB	AB
D765	VHD1SS355/-1Y	1SS355TE-17	R AB	AB
D767	VHD1SS355/-1Y	1SS355TE-17	R AB	AB
D771	VHEST03D-82-1	ZENER DIODE	R AG	AG
D772	RH-EXA102WJZZY	UDZSTE-1733B	R AB	AB
D773	VHD1SS355/-1Y	1SS355TE-17	R AB	AB
D774	VHD1SS355/-1Y	1SS355TE-17	R AB	AB
D775	VHD1SS355/-1Y	1SS355TE-17	R AB	AB
D776	RH-EX1234CEZZY	ZENER DIODE, 3.6V	R AE	AE
D777	VHDU05NU44+-1Y	U05NU44(TE12L,Q)	R AE	AE
D778	VHDU05NU44+-1Y	U05NU44(TE12L,Q)	R AE	AE
D779	VHD1SS355/-1Y	1SS355TE-17	R AB	AB
D780	RH-EX1015GEZZY	PTZTE2516B	R AD	AD
D781	RH-EX1015GEZZY	PTZTE2516B	R AD	AD
D782	RH-EXA359WJZZY	ZENER DIODE, 33V	R AE	AE
D783	RH-EXA359WJZZY	ZENER DIODE, 33V	R AE	AE
THERMISTOR				
△ TH701	RH-HXA033WJZZ	Thermistor	R AG	AG
VARIATOR				
△ VA701	RH-VXA071WJQZ	ERZV10D471CS	R AD	AD
△ VA702	RH-VXA071WJQZ	ERZV10D471CS	R AD	AD
COILS AND TRANSFORMERS				
△ L701	RCILFA211WJZZ	Coil	R AG	AG
△ L702	RCILF0024PEZZ	Coil	R AN	AN

REF No.	PARTS	DESCRIPTION	* SN CODE	EX CODE
L753	RCILPA642WJZZ	Coil	R AE	AE
△ T701	RTRNWA230WJZZ	Transformer	R AP	AP
△ T702	RTRNWA231WJZZ	Transformer	R AR	AR
△ T703	RTRNCA022WJZZ	Choke Transformer	R AW	AW
		(LC-32GD8E/RU, LC-32BT8E/RU)		
△ T703	RTRNCA023WJZZ	Choke Transformer	R AW	AW
		(LC-37GD8E/RU, LC-37BT8E/RU)		
CAPACITORS				
△ C704	RC-FZA026WJZZ	0.47 275V Film	R AE	AE
C705	RC-EZA985WJZZ	Capacitor	R AR	AR
		(LC-32GD8E/RU, LC-32BT8E/RU)		
C705	RC-EZA986WJZZ	1SS390TE61	R AT	AT
		(LC-37GD8E/RU, LC-37BT8E/RU)		
C706	RC-EZA985WJZZ	Capacitor	R AR	AR
		(LC-32GD8E/RU, LC-32BT8E/RU)		
C706	RC-EZA986WJZZ	1SS390TE61	R AT	AT
		(LC-37GD8E/RU, LC-37BT8E/RU)		
△ C708	RC-KZ0105GEZZ	2200p 250V Ceramic	R AD	AD
△ C709	RC-KZ0105GEZZ	2200p 250V Ceramic	R AD	AD
△ C712	RC-FZA026WJZZ	0.47 275V Film	R AE	AE
C713	RC-KZA388WJZZY	10 6.3V Ceramic	R AC	AC
C716	VCKYCY1HB104KY	0.1 50V Ceramic	R AA	AA
C717	VCKYCY1HB104KY	0.1 50V Ceramic	R AA	AA
C720	VCKYCY1HB104KY	0.1 50V Ceramic	R AA	AA
C722	VCCCCY1HH470JY	47p 50V Ceramic	R AA	AA
C723	RC-EZA489WJZZ+	47 35V Electrolytic	R AC	AC
C725	RC-KZA304WJZZ	470p 2KV Ceramic	R AD	AD
C726	VCCCCY1HH101JY	100p 50V Ceramic	R AA	AA
C728	VCKYCY1HB323KY	3300p 50V Ceramic	R AA	AA
C730	VCKYCY1HB104KY	0.1 50V Ceramic	R AA	AA
C732	VCKYCY1HB104KY	0.1 50V Ceramic	R AA	AA
C733	VCKYCY1HB222KY	2200p 50V Ceramic	R AA	AA
C734	RC-KZA304WJZZ	470p 2KV Ceramic	R AD	AD
C735	RC-EZA489WJZZ+	47 35V Electrolytic	R AC	AC
C736	RC-EZA489WJZZ+	47 35V Electrolytic	R AC	AC
C739	VCCCCY1HH102JY	1000p 50V Ceramic	R AB	AB
△ C740	RC-KZ0105GEZZ	2200p 250V Ceramic	R AD	AD
△ C741	RC-KZ0105GEZZ	2200p 250V Ceramic	R AD	AD
△ C742	RC-KZ0105GEZZ	2200p 250V Ceramic	R AD	AD
C743	RC-EZA513WJZZ	470 50V Electrolytic	R AH	AH
C744	RC-EZA499WJZZ	330 25V Electrolytic	R AH	AH
C745	VCKYCY1HB472KY	4700p 50V Ceramic	R AA	AA
C749	VCKYTV1HB683KY	0.068 50V Ceramic	R AB	AB
C751	RC-EZA499WJZZ	330 25V Electrolytic	R AH	AH
C752	RC-EZA452WJZZ	2200 10V Electrolytic	R AG	AG
C753	VCKYTV1HB683KY	0.068 50V Ceramic	R AB	AB
C754	RC-EZA510WJZZ	220 50V Electrolytic	R AF	AF
C755	RC-EZA499WJZZ	330 25V Electrolytic	R AH	AH
C756	RC-EZA452WJZZ	2200 10V Electrolytic	R AG	AG
C757	RC-EZA480WJZZ	680 25V Electrolytic	R AD	AD
C758	RC-EZA490WJZZ+	100 35V Electrolytic	R AD	AD
C762	RC-EZA513WJZZ	470 50V Electrolytic	R AH	AH
C763	VCKYCY1HB104KY	0.1 50V Ceramic	R AA	AA
C764	VCKYCY1HB104KY	0.1 50V Ceramic	R AA	AA
C765	VCKYCY1HB104KY	0.1 50V Ceramic	R AA	AA
C767	RC-EZA510WJZZ	220 50V Electrolytic	R AF	AF
C768	RC-EZA452WJZZ	2200 10V Electrolytic	R AG	AG
C771	VCKYCY1HB272KY	2700p 50V Ceramic	R AA	AA
C772	VCKYCY1HB104KY	0.1 50V Ceramic	R AA	AA
C774	VCKYCY1CB104KY	0.1 16V Ceramic	R AB	AB
C776	RC-KZA213WJZZY	4.7 25V Ceramic	R AC	AC
△ C777	RC-KZ0105GEZZ	2200p 250V Ceramic	R AD	AD
△ C778	RC-KZ0105GEZZ	2200p 250V Ceramic	R AD	AD

REF No.	PARTS	DESCRIPTION	* SN CODE	EX CODE
DUNTKD605FM14/03 (LC-32GD8, LC-32BT8 / (LC-37GD8, LC-37BT8)				
POWER Unit (Continued)				
C781	VCFYAA2JA103K+	0.01 630V Capacitor	R AC	AC
C782	VCFYAA2JA103K+	0.01 630V Capacitor	R AC	AC
C783	RC-KZA213WJZZY	4.7 25V Ceramic	R AC	AC
C789	VCKYCY1HB104KY	0.1 50V Ceramic	R AA	AA
C790	VCKYCY1HB104KY	0.1 50V Ceramic	R AA	AA
C792	VCKYCY1AB105KY	1 10V Ceramic	R AB	AB
C793	VCKYCY1CB104KY	0.1 16V Ceramic	R AB	AB
C794	RC-KZA388WJZZY	10 6.3V Ceramic	R AC	AC
C795	VCKYCY1AB105KY	1 10V Ceramic	R AB	AB
C796	VCKYCY1AB105KY	1 10V Ceramic	R AB	AB
C798	VCKYCY1CB104KY	0.1 16V Ceramic	R AB	AB
C799	VCKYCY1CB104KY	0.1 16V Ceramic	R AB	AB
C800	VCKYCY1CB104KY	0.1 16V Ceramic	R AB	AB
C801	VCKYCY1CB104KY	0.1 16V Ceramic	R AB	AB
C804	VCKYCY1CB104KY	0.1 16V Ceramic	R AB	AB
RESISTORS				
△ R701	RR-HZ0008GEZZY	Resistor	R AE	AE
△ R702	RR-HZ0008GEZZY	Resistor	R AE	AE
R727	VRS-TV1JD563JY	56k 1/10W Metal Oxide	R AA	AA
R730	VRS-TQ2EF124FY	120k 1/4W Metal Oxide	R AA	AA
R731	VRS-TQ2EF124FY	120k 1/4W Metal Oxide	R AA	AA
R732	VRS-TQ2EF124FY	120k 1/4W Metal Oxide	R AA	AA
R740	VRS-TV1JD564JY	560k 1/10W Metal Oxide	R AA	AA
R741	VRS-TV1JD103JY	10k 1/10W Metal Oxide	R AA	AA
R742	VRS-TV1JD103JY	10k 1/10W Metal Oxide	R AA	AA
R743	VRS-CY1JF224JY	220k 1/16W Metal Oxide	R AA	AA
R745	VRS-TV1JD912JY	9.1k 1/10W Metal Oxide	R AA	AA
R746	VRS-TV1JD103JY	10k 1/10W Metal Oxide	R AA	AA
R747	VRS-TV1JD103FY	10k 1/10W Metal Oxide	R AA	AA
R748	VRS-TV1JD103JY	10k 1/10W Metal Oxide	R AA	AA
R751	VRN-VV3DBR10J	0.1 2W Metal Film	R AB	AB
R752	VRS-TV1JD000JY	0 1/10W Metal Oxide	R AA	AA
R753	VRS-TV1JD133JY	13k 1/10W Metal Oxide	R AA	AA
R755	VRS-TV1JD203FY	20k 1/10W Metal Oxide	R AA	AA
R756	VRS-TV1JD183FY	18k 1/10W Metal Oxide	R AA	AA
R757	VRS-TV1JD103JY	10k 1/10W Metal Oxide	R AA	AA
R758	VRS-TV1JD564JY	560k 1/10W Metal Oxide	R AA	AA
R759	VRS-TV1JD103JY	10k 1/10W Metal Oxide	R AA	AA
R760	VRN-VV3DBR15J	0.15 2W Metal Film	R AB	AB
R761	VRS-TV1JD103JY	10k 1/10W Metal Oxide	R AA	AA
R764	VRS-TV1JD103JY	10k 1/10W Metal Oxide	R AA	AA
R765	VRS-TV1JD104JY	100k 1/10W Metal Oxide	R AA	AA
R766	VRS-TV1JD103JY	10k 1/10W Metal Oxide	R AA	AA
R767	VRS-TQ2EF391JY	390 1/4W Metal Oxide	R AA	AA
R770	VRS-TQ2BD000JY	0 1/8W Metal Oxide	R AA	AA
R773	VRS-TV1JD103JY	10k 1/10W Metal Oxide	R AA	AA
R774	VRS-TV1JD103JY	10k 1/10W Metal Oxide	R AA	AA
R775	VRS-TV1JD153FY	15k 1/10W Metal Oxide	R AA	AA
R776	VRS-TV1JD102JY	1k 1/10W Metal Oxide	R AA	AA
R777	VRS-TV1JD242FY	2.4k 1/10W Metal Oxide	R AA	AA
R778	VRS-TV1JD242FY	2.4k 1/10W Metal Oxide	R AA	AA
R779	VRS-TV1JD103JY	10k 1/10W Metal Oxide	R AA	AA
R780	VRS-TV1JD682JY	6.8k 1/10W Metal Oxide	R AA	AA
R781	VRS-TV1JD242FY	2.4k 1/10W Metal Oxide	R AA	AA
R782	VRS-TV1JD102JY	1k 1/10W Metal Oxide	R AA	AA
R783	VRS-TV1JD223JY	22k 1/10W Metal Oxide	R AA	AA
R784	VRS-TV1JD242JY	2.4k 1/10W Metal Oxide	R AA	AA
R785	VRS-TV1JD103JY	10k 1/10W Metal Oxide	R AA	AA
R787	VRS-TV1JD103JY	10k 1/10W Metal Oxide	R AA	AA
R788	VRS-TV1JD202FY	2.0k 1/10W Metal Oxide	R AA	AA
R789	VRS-TV1JD681FY	680 1/10W Metal Oxide	R AA	AA

REF No.	PARTS	DESCRIPTION	* SN CODE	EX CODE
R791	VRS-TV1JD103JY	10k 1/10W Metal Oxide	R AA	AA
R792	VRS-TV1JD272JY	2.7k 1/10W Metal Oxide	R AA	AA
R793	VRS-TV1JD103JY	10k 1/10W Metal Oxide	R AA	AA
R794	VRS-TV1JD821FY	820 1/10W Metal Oxide	R AA	AA
R795	VRS-TV1JD203FY	20k 1/10W Metal Oxide	R AA	AA
R796	VRS-TV1JD272JY	2.7k 1/10W Metal Oxide	R AA	AA
R797	VRS-TV1JD104FY	100k 1/10W Metal Oxide	R AA	AA
R801	VRS-CY1JF122JY	1.2k 1/16W Metal Oxide	R AA	AA
R805	VRS-TV1JD224JY	220k 1/10W Metal Oxide	R AA	AA
R809	VRS-CY1JF122JY	1.2k 1/16W Metal Oxide	R AA	AA
R812	VRS-CY1JF122JY	1.2k 1/16W Metal Oxide	R AA	AA
R817	VRS-TQ2EF122JY	1.2k 1/4W Metal Oxide	R AA	AA
R820	VRS-CY1JF122JY	1.2k 1/16W Metal Oxide	R AA	AA
R823	VRS-TV1JD103JY	10k 1/10W Metal Oxide	R AA	AA
R824	VRS-TQ2EF332JY	3.3k 1/4W Metal Oxide	R AA	AA
R825	VRS-TV1JD103JY	10k 1/10W Metal Oxide	R AA	AA
R828	VRS-TQ2EF220JY	22 1/4W Metal Oxide	R AA	AA
R831	VRS-TV1JD103JY	10k 1/10W Metal Oxide	R AA	AA
R833	VRS-TQ2EF223FY	22k 1/4W Metal Oxide	R AA	AA
R834	VRS-TV1JD103JY	10k 1/10W Metal Oxide	R AA	AA
R835	VRS-TQ2BD000JY	0 1/8W Metal Oxide	R AA	AA
R836	VRS-TV1JD103JY	10k 1/10W Metal Oxide	R AA	AA
R851	VRS-TQ2EF221JY	220 1/4W Metal Oxide	R AA	AA
R852	VRS-TQ2EF221JY	220 1/4W Metal Oxide	R AA	AA
R854	VRS-VV3DB102J	1k 2W Metal Oxide	R AA	AA
R857	VRS-TQ2BD000JY	0 1/8W Metal Oxide	R AA	AA
R858	VRS-TV1JD272JY	2.7k 1/10W Metal Oxide	R AA	AA
R859	VRS-CY1JF123JY	12k 1/16W Metal Oxide	R AA	AA
R860	VRS-CY1JF472JY	4.7k 1/16W Metal Oxide	R AA	AA
R861	VRS-CY1JF272JY	2.7k 1/16W Metal Oxide	R AA	AA
R862	VRS-CY1JF272JY	2.7k 1/16W Metal Oxide	R AA	AA
R863	VRS-CY1JF472JY	4.7k 1/16W Metal Oxide	R AA	AA
R864	VRS-CY1JF333JY	33k 1/16W Metal Oxide	R AA	AA
R865	VRS-CY1JF333JY	33k 1/16W Metal Oxide	R AA	AA
R866	VRS-CY1JF473JY	47k 1/16W Metal Oxide	R AA	AA
R867	VRS-CY1JF123JY	12k 1/16W Metal Oxide	R AA	AA
R868	VRS-CY1JF122JY	1.2k 1/16W Metal Oxide	R AA	AA
R869	VRS-CY1JF332JY	3.3k 1/16W Metal Oxide	R AA	AA
R870	VRS-CY1JF222JY	2.2k 1/16W Metal Oxide	R AA	AA
R871	VRS-CY1JF122JY	1.2k 1/16W Metal Oxide	R AA	AA
R872	VRS-CY1JF472JY	4.7k 1/16W Metal Oxide	R AA	AA
R873	VRS-CY1JF122JY	1.2k 1/16W Metal Oxide	R AA	AA
R877	VRS-TQ2EF124FY	120k 1/4W Metal Oxide	R AA	AA
R878	VRS-TQ2EF124FY	120k 1/4W Metal Oxide	R AA	AA
MISCELLANEOUS PARTS				
F701	QFS-ZA007WJZZ	Fuse, 4A/250V	R AC	AC
RY701	RRLYDA008WJZZ	Relay	R AG	AG
SC701	QSOCAA008WJZZ	AC INPUT Terminal	R AE	AE
LUG701	QLUGHA002WJZZ	Lug	R AB	AB
LUG702	QLUGHA002WJZZ	Lug	R AB	AB
LUG703	QLUGHA002WJZZ	Lug	R AB	AB
LUG704	QLUGHA002WJZZ	Lug	R AB	AB
P701	QCNCMA250WJZZ	Connector, 23-pin	R AE	AE
P702	QCNCMA247WJZZ	Connector, 9-pin	R AD	AD
P703	QPLGZ0738CEZZ	Plug, 7-pin	R AC	AC
P704	QPLGNA053WJZZ	Plug, 14-pin(LA)	R AF	AF
E701	LANGQA027WJFW	Fixing Metal	R AE	AE
RDA701	PRDARA323WJFW	Heat Sink	R AG	AG
RDA702	PRDARA306WJFW	Heat Sink	R AG	AG
RDA703	PRDARA307WJFW	Heat Sink	R AK	AK
		(LC-32GD8E/RU, LC-32BT8E/RU)		
RDA703	PRDARA340WJFW	Heat Sink	R AL	AL
		(LC-37GD8E/RU, LC-37BT8E/RU)		

REF No.	PARTS	DESCRIPTION	* SN CODE	EX CODE
RDA704	PRDARA308WJFW	Heat Sink	R AH	AH
RDA705	PRDARA309WJFW	Heat Sink	R AH	AH
RDA706	PRDARA334WJFW	1SS390TE61	R AF	AF
		(LC-37GD8E/RU, LC-37BT8E/RU)		
RJ1	VRS-CY1JF000JY	0 1/16W Metal Oxide	R AA	AA
RJ2	VRS-CY1JF000JY	0 1/16W Metal Oxide	R AA	AA
RJ3	VRS-CY1JF000JY	0 1/16W Metal Oxide	R AA	AA
RJ4	VRS-CY1JF000JY	0 1/16W Metal Oxide	R AA	AA
	LX-BZ3049GEF7	Screw, x7	R AA	AA
	LX-BZA165WJZZ	Screw	R	
	XBSSN30P06000	Screw	R AA	AA
		(LC-37GD8E/RU, LC-37BT8E/RU)		
DUNTKD606FMV0				
KEY Unit				
DIODE				
D151	RH-EX0641GEZZY	Zener Diode	R AA	AA
RESISTORS				
R151	VRD-RA2BE182JY	Carbon 1.8k 1/8W	R AA	AA
R152	VRD-RA2BE431JY	Carbon 430 1/8W	R	
R153	VRD-RA2BE822JY	Carbon 8.2k 1/8W	R AA	AA
R155	VRD-RA2BE432JY	Carbon 4.3k 1/8W	R	
R156	VRD-RA2BE911JY	Carbon 910 1/8W	R	
SWITCHES				
S151	QSW-K0003AJZZ+	Switch, CH-UP	R AB	AB
S152	QSW-K0003AJZZ+	Switch, CH-DOWN	R AB	AB
S153	QSW-K0003AJZZ+	Switch, MENU	R AB	AB
S154	QSW-K0003AJZZ+	Switch, VOL-UP	R AB	AB
S155	QSW-K0003AJZZ+	Switch, VOL-DOWN	R AB	AB
S156	QSW-PA020WJZZ	Switch,	R	
MISCELLANEOUS PART				
P153	QPLGNA057WJZZ	Plug, 3pin (KM) (to MAIN5)	R AB	AB
DUNTKD607FMV0				
R/C, LED Unit				
INTEGRATED CIRCUITS				
IC101	VHITPS8501Y	TPS850	R AG	AG
DIODE				
D101	RH-EXA092WJZZY	Zener Diode, 12V	R AB	AB
D102	RH-PX0202TAZZY	GR1102W-330-TR	R AC	AC
D103	RH-PX0210TAZZY	BRPG1211C-TR	R AC	AC
D104	RH-PX0419CEZZY	PhotoDiode	R AC	AC
CAPACITORS				
C101	VCEASY1CN107MY	Electrolytic 100 16V	R AC	AC
C102	VCKYTV1CF225ZY	Ceramic 2.2 16V	R AB	AB
C104	VCEASX1CN106MY	Electrolytic 10 16V	R AC	AC
C105	VCKYCY1HF103ZY	Ceramic 0.01 50V	R AA	AA
RESISTORS				
R101	VRS-CY1JF101JY	Metal Oxide 100 1/16W	R AA	AA
R108	VRS-CY1JF271JY	Metal Oxide 270 1/16W	R AA	AA
R109	VRS-CY1JF122JY	Metal Oxide 1.2k 1/16W	R AA	AA
R112	VRS-CY1JF471JY	Metal Oxide 470 1/16W	R AA	AA
R114	VRS-CY1JF821JY	Metal Oxide 820 1/16W	R AA	AA
MISCELLANEOUS PARTS				
P101	QPLGNA344WJZZY	Plug, 10pin (RA) (to MAIN5)	R AD	AD
RMC101	RRMCUA053WJZZ	Remote Receiver	R	
SLD101	PSLDM4646CEFW	Shield	R AD	AD

REF No.	PARTS	DESCRIPTION	* SN CODE	EX CODE
CKITKD609FM01				
DIGITAL TUNER Unit				
TUNER				
TU201	RTUNQA033WJZZ	Tuner	S	AN AZ
INTEGRATED CIRCUITS				
IC201	VHITDA9886+-1Y	TDA9886	R	
IC202	RH-IXB682WJZZQ	STV0360C	R	
IC203	VHISN2G53CT-1Y	SN74AHC2G53HDC	R	AE AE
IC204	VHILV4053AT-1Y	SN74LV4053APWR	R	AE AE
IC205	VHIPQ1M185M-1Y	PQ1M185M2SPQ	R	AD AD
IC206	VHIMM3033E+-1Y	MM3033EURE	R	
IC207	VSSSM6J51TU-1Y	SSM6J51TU	R	
TRANSISTORS				
IC201	VHITDA9886+-1Y	TDA9886	R	
IC202	RH-IXB682WJZZQ	STV0360C	R	
IC203	VHISN2G53CT-1Y	SN74AHC2G53HDC	R	AE AE
IC204	VHILV4053AT-1Y	SN74LV4053APWR	R	AE AE
IC205	VHIPQ1M185M-1Y	PQ1M185M2SPQ	R	AD AD
IC206	VHIMM3033E+-1Y	MM3033EURE	R	
IC207	VSSSM6J51TU-1Y	SSM6J51TU	R	
DIODES				
D201	VHD1SS390+-1Y	1SS390	R	AB AB
D203	VHD1SS390+-1Y	1SS390	R	AB AB
D204	VHD1SS390+-1Y	1SS390	R	AB AB
D205	VHD1SS390+-1Y	1SS390	R	AB AB
D206	VHD1SS390+-1Y	1SS390	R	AB AB
D207	VHD1SS390+-1Y	1SS390	R	AB AB
PACKAGED CIRCUITS				
X201	RCRSAA029WJZZ	Crystal	R	AF AF
X202	RCRSCA039WJZZY	Crystal AG	R	
COILS AND FILTERS				
FL201	RFILC0278BMZZ	Filter	R	AM AM
FL202	RFILC0294BMZZ	Filter	R	
L203	VPCNN100J1R6NY	Peaking, 10µH	R	AB AB
L204	VPCNN120J1R9NY	Peaking, 12µH	R	
L205	VPCNN330J4R2NY	Peaking, 33µH	R	
L206	VPCUN1R5MR12NY	Peaking, 1.5µH	R	
L207	VPCNN2R2JR77NY	Peaking, 2.2µH	R	
L208	VPCNN2R2JR77NY	Peaking, 2.2µH	R	
L209	VPCNN2R2JR77NY	Peaking, 2.2µH	R	
L210	VPCNN2R2JR77NY	Peaking, 2.2µH	R	
L212	VPD9MR18JR21NY	Peaking, 0.18µH	R	
L213	VPCKM330J3R9NY	Peaking, 33µH	R	AB AB
CAPACITORS				
C201	VCEASX1AN336MY	33 10V Electrolytic	R	AC AC
C202	VCCCCY1HH220JY	22p 50V Ceramic	R	AA AA
C203	VCCCCY1HH220JY	22p 50V Ceramic	R	AA AA
C204	VCEASX1CN477MY	470 16V Electrolytic	R	AE AE
C205	VCKYCY1HF103ZY	0.01 50V Ceramic	R	AA AA
C206	VCEASX1CN107MY	100 16V Electrolytic	R	AC AC
C207	VCKYCY1HF103ZY	0.01 50V Ceramic	R	AA AA
C215	VCKYCY1HF103ZY	0.01 50V Ceramic	R	AA AA
C216	VCKYCY1HF103ZY	0.01 50V Ceramic	R	AA AA
C217	VCEASX1HN106MY	10 50V Electrolytic	R	AC AC
C218	VCKYCY1HB103KY	0.01 50V Ceramic	R	AA AA
C219	VCKYCY1EF104ZY	0.1 25V Ceramic	R	AA AA
C220	VCKYCY1HF103ZY	0.01 50V Ceramic	R	AA AA
C221	VCEASX1CN107MY	100 16V Electrolytic	R	AC AC
C222	VCKYCY1EF104ZY	0.1 25V Ceramic	R	AA AA

REF No.	PARTS	DESCRIPTION	* SN CODE	EX CODE
CKITKD609FM01				
DIGITAL TUNER Unit (Continued)				
C223	VCCCCY1HH391JY	390p 50V Ceramic	R	AB AB
C224	VCKYTV1CB224KY	0.22 16V Ceramic	R	AB AB
C225	VCKYCY1HB152KY	1500p 50V Ceramic	R	AA AA
C226	VCEASX1AN227MY	220 10V Electrolytic	R	AD AD
C227	VCKYCY1HF103ZY	0.01 50V Ceramic	R	AA AA
C228	VCKYTV1CB474KY	0.47 16V Ceramic	R	AC AC
C229	VCCCCY1HH120JY	12p 50V Ceramic	R	AA AA
C230	VCEASX1HN106MY	10 50V Electrolytic	R	AC AC
C231	VCKYCY1HF103ZY	0.01 50V Ceramic	R	AA AA
C232	VCCCCY1HH330JY	33p 50V Ceramic	R	AA AA
C233	VCKYCY1HB102KY	1000p 50V Ceramic	R	AA AA
C234	VCKYCY1EF104ZY	0.1 25V Ceramic	R	AA AA
C235	VCCCCY1HH150JY	15p 50V Ceramic	R	AA AA
C236	VCKYCY1HF103ZY	0.01 50V Ceramic	R	AA AA
C237	VCEASX1HN225MY	2.2 50V Electrolytic	R	AB AB
C241	VCEASX1AN336MY	33 10V Electrolytic	R	AC AC
C242	VCEASX1CN106MY	10 16V Electrolytic	R	AC AC
C243	VCKYCY1EF104ZY	0.1 25V Ceramic	R	AA AA
C244	VCEASX0JN226MY	22 6.3V Electrolytic	R	AB AB
C245	VCKYCY1EF104ZY	0.1 25V Ceramic	R	AA AA
C246	VCEASX1CN106MY	10 16V Electrolytic	R	AC AC
C247	VCEASX1CN106MY	10 16V Electrolytic	R	AC AC
C248	VCKYCY1HF103ZY	0.01 50V Ceramic	R	AA AA
C249	VCEASX1CN106MY	10 16V Electrolytic	R	AC AC
C250	VCKYCY1HF103ZY	0.01 50V Ceramic	R	AA AA
C251	VCKYCY1HF103ZY	0.01 50V Ceramic	R	AA AA
C252	VCEASX1CN106MY	10 16V Electrolytic	R	AC AC
C253	VCKYCY1HF103ZY	0.01 50V Ceramic	R	AA AA
C254	VCKYCY1HF103ZY	0.01 50V Ceramic	R	AA AA
C255	VCKYCY1EF104ZY	0.1 25V Ceramic	R	AA AA
C256	VCKYCY1EF104ZY	0.1 25V Ceramic	R	AA AA
C257	VCKYCY1HB103KY	0.01 50V Ceramic	R	AA AA
C258	VCKYCY1HB103KY	0.01 50V Ceramic	R	AA AA
C259	VCCCCY1HH2R0CY	2.0p 50V Ceramic	R	AA AA
C260	VCCCCY1HH150JY	15p 50V Ceramic	R	AA AA
C261	VCEASX1CN106MY	10 16V Electrolytic	R	AC AC
C262	VCKYCY1EF104ZY	0.1 25V Ceramic	R	AA AA
C263	VCKYCY1EF104ZY	0.1 25V Ceramic	R	AA AA
C266	VCKYCY1HF103ZY	0.01 50V Ceramic	R	AA AA
C267	VCKYCY1HF103ZY	0.01 50V Ceramic	R	AA AA
C268	VCKYCY1EB104KY	0.1 25V Ceramic	R	AB AB
C269	VCKYCY1EB104KY	0.1 25V Ceramic	R	AB AB
C270	VCAAPD0J227MY	220 6.3V Electrolytic	R	AF AF
C271	VCKYCY1HF103ZY	0.01 50V Ceramic	R	AA AA
C272	VCKYCY1HB102KY	1000p 50V Ceramic	R	AA AA
C273	VCAAPD0J227MY	220 6.3V Electrolytic	R	AF AF
C274	VCKYCY1EF104ZY	0.1 25V Ceramic	R	AA AA
C275	VCKYCY1EF104ZY	0.1 25V Ceramic	R	AA AA
C276	VCKYCY1HB103KY	0.01 50V Ceramic	R	AA AA
C279	RC-KZA073WJZZY	10 16V Ceramic	R	
RESISTORS				
R201	VRS-CY1JF104JY	100k 1/16W Metal Oxide	R	AA AA
R202	VRS-CY1JF681JY	680 1/16W Metal Oxide	R	AA AA
R203	VRS-CY1JF683JY	68k 1/16W Metal Oxide	R	AA AA
R204	VRS-CY1JF123JY	12k 1/16W Metal Oxide	R	AA AA
R205	VRS-CY1JF473JY	47k 1/16W Metal Oxide	R	AA AA
R206	VRS-CY1JF000JY	0 1/16W Metal Oxide	R	AA AA
R207	VRS-CY1JF470JY	47 1/16W Metal Oxide	R	AA AA
R208	VRS-CY1JF470JY	47 1/16W Metal Oxide	R	AA AA
R209	VRS-CY1JF123JY	12k 1/16W Metal Oxide	R	AA AA
R219	VRS-CY1JF222JY	2.2k 1/16W Metal Oxide	R	AA AA

REF No.	PARTS	DESCRIPTION	* SN CODE	EX CODE
R223	VRS-CY1JF562JY	5.6k 1/16W Metal Oxide	R AA	AA
R224	VRS-CY1JF562JY	5.6k 1/16W Metal Oxide	R AA	AA
R226	VRS-CY1JF103JY	10k 1/16W Metal Oxide	R AA	AA
R227	VRS-CY1JF103JY	10k 1/16W Metal Oxide	R AA	AA
R228	VRS-CY1JF223JY	22k 1/16W Metal Oxide	R AA	AA
R229	VRS-CY1JF223JY	22k 1/16W Metal Oxide	R AA	AA
R230	VRS-CY1JF562JY	5.6k 1/16W Metal Oxide	R AA	AA
R231	VRS-TQ2BD330JY	33 1/8W Metal Oxide	R AA	AA
R232	VRS-CY1JF331JY	330 1/16W Metal Oxide	R AA	AA
R233	VRS-CY1JF821JY	820 1/16W Metal Oxide	R AA	AA
R234	VRS-CY1JF271JY	270 1/16W Metal Oxide	R AA	AA
R235	VRS-CY1JF101JY	100 1/16W Metal Oxide	R AA	AA
R236	VRS-CY1JF101JY	100 1/16W Metal Oxide	R AA	AA
R237	VRS-CY1JF331JY	330 1/16W Metal Oxide	R AA	AA
R238	VRS-CY1JF151JY	150 1/16W Metal Oxide	R AA	AA
R239	VRS-CY1JF101JY	100 1/16W Metal Oxide	R AA	AA
R240	VRS-CY1JF331JY	330 1/16W Metal Oxide	R AA	AA
R241	VRS-CY1JF103JY	10k 1/16W Metal Oxide	R AA	AA
R242	VRS-CY1JF392JY	3.9k 1/16W Metal Oxide	R AA	AA
R243	VRS-CY1JF101JY	100 1/16W Metal Oxide	R AA	AA
R244	VRS-CY1JF221JY	220 1/16W Metal Oxide	R AA	AA
R245	VRS-CH1JF103JY	10k 1/16W Metal Oxide	R AA	AA
R246	VRS-CY1JF681JY	680 1/16W Metal Oxide	R AA	AA
R247	VRS-CY1JF000JY	0 1/16W Metal Oxide	R AA	AA
R248	VRS-CY1JF153JY	15k 1/16W Metal Oxide	R AA	AA
R251	VRS-CY1JF332JY	3.3k 1/16W Metal Oxide	R AA	AA
R255	VRS-CY1JF470JY	47 1/16W Metal Oxide	R AA	AA
R256	VRS-CY1JF470JY	47 1/16W Metal Oxide	R AA	AA
R259	VRS-CY1JF151JY	150 1/16W Metal Oxide	R AA	AA
R263	VRS-CY1JF472JY	4.7k 1/16W Metal Oxide	R AA	AA
R264	VRS-CY1JF101JY	100 1/16W Metal Oxide	R AA	AA
R265	VRS-CY1JF101JY	100 1/16W Metal Oxide	R AA	AA
R266	VRS-CY1JF000JY	0 1/16W Metal Oxide	R AA	AA
R267	VRS-CY1JF000JY	0 1/16W Metal Oxide	R AA	AA
R268	VRS-CY1JF000JY	0 1/16W Metal Oxide	R AA	AA
R269	VRS-CY1JF000JY	0 1/16W Metal Oxide	R AA	AA
R270	VRS-CY1JF514JY	510k 1/16W Metal Oxide	R AA	AA
R271	VRS-CY1JF102JY	1k 1/16W Metal Oxide	R AA	AA
R272	VRS-CH1JF000JY	0 1/16W Metal Oxide	R AA	AA
R273	VRS-CH1JF000JY	0 1/16W Metal Oxide	R AA	AA
R274	VRS-CY1JF000JY	0 1/16W Metal Oxide	R AA	AA
R275	VRS-TW2HF2R7JY	2.7 1/2W Metal Oxide	R	
R276	VRS-TW2HF2R7JY	2.7 1/2W Metal Oxide	R	
R281	VRS-CY1JF000JY	0 1/16W Metal Oxide	R AA	AA
R282	VRS-CY1JF000JY	0 1/16W Metal Oxide	R AA	AA
R283	VRS-CY1JF000JY	0 1/16W Metal Oxide	R AA	AA
R284	VRS-CY1JF103JY	10k 1/16W Metal Oxide	R AA	AA
R285	VRS-CY1JF103JY	10k 1/16W Metal Oxide	R AA	AA
R288	VRS-CY1JF000JY	0 1/16W Metal Oxide	R AA	AA
R289	VRS-CY1JF103JY	10k 1/16W Metal Oxide	R AA	AA
R290	VRS-CY1JF181JY	180 1/16W Metal Oxide	R AA	AA
R291	VRS-CY1JF332JY	3.3k 1/16W Metal Oxide	R AA	AA
R292	VRS-CY1JF332JY	3.3k 1/16W Metal Oxide	R AA	AA
MISCELLANEOUS PARTS				
P202	QCNCMA250WJZZ	Connector	R AE	AE
	LHLDW1072GEZZ	Holder	R AA	AA
SLD201	PSLDMA898WJFW	Shield	R	
DUNTKD628FM01 DIGITAL Unit				
INTEGRATED CIRCUITS				
IC4001	RH-IXB680WJZZQ	ST15516AUCL	R	
IC4002	VHISN1G08DC-1Y	SN74AHC1G08HDC	R AD	AD
IC4003	VHIBU4228G+-1Y	BU4228G-TR	R	

REF No.	PARTS	DESCRIPTION	* SN CODE	EX CODE
IC4005	VHISN1GU04C-1Y	SN74AHC1GU04DC	R AD	AD
IC4201	RH-IXB076WJZZQ	K4S641632H-UC7	R BB	BB
IC4202	RH-IXB076WJZZQ	K4S641632H-UC7	R BB	BB
IC4203	RH-IXB681WJZZQ	M29W160ET70N6E	R	
IC4204	VHIBR24L64F-1Y	BR24L64F-WE2	R AK	AK
IC4401	VHITCLCX245-2Y	TC74LCX245FS	R	
IC4402	VHILVC573AP-1Y	SN74LVC573APWR	R AF	AF
IC4403	VHISN1G08DC-1Y	SN74AHC1G08HDC	R AD	AD
IC4404	VHILCX244MT-1Y	74LCX244 AE	R	
IC4405	VHILVC573AP-1Y	SN74LVC573APWR	R AF	AF
IC4406	VHISN1G32DC-1Y	SN74AHC1G32HDC	R AD	AD
IC4407	VHISN1G32DC-1Y	SN74AHC1G32HDC	R AD	AD
IC4408	VHISN1G02DC-1Y	SN74AHC1G02HDC	R AD	AD
IC4604	VHITSH73CPT-1Y	TSH73CPT	R	
IC4701	VHIMP1583+-1Y	MP1583DN-LF-Z	R AH	AH
IC4704	VHIPQ018ENA-1Y	PQ018ENA1ZPH	R	
TRANSISTORS				
IC4702	VSSSM6J51TU-1Y	SSM6J51TU	R	
Q4001	VS2SC3928AR-1Y	2SC3928AR	R AB	AB
Q4002	VS2SC3928AR-1Y	2SC3928AR	R AB	AB
Q4201	VS2SA1530AR-1Y	2SA1530AR	R AB	AB
Q4601	VS2SC3928AR-1Y	2SC3928AR	R AB	AB
Q4602	VS2SC3928AR-1Y	2SC3928AR	R AB	AB
Q4603	VS2SC3928AR-1Y	2SC3928AR	R AB	AB
Q4604	VS2SC3928AR-1Y	2SC3928AR	R AB	AB
Q4605	VS2SC3928AR-1Y	2SC3928AR	R AB	AB
Q4606	VS2SC3928AR-1Y	2SC3928AR	R AB	AB
Q4607	VS2SC3928AR-1Y	2SC3928AR	R AB	AB
Q4701	VSDTC144EE/-1Y	DTC144EE	R AA	AA
Q4702	VSDTC144EE/-1Y	DTC144EE	R AA	AA
Q4703	VS2SC3928AR-1Y	2SC3928AR	R AB	AB
DIODES AND LEDS				
D4701	RH-EX1234CEZZY	Zener Diode, 3.6V	R AE	AE
D4702	VHDSFPA73/2EY	SFPA73	R AD	AD
D4703	VHDHSU119/-1Y	HSU119	R AB	AB
Q4401	RH-TXA026WJZZY	TXA026WJ	R	
PACKAGED CIRCUITS				
X4001	RCRSC0032TAZZY	Crystal	R AG	AG
X4002	RCRUAA075WJZZY		R	
COILS				
L4601	VPD9M100J1R7NY	Peaking, 10µH	R AC	AC
L4603	VPD9MSR6J1R6NY	Peaking, 5.6µH	R AB	AB
L4604	VPD9MSR6J1R6NY	Peaking, 5.6µH	R AB	AB
L4605	VPD9MSR6J1R6NY	Peaking, 5.6µH	R AB	AB
L4701	RCILPA214WJZZY	Coil	R AG	AG
CAPACITORS				
C4001	VCEASX1HN105MY	1 50V Electrolytic	R AB	AB
C4002	VCKYCY1HB103KY	0.01 50V Ceramic	R AA	AA
C4003	VCKYCY1EF104ZY	0.1 25V Ceramic	R AA	AA
C4004	VCKYCY1EF104ZY	0.1 25V Ceramic	R AA	AA
C4005	VCKYCY1HB103KY	0.01 50V Ceramic	R AA	AA
C4006	VCCCCY1HH180JY	18p 50V Ceramic	R AA	AA
C4007	VCCCCY1HH150JY	15p 50V Ceramic	R AA	AA
C4008	VCEASX1CN106MY	10 16V Electrolytic	R AC	AC
C4009	VCKYCY1HB103KY	0.01 50V Ceramic	R AA	AA
C4010	VCKYCY1EF104ZY	0.1 25V Ceramic	R AA	AA
C4011	VCKYCY1EF104ZY	0.1 25V Ceramic	R AA	AA
C4012	VCKYCY1EF104ZY	0.1 25V Ceramic	R AA	AA
C4013	VCKYCY1HB103KY	0.01 50V Ceramic	R AA	AA
C4014	VCKYCY1EF104ZY	0.1 25V Ceramic	R AA	AA

REF No.	PARTS	DESCRIPTION	* SN CODE	EX CODE
C4015	VCKYCY1EF104ZY	0.1 25V Ceramic	R AA	AA
C4016	VCKYCY1HB103KY	0.01 50V Ceramic	R AA	AA
C4018	VCKYCY1EF104ZY	0.1 25V Ceramic	R AA	AA
C4019	VCEASX1CN106MY	10 16V Electrolytic	R AC	AC
C4020	VCKYCY1EF104ZY	0.1 25V Ceramic	R AA	AA
C4021	VCKYCY1EF104ZY	0.1 25V Ceramic	R AA	AA
C4022	VCKYCY1EF104ZY	0.1 25V Ceramic	R AA	AA
C4023	VCKYCY1EF104ZY	0.1 25V Ceramic	R AA	AA
C4024	VCKYCY1EF104ZY	0.1 25V Ceramic	R AA	AA
C4025	VCKYCY1EF104ZY	0.1 25V Ceramic	R AA	AA
C4026	VCKYCY1EF104ZY	0.1 25V Ceramic	R AA	AA
C4027	VCKYCY1EF104ZY	0.1 25V Ceramic	R AA	AA
C4028	VCKYCY1EF104ZY	0.1 25V Ceramic	R AA	AA
C4029	VCKYCY1HB103KY	0.01 50V Ceramic	R AA	AA
C4030	VCEASX0JN476MY	47 6.3V Electrolytic	R AC	AC
C4031	VCKYCY1EF104ZY	0.1 25V Ceramic	R AA	AA
C4032	VCEASX1CN106MY	10 16V Electrolytic	R AC	AC
C4033	VCKYCY1EF104ZY	0.1 25V Ceramic	R AA	AA
C4201	VCEASX1CN106MY	10 16V Electrolytic	R AC	AC
C4202	VCKYCY1EF104ZY	0.1 25V Ceramic	R AA	AA
C4203	VCEASX1CN106MY	10 16V Electrolytic	R AC	AC
C4204	VCKYCY1HB103KY	0.01 50V Ceramic	R AA	AA
C4205	VCKYCY1EF104ZY	0.1 25V Ceramic	R AA	AA
C4206	VCKYCY1HB103KY	0.01 50V Ceramic	R AA	AA
C4207	VCKYCY1EF104ZY	0.1 25V Ceramic	R AA	AA
C4209	VCKYCY1EF104ZY	0.1 25V Ceramic	R AA	AA
C4401	VCEASX1CN106MY	10 16V Electrolytic	R AC	AC
C4402	VCKYCY1EF104ZY	0.1 25V Ceramic	R AA	AA
C4403	VCKYCY1EF104ZY	0.1 25V Ceramic	R AA	AA
C4404	VCKYCY1EF104ZY	0.1 25V Ceramic	R AA	AA
C4405	VCKYCY1EF104ZY	0.1 25V Ceramic	R AA	AA
C4406	VCKYCY1EF104ZY	0.1 25V Ceramic	R AA	AA
C4407	VCKYCY1EF104ZY	0.1 25V Ceramic	R AA	AA
C4408	VCKYCY1EF104ZY	0.1 25V Ceramic	R AA	AA
C4409	VCKYCY1EF104ZY	0.1 25V Ceramic	R AA	AA
C4410	VCKYCY1EF104ZY	0.1 25V Ceramic	R AA	AA
C4411	VCKYCY1EF104ZY	0.1 25V Ceramic	R AA	AA
C4412	VCEASX1CN106MY	10 16V Electrolytic	R AC	AC
C4420	VCAAPD1AJ686MY	68 10V Electrolytic	R AE	AE
C4606	VCEASX1CN106MY	10 16V Electrolytic	R AC	AC
C4607	VCCCCY1HH470JY	47p 50V Ceramic	R AA	AA
C4608	VCCCCY1HH100DY	10p 50V Ceramic	R AA	AA
C4610	VCCCCY1HH470JY	47p 50V Ceramic	R AA	AA
C4611	VCCCCY1HH330JY	33p 50V Ceramic	R AA	AA
C4612	VCCCCY1HH330JY	33p 50V Ceramic	R AA	AA
C4613	VCCCCY1HH330JY	33p 50V Ceramic	R AA	AA
C4614	VCCCCY1HH6R0DY	6.0p 50V Ceramic	R AA	AA
C4615	VCCCCY1HH6R0DY	6.0p 50V Ceramic	R AA	AA
C4616	VCCCCY1HH6R0DY	6.0p 50V Ceramic	R AA	AA
C4617	VCCCCY1HH820JY	82p 50V Ceramic	R AA	AA
C4618	VCCCCY1HH820JY	82p 50V Ceramic	R AA	AA
C4619	VCCCCY1HH820JY	82p 50V Ceramic	R AA	AA
C4621	VCKYCY1EF104ZY	0.1 25V Ceramic	R AA	AA
C4622	RC-KZA073WJZZY	10 16V Ceramic	R	
C4623	VCEASX1CN106MY	10 16V Electrolytic	R AC	AC
C4624	VCKYCY1EF104ZY	0.1 25V Ceramic	R AA	AA
C4625	VCEASX1CN106MY	10 16V Electrolytic	R AC	AC
C4626	VCKYCY1EF104ZY	0.1 25V Ceramic	R AA	AA
C4627	VCKYCY1HB332KY	3300p 50V Ceramic	R AA	AA
C4628	VCKYCY1HB332KY	3300p 50V Ceramic	R AA	AA
C4629	VCKYCY1EF104ZY	0.1 25V Ceramic	R AA	AA
C4632	VCKYCY1HB332KY	3300p 50V Ceramic	R AA	AA
C4633	VCKYCY1HB332KY	3300p 50V Ceramic	R AA	AA
C4634	VCEASX1CN106MY	10 16V Electrolytic	R AC	AC

REF No.	PARTS	DESCRIPTION	* SN CODE	EX CODE
DUNTKD628FM01				
DIGITAL Unit (Continued)				
C4635	VCEASX1CN106MY	10 16V Electrolytic	R AC	AC
C4636	VCKYCY1HB104KY	0.1 50V Ceramic	R AA	AA
C4637	VCKYCY1HB104KY	0.1 50V Ceramic	R AA	AA
C4638	VCKYCY1HB104KY	0.1 50V Ceramic	R AA	AA
C4639	VCEASX1CN106MY	10 16V Electrolytic	R AC	AC
C4640	VCEASX1CN106MY	10 16V Electrolytic	R AC	AC
C4641	VCEASX1CN106MY	10 16V Electrolytic	R AC	AC
C4701	RC-KZA070WJZZY	22 6.3V Ceramic	R AD	AD
C4702	VCKYTV1CB105KY	1 16V Ceramic	R	
C4703	VCKYCY1EF104ZY	0.1 25V Ceramic	R AA	AA
C4705	VCKYCY1HB152KY	1500p 50V Ceramic	R AA	AA
C4706	VCKYCY1EF104ZY	0.1 25V Ceramic	R AA	AA
C4707	VCAAPD1AJ686MY	68 10V Electrolytic	R AE	AE
C4708	VCKYCY1EF104ZY	0.1 25V Ceramic	R AA	AA
C4709	RC-KZA073WJZZY	10 16V Ceramic	R	
C4710	VCEASX1CN476MY	47 16V Electrolytic	R AC	AC
C4711	RC-KZA073WJZZY	10 16V Ceramic	R	
C4713	VCKYCY1EF104ZY	0.1 25V Ceramic	R AA	AA
C4714	VCKYCY1EF104ZY	0.1 25V Ceramic	R AA	AA
C4715	VCEASX0JN476MY	47 6.3V Electrolytic	R AC	AC
C4716	VCKYCY1EF104ZY	0.1 25V Ceramic	R AA	AA
C4717	VCEASX0JN226MY	22 6.3V Electrolytic	R AB	AB
RESISTORS				
R4001	VRS-CY1JF000JY	0 1/16W Metal Oxide	R AA	AA
R4002	VRS-CY1JF201FY	200 1/16W Metal Oxide	R AA	AA
R4003	VRS-CY1JF103JY	10k 1/16W Metal Oxide	R AA	AA
R4004	VRS-CY1JF000JY	0 1/16W Metal Oxide	R AA	AA
R4005	VRS-CY1JF103JY	10k 1/16W Metal Oxide	R AA	AA
R4006	VRS-CY1JF103JY	10k 1/16W Metal Oxide	R AA	AA
R4007	VRS-CY1JF103JY	10k 1/16W Metal Oxide	R AA	AA
R4008	VRS-CY1JF103JY	10k 1/16W Metal Oxide	R AA	AA
R4009	VRS-CY1JF104JY	100k 1/16W Metal Oxide	R AA	AA
R4010	VRS-CY1JF000JY	0 1/16W Metal Oxide	R AA	AA
R4011	VRS-CY1JF103JY	10k 1/16W Metal Oxide	R AA	AA
R4012	VRS-CY1JF103JY	10k 1/16W Metal Oxide	R AA	AA
R4013	VRS-CY1JF103JY	10k 1/16W Metal Oxide	R AA	AA
R4015	VRS-CY1JF103JY	10k 1/16W Metal Oxide	R AA	AA
R4016	VRS-CY1JF101JY	100 1/16W Metal Oxide	R AA	AA
R4017	VRS-CY1JF103JY	10k 1/16W Metal Oxide	R AA	AA
R4018	VRS-CY1JF000JY	0 1/16W Metal Oxide	R AA	AA
R4019	VRS-CY1JF000JY	0 1/16W Metal Oxide	R AA	AA
R4020	VRS-CY1JF472JY	4.7k 1/16W Metal Oxide	R AA	AA
R4021	VRS-CY1JF222JY	2.2k 1/16W Metal Oxide	R AA	AA
R4024	VRS-CY1JF000JY	0 1/16W Metal Oxide	R AA	AA
R4025	VRS-CY1JF000JY	0 1/16W Metal Oxide	R AA	AA
R4026	VRS-CY1JF103JY	10k 1/16W Metal Oxide	R AA	AA
R4027	VRS-CH1JF000JY	0 1/16W Metal Oxide	R AA	AA
R4028	VRS-CY1JF103JY	10k 1/16W Metal Oxide	R AA	AA
R4029	VRS-CY1JF330JY	33 1/16W Metal Oxide	R AA	AA
R4030	VRS-CH1JF470JY	47 1/16W Metal Oxide	R AA	AA
R4031	VRS-CH1JF470JY	47 1/16W Metal Oxide	R AA	AA
R4032	VRS-CY1JF103JY	10k 1/16W Metal Oxide	R AA	AA
R4035	VRS-CY1JF103JY	10k 1/16W Metal Oxide	R AA	AA
R4036	VRS-CH1JF103JY	10k 1/16W Metal Oxide	R AA	AA
R4037	VRS-CY1JF103JY	10k 1/16W Metal Oxide	R AA	AA
R4038	VRS-CY1JF101JY	100 1/16W Metal Oxide	R AA	AA
R4039	VRS-CY1JF101JY	100 1/16W Metal Oxide	R AA	AA
R4190	VRS-CY1JF101JY	100 1/16W Metal Oxide	R AA	AA
R4191	VRS-CY1JF101JY	100 1/16W Metal Oxide	R AA	AA
R4192	VRS-CY1JF101JY	100 1/16W Metal Oxide	R AA	AA
R4193	VRS-CY1JF101JY	100 1/16W Metal Oxide	R AA	AA

REF No.	PARTS	DESCRIPTION	* SN CODE	EX CODE
R4649	VRS-CY1JF470JY	47 1/16W Metal Oxide	R AA	AA
R4650	VRS-CY1JF470JY	47 1/16W Metal Oxide	R AA	AA
R4651	VRS-CY1JF183JY	18k 1/16W Metal Oxide	R AA	AA
R4652	VRS-CY1JF183JY	18k 1/16W Metal Oxide	R AA	AA
R4657	VRS-CY1JF101JY	100 1/16W Metal Oxide	R AA	AA
R4658	VRS-CY1JF101JY	100 1/16W Metal Oxide	R AA	AA
R4659	VRS-CY1JF331FY	330 1/16W Metal Oxide	R AA	AA
R4660	VRS-CY1JF473JY	47k 1/16W Metal Oxide	R AA	AA
R4661	VRS-CY1JF473JY	47k 1/16W Metal Oxide	R AA	AA
R4662	VRS-CY1JF271FY	270 1/16W Metal Oxide	R AA	AA
R4663	VRS-CY1JF271FY	270 1/16W Metal Oxide	R AA	AA
R4664	VRS-CY1JF271FY	270 1/16W Metal Oxide	R AA	AA
R4665	VRS-CY1JF161FY	160 1/16W Metal Oxide	R AA	AA
R4666	VRS-CY1JF103JY	10k 1/16W Metal Oxide	R AA	AA
R4667	VRS-CY1JF161FY	160 1/16W Metal Oxide	R AA	AA
R4668	VRS-CY1JF103JY	10k 1/16W Metal Oxide	R AA	AA
R4669	VRS-CY1JF161FY	160 1/16W Metal Oxide	R AA	AA
R4670	VRS-CY1JF103JY	10k 1/16W Metal Oxide	R AA	AA
R4672	VRS-CY1JF103JY	10k 1/16W Metal Oxide	R AA	AA
R4673	VRS-CY1JF103JY	10k 1/16W Metal Oxide	R AA	AA
R4674	VRS-CY1JF000JY	0 1/16W Metal Oxide	R AA	AA
R4675	VRS-CY1JF470JY	47 1/16W Metal Oxide	R AA	AA
R4701	VRS-CY1JF474FY	470k 1/16W Metal Oxide	R AA	AA
R4702	VRS-CY1JF273FY	27k 1/16W Metal Oxide	R AA	AA
R4703	VRS-CY1JF153FY	15k 1/16W Metal Oxide	R AA	AA
R4704	VRS-CY1JF582JY	5.6k 1/16W Metal Oxide	R AA	AA
R4705	VRS-CY1JF103JY	10k 1/16W Metal Oxide	R AA	AA
R4706	VRS-CY1JF103JY	10k 1/16W Metal Oxide	R AA	AA
R4707	VRS-CY1JF103JY	10k 1/16W Metal Oxide	R AA	AA
R4708	VRS-CY1JF332JY	3.3k 1/16W Metal Oxide	R AA	AA
R4709	VRS-TX2HF000JY	0 1/2W Metal Oxide	R AB	AB
R4710	VRS-CY1JF101JY	100 1/16W Metal Oxide	R AA	AA
R4711	VRS-TX2HF000JY	0 1/2W Metal Oxide	R AB	AB
R4712	VRS-CY1JF103JY	10k 1/16W Metal Oxide	R AA	AA
R4713	VRS-TX2HF1R0JY	1 1/2W Metal Oxide	R AB	AB
R4715	VRS-TX2HF000JY	0 1/2W Metal Oxide	R AB	AB
R4716	VRS-TX2HF000JY	0 1/2W Metal Oxide	R AB	AB
R4717	VRS-CY1JF101JY	100 1/16W Metal Oxide	R AA	AA
MISCELLANEOUS PARTS				
CN4190	QPLGNA524WJZZ	Plug	R	
FB4001	RBLN-A215WJZZY	Ferrite Beads	R AB	AB
FB4002	RBLN-A215WJZZY	Ferrite Beads	R AB	AB
FB4003	RBLN-A215WJZZY	Ferrite Beads	R AB	AB
FB4004	RBLN-A215WJZZY	Ferrite Beads	R AB	AB
FB4005	RBLN-A215WJZZY	Ferrite Beads	R AB	AB
FB4006	RBLN-A215WJZZY	Ferrite Beads	R AB	AB
FB4007	RBLN-A215WJZZY	Ferrite Beads	R AB	AB
FB4008	RBLN-A303WJZZY	Ferrite Beads	R AB	AB
FB4009	RBLN-A303WJZZY	Ferrite Beads	R AB	AB
FB4201	RBLN-A215WJZZY	Ferrite Beads	R AB	AB
FB4202	RBLN-A215WJZZY	Ferrite Beads	R AB	AB
FB4401	RBLN-A215WJZZY	Ferrite Beads	R AB	AB
FB4402	RBLN-A215WJZZY	Ferrite Beads	R AB	AB
FB4601	RBLN-A215WJZZY	Ferrite Beads	R AB	AB
FB4602	RBLN-A215WJZZY	Ferrite Beads	R AB	AB
FB4603	RBLN-A215WJZZY	Ferrite Beads	R AB	AB
FB4701	RBLN-0250TAZZY	Ferrite Beads	R AC	AC
LUG4601	QLUGHA009WJZZY	Lug	R AC	AC
LUG4602	QLUGHA006WJZZY	Lug	R AC	AC
LUG4603	QLUGHA006WJZZY	Lug	R AC	AC
LUG4604	QLUGHA009WJZZY	Lug	R AC	AC
P4001	QPLGN0463TAZZY	Plug	R AC	AC
P4003	QPLGN0463TAZZY	Plug	R AC	AC

REF No.	PARTS	DESCRIPTION	* SN CODE	EX CODE
SC4601	QCNCWA202WJZZY	Connector	R AK	AK
SC4602	QSOCNA003WJZZY	Socket	R AM	AM
	LCHSMA283WJZZ	Chassis	R	
	LHLDWA1033CE00	Holder, LB	R AA	AA
	LHLDW1123GEZZ	Wire Holder, CONTROL	R AB	AB
	LHLDW1205CEZZ	Wire Holder, CHASSIS TRAY	R AC	AC
	LHLDWA055WJKZ	Wire Holder, CHASSIS TRAY	R AC	AC
	LHLDWA137WJZZ	Wire Holder, LED	R	
	PMLT-A255WJZZ	Absorber	R AD	AD
	PMLT-A314WJZZ	Absorber	R	
	PSLDMA943WJFW	DIGITAL Shield	R	
	QCNCMA199WJSA	Connector	R	
	QCNCW-E232WJQZ	Connecting Cord (KM) (LC-32GD9E)	R	
	QCNCW-E609WJQZ	Connecting Cord (SH)	R	
	QCNCW-E235WJQZ	Connecting Cord (LA) (LC-32GD9E)	R	
	QCNCW-E399WJQZ	Connecting Cord (LB) (LC-32GD9E)	R	
	QCNCW-E412WJQZ	Connecting Cord (KM) (LC-37GD9E)	R	
	QCNCW-E415WJQZ	Connecting Cord (LA) (LC-37GD9E)	R	
	QCNCW-E419WJQZ	Connecting Cord (LB) (LC-37GD9E)	R	
	QEARPA212WJFW	Ground-Part	R	
	RCORFA023WJZZ	Core, for LB Wire	R AK	AK
	XBPS830P06000	Screw, for HDMI	R AA	AA
	XBPSN20P14JS0	Screw, x4 for Card Slot	R	
	XEBS930P08000	Screw, x3	R AA	AA
	XJPS730P08WS0	Screw, x14 for PWB,SLD	R AA	AA
	XNESN20-16000	Nut, x4 for Card Slot Nut	R AA	AA

CABINET AND MECHANICAL PARTS LISTING (LC-32GD8E/RU, LC-32BT8E/RU)					
REF No.	PARTS	DESCRIPTION	*	SN CODE	EX CODE
1	CCABAB441WJ01	Cabinet A Ass'y (LC32-GD8E/RU)	S	--	--
1	CCABAB441WJ02	Cabinet A Ass'y (LC32-BT8E/RU)	S	--	--
1_1	Not Available	Cabinet A	-	--	--
1_2	GCOVAB478WJSA	R/C LED Cover	S	--	--
1_3	HBGDBA056WJSA	Badge, "SHARP"	S	--	--
1_4	LHLDW1033PEZZ	Wire Holder, x1	R	AA	AA
1_5	PSPAHA607WJZZ	Mask Spacer, x2	S	--	--
1_6	PSPAHA608WJZZ	Mask Spacer, x2	S	--	--
1_7	PSPAHA786WJZZ	Spacer, x2	S	--	--
1_8	PSPAHA790WJZZ	Spacer, x2	S	--	--
1_9	PSPAAB211WJZZ	Spacer, x4	S	--	--
1_10	QCNW-E233WJQZ	Connecting Cord	S	--	--
1_11	QCNW-E800WJQZ	Connecting Cord	S	--	--
1_12	RCORF0103CEZZ	Ferrite Core, x2	R	AK	AK
1_13	RSP-ZA184WJN1	Speaker, (L)	S	--	--
1_14	RSP-ZA184WJN2	Speaker, (R)	S	--	--
1_15	XEBS930P08000	Screw, x2	R	AA	AA
1_16	LX-HZA003WJFN	Screw, x2	R	AC	AC
2	CCABBA861WJ01	Cabinet B Ass'y	S	AW	BK
2_1	Not Available	Cabinet B	-	--	--
2_2	LHLDWA055WJKZ	Wire Holder, x1	R	AC	AC
3	CCOVAB480WJ01	Top Cover Ass'y	S	--	--
3_1	Not Available	Top Cover	-	--	--
3_2	JBTN-A524WJKA	Power Button	S	--	--
3_3	JBTN-A525WJKA	Operation Button	S	--	--
3_4	MSPRCA068WJFW	Spring, for Power Button	S	--	--
3_5	XEBS930P08000	Screw, x2	R	AA	AA
4	CDAI-A290WJ01	Stand Support Ass'y (LC32-GD8E/RU)	S	--	--
4	CDAI-A290WJ03	Stand Support Ass'y (LC32-BT8E/RU)	S	--	--
4_1	Not Available	Stand Support	-	--	--
4_2	GDAI-A290WJSA	Support Cover (LC32-GD)	S	--	--
4_2	GDAI-A290WJSC	Support Cover (LC32-BT)	S	--	--
4_3	HDECQA600WJKA	Decoration Cover, x4	S	--	--
5	CDAI-A287WJ01	Stand Base Ass'y (LC32-GD8E/RU)	S	--	--
5	CDAI-A287WJ05	Stand Base Ass'y (LC32-BT8E/RU)	S	--	--
5_1	Not Available	Base Cover	-	--	--
5_2	LANGKA748WJZZ	Base Angle	S	--	--
5_3	PSPAZA949WJZZ	Leg Cushion A, x4	S	--	--
5_4	PSPAZA950WJZZ	Leg Cushion B, x4	S	--	--
5_5	XEBS740P10000	Screw, x10	S	--	--
6	R1LK315T3LF15	32" LCD Panel Module	R		
7	GCOVAB488WJKA	Stand Cover	S	--	--
8	HINDPB760WJSA	Model Label (LC32-GD8EE/EK/EF)	S	--	--
8	HINDPB761WJSA	Model Label (LC32-GD8EI)	S	--	--
8	HINDPB762WJSA	Model Label (LC32-GD8RU)	S	--	--
8	HINDPB791WJSA	Model Label (LC32-BT8EE/EK/EF)	S	--	--
8	HINDPB792WJSA	Model Label (LC32-BT8EI)	S	--	--
8	HINDPB793WJSA	Model Label (LC32-BT8RU)	S	--	--
9	LANGKA638WJFW	LCD Angle-A, x2	S	--	--
10	LANGKA639WJFW	LCD Angle-B, x2	S	--	--
11	LANGKA672WJFW	LCD Angle-C, x1	S	--	--
12	LANGTA263WJFW	Center Angle (L)	S	--	--
13	LANGTA266WJFW	Stand Angle	S	--	--
14	LANGTA267WJFW	Center Angle (R)	S	--	--
15	LCHSMA324WJZZ	Chassis Tray	R	--	--
16	LHLDW1033CE00	Wire Holder, x1	R	AA	AA
17	LHLDW1123GEZZ	Wire Holder, x1	R	AB	AB
18	LHLDW1173CEZZ	Wire Holder, x2	R	AD	AD
19	LHLDW1205CEZZ	Wire Holder, x2	R	AC	AC
20	LHLDWA055WJKZ	Wire Holder, x1	R	AC	AC
21	LHLDWA137WJZZ	Wire Holder, x2	R	AB	AB

REF No.	PARTS	DESCRIPTION	*	SN CODE	EX CODE
22	LHLDW1072GEZZ	Wire Holder, x1	R	AA	AA
23	PCUSGA009WJKZ	Cushion Spacer, x1	S	--	--
24	PFLT-A004WJZZ	Felt Sheet, x4	R	AE	AE
25	PMLT-A255WJZZ	Spacer, x1	R	AD	AD
26	PMLT-A315WJZZ	Spacer, x2	R	AP	AP
27	PSLDMA584WJZZ	Shield, x1	R	AE	AE
28	PSLDMA770WJZZ	Shield, x1	S	--	--
29	PSLDMA877WJFW	Control PWB Shield, x1	S	--	--
30	PSLDMA943WJFW	Digital PWB Shield, x1	S	--	--
31	PSPAHA902WJZZ	Spacer, x2	S	--	--
32	DUNTKD890FM06	Main Unit	-	--	--
33	DUNTKD604FM10	AV Unit	-	--	--
34	DUNTKD605FM01	Power Unit	-	--	--
35	DUNTKD628FM01	Digital Unit	-	--	--
36	CKITKD609FM01	DIGITAL TUNER Unit	S	AY	BN
37	DUNTKD606FMV0	Operation Unit	-	--	--
38	DUNTKD607FMV0	R/C, LED Unit	-	--	--
39	QCNW-E232WJQZ	Connecting Cord	R	AG	AG
40	QCNW-E234WJQZ	Connecting Cord	R	AH	AH
41	QCNW-E237WJPZ	Connecting Cord	S	--	--
42	QCNW-E799WJQZ	Connecting Cord	R		
43	QEARPA212WJFW	Ground Part	R	AE	AE
44	QEARZA096WJFW	Ground Part	R		
45	RCORFA023WJZZ	Ferrite Core, x1	R	AK	AK
46	TLABZB122WJZZ	POP Label	S	--	--
47	Not Available	Serial No Label	-	--	--
48	LX-WZA042WJZZ	Washer, x1	S	--	--
49	LX-BZA146WJF7	Screw, x4	S	--	--
50	LX-BZA147WJF7	Screw, x4	S	--	--
51	XBBS930P06000	Screw, x10	R	AA	AA
52	XBPS730P06WS0	Screw, x17	R	AA	AA
53	XBPS830P06000	Screw, x1	R	AA	AA
54	XEBS930P08000	Screw, x4	S	--	--
55	XEBS940P16000	Screw, x11	R	AB	AB
56	XEBSN40P10000	Screw, x5	R	AB	AB
57	XJPS730P04WS0	Screw, x2	S	--	--
58	XJPS730P08WS0	Screw, x19	R	AA	AA
59	RCORFA064WJZZ	FPC Wire Ferrite Core, x2	D		

CABINET AND MECHANICAL PARTS (LC-32GD8E/RU, LC-32BT8E/RU)

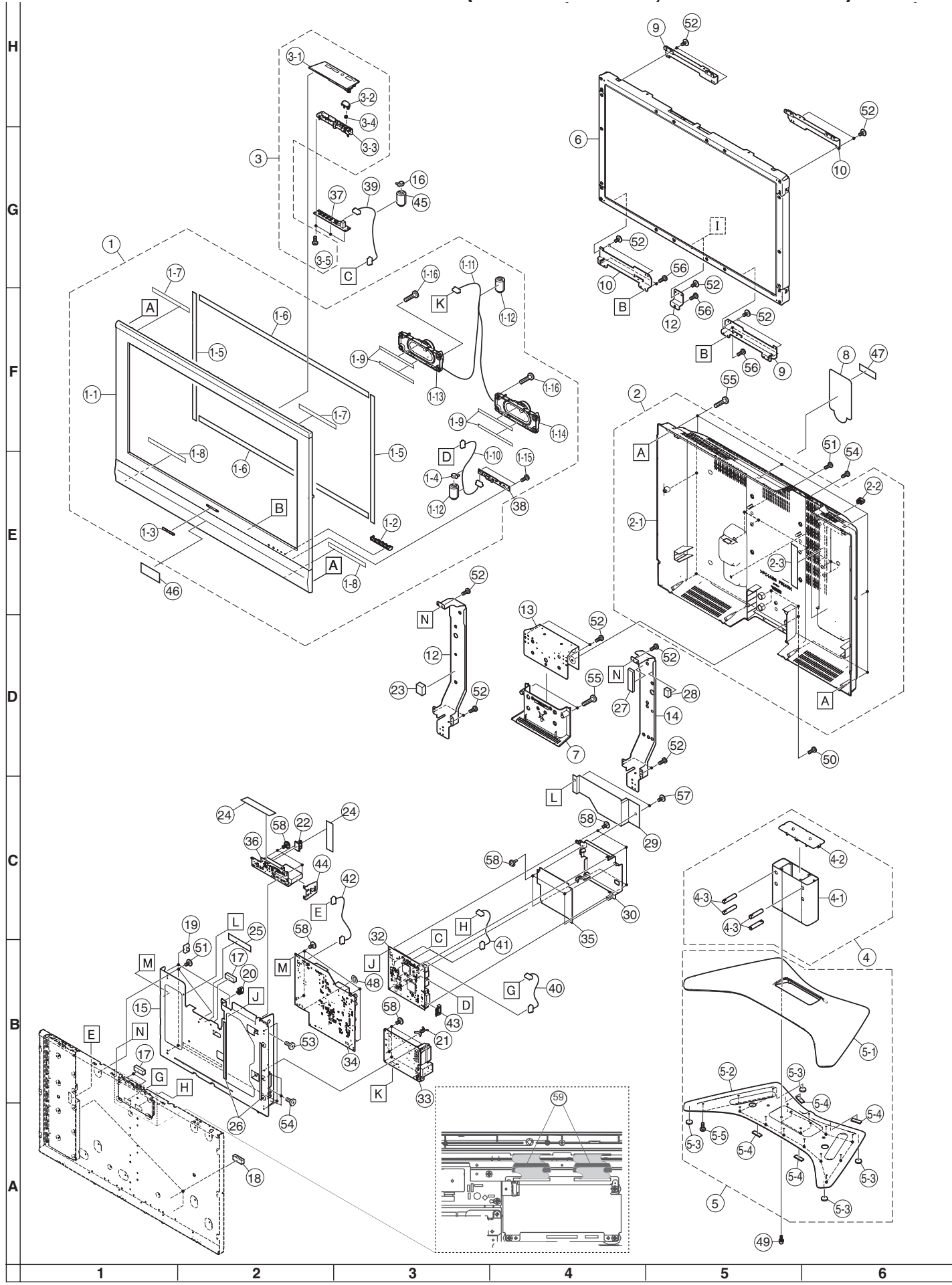

CABINET AND MECHANICAL PARTS LISTING (LC-37GD8E/RU, LC-37BT8E/RU)					
REF No.	PARTS	DESCRIPTION	*	SN CODE	EX CODE
1	CCABAB443WJ01	Cabinet A Assy (LC-37GD8E/RU)	S	--	--
1	CCABAB443WJ02	Cabinet A Assy (LC-37BT8E/RU)	S	--	--
1_1	Not Available	Cabinet A	-	-	-
1_2	GCOVAB478WJSA	R/C, LED Cover	S	--	--
1_3	HDBGAB060WJSA	Badge, "SHARP"	S	--	--
1_4	LX-HZA003WJFN	Screw, x2	S	--	--
1_5	PSPAHA858WJZZ	Mask Spacer, x2	S	--	--
1_6	PSPAHA859WJZZ	Mask Spacer, x2	S	--	--
1_7	PSPA2B211WJZZ	Spacer for Speaker, x4	S	--	--
1_8	QCNW-E413WJQZ	Connecting Cord	S	--	--
1_9	QCNW-E801WJQZ	Connecting Cord	S	--	--
1_10	RCORFA0103CEZZ	Ferrite Core, x1	R	AK	AK
1_11	RCORFA023WJZZ	Ferrite Core, x2	R	AK	AK
1_12	RSP-ZA184WJN1	Speaker-L	S	--	--
1_13	RSP-ZA184WJN2	Speaker-R	S	--	--
1-14	XEBS930P08000	Screw, x2	R	AA	AA
2	CCABBA714WJ01	Cabinet B Assy	S	AY	BM
2_1	Not Available	Cabinet B	-	-	-
2_2	LHLDWA055WJKZ	Wire Holder, x1	R	AC	AC
2_3	PSPAHA823WJZZ	Spacer-A, x1	S	--	--
2_4	PSPAHA824WJZZ	Spacer-B, x1	S	--	--
2_5	PSPAHA834WJZZ	Spacer-C, x2	S	--	--
2_6	PSPAHA826WJZZ	Spacer-D, x2	S	--	--
3	CCOVAB480WJ01	Top Cover Assy	S	--	--
3_1	Not Available	Top Cover	-	-	-
3_2	JBTN-A524WJKA	Power Button	S	--	--
3_3	JBTN-A525WJKA	Operation Button	S	--	--
3_4	MSPRCA068WJFW	Spring, for Power Button	S	--	--
3_5	XEBS930P08000	Screw, x3	R	AA	AA
4	CDAI-A290WJ01	Stand Support Assy (LC-37GD8E/RU)	S	--	--
4	CDAI-A290WJ03	Stand Support Assy (LC-37BT8E/RU)	S	--	--
4_1	Not Available	Stand Support	-	-	-
4_2	GDAI-A290WJSA	Support Cover (LC-37GD8E/RU)	S	--	--
4_2	GDAI-A290WJSC	Support Cover (LC-37BT8E/RU)	S	--	--
4_3	HDECQA600WJKA	Decoration Cover, x4	S	--	--
5	CDAI-A301WJ01	Stand Base Assy (LC-37GD8E/RU)	S	--	--
5	CDAI-A301WJ03	Stand Base Assy (LC-37BT8E/RU)	S	--	--
5_1	Not Available	Stand Base Cover	-	-	-
5_2	LANGKA635WJZZ	Base Angle	S	--	--
5_3	PSPA2A949WJZZ	Leg Cushion A, x4	S	--	--
5_4	PSPA2A950WJZZ	Leg Cushion B, x4	S	--	--
5_5	XEBS740P10000	Screw, x10	S	--	--
6	R1LK370T3L25BX	37" LCD Panel Module	R	EZ	EZ
7	GCOVAB488WJKA	Stand Cover	S	--	--
8	HINDPB763WJSA	Model Label (LC-37GD8EE/EK/EF)	S	--	--
8	HINDPB764WJSA	Model Label (LC-37GD8EI)	S	--	--
8	HINDPB765WJSA	Model Label (LC-37GD8RU)	S	--	--
8	HINDPB794WJSA	Model Label (LC-37BT8EE/EK/EF)	S	--	--
8	HINDPB795WJSA	Model Label (LC-37BT8EI)	S	--	--
8	HINDPB796WJSA	Model Label (LC-37BT8RU)	S	--	--
9	LANGKA672WJFW	LCD Angle C, x1	S	--	--
10	LANGKA675WJFW	LCD Angle, x4	S	--	--
11	LANGTA266WJFW	Stand Angle	S	--	--
12	LANGTA268WJFW	Center Angle (L)	S	--	--
13	LANGTA269WJFW	Center Angle (R)	S	--	--
14	LCHSMA324WJZZ	Chassis Tray	R	--	--
15	LHLDW1033CE00	Wire Holder, x1	R	--	--
16	LHLDW1123GEZZ	Wire Holder, x3	R	AB	AB

REF No.	PARTS	DESCRIPTION	*	SN CODE	EX CODE
17	LHLDW1173CEZZ	Wire Holder, x3	R	AD	AD
18	LHLDW1205CEZZ	Wire Holder, x2	R	AC	AC
19	LHLDWA055WJKZ	Wire Holder, x1	R	AC	AC
20	LHLDW1072GEZZ	Wire Holder, x1	R	--	--
21	PCUSGA009WJKZ	Cushion Spacer			
22	PFLT-A004WJZZ	Felt Sheet, x2	R	AE	AE
23	PMLT-A255WJZZ	Spacer, x1	R	AD	AD
24	PMLT-A315WJZZ	Spacer, x2	R	AP	AP
25	PSHEFA018WJZZ	Sheet, x1	S	--	--
26	PSLDMAT70WJZZ	Shield, x1	S	--	--
27	PSLDMA584WJZZ	Shield, x1	R	AE	AE
28	PSLDMA877WJFW	Control PWB Shield	S	--	--
29	PSLDMA943WJFW	Digital PWB Shield	S	--	--
30	PSLDMA840WJZZ	Shield, x1	R	AD	AD
31	PSPAHA902WJZZ	Spacer, x2	S	--	--
32	DUNTKD890FM07	Main Unit	-	-	-
33	DUNTKD604FM10	AV Unit	-	-	-
34	DUNTKD605FM03	Power Unit	-	-	-
35	DUNTKD628FM01	Digital Unit	-	-	-
36	CKITKD609FM01	DIGITAL TUNER Unit	S	AY	BN
37	DUNTKD606FMV0	Operation Unit	-	-	-
38	DUNTKD607FMV0	R/C LED Unit	-	-	-
39	QCNW-E412WJQZ	Connecting Cord	R	AG	AG
40	QCNW-E415WJQZ	Connecting Cord	R	AP	AP
41	QCNW-E237WJPZ	Connecting Cord	S	--	--
42	QCNW-E419WJQZ	Connecting Cord	R	AM	AM
43	QCNW-E609WJQZ	Connecting Cord	R	AH	AH
44	QEARPA212WJFW	Grounding Part	R	AE	AE
45	QEARZA096WJFW	Grounding Part	S	--	--
46	RCORFA0103CEZZ	Ferrite Core, x2	S	AK	AK
47	TLABZB122WJZZ	POP Label	S	--	--
48	Not Available	Serial No Label	-	-	-
49	LX-BZA146WJF7	Screw, x4	S	--	--
50	LX-BZA147WJF7	Screw, x4	S	--	--
51	XBBS930P06000	Screw, x10	R	AA	AA
52	XBPS730P06WS0	Screw, x17	R	AA	AA
53	XBPS830P06000	Screw, x1	R	AA	AA
54	XEBS930P08000	Screw, x4	S	AA	AA
55	XEBS940P16000	Screw, x11	R	AB	AB
56	XEBSN40P10000	Screw, x5	R	AB	AB
57	XJPS730P04WS0	Screw, x2	S	--	--
58	XJPS730P08WS0	Screw, x4	R	AA	AA
59	RCORFA064WJZZ	FPC WireFerrite Core, x2	D		

PACKING OF THE SET

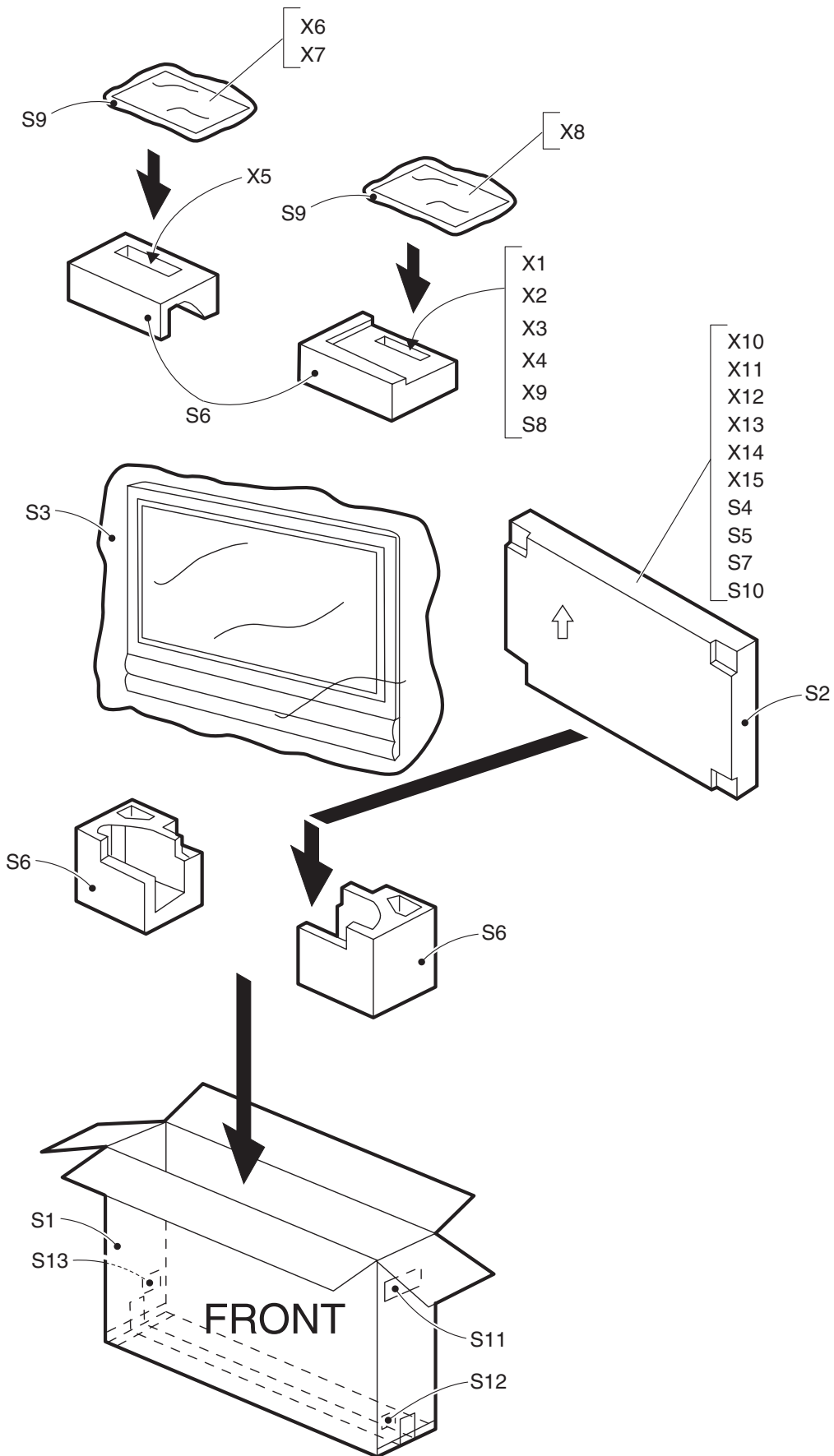

PACKING PARTS LISTING					
REF No.	PARTS	DESCRIPTION	*	SN CODE	EX CODE
S1	SPAKCC720WJZZ	Packing Case (LC-32GD8EE/EK/EF/EI)	-	-	-
S1	SPAKCC795WJZZ	Packing Case (LC-32GD8RU)	-	-	-
S1	SPAKCC756WJZZ	Packing Case (LC-32BT8EE/EK/EF/EI)	-	-	-
S1	SPAKCC759WJZZ	Packing Case (LC-32BT8RU)	-	-	-
S1	SPAKCC721WJZZ	Packing Case (LC-37GD8EE/EK/EF/EI)	-	-	-
S1	SPAKCC796WJZZ	Packing Case (LC-37GD8RU)	-	-	-
S1	SPAKCC757WJZZ	Packing Case (LC-37BT8EE/EK/EF/EI)	-	-	-
S1	SPAKCC760WJZZ	Packing Case (LC-37BT8RU)	-	-	-
S2	SPAKFB018WJZZ	Packing Case (Stand) (LC-32GD8E/RU, LC-32BT8E/RU)	-	-	-
S2	SPAKFA916WJZZ	Packing Case (Stand) (LC-37GD8E/RU, LC-37BT8E/RU)	-	-	-
S3	SPAKPA382WJZZ	Wrapping Paper (LC-32GD8E/RU, LC-32BT8E/RU)	-	-	-
S3	SPAKPA338WJZZ	Wrapping Paper (LC-37GD8E/RU, LC-37BT8E/RU)	-	-	-
S4	SPAKPA601WJZZ	Wrapping Paper (Stand) (LC-37GD8E/RU, LC-37BT8E/RU)	-	-	-
S5	SPAKPA602WJZZ	Wrapping Paper (Stand) (LC-37GD8E/RU, LC-37BT8E/RU)	-	-	-
S4	SPAKPA684WJZZ	Wrapping Paper (Stand) (LC-32GD8E/RU, LC-32BT8E/RU)	-	-	-
S5	SPAKPA685WJZZ	Wrapping Paper (Stand) (LC-32GD8E/RU, LC-32BT8E/RU)	-	-	-
S6	SPAKXA919WJZZ	Buffer Material (LC-32GD8E/RU, LC-32BT8E/RU)	-	-	-
S6	SPAKXA920WJZZ	Buffer Material (LC-37GD8E/RU, LC-37BT8E/RU)	-	-	-
S7	SPAKFB019WJZZ	Buffer Material (Stand) (LC-32GD8E/RU)	-	-	-
S7	SPAKFB027WJZZ	Buffer Material (Stand) (LC-32BT8E/RU)	-	-	-
S7	SPAKFB043WJZZ	Buffer Material (Stand) (LC-37GD8E/RU)	-	-	-
S7	SPAKFB029WJZZ	Buffer Material (Stand) (LC-37BT8E/RU)	-	-	-
S8	SSAKAA009WJZZ	Polyethylene Bag	-	-	-
S9	SSAKAA010WJZZ	Polyethylene Bag, x2	-	-	-
S10	SSAKHA020WJZZ	Polyethylene Bag (Stand)	-	-	-
S11	TLABKA002WJZZ	No. Label	-	-	-
S12	TLABSA050WJZZ	Green Dot Label (LC-32/37GD8E(F), LC-32/37BT8E(F))	-	-	-

SUPPLIED ACCESSORIES PARTS LISTING					
REF No.	PARTS	DESCRIPTION	*	SN CODE	EX CODE
X1	LHLDW0110CESB	Cable Clamp	S	--	--
X2	LHLDWA083WJ00	Cable Tie	S	--	--
△ X3	QACCB A073WJPZ	AC Cord (LC-32/37GD8EK, LC-32/37BT8EK)	S	--	--
△ X3	QACCKA021WJPZ	AC Cord (LC-32/37GD8EE/EF/EI/RU, LC-32/37BT8EE/EF/EI/RU)	S	--	--
X4	QCNWGA075WJPZ	3 RCA to 15-pin D-sub Adapter	S	--	--
X5	RRMCGA472WJSA	Remote Control Unit (LC-32/37GD8E/RU)	S	--	--
X5	RRMCGA490WJSA	Remote Control Unit (LC-32/37BT8E/RU)	S	--	--
X6	TGAN-A077WJZZ	Guarantee card (LC-32/37GD8RU, LC-32/37BT8RU)	S	--	--
X6	TGAN-A342WJZZ	Guarantee card (LC-32/37GD8EK, LC-32/37BT8EK)	S	--	--
X6	TGAN-A512WJZZ	Guarantee card (LC-32/37GD8EK, LC-32/37BT8EK)	S	--	--
X7	TINS-C483WJZZ	Operation Manual (LC-32/37GD8EE/EK/EF/EI, LC-32/37BT8EE/EK/EF/EI)	S	AK	AW
X7	TINS-C484WJZZ	Operation Manual (LC-32/37GD8EE/EF, LC-32/37BT8EE/EF)	S	AK	AW
X8	TINS-C485WJZZ	Operation Manual (LC-32/37GD8EE, LC-32/37BT8EE)	S	AH	AT
X7	TINS-C486WJZZ	Operation Manual (LC-32/37GD8RU, LC-32/37BT8RU)	S	AD	AL
X9	Not Available	"AAA" size Battery, x2	-	-	-
X10	CDAI-A290WJ01	Stand Support (LC-32/37GD8E/RU)	S	--	--
X10	CDAI-A290WJ03	Stand Support (LC-32/37BT8E/RU)	S	--	--
X11	CDAI-A287WJ01	Stand Base (LC-32GD8E/RU)	S	--	--
X11	CDAI-A287WJ05	Stand Base (LC-32BT8E/RU)	S	--	--
X11	CDAI-A301WJ01	Stand Base (LC-37GD8E/RU)	S	--	--
X11	CDAI-A301WJ03	Stand Base (LC-37BT8E/RU)	S	--	--
X12	LX-BZA146WJF7	Screw, x4	S	--	--
X13	LX-BZA147WJF7	Screw, x4	S	--	--
X14	TCAUZA229WJZZ	Caution Sheet (LC-37BT8E/RU)	S	--	--
X15	UKOGLA001WJZZ	Tool For Stand	S	--	--

SERVICE JIGS (USE FOR SERVICING)					
REF No.	PARTS	DESCRIPTION	*	SN CODE	EX CODE
EXTENSION CABLES					
	QCNW-E542WJZZ	23pins Board to Board	J		
	QCNW-E543WJZZ	9pins Board to Board	J		
	QCNW-E544WJZZ	15pins Board to Board	J		
	QCNW-E546WJZZ	7pins Board to Board	J		
	QCNWKA011WJZZ	Extension Cable for Digital Unit	S	AW	BH
SOFTWARE UPGRADING JIG					
1	CKIT-0004WJV0	P55 VCTP SOFT UPDATING WITH WIRE 20 TO 3	S	BC	BT
1.1	QPWBX0004WJZZ	P55 I2C INTERFACE PWB (NOT AVAILABLE)	-	-	-
1.2	QCNWGA100WJZZ	WIRE 20 TO 3 PIN SOFT UPDATING P55	S	AM	AY
2	QCNWGA015WJPZ	Cable adaptor (DB9 male to mini-Din 9 pin male)	S	AG	AS
3	QCNWKA012WJZZ	P70 Digital Board Software Updating Jig	S	AZ	BP