

LCN GENERAL CATALOG



LCN CLOSERS

121 West Railroad Avenue
P.O. Box 100
Princeton, IL 61356-0100

Phone 800-526-2400
Fax 800-248-1460
Web Site: www.lcn.ingersollrand.com
E-Mail: lcinfo@irco.com

**To request this catalog on CD or to view or download an electronic copy, visit our website.
LCN reserves the right to change the information contained in this catalog without notice.**



A BRIEF HISTORY of DOOR CLOSERS & LCN

Trinity Church...

In 1876, **Mr. L. C. Norton** was sent to Boston, Massachusetts to help build the Boston Trinity Church. The church took over four years to complete. The church was located on the Back Bay facing south and west thus at times, encountering some very severe wind conditions. The church began operation in 1880, the pastor, Rev. Brooks and his congregation quickly found out that the strong winds would make the doors close with a thunderous bang. Needless to say, the pastor was not going to stand for all the noise; those doors needed to be controlled! This prompted Mr. Norton to action.



Mr. Norton's first attempt to remedy the situation was to hang the doors on double-spring hinges. Mr. Norton had now uncovered a second problem. The slamming stopped but now the strong winds made the doors stand open. The cold, drafting air raised protest amongst the people in the church. He tried rubber stops, special door linings, and some other ideas. Nothing worked. One day, continuing to ponder the problem with the doors at the Trinity Church, he put some things away in a closet and being in a hurry, he threw the door shut. To his amazement, the door did not slam. Instead, the door bounced back. He tried this over and over with the same result. An idea came to him; he rushed to town and purchased a beer pump. With the beer pump, a makeshift arm, and some special brackets he had designed, Mr. Norton installed his invention on one of the exterior church doors. He opened the door and let it go...CRASH! The door slammed so hard it broke the pump into many pieces.

Mr. Norton spent many months trying to solve the problem; finally, he used the principles of the lever, improved the main components, and decided to reposition the device on the door. He took his updated version and again installed it on one of the troublesome church doors. Rev. Brooks saw Mr. Norton's new design and to his delight, the closer

worked perfectly. Mr. Norton had used air pressure to make the doors close quietly. The problems with the doors at the Boston Trinity Church were now solved.

Growing Pains...

Soon after the doors at the Trinity Church were under control, Mr. Norton formed a company to manufacture his new found invention. The factory was located in Boston, Massachusetts and business started out strong. In fact, at times, there were more orders than production could match.

Time flew by. Mr. Norton's company began to experience difficulty. Competition was fierce. Some competitors began to infringe on patents, which drained Mr. Norton of both cash flow and other resources. Mr. Norton also made a few business decisions that would hamper company growth. The early years presented other challenges too. New closer designs were being introduced at an increasingly fast pace. This quick growth brought about some challenging quality issues. Business associates both good and bad, came and went. The factory moved to Brooklyn, New York and then back to Boston, Massachusetts. In these years, the door closer business was a volatile one. Most good companies were forced into change whether they liked it or not. The door closer industry was no exception.

New Beginnings...

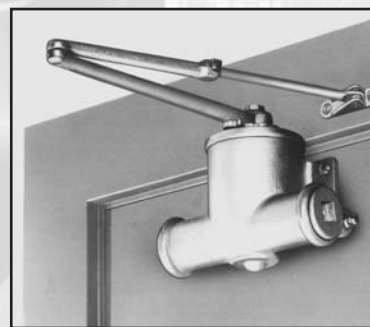

Competition drove Mr. Norton in a new direction. His air check had worked well but was slowly giving way to new technology. In 1900, Mr.

Norton developed a liquid door check. This new liquid door check controlled the door through the entire door swing by incorporating three independent hydraulic regulations. Back-check, general speed, and latch speed were necessary for total door control. In 1908, the company was moved to Chicago, Illinois. By the early 1920's, the door closer business was doing well but Mr. Norton was wearing down, he needed help.

In 1925, **Mr. L. C. Norton** teamed with **Mr. D. R. Lasier** and formed the Norton-Lasier Company. The business was located at 466 West Superior Street in Chicago, Illinois. Norton & Lasier knew that if their company was to survive, they must build a far superior product at a very fair price. They called their improved door closer an LCN. After a few years, Mr. Norton left the business to Mr. Lasier and moved to California. During the years of 1926 through 1948, under the leadership of **Mr. D. R. Lasier**, LCN manufactured and shipped high-quality traditional style closers all over the world. Many of these closers are still in use today. In 1949, the factory moved to Princeton, Illinois. In 1958, LCN introduced

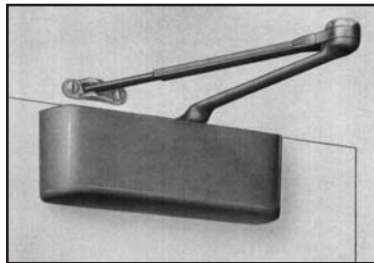

the heavy-duty 4010/4110 series closer. Schlage Lock Company purchased LCN in 1959. In 1974, Ingersoll-Rand

purchased Schlage Lock Company (and LCN). Today, LCN offers a complete line of door control products including heavy-duty hydraulic closers, power operators, fire/life safety closer/holders, high security closers & more.

The model numbers may have changed but the passion, quality, and excitement will always remain. Cast iron, forged steel arms, double heat treating, powder coat finishes, all-weather fluid, and 10 million cycles are just a few of the features and benefits that LCN offers in producing the finest door closers in the world!



- 1851** – Lewis C. Norton born May 5th in New Hampshire.
- 1880** – First door closer installed at Boston Trinity Church.
- 1881** – Manufacturing begins at Boston plant.
- 1900** – Mr. Norton introduces a liquid door check.
- 1908** – Company moves to Chicago.
- 1917** – David R. Lasier joins company as timekeeper.
- 1925** – Norton-Lasier Company begins operation.
- 1929** – L. C. Norton moves to California. D. R. Lasier heads up company.
- 1930** – Norton-Lasier Company produces wooden riding toys to cope with the Great Depression.
- 1937** – L. C. Norton passes away on November 4th.
- 1942** – Norton-Lasier Company produces hydraulic aircraft fittings for the war effort.
- 1948** – Norton-Lasier Company officially changes name to **LCN**.
- 1958** – **LCN** introduces the 4010/4110 series door closer.
- 1959** – **LCN** sold to Schlage Lock Company.
- 1972** – **LCN** introduces Sentronic line of fire/life safety holder/closers.
- 1973** – **LCN** introduces the 4040 series door closer.
- 1974** – Schlage Lock (and LCN) sold to Ingersoll-Rand.
- 1978** – **LCN** introduces Equalizer units.
- 1980** – Production on traditional series ends.
- 1981** – **LCN** introduces the 1460 series door closer.
- 1981** – **LCN** introduces AutoEqualizer™ units.
- 1985** – **LCN** introduces the 1070 series door closer.
- 1993** – **LCN** introduces the powder coat finish.
- 1995** – **LCN** introduces Electric Operator units.
- 1996** – **LCN** introduces the 1520 series door closer.
- 1998** – **LCN** introduces the 1370 series door closer.
- 2006** – **LCN** introduces the new 4030 series door closer to replace the 1520 closer series.
- 2006** – **LCN** introduces the new Senior, Astro and Middle Swing Digital Control Box.
- 2007** – **LCN** introduces the new Tri-Volt Magnets.
- 2007** – **LCN** introduces the new 4040XP.
- 2007** – **LCN** introduces the new 1260 Series.

LCN TABLE OF CONTENTS

GENERAL SECTION

History of the Door Closer & LCN	2-3
Table of Contents	4
Finishes	5
Warranty	6
Door Closer Specialists	7
SSC Representative List	8
Contact Information.....	9
Suggested Specification.....	10-12
BMHA Cross Reference	13-16
Trademarks/Materials.....	17
Proper Door Control	18
Mechanical Considerations	19-24
Glossary of Abbreviations	26
Glossary of Terms.....	27-36

4000 SERIES SURFACE MOUNTED CLOSERS

Product Selection Guide.....	1
4010	3
4010T	9
4020	15
4020T	19
4030	25
4030T	33
4040/4040XP	39
4040T	51
4110	59
4110T	65
4000T	71

1000 SERIES SURFACE MOUNTED CLOSERS

Product Selection Guide.....	1
1260	3
1460	11
1460T	21

CONCEALED CLOSERS

Product Selection Guide.....	1
330	3
2010	7
2030	11
3030	17
3130	21
5010	25
5030	29
6030	33

FIRE/LIFE SAFETY CLOSER/HOLDERS

Product Selection Guide.....	1
7800SEM	5
3130SE	13
4040SE	17
2310ME	23
4310ME	27
4410ME	33

FIRE/LIFE SAFETY CLOSER/HOLDERS Cont.

4310HSA	39
4410HSA	43
SEH.....	47

HIGH SECURITY CLOSERS

Product Selection Guide.....	1
2210	3
4210	7
4210T	11
4510	15
4510T	19

AUTOMATIC OPERATORS

Product Selection Guide	1-6
Pneumatic Powered Systems	7-10
2610 Pneumatic	11
4810 Pneumatic	15
4820 Pneumatic	19
4840 Pneumatic	23
7900 Series Control Boxes	28-30
7900 Series Control Boxes Accessories.....	31-33
900 Series Compressors.....	34
Electrohydraulic Powered Systems	35-40
4630 Electrohydraulic	41
4640 Electrohydraulic	47
Electromechanical Powered Systems	53-58
9130 Electromechanical	61
9140 Electromechanical	67
9150 Electromechanical	73
2810 Electromechanical	81
2850 Electromechanical	87
2860 Electromechanical	93
9530 Electromechanical	99
9540 Electromechanical	105
9550 Electromechanical	111
9560 Electromechanical	117
2910 Electromechanical	125
2950 Electromechanical	131
2960 Electromechanical	137
9730 Electromechanical	143
9740 Electromechanical	149
9750 Electromechanical	155
9760 Electromechanical	161
2510 Electromechanical	169
2550 Electromechanical	175
9330 Electromechanical	181
9340 Electromechanical	187
9350 Electromechanical	193
Actuators & Accessories	199-216

DOOR HARDWARE PRODUCTS

PAH 60	1
Safety-Guard	2

LCN THE DOOR CLOSER SPECIALISTS

Since its founding in 1926, LCN has specialized in solving door control problems through the use of high quality, innovative door control products. By adhering to high standards of performance, LCN has earned a leadership role within the industry and is committed to meeting door control challenges of the future. With representatives located throughout the world, LCN provides the products and services necessary to solve your door control problems.

The LCN formula for success



Cast Iron

Heavy-duty cast iron. There isn't a stronger, harder, more reliable material for door closers that are expected to deliver millions of cycles. Cast iron is more compatible with high grade steel components and is more resistant to the wear of millions of opening/closing cycles.



10 Million Cycles

Why do some hardware professionals claim that LCN stands for "Last Closer Needed?" LCN closers were put through grueling independent cycle tests and have exceeded 10 million cycles.



Forged Steel Arms

The closing power and control generated within LCN closers is transferred to the door through forged steel arms. Forged steel arms have greater strength, better appearance and less bulk.

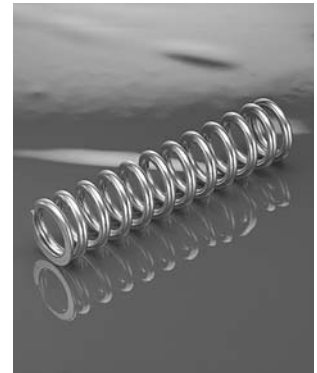

Chrome Silicon

Many closer manufacturers use less expensive oil-tempered springs, but LCN engineers know that such a spring loses up to 20% of its power after a few thousand cycles. The chrome silicone springs used in LCN closers have the strength to perform beyond 10 million cycles.



Heat-Treated

LCN steel pinions have larger, stronger teeth and are double heat-treated for the greatest possible strength on the shaft. Heat treating makes the pinion harder, better able to resist wear after years of service and results in less stress on the cylinder.



Special Templates

When a standard door closer won't do the job, there is only one proven, reliable source for special solutions—LCN. With over 3,000 special templates on file, LCN can provide a door control solution for one-of-a-kind doors such as vault, balanced, oversized and arch doors.



Hydraulic Fluid

LCN uses a special formula hydraulic fluid with special lubrication properties to keep closer components working smoothly. This unique all-weather hydraulic fluid eliminates the need for seasonal adjustments.



Customer Service

At a time when machines are picking up more and more customer calls, real people are answering the phones at LCN. Every member of our customer service staff is trained and qualified to assist you with orders, closer selection and special applications.

SSC REPRESENTATIVE INFORMATION

Security Technologies Consultants

New England
77 Wexford Street
Box 801
Needham Heights, MA 02494
Phone (781) 449-2860
Fax (781) 449-5734

Security Technologies Consultants

Metro New York
7 West Cross Street
Hawthorne, NY 10532
Phone (914) 747-4200
Fax (914) 747-4040

Security Technologies Consultants

Great Lakes
1169 Pittsford Victor Rd
Building 3, Suite 250
Pittsford, NY 14534
Phone (585) 381-1360
Fax (585) 381-1509

Security Technologies Consultants

Mid Atlantic
824 Philadelphia Pike
Wilmington, DE 19809
Phone (302) 765-2190
Fax (302) 765-2192

Security Technologies Consultants

Carolinas
800 - B Beaty St.
Davidson, NC 28036
Phone (704) 549-1999
Fax (704) 549-8010

Security Technologies Consultants

South
3120 Medlock Bridge Road
Building A1
Norcross, GA 30071
Phone (770) 662-0059
Fax (770) 662-0509

Security Technologies Consultants

Florida
735 W. State Road 434
Suite H
Longwood, FL 32750
Phone (407) 571-2000
Fax (407) 571-2006

Security Technologies Consultants

Michigan
37564 Amrheim Rd.
Livonia, MI 48150
Phone (734) 655-8181
Fax (734) 655-8183

Security Technologies Consultants

Midwest
6810 Hillisdale Court
Indianapolis, IN 46250
Phone (877) 238-2022
Fax (877) 238-2024

Security Technologies Consultants

Chicago
2171 Executive Dr. Suite 200
Addison, IL 60101
Phone (877) 282-1721
Fax (630) 652-4898

Security Technologies Consultants

North Central
6230 Bury Dr.
Eden Prairie, MN 55346
Phone (952) 674-4940
Fax (952) 893-3061

Security Technologies Consultants

Central
2119 East Kansas City Rd.
Olathe, KS 66061
Phone (913) 393-8700
Fax (913) 393-8720

Security Technologies Consultants

Central / St Louis Office
12900 Enterprise Way
Bridgeton, MO 63044
Phone (636) 343-0100
Fax (314) 298-4873

Security Technologies Consultants

Texas
5200 Tennyson Pkwy Suite 300
Plano, TX 75024
Phone (972) 378-1191
Fax (972) 377-9536

Security Technologies Consultants

Texas / Houston Office
13810 Hollister Rd. Suite 100
Houston, TX 77086
Phone (713) 683-6400
Fax (713) 683-6446

Security Technologies Consultants

Mountain States
6377 South Revere Parkway
Suite 101
Centennial, CO 80111
Phone (303) 790-8240
Fax (303) 790-8260

Security Technologies Consultants

Mountain States / SLC Office
300 Mercer Way
Salt Lake City, UT 84115
Phone (801) 401-5400
Fax (801) 401-5401

Security Technologies Consultants

Southwest
315 S. 48th Street
Suite 104
Tempe, AZ 85281
Phone (866) 494-7772
Fax (866) 655-7263

Security Technologies Consultants

Northwest
19017-120th Avenue, NE
Suite 101
Bothell, WA 98011
Phone (425) 402-4114
Fax (425) 402-4116

Security Technologies Consultants

Northwest / Vancouver Office
501 SE Columbia Shores Blvd. Suite 300
Vancouver, WA 98661
Phone (360) 356-3035
Fax (360) 546-2616

Security Technologies Consultants

Northern California
6689 Owens Dr. Suite 200
Pleasanton, CA 94588
Phone (925) 462-4777
Fax (925) 846-5952

Security Technologies Consultants

Southern California
488 E. Santa Clara Street
Suite 101
Arcadia, CA 91006
Phone (626) 359-5555
Fax (626) 359-1511

CONTACT INFORMATION

IR SECURITY TECHNOLOGIES

Administrative Offices

11819 N. Pennsylvania St.
Carmel, IN 46032
317-810-3700
www.securitytechnologies.ingersollrand.com

INTERNATIONAL & CANADA

International Division - Canada

IR Security Technologies
1076 Lakeshore Road East
Mississauga, Ontario,
L5E 1E4, Canada
905-278-6128
905-278-1413 FAX
877-590-4734

Ingersoll-Rand S.A. De C.v.

Mexico

Ingersoll-Rand Architectural Hardware
Blvd. Centro Industrial No. 11
Industrial Puente De Vigas
54090 Tlalnepantia, Edo De Mex.
Mexico
Tel 525-390-2484
Fax 525-390-4031

Ingersoll-Rand Architectural Hardware France

Hameau de Malzaize BP 96
76360 Pissy-Poville
France
Tel +33(0)2 32949595
Fax +33(0)2 35927651

Ingersoll-Rand Architectural Hardware U.K.

Ingersoll-Rand Architectural Hardware
Bescot Crescent
Walsall, West Midlands WS1 4DL
England - UK
Tel +44(0)1922 707400
Fax +44(0)1922 646303
www.irarchitecturalhardware.co.uk

DOMESTIC

DOR-O-MATIC CLOSERS

Administrative Offices

121 W. Railroad Avenue
P.O. Box 100
Princeton, IL 61356-0100
800-815-1517
800-666-0472 FAX
www.doromatic.com

DOR-O-MATIC EXIT DEVICES

Administrative Offices

2720 Tobey Drive
Indianapolis, IN 46208
317-613-8944
317-613-8302 FAX
Customer Service
877-243-4830
877-793-6177 FAX

FALCON LOCK COMPANY

Administrative Offices

1915 Jamboree drive, Ste. 165
Colorado Springs, CO 80920
719-388-7300
719-388-7301 FAX

FALCON LOCK COMPANY

Customer Service

2315 Briargate Parkway
800-266-4456
800-777-8229 FAX
www.falconlock.com

GLYNN-JOHNSON

Administrative Offices

2720 Tobey Drive
Indianapolis, IN 46219
317-613-8944
317-613-8302 FAX
Customer Service
877-613-8766
877-424-8494 FAX
www.glynn-johnson.com

IVES

Administrative Offices

2720 Tobey Drive
Indianapolis, IN 46219
317-613-8944
317-613-8302 FAX
Customer Service
877-613-8766
877-424-8494 FAX
www.iveshardware.com

LCN

Administrative Offices

121 W. Railroad Avenue
P.O. Box 100
Princeton, IL 61356-0100
815-875-3311
815-879-1497 FAX
Customer Service
800-526-2400
800-248-1460 FAX
www.lcn.ingersollrand.com

MONARCH HARDWARE

Administrative Offices

805 N. Buckman Street
Shepherdsville, KY 40165
800-826-5792
800-924-3551 FAX
www.monarchhardware.com

RECOGNITION SYSTEMS

Administrative Offices

1520 Dell Avenue
Campbell, CA 95008
408-341-4100
800-700-7447
408-341-4101 FAX
www.handreader.com

SCHLAGE

Administrative Offices

1915 Jamboree Drive, Ste. 165
Colorado Springs, CO 80920
719-388-7300
719-388-7301 FAX

Customer Service

2315 Briargate Parkway
Colorado Springs, CO 80920
800-847-1864
800-452-0663 FAX
Order Entry: 800-452-0665 FAX
www.schlage.com

STEELCRAFT

Administrative Offices

9017 Blue Ash Road
Cincinnati, OH 45242
513-745-6400
800-243-9780
513-745-6657 FAX
www.steelcraft.com

VON DUPRIN

Administrative Offices

2720 Tobey Drive
Indianapolis, IN 46219
317-613-8944
317-613-8302 FAX
Customer Service
800-999-0408
800-999-0328 FAX
www.vonduprin.com

LCN SPECIFICATIONS

PART 1 - GENERAL

1.1 QUALITY ASSURANCE

A. Reference Standards

- American National Standards Institute (ANSI/BHMA):
 - A117.1 Providing Accessibility and Usability for Physically Handicapped People
 - A156.10 For Power Operated Pedestrian Doors
 - A156.4 Door Controls - Closers
 - A156.15 Life Safety Closer Holder Release Devices
 - A156.18 Materials and Finishes
 - A156.19 Power Assist and Low Energy Power Operated Doors
- Americans with Disabilities Act (ADA)
- American Society for Testing and Material (ASTM): Specification B117-9 Method of Finish Corrosion Testing
- Underwriters Laboratory (UL):
 - 228 Door Closers-Holders
 - UL10C Standard Positive Pressure Fire Test of Door Assemblies
 - UL10B Standard for Fire Test of Door Assemblies
- National Fire Protection Association (NFPA):
 - No. 80 Fire Doors and Windows
 - No. 101 Life Safety Code

B. Source Quality Control

- Obtain each kind of hardware (latch and lock sets, hinges, closers, etc.) from only one manufacturer, although several may be indicated as offering products complying with requirements.
- All products shall meet grade 1 or the highest level of cycle test requirements of the applicable ANSI/BHMA standard.

C. Supplier Qualifications

- Supplier must be a recognized builders hardware supplier who has been furnishing hardware in the projects vicinity for a period of not less than two years.
- Supplier must be or employ an experienced hardware consultant who is available, at reasonable times during the course of the work, for consultation about the project's hardware requirements, to Owner, Architect, and Contractor.

D. Fire-rated Openings

- Provide hardware for fire rated openings in compliance with NFPA Standard No. 80, NFPA Standard No. 101, and local building codes.
- [Manual hold-open arm function not allowed.]** Provide hardware which has been tested and listed by UL for types and sizes of doors required and complies with the requirements of door and frame labels.

PART 2 - PRODUCTS

2.3 MATERIALS AND FABRICATION

A. General

- Closers shall be installed to allow door swing as shown on plans. Doors swinging into exit corridors should provide for corridor clear width as required by codes.

2.8 CLOSERS AND DOOR CONTROL DEVICES

A. General

All closers shall be as manufactured by LCN CLOSERS, Princeton, Illinois, USA, and shall have the following features:

- [Applies to 4010, 4020, 4040, 4110, 4210, 4510, 5010 Series only.]** All manual door closers shall be certified to exceed ten million (10,000,000) full load operating cycles by a recognized independent testing laboratory.
- All manual closers shall carry a manufacturers ten (10) year warranty.
- All closers with electrical or pneumatic components shall carry a manufacturers two (2) year warranty. **[Items 4 through 12 apply to closer cylinder, items 13 through 16 apply to closer arms.]**
- Fully hydraulic, rack and pinion action with high strength cast iron cylinders and one piece forged steel pistons.
- Fluid of a type requiring no seasonal adjustments.
- [Delete for 1460, 1260, 330, 3030, 3130 and 4030 Series.]** Pinion shaft minimum diameter of 11/16".
- Hydraulic regulation controlled by tamper-proof, non-critical screw valves, adjustable with a hex wrench.
- Separate adjustments for backcheck, general speed, and latch speed.
- [Applies to 1260, 1460, 4010, 4020, 4040, 4110, 4210, 4510, 5010 Series.]** Where detailed on double lever arm closers, provide a delayed action feature to delay closing up to one minute from maximum opening to approximately 75°.
- Backcheck shall be properly located for protection of the door, frame, and applied hardware.
- [Applies to 2210, 4110, 4210, 4210T, 4510, and 4510T Series only.]** Where detailed, provide advanced variable backcheck to start backcheck function at approximately 45°.
- Include high efficiency, low friction full compliment pinion bearings.
- [Delete for 1260, 1460, 6030 Series.]** Forged steel main arms.
- [Applies to 4110, 4210, 4510 Series and all EDA and CUSH arms.]** Forged steel main and forearm.
- [Applies to all single lever arm (track type) closers.]** Where detailed, provide a quiet, low friction track and roller assembly and provisions for an optional bumper assembly to assist backcheck and/or hold-open clip.
- [Applies to all double lever arm closers, except EDA or CUSH arms.]** Reversible shoe to increase latching power of the closer.

B. Size of Closers

1. Sized in accordance with ANSI/BHMA Standard A156.4 as shown in the applicable TABLE OF SIZES listed in the current LCN General Catalog.
2. **[Applies to 330, 2010, 2310ME, 2610, 3030, 4010T, 4020T, 4110T, 4210T, 4310ME, 4410ME, 4510T Series.]** Closing power of sized closers shall be adjustable to increase closing power fifteen (15) percent.
3. **[Applies to 2030, 6030 Series.]** Closing power of sized closers shall be adjustable to increase closing power thirty five (35) percent.
4. **[Applies to 1460T, 2210, 4010, 4020, 4110, 4210, 4510, 4820, 5010, 5030 Series.]** Closing power of sized closers shall be adjustable to increase closing power fifty (50) percent.
5. Closing power of non-sized cylinders shall be adjustable over a range of sizes; **[Applies to 1261, 1461, 1460T, 4011, 4021, 4040SE, 4041, 4041T, 4111, 4211, 4511, 4631, 4642, 4811, 4822, 4841, 4031, 4031T Cylinders.]**

C. Barrier Free Manual Closers

1. All closers for openings that must meet the minimum requirements of the ADA act, in lieu of ANSI/BHMA Standard A156.4, shall be sized in accordance with the applicable REDUCED OPENING FORCE table in the current LCN General Catalog.
2. All size 1 manual closers shall provide or be adjustable to provide less than 5 pounds opening force on a 36" door leaf and delay closing time in accordance with the ADA requirements.

D. Combination Door Closers and Holders

1. Provide closer/holders designed to hold the door in the open position under normal usage and to release and automatically close the door under fire conditions. Closer will include an integral electro-magnetic holder mechanism designed for use with UL listed fire detectors, provided with normally closed switching contacts.
2. **[Applies to all ME models.]** Where detailed, multi-point closer/holders shall incorporate a hold-open bypass feature from 0° up to either 80° or 140°.
3. **[Applies to 4310 ME only.]** Where detailed, multi-point closer/holders shall provide a swing-free function with a no-drift feature.

E. High Security Closers

1. Provide closers designed to resist vandalism and tampering.
2. All exposed fasteners shall be TORX machine screws with a security pin.
3. All closer adjustments shall be shielded by the cover or finish plate, after installation.
4. Arm and, where furnished, high security roller assembly shall be designed to prevent disassembly.
5. **[4210 and 4510 Series only.]** All surface mounted high security closers shall include a cast iron cylinder certified by an independent testing

- laboratory to exceed ten million (10,000,000) operating cycles, heavy gauge metal covers with four mounting screws and double lever arms manufactured to prevent disassembly.
6. **[4210T and 4510T Series only.]** All surface mounted high security closers shall include a cast iron cylinder certified by an independent testing laboratory to exceed ten million (10,000,000) operating cycles, heavy gauge metal covers with four mounting screws, heavy duty arm with special security roller, and a heavy gauge high security track designed to eject foreign objects.
 7. **[2210 and 2210 DPS only.]** All concealed high security closers shall include a cast iron cylinder certified by an independent testing laboratory to exceed ten million (10,000,000) operating cycles, 3/8" steel mounting plate, heavy duty arm with special security roller, and a heavy gauge high security track designed to eject foreign objects.
 8. **[2210 DPS only.]** A built-in door position switch shall be optional with concealed closers.

F. Automatic Operators

1. Where low kinetic energy, as defined by ANSI/BHMA Standard 156.19, automatic operators are indicated for doors required to be accessible to the disabled. Provide pneumatic, electrohydraulic or electromechanical **[2610, 2810, 2850, 2860, 2910, 2950, 2960, 4630, 4640, 4810, 4820, 4840, 9130, 9140, 9150, 9530, 9540, 9550, 9560, 9730, 9740, 9750, 9760 Series]** operators complying with the ADA for opening force and time to close standards.

-Or-

1. Where high energy, as defined by ANSI/BHMA Standard 156.10 automatic operators are indicated for pedestrian doors. Provide electromechanical high energy operators **[2510, 2550, 9330, 9340, 9350 Series]**. These automatic operators require the use of guide rails and safety devices. Must be installed by a certified American Association of Automatic Door Manufacturers Installer (AAADM installer).
2. Full closing force shall be provided when the power or assist cycle ends **[2610, 2810, 2850, 2860, 2910, 2950, 2960, 4630, 4640, 4810, 4820, 4840, 9130, 9140, 9150, 9530, 9540, 9550, 9560, 9730, 9740, 9750, 9760 Series]**.
3. **[2610, 4810, 4820, 4840]** Locate power unit and pneumatic exhaust away from door to minimize noise and vibration in pedestrian areas.
4. All automatic operator systems shall include the following features and functions.
 - a) Provisions for separate conduits to carry high and low voltage wiring in compliance with the National Electrical Code, section 725-31.
 - b) The operator will be designed to prevent damage to the mechanism if the system is actuated while the door is latched or if the door is forced closed during the opening cycle.
 - c) All covers, mounting plates and arm systems shall be powder coated and successfully pass a minimum

LCN SPECIFICATION

of 100 hours testing as outlined in ANSI/BHMA Standard A156.18 [2610, 4630, 4640, 4810, 4820, 4840 Series].

-Or-

c) Electromechanical automatic operators shall be standard anodized either in aluminum or dark bronze. Custom anodized finishes and custom paint are available and can be specified. [2810, 2850, 2860, 2910, 2950, 2960, 9130, 9140, 9150, 9530, 9540, 9550, 9560, 9730, 9740, 9750, 9760 Series]

d) UL listed for use on labeled doors

e) [4630, 4640, 4810, 4820, 4840 Series] shall be non-handed with spring power over a range of at least four sizes either 1 through 4 or 2 through 5.

-Or-

e) [2810, 2850, 2860, 2910, 2950, 2960, 9130, 9140, 9150, 9530, 9540, 9550, 9560, 9730, 9740, 9750, 9760 Series] are handed and feature a spring return.

f) Provisions in the control box or module shall provide control {inputs and outputs} for; electric strike delay, auxiliary contact, sequential operations, fire alarm systems, actuators, swing side sensors, stop side sensors. [2610, 4630, 4640, 4810, 4820, 4840, 9130, 9140, 9150 Series]

5. [4630, 4640 Series] All electrohydraulic automatic operators shall include the following features or functions:

- Second Chance Feature: When an obstruction or resistance to the opening swing is encountered the operator will pause at that point, then attempt to continue opening the door. If the obstruction or resistance remains, the operator will again pause the door.
- Easily accessible main power and maintain hold-open switches will be provided on the operator.
- An electronically controlled clutch to provide adjustable opening force.
- A microprocessor to control all motor and clutch functions.
- An on-board power supply capable of delivering both 12V and 24V outputs up to a maximum of 1.0 ampere combined load.
- All input and output power wiring shall be protected by a resettable circuit breaker.

-Or-

5. All electromechanical automatic operators shall include the following features of functions:
- Maximum 8 1/2 lbs of manual opening force [2910, 2950, 2960, 9130, 9140, 9150, 9730, 9740, 9750, 9760 Series].
 - Maximum 15 lbs of manual opening force [2810, 2850, 2860, 9530, 9540, 9550, 9560 Series].
 - Maximum 30 lbs of manual opening force [2510, 2550, 9330, 9340, 9350 Series].
 - Bottom loaded header for easy access to controls [2810, 2850, 2860, 2910, 2950, 2960, 9540, 9550,

9560, 9730, 9740, 9750, 9760 Series].

e) Power Boost, which adds an additional 25 lbs of closing force at latch [2510, 2550, 2810, 2850, 2860, 9330, 9340, 9350, 9530, 9540, 9550, 9560 Series].

f) Self contained automatic operators in a cast aluminum housing and a forged steel arm [2510, 2550, 2810, 2850, 2860, 2910, 2950, 2960, 9130, 9140, 9150, 9330, 9340, 9350, 9530, 9540, 9550, 9560, 9730, 9740, 9750, 9760 Series].

2.12 HARDWARE FINISHES

A. Finish

- All closers with powder coat finishes shall exceed a minimum 100 hour salt spray test, as described in ANSI/BHMA Standard A156.4 and ASTM B117.
- All closers detailed with plated finishes shall include plated covers (or finish plates), arms, and visible fasteners.
- All electromechanical automatic operators supplied with anodized finishes.
- All closers must be shipped with a finish.

PART 3 - EXECUTION

3.1 INSTALLATION

A. General

- Installation shall be in accordance with the templates and installation instructions packaged with the closers at the time of manufacture.
- Installation shall be made with fasteners packaged with the closer by the manufacturer.
- All electrical connections shall be made in accordance with the manufacturers recommendations.
- Clean installed closer to remove dirt, debris, and marks incidental to installation work.
- Installation instructions and templates are to be turned over to the Owners representative upon completion of the installation work.
- Factory trained representative will be available for job site inspection of major projects upon completion of the hardware installation work.

3.2 ADJUSTMENT

A. Adjustment

- Install and regulate all closers in accordance with the installation instructions packaged with the closers at the time of manufacture.
- If unfamiliar with LCN products furnished, consult factory representative prior to installation for assistance.

LCN ANSI CROSS REFERENCE

ANSI FUNCTION NUMBER TO LCN PRODUCT SURFACE MOUNTED ANSI Standard A156.4-2000

ANSI NUMBER	MOUNTING	LCN CLOSER	ANSI Standard A156.4-2000								
			PT-4A	PT-4B	PT-4C	PT-4D	PT-4F	PT-4G	PT-4H	PT-4J	
C02011	HINGE SIDE	4031	X	X	X	X	X				
		4040XP	X	X	X	X	X	1070	X	X	
XX	X	X	1260	X	X	X	X	X	X	X	
		1460	X	X	X	X	X	X	4010X	X	
XX	X	X	4040	X	X	X	X	X	X	X	
		4510	X	X	X	X	X	X	X		
C02021	PARALLEL	1070	X	X	X	X	X				
		4031	X	X	X	X	X	X			
		4040XP	X	X	X	X	X	X	1260X	X	
XX	X	X									
		1460	X	X	X	X	X	X	X	4040	
XX	X	X	X	X	4110X	X	X	X	X	X	
XX											
		4210	X	X	X	X	X	X	X	X	
C02031	BRACKET	4040XP	X	X	X	X	X				
		4010	X	X	X	X	X	X			
		4040	X	X	X	X	X	X	C02041		
TOP JAMP		1070	X	X	X	X					
		4031	X	X	X	X	X	4040XP	X	X	
XX		X	1260	X	X	X	X	X	X	X	
		1460	X	X	X	X	X	X	4020X	X	
XX	X	X	4040	X	X	X	X	X	X	X	
C02051	HINGE SIDE HOLD OPEN	1070	X	X	X	X	X				
		4031	X	X	X	X	X	4040XP	X	X	
XX		X	1260	X	X	X	X	X	X	X	
		1460	X	X	X	X	X	X	4010X	X	
XX	X	X	4040	X	X	X	X	X	X	X	
C02061	PARALLEL HOLD OPEN	1070	X	X	X	X	X				
		4031	X	X	X	X	X	X			
		4040XP	X	X	X	X	X	X	1260X	X	
XX	X	X	1460	X	X	X	X	X	X	X	
		4040	X	X	X	X	X	X	X	4110	
XX	X	X	X	X	X						
		4210	X	X	X	X	X	X	X	X	
C02071	BRACKET HOLD OPEN	4010	X	X	X	X	X	X			
		4040	X	X	X	X	X	X	C02081		
TOP JAMP HOLD OPEN		1070	X	X	X	X					
		4031	X	X	X	X	X	4040XP	X	X	
XX		X									
		1260	X	X	X	X	X	X			
		1460	X	X	X	X	X	X	4020X	X	
XX	X	X	4040	X	X	X	X	X	X	X	
C02091	HINGE SIDE FUSIBLE LINK	4010	X	X	X	X	X	X			
C02101	PARALLEL FUSIBLE LINK	4110	X	X	X	X	X	X	X		
C02111	BRACKET FUSIBLE LINK	4010	X	X	X	X	X	X			
C02121	TOP JAMP FUSIBLE LINK	4020	X	X	X	X	X	X			
C02171	HINGE SIDE TELEPHONE BOOTH TRACK	4010TEL	X	4110TEL	X			C02211	HINGE SIDE		
		1460T	X	X	X	X					
		4010T	X	X	X	X	X	4031T	X	X	
XX		X	4040T	X	X	X	X	X	X		

Note: All closers listed in this section are certified grade 1 = 1,500,000 cycles, PT4A = 15% adjustable closing force, PT4B = 35% adjustable closing force, PT4C = 50% adjustable closing force, PT4D = adjustable hydraulic backcheck, PT4F = delayed action, PT4G = built-in factory dead stop (Cush-N-Stop), PT4H = spring power adjustable over a range of sizes, PT4J = backcheck position advanced 15 degrees.

LCN ANSI CROSS REFERENCE

ANSI FUNCTION NUMBER TO LCN PRODUCT SURFACE MOUNTED ANSI Standard A156.4-2000

ANSI NUMBER	MOUNTING	LCN CLOSER	SURFACE MOUNTED										
			PT-4A	PT-4B	PT-4C	PT-4D	PT-4F	PT-4G	PT-4H	PT-4J			
4510T	X X	X	X	X	X								
C02221	HINGE SIDE HOLD OPEN TRACK	1460	X	X	X	X	X						
		4010	X	X	X	X	X	4031	X	X			
X X		X	4040	X	X	X	X	X	X				
C02231	STOP FACE TRACK	1460	X	X	X	X	X						
		4031	X	X	X	X	X	4040	X	X			
X X		X	4110	X	X	X	X	X	X			4210	
X X	X X	X	X										
C02241	STOP FACE HOLD OPEN TRACK	1460	X	X	X	X	X						
		4031	X	X	X	X	X	4040	X	X			
X X		X	4110	X	X	X	X	X	X				
C02251	TOP JAMB TRACK	1460	X	X	X	X	X	4000	X	X			
X X		X	4020	X	X	X	X	X	X			4031	
X X	X X	X	4040	X	X	X	X	X	X				
C02261	TOP JAMB HOLD OPEN TRACK	1460	X	X	X	X	X	4020	X	X			
X X		X	4031	X	X	X	X	X	X			4040	
X X	X X	X	C02271	TOP JAMB PUSH SIDE FLUSH FRAME TRACK									
TRACK	4031 X	X	X	X	X								
C02281	TOP JAMB PUSH SIDE FLUSH FRAME HOLD OPEN TRACK	4031	X	X	X	X	X						
C03011	HINGE SIDE	1070	X	X	X	X	X	1260	X	X			
X X	X	X											
		1371	X	X	X	X	X	X				C03021	
PARALLEL	1070	X	X	X	X	X							
		1370	X	X	X	X	X	X					
		1260	X	X	X	X	X	X	X				
C03041	TOP JAMB	1070	X	X	X	X	X						
		1260	X	X	X	X	X	X					
		1370	X	X	X	X	X	X				C03051	
HINGE SIDE HOLD OPEN	1070	X	X	X	X	X							
		1260	X	X	X	X	X	X					
		1370	X	X	X	X	X	X					
C03061	PARALLEL HOLD OPEN	1070	X	X	X	X	X						
		1370	X	X	X	X	X	X					
		1260	X	X	X	X	X	X	X				
C03081	TOP JAMB HOLD OPEN	1070	X	X	X	X	X						
		1260	X	X	X	X	X	X					
		1370	X	X	X	X	X	X					

Note: All closers listed in this section are certified grade 1 = 1,500,000 cycles, PT4A = 15% adjustable closing force, PT4B = 35% adjustable closing force, PT4C = 50% adjustable closing force, PT4D = adjustable hydraulic backcheck, PT4F = delayed action, PT4G = built-in factory dead stop (Cush-N-Stop), PT4H = spring power adjustable over a range of sizes, PT4J = backcheck position advanced 15 degrees.

LCN ANSI CROSS REFERENCE

ANSI FUNCTION NUMBER TO LCN PRODUCT

CONCEALED IN DOOR ANSI Standard A156.4-2000

ANSI NUMBER	MOUNTING	ARM	LCN CLOSER	PT-4A	PT-4D			
C04011	CONCEALED IN DOOR	REG	3030	X	X			
		HO	3030H	X	X			
C04021	CONCEALED IN DOOR	REG	330	X	X			
		HO	330H	X	X			
C04031	CONCEALED IN DOOR	STANDARD	3130		X			
		HO	3130H		X			

Note: All closers listed in this section are certified grade 1 = 1,500,000 cycles.
PT4A = 15% adjustable closing force, PT4D = adjustable hydraulic backcheck.

OVERHEAD CONCEALED ANSI Standard A156.4-2000

ANSI NUMBER	MOUNTING	ARM	LCN CLOSER	PT-8A	PT-8B	PT-8D	PT-8E	PT-8F	PT-8J	PT-8L			
C05011	BUTT HINGE	REG	5010	X	X	X	X	X	X				
			5030	X	X	X	X	X	X				
C05021	PIVOT	REG	5010	X	X	X	X	X	X				
			5030	X	X	X	X	X	X				
C05031	BUTT HINGE	STANDARD	2010	X	X		X	X	X				
			2030	X	X		X	X	X				
			2210	X		X	X	X	X				
			2210 DPS	X		X	X	X	X				
C05041	PIVOT	STANDARD	2010	X	X		X	X	X				
			2030	X	X		X	X	X				
			2210	X		X	X	X	X				
			2210 DPS	X		X	X	X	X				
C05071	PIVOT	STANDARD	2010	X	X		X	X	X				
			2030	X	X		X	X	X				
C05081	PIVOT	STANDARD	6030	X	X		X	X	X				
C05091	BUTT HINGE	HO	5010	X	X	X	X	X	X				
			5030	X	X	X	X	X	X				

Note: All closers listed in this section are certified grade 1 = 1,500,000 cycles.
PT8A = door under control from 7 degrees of maximum door opening to close,
PT8B = hold-open between 85 and 180 degrees, PT8D = 50% adjustable

PT8E = single acting, 165 degrees of opening, double acting 165 degrees of opening either way, PT8F = adjustable hydraulic backcheck, PT8J = delayed action, PT8L = 35% adjustable closing force.

LCN ANSI CROSS REFERENCE

ANSI FUNCTION NUMBER TO LCN PRODUCT

LIFE SAFETY CLOSER/ HOLDER RELEASE DEVICES

ANSI Standard A156.15-2001

ANSI NUMBER	MOUNTING	ARM	LCN CLOSER	PT4D	PT4N	PT4P												
C00011	WALL	N/A	7830, 7840, 7850															
	WALL	N/A	1960, 1970, 1980															
C00021	FLOOR	N/A	7820															
C00031	FLOOR	N/A	7870															
C00191	HINGE SIDE	STANDARD	4040SE	X	X	X												
			4040SEL	X	X	X												
C00231	STOP FACE	STANDARD	4040SE	X	X	X												
			4040SEL	X	X	X												
C00311	TOP JAMB	REG	4410HSA	X	X													
			4410ME	X	X													
C00351	HINGE SIDE	STANDARD	4310HSA	X	X													
			4310ME	X	X													
C00371	HINGE SIDE	SF	4310ME	X	X													
C00391	TOP JAMB	DE	4310HSA	X	X													
			4310ME	X	X													
C00471	HINGE SIDE	REG	4040SEH			X												
C00511	PUSH SIDE	REG	4040SEH			X												
C00611	CONCEALED	STANDARD	3130SE	X		X												
			3130SEL	X		X												
C00651	CONCEALED	STANDARD	2310ME	X	X													

Note: Options are; PT4D = adjustable hydraulic backcheck, PT4N = adjustable spring power, and PT4P = adjustable hold-open intensity.

MATERIALS

LCN is committed to providing the best door closers in the world. In addition to the mechanical advantages derived from proven designs, much of the durability of the closer and arm system is directly related to the materials used in their manufacture.

Precision machined **cast iron cylinders** and **forged steel pistons** work together because of the compatibility of their basic elements. **Heat treated pinions and pistons** spread the load over a large gear tooth system to better handle the wear and stress of millions of operating cycles. Upper and lower full compliment pinion bearings provide the support and load capacity required by the design of the closer. **All weather fluid** eliminates the need for seasonal adjustments.

Forged steel main arms are superior to stamped steel arms used on closers where price is the primary concern. Specially designed shoe and elbow joints provide maintenance free service. A state-of-the-art, **powder coat** process delivers a high quality, corrosion resistant finish on all metal parts in popular architectural finishes.

LCN always uses the best materials available to provide the exceptional value and long service life that you, our customer, have every right to expect.

PROPER DOOR CONTROL

Today practically every door in modern commercial, industrial, and institutional buildings is opened by the person passing through and closed by a mechanical door closer which should keep the door under orderly control at all times. The power to close the door is generated by the springs inside the closer. Regulated hydraulic circuits control the speed of the doors closing swing. Ideal door "conduct" is illustrated and described in the diagram below. It can be achieved by equipping each door with the appropriate LCN door closer.

Perfect door operation...

The aim of mechanical control.

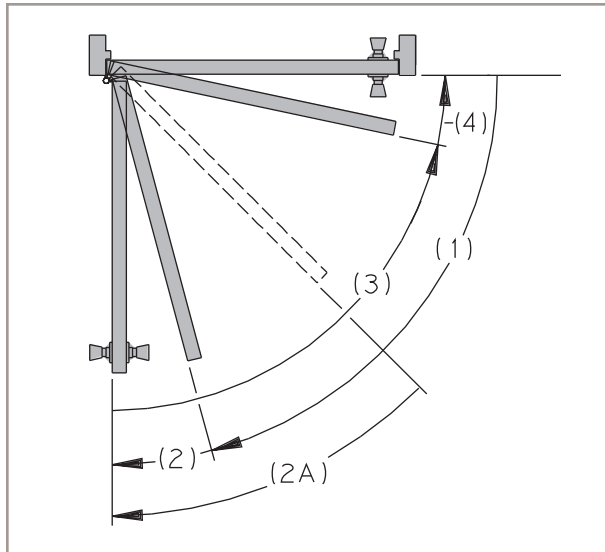

This diagram shows the main part or stages in correct door operation, whether under manual or mechanical control or a combination of the two.

- (1) On the opening swing, the door closers function is to let the door open easily, except at the end of the swing where backcheck is applied.
- (2) Backcheck is a feature that cushions the opening swing to prevent the door from slamming into the stop. Special closers designed for potentially abusive applications begin the backcheck function much earlier (2A) such as LCN's advanced variable backcheck (AVB).
- (3) Through the long closing arc, a uniform, reasonable (main) speed should be maintained.
- (4) The latching arc allows the door to close quietly and firmly.

Opening the door builds up the power, which later closes the door.

As a controlled door is opened, the spring of the closer is compressed which builds up the power to close the door. Normally, more opening force would be required as spring compression increases. However, as an LCN closer changes its arm geometry while the door opens, it increases the door leverage. This offsets the spring compression, resulting in greater ease in opening the door.

In opening, more leverage for the person.

The changing arm geometry gives increased leverage over the door to overcome the growing power of the spring allowing one to pass through the door easily.

In closing, more leverage for the closer.

When the person releases the door and the closer takes over, spring power is applied through the arm system to close the door. Because the spring has been compressed, its power is very high. As the door closes the spring expands, providing the power to close the door.

Special closers for reduced opening force.

The 1990 Americans with Disabilities Act (ADA) and ANSI Standard A117.1 describe maximum opening force limitations for certain non-fire rated doors. The last page of each closer section in the catalog includes a section titled REDUCED OPENING FORCE CLOSERS. This section lists closers in that specific series that will comply with a maximum opening force based on the width of the door.

Any manual door closer, including those certified by BHMA to conform to ANSI Standard A156.4, that is selected, installed, and adjusted based on ADA or other reduced opening force requirements may not provide sufficient power to reliably close and latch the door.

Refer to AUTOMATIC OPERATORS section for information on electric, pneumatic and electromechanical systems that meet reduced opening force requirements without affecting closer power.



MECHANICAL CONSIDERATIONS

HOW TO SELECT A DOOR CLOSER

CONCEALED OR SURFACE MOUNTED CLOSERS

Door closers are available in two styles - concealed or surface mounted. In choosing a closer style for a particular application, consideration should be given to the type of door being controlled, frame conditions, aesthetic requirements, and control features needed. Information contained in the following material can serve as a guide in selecting the style and model of closer to meet specific requirements.

IF CONCEALED, WHERE?

Closers concealed in the head frame over the door are out of sight and entirely out of the pedestrians way. They cannot be harmed by scrub water, cleaning chemicals or floor dirt, and are protected from airborne contaminants, like dust. They are easy to reach for regulation without removing any parts. Closers for frame sections as thin as 1 3/4" (44 mm) are available.

Closers located within the door itself are also hidden and protected but recommended for interior doors only.

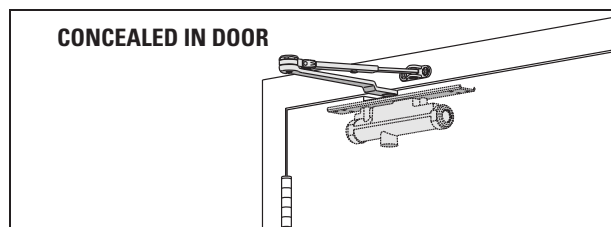
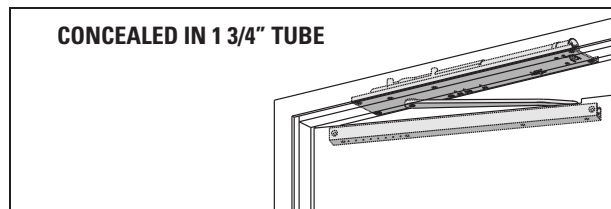
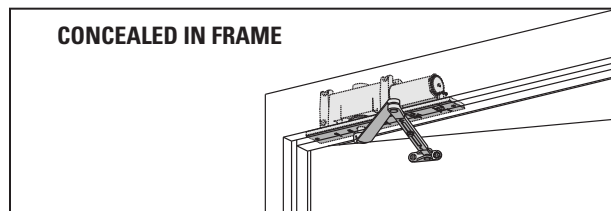

SURFACE MOUNTED CLOSERS - LOCATION?

Closer location is subject to the considerations of practicality and appearance. Good taste usually decrees that closers on doors along a corridor be located on the room side of the door so they are out of the line of sight from the corridor. Closers should be placed on the inside of exterior doors for appearance and to shelter them from the elements.

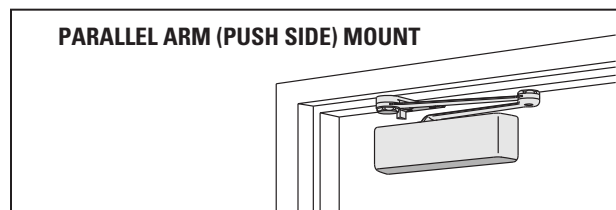
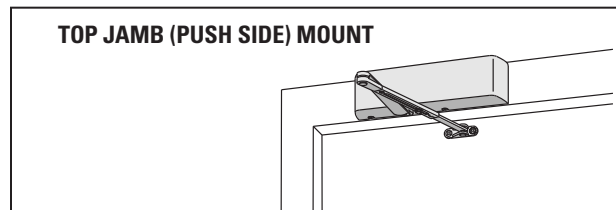
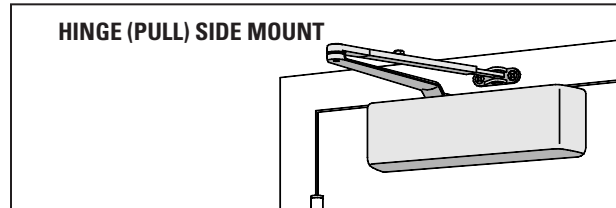

WHERE ARE HEAVY DUTY CLOSERS REQUIRED?

Heavy duty closers should always be used in these places:

- 1) Schools or public buildings where heavy or abusive usage is expected.
- 2) Exterior doors.
- 3) Doors subject to draft, winds, or air pressure differentials.
- 4) High frequency doors such as those on department stores, malls, or mixed use tenancies.

MECHANICAL CONSIDERATIONS

WHICH ARM SYSTEM?

Double lever arm closers can provide control under difficult conditions for either interior or exterior doors. A parallel arm system is a type of double lever arm where the main arm is parallel to the face of the closed door. Functions available in double lever arm systems are;

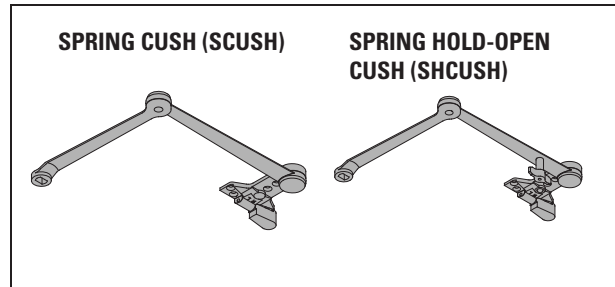
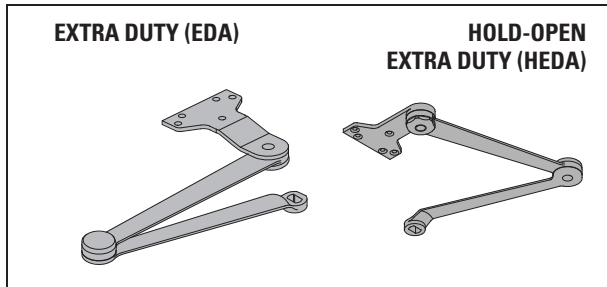
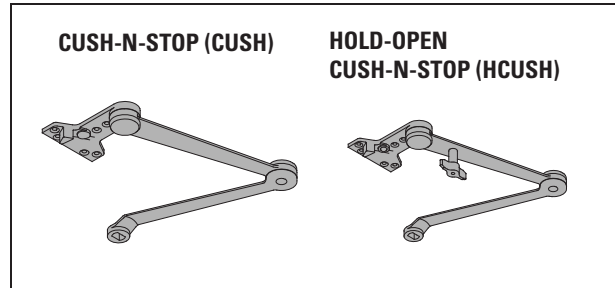
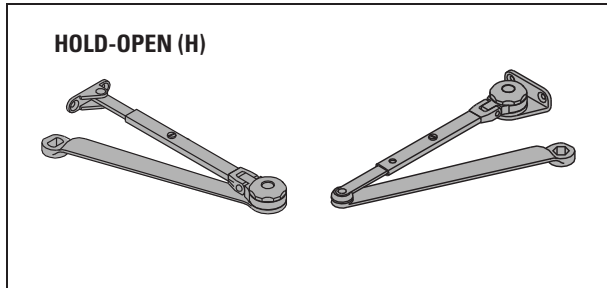
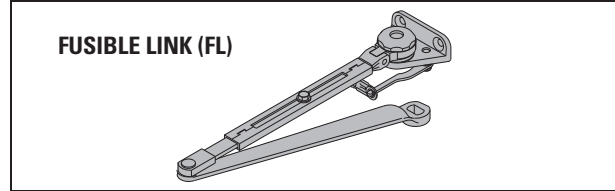
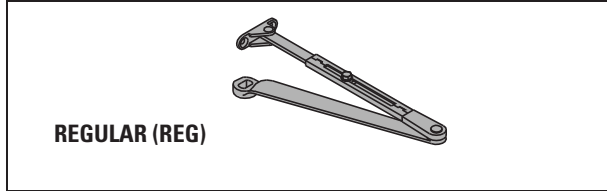

Single lever arm (track) closers may be used on interior or sheltered exterior doors. The hold-open function in a single lever arm system is provided by either the track or the cylinder assembly. Available single lever arms are;

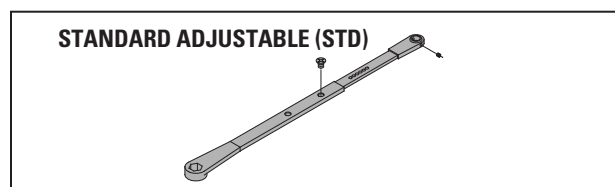
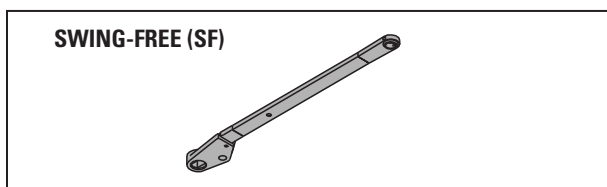
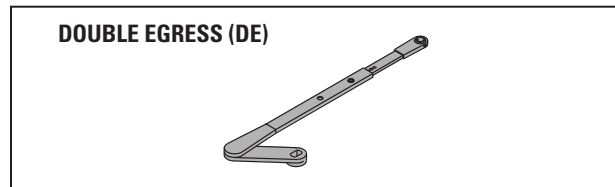
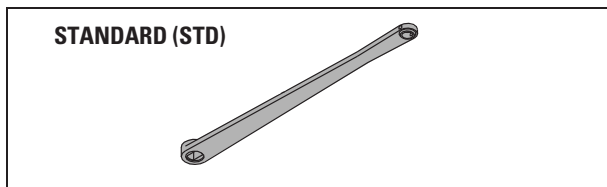

MECHANICAL CONSIDERATIONS

DO YOU NEED SPECIAL CYLINDER FUNCTIONS?

Many LCN closers can be ordered with a delayed action function built into the cylinder. **Delayed action** (DEL) is a special hydraulic circuit that provides additional time to pass through the door. A special regulating screw controls the closing speed from maximum opening through approximately 75°. After that point the normal main speed resumes control to close the door. Delayed action is not available with single lever arm (track) closers.

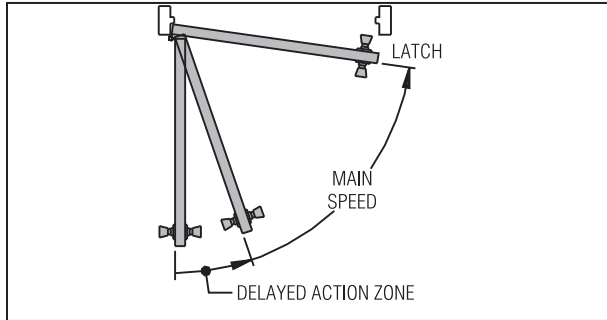

Advanced Variable Backcheck (AVB) is available with high security and 4110 series closers to begin cushioning the opening swing at about 45° (2A) instead of the usual 75° (2). AVB is especially suited for potentially abusive applications.

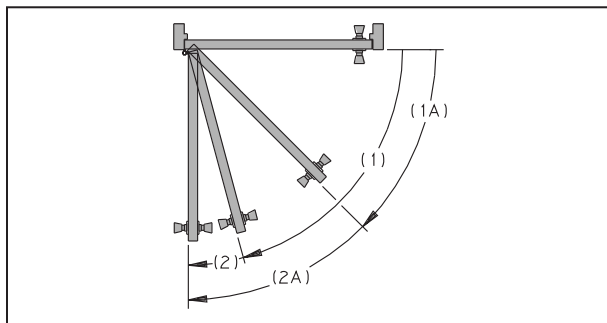

Multi-point (ME series) closer/holders can be ordered with a hold-open bypass at either 80° or 140° function. This feature does not allow hold-open to take effect until opened beyond the selected degree of bypass.

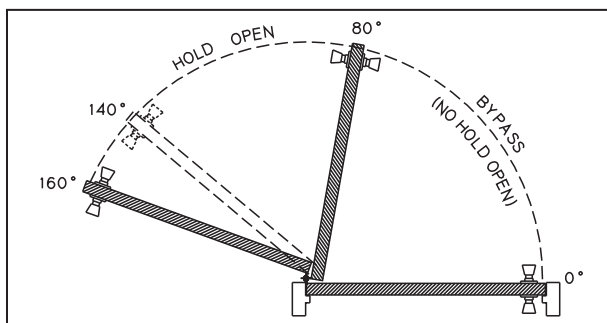

IS SEASONAL ADJUSTMENT REQUIRED?

Temperature changes can affect the operation of common door closers by changing the viscosity of the hydraulic fluid inside the closer. As temperature rises, the fluid thins out and closes the door more rapidly. As temperatures decrease, the fluid thickens causing the closer to close the door very slowly.

LCN uses all weather Ultra X fluid to eliminate the need for seasonal adjustment.

HOW WILL THE DOORS BE HUNG?

While butt hinges provide the most common method of hanging doors, some doors are hung on pivots centered in the door, others on offset pivots. Surface mounted closers will handle doors hung in any of these three ways. LCN 4020 Series closers can even control a "balanced" door installation. Concealed closers may conflict in location with pivot leaves and thus may require special templating.

MECHANICAL CONSIDERATIONS

HOW FAR SHOULD THE DOOR OPEN?

Three basic rules apply to maximum degree of opening.

1. It is best to let the door swing as far as it can swing freely. Some closers are mounted in different locations for different degrees of opening.
2. Use a mechanical stop when a door can not swing 180° or at the selected hold-open point of a double lever arm system. The mechanical stop can be mounted on the floor, wall, overhead, or built into the closer arm.
3. The closer should be positioned so backcheck takes place well in advance of the stop position to cushion the opening swing and prevent door and frame damage from an abrupt stop.

DOOR DIMENSIONS?

The width of the door is the main consideration in determining the correct closer size. Size here refers to the minimum spring power and hence the closing force, generated by the closer. In the catalog, the interior and exterior TABLE OF SIZES for each closer are set up for ranges of door width and assume normal operating conditions. If a door is of exceptional height, weight, special construction, or if drafts and air pressure differentials exist, increased closer power should be considered.

Door thickness may be a factor. A concealed-in-the-door closer should not be used in a hollow metal door less than 1 1/2" (38 mm) thick or a wood door under 1 3/4" (44 mm). Exceptionally thick doors can affect hinge and pivot centers to the extent that closer functions and geometry are also affected.

The depth of the doors top rail is important to nearly every closer installation. Narrow top rails may require plates to successfully mount the closer. An insufficient top rail in flush, hollow, or composite filled doors may make concealed-in-the-door installations impractical.

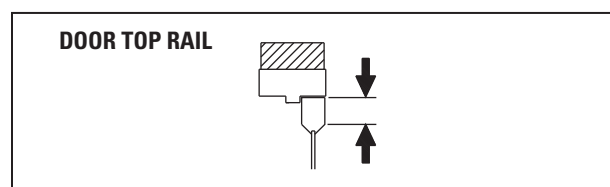

HAND OF A DOOR?

Some door closers are handed. When approaching a door from the push side, if hinged on the left, it is a left hand door; if hinged on the right, it is a right hand door.

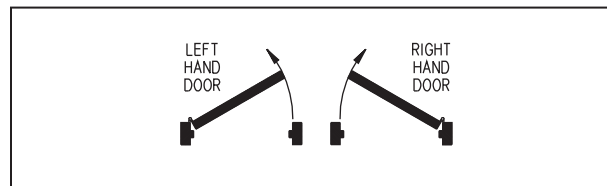

For purposes of handing door closers, right hand reverse bevel and left hand are identical. Also, left hand reverse bevel and right hand are identical.

The hand of the closer is the same as the hand of the door for all except corner bracket installations that require a closer handed opposite the hand of the door.

WILL A STANDARD CLOSER AND TEMPLATE MEET YOUR NEEDS?

Occasionally the physical limitations of the selected closer may not provide the desired functions or degree of opening. Standard templated locations may interfere with other applied hardware. In these situations, contact the LCN Applications Engineering Department for assistance. Customized installation templates or products may be available to solve an unusual application.

MECHANICAL CONSIDERATIONS

WHY USE PLATES, BRACKETS, ADAPTERS AND OTHER SPECIAL PIECES?

Corner brackets were once the only satisfactory way to install a closer on the push side of a door. They still meet special requirements which other mountings do not satisfy.

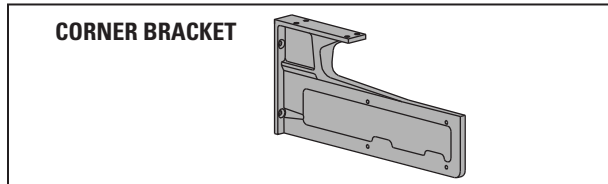

A drop plate is now commonly used to drop (lower) closers to meet special conditions or adapt a closer to door or frame surfaces that are not adequate for normal mounting patterns.

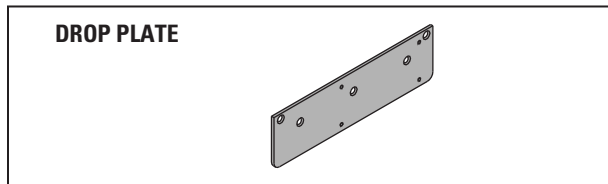

Specialized brackets, adapters, and parallel arm shoes are available to simplify the installation of closers with a variety of frame and door conditions. The most commonly used are listed with each closer. Consult LCN for assistance if you are not sure.

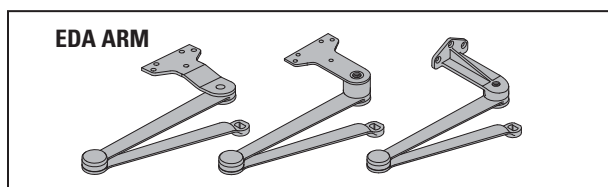
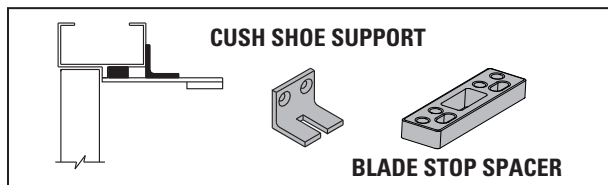

WHAT FASTENERS SHOULD BE USED?

LCN closers are shipped with a wood and machine screw pack or Self-Reaming and Tapping screws (SRT) unless other fasteners are ordered. These screw packs are suitable for wood or properly reinforced hollow metal frames and metal or solid core wood doors. For wood door applications, LCN recommends the use of wood screws. For selected closers, metric machine screws are available in lieu of UNC/UNF machine screws.

When attaching closers to hollow core doors, optional THROUGH BOLTS (TB) are recommended to minimize crushing or squeezing the door. Through bolting can also provide a very strong mechanical connection for potentially abusive applications. Because the TB barrel extends completely through the door, the door thickness must be specified when ordering if it is other than 1 3/4" (44 mm). TB's are only available for 1/4-20 machine screws.

For high security applications, TORX machine screws are available with most closers. These are standard for all exposed fasteners with HIGH SECURITY CLOSERS. TORX fasteners feature a hex lobular drive with a security pin in the center. They can only be installed or removed with a special set of bits that are available from LCN.

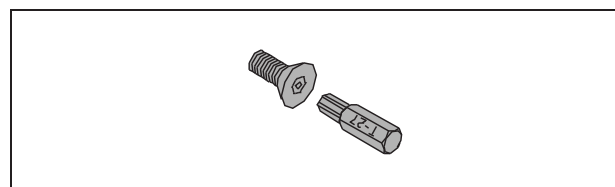

MECHANICAL CONSIDERATIONS

WHAT FINISH IS DESIRED?

The finest closers in the world feature a state-of-the-art metal finishing process. Powder coating provides superior protection against the effects of weathering and is an environmentally friendly process. The high quality, chip resistant finish is far superior to any previously offered. Corrosion resistance surpasses 100 hours salt spray testing (four times the industry standard), a level previously attainable only with top coated, two part epoxy based primers. Non-metallic components and fasteners also provide the same high level of corrosion resistance.

LCN offers custom finishing services to complement special installations. This provides a custom appearance and all the corrosion resistance inherent in the standard powder coated finishes. It is recommended that the customer submit a physical sample of desired custom finish with the closer order. Custom powder coat finishes are available at additional cost. A metal cover must be ordered when custom powder coat finishes are desired.

With some exceptions, visible components such as covers, arms, fasteners, and finish plates are available in plated finishes. Tracks are painted to complement the plated finish. Hidden assemblies such as cylinders and mounting plates are supplied with a powder coated finish. Plated finishes are available at additional cost.

For installations where a higher level of protection against weathering is required, LCN offers a special rust inhibiting (SRI) process at an additional cost. Metal components receive an SRI pretreatment and a standard or custom powder coat finish. The SRI process with a powder coat finish exceeds the protection level available with powder coated parts. SRI can not be ordered with plated or anodized finishes.

All closers must be shipped with a finish.

INSTALLATION PROCESS?

Before installation of the door closer;

- ▶ review the installation instructions provided with the door closer.
- ▶ verify the desired installation and template with the hardware schedule. Review other applied door hardware for possible interference.
- ▶ verify that the frame attachments and door hinges or pivots are securely installed.
- ▶ verify that the door is hung properly and operates smoothly through its entire range of opening.

Misalignment, sagging or other conditions that prevent free movement of the door must be corrected prior to installation of the door closer. LCN recommends $\leq 1/4$ lbf to open the door before installing closers for ADA applications.

- ▶ check latching mechanisms for proper operation and release.
- ▶ verify that the door and frame have specified reinforcements.
- ▶ verify that all required tools are available.

Complete the installation by;

- ▶ follow the installation instructions and use fasteners provided with the closer.
- ▶ using the template provided with the closer, layout, drill and tap (for metal screws) the required mounting holes. Be sure to use the proper size drill bit and tap to ensure maximum holding power by the screws.
- ▶ for closers with adjustable spring power, adjust the cylinder spring power based on the width of the door as described in the installation instructions.
- ▶ the hydraulic back check, main speed and latch speed regulation adjustments of the door closer have been adjusted at the factory to meet normal installation conditions. If further adjustments are required to the hydraulic regulation, follow the directions included with the installation instructions.
- ▶ lightly wipe the cover and arm surfaces with a soft, clean, dry cloth to remove any dirt or smudges that occurred during the installation.

LCN GLOSSARY OF ABBREVIATIONS

Arm Options

STD	- Standard Arm
REG	- Regular Arm
Rw/PA	- Regular Arm with Parallel Arm Shoe
R/62A	- Regular Arm with Auxiliary Parallel Arm Shoe
H	- Hold Open Arm
Hw/PA	- Hold Open Arm with Parallel Arm Shoe
LONG	- Long Arm
XLONG	- Extra Long Arm
HLONG	- Hold Open Long Arm
EDA	- Extra Duty Arm
EDAw/145	- Extra Duty Arm with Flush Transom Shoe
EDAw/62G	- Extra Duty Arm with Thick Hub Shoe
HEDA	- Hold Open Extra Duty Arm
HEDAw/145	- Hold Open Extra Duty Arm w/ Flush Transom Shoe
HEDAw/62G	- Hold Open Extra Duty Arm w/ Thick Hub Shoe
CUSH	- Cush -n- Stop Arm
HCUSH	- Hold Open Cush -n- Stop Arm
SCUSH(SCNS)	- Spring Cush -n- Stop Arm
SHCUSH(SHCNS)	- Spring Hold Open Cush -n- Stop Arm
SF	- Swing Free Arm
DE	- Double Egress Arm
FL	- Fusible Link Arm

Control Box Options

SC	- Standard Control Box
PC	- Premium Control Box

Cylinder Options

STD	- Standard Cylinder
DEL(DA)	- Delayed Action Cylinder
AVB	- Advanced Variable Backcheck
B80	- Bypass 80 Degree ME Cylinder
B140	- Bypass 140 Degree ME Cylinder
TEL	- Telephone Cylinder

Cover Option

STD	- Standard Plastic Cover
MC	- Metal Cover
LL	- Lead Lined Cover
FC	- Full Cover
CL	- Cover Length
CAPS	- Cover Caps (1370)
DS1	- Designer Series Cover
EC	- Smooth Slim Line Cover (European Cover)

Track Options

STD	- Standard Track
HO	- Hold Open Track
BUMPER	- Track with Bumper
HBUMPER	- Hold Open Track with Bumper

Fastener Pack Options

WMS	- Wood & Machine Screws
TBWMS	- Thru-Bolt, Wood & Machine Screws
SRT	- Self Reaming & Tapping Screws
TBSRT	- Thru-Bolt, Self Reaming & Tapping Screws
TORX	- 'Torx' Machine Screws
TBTRX	- Thru-Bolt, 'Torx' Machine Screws

Motor Gearbox Options

SF	- Standard Force Motor Gearbox
RF	- Reduced Force Motor Gearbox

Powder Coat Finishes

AL	- Aluminum
DKBRZ	- Dark Bronze
TAN	- Tan
STAT	- Statuary Bronze
LTBRZ	- Light Bronze
BLK	- Black
BRASS	- Brass
MTLPC	- Bright Metallic

Miscellaneous Terms

ELR	- Extra Long Rod
SRI	- Special Rust Inhibitor
SE	- Single Point Electronic
ME	- Multi-Point Electronic
PAH	- Parallel Arm Holder
HSA	- Hold Open / Scanner Activated
ES	- Electric Strike Relay (Control Boxes)
S	- Sequential (Control Boxes)
RF	- Radio Frequency
TJ	- Top Jamb
PA	- Parallel Arm
G	- Flush Ceiling
T	- Track
DPS	- Door Position Switch
LR	- Long Rod
ST	- Special Template
RH	- Right Hand
LH	- Left Hand
HL	- Header Length
DD	- Double Door Header
POS	- Positive Mechanical Stop
BKY	- Panic Breakaway Stop
XP	- Extra Protection

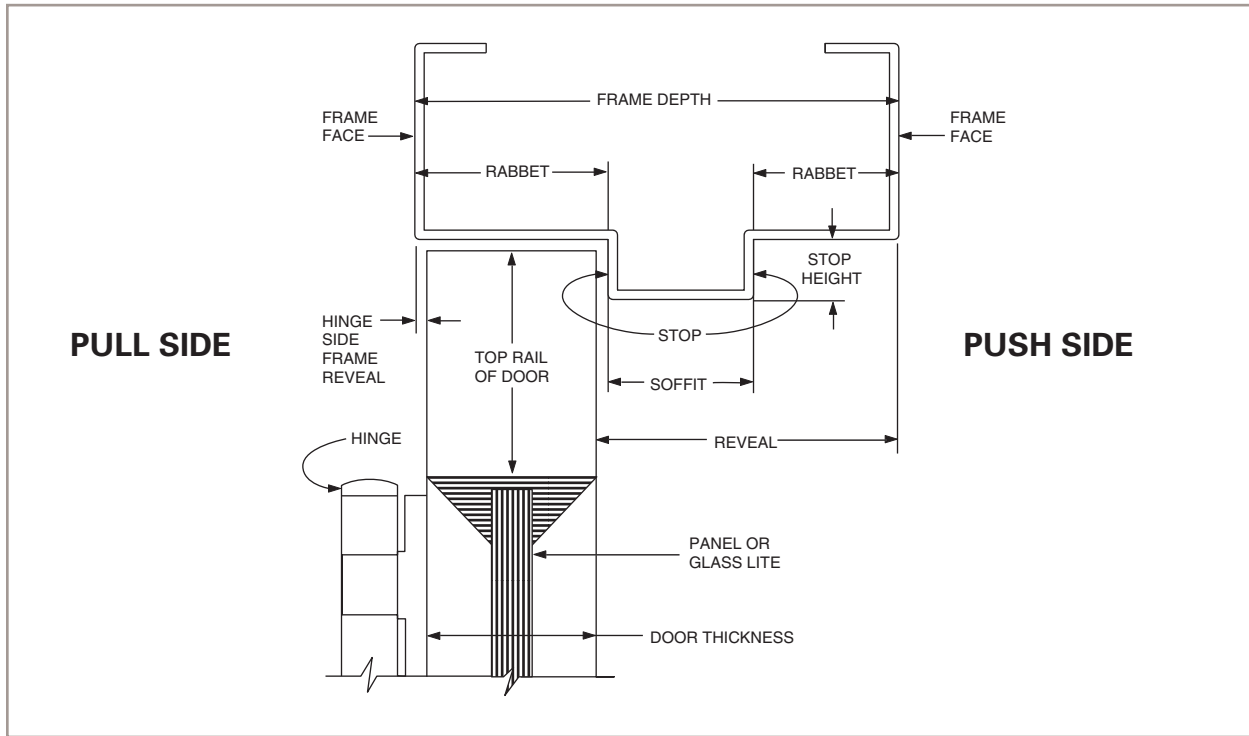

A

ADA - Americans with Disabilities Act

ADVANCED VARIABLE BACKCHECK CYLINDER (AVB) – Optional cylinder that starts backcheck at about 45° (2A) instead of the normal 75°(2). (See Illus.)

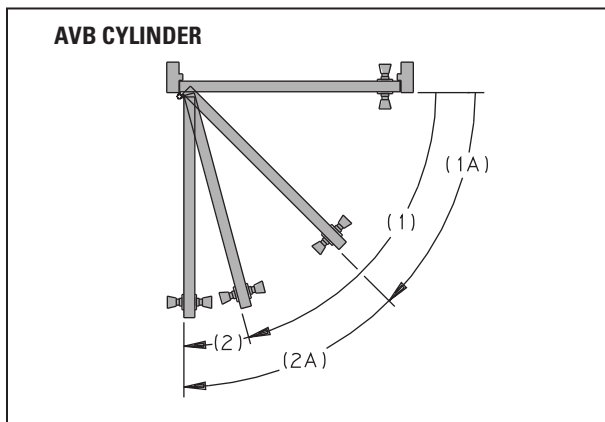

ANODIZED – An electrochemical process that thickens and toughens the protective oxide on aluminum metal.

ANSI – American National Standards Institute publishes standards for commercial hardware. A156.4 is the basic door closer standard.

APPLIED STOP – Surface mounted stop attached to a cased opening frame.

ARCH TOP DOOR – Any door with an arched top rail.

ARMATURE EXTENTION - Standard metal extensions available for SEM magnets where the armature does not reach the magnet. Available in 1/2", 3/4", 1", 2", 4" or a kit including all sizes.

AUTOEQUALIZER™ - An LCN specific term for an electric or a pneumatic power operator. System is low-energy & carries a two-year warranty.

AUTOMATIC OPERATOR – A term used to describe a type of automated opening system.

AUXILIARY DOOR STOP – Hardware designed and installed to limit the swing of a door.

B

BACKCHECK – Hydraulic circuit designed to cushion the doors opening swing at about 75°. Standard on all LCN closers. (See Illus.)

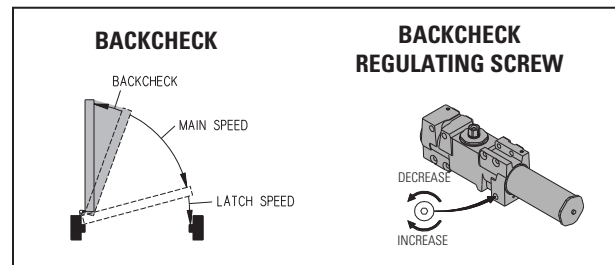

LCN GLOSSARY

B-G

BACKCHECK SELECTOR VALVE – Valve used to provide proper backcheck location for 4041 parallel arm mounting. (See Illus.)

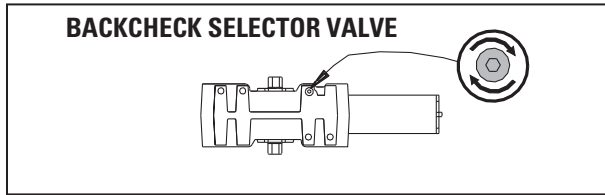

BLADE STOP – Narrow frame stop that will not accept a parallel arm shoe.

BLADE STOP SPACER – Spacer lowers a parallel arm 1/2" so the arm will clear a blade stop. (See Illus.)

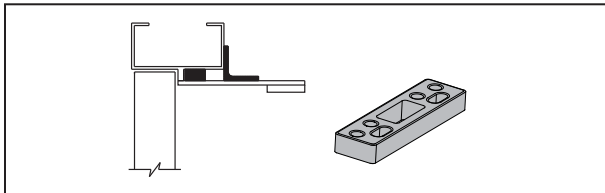

BLOW-OPEN – A type of control box that is used for a smoke evacuation system. Can be used with or without a normal power operator system.

BRIGHT METALLIC – Custom power coat finish, which resembles that of US26 or US26D plated finish.

BULL NOSE TRIM – Face and jamb width joined by a radius rather than a 90° break. Requires -65 soffit shoe. (See Illus.)

BYPASS CYLINDER – ME cylinder that will not hold-open

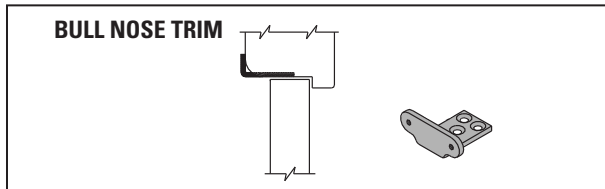

within a specified range of door swing. (See Illus.)

C

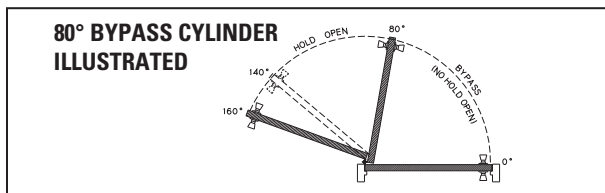

CASED OPENING – Frame section without stops.

CAST IRON – Material used in producing high quality door closers.

CLEARANCE – Distance from a PA SHOE to the push side of door or distance from the pull side of door to the wall on 90° installations. (See Illus.)

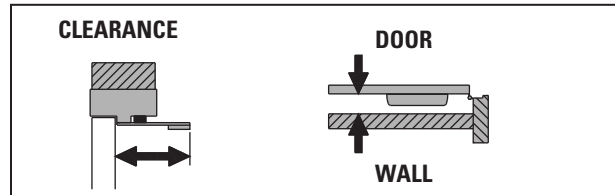

CLOSING FORCE – Energy generated by a closer to close and latch the door.

CONTROL BOX, Premium, 9100 Series – Microprocessor door control with Power Boost and built in power supply.

CONTROL BOX, Standard, 9100 Series – Microprocessor door control without Power Boost or built in power supply.

CONTROL BOX, 2800, 9500 SERIES – Microprocessor door control, includes adjustment for opening, closing & backcheck speeds. Features Push 'N Go & Power Boost.

CONTROL BOX, 2900, 9700 SERIES – Microprocessor door control, includes adjustment for opening, closing & backcheck speeds. Features Push 'N Go.

CONTROL BOX, 2500, 9300 SERIES – Microprocessor door control, includes adjustment for opening, closing & backcheck speeds. Features Power Boost.

CONTROL BOX, 7900 SERIES – Heavy duty, surface mounted control box that contains one or two electrically controlled pneumatic circuits.

CONTROLLER ASSEMBLY – Digital control suite used in the LCN electric power operator. Includes adjustments for opening force and opening speed.

CONCEALED IN DOOR – Closer with cylinder concealed in the top rail of the door with either an exposed or concealed arm.

CORNER BRACKET – Push side frame mounted adapter used to position closer in frame opening. (See Illus.)

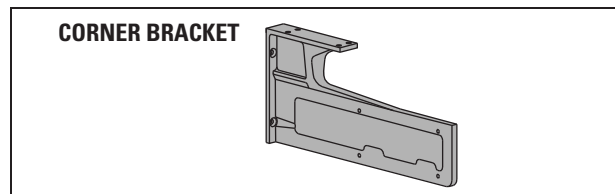

CUSH SHOE SUPPORT – Support provides fifth screw anchorage of CUSH shoes on frames with narrow push side reveals. (See Illus.)

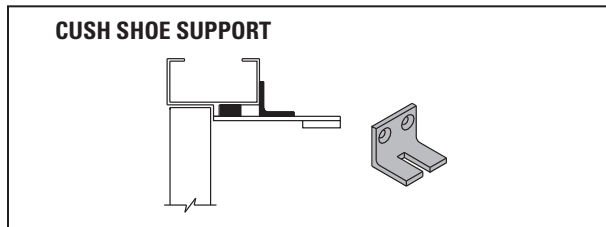

CUSH-N-STOP ARMS (CUSH) – Extra duty, parallel arm that includes a stop in the CUSH shoe. (See Illus.)

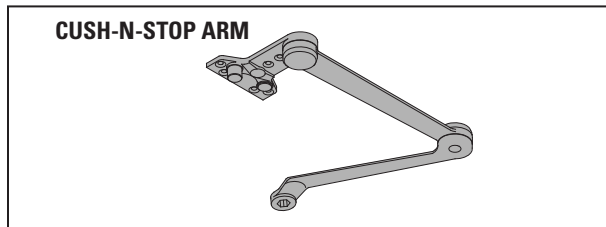

CUSTOM POWDER COAT (RAL) – An optional powder coat finish. Currently, LCN offers a wide selection for special powder coat finishes. LCN uses a European color standard, referred to as an RAL #, to differentiate between finishes.

CUTOUT – Preparation of the top rail of a door or frame for concealment of the closer, arm or track.

CYLINDER ASSEMBLY – Main closer component complete with any mounting plates or electronics. (See Illus.)

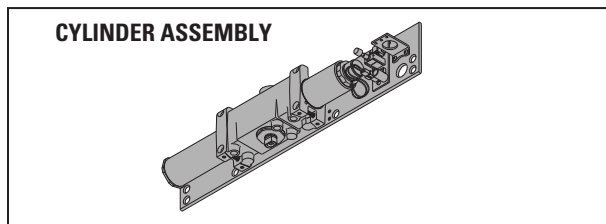

CYLINDER ONLY – Hydraulic cast iron cylinder.

D

DEEP REVEAL – Reveal deeper than what an arm will accommodate.

DELAYED ACTION (DEL) – Delays closing from maximum opening to approximately 75°. (See Illus.)

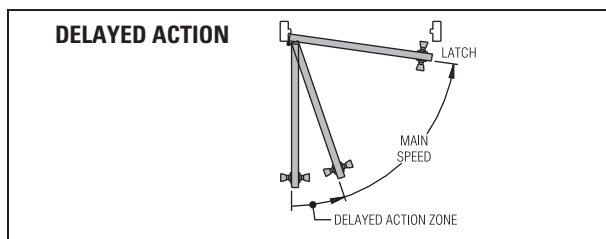

DESIGNER SERIES COVER (DS1) – An aesthetically pleasing cover design that appeals to many types of facilities & architects.

DOOR POSITION SWITCH (DPS) – A security option specific to the 2210 Series closer. A door position switch is used to monitor the closed position of a door in an opening.

DOUBLE DOOR HEADER – One automatic electromechanical power operator and one manual door within the same header.

DOUBLE ACTING – Term used to describe door swing. A double acting frame does not have a stop thus allowing the door to swing 95 degrees in both directions.

DOUBLE EGRESS ARM (DE) – Designed for pull side installation on double egress frames. Actual arm varies depending on selected closer. (See Illus.)

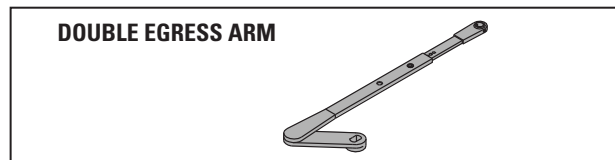

DOUBLE LEVER ARM – Two-part arm hinged at the elbow that provides superior leverage. Used on hinge side, top jamb and parallel arm mountings, the geometry of the arm provides greater mechanical advantage to the closer. (See Illus.)

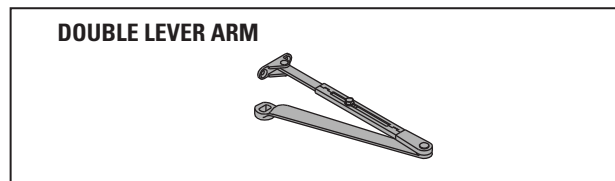

DOUBLE RABBET FRAME – Frame with a recess or offset formed on both sides of a stop to receive a door. (See Illus.)

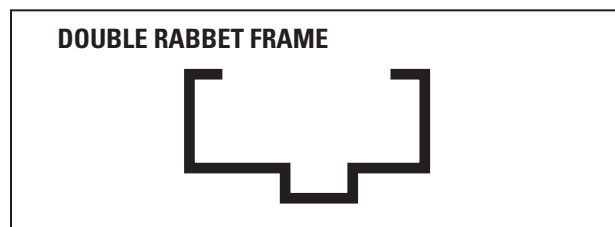

DROP PLATE – Designed to mount a closer on top rail or head frame to meet special conditions or mounting surface dimensions that are below minimums.

E

ELECTRIC STRIKE – An optional, electronic latching device that replaces a regular lock strike in a doorframe that allows the door to open from a remote location or by special access equipment.

LCN GLOSSARY

E-F

ELECTRIC STRIKE RELAY (ES) – An optional feature found in an LCN 7900 Series control box that can be used to control an electric strike.

ELECTROHYDRAULIC POWER OPERATOR – Power operator with an electrically controlled opening feature and hydraulic closing feature.

ELECTROMECHANICAL POWER OPERATOR – Power operator with an electrically controlled opening feature and closing feature.

ESCUTCHEON – An optional, protective or decorative plate that can be installed with many surface mounted actuators.

EXTRA DUTY ARM (EDA) – Double lever arm with both main and forearm made of solid forged steel for extra strength. (See Illus.)

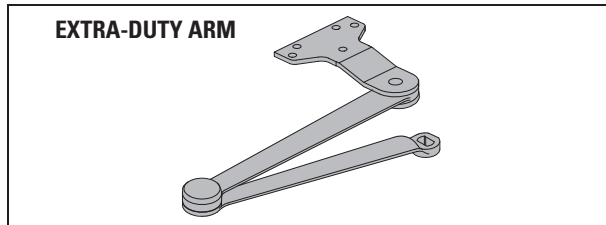

EXTRA LONG ARM (XLONG) – 4040 Series double lever arm for exceptionally deep reveals or other special applications.

F
(LCN®) FAST™ POWER ADJUST – A green dial located on the end of the spring tube on selected heavy duty closers. Designed to help installers accurately adjust the closer power to match the conditions of the entrance. (See Illus.)

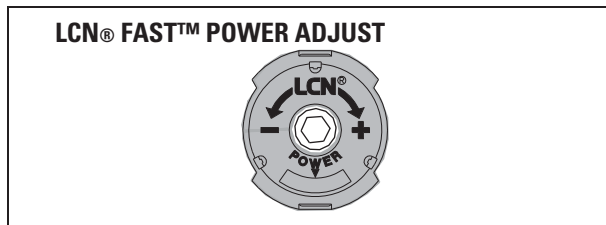

FIFTH SCREW – Mounting screw farthest from the door on a parallel arm shoe.

FIFTH SCREW SPACER – Supports PA shoe mounted on frame stop.

FINISH PLATE – Decorative plate applied to overhead concealed closer to conceal closer mounting plate and screws.

FIRE SHIELD – 22-gage steel liner mounts in the track mortise of the door's top rail for 20 minute labeled wood doors.

FLUSH CEILING – Condition when the ceiling is at the same height as the top of the frame. (See Illus.)

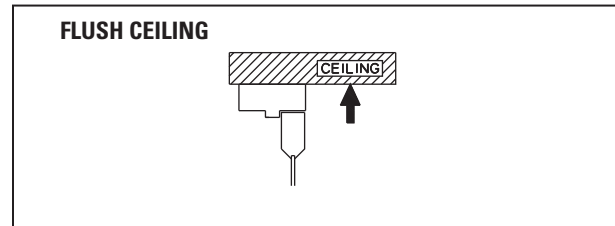

FLUSH PANEL ADAPTER – Adapter provides PA shoe mounting surface when door and frame are flush. (See Illus.)

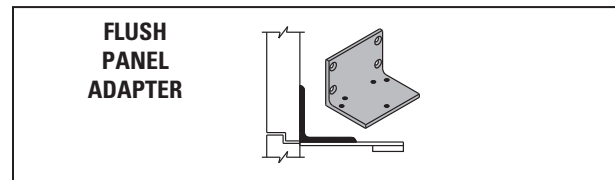

FLUSH TRANSOM SHOE – Substituted for standard EDA shoe when door and frame are flush. (See Illus.)

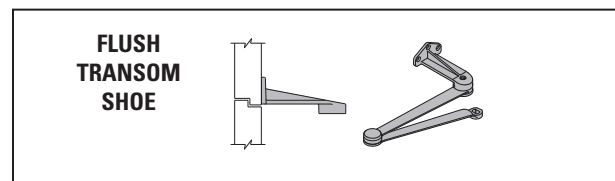

FOREARM – Arm part that connects main arm to the shoe attachments in a double lever arm system.

FRAME DEPTH – Face to face dimension of the frame.

FRAME FACE – Exposed part of frame parallel to face of the wall. (See Illus.)

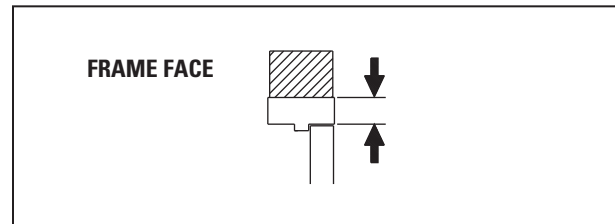

FULL COMPLIMENT BEARINGS – Low friction, high load needle bearings found in all LCN closers.

FULL COVER (FC) – Cover that encloses cylinder assembly except for shaft/arm attachment.

FUSIBLE LINK ARM (FL) – Releases hold-open function when exposed to high temperatures. 135°F and 165°F available. (See Illus.)

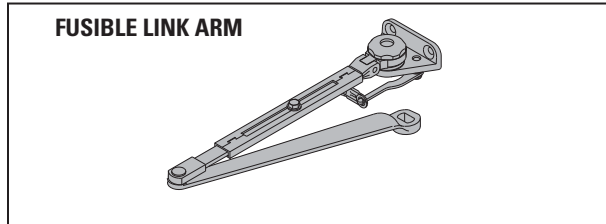

G
GUIDE RAIL(S) – A separator used with high energy power operated doors for safety, traffic separation and control.

H
HAND – Direction of a doors' swing, either right or left. (See Illus.)

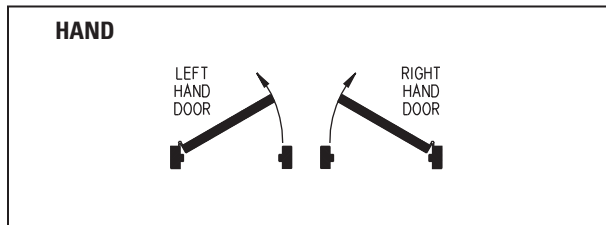

HANDED – Closer or part designed for ONLY right or left swinging doors.

HEAD FRAME – Member of the frame above the door.

HEADER – Aluminum enclosure for motor gearbox & controller.

HIGH ENERGY OPERATOR – A type of automated opener used on a door that should take approximately 2 seconds to open to 90°. High energy operators do require safety devices and guide rails. Conforms to ANSI A156.10.

HINGE SIDE – Face of door and frame on which the hinge pivot point is located.

HINGE SIDE MOUNT – Mounting with the closer cylinder on the hinge side of the door top rail. (See Illus.)

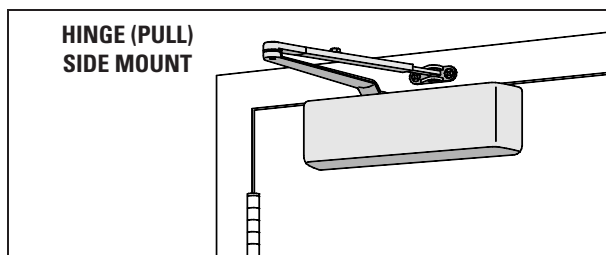

HINGE SIDE REVEAL – Depth measured from the frame face to the pull side of the door face. (See Illus.)

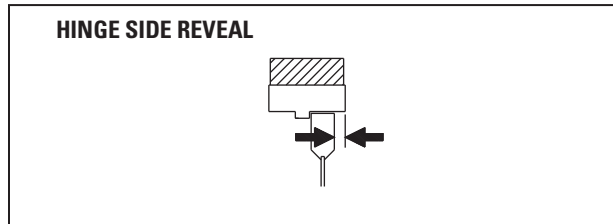

HINGE STILE – Vertical member of a door prepared for installation of hinges.

HOLD-OPEN ARM (H) – Double lever arm that provides hold-open function that is either adjustable at elbow or shoe.

HOLD-OPEN CLIP – Located in track to provide hold-open function for single lever arms.

HOLD-OPEN CUSH (HCUSH) – Parallel arm that features solid forged steel main arm and forearm with stop in soffit shoe. Uses control handle to select hold-open function.

HOLD-OPEN LONG ARM (HLONG) – Hold-open arm extended by a long head and tube for deep reveals.

HOLD-OPEN TRACK (HO) – Track with hold-open clip installed.

HOLD-OPEN TRACK with BUMPER (HBUMPER) – Track with hold-open clip and bumper assembly installed.

HOLDER SCANNER-ACTIVATED (HSA) – Electrically controlled closer/holder with built-in scanner.

HYDRAULIC FLUID – Fluid metered by valve system to control door.

I
INDEPENDENT PAIR – Two automatic doors that function separately.

J
JAMB – The vertical member that forms the sides of a door frame. There is a hinge side jamb and a strike side jamb.

L
LABELED DOOR – Conforms to all applicable codes, requirements, and procedures governing fire rated doors and bears the manufacturer's identification label.

LCN GLOSSARY

L-P

LATCH SPEED – Separate adjustment to control the last few degrees of the door's closing swing. (See Illus.)

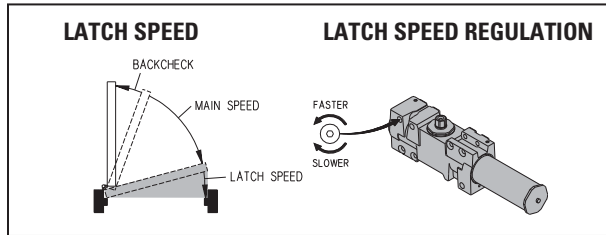

LEAD LINED COVER (LL) – Cover with lead lining for x-ray applications.

LOCK STILE – Vertical member of a door prepared for installation of a lock.

LONG ARM (LONG) – Extended arm for deep reveals or other special applications.

LOW ENERGY OPERATOR – A type of automated opener used on a door that should take approximately 5 seconds to open to 90°. Low Energy operators do not require safety devices or guide rails. Conforms to ANSI A156.19.

M

MAIN ARM – Connects to the cylinder in a double lever arm system.

MAIN SPEED – Separate adjustment to control closing swing of the door to within a few degrees of latch. (See Illus.)

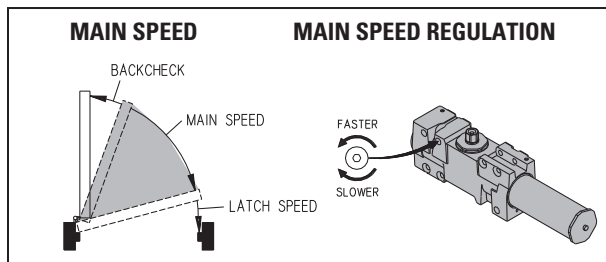

MAXIMUM OPENING – Furthest degree of door opening.

METAL COVER (MC) – Stamped metal cover required for optional plated finishes and custom powder coat finishes. Standard cover with High Security Series closers.

MOTOR CLUTCH – The geared assembly in an LCN electric power operator. Once activated, the motor clutch drives the door open.

MOTOR GEARBOX – Electromechanical drive unit.

MORTISE – Material removed from frame and/or top rail of door.

MOUNTING/FINISH PLATE – Plate with exposed mounting screws and finish applied.

MULTI-POINT HOLD-OPEN (ME) – Infinite hold-open points from 0° up to maximum opening.

N

NO DESTRUCT FEATURE – A feature specific to the motor clutch assembly portion of an LCN electric power operator. This feature does not allow the user to back drive the motor, which could cause damage to the unit.

NON-HANDED – Closer or part designed for both right and left hand swinging doors.

NON-SIZED – Cylinder assembly with spring power adjustable over a range of sizes.

O

OPENING FORCE – Force required to open the door against the closers spring power.

OVERHEAD CONCEALED – Closer with cylinder concealed in head frame and either a concealed or exposed arm.

P

PA SHOE ADAPTER – Adapter provides horizontal mounting for PA shoe on a flush door and frame. (See Illus.)

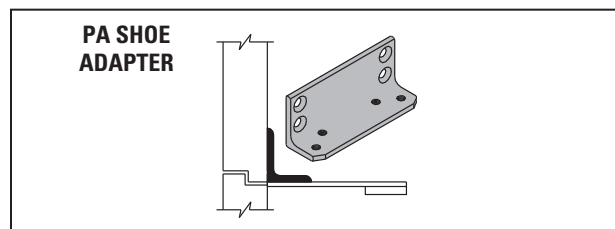

PA SHOE – Attaches the forearm to the soffit for a parallel arm system.

PACKING NUT – A threaded part that holds the pinion in place. Usually, the LCN model number and date of manufacture are stamped into this part. The date of manufacture is important because the owner can determine if the cylinder is in or out of warranty. (See Illus.)

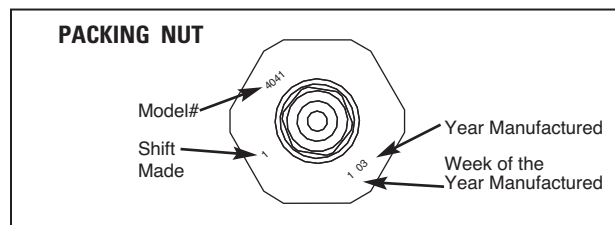

PANIC BREAKAWAY STOP – An optional safety device that permits egress on in-swinging exterior doors by allowing them to swing out in case of an emergency. Used with overhead concealed, center pivoted in-swinging doors.

PARALLEL ARM – A push side mounted double lever arm system where main arm is parallel to the door when in the closed position. (See Illus. page 33)

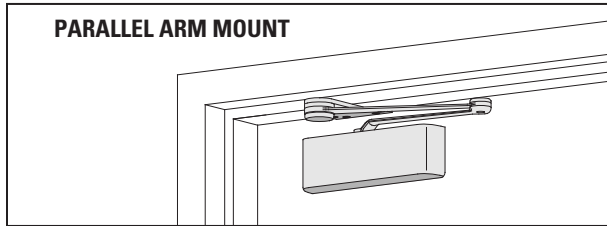

PARALLEL ARM MOUNT – An item usually used on the inactive leaf of a pair of doors for hold-open where the active leaf has a closer installed.

PINION – Transfers rotary motion of the arm system to the piston. Also provides attachment of arms to closer.

PISTON – One of the internal pieces of a door closer. The piston is moved by the rotating pinion, which in turn compresses the spring.

POSITIVE MECHANICAL STOP – Door stop for overhead concealed, center pivoted out swinging doors.

PNEUMATIC – This type of LCN Automatic Operator is driven by an air source. The air source can be built into the control box or provided separately within the building.

POWER BOOST – Provides additional closing force to ensure latching.

POWER OPERATOR – A term used to describe a type of automated opening system. Refer to “Automatic Operators”

POWDER COAT – A standard finishing process that provides a very durable, corrosion resistant covering to the majority of products that LCN offers. An LCN powder coat finish offers over four times the ANSI salt spray test of 25 hours.

PULL SIDE – Hinge side of door. (See Illus.)

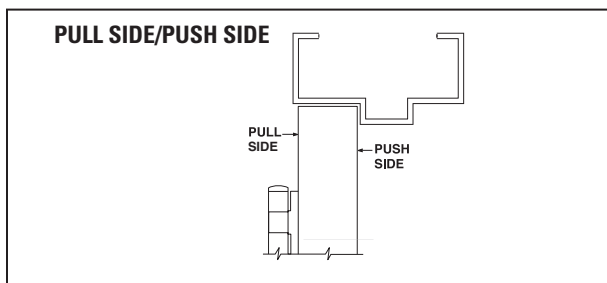

PUSH SIDE – Face of door on stop side of frame. (See Illus.)

PUSH 'N GO – Provides power opening after partial (5°) manual opening of door.

Q

QUICK FIX PLATE™ – Retrofit mounting plate for the LCN 1260 closer used for closer replacement in push/pull applications.

R

RABBET – Recess or offset formed in the face to receive a door.

RADIO FREQUENCY (RF) – A method of actuating LCN Automatic Operators. A RF transmitter signals a RF receiver to open a door.

RAPIDOR™ BRACKET – Hands free mounting bracket.

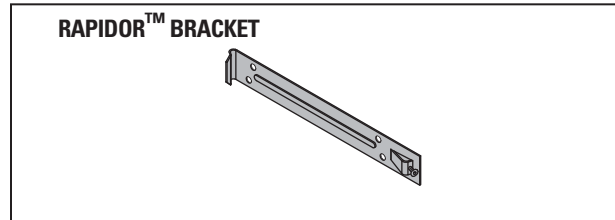

REGULAR ARM – A double lever, non hold-open arm. (See Illus.)

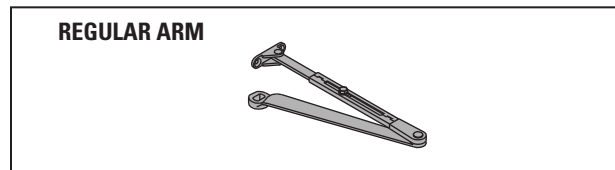

REGULATING SCREW – Valve that adjusts flow of hydraulic fluid within cylinder to control door closing speed. (See Illus.)

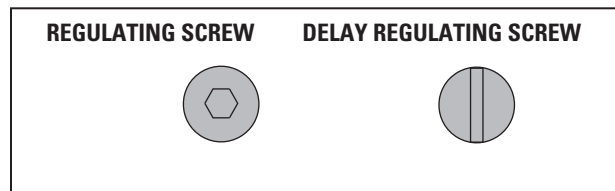

REVEAL – Depth measured from the frame face to the door face. (See Illus.)

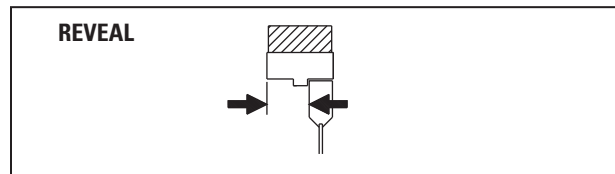

ROD & SHOE – Part of forearm that provides adjustable length feature for double lever arms. (See Illus.)

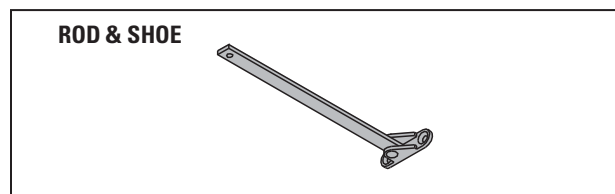

ROTATIONAL INDICATOR - An indicator located on the spring adjuster. Used when adjusting spring power to indicate each revolution. (See Illus.)

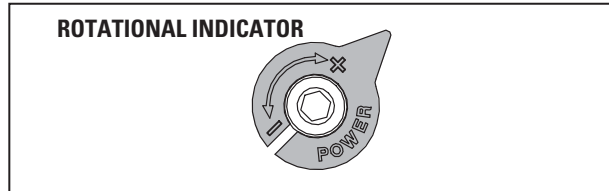

SINGLE LEVER (STANDARD) ARM (STD) – Directly connects cylinder and track/roller assembly on the door or frame. (See Illus.)

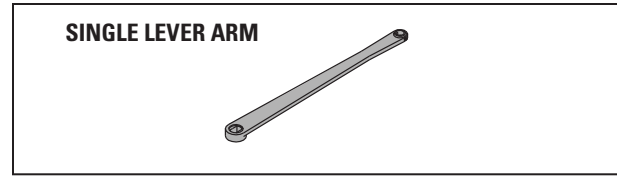

S SAFETY GUARD – A product that mounts on the hinge edge of the door. This is a heavy-duty vinyl product that covers the opening between the door and frame where many injuries occur. One suggested use is on doors within childcare facilities.

SELF-REAMING and TAPPING SCREW (SRT) – Philips head screw with self-reaming and self-tapping capability used in mounting installations. (See Illus.)

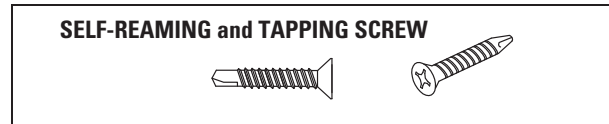

SINGLE RABBET FRAME – Frame with a recess or offset formed on one side of a stop to receive a door. (See Illus.)

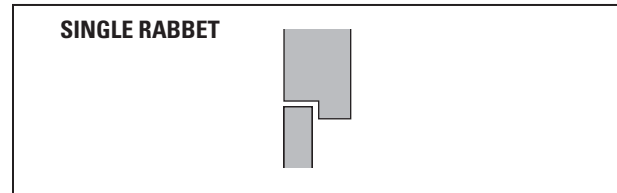

SECOND CHANCE FEATURE – A feature that allows the Automatic Operator two attempts at opening the door. If resistance is encountered on the first attempt, the operator will pause and then try a second time. This feature is standard on the LCN electric automatic operators.

SEM – SEM is short for ‘single-point electronic magnet’. An actual product number is required when ordering.

SENTRONIC – A general term for the fire/life safety products that are offered by LCN.

SEQUENCE – An option to the LCN series of automatic operators. This option allows a pair of vestibule doors to open one after the other.

SHOE – Attaches forearm to frame or door face in a double lever arm system.

SIMULTANEOUS PAIR – Two automatic doors that open at the same time.

SINGLE POINT HOLD-OPEN (SE) – Electrically controlled hold-open using a special track and single lever arm.

SIZED – A closer with a specific closer power for proper door applications.

SLIDER – This part is used in conjunction with a track roller in a Sentronic track assembly.

SLIM LINE COVER – A cover that conceals the cylinder but exposes both pinion shafts.

SOFFIT – Horizontal surface of a frame between vertical stops on a double rabbet frame.

SOFFIT SHOE – Connects parallel arm shoe to soffit.

SPECIAL RUST INHIBITOR (SRI) – A special corrosion resistant pre-treatment that is available for most LCN closers. Adding SRI to the standard LCN powder coat finish gives the closer a tremendous advantage over a potentially corrosive environment.

SPECIAL TEMPLATE (ST) – A special template is usually a modification to a standard product. Either the product itself changes location in the opening or a component is modified from the standard offering to accommodate other hardware or door and frame dimensions.

SPRING CUSH ARM (SCUSH) – Non-handed parallel arm for abusive applications. Features solid forged steel main arm and forearm with spring loaded stop in the soffit shoe.

SPRING HOLD-OPEN CUSH ARM (SHCUSH) – Non-handed parallel arm for abusive applications features solid forged steel main arm and forearm with spring loaded stop in the soffit shoe. Uses control handle to select hold-open function.

SPRING POWER – Closing force exerted by the spring inside the cylinder to close the door.

SPRING POWER ADJUSTMENT – Mechanical pre-loading of spring to adjust closing force. (See Illus.)

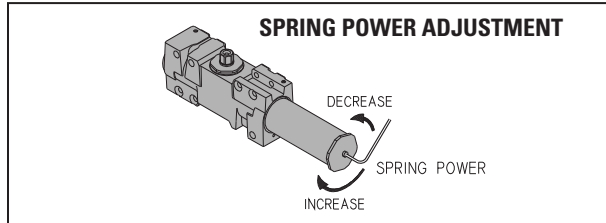

SPRING TUBE – Part of the closer assembly that contains the spring.

STANDARD CYLINDER – Cylinder with main speed, latch speed, and backcheck adjustments.

STANDARD TRACK – Non hold-open track. (See Illus.)

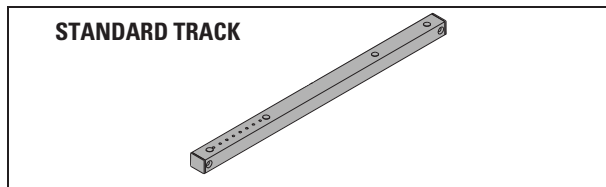

STOP – Part of frame against which the door closes.

STOP HEIGHT – Distance the stop extends below the frame face. (See Illus.)

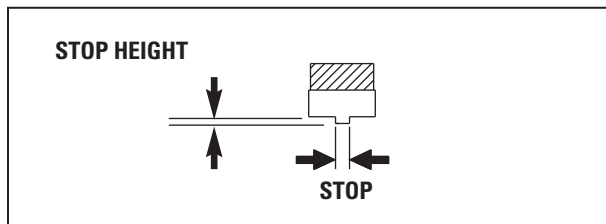

SWING FREE ARM – ME arm designed to allow free movement of the door without disengaging the holding mechanism. (See Illus.)

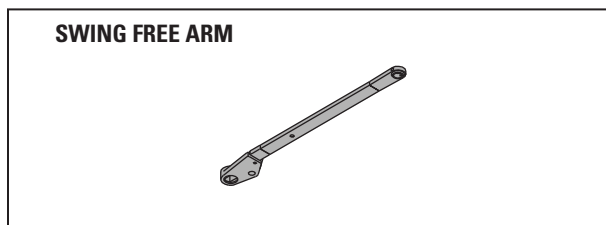

T

TBSRT – Thru bolts and self-reaming and tapping screw package.

TBTRX – Thru bolts and TORX security machine screw package.

TBWMS – Thru bolt, wood and machine screw package.

THICK HUB SHOE – Substituted for soffit shoe on EDA arm to clear blade stop.

TOP JAMB – Mounting with closer installed on frame face. (See Illus.)

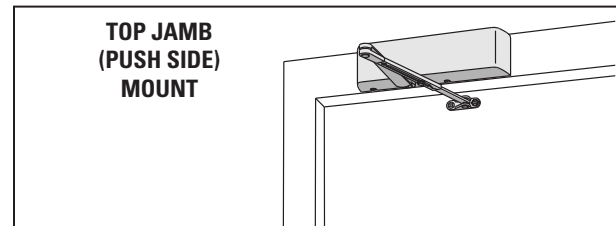

TOP RAIL – Horizontal top member of a door that connects the latch and hinge stiles. Height is measured from stop on push side. (See Illus.)

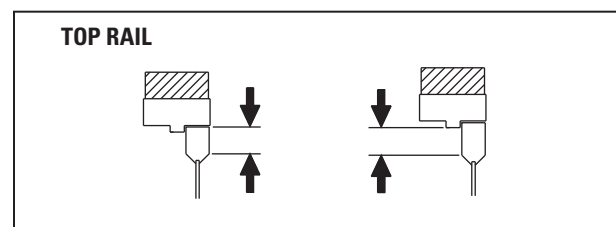

TORX – Security machine screw with TORX drive and security pin for tamper resistant applications. (See Illus.)

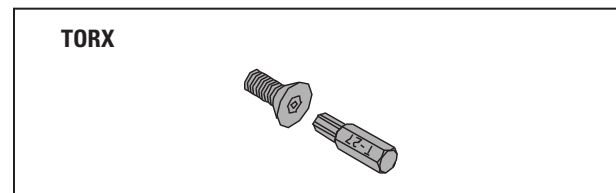

TRACK BUMPER – Mounts in track to cushion opening swing, but reduces maximum opening. This is not a substitute for a mechanical door stop. (See Illus.)

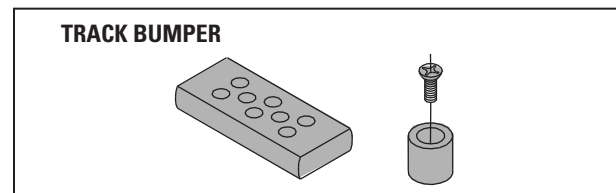

TRANSFORMER – Electrical device to reduce voltage from 120V AC to 24V AC. (See Illus.)

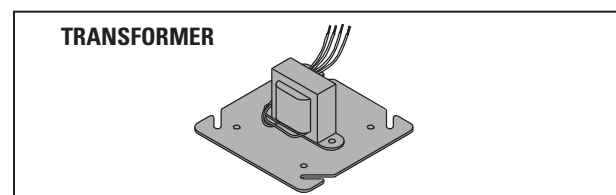

LCN GLOSSARY

U-W

TRI-VOLTAGE – SEM magnets available with current inputs of 12v, 24v and 120v.

U

ULTRA LIQUID X – All weather fluid that does not change viscosity over a wide temperature range.

UNIVERSAL – A term used to describe a door closer. Closers of this nature are non-sized and non-handed.

V

VESTIBULE – A small lobby or entrance that has at least two doors. One door is to the exterior and the other to the interior of the building. A variation could be multiple doors or banks of doors.

W

WMS – Standard wood and machine screw package.

WOOD MOUNTING CLIP – Designed to ease installation of concealed closer in wood frame.