

LIFE M9 X/M9 X UC NEXT GENERATION

User Manual



Welcome to the LIFE Ionizers family!

Congratulations on the purchase of your new alkaline mineral water ionizer. We are grateful to our many customers for recognizing our efforts in providing the best water ionizer available!

Ionized Alkaline Mineral Water promotes good health with its superior hydration, mineralization, oxygenation and cellular detoxification. Our ionizers use a series of internal and external filtration systems and the finest-quality platinum-coated titanium plates, to create alkaline water with the highest anti-oxidant potential in the industry.

What do I need to know?

- Please **read all safety warnings** before the installation or operation of your LIFE Ionizer to ensure proper product usage.
- To receive warranty service, you must **register your warranty** online. Please see enclosed warranty card for detailed instructions.
- **Refer to this manual** when you have questions on adjustments and how to change your filters. We also have instructional videos and help guides online at **Lifelionizers.com/support**.
- **Filters are important!** To ensure optimal performance and to guarantee your warranty, internal filters should be changed annually and a citric acid cleaning filter should be used up to three times per year to reduce the build-up of minerals found in the source water which can cause blockage in the ionizer.

Table of Contents

Safety Guide	4
Product Specifications	7
Package Contents	8
Important to Remember	10
Parts of the Ionizer	12
M9 X NG Installation (counter top)	14
M9 X NG UC Installation (under counter)	16
Quick Connect Fittings and Tubing	18
Display Overview	19
Function Options	20
M9 X NG Operation Method (counter top)	25
M9 X NG UC Operation Method (under counter)	26
Internal Filter Replacement	28
Filter Reset Instructions (counter top)	29
Filter Reset Instructions (under counter)	30
Citric Acid (Scaling) Cleaning Filter	31
Filtration Media	33
Pre-Filter Replacement	34
Acidic Cleaning Instructions & Routine Maintenance	35
Common Problems and Solutions	36
Operation Warnings/Error Messages	37
How Alkaline Water is Made	38
Alkaline/Acidic/Purified Water	39
Uses of Ionized Alkaline/Acidic Water	40
Performance Features	43
Frequently Asked Questions	44

Safety Guide



Power Plug

As with most electrical appliances, electrical parts in this ionizer are electrically live even when the switch is off.

- Power cord should not be touched with wet hands
- Use only (110v) in the USA, Mexico and Japan. Most other countries require (220v). The power cord cannot be altered from manufacturer's specs.
- Do not crimp or staple the power cord
- Power cord should be plugged directly into an electrical outlet
- Do not connect multiple appliances into a single power receptacle.
- Dusty or dirty electrical outlets may cause safety issues
- Bending, twisting, pulling or putting heavy objects onto the power cord may cause electrical problems including fire.
- If power cord, plug or electrical outlet are damaged, discontinue use immediately.
- Unplug the electric power when not in use for a long time (over 3 days)

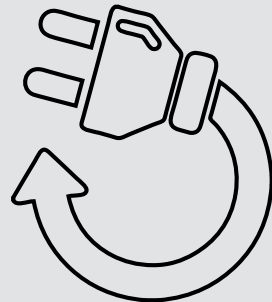

Ionizer

- Place machine in an upright position only
- Do not install this unit in direct sunlight or near a heater, fireplace or other heat source
- Do not place the machine in humid areas such as bathrooms
- If wall mounted, secure firmly and correctly
- Do not use water with a temperature of over 95 degrees Fahrenheit or 35 degrees Celsius
- This machine should not be repaired or otherwise disassembled by any unauthorized person as it may cause electrical fire or shock and will void the manufacturer's warranty
- Do not clean this machine by spraying the ionizer with water as it may cause electrical shock.
- Do not use benzene, thinner, or chemicals to clean the unit as it can damage the housing.
- Do not block the unit vent as it can cause overheating and/or electrical problems.
- Do not block the water passage or tubing
- Do not place anything on the unit
- Don't shake or drop the unit
- If the ionizer machine falls into water:
 1. Unplug power cord from electrical outlet
 2. Wipe the machine down and place in shaded area
 3. Contact your LIFE ionizer dealer

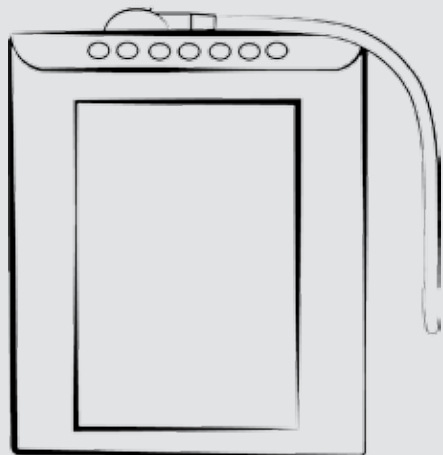

Ionized water

- If inexperienced with drinking Ionized Alkaline Water, users are encouraged to start with level 1
- When drinking Ionized Alkaline Water - Do not take prescription or other medications for approximately one hour before and after drinking water. Ionized alkaline water hydrates more efficiently, therefore will deliver more medication than tap water.
- Store Ionized Alkaline Water in an air-tight glass container and refrigerate for up to 2 days
- **DO NOT DRINK ACIDIC WATER**
- Do not store Alkaline or Acidic water in metal containers, although you can put alkaline water in the Water for LIFE Stainless Steel bottles as they are designed to maintain pH and ORP
- Aluminum and brass containers will be tarnished by alkaline and acidic water
- If not used for several days, run water through the unit for 1 to 3 minutes before starting
- If the machine will not be used for several days:
 1. Unplug the power cord from the electrical outlet
 2. Turn off the water valve to avoid leaking
 3. Remove filters, drain and place in refrigerator in plastic bags.
 4. Let water run on the "Purified Water" setting for at least 3-5 minutes before any operation



Product Specifications



Special features	Fully convertible: counter-top to under counter
Cleaning function	Advanced RADC Cleaning System
Display	Full Color LED Display w/ Automatic Voice Prompting
Filtration	Dual Internal, Custom Pre-filter
Flow Control	Automatic
Power in watts	Adjusts up to 504 watts
ORP Output	up to -800 (Enhanced ORP at drinkable levels)
pH Output	pH range from 2.0 up to 11.5
Protection	Automatic Heat Sensor
Power System	MAX Yield SMPS Power System™
Rated Voltage	110v or 220v
Settings	1 Purified, 3 Acidic, 4 Alkaline
Warranty	Guaranteed LIFEtime warranty
Dimensions	13" x 13" ¾ x 6"
Plate Material	Platinum over Industrial Titanium

Package Contents

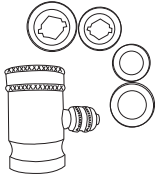

Pull down
Diverter Valve

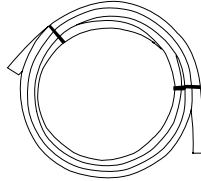

1/4" Tubing Hose

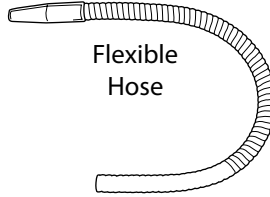

Flexible
Hose



User Manual



Suction Cup



pH Color
Chart



Reagent Drops
(pH Test Drops)
BTB Chemical

Extra Fuse



Located in the Power
Switch at the bottom of the
machine

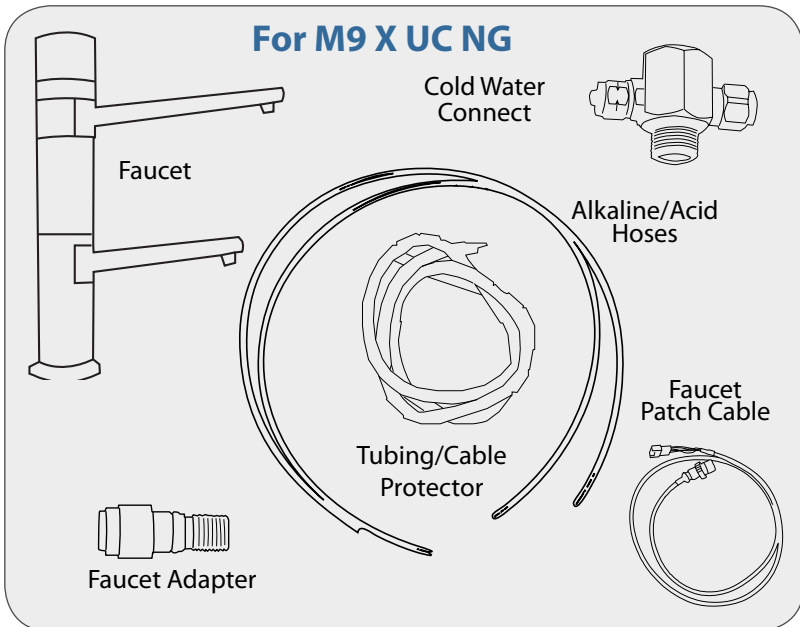

How to measure the pH of your water

A pH color chart and a bottle of Reagent Drops are included with your ionizer in case you would like to test the water from your new ionizer.

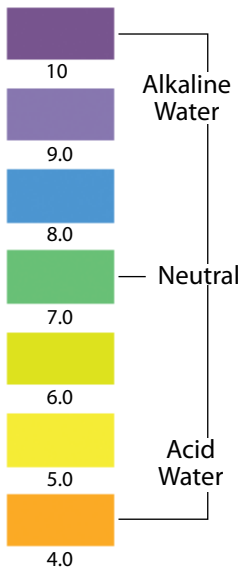

PH Tester Kit Instructions:

1. Place 1-2 ounces of water you are testing into a glass
2. Add 2-3 drops of Reagent Drops
3. Stir water to observe the color change
4. Compare to "pH COLOR CHART" to determine pH and acid levels.

When handling the pH test (reagent drops):

1. Keep away from eye area. If eyes become irritated, flush thoroughly and consult a doctor.
2. If accidentally swallowed, drink water and consult a doctor.
3. Store in an airtight container away from the reach of children.
4. Drops are flammable. Keep away from children.

Important to Remember



Pre-filter Installation

You must run 2-3 gallons of water through the pre-filters before you connect them to the ionizer. To do this, install the pre filters into their housings, connect a piece of tubing to the outlet connection on the pre filter housing and run it into the sink so you can flush them out with water. This hydrates the filters and cleans them from any loose media. After you finish this procedure, connect your pre filter back to your ionizer and run normally. This needs to be done every time you put in new pre-filters.

Ionizer Installation

- Plugs located on the bottom of the ionizer must be removed before installation.
- Do not over tighten the patch cable connection on the back of the ionizer when plugging in patch cable.
- Run the ionizer and check for leaks at all tubing locations from the Diverter Valve to the Ionizer itself before operating the unit.

Settings

- Flow rate must be set before adjusting or running your ionizer.
- Set flow rate no higher than 2.5 liters per minute. Anything higher could cause internal damage.
- When adjusting the settings, the buttons must be pressed quickly as failure to do so will result in booting you out of the program menu.
- The unit must be dispensing water before pressing the buttons.
- Adjust the flow rate (LPM) by slowing down the water flow to ionizer from the source water:
 - Cold Water Connect (for under undercounter units)
 - Faucet Diverter (for countertop units)

Ionizer Care

- Do not twist top of faucet. This will damage the faucet.
- We recommend internal filters and pre-filters be changed annually.
- Citric acid cleaning filter should be used 3 to 4 times per year.
- Use cold water only with your ionizer

Parts of the Ionizer

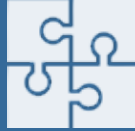

BACK

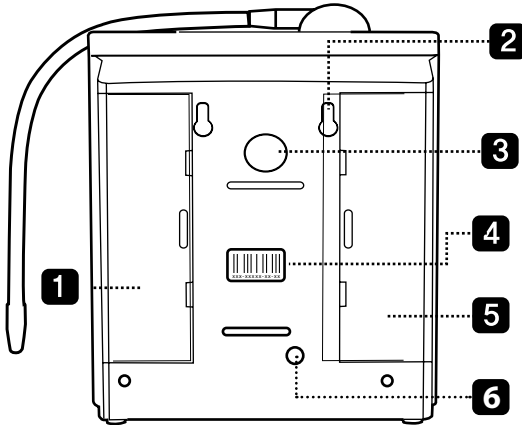

- 1. First Filter Cover
- 2. Wall Mount Screw Holes
- 3. Speaker
- 4. Bar Code and Serial Number
- 5. Second Filter
- 6. Under Counter Installation Plug/Connector

BOTTOM

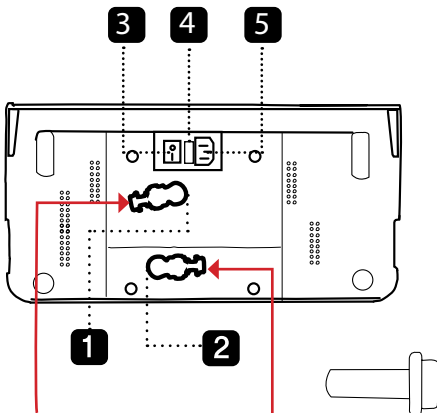

- 1. Source water inlet
- 2. Acidic outlet
- 3. On/Off Power Switch
- 4. Fuse Box
- 5. Power Plug

**** Plugs must be removed before installation.**
See page 18 for Quick Connect Fittings and Tubing instructions.

FRONT

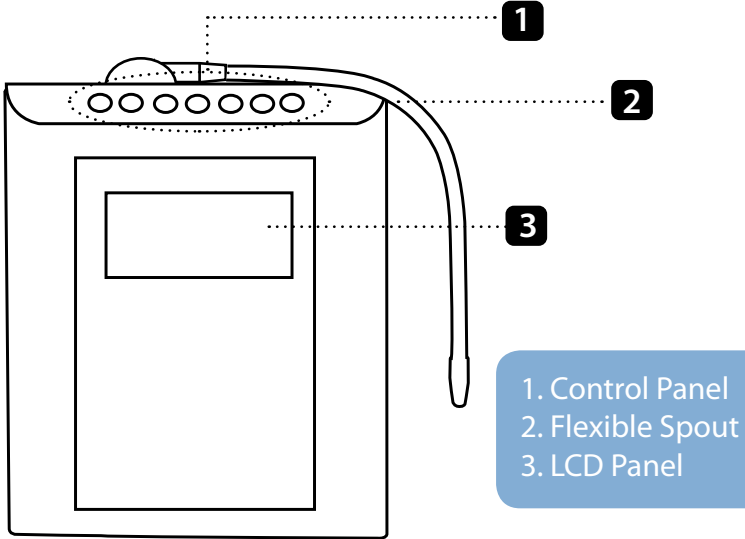

FAUCET (for M9 X UC)

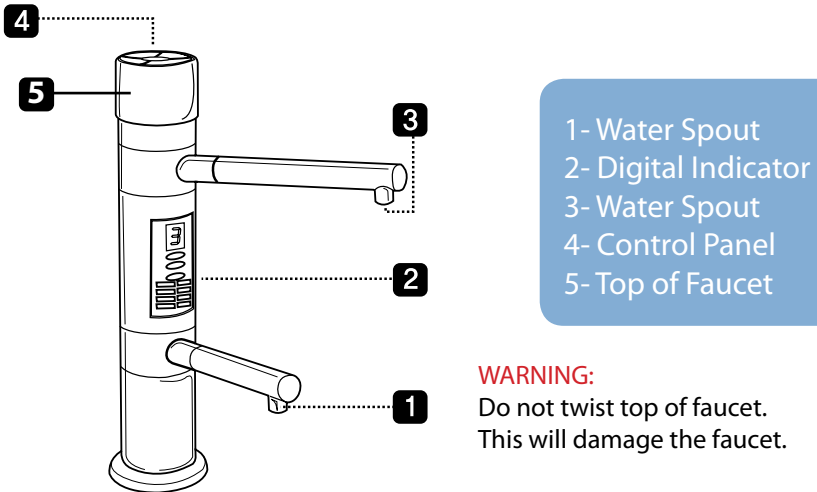

WARNING:
Do not twist top of faucet.
This will damage the faucet.

counter hole for faucet
should be 1 3/8"

M9 X NG Installation

(counter top)



(help video on [Lifelonizers.com/support](https://www.lifelonizers.com/support))

Refer to diagrams on page 15.

STEP 1: Unscrew the existing aerator from your faucet.

STEP 2: Use Teflon plumbers tape on the threads. Make sure the black rubber washer is inside the diverter valve before you screw it onto your faucet. This assures a proper seal. *(Three different sized adaptors are included for non-standard sized faucets).*

STEP 3: Unscrew the round nut from the side of the diverter valve. Place the 1/4" tubing through the nut and over the opening. Screw the nut back onto the diverter valve over the tubing. Tubing should now fit snugly onto the diverter valve.

STEP 4: Run the other end of the 1/4" tubing that you attached to the diverter valve to the **(IN)** on the Pre filter. Connect another piece of 1/4" tubing to the **(OUT)** on the Pre filter. This tube will go to the inlet valve on the bottom of the ionizer in STEP 6.

STEP 5: Remove the plugs in the following manner: Lay the ionizer down on its back and you will see two white elbows extruding from the bottom of the machine. There will be an off-white collar around the base of the elbow *(see page 18)*. Push in the collar against the face of the fitting. With the collar held in this position, you can extract the elbow from the machine. It is sometimes helpful to use the back of a butter knife or screw driver to remove the plugs.

STEP 6: Insert the 1/4" tubing from the **(OUT)** on the Pre filter to the **inlet valve** on the bottom of the ionizer using the quick connect instructions on page 18. Insert another 1/4" tube in the outlet valve on the bottom of the ionizer and run the other end into the sink securing it with the suction cup provided. Some units may contain water. Don't be alarmed; we test units for quality before shipment.

STEP 7: Run the ionizer and check for leaks at all tubing locations from the Diverter Valve to the Ionizer itself before operating the unit.

DIVERTER CONNECTION

STEP 1:

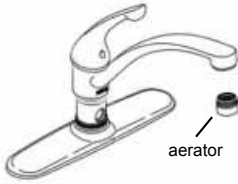

Option:
Diverter Valve Adapter if needed for your type of sink.

STEP 2:

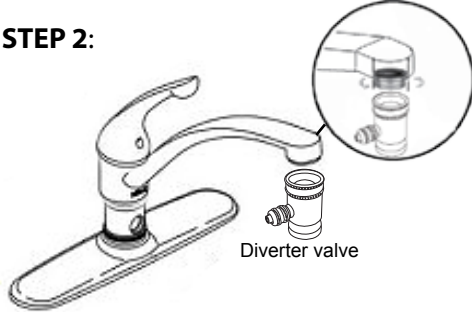

STEP 3:

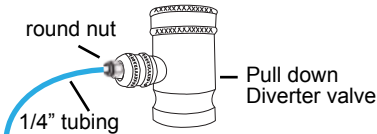

STEP 5:

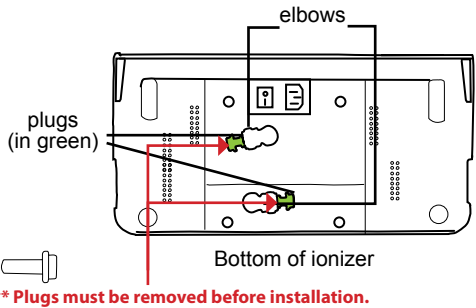

STEP 4:



STEP 6:

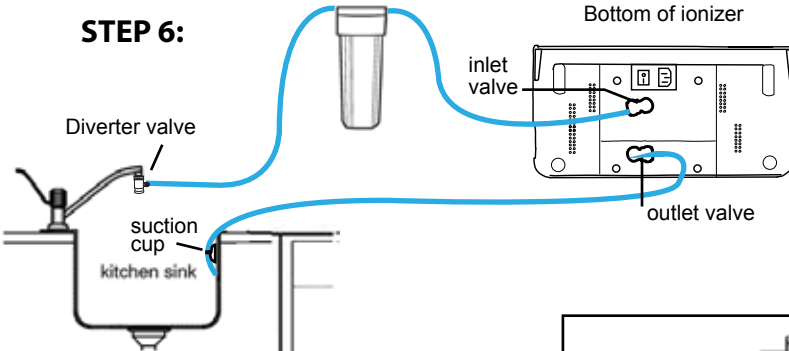

Pre-filters

NOTE: Run 2-3 gallons of water through the pre-filters before you connect them to the ionizer.

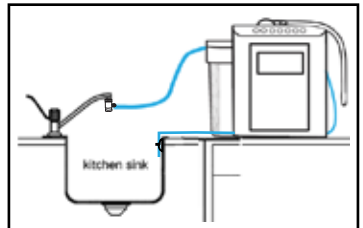



M9 X NG UC Installation

(under counter)



(help video on Lifelonizers.com/support)

-  Angle stop valve
-  Cold water connect valve

COLD WATER CONNECT



1. Find the raw water valve under sink. Turn the main valve (angle stop) off.

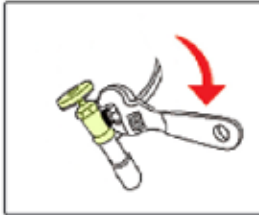

2. Take off the cold water line from the angle stop valve as pictured.

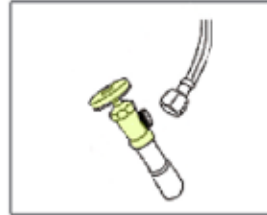

3. Totally disconnect the line as shown above.



4. Connect the Cold Water Connect to the angle stop valve. Then connect the cold water line to the Cold Water Connect valve.

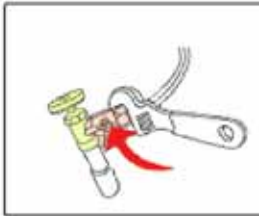

5. Close tight with pliers.

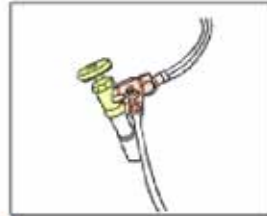

6. Connect the 1/4" tubing and open the Cold Water Connect valve. Turn the main valve back on.

7. Run the ionizer and check for leaks at all tubing locations from the Diverter Valve to the Ionizer itself before operating the unit.

IMPORTANT

**** Highlighted plugs must be removed before installation.**



Source Water

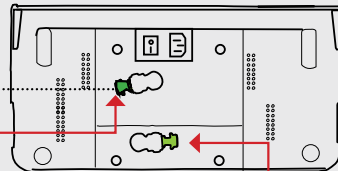

See page 18 for Quick Connect Fittings and Tubing instructions.

LAYOUT DIAGRAM

Cold Water Connect

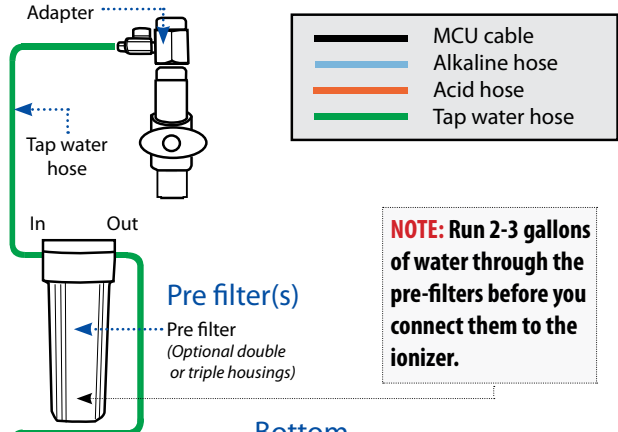

Bottom

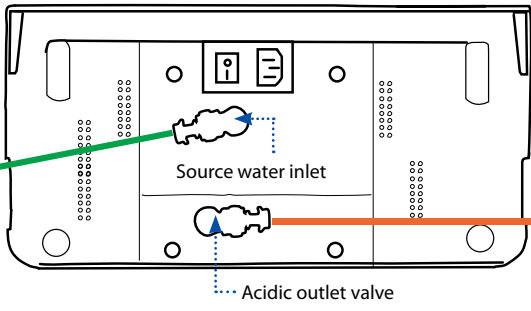

Front

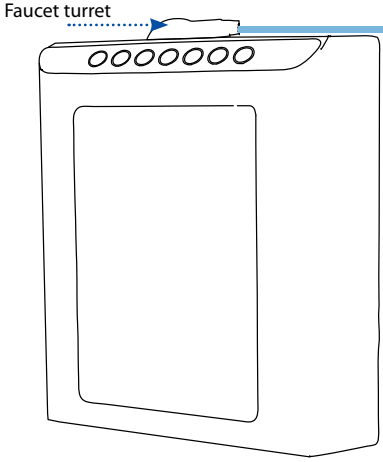

Back

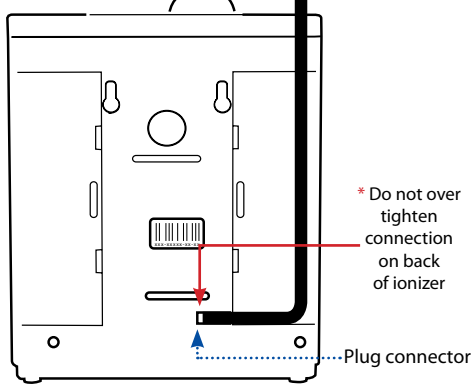

counter hole for faucet should be 1 3/8"

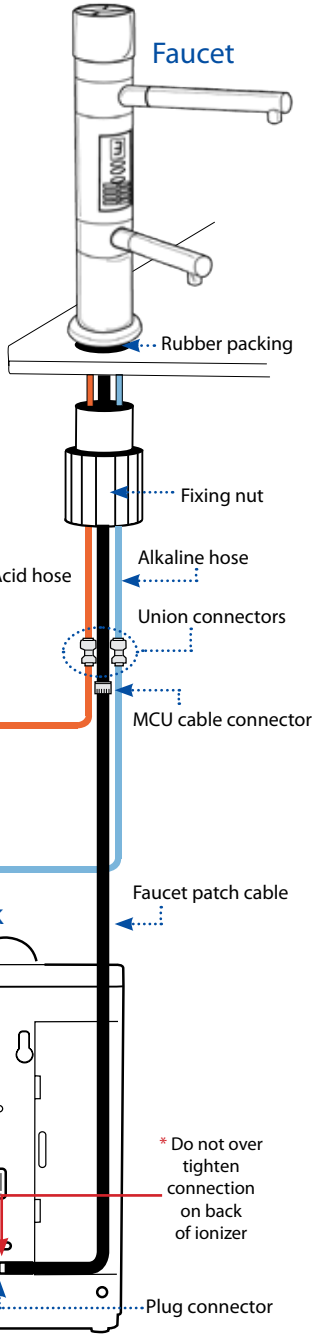

Quick Connect Fittings and Tubing



To ensure an optimal seal, tubing should be cut with the end square. An angled cut or distortion of the tubing will not provide an efficient seal and may cause leaks. Determine the length of tubing needed for the connection and cut the segment of tubing to the appropriate length.

TO CONNECT:

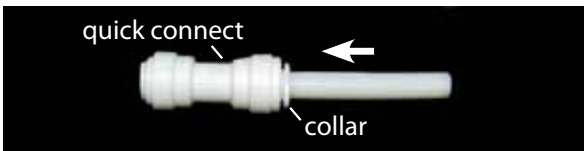

Push the tubing into the quick connect. The collar (gripper) has teeth which hold the tubing firmly in position while the “O” Ring provides a permanent leak proof seal.

Check the Seal: Pull on the tubing to see if the seal is secure. Check for leaks.

TO DISCONNECT:

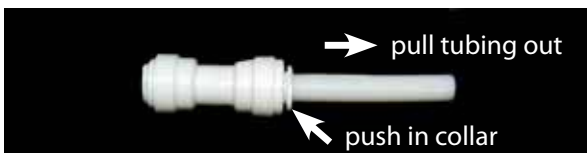

Ensure system is depressurized before removing fittings. Push in the collar against the face of the fitting. With the collar held in this position, the tube can be removed. The fitting can then be re-used.



Display Overview

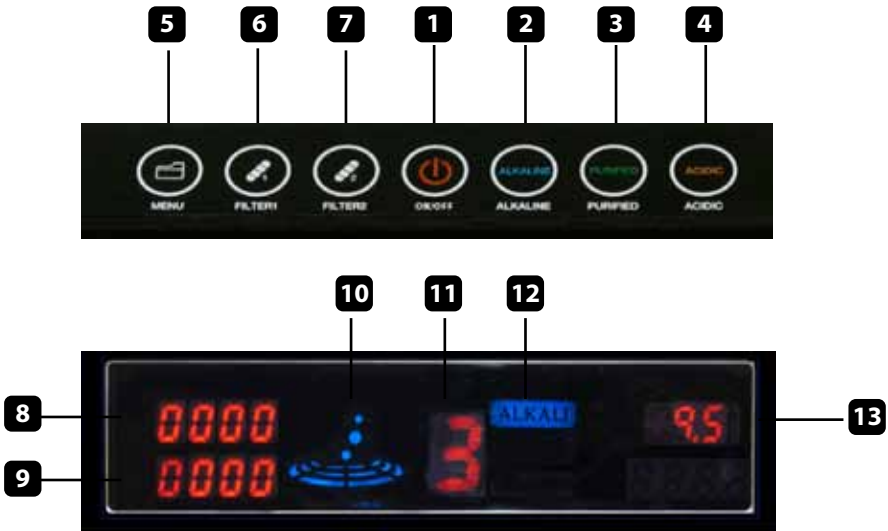

1. ON/OFF Button
2. Alkaline Selector
3. Purify Selector
4. Acidic Selector
5. Menu/Function
6. Filter 1 Indicator/Reset
7. Filter 2 Indication/Reset
8. Filter 1/Life Indicator
9. Filter 2/Life Indicator
10. Operation Display Lamp
11. Level Indicator
12. Indicator Water Type (Alkaline/Acidic/Purify)
13. pH Indicator

Function Options



NOTE: FLOW RATE MUST BE SET TO GET PROPER PH LEVELS.

Set flow rate no higher than 2.5 liters per minute. Anything higher could cause internal damage.

AMPS AND LITERS PER MINUTE (LPM)

NOTE: the unit must be dispensing water before pressing the buttons.

- Press and hold “**FILTER 1**” & “**FILTER 2**” simultaneously for 5 seconds in order to enable the display of the Amps & LPM reading indicator light.



Amps & LPM (liters per minute) indicators

- Two numbers will then appear on the indicator.
- The top number is the amps number followed by the digit A.
- The bottom number is the Liters per Minute (LPM) followed by the digit L.
- Once the LPM is displayed, you can make the necessary adjustment to the water flow in order to adjust the LPM to the unit. Adjust the LPM by slowing down water flow to ionizer from the source water:

- **Under Counter** - *Cold Water Connect*
- **Counter Top** - *Faucet Adapter*

KEY NOTE: The slower the flow, the stronger the alkaline or acidic water is produced. We recommend that you set the machine between a flow of 1.5-2.5LPM.

- For strong 11+pH alkaline or 2.5 pH acid water, we recommend that the flow rate be set at 1.1-1.5 LPM. Do not set below 1.0 LPM because it will error out and display E1.

NOTE: Your pH will be determined by your water source. If you're on well water, your water is soft, or your TDS is too low, then you might need a remineralizing cartridge or a pre-filter to add alkaline minerals so your unit can ionize properly.

SOUND/VOLUME ADJUSTMENT (F10)

To enter the Volume Adjustment please do the following:

- Press and hold the **"MENU"** button for 5 seconds.
- Once you do this **"VOL"** will appear on the display and below that it will show a number.
- To increase volume, press and release the **"FILTER 2"** button, to decrease the volume setting press and release the **"FILTER 1"** button.



PH TESTING WITH DROPS

To test and to determine the pH of your water, you will have to select the level you are testing as well as combining the liquid reagent pH drops provided with the purchase of your ionizer with a sample of water gathered from your ionizer.

1. To begin this process, you will need a small clear glass of some sort.
2. Turn on your water ionizer and select the level of alkaline or acidic water you will want to test. Please wait 10 seconds before collecting the water.
3. You will then need to add 2-3 liquid reagent pH drops to the glass first and collect 1 ounce (2 tbsp) of water from your ionizer.
4. After that you will need to compare the water you tested with the color ph chart provided with the pH drops.
5. You will need to adjust the amperage levels depending on your source water. We recommend you set water pH to **ALK1**-light blue/**ALK2**-dark blue/**ALK3**-light purple/**ALK4**-dark purple.
6. To do this follow the F-20 steps on the next page.

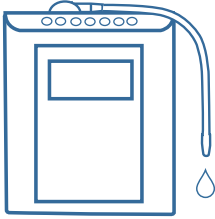
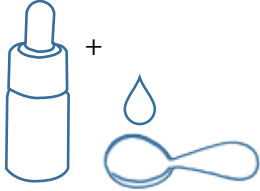
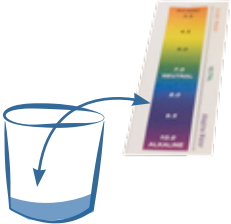
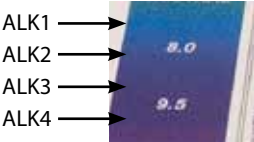
<p>1.</p>  <p>small clear glass</p>	<p>2.</p>  <p>collect water</p>	<p>3. Add to glass:</p>  <p>2-3 drops 2 tbsp water</p>
<p>4.</p> 	<p>5.</p>  <p>ALK1 → ALK2 → ALK3 → ALK4 →</p>	<p>6.</p> <p>Adjust amperage levels by following the F-20 steps on the next page</p>

AMPERAGE ADJUSTMENT (F20)

(help video on [Lifelonizers.com/support](https://www.lifelonizers.com/support))

To enter into the F20 you will need to do the following:

NOTE: The buttons must be pressed quickly as failure to do so will result in booting you out of the program menu. **The unit must be dispensing water before pressing the buttons.**

- Press and hold the “MENU” & “FILTER 1” buttons simultaneously for 5 to 10 seconds (or until F20 appears on screen).
- F20 will appear on the display screen.
- Below the F20, the amperage number will display and start flashing. These numbers will vary depending on the level of alkaline or acid you are on.
- Scroll through the alkaline and acid levels by pressing the “ALKALINE” or “ACID” button.
- Once you are on the level you want to adjust, the amperage number will be flashing.
- To increase the amperage number, press and release the “FILTER 2” button.
- To decrease the amperage number, press and release the “FILTER 1” button.
- Repeat the process to adjust the other levels of alkaline or acid.
- To save your adjustments, press the “PURIFY” button and the display screen will go back to its normal operation.
- **NOTE:** You cannot adjust the “PURIFY” selection.
- For optimum performance of the unit, you will need to clean your ionizer with the **CITRIC ACID CLEANING FILTER** also known as the **SCALING FILTER**. We recommend using this cleaning cartridge 3-4 times a year depending on the hardness of your water.

FUNCTIONS F-30 AND AFTER

To enter F-30 and after functions you will need to do the following.

- Press and hold the “MENU” & “FILTER 1” buttons simultaneously for 5 seconds.
- The machine will display F20 and the screen.
- Press and release the “MENU” button continuously to scroll through the other **F-functions**.

PLATE SELECTION (F-30)

- Select number of plates (5,7,9,11 & 13) **UNITS COME PRE-SELECTED**

LANGUAGE SELECTION (F-40)

- Select preferred language. (*English is the default language*)
 - 1- Korean
 - ② English
 - 3- Chinese
 - 4 -Russian
 - 5 -Spanish

PH DISPLAY OPTIONS (F-50/F-51)

- Default will show pH setting only
- pH Ho - Fixed level (use this level)
- pH En - Adjustable level

CLEANING (F-60) (*reverses the electric power to clean the plates*)

- (1) Washes beginning & end of water usage
- (2) Washes at the beginning only (*default setting*)
- (3) Washes at the end only
- (4) Does not wash at all

F-70 AND AFTER FOR ENGINEER USE ONLY

DO NOT CHANGE. LEAVE AT DEFAULT SETTINGS.

1st FILTER SETTING (F-70) 3,000 liters (*30 is default setting*)

2nd FILTER SETTINGS (F-71) 6,000 liters (*60 is default setting*)

WATER FLOW CHECK (F-80) (*0 is default setting*)

RUN TIMER (F-81) 10 minutes (*10 is default setting*)

To show the power consumption and water flow information, press the “Menu” button and “Filter 1” button simultaneously and hold down for about 8 seconds. **NOTE: Water must be running**

M9 X NG Operation Method

(counter top)



* **Make sure the cold water is on and diverted to the ionizer.**

Alkaline water discharge method



Press the "ON/OFF" button. Then press the "ALKALINE" button and keep tapping that button until the desired **alkaline** level displays on the screen. The level indicator will display the level you selected. To STOP collecting water, press the "ON/OFF" button.

Acidic water discharge method



Press the "ON/OFF" button. Then press the "ACIDIC" button and keep tapping that button until the desired **acidic** level displays on the screen. The level indicator will display the level you selected. To STOP collecting water, press the "ON/OFF" button.

Purified water discharge method



Press the "ON/OFF" button and then select the "PURIFIED" button to start dispensing filtered, purified water. To STOP collecting water, press the "ON/OFF" button.









First time users who are not familiar with this water are recommended to start with Ionized **Alkaline Water level 1** for *two weeks*, then adjust the level to **Alkaline Water level 2** for *two weeks*, and then adjust again to **Alkaline Water level 3** for daily drinking. This gradual adjustment will help your body get accustomed to the higher alkaline pH levels.

* **Make sure to turn off the ionizer before turning off the water.**

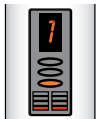
M9 X NG UC Operation Method

(under counter)

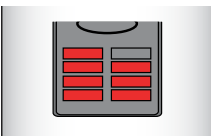

DISPLAY WINDOW	OPERATION MENU	DESCRIPTION
		<p>When you select alkaline water, 1~4 phases appear in number and light is marked by blue color.</p>
		<p>When you select acid water, 1~3 phases appear in number and light is marked by orange color.</p>
		<p>When you select purified water, the number and light is marked by green color.</p>
		
<p>Early stages of filter life.</p>	<p>In-need of filter change.</p>	<p>The lifetime of the filter is shown by four phases of light. You should change the filter when only one bar is not lit up and the machine tells you to.</p>

NOTE: Please see page 39 for recommended Alkaline Water Level for drinking.

*** Water will come out of both spouts when dispensing water.**

When the Alkaline button is pressed

- Alkaline water will be dispensed from the top spout
- Acid water will be dispensed from the bottom spout

When the Acid button is pressed

- Acid water will be dispensed from the top spout
- Alkaline water will be dispensed from the bottom spout

When the Purify button is pressed

- Purified water will be dispensed from the bottom and top spouts.

Indicator Functions:

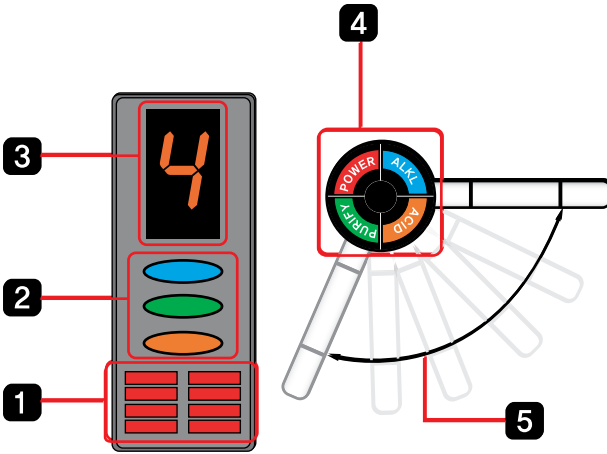

1. Filter Indicator
2. Indicates Ionized Water Type
3. Indicates Selected Ionization Water Setting
4. Ionization Water Selection Button
5. The Faucet Can Swivel Up to 120°

Voice Functions

*It is being washed now, Please wait a minute.

Alkaline Water Button

*Alkaline 4 - 4th grade of alkaline water is being extracted now.

*Alkaline 3 - 3rd grade of alkaline water is being extracted now.

*Alkaline 2 - 2nd grade of alkaline water is being extracted now.

*Alkaline 1 - 1st grade of alkaline water is being extracted now.

Acid Water Button

*Acidic Water 3 - 3rd grade of acid water is being extracted now.

*Acidic Water 2 - 2nd grade of acid water is being extracted now.

*Acidic Water 1 - 1st grade of acid water is being extracted now.

Purified Water Button

*Purified Water is being extracted now.

Internal Filter Replacement



For installation video, go to www.lifeionizers.com/support and click the Next Generation filter replacement video.



The sticker on the filter must be removed.

How to Change the Filters

1. Remove the filter cover for the filter you want to change.
2. Turn the filter counter clockwise to release it out of the socket using the wrench provided (Open and close indicator will be on top of the filter).
3. Pull up on the filter to remove it from the ionizer.
4. Be sure to take the sticker off of the new filter.
5. For easy installation, lube new filters with a food safe lubricant like olive oil to the outside O-ring. This will help the filters turn more easily.
6. Line up the filter tabs and press the filter down into the socket.
7. Turn the filter clockwise until it stops.
8. Replace the filter cover.
9. Reset the filter counter (see page 29 for counter top and page 30 for under counter).

Internal Filter Wrench
(comes with ionizer)



Filter Reset Instructions

(counter top)



(help video on [Lifelonizers.com/support](https://www.lifelonizers.com/support))

Filter 1



After changing the first filter, press and hold the **"FILTER 1"** button for 10 seconds. You will hear 2 beeps and the filter counter indicator will reset to 3000.

Filter 2



After changing the second filter, press and hold the **"FILTER 2"** button for 10 seconds. You will hear 2 beeps and the filter counter indicator will reset to 5000 or 6000.

Tips After Filter Replacement:

- Select the **"PURIFIED WATER"** setting and let the water run for 3-5 minutes after any filter replacement .
- If the machine has not been used for a few days, let the water run for 3-5 minutes at the **"PURIFIED WATER"** setting before making Ionized Alkaline water for consumption.
- Consult with the installer or retailer on the purchase of filters if in question about usage or installation.

Filter Reset Instructions

(under counter)



Undercounter Filter Reset

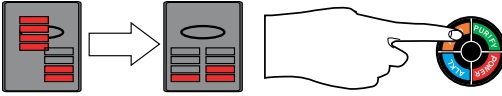

* After changing the first filter, you can reset it by pressing and holding the **"ACIDIC"** button for 10 seconds and you will hear 2 beeps.

Volume Control

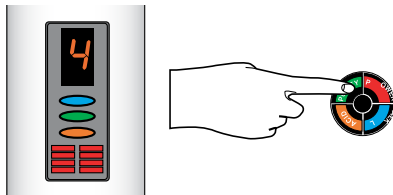

* After changing the second filter; you can reset it by pressing and holding the **"ALKALINE"** button for 10 seconds and you will hear 2 beeps.

For volume control, press the **"PURIFIED"** button for 5 seconds. All control settings (**"ALKALINE"**, **"ACIDIC"** & **"PURIFIED"**) buttons will light up.

* To increase volume, press the **"ACIDIC"** button.

* To decrease volume, press the **"ALKALINE"** button.

Tips After Filter Replacement:

- Select the **"PURIFIED WATER"** setting and let the water run for 3-5 minutes after any filter replacement .
- If the machine has not been used for a few days, let the water run for 3-5 minutes at the **"PURIFIED WATER"** setting before making Ionized Alkaline water for consumption.
- Consult with the installer or retailer on the purchase of filters if in question about usage or installation.

Citric Acid (Scaling) Cleaning Filter



(Step by Step Installation Guide on Lifelonizers.com/support)

Citric Acid (Scaling) cleaning filter should be used 3 to 4 times per year. Cartridge is only good for one cleaning.



NOTE: If the water dispersed from the spout is still slower than the waste water, the machine may need to be sent in for deep cleaning.

NOTE: If you are putting in any new filters, do so after the cleaning.

1. Turn off power to the ionizer by pressing the circle side of the power switch located at the bottom of the ionizer.
2. Remove the **#2 filter cover** located on the right side when looking at the back of the ionizer.
3. Remove the **#2 filter** by twisting the filter and then lifting it out of the ionizer.
4. Remove the clear plastic packaging and dust cover from the bottom of the scaling filter.
5. Before installing the filter, lube up the large outer O-ring with either olive oil or vaseline. Line up the 2 tabs on the filter to the filter base in the ionizer.
6. Once you have aligned the tabs on the filter with the ionizer, press down and twist the filter until it stops.
7. Replace the cover and turn the power switch back on.
8. Apply water pressure, press the **"ON/OFF"** button and produce water for 15 seconds. Press the **"ON/OFF"** button to stop extraction. For counter top applications, remove the acidic tube from the sink and fasten it to the ionizer ensuring that the cleaning solution will not leak out of the ionizer.

Now let the unit sit for a minimum of 6-8 hours or for best results, overnight. The unit is full of a citric acid solution that will take many hours to break down the scale that has built up in your unit. Letting it sit in the unit for over a 6 hour period is okay and will not harm the ionizer.

9. Once the unit has sat for the recommended time, (leaving scaling filter in place) unfasten the acidic tube from the ionizer and place it back in the sink (for counter top applications) and then press the center **"ON/OFF"** button. Let the unit extract water for 3-5 minutes. This step will purge all of the citric solution, along with any scale, out of the machine.

The cleaning process is now complete. Remove the scaling filter and throw it way or recycle it and reinstall a #2 filter.



Filter 1



- 1. Sediment**
Used to filter sediments (mud, rust, sand, etc) 10 microns or larger.
- 2. Pre-Carbon**
Used for chlorine Trihalomethanes and other Volatile Organic Compounds
- 3. Activated Carbon Filters**
Ultra-fine coconut shell carbon and silver impregnated carbon.
- 4. Final Stage Sediment Filter**
For trapping any remaining sediments.

Filter 2



- 1. Granule type Carbon Filter**
Fast absorbing media for powerful purification
- 2. Pi-Ceramic Negative Ion Filter**
Generates negative ions, increases water's ionization
- 3. BioMass ball-Ceramic Filter** - High quality ceramic filter designed for bacteria control.
- 4. Vitamin C Ceramic Technology™**
Laboratory filtration technology for Chlorine and Chloramines.
- 5. Special Quality Sediment Filter**
Prevents sediment discharge.

Pre-filter Replacement



1. Shut off water supply at source (cold water connect or diverter valve). Turn on the ionizer to relieve water pressure. Shut off ionizer.
2. Disconnect 1/4" tubing from inlet and outlet from pre-filter. Press collar in the then pull on tubing to release.



3. Lay down the pre-filter and use the pre-filter wrench to loosen filter from housing. Slide pre-filter wrench from bottom to top. Twist pre-filter wrench counter clockwise to loosen.

4. Remove filter housing from bracket. Discard old pre-filter. Install new pre-filter (Some pre-filters are directional. These will say "this side toward cap").



5. Lube up large black O-ring located in filter housing next to the threads.

6. Install filter housing with filter onto the cap. Tighten with pre-filter wrench clockwise.



7. Repeat process if needed to your other filters.
8. Connect inlet and outlet tubing.
9. Apply water pressure.

10. Run ionizer on "PURIFY" mode for around 3-5 minutes to flush out pre-filter.

Acidic Cleaning Instructions & Routine Maintenance



Many locations have excessive mineral content in the source water that can build up inside the ionizer over time and cause blockage. A routine acidic cleaning of the ionizer chamber will help maximize the life and performance of your ionizer by reducing the build-up of these minerals.

In areas with heavy mineral content, this is recommended once a week. It is also recommended to do this procedure in the evening as it takes several hours to be effective.

- Run the ionizer on acid level 3 for one minute.
- Turn off the source water to the ionizer.
- Let the water “soak” in the chamber overnight (several hours).
- Run the unit again on acid level 3 to rinse the minerals from the machine.
- Return the unit to normal operation.

Note:

Our Citric Acid Cleaning Filter (available for purchase online) will be needed to clean the internal workings of the machine. This procedure must be performed 3-4 times per year to keep warranty intact. See page 31 for instructions on how to do this.



Common Problems and Solutions



Condition	Possible Problem	Solutions
The power light is not on or the power switch doesn't seem to work	<ul style="list-style-type: none"> Unit may not be plugged in correctly Unit may be plugged into an outlet controlled by a switch Fuse at the bottom of the machine may be blown 	<ul style="list-style-type: none"> Make sure power plug is plugged into outlet correctly Plug unit into an outlet that is constantly 'hot' Replace the fuse at the bottom of the unit
Water volume is low or doesn't come out of the unit	<ul style="list-style-type: none"> Angle valve adapter and/or cold water supply are turned off One or more of the water supply tubes is crimped House water pressure is too low Pre-filter and/or unit filters are blocked 	<ul style="list-style-type: none"> Make sure all water supply valves are open Check all hoses and tubes Water pressure may be low for many reasons (RO system, sprinkler system, etc) Call LIFE Ionizers Tech Support for assistance If unit has been used for 6 months or more, replace filters as needed
Tubing is leaking	<ul style="list-style-type: none"> Tube is not seated properly or there is a hole in the tubing 	<ul style="list-style-type: none"> Disconnect and reconnect tubing making sure it is seated 3/4 inches deep or replace tubing
Pre-filter is leaking	<ul style="list-style-type: none"> Tubing to pre-filter is not seated deeply enough O-rings inside the pre-filter are not seated correctly or are being crimped due to cover being on too tight 	<ul style="list-style-type: none"> Disconnect and reseal tubing at least 3/4 inches in to filter Disconnect tubing and unscrew cover. Make sure O-rings are seated properly
Water has an unpleasant odor or taste	<ul style="list-style-type: none"> The internal filters may need to be replaced Water source requires a pre-filter or RO filter 	<ul style="list-style-type: none"> Call your dealer to place an order for new filters Call LIFE Ionizers for a water quality report for your area
Unit is making an unusual noise	<ul style="list-style-type: none"> The problem is internal and requires a qualified technician 	<ul style="list-style-type: none"> Unplug the unit from the power source and call Technical Support
Ionizer is leaking	<ul style="list-style-type: none"> The problem is internal and requires a qualified technician 	<ul style="list-style-type: none"> Unplug the unit from the power supply and call Technical Support

Operation Warnings/Error Messages

- Improper use may cause structural damage to the unit or physical injury.
- Do not make any adjustments after F60 in the mode menu.
- Do not place anything on the unit.
- Disassemble the alkaline water outlet pipe (power set hose) before picking up the unit. Failure to do so may cause the hose to break which will result in water leakage.
- Water drain outlet should not be closed.
- Be sure to check the electric power 110V/220V prior to use.
- In case of malfunction, contact LIFE Ionizers® Technical Support at 760.585.1692.
- Do not use hot water as the ionizer is meant for cool water only.
- Unplug the electric power when not in use for a long time (over 3 days).
- Do not use underground water, polluted water or metallic water.
- Do not use water with a temperature of over 35° Celcius/ 95° Fahrenheit as it may cause damage or short filter life (Room temperature is best).
- Do not use pre-ionized water.
- Do not clean the unit with alcohol.
- Only use certified replacement filters.
- Be careful not to shake or drop the unit.

Error Codes:

E1 : Water flow from ionizer is too low

If the following error messages appear on the LCD screen, be sure to contact our technical support at 866.321.3116.

E2 : Water flow from faucet is too high

How Alkaline Water is Made

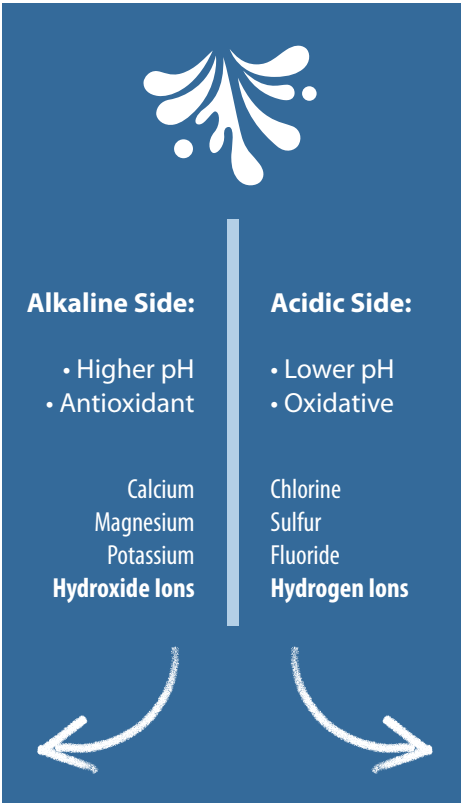

1 **Converts** the existing mineral *carbonates* in tap water into mineral *hydrates*.

2 **Splits** alkaline minerals – calcium and magnesium – from the carbonate in water using electromagnetism.

3 **Separates** water into an alkaline stream and an acidic stream.

4 The alkaline water side of the ionizer attracts alkaline mineral ions, mostly calcium and magnesium.

5 Pure calcium and magnesium combine with water molecules by splitting them into a hydroxyl ion, and a hydrogen ion.

6 The hydroxyl ion combines with the minerals to form a solution of water and mineral hydrates - Calcium hydroxide and magnesium hydroxide.

7 Both of these mineral hydrates are more alkaline than the mineral carbonates they replace, so they raise the pH of the water making it more alkaline.

Alkaline/Acidic/Purified Water



ALKALINE WATER

- 1. If the machine has not been used for several days, let the water run on the “Purified Water” setting for at least 3-5 minutes before any operation.
- First time users who are not familiar with this water are recommended to start with Ionized **Alkaline Water level 1** for *two weeks*, then adjust the level to **Alkaline Water level 2** for *two weeks*, and then adjust again to **Alkaline Water level 3** for daily drinking. This gradual adjustment will help your body get accustomed to the higher alkaline pH levels
- Store Ionized Alkaline Water in an airtight glass container, or our special stainless steel bottle, and put it in a refrigerator for no longer than 2 days for maximum benefit. The first 12 hours after ionization the water is most effective.

ACIDIC WATER

Acidic water is not drinkable – DO NOT DRINK

- Use acid water only for disinfecting, cleaning, plants and as a face/skin toner.
- Acidic water properties are the best 1-7 days after ionization if it is put in an airtight glass container and kept refrigerated.

PURIFIED WATER

- It is best to drink purified water when taking medication.
- Children: Use purified water when preparing baby food.

Please note that water will come out of both spouts when dispensing water.

- A) When the Alkaline button is pressed, Alkaline water will be dispensed from the top spout and acid water will be dispensed from the bottom spout.
- B) When the Acid button is pressed, Acid water will be dispensed from the top spout and Alkaline water will be dispensed from the bottom spout.
- C) When the purify button is pressed, purified water will be dispensed from the bottom and top spouts.

Uses for Ionized Alkaline/Acidic Water



Highly Ionized Alkaline Water: pH 11.0+

Highly Ionized Alkaline Water is useful for cleaning and preparing food.

Food Preparation: Wash Vegetables and fruit.

Cleaning: Clean cutting boards with. Good for cleaning oil and tough grime from vents, as well as for general cleaning in the kitchen.

Stain Removal: The extra strength, absorption power will remove coffee, soy sauce and oil stains. Also great for getting out stubborn toilet bowl stains.

Dishes: Use less detergent when hand washing dishes. Save on water bills, as only one-third to one-fourth of the usual amount of water is adequate cleaning and for rinsing with detergent.

Alkaline Water pH: 8.0-10.0

For drinking, food preparation, watering plants, health maintenance.

Drinking: Drink at least eight 8 ounce glasses of water every day. Alkaline water is part of a healthy diet.

Food Preparation: Clean vegetables and fish. Enhance the flavor of broccoli, onions, etc. by pre-boiling them in Ionized Alkaline Water. Use less condiments and salt in your diet.

Rice: Use Ionized Alkaline Water for washing and cooking rice. The result is delicious and fluffy rice.

Tea: Taste and aroma are everything to many people. You will be surprised at the improved color, taste, and aroma. You can use less tea and still achieve a full rich taste.

Soups and Stews: Ionized Alkaline Water draws out the flavor of ingredients so they get tender and juicy. Therefore, less seasoning such as salt and soy sauce are needed. This water is good for people who want to reduce their salt intake.

Animals: Give purified water with food. Just like humans, animals should not drink alkaline water for an hour before, during, or an hour after meals.

Crafts: Excellent for dyeing cloths, as well as other craft projects. You will love the vibrant colors obtained when using this water.

Health: Through continuous use, the acidic tendency of your body can be gradually corrected to an Alkaline levels. Drink at least half your body weight in ounces in order to gradually change an acidic level to a slightly Alkaline one.

Neutral Water pH: 7.0

Free of chlorine, rust and cloudiness. Clean water is delicious drinking water.

Children: Use purified water with a pH of 7.0 when preparing baby food.

Slightly Acidic Water pH: 6.0

Plants: Watering plants and flowers. Ionized Alkaline Water extends the freshness and life of plants. Ionized Alkaline Water with a pH level of 9.0 can also restore the health of sick plants. Ionized Alkaline Water stimulates germination and improves seeding development.

Acidic Water pH: 4.0-6.0

Face wash: The astringent properties of acidic water are effective in toning and firming your skin. Pat the skin and leave to dry. This water is also excellent as a toner after shaving.

Hair Care: Use this water to rinse your hair after shampooing. Reduces annoying tangles and brings out a radiant shine. Keep in a spray bottle and spray your hair and face when you're out and about.

Bath Water: Add acidic water to your bath water to keep your tub free of bathtub rings. Bathing in this water gives your body a warm and comfortable feeling.

Pet Care: Spray your pet with this water and brush afterwards to obtain soft and shiny fur. Great for grooming your pet!

Rinse Cycle: Soaking with acidic water before the spin cycle will soften your clothes.

Cooking beans: Various types of beans, such as kidney beans and green peas, will cook to perfection. Just be careful not to overcook your beans. Acidic water will speed up the cooking time! This is energy saving water!

Fried Food: Fried food comes out nice and crispy if you rinse it in acidic water before frying.

Frozen food: Spray foods with acidic water when freezing so that the food, including fish and shrimp, does not lose its flavor when thawed.

Stains: To remove stains, grime and grease, leave to soak in water for 24 hours.

Dishes: Dishes and glasses come out sparkling clean.

Polishing: Polish mirrors, eyeglasses, glass objects and windows to a high sheen.

House Cleaning: Remove dirt from hardwood floors, ceramic tiles, etc. without leaving a sticky residue.

Performance Features



LIFE GRID Technology™ Drop-forged for greater durability, GRID plates Increase the antioxidant power and pH of alkaline water by as much as 15%, like MESH plates, but GRID plates are far more durable. GRID plates are the toughest, longest lasting water ionizer plates made, they outlast flat, MESH, and Hybrid plates.

SMPS Power System- Combine GRID Technology™ with our advanced SMPS Power System (the same system used in High Definition Televisions) and your LIFE Ionizer® M series will outperform any other model in its class. The system generates up to 504 watts of power and it can be adjusted to compensate for hard water problems. SMPS Power means your system will run more efficiently provide consistent power, and will last longer.

UV Light System- LIFE UV Light Technology™ is an optional feature on our LIFE Ionizers®. UV light addresses cysts and bacteria as the water passes around the light inside the unit. UV Light is being used by major municipal water authorities such as New York City and Orange County, CA as added treatment to disinfect their water.



Frequently Asked Questions



Q: What should I expect from drinking Ionized Alkaline Water?

A: Everybody's body is different, but typically new alkaline water drinkers say they see or feel effects in a month or two. You will notice a difference in taste: Ionized Water is much smoother tasting than conventional water. It makes better coffee, tea, juice, etc.

Q: Who should drink Ionized Alkaline Water?

A: People and pets can drink Ionized Alkaline Water.

Q: Is there anyone who should not drink Ionized Alkaline Water?

A: Some people must start by drinking very small amounts of Ionized Alkaline Water, such as 8 oz. of strength level 1 (one) Ionized Alkaline Water per day. This is especially true of the elderly who often have unfortunately allowed heavy metals and other toxins to accumulate in their bodies. Sometimes years of medication has accumulated in them. The health benefits for adults is well established through University studies and other studies done on a variety of health issues. Since no one has tested children we are making the following suggestions: Children 3 years and younger should drink water from the purified mode and then start on the low levels of Ionized Alkaline Water when they are older. Children between the ages of 4 years and 12 years should only drink Ionized Alkaline Water at strength level 1 (one) and strength level 2 (two). Children between the ages of 4 and 12 years of age should never drink Ionized Alkaline Water at strength level 3 (three) or strength level 4 (four).

Q: Should I take medication or supplements with Ionized Alkaline Water?

A: Do not take prescription or other medications for approximately one hour before and after drinking water. Ionized alkaline water hydrates more efficiently, therefore will deliver more medication than tap water. However, we highly recommend its use with vitamins, supplements, nutritional powders and other nutraceuticals because of its superior quality and enhanced absorption capabilities.

Q: Can a person become too Alkaline from drinking Ionized Alkaline Water?

A: People have been known to drink as much as 1 to 2 gallons of Ionized Water every day without a problem. It is rare for a person to acquire Alkalosis, the condition of being too Alkaline.

Q: Should I drink alkaline water when I eat?

A: No matter what type of water, it is not suggested to drink excessive amounts of liquids during meals. Small sips are suggested to cleanse the palette, but you should not gulp any type of water - alkaline, purified, etc.

Q: How much water should I drink and at what level?

A: At a minimum, you should drink half your body weight in ounces per day. For example, a person weighing 100 pounds should drink 50 ounces. You should start slow at strength Level 1 (one), drinking 1-3 glasses per day for the first week. You may increase the number of glasses per day during the first week if you do not notice any side effects. If you do not feel any flu-like symptoms at the end of the first week, move up to strength Level 2 (two). On strength Level 2 (two), drink 1-3 glasses per day for the first week. You may increase the number of glasses per day during the first week if you're feeling good. On average, two to three weeks per level; work your way up to a 10.5 pH (strength Level 4 (four)).

Q: Why do some people have flu like symptoms when first drinking Ionized Alkaline Water?

A: If you start drinking Ionized Alkaline Water at too high of a strength level (high pH level) then you might notice flu like symptoms. These symptoms are mild and they clear up in about a week. This effect is typically noticed by people whose bodies have accumulated toxins in them.

Q: How does Ionized Alkaline Water affect athletes?

A: Many athletes alkalize their bodies prior to working out. Alkaline water can help. Additionally, drinking alkaline water during workouts is a great way to stay hydrated. Numerous studies conducted on athletes since the 1940s have demonstrated that even mild dehydration impairs performance. Dr. Peter L. Kopko, D.C. (Retired), recommends drinking 13 to 20 ounces (2-3 cups) of water 2 hours before exercise and 5 to 10 ounces (about 1-2 cups) every 15 to 20 minutes of exercise, depending on your total body weight.

Q: How long does Ionized Alkaline Water stay Ionized?

A: The Antioxidant (hydroxyl ions) will last approximately 18-24 hours. The Higher pH (Alkaline properties) will last approximately 1-2 weeks.

Q: Does Ionized Alkaline Water have any negative effects?

Absolutely none, as long as it is used properly. Only the Ionized Alkaline Water should be consumed. NEVER DRINK THE ACIDIC WATER.

Q: How does a water ionizer work?

A: Your counter top Alkaline LIFE Ionizer® M9 X NG can be directly connected to a diverter valve at the end of your faucet. Connecting directly to your faucet takes about 10-15 minutes. Once connected your water ionizer uses a two step process to transform your tap water into refreshing, healthy alkaline water.

Your ionizer's first task is to help filter out harmful components of the water with our built-in dual filter system. The LIFE Ionizer® achieves this by using multi-stage filters. In the second stage, the filtered water passes into the electro dialysis chamber, which is equipped with platinum-coated titanium plates. An electrical charge is introduced into this water. This is where the electro dialysis takes place.

The water is separated into two streams (acid and Alkaline) of Ionized water. The acid water (oxidized) makes up about 30% of the water and the Ionized Alkaline Water 70%. The Ionized Alkaline Water comes out of the faucet, and you use it for drinking or cooking.

The acid (oxidized) water comes out of a separate hose leading into the sink. The oxidation potential of the acid water makes it a good sanitizing agent, ideal for washing your hands, cleaning food or kitchen utensils, and treating minor wounds and eczema. Ionized acidic water is a miracle hair rinse!

The Chemistry of Ionized Water

A water ionizer splits the mineral carbonates found in tap water into alkaline and acidic parts. The minerals, mostly calcium and magnesium are alkaline, the carbonate, which is CO₂ dissolved in water, is acidic.

Alkaline minerals produce positively-charged ions which gather at the negative electrode. These minerals chemically combine with hydroxyl ions taken from water molecules and form mineral hydrates.

Carbonate produces negatively charged ions which gather at the positive electrode and combine with water to create a weak solution of carbonic acid.

Alkaline Ionized Water is drawn for drinking and cooking through the main stainless steel spout. Acidic water drains into the sink from a separate spout.

Q: How do I know when the filter needs replacing?

A: An LED or counter indicator on the front panel gives an indication of remaining filter life. Generally the 1st filter will last for about 8 months, the 2nd filter for about 12 months (when up to 2.5 gallons of water is produced per day), but this depends on the source of water and the amount of use. For example, if your tap water contains between 0.4 and 1.0 ppm (parts per million) of chlorine, a filter can last 12 months for one person's use. If greater than 1.0 ppm, the filter may last 8 months. By changing your filters at regular intervals at least once a year, you are assured of the quality of your water.

NOTE: All water filters have both a liters/gallons life **and** a time period before they stop working optimally. If you only use your ionizer on a limited basis, you will still need to change them annually so they are working correctly.

Q: Where is the serial number located?

A: On the back of the ionizer, you will see a bar code sticker. The serial number is located below the bar code.

Q: What should be done if the machine is not to be used for 7 days or more?

A: Remove the filter from the main body, wrap in plastic wrapping, and store in a refrigerator. Remove the power plug. When ready to use again, install the filter and run in the Ionizer in the 'PURIFIED' mode for approximately 3 minutes before using the water.

Q: What does it mean when water flows through the main body and it becomes warm?

A: At the start of water flow, warm water may flow out due to room temperature or heat from the main body during stoppage. This is not a malfunction. Use the machine after starting water flow.

Q: There are white substances on the bottom of my Alkaline Ionized water storage container. What are these?

A: This phenomenon is caused by the calcium mineral substances in Alkaline Ionized water. Particularly, if the carboxyl group (CO₃) is present, it will bind to the calcium carbonate (Ca CO₃), creating such substances. This is apparent evidence of electrolysis. Although it is safe to drink, wash the container - add one spoon of edible vinegar and water to the container, leave the container for approximately 1 hour, and wash the container.

Q: What is hard water?

A: According to the U.S. Geological Survey, more than 85 percent of the United States geography has hard water. Hard water forms when naturally occurring minerals enter water sources. Over time these minerals are absorbed by groundwater. The two most common types of minerals found in hard water are calcium and magnesium compounds. The Water Quality Association of the United States defines hard water as water containing dissolved hardness minerals above 1 GPG (grains per gallon). The most common hardness causing minerals are Calcium and Magnesium. Levels of hardness are classified as follows:

Soft Water - less than 1 GPG,

Slightly hard - 1 to 3.5 GPG

Moderately hard - 3.5 to 7 GPG

Hard - 7 to 10.5 GPG

Very Hard - 10.5 and higher GPG

Q: Why do I want to adjust the amperage on my Water Ionizer?

A: As you know, all water sources are not created equal. Your water source plays an important role on how your water Ionizer creates Ionized Alkaline Water. Being able to adjust the amperage will allow you to find the optimum pH for the best production of Alkaline Ionized water based on your water source.

Q: Do I need to hire a plumber to install the units?

A: Most people find it is not necessary to call a plumber for most standard installations. For custom installations, a plumber may be needed depending on the individual circumstances.

Q: What do I do if the filters are leaking?

A: It is important to note where on the filter it is leaking. Most leaking comes from fittings that are not seated properly. Reseat the tubing into the filter by pushing in firmly and then pulling back. It may be necessary to re-trim the end of the tubing to get a fresh surface. Make sure to shut off the water before working with the water supply lines.

Q: How do I set up the pre-filter unit?

A: The pre-filter is installed in the supply line on the ionizer. Quick connects are provided for your convenience. Simply push the tubing in the connector and it seals automatically. When installing the filter for the first time, it is suggested to let the filter fill with water for a few minutes before turning on the ionizer.

Q: How do I know what pre-filter I need?

A: A water report is necessary to determine what type of filter is needed. Well water may need to be tested by an independent water testing company. Please contact your sales representative and they will pull your Federal Water Report, analyze it, and recommend filters.

Q: How do I clean the internal plates?

A: Use the Citric Acid Cleaning Filter 3 to 4 times per year.

Q: What is the product warranty?

A: To validate your warranty, you must complete the warranty card and return it or register online within 30 days of purchase. The warranty that is in effect at the time the machine is purchased is the one that is honored. Our warranty centers are in the US, Canada, Australia and Europe for your convenience. We are the oldest and largest distributors of Alkaline home, commercial and industrial water ionizers in North America with the finest quality service second to none. For Europe, Asia and Africa we have a service center in the UK. We value our customers and are very grateful for referrals. This is why we promote such a generous return policy and why we can do with confidence based on 18 years of growth and happy testimonials. Neglect includes using the unit in a matter inconsistent with the directions in the owner's manual, as breakage resulting from dropping the unit or other carelessness. The international customer pays all international customs, government fees, levies and/or any other fees that are incurred. Warranties are non-transferable. The warranty is valid when all regular maintenance routines are followed. The following routine maintenance procedures will help keep your Ionizer running at the optimal performance level:

- We recommend Internal filters be changed annually.
- Citric acid cleaning filter should be used 3 to 4 times per year.
- Pre-filters should be changed annually.
- Pre-filter housings should be changed every two years.

Following these easy steps ensures optimal performance and guarantees your Lifetime Warranty on part & labor.

If you buy a LIFE Ionizer® from an unauthorized seller/dealer, your warranty is void and will not be honored by life Ionizers®. Feel Free to contact us to confirm if the Dealer is an Authorized Dealer - 888 688 8889: Jeff or Kara

The LIFE M9 X NG has a LIFEtime warranty on both parts & labor.

Q: What is your return policy?

A: We invite you to try out our new range of LIFE Ionizer® and enjoy the benefits for 60 days. We are so sure that you will be satisfied with your ionizer that we offer you a 60-day money back guarantee. If at any time in the first 60 days you wish to return your unit, we will give you a full refund, minus a 15% return fee and processing fee, as long as your ionizer is returned in as-new condition and in its original packing. "As-new condition" means the ionizer is not scratched, damaged or broken in any way and is returned with all hoses, connectors, parts, manuals and DVDs etc. The original shipping charges will be deducted and return shipping charges must be prepaid by the purchaser. No return can be accepted without our prior authorization. We will refuse unauthorized returns. There are no returns on merchandise purchased wholesale or through finance plans.

Q: What is your repair policy?

Warranties cover failures due to defects in materials and workmanship which occur during normal wear and tear. Warranty does not cover damage which occurs in return shipment, or failures which result from accident, misuse, abuse, neglect, mishandling, faulty installation, misapplication, improper insertion of consumables, set-up adjustments, maladjustment of consumer controls, improper operation or maintenance, alteration, modification, power line surge,

improper voltage supply, or service by anyone other than a LIFE Ionizer® authorized repair facility. LIFE Ionizer® will repair or replace any malfunctioning ionizer for the specified time frames disclosed above. If you are out of your warranty period, then labor is billed at \$60/hr. Average repair time is less than one hour and in some cases there is no charge. Minimum charge is \$0 to a maximum of \$199 per occurrence. Customer is responsible for shipping and shipping charges to and from Repair Center.

Limits and Exclusions:

There are no express warranties except as listed above. From the date of purchase the warrantor is not responsible for incidental or consequential damage; for damages arising out of the use of any unauthorized attachment; for damages resulting from the use of the product with a defective water faucet. All expressed and implied warranties, including warranties of merchantability and fitness for particular purpose, are limited to the applicable warranty period. The warranty is voided if parts used are not provided by LIFE Ionizer®. Company products are sold subject only to the applicable company standard printed warranty in effect at the time of sale and such warranty shall be in lieu of all other warranties expressed or implied. In addition, this equipment, technology and products have not been evaluated by the FDA, nor are they intended to treat, cure, mitigate, diagnose or prevent any illness or disease. The following technology is not intended to replace the advice of your family physician.

Contact Us

6352 Corte Del Abeto, Suite H
Carlsbad, CA 92011

866.321.3116

760.431.8047

*When calling technical support please be prepared to give your ionizer serial number located on the back of the unit.

www.Lifelonizers.com/Support



LIFE M9 X Next Generation

GLICE

 LIFE IONIZERS