

# 2013 Owner's Manual

## Portable Spas

United States and Canada



© 2013 LMS, Inc.



Cal Spas Home Resort™

## Preparing for Your New Portable Spa

Pre-Delivery Checklist . . . . .	3
Planning the Best Location . . . . .	3
Preparing a Good Foundation . . . . .	4
240 Volt Electrical Installation . . . . .	5
Electrical Installation for 11 kW Heater . . . . .	6
GFCI Wiring Diagram . . . . .	7
High Power Configuration . . . . .	8
Testing the GFCI Breaker . . . . .	8
120 Volt Electrical Installation . . . . .	9
Filling and Powering Up Your Portable Spa . . . . .	10
Priming the Pump . . . . .	12

## Operating Your Spa

VS300, VS513Z, and 5100 Control Operation . . . . .	13
9800 Electronic Control Operation . . . . .	17
BP2000 Control Operation . . . . .	22
Electrical Power Efficiency . . . . .	28
Jets . . . . .	28
LED Perimeter Lighting . . . . .	28
Diverter Knobs . . . . .	29
Waterfalls . . . . .	29
Air Venturis . . . . .	29
Hydro Streamer Waterfall . . . . .	29
Adjustable Therapy System . . . . .	30
Wireless Spa Monitor . . . . .	30

## Water Clarity

The Key to Clear Water . . . . .	31
Testing and Adjusting Spa Water . . . . .	32
Sanitation . . . . .	33
Bather Load . . . . .	34
Pure XL™ and Pure Cure™ Water Sanitizers . . . . .	35
Ozonator . . . . .	35
Filter Cleaning . . . . .	35

Cal Clarity II Bromine Generator . . . . .	36
Maintenance Schedule . . . . .	38
Troubleshooting Water Clarity Problems . . . . .	39
Jet Removal and Replacement . . . . .	40

## Cleaning and Maintenance

Removing and Reseating the Pillows . . . . .	40
Spa Cover . . . . .	40
Draining Your Portable Spa . . . . .	41
Winterizing (Cold Climate Draining) . . . . .	42
Cleaning and Replacing the Filter . . . . .	43
Vacation Care . . . . .	43
Cleaning Your Spa . . . . .	43
Changing the UV Lamp . . . . .	44

## Using the Entertainment System

Operating the CD Player . . . . .	45
Remote Control . . . . .	46
iPod™ Docking Station . . . . .	46

## Keeping Fit With Your Swim Spa

Jetstream Propulsion System . . . . .	48
Assembling the Swim Tether . . . . .	48
Using the Exercise Equipment . . . . .	49

## Appendix

Replacement Parts . . . . .	51
Basic Troubleshooting . . . . .	58
Limited Warranty . . . . .	60
Warranty Registration . . . . .	62

Copyright 2011-2013 LMS. All rights reserved. Duplication without written consent is strictly prohibited.

Cal Spas®, Adjustable Therapy System™, ATS™, Cal Premium™, Cal Select™, Cal Stone™, and Ultimate Fitness Spa Series™ are registered trademarks.

Due to continuous improvement programs, all models, operation, and/or specifications are subject to change without prior notice.

LTR20131000, Rev. E  
9/18/13  
100-1273

### CONTACT INFORMATION

For customer service, please contact your authorized dealer immediately. If you need additional information and/or assistance, contact:

**LMS Customer Service Department**  
**1462 East Ninth Street**  
**Pomona, CA 91766.**

Toll Free: 1-800-CAL-SPAS  
Fax: 1-909-629-3890

# Important Safety Instructions

## READ AND FOLLOW ALL INSTRUCTIONS.

### **DANGER -- Risk of accidental drowning:**

Do not allow children to be in or around a spa unless a responsible adult supervises them. Keep the spa cover on and locked when not in use. See instructions enclosed with your cover for locking procedures.

### **DANGER -- Risk of injury:**

The suction fittings in this spa are sized to match the specific water flow created by the pump. Should the need arise to replace the suction fittings, or the pump, be sure the flow rates are compatible.

Never operate the spa if the suction fitting or filter baskets are broken or missing. Never replace a suction fitting with one that is rated less than the flow rate marked on the original suction fitting.

### **DANGER -- Risk of electric shock:**

Install the spa at least 5 feet (1.5 meters) from all metal surfaces. As an alternative, a spa may be installed within 5 feet of metal surfaces if each metal surface is permanently bonded by a minimum #8 AWG solid copper conductor to the outside of the spa's control box.

Do not permit any external electrical appliances, such as lights, telephones, radios, televisions, and etc., within five feet (1.5 meters) of the spa. Never attempt to operate any electrical device from inside the spa.

Replace a damaged power cord immediately.

Do not bury the power cord.

Connect to a grounded, grounding-type receptacle only.

### **WARNING -- To reduce the risk of injury:**

The spa water should never exceed 104°F (40°C). Water temperatures between 100°F (38°C) and 104°F (40°C) are considered safe for a healthy adult. Lower water temperatures are recommended for young children and when spa use exceeds 10 minutes.

High water temperatures have a high potential for causing fetal damage during pregnancy. Women who are pregnant, or who think they are pregnant, should always check with their physician prior to spa usage.

The use of alcohol, drugs or medication before or

during spa use may lead to unconsciousness, with the possibility of drowning.

Persons suffering from obesity, a medical history of heart disease, low or high blood pressure, circulatory system problems or diabetes should consult a physician before using the spa.

Persons using medications should consult a physician before using the spa since some medications may induce drowsiness while others may affect heart rate, blood pressure and circulation.

### **HYPERTHERMIA DANGER:**

Prolonged exposure to hot air or water can induce hyperthermia. Hyperthermia occurs when the internal temperature of the body reaches a level 3°F to 6°F above the normal body temperature of 98.6°F (or 2°C to 4°C above 37°C). While hyperthermia has many health benefits, it is important not to allow your body's core temperature to rise above 103°F (39.5°C).

Symptoms of excessive hyperthermia include dizziness, lethargy, drowsiness and fainting. The effects of excessive hyperthermia may include:

- Failure to perceive heat
- Failure to recognize the need to exit spa or hot tub
- Unawareness of impending hazard
- Fetal damage in pregnant women
- Physical inability to exit the spa
- Unconsciousness

**WARNING:** The use of alcohol, drugs, or medication can greatly increase the risk of fatal hyperthermia.

**WARNING:** People with infectious diseases should not use a spa or hot tub.

**WARNING:** To avoid injury, exercise care when entering or exiting the spa or hot tub.

**WARNING:** Do not use drugs or alcohol before or during the use of a spa or hot tub to avoid unconsciousness and possible drowning.

**WARNING:** Do not use a spa or hot tub immediately following strenuous exercise.

**WARNING:** Prolonged immersion in a spa or hot tub may be injurious to your health.

**CAUTION:** Maintain water chemistry in accordance with manufacturer's instructions.

## SAVE THESE INSTRUCTIONS.



# Preparing for Your New Portable Spa

## Pre-Delivery Checklist

Most cities and counties require permits for exterior construction and electrical circuits. In addition, some communities have codes requiring residential barriers such as fencing and/or self-closing gates on property to prevent unsupervised access to the property by children. Your dealer can provide information on which permits may be required and how to obtain them prior to the delivery of your spa.

Before Delivery	
	Plan your delivery route
	Choose a suitable location for the spa
	Lay a 5 - 8 cm concrete slab
	Install dedicated electrical supply
After Delivery	
	Place spa on slab
	Connect electrical components

## Planning the Best Location

### Safety First

Do not place your spa within 10 feet (3 m) of overhead power lines.

### Consider How You Will Use Your Spa

How you intend to use your spa will help you determine where you should position it. For example, will you use your spa for recreational or therapeutic purposes? If your spa is mainly used for family recreation, be sure to leave plenty of room around it for activity. If you will use it for relaxation and therapy, you will probably want to create a specific mood around it.

### Plan for Your Environment

If you live in a region where it snows in the winter or rains frequently, place the spa near a house entry. By doing this, you will have a place to change clothes and not be uncomfortable.

### Consider Your Privacy

In a cold-weather climate, bare trees won't provide much privacy. Think of your spa's surroundings during all seasons to determine your best privacy options. Consider the view of your neighbors as well when you plan the location of your spa.

### Provide a View with Your Spa

Think about the direction you will be facing when sitting in your spa. Do you have a special landscaped area in your yard that you find enjoyable? Perhaps there is an area that catches a soothing breeze during the day or a lovely sunset in the evening.

### Keep Your Spa Clean

In planning your spa's location, consider a location where the path to and from the house can be kept clean and free of debris.

Prevent dirt and contaminants from being tracked into your spa by placing a foot mat at the spa's entrance where the bathers can clean their feet before entering your spa.

### Allow for Service Access

Make sure the spa is positioned so that access to the equipment compartment and all side panels will not be blocked.

Many people choose to install a decorative structure around their spa. If you are installing your spa with any type of structure on the outside, such as a gazebo, remember to allow access for service. It is always best to design special installations so that the spa can still be moved, or lifted off the ground.

## Preparing a Good Foundation

Your spa needs a solid and level foundation. The area that it sits on must be able to support the weight of the spa, with water and the occupants who use it. If the foundation is inadequate, it may shift or settle after the spa is in place, causing stress that could DAMAGE YOUR SPA SHELL AND FINISH.

***Damage caused by inadequate or improper foundation support is not covered by the warranty. It is the responsibility of the spa owner to provide a proper foundation for the spa.***

Place the spa on an elevated 3 to 4" / 30 cm concrete slab. Pavers, gravel, brick, sand, timbers or dirt foundations are **not** adequate to support the spa.

We strongly recommend that a qualified, licensed contractor prepare the foundation for your spa.

If you are installing the spa indoors, pay close attention to the flooring beneath it. Choose flooring that will not be damaged or stained.

If you are installing your spa on an elevated wood deck or other structure, it is highly recommended that you consult a structural engineer or contractor to ensure the structure will support the weight of 150 pounds per square foot (732 kg / m<sup>2</sup>).

To properly identify the weight of your new spa when full, remember water weighs 8.33 lbs. per gallon, or 1 kg per liter. For example, an average 8' spa holds approximately 500 gallons, or 1892 liters, of water. Using this formula, you will find that the weight of the water alone is 4,165 lbs, or 1892 kg. Combined with the dry weight of the spa you will note that this spa will weigh approximately 5,000 lbs, or 2267 kg, when full of water.



## 240 Volt Electrical Installation

All 240V spas must be permanently connected (hard wired) to the power supply. See the wiring diagram on page 7.

**These instructions describe the only acceptable electrical wiring procedure. Spas wired in any other way will void your warranty and may result in serious injury.**

When installed in the United States, the electrical wiring of this spa must meet the requirements of NEC 70 and any applicable local, state, and federal codes.

**The electrical circuit must be installed by an electrical contractor and approved by a local building or electrical inspector.**

**Failure to comply with state and local codes**

**may result in fire or personal injury and will be the sole responsibility of the spa owner.**

The power supplied to the spa must be on a dedicated GFCI protected circuit as required by NEC 70 with no other appliances or lights sharing the power.

Use copper wire with THHN insulation. Do not use aluminum wire.

Use the table below and on the next page to determine your GFCI and wiring requirements.

Wire runs over 85 feet must increase wire gauge to the next lower number. For example: A normal 50 amp GFCI with four #6 AWG copper wires run over 85 feet would require you to go to four #4 AWG copper wires.

### GFCI and Wiring Requirements

Single voltage systems (except Ultimate Fitness -- see next page)

Control System	GFCI Required	Wires Required
VS300	One 40 amp GFCI	Four #8 AWG copper wires
9800 (except Ultimate Fitness spas - see next page)	One 50 amp GFCI	Four #6 AWG copper wires
VS513Z	One 50 amp GFCI	Four #6 AWG copper wires
BP2000	One 60 amp GFCI	Four #6 AWG copper wires

### Dual voltage system

The 5100DV control system is set at the factory to run on the low power setting for 40 amp operation. This is the default setting. Spa owners can have their installer change this setting so the spa will run on high power for 50 amp operation. **See configuration instructions on page 8.**

**Warning: Never set a spa to run on high power without installing a properly rated GFCI.**

Control System	Default setting	Power Setting	GFCI Required	Wires Required
5100DV	▶	Power saver mode <b>Factory default</b>	One 40 amp GFCI	Four #8 AWG copper wires
		High power setting <b>See configuration instructions on page 8.</b>	One 50 amp GFCI	Four #6 AWG copper wires

**Ultimate Fitness Spas**

Spa Model		GFCI Required	Wires Required	GFCI Required	Wires Required
		Standard configuration (5.5 kW heater)		Configuration for Option 499 (11 kW heater) and Option 157 (swim jets with Speck pump)	
F1418	Service 1	One 40 amp GFCI	Four #8 AWG copper wires	One 40 amp GFCI	Four #8 AWG copper wires
	Service 2	N/A	N/A	One 30 amp GFCI	Three #8 AWG copper wires
F1239	Service 1	One 50 amp GFCI	Four #8 AWG copper wires	One 60 amp GFCI	Four #8 AWG copper wires
F1249	Service 2	N/A	N/A	One 30 amp GFCI	Three #8 AWG copper wires
F1640	Service 1	One 60 amp GFCI	Four #8 AWG copper wires	One 60 amp GFCI	Four #8 AWG copper wires
	Service 2	N/A	N/A	One 30 amp GFCI	Three #8 AWG copper wires
F1770	Service 1 (swim side)	One 60 amp GFCI	Four #8 AWG copper wires	One 60 amp GFCI	Four #8 AWG copper wires
	Service 2 (swim side)	N/A	N/A	One 30 amp GFCI	Three #8 AWG copper wires
	Service 3 (spa side)	One 40 amp GFCI	Four #8 AWG copper wires	One 40 amp GFCI	Four #8 AWG copper wires

Note: Fitness Spa model F1770 has two equipment packs and requires two separate electrical services. Install each electrical service as described above and as shown below.

**Electrical Installation for 11 kW Heater**

This applies to Fitness spas with the 11 kW heater only.

Two electrical services are required to heat the swim side of the Fitness Spa.

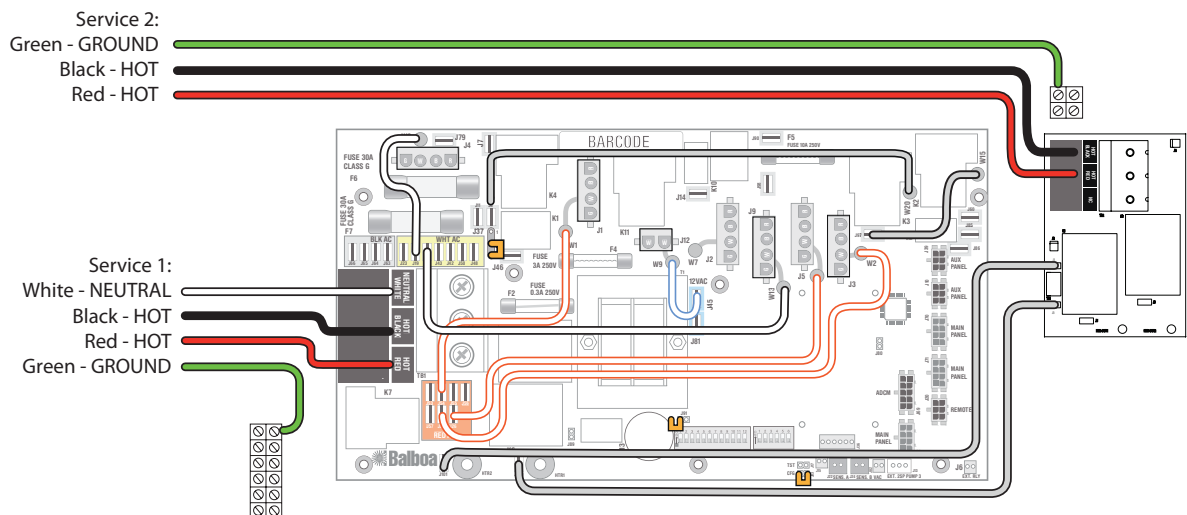



# GFCI Wiring Diagram

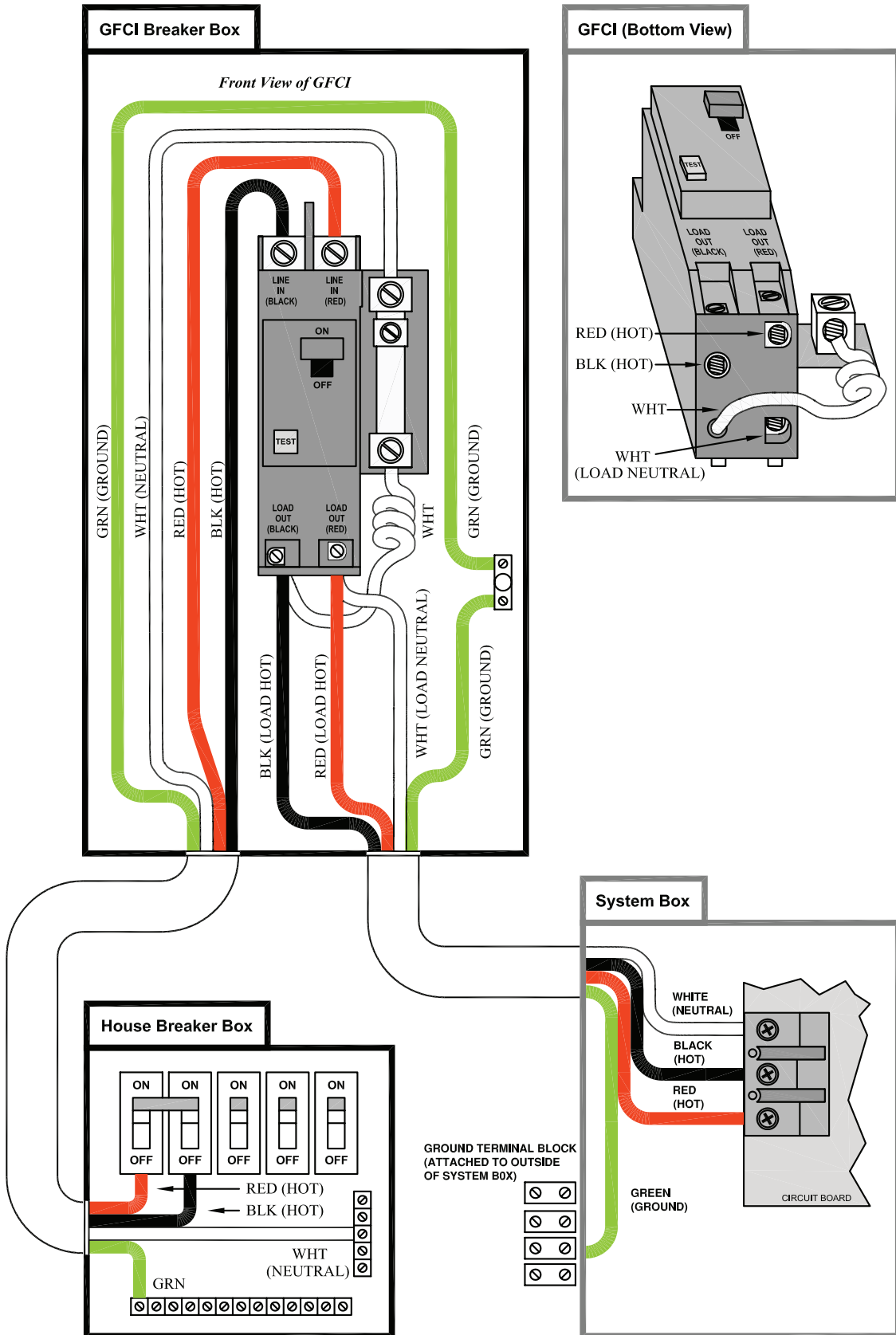

# High Power Configuration

## DIP Switch Definitions for 5100DV

OFF Position (Down)		ON Position (Up)
Test Mode OFF	◀ <b>A1</b>	Test mode (normally OFF)
Standard / Economy / Sleep Mode changes allowed	◀ <b>A2</b>	Standard Mode only
Use Digital Duplex or Light Duplex plane	◀ <b>A3</b>	Use Mini Panel
Pump 2 enabled	◀ <b>A4</b>	Pump 2 disabled
Single voltage heating (240VAC only)	<b>A5</b> ▶	Dual voltage heating enabled
Safety Suction (must be OFF)	◀ <b>A6</b>	
See table at right	<b>A7</b> ▶	See table at right
Temperature displayed in Fahrenheit	◀ <b>A8</b>	Temperature displayed in Celsius
No circ pump; Pump 1 is two-speed	◀ <b>A9</b>	Circ pump acts like Pump 1 low speed (filter cycle, polling); Pump 1 is one-speed  <i>See page 16 for description of circulation pump operation.</i>
See table at right	◀ <b>A10</b>	See table at right

Note: Arrow indicates factory default setting.

Number of high speed pumps that can be run before heater is disabled (A5 OFF)

OR

before heater runs at 120VAC (A5 ON)

No. of Pumps	A7	A10
0	OFF	OFF
1	ON	OFF
2	OFF	ON
3	ON	ON

### Testing the GFCI Breaker

Test the GFCI breaker prior to first use and periodically when the spa is powered. To test the GFCI breaker follow these instructions (spa should be operating):

1. Press the TEST button on the GFCI. The GFCI will trip and the spa will shut off.
2. Reset the GFCI breaker by switching the breaker to the full OFF position, wait a moment, then turn the breaker back on. The spa should have power again.

## 120 Volt Electrical Installation

Always follow applicable local, state and federal codes and guidelines.

Use only a dedicated electrical line with a 15 amp breaker.

Cord-and-plug connections may not use a cord longer than 15 feet (4.6 m) and must be plugged into a dedicated 15 amp GFCI connection (NEC 680.42(A) (2)). Do not use extension cords!

Always use a weatherproof-covered receptacle.

Receptacle shall be located not less than 5 feet (1.5 m) from and not exceeding 10 feet (3.0 m) from the inside wall of the spa. (NEC 680.43(A))

Do not bury the power cord. If your cord becomes damaged, replace it before next usage.

All 120V spas must have a GFCI. This can be either a 15 amp GFCI receptacle or a 15 amp GFCI cord and plug kit as shown (CKIT110 - P/N ELE09700086).

### Testing the GFCI

Test the GFCI plug prior to first use and periodically when the spa is powered.

1. Plug in the GFCI into the power outlet. The indicator should turn on.
2. Press the TEST button. The GFCI will trip, the indicator will turn off, and the spa will stop operating.
3. Press the RESET button. The GFCI will reset, the indicator will turn on again, and the spa will turn back on.

The spa is now safe to use.

If the GFCI trips while the spa is in use, press the RESET button. If the GFCI does not reset, unplug the spa and call your local Cal Spas dealer for service. **DO NOT USE THE SPA!**

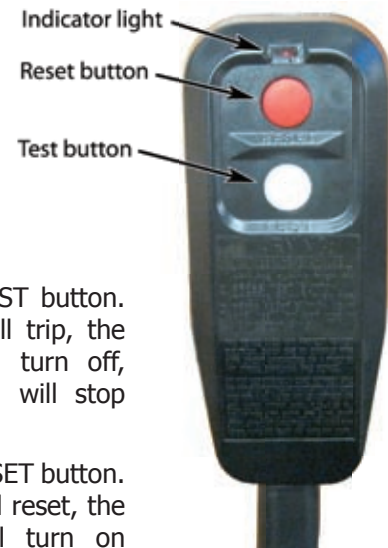

## Filling and Powering Up Your Portable Spa

This applies to all spa owners **EXCEPT** those with the Cal Clarity II bromine generator. See instructions on page 36 for bromine generator operating instructions and spa filling procedures.

### 1. Inspect the spa equipment.

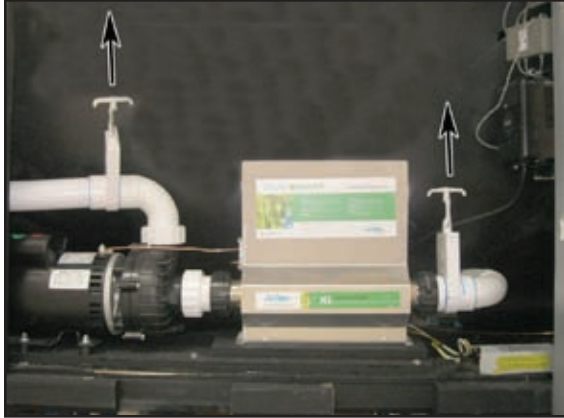

After the spa has been placed on an approved surface and has been correctly wired by a licensed electrician, inspect all plumbing connections in the equipment area of your spa. Ensure that these connections are secure and that they did not loosen during shipment.

If your spa has gate valves, make sure they are all in the UP or OPEN position.

Never run the spa with the gate valves closed or without water circulating for long periods of time. Be careful not to over-tighten the plumbing fittings.

### 2. Remove the cartridge from filter canister.



Unscrew the cartridge and remove it.



After you remove the filter, remove the plastic wrapper and soak it in water for 30 minutes before you replace it. A dry filter can allow air into the filtration system which can cause the pump to fail to prime.

### 3. Fill the spa.



Place a garden hose in the filter canister and fill your spa with **regular tap water** about six inches from the top.

If the water level is too low or too high, your spa will not operate properly.



Always fill the spa through the filter canister! Failure to do so may cause air to be trapped in the filtration system and prevent the pumps from operating properly.

#### **Never fill your spa with soft water.**



Soft water makes it impossible to maintain the proper water chemistry and may cause the water to foam, which will ultimately harm the finish of the spa and void your warranty.

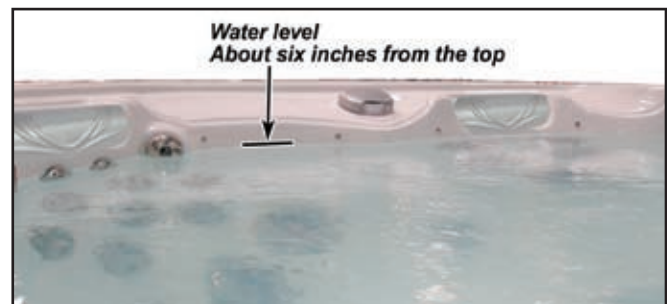

#### 4. Turn on power to the spa.



When the spa is filled to the correct level, turn on the power at the GFCI breaker. (Ensure that the 120V spas are connected to the proper electrical outlet.)

#### 5. Prime the pump.



Your spa will perform a self-diagnostic check and go into priming mode. When the control panel displays **PR**, do the following:

- Press the JETS button to turn on the pump and let it run for 10 seconds. The pump should be running in low speed.
- Press the JETS buttons again and let the pump run in high speed for 10 seconds.
- Press the JETS button again to turn off the pump. The pump should be left off for 10 to 15 seconds.
- Repeat steps a through c until water is flowing through all the jets and all air is removed from the plumbing.

If spa fails to prime, there could be an air pocket at the suction side of the pump. Follow the priming instructions on page 12 using the bleeder valve.

#### 6. Install the filter into the filter canister.



Make sure the filter has soaked at least 30 minutes before you install it.

#### 7. Let the spa heat up.

When the spa has finished priming, the heater will activate.

Put the cover on and let the spa run for two hours.

#### 8. Adjust water chemistry.

After the spa has run for two hours, test and adjust the water chemistry. See the section on page 31 for instructions on water clarity.

## Priming the Pump

New spa owners often have difficulty the first time they start their spa and the pump fails to prime. This can be frustrating, but these simple instructions can help you.

Sometimes air can become trapped in the pump while filling the spa. You will know this has happened when after you have filled and started the spa, the pump does not seem to function. You will hear the pump operating, but no water will be moving.

There are two methods of priming the pump.



The pump will not work properly while air is trapped in it. Continuing to operate the pump in this way will cause damage.

### Using the control panel:

1. Turn the spa on and wait for PR (Priming Mode) to appear on the topside display.
2. Press the JETS button to turn on the pump and let it run for 10 seconds. The pump should be running in low speed.
3. Press the JETS buttons again and let the pump run in high speed for 10 seconds.
4. Press the JETS button again to turn off the pump.
5. Repeat steps 1 through 4 until water is flowing through all the jets and all air is removed from the plumbing.

The pump should be left in the off position for 10 to 15 seconds.

Note: If you press the **Temp** button any time during Priming Mode, it will exit that mode and begin Standard Mode.

### Using the bleeder valve:

1. Using a Phillips screwdriver, remove the front panel from the spa and locate the pump.
2. Shut off the power to the spa.
3. Close the gate valve on the discharge side of the pump.
4. Turn the bleeder valve counter clockwise with a small pair of pliers or a flat head screwdriver until the air has been released from the pump.
5. If this is unsuccessful, loosen the white union nut on side of the pump with channel locks. When air is bled out, tighten the nut.
6. Turn on power to the spa and press the JETS button. If there is still air trapped in the pump, repeat steps 2 through 5 until the pump primes.

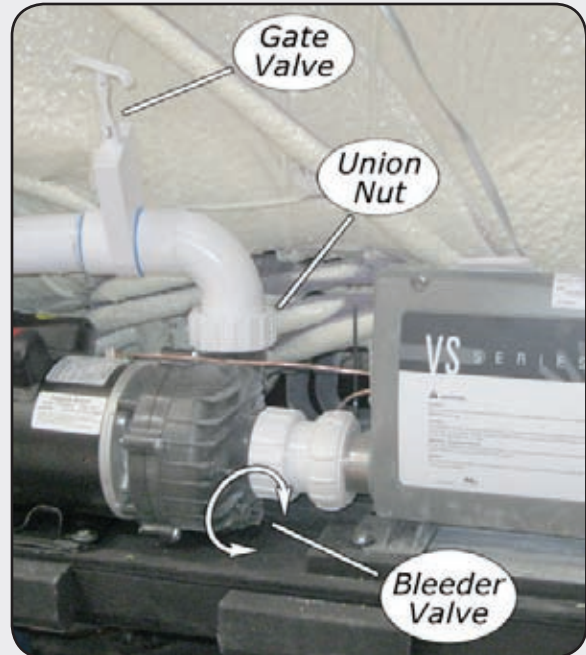

# Operating Your Spa

## VS300, VS513Z, and 5100 Control Operation

This section shows you how to use these control boxes:

VS300  
VS513Z

5100 (single voltage)  
5100 (dual voltage)

If you are unsure which control box your spa has, contact your spa dealer.

These instructions will describe features and options that your particular spa may not be equipped with.

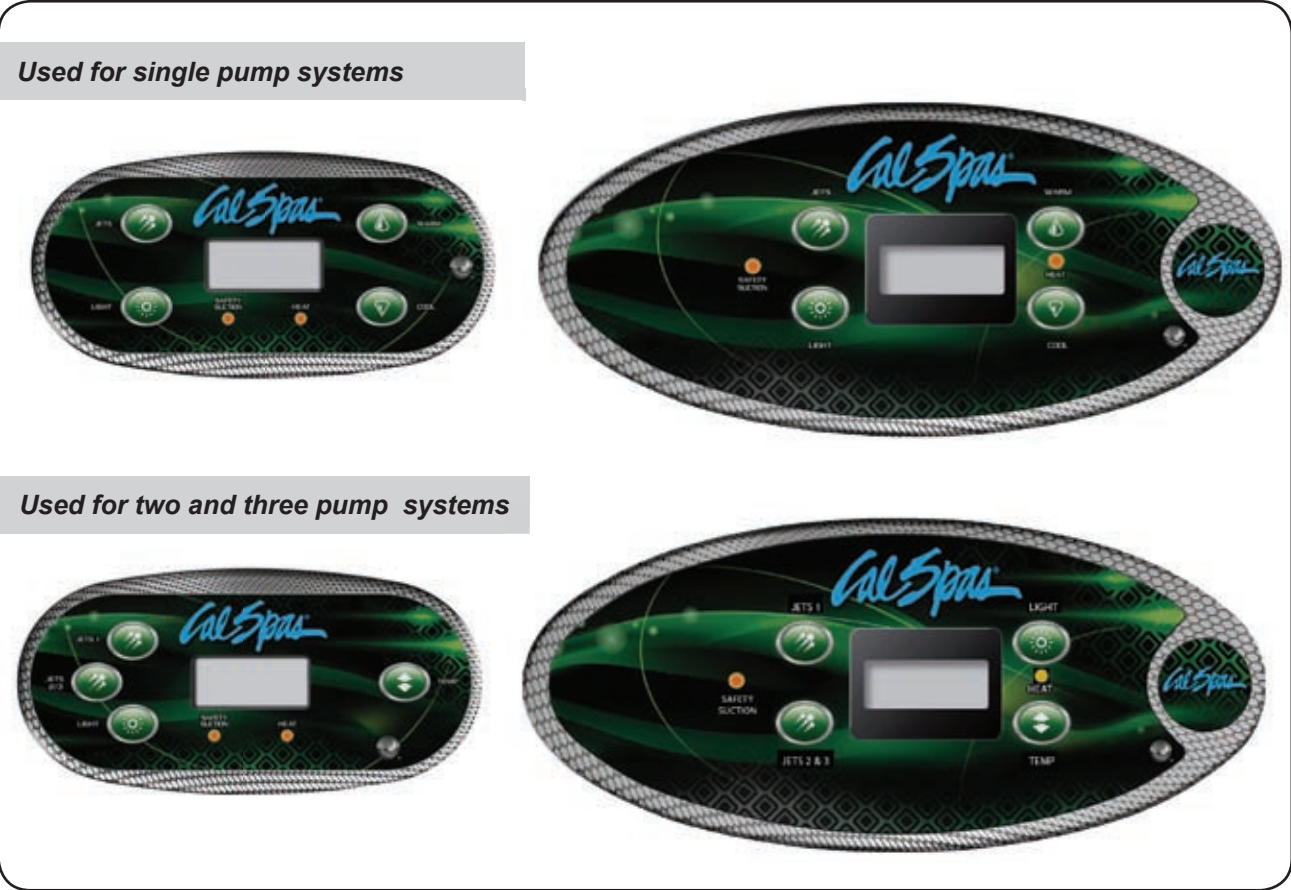

### Initial Start up

When first powered up, your spa will perform a self-diagnostic check and go into priming mode. When the control panel displays **PR**, do the following:

1. Press the **JETS** button to turn on the pump and let it run for 10 seconds. The pump should be running in low speed.
2. Press the **JETS** buttons again and let the pump run in high speed for 10 seconds.
3. Press the **JETS** button again to turn off the pump.



The pump should be left in the off position for 10 to 15 seconds.

4. Repeat steps 1 through 3 until water is flowing through all the jets and all air is removed from the plumbing.

When the spa has finished priming, the heater will be activated and the water temperature will be maintained in standard mode. The spa will heat to 100°F (37.5°C) at start up until the set temperature is changed as described below.

## Jet Operation: VS300, VS513Z, and 5100 (single voltage) systems

### One Pump Systems

Single pump systems operate on high power only.

To operate the jets, press the **JETS** button:

- Once to turn the pump ON.
- Twice to turn the pump OFF.



### Two and Three pump Systems

Press the **OPTION** or **JETS 2** button:

- Once to turn pump 2 ON.
- Twice to turn pump 3 ON.
- Three times to turn pump 2 OFF.
- Four times to turn pump 2 OFF.

## Jet Operation: 5100 (dual voltage) system ONLY

### One Pump Systems

Single pump systems operate on high power only.

To operate the jets, press the **JETS** button:

- Once to turn the pump ON.
- Twice to turn the pump OFF.



When only one pump is running, the heater will operate at 220V. When two or three pumps are running, the heater will automatically switch to operate at 110V.

The heater light will tell you when it is operating and what voltage it is using. See the "Heater Light" section above.

### Jet Operation: Two and Three Pump Systems

*Two and three pump systems can be configured to operate on low or high power. The factory default is low power. This section describes how the spa operates when it is configured for low power operation.*

*See page 8 for GFCI and wiring requirements for both low and high power operation and for switch settings for high power configuration.*

Spas configured for low power operation require approximately 20% less power to operate. With low power configuration, the spa will never use more than 30 amps while in operation and will alternate between 110V and 220V, while spas configured for high power will operate continuously at 220V.

For spas configured for high power operation, the heater will turn on when (1) the water temperature drops or (2) the jets are in use.

### Operating the jets

Press the **JETS** or **JETS 1** button:

- Once to turn pump 1 ON.
- Twice to turn pump 1 OFF.

Press the **OPTION** or **JETS 2** button:

- Once to turn pump 2 ON.
- Twice to turn pump 3 ON.
- Three times to turn pump 2 OFF.
- Four times to turn pump 2 OFF.



### Heating Modes

The spa can be set to operate in three different heating modes:

- **Standard:** When the spa is powered up, it will automatically start in Standard heating mode. In Standard mode, the heating system will automatically maintain the set spa temperature. **STD** or **ST** will light briefly on the main display.
- **Economy:** In Economy mode, the heating system will only activate during filtration times and will heat the water to the set temperature. **Ecn** or **Ec** will display solid if temperature is not current and will alternate with spa temperature if measured temperature is current.
- **Sleep:** In Sleep mode, the heating system will only activate the heater during the filtering cycles but will only heat the water to within 20°F (10°C) of the set temperature. Like Economy mode, **SLP** or **SL** will display solid when temperature is not current and will alternate with actual temperature when it is current.

NOTE: Displayed temperature will only be current after the pump has been running for at least two minutes.

### Switching Heating Modes

- Press **Temp** button followed by the **Light** button.
- Press the same sequence to switch to the next mode.



### Temperature Adjustment

(Range 80°F to 104°F, 26°C to 40°C)

The electronic control panel displays the actual water temperature in degrees Fahrenheit. The displayed temperature will only be current after the pump has been running for at least two minutes.

#### To set the temperature on single pump spas

- Press the **Temp** button. The temperature setting will flash.
- While the display is flashing, each time you press **Temp** button, the set temperature will change up or down one degree.
- If the desired temperature is opposite of the direction each press of the button is making, release button, allow display to stop flashing and then press **Temp** button to change temperature the other direction.



#### To set the temperature on two or three pump spas

- Press the **Temp UP** or **Temp DOWN** button. The temperature setting will flash.
- While the display is flashing, each time you press the **Temp UP** or **Temp DOWN** button, the set temperature will change up or down one degree.



### Heater Light

The heater light will turn on whenever the heater is operating. It will appear different ways when the spa is operating:

#### VS300, VS513Z, and 5100 (single voltage) systems

A steady light means that the spa is operating at 220V.

A rapidly flashing light means that the heater is reading the water temperature. When the temperature has been determined, the heater light will stop flashing. You will frequently see the heater light flashing rapidly while it is also steady or slowly blinking.

#### 5100 (dual voltage) system ONLY

A steady light means that the spa is operating at 220V.

A slowly blinking light means that the spa is operating at 120V.



A rapidly flashing light means that the heater is reading the water temperature. When the temperature has been determined, the heater light will stop flashing. You will frequently see the heater light flashing rapidly while it is also steady or slowly blinking.

## Setting Filtration Cycles

Your spa is programmed to filter twice a day. The first cycle will begin six minutes after the spa is turned on and the second cycle 12 hours later. The factory has programmed the cycle to last for two hours but this can be reset according on your requirements.

To set the time of day filtration begins, turn off the power to the spa at the time you would like one of the filtration cycles to begin, then turn back on after 30 seconds.

To set the length of filtration cycles:

- Press the **Temp** button or the **Warm/Cool** button. The temperature setting will flash.  
- Press the **Jets** button. The filter cycle duration will appear. 

F2	Two hours
F4	Four hours
F6	Six hours
F8	Eight hours
FC	Continuous filtration
- Press **Temp** or **Warm/Cool** button to change the filtering cycle duration.
- Press the **Jets** button to exit.

If you have an ozonator, it will activate during the filtration cycles.

## Circulation Pump

This is an optional feature. If you have the optional circulation pump, it will come on when the system is checking temperature, during filter cycles, during freeze conditions, or when another pump is on.

When the circulation pump is installed, pump 1 is one-speed only. Otherwise, pump 1 is two-speed, with the low speed performing filtration. (See page 8 for control box settings.)

## Light

Press the **Light** button to turn on the light. Press it once again to turn the light off. All optional lighting such as the control panel light and cabinet perimeter lighting is controlled by the **Light** button and will turn on and off with the spa light. 

## Automatic Time outs

These features will automatically turn themselves off during periods of continuous use:

- Low speed pump After 4 hours
- High speed pumps After 15 minutes
- Optional circulation pump After 15 minutes
- Optional turbo After 15 minutes
- Spa light After 4 hours

# 9800 Electronic Control Operation

These instructions will describe features and options that your particular spa may not be equipped with.

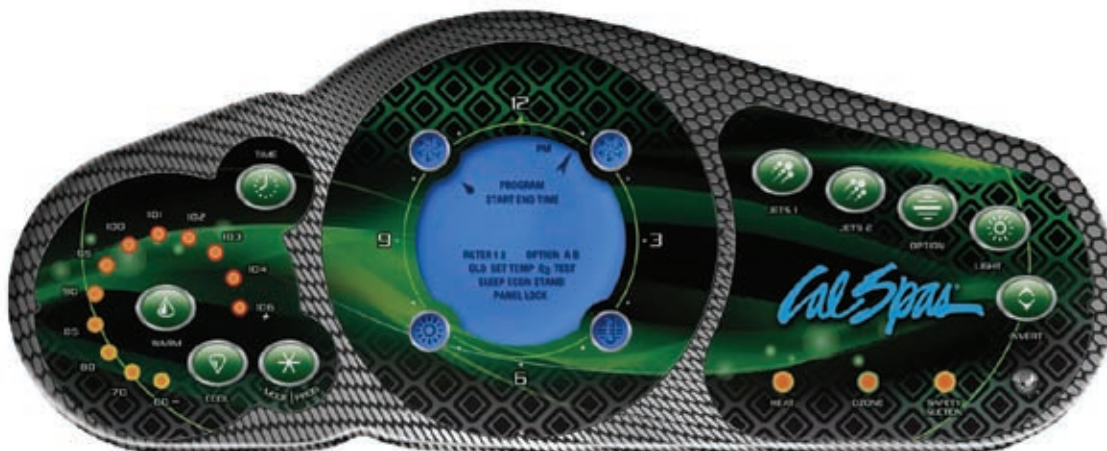

### Initial Start up

When first powered up, your spa will perform a self-diagnostic check and go into priming mode. When the control panel displays **PR**, IMMEDIATELY do the following:

1. Press the **JETS 1** button to turn on the pump and let it run for 10 seconds. The pump should be running in low speed.
2. Press the **JETS 1** buttons again and let the pump run in high speed for 10 seconds.



3. Press the **JETS 1** button again to turn off the pump. The pump should be left in the off position for 10 to 15 seconds.
4. Repeat steps 1 through 3 until water is flowing through all the jets and all air is removed from the plumbing.

When the spa has finished priming, the heater will be activated and the water temperature will be maintained in standard mode. The spa will heat to 100°F (37.5°C) at start up until the set temperature is changed as described below.

### Auxiliary Control Operation

The auxiliary control option is available with the 9800 control panel only. It is a small panel with four buttons: JETS1, JETS2, LIGHT, and OPTION. It conveniently puts the control of several spa functions at your fingertips without having to get up.



### Temperature Adjustment

**(Range 80°F to 104°F, 26°C to 40°C)**

The start-up temperature is set at 100°F (37.5°C). The last measured temperature is constantly displayed on the control panel. Note that the last measured spa temperature is displayed. The displayed temperature will be updated when the pump has been running for at least two minutes.

Press the "UP" or "DOWN" buttons once to display the set temperature. Each time either button is pressed again, the set temperature will increase or decrease depending on which button is pressed. After three seconds, the control panel will automatically display the last measured spa temperature.

## Time

When time hasn't been programmed, the "TIME" icon flashes. To set the time, press the "TIME" button and then the "MODE/PROG" button. Use the "UP" and "DOWN" buttons to adjust time. See the next page for more detailed instructions.

## Standard, Economy, Sleep, and Standby Modes

**Mode/Prog:** This button is used to switch between standard, economy, and sleep modes.

1. Press "MODE/PROG" to enter mode programming.
2. Press the "DOWN" button to cycle through to the desired mode.
3. Press "MODE/PROG" to confirm selection.

**Standard Mode:** Standard mode maintains the desired temperature. The last measured spa temperature displayed is current only when the pump has been running for at least two minutes. **STAND** will display until the mode is changed.

**Economy Mode:** Economy mode heats the spa to the set temperature only during filter cycles. **ECON** will display until the mode is changed. Pressing the "JETS 1" button while in economy mode puts the spa in standard-in-economy mode, which operates the same as standard mode but reverts back to economy mode automatically after one hour. During this time, pressing the "MODE/PROG" button will revert to economy mode immediately.

**Sleep Mode:** Sleep mode heats the spa to within 20°F (11°C) of the set temperature only during filter cycles. **SLEEP** will display until the mode is changed.

**Standby Mode:** Pressing "Warm" or "Cool" then "JETS 2" will turn off all spa functions temporarily. This is helpful when changing a filter. Pressing any button resets the spa.

## Jets 1

Press the "JETS 1" button once to turn pump 1 on or off and to shift between low and high speeds if equipped. If left running, the low speed turns off after two hours and the high speed turns off after 15 minutes. On non-circulation systems, the low speed of pump 1 runs when the blower or any other pump is on. It may also activate for at least two minutes every 30 minutes to detect the spa temperature and then to heat to the set temperature if needed, depending upon the mode. When the low speed turns on automatically, it cannot be deactivated from the panel; however, the

high speed may be started.

## Jets 2

Press the "JETS 2" button once to turn pump 2 on or off and to shift between low and high speeds if it is a two-speed pump. If left running, the pump will turn off after 15 minutes.

## Option

This is an optional feature. Press the "OPTION" button to turn the optional equipment on and off. If left on, the equipment will automatically turn off after 15 minutes.

## Light

Press the "LIGHT" button to turn the spa light on and off and to shift between dim and bright settings if your light is dimmable. On dim, the control panel will show the center circle plus one quarter of the light beams. Half of the light beams will show on medium brightness, and all of the light beams will show on bright.

## Invert

Press the "INVERT" button to change the numbers in the display to read upside down. Another press returns the display to the right-side-up position. This enables you to read the display while you are in the spa.

## Locking the Panel

To lock the panel:

- Press "TIME", "JETS 1", and the "UP" button within three seconds. When locked, the panel will display "LOCK". All buttons are frozen except the "TIME" button.

To unlock the panel:

- Press "TIME", "JETS 1" then the "DOWN" button within three seconds.

## Setting the Temperature Lock

To activate the temperature lock:

- Press the "UP" or "DOWN" button, "TIME", "JETS 1", then the "UP" button within three seconds. The panel will display "TEMP LOCK" when the set temperature is locked.

To unlock the set temperature:

- Press the "UP" or "DOWN" button, "TIME", "JETS 1", and then the "DOWN" button.

## Circulation Pump

This is an optional feature. The circulation pump will come on when the system is checking temperature, during filter cycles, during freeze conditions, or when another pump is on.

## Preset Filter Cycles

There are two filter cycles per day. The start and end times of each cycle are programmable. To program, set the time as instructed above, then press "MODE/PROG" to advance to the next setting (or to exit after the last setting). The default filter cycles are as follows:

- The first filter cycle is automatically activated at 8:00 AM and operates the pump until 10:00 AM. The "FILTER 1" indicator icon will light when filter 1 is running.
- The second filter cycle is automatically activated at 8:00 PM and operates the pump until 10:00 PM. The "FILTER 2" indicator icon will light when filter 2 is running.

The pump and the ozone generator will run during filtration. At the start of each filter cycle, the blower will run on highest speed for 30 seconds to clean out the air channels. The lowest speed of pump 2 and pump 3 will run for five minutes. In the event of power loss or shut down, the time of day will need to be reset for filter cycles to run according to your desired programming.

## Clean up Cycle

When the pump or blower is turned on by a button press, a clean-up cycle begins 30 minutes after the pump or blower is turned off or times out. The pump and the ozone generator will run for one hour.

## Ozone

This is an optional feature. On most systems, the ozone generator (if installed) runs during filter cycles (except when pump 1 is operating at high speed on a non-circulating system) and during clean-up cycles. On some systems, the ozone generator operates whenever the pump runs. If your system is configured with the optional ozone disable feature, the ozone generator will turn off for one hour any time a function button ("JETS 1", "JETS 2", "OPTION" etc.) is pressed.

## Freeze Protection

If the temperature sensors detect a drop to 44°F within the heater, the pump automatically activates to provide freeze protection. The equipment stays on until four minutes after the sensors detect that the spa temperature has risen to 45°F or higher. In colder climates, an optional additional freeze sensor may be added to protect against freeze conditions that may not be sensed by the standard sensors. Auxiliary freeze sensor protection acts similarly except with the temperature thresholds determined by the switch and without a four-minute delay in turnoff.



## Periodic Reminder Messages

Applies to 5100DV, 6200DV, 6300DV, and 9800 control systems. Press the "Mode" button to reset a displayed reminder.

Message	Frequency	Action Required
<b>rPH</b>	Every 7 days	Test and adjust chemical levels per manufacturer's instructions.
<b>rSA</b>	Every 7 days	Test and adjust chemical levels per manufacturer's instructions.
<b>rCL</b>	Every 30 days	Remove, clean, and reinstall filter per manufacturer's instructions.
<b>rtg</b>	Every 30 days	Test and reset GFCI per manufacturer's instructions. Drain and refill spa per manufacturer's instructions.
<b>rdr</b>	Every 90 days	Drain and refill spa per manufacturer's instructions.
<b>rCO</b>	Every 180 days	Clean and condition spa cover.
<b>rCH</b>	Every 365 days	Install a new filter.

## Diagnostic Messages

Applies to 5100DV, 6200DV, 6300DV, and 9800 control systems.

Message	Meaning	Action Required
<b>No message on display</b>	1) Spa temperature is unknown. 2) Spa is in Economy or Sleep mode. 3) Power has been cut off to the spa.	1) After pump has been running for 2 minutes temperature will be displayed. 2) In Economy or Sleep mode, the pump may be off for hours outside a filter cycle. If you wish to see the current spa temperature, either switch to Standard mode or turn Jets 1 on for at least two minutes. 3) The control panel will be disabled until power returns. Spa settings and time of day will be preserved for 30 days with a battery back-up.
<b>BUF</b>	Internal problem detected.	Repair required. Contact your dealer or service organization.
<b>dr</b>	Insufficient water detected in heater. Spa will be shut down for 15 minutes.	Check water level in spa. Refill if necessary. Make sure pumps have been primed and filter cartridges are clean. Press any button to reset or wait 15 minutes and spa will automatically reset. If message spa does not reset, call your dealer or service organization.
<b>dry dY</b>	Insufficient water detected in heater. Spa is shut down. (Displays on third occurrence of dr message.)	Follow directions for dr message and press any button to reset spa. Spa will not automatically reset when dry or dY is displayed.
<b>Ec</b>	Indicates heater is in Economy Mode.	None.
<b>--F or --C</b>	Temperature unknown	After the pump has been running for two minutes, the temperature will be displayed.
<b>HL HFL</b>	A difference in readings between temperature sensors has been detected indicating a possible water flow problem.	Make sure spa is filled to proper level and that pumps are primed and filter cartridges are clean. If message does not reset, call your dealer or service organization.

Message	Meaning	Action Required
<b>IC</b> <b>ICE</b>	Potential freeze condition detected.	No action required. The pumps and the blower will automatically activate regardless of spa status.
<b>LF</b>	Persistent low flow problems. Heater is shut down, but other spa functions continue to run normally. Displays on the fifth occurrence of the HL or HFL message within 24 hours.	Follow action required for HL or HFL message. Heating capacity of the spa will not reset automatically. Press any button to reset.
<b>OH</b> <b>OHS</b>	Overheat protection. The spa has shut down. One of the sensors has detected that the spa water is 110°F.	DO NOT ENTER THE WATER. Remove the spa cover and allow water to cool. At 107°F, the spa should automatically reset. If spa does not reset, shut off the power to the spa and call your dealer or service organization.
<b>HH</b> <b>OHH</b>	Overheat protection (spa is shutdown). One sensor has detected 118°F (48°C) at the heater.	DO NOT ENTER THE WATER! Remove the spa cover and allow spa to cool below 107°F (42°C). Press any button on the topside display to reset spa. If spa will not reset after spa has cooled, turn off power for approximately 30 seconds and then turn power back on. If display message is repeated then shut the power off to the spa and call your dealer or service organization.
<b>Pr</b>	When your spa is first actuated, it will go into priming mode.	The priming mode will last for up to four minutes and then the spa will begin to heat and maintain the water temperature in the Standard mode.
<b>SF</b>	Safety Suction. Spa is shut down.	The display will show SF when a vacuum switch closes. All functions will turn off and the system will be disabled until a panel button is pressed.
<b>SL</b>	Indicates heater is in Sleep Mode.	None.
<b>SA</b> <b>Sb</b> <b>SNA</b> <b>Snb</b>	Spa is shut down. The sensor that is plugged into the sensor "A" or "B" jack is not working.	If the problem persists, contact your dealer or service organization. (May appear temporarily in an overheat situation and disappear when the heater cools.)
<b>Sns</b> <b>Sn</b>	Sensors are out of balance. <ul style="list-style-type: none"> <li>If this is alternating with the temperature, it may just be a temporary condition.</li> <li>If the display shows only this message (periodically blinking), the spa is shut down.</li> </ul>	Contact your dealer or service organization.
<b>ST</b>	Indicates heater is in Standard Mode.	None.
<b>Stby</b>	Pressing a button combination on the user panel has activated Standby Mode.	Press any button to leave Standby Mode and return to normal operation.

## BP2000 Control Operation



### Priming Mode

After the initial start-up sequence, the control will enter Priming Mode, which lasts 4 to 5 minutes. The Priming Mode screen will appear, which will only show pump icons. The system will automatically return to normal heating and filtering at the end of the priming mode.

During the priming mode, the heater is disabled to allow the priming process to be completed without the possibility of energizing the heater under low-flow or

no-flow conditions. Nothing comes on automatically, but the pump(s) can be energized by selecting the "Jet" buttons. If the spa has a Circ Pump, it can be turned on and off by pressing the "Circ Pump" button during Priming Mode. In addition, if the spa has a Circ Pump, it can be activated by pressing the dedicated "Light" button during Priming Mode.

Manually exit Priming Mode by pressing the "Exit" Button.

### Priming the Pump

As soon as the Priming Mode screen appears on the panel, press the **Jets 1** button once to start Pump 1 in low speed and then again to switch to high speed. Also, select the other pumps, to turn them on. The pumps should be running in high speed to facilitate priming.

If the pumps have not primed after two minutes, and water is not flowing from the jets in the spa, do not allow the pumps to continue to run. Turn off the pumps and repeat the process. Note: Turning the power off and back on again will initiate a new pump priming session.

Sometimes momentarily turning the pump off and on will help it to prime. Do not do this more than five times. If the pumps will not prime, shut off the power to the spa and call for service.

Important: A pump should not be allowed to run without priming for more than two minutes. Under NO circumstances should a pump be allowed to run without priming beyond the end of the 4 to 5 minute priming mode. Doing so may cause damage to the pump and cause the system to energize the heater and go into an overheat condition.

### Exiting Priming Mode

You can manually exit Priming Mode by pressing an Up or Down button. Note that if you do not manually exit the priming mode as described above, the priming mode will be automatically terminated after 4 to 5 minutes. Be sure that the pumps have been primed by this time.

Once the system has exited Priming Mode, the top-side panel will momentarily display the set temperature but the display will not show the temperature yet. This is because the system requires approximately one minute of water flowing through the heater to determine the water temperature and display it.



### The Main Screen

When the spa has finished priming, you will see the Main Screen. Important information about spa operation can be seen quickly from the Main Screen. The most important features can be accessed from this screen.

- The actual water temperature can be seen in large text and the desired, or Set Temperature, can be selected and adjusted.
- Time-of-day, ozone operation and filter operation status are shown, along with other messages and alerts.
- Temperature Range (High or Low) is indicated in the upper right corner.
- A Lock icon is visible if the panel or settings are locked.

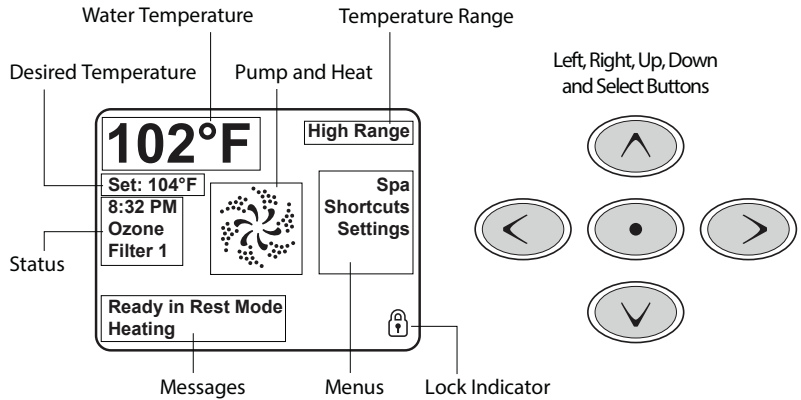

Set Temperature can then be adjusted with the up and down buttons. Pressing the Select button or the Right Arrow button will save the new set temperature.

**Menu selections** - The three menu choices on the right, **Spa**, **Shortcuts**, and **Settings**, can be selected and the screen will change to show more detailed controls or programming functions. They will be discussed further in this section.

### Navigation

There are four selections you can make on the Main Screen:

**Set temperature** - Press the left arrow button to change the Set Temperature number to white. The

### Messages

At the bottom of the screen, messages may appear at various times. Some of these messages must be dismissed by the user (see page 17).

### Spa Screen

The Spa Screen shows all available equipment to control, as well as other features, like Invert, in one easy-to-navigate screen. The display shows icons that are related to the equipment installed on a particular spa model, so this screen may change depending on the installation.

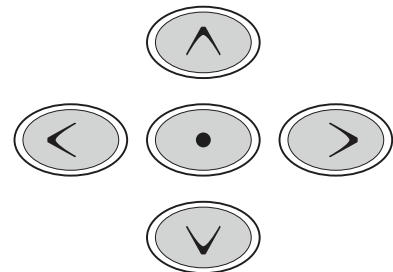
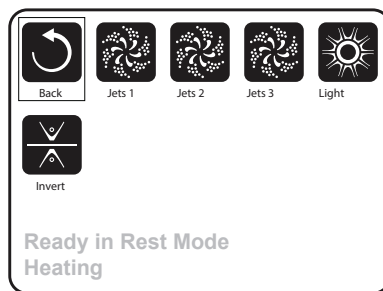

The navigation buttons are used to select an individual device. The device that is chosen is highlighted with a white outline and the text under the icon changes to white. Once a device is selected, it can be controlled using the center Select Button.

Some devices, like pumps, may have more than one ON state, so the icon will change to reflect the state that the equipment is in. Below are some examples

of 2-speed Pump indicators.

If the Spa has a Circ Pump, a Circ Pump Icon will appear to indicate its activity, but outside of Priming Mode, the Circ Pump cannot be controlled directly. NOTE: The icon for the pump that is associated with the heater (Circ or P1 Low) will have a red glow in the center when the heater is running.

## Shortcut Screen

The Shortcut Screen requires no navigation. Each button is fixed on a specific function and can be used as a very simple user interface for the spa.

Each button function is illustrated in the display and mapped according to the manufacturer's instructions.

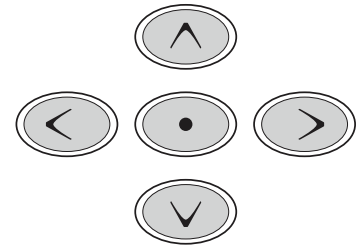
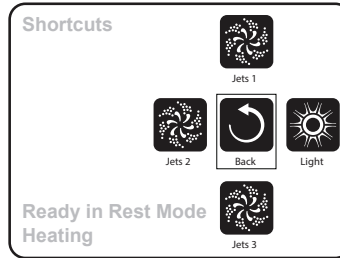

## Settings Screen

The Settings Screen is where all programming and other spa behaviors are controlled.

This screen has several features that can be acted on directly. These features include Temp Range, Heat Mode, and Invert Panel. When one of these items is highlighted, the Select Button is used to toggle between two settings. All other menu items (with an arrow pointing to the right) go to another level in the menu.

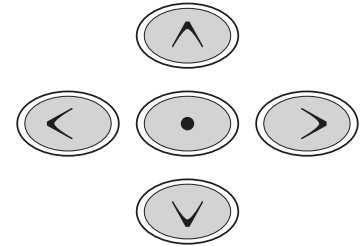
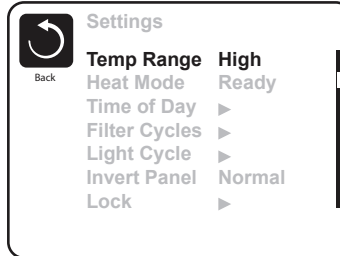

### Temperature Range – High or Low

This system incorporates two temperature range settings with independent set temperatures. The specific range can be selected on the Settings screen and is visible on the Main Screen in the upper right corner of the display.

These ranges can be used for various reasons, with a common use being a “ready to use” setting vs. a “vacation” setting. Each range maintains its own set temperature as programmed by the user. This way, when a range is chosen, the spa will heat to the set temperature associated with that range.

High Range can be set between 80°F and 104°F. Low Range can be set between 50°F and 99°F. More specific Temp Ranges may be determined by the Manufacturer. Freeze Protection is active in either range.

### Heat Mode – Ready vs. Rest

In order for the spa to heat, a pump needs to circulate water through the heater. The pump that performs this function is known as the “heater pump.”

The heater pump can be either a 2-speed pump (Pump 1) or a circulation pump. If the heater pump is a 2-Speed Pump 1, READY Mode will circulate water every 1/2 hour, using Pump 1 Low, in order

to maintain a constant water temperature, heat as needed, and refresh the temperature display. This is known as “polling.”

REST Mode will only allow heating during programmed filter cycles. Since polling does not occur, the temperature display may not show a current temperature until the heater pump has been running for a minute or two. While Pump 1 High can be turned on and off, Pump 1 Low will run until set temperature is reached, or 1 hour has passed.

### Time of Day

Setting the time of day is important for determining filtration times and other background features. “Set Time” will appear on the Main Screen if no time of day is set.

### Filter Cycles

Filter cycles are set using a start time and a duration. Each setting can be adjusted in 15-minute increments. The panel calculates the end time and displays it automatically.

Filter cycle 2 is off by default, but can be selected for use if desired.

### Light Cycle

If Light Cycle does not appear in the Settings Menu, the light timer feature is not enabled by the manufacturer. When available, the light timer is OFF by default. The settings can be edited the same way as filter cycles.

**Invert Panel**

Selecting Invert Panel will flip the display and the buttons so the panel can be easily operated from inside or outside the hot tub.

**Lock**

The control can be restricted to prevent unwanted use or temperature adjustments.

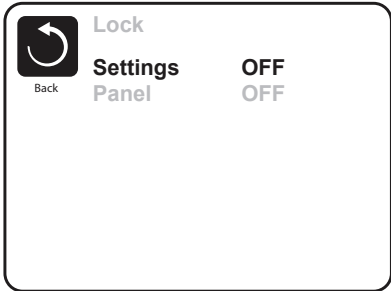

- Locking the Settings allows jets and other features to be used, but the set temperature and other programmed settings cannot be adjusted.

When settings are locked, there is a reduced selection of menu items. These include Set Temperature, Invert, Lock, Utilities, Information and Fault Log. They can be seen, but not changed or edited.

- Locking the Panel prevents the controller from being used, but all automatic functions are still active.



**Unlocking** -- An unlock sequence using the navigation buttons can be used from the Lock Screen. The Unlock Sequence is the same for both Panel Lock and Settings Lock.

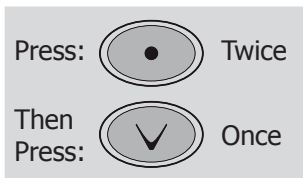

**Hold**

Hold Mode is used to disable the pumps during service functions like cleaning or replacing the filter. Hold Mode will last for 1 hour unless the mode is exited manually. If spa service will require more than an hour, it may be best to simply shut down power to the spa.

**Utilities**

This menu feature is for system information only and is used mainly for repair and troubleshooting.

**Preferences**

This allows you to set the following preferences for system operation:

- Change the temperature between Fahrenheit and Celsius
- Change the clock between 12-hour and 24-hour display
- Turn periodic reminded (like "CLEAN FILTER") on or off

**Information**

This menu feature is for system information only and is used mainly for repair and troubleshooting.

**Circulation Mode (See Page 8, under Pumps, for other circulation modes)**

If the spa is configured for 24HR circulation, the heater pump generally runs continuously. Since the heater pump is always running, the spa will maintain set temperature and heat as needed in Ready Mode, without polling. In Rest Mode, the spa will only heat to set temperature during programmed filter times, even though the water is being filtered constantly when in Circulation Mode.

**Ready-in-Rest Mode**

READY/REST appears in the display if the spa is in Rest Mode and the Jets 1 Button is pressed. It is assumed that the spa is being used and will heat to set temperature. While Pump 1 High can be turned on and off, Pump 1 Low will run until set temperature is reached, or 1 hour has passed. After 1 hour, the System will revert to Rest Mode. This mode can also be reset by entering the Settings Menu and changing the Heat Mode.

## Diagnostic Messages

Message	Meaning
---F - ---C	Water temperature is unknown. After the pump has been running for one minute, the temperature will be displayed.
Possible freezing condition	A potential freeze condition has been detected, or the Aux Freeze Switch has closed. All water devices are activated. In some cases, pumps may turn on and off and the heater may operate during Freeze Protection. This is an operational message, not an error indication.
The water is too hot	The system has detected a spa water temp of 110°F (43.3°C) or more, and spa functions are disabled. System will auto reset when the spa water temp is below 108°F (42.2°C). Check for extended pump operation or high ambient temp.
Water flow is low	There may not be enough water flow through the heater to carry the heat away from the heating element. Heater start up will begin again after about 1 min. See "Flow Related Checks" below.
Water flow has failed	There is not enough water flow through the heater to carry the heat away from the heating element and the heater has been disabled. See "Flow Related Checks" below. After the problem has been resolved, you must press any button to reset and begin heater start up.
The heater may be dry	Possible dry heater, or not enough water in the heater to start it. The spa is shut down for 15 min. Press any button to reset the heater start-up. See "Flow Related Checks" below.
The heater is dry	There is not enough water in the heater to start it. The spa is shut down. After the problem has been resolved, you must clear the message to restart heater start up. See "Flow Related Checks" below.
The heater is too hot	One of the water temp sensors has detected 118°F (47.8°C) in the heater and the spa is shut down. You must clear the message when water is below 108°F (42.2°C). See "Flow Related Checks" below.
Sensors are out of sync	The temperature sensors MAY be out of sync by 2°F or 3°F. Call for service.
Sensors are out of sync -- Call for service	The temperature sensors ARE out of sync. The fault above has been established for at least 1 hour. Call for service.
Sensor A Fault, Sensor B Fault	A temperature sensor or sensor circuit has failed. Call for service.
Communications error	The control panel is not receiving communication from the System. Call for service.
°F or °C is replaced by °T	The Control System is in Test Mode. Call for service.

### Flow-Related Checks

Check for low water level, suction flow restrictions, closed valves, trapped air, too many closed jets and pump prime. On some systems, even when spa is shut down by an error condition, some equipment may occasionally turn on to continue monitoring temperature or if freeze protection is needed.

### Setting up the WiFi Interface Connection for the Smart Phone App

This feature is available for use with the BP500 control system and any of these mobile devices:

- iPhone 3G, 3GS, 4, 4S
- iPod Touch
- iPad or iPad 2G

#### Downloading the app

1. Go to the Apple app store.
2. Search for the free Balboa spa app.
3. Select "Balboa Water Group - WiFi Spa Control".
4. Sign in and download the app.

#### Installing the app

1. Touch the Settings icon to go to the Wi-Fi Networks screen.
2. Touch the Wi-Fi on the Settings page.
3. The Spa Control network link will appear as BWGSpa\_XXXXX in the "Choose a Network" list.

Note: XXXXXX are the last 6 characters in the MAC address of the module.

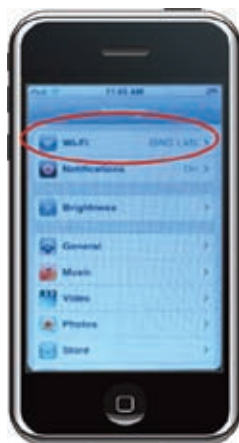

It will take several seconds for the wireless connection to the spa to be available. To speed up this process, a static IP address can be assigned to the iPhone, iPod Touch, or iPad for the point-to-point network:

1. On the WiFi Networks page, touch the blue right-arrow next to the BWGSpa\_XXXXXX entry to display the address setup page.
2. Touch the Static button under IP Address.
3. Enter 169.254.1.2 for IP Address.
4. Enter 255.255.0.0 for the Subnet Mask.
5. Enter 169.254.1.1 for the Router.
6. Touch the "Wi-Fi Networks" button at the top of the page to exit the screen.

This address setup only has to be done once.

#### Using the app

When the app has been installed, it will provide you with instant access and control of your spa wherever you connect within the spa's Wi-Fi range.

## Electrical Power Efficiency

Your new spa comes equipped with an electric heater. Following the directions listed below will ensure the most efficient operation:

NOTE: This method is only for spa usage under two hours a week.

- Keep the spa's operating temperature 5°F below the desired usage temperature when not in use. One or two hours before use, set the temperature to the desired temperature.
- If the spa usage exceeds two hours a week, the set temperature should remain at the desired usage temperature.
- The air venturis should be used sparingly. When open, water temperature drops quite rapidly and can also dissipate chemicals.

Allowing the water temperature to lower more than 10°F below the desired usage temperature and reheating it prior to usage will cause the heater to operate longer than it normally would maintaining the desired temperature. Doing this will increase your operating cost and makes your heater work more than necessary.

## Jets

Almost all of the jets in your spa are adjustable. Rotating the face of an adjustable jet to the left (counter-clockwise) will decrease the amount of water flow through the jet. Rotating the face of an adjustable jet to the right (clockwise) will increase the amount of water flow through the jet. (See example shown below.)

Neck jets adjust in the opposite directions (counter-clockwise to increase, clockwise to decrease).



## LED Perimeter Lighting

Press the LIGHT button on the topside control panel to turn the spa light on. If your spa has perimeter LED lights, they will also light up at the same time as the spa light.

The perimeter lights operate in three modes:

- 1. Cycle:** The first time you press the LIGHT button, the lights will cycle through all the colors in this order:

White  
Cyan  
Magenta  
Blue  
Yellow/green  
Green  
Red

To cycle through the different color choices, press the button repeatedly. Each time you press the button, you advance to the next color.

- 2. Flashing white:** When you have cycled through all the colors, the next time you push the LIGHT button, the LED lights will flash white.
- 3. Fading cycle:** The next time you push the LIGHT button, the lights will gradually fade from one color to the next in the order shown above.

Spas with exterior corner LED lighting work in the same modes as described above but do not light up when the interior perimeter lights are yellow/green, green or red.

### Diverter Knobs

Diverter knobs are 1" and 2" knobs located around the top of your spa. They allow you to divert water through jets from one side of the spa to the other, or in most cases from floor jets to wall jets. This is accomplished by rotating the diverter knob to the left (counterclockwise), decreasing the amount of water flow through a section of jets. To increase the amount of water flow through the other section of jets, rotate the handle to the right (clockwise).



### Waterfalls

Some spa series include optional waterfalls. When the booster pump is on, turn the knob near the waterfall, or rotate the dial on top of the waterfall. Water will immediately start flowing through it.

### Air Venturis

Air venturis are the 1" knobs located around the top of your spa. Each one will let you add a mixture of air with the jet pressure. This is accomplished by rotating the air venturi knob to the left (counterclockwise) to increase the amount of airflow through the jets. To decrease the amount of airflow through the jets, rotate the handle to the right (clockwise).



### Hydro Streamer Waterfall

Your spa may include two to eight streamer waterfalls. When the booster pump is on, turn the 1" diverter knob to adjust the rate of flow to the waterfall jets.

The waterfall jet faces are not adjustable. Do not turn the jet faces because you may accidentally remove them.

Always shut off water to the hydro streamer jets before you place the cover on the spa.

Water from the hydro streamer jets sprays in an arc that is higher than the top surface of the spa. When water from the hydro streamer sprays the bottom of the cover, it will collect and run to the edge of the spa and drip over the top.



## Adjustable Therapy System

### Pump On/Off

This button allows the user to turn on and off the ATS seat pump. Press this button once to turn the pump on. Once on, the green LED light on the control panel will illuminate, indicating that the system is operational. To turn off the pump, press the "PUMP ON/OFF" button a second time. Note: The pump must be on prior to operating any other features of this system.

### Pulse Mode

This button allows the user to turn the ATS massage control on and off. Press the pulse button once to turn on the massage control. Once pressed, the orange LED in position number 1 will light, indicating the number one pulse mode. Each press of either the up or down button will move the orange LED up or down to the next pulse mode.

Note: Allow one second between each button press. Pressing the button quickly may cause improper operation. To turn the pulse mode off and return to normal pump operation, press the "PULSE MODE" button a second time.

### Up

This button allows the user to cycle up from one through seven massage modes one at a time. Each mode offers a different pulsating massage. Some modes are faster than others, so just cycle through them to find the massage you like best.

### Down

This button allows the user to cycle down through all seven massage modes, one at a time.

### Time Reset Mode

Pulse mode will normally run for 15 minutes then automatically shut off. For another 15-minute session, press the "PUMP ON/OFF" button and the "PULSE

MODE" button. A green LED will blink and the pump will run on high-speed mode as part of a 15-minute cool down period. After that, the pump will stop automatically and the green LED light on the panel will continue to blink for one minute then shut off automatically. After the second 15-minute session, the system will run through a cool down cycle for up to two hours. In this cool down mode, the user will only be able to operate the pump (by again pressing the "PUMP ON/OFF" button). However, the massage mode will remain off until the cool down mode is completed.

### Pulse Mode System

Pulse mode system will shut off for two hours unless reset by the following procedure. During this time the pump will run at a maximum speed.

- In the off position, press the "PULSE MODE" button once.
- The green power light will flash to indicate reset.



## Wireless Spa Monitor

The wireless spa monitor allows you to monitor and change your spa's activity from a distance. The table below describes each button's function.

<b>Light</b>	Operates spa light and LED mood lighting
<b>Temp</b>	Display or adjust the set temperature control
<b>Jet 1</b>	Turn on or off jet 1
<b>Mode</b>	Switch between Standard, Economy, and Sleep Modes





# Water Clarity

This section is intended for new spa owners with no experience with water chemistry. Everyone's experience with maintaining water quality is different, but there are some general concepts you need to know.

Water maintenance is not difficult, although it requires regular attention. The most important thing to understand about taking care of your spa water is that preventive action is much easier than correcting water quality issues.

## A Note on the Cal Clarity II System

The information in this section applies to all spas. However, the Cal Clarity II bromine generator has a few specific requirements and exclusions, which are called out where they occur in this section.

The Cal Clarity II system uses its own bromine chemical additive and does not require a sanitizer. Spa owners with the Cal Clarity II system need to learn how to use the system to prevent voiding their warranty.

## The Key to Clear Water

Excellent water quality is a simple matter of four things:

**Chemical Balance**

You will need to test and adjust the chemical balance of your spa water. Although this is not difficult, it needs to be done regularly.

Depending on your choice of sanitizer, you need to test the level of calcium hardness, total alkalinity, and pH. Spa owners with a Cal Clarity II bromine generator also need to check total dissolved solids and phosphates.

See page 32 to learn how to balance your spa water.

**Sanitation**

Sanitizers kill bacteria and viruses and keep the water clean. A low sanitizer level will allow microbes to grow quickly in the spa water. We recommend using either chlorine or bromine as your sanitizer.

Spa owners with an ozonator also need to add sanitizer, although their requirements are different.

See page 33 to learn how to use sanitizer.

The Cal Clarity II bromine generator does NOT require sanitizer. See page 36 for a description of its use.

**Filtration**

Cleaning your filter regularly is the easiest and most effective single thing you can do to keep your water clear.

A clogged or dirty filter will cause the heater and pump to work harder than they need to, possibly causing them to fail.

The spa's heating system will only function with the proper amount of water flow through the system.

See page 35 for filter cleaning instructions.

**Regularity**

Clear water requires regular maintenance. Establish a routine based on a regular schedule for your spa water maintenance.

Maintaining your water quality helps the enjoyment of your spa and extends your spa's life by preventing damage from neglect and chemical abuse.

See page 38 for the schedule of recommended maintenance.



## Testing and Adjusting Spa Water

You have two types of testing methods to choose from:

- **The reagent test kit** is a method which provides a high level of accuracy. It is available in either liquid or tablet form.
- **Test strips** are a convenient testing method commonly used by spa owners.

### Balancing the Total Alkalinity

Total alkalinity (TA) is the measure of the total levels of carbonates, bicarbonates, hydroxides, and other alkaline substances in the water. TA can be considered a "pH buffer". It is the measure of the ability of the water to resist changes in pH level.

**The recommended total alkalinity is 80 - 120 ppm.**

If the TA is too low, the pH level will fluctuate widely from high to low. Low TA can be corrected by adding an alkalinity increaser

If the TA is too high, the pH level will tend to be too high and may be difficult to bring down. High TA can be corrected by adding an alkalinity decreaser.

When the TA is balanced, it normally remains stable, although adding water with high or low alkalinity will raise or lower the TA level.

### Balancing the Calcium Hardness

Calcium hardness (CH) is a measure of the total amount of dissolved calcium in the water. Calcium helps control the corrosive nature of the spa's water and is why soft water is not recommended. The low calcium content of soft water is very corrosive to the equipment and can cause staining of the spa shell.

**The recommended calcium hardness is 150 - 200 ppm.**

If the CH is too low, add a calcium hardness increaser.

If the CH is too high, dilute the spa water with soft water.

When the CH is balanced, it normally remains stable, although adding soft water or very hard water will raise or lower the CH level.

### Balancing the pH

The pH level is the measure of the balance between acidity and alkalinity.

If the pH is too low, it can cause corrosion of metal fixtures and the heating element. Low pH can be corrected by adding a pH decreaser.

If the pH is too high, it can cause scaling by allowing metals or minerals to form deposits and stain spa surfaces. High pH can be corrected by adding a pH increaser

Too alkaline, causes scaling	8.2	↓ <i>Need to lower the pH level</i>
	8.0	
	7.8	
Ideal balance	7.6	
	7.4	
	7.2	
Too acidic, causes corrosion	7.0	↑ <i>Need to raise the pH level</i>
	6.8	
	6.6	

### Ideal Water Chemistry

Testing For:	Ideal Range (ppm)	
	Minimum	Maximum
Total Alkalinity	80	120
Calcium Hardness	150	200
pH	7.2	7.6

## Sanitation

Sanitizers kill bacteria and other organic waste by breaking them down to non-harmful levels and are filtered out. Before you fill your spa, you need to decide which chemical sanitizer you wish to use. Consult your Cal Spas dealer for the right decision with regards to your lifestyle and spa usage.

*Do not use a sanitizer with the Cal Clarity II bromine generator. See page 36 for instructions on its use.*

We recommend either **bromine** or **chlorine** as your sanitizer. Both work well when maintained regularly.



**DO NOT use trichlor. Trichlor is very acidic and the hot temperature of the spa causes it to dissolve too quickly. It will cause damage to your spa and will void your warranty.**

Whichever plan you decide on, follow it completely and don't take shortcuts. It will provide you with clean, safe, clear spa water with a minimum of effort. Spa owners with an ozonator still need to use a chemical sanitizer. See page 35 for instructions on usage.

### Using Chlorine as a Sanitizer

If you choose to use chlorine as a sanitizer, only use granulated chlorine, not liquid chlorine.

Once a week, check the chlorine level using either a test strip or a reagent kit. See the table on the following page for the ideal range.

Add one or two tablespoons granulated chlorine to the spa water weekly. Note that chlorine dissipation rate will be faster at higher water temperatures and slower at lower temperatures.

When you add chlorine, open all of the jets and run the spa at high speed with the cover open for at least 30 minutes.

Follow the maintenance schedule on page 38.

### Using Bromine as a Sanitizer

Bromine is a very effective sanitizer that produces low chemical odors. Unlike chlorine, it can break down bacteria and other impurities to a safe level with a low burn-out rate.

Bromine is available in both granulated and tablet form. Use granulated sodium bromide to establish your bromine base. Use tablets to maintain it.

When you begin with fresh water, add 2 ounces of granulated bromide. Open all of the jets and run the spa at high speed with the cover open for at least 30 minutes. This is your base bromine level as the tablets will take a while to dissolve.

Place three or four bromine tablets in your chemical floater.

Follow the maintenance schedule on page 38.

Testing For:	Ideal Range (ppm)	
	Minimum	Maximum
<b>Chlorine level</b>		
Without ozonator	3.0	5.0
With ozonator	2.0	4.0
<b>Bromine level</b>		
Without ozonator	6.7	11.0
With ozonator	5.7	10.0

## Shocking the Water

In addition to using a chemical sanitizer, you will periodically need to shock the water. Shocking the water helps remove burned-out chemicals, bacteria, and other organic material from your spa's water and improves your sanitizer's effectiveness.

Do not use chlorinating shock, which will damage your spa's jets and pump seals. Only use an oxidizer shock. It can be used with either chlorine or bromine sanitizers.

*Do not use shock with the Cal Clarity II bromine generator. See page 36 for instructions on its use.*

Add one ounce of oxidizer shock once a week, after heavy bather loads, or if water has a strong odor.

Spa must be running with all of the jets on high for 30 minutes with the cover open. If necessary, repeat oxidizer shock in 30 minute intervals.

## Chemical Safety



**Read and follow all printed instructions listed on bottles and packages. Failure to follow chemical directions may result in serious injury, sickness, or even death.**

Do not exceed chemical dosages as recommended on chemical bottles and packages.

Never change chemical brands or types without completely draining, flushing and thoroughly cleaning the spa and cover first.

Never mix chemicals together.

Do not allow chemicals to come in contact with skin, eyes or clothing. Remove and wash clothing that may have been exposed to chemical contact prior to

wearing them again.

Inhaling or ingesting chemicals will cause serious injury, sickness, or even death.

Chemicals must be stored completely out of the reach of children in an area that is well vented, cool, and dry. Failure to provide a proper area for chemical storage may result in serious injury, sickness, fire explosion and even death. Do not store your chemicals inside the equipment area of your spa.

## Bather Load

"Bather Load" is the term used to describe the number of people using a spa, combined with the length of usage, and the frequency of usage. All these factors have a great effect on the spa water. The higher the bather load, the more chemicals need to be added and a longer filtration time will be needed.

Recommendations are designed for spas with average bather load (3 to 4 people, 15 minutes of usage, three

times a week at 100 degrees) If your bather load exceeds these guidelines, and you experience water quality problems, increase the amount of filtration first, (go to the next higher filtration number) then if water quality is still not adequate, consult the advice of your Cal Spas dealer for additional chemical or system recommendations. Be sure to give them your bather load information.

## Filter Cleaning

The filter is the part of your spa that removes the debris from the water and needs to be cleaned on a regular basis to maximize your spa's filtering performance and heating efficiency.

In addition to spraying off the filter weekly to remove surface debris, your filter should be deep cleaned periodically to dissolve scale and particles that get lodged deep within the filter fibers and impede the filtration process. Even if the filter looks clean, scale and particles can clog the fibers and prevent water from flowing through the filter resulting in the most common spa problem—no heat, caused by a dirty filter.

We recommend you clean your filter once a month and replace it once a year or as necessary.

1. Remove the filter by turning it counterclockwise, unscrewing the bottom threads, then pulling it up and out.
2. Place the dirty filter into a bucket of water deep enough to cover the filter. Add 8 oz of liquid filter cleaner to the bucket of water.

**Note:** It is a good idea to keep a spare filter to use in the spa while the dirty filter is being deep cleaned. This way, you can rotate the filters and both will last longer.

3. Soak the filter for a minimum of 24 hours.
4. Spray the filter with a water hose. Spray each pleat carefully.
5. Reinstall the filter. Do not overtighten.

## Pure XL™ and Pure Cure™ Water Sanitizers

The Pure XL™ and Pure Cure™ water sanitizers are optional water purification systems installed at the factory. They eradicate germs in the water that are resistant to chlorine-based chemicals using high intensity UV light.

Both water sanitizers work automatically during the spa's filtration cycle. We recommend increasing filtration time setting from F2 (two hours twice a day) to F6 (six hours twice a day). See page 16 or page 19 for setting filtration cycle.

Both water sanitizers are virtually maintenance-free. Once a year the UV light needs to be replaced. See page 44 for instructions. **However, the water sanitizer is not a user-serviceable item and maintenance must be performed by a spa technician. Have your service technician consult the manufacturer's instruction and service manual.**

## Ozonator

The ozone generator releases ozone into the spa water. You will still need to test for chlorine or bromine and occasionally replenish it to return the sanitizer level to the baseline.

Set the spa's filtration time for "F4" (described on page 16 and page 19). This activates the ozonator and produces the ozone gas. Note: Filtration time may need to be increased with heavy bather load.

## Cal Clarity II Bromine Generator

The Cal Clarity II bromine generator automatically generates and releases free bromine into the spa water. You will still need to test for bromine and occasionally adjust it to return the bromine level to the baseline.

### Starting the Spa with Fresh Water

This applies to spa owners with the Cal Clarity II bromine generator **ONLY**.

Prior to filling a spa for the first time, or after a routine draining, you will want to follow this start-up plan to extend water life and performance.

- Fill the spa to the proper water level with normal tap water. (Do not use soft water.) **See page 10 for filling instructions.**
- Turn on the spa and allow it to prime. **See page 12 for priming instructions.**
- Turn on the jets.
- Press the **Boost** button to turn on the Cal Clarity II system. The red ON light should appear steady. If it blinks, make sure the jets are running.
- Press and hold the **Prog** button for two seconds. When the flashing number appears, press the **Prog** button a second time. An animation will appear, then a number showing the total dissolved solids (TDS) level will be shown.
- Add BromiCharge™ to the spa water. Use the table below to determine how much you should use.
- Let the spa run for 15 minutes. Leave it uncovered during this time.
- Check the TDS level again (described in step 5).
- Set the Maintenance level. Press and hold the **Prog** button for two seconds. A number will flash showing the Maintenance Mode bromine level. Press the **UP** or **DOWN** buttons to raise or lower it. Press the **Boost** button to return Maintenance Mode.
- Put cover on spa and let spa run for 24 hours to allow it to heat to desired temperature.
- After 24 hours, check TDS level again (as described in step 5). TDS should be between 3 - 5 ppm. If it is too low, raise it in increments of 5 (as described in step 9).

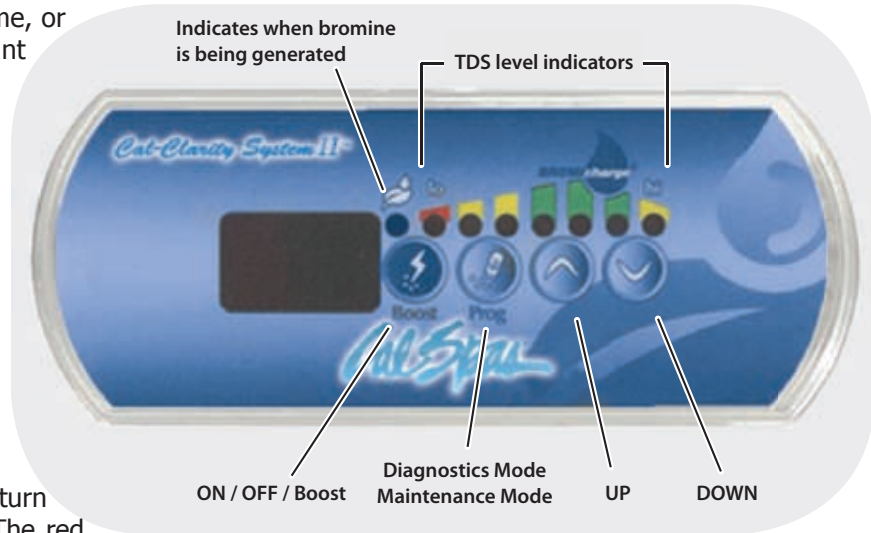

Use the table below to determine which level to start at.

Spa capacity (gallons)	Maintenance level
300 - 400	10
400 - 500	15
> 500	20

Spa Capacity		Amount of BromiCharge™	
Gallons	Liters	Pounds	Kilograms
300	1135	3.6	1.6
400	1515	4.8	2.2
450	1700	5.4	2.5
500	1890	6	2.7

Use 1.2 lbs. per 100 gallons, or .5 kg per 378 liters.

### Cal Clarity II Settings

Before entering the spa, the bromine level should be tested. The bromine generator can only produce bromine when:

- the spa is running,
- BromiCharge™ has been added, and
- the bromine generator is in the proper mode.

#### 1. ON / Maintenance Mode

Press the **Boost** button briefly while the jets are running. The system will activate in Maintenance Mode and the word **ON** will appear on the display.

#### 2. Adjusting the Maintenance Mode

To adjust the Maintenance Mode bromine level, press and hold the **Prog** button for two seconds. A number will flash showing the Maintenance Mode bromine level. Press the **UP** or **DOWN** buttons to raise or lower it. After seven seconds, the number will stop flashing, meaning the bromine level is active. Press the **Boost** button to return Maintenance Mode.

#### 3. Boost Mode

The Boost Mode is used each time you use the spa. Press the **Boost** button once to activate the Boost Mode. A number with a dash before and after it will flash for about five seconds showing the boost level. This number corresponds to the number of bathers. While the number is flashing, press the **UP** or **DOWN** buttons to raise or lower it. When the number stops flashing, the system will remain in Boost Mode.

#### 4. Using the Diagnostic Mode

Press and hold the **Prog** button for two seconds. When the flashing number appears, press the **Prog** button a second time. An animation will appear, and within 10 seconds the TDS level will be shown.

#### 5. Turning OFF

Press and hold the **Boost** button for two seconds. The system will shut off and the word **OFF** will appear on the display.

### Adding BromiCharge™ to the Water

BromiCharge™ is the chemical additive used with the Cal Clarity II. It can be added anywhere in the spa by simply pouring it from the container. Do not breathe or get into your eyes.

### Operating Modes

#### Maintenance Mode

Maintenance Mode is the “everyday” mode and is automatically on when the system is activated. Its primary function is to keep the bromine level at a stable and acceptable range when the spa is not being used.

#### Boost Mode

Use the Boost Mode each time you use the spa. Boost Mode increases the bromine generation rate to attack pollutants in the water. Activating the Boost Mode when you enter the spa will prevent inadequate bromine levels and will regenerate your bromine to the proper residual level.

#### Diagnostic Mode

The Diagnostic Mode indicates the BromiCharge™ salt level of your spa. This is a useful tool when adding BromiCharge™ to the water. Keep the TDS level indicators in the green zone and value between 11 and 14 for optimal performance.

### Testing the Water

In addition to testing the water for levels of calcium, alkalinity, and pH, you also need to test for bromine and total dissolved solids (TDS).

See page 32 for instructions on testing the water and for Ideal Water Chemistry levels.

The bromine level should be maintained between 3-5 ppm and can be tested with a DPD test kit, or bromine test strips, found at any spa/pool store.

If the bromine generator does not produce enough bromine, make sure the recommended level of 1440 ppm of BromiCharge™ salt is still present in the spa water. The bromine generator can test the water using the Diagnostic mode. This is described in the “Operating Modes” section above.

If the bromine level is too high, remove a small amount of spa water until the bromine level is between 3-5 ppm. For more immediate results, dilution with fresh water will lower the bromine level.

	Ideal Range	
	Minimum	Maximum
BromiCharge™ (ppm)	1300	1600
Bromine (ppm)	3	5
TDS level	11	14

## Maintenance Schedule

<b>Each time you refill the spa</b>	Follow the section "Filling and Powering Up Your Portable Spa" on page 10.
<b>Prior to each use</b>	Test the spa water using either test strips a reagent test kit. Adjust chemical levels as necessary.
<b>Once a week</b>	Test the spa water using either test strips a reagent test kit. Adjust chemical levels as necessary. If your water source is high in calcium, add stain and scale preventer.
<b>Once a month</b>	Deep clean your spa's filter. (Follow filter cleaning instruction at beginning of this section)
<b>Every two to four months</b>	Drain and clean your spa with a multi-purpose cleaner for spas. Polish the acrylic surface with a surface protectant for spas. Clean and treat spa cover, pillows, and Cal Select cabinet (if equipped) with a vinyl cleaner for spas. Refill your spa, following the section "Filling and Powering Up Your Portable Spa" on page 10. If you are using the Cal Clarity II Automatic Bromine Generator, add new sodium bromide to the water.
<b>Once a year</b>	Replace filter cartridges if the pleats appear frayed. If you use an ozonator, you will need to replace the ozone cartridge. If you use the Cal Pure UV water sanitizer, you will need to replace the UV lamp.

We recommend that your spa water be changed every 4 to 6 months. You may find the need to change your spa water more frequently with heavy use. When empty, your spa should be cleaned with a non-abrasive cleaner and then rinsed thoroughly.



## Troubleshooting Water Clarity Problems

Problem	Probable Causes	Possible Solutions
Cloudy Water	<ul style="list-style-type: none"> <li>• Dirty filter</li> <li>• Excessive oils / organic matter</li> <li>• Improper sanitization</li> <li>• Suspended particles / organic matter</li> <li>• Overused or old water</li> </ul>	<ul style="list-style-type: none"> <li>• Clean filter</li> <li>• Shock spa with sanitizer</li> <li>• Add sanitizer</li> <li>• Adjust pH and/or alkalinity to recommended range</li> <li>• Run jet pump and clean filter</li> <li>• Drain and refill the spa</li> </ul>
Water Odor	<ul style="list-style-type: none"> <li>• Excessive organics in water</li> <li>• Improper sanitization</li> <li>• Low pH</li> </ul>	<ul style="list-style-type: none"> <li>• Shock spa with sanitizer</li> <li>• Add sanitizer</li> <li>• Adjust pH to recommended range</li> </ul>
Chlorine Odor	<ul style="list-style-type: none"> <li>• Chloramine level too high</li> <li>• Low pH</li> </ul>	<ul style="list-style-type: none"> <li>• Shock spa with sanitizer</li> <li>• Adjust pH to recommended range</li> </ul>
Musty Odor	<ul style="list-style-type: none"> <li>• Bacteria or algae growth</li> </ul>	<ul style="list-style-type: none"> <li>• Shock spa with sanitizer – if problem is visible or persistent, drain, clean and refill the spa</li> </ul>
Organic buildup / scum ring around spa	<ul style="list-style-type: none"> <li>• Buildup of oils and dirt</li> </ul>	<ul style="list-style-type: none"> <li>• Wipe off scum with clean rag – if severe, drain the spa, use a spa surface and tile cleaner to remove the scum and refill the spa</li> </ul>
Algae Growth	<ul style="list-style-type: none"> <li>• High pH</li> <li>• Low sanitizer level</li> </ul>	<ul style="list-style-type: none"> <li>• Shock spa with sanitizer and adjust pH</li> <li>• Shock spa with sanitizer and maintain sanitizer level</li> </ul>
Eye Irritation	<ul style="list-style-type: none"> <li>• Low pH</li> <li>• Low sanitizer level</li> </ul>	<ul style="list-style-type: none"> <li>• Adjust pH</li> <li>• Shock spa with sanitizer and maintain sanitizer level</li> </ul>
Skin Irritation / Rash	<ul style="list-style-type: none"> <li>• Unsanitary water</li> <li>• Free chlorine level above 5 ppm</li> </ul>	<ul style="list-style-type: none"> <li>• Shock spa with sanitizer and maintain sanitizer level</li> <li>• Allow free chlorine level to drop below 5 ppm before spa use</li> </ul>
Stains	<ul style="list-style-type: none"> <li>• Total alkalinity and/or pH too low</li> <li>• High iron or copper in source water</li> </ul>	<ul style="list-style-type: none"> <li>• Adjust total alkalinity and/or pH</li> <li>• Use a stain and scale inhibitor</li> </ul>
Scale	<ul style="list-style-type: none"> <li>• High calcium content in water – total alkalinity and pH too high</li> </ul>	<ul style="list-style-type: none"> <li>• Adjust total alkalinity and pH – if scale requires removal, drain the spa, scrub off the scale, refill the spa and balance the water</li> <li>• Use a stain and scale inhibitor</li> </ul>

## Cleaning and Maintenance

### Removing and Reseating the Pillows

You can remove the pillows for cleaning and maintenance quickly and easily. This method works for all types of pillows.

Grab the lower edge of the pillow with both hands firmly and pull up. As you do this, the pillow inserts will pop out of the holes.



Reseat the pillows by aligning the pillow inserts with the holes and striking the pillow hard enough to insert the pegs back into the holes.

### Jet Removal and Replacement

Jets can be easily removed for cleaning.

Grasp the outer rim of the jet and turn it counter-clockwise. The jet will unscrew from the fitting until it is free.

To replace the jet, place it in the fitting and turn it clockwise until it is snug in place. Do not overtighten the jet.



### Spa Cover

**Important!** Keep the spa covered when not in use!

- Covered spas will use less electricity in maintaining your set temperature.
- Covering your spa will protect your spa's finish from the sun's ultraviolet rays.
- You are required to keep the spa covered to maintain warranty coverage.
- Covering your spa helps prevent children from drowning in the spa.

See the manual enclosed with your cover for instructions on mounting the locks and how to lock and unlock the cover.

In addition, while the spa cover is rigid, it is not designed to support any weight. Therefore, as a safety precaution and to preserve the life of your cover, you must not sit, stand, or lie on it, nor should you place objects of any kind on top of it.

# Draining Your Portable Spa

Your spa should be drained every four to six months, and refilled with fresh tap water. The following is the recommended method for draining your spa.

## For spas with cabinet mounted drain:



1. Turn off the power at the breaker.
2. Remove all filters.
3. Pull the knob out about 2" until it snaps into place.

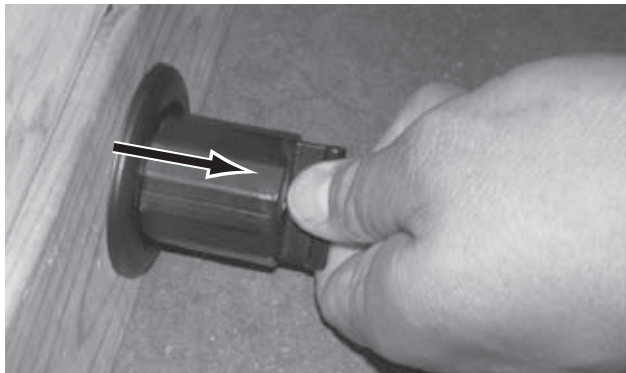

4. Unscrew the cap.

5. Hook up the female end of a garden hose to the drain fitting.

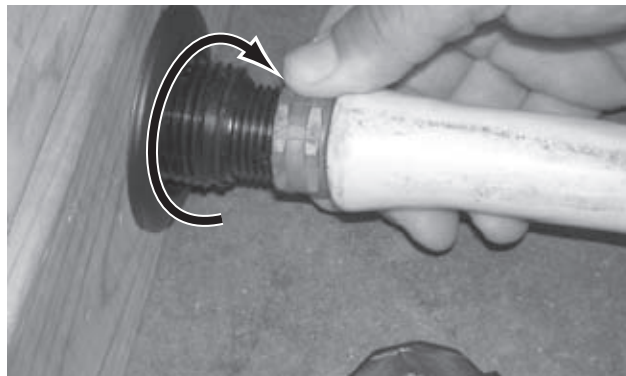
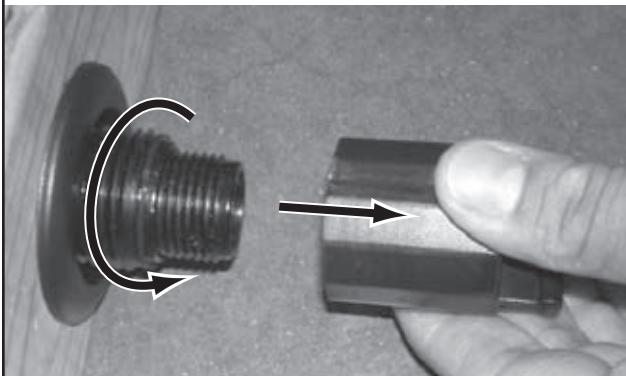

6. Place the other end of the garden hose where you would like the water to drain to.
7. Pull the hose outward about 1/2" to start water flow. Push inward to shut off water flow.

8. Let spa drain completely.
9. Push the hose inward about 1/2 inch, then remove the garden hose.
10. Replace the cap.
11. Push the knob in about 2" until it snaps back into place.

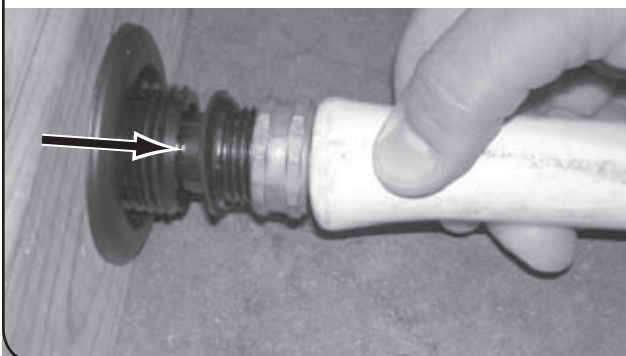

**For spas with drain inside the spa:**

1. Turn off the power at the breaker.
2. Remove all filters.
3. Using a Phillips screwdriver, remove the screws to the access panel and open it.

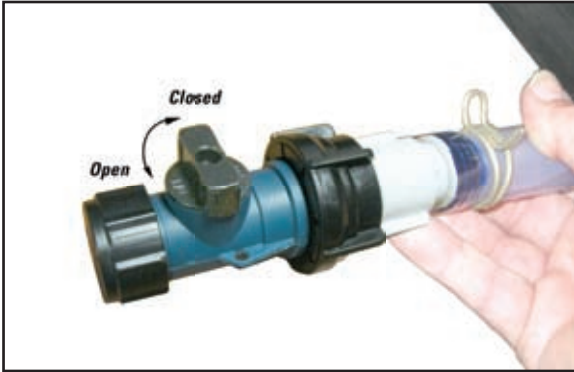

4. Locate hose ending with the  $\frac{3}{4}$  inch hose-bib fixture.
5. Unscrew the cap.
6. Hook up the female end of a garden hose to the drain fitting.
7. Place the other end of the garden hose where you would like the water to drain to.
8. Turn the valve on the hose-bib fixture to open the drain.
9. Let spa drain completely, then remove garden hose.
10. Turn the valve on the hose-bib fixture to close the drain.
11. Replace the cap.

**Winterizing (Cold Climate Draining)**

In many areas of the country, the temperature drops below 32°F (0°C). We recommend that you always have your spa full of water and running at normal spa temperatures (80°F to 100°F, 26.7°C to 37.8°C). This will help reduce the risk of freezing in your spa and your spa's equipment.

**Warning: If you find the need to drain your spa, be aware of the potential of freezing in your spas equipment and plumbing. Even if the directions below are followed perfectly, there is no guarantee that your spa will not suffer freeze damage.**

**Freeze damage is not covered by your warranty.**

1. Open all filter covers.
2. Remove the filter baskets and filters.
3. Drain your spa completely as described in the instructions above.
4. Vacuum water from the spa's main drain fitting with a wet/dry vacuum.
5. Remove drain plugs from the front of the pumps.
6. Disconnect the unions from both sides of the pump.
7. Blow any remaining water out of the jets and equipment area with the wet/dry vacuum.
8. Cover your spa with a good spa cover and an all-weather tarp to ensure that neither rain nor snow enters the spa.

NOTE: All manifolds are plumbed in series directly to the main drain (see example at right), making it easier to remove water and reducing the possibility of freeze damage.

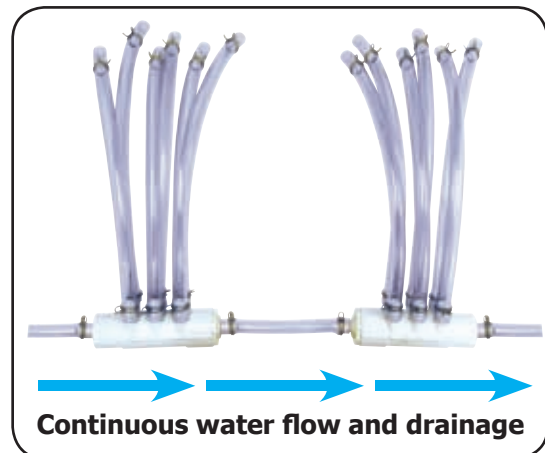

## Cleaning and Replacing the Filter

Filtration is one of the most important steps you can take to ensure clean, clear water. It is far less expensive to fix water clarity problems by filtering your spa than by using excessive amounts of chemicals, excessive filtration times, or by water replacement.

See the section "Water Clarity" for more information on cleaning your filter.

## Vacation Care

You can leave your spa unattended for up to two weeks if you follow these instructions.

**ALWAYS lock your cover using the cover locks if you plan to be away from home and the spa is filled with water.**

1. Set the spa to Sleep Mode. (See instructions on page 15 or page 18 for changing modes.)
2. Following the water quality instructions starting on page 32, adjust the pH.
3. Shock the water (add either chlorine or bromine sanitizer).
4. When you return, check and adjust the pH and shock the water.

If you will not be using your spa for longer than 14 days and a spa maintenance service is not available, we strongly recommend you drain or winterize your spa.

## Cleaning Your Spa

### Spa Cover and Pillows

Due to the constant punishment your spa cover and pillows receive, you should protect them by applying a vinyl and leather cleaner as part of your monthly maintenance plan. Use a product that is specifically designed to protect spa covers and pillows from chemical and ultraviolet light damage without leaving an oily residue behind that is normally associated with common automotive vinyl protectants.

**Warning: Do not** use automotive vinyl protectants on spa covers or pillows. These products are generally oil-based and will cause severe water clarity issues that are difficult to correct.

### Spa Shell

Each time you drain your spa, before you refill it you should clean your spa shell with an all-purpose cleaner and apply a coat of surface protectant.

Use a low detergent, non-abrasive cleaner specifically formulated to clean the spa without damaging its acrylic finish.

Use a non-oil based surface protectant that is specifically formulated to protect the spa's finish from the chemicals and minerals associated with normal spa use.

## Changing the UV Lamp



**CAUTION:** Always turn off power to the spa at the GFCI prior to any maintenance.

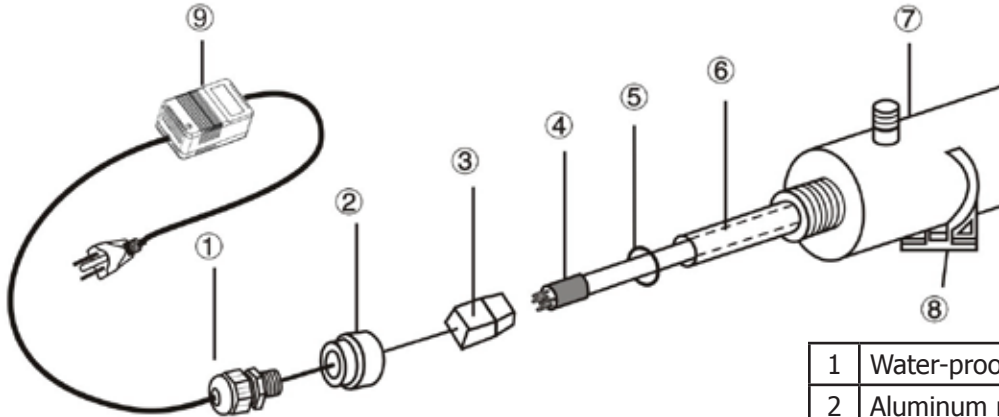

### To remove the UV lamp

1. Disconnect power.
2. Turn water off and open down stream of system to relieve pressure.
3. Remove the water-proof strainer (1) and unscrew the aluminum nut (2).
4. Pull out the lamp (4) approximately 2" from the chamber (7).
5. While holding the lamp end, remove the lamp socket (3) from the end now exposed.
6. Remove the lamp from the chamber.
7. Remove the O-ring (5) from the end of the quartz thimble (6).
8. Remove the quartz thimble.

1	Water-proof strainer
2	Aluminum nut
3	Lamp socket and lead wire
4	Germicidal UV lamp
5	Rubber O-ring
6	Quartz thimble
7	Chamber
8	Clip
9	Ballast

See page 53 for part numbers for replacement parts.

To reinstall the replacement UV lamp, follow these steps in reverse.

When replacement UV lamp has been installed, conduct a final leak check:

1. Restore power to the spa at the GFCI.
2. Turn on the pump and let water run for five minutes to check for leaks.

## Using the Entertainment System

Some spas may be equipped with audio/visual entertainment options. Several options are available and include marine grade CD players and an iPod docking station. Each spa equipped with an audio/visual system is delivered with the manufacturer's operating instructions in a clear plastic bag.

The instructions contained in this manual describe only basic functions. See the manufacturer's operating instructions for other features and functions. We strongly recommend that you read the manufacturer's instructions prior to operating this unit.

Observe the following precautions for your entertainment system:

- Make sure that hands and CDs are dry before coming in contact with this or any electronic option.
- Always close the protective door.
- Do not place wet CD's into this unit at any time.

Although the marine grade entertainment system is encased in a plastic housing with weather seals, the system is **water resistant** and **NOT waterproof**. You must take every precaution to keep this system dry!

**Water damage is not covered by Cal Spas or the manufacturer's warranty.**

### Operating the CD Player

The manufacturer's operating instructions are delivered with your spa. We strongly recommend that you read these instructions prior to operating this unit.

Press the POWER button on the unit or the remote control to turn the system on. The system automatically starts in the mode it was in when it was last shut off.

#### Listening to the Radio

1. Press the MODE button to switch to the radio mode.
2. Press the left and right arrows located at the far right of the panel to tune the radio to a station.

#### Inserting a Disk

For the Sony CDX-HS70MW system:

1. Press the OPEN button on the unit. The faceplate will gently lower and expose the disk drive.
2. Insert a disk in the disk drive.
3. Flip up the faceplate.

For the Sony CDX-GT10M system, simply insert a disk into the slot in the faceplate.

#### Playing a CD

1. Insert a disk in the disk drive as described above. The player will identify the type of disk and begin playing it.
2. Use either the remote control or the buttons on the faceplate to start and stop the player and to jump to selections.
3. To remove the disk, press the EJECT button.

## Remote Control

Some spas equipped with the optional marine grade stereo use the Sony RM-X201 remote control. It requires a direct line of sight in order to control the stereo. You need to be able to see the stereo in order for the remote to function. It WILL NOT function from inside the spa.

The remote control is NOT waterproof or water resistant. You must take every precaution to keep the remote control dry. DO NOT take the remote control

into the spa. Water will cause permanent damage and prevent it from functioning.

Water damage to the remote control or the marine grade stereo is not covered by Cal Spas or the manufacturer's warranty.

If you damage your remote control, you can order a new one from Cal Spas by calling 800-225-7727. Replacement part number is ELE09300064.

## iPod™ Docking Station

The iPod™ docking station is fully integrated with your Cal Spa. The docking station is tailored to the needs of Apple iPod™ owner, although it will play most other MP3 players. The docking station is specially configured to accommodate currently available iPods, using five interchangeable inserts in the docking bay.

The docking station comes with its own owner's manual. It describes parts included, installation, and proper use. Owners of this system must read the manufacturer's instructions prior to operating this unit. The instructions are shipped inside the docking station behind the remote control.

The instructions contained in this manual describe only basic functions. See the manufacturer's operating instructions for other features and functions. We strongly recommend that you read the manufacturer's instructions prior to operating this unit.

Observe the following precautions for your entertainment system:

- Make sure that hands are dry before coming in contact with this or any electronic option.
- Always close the protective door.

Although the marine grade entertainment system is encased in a plastic housing with weather seals, the system is **water resistant** and **NOT waterproof**. You must take every precaution to keep this system dry!

**Water damage is not covered by Cal Spas or the manufacturer's warranty.**

**Note: The system includes an MP3 docking station and remote control and does NOT INCLUDE an MP3 player such as an iPod.**



### Synchronizing the Remote Control with the Docking Station

Before you can use the remote control with the docking station, they need to be synchronized.

Note: Synchronizing instructions apply to both Aquatic AV model AQ-DM-4B and model AQ-DM-4UBT. Both the unit and the remote must be marked "Version 1.1" to be compatible. The docking station has a small label inside the unit and the remote is marked on its reverse side. If your docking bay or remote do not have these labels, contact Cal Spas customer support at 1-800-225-7727 for instructions on synchronizing your remote and docking station.

Before you begin, make sure the docking bay is OFF.  
If the red **Power** light inside the docking bay is on, press it once to turn it off.

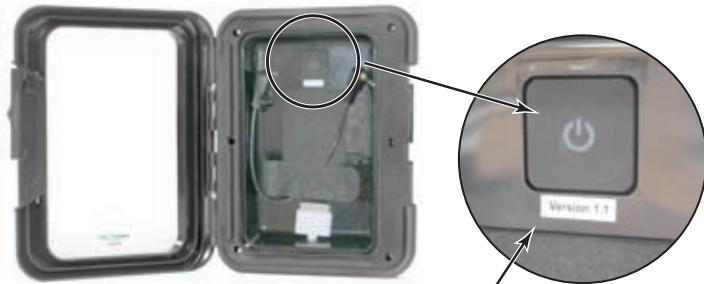

1 Press the red **Power** button on the remote.



2 Press and hold the **Mode** button on the remote. The display on the remote will read PAIR.

3 While still holding the **Mode** button, press the **Power** button inside the docking station.

If this is done correctly, the display on the remote will read WELCOME or show a mode position such as RADIO, IPOD, or AUX IN.

### Using the Docking Station Panel Controls

Model AQ-DM-4UBT has basic controls built into the front panel. They are briefly described below. For further information, see the manufacturer's manual.

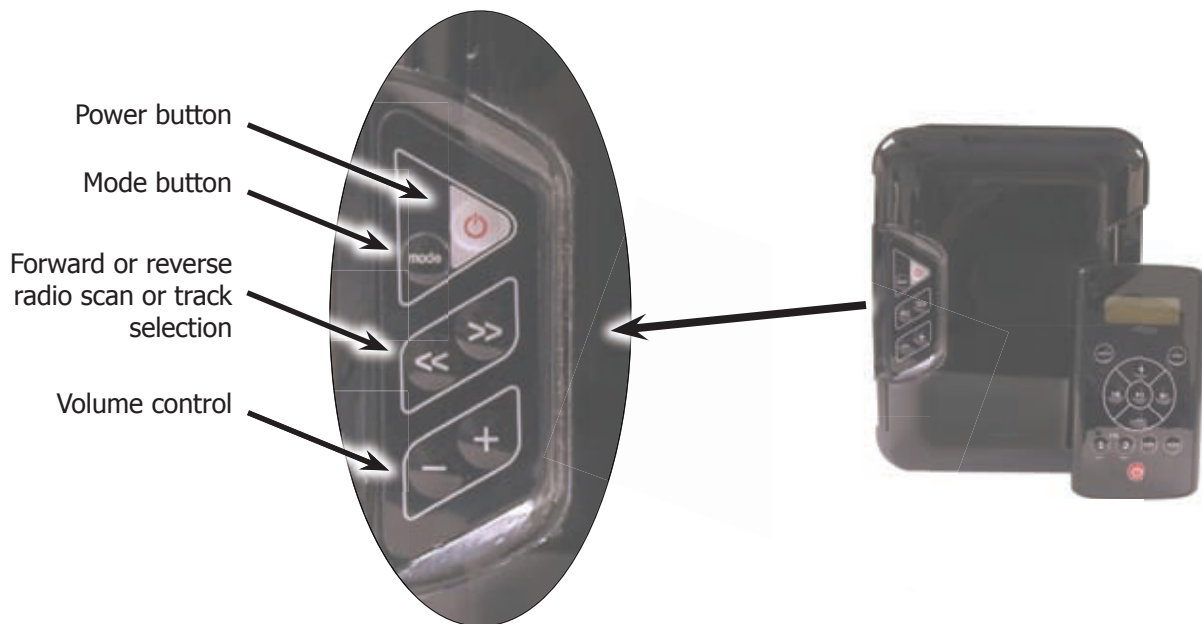

## Keeping Fit With Your Swim Spa

### Jetstream Propulsion System

Use the control panel to start and stop the Jetstream Propulsion System. The **Jets 2 & 3** button controls the top and bottom jets.



Use the air venturi valves to inject air in the water streams.



### Assembling the Swim Tether

The swim tether pole has three pieces and assembles easily. Slide the ends of the top and middle sections into the middle and bottom sections as shown at right.

Insert the tether in the anchor hole when you are ready to use it.

Buckle the strap around your waist. It is easily adjustable and can accommodate most sizes.



## Using the Exercise Equipment

**IMPORTANT:** Always consult your physician before starting any exercise activity or program. The Ultimate Fitness series spas feature rubber exercise bands. When stretched, these bands create a high tension condition. Improper use or failure to connect the exercise bands properly may cause injury. Always inspect all of the exercise equipment prior to beginning any exercise. Do not use any damaged equipment.

This equipment attaches to the exercise anchors located on the spa walls.

## Connecting the Exercise Equipment

The drawings below show different ways the exercise kit can be connected depending on the exercises you wish to do.

### For 7 foot and 8 foot spas:

The exercise kit for 7 and 8 foot spas contains:

- Two hand grips
- Two 6" elastic bands
- One 18" elastic band

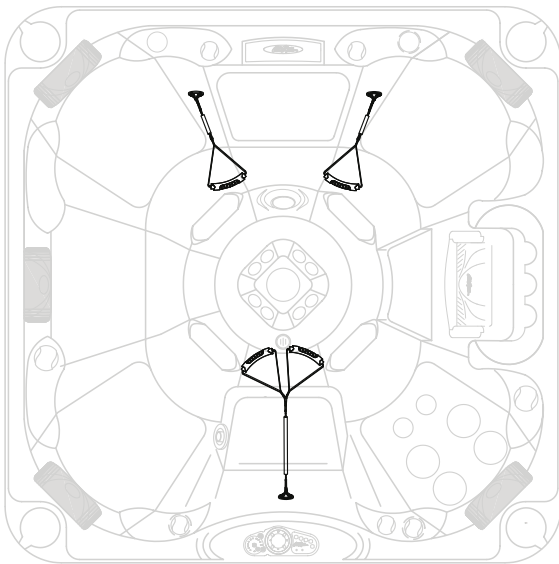

### For 11 foot spas:

The exercise kit for 11 foot spas contains:

- Two hand grips
- Two 6" elastic bands
- One 56" elastic band

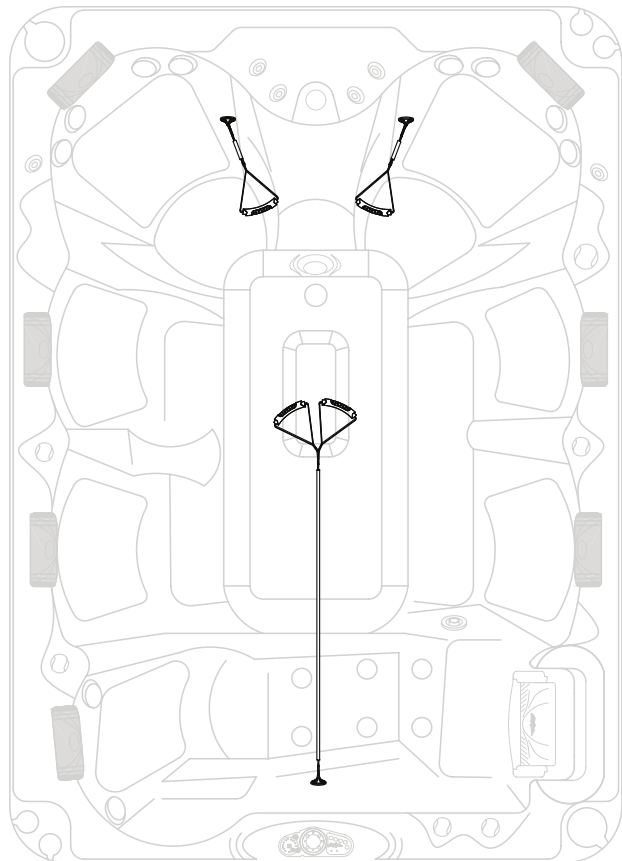

**For 12 and 14 foot spas:**

The exercise kit for 12 and 14 foot spas contains:

- Two hand grips
- Two ankle braces
- Two 6" elastic bands
- Two 18" elastic bands
- Two 25" elastic bands
- Two rowing bars

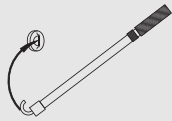

When attaching the rowing bar, place the hook into the eye pad as shown.

**For 16 and 17 foot spas:**

The exercise kit for 16 and 17 foot spas contains:

- Two hand grips
- Two ankle braces
- Two 18" elastic bands
- Two 25" elastic bands
- Two 56" elastic bands
- Two rowing bars

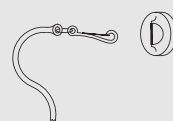

Elastic bands attach to the eye pad as shown.

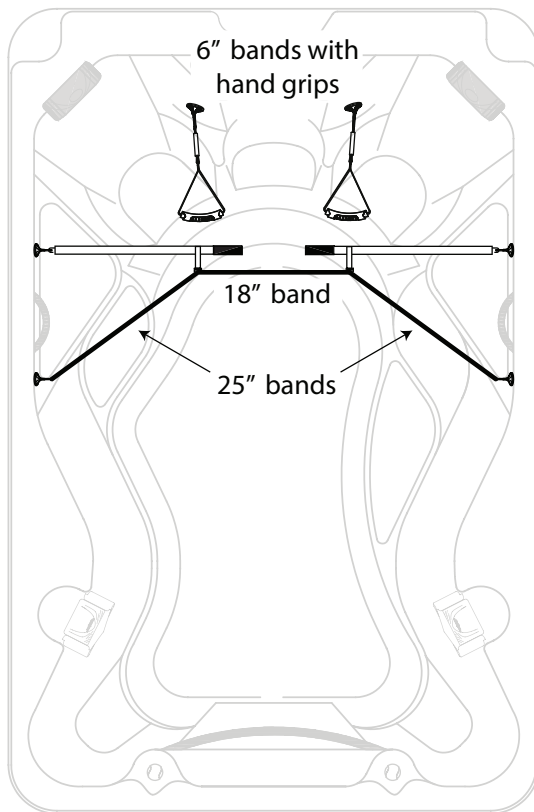

All elastic bands can be connected to the end of the spa and used with either hand grips or ankle braces.

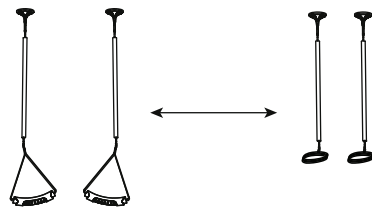
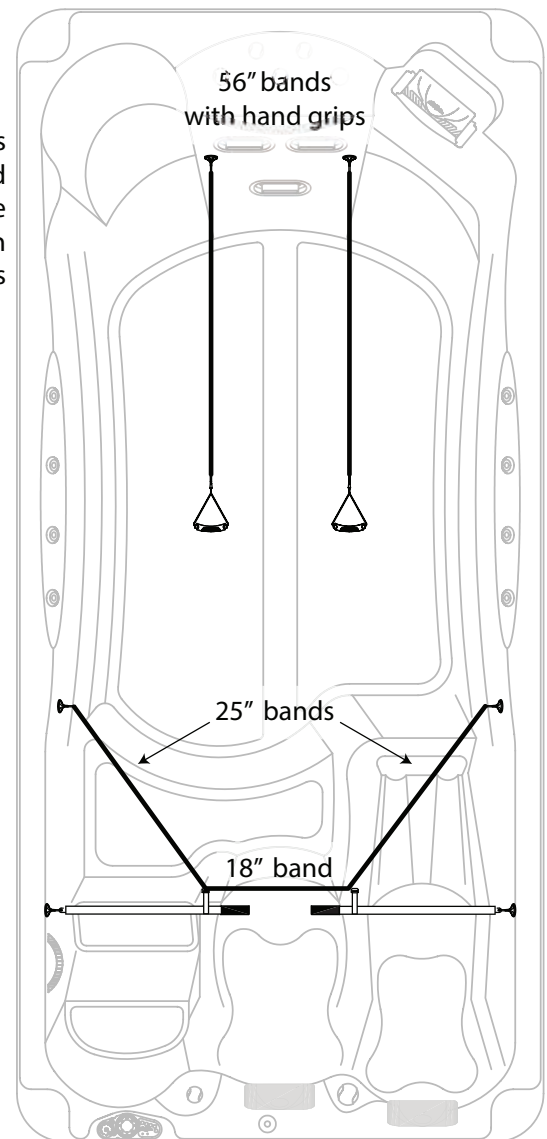

All elastic bands can also be used with either hand grips or ankle braces.

# Appendix

## Replacement Parts

Please visit [www.quickspaparts.com](http://www.quickspaparts.com) to order your replacement parts.

Jets
<p><b>Note:</b> Beginning with 2013, all spa models use screw-in jet inserts where removable jets are used. (The River Jet and Old Faithful jets do not have removable jet inserts.) Spas built before 2013 use snap-in jet inserts.</p>
<p><b>ELE 2" Euro No Eyeball</b> PLUCS2295028S</p> 
<p><b>ED 2" Euro Directional</b> PLUCS2295058S</p> 
<p><b>NJD 2" Directional Neck Jet 100% Shut Off</b> PLUCS2255048S</p> 
<p><b>MED 3" Micro XL Directional</b> PLUCS2125038S</p> 
<p><b>mfd 3" Micro Flow Directional</b> PLUCS2295068S</p> 

Jets
<p><b>MFD 3.5" Maxi Flow Directional</b> PLUCS2295098S</p> 
<p><b>MFS 3.5" Maxi Flow Swirl</b> PLUCS2295108S</p> 
<p><b>PSD 5" Power Storm</b> PLUCS2295138S</p> 
<p><b>PSR 5" Power Storm Riffled</b> PLUCS2295148S</p> 

Please visit [www.quickspaparts.com](http://www.quickspaparts.com) to order your replacement parts.

### Jets

#### PST 5" Power Storm Wagon Wheel

PLUCS2295198S

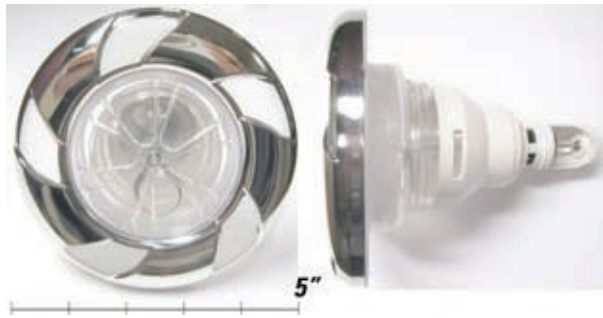

#### T 5" Tornado Adjustable

PLUCS2295208S

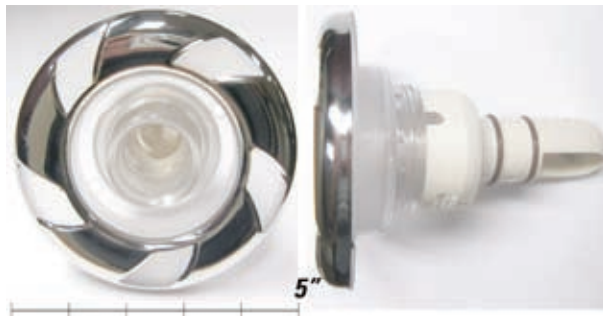

#### River Jet Assembly Black 210-5101CS

PLU21703466



#### Old Faithful Jet Black

PLU21703739



### Pillows

#### Cascade Pillow No Insert Black

ACC01401031

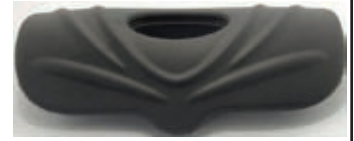

#### Infinity Pillow Ribbed Black

ACC01401051



#### Infinity Pillow Plain Black

ACC01401061



### Water Diverter Valves

#### Diverter Valve 2" with Swoosh Logo Black (CS6003038-1)

PLU21300461



#### Diverter Valve 1" with Swoosh logo Black (CS6004231)

PLU21300451



#### Diverter Valve 1 1/2" On/Off ASSY (600-4601)

PLU21100045



### Air Control Valve

#### Air Control with Swoosh Logo Black CS6603508-1

PLU21300501





Please visit [www.quickspaparts.com](http://www.quickspaparts.com) to order your replacement parts.

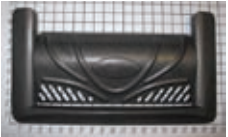

Waterfalls	
<b>Cascade Black Waterfall With Valve CS6759508L</b> PLU21800825	
<b>Cascade Black Waterfall With Valve No Logo CS6759508L</b> PLU21800825	
<b>Hydro Stream Waterfall</b> PLU21800623	

Drains	
<b>Drain Super Hi Flo Suction 2 1/2" Black (640-3581LGV)</b> PLU21400146	
<b>Low Profile Drain 3/4" Black (640-0511)</b> PLU21400401	
<b>Bottom Drain Filtration Return Assembly</b> PLU21400215	

Weir Skimmers	
<b>Weir Skimmer Gate Small Black</b> PLU21600284	
<b>Weir Skimmer Gate Large Black</b> PLU21600294	

Filters		
All filters are anti-bacterial threaded cartridges.		
<b>25 Sq Ft</b> FIL11100303 	<b>50 Sq Ft</b> FIL11100202 	<b>75 Sq Ft</b> FIL11100212 

Pure Cure™ UV Water Sanitizer	
<b>Pure Cure complete system</b> LIT16000380	
<b>Germicidal UV lamp (T515)</b> LIT16000381	
<b>Rubber O-ring (D24.5)</b> LIT16000384	
<b>Quartz thimble (24.5X350)</b> LIT16000383	
<b>Ballast (UV-3)</b> LIT16000382	
<b>Clips</b> LIT16000385	

Lights	
<b>Light Assembly Complete</b> LIT16000150	
<b>Light Mini 2" Diameter</b> LIT16000151	

LED Lights	
<b>Small Controller Daisy Chain</b> LIT16100218	
<b>Large Controller</b> LIT16100241	
<b>Quad LED Daisy Chain Assembly</b> LIT16100211	
<b>Dual LED Daisy Chain Assembly</b> LIT16100212	
<b>7 LED 2" Light Daisy Chain with Stand-Off</b> LIT16100214	
<b>LED Light, 12 LED</b> LIT16100206	

Please visit [www.quickspaparts.com](http://www.quickspaparts.com) to order your replacement parts.

Exercise Equipment	
<b>Exercise Kit for 7 Foot and 8 Foot Spas</b> EXC10000003	
<b>Exercise Kit for 9 Foot Spas</b> EXC10000004	
<b>Exercise Kit for Fitness Spas (F1239 &amp; F1439)</b> EXC10000002	
<b>Exercise Kit for Fitness Spas (F1418, F1640, F1770)</b> EXC10000001	
<b>Exercise Kit Attachment Plate</b> EXC11000065	

Replacement Cabinet Panels
The complete selection of replacement cabinets for all models is very extensive and too lengthy for this owner's manual. See your Cal Spas deal to order replacement panels for your spa, call 1-800-CAL-SPAS, or visit <a href="http://www.quickspaparts.com">www.quickspaparts.com</a>



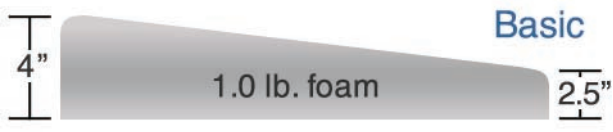

The basic spa cover is designed with a tapered height, angling downward from four inches in the center to two-and-a-half inches on the sides to drive off rain and prevent water from pooling. Filled with 1 lb. foam.

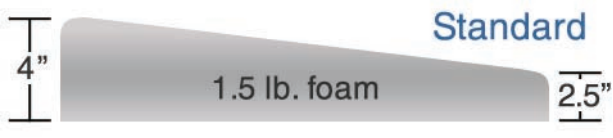

The standard spa cover is designed with a tapered height, angling downward from four inches in the center to two-and-a-half inches on the sides to drive off rain and prevent water from pooling. Filled with 1.5 lb. foam.

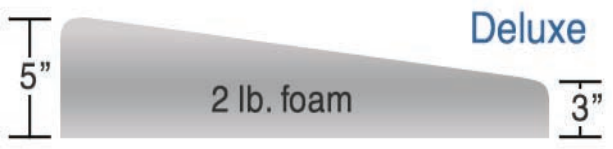

The deluxe spa cover is designed with a tapered height, angling downward from five inches in the center to three inches on the sides to drive off rain and prevent water from pooling. Filled with 2 lb. foam.

Covers			
Size	Fits spa models	Taper and type	Part numbers
54" x 78"	Z522L	4" to 2½" Basic	Gray: COV5478BAS42G1.0 Rust: COV5478BAS42R1.0 Slate: COV5478BAS42S1.0
64" x 84"	Z536L	4" to 2½" Basic	Gray: COV6484BAS42G1.0 Rust: COV6484BAS42R1.0 Slate: COV6484BAS42S1.0
72" x 72" triangle	A621T, Z628T	4" to 2½" Basic	Gray: COV7272TRBAS42G1.0 Rust: COV7272TRBAS42R1.0 Slate: COV7272TRBAS42S1.0 Palomino: COV7272TRBAS42P1.0
		5" to 3" Standard	Gray: COV7272TRSTD53G1.5 Rust: COV7272TRSTD53R1.5 Slate: COV7272TRSTD53S1.5 Palomino: COV7272TRSTD53P1.5
76" x 84"	Z630B	4" to 2½" Basic	Gray: COV7684BAS42G1.0 Rust: COV7684BAS42R1.0 Slate: COV7684BAS42S1.0
78" x 84"	Z630L	4" to 2½" Basic	Gray: COV7884BAS42G1.0 Rust: COV7884BAS42R1.0 Slate: COV7884BAS42S1.0
78" round	A511R	4" to 2½" Basic	Gray: COV78RDBAS42G1.0 Rust: COV78RDBAS42R1.0 Slate: COV78RDBAS42S1.0

Please visit [www.quickspaparts.com](http://www.quickspaparts.com)  
to order your replacement parts.

Covers			
Size	Fits spa models	Taper and type	Part numbers
84" x 84"	Aqua: 730B, A730L, A750L, A750B	4" to 2½" Basic	Gray: COV8484BAS42G1.0 Rust: COV8484BAS42R1.0 Slate: COV8484BAS42S1.0
	Classic: C736L, C736B	5" to 3" Standard	Gray: COV8484STD53G1.5 Rust: COV8484STD53R1.5 Slate: COV8484STD53S1.5
	Diamond: DI760B, DI760L, DI780B, DI780L		Gray: COV8484DLX53G2.0 Rust: COV8484DLX53R2.0 Slate: COV8484DLX53S2.0
84" x 84" octave (see note below)	Escape: ES734B, ES734L, ES750B, ES750L	5" to 3" Deluxe	
	Aqua: 730B, A730L, A750L, A750B	4" to 2½" Basic	Gray: COV8484BAS42G1.0-OCT Rust: COV8484BAS42R1.0-OCT Slate: COV8484BAS42S1.0-OCT
84" x 84" octave (see note below)	Classic: C736L, C736B	5" to 3" Standard	Gray: COV8484STD53G1.5-OCT Rust: COV8484STD53R1.5-OCT Slate: COV8484STD53S1.5-OCT
	Diamond: DI736B, DI736L, DI760B, DI760L, DI780B, DI780L		
84" x 84" octave (see note below)	Escape: ES734B, ES734L, ES750B, ES750L		
	R890B, R890L	4" to 2½" Basic	Gray: COV9090BAS42G1.0 Rust: COV9090BAS42R1.0 Slate: COV9090BAS42S1.0
90" x 90"			
91" x 91"	X750B, X750L, X770B, X770L		Gray: COV8484BAS42G1.0 Rust: COV8484BAS42R1.0 Slate: COV8484BAS42S1.0
93" X 93"	Aqua: A830L, A830B, A850L, A850B	4" to 2½" Basic	Gray: COV9393BAS42G1.0 Rust: COV9393BAS42R1.0 Slate: COV9393BAS42S1.0
	Classic: C836L, C836B	5" to 3" Standard	Gray: COV9393STD53G1.5 Rust: COV9393STD53R1.5 Slate: COV9393STD53S1.5
	Escape: ES850B, ES850L, ES861B, ES861L, ES864B, ES864L		Palomino: COV9393STD53P1.5
93" X 93"	Diamond: DI860B, DI860L, DI880B, DI880L	5" to 3" Deluxe	Gray: COV9393DLX53G2.0
	Resort: R862		
	93" x 93" octave (see note below)	Aqua: A830L, A830B, A850L, A850B	4" to 2½" Basic
93" x 93" octave (see note below)	Classic: C836L, C836B		
	Escape: ES850B, ES850L, ES861B, ES861L, ES864B, ES864L, ES870B, ES870L		
	Diamond: DI860B, DI860L, DI880B, DI880L		
93" x 93" octave (see note below)	Resort: R862		

Please visit [www.quickspaparts.com](http://www.quickspaparts.com) to order your replacement parts.

Covers			
Size	Fits spa models	Taper and type	Part numbers
93" x 130"	DI970N, DI970A, ES938L	5" to 3" Standard	Gray: COV93130STD53G1.5 Rust: COV93130STD53R1.5 Slate: COV93130STD53S1.5
93" x 132"	ES947E	5" to 3" Standard	Gray: COV93132STD53G1.5 Rust: COV93132STD53R1.5 Slate: COV93132STD53S1.5
93" x 141"	F1239	5" to 3" Standard	Gray: COV93141STD53G1.5 Rust: COV93141STD53R1.5 Slate: COV93141STD53S1.5
93" x 167"	F1418	5" to 3" Standard	Gray: COV93167STD53G1.5 Rust: COV93167STD53R1.5 Slate: COV93167STD53S1.5
93" x 171"	F1439	5" to 3" Standard	Gray: COV93171STD53G1.5 Rust: COV93171STD53R1.5 Slate: COV93171STD53S1.5
93" x 200'	F1640, F1770	5" to 3" Standard	Gray: COV93200STD53G1.5 Rust: COV93200STD53R1.5 Slate: COV93200STD53S1.5

**Covers for the Octave Sound System**

Note: Spa covers for the Octave Sound System are designed to accommodate the shape of the corner speaker system. Regular spa covers will not fit on spas with the Octave Sound System.



## Basic Troubleshooting

Symptom	Possible Solutions
<b>Problems starting up</b>	
Pump won't prime	See priming instructions on page 12.
Breaker keeps shutting off	Reset the GFCI breaker. If this continues, contact your dealer or a qualified spa technician.
<b>Power and system problems</b>	
System won't start up or breaker keeps shutting off	Power may be shut off. Turn on GFCI circuit breaker. If this continues, contact your dealer or a qualified spa technician.
Control panel doesn't responde	Turn on or reset the GFCI circuit breaker. If this does not solve the problem, contact your dealer or a qualified spa technician.  If you hear the pump running but the control panel doesn't respond, contact your dealer
Spa does not turn off	Spa may be trying to heat up. Check if the spa setting is in Standard mode.  In cold climates, if spa is not equipped with full foam or any kind of insulation, it will try to maintain the set temperature. Set the spa to Economy Mode and set the temperature to 80°F.  Spa may be in filter cycle. If it is, this is normal and no adjustment is necessary.
Message on the control panel	There may be a problem. See Diagnostic Messages on page 20.
<b>Heat problems</b>	
Spa water does not get hot	Spa may be in Economy Mode. Set the spa to Standard Mode.  The filter may be dirty or may need to be replaced. Clean or replace the filter.  The water level may be too low. Fill the spa with water level at 4 to 6 inches from the top.  The temperature is not turned up high enough. Raise temperature on topside control.  Cover the spa. The cover will keep heat in the spa and help keep heat from escaping. Make sure cover is on at all times when spa is not in use.  The heater element may be old, deteriorated, coated with scale, or defective. Contact your dealer for more assistance.  The gate valves may be partially or completely closed. NEVER OPERATE YOUR SPA WITH THE GATE VALVES CLOSED!
Spa overheats - temperature greater than 110°F / 43°C	Overheating can occur during summer months and may not necessarily indicate a malfunction. When it occurs, a message code may also appear on the control panel. Depending on the problem, the message code may be OH, OHS, HH, or OHH.  Temperature may be set too high. Turn the set temperature down to a lower temperature.  Filtration time may be too long. Turn the filtration cycles down during the warm months.  The spa may not be properly ventilated. Make sure the front of the spa is not blocked to allow air flow.  High speed pumps may have been running too long. Limit pump running time to no more than 15 to 30 minutes.

Symptom	Possible Solutions
---------	--------------------

**Water pressure problems**

Low water pressure	<p>Jet valves may be partially or fully closed. Open the jet valves.</p> <p>Filter cartridge may be dirty. Clean or replace the filter.</p> <p>Pump may have airlock. Remove airlock by priming spa (page 12)</p> <p>The suction fittings may be blocked. Remove any debris that may be blocking them.</p> <p>The filter skimmer may be blocked. Remove the blockage.</p> <p>Gate valves may be closed. Open gate valves. Note: Never operate your spa with the gate valves closed!</p> <p>Spa may be running in filtration mode. Press JETS or JETS 1 button to turn on high speed pump.</p>
No water pressure (no water stream from any jets)	<p>Power may be switched off. Turn the power back on.</p> <p>The pump may be defective. After you have tried all other troubleshooting, contact your dealer for assistance.</p>
Jets surge on and off	Water level may be too low. Add water to normal level.

**Pump problems**

Pump runs constantly – will not shut off	There may be a problem with circuit board. Contact your dealer.
Noisy pump	<p>The water level may be too low. Fill the spa with water level at 4 to 6 inches from the top.</p> <p>Filter cartridge may be dirty. Clean or replace the filter.</p> <p>Pump may have airlock. Remove airlock by priming spa (page 12)</p> <p>The suction fittings may be blocked. Remove any debris that may be blocking the suction fittings.</p> <p>Gate valves may be closed. Open gate valves. Note: Never operate your spa with the gate valves closed!</p> <p>Air may be leaking into the suction line. Contact your dealer for assistance.</p> <p>Debris may be inside the pump. Contact your dealer for assistance.</p> <p>Noise may be a sign of damage. Contact your dealer for service.</p>
Pump turns off during operation	<p>Automatic timer may have completed its cycle. Press JETS or JETS 1 button to start the cycle again.</p> <p>Pump may have overheated due to the vents on the equipment door being blocked. Make sure the front of the spa is not blocked to allow air flow.</p> <p>The pump motor may be defective. Contact your dealer for assistance.</p>
Pump has a burning smell while running	A burning smell may be a sign of damage. Contact your dealer for service.
Pump does not run	<p>Pump may have over heated. Let it cool for an hour and try operating the spa for a shorter time.</p> <p>Power to the spa may be shut off. Turn on or reset the GFCI circuit breaker. If this does not solve the problem, contact your dealer or a qualified spa technician.</p>

# LIMITED WARRANTY

This Limited Warranty is extended to the original purchaser of a Cal Spa brand portable spa manufactured after January 1, 2013 and installed for residential use in the United States of America and Canada. This warranty begins on the date of delivery of the spa, but in no event later than one year from the date of manufacture.

This warranty applies only to these eight spa lines: 

	<b>Aqua, Resort, Xtream, Zone</b>	<b>Connect</b>	<b>Escape, Diamond, Fitness</b>
<b>Shell Structural</b> Warranted against water loss due to defects in the spa shell.	5 years	7 years	10 years
<b>Shell Finish</b> Warranted against blistering, cracking, or delaminating of the interior surface of the spa shell.	2 years	5 years	7 years
<b>Pure Heat™ Heater</b> Warranted to be free from defects in materials and workmanship. (Optional feature for Connect)	N/A	7 years	7 years
<b>Equipment and Controls</b> Electrical equipment components – specifically limited to the pumps and control system – are warranted against malfunctions due to defects in workmanship or materials.	2 years	3 years	5 years
<b>Plumbing</b> Warranted against leaks due to defects in workmanship or materials.	2 years	3 years	5 years
<b>Cabinet - synthetic, fiberglass, or wicker</b> Warranted against defects in workmanship or materials. Normal wear and weathering of the finish will occur naturally over time and are not defects.	1 year	1 year	5 years
<b>Hercules™ Cabinets and panels</b> Lifetime guarantee against defects in workmanship or materials. Normal wear and weathering of the finish will occur naturally over time and are not defects. Applies to Xtream series only.	Lifetime guarantee	N/A	N/A

## Warranties for Other Components

The fuses, headrests, cabinet finish, and filters are warranted to be free of defects in workmanship and material at the time of delivery. The factory installed Pure Cure water purification system is warranted against malfunction due to defects in workmanship or material for one year from the original date of delivery except the UV bulb and quartz tube. The UV bulb and quartz tube are warranted for ninety (90) days from the original date of the spa delivery. All stereo-related components (receiver, speakers, sub-woofer, stereo media locker, power supply, wireless remote control etc.) are warranted against malfunction due to defects in workmanship or material for one year from the original date of delivery. All other factory-installed components not mentioned specifically, including, but not limited to the wood frame, jets, diverter valves, LED lighting systems, filter lids, and mechanical

components, are warranted against malfunction due to defects in workmanship and material for two years from the original date of delivery.

## Genuine Cal Spas Parts & Accessories

This Limited Warranty is void if Cal Spas (the "Manufacturer") or its designated representative determines that the spa has been subjected to damage or failure due to installation of aftermarket parts that are not genuine Cal Spas branded parts and accessories. This disclaimer includes, but is not limited to filters, UV bulbs, ozone systems, salt systems, repair parts and other accessories. Genuine Cal Spas brand parts and accessories are built to our highest standards of quality, durability and performance, and they are designed to work with your Spa to ensure optimal performance and function.

## Performance

This warranty begins on the date of delivery of the spa, but in no event later than one year from the date of manufacture. To obtain service in the event of a defect covered by this Limited Warranty, notify your Cal Spa dealer or Cal Spas (the "Manufacturer") as soon as possible and use all reasonable means to protect the spa from further damage. Upon proof of purchase, a designated service representative will correct the defect subject to the terms and conditions contained in this Limited Warranty. There will be no charge for parts or labor to repair the defect, although providing access to affect the repair is your responsibility as the spa owner. Freight charges for replacement parts is the responsibility of the spa owner. You may be assessed reasonable repairman travel mileage charges. In the event that the spa is removed to a repair facility for repair and reinstalled, the cost of removal and reinstallation will be your responsibility as the spa owner. If the Manufacturer determines that repair of the covered defect is not feasible, it reserves the right to provide a replacement spa instead, equal in value to the purchase price of the original spa. In such an event, reasonable costs for removal of the original spa, shipping costs from the factory for the replacement spa and delivery and installation of the replacement will be your responsibility as the spa owner. The replacement spa will carry the balance of the original spa's warranty. Spa covers are not included. This warranty ends either by specified time frame, owner-transfer, relocation, or installation of any component other than by manufacturer.

## Warranty Limitations

This Limited Warranty is void if: Cal Spas (the "Manufacturer") or its designated representative determines that the spa has been subjected to alteration, neglect, misuse or abuse, or freight damage caused by the common carrier; any repairs have been attempted by anyone other than a designated representative; or if the failure is caused by accident, acts of God or other causes beyond the control of the Manufacturer. Neglect, misuse and abuse include any installation, operation or maintenance of the spa other than in accordance with the instructions contained in the owner's manual provided with the spa, including but not limited to the failure to maintain proper water chemistry and chemical balance and the use of abrasive or improper cleaners or non-genuine parts and accessories. This Limited Warranty does not provide coverage for the insulating cover, any item attached to or installed on the spa after the date of manufacture, or for gaining access to any component for repair or replacement. Spa units in commercial use

are excluded from any coverage whatsoever. The spa owner accepts liability for repair work performed by anyone other than the Manufacturer or a designated Cal Spa representative.

## Limitations

The Manufacturer disclaims all warranties, expressed or implied, in fact or in law, to the extent allowed by your State's Law, including the warranty of merchantability and fitness for use, except as stated specifically herein. All warranty service must be performed by the Manufacturer or its designated representative using authorized Cal Spa parts. No agent, dealer, distributor, service company or other party is authorized to change, modify or extend the terms of this limited warranty in any manner whatsoever. The Manufacturer will not be responsible for any statements or representations made in any form that go beyond, are broader than, or are inconsistent with any authorized literature or specifications furnished by Cal Spas.

## Disclaimers

The Manufacturer and its representatives shall not be liable for any injury, loss, cost or other damage, whether incidental or consequential, arising out of any defect covered by this limited warranty, including without limitation, loss of use of the spa and cost for removal of defective product even if the Manufacturer was advised of the possibility of damage. The liability of the Manufacturer under this limited warranty, if any, shall not exceed the original amount paid for the defective product. Coverage under this limited warranty shall commence as of the original date of delivery and the duration of such coverage shall not extend for any reason whatsoever beyond the stated time periods. These disclaimers shall be equally applicable to any service provided by the Manufacturer and its designated representatives.

## Legal Rights

This Limited Warranty gives you specific legal rights. You may also have other rights that vary from state to state. Some states do not allow limitations on how long an implied warranty lasts, so this limitation may not apply to you.

# Warranty Registration

## Easy Online Registration

Registering your new Cal Spas product is quick and easy! It is important that you register your Cal Spas product as soon as possible. By taking just a few quick minutes to register, you can enjoy product alerts, more efficient support, and quicker service.

Register now -- it's fast and it's easy!

- 1) Go to [www.calspas.com/warranty](http://www.calspas.com/warranty)
- 2) Fill in your information and click "Send Warranty Info"

### Locating the product serial number

The serial number of your spa is located on a metal plate attached to the inside of the door for the equipment area. You will need this number to properly register your spa and activate coverage. Write this information in the space provided below.

Spa Model: \_\_\_\_\_

Spa Serial Number: \_\_\_\_\_

Date Purchased: \_\_\_\_\_

Date Installed: \_\_\_\_\_

Dealer's Phone Number: \_\_\_\_\_

Dealer's Address: \_\_\_\_\_



Please visit [www.quickspaparts.com](http://www.quickspaparts.com)  
to order your replacement parts.