

# JVC

ENGLISH

## DIGITAL VIDEO CAMERA

# GR-DV900

# GR-DV800

# GR-DV500

Please visit our Homepage on the World Wide Web for Digital Video Camera:

<http://www.jvc-victor.co.jp/english/cyber/>

For Accessories:

<http://www.jvc-victor.co.jp/english/accessory/>

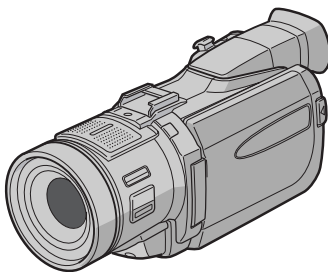

Mini DV NTSC

DSC  
DIGITAL  
STILL CAMERA

The camcorder illustrations appearing in this instruction manual are of the GR-DV900.

## INSTRUCTIONS

### For Customer Use:

Enter below the Model No. and Serial No. which is located on the bottom of the camcorder. Retain this information for future reference.

Model No. \_\_\_\_\_

Serial No. \_\_\_\_\_

<i>AUTOMATIC DEMONSTRATION</i>	9
<i>GETTING STARTED</i>	10
<i>VIDEO RECORDING &amp; PLAYBACK</i>	17
<i>DIGITAL STILL CAMERA (D.S.C.) RECORDING &amp; PLAYBACK</i>	23
<i>ADVANCED FEATURES</i>	31
<i>REFERENCES</i>	68
<i>TERMS</i>	86

**Dear Customer,**

Thank you for purchasing this digital video camera. Before use, please read the safety information and precautions contained in the following pages to ensure safe use of this product.

**Using This Instruction Manual**

- All major sections are listed in the Table Of Contents on the cover page.
- Notes appear after most subsections. Be sure to read these as well.
- Basic and advanced features/operation are separated for easier reference.

**It is recommended that you...**

- ... refer to the Index (☞ pg. 80 – 85) and familiarize yourself with button locations, etc. before use.
- ... read thoroughly the Safety Precautions and Safety Instructions that follow. They contain extremely important information regarding the safe use of this product.

You are recommended to carefully read the cautions on pages 74 through 76 before use.

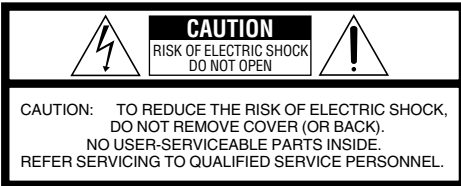
**SAFETY PRECAUTIONS**

The lightning flash with arrowhead symbol, within an equilateral triangle, is intended to alert the user to the presence of uninsulated "dangerous voltage" within the product's enclosure that may be of sufficient magnitude to constitute a risk of electric shock to persons.



The exclamation point within an equilateral triangle is intended to alert the user to the presence of important operating and maintenance (servicing) instructions in the literature accompanying the appliance.

**WARNING:**  
**TO PREVENT FIRE OR SHOCK HAZARD, DO NOT EXPOSE THIS UNIT TO RAIN OR MOISTURE.**

**NOTES:**

- *The rating plate (serial number plate) and safety caution are on the bottom and/or the back of the main unit.*
- *The rating information and safety caution of the AC Adapter are on its upper and lower sides.*

**CAUTIONS:**

- This camcorder is designed to be used with NTSC-type color television signals. It cannot be used for playback with a television of a different standard. However, live recording and LCD monitor/viewfinder playback are possible anywhere.
- Use the JVC BN-V408U/V416U/V428U battery packs and, to recharge them or to supply power to the camcorder from an AC outlet, use the provided multi-voltage AC Adapter. (An appropriate conversion adapter may be necessary to accommodate different designs of AC outlets in different countries.)

When the equipment is installed in a cabinet or on a shelf, make sure that it has sufficient space on all sides to allow for ventilation (10 cm (3-15/16") or more on both sides, on top and at the rear).

Do not block the ventilation holes.

(If the ventilation holes are blocked by a newspaper, or cloth etc. the heat may not be able to get out.)

No naked flame sources, such as lighted candles, should be placed on the apparatus.

When discarding batteries, environmental problems must be considered and the local rules or laws governing the disposal of these batteries must be followed strictly.

The apparatus shall not be exposed to dripping or splashing.

Do not use this equipment in a bathroom or places with water.

Also do not place any containers filled with water or liquids (such as cosmetics or medicines, flower vases, potted plants, cups etc.) on top of this unit.

(If water or liquid is allowed to enter this equipment, fire or electric shock may be caused.)

This product has a fluorescent lamp that contains a small amount of mercury. Disposal of these materials may be regulated in your community due to environmental considerations.

For disposal or recycling information please contact your local authorities, or the Electronics Industries Alliance:

<<http://www.eiae.org>>

## IMPORTANT SAFTY INSTRUCTIONS

- 1) Read these instructions.
- 2) Keep these instructions.
- 3) Heed all warnings.
- 4) Follow all instructions.
- 5) Do not use this apparatus near water.
- 6) Clean only with dry cloth.
- 7) Do not block any ventilation openings. Install in accordance with the manufacturer's instructions.
- 8) Do not install near any heat sources such as radiators, heat registers, stoves, or other apparatus (including amplifiers) that produce heat.
- 9) Only use attachments/accessories specified by the manufacturer.
- 10) Use only with the cart, stand, tripod, bracket, or table specified by the manufacturer, or sold with the apparatus. When a cart is used, use caution when moving the cart/apparatus combination to avoid injury from tip-over.
- 11) Unplug this apparatus during lightning storms or when unused for long periods of time.
- 12) Refer all servicing to qualified service personnel. Servicing is required when the apparatus has been damaged in any way, such as power-supply cord or plug is damaged, liquid has been spilled or objects have fallen into the apparatus, the apparatus has been exposed to rain or moisture, does not operate normally, or has been dropped.



## SAFETY PRECAUTIONS

Do not point the lens or the viewfinder directly into the sun. This can cause eye injuries, as well as lead to the malfunctioning of internal circuitry. There is also a risk of fire or electric shock.

### CAUTION!

The following notes concern possible physical damage to the camcorder and to the user.

When carrying, be sure to always securely attach and use the provided strap. Carrying or holding the camcorder by the viewfinder and/or the LCD monitor can result in dropping the unit, or in a malfunction.

Take care not to get your finger caught in the cassette holder cover. Do not let children operate the camcorder, as they are particularly susceptible to this type of injury.

Do not use a tripod on unsteady or unlevel surfaces. It could tip over, causing serious damage to the camcorder.

### CAUTION!

Connecting cables (Audio/Video, S-Video, etc.) to the camcorder and leaving it on top of the TV is not recommended, as tripping on the cables will cause the camcorder to fall, resulting in damage.

Attach only the optional JVC VL-V3U Video Light, VL-F3U Video Flash or MZ-V3U Stereo Zoom Microphone to the camcorder's Info-Shoe.

Mini **DV** NTSC  **MultiMediaCard**

- This camcorder is designed exclusively for the digital video cassette, SD Memory Card and MultiMediaCard. Only cassettes marked "Mini **DV**" and memory cards marked "**SD**" or "**MultiMediaCard**" can be used with this unit.

### Before recording an important scene...

- ... make sure you only use cassettes with the Mini DV mark .
- ... make sure you only use memory cards with the mark  or **MultiMediaCard**.
- ... remember that this camcorder is not compatible with other digital video formats.
- ... remember that this camcorder is intended for private consumer use only. Any commercial use without proper permission is prohibited. (Even if you record an event such as a show, performance or exhibition for personal enjoyment, it is strongly recommended that you obtain permission beforehand.)

## Provided Accessories

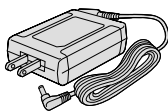

- AC Adapter  
AP-V13U

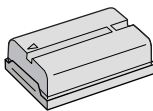

- Battery Pack  
BN-V408U-B



- Audio/Video Cable  
(ø3.5 mini-plug to RCA  
plug)

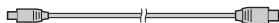

- USB Cable

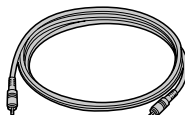

- Editing Cable  
(GR-DV900 only)

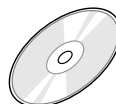

- CD-ROM

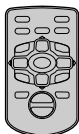
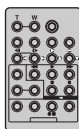

- Remote Control Unit  
RM-V717U (GR-DV900 only)  
RM-V718U\* (GR-DV800/500 only)

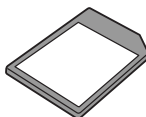

- Memory Card 8 MB  
(Already inserted in the  
camcorder)



- Lens Cap  
(pg. 7 for  
attachment)

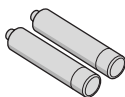

- AAA (R03) Battery x 2 (GR-DV900 only)  
Lithium Battery CR2025\* (GR-DV800/  
500 only)  
(for remote control unit)

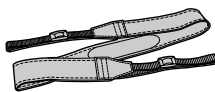

- Shoulder Strap  
(pg. 7 for  
attachment)



- Audio Cable  
(for connection of  
optional headphones  
(pg. 6))

\* A lithium battery is pre-installed in the Remote Control Unit at time of shipment (with insulation sheet). To use the Remote Control Unit, remove the insulation sheet.



- Core Filter (GR-DV800/  
500 only) (for optional  
editing cable (pg. 6  
for attachment))

### NOTES:

- In order to maintain optimum performance of the camcorder, provided cables may be equipped with one or more core filter. If a cable has only one core filter, the end that is closest to the filter should be connected to the camcorder.
- Make sure to use the provided cables for connections. Do not use any other cables.

## How To Attach The Core Filter (GR-DV800/500 only) (for optional editing cable)

Attach the core filter to an optional editing cable. The core filter reduces interference.

- 1 Release the stoppers on both ends of the core filter.

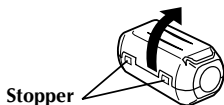

- 2 Run the cable through the core filter, leaving approx. 3 cm (1-3/16") of cable between the cable plug and the core filter. Wind the cable twice around the outside of the core filter as shown in the illustration.

- Wind the cable so that it is not slack.

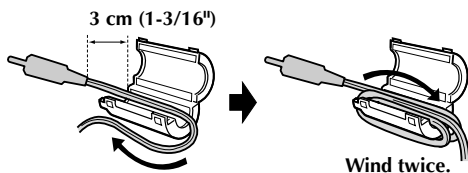

- 3 Close the core filter until it clicks shut.

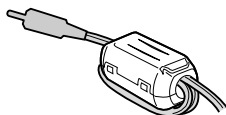

### NOTES:

- Take care not to damage the cable.
- When connecting a cable, attach the end with the core filter to the camcorder.

## How To Use The Audio Cable

When using optional headphones, connect to the provided Audio cable (with a core filter attached), then connect the Audio cable to the camcorder. The core filter reduces interference.

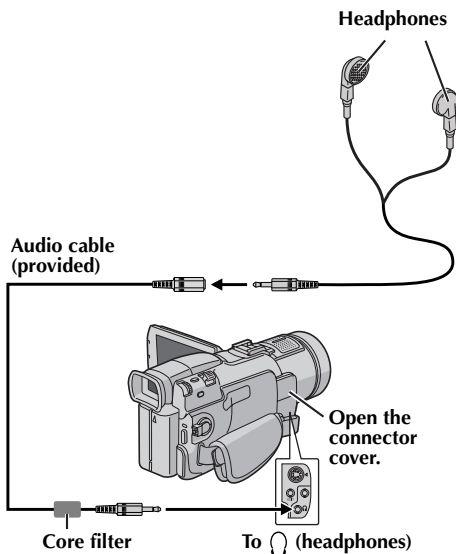

## How To Attach The Lens Cap

To protect the lens, attach the provided lens cap to the camcorder as shown in the illustration.

### NOTE:

To confirm the lens cap is on correctly make sure the cap is flush to the camcorder.

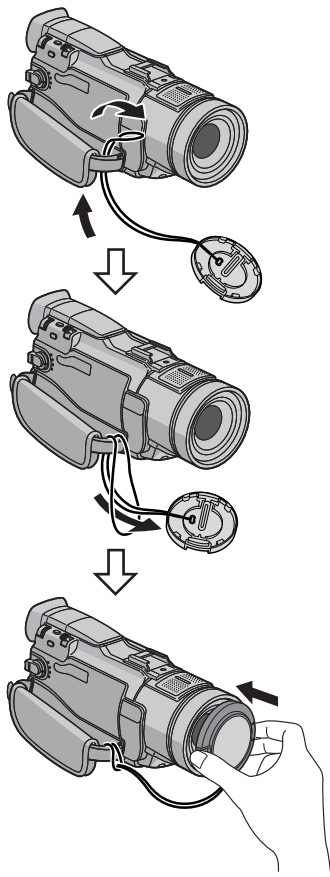

- During shooting

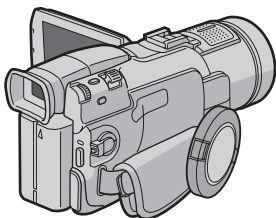

## How To Attach The Strap

- 1 Following the illustration, thread the strap through the eyelet ①.
- 2 Fold it back and thread it through the buckle ②.
- 3 Repeat the procedure to attach the other end of the strap to the other eyelet ③ located under the Grip Strap.
- 4 Confirm the strap is not twisted.

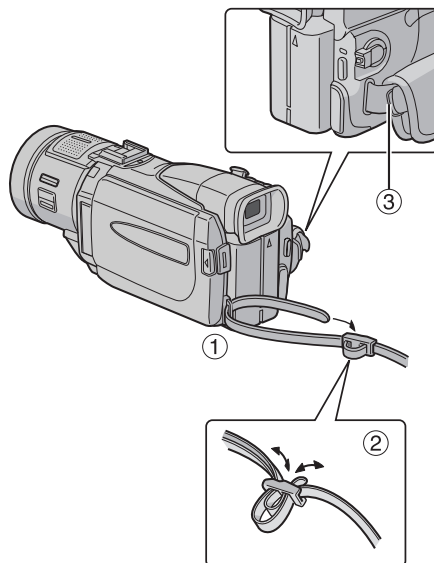

<b>AUTOMATIC DEMONSTRATION</b>	<b>9</b>	<b>ADVANCED FEATURES</b>	<b>31</b>
<b>GETTING STARTED</b>	<b>10</b>	<b>MENUS FOR DETAILED ADJUSTMENT</b>	<b>31</b>
Power	10	Changing The Menu Settings	31
Grip Adjustment	12	<b>RECORDING MENUS</b>	<b>32</b>
Viewfinder Adjustment	12	Wipe Or Fader Effects	32
Tripod Mounting	12	Program AE With Special Effects	33
LCD Monitor And Viewfinder	12	White Balance Adjustment	34
Brightness Adjustment Of The Display	13	<b>PLAYBACK MENUS</b>	<b>40</b>
Operation Mode	13	<b>FEATURES FOR RECORDING</b>	<b>42</b>
Date/Time Settings	14	Night Alive	42
Loading A Cassette		Snapshot (For Video Recording)	42
/Unloading A Cassette	15	Self-Timer	43
Loading A Memory Card		Title Impose	44
/Unloading A Memory Card	16	Auto Focus	45
<b>VIDEO RECORDING &amp; PLAYBACK</b>	<b>17</b>	Manual Focus	45
<b>VIDEO RECORDING</b>	<b>17</b>	Exposure Control	46
Basic Recording	17	Iris Lock	46
Tape Remaining Time	17	Backlight Compensation	47
Zooming	18	White Balance Adjustment	47
Journalistic Shooting	18	Manual White Balance Adjustment	47
Time Code	19	NAVIGATION Function	48
Recording From The Middle Of A Tape	19	E-Mail Clip Recording	50
<b>VIDEO PLAYBACK</b>	<b>20</b>	<b>DUBBING</b>	<b>52</b>
Normal Playback	20	Dubbing To Or From A VCR	52
Still Playback	20	Dubbing To A Video Unit Equipped With	
Shuttle Search	21	A DV IN Connector (Digital Dubbing)	53
Blank Search	21	Dubbing From A Video Unit Equipped With	
Connections To A TV Or VCR	22	A DV OUT Connector (Digital Dubbing)	54
<b>DIGITAL STILL CAMERA (D.S.C.) RECORDING &amp; PLAYBACK</b>	<b>23</b>	Dubbing Still Images Recorded On A Tape To	
<b>D.S.C. RECORDING</b>	<b>23</b>	A Memory Card	55
Basic Shooting (D.S.C. Snapshot)	23	<b>USING THE REMOTE CONTROL UNIT</b>	<b>56</b>
<b>D.S.C. PLAYBACK</b>	<b>24</b>	Audio Dubbing	59
Normal Playback Of Images	24	Insert Editing	60
Auto Playback Of Images	24	Random Assemble Editing [R.A.Edit]	60
Playback Of Video Clips	25	<b>SYSTEM CONNECTIONS</b>	<b>66</b>
Playback Of Title Images	25	Connection To A Personal Computer	66
Index Playback Of Files	26	Using The Camcorder As A WebCam	67
Viewing File Information	26	<b>REFERENCE</b>	<b>68</b>
Removing On-Screen Display	26	<b>DETAILS</b>	<b>68</b>
Protecting Files	27	<b>TROUBLESHOOTING</b>	<b>69</b>
Deleting Files	28	<b>CAUTIONS</b>	<b>74</b>
Resetting The File Name	29	<b>USER MAINTENANCE</b>	<b>77</b>
Setting Print Information (DPOF Setting)	29	<b>SPECIFICATIONS</b>	<b>78</b>
Initializing A Memory Card	30	<b>INDEX</b>	<b>80</b>
		<b>TERMS</b>	<b>86</b>



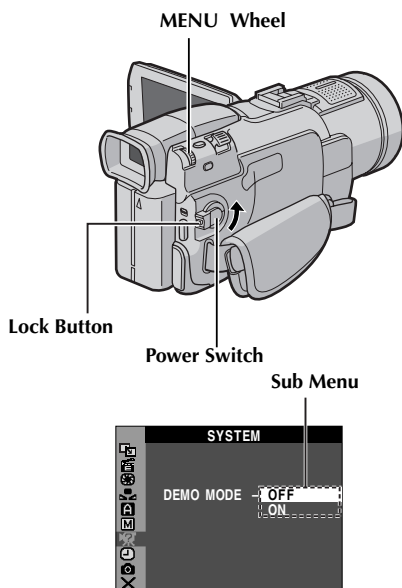

## Automatic Demonstration

Automatic Demonstration takes place when “DEMO MODE” is set to “ON” (factory-preset).



- Automatic Demonstration starts when there is no operation for about 3 minutes after the Power Switch is set to “A” or “M” and no cassette is in the camcorder.
- Performing any operation during the demonstration stops the demonstration temporarily. If no operation is performed for more than 3 minutes after that, the demonstration will resume.
- “DEMO MODE” remains “ON” even if the camcorder power is turned off.

### To cancel Automatic Demonstration

- 1** Set the Power Switch to “M” while pressing down the Lock Button located on the switch.
- 2** Open the LCD monitor fully, or pull out the viewfinder fully.
- 3** Press the MENU Wheel in. The Menu Screen appears.
- 4** Rotate the MENU Wheel to select “”, and press it. The SYSTEM Menu appears.
- 5** Rotate the MENU Wheel to select “DEMO MODE”, and press it. The Sub Menu appears.
- 6** Rotate the MENU Wheel to select “OFF”, and press it.
- 7** Rotate the MENU Wheel to select “RETURN”, and press it twice. The normal screen appears.

#### NOTE:

Detach the lens cap to see the actual changes of the Automatic Demonstration activated on the LCD monitor or viewfinder.

## Power

This camcorder's 2-way power supply system lets you choose the most appropriate source of power. Do not use provided power supply units with other equipment.

### Charging The Battery Pack

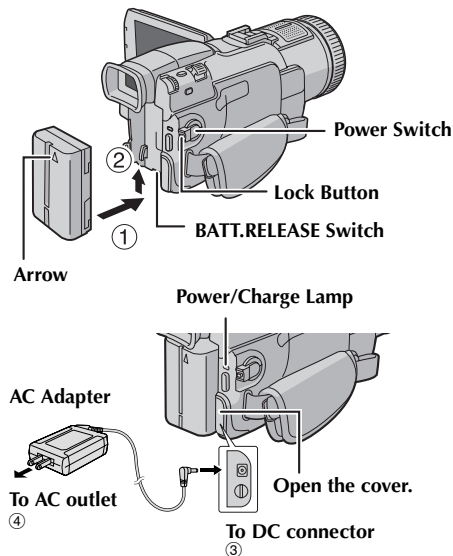

- 1** With the arrow on the battery pack pointing upward, push the battery pack slightly against the battery pack mount ①.
- 2** Slide up the battery pack until it locks in place ②.
- 3** Set the Power Switch to "OFF" while pressing down the Lock Button located on the switch.
- 4** Connect the AC Adapter to the camcorder ③.
- 5** Plug the AC Adapter into an AC outlet ④.
- 6** The power/charge lamp on the camcorder blinks to indicate charging has started.
- 7** When the power/charge lamp goes out, charging is finished.
- 8** Unplug the AC Adapter from the AC outlet.
- 9** Disconnect the AC Adapter from the camcorder.

#### To detach the battery pack...

Slide the battery pack down slightly while sliding **BATT. RELEASE** to detach it.

Battery pack	Charging time
BN-V408U	Approx. 1 hr. 30 min.
BN-V416U (optional)	Approx. 2 hr.
BN-V428U (optional)	Approx. 3 hr. 20 min.

#### NOTES:

- If the protective cap is attached to the battery pack, remove it first.
- During charging, the camcorder cannot be operated.
- Charging is not possible if the wrong type of battery is used.
- When charging the battery pack for the first time or after a long storage period, the power/charge lamp may not light. In this case, remove the battery pack from the AC Adapter, then try charging again.
- If the battery operation time remains extremely short even after having been fully charged, the battery is worn out and needs to be replaced. Please purchase a new one.
- Using the optional AA-V40 AC Power Adapter/Charger, you can charge the BN-V408U/V416U/V428U battery pack without the camcorder. However, it cannot be used as an AC Adapter.
- For other notes, see pg. 68.

### Using The Battery Pack

Perform steps 1 and 2 in "Charging The Battery Pack" in the left column.

#### Maximum continuous recording time

Battery pack	LCD monitor on	Viewfinder on
BN-V408U*	1 hr. 10 min.	1 hr. 30 min.
BN-V416U	2 hr. 20 min.	3 hr.
BN-V428U	4 hr.	5 hr. 10 min.
BN-V840U	5 hr. 30 min.	7 hr. 15 min.
BN-V856U	7 hr. 40 min.	10 hr. 20 min.

\* Provided

#### NOTES:

- Recording time is reduced significantly under the following conditions:
  - Zoom or Record-Standby mode is engaged repeatedly.
  - The LCD monitor is used repeatedly.
  - The playback mode is engaged repeatedly.
- Before extended use, it is recommended that you prepare enough battery packs to cover 3 times the planned shooting time.

**ATTENTION:**

Before detaching the power source, make sure that the camcorder's power is turned off. Failure to do so can result in a camcorder malfunction.

**INFORMATION:**

The optional extended-use battery pack kit is a set composed of a battery pack and AC Power Adapter/Charger:

VU-V840 KIT: BN-V840U battery pack & AA-V15U AC Power Adapter/Charger

VU-V856 KIT: BN-V856U battery pack & AA-V80U AC Power Adapter/Charger

Read the kit's instruction manual before using. Also, by using the optional JVC VC-VBN856U DC Cord, it will be possible to connect BN-V840U or BN-V856U battery packs to the camcorder and supply power directly to the camcorder.

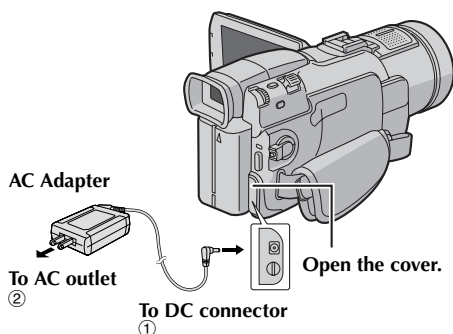
**Using AC Power**

- 1 Connect the AC Adapter to the camcorder ①.
- 2 Plug the AC Adapter into an AC outlet ②.

**NOTES:**

- The provided AC Adapter features automatic voltage selection in the AC range from 110 V to 240 V.
- For other notes, see pg. 68.

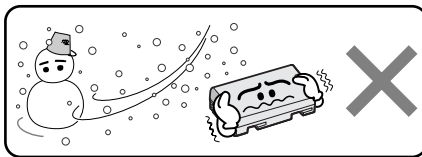
**About Batteries**

**Lithium-ion is vulnerable in colder temperatures.**



**DANGER!** Do not attempt to take the batteries apart, or expose them to flame or excessive heat, as it may cause a fire or explosion.

**WARNING!** Do not allow the battery or its terminals to come in contact with metals, as this can result in a short circuit and possibly start a fire.

**The Benefits Of Lithium-Ion Batteries**

Lithium-ion battery packs are small but have a large power capacity. However, when one is exposed to cold temperatures (below 10°C/50°F), its usage time becomes shorter and it may cease to function. If this happens, place the battery pack in your pocket or other warm, protected place for a short time, then re-attach it to the camcorder. As long as the battery pack itself is not cold, it should not affect performance.

(If you're using a heating pad, make sure the battery pack does not come in direct contact with it.)

**For other notes, see pg. 68.**

## Grip Adjustment

- 1 Adjust the velcro strip.
- 2 Pass your right hand through the loop and grasp the grip.
- 3 Adjust your thumb and fingers through the grip to easily operate the Recording Start/Stop Button, Power Switch and Power Zoom Lever. Be sure to fasten the velcro strip to your preference.

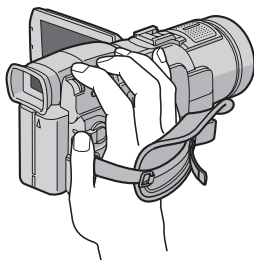

## Viewfinder Adjustment

- 1 Set the Power Switch to "A" or "M" while pressing down the Lock Button located on the switch.
- 2 Pull out the viewfinder fully and adjust it manually for best visibility.
- 3 Turn the Diopter Adjustment Control until the indications in the viewfinder are clearly focused.

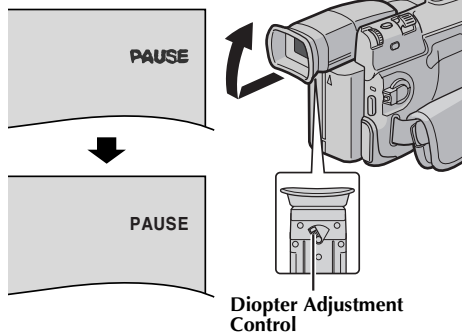

## Tripod Mounting

To attach the camcorder to a tripod, align the direction stud and screw to the mounting socket and stud hole on the camcorder. Then tighten the screw clockwise.

- Some tripods are not equipped with studs.

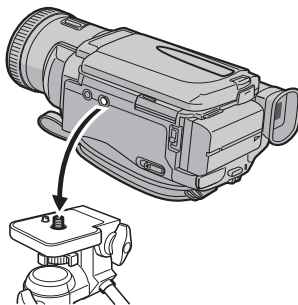

### CAUTION:

When attaching the camcorder to a tripod, extend its legs to stabilize the camcorder. It is not advised to use small sized tripods. This may cause damage to the unit by falling over.

## LCD Monitor And Viewfinder

### While using the LCD monitor:

Make sure the viewfinder is pushed back in. Open the LCD monitor fully. It can rotate 270° (90° downward, 180° upward).

### While using the viewfinder:

Make sure the LCD monitor is closed and locked. Pull out the viewfinder fully.

- Be sure to pull out the viewfinder until you hear a click, otherwise it may be pushed back in during use.

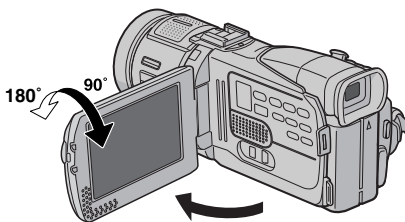

### NOTES:

- The image will not appear simultaneously on the LCD monitor and the viewfinder. When the viewfinder is pulled out while the LCD monitor is opened, you can select which one to use. Set "PRIORITY" to the desired mode in SYSTEM Menu. (☞ pg. 31, 38)
- Colored bright spots may appear all over the LCD monitor or the viewfinder. However, this is not a malfunction. (☞ pg. 73)

## Brightness Adjustment Of The Display

- 1 Set the Power Switch to "M" or "PLAY" while pressing down the Lock Button located on the switch.
- 2 Open the LCD monitor fully, or pull out the viewfinder fully.
- 3 Press the MENU Wheel in. The Menu Screen appears.
- 4 Rotate the MENU Wheel to select "CAM", and press it. The CAMERA DISPLAY Menu appears.
- 5 Rotate the MENU Wheel to select "BRIGHT", and press it. The Menu Screen closes and the brightness control indicator appears.
- 6 Rotate the MENU Wheel until the appropriate brightness is reached.
- 7 Press the MENU Wheel in.
  - It is also possible to adjust the brightness of the viewfinder.

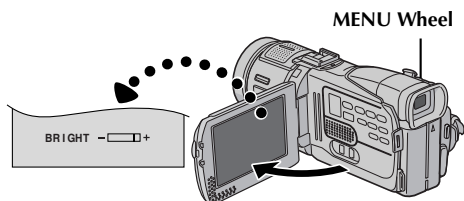

## Operation Mode

To turn on the camcorder, set the Power Switch to any operation mode except "OFF" while pressing down the Lock Button located on the switch.

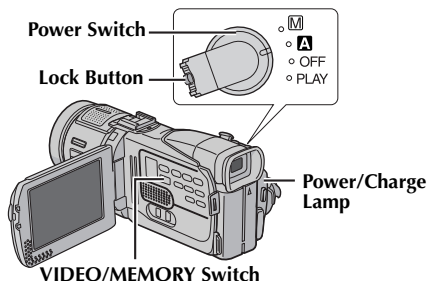

Choose the appropriate operation mode according to your preference using the Power Switch and VIDEO/MEMORY Switch.

### Power Switch Position

#### A (Full Auto Recording):

Allows you to record using NO special effects or manual adjustments. Suitable for standard recording.

The "A" indicator appears on the display.

#### M (Manual Recording):

Allows you to set various recording functions using the Menus. (☞ pg. 31)

If you want more creative capabilities than Full Auto Recording, try this mode.

There is no indication on the display.

#### OFF:

Allows you to switch off the camcorder.

#### PLAY:

- Allows you to play back a recording on the tape.
- Allows you to play back a video clip on the memory card.
- Allows you to display a still image stored in the memory card or to transfer a still image stored in the memory card to a PC.
- Allows you to set various playback functions using the Menus. (☞ pg. 31)

### VIDEO/MEMORY Switch Position

#### VIDEO:

Allows you to record on a tape or play back a tape. If "REC SELECT" is set to "▶CAM▶M" (☞ pg. 39), still images are recorded both on the tape and the memory card.

#### MEMORY:

- Allows you to record in a memory card or access data stored in a memory card.
- When the Power Switch is set to "A" or "M", the currently selected image size appears.

## Power-Linked Operation

When the Power Switch is set to "A" or "M", you can also turn on/off the camcorder by opening/closing the LCD monitor or pulling out/pushing in the viewfinder.

## Date/Time Settings

The date/time is recorded onto the tape at all times, but its display can be turned on or off during playback. (▶ pg. 31, 41)

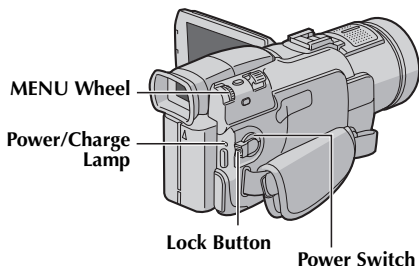

- 1 Set the Power Switch to "M" while pressing down the Lock Button located on the switch.
- 2 Open the LCD monitor fully, or pull out the viewfinder fully.
- 3 Press the **MENU** Wheel in. The Menu Screen appears.

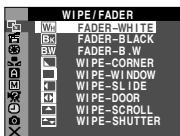

- 4 Rotate the **MENU** Wheel to select "CAMERA DISPLAY", and press it. The CAMERA DISPLAY Menu appears.
- 5 Rotate the **MENU** Wheel to select "CLOCK ADJ.", and press it. The parameter for "Month" is highlighted.

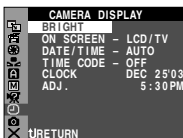

- 6 Rotate the **MENU** Wheel to input the month, and press it. Repeat to input the day, year, hour and minute.

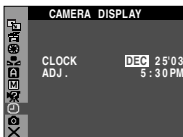

- 7 Rotate the **MENU** Wheel to select "RETURN", and press it twice. The Menu Screen closes.

## Built-in Clock's Rechargeable Lithium Battery

To store the date/time in memory, the clock's rechargeable lithium battery is integrated in the camcorder. While the camcorder is connected to an AC outlet using the AC Adapter, or while the battery pack attached to the camcorder continues to supply power, the clock's rechargeable lithium battery is always charged. However, if the camcorder is not used for approx. 3 months, the clock's lithium battery will become discharged and the date/time stored in memory will be lost. When this occurs, first connect the camcorder to an AC outlet using the AC Adapter for over 24 hours to charge the clock's rechargeable lithium battery. Then perform the date/time setting before using the camcorder.

Note that the camcorder can be used without setting the date/time.

### NOTE:

*Even if you select "CLOCK ADJ.", if the parameter is not highlighted, the camcorder's internal clock continues to operate. Once you move the highlight bar to the first date/time parameter (month), the clock stops. When you finish setting the minute and press the **MENU** Wheel in, the date and time begin operation from the date and time you have just set.*

## Loading A Cassette /Unloading A Cassette

The camcorder needs to be powered up to load or eject a cassette.

- Slide and hold **OPEN/EJECT** in the direction of the arrow, then pull the cassette holder cover open until it locks. The cassette holder opens automatically.
  - Do not touch internal components.
- Insert or remove a tape and press "PUSH HERE" to close the cassette holder.
  - Be sure to press only the section labeled "PUSH HERE" to close the cassette holder; touching other parts may cause your finger to get caught in the cassette holder, resulting in injury or product damage.
  - Once the cassette holder is closed, it recedes automatically. Wait until it recedes completely before closing the cassette holder cover.
  - When the battery pack's charge is low, you may not be able to close the cassette holder cover. Do not apply force. Replace the battery pack with a fully charged one or use AC power before continuing.
- Close the cassette holder cover firmly until it locks into place.

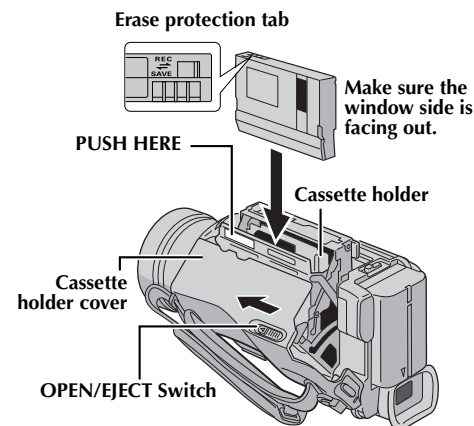

### To protect valuable recordings...

Slide the erase protection tab on the back of the tape in the direction of "SAVE". This prevents the tape from being recorded over. To record on this tape, slide the tab back to "REC" before loading it.

### Approximate recording time

Tape	Recording mode	
	SP	LP
30 min.	30 min.	45 min.
60 min.	60 min.	90 min.
80 min.	80 min.	120 min.

To switch the recording mode, refer to pages 31 and 34.

### NOTES:

- It takes a few seconds for the cassette holder to open. Do not apply force.
- If you wait a few seconds and the cassette holder does not open, close the cassette holder cover and try again. If the cassette holder still does not open, turn the camcorder off then on again.
- If the tape does not load properly, open the cassette holder cover fully and remove the cassette. A few minutes later, insert it again.
- When the camcorder is suddenly moved from a cold place to a warm environment, wait a short time before opening the cassette holder cover.
- Closing the cassette holder cover before the cassette holder recedes may cause damage to the camcorder.
- Even when the camcorder is switched off, a cassette can be loaded or unloaded. After the cassette holder is closed with the camcorder switched off, however, it may not recede. It is recommended to turn the power on before loading or unloading.
- When resuming recording, once you open the cassette holder cover a blank portion will be recorded on the tape or a previously recorded scene will be erased (recorded over) regardless of whether the cassette holder came out or not. See "Recording From The Middle Of A Tape" (pg. 19).

## Loading A Memory Card /Unloading A Memory Card

The provided memory card is already inserted in the camcorder at the time of purchase.

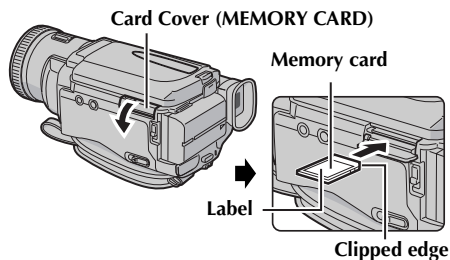

- 1** Make sure the camcorder's power is off.
- 2** Open the card cover (MEMORY CARD).
- 3** **To load a memory card**, firmly insert it with its clipped edge first.  
**To unload a memory card**, push it once. After the memory card comes out of the camcorder, pull it out.
  - Do not touch the terminal on the reverse side of the label.
- 4** Close the card cover.

To protect valuable files (available only for SD Memory Card)...

Write/erase protection tab

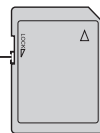

Slide the write/erase protection tab on the side of the memory card in the direction of "LOCK". This prevents the memory card from being recorded over. To record on this memory card, slide the tab back to the position opposite to "LOCK" before loading it.

### NOTES:

- Be sure to use only SD Memory Cards marked "SD" or MultiMediaCards marked "MultiMediaCard".
- Some brands of memory cards are not compatible with this camcorder. Before purchasing a memory card, consult its manufacturer or dealer.
- Before using a new memory card, it is necessary to **FORMAT** the card. (☞ pg. 30)

### ATTENTION:

Do not insert or remove the memory card while the camcorder is turned on, as this may cause the memory card to be corrupted or cause the camcorder to become unable to recognize whether or not the card is installed.



## Basic Recording

**NOTE:**

Before continuing, perform the procedures listed below:

- Power (☞ pg. 10)
- Loading A Cassette (☞ pg. 15)

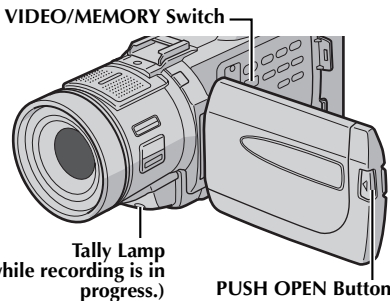
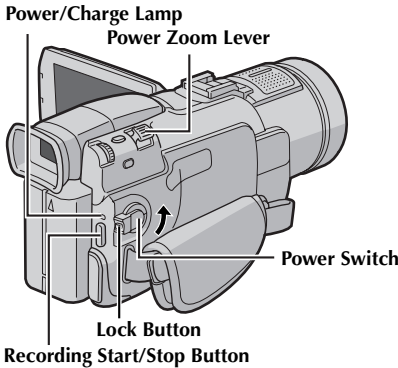

- 1 Remove the lens cap.
- 2 Press **PUSH OPEN** and open the LCD monitor fully, or pull out the viewfinder fully.
- 3 Set the **VIDEO/MEMORY** Switch to "VIDEO".
- 4 Set the Power Switch to "A" or "M" while pressing down the Lock Button located on the switch.
  - The power/charge lamp lights and the camcorder enters the Record-Standby mode. "PAUSE" is displayed.
- 5 To start recording, press the Recording Start/Stop Button. The tally lamp lights and "REC" appears on the display while recording is in progress.
- 6 To stop recording, press the Recording Start/Stop Button again. The camcorder re-enters the Record-Standby mode.

**NOTES:**

- The image will not appear simultaneously on the LCD monitor and the viewfinder.
- If the Record-Standby mode continues for 5 minutes, the camcorder's power shuts off automatically. To turn the camcorder on again, push back and pull out the viewfinder again or close and re-open the LCD monitor.
- LCD monitor/viewfinder indications:
  - When power is supplied from a battery: the "☐" battery indicator is displayed. (☞ pg. 84)
  - When power is supplied from an AC outlet: the "☐" battery indicator does not appear.
- When a blank portion is left between recorded scenes on the tape, the time code is interrupted and errors may occur when editing the tape. To avoid this, refer to "Recording From The Middle Of A Tape" (☞ pg. 19).
- To turn the tally lamp or beep sounds off, ☞ pg. 31, 37.
- To record in LP (Long Play) mode, ☞ pg. 31, 34.
- For other notes, ☞ pg. 68.

### Tape Remaining Time

Approximate tape remaining time appears on the display. "- h - - m" means the camcorder is calculating the remaining time. When the remaining time reaches 2 minutes, the indication starts blinking.

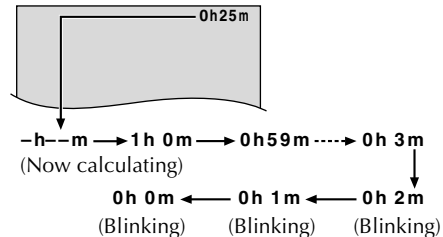

## Zooming

Produces the zoom in/out effect, or an instantaneous change in image magnification.

### Zoom In

Slide the Power Zoom Lever towards "T".

### Zoom Out

Slide the Power Zoom Lever towards "W".

- The further you slide the Power Zoom Lever, the quicker the zoom action.

### Zoom in (T: Telephoto)

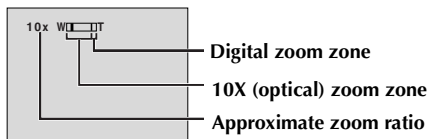
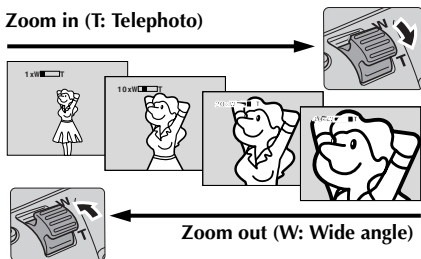

## NOTES:

- Focusing may become unstable during Zooming. In this case, set the zoom while in Record-Standby, lock the focus by using the manual focus (pg. 45), then zoom in or out in Record mode.
- Zooming is possible to a maximum of 200X, or it can be switched to 10X magnification using the optical zoom. (pg. 35)
- Zoom magnification of over 10X is done through Digital image processing, and is therefore called Digital Zoom.
- During Digital zoom, the quality of image may suffer.
- Digital zoom cannot be used when the VIDEO/MEMORY Switch is set to "MEMORY".
- Macro shooting (as close as approx. 5 cm (2") to the subject) is possible when the Power Zoom Lever is set all the way to "W". Also see "TELE MACRO" in MANUAL Menu on page 36.
- For other notes, pg. 68.

## Journalistic Shooting

In some situations, different shooting angles may provide more dramatic results. Hold the camcorder in the desired position and tilt the LCD monitor in the most convenient direction. It can rotate 270° (90° downward, 180° upward).

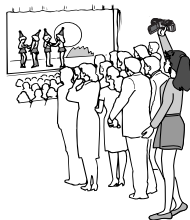

## Time Code

During recording, a time code is recorded on the tape. This code is to confirm the location of the recorded scene on the tape during playback.

If recording starts from a blank portion, the time code begins counting from "00:00:00" (minute:second:frame). If recording starts from the end of a previously recorded scene, the time code continues from the last time code number.

To perform Random Assemble Editing (☞ pg. 60 – 65), time code is necessary. If during recording a blank portion is left partway through the tape, the time code is interrupted. When recording is resumed, the time code starts counting up again from "00:00:00". This means the camcorder may record the same time codes as those existing in a previously recorded scene. To prevent this, perform "Recording From The Middle Of A Tape" (☞ pg. 19) in the following cases;

- When shooting again after playing back a recorded tape.
- When power shuts off during shooting.
- When a tape is removed and re-inserted during shooting.
- When shooting using a partially recorded tape.
- When shooting on a blank portion located partway through the tape.
- When shooting again after shooting a scene then opening/closing the cassette holder cover.

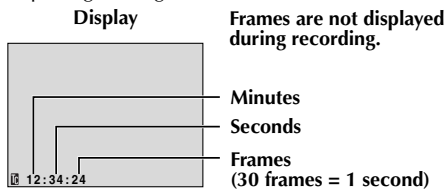

## Recording From The Middle Of A Tape

- 1) Play back a tape or use Blank Search (☞ pg. 21) to find the spot at which you want to start recording, then engage the Still Playback mode. (☞ pg. 20)
- 2) Set the Power Switch to "A" or "M" while pressing down the Lock Button located on the switch, then start recording.

### NOTES:

- The time code cannot be reset.
- During fast-forwarding and rewinding, the time code indication does not move smoothly.
- The time code is displayed only when "TIME CODE" is set to "ON". (☞ pg. 38)

### When a blank portion is recorded on a tape

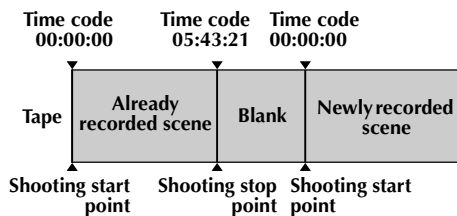

### Proper recording

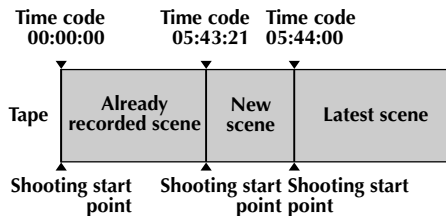

## Normal Playback

### MENU Wheel (VOLUME)

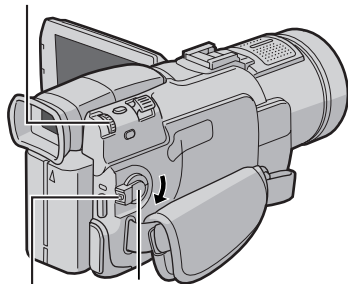

Power Switch

Lock Button

### VIDEO/MEMORY Switch

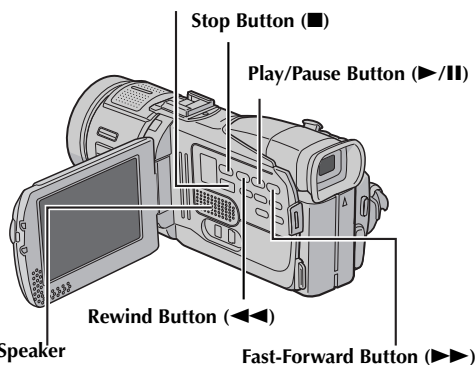

Stop Button (■)

Play/Pause Button (▶/||)

Rewind Button (◀◀)

Fast-Forward Button (▶▶)

Speaker

- The playback picture can be viewed in the LCD monitor, viewfinder or on a connected TV. (☞ pg. 22)
- You can also view the playback picture on the LCD monitor with it flipped over and pushed against the camcorder body.
- LCD monitor/viewfinder indications:
  - When power is supplied from a battery: the "☐" battery indicator is displayed. (☞ pg. 84)
  - When power is supplied from an AC outlet: the "☐" battery indicator does not appear.
- When a cable is connected to the AV connector, the sound is not heard from the speaker.

### To control the speaker volume...

Rotate the **MENU Wheel** towards "+" to turn up the volume, or towards "-" to turn down the volume.

## Still Playback

Pauses during video playback.

- 1) Press ▶/|| during playback.
- 2) To resume normal playback, press ▶/|| again.
  - If still playback continues for more than about 3 minutes, the camcorder's Stop mode is automatically engaged.
  - When ▶/|| is pressed, the image may not pause immediately while the camcorder stabilizes the still image.

- 1 Load a cassette. (☞ pg. 15)
- 2 Set the **VIDEO/MEMORY Switch** to "VIDEO".
- 3 Set the Power Switch to "PLAY" while pressing down the Lock Button located on the switch.
- 4 To start playback, press ▶/||.
- 5 To stop playback, press ■.
  - During Stop mode, press ◀◀ to rewind, or ▶▶ to fast-forward the tape.

### NOTES:

- Clean the video heads using an optional dry cleaning cassette when:
  - No picture during playback.
  - Blocks of noise appear during playback.
 For details, ☞ pg. 75.
- If Stop mode continues for 5 minutes when power is supplied from a battery, the camcorder shuts off automatically. To turn on again, set the Power Switch to "OFF", then to "PLAY".

## Shuttle Search

Allows high-speed search in either direction during video playback.

- 1) During playback, press ►► for forward search, or ◀◀ for reverse search.
- 2) To resume normal playback, press ►/II.
  - During playback, press and hold ►► or ◀◀. The search continues as long as you hold the button. Once you release the button, normal playback resumes.
  - A slight mosaic effect appears on the display during Shuttle Search. This is not a malfunction.

### ATTENTION:

During Shuttle Search, parts of the picture may not be clearly visible, particularly on the left side of the screen.



## Blank Search

Helps you find where you should start recording in the middle of a tape to avoid time code interruption. (☞ pg. 19)

- 1 Load a cassette. (☞ pg. 15)
- 2 Set the **VIDEO/MEMORY** Switch to "VIDEO".
- 3 Set the Power Switch to "PLAY" while pressing down the Lock Button located on the switch.
- 4 During Stop mode, press **BLANK SEARCH**.
  - The "BLANK SEARCH" indication appears and the camcorder automatically starts reverse or forward search, then stops at the spot which is about 3 seconds of tape before the beginning of the detected blank portion.
  - To cancel Blank Search midway, press ■.



### NOTES:

- Before starting Blank Search, if the current position is at a blank portion, the camcorder searches in the reverse direction. If the current position is at a recorded portion, the camcorder searches in the forward direction.
- Blank Search does not work if "HEAD CLEANING REQUIRED. USE CLEANING CASSETTE" has appeared with the tape.
- If the beginning or end of the tape is reached during Blank Search, the camcorder stops automatically.
- A blank portion which is shorter than 5 seconds of tape may not be detected.
- The detected blank portion may be located between recorded scenes. Before you start recording, make sure there is no recorded scene after the blank portion.

## Slow-Motion Playback Frame-By-Frame Playback Playback Zoom Playback Special Effects

Available only with the remote control (provided). (☞ pg. 58)

## Connections To A TV Or VCR

These are some basic types of connections. When making the connections, refer also to your VCR and TV instruction manuals.

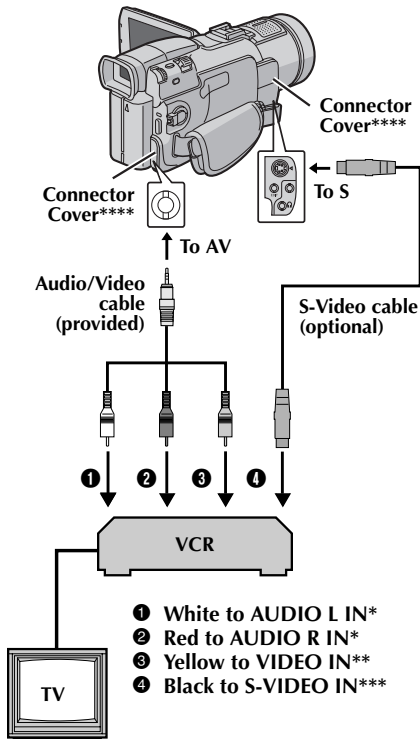

- \* Not required for watching still images only.
- \*\* Connect when your TV/VCR has only A/V input connectors.
- \*\*\* Connect when your TV/VCR has S-VIDEO IN and A/V input connectors.
- \*\*\*\* When connecting the cable, open the cover.

- 1 Make sure all units are turned off.
- 2 Connect the camcorder to a TV or VCR as shown in the illustration.

If using a VCR, go to step 3.

If not, go to step 4.

- 3 Connect the VCR output to the TV input, referring to your VCR's instruction manual.
- 4 Turn on the camcorder, the VCR and the TV.
- 5 Set the VCR to its AUX input mode, and set the TV to its VIDEO mode.

To choose whether or not the following displays appear on the connected TV...

- Date/Time  
Set "DATE/TIME" to "AUTO", "ON" or "OFF".  
(☞ pg. 31, 41)  
Or, press **DISPLAY** on the remote control to turn on/off the date indication.
- Time Code  
Set "TIME CODE" to "ON" or "OFF".  
(☞ pg. 31, 41)
- Indications other than date/time and time code  
Set "ON SCREEN" to "OFF", "LCD" or "LCD/TV".  
(☞ pg. 31, 41)

### NOTES:

- It is recommended to use the AC Adapter as the power supply instead of the battery pack.  
(☞ pg. 11)
- The S-Video cable is optional. Be sure to use the YTU94146B S-Video cable. Consult the JVC Service Center described on the sheet included in the package for details on its availability. Make sure to connect the end with a core filter to the camcorder. The core filter reduces interference.
- To monitor the picture and sound from the camcorder without inserting a tape or memory card, set the camcorder's Power Switch to "A" or "M", then set your TV to the appropriate input mode.
- Make sure you adjust the TV sound volume to its minimum level to avoid a sudden burst of sound when the camcorder is turned on.
- If you have a TV or speakers that are not specially shielded, do not place the speakers adjacent to the TV as interference will occur in the camcorder playback picture.
- When a cable is connected to the AV or headphone connector, sound cannot be heard from the speaker.

## Basic Shooting (D.S.C. Snapshot)

You can use your camcorder as a Digital Still Camera for taking snapshots. Still images are stored in the memory card.

### NOTE:

Before continuing, perform the procedures listed below:

- Power (☞ pg. 10)
- Loading A Memory Card (☞ pg. 16)



Snapshot mode with no frame

There is the sound of a shutter closing.

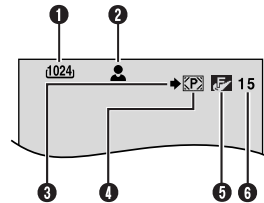
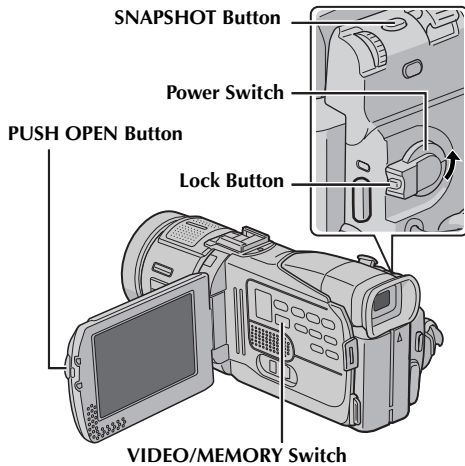

- 1 Image Size (☞ pg. 39, 82)
- 2 Focus Icon (☞ pg. 82)
- 3 Shooting Icon (☞ pg. 82)
- 4 Card Icon (☞ pg. 82)
- 5 Picture Quality (☞ pg. 39, 82)
- 6 Remaining Number Of Shots (☞ pg. 82)

### NOTES:

- Even if "DIS" is set to "ON" (☞ pg. 36), the Stabilizer will be disabled.
- If Snapshot recording is not possible, "PHOTO" blinks when **SNAPSHOT** is pressed.
- If Program AE with special effects (☞ pg. 33) is engaged, certain modes of Program AE with special effects are disabled during Snapshot recording. In such a case, the icon blinks.
- If shooting is not performed for approx. 5 minutes when the Power Switch is set to "A" or "M" and power is supplied from the battery pack, the camcorder shuts off automatically to save power. To perform shooting again, push back and pull out the viewfinder again or close and re-open the LCD monitor.
- The Motor Drive mode (☞ pg. 43) is disabled when the **VIDEO/MEMORY** Switch is set to "MEMORY".
- When a cable is connected to the AV connector, the shutter sound is not heard from the speaker, however it is recorded onto the tape.
- Still images taken are compliant to DCF (Design rule for Camera File system). They do not have any compatibility with devices which are not compliant to DCF.

- 1 Remove the lens cap.
- 2 Press **PUSH OPEN** and open the LCD monitor fully, or pull out the viewfinder fully.
- 3 Set the **VIDEO/MEMORY** Switch to "MEMORY".
- 4 Set the Power Switch to "A" or "M" while pressing down the Lock Button located on the switch.
- 5 Press **SNAPSHOT**. The "PHOTO" indication appears while the snapshot is being taken.
  - To check how the image looks before recording it in the memory card, press **SNAPSHOT** halfway and hold. The "A" indicator appears and stops blinking when the captured image is focused. To cancel the recording, release **SNAPSHOT**. To record it in the memory card, press **SNAPSHOT** fully.
  - Still images are recorded in the snapshot mode with no frame.
  - To delete unwanted still images, refer to "Deleting Files" (☞ pg. 28).
  - When you do not want to hear the shutter sound, set "BEEP" to "OFF". (☞ pg. 31, 37)
  - To change the Image Size and/or Picture Quality, ☞ pg. 31, 39.

## Normal Playback Of Images

Images shot with the camcorder are automatically numbered, then stored in numerical order in the memory card. You can view the stored images, one at a time, much like flipping through a photo album.

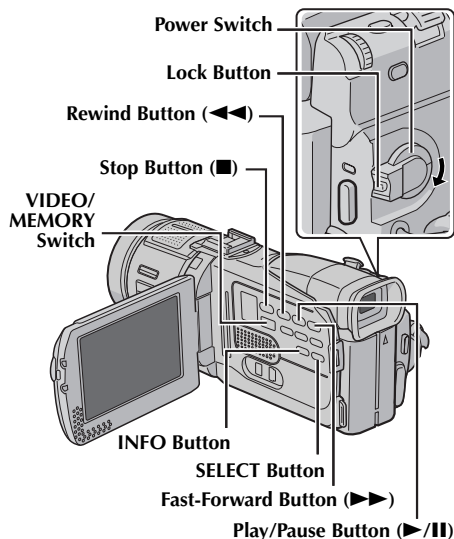

- 1 Load a memory card. (☞ pg. 16)
- 2 Set the **VIDEO/MEMORY** Switch to "MEMORY".
- 3 Set the Power Switch to "PLAY" while pressing down the Lock Button located on the switch.
- 4 Open the LCD monitor fully, or pull out the viewfinder fully.
  - The type of file (IMAGE, E-MAIL CLIP or TITLE) which has been played back at the last time is displayed.
- 5 If the video clip playback (E-MAIL CLIP, ☞ pg. 25) or the title image playback (TITLE, ☞ pg. 25) screen appears, press **SELECT**. The MEMORY SELECT screen appears.
- 6 Rotate the **MENU** Wheel to select "IMAGE", and press it. The image playback screen (IMAGE) appears.
- 7 Press ◀◀ to display the previous file. Press ▶▶ to display the next file.
  - Pressing **INFO** gives you details on the displayed file. (☞ pg. 26)
  - You can also look for the desired file using Index Screen. (☞ pg. 26)
  - You can turn off the on-screen playback display. (☞ pg. 26)

### NOTES:

- Even if you shoot a new image after playing back a low-numbered one, this will not overwrite an existing image, because new images are automatically stored after the last-recorded one.
- Images shot in a file size other than "640 x 480", "1024 x 768", "1280 x 960" and "1600 x 1200" with another devices will be displayed thumbnail images. These thumbnail images cannot be transferred to a PC.
- Images shot with devices (such as JVC GR-DVM70) that are not compatible with DCF cannot be viewed with this camcorder; "UNSUPPORTED FILE!" will be displayed.

### Playback Zoom

Available only with the remote control (provided). (☞ pg. 58)

## Auto Playback Of Images

You can run through all the images stored in memory card automatically.

- 1 Perform steps 1 – 6 in "Normal Playback Of Images".
- 2 Press ▶/|| to start Auto Playback.
  - If you press ◀◀ during Auto Playback, files are displayed in descending order.
  - If you press ▶▶ during Auto Playback, files are displayed in ascending order.
- 3 To end Auto Playback, press ■.

[For Normal Playback]      [For Auto Playback]  
To display the next image

Image playback screen (IMAGE)

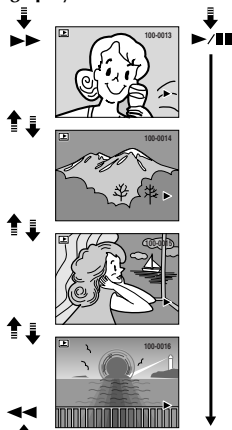

To display the previous image



## Playback Of Video Clips

You can view video clips (☞ pg. 50) stored in the memory card.

- 1 Load a memory card. (☞ pg. 16)
- 2 Set the **VIDEO/MEMORY** Switch to "MEMORY".
- 3 Set the Power Switch to "PLAY" while pressing down the Lock Button located on the switch.
- 4 Open the LCD monitor fully, or pull out the viewfinder fully.
  - The type of file (IMAGE, E-MAIL CLIP or TITLE) which has been played back at the last time is displayed.
- 5 If the image playback (IMAGE) or the title image playback (TITLE) screen appears, press **SELECT**. The MEMORY SELECT screen appears.
- 6 Rotate the **MENU** Wheel to select "E-MAIL CLIP", and press it. The video clip playback screen (E-MAIL CLIP) appears.
- 7 Press ◀◀ to select the previous file. Press ▶▶ to select the next file.
  - Pressing **INFO** gives you details on the displayed file. (☞ pg. 26)
  - You can also look for the desired file using Index Screen. (☞ pg. 26)
- 8 To start playback, press ▶/II.
- 9 To stop playback, press ■.



## Playback Of Title Images

9 title images are pre-stored in the provided memory card. You can view these files. The title images can be also superimposed during recording. (☞ pg. 44)

- 1 Load the provided memory card. (☞ pg. 16)
- 2 Set the **VIDEO/MEMORY** Switch to "MEMORY".
- 3 Set the Power Switch to "PLAY" while pressing down the Lock Button located on the switch.
- 4 Open the LCD monitor fully, or pull out the viewfinder fully.
  - The type of file (IMAGE, E-MAIL CLIP or TITLE) which has been played back at the last time is displayed.
- 5 If the image playback (IMAGE) or the video clip playback (E-MAIL CLIP) screen appears, press **SELECT**. The MEMORY SELECT screen appears.
- 6 Rotate the **MENU** Wheel to select "TITLE", and press it. The title image playback screen (TITLE) appears.
- 7 Press ◀◀ to select the previous file. Press ▶▶ to select the next file.
  - Pressing **INFO** gives you details on the displayed file. (☞ pg. 26)
  - You can also look for the desired file using Index Screen. (☞ pg. 26)

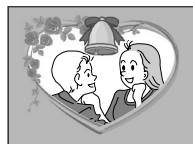

### NOTE:

*If the pre-stored title images in the provided memory card have been deleted accidentally, you can copy the image files from the provided CD-ROM. For details, refer to the provided software's instruction manual included in the CD-ROM.*

## Index Playback Of Files

You can view several different files stored in the memory card at a time. This browsing capability makes it easy to locate a particular file you want.

**1** For **Index Playback of image files**, perform **1 – 6** in “Normal Playback Of Images” (☞ pg. 24).

For **Index Playback of video clip files**, perform **1 – 6** in “Playback Of Video Clips” (☞ pg. 25).

For **Index Playback of title files**, perform **1 – 6** in “Playback Of Title Images” (☞ pg. 25).

**2** Press **INDEX**. The Index Screen of the selected type of file appears.

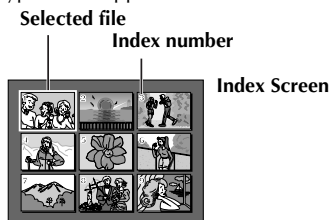

**3** Rotate the **MENU** Wheel to move the frame to the desired file.

- Press **◀** to display the previous page. Press **▶** to display the next page.

**4** Press the **MENU** Wheel in. The selected file is displayed.

- Pressing **INFO** gives you details on the displayed file. (See below.)

## Viewing File Information

You can get the relevant file information by pressing the **INFO** Button during normal playback or Index Playback.

- FOLDER : Folder name (☞ pg. 29)  
 FILE : File name (☞ pg. 29)  
 DATE : Date the file was made  
 SIZE : Image size  
 QUALITY : Picture quality (IMAGE only)  
 TIME : Playback time (E-MAIL CLIP only)  
 PROTECT : When set to “ON”, the file is protected from accidental erasure. (☞ pg. 27)



Information Screen

- Press the **INFO** Button again to close the Information Screen.

### NOTE:

With images shot with other devices or processed on a PC, “QUALITY: ---” will be displayed.

## Removing On-Screen Display

**1** Perform steps **1 – 6** in “Normal Playback Of Images” (☞ pg. 24) or “Playback Of Title Images” (☞ pg. 25).

**2** Press the **MENU** Wheel in. The Menu Screen appears.

**3** Rotate the **MENU** Wheel to select “DISPLAY”, and press it. The Sub Menu appears.

**4** Rotate the **MENU** Wheel to select “OFF”, and press it. The operation mode indicator, folder/file number and battery indicator (☞) disappear.

- To display the indicators again, select “ON”.

### Operation mode indicator

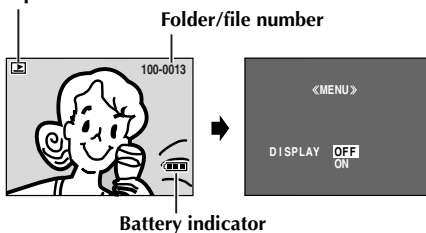

Battery indicator

## Protecting Files

The Protect mode helps prevent the accidental erasure of files.

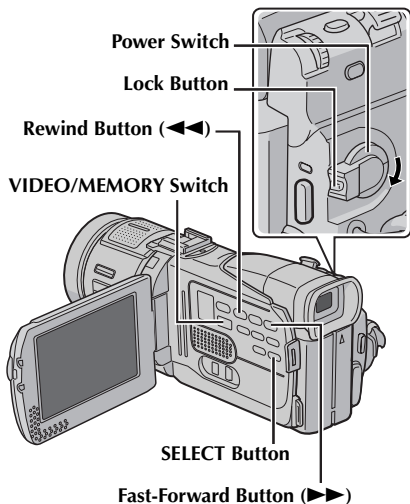

- 1 Load a memory card. (pg. 16)
- 2 Set the **VIDEO/MEMORY** Switch to "MEMORY".
- 3 Set the Power Switch to "PLAY" while pressing down the Lock Button located on the switch.
- 4 Open the LCD monitor fully, or pull out the viewfinder fully.
  - The type of file (IMAGE, E-MAIL CLIP or TITLE) which has been played back at the last time is displayed.

If you want to select another type of file, go to step 5.

If not, go to step 7.

- 5 Press **SELECT**. The MEMORY SELECT screen appears.
- 6 Rotate the **MENU** Wheel to select the desired type of file, and press it.
- 7 Press the **MENU** Wheel in. The Menu Screen appears.
- 8 Rotate the **MENU** Wheel to select "PROTECT", and press it. The Sub Menu appears.



### To protect the currently displayed file

- 9 Rotate the **MENU** Wheel to select "CURRENT", and press it. The PROTECT screen appears.



- 10 Press **◀** or **▶** to select the desired file.

- 11 Rotate the **MENU** Wheel to select "EXECUTE", and press it.

- To cancel protection, select "RETURN".
- Repeat steps 10 and 11 for all files you want to protect.



### To protect all files stored in the memory card

- 9 Rotate the **MENU** Wheel to select "PROT.ALL", and press it. The PROTECT screen appears.
- 10 Rotate the **MENU** Wheel to select "EXECUTE", and press it.
  - To cancel protection, select "RETURN".

#### NOTES:

- If the "Ⓜ" mark appears, the currently displayed file is protected.
- When the memory card is initialized or corrupted, even protected files are deleted. If you do not want to lose important files, transfer them to a PC and save them.

### To Remove Protection

Before doing the following, perform steps 1 – 8 in "Protecting Files" in the left column.

#### To remove protection from the currently displayed file

- 9 Rotate the **MENU** Wheel to select "CURRENT", and press it. The PROTECT screen appears.
- 10 Press **◀** or **▶** to select the desired file.
- 11 Rotate the **MENU** Wheel to select "EXECUTE", and press it.
  - To cancel selection, select "RETURN".
  - Repeat steps 10 and 11 for all files you want to remove protection.

## To remove protection from all files stored in the memory card

- 9 Rotate the **MENU** Wheel to select "CANC.ALL", and press it. The PROTECT screen appears.
- 10 Rotate the **MENU** Wheel to select "EXECUTE", and press it.
  - To cancel selection, select "RETURN".

## Deleting Files

Previously stored files can be deleted either one at a time or all at once.

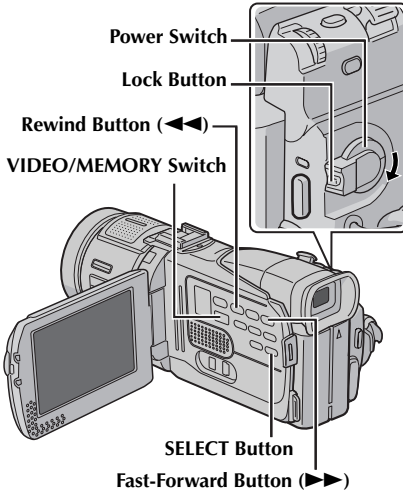

- 1 Load a memory card. (☞ pg. 16)
- 2 Set the **VIDEO/MEMORY** Switch to "MEMORY".
- 3 Set the **Power Switch** to "PLAY" while pressing down the **Lock Button** located on the switch.
- 4 Open the LCD monitor fully, or pull out the viewfinder fully.
  - The type of file (IMAGE, E-MAIL CLIP or TITLE) which has been played back at the last time is displayed.

If you want to select another type of file, go to step 5.

If not, go to step 7.

- 5 Press **SELECT**. The MEMORY SELECT screen appears.
- 6 Rotate the **MENU** Wheel to select the desired type of file, and press it.
- 7 Press the **MENU** Wheel in. The Menu Screen appears.

- 8 Rotate the **MENU** Wheel to select "DELETE", and press it. The Sub Menu appears.

## To delete the currently displayed file

- 9 Rotate the **MENU** Wheel to select "CURRENT", and press it. The DELETE screen appears.

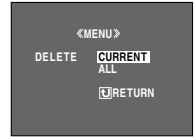

- 10 Press ◀◀ or ▶▶ to select the desired file.

- 11 Rotate the **MENU** Wheel to select "EXECUTE", and press it.

- To cancel deletion, select "RETURN".
- Repeat steps 10 and 11 for all files you want to delete.



### NOTE:

If the "Ⓢ" mark appears, the selected file is protected and cannot be deleted.

## To delete all files stored in the memory card

- 9 Rotate the **MENU** Wheel to select "ALL", and press it. The DELETE screen appears.
- 10 Rotate the **MENU** Wheel to select "EXECUTE", and press it.
  - To cancel deletion, select "RETURN".

### NOTES:

- Protected files (☞ pg. 27) cannot be deleted. To delete them, remove protection first.
- Once files are deleted, they cannot be restored. Check files before deleting.

### CAUTION:

Do not remove the memory card or perform any other operation (such as turning off the camcorder) during deletion. Also, be sure to use the provided AC Adapter, as the memory card may be corrupted if the battery becomes exhausted during deletion. If the memory card becomes corrupted, initialize it. (☞ pg. 30)

## Resetting The File Name

By resetting the file name, a new folder will be made. The new files you are going to make will be stored in the new folder. It is convenient to separate the new files from previously made files. (Available only for Image and video clip files.)

- 1 Load a memory card. (☞ pg. 16)
- 2 Set the **VIDEO/MEMORY** Switch to "MEMORY".
- 3 Set the Power Switch to "PLAY" while pressing down the Lock Button located on the switch.
- 4 Open the LCD monitor fully, or pull out the viewfinder fully.
  - The type of file (IMAGE, E-MAIL CLIP or TITLE) which has been played back at the last time is displayed.
- 5 If the title image playback (TITLE, ☞ pg. 25) screen appears, press **SELECT**. The MEMORY SELECT screen appears.
- 6 Rotate the **MENU** Wheel to select the desired type of file (IMAGE or E-MAIL CLIP), and press it. The image or video clip playback screen (IMAGE or E-MAIL CLIP) appears.
- 7 Press the **MENU** Wheel in. The Menu Screen appears.
- 8 Rotate the **MENU** Wheel to select "NO. RESET", and press it. The NO. RESET screen appears.
- 9 Rotate the **MENU** Wheel to select "EXECUTE", and press it. The new folder (such as "101JVCGR") will be made and the file made of the next shot starts from DVC00001.

### Folder and File names

Each time shooting takes place, a file name is made using a number which is larger by one than the largest number of the file names which are in use. Even if you delete an image or video clip file with a number in the middle of range, the number will not be used for a new shot; a gap will remain in the numerical sequence. If the file name reaches DVC09999, a new folder (such as "101JVCGR") will be made and the file name will start again from DVC00001.

## Setting Print Information (DPOF Setting)

This camcorder is compatible with the DPOF (Digital Print Order Format) standard in order to support future systems such as automatic printing. You can select one of the 2 print information settings for images stored in the memory card: "To Print All Still Images (One Print For Each)" or "To Print By Selecting Still Images And Number Of Prints".

### NOTES:



- If you load a memory card already set as shown below in a printer compatible with DPOF, it will make prints of the selected still images automatically.
- To print images recorded on a tape, first dub them to a memory card. (☞ pg. 55)

### To Print All Still Images (One Print For Each)

- 1 Load a memory card. (☞ pg. 16)
- 2 Set the **VIDEO/MEMORY** Switch to "MEMORY".
- 3 Set the Power Switch to "PLAY" while pressing down the Lock Button located on the switch.
- 4 Open the LCD monitor fully, or pull out the viewfinder fully.
  - The type of file (IMAGE, E-MAIL CLIP or TITLE) which has been played back at the last time is displayed.
- 5 If the video clip playback (E-MAIL CLIP, ☞ pg. 25) or the title image playback (TITLE, ☞ pg. 25) screen appears, press **SELECT**. The MEMORY SELECT screen appears.
- 6 Rotate the **MENU** Wheel to select "IMAGE", and press it. The image playback screen (IMAGE) appears.
- 7 Press the **MENU** Wheel in. The Menu Screen appears.
- 8 Rotate the **MENU** Wheel to select "DPOF", and press it. The Sub Menu appears.
- 9 Rotate the **MENU** Wheel to select "ALL 1", and press it. The DPOF screen appears.
- 10 Rotate the **MENU** Wheel to select "EXECUTE", and press it. The normal playback screen appears.
  - To cancel selection, select "RETURN".



## To Print By Selecting Still Images And Number Of Prints

- 1 Perform steps **1 – 8** in “To Print All Still Images (One Print For Each)” (pg. 29).
- 2 Rotate the **MENU** Wheel to select “CURRENT”, and press it. The DPOF screen appears.
 
- 3 Press **◀** or **▶** to select the desired file.
- 4 Rotate the **MENU** Wheel to select the number indication (00), and press it.
 
- 5 Select the number of prints by rotating the **MENU** Wheel towards “+” to increase number, or towards “-” to decrease the number, and press it.
  - Repeat steps **3** through **5** for the desired number of prints.
  - The number of prints can be set up to 15.
  - To correct the number of prints, select the image again and change the number.
- 6 Rotate the **MENU** Wheel to select “EXECUTE”, and press it. The “SAVE?” appears.
  - If you did not change any settings in step **3** through **5**, the Menu Screen reappears.
- 7 Rotate the **MENU** Wheel to select “EXECUTE” to save the setting you have just made, and press it.
  - To cancel selection, select “CANCEL”.

## To Reset The Number Of Prints



- 1 Perform steps **1 – 8** in “To Print All Still Images (One Print For Each)” (pg. 29).
- 2 Rotate the **MENU** Wheel to select “RESET”, and press it. The DPOF screen appears.
- 3 Rotate the **MENU** Wheel to select “EXECUTE”, and press it. The normal playback screen appears.
  - To cancel selection, select “RETURN”.
  - The number of prints is reset to 0 for all still images.

### CAUTION:

While performing the above, never disconnect power, as this may cause the memory card to be corrupted.

## Initializing A Memory Card

You can initialize a memory card anytime. After initializing, all files and data stored in the memory card, including those which have been protected, are cleared.

- 1 Set the **VIDEO/MEMORY** Switch to “MEMORY”.
- 2 Set the Power Switch to “PLAY” while pressing down the Lock Button located on the switch.
- 3 Open the LCD monitor fully, or pull out the viewfinder fully.
- 4 Press the **MENU** Wheel in. The Menu Screen appears.
 
- 5 Rotate the **MENU** Wheel to select “FORMAT”, and press it. The FORMAT screen appears.
 
- 6 Rotate the **MENU** Wheel to select “EXECUTE”, and press it. The memory card is initialized.
  - When initialization is finished, “NO IMAGES STORED”, “NO E-MAIL CLIP STORED” or “NO TITLE DATA STORED” appears.
  - To cancel initialization, select “RETURN”.

### CAUTION:

Do not perform any other operation (such as turning off the camcorder) during initialization. Also, be sure to use the provided AC Adapter, as the memory card may be corrupted if the battery becomes exhausted during initialization. If the memory card becomes corrupted initialize it.

## Changing The Menu Settings

This camcorder is equipped with an easy-to-use, on-screen menu system that simplifies many of the more detailed camcorder settings. (➔ pg. 32 – 41)

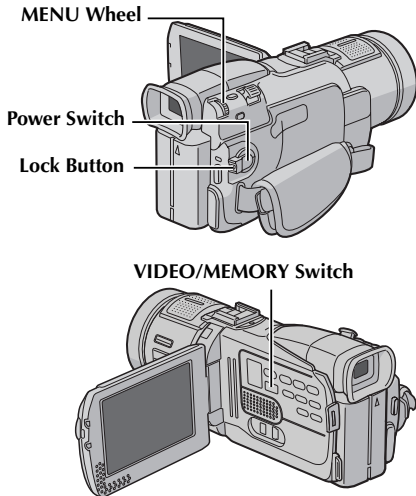

### 1 For Video and D.S.C. Recording Menus:

- Set the VIDEO/MEMORY Switch to “VIDEO” or “MEMORY”.
- Set the Power Switch to “” while pressing down the Lock Button located on the switch.

### For Video Playback Menus:

- Set the VIDEO/MEMORY Switch to “VIDEO”.
- Set the Power Switch to “PLAY” while pressing down the Lock Button located on the switch.
- For D.S.C. Playback Menus, refer to “D.S.C. PLAYBACK” (➔ pg. 24).

2 Open the LCD monitor fully, or pull out the viewfinder fully.

3 Press the MENU Wheel in. The Menu Screen appears.

#### Menu Screen for Video and D.S.C. Recording Menu

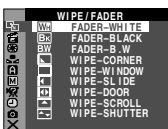

#### Menu Screen for Video Playback Menu

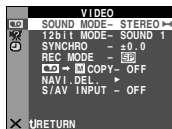

4 Rotate the MENU Wheel to select the desired function, and press it. The selected function menu appears.

5 Setting procedure hereafter depends on the selected function.

## Menu without Sub Menu

- WIPE/FADER, PROGRAM AE, EXPOSURE, W. BALANCE

1) Rotate the MENU Wheel to select the desired parameter.

Example: PROGRAM AE Menu

Selected menu icon is displayed in reverse.



Selected parameter

2) Press the MENU Wheel in. Selection is complete. The Menu Screen returns.

- Repeat the procedure if you wish to set other function menus.

3) Press the MENU Wheel in again. The Menu Screen closes.

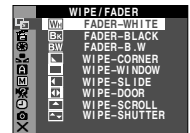

## Menu with Sub Menu

- CAMERA, MANUAL, SYSTEM, CAMERA DISPLAY, DSC, VIDEO, VIDEO DISPLAY

1) Rotate the MENU Wheel to select the desired function, and press it. The Sub Menu appears.

Example: CAMERA Menu

Selected function

Selected menu icon is displayed in reverse.

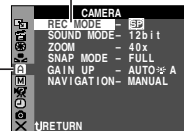

2) Rotate the MENU Wheel to select the desired parameter.

Sub Menu



3) Press the MENU Wheel in. Selection is complete.

- Repeat the procedure if you wish to set other function menus.

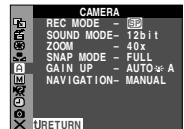

ADVANCED FEATURES

- 4) Press the **MENU** Wheel in. The Menu Screen returns.
  - Repeat the procedure if you wish to set other function menus.
- 5) Press the **MENU** Wheel in again. The Menu Screen closes.

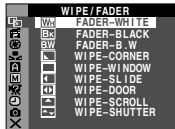
**NOTES:**

- The **[A]** settings are effective when the Power Switch is set to both **[A]** and **[M]**. However, the menu settings can be changed only when the Power Switch is set to **[M]**.
- The **[M]** settings are effective only when the Power Switch is set to **[M]**.
- The **[R]** functions which are set when the Power Switch is set to **[M]** are also applied when the Power Switch is set to **[PLAY]**.
- The **[C]** (CAMERA DISPLAY) settings are effective even when the Power Switch is set to **[A]**. However, the menu settings can be changed only when the Power Switch is set to **[M]**.
- The **[C]** (CAMERA DISPLAY) settings are effective only for shooting except **[BRIGHT]**.
- The **[V]** (VIDEO DISPLAY) settings are effective only for video playback except **[BRIGHT]**.
- The date indication can also be turned on/off by pressing the **DISPLAY** Button on the remote control (provided). (☞ pg. 22, 52, 62)

**Wipe Or Fader Effects****IMPORTANT:**

Some Wipe/Fader Effects cannot be used with certain modes of Program AE with special effects. (☞ pg. 33) If an unusable Wipe/Fader Effect is selected, its indicator blinks in blue or goes out.

These effects let you make pro-style scene transitions. Use them to spice up the transition from one scene to the next.

Wipe or Fader works when video recording is started or stopped.

- 1** Set the **VIDEO/MEMORY** Switch to **[VIDEO]**.
- 2** Set the Power Switch to **[M]** while pressing down the Lock Button located on the switch.
- 3** Open the LCD monitor fully, or pull out the viewfinder fully.
- 4** Set **[E]** to the desired mode. (☞ pg. 31)
- 5** To activate the **Fade-in or Wipe-in**, press **FADE/WIPE** during Record-Standby mode.
  - The selected effect indicator appears.

To activate the **Fade-out or Wipe-out**, press **FADE/WIPE** during recording.

  - The selected effect indicator appears.
- 6** Press the Recording Start/Stop Button to activate the Fade-in/out or Wipe-in/out.

**To deactivate the selected effect...**

Press **FADE/WIPE** again in step **6**. The effect indicator disappears.

**NOTE:**

You can extend the length of a Wipe or Fader by pressing and holding the Recording Start/Stop Button.

**[E] WIPE/FADER**

(Factory-preset: **FADER-WHITE**)

**[Wh]** **FADER-WHITE**: Fade in or out with a white screen.

**[Bk]** **FADER-BLACK**: Fade in or out with a black screen.

**[Bw]** **FADER-B.W**: Fade in to a color screen from a black and white screen, or fade out from color to black and white.





 **WIPE – CORNER:** Wipe in on a black screen from the upper right to the lower left corner, or wipe out from lower left to upper right, leaving a black screen.

 **WIPE – WINDOW:** The scene starts in the center of a black screen and wipes in toward the corners, or comes in from the corners, gradually wiping out to the center.

 **WIPE – SLIDE:** Wipe in from right to left, or wipe out from left to right.

 **WIPE – DOOR:** Wipe in as the two halves of a black screen open to the left and right, revealing the scene, or wipe out and the black screen reappears from left and right to cover the scene.



 **WIPE – SCROLL:** The scene wipes in from the bottom to the top of a black screen, or wipes out from top to bottom, leaving a black screen.

 **WIPE – SHUTTER:** Wipe in from the center of a black screen toward the top and bottom, or wipe out from the top and bottom toward the center leaving a black screen.

## Program AE With Special Effects

### IMPORTANT:

Some modes of Program AE with special effects cannot be used with certain Wipe/Fader effects. (☞ pg. 32) If an unusable mode is selected, the indicator of Wipe/Fader effects blinks or goes out.

- 1 Set the Power Switch to “” while pressing down the Lock Button located on the switch.
- 2 Open the LCD monitor fully, or pull out the viewfinder fully.
- 3 Set “” to the desired mode. (☞ pg. 31)
- 4 Press **PROG.AE** to activate the selected effect.
  - The selected effect indicator appears.

### To deactivate the selected effect...

Press **PROG.AE** again. The effect indicator disappears.

### NOTES:

- Program AE with special effects can be changed during recording or during Record-Standby.
- Some modes of Program AE with special effects cannot be used during Night-Alive.

## PROGRAM AE

(Factory-preset: **SHUTTER 1/60**)

**1/60 SHUTTER 1/60:** The shutter speed is fixed at 1/60th of a second. Black bands that usually appear when shooting a TV screen become narrower.

**1/100 SHUTTER 1/100:** The shutter speed is fixed at 1/100th of a second. The flickering that occurs when shooting under a fluorescent light or mercury-vapor lamp is reduced.

### SPORTS

**(Variable Shutter Speed: 1/250 – 1/4000)**

This setting allows fast-moving images to be captured one frame at a time, for vivid, stable slow-motion playback. The faster the shutter speed, the darker the picture becomes. Use the shutter function under good lighting conditions.

### SNOW

Compensates for subjects that may otherwise appear too dark when shooting in extremely bright surroundings such as in the snow.

### SPOTLIGHT

Compensates for subjects that may otherwise appear too bright when shooting under extremely strong direct lighting such as spotlights.

### NOTE:

“**SPOTLIGHT**” has the same effect as **-3** with the exposure control. (☞ pg. 46)

### TWILIGHT

Makes evening scenes look more natural. White Balance (☞ pg. 34, 47) is automatically set to “”, but can be changed to your desired setting. When Twilight is chosen, the camcorder automatically adjusts the focus from approx. 10 m (32 ft) to infinity. From less than 10 m (32 ft), adjust the focus manually. The flash does not fire in this mode.

 **SEPIA**: Recorded scenes have a brownish tint like old photos. Combine this with the Cinema mode for a classic look.

**B/W MONOTONE**: Like classic black and white films, your footage is shot in B/W. Used together with the Cinema mode, it enhances the “classic film” effect.

 **CLASSIC FILM\***: Gives recorded scenes a strobe effect.

 **STROBE\***: Your recording looks like a series of consecutive snapshots.

 **MIRROR\***: Creates a mirror image on the right half of the screen, juxtaposed to the normal image on the other half.

\* Available only when the **VIDEO/MEMORY** Switch is set to “VIDEO”.

## Exposure Control

 **EXPOSURE** (Factory-preset: **AUTO**)

For details, refer to “Exposure Control” (☞ pg. 46).

**AUTO** : Returns to automatic exposure control.

**MANUAL** : Makes the exposure control indicator appear.

## White Balance Adjustment

 **W. BALANCE** (Factory-preset: **AUTO**)

For details, refer to “White Balance Adjustment” (☞ pg. 47).

**AUTO**: White balance is adjusted automatically.

 **MWB**: Adjust the white balance manually when shooting under various types of lighting.

 **FINE**: Outdoors on a sunny day.

 **CLOUD**: Outdoors on a cloudy day.

 **HALOGEN**: A video light or similar type of lighting is used.

## Camera Menu

### CAMERA

#### Recording mode

Allows you to set the recording mode (SP or LP) depending on your preference.

**REC MODE** (Factory-preset: **SP**)

**SP**: Standard Play

**LP**: Long Play—more economical, providing 1.5 times the recording time.

#### NOTES:

- *Audio Dubbing* (☞ pg. 59) and *Insert Editing* (☞ pg. 60) are possible on tapes recorded in the SP mode.
- *If the recording mode is switched during recording, the playback picture will be blurred at the switching point.*
- *It is recommended that tapes recorded in the LP mode on this camcorder be played back on this camcorder.*
- *During playback of a tape recorded on another camcorder, blocks of noise may appear or there may be momentary pauses in the sound.*

#### Sound mode

**SOUND MODE** (Factory-preset: **12 bit**)

**12 bit**: Enables video recording of stereo sound on four separate channels, and is recommended for use when performing Audio Dubbing. (Equivalent to the 32 kHz mode of previous models)

**16 bit**: Enables video recording of stereo sound on two separate channels. (Equivalent to the 48 kHz mode of previous models)

## Zooming

**ZOOM** (Factory-preset: **40X**)

**10X**: When set to “10X” while using digital zoom, the zoom magnification will reset to 10X since digital zoom will be disengaged.

**40X\***: Allows you to use the Digital Zoom. By digitally processing and magnifying images, zooming is possible from 10X (the optical zoom limit), to a maximum of 40X digital magnification.

**200X\***: Allows you to use the Digital Zoom. By digitally processing and magnifying images, zooming is possible from 10X (the optical zoom limit), to a maximum of 200X digital magnification.

\* Available only when the **VIDEO/MEMORY** Switch is set to “VIDEO”.

## Snapshot mode for video recording

For details on the procedure, refer to “Snapshot (For Video Recording)” (☞ pg. 42). There is the sound effect of a shutter closing.

**SNAP MODE** (Factory-preset: **FULL**)

**FULL**: Snapshot mode with no frame

**NEGA**: Nega mode

**PIN-UP**: Pin-Up mode

**FRAME**: Snapshot mode with frame



FULL



NEGA



PIN-UP





FRAME

## Gain up

**GAIN UP** (Factory-preset: **AGC**)

**OFF**: Allows you to shoot dark scenes with no picture brightness adjustment.

**AGC**: The overall appearance may be grainy, but the image is bright.

**AUTO** : The shutter speed is automatically adjusted. Shooting a subject in low or poor lighting at slow shutter speed provides a brighter image than in the AGC mode, but the subject's movements are not smooth or natural. The overall appearance may be grainy. While the shutter speed is being automatically adjusted, “A” is displayed.

## Navigation time

**NAVIGATION** (Factory-preset: **MANUAL**)

**5SEC / 15SEC / 30SEC / 60SEC**:

The captured image is stored in the memory card as a thumbnail image when the recording time is over the navigation time.

For example, “5SEC” is suitable to record short scenes with the thumbnail images. (☞ pg. 48) However, the stored thumbnail images may take up a lot of memory. In this case, using the memory card with large capacity is recommended.

**MANUAL**: Enables thumbnail images to be made manually. (☞ pg. 49).

## Manual Menu

### MANUAL

#### Digital Image Stabilization

To compensate for unstable images caused by camera-shake, particularly at high magnification.

**DIS** (Factory-preset: **ON**)

OFF / ON 

#### NOTES:

- Accurate stabilization may not be possible if hand shake is excessive, or under the following conditions:
  - When shooting subjects with vertical or horizontal stripes.
  - When shooting dark or dim subjects.
  - When shooting subjects with excessive backlighting.
  - When shooting scenes with movement in various directions.
  - When shooting scenes with low-contrast backgrounds.
- Switch off this mode when recording with the camcorder on a tripod.
- The "" indicator blinks or goes out if the Stabilizer cannot be used.

#### Self-Timer

For details, refer to "Self-Timer" (☞ pg. 43).

**SELF-TIMER** (Factory-preset: **OFF**)

OFF / ON 

#### 5-Second Recording

Record a vacation or an important event in 5-second clips to keep the action moving. This function is available only for video recording.

- 1 Set "5S" to "5S". (☞ pg. 31)
  - "5S" appears.
- 2 Press the Recording Start/Stop Button to start recording, and after 5 seconds the camcorder enters Record-Standby mode automatically.
  - Even if you press the Recording Start/Stop Button again within 5 seconds after recording starts, Record-Standby mode is not engaged.
- 3 To exit the 5S mode, select "OFF" in step 1.

#### To take a snapshot in the 5-second recording mode...

Instead of pressing the Recording Start/Stop Button in step 2, select the desired Snapshot mode in CAMERA Menu (☞ pg. 35), then press **SNAPSHOT**. The camcorder records a 5-second still. When "5S" is set to "Anim.", this function is not available.

**5S** (Factory-preset: **OFF**)

**OFF:** Disables 5-Second Recording.

**5S:** Enables 5-Second Recording.

**Anim.:** Allows you to record a few frames only. By using an inanimate object and changing its position between shots, you can record the subject as though it is moving.

#### NOTE:

When "5S" is set to "Anim.", the 5-Second Recording mode is not available. Animation recording of a few frames only is taken instead.

#### Maximum telephoto setting

Usually the distance to a subject where the lens is in focus depends on the zoom magnification. Unless there is a distance more than 1 m (3.3 ft) to the subject, the lens is out of focus at the maximum telephoto setting.

**TELE MACRO** (Factory-preset: **OFF**)

**OFF:** Disables the function.

**ON:** When set to "ON", you can shoot a subject as large as possible at a distance of approx. 60 cm (2 ft).



#### NOTE:



Depending on the zoom position, the lens may go out of focus.



## Wide mode

**WIDE MODE** (Factory-preset: **OFF**)

**OFF:** Records with no change in the screen ratio. For playback on a TV with a normal screen ratio.

**CINEMA\***: Inserts black bands at the top and bottom of the screen. The  indicator appears. During playback on wide-screen TVs, the black bands at the top and bottom of the screen are cut and the screen ratio becomes 16:9. When using this mode, refer to your wide-screen TV's instruction manual. During playback/recording on 4:3 TVs/LCD monitor/viewfinder, black bands are inserted at the top and bottom of the screen and the image appears like a letter boxed 16:9 movie.

**SQUEEZE\***: For playback on TVs with an aspect ratio of 16:9. Naturally expands the image to fit the screen without distortion. The  indicator appears. When using this mode, refer to your wide-screen TV's instruction manual. During playback/recording on 4:3 TVs/LCD monitor/viewfinder, the image is elongated vertically.



**D.WIDE\***: The  indicator appears. The zoom range is extended beyond the maximum optical zoom wide angle range. This mode's wide angle setting is equivalent to using a 0.7X wide conversion lens. Zooming is possible from 0.7X to a magnification set in CAMERA Menu. This mode is suitable for shooting in a small room.

\* Available only when the **VIDEO/MEMORY** Switch is set to "VIDEO".

## Wind cut

**WIND CUT** (Factory-preset: **OFF**)

**OFF:** Disengages the function.

**ON** : Helps cut down on noise created by wind. The "" indicator appears. The quality of the sound will change. This is normal.

## System Menu

### SYSTEM

#### Beep, melody and shutter sound

**BEEP** (Factory-preset: **MELODY**)

**OFF:** Even though not heard while shooting, shutter sound is recorded on the tape.

**BEEP:** The beep sounds when the power is turned on or off, and at the beginning and end of recording. It also activates the shutter sound effect. (☞ pg. 23, 42)

**MELODY:** Instead of a beep, a melody sounds when any operation is performed. It also activates the shutter sound effect. (☞ pg. 23, 42)

#### Tally lamp setting

**TALLY** (Factory-preset: **ON**)

**OFF:** The tally lamp remains off at all times.

**ON:** The tally lamp comes on to signal the start of recording.

#### Remote control setting

For details, refer to "USING THE REMOTE CONTROL UNIT" (☞ pg. 56).

**REMOTE** (Factory-preset: **ON**)

**OFF:** Disables the remote control operations.

**ON:** Enables the remote control operations.

## Automatic demonstration mode

Demonstrates certain functions such as Program AE with special effects, etc., and can be used to confirm how these functions operate. (☞ pg. 9)

**DEMO MODE** (Factory-preset: **ON**)

**OFF:** Automatic demonstration will not take place.

**ON:** Demonstrates certain functions such as Program AE with special effects, etc., and can be used to confirm how these functions operate.

Demonstration starts in the following cases:

- When the Menu Screen is closed after “DEMO MODE” is turned “ON”.
- With “DEMO MODE” set to “ON”, if there is no operation for about 3 minutes after the Power Switch is set to “**A**” or “**M**”.

Performing any operation during the demonstration stops the demonstration temporarily. If no operation is performed for more than 3 minutes after that, the demonstration will resume.

### NOTES:

- If a cassette is in the camcorder, the demonstration cannot be turned on.
- “DEMO MODE” remains “ON” even if the camcorder power is turned off.
- If “DEMO MODE” remains “ON”, some functions will not be available. After viewing demo, set to “OFF”.

## Title impose

For details, refer to “Title Impose” (☞ pg. 44).

**TITLE W/** (Factory-preset: **IMAGE**)

**BACKGRND:** Superimposes the title/frame over images.

**IMAGE:** Superimposes the title/frame with its white background.

## Priority setting

When the viewfinder is pulled out while the LCD monitor is opened, you can select which one to use.

**PRIORITY** (Factory-preset: **LCD**)

**LCD:** Allows you to use the LCD monitor.

**FINDER:** Allows you to use the viewfinder.

## Resetting menu settings

**CAM RESET**

**EXECUTE:** Resets all settings to the factory-preset.

**RETURN:** Does not reset all settings to the factory-preset.

## Display Menu

### CAMERA DISPLAY

#### Brightness adjustment of the display

For details, refer to “Brightness Adjustment Of The Display” (☞ pg. 13).

#### Display setting

**ON SCREEN** (Factory-preset: **LCD/TV**)

**LCD:** Keeps the camcorder’s display (except the date, time and time code) from appearing on the connected TV screen.

**LCD/TV:** Makes the camcorder’s display appear on screen when the camcorder is connected to a TV.

#### Date and time display setting

**DATE/TIME** (Factory-preset: **AUTO**)

**OFF:** The date/time does not appear.

**AUTO:** Displays the date/time for approx. 5 seconds when the Power Switch is set from “OFF” to “**A**” or “**M**”.

**ON:** The date/time is always displayed.

#### Time code setting

**TIME CODE** (Factory-preset: **OFF**)

**OFF:** Time code is not displayed.

**ON:** Time code is displayed on the camcorder and on the connected TV. Frame numbers are not displayed during recording.

#### Clock adjustment

**CLOCK ADJ.**



Allows you to set the current date and time.

(☞ pg. 14)

## DSC Menu

### DSC

### Picture quality

The Picture Quality mode can be selected to best match your needs. Two Picture Quality modes are available: FINE () and STANDARD () (in order of quality).

**QUALITY** (Factory-preset: **FINE**)  
FINE / STANDARD

#### NOTE:

The number of storable images depends on the selected picture quality as well as the composition of the subjects in the images and the type of memory card being used.

### Image size

The Image Size mode can be selected to best match your needs.

**IMAGE SIZE** (Factory-preset: **1280 x 960**)  
640 x 480 / 1024 x 768 / 1280 x 960 /  
1600 x 1200

#### NOTE:

The settings can be changed only when the **VIDEO/MEMORY** Switch is set to "MEMORY".

#### Approximate Number of Storable Images

Image Size/Picture Quality	SD Memory Card			
	8 MB*	16 MB*	32 MB*	64 MB*
640 x 480/ FINE	47	95	205	405
640 x 480/ STANDARD	160	295	625	1285
1024 x 768/ FINE	21	47	95	200
1024 x 768/ STANDARD	65	145	310	640
1280 x 960/ FINE	13	29	60	125
1280 x 960/ STANDARD	45	95	205	425
1600 x 1200/ FINE	8	19	41	80
1600 x 1200/ STANDARD	28	60	130	275

Image Size/Picture Quality	MultiMediaCard			
	8 MB**	8 MB*	16 MB*	32 MB*
640 x 480/ FINE	49	55	105	215
640 x 480/ STANDARD	165	190	320	645
1024 x 768/ FINE	22	25	50	100
1024 x 768/ STANDARD	70	75	160	320
1280 x 960/ FINE	14	16	32	60
1280 x 960/ STANDARD	47	50	105	215
1600 x 1200/ FINE	9	10	21	42
1600 x 1200/ STANDARD	30	34	65	135



\* Optional

\*\* Provided (9 title images pre-stored)

### Recording media selection

**REC SELECT** (Factory-preset: )

 : When Snapshot recording is performed with the **VIDEO/MEMORY** Switch set to "VIDEO", still images are recorded only onto the tape.

  : When Snapshot recording is performed with the **VIDEO/MEMORY** Switch set to "VIDEO", still images are recorded not only onto the tape but also in the memory card (640 x 480 pixels). In this mode, the "SNAP MODE" selection in CAMERA Menu is also applicable to memory card recording.

## Video Menu

### VIDEO

#### Playback sound

During tape playback, the camcorder detects the sound mode in which the recording was made, and plays the sound back. Select the type of sound to accompany your playback picture. According to the menu access explanation on page 31, select "SOUND MODE" or "12bit MODE" from the Menu Screen and set it to the desired parameter.

**SOUND MODE** (Factory-preset: **STEREO** )

**STEREO** : Sound is output on both "L" and "R" channels in stereo.

**SOUND L** : Sound from the "L" channel is output.

**SOUND R** : Sound from the "R" channel is output.

**12bit MODE** (Factory-preset: **SOUND 1**)

**MIX**: Original and dubbed sounds are combined and output in stereo on both "L" and "R" channels.

**SOUND 1**: Original sound is output on both "L" and "R" channels in stereo.

**SOUND 2**: Dubbed sound is output on both "L" and "R" channels in stereo.

#### NOTES:

- **For GR-DV800/500 owners:** You can also use **AUDIO** button on the provided remote control ( pg. 56) to change the output sound (without having to access the Playback Menu).
- The "SOUND MODE" setting is available for both 12-bit and 16-bit sound. (In previous models' functions, "12-bit" is called "32 kHz" and "16-bit" is called "48 kHz".)
- The camcorder cannot detect the sound mode in which the recording was made during fast-forward or rewind. During playback the sound mode is displayed in the upper left corner.

#### Synchro adjustment

For details, refer to "For More Accurate Editing" ( pg. 65).

**SYNCHRO** (Factory-preset: **±0.0**)

#### Recording mode

Allows you to set the video recording mode (SP or LP) depending on your preference. It is recommended you use "REC MODE" in VIDEO Menu when using this camcorder as a recorder during dubbing. ( pg. 52, 54)

**REC MODE** (Factory-preset: **SP**)  
SP / LP

#### NOTE:

"REC MODE" can be set when the Power Switch is set to "PLAY" or .

#### Dubbing from tape to memory card

  **COPY** (Factory-preset: **OFF**)

**OFF**: Enables snapshots to be taken during tape playback.

**ON**: Enables dubbing of images recorded on a tape to a memory card. ( pg. 55)

#### Deleting thumbnail images

For details, refer to "To delete thumbnail images" ( pg. 49).

**NAVI.DEL.**

**IMAGE SEL. / TAPE SEL. / ALL / RETURN**

#### S-Video/AV input

**S/AV INPUT** (Factory-preset: **OFF**)



**OFF**: Enables audio and video signal input from DV IN/OUT connector. ( pg. 54)

**ON**: Enables audio/video signal input from the AV and S-Video connectors. ( pg. 52)



## System Menu

### SYSTEM

Each setting is linked with “”, which appears when the Power Switch is set to “”. (☞ pg. 31) The parameters are the same as in the description on page 37.

**BEEP** (Factory-preset: **MELODY**)  
OFF / BEEP / MELODY

**TALLY** (Factory-preset: **ON**)  
OFF / ON

**REMOTE** (Factory preset: **ON**)  
OFF / ON

**DEMO MODE** (Factory-preset: **ON**)  
OFF / ON

## Display Menu

### VIDEO DISPLAY

The parameters (except “OFF” in ON SCREEN settings) are the same as in the description on page 38.

### Brightness adjustment of the display

For details, refer to “Brightness Adjustment Of The Display” (☞ pg. 13).

**ON SCREEN** (Factory-preset: **LCD**)  
OFF / LCD / LCD/TV

When set to “OFF”, the camcorder’s display disappears.

**DATE/TIME** (Factory-preset: **OFF**)  
OFF / AUTO / ON

When set to “AUTO”, the date/time are displayed in the following cases:



- When playback starts. The camcorder displays the date/time when scenes are recorded.
- When the date is changed during playback.

**TIME CODE** (Factory-preset: **OFF**)  
OFF / ON

### NOTE:

The date indication can also be turned on/off by pressing the **DISPLAY** Button on the remote control (provided). (☞ pg. 22, 52, 62)

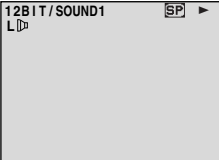
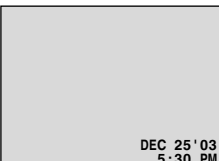
### Display

**ON SCREEN Setting:**  
For playback sound, tape speed and tape running during video playback.

**DATE/TIME Setting:**  
For date/time.

**TIME CODE Setting:**  
For time code.

Minutes  
Seconds  
Frames\*

\* 30 frames = 1 second

## Night Alive

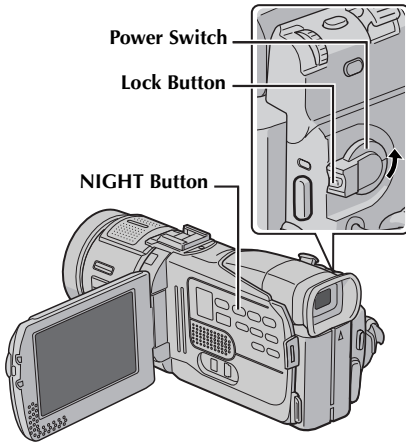

Makes dark subjects or areas even brighter than they would be under good natural lighting. Although the recorded image is not grainy, it may look as if it is strobing due to the slow shutter speed.

- 1 Set the Power Switch to “**M**” while pressing down the Lock Button located on the switch.
- 2 Open the LCD monitor fully or pull out the viewfinder fully.
- 3 Press **NIGHT** so that the Night-Alive indicator “**NA**” appears.
  - The shutter speed is automatically adjusted to provide up to 30 times sensitivity.
  - “**A**” appears beside “**NA**” while the shutter speed is being automatically adjusted.

### To deactivate Night-Alive...

Press **NIGHT** again so that the Night-Alive indicator disappears.

### NOTES:

- During Night-Alive, the following functions or settings cannot be activated and its indicator blinks or goes out:
  - Some modes of “Program AE With Special Effects” (☞ pg. 33).
  - “GAIN UP” in CAMERA Menu. (☞ pg. 35)
  - “DIS” in MANUAL Menu. (☞ pg. 36)
- During Night-Alive, it may be difficult to bring the camcorder into focus. To prevent this, use of a tripod is recommended.

## Snapshot (For Video Recording)

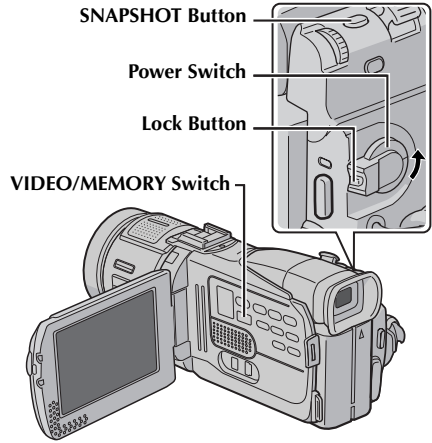

This feature lets you record still images that look like photographs onto a tape.

- 1 Set the **VIDEO/MEMORY** Switch to “VIDEO”.
- 2 Set the Power Switch to “**M**” while pressing down the Lock Button located on the switch.
- 3 Open the LCD monitor fully, or pull out the viewfinder fully.
- 4 Set “SNAP MODE” to the desired mode. (☞ pg. 31, 35)
- 5 Press **SNAPSHOT**.
  - The “**PHOTO**” indication appears and a still image will be recorded for approx. 6 seconds, then the camcorder re-enters the Record-Standby mode.
  - You can perform Snapshot also during recording. A still image will be recorded for approx. 6 seconds, then the normal recording resumes.
  - Regardless of the Power Switch position (“**A**” or “**M**”), Snapshot recording takes place using the selected Snapshot mode.

### NOTES:

- To remove the shutter sound, refer to “BEEP” on page 37.
- If Snapshot recording is not possible, the “**PHOTO**” indication blinks when **SNAPSHOT** is pressed.

- If Program AE with special effects (☞ pg. 33) is engaged, certain modes of Program AE with special effects are disabled during Snapshot recording. In such a case, the icon blinks.
- If **SNAPSHOT** is pressed when "DIS" is set to "ON" (☞ pg. 36), the Stabilizer will be disabled.
- During playback as well, all snapshot modes except Nega mode are available when "☞ ➔ M COPY" is set to "OFF" in VIDEO Menu. (☞ pg. 40) However, the shutter sound is not heard.
- During Snapshot recording, the image displayed in the viewfinder may be partially missing. However, there is no effect in the recorded image.
- When a cable is connected to the AV connector, the shutter sound is not heard from the speaker, however it is recorded onto the tape.

## Motor Drive Mode

Keeping **SNAPSHOT** pressed in step 5 provides an effect similar to serial photography. (Interval between still images: approx. 1 second)

- The Motor Drive mode is disabled when "REC SELECT" is set to "☞ ➔ M". (☞ pg. 39)

## Self-Timer

Once the camcorder is set, the camcorder operator can become part of the scene in a more natural way, adding the final touch to a memorable picture.

- 1 Set the Power Switch to "M" while pressing down the Lock Button located on the switch.
- 2 Open the LCD monitor fully, or pull out the viewfinder fully.
  - You can tilt the LCD monitor upward to 180° so that it faces forward and view yourself while self-recording with the viewfinder pushed back.
- 3 Set "SELF-TIMER" to "M" (☞ pg. 31, 36)

- 4 To engage the Self-Timer for video recording, press the Recording Start/Stop Button.

- After 15 seconds, the beep sounds and video recording starts.

- 5 To stop Self-Timer recording, press the Recording Start/Stop Button again.

- The camcorder re-enters Record-Standby mode.

### OR

- 5 Press **SNAPSHOT**.
  - After 15 seconds, the beep sounds and snapshot recording starts. After that, the camcorder re-enters Record-Standby mode.
- 6 To end Self-Timer recording, select "OFF" in step 3.

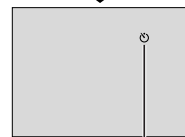
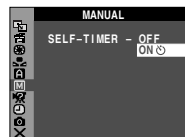

Self-Timer indication

**NOTE:**

If "BEEP" and "TALLY" are set to "OFF" (☞ pg. 37), the beep does not sound and the tally lamp does not light.

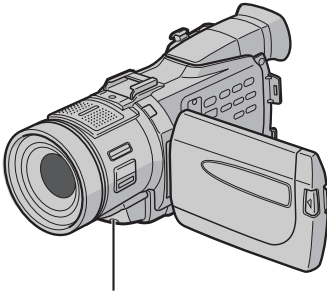

When the Recording Start/Stop Button or SNAPSHOT is pressed, the tally lamp changes as shown:

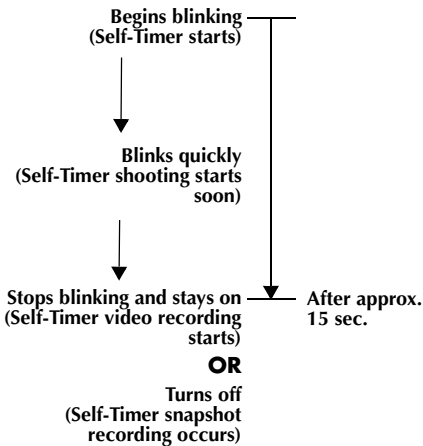
**Title Impose**

A selection of titles/frames stored in the provided memory card can be superimposed.

**Title Selection**

- 1** Perform steps **1** to **6** in "Playback Of Title Images" (☞ pg. 25).
- 2** Press **INDEX**. The title index screen appears.
- 3** Rotate the **MENU** Wheel to select the desired title, and press it.
- 4** Set "TITLE W/" to the desired mode. (☞ pg. 31, 38)

**Title Recording**

- 5** Press **TITLE** during recording. The selected title/frame is recorded.
  - Press **TITLE** again to turn off the title/frame.

**NOTES:**

- *Title Impose* can also be used for dubbing.
- You can delete unwanted titles/frames ("Deleting Files" (☞ pg. 28)) or protect important ones from accidental erasure ("Protecting Files" (☞ pg. 27)).
- A title/frame created on a PC can be transferred to a memory card using the provided software. Transferred titles/frames are displayed from title index number 12. They can be used together with the titles/frames in the provided memory card. For details on creating/transferring titles/frames, refer to the software instructions.

## Auto Focus

The camcorder's Full Range AF system offers continuous shooting ability from close-up (as close as approx. 5 cm (2") to the subject) to infinity.

### Focus detection zone

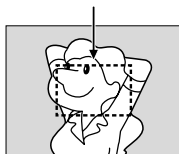

However, correct focus may not be obtainable in the situations listed below (in these cases perform "Manual Focus"):

- When two subjects overlap in the same scene.
- When illumination is low.\*
- When the subject has no contrast (difference in brightness and darkness), such as a flat, one-color wall, or a clear, blue sky.\*
- When a dark object is barely visible in the LCD monitor or the viewfinder.\*
- When the scene contains minute patterns or identical patterns that are regularly repeated.
- When the scene is affected by sunbeams or light reflecting off the surface of a body of water.
- When shooting a scene with a high-contrast background.

\* The following low-contrast warnings appear blinking: ▲, ◀, ▶ and 👤

### NOTES:

- If the lens is smeared or blurred, accurate focusing is not possible. Keep the lens clean. (☞ pg. 77) When condensation occurs, wipe with a soft cloth or wait for it to dry naturally.
- When shooting a subject close to the lens, zoom out first. (☞ pg. 18) If zoomed-in in the auto focus mode, the camcorder may automatically zoom out depending on the distance between the camcorder and the subject. This will not occur when "TELE MACRO" is set to "ON". (☞ pg. 36)

## Manual Focus

### NOTE:

If you are using the viewfinder, you should already have performed "Viewfinder Adjustment" (☞ pg. 12).

- 1 Set the Power Switch to "M" while pressing down the Lock Button located on the switch.
- 2 Press **FOCUS**. The manual focus indicator appears.
- 3 To focus on a further subject, rotate the **MENU** Wheel clockwise. The "▶" indicator appears and blinks.

### While focusing on a further subject

Manual focus indicator

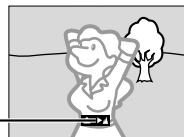

To focus on a nearer subject, rotate the **MENU** Wheel counterclockwise. The "◀" indicator appears and blinks.

### While focusing on a nearer subject

Manual focus indicator



### To reset to Auto Focus...

Press **FOCUS** twice or set the Power Switch to "A".

### NOTES:

- Be sure to focus the lens in the maximum telephoto position when you use the Manual Focus mode. If you focus in on a subject in the wide-angle position, sharply focused images cannot be obtained when zoomed up because the depth-of-field is reduced at longer focal lengths.
- When the focus level cannot be adjusted any further or closer, "▲" or "👤" will blink.

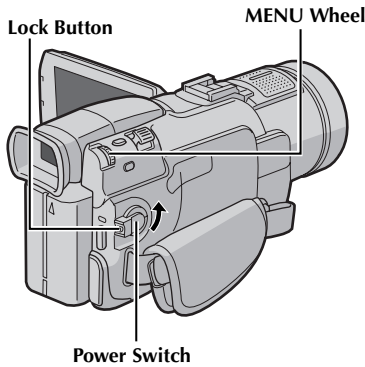

## Exposure Control

Manual exposure control is recommended in the following situations:

- When shooting using reverse lighting or when the background is too bright.
- When shooting on a reflective natural background such as at the beach or when skiing.
- When the background is overly dark or the subject is bright.

- 1 Set the Power Switch to "M" while pressing down the Lock Button located on the switch.
- 2 Open the LCD monitor fully, or pull out the viewfinder fully.
- 3 Set "E" to "MANUAL". (☞ pg. 31, 34)
  - The exposure control indicator appears.
- 4 To brighten the image, rotate the MENU Wheel towards "+". To darken the image, rotate the MENU Wheel towards "-". (maximum  $\pm 6$ )
  - +3 exposure has the same effect as the backlight compensation. (☞ pg. 47)
  - -3 exposure has the same effect as when "E" is set to "SPOTLIGHT". (☞ pg. 33)
- 5 Press the MENU Wheel in. Exposure adjustment is complete.

### To return to automatic exposure control...

Set "E" to "AUTO". (☞ pg. 31, 34) Or, set the Power Switch to "A".

### NOTES:

- You cannot use the manual exposure control at the same time when "E" is set to "SPOTLIGHT" or "SNOW" (☞ pg. 33), or with the backlight compensation. (☞ pg. 47)
- If the adjustment does not cause any visible change in brightness, set "GAIN UP" to "AUTO". (☞ pg. 31, 35)

## Iris Lock

Like the pupil of the human eye, the iris contracts in well-lit environments to keep too much light from entering, and dilates in dim environments to allow in more light.

Use this function in the following situations:

- When shooting a moving subject.
- When the distance to the subject changes (so its size in the LCD monitor or the viewfinder changes), such as when the subject is backing away.
- When shooting on a reflective natural background such as at the beach or when skiing.
- When shooting objects under a spotlight.
- When zooming.

When the subject is close, keep the iris locked. Even when the subject moves away from you, the image will not darken or brighten.

- 1 Set the Power Switch to "M" while pressing down the Lock Button located on the switch.
- 2 Open the LCD monitor fully, or pull out the viewfinder fully.
- 3 Set "E" to "MANUAL". (☞ pg. 31, 34)
  - The exposure control indicator appears.
- 4 Adjust zoom so that the subject fills the LCD monitor or the viewfinder, then press and hold the MENU Wheel in for over 2 seconds. The exposure control indicator and the "L" indication appear.
- 5 Press the MENU Wheel in. The "L" indication changes to "I" and the iris is locked.



Iris Lock Indicator

### To return to automatic iris control...

Set "E" to "AUTO".

(☞ pg. 31, 34) Or, set the Power Switch to "A".



- The exposure control indicator and "L" disappear.

### To lock the exposure control and the iris...

After step 3 of "Exposure Control", adjust the exposure by rotating the MENU Wheel. Then lock the iris in step 5 of "Iris Lock". For automatic locking, select "AUTO" in step 3. The iris becomes automatic after about 2 seconds.

## Backlight Compensation

Backlight compensation brightens the subject quickly.

Press **BACK LIGHT**. The  indicator is displayed and the subject is brightened. If pressed again,  disappears and the brightness returns to the previous level.

- Using the **BACK LIGHT** Button may cause the light around the subject to become too bright and the subject to become white.
- Backlight compensations is also available when the Power Switch is set to “”.

## White Balance Adjustment

The white balance that refers to the correctness of color reproduction under various lighting. If the white balance is correct, all other colors will be accurately reproduced.

The white balance is usually adjusted automatically. However, more advanced camcorder operators control this function manually to achieve a more professional color/tint reproduction.

(Factory-preset: **AUTO**)

**AUTO:** White balance is adjusted automatically.

 **MWB:** Adjust the white balance manually when shooting under various types of lighting. (☞ “Manual White Balance Adjustment”)



 **FINE:** Outdoors on a sunny day.

 **CLOUD:** Outdoors on a cloudy day.

 **HALOGEN:** A video light or similar type of lighting is used.

- For the setting, refer to “Changing The Menu Settings” (☞ pg. 31).
- The selected mode indicator except “AUTO” appears.

**To return to automatic white balance...**

Set “” to “AUTO”. (☞ pg. 31, 34) Or, set the Power Switch to “”.





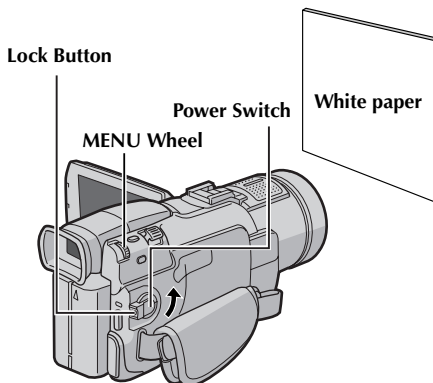

### NOTE:

White balance cannot be used when “” is set to “SEPIA” or “MONOTONE”. (☞ pg. 34)

## Manual White Balance Adjustment

Adjust the white balance manually when shooting under various types of lighting.



- 1 Set the Power Switch to “” while pressing down the Lock Button located on the switch.
- 2 Open the LCD monitor fully, or pull out the viewfinder fully.
- 3 Set “” to “MWB”. (☞ pg. 31, 34)
  - The  indication blinks slowly.
- 4 Remove the lens cap.
- 5 Hold a sheet of plain white paper in front of the subject. Adjust zoom or position yourself so that the white paper fills the screen.
- 6 Press the **MENU** Wheel in until  begins blinking rapidly. When the setting is completed,  resumes normal blinking.
- 7 Press the **MENU** Wheel in twice. The Menu Screen closes and the Manual White Balance indicator  is displayed.

### NOTES:

- In step 5, it may be difficult to focus on the white paper. In such a case, adjust focus manually. (☞ pg. 45)
- A subject can be shot under various types of lighting conditions indoors (natural, fluorescent, candlelight, etc.). Because the color temperature is different depending on the light source, the subject tint will differ depending on the white balance settings. Use this function for a more natural result.
- Once you adjust white balance manually, the setting is retained even if the power is turned off or the battery removed.

## NAVIGATION Function

The Navigation Function helps you check tape contents by making thumbnail images on a memory card.

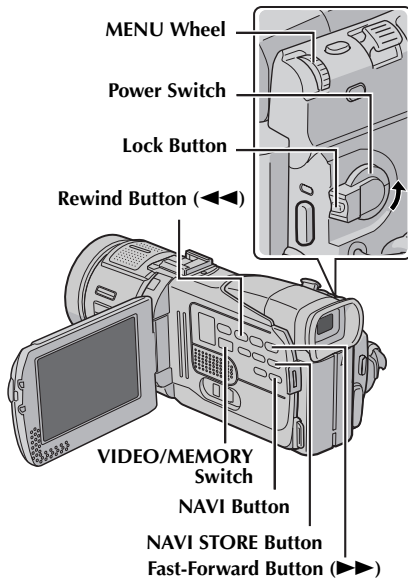

### To make thumbnail images during video recording automatically

- 1 Load a cassette. (☞ pg. 15)
- 2 Load a memory card. (☞ pg. 16)
- 3 Set the **VIDEO/MEMORY** Switch to "VIDEO".
- 4 Set the Power Switch to "A" or "M" while pressing down the Lock Button located on the switch.
- 5 Set "NAVIGATION" to the desired navigation storing time. (☞ pg. 31, 35)
  - If the "M" indicator appears blinking on the screen, wait until it stops blinking. If it does not stop blinking after a while, check if a memory card is loaded.
- 6 Press the Recording Start/Stop Button to start recording.

- When the recording time is over the navigation time set in step 5, "M" appears briefly, then the image of the point where recording is started is captured and stored in the memory card as a thumbnail image.
- If the Recording Start/Stop button is pressed before "M" stops blinking, the image of the point where the loaded memory card is recognised is captured.



Displayed while the captured image is being stored in the memory card.

- 7 Press the Recording Start/Stop Button to stop recording.

### To make thumbnail images after video recording manually...

- 1) Perform steps 1 to 4 above.
- 2) Set "NAVIGATION" to "MANUAL". (☞ pg. 31, 35)
- 3) After the recording, press **NAVI STORE**.
  - The "M" indicator appears briefly and the captured image is stored in the memory card as a thumbnail image.

### NOTES:

- The remaining number of storable thumbnail images also appears on the screen when it reaches 10 or less. If "REC SELECT" is set to "D" or "M" in DSC Menu, the number shows how many 640 x 480 pixel images can be stored.
- If "5S" is set to "5S" or "Anim." in MANUAL Menu, the NAVIGATION function will not work properly.

### To find scenes on tape using thumbnail images (NAVIGATION Search)

- 1 Load a cassette. (☞ pg. 15)
- 2 Load a memory card. (☞ pg. 16)
- 3 Set the **VIDEO/MEMORY** switch to "VIDEO".
- 4 Set the Power Switch to "PLAY" while pressing down the Lock Button located on the switch.
- 5 Press **NAVI** during video playback or stop mode.
  - The loaded cassette's NAVIGATION thumbnail image screen appears.
  - Press ◀◀ to display the previous page. Press ▶▶ to display the next page.
- 6 Rotate the **MENU** Wheel to select the desired image, and press it.





- The “NAVIGATION SEARCH” indication appears blinking and the camcorder starts searching the tape for the relevant point of the selected thumbnail image.

To cancel NAVIGATION search midway...

Press ►/II, ◀◀, ▶▶ or ■.

## To add thumbnail images during video playback

- 1 Perform steps 1 to 4 in “To find scenes on tape using thumbnail images (NAVIGATION Search)”.
- 2 Press ►/II to start video playback.
- 3 Press NAVI STORE at the desired point.
  - The “” indicator appears briefly and the image of the point where NAVI STORE is pressed is stored in the memory card as a thumbnail image.

## To delete thumbnail images

- 1 Load a memory card. (☞ pg. 16)
- 2 Set the VIDEO/MEMORY switch to “VIDEO”.
- 3 Set the Power Switch to “PLAY” while pressing down the Lock Button located on the switch.
- 4 Press the MENU Wheel in. The Menu Screen appears.
- 5 Rotate the MENU Wheel to select “”, and press it. The VIDEO Menu appears.
- 6 Rotate the MENU Wheel to select “NAVI.DEL.”, and press it. The Sub Menu appears.
- 7 By rotating the MENU Wheel...

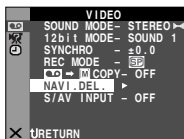

Select “IMAGE SEL.” to delete the currently displayed thumbnail image.

Select “TAPE SEL.” to delete all thumbnail images for the tape which contains the currently displayed image.

Select “ALL” to delete all thumbnail images stored in the memory card at once.

- 8 Press the MENU Wheel in. The NAVIGATION screen appears.
- 9 Rotate the MENU Wheel to select “EXECUTE”, and press it.
  - Press ◀◀ to display the previous page. Press ▶▶ to display the next page.
  - To cancel deletion, select “RETURN”.
  - Thumbnail images cannot be deleted during video playback.



## CAUTION:

Do not remove the memory card or perform any other operation (such as turning off the camcorder) during deletion. Also, be sure to use the provided AC Adapter, as the memory card may be corrupted if the battery becomes exhausted during deletion. If the memory card becomes corrupted, initialize it.

## NOTE:

Once images are deleted, they cannot be restored. Check images before deleting.

## IMPORTANT:

- Be sure to always use the same tape and memory card together as they were during recording; otherwise, the camcorder cannot recognize Tape and Memory Card IDs to perform NAVIGATION function properly.
- Check if an appropriate tape and memory card are loaded when the following messages appear: “NO ID ON TAPE OR CARD”, “UNABLE TO USE NAVIGATION”, “THIS MEMORY CARD IS NOT COMPATIBLE”.
- If you change the memory card while shooting on one tape, two memory cards will share the tape’s thumbnail images. We recommend that you use one memory card for one tape.
- NAVIGATION Search does not work if the current position is at a blank portion on the tape. Also, do not leave a blank portion partway through the tape when shooting; otherwise, NAVIGATION function does not work properly.
- Before shooting newly over a recorded tape, be sure to delete all thumbnail images of the previous recording from the relevant memory card.
- If you copy thumbnail images from one memory card to another via a PC, NAVIGATION Search does not work with the copied memory card.

## E-Mail Clip Recording

You can make video clips in 160 x 120 pixels from real-time camera image or recorded video footage and store them in a memory card as files which can be conveniently sent via E-Mail.

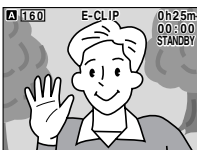
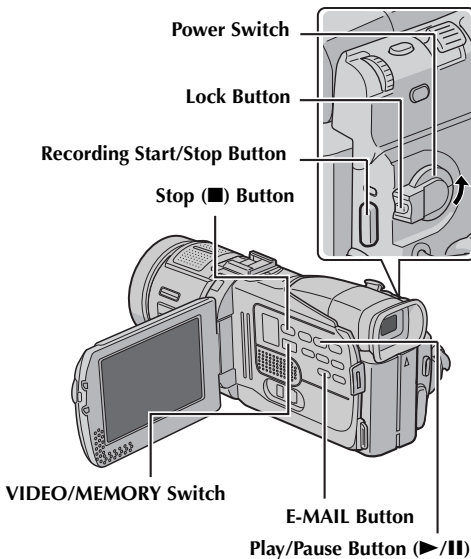

Remaining time

Shooting starts when the Recording Start/Stop Button is pressed.

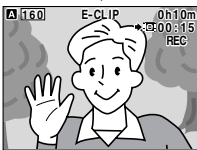

Shooting stops when the Recording Start/Stop Button is pressed again.



Recording is complete.

## To make video clips from real-time camera image

- 1 Load a memory card. (☞ pg. 16)
- 2 Set the **VIDEO/MEMORY** Switch to "MEMORY".
- 3 Set the Power Switch to "A" or "M" while pressing down the Lock Button located on the switch.
- 4 Press **E-MAIL** to engage the E-Mail Clip Record-Standby mode.
  - "E-CLIP" appears.
- 5 Press the Recording Start/Stop Button to start recording.
- 6 Press the Recording Start/Stop Button to stop recording.
  - "COMPLETED" is displayed, then the camcorder re-enters the E-Mail Clip Record-Standby mode.
- 7 Press **E-MAIL** to end E-Mail Clip Recording. The normal screen reappears.

**To view video clips stored in a memory card...**  
Refer to "Playback Of Video Clips" (☞ pg. 25).

**To delete unwanted video clips stored in a memory card...**  
Refer to "Deleting Files" (☞ pg. 28).

## Approximate recording time

MultiMediaCard	
8 MB**	7 min.
8 MB*	8 min.
16 MB*	17 min.

\* Optional

\*\* Provided (9 title images pre-stored)

### NOTE:

*It is not possible to adjust the speaker and headphone volume during E-Mail Clip Recording mode.*

## To make video clips from recorded video footage

- 1** Load a cassette. (☞ pg. 15)
- 2** Load a memory card. (☞ pg. 16)
- 3** Set the **VIDEO/MEMORY** Switch to "VIDEO".
- 4** Set the Power Switch to "PLAY" while pressing down the Lock Button located on the switch.
- 5** Press ►/II to start video playback.
- 6** Press **E-MAIL** to engage the E-Mail Clip Record-Standby mode.
  - "E-CLIP" appears.
  - To cancel E-Mail Clip Recording, press **E-MAIL** again or press ■ to stop video playback.
- 7** At the point you want to start dubbing, press the Recording Start/Stop Button to start E-Mail Clip Recording.
- 8** Press the Recording Start/Stop Button to stop E-Mail Clip Recording.
  - "COMPLETED" is displayed, then the camcorder re-enters the E-Mail Clip Record-Standby mode.
- 9** Press **E-MAIL** to end E-Mail Clip Recording. The normal screen reappears.

### To view video clips stored in a memory card...

Refer to "Playback Of Video Clips" (☞ pg. 25).

### To delete unwanted video clips stored in a memory card...

Refer to "Deleting Files" (☞ pg. 28).

### NOTES:

- Approximate maximum recording time per video clip is 3 minutes.
- Playback operation cannot be performed during E-Mail Clip Recording.
- If the end of the tape is reached during E-Mail Clip Recording, that portion will be automatically stored in the memory card.
- If the end of the tape is reached in step **6**, the E-Mail Clip Record-Standby mode will be automatically cancelled.
- The video clip files stored with this camcorder are compatible with MPEG4. Some MPEG4 files stored with other devices cannot be played back with this camcorder.
- The title image playback (TITLE) screen and the title index screen (☞ pg. 25, 26) cannot be used during E-Mail Clip Recording.
- Video noise may appear while viewing video clips in the LCD monitor or viewfinder, however, this noise is not present in the actual video clips stored in the memory card.
- You can also view video clips on your PC by using Windows® Media Player version 6.4 or later. Refer to the instructions of PC and software.

## Dubbing To Or From A VCR

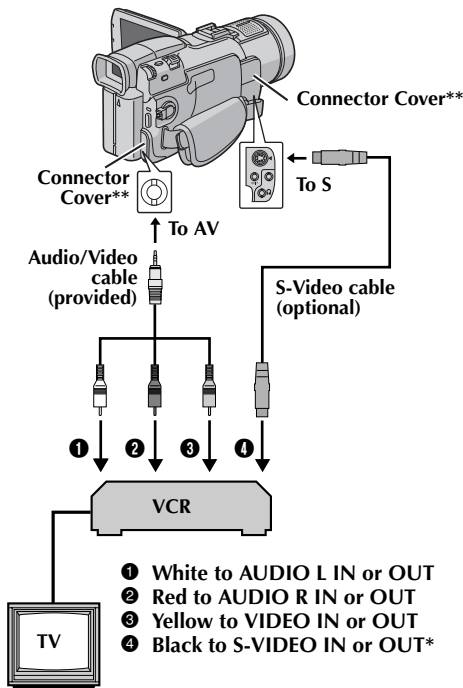

\* Connect when your TV/VCR has an S-VIDEO IN/OUT connector.

\*\* When connecting the cable, open the cover.

### To use this camcorder as a player...

- Following the illustrations, connect the camcorder and the VCR. Also refer to page 22.
- Set the camcorder's VIDEO/MEMORY Switch to "VIDEO".
- Set the camcorder's Power Switch to "PLAY" while pressing down the Lock Button located on the switch.
- Turn on the VCR's power.
- Insert the source cassette in the camcorder.
- Insert the recording cassette in the VCR.
- Engage the VCR's AUX and Record-Pause modes.
  - Refer to the instruction manual for the VCR.
- Press ►/|| on the camcorder to start playback of the source tape.
- At the point you want to start dubbing, engage the VCR's Record mode.
- To pause dubbing, engage the VCR's Record-Pause mode and press ►/|| on the camcorder.

- Repeat steps 8 – 10 for additional editing. Stop the VCR and camcorder.

### NOTES:

- It is recommended to use the AC Adapter as the power supply instead of the battery pack. (☞ pg. 11)
  - The S-Video cable is optional. Be sure to use the YTU94146B S-Video cable. Consult the JVC Service Center described on the sheet included in the package for details on its availability. Make sure to connect the end with a core filter to the camcorder. The core filter reduces interference.
  - As the camcorder starts to play your footage, it will appear on your TV. This will confirm the connections and the AUX channel for dubbing purposes.
  - Before you start dubbing, make sure that the indications do not appear on the connected TV. If they do, they are being recorded onto the new tape.
- To choose whether or not the following displays appear on the connected TV...**
- Date/time  
Set "DATE/TIME" to "AUTO", "ON" or "OFF". (☞ pg. 31, 41) Or, press **DISPLAY** on the remote control to turn on/off the date indication.
  - Time code  
Set "TIME CODE" to "OFF" or "ON". (☞ pg. 31, 41)
  - Indications other than date/time and time code  
Set "ON SCREEN" to "OFF", "LCD" or "LCD/TV". (☞ pg. 31, 41)

### To use this camcorder as a recorder...

- Perform steps 1 to 3 in the left column.
- Set "S/AV INPUT" to "ON". (☞ pg. 31, 40)
- Set "REC MODE" to "SP" or "LP". (☞ pg. 31, 34)
- Insert the recording cassette in this camcorder.
- Press the Recording Start/Stop Button to engage the Record-Pause mode. The "AV.IN" indication appears on the screen.
- Press the Recording Start/Stop Button to start recording. The ⚙ indication rotates.
- Press the Recording Start/Stop Button again to stop recording. The ⚙ indication stops rotating.

### NOTES:

- After dubbing, set "S/AV INPUT" back to "OFF".
- Analog signals can be converted to digital signals with this procedure.
- It is also possible to dub from another camcorder.

## Dubbing To A Video Unit Equipped With A DV IN Connector (Digital Dubbing)

It is also possible to copy recorded scenes from the camcorder onto another video unit equipped with a DV connector. Since a digital signal is sent, there is little if any image or sound deterioration.

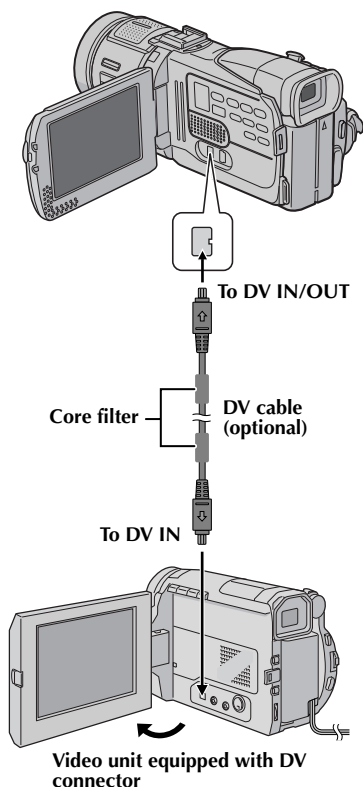

- 1** Make sure all units are turned off.
- 2** Connect this camcorder to a video unit equipped with a DV input connector using a DV cable as shown in the illustration.
- 3** Set this camcorder's **VIDEO/MEMORY** Switch to "VIDEO".
- 4** Set this camcorder's Power Switch to "PLAY" while pressing down the Lock Button located on the switch.
- 5** Turn on the video unit's power.
- 6** Insert the source cassette in this camcorder.
- 7** Insert the recording cassette in the video unit.
- 8** Press **▶/||** on this camcorder to start playback of the source cassette.
- 9** At the point you want to start dubbing, engage the video unit's Record mode.
- 10** To pause dubbing, engage the video unit's Record-Pause mode and press **▶/||** on this camcorder.
- 11** Repeat steps **8 – 10** for additional editing. Stop the video unit and camcorder.

### NOTES:

- **It is recommended to use the AC Adapter as the power supply instead of the battery pack.** (☞ pg. 11)
- If the remote control is used when both the player and recorder are JVC video units, both units will perform the same operation. To prevent this from happening, press the buttons on both units.
- If a blank portion or disturbed image is played back on the player during dubbing, the dubbing may stop so that an unusual image is not dubbed.
- Even though the DV cable is connected correctly, sometimes the image may not appear in step **9**. If this occurs, turn off the power and make connections again.
- If "Title Impose" (☞ pg. 44), "Playback Zoom" (☞ pg. 58) or "Playback Special Effects" (☞ pg. 58) is attempted or **SNAPSHOT** is pressed during playback, only the original playback image recorded on the tape is output from the DV IN/OUT connector.
- When using a DV cable, be sure to use the optional JVC VC-VDV204U DV cable.

## Dubbing From A Video Unit Equipped With A DV OUT Connector (Digital Dubbing)

It is also possible to copy recorded scenes from another video unit equipped with a DV connector onto the camcorder. Since a digital signal is sent, there is little if any image or sound deterioration.

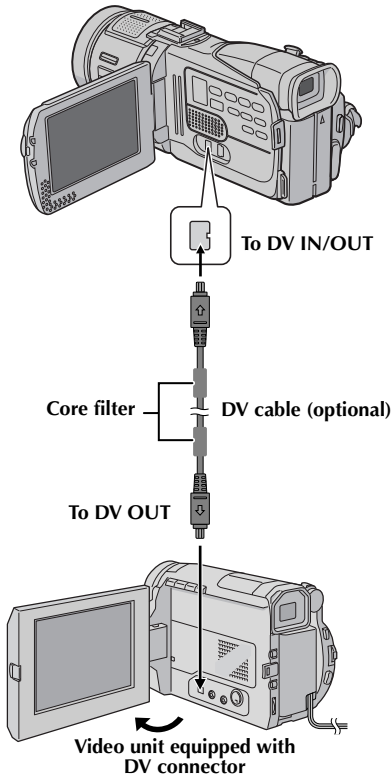

- 1** Make sure all units are turned off.
- 2** Connect this camcorder to a video unit equipped with a DV output connector using a DV cable as shown in the illustration.
- 3** Set this camcorder's **VIDEO/MEMORY** Switch to "VIDEO".
- 4** Set this camcorder's Power Switch to "PLAY" while pressing down the Lock Button located on the switch.
- 5** Set "REC MODE" to "SP" or "LP". (☞ pg. 31, 34)
- 6** Turn on the video unit's power.
- 7** Insert the source cassette in the video unit.
- 8** Insert the recording cassette in this camcorder.
- 9** Press the Recording Start/Stop Button to engage the Record-Pause mode.
  - The "DV.IN" indication appears on the screen.
- 10** Press the Recording Start/Stop Button to start recording.
  - The ⏪ indication rotates.
- 11** Press the Recording Start/Stop Button again to engage the Record-Pause mode.
  - The ⏪ indication stops rotating.
- 12** Repeat steps 10 – 11 for additional editing. Stop the video unit and camcorder.

### NOTES:

- **It is recommended to use the AC Adapter as the power supply instead of the battery pack.** (☞ pg. 11)
- **If no image is displayed on the LCD monitor, set "S/AV INPUT" to "OFF".** (☞ pg. 31, 40)
- **If the remote control is used when both the player and recorder are JVC video units, both units will perform the same operation. To prevent this from happening, press the buttons on both units.**
- **If a blank portion or disturbed image is played back on the player during dubbing, the dubbing may stop so that an unusual image is not dubbed.**
- **Even though the DV cable is connected correctly, sometimes the image may not appear in step 9. If this occurs, turn off the power and make connections again.**
- **Digital Dubbing is performed in the sound mode recorded on the original tape, regardless of the current "SOUND MODE" setting.** (☞ pg. 34)
- **When using a DV cable, be sure to use the optional JVC VC-VDV204U DV cable.**

## Dubbing Still Images Recorded On A Tape To A Memory Card

Still images can be dubbed from a tape to a memory card.

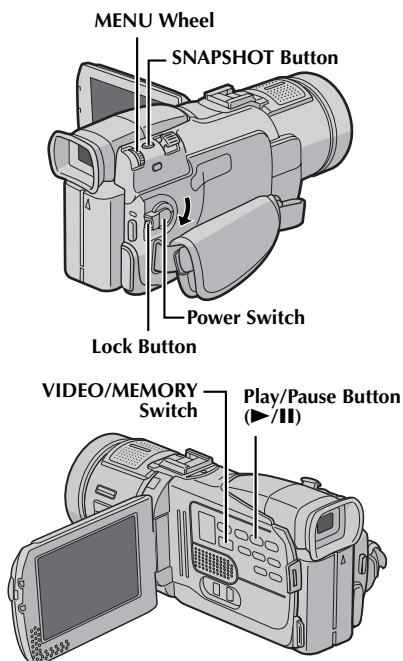

- 1** Load a cassette. (☞ pg. 15)
- 2** Load a memory card. (☞ pg. 16)
- 3** Set the **VIDEO/MEMORY** Switch to "VIDEO".
- 4** Set the Power Switch to "PLAY" while pressing down the Lock Button located on the switch.
- 5** Set "**CO** ➔ **M** COPY" to "ON". (☞ pg. 31, 40)
- 6** Press **▶/||** to start playback.
- 7** At the point you want to dub, press **▶/||** again to engage Still Playback.
- 8** To dub the image, press **SNAPSHOT**.
  - The "▶" indication blinks during dubbing.
  - The selected image is stored in the memory card.

### NOTES:

- If **SNAPSHOT** is pressed in step **8** when a memory card is not loaded, the message "COPYING FAILED" is displayed.
- If an image recorded on the tape using "WIDE MODE" (☞ pg. 37) is dubbed to a memory card, the WIDE mode identifying signal is not dubbed with it.
- To use Playback Special effects with a video image you wish to dub, perform up to step **8** using the remote control (provided). (☞ pg. 58)
- Images are dubbed in 640 x 480 pixels.

The Full-Function Remote Control Unit can operate this camcorder from a distance as well as the basic operations (Playback, Stop, Pause, Fast-Forward and Rewind) of your VCR. It also makes additional playback functions possible. (☞ pg. 58)

#### For GR-DV800/500 owners:

If you want to perform Random Assemble Editing (☞ pg. 60 – 65), use the optional RM-V700U remote control.

## Installing The Batteries

### RM-V717U (provided with GR-DV900 only)

The remote control uses two “AAA (R03)” size batteries. Refer to “General Battery Precautions (GR-DV900 only)” (☞ pg. 74).

- 1 Remove the battery compartment cover while pushing up the tab as illustrated.
- 2 Insert two “AAA (R03)” size batteries in the correct direction.
- 3 Re-attach the battery compartment cover.

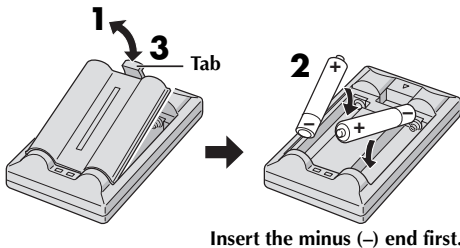

## Install The Battery

### RM-V718U (provided with GR-DV800/500 only)

The remote control uses one lithium battery (CR2025).

- 1 Pull out the battery holder by inserting a pointed instrument into the slot.
- 2 Insert the battery in the holder, and be sure to have the “+” mark visible.
- 3 Slide the holder back in until you hear a click.

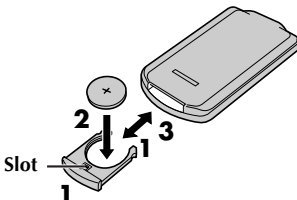

## Installing The Battery

### RM-V700U (optional)

The remote control uses one lithium battery (CR2025).

- 1 There are 2 ways to pull the battery holder out of the RM-V700U.
  - A Pull out the battery holder while sliding the lock hole.
  - B Pinch the release tab and pull out the battery holder.
- 2 Insert the battery in the holder, and be sure to have the “+” mark visible.
- 3 Slide the holder back in until you hear a click.

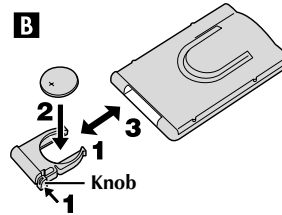
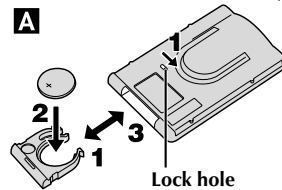

## Beam Effective Area (indoor use)

When using the remote control, be sure to point it at the remote sensor. The transmitted beam's approximate effective distance for indoor use is 5 m (16 ft).

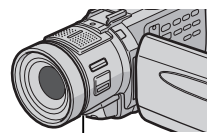

Remote sensor

### NOTE:

The transmitted beam may not be effective or may cause incorrect operation when the remote sensor is directly exposed to sunlight or powerful lighting.



## Buttons And Functions

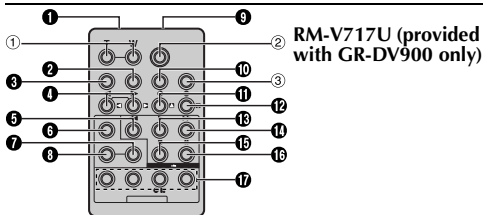

### 1 Infrared beam transmitting window

The following buttons are available only when the camcorder's Power Switch set to "PLAY".

- 2 **DISPLAY Button** ..... (☞ pg. 22, 52, 62)
- 3 **SHIFT Button** ..... (☞ pg. 58, 60)
- 4 **SLOW Rewind/Forward Buttons** ..... (☞ pg. 58)  
Left/Right Buttons ..... (☞ pg. 58)
- 5 **REW Button\*** ..... (☞ pg. 21, 24)
- 6 **FADE/WIPE Button** ..... (☞ pg. 63)
- 7 **EFFECT ON/OFF Button** ..... (☞ pg. 58)
- 8 **EFFECT Button** ..... (☞ pg. 58)
- 9 **PAUSE IN Connector** ..... (☞ pg. 62)
- 10 **MBR SET Button** ..... (☞ pg. 61)
- 11 **Up Button** ..... (☞ pg. 58)
- INSERT Button**..... (☞ pg. 60)
- 12 **Down Button** ..... (☞ pg. 58)
- A. DUB Button** ..... (☞ pg. 59)
- 13 **PLAY Button\***..... (☞ pg. 20, 24)
- 14 **FF Button\*** ..... (☞ pg. 21, 24)
- 15 **STOP Button\***..... (☞ pg. 20, 24)
- 16 **PAUSE Button\***..... (☞ pg. 58)
- 17 **R.A.EDIT Buttons** ..... (☞ pg. 60 – 65)

The following buttons are available when the camcorder's Power Switch set to "A" or "M".

- 1 **Zoom (T/W) Buttons\*\*** ..... (☞ pg. 18, 58)
- 2 **START/STOP Button\***
- 3 **SNAPSHOT Button\***

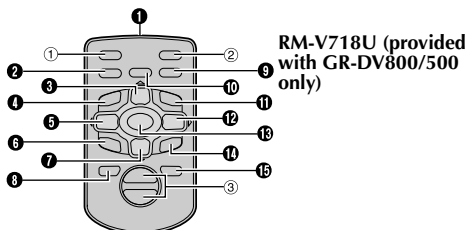

### 1 Infrared beam transmitting window

The following buttons are available only when the camcorder's Power Switch set to "PLAY".

- 2 **AUDIO Button** ..... (☞ pg. 31, 40)
- 3 **PAUSE Button\***..... (☞ pg. 58)
- Up Button** ..... (☞ pg. 58)
- 4 **SLOW Rewind Button**..... (☞ pg. 58)
- 5 **REW Button\*** ..... (☞ pg. 21, 24)  
Left Button ..... (☞ pg. 58)

- 6 **INSERT Button**..... (☞ pg. 60)
- 7 **STOP Button\*** ..... (☞ pg. 20, 24)  
Down Button ..... (☞ pg. 58)
- 8 **SHIFT Button** ..... (☞ pg. 58, 61)
- 9 **EFFECT ON/OFF Button** ..... (☞ pg. 58)
- 10 **EFFECT Button** ..... (☞ pg. 58)
- 11 **SLOW Forward Button** ..... (☞ pg. 58)
- 12 **FF Button\*** ..... (☞ pg. 21, 24)  
Left Button ..... (☞ pg. 58)
- 13 **PLAY Button\***..... (☞ pg. 20, 24)
- 14 **A. DUB Button**..... (☞ pg. 59)
- 15 **DISPLAY Button** ..... (☞ pg. 22, 52, 62)

The following buttons are available when the camcorder's Power Switch set to "A" or "M".

- 1 **S.SHOT (Snapshot) Button\***
- 2 **START/STOP Button\***
- 3 **Zoom (T/W) Buttons\*\*\*** ..... (☞ pg. 18, 58)

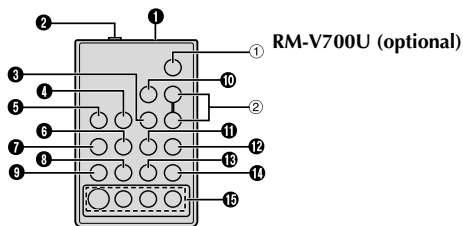

### 1 Infrared beam transmitting window

The following buttons are available only when the camcorder's Power Switch set to "PLAY".

- 2 **PAUSE IN Connector** ..... (☞ pg. 62)
- 3 **MBR SET Button** ..... (☞ pg. 61)
- 4 **INT. TIME Button\*\***  
**SELF TIMER Button\*\***
- 5 **REC TIME Button\*\***  
**ANIM. Button\*\***
- 6 **FF Button\*** ..... (☞ pg. 21, 24)
- 7 **REW Button\***..... (☞ pg. 21, 24)
- 8 **PAUSE Button\*** ..... (☞ pg. 58)
- 9 **PLAY Button\***..... (☞ pg. 20, 24)
- 10 **VISS Button\*\***
- 11 **VCR CTL Button** ..... (☞ pg. 60)
- 12 **A. DUB Button**..... (☞ pg. 59)
- 13 **STOP Button\***..... (☞ pg. 20, 24)
- 14 **INSERT Button**..... (☞ pg. 60)
- 15 **R.A.EDIT Buttons** ..... (☞ pg. 60 – 65)

The following buttons are available when the camcorder's Power Switch set to "A" or "M".

- 1 **START/STOP Button\***
- 2 **Zoom (T/W) Buttons\*\*\*** ..... (☞ pg. 18, 58)

\* Functions the same as each corresponding button on the camcorder. (☞ pg. 81)

\*\* Unavailable with this camcorder

\*\*\* Functions when the camcorder's Power Switch set to "PLAY" as well

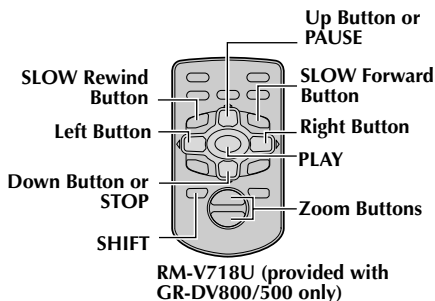
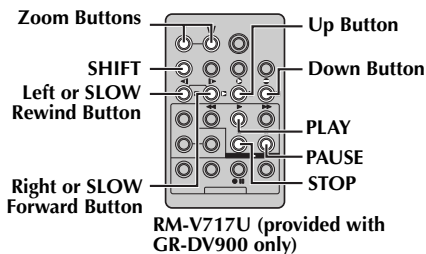

## Frame-By-Frame Playback

Allows frame-by-frame search during video playback.

During normal or still playback, press **SLOW** (◀▶) repeatedly for forward or **SLOW** (◀▶) repeatedly for reverse. Each time **SLOW** (◀▶) is pressed, the frame is played back.

## Playback Zoom

Magnifies the recorded image up to 30X at any time during video playback and D.S.C. playback.

1) Press **PLAY** (▶) to start video playback. Or perform normal playback of images.



2) At the point you want to zoom in, press the Zoom Button (T).  
● To zoom out, press the Zoom Button (W).



3) You can move the image on the screen around to find a particular portion of the picture. While holding down **SHIFT**, press Left ◀, Right ▶, Up ▲ and Down ▼.



● To end zoom, press and hold **W** until magnification returns to normal. Or, press **STOP** (■) and then press **PLAY** (▶) during video playback.

### NOTES:

- Zoom can also be used during slow-motion and still playback.
- Due to digital image processing, the quality of the image may suffer.

## Playback Special Effects

Allows you to add creative effects to the video playback image.

The effects that can be used during playback are CLASSIC FILM, MONOTONE, SEPIA and STROBE. The effects work the same in playback as they did in recording. (☞ pg. 33)

 **CLASSIC FILM:** Gives recorded scenes a strobe effect.

 **B/W MONOTONE:** Like classic black and white films, your footage is shot in B/W. Used together with the Cinema mode, it enhances the "classic film" effect.

 **SEPIA:** Recorded scenes have a brownish tint like old photos. Combine this with the Cinema mode for a classic look.

 **STROBE:** Your recording looks like a series of consecutive snapshots.

## Slow-Motion Playback

Allows slow-speed search in either direction during video playback.

During normal video playback, press **SLOW** (◀▶) more than approx. 2 seconds.

- After approx. 5 minutes (approx. 20 seconds with an 80-minute cassette) in Slow Rewind or approx. 5 minutes in Slow Forward, normal playback resumes.
- To pause Slow-Motion playback, press **PAUSE** (||).
- To stop Slow-Motion playback, press **PLAY** (▶).

### NOTES:

- You can also engage Slow-Motion Playback from Still Playback by pressing **SLOW** (◀▶) more than approx. 2 seconds.
- During Slow-Motion Playback, due to digital image processing, the picture may take on a mosaic effect.
- After **SLOW** (◀▶) is pressed and held, the still image may be displayed for a few seconds, followed by a blue screen for a few seconds. This is not a malfunction.
- There may be a small margin between the slow-motion playback start point you chose and the actual start point for Slow-Motion Playback.
- During Slow-Motion Playback, there will be disturbances in video and the picture may seem unstable, especially with steady images. This is not a malfunction.

- 1) To start playback, press **PLAY** (▶).
- 2) Press **EFFECT**. The **PLAYBACK EFFECT Select Menu** appears.
- 3) Press **EFFECT** repeatedly to move the highlight bar to the desired effect.
  - The selected function is activated and after 2 seconds the menu disappears.
  - To deactivate the selected effect, press **EFFECT ON/OFF**. To reactivate the selected effect press **EFFECT ON/OFF** again.
  - To change the selected effect, repeat from step 2 above.

## Audio Dubbing

The audio track can be customised only when recorded in the 12-bit and SP modes. (☞ pg. 43)

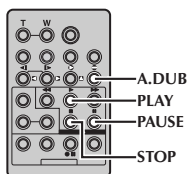
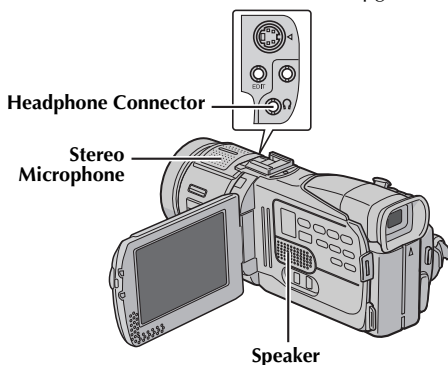

RM-V717U (provided with GR-DV900 only)

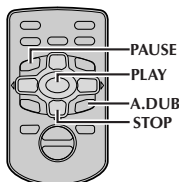

RM-V718U (provided with GR-DV800/500 only)

### To hear the sound during Audio Dubbing...

Connect optional headphones to the headphone connector or use the AV connector, and set the "12bit MODE" to the desired mode;

- "SOUND 1" for the playback sound.
- "SOUND 2" for the dubbed sound.
- "MIX" for the playback and dubbed sound.

### To hear the dubbed sound during playback...

Set "12bit MODE" to "SOUND 2" or "MIX". (☞ pg. 31, 40)

### NOTES:

- When editing onto a tape that was recorded at 12-bit, the old and new soundtracks are recorded separately.
- If you dub onto a blank space on the tape, the sound may be disrupted. Make sure you only edit recorded areas.
- If feedback or howling occurs during TV playback, move the camcorder's microphone away from the TV, or turn down the TV's volume.
- If you change from 12-bit to 16-bit in mid-recording and then use the tape for Audio Dubbing, it is not effective from the point where 16-bit recording began.
- During Audio Dubbing, when the tape moves to scenes recorded in the LP mode, scenes recorded in 16-bit audio or a blank portion, Audio Dubbing stops.
- To perform Audio Dubbing while watching on the television, make connections. (☞ pg. 22)
- To perform Audio Dubbing with a video unit connected to the camcorder's AV connector, first set "S/AV INPUT" to "ON" in VIDEO Menu. (☞ pg. 31, 40) The "AUX" indication appears instead of "MIC".

- 1) Play back the tape to locate the point where editing will start, then press **PAUSE** (II).
- 2) While holding **A. DUB** (⊖) on the remote control, press **PAUSE** (II). The "II⊖" and "MIC" indicators appear.
- 3) Press **PLAY** (▶), then begin "narrating". Speak into the microphone.
  - To pause dubbing, press **PAUSE** (II).
- 4) To end Audio Dubbing, press **PAUSE** (II), then **STOP** (■).

## Insert Editing

You can record a new scene into a previously recorded tape, replacing a section of the original recording with minimal picture distortion at the in and outpoints. The original audio remains unchanged.

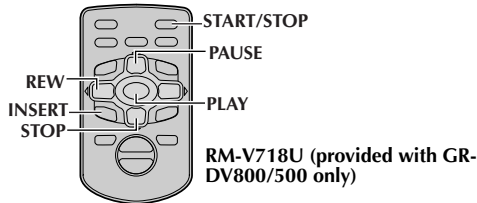
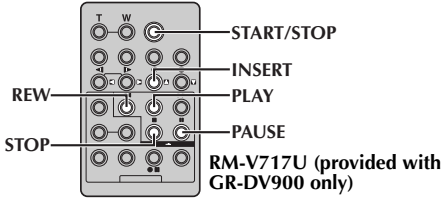

### NOTES:

- Before performing the following steps, make sure that "TIME CODE" is set to "ON". (☞ pg. 31, 41)
- Insert Editing is not possible on a tape recorded in the LP mode or on a blank portion of a tape.
- To perform Insert Editing while watching in the television, make connections. (☞ pg. 22)

- 1 Play back the tape, locate the Edit-Out point and press **PAUSE** (II). Confirm the time code at this point. (☞ pg. 41)
- 2 Press **REW** (◀) until the Edit-In point is located, then press **PAUSE** (II).
- 3 Press and hold **INSERT** (C) on the remote control, then press **PAUSE** (II). The "II C" indicator and the Time Code (min.:sec.) appear and the camcorder enters Insert-Pause mode.
- 4 Press **START/STOP** to begin editing.
  - Confirm the insert at the time code you checked in step 1.
  - To pause editing, press **START/STOP**. Press it again to resume editing.
- 5 To end Insert Editing, press **START/STOP**, then **STOP** (■).

### NOTES:

- Program AE with special effects (☞ pg. 33) can be used to spice up the scenes being edited during Insert Editing.
- During Insert Editing, the date and time information changes.

- If you perform Insert Editing onto a blank space on the tape, the audio and video may be disrupted. Make sure you only edit recorded areas.
- During Insert Editing, when the tape moves to scenes recorded in the LP mode or a blank portion, Insert Editing stops. (☞ pg. 84, 85)
- If a memory card is loaded and "NAVIGATION" is set to other than "MANUAL", a NAVIGATION thumbnail image is stored in the memory card. (☞ pg. 48)

## Random Assemble Editing [R.A.Edit]

Create edited videos easily using your camcorder as the source player. You can select up to 8 "cuts" for automatic editing, in any order you like. R.A.Edit is more easily performed when the MBR (Multi-Brand Remote) is set to operate with your brand of VCR (see "VCR CODE LIST"), but can also be performed by operating the VCR manually. Before operation, make sure the batteries are installed in the remote control. (☞ pg. 56)

### For GR-DV800/500 owners:

Use the optional RM-V700U remote control.

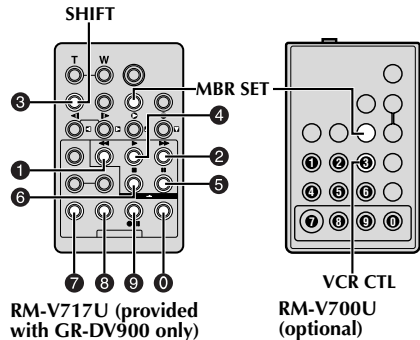

## Set Remote/VCR Code

**1** Turn off the power to the VCR and point the remote towards the VCR's infrared sensor. Then, referring to the VCR CODE LIST, press and hold **MBR SET**, and enter the brand code. The code is automatically set once you release **MBR SET**, and the VCR's power comes on.

**2** Make sure the VCR's power is on. Then, while holding **SHIFT** or **VCR CTL**, press the button on the remote for the desired function. The functions the remote can control are **PLAY**, **STOP**, **PAUSE**, **FF**, **REW** and **VCR REC STBY** (you do not need to press **SHIFT** or **VCR CTL** for this one).

**You are now ready to try Random Assemble Editing.**

### IMPORTANT:

Although the MBR is compatible with JVC VCRs and those of many other makers, it may not work with yours or may offer limited functions.

### NOTES:

- If the VCR's power does not come on in step 1, try another code from the VCR CODE LIST.
- Some brands of VCR do not come on automatically. In this case, turn the power on manually and try step 2.
- If the remote control is not able to control the VCR, use the controls on the VCR.
- When the remote control's batteries run out, the VCR brand you have set will be erased. In that case, replace the old battery with a new one to reset the VCR brand.

## VCR CODE LIST

VCR BRAND NAME	CODE	VCR BRAND NAME	CODE
DAEWOO	1 8	PANASONIC	1 3 1 7 1 1 9 4 1 8
GE	1 1 9 2 9 0 9 4	RCA	9 2 9 4 6 6 6 3 9 0
HITACHI	6 6 6 3	SAMSUNG	9 4
JVC A B C	9 1 9 6 9 3	SANYO	3 6 3 5
LG/GOLDSTAR	1 1	SHARP	1 5 1 0
MAGNAVOX	9 5 1 1 7 1 7 6	SONY	6 5 6 0 3 9 3 1
MITSUBISHI	6 7 6 8	TOSHIBA	6 9 6 1
NEC	3 7 3 8	ZENITH	1 6
PHILIPS	1 9 9 5 1 1 9 4 9 1 9 6 1 2 3 3 7 2		

## Make Connections

Also refer to page 22.

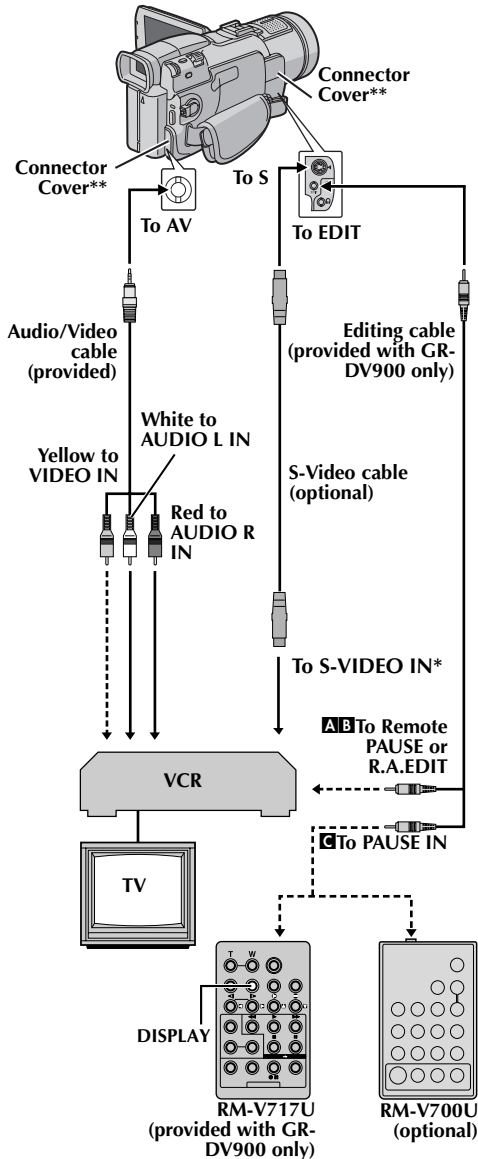

\* Connect when your TV/VCR has an S-VIDEO IN connector.

\*\* When connecting the cable, open the cover.

### 1 **A** A JVC VCR equipped with a Remote PAUSE connector...

...Connect the editing cable to the Remote PAUSE connector.

### 1 **B** A JVC VCR not equipped with a Remote PAUSE connector but equipped with an R.A.EDIT connector...

...Connect the editing cable to the R.A.EDIT connector.

### 1 **C** A VCR other than above...

...Connect the editing cable to the remote control's PAUSE IN connector.

### 2

Insert a recorded tape into the camcorder.

### 3

Set the **VIDEO/MEMORY** Switch to "VIDEO".

### 4

Set the Power Switch to "PLAY" while pressing down the Lock Button located on the switch.

### 5

Turn the VCR power on, insert a recordable tape and engage the AUX mode.

- Refer to the VCR's instructions.

## NOTES:

- *The S-Video cable is optional. The Editing cable is optional for GR-DV800/500. Be sure to use the following cables:*

- YTU94146B S-Video cable.

- PEAC0369-150 Editing cable.

*Consult the JVC Service Center described on the sheet included in the package for details on its availability. Make sure to connect the end with a core filter to the camcorder. The core filter reduces interference.*

- *Before Random Assemble Editing, make sure the indications do not appear on the TV monitor. If they do, they will be recorded onto the new tape. To choose whether or not the following displays appear on the connected TV...*

- *Date/time*

*Set "DATE/TIME" to "AUTO", "ON" or "OFF".*

*(☞ pg. 31, 41) Or, press **DISPLAY** on the remote control (provided with GR-DV900 only) to turn on/off the date indication.*

- *Time code*

*Set "TIME CODE" to "OFF" or "ON".*

*(☞ pg. 31, 41)*

- *Indications other than date/time and time code*

*Set "ON SCREEN" to "OFF", "LCD" or "LCD/TV". (☞ pg. 31, 41)*

- *When editing on a VCR equipped with a DV input connector, an optional DV cable can be connected instead of an S-Video cable and audio/video cable.*

## Select Scenes

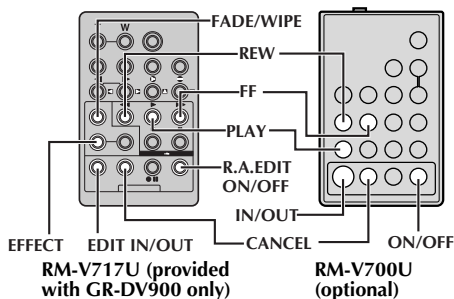

**6** Press **PLAY** (▶) and then press **R.A.EDIT ON/OFF** on the remote control. The Random Assemble Editing Menu appears.

**7** For **GR-DV900 owners**: If using a Wipe/Fader at the beginning of the scene, press **FADE/WIPE** on the remote control.

- Cycle through the effects by pressing repeatedly, and stop when the one you want is displayed.
- You cannot use a Picture Wipe/Dissolve at the beginning of Program 1.

**8** At the beginning of the scene, press **EDIT IN/OUT** or **IN/OUT** on the remote control. The Edit-In position appears in the Random Assemble Editing Menu.

**9** At the end of the scene, press **EDIT IN/OUT** or **IN/OUT**. The Edit-Out position appears in the Random Assemble Editing Menu.

**10** For **GR-DV900 owners**: If using a Wipe/Fader at the end of the scene, press **FADE/WIPE**.

- Cycle through the effects by pressing repeatedly, and stop when the one you want is displayed.
- If you select a Wipe/Fader effect for an Edit-Out point, the effect is automatically applied to the following Edit-In point.
- You cannot use a Picture Wipe/Dissolve at the end of the last scene.
- When you use Fader/Wipe effects, that time is included in the total time (this does not apply to Picture Wipe/Dissolve.)

Selected parameter

	IN	OUT	MODE
1	---	---	---
2	---	---	---
3	---	---	---
4	---	---	---
5	---	---	---
6	---	---	---
7	---	---	---
8	---	---	---
9	---	---	---
0	---	---	---
TIME CODE	---	---	---
TOTAL	---	---	00:00

**11** For **GR-DV900 owners**: If using Playback Special Effects, press **EFFECT**. (☞ pg. 58)

**12** Repeat steps **8** through **11** to register additional scenes.

- To change previously registered points, press **CANCEL** on the remote control. The registered points disappear, one at a time, from the most recently registered point.
- If you are not using Wipe/Fader (GR-DV900 only) or Program AE with special effects, repeat steps **8** and **9** only.

### NOTES:

- When choosing a scene, set Edit-In and Edit-Out points so that there is a relatively large difference between them.
- If the search time for an in-point exceeds 5 minutes, the recording deck's Record-Standby mode will be cancelled and editing will not take place.
- If there are blank portions before or after the Edit-In and Edit-Out points, a blue screen may be included in the edited version.
- Since time codes register time only as accurately as seconds, the time code total time may not match the total program time exactly.
- Turning off the camcorder's power erases all registered Edit-In and Edit-Out points.
- For **GR-DV900 owners**: If you select Sepia or Monotone mode from Program AE with special effects, you cannot use the Dissolve or Black & White Fader. In this case the Dissolve or Black & White indicator begins blinking. Once the next Edit-In point is registered, the effect is turned off. To combine these effects, use Sepia or Monotone during recording, then use the Dissolve or Black & White Fader during Random Assemble Editing.
- For **GR-DV900 owners**: It is not possible to use Wipe/Fader effects and Program AE with special effects during Random Assemble Editing using a DV cable.



## Picture Wipe And Dissolve Menu (available only for Random Assemble Editing with GR-DV900)

You can use not only the wipe/fader effects on page 32 but also the picture wipe and dissolve effects below.

**[P] DISSOLVE:** The new scene gradually appears as the old one gradually disappears.

**[P] WIPE – CORNER:** The new scene wipes in over the previous one from the upper right corner to the lower left corner.

**[P] WIPE – WINDOW:** The next scene gradually wipes in from the center of the screen toward the corners, covering the previous scene.

**[P] WIPE – SLIDE:** The next scene gradually wipes in over the previous one from right to left.

**[P] WIPE – DOOR:** The previous scene wipes out from the center to the right and left, like a door being pushed open to reveal the next scene.

**[P] WIPE – SCROLL:** The new scene wipes in over the last one from the bottom of the screen to the top.

**[P] WIPE – SHUTTER:** The new scene wipes in over the previous one from the center toward the top and bottom of the screen.

## Automatic Editing To VCR

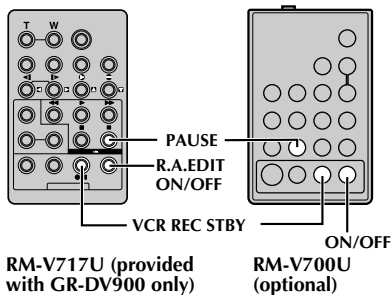

**13** Rewind the tape in the camcorder to the beginning of the scene you want to edit and press **PAUSE (II)**.

**14** Press **VCR REC STBY (●II)**, or manually engage the VCR's Record-Pause mode.

**15** Press the Recording Start/Stop Button on the camcorder. Editing proceeds as programmed, right through to the end of the last registered scene.

- When dubbing is complete, the camcorder enters the Pause mode, and the VCR enters its Record-Pause mode.
- If you do not register an Edit-Out point, the tape will be dubbed all the way to the end automatically.
- If you operate the camcorder during automatic editing, the VCR will enter its Record-Pause mode and automatic editing will stop.

**16** Engage the Stop modes for the camcorder and the VCR.

To make the R.A.Edit counter display disappear, press **R.A.EDIT ON/OFF** or **ON/OFF** on the remote control.

### NOTES:

- Pressing **R.A.EDIT ON/OFF** or **ON/OFF** on the remote control clears all settings registered during Random Assemble Editing.
- When the editing cable is connected to the remote control's **PAUSE IN** connector during dubbing, make sure the remote control is pointed at the VCR's sensor, and the path between the two is unobstructed.
- Random Assemble Editing may not function properly when using a tape including several duplicated time codes. (☞ pg. 19)



## For More Accurate Editing

Some VCRs make the transition from Record-Pause to Record mode faster than others. Even if you begin editing for the camcorder and the VCR at exactly the same time, you may lose scenes you wanted, or find that you have recorded scenes you did not want. For a cleanly edited tape, confirm and adjust the timing of the camcorder against your VCR.

### Diagnosing VCR/Camcorder Timing

- 1 Play back the tape in the camcorder, then point the remote control at the camcorder's remote sensor and press **R.A.EDIT ON/OFF**. Random Assemble Editing Menu appears.

Program 1

	IN	OUT	MODE
1	-	-	-
2	-	-	-
3	-	-	-
4	-	-	-
5	-	-	-
6	-	-	-
7	-	-	-
8	-	-	-
TIME CODE			-:--
TOTAL			00:00

Random Assemble Editing Menu

- 2 Perform Random Assemble Editing on Program 1 only. In order to check VCR and camcorder timing, select the beginning of a scene transition as your Edit-In point.
- 3 Play back the dubbed scene.
  - If any images from the scene prior to the transition you chose for your Edit-In point were recorded, that means your VCR moves too quickly from Record-Pause to Record mode.
  - If the scene you tried to dub starts in progress, the VCR is slow to start recording.

## Adjustment Of VCR/Camcorder Timing

- 4 Press **R.A.EDIT ON/OFF** to make the Random Assemble Editing menu disappear, then press the **MENU** Wheel in. The Menu Screen appears.
- 5 Rotate the **MENU** Wheel to select "**∞**", and press it. The VIDEO Menu appears.
- 6 Rotate the **MENU** Wheel to select "SYNCHRO", and press it. The value for "SYNCHRO" is highlighted.
- 7 Based on the diagnostics performed, you can now advance the VCR's record timing by rotating the **MENU** Wheel towards "+". You can also delay the VCR's record timing by rotating the **MENU** Wheel towards "-". The adjustment range is from -1.3 to +1.3 seconds, in 0.1-second increments. Press the **MENU** Wheel in to finish the setting.
- 8 Rotate the **MENU** Wheel to select "URETURN", and press it twice. Now perform Random Assemble Editing beginning with step 6 on page 63.

### NOTES:

- Before performing actual Random Assemble Editing, do a few Random Assemble Editing trial runs to check whether the value you have input is appropriate or not, and make adjustments accordingly.
- Depending on the recorder, there may be situations where the timing difference cannot be fully corrected.

## Connection To A Personal Computer

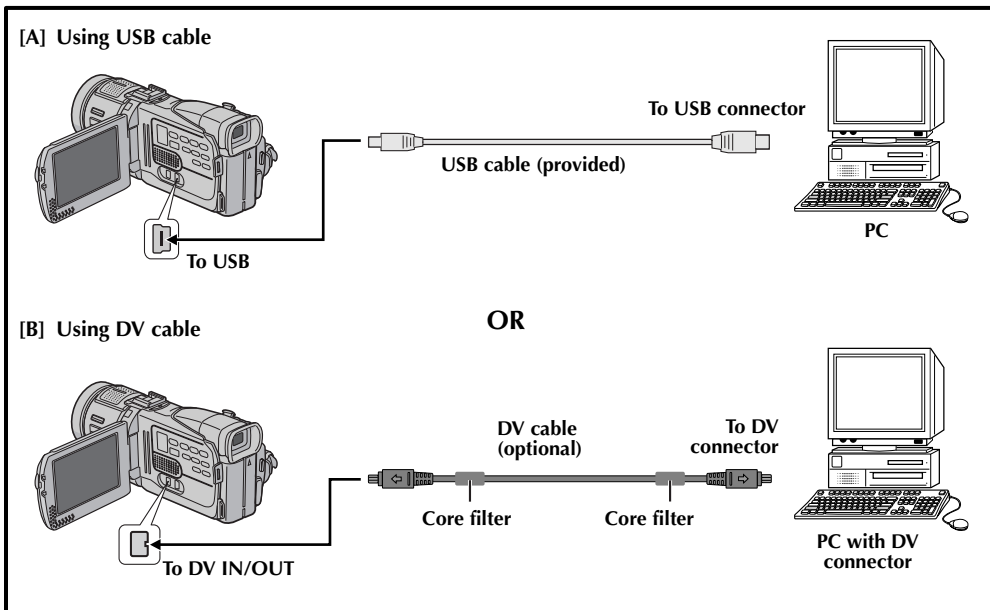

### [A] Using USB cable

It is possible to do the following things:

- Transfer still images stored on a memory card to a PC.
- Transfer still/moving images recorded on a tape to a PC.
- Capture still/moving images in real-time.
- Use this camcorder as a WebCam. (☞ pg. 67)

### [B] Using DV cable

It is also possible to transfer still/moving images to a PC with a DV connector by using the provided software, software equipped with the PC or commercially available software.

#### NOTES:

- Refer to "SOFTWARE INSTALLATION AND USB CONNECTION GUIDE" for the installation of the bundled software and drivers.
- It is recommended to use the AC Adapter as the power supply instead of the battery pack. (☞ pg. 11)
- Never connect the USB cable and the DV cable simultaneously to the camcorder. Connect only the cable you wish to use to the camcorder.

- When using a DV cable, be sure to use the optional JVC VC-VDV206U or VC-VDV204U DV cable depending on the type of DV connector (4 or 6 pins) on the PC.
- If the PC connected to the camcorder via the USB cable is not powered, the camcorder does not enter the USB mode.
- The date/time information cannot be captured into the PC.
- Refer to the instruction manuals of the PC and Software.
- The still images can also be transferred to a PC with a DV connector-equipped capture board.
- The system may not work properly depending on the PC or capture board you are using.

"USB MODE" and/or "ACCESSING FILES" appears on the LCD monitor while the PC is accessing data in the camcorder or the camcorder is transferring a file to the PC.  
**NEVER disconnect the USB cable while "ACCESSING FILES" is displayed on the LCD monitor since this can result in product damage.**

## Using The Camcorder As A WebCam

This camcorder can be used as a WebCam via USB connection.

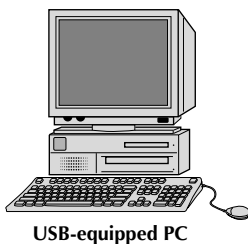
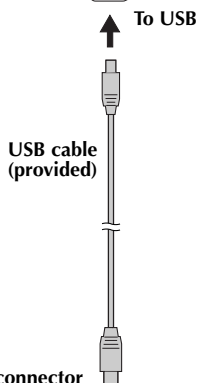
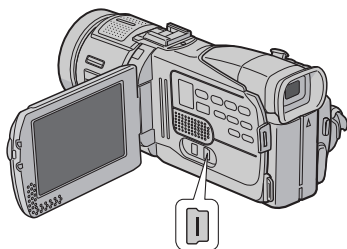

- 1 Make sure all necessary software (provided) are installed in your PC and all units are turned off.
- 2 Connect the camcorder to your PC using the USB cable.
- 3 Set the **VIDEO/MEMORY** Switch to "MEMORY".
- 4 Set the Power Switch to "A" or "M" while pressing down the Lock Button located on the switch.
- 5 Turn on the PC.
  - "☒" appears on the screen.
  - If the PC is not powered on, the camcorder does not enter the Web Camera mode.
- 6 When finished, turn off the PC first, then the camcorder. Disconnect the USB cable from the camcorder and PC.

### NOTES:

- *It is recommended to use the AC Adapter as the power supply instead of the battery pack.* (☞ pg. 11)
- *Use the provided software PIXELA ImageMixer to capture video in real time.*
- *You can also use the camcorder for web conference by using Microsoft Windows® NetMeeting® and signing up for MSN Hotmail.*
- *In the Web Camera mode, the following buttons cannot be operated: TITLE, E-MAIL, SNAPSHOT, INDEX, NAVI, NAVI STORE, the Recording Start/ Stop Button.*

Refer to the instruction manuals of the PC and provided Software.

ITEMS	NOTES
⇨ Power (☞ pg. 10)	<ul style="list-style-type: none"> <li>● Perform charging where the temperature is between 10°C and 35°C (50°F and 95°F). 20°C to 25°C (68°F to 77°F) is the ideal temperature range for charging. If the environment is too cold, charging may be incomplete.</li> <li>● Charging times are for a fully discharged battery pack.</li> <li>● Charging time varies according to the ambient temperature and the status of the battery pack.</li> <li>● To avoid interference with reception, do not use the AC Adapter near a radio.</li> <li>● Since the AC Adapter processes electricity internally, it becomes warm during use. Be sure to use it only in well-ventilated areas.</li> <li>● The following operation stops charging: <ul style="list-style-type: none"> <li>• Set the Power Switch to "PLAY", "A" or "M".</li> <li>• Disconnect the AC Adapter from the camcorder.</li> <li>• Unplug the AC Adapter from the AC outlet.</li> <li>• Detach the battery from the camcorder.</li> </ul> </li> </ul>
⇨ VIDEO RECORDING (☞ pg. 17)	<ul style="list-style-type: none"> <li>● When you use the LCD monitor outdoors in direct sunlight, the LCD monitor may be difficult to see. If this happens, use the viewfinder instead.</li> <li>● The cassette holder cannot be opened unless a power supply is attached.</li> <li>● There may be a delay after you open the cassette holder cover until the cassette holder opens. Do not use force.</li> <li>● Once the cassette holder is closed, it recedes automatically. Wait until it recedes completely before closing the cassette holder cover.</li> <li>● When the Recording Start/Stop button is pressed, it may take a few seconds before actual recording starts. The "⏻" indicator starts rotating when the camcorder actually starts recording.</li> <li>● The time required to calculate and display the remaining tape length, and the accuracy of the calculation, may vary according to the type of tape used.</li> <li>● "TAPE END" appears when the tape reaches its end, and the power goes off automatically if left in this condition for 5 minutes. "TAPE END" also appears when a cassette at its end is loaded.</li> <li>● During recording, sound is not heard from the speaker. To hear the sound, connect optional headphones to the headphone connector. Adjust the sound volume by rotating the <b>MENU</b> Wheel. (☞ pg. 20)</li> </ul>

If, after following the steps in the chart below, the problem still exists, please consult your nearest JVC dealer.

The camcorder is a microcomputer-controlled device. External noise and interference (from a TV, a radio, etc.) might prevent it from functioning properly. In such cases, first disconnect its power supply unit (battery pack, AC Adapter, etc.) and wait a few minutes; and then re-connect it and proceed as usual from the beginning.

**Power**

SYMPTOM	POSSIBLE CAUSES	CORRECTIVE ACTION
1. No power is supplied.	1. <ul style="list-style-type: none"> <li>• The power is not connected properly.</li> <li>• The battery is dead.</li> <li>• The LCD monitor is not open fully or the viewfinder is not pulled out when recording.</li> </ul>	1. <ul style="list-style-type: none"> <li>• Connect the AC Adapter securely. (☞ pg. 11)</li> <li>• Replace the dead battery with a fully charged one. (☞ pg. 10, 11)</li> <li>• Open the LCD monitor fully or pull out the viewfinder.</li> </ul>

**Video and D.S.C. Recording**



SYMPTOM	POSSIBLE CAUSES	CORRECTIVE ACTION
2. Recording cannot be performed.	2. <ul style="list-style-type: none"> <li>• The Power Switch is set to "PLAY" or "OFF". — For Video Recording —</li> <li>• The tape's erase protection tab is set to "SAVE".</li> <li>• The <b>VIDEO/MEMORY</b> Switch is set to "MEMORY".</li> <li>• "TAPE END" appears.</li> <li>• The cassette holder cover is open. — For D.S.C. Recording —</li> <li>• The <b>VIDEO/MEMORY</b> Switch is set to "VIDEO".</li> </ul>	2. <ul style="list-style-type: none"> <li>• Set the Power Switch to "A" or "M". (☞ pg. 17, 23) — For Video Recording —</li> <li>• Set the tape's erase protection tab to "REC". (☞ pg. 15)</li> <li>• Set the <b>VIDEO/MEMORY</b> Switch to "VIDEO".</li> <li>• Replace with new cassette. (☞ pg. 15)</li> <li>• Close the cassette holder cover. — For D.S.C. Recording —</li> <li>• Set the <b>VIDEO/MEMORY</b> Switch to "MEMORY".</li> </ul>
3. When shooting a subject illuminated by bright light, vertical lines appear.	3. <ul style="list-style-type: none"> <li>• This is a result of exceedingly high contrast, and is not a malfunction.</li> </ul>	3. —
4. When the screen is under direct sunlight during shooting, the screen becomes red or black for an instant.	4. <ul style="list-style-type: none"> <li>• This is not a malfunction.</li> </ul>	4. —
5. During recording, the date/time does not appear.	5. <ul style="list-style-type: none"> <li>• "DATE/TIME" is set to "OFF".</li> </ul>	5. <ul style="list-style-type: none"> <li>• Set "DATE/TIME" to "ON". (☞ pg. 31, 38)</li> </ul>
6. During recording, sound cannot be heard.	6. <ul style="list-style-type: none"> <li>• The optional headphones are not connected to the headphones connector.</li> </ul>	6. <ul style="list-style-type: none"> <li>• Connect the optional headphones to the headphone connector. (☞ pg. 81)</li> </ul>

7. The LCD monitor or viewfinder indications blink.	7. • Certain Wipe/Fader effects, certain modes of Program AE with special effects, "DIS" and other functions that cannot be used together are selected at the same time.	7. • Re-read the sections covering Wipe/Fader effects, Program AE with special effects and "DIS". (☞ pg. 31 – 34, 36)
8. Digital Zoom does not work.	8. • 10X optical zoom is selected. • The <b>VIDEO/MEMORY</b> Switch is set to "MEMORY".	8. • Set "ZOOM" to "40X" or "200X". (☞ pg. 35) • Set the <b>VIDEO/MEMORY</b> Switch to "VIDEO".

## Video and D.S.C. Playback

SYMPTOM	POSSIBLE CAUSES	CORRECTIVE ACTION
9. Play, Rewind and Fast-Forward functions do not work.	9. • The Power Switch is set to "A" or "M". • <b>VIDEO/MEMORY</b> Switch is set to "MEMORY".	9. • Set the Power Switch to "PLAY". (☞ pg. 20) • Set the <b>VIDEO/MEMORY</b> Switch to "VIDEO".
10. The tape is moving, but there is no picture.	10. • Your TV has AV input terminals, but is not set to its VIDEO mode. • The cassette holder cover is open.	10. • Set the TV to the mode or channel appropriate for video playback. (☞ pg. 22) • Close the cassette holder cover. (☞ pg. 15)
11. Blocks of noise appear during playback, or there is no playback picture and the screen becomes blue.	11. —	11. • Clean the video heads with an optional cleaning cassette. (☞ pg. 77)
12. A memory card cannot be played back.	12. • The Power Switch is set to "A" or "M". • The <b>VIDEO/MEMORY</b> Switch is set to "VIDEO".	12. • Set the Power Switch to "PLAY". (☞ pg. 24) • Set the <b>VIDEO/MEMORY</b> Switch to "MEMORY".

## Advanced features

SYMPTOM	POSSIBLE CAUSES	CORRECTIVE ACTION
13. The focus does not adjust automatically.	13. <ul style="list-style-type: none"> <li>• Focus is set to the Manual mode.</li> <li>• The recording was done in a dark place, or the contrast was low.</li> <li>• The lens is dirty or covered with condensation.</li> </ul>	13. <ul style="list-style-type: none"> <li>• Set Focus to the Auto mode. (☞ pg. 45)</li> <li>• Clean the lens and check the focus again. (☞ pg. 77)</li> </ul>
14. In the 5-Second mode, recording ends before 5 seconds have elapsed.	14. <ul style="list-style-type: none"> <li>• The 5-Second mode is set to "Anim." in MANUAL Menu.</li> </ul>	14. <ul style="list-style-type: none"> <li>• Set "5S" to "5S" in MANUAL Menu. (☞ pg. 31, 36)</li> </ul>
15. Snapshot mode cannot be used.	15. <ul style="list-style-type: none"> <li>• The Squeeze mode (SQUEEZE) is selected.</li> </ul>	15. <ul style="list-style-type: none"> <li>• Disengage the Squeeze (SQUEEZE) mode. (☞ pg. 31, 37)</li> </ul>
16. The color of Snapshot looks strange.	16. <ul style="list-style-type: none"> <li>• The light source or the subject does not include white. Or there are various different light sources behind the subject.</li> <li>• The Sepia (SEPIA) or Monotone (MONOTONE) mode is activated.</li> </ul>	16. <ul style="list-style-type: none"> <li>• Find a white subject and compose your shot so that it also appears in the frame. (☞ pg. 23, 42)</li> <li>• Disengage the Sepia (SEPIA) and Monotone (MONOTONE). (☞ pg. 31, 34)</li> </ul>
17. The image taken using Snapshot is too dark.	17. <ul style="list-style-type: none"> <li>• Shooting was performed under backlit conditions.</li> </ul>	17. <ul style="list-style-type: none"> <li>• Press <b>BACK LIGHT</b>. (☞ pg. 47)</li> </ul>
18. The image taken using Snapshot is too bright.	18. <ul style="list-style-type: none"> <li>• The subject is too bright.</li> </ul>	18. <ul style="list-style-type: none"> <li>• Set "" to "SPOTLIGHT". (☞ pg. 33)</li> </ul>
19. White Balance cannot be activated.	19. <ul style="list-style-type: none"> <li>• The Sepia (SEPIA) or Monotone (MONOTONE) mode is activated.</li> </ul>	19. <ul style="list-style-type: none"> <li>• Disengage the Sepia (SEPIA) or Monotone (MONOTONE) mode before setting White Balance. (☞ pg. 34)</li> </ul>
20. Wipe/Fader effects do not work.	20. <ul style="list-style-type: none"> <li>• The Power Switch is set to "<b>A</b>".</li> </ul>	20. <ul style="list-style-type: none"> <li>• Set the Power Switch to "". (☞ pg. 13)</li> </ul>
21. The Black & White Fader does not work.	21. <ul style="list-style-type: none"> <li>• The Sepia (SEPIA) or Monotone (MONOTONE) mode is activated.</li> </ul>	21. <ul style="list-style-type: none"> <li>• Disengage the Sepia (SEPIA) and Monotone (MONOTONE). (☞ pg. 31, 34)</li> </ul>
22. Program AE with special effects does not work.	22. <ul style="list-style-type: none"> <li>• The Power Switch is set to "<b>A</b>".</li> </ul>	22. <ul style="list-style-type: none"> <li>• Set the Power Switch to "". (☞ pg. 13)</li> </ul>
23. The image looks like the shutter speed is too slow.	23. <ul style="list-style-type: none"> <li>• When shooting in the dark, the unit becomes highly sensitive to light when "GAIN UP" is set to "AUTO".</li> </ul>	23. <ul style="list-style-type: none"> <li>• If you want the lighting to look more natural, set "GAIN UP" to "AGC" or "OFF". (☞ pg. 31, 35)</li> </ul>

## Other problems

SYMPTOM	POSSIBLE CAUSES	CORRECTIVE ACTION
24. The power/charge lamp on the camcorder does not light when the charging is attempted.	24. • The temperature of the battery is extremely high/low. • Charging is difficult in places subject to extremely high/low temperatures.	24. • To protect the battery, it is recommended to charge it in places with a temperature of 10°C to 35°C (50°F to 95°F). (☞ pg. 74)
25. "SET DATE/TIME!" appears.	25. • The built-in clock's rechargeable lithium battery is discharged. • The previously set date/time is erased.	25. • Connect the camcorder to an AC outlet using the AC Adapter for over 24 hours to charge the clock's lithium battery. (☞ pg. 14)
26. There is no picture.	26. • The camcorder is not getting power, or some other malfunction exists.	26. • Turn the camcorder's power off and on again. (☞ pg. 13)
27. Some functions are not available using the MENU Wheel.	27. • The Power Switch is set to "A".	27. • Set the Power Switch to "M". (☞ pg. 13)
28. Files stored in the memory card cannot be deleted.	28. • Files stored in the memory card are protected.	28. • Remove protection from the files stored in the memory card and delete them. (☞ pg. 27 -28)
29. When the image is printed from the printer, a black bar appears at the bottom of the screen.	29. • This is not a malfunction.	29. • By recording with "DIS" activated (☞ pg. 31, 36) this can be avoided.
30. When the camcorder is connected via the DV connector, the camcorder does not operate.	30. • The DV cable was plugged/unplugged with power turned on.	30. • Turn the camcorder's power off and on again, then operate it.
31. The rear of the LCD monitor is hot.	31. • The light used to illuminate the LCD monitor causes it to become hot.	31. • Close the LCD monitor to turn it off or set the Power Switch to "OFF", and let the unit cool down.
32. Images on the LCD monitor appear dark or whitish.	32. • In places subject to low temperature, images become dark due to the characteristics of the LCD monitor. When this happens, the displayed colors differ from those that are actually recorded. This is not a defect of the camcorder. • When the LCD monitor's fluorescent light reaches the end of its service life, images on the LCD monitor become dark. Consult your nearest JVC dealer.	32. • Adjust the brightness and angle of the LCD monitor. (☞ pg. 12, 13)



<p><b>33.</b> Colored bright spots appear all over the LCD monitor or the viewfinder.</p>	<p><b>33.</b> • The LCD monitor and the viewfinder are made with high-precision technology. However, black spots or bright spots of light (red, green or blue) may appear constantly on the LCD monitor or the viewfinder. These spots are not recorded on the tape. This is not due to any defect of the unit. (Effective dots: more than 99.99 %)</p>	<p><b>33.</b></p> <p style="text-align: center;">—</p>
<p><b>34.</b> The indicators and the image color on the LCD monitor are not clear.</p>	<p><b>34.</b> • This may occur when the surface or the edge of the LCD monitor is pressed.</p>	<p><b>34.</b></p> <p style="text-align: center;">—</p>
<p><b>35.</b> The cassette will not load properly.</p>	<p><b>35.</b> • The battery's charge is low.</p>	<p><b>35.</b> • Install a fully charged battery. (☞ pg. 10, 11)</p>
<p><b>36.</b> The memory card cannot be removed from the camcorder.</p>	<p><b>36.</b></p> <p style="text-align: center;">—</p>	<p><b>36.</b> • Push in the memory card a few more times. (☞ pg. 16)</p>
<p><b>37.</b> Picture does not appear on the LCD monitor.</p>	<p><b>37.</b> • The viewfinder is pulled out and "PRIORITY" is set to "FINDER".</p> <ul style="list-style-type: none"> <li>• The LCD monitor's brightness setting is too dark.</li> </ul>	<p><b>37.</b> • Push the viewfinder back in or set "PRIORITY" to "LCD". (☞ pg. 12, 31, 38)</p> <ul style="list-style-type: none"> <li>• Adjust the brightness of the LCD monitor. (☞ pg. 13)</li> <li>• If the monitor is tilted upward 180 degrees, open the monitor fully. (☞ pg. 12)</li> </ul>
<p><b>38.</b> Images on the LCD monitor are jittery.</p>	<p><b>38.</b> • The speaker volume is too great.</p>	<p><b>38.</b> • Turn the speaker volume down. (☞ pg. 20)</p>
<p><b>39.</b> The LCD monitor, the viewfinder and the lens have become dirty (ex. fingerprints).</p>	<p><b>39.</b></p> <p style="text-align: center;">—</p>	<p><b>39.</b> • Wipe them gently with soft cloth. Wiping strongly can cause damage. (☞ pg. 77) To clean the viewfinder, please consult your nearest JVC dealer.</p>
<p><b>40.</b> Time code does not appear.</p>	<p><b>40.</b> • "TIME CODE" is set to "OFF".</p>	<p><b>40.</b> • Set "TIME CODE" to "ON". (☞ pg. 31, 38, 41)</p>
<p><b>41.</b> An error indication (E01, E02 or E06) appears.</p>	<p><b>41.</b> • A malfunction of some kind has occurred. In this case the camcorder's functions become unusable.</p>	<p><b>41.</b> • ☞ pg. 85.</p>
<p><b>42.</b> An error indication (E03 or E04) appears.</p>	<p><b>42.</b> • A malfunction of some kind has occurred. In this case the camcorder's functions become unusable.</p>	<p><b>42.</b> • ☞ pg. 85.</p>
<p><b>43.</b> The remote control does not work.</p>	<p><b>43.</b> • "REMOTE" is set to "OFF".</p> <ul style="list-style-type: none"> <li>• The remote control does not point at the remote sensor.</li> <li>• The remote control batteries are exhausted.</li> </ul>	<p><b>43.</b> • Set "REMOTE" to "ON". (☞ pg. 31, 37)</p> <ul style="list-style-type: none"> <li>• Point at the remote sensor. (☞ pg. 56)</li> <li>• Replace the batteries with fresh ones. (☞ pg. 56)</li> </ul>

### When using the AC Power Adapter in areas other than the USA

- The provided AC Power Adapter features automatic voltage selection in the AC range from 110 V to 240 V.

### USING HOUSEHOLD AC PLUG ADAPTER

In case of connecting the unit's power cord to an AC wall outlet other than American National Standard C73 series type use an AC plug adapter, called a "Siemens Plug", as shown.

For this AC plug adapter, consult your nearest JVC dealer.

Plug adapter

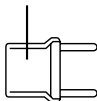

### General Battery Precautions (GR-DV900 only)

If the remote control is not functioning even if it is being operated correctly, the batteries are exhausted. Replace them with fresh ones.

**Use only the following batteries:** AAA (R03) size x 2

Please make note of the following rules for battery use. When misused, the batteries can leak or explode.

1. When replacing batteries, refer to page 56.
2. **Do not** use any different size of batteries from those specified.
3. Be sure to install batteries in the correct direction.
4. **Do not** use rechargeable batteries.
5. **Do not** expose the batteries to excessive heat as they can leak or explode.
6. **Do not** dispose of the batteries in a fire.
7. Remove the batteries from the unit if it is to be stored for an extended period to avoid battery leakage which can cause malfunctions.
8. **Do not** recharge the provided batteries.

### Caution on Replaceable lithium battery (GR-DV800/DV500 only)

The battery used in this device may present a fire or chemical burn hazard if mistreated.

Do not recharge, disassemble, heat above 100°C (212°F) or incinerate.

Replace battery with Panasonic (Matsushita Electric), Sanyo, Sony or Maxell CR2025.

Danger of explosion or Risk of fire if the battery is incorrectly replaced.

- Dispose of used battery promptly.
- Keep away from children.
- Do not disassemble and do not dispose of in fire.

### Battery Packs

The supplied battery pack is a lithium-ion battery.

Before using the supplied battery pack or an optional battery pack, be sure to read the following cautions:

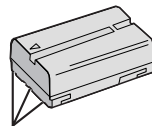

Terminals

#### 1. To avoid hazards...

- ... **do not** burn.
- ... **do not** short-circuit the terminals. When transporting, make sure the provided battery cap is attached to the battery. If the battery cap is misplaced, carry the battery in a plastic bag.
- ... **do not** modify or disassemble.
- ... **do not** expose the battery to temperatures exceeding 60°C (140°F), as this may cause the battery to overheat, explode or catch fire.
- ... use only specified chargers.

#### 2. To prevent damage and prolong service life...

- ... do not subject to unnecessary shock.
- ... charge in an environment where temperatures are within the tolerances shown in the chart below. This is a chemical reaction type battery — cooler temperatures impede chemical reaction, while warmer temperatures can prevent complete charging.
- ... store in a cool, dry place. Extended exposure to high temperatures will increase natural discharge and shorten service life.
- ... fully charge and then fully discharge the battery every 6 months when storing the battery pack over a long period time.
- ... remove from charger or powered unit when not in use, as some machines use current even when switched off.

#### NOTES:

- *It is normal for the battery pack to be warm after charging, or after use.*
- **Temperature Range Specifications**  
Charging.....10°C to 35°C (50°F to 95°F)  
Operation.....0°C to 40°C (32°F to 104°F)  
Storage.....-20°C to 50°C (-4°F to 122°F)
- *Recharging time is based on room temperature of 20°C (68°F).*
- *The lower the temperature, the longer recharging takes.*

### Cassettes

To properly use and store your cassettes, be sure to read the following cautions:

#### 1. During use...

- ... make sure the cassette bears the Mini DV mark.
- ... be aware that recording onto prerecorded tapes automatically erases the previously recorded video and audio signals.

- ... make sure the cassette is positioned properly when inserting.
- ... do not load and unload the cassette repeatedly without allowing the tape to run at all. This slackens the tape and can result in damage.
- ... do not open the front tape cover. This exposes the tape to fingerprints and dust.

## 2. Store cassettes...

- ... away from heaters or other heat sources.
- ... out of direct sunlight.
- ... where they won't be subject to unnecessary shock or vibration.
- ... where they won't be exposed to strong magnetic fields (such as those generated by motors, transformers or magnets).
- ... vertically, in their original cases.

## Memory Cards

To properly use and store your memory cards, be sure to read the following cautions:

### 1. During use...

- ... make sure the memory card bears the SD or MultiMediaCard mark.
- ... make sure the memory card is positioned properly when inserting.

### 2. While the memory card is being accessed (during recording, playback, deletion, initialization, etc.)...

- ... never unload the memory card and never turn off the camcorder.

### 3. Store memory cards...

- ... away from heaters or other heat sources.
- ... out of direct sunlight.
- ... where they won't be subject to unnecessary shock or vibration.
- ... where they won't be exposed to strong magnetic fields (such as those generated by motors, transformers or magnets).

## LCD Monitor

### 1. To prevent damage to the LCD monitor, DO NOT...

- ... push it strongly or apply any shocks.
- ... place the camcorder with the LCD monitor on the bottom.

### 2. To prolong service life...

- ... avoid rubbing it with coarse cloth.

### 3. Be aware of the following phenomena for LCD monitor use.

#### These are not malfunctions:

- While using the camcorder, the surface around the LCD monitor and/or the back of the LCD monitor may heat up.
- If you leave power on for a long time, the surface around the LCD monitor becomes hot.

## Main Unit

### 1. For safety, DO NOT...

- ... open the camcorder's chassis.
- ... disassemble or modify the unit.
- ... short-circuit the terminals of the battery pack. Keep it away from metallic objects when not in use.
- ... allow inflammables, water or metallic objects to enter the unit.
- ... remove the battery pack or disconnect the power supply while the power is on.
- ... leave the battery pack attached when the camcorder is not in use.

### 2. Avoid using the unit...

- ... in places subject to excessive humidity or dust.
- ... in places subject to soot or steam such as near a cooking stove.
- ... in places subject to excessive shock or vibration.
- ... near a television set.
- ... near appliances generating strong magnetic or electric fields (speakers, broadcasting antennas, etc.).
- ... in places subject to extremely high (over 40°C or 104°F) or extremely low (under 0°C or 32°F) temperatures.

### 3. DO NOT leave the unit...

- ... in places of over 50°C (122°F).
- ... in places where humidity is extremely low (below 35%) or extremely high (above 80%).
- ... in direct sunlight.
- ... in a closed car in summer.
- ... near a heater.

### 4. To protect the unit, DO NOT...

- ... allow it to become wet.
- ... drop the unit or strike it against hard objects.
- ... subject it to shock or excessive vibration during transportation.
- ... keep the lens directed at extremely bright objects for long periods.
- ... expose the lens and viewfinder's lens to direct sunlight.
- ... carry it by holding the LCD monitor or the viewfinder.
- ... swing it excessively when using the hand strap or the grip.
- ... swing the soft camera case excessively when the camcorder is inside it.

### 5. Dirty heads can cause the following problems:



- No picture during playback.
- Blocks of noise appear during playback.

- During recording or playback, the Head Clog Warning indicator “⊗” appears.
  - Recording cannot be performed properly.
- In such cases, use an optional cleaning cassette. Insert it and play back. If the cassette is used more than once consecutively, damage to the video heads may result. After the camcorder plays back for about 20 seconds, it stops automatically. Also refer to the cleaning cassette's instructions.
- If, after using the cleaning cassette, the problems still exist, consult your nearest JVC dealer.
- Mechanical moving parts used to move the video heads and video tape tend to become dirty and worn out over time. In order to maintain a clear picture at all times, periodic check-ups are recommended after using the unit for about 1,000 hours. For periodic check-ups please consult your nearest JVC dealer.

## How To Handle A CD-ROM

- Take care not to soil or scratch the mirror surface (opposite to the printed surface). Do not write anything or put a sticker on either the front or back surface. If the CD-ROM gets dirty, gently wipe it with a soft cloth outward from the center hole using a circular motion.
- Do not use conventional disc cleaners or cleaning spray.
- Do not bend the CD-ROM or touch its mirror surface.
- Do not store your CD-ROM in a dusty, hot or humid environment. Keep it away from direct sunlight.

### About moisture condensation...

- You have observed that pouring a cold liquid into a glass will cause drops of water to form on the glass' outer surface. This same phenomenon occurs on the head drum of a camcorder when it is moved from a cool place to a warm place, after heating a cold room, under extremely humid conditions or in a place directly subjected to the cool air from an air conditioner.
- Moisture on the head drum can cause severe damage to the video tape, and can lead to internal damage to the camcorder itself.

### Serious malfunctioning

If malfunctioning occurs, stop using the unit immediately and consult your local JVC dealer.

The camcorder is a microcomputer-controlled device. External noise and interference (from a TV, a radio, etc.) might prevent it from functioning properly. In such cases, first disconnect its power supply unit (battery pack, AC Adapter, etc.) and wait a few minutes and then re-connect it and proceed as usual from the beginning.

### Declaration of Conformity

Model Number : GR-DV900US  
 GR-DV800US  
 GR-DV500US

Trade Name : JVC

Responsible party : JVC AMERICAS CORP.

Address : 1700 Valley Road Wayne,  
 N. J. 07470

Telephone Number : 973-317-5000

This device complies with Part 15 of FCC Rules. Operation is subject to the following two conditions: (1) This device may not cause harmful interference, and (2) this device must accept any interference received, including interference that may cause undesired operation.

Change or modifications not approved by the party responsible for compliance could void the user's authority to operate the equipment. This equipment has been tested and found to comply with the limits for a Class B digital device, pursuant to Part 15 of the FCC Rules. These limits are designed to provide reasonable protection against harmful interference in a residential installation. This equipment generates, uses, and can radiate radio frequency energy and, if not installed and used in accordance with the instructions, may cause harmful interference to radio communications. However, there is no guarantee that interference will not occur in a particular installation. If this equipment does cause harmful interference to radio or television reception, which can be determined by turning the equipment off and on, the user is encouraged to try to correct the interference by one or more of the following measures:

- Reorient or relocate the receiving antenna.
- Increase the separation between the equipment and receiver.
- Connect the equipment into an outlet on a circuit different from that to which the receiver is connected.
- Consult the dealer or an experienced radio/ TV technician for help.

This Class B digital apparatus complies with Canadian ICES-003.

Cet appareil numérique de la classe B est conforme à la norme NMB-003 du Canada.

## After Use

- 1 Turn off the camcorder.
- 2 Slide and hold **OPEN/EJECT** in the direction of the arrow, then pull the cassette holder cover open until it locks. The cassette holder opens automatically. Remove the cassette.
- 3 Press "PUSH HERE" to close the cassette holder.
  - Once the cassette holder is closed, it recedes automatically. Wait until it recedes completely before closing the cassette holder cover.
- 4 Slide **BATT.RELEASE** ① and remove the battery pack ② ③.

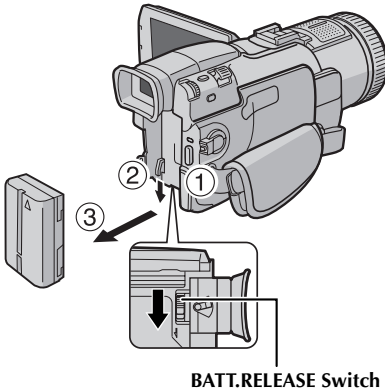
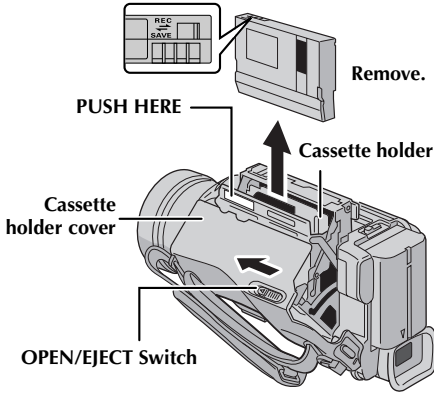

## Cleaning The Camcorder

- 1 To clean the exterior, wipe gently with a soft cloth. Put the cloth in diluted mild soap and wring it well to wipe off heavy dirt. Then wipe again with a dry cloth.
- 2 Press **PUSH OPEN** and open the LCD monitor. Wipe gently with a soft cloth. Be careful not to damage the monitor. Close the LCD monitor.
- 3 To clean the lens, blow it with a blower brush, then wipe gently with lens cleaning paper.

### NOTES:

- Avoid using strong cleaning agents such as benzine or alcohol.
- Cleaning should be done only after the battery pack has been removed or other power units have been disconnected.
- Mould may form if the lens is left dirty.
- When using a cleaner or chemically treated cloth refer to the cautions of each product.
- To clean the viewfinder, please consult your nearest JVC dealer.

## Camcorder

## For General

<b>Power supply</b>	: DC 11 V (Using AC Adapter) DC 7.2 V (Using battery pack)
<b>Power consumption</b>	
<b>LCD monitor off, viewfinder on</b>	: Approx. 3.7 W
<b>LCD monitor on, viewfinder off</b>	: Approx. 4.8 W
<b>Dimensions (W x H x D)</b>	: 74.5 mm x 91 mm x 185 mm (2-15/16" x 3-5/8" x 7-5/16") (with the LCD monitor closed and the viewfinder pushed back in)
<b>Weight</b>	: Approx. 610 g (1.4 lbs) (GR-DV900/800) Approx. 575 g (1.3 lbs) (GR-DV500) (without cassette, memory card and battery) Approx. 750 g (1.7 lbs) (GR-DV900/800) Approx. 715 g (1.6 lbs) (GR-DV500) (incl. cassette, memory card and battery)
<b>Operating temperature</b>	: 0°C to 40°C (32°F to 104°F)
<b>Operating humidity</b>	: 35% to 80%
<b>Storage temperature</b>	: -20°C to 50°C (-4°F to 122°F)
<b>Pickup</b>	: 1/4" CCD
<b>Lens</b>	: F 1.2, f = 3.8 mm to 38 mm, 10:1 power zoom lens (GR-DV900) F 1.8, f = 3.8 mm to 38 mm, 10:1 power zoom lens (GR-DV800/500)
<b>Filter diameter</b>	: ø52 mm
<b>LCD monitor</b>	: 3.5" diagonally measured, LCD panel/TFT active matrix system (GR-DV900/800) 2.5" diagonally measured, LCD panel/TFT active matrix system (GR-DV500)
<b>Viewfinder</b>	: Electronic viewfinder with 0.24" color LCD
<b>Speaker</b>	: Monaural

## For Digital Video Camera

<b>Format</b>	: DV format (SD mode)
<b>Signal format</b>	: NTSC standard
<b>Recording/Playback format</b>	: Video : Digital component recording Audio : PCM digital recording, 32 kHz 4-channel (12-bit), 48 kHz 2-channel (16-bit)
<b>Cassette</b>	: Mini DV cassette
<b>Tape speed</b>	: SP: 18.8 mm/s LP: 12.5 mm/s
<b>Maximum recording time (using 80 min. cassette)</b>	: SP: 80 min. LP: 120 min.

**For Digital Still Camera**

---

<b>Storage media</b>	:	SD Memory Card/MultiMediaCard
<b>Compression system</b>	:	Still image : JPEG (compatible) Moving image : MPEG4 (compatible)
<b>File size</b>		
<b>Still image</b>	:	4 modes (1600 x 1200 pixels/1280 x 960 pixels/1024 x 768 pixels/ 640 x 480 pixels)
<b>Moving image</b>	:	1 mode (160 x 120 pixels)
<b>Picture quality</b>	:	2 modes (FINE/STANDARD)
<b>Approximate number of storable images</b>	:	 pg. 39

**For Connectors**

---

<b>S</b>		
<b>S-Video input</b>	:	Y: 0.8 V to 1.2 V (p-p), 75 $\Omega$ analog C: 0.2 V to 0.4 V (p-p), 75 $\Omega$ analog
<b>S-Video output</b>	:	Y: 1.0 V (p-p), 75 $\Omega$ analog C: 0.29 V (p-p), 75 $\Omega$ analog
<b>AV</b>		
<b>Video input</b>	:	Y: 0.8 V to 1.2 V (p-p), 75 $\Omega$ analog
<b>Video output</b>	:	Y: 1.0 V (p-p), 75 $\Omega$ analog
<b>Audio input</b>	:	300 mV (rms), 50 k $\Omega$ analog, stereo
<b>Audio output</b>	:	300 mV (rms), 1 k $\Omega$ analog, stereo
<b>EDIT</b>	:	$\varnothing$ 3.5 mm, 2-pole
<b>Headphone output</b>	:	Stereo
<b>DV</b>		
<b>Input/output</b>	:	4-pin, IEEE 1394 compliant
<b>USB</b>	:	5-pin

**AC Adapter****For General**

---

<b>Power requirement</b>	:	
<b>U.S.A. and Canada</b>	:	AC 120 V $\sim$ , 60 Hz
<b>Other countries</b>	:	AC 110 V to 240 V $\sim$ , 50 Hz/60 Hz
<b>Output</b>	:	DC 11 V  , 1 A

Specifications shown are for SP mode unless otherwise indicated. E & O.E. Design and specifications subject to change without notice.

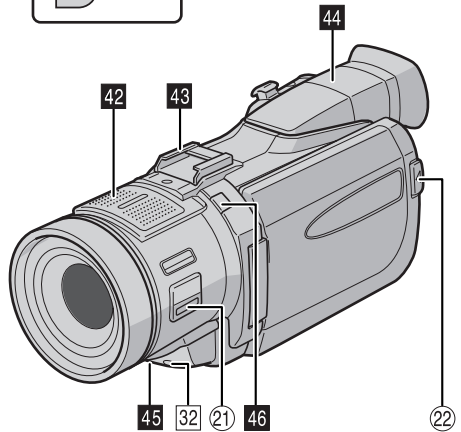
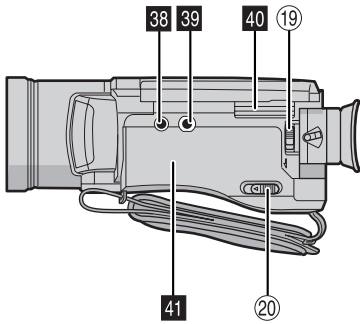
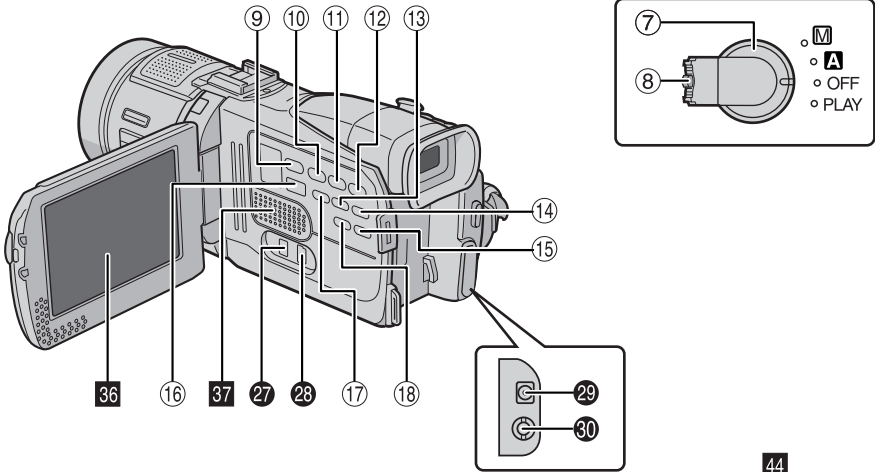
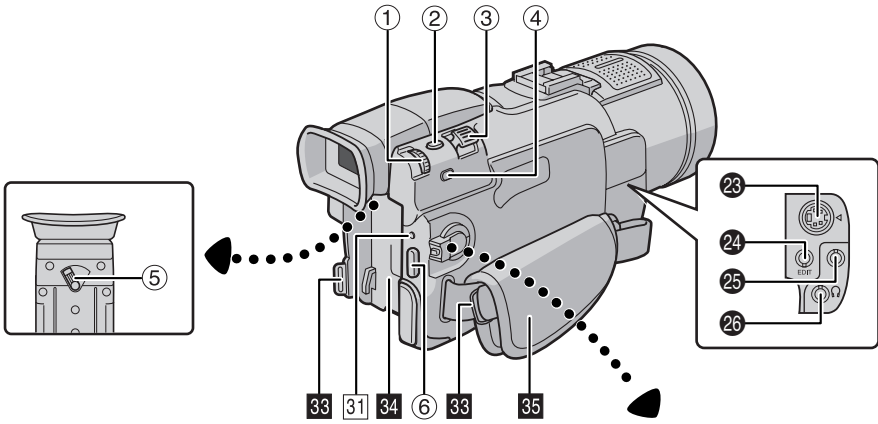



## Controls

- ① • Menu Wheel [MENU] ..... pg. 31
- Speaker/Headphone Volume Control  
[MENU/VOLUME +, -] ..... pg. 20
- ② Snapshot Button [SNAPSHOT] ..... pg. 23, 42
- ③ Power Zoom Lever [T/W] ..... pg. 18
- ④ • Focus Adjustment Button [FOCUS] ... pg. 45
- Blank Search Button  
[BLANK SEARCH] ..... pg. 21
- ⑤ Diopter Adjustment Control ..... pg. 12
- ⑥ Recording Start/Stop Button ..... pg. 17
- ⑦ Power Switch [A, M, PLAY, OFF] ..... pg. 13
- ⑧ Lock Button ..... pg. 13
- ⑨ • Stop Button [■] ..... pg. 20
- Program AE Button [PROG.AE] ..... pg. 33
- ⑩ • Rewind Button [◀◀] ..... pg. 20
- NIGHT Button ..... pg. 42
- ⑪ Play/Pause Button [▶/⏸] ..... pg. 20
- ⑫ • Fast-Forward Button [▶▶] ..... pg. 20
- Wipe or Fader Effect Button  
[FADE/WIPE] ..... pg. 32
- ⑬ Index Button [INDEX] ..... pg. 26
- ⑭ Thumbnail Storing Button  
[NAVI STORE] ..... pg. 49
- ⑮ • D.S.C. Playback Select Button  
[SELECT] ..... pg. 24 – 29
- Navigation Button [NAVI] ..... pg. 48
- ⑯ VIDEO/MEMORY Switch  
[VIDEO/MEMORY] ..... pg. 13
- ⑰ Title Button [TITLE] ..... pg. 44
- ⑱ • Information Button [INFO] ..... pg. 26
- E-Mail Clip Recording Button  
[E-MAIL] ..... pg. 50
- ⑲ Battery Release Switch  
[BATT.RELEASE] ..... pg. 10
- ⑳ Cassette Open/Eject Switch  
[OPEN/EJECT] ..... pg. 15
- ㉑ Backlight Compensation Button  
[BACK LIGHT] ..... pg. 47
- ㉒ Monitor Opening Button  
[PUSH OPEN] ..... pg. 17

## Connectors

The connectors are located beneath the covers.

- ㉓ S-Video Input/Output Connector  
[S-VIDEO] ..... pg. 22, 52, 62
- ㉔ Edit Connector [EDIT] ..... pg. 62
- ㉕ Microphone connector [MIC]  
Attach the optional microphone.
- ㉖ Headphone Connector [⌋] ..... pg. 59  
No sound is output from the speaker when headphones are connected to this connector.

- ㉗ Digital Video Connector [DV IN/OUT]  
(i.Link\*) ..... pg. 53, 54, 66  
\* i.Link refers to the IEEE1394-1995 industry specification and extensions thereof. The logo is used for products compliant with the i.Link standard.
- ㉘ USB (Universal Serial Bus)  
Connector ..... pg. 66
- ㉙ DC Input Connector [DC] ..... pg. 10, 11
- ㉚ Audio/Video Input/Output Connector  
[AV] ..... pg. 22, 52, 62

## Indicators

- ㉛ Power/Charge Lamp ..... pg. 13, 17
- ㉜ Tally Lamp ..... pg. 17, 37

## Other Parts

- ㉝ Shoulder Strap Eyelet ..... pg. 7
- ㉞ Battery Pack Mount ..... pg. 10
- ㉟ Grip Strap ..... pg. 12
- ㊱ LCD Monitor ..... pg. 12, 18
- ㊲ Speaker ..... pg. 20
- ㊳ Stud Hole
- ㊴ Tripod Mounting Socket ..... pg. 12
- ㊵ Card Cover [MEMORY CARD] ..... pg. 16
- ㊶ Cassette Holder Cover ..... pg. 15
- ㊷ Stereo Microphone ..... pg. 59
- ㊸ Info-Shoe  
Attach the optional JVC video light (VL-V3U)/flash (VL-F3U)/zoom microphone (MZ-V3U).  
Make sure to turn off the power of the camcorder and the video light/flash/zoom microphone before attaching and removing them.
- ㊹ Viewfinder ..... pg. 12
- ㊺ Remote Sensor ..... pg. 56
- ㊻ Camera Sensor  
Be careful not to cover this area, a sensor necessary for shooting is built-in here.

## Indications

### LCD Monitor/Viewfinder Indications During Video Recording Only

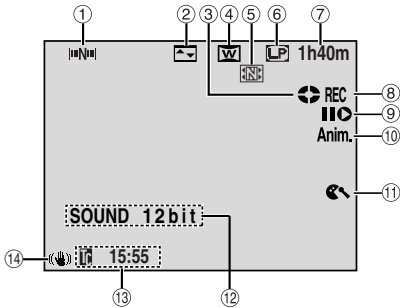

- ① **Navigation Indicator** (☞ pg. 48)  
(Appears when "NAVIGATION" is set to other than "MANUAL".)
- ② **Selected Wipe/Fader Effect Indicator** (☞ pg. 32)
- ③ **Tape Running Indicator** (☞ pg. 17)  
(Rotates while tape is running.)
- ④ **Selected Wide Mode Indicator** (☞ pg. 37)
- ⑤ **Thumbnail Storing Indicator** (☞ pg. 48)  
(Appears while the captured image is being stored as a thumbnail image in the memory card.)
- ⑥ **Recording Speed Mode (SP/LP)** (☞ pg. 34)
- ⑦ **Tape Remaining Time** (☞ pg. 17)
- ⑧ **•REC:** (Appears during recording.) (☞ pg. 17)  
**•PAUSE:** (Appears during Record-Standby mode.) (☞ pg. 17)
- ⑨ **Insert Editing/Insert Editing Pause Mode** (☞ pg. 60)
- ⑩ **5S/Anim.:** Displays the 5-Second Recording mode or Animation recording mode. (☞ pg. 36)
- ⑪ **Wind Cut Indicator** (☞ pg. 37)
- ⑫ **Sound Mode Indicator** (☞ pg. 34)  
(Appears for approx. 5 seconds after turning on the camcorder.)
- ⑬ **Time Code** (☞ pg. 38, 41)
- ⑭ **Digital Image Stabilizer ("DIS")** (☞ pg. 36)

### LCD Monitor/Viewfinder Indications During D.S.C. Recording Only

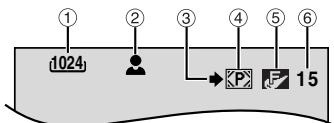

- ① **Image Size: 1600 (1600 x 1200), 1280 (1280 x 960), 1024 (1024 x 768) or 640 (640 x 480)** (☞ pg. 39)
- ② **Focus Icon** (☞ pg. 23)

(Blinks while the focus is being adjusted and stops blinking when the focus is locked.)

- ③ **Shooting Icon** (☞ pg. 23)  
(Appears and blinks during shooting.)
- ④ **Card Icon** (☞ pg. 23)  
☞: Appears during shooting.  
☞: Blinks in white when a memory card is not loaded.  
☞: Blinks in yellow while the camcorder is reading the data in the memory card such as titles/frames, NAVIGATION thumbnail images, video clips, still images, etc.
- ⑤ **Picture Quality: ☞ (FINE) and ☞ (STANDARD) (in order of quality)** (☞ pg. 39)
- ⑥ **Remaining Number Of Shot** (☞ pg. 23)  
(Displays the approximate remaining number of shots that can be stored during D.S.C. recording, or the remaining number of storable thumbnail images when it reaches 10 or less during video recording. The number increases or decreases depending on the Picture Quality/Image Size, etc.)

### LCD Monitor/Viewfinder Indications During E-Mail Clip Recording

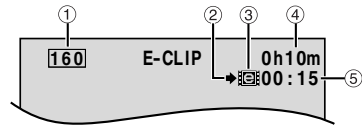

- ① **Image Size: 160 (160 x 120)** (☞ pg. 38)
- ② **Shooting Icon** (☞ pg. 23)  
(Appears and blinks during shooting.)
- ③ **E-Mail Clip Recording Indicator** (☞ pg. 50)
- ④ **Memory Card Remaining Time For E-Mail Clip Recording** (☞ pg. 50)
- ⑤ **E-Mail Clip Recording Time** (☞ pg. 50)

### LCD Monitor/Viewfinder Indications During Both Video And D.S.C. Recording

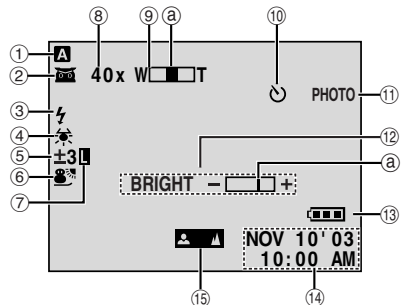

- ① **Operation Mode** (☞ pg. 13)
- ② **•A: Night-Alive Indicator** (☞ pg. 42)

- (Appears when Night-Alive is engaged.)
- **Gain Up Mode** (pg. 35)  
(Appears when "GAIN UP" is set to "AUTO" and the shutter speed is automatically adjusted.)
- ③ **Flash Indicator**  
(Appears when the optional flash attached to the info-shoe is ready.)
- ④ **White Balance Indicator** (pg. 47)
- ⑤ **Backlight Compensation Indicator** (pg. 47)
  - **Exposure Adjustment Indicator** (pg. 46)
- ⑥ **Selected Program AE With Special Effects Indicator** (pg. 33)
- ⑦ **Iris Lock Indicator** (pg. 46)
- ⑧ **Approximate Zoom Ratio** (pg. 18)  
(Appears during zooming.)
- ⑨ **Zoom Indicator** (pg. 18)  
(Appears during zooming.)  
(The level indicator @ moves.)
- ⑩ **Self-Timer Recording Indicator** (pg. 43)
- ⑪ **PHOTO:** (Appears when taking Snapshot.) (pg. 42)
- ⑫ **BRIGHT: Brightness Control Indicator (LCD monitor/Viewfinder)** (pg. 13)  
(The level indicator @ moves.)
- ⑬ **Battery Indicator** (pg. 84)
- ⑭ **Date/Time** (pg. 14)
- ⑮ **Manual Focus Adjustment Indicator** (pg. 45)

## LCD Monitor/Viewfinder Indications During Video Playback

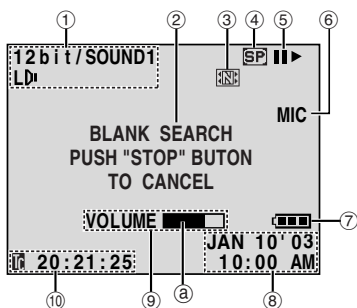

- ① **Sound Mode Indicator** (pg. 40)
- ② **Blank Search Indicator** (pg. 21)
- ③ **Thumbnail Storing Indicator** (pg. 49)  
(Appears while the captured image is being stored as a thumbnail image in the memory card.)
- ④ **Tape Speed** (pg. 34)
- ⑤ **▶**: Playback
- ⑥ **▶▶**: Fast-Forward/Shuttle Search
- ⑦ **◀◀**: Rewind/Shuttle Search
- ⑧ **||**: Pause





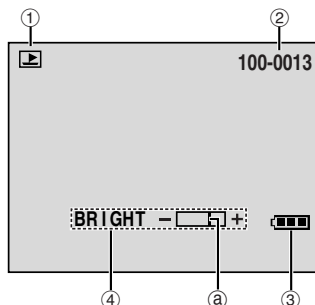

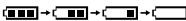

- ⑥ **▶▶**: Forward Frame-By-Frame Playback/Slow-Motion
- ⑦ **◀◀**: Reverse Frame-By-Frame Playback/Slow-Motion
- ⑧ **●●**: Audio Dubbing
- ⑨ **●●●**: Audio Dubbing Pause  
(Appear while a tape is running.)
- ⑩ **Sound Input For Audio Dubbing** (pg. 59)
- ⑪ **Battery Indicator** (pg. 84)
- ⑫ **Date/Time** (pg. 38, 41)
- ⑬ **VOLUME: Volume Level Indicator (Speaker or headphone)** (pg. 20)  
(The level indicator @ moves.)
- ⑭ **BRIGHT: Brightness Control Indicator (LCD monitor/Viewfinder)** (pg. 13)  
(The level indicator @ moves.)
- ⑮ **Time Code** (pg. 38, 41)

## LCD Monitor/Viewfinder Indications During D.S.C. Playback





- ① **Operation Mode Indicator** (pg. 26)
- ② **Folder/File Number** (pg. 26)
- ③ **Battery Indicator** (pg. 84)
- ④ **Brightness Control Indicator (LCD monitor/Viewfinder)** (pg. 13)  
(The level indicator @ moves.)

## Warning Indications

Indications	Function
	Displays the battery remaining power. Remaining power level: high  →  →  →  Remaining power level: exhausted  As the battery power comes close to nil, the battery indicator blinks. When the battery power is exhausted, power turns off automatically.
	Appears when no tape is loaded. (☞ pg. 15)
<b>CHECK TAPE'S ERASE PROTECTION TAB</b>	Appears when the erase protection tab is set to "SAVE" while the Power Switch is set to "A" or "M" and the VIDEO/MEMORY Switch is set to "VIDEO". (☞ pg. 13)
 <b>HEAD CLEANING REQUIRED USE CLEANING CASSETTE</b>	Appears if dirt is detected on the heads during recording. Use an optional cleaning cassette. (☞ pg. 77)
 <b>CONDENSATION OPERATION PAUSED PLEASE WAIT</b>	Appears if condensation occurs. When this indication is displayed, wait more than 1 hour until condensation disappears.
<b>TAPE!</b>	Appears if a tape is not loaded when the Recording Start/Stop Button or SNAPSHOT Button is pressed while the Power Switch is set to "A" or "M" and the VIDEO/MEMORY Switch is set to "VIDEO".
<b>TAPE END</b>	Appears when the tape ends during recording or playback. (☞ pg. 68)
<b>SET DATE/TIME!</b>	<ul style="list-style-type: none"> <li>● Appears when the date/time is not set. (☞ pg. 14)</li> <li>● Appears when the built-in clock (lithium) battery is discharged and the previously set date/time is erased. (☞ pg. 14)</li> </ul>
<b>LENS CAP</b>	Appears for 5 seconds after power is turned on if the lens cap is attached.
<b>A. DUB ERROR!</b>	Appears if Audio Dubbing is attempted on a blank portion of a tape. (☞ pg. 59)
<b>A. DUB ERROR! &lt;CANNOT DUB ON A LP RECORDED TAPE&gt; &lt;CANNOT DUB ON A 16bit RECORDING&gt; &lt;CHECK TAPE'S ERASE PROTECTION TAB&gt; &lt;MEMORY CARD!&gt;</b>	<ul style="list-style-type: none"> <li>● Appears if Audio Dubbing is attempted on a tape recorded in the LP mode. (☞ pg. 59)</li> <li>● Appears if Audio Dubbing is attempted on a tape recorded in 16-bit audio. (☞ pg. 59)</li> <li>● Appears if A. DUB (⊖) on the remote control is pressed when the erase protection tab is set to "SAVE". (☞ pg. 59)</li> </ul>
<b>INSERT ERROR!</b>	Appears if Insert Editing is attempted on a blank portion of a tape. (☞ pg. 60)

Indications	Function
<b>INSERT ERROR! &lt;CANNOT EDIT ON A LP RECORDED TAPE&gt; &lt;CHECK TAPE'S ERASE PROTECTION TAB&gt;</b>	<ul style="list-style-type: none"> <li>● Appears if Insert Editing is attempted on a tape recorded in the LP mode. (☞ pg. 60)</li> <li>● Appears if <b>INSERT (D)</b> on the remote control is pressed when the erase protection tab is set to "SAVE". (☞ pg. 60)</li> </ul>
<b>MEMORY IS FULL</b>	Appears when the memory card's memory is full and shooting is not possible.
<b>COPYING FAILED</b>	<ul style="list-style-type: none"> <li>● Appears if dubbing of copyguarded signals is attempted while this camcorder is being used as a recorder.</li> <li>● Appears in the following cases when dubbing from a tape to a memory card (as digital stills or video clips): <ul style="list-style-type: none"> <li>– when no memory card is loaded.</li> <li>– when the memory card's memory is full.</li> <li>– when the memory card is not formatted.</li> <li>– when a write-protected SD Memory Card is loaded. (☞ pg. 51, 55)</li> </ul> </li> </ul>
<b>MEMORY CARD!</b>	Appears if there is no memory card loaded when you attempt to record on a memory card or access data on a memory card.
<b>PLEASE FORMAT</b>	Appears when there is a problem with a memory card and its memory is corrupt, or it has not been initialized. Initialize the memory card. (☞ pg. 30)
<b>NO IMAGES STORED</b>	Appears if there are no image files stored in the memory card when you attempt memory card playback.
<b>NO E-MAIL CLIP STORED</b>	Appears if there are no video clip files stored in the memory card when you attempt memory card playback.
<b>PICTURE SELECTION NOT FOUND</b>	Appears when <b>NAVI STORE</b> is pressed to make a thumbnail image before recording or playback. (☞ pg. 48)
<b>NO TITLE DATA STORED</b>	<ul style="list-style-type: none"> <li>● Appears if there are no title/frame files stored in the memory card when you attempt to use titles/frames.</li> <li>● Appears when you attempt to use titles/frames during video playback.</li> </ul>
<b>CARD ERROR!</b>	Appears when the camcorder does not recognise the loaded memory card. Remove the memory card once and insert it again. Repeat these procedures until no indication appears. If the indication still appears, the memory card is corrupted.
<b>UNSUPPORTED FILE!</b>	Appears when playing back a file that is not compatible with DCF or a file with a size that is not compatible with this camcorder.
<b>CHECK CARD'S WRITE PROTECTION SWITCH</b>	<ul style="list-style-type: none"> <li>● Appears when you attempt to shoot digital still images when the write protection tab on the SD Memory Card is set to the "LOCK" position.</li> <li>● Appears when you attempt MEMORY SELECT menu operation with a write-protected SD Memory Card loaded.</li> </ul>
<b>E01, E02 or E06 UNIT IN SAFEGUARD MODE REMOVE AND REATTACH BATTERY</b>	The error indications (E01, E02 or E06) show what type of malfunction has occurred. When an error indication appears, the camcorder turns off automatically. Remove the power supply (battery, etc.) and wait a few minutes for the indication to clear. When it does, you can resume using the camcorder. If the indication remains, consult your nearest JVC dealer.
<b>E03 or E04 UNIT IN SAFEGUARD MODE EJECT AND REINSERT TAPE</b>	The error indications (E03 or E04) show what type of malfunction has occurred. When an error indication appears, the camcorder turns off automatically. Eject the cassette once and re-insert it, then check if the indication clears. When it does, you can resume using the camcorder. If the indication remains, consult your nearest JVC dealer.

<b>A</b>		<b>G</b>	
AC Adapter .....	10, 11	Gain Up (GAIN UP) .....	35
Animation .....	36	Grip Adjustment .....	12
Audio Dubbing .....	59	<b>I</b>	
Auto Focus .....	45	Image Size (IMAGE SIZE) .....	39
Auto Playback Of Images .....	24	Index Playback Of Files .....	26
Auto Shut Off .....	17, 23	Indications on the LCD Monitor/Viewfinder ..	82, 83
<b>B</b>		Indicators .....	32 – 41
Backlight Compensation .....	47	Initialising A Memory Card (FORMAT) .....	30
Battery Pack .....	10, 11, 74	Insert Editing .....	60
Beep (BEEP) .....	37	Iris .....	46
Blank search .....	21	Iris Lock .....	46
Brightness Adjustment Of The Display (BRIGHT) .....	13	<b>J</b>	
Built-in Clock's Rechargeable Lithium Battery .....	14	Journalistic Shooting .....	18
<b>C</b>		<b>L</b>	
Changing The Menu Settings .....	31	Loading A Cassette .....	15
Channels (Left/Right) .....	40	Loading A Memory Card .....	16
Charging The Battery Pack .....	10	<b>M</b>	
Cleaning The Camcorder .....	77	Manual Focus .....	45
Clock adjustment (CLOCK ADJ.) .....	14	Memory Card .....	16, 75
Connections		Menu Screen	
Charging .....	10	CAMERA .....	34, 35
Dubbing .....	52 – 55	CAMERA DISPLAY .....	38
Random Assemble Editing .....	60 – 65	DSC .....	39
To A PC .....	66	D.S.C. Playback .....	26 – 30
To A TV Or VCR .....	22	MANUAL .....	36, 37
WebCam .....	67	SYSTEM .....	37, 41
<b>D</b>		VIDEO .....	40
Date/Time		VIDEO DISPLAY .....	41
Display (DATE/TIME) .....	38, 41	Motor Drive Mode .....	43
Settings .....	14	MultiMediaCard .....	16, 75
DCF (Design rule for Camera File system) .....	23, 24	<b>N</b>	
Deleting Files (DELETE) .....	28	Navigation (NAVIGATION) .....	35, 48, 49
Deleting thumbnail images (NAVI.DEL.) .....	40	Night-Alive .....	42
Demonstration Mode (DEMO MODE) .....	9, 38		
Digital Image Stabilization (DIS) .....	36		
Display setting (ON SCREEN) .....	38		
DPOF Setting (Digital Print Order Format) .....	29, 30		
Dubbing .....	52 – 55		
Dubbing from tape to memory card (    COPY) .....	40, 55		
<b>E</b>			
E-Mail Clip Recording (E-CLIP REC) .....	38, 50, 51		
Erase Protection .....	15, 16		
Exposure Control (EXPOSURE) .....	46		
<b>F</b>			
Fade-In/Out .....	32		
Fast-Forward The Tape .....	20		
Frame-By-Frame Playback .....	58		

<b>P</b>	
Picture Quality (QUALITY) .....	39
Playback sound	
(SOUND MODE, 12BIT MODE) .....	40
Playback Special Effects .....	58
Playback Zoom .....	58
Power Switch Position .....	13
Priority Setting (PRIORITY) .....	38
Program AE With Special Effects (PROGRAM AE)	
Classic Film (CLASSIC FILM) .....	34
Mirror (MIRROR) .....	34
Monotone (MONOTONE) .....	34
Sepia (SEPIA) .....	34
Shutter Speed (SHUTTER) .....	33
Snow (SNOW) .....	33
Sports (SPORTS) .....	33
Spotlight (SPOTLIGHT) .....	33
Strobe (STROBE) .....	34
Twilight (TWILIGHT) .....	33
Protecting Files (PROTECT) .....	27
Provided Accessories .....	6
<b>R</b>	
Random Assemble Editing .....	60 – 65
Recording media selection (REC SELECT) .....	39
Recording Mode (REC MODE) .....	34, 40
Recording Time	
SD Memory Card .....	50
Tape .....	15
Record-Standby .....	17
Remaining Power Level .....	84
Remote Control .....	56
Remote control setting (REMOTE) .....	37
Resetting Menu Settings (CAM RESET) .....	38
Resetting The File Name .....	29
Rewind The Tape .....	20
<b>S</b>	
SD Memory Card .....	16, 75
Self-Timer (SELF-TIMER) .....	36, 43
Set Remote/VCR Code .....	61
Shuttle Search .....	21
Slow-Motion Playback .....	58
Snapshot .....	23, 42
Snapshot Mode (SNAP MODE) .....	35
Sound Mode (SOUND MODE) .....	34, 40
Speaker Volume .....	20
Specifications .....	78, 79
Still Playback .....	20
S-Video/AV input (S/AV INPUT) .....	40, 52
Synchro adjustment (SYNCHRO) .....	65
<b>T</b>	
Tally Lamp (TALLY) .....	17, 37
Telephoto setting (TELE MACRO) .....	36
Time Code (TIME CODE) .....	19, 38, 41
Title Image .....	25
Title Impose (TITLE W/) .....	44
Tripod Mounting .....	12
<b>U</b>	
Unloading A Cassette .....	15
Unloading A Memory Card .....	16
<b>V</b>	
VIDEO/MEMORY Switch Position .....	13
Viewfinder Adjustment .....	12
<b>W</b>	
WebCam .....	67
White Balance (W.BALANCE) .....	34, 47
Wide Mode (WIDE MODE)	
Cinema (CINEMA) .....	37
Squeeze (SQUEEZE) .....	37
Wide (D.WIDE) .....	37
Wind Cut (WIND CUT) .....	37
Wipe In/Out .....	32
<b>Z</b>	
Zooming (ZOOM) .....	18, 35
5-Second Recording (5S) .....	36

**EN**

**GR-DV900**  
**GR-DV800**  
**GR-DV500**

**JVC**

VICTOR COMPANY OF JAPAN, LIMITED

