

Instruction Manual

LIQ_MAN_5081T/rev.G

January 2015

5081-T

Two-Wire Toroidal Conductivity Transmitter



ESSENTIAL INSTRUCTIONS

READ THIS PAGE BEFORE PROCEEDING!

Rosemount Analytical designs, manufactures, and tests its products to meet many national and international standards. Because these instruments are sophisticated technical products, you must properly install, use, and maintain them to ensure they continue to operate within their normal specifications. The following instructions must be adhered to and integrated into your safety program when installing, using, and maintaining Rosemount Analytical products. Failure to follow the proper instructions may cause any one of the following situations to occur: Loss of life; personal injury; property damage; damage to this instrument; and warranty invalidation.

- Read all instructions prior to installing, operating, and servicing the product. If this Instruction Manual is not the correct manual, telephone 1-800-654-7768 and the requested manual will be provided. Save this Instruction Manual for future reference.
- If you do not understand any of the instructions, contact your Rosemount representative for clarification.
- Follow all warnings, cautions, and instructions marked on and supplied with the product.
- Inform and educate your personnel in the proper installation, operation, and maintenance of the product.
- Install your equipment as specified in the Installation Instructions of the appropriate Instruction Manual and per applicable local and national codes. Connect all products to the proper electrical and pressure sources.
- To ensure proper performance, use qualified personnel to install, operate, update, program, and maintain the product.
- When replacement parts are required, ensure that qualified people use replacement parts specified by Rosemount. Unauthorized parts and procedures can affect the product's performance and place the safe operation of your process at risk. Look alike substitutions may result in fire, electrical hazards, or improper operation.
- Ensure that all equipment doors are closed and protective covers are in place, except when maintenance is being performed by qualified persons, to prevent electrical shock and personal injury.

CAUTION

If a Model 375 Universal Hart® Communicator is used with these transmitters, the software within the Model 375 may require modification. If a software modification is required, please contact your local Emerson Process Management Service Group or National Response Center at 1-800-654-7768.

About This Document

This manual contains instructions for installation and operation of the Model 5081-T Two-Wire Conductivity Transmitter. The following list provides notes concerning all revisions of this document.

<u>Rev. Level</u>	<u>Date</u>	<u>Notes</u>
A	1/05	This is the initial release of the product manual. The manual has been reformatted to reflect the Emerson documentation style and updated to reflect any changes in the product offering. This manual contains information on HART Smart and FOUNDATION Fieldbus versions of 5081-T.
B	5/05	Fix LED font on pages 4, 30, 34, 35, 39.
C	10/05	Add instructions to enable autoranging or fixed measurement ranges on page 50.
D	2/06	Add FISCO agency certifications drawings, pp. 30-36.
E	1/11	Update enclosure specifications, © info and dnv logo.
F	11/12	Add Fieldbus specifications, update ITK revision and CE certifications.
G	7/14	Revised Fig. 3-6 on p. 17 for EMI/RFI immunity protection installations

Emerson Process Management

2400 Barranca Parkway
Irvine, CA 92606 USA
Tel: (949) 757-8500
Fax: (949) 474-7250

<http://www.rainhome.com>

5081-T TWO-WIRE TRANSMITTER

TABLE OF CONTENTS

Section	Title	Page
1.0	DESCRIPTION AND SPECIFICATIONS	1
1.1	Features and Applications.....	1
1.2	Specifications.....	2
1.3	Hazardous Location Approval.....	3
1.4	Transmitter Display During Calibration and Programming.....	4
1.5	Infrared Remote Controller	4
1.6	HART Communications	5
1.7	FOUNDATION Fieldbus.....	6
1.8	General Specifications	6
1.8	Asset Management Solutions	7
2.0	INSTALLATION	8
2.1	Unpacking and Inspection.....	8
2.2	Orienting the Display Board	8
2.3	Mechanical Installation.....	8
2.4	Power Supply/Current Loop Wiring for Model 5081-T-HT	12
2.5	Power Supply Wiring for Model 5081-T-FF/FI.....	13
3.0	WIRING.....	14
3.1	Sensor Wiring	14
3.2	Electrical Installation	16
4.0	INTRINSICALLY SAFE AND EXPLOSION PROOF INSTALLATIONS.....	19
4.1	Intrinsically Safe and Explosion-Proof Installation for Model 5081-T-HT	19
4.2	Intrinsically Safe and Explosion-Proof Installation for Model 5081-T-FF	24
4.3	Intrinsically Safe and Explosion-Proof Installation for Model 5081-T-FI	28
5.0	DISPLAY AND OPERATION	34
5.1	Displays	34
5.2	Infrared Remote Controller (IRC) — Key Functions	35
5.3	Quick Start for Model 5081-T-HT	36
5.4	Quick Start for Model 5081-T-FF/FI	36
5.5	Menu Tree.....	37
5.6	Diagnostic Messages.....	37
5.7	Default Setting	38
5.8	Security	39
5.9	Using Hold	40
6.0	START-UP AND CALIBRATION	42
6.1	Accessing the Calibrate Menu	42
6.2	Calibrate Menu.....	43

.....Continued on following page

TABLE OF CONTENTS CONT'D

7.0	PROGRAMMING	44
7.1	General	44
7.2	Output	45
7.3	Temp	49
7.4	Display	50
7.5	HART	51
7.6	Setup Cust	52
7.7	Range	53
7.8	Default.....	53
8.0	FOUNDATION FIELDBUS OPERATION	54
9.0	OPERATION WITH MODEL 375	55
9.1	Note on Model 375 or 475 Communicator	55
9.2	Connecting the Communicator	55
9.3	Operation	56
10.0	DIAGNOSIS AND TROUBLESHOOTING	71
10.1	Overview	71
10.2	Fault Conditions	73
10.3	Diagnostic Messages	74
10.4	Quick Troubleshooting Guide.....	75
10.5	Systematic Troubleshooting	76
10.6	RTD Resistance Values	77
10.7	Warning and Fault Messages	78
10.8	Troubleshooting When a Fault or Warning Message is Showing	79
11.0	MAINTENANCE	82
11.1	Overview	82
11.2	Preventative Maintenance	82
11.3	Corrective Maintenance	82
12.0	THEORY OF OPERATION	84
12.1	Overview	84
12.2	Conductivity	84
12.3	HART Communication	84
12.4	Output Logic.....	84
13.0	RETURN OF MATERIAL	85

LIST OF FIGURES

Number	Title	Page
1-1	Transmitter Display During Calibration and Programming	4
1-2	Infrared Remote Controller	4
1-3	HART Communicator	5
1-4	Configuring Model 5081-T Transmitter with Foundation Fieldbus	6
1-5	AMS Main Menu Tools	7
2-1	Mounting the Model 5081-T Transmitter on a Flat Surface	9
2-2	Using the Pipe Mounting Kit to Attach the Model 5081-T to a pipe	10
2-3	Load/Power Supply Wiring Requirements.....	12
2-4	Model 5081-T-HT Power Wiring Details	12
2-5	Typical Fieldbus Network Electrical Wiring Configuration	13
2-6	Model 5081-T-FF Power Wiring Details	13
3-1	Wiring Model 5081-T-HT	14
3-2	Power Supply/Current Loop Wiring for Model 5081-T-HT	15
3-3	Power Supply/Current Loop Wiring for Model 5081-T-FF	15
3-4	Power Supply and Sensor Wiring for Model 5081-T	15
3-5	Wiring Model 242 Sensor to Model 5081-T Transmitter	16
3-6	Wiring Models 222, 225, 226, 228, 242, 247 to Model 5081-T Transmitter	17
3-7	Wiring Models 222, 225, 226, 228 to Model 5081-T Transmitter	18
4-1	Model 5081-T-HT Infrared Remote Control — CSA, FM, & ATEX approvals.....	19
4-2	Model 5081-T-FF Infrared Remote Control — CSA, FM, & ATEX approvals	19
4-3	FM Explosion-Proof Installation for Model 5081-T-HT	20
4-4	FM Intrinsically Safe Installation for Model 5081-T-HT.....	21
4-5	CSA Intrinsically Safe Installation for Model 5081-T-HT.....	22
4-6	ATEX Intrinsically Safe Label for Model 5081-T-HT	23
4-7	FM Explosion-Proof Installation for Model 5081-T-FF	24
4-8	FM Intrinsically Safe Installation for Model 5081-T-FF	25
4-9	CSA Intrinsically Safe Installation for Model 5081-T-FF	26
4-10	ATEX Intrinsically Safe Label for Model 5081-T-FF	27
4-11	FM Explosion-Proof Installation for Model 5081-T-FI	28
4-12	FM Intrinsically Safe Label for Model 5081-T-FI.....	29
4-13	FM Intrinsically Safe Installation for Model 5081-T-FI	30
4-14	CSA Intrinsically Safe Label for Model 5081-T-FI.....	31
4-15	CSA Intrinsically Safe Installation for Model 5081-T-FI	32
4-16	ATEX Intrinsically Safe Label for Model 5081-T-FI.....	33

LIST OF FIGURES - CONT'D

Number	Title	Page
5-1	Process Display Screen	34
5-2	Program Display Screen	34
5-3	Infrared Remote Controller	35
5-4	Menu Tree for Model 5081-T-HT	38
5-5	Menu Tree for Model 5081-T-FF	39
6-1	Menu Tree	42
6-2	Current Output Calibration	44
8-1	Functional Block Diagram for the Model 5081-T with FOUNDATION Fieldbus.....	54
9-1	Connecting the HART Communicator	55
9-2	5081-T-HT HART/Model 375 Menu Tree.....	57
9-3	5081-T-FF/FI Model 375 Menu Tree	58
10-1	Diagnose Menu Segments	71
10-2	Disabling Fault Annunciation	73
10-3	Warning Annunciation.....	73
10-4	Troubleshooting Flow Chart	76
10-5	Conductivity Determination	77
11-1	Hold Annunciation	82
11-2	5081-T Exploded View	83

LIST OF TABLES

Number	Title	Page
5-1	Default Settings fro Model 5081-T-FF	40
5-2	Default Settings fro Model 5081-T-HT	41
6-1	Calibrate Menu Mnemonics.....	45
10-1	Diagnostic Variables Mnemonics	72
10-2	Diagnostic Fault Messages	74
10-3	Quick Troubleshooting Guide	75
10-4	RTD Resistance Values.....	77
11-1	Model 5081-T Replacement Parts and Accessories	83

SECTION 1.0

DESCRIPTION AND SPECIFICATIONS

- CHOICE OF COMMUNICATION PROTOCOL: HART® or FOUNDATION Fieldbus.
- LARGE, EASY-TO-READ two-line display shows the process measurement and temperature.
- SIMPLE MENU STRUCTURE.
- ROBUST TYPE 4X ENCLOSURE.
- INTRINSICALLY SAFE DESIGN allows the transmitter to be used in hazardous environments (with appropriate safety barriers).
- NON-VOLATILE MEMORY retains program settings and calibration data during power failures.
- MEASURES CONDUCTIVITY, % CONCENTRATION, PPM, OR CUSTOM CURVE VARIABLE.
- AUTOMATIC TC RECOGNITION simplifies start up.
- AUTOMATIC/MANUAL TEMPERATURE COMPENSATION ensures accurate monitoring and control.
- AUTOMATIC COMPENSATION FOR SENSOR CABLE RESISTANCE improves accuracy of high conductivity/ low resistivity measurements.
- BUILT-IN PERCENT CONCENTRATION CURVES INCLUDE 0-15% NaOH, 0-16% HCl, 0-30% and 96-99.7% H₂SO₄.

1.1 FEATURES AND APPLICATIONS

The Model 5081-T can be used to measure conductivity in a variety of process liquids. The 5081 is compatible with most Rosemount Analytical sensors. See the Specifications section for details.

The transmitter has a rugged, weatherproof, corrosion-resistant enclosure (Type 4X and IP65) of epoxy-painted aluminum. The enclosure also meets explosion-proof standards.

The transmitter has a two-line seven-segment display. The main measurement appears in 0.8-inch (20 mm) high numerals. The secondary measurement, temperature (and pH if free chlorine is being measured), appears in 0.3-inch (7 mm) high digits.

Two digital communication protocols are available: HART (model option -HT) and FOUNDATION Fieldbus (model options -FF and FI). Digital communications allows access to AMS (Asset Management Solutions). Use AMS to set up and configure the transmitter, read process variables, and troubleshoot problems from a personal computer or host anywhere in the plant.

A handheld infrared remote controller or the HART and FOUNDATION Fieldbus Model 375 and 475 communicator can also be used for programming and calibrating the transmitter. The remote controller works from as far away as six feet.

Housed in a rugged Type 4X and case, the 5081T measures conductivity or resistivity in the harshest environments. Transmitter can also be configured, using the "Custom Curve" feature, to measure ppm, %, or a no unit variable according to a programmable conductivity vs. variable curve. The transmitter will automatically recognize the type of RTD (Pt100 or Pt1000) being used. Measurements are automatically corrected for the resistance of the sensor cable to improve accuracy of high conductivity readings. Temperature compensation choices are linear slope correction or none (display of raw conductivity).

1.2 SPECIFICATIONS

1.2.1 GENERAL SPECIFICATIONS

Housing: Cast aluminum with epoxy coating. Type 4X (IP65). Neoprene O-ring cover seals.

Dimensions: 160.5 mm x 175.3 mm x 161.3 mm (6.3 in. x 6.9 in. x 6.4 in.) See drawing.

Conduit Openings: 3/4-in. FNPT

Ambient Temperature: -4 to 149°F (-20 to 65°C)

Storage Temperature: -22 to 176°F (-30 to 80°C)

Relative Humidity: 0 to 95% (non-condensing)

Weight/Shipping Weight: 10 lb/10 lb (4.5/5.0 kg)

Display: Two-line LCD; first line shows process variable (pH, ORP, conductivity, % concentration, oxygen, ozone, or chlorine), second line shows process temperature and output current. For pH/chlorine combination, the second line can be toggled to show pH. Fault and warning messages, when triggered, alternate with temperature and output readings.

First line: 7 segment LCD, 0.8 in. (20 mm) high.

Second line: 7 segment LCD, 0.3 in. (7mm) high.

Display board can be rotated 90 degrees clockwise or counterclockwise.

During calibration and programming, messages and prompts appear in the second line.

Temperature resolution: 0.1°C

Hazardous Location Approval: For details, see specifications for the measurement of interest.

RFI/EMI: EN-61326 

Digital Communications:

HART —

Power & Load Requirements:

Supply voltage at the transmitter terminals should be at least 12 Vdc. Power supply voltage should cover the voltage drop on the cable plus the external load resistor required for HART communications (250 Ω minimum). Minimum power supply voltage is 12 Vdc. Maximum power supply voltage is 42.4 Vdc (30 Vdc for intrinsically safe operation). The graph shows the supply voltage required to maintain 12 Vdc (upper line) and 30 Vdc (lower line) at the transmitter terminals when the current is 22 mA.

Analog Output: Two-wire, 4-20 mA output with superimposed HART digital signal. Fully scalable over the operating range of the sensor.

Output accuracy: ±0.05 mA

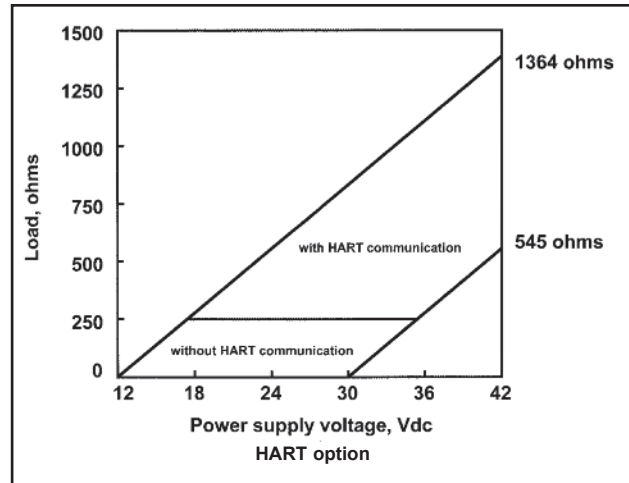

FOUNDATION FIELDBUS —

Power & Load Requirements: A power supply voltage of 9-32 Vdc at 22 mA is required.

1.2.2 FUNCTIONAL SPECIFICATIONS

Calibration: Calibration is easily accomplished by immersing the sensor in a known solution and entering its value.

Automatic Temperature Compensation:

3-wire Pt 100 RTD

Conductivity: 0 to 200°C (32 to 392°F)

% Concentration: 0 to 100°C (32 to 212°F)

Diagnostics: The internal diagnostics can detect:

Calibration Error	Zero Error
Temperature Slope Error	Low Temperature Error
High Temperature Error	Sensor Failure
Line Failure	CPU Failure
ROM Failure	Input Warning

Once one of the above is diagnosed, the LCD will display a message describing the failure/default detected.

Digital Communications:

HART: PV, SV, and TV assignable to measurement (conductivity, resistivity, or concentration), temperature, and raw conductivity. Raw conductivity is measured conductivity before temperature correction.

Fieldbus: Three AI blocks assignable to measurement (conductivity, resistivity, or concentration), temperature, and raw conductivity. Raw conductivity is measured conductivity before temperature correction.

1.2.3 TRANSMITTER SPECIFICATIONS @ 25°C

Measured Range*: 50 to 2,000,000 μS/cm (see chart)

Accuracy: ± 1.0% of reading

Repeatability: ± 0.25% of reading

Stability: 0.25% of output range/month,
non-cumulative

Ambient Temperature Coefficient: ± 0.2% of FS/°C

Temperature Slope Adjustment: 0-5%/° C

% Concentration Ranges:

Sodium Hydroxide: 0 to 15%

Hydrochloric Acid: 0 to 16%

Sulfuric Acid: 0 to 25% and 96 to 99.7%

1.2.4 LOOP SPECIFICATIONS

Loop Accuracy: With a standard Model 228 or 225 sensor with 20' cable, laboratory accuracy at 25°C can be as good as ±2% of reading and ±50 μS/cm.

To achieve optimum performance, standardize the sensor in the process at the conductivity and temperature of interest.

Results under real process conditions, at different temperatures, or using other sensors may differ from above.

RTD accuracy: Utilizing a perfect 100 Ohm RTD after 1 point temperature standardization, temperature reading can be as good as ±0.5°C.

RECOMMENDED SENSORS:

Model 222 Flow-Through

Model 225 Clean-In-Place (CIP)

Model 226 Submersion/Insertion

Model 228 Submersion/Insertion/Retractable

Model 242* Flow-Through

**no I.S. approval for loops of 5081-T with 242-06 or 242-08*

1.3 HAZARDOUS LOCATION APPROVAL

Intrinsic Safety:



Class I, II, III, Div. 1
Groups A-G
T4 Tamb = 70°C



Exia Entity
Class I, Groups A-D
Class II, Groups E-G
Class III
T4 Tamb = 70°C



IECEX BAS 09.0159X

Ex ia IIC T4 Ga

ATEX

CE 1180



II 1 G

Baseefa03ATEX0399

EEx ia IIC T4

Tamb = -20°C to +65°C

ATEX and IECEx Special Conditions for Use: The model 5081 enclosure is made of aluminum alloy and is given a protective polyurethane paint finish. However, care should be taken to protect it from impact or abrasion if located in a zone 0 hazardous area.

Non-Incendive:



Class I, Div. 2, Groups A-D
Dust Ignition Proof
Class II & III, Div. 1, Groups E-G
Type 4X Enclosure



Class I, Div. 2, Groups A-D
Suitable for
Class II, Div. 2, Groups E-G
T4 Tamb = 70°C

Explosion-Proof:



Class I, Div. 1, Groups B-D
Class II, Div. 1, Groups E-G
Class III, Div. 1



Class I, Groups B-D
Class II, Groups E-G
Class III
Tamb = 65°C max

RECOMMENDED RANGES FOR TOROIDAL SENSORS						
Conductivity Sensor Model Number	226	228	225	222 (1in.)	222 (2 in.)	242
Nominal Cell Constant	1.0	3.0	3.0	6.0	4.0	*
Minimum Conductivity (μS/cm)	50	200	200	500	500	100*
Maximum Conductivity (μS/cm)	1,000,000	2,000,000	2,000,000	2,000,000	2,000,000	2,000,000*

* Model 242 values depend on sensor configuration and wiring.

1.4 TRANSMITTER DISPLAY DURING CALIBRATION AND PROGRAMMING (FIGURE 1-1)

1. Continuous display of conductivity or resistivity readings.
2. Units: $\mu\text{S/cm}$, mS/cm , ppm, or %.
3. Current menu section appears here.
4. Submenus, prompts, and diagnostic readings appear here.
5. Commands available in each submenu or at each prompt appear here.
6. Hold appears when the transmitter is in hold.
7. Fault appears when the transmitter detects a sensor or instrument fault.
8. © flashes during digital communication.

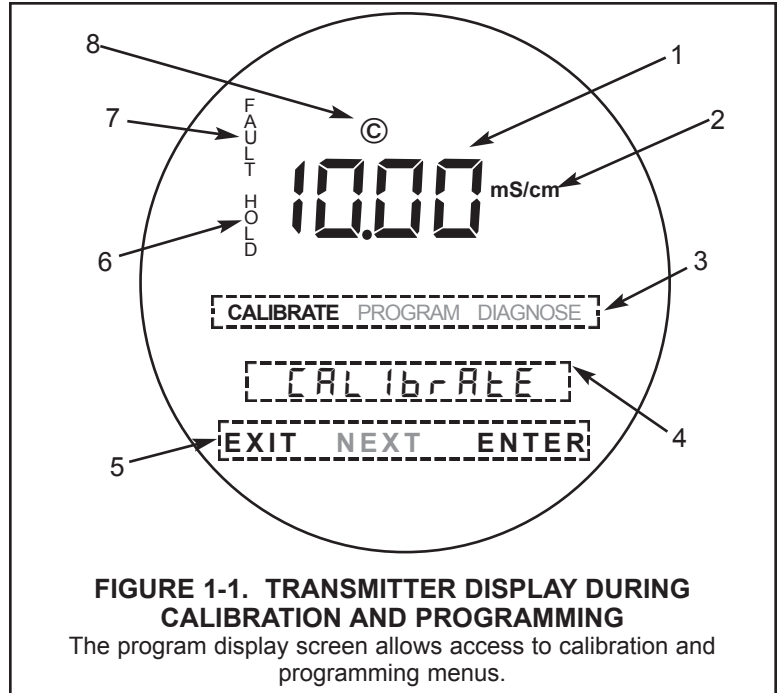

1.5 INFRARED REMOTE CONTROLLER (FIGURE 1-2)

1. Pressing a menu key allows the user access to calibrate, program, or diagnostic menus.
2. Press ENTER to store data and settings. Press NEXT to move from one submenu to the next. Press EXIT to leave without storing changes.
3. Use the editing arrow keys to scroll through lists of allowed settings or to change a numerical setting to the desired value.
4. Pressing HOLD puts the transmitter in hold and sends the output current to a pre-programmed value. Pressing RESET causes the transmitter to abandon the present menu operation and return to the main display.

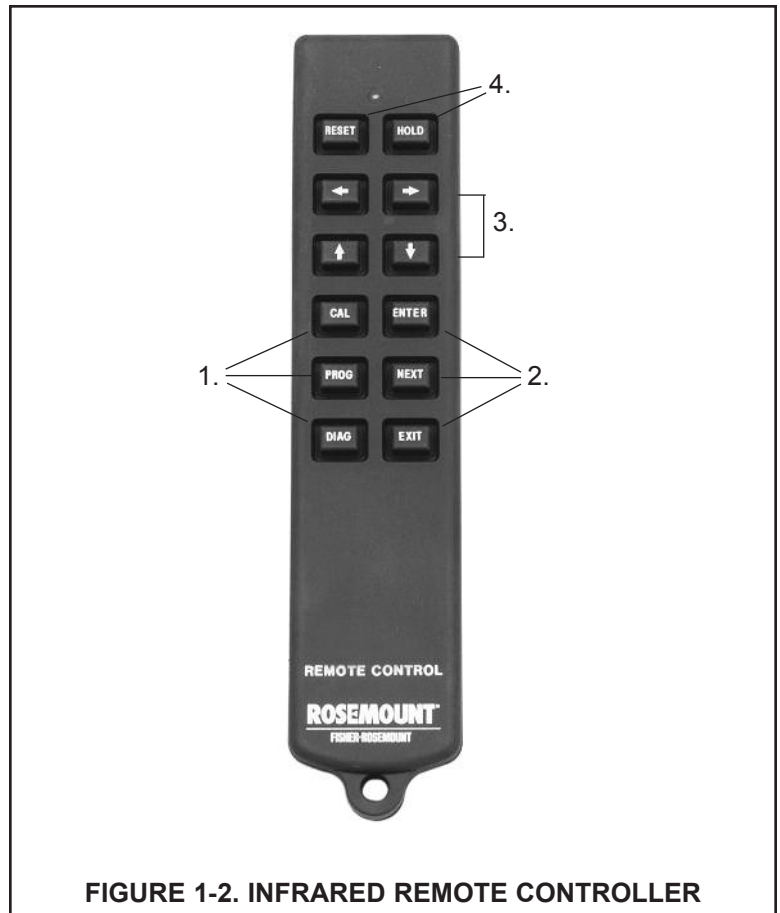

1.6 HART COMMUNICATIONS

1.6.1 OVERVIEW OF HART COMMUNICATION

HART (highway addressable remote transducer) is a digital communication system in which two frequencies are superimposed on the 4 to 20 mA output signal from the transmitter. A 1200 Hz sine wave represents the digit 1, and a 2400 Hz sine wave represents the digit 0. Because the average value of a sine wave is zero, the digital signal adds no dc component to the analog signal. HART permits digital communication while retaining the analog signal for process control.

The HART protocol, originally developed by Fisher-Rosemount, is now overseen by the independent HART Communication Foundation. The Foundation ensures that all HART devices can communicate with one another. For more information about HART communications, call the HART Communication Foundation at (512) 794-0369. The internet address is <http://www.hartcomm.org>.

1.6.2 HART INTERFACE DEVICES

HART communicators allow the user to view measurement data (pH, ORP and temperature), program the transmitter, and download information from the transmitter for transfer to a computer for analysis. Downloaded information can also be sent to another HART transmitter. Either a hand-held communicator, such as the Rosemount Model 375, or a computer can be used. HART interface devices operate from any wiring termination point in the 4 - 20 mA loop. A minimum load of 250 ohms must be present between the transmitter and the power supply. See Figure 1-3.

If your communicator does not recognize the Model 5081-T transmitter, the device description library may need updating. Call the manufacturer of your HART communication device for updates.

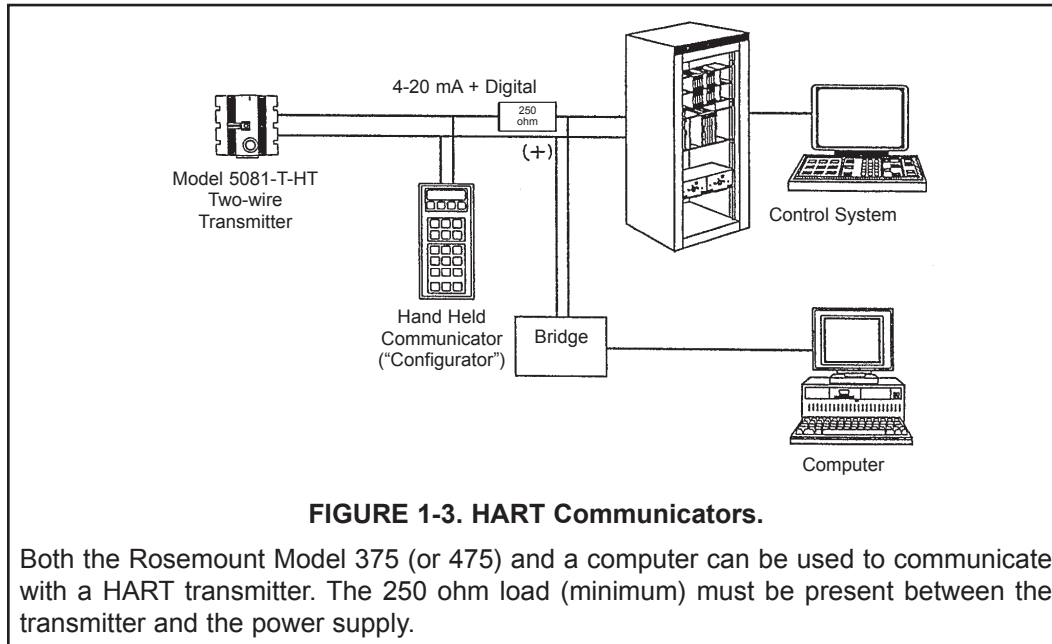

1.7 FOUNDATION FIELDBUS

Figure 1-4 shows a 5081-T-FF being used to measure conductivity. The figure also shows three ways in which Fieldbus communication can be used to read process variables and configure the transmitter.

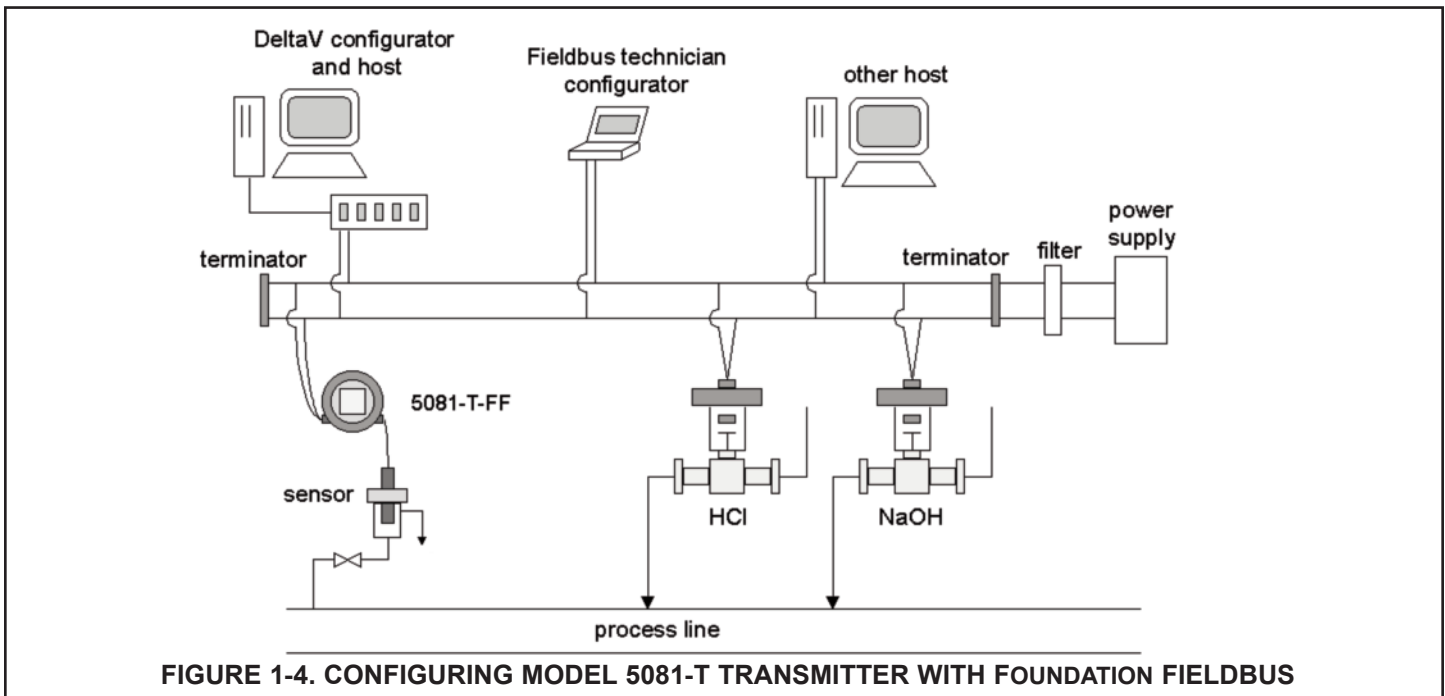

FIGURE 1-4. CONFIGURING MODEL 5081-T TRANSMITTER WITH FOUNDATION FIELDBUS

1.8 GENERAL SPECIFICATIONS

Model: 5081-T-FF Fieldbus Transmitter

Type: Toroidal Conductivity Transmitter

Device ITK Profile: 6 (Released for ITK 6.0.0 / 6.0.1)

Manufacturer Identification (MANUFAC_ID): 0x524149

Device Type (DEV_TYPE): 0x4084

Device Revision (DEV_REV): 0x03

Linkmaster: Yes

Number of Link Objects: 20

VCR's supported: 20

Mandatory Features:

- Resource Block
- Alarm and Events
- Function Block Linking
- Trending
- Multi-Bit Alert Reporting
- Field Diagnostics

Additional Features:

- Common Software Download
- Block Instantiation

- Supports DeltaV Auto Commissioning
- Supports DeltaV Auto Replacement
- Supports DeltaV Firmware Live Download
- PlantWeb Alerts with re-annunciation / multibit
- Supports Easy Configuration Assistant

Function Blocks (Execution Time):

- 4 – Analog Input Blocks (15 mseconds)
- AI Block Channels:
 - Channel 1: Conductivity, Resistivity, Concentration
 - Channel 2: Temperature
 - Channel 3: Raw Conductivity
- Proportional Integral Derivative (25 mseconds)

Power:

- Two Wire Device; Fieldbus Polarity Insensitive
- Current Draw: 21 mA
- Device Certifications: IS / FISCO
- Maximum certified input Voltage for IS: 30V
- Maximum certified input current for IS: 300mA
- Maximum certified input power for IS: 1.3W
- Internal Capacitance (Ci): 0 nF
- Internal Inductance (Li): 0 μ H

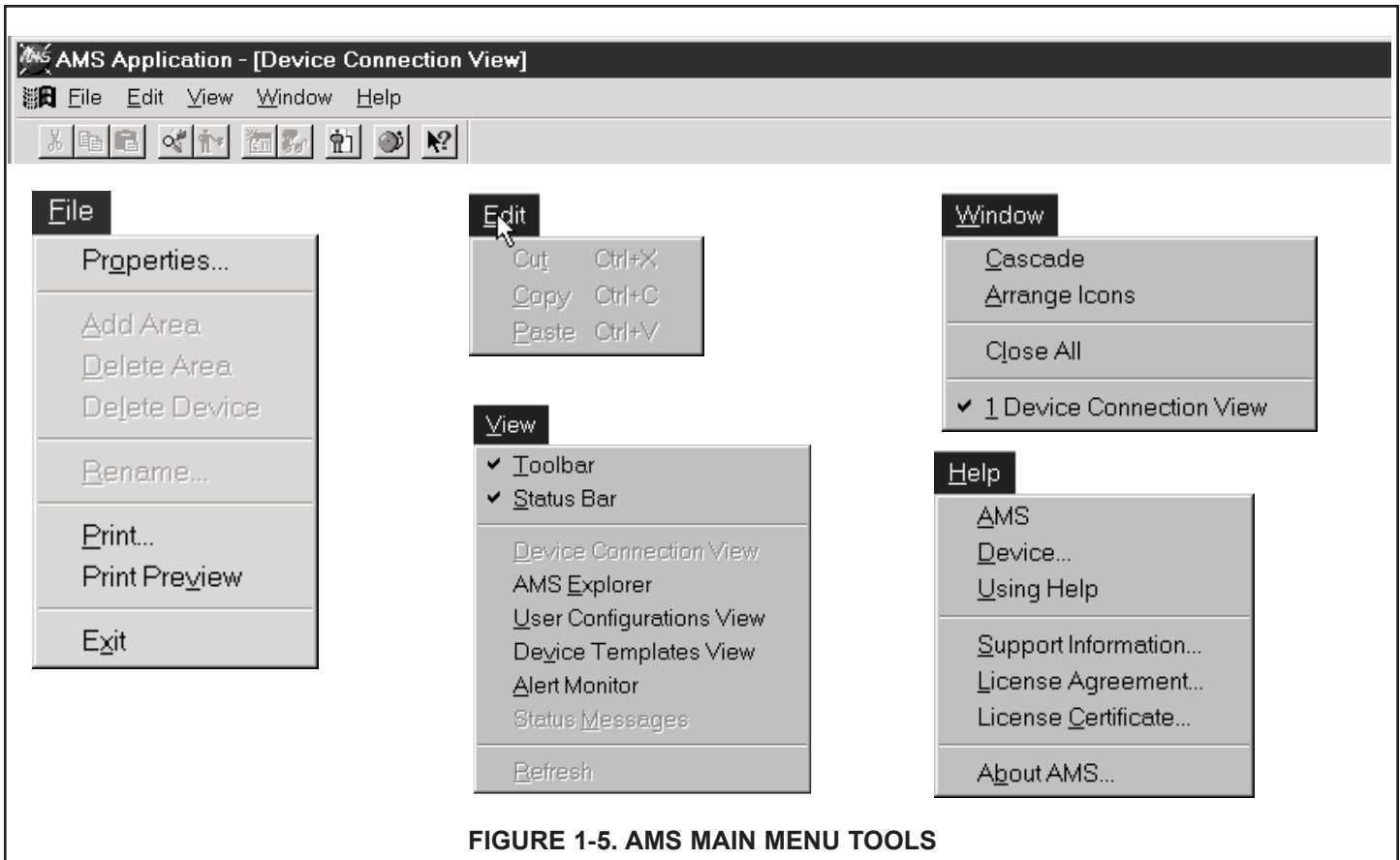

FIGURE 1-5. AMS MAIN MENU TOOLS

1.9 ASSET MANAGEMENT SOLUTIONS

Asset Management Solutions (AMS) is software that helps plant personnel better monitor the performance of analytical instruments, pressure and temperature transmitters, and control valves. Continuous monitoring means maintenance personnel can anticipate equipment failures and plan preventative measures before costly breakdown maintenance is required.

AMS uses remote monitoring. The operator, sitting at a computer, can view measurement data, change program settings, read diagnostic and warning messages, and retrieve historical data from any HART-compatible device, including the Model 5081-T transmitter. Although AMS allows access to the basic functions of any HART compatible device, Rosemount Analytical has developed additional software for that allows access to all features of the Model 5081-T transmitter.

AMS can play a central role in plant quality assurance and quality control. Using AMS Audit Trail, plant operators can track calibration frequency and results as well as warnings and diagnostic messages. The information is available to Audit Trail whether calibrations were done using the infrared remote controller, the Model 375 HART communicator, or AMS software.

AMS operates in Windows 95. See Figure 1-5 for a sample screen. AMS communicates through a HART-compatible modem with any HART transmitters, including those from other manufacturers. AMS is also compatible with FOUNDATION[®] Fieldbus, which allows future upgrades to Fieldbus instruments.

Rosemount Analytical AMS windows provide access to all transmitter measurement and configuration variables. The user can read raw data, final data, and program settings and can reconfigure the transmitter from anywhere in the plant.

SECTION 2.0 INSTALLATION

- 2.1 Unpacking and Inspection**
- 2.2 Orienting the Display Board**
- 2.3 Mechanical Installation**
- 2.4 Power Supply/Current Loop — Model 5081-T-HT**
- 2.5 Power Supply Wiring for Model 5081-T-FF/FI**

2.1 UNPACKING AND INSPECTION

Inspect the shipping container. If it is damaged, contact the shipper immediately for instructions. Save the box. If there is no apparent damage, remove the transmitter. Be sure all items shown on the packing list are present. If items are missing, immediately notify Rosemount Analytical.

Save the shipping container and packaging. They can be reused if it is later necessary to return the transmitter to the factory.

2.2 ORIENTING THE DISPLAY BOARD

The display board can be rotated 90 degrees, clockwise or counterclockwise, from the original position. To reposition the display:

1. Loosen the cover lock nut until the tab disengages from the circuit end cap. Unscrew the cap.
2. Remove the three bolts holding the circuit board stack.
3. Lift and rotate the display board 90 degrees, clockwise or counterclockwise, into the desired position.
4. Position the display board on the stand offs. Replace and tighten the bolts.
5. Replace the circuit end cap.

2.3 MECHANICAL INSTALLATION

2.3.1 General information

1. The transmitter tolerates harsh environments. For best results, install the transmitter in an area where temperature extremes, vibrations, and electromagnetic and radio frequency interference are minimized or absent.
2. To prevent unintentional exposure of the transmitter circuitry to the plant environment, keep the security lock in place over the circuit end cap. To remove the circuit end cap, loosen the lock nut until the tab disengages from the end cap, then unscrew the cover.
3. The transmitter has two 3/4-inch conduit openings, one on each side of the housing. Run sensor cable through the left side opening (as viewed from the wiring terminal end of the transmitter) and run power wiring through the right side opening.
4. Use weathertight cable glands to keep moisture out of the transmitter.
5. If conduit is used, plug and seal the connections at the transmitter housing to prevent moisture from getting inside the transmitter.

NOTE

Moisture accumulating in the transmitter housing can affect the performance of the transmitter and may void the warranty.

6. If the transmitter is installed some distance from the sensor, a remote junction box with preamplifier in the junction box or in the sensor may be necessary. Consult the sensor instruction manual for maximum cable lengths.

2.3.2 Mounting on a Flat Surface.

See Figure 2-1.

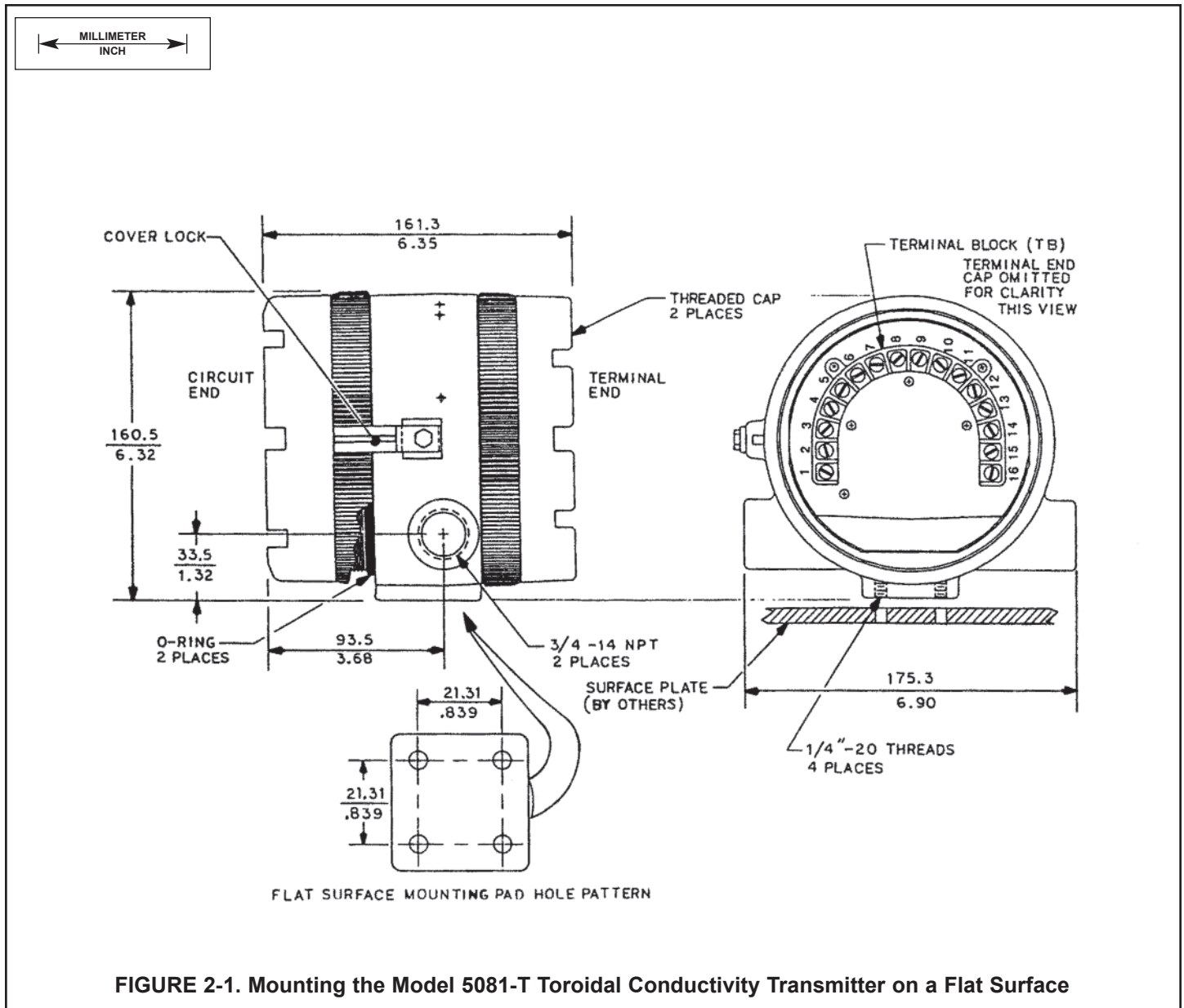

FIGURE 2-1. Mounting the Model 5081-T Toroidal Conductivity Transmitter on a Flat Surface

2.3.3 Pipe Mounting.

See Figure 2-2. The pipe mounting kit (PN 2002577) accommodates 1-1/2 to 2 in. pipe.

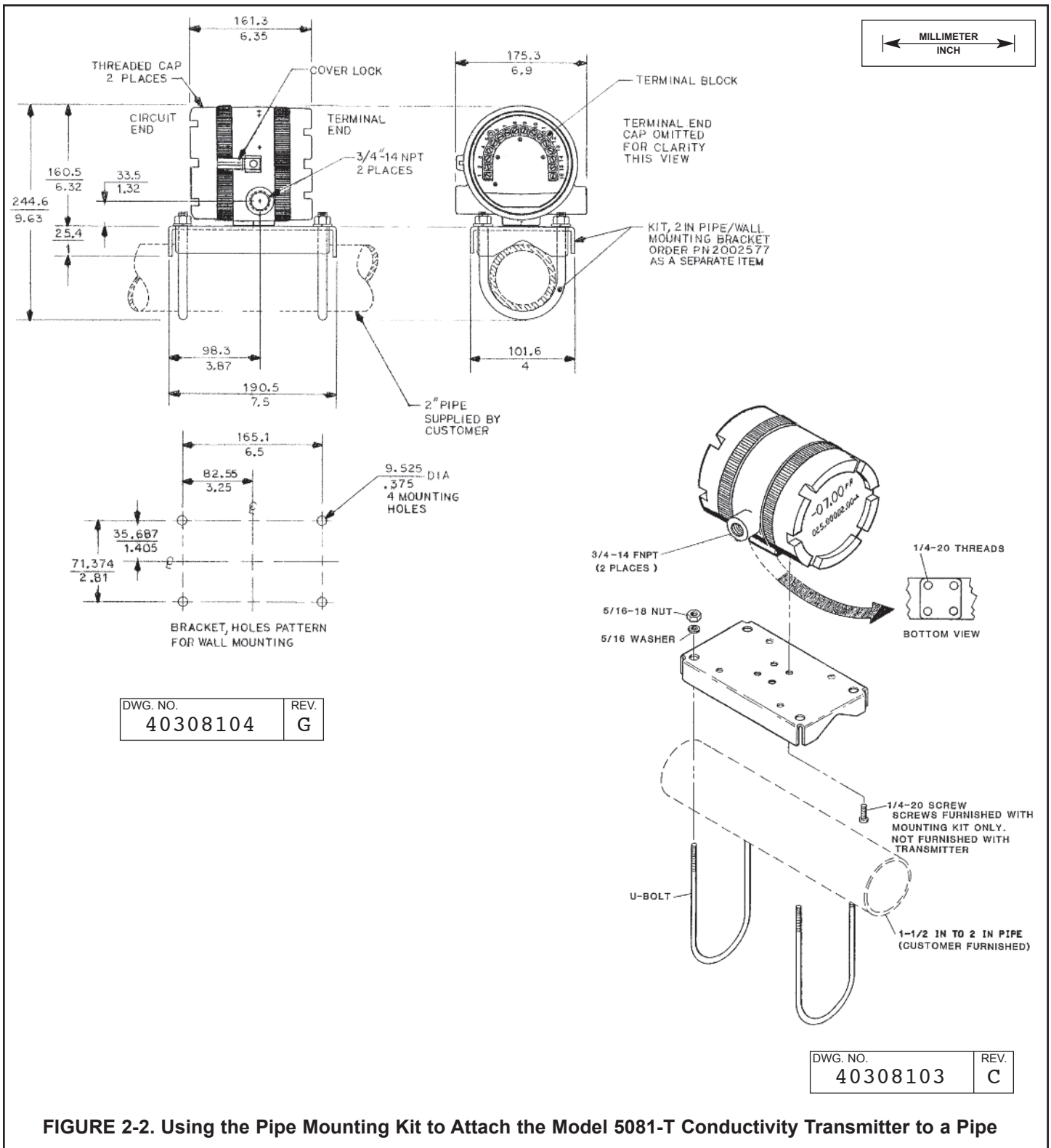

FIGURE 2-2. Using the Pipe Mounting Kit to Attach the Model 5081-T Conductivity Transmitter to a Pipe

2.3.4 Inductive Loops.

The Model 5081-T conductivity transmitter is designed to make accurate measurements while in contact with the process stream. Measurements can also be tailored to high temperature and/or high pressure streams.

2.3.5 Sensor Selection.

All Rosemount Analytical contacting conductivity sensors with PT100 RTD or PT1000 RTD are compatible with the Model 5081-T transmitter. Please refer to Figures 3-5 thru 3-7 for appropriate sensor to transmitter wiring. The sensor cable should be routed through the left inlet closest to the connector.

Choose an inductive conductivity sensor that is appropriate for your process conditions and range of conductivity measurement.

TABLE 2-1. Model 5081-T Sensor Selection

RECOMMENDED RANGES FOR TOROIDAL SENSORS						
Conductivity Sensor Model Number	226	228	225	222 (1in.)	222 (2 in.)	242
Nominal Cell Constant	1.0	3.0	3.0	6.0	4.0	*
Min. Conductivity (µS/cm)	50	200	200	500	500	100*
Max. Conductivity (µS/cm)	1,000,000	2,000,000	2,000,000	2,000,000	2,000,000	2,000,000*

* Model 242 values depend on sensor configuration and wiring.

NOTE: Values shown are for 25°C conductivity with a temperature slope of 2% per degree C. The maximum range value will be lower for solutions with a higher temperature slope. Minimum conductivity depends on sensor.

RECOMMENDED SENSORS:

- Model 222 Flow-Through
- Model 225 Clean-In-Place (CIP)
- Model 226 Submersion/
Insertion
- Model 228 Submersion/
Insertion/
Retractable
- Model 242 Flow-Through*

* Model 242-06 or 242-08 with 5081T do not have Intrinsically Safe approvals.

2.4 POWER SUPPLY/CURRENT LOOP — MODEL 5081-T-HT

2.4.1 Power Supply and Load Requirements.
Refer to Figure 2-3.

The minimum power supply voltage is 12.5 Vdc and the maximum is 42.4 Vdc. The top line on the graph gives the voltage required to maintain at least 12.5 Vdc at the transmitter terminals when the output signal is 22 mA. The lower line is the supply voltage required to maintain a 30 Vdc terminal voltage when the output signal is 22 mA.

The power supply must provide a surge current during the first 80 milliseconds of start-up. For a 24 Vdc power supply and a 250 ohm load resistor the surge current is 40 mA. For all other supply voltage and resistance combinations the surge current is not expected to exceed 70 mA.

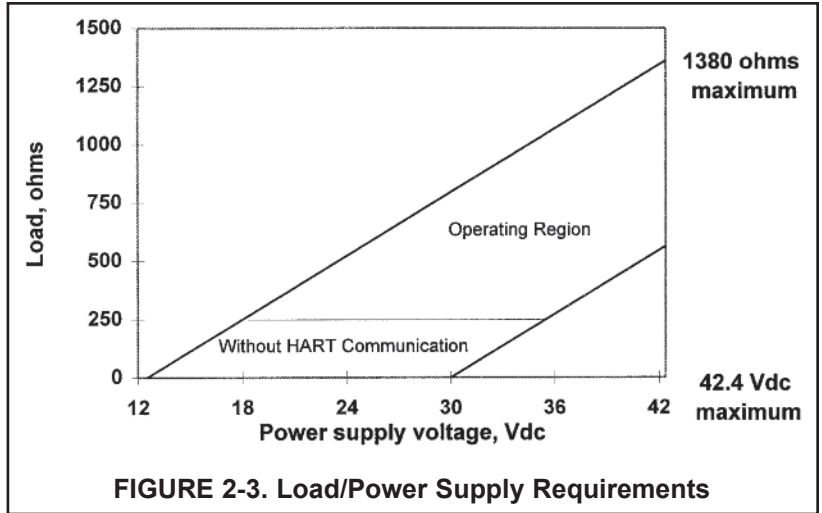

For digital (HART or AMS) communications, the load must be at least 250 ohms. To supply the 12.5 Vdc lift off voltage at the transmitter, the power supply voltage must be at least 18 Vdc.

For intrinsically safe operation the supply voltage should not exceed 30.0 Vdc.

2.4.2 Power Supply-Current Loop Wiring. Refer to Figure 2-4.

Run the power/signal wiring through the opening nearest terminals 15 and 16. Use shielded cable and ground the shield at the power supply. To ground the transmitter, attach the shield to the grounding screw on the inside of the transmitter case. A third wire can also be used to connect the transmitter case to earth ground.

NOTE

For optimum EMI/RFI immunity, the power supply/output cable should be shielded and enclosed in an earth-grounded metal conduit.

Do not run power supply/signal wiring in the same conduit or cable tray with AC power lines or with relay actuated signal cables. Keep power supply/ signal wiring at least 6 ft (2 m) away from heavy electrical equipment.

An additional 0-1 mA current loop is available between TB-14 and TB-15. A 1 mA current in this loop signifies a sensor fault. See Section 3.0 for wiring instructions. See Section 8.4 or 10.6 and Section 12.0 for more information about sensor faults.

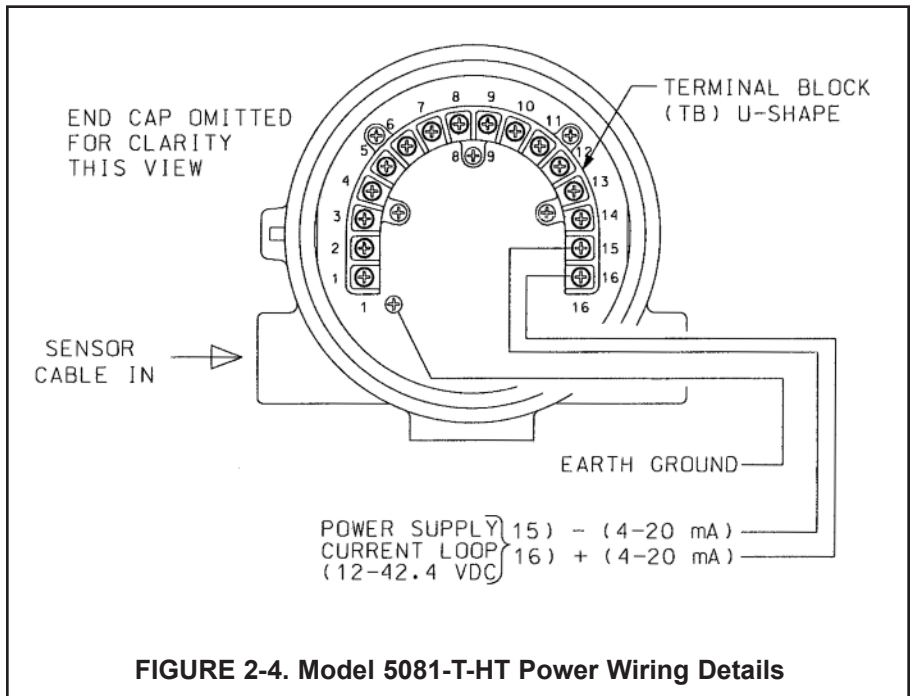

2.5 POWER SUPPLY WIRING FOR MODEL 5081-T-FF/FI

2.5.1 Power Supply Wiring. Refer to Figure 2-5 and Figure 2-6.

Run the power/signal wiring through the opening nearest terminals 15 and 16. Use shielded cable and ground the shield at the power supply. To ground the transmitter, attach the shield to the grounding screw on the inside of the transmitter case. A third wire can also be used to connect the transmitter case to earth ground.

NOTE

For optimum EMI/RFI immunity, the power supply/output cable should be shielded and enclosed in an earth-grounded metal conduit.

Do not run power supply/signal wiring in the same conduit or cable tray with AC power lines or with relay actuated signal cables. Keep power supply/signal wiring at least 6 ft (2 m) away from heavy electrical equipment.

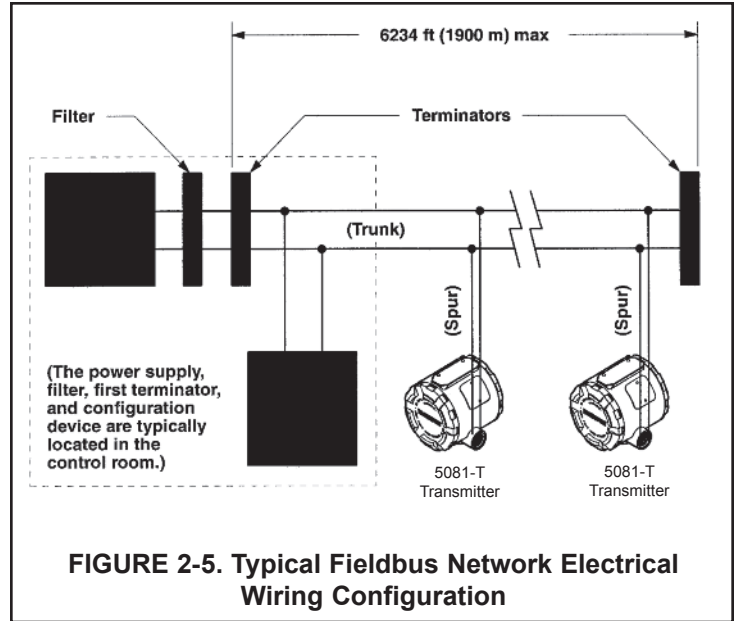

FIGURE 2-5. Typical Fieldbus Network Electrical Wiring Configuration

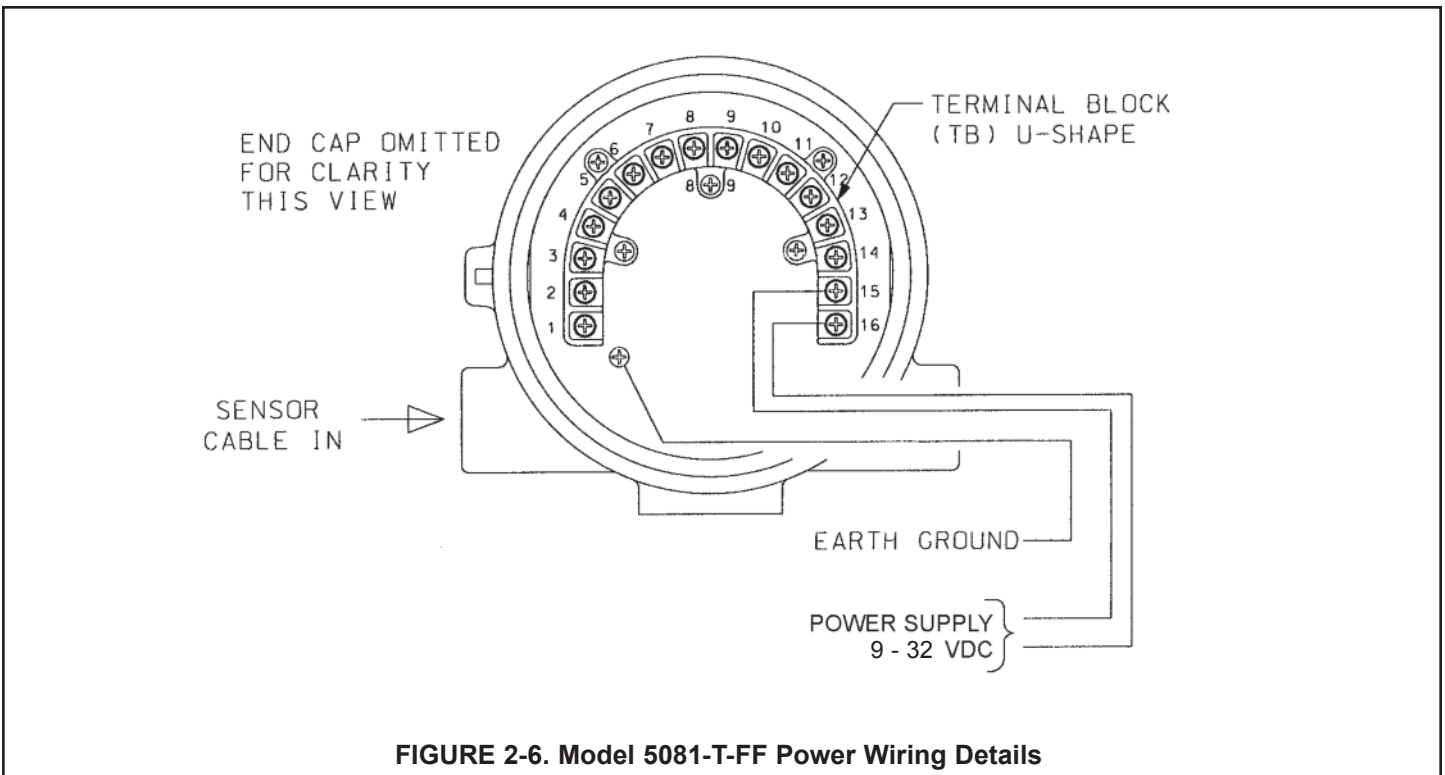

FIGURE 2-6. Model 5081-T-FF Power Wiring Details

SECTION 3.0 WIRING

- 3.1 Sensor Wiring
- 3.2 Electrical Installation

3.1 SENSOR WIRING

Wire sensor as shown below in Figure 3-1. Keep sensor wiring separate from power wiring. For best EMI/RFI protection, use shielded output signal cable in an earth-grounded metal conduit. Refer to the sensor instruction manual for more details.

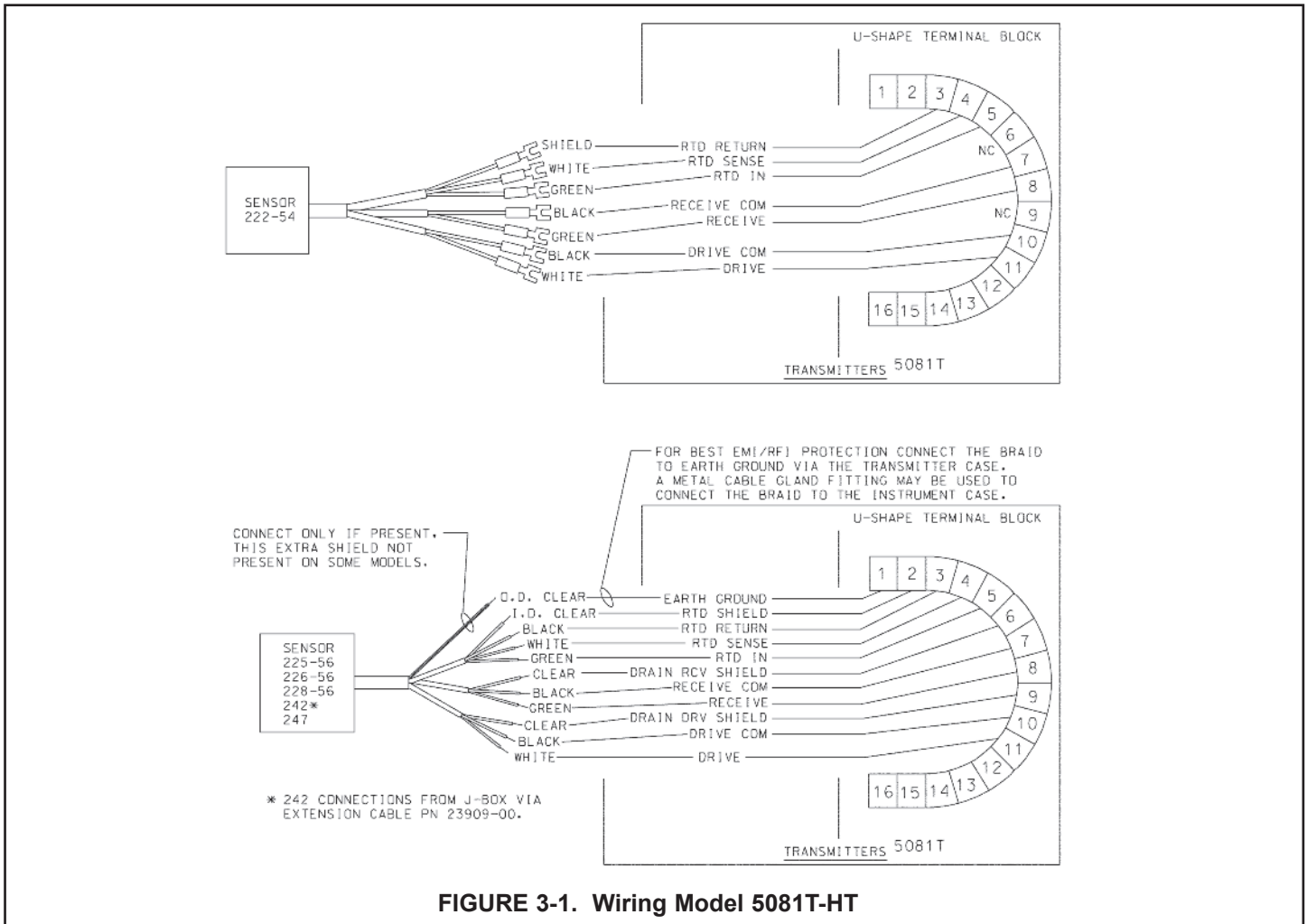

3.1.1 WIRING THROUGH A JUNCTION BOX

The sensor can be wired to the analyzer through a remote junction box (PN 23550-00). Wire the extension cable and sensor cable point-to-point. Refer to the sensor instruction manual for more details.

Factory-terminated (PN 23294-05) and unterminated (PN 9200276) connecting cable are available. The use of factory-terminated cable is strongly recommended. To prepare unterminated cable for use, follow the instructions in the sensor instruction manual.

For maximum EMI/RFI protection, the outer braid of the sensor cable should be connected to the outer braided shield of the extension cable. At the instrument, connect the outer braid of the extension cable to earth ground.

3.1.2 POWER WIRING MODEL 5081-T-HT

For general purpose areas, wire power as shown in Figure 3-2. For hazardous areas, please see hazardous area installation drawings.

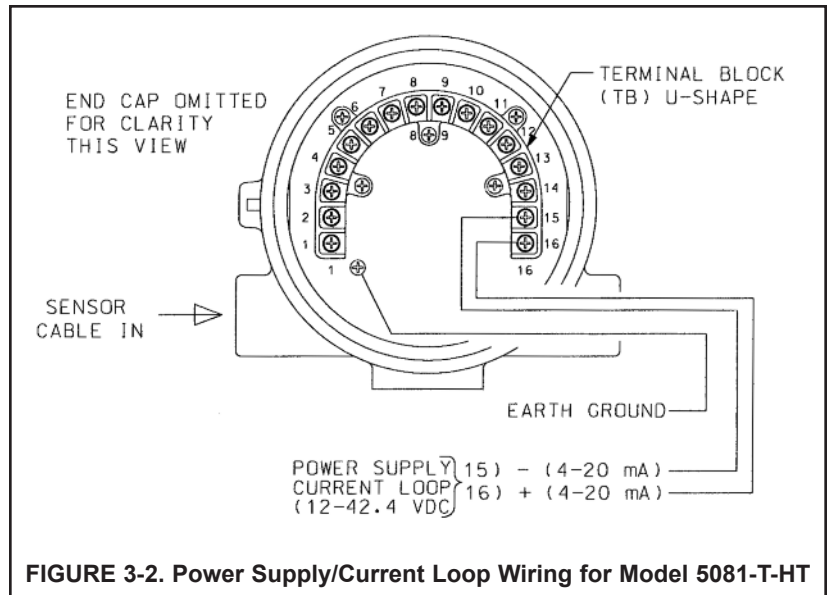

FIGURE 3-2. Power Supply/Current Loop Wiring for Model 5081-T-HT

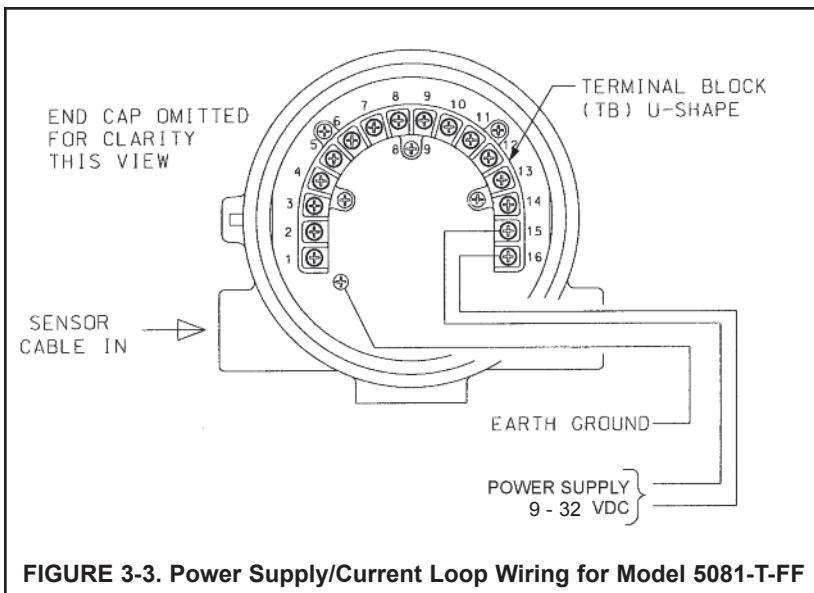

FIGURE 3-3. Power Supply/Current Loop Wiring for Model 5081-T-FF

3.1.3 POWER WIRING MODEL 5081-T-FF

For general purpose areas, wire power as shown in Figure 3-3. For hazardous areas, please see hazardous area installation drawings.

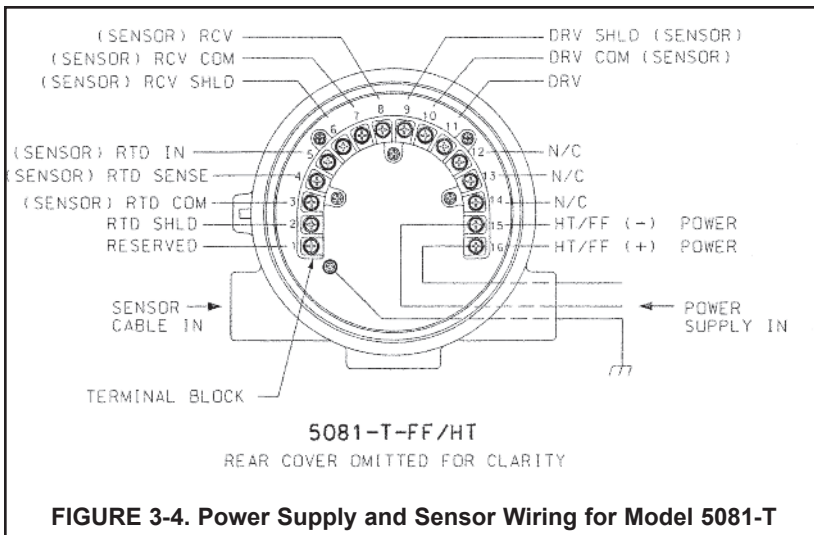

FIGURE 3-4. Power Supply and Sensor Wiring for Model 5081-T

3.2 ELECTRICAL INSTALLATION

All Rosemount Analytical contacting conductivity sensors with PT100 RTD or PT1000 RTD are compatible with the Model 5081-T transmitter. Please refer to Figures 3-5 thru 3-7 for appropriate sensor to transmitter wiring. The sensor cable should be routed through the left inlet closest to the connector.

NOTE

Optimum EMI/RFI immunity may be achieved on sensors whose interconnecting cable has an outer braided shield by utilizing a cable gland fitting that provides for continuity between the braided shield and the transmitter enclosure. An equivalent conduit connector may also be used if the sensor cable is to be enclosed in conduit.

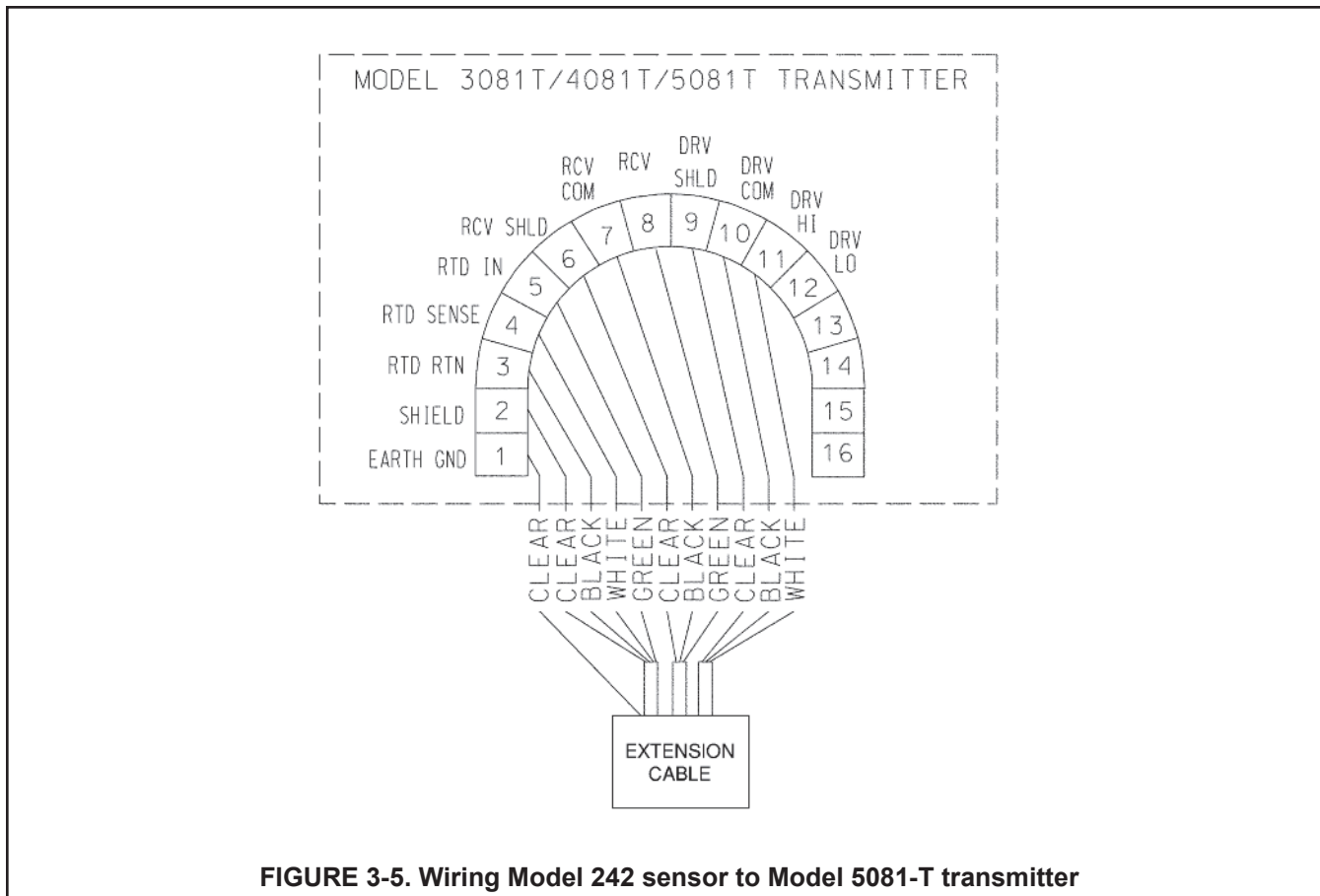
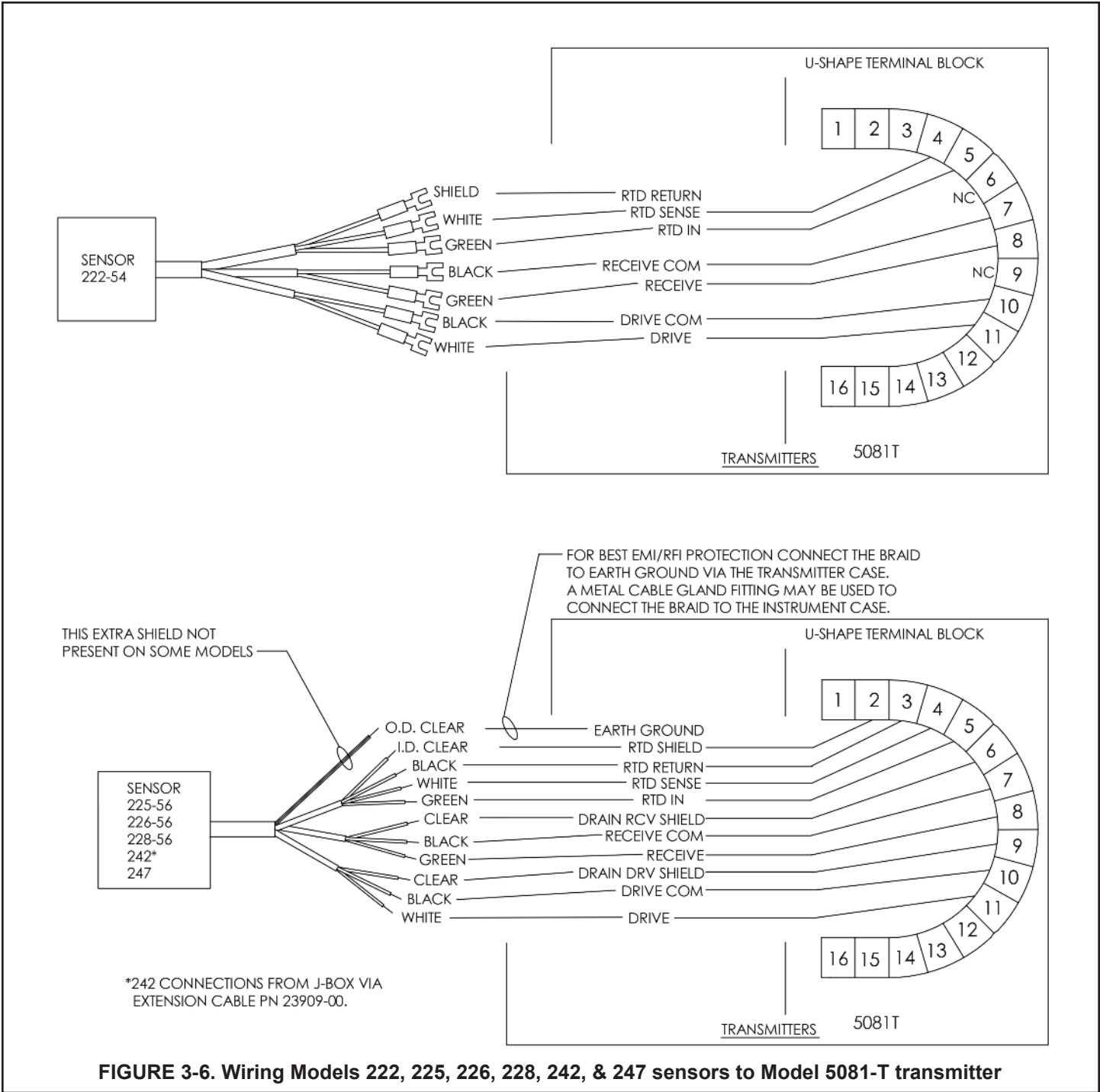

FIGURE 3-5. Wiring Model 242 sensor to Model 5081-T transmitter



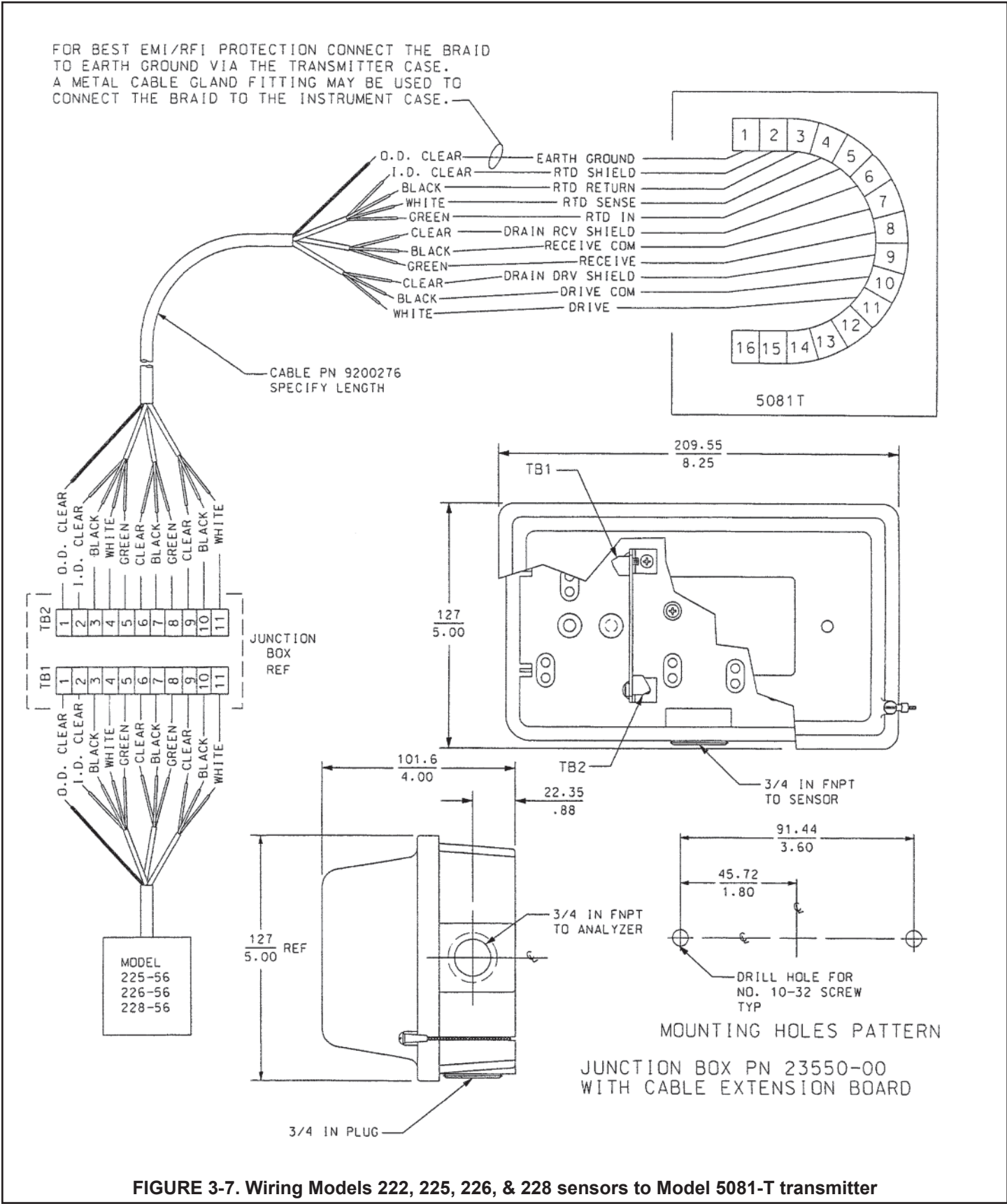

FIGURE 3-7. Wiring Models 222, 225, 226, & 228 sensors to Model 5081-T transmitter

SECTION 4.0 INTRINSICALLY SAFE & EXPLOSION PROOF

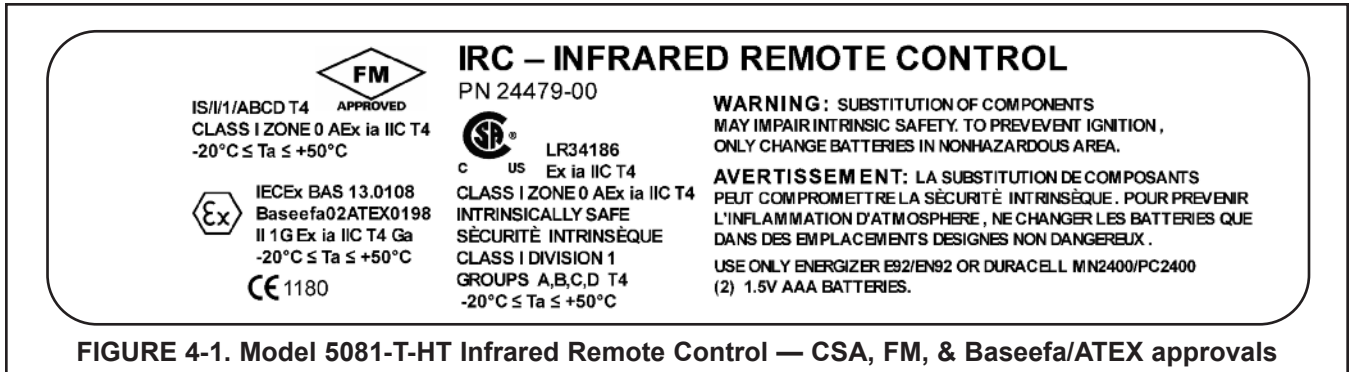

FIGURE 4-1. Model 5081-T-HT Infrared Remote Control — CSA, FM, & Baseefa/ATEX approvals

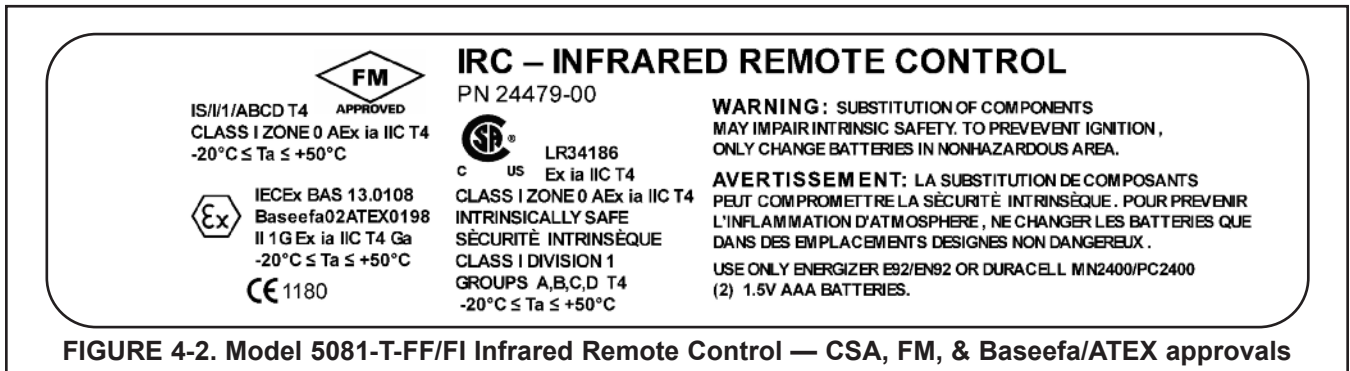

FIGURE 4-2. Model 5081-T-FF/FI Infrared Remote Control — CSA, FM, & Baseefa/ATEX approvals

4.1 INTRINSICALLY SAFE AND EXPLOSION-PROOF INSTALLATION FOR MODEL 5081-T-HT

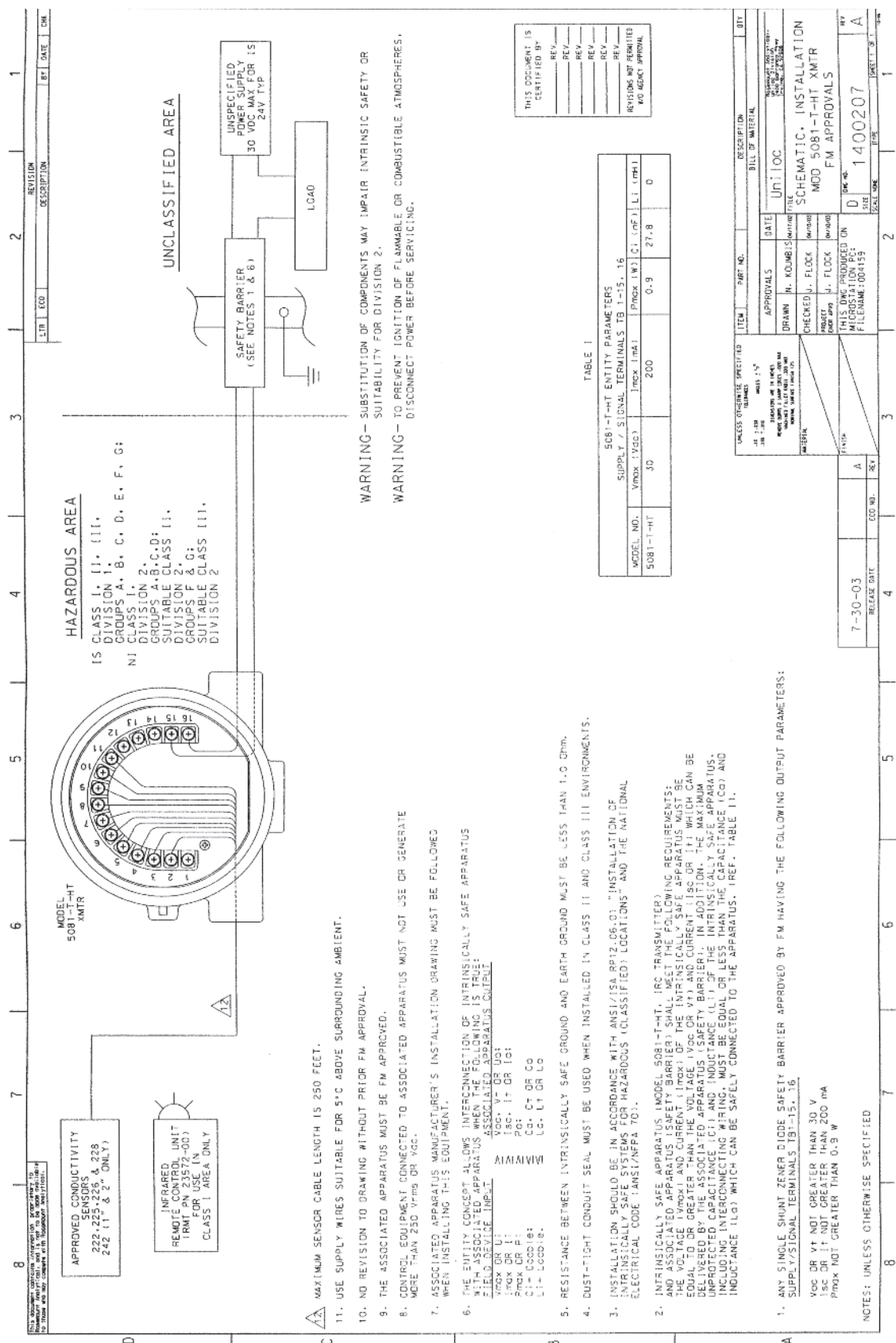

FIGURE 4-3. FM Explosion-Proof Installation for Model 5081-T-HT

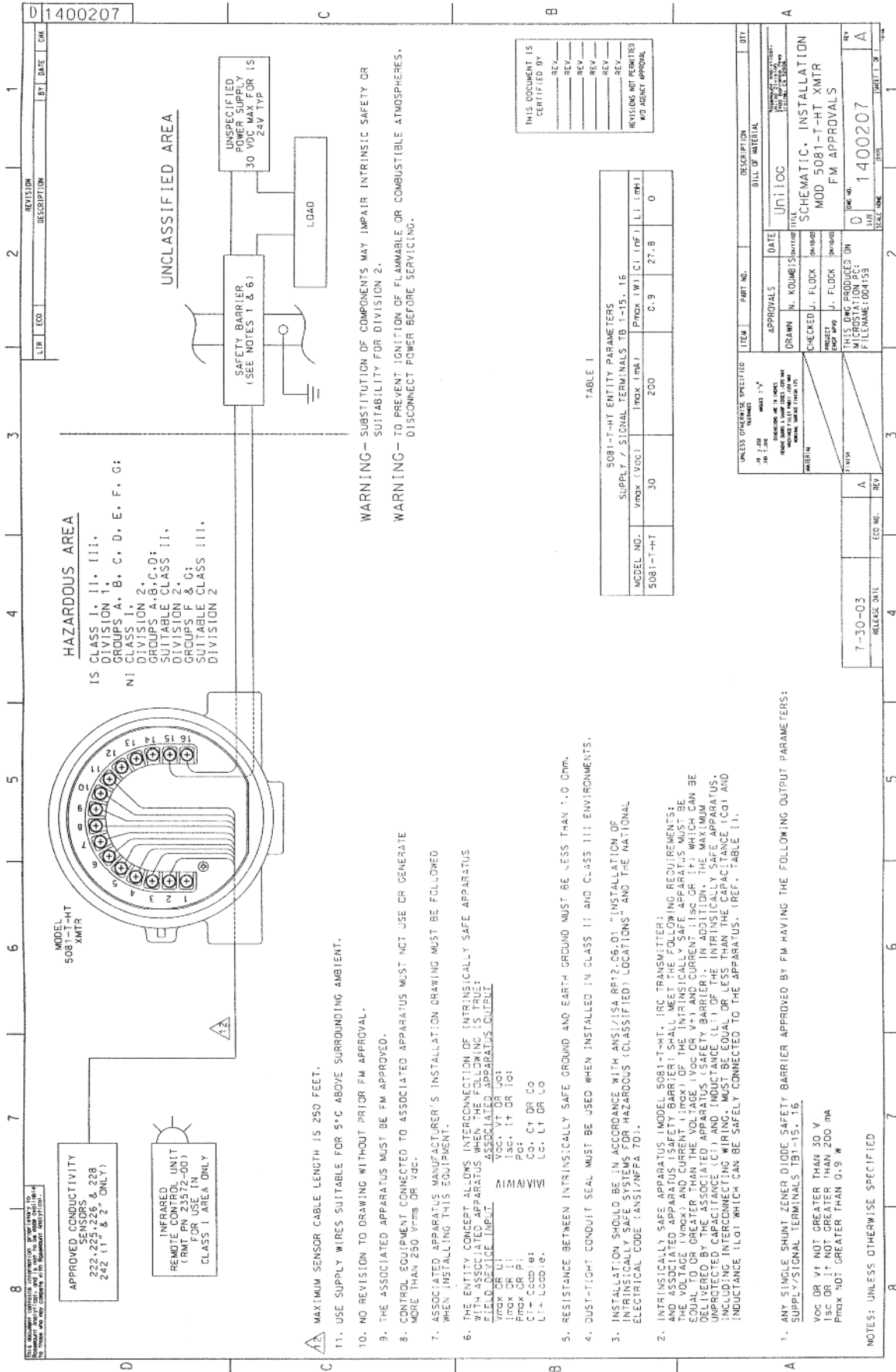

FIGURE 4-4. FM Intrinsically Safe Installation for Model 5081-T-HT

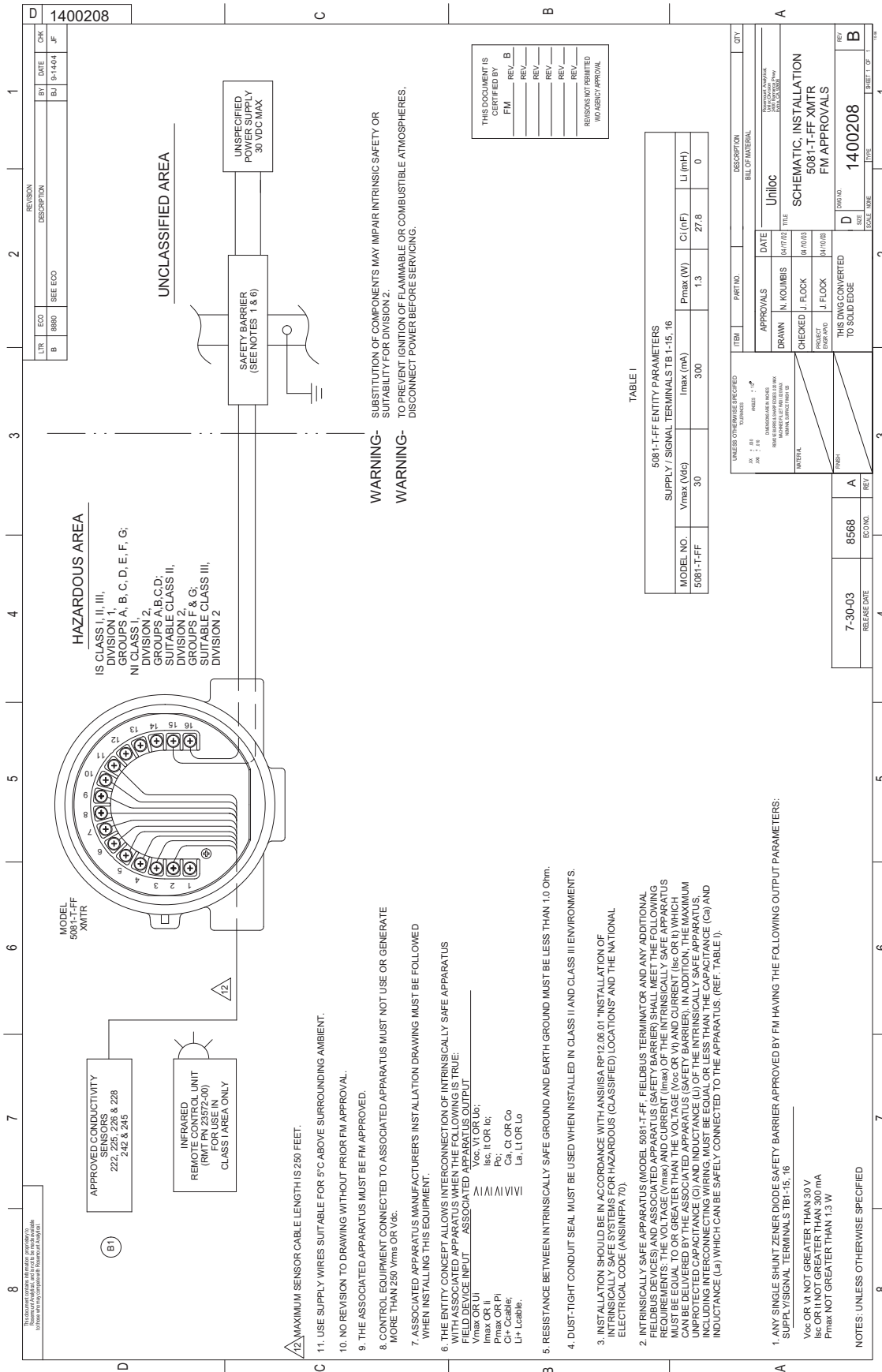

FIGURE 4-8. FM Intrinsically Safe Installation for Model 5081-T-FF

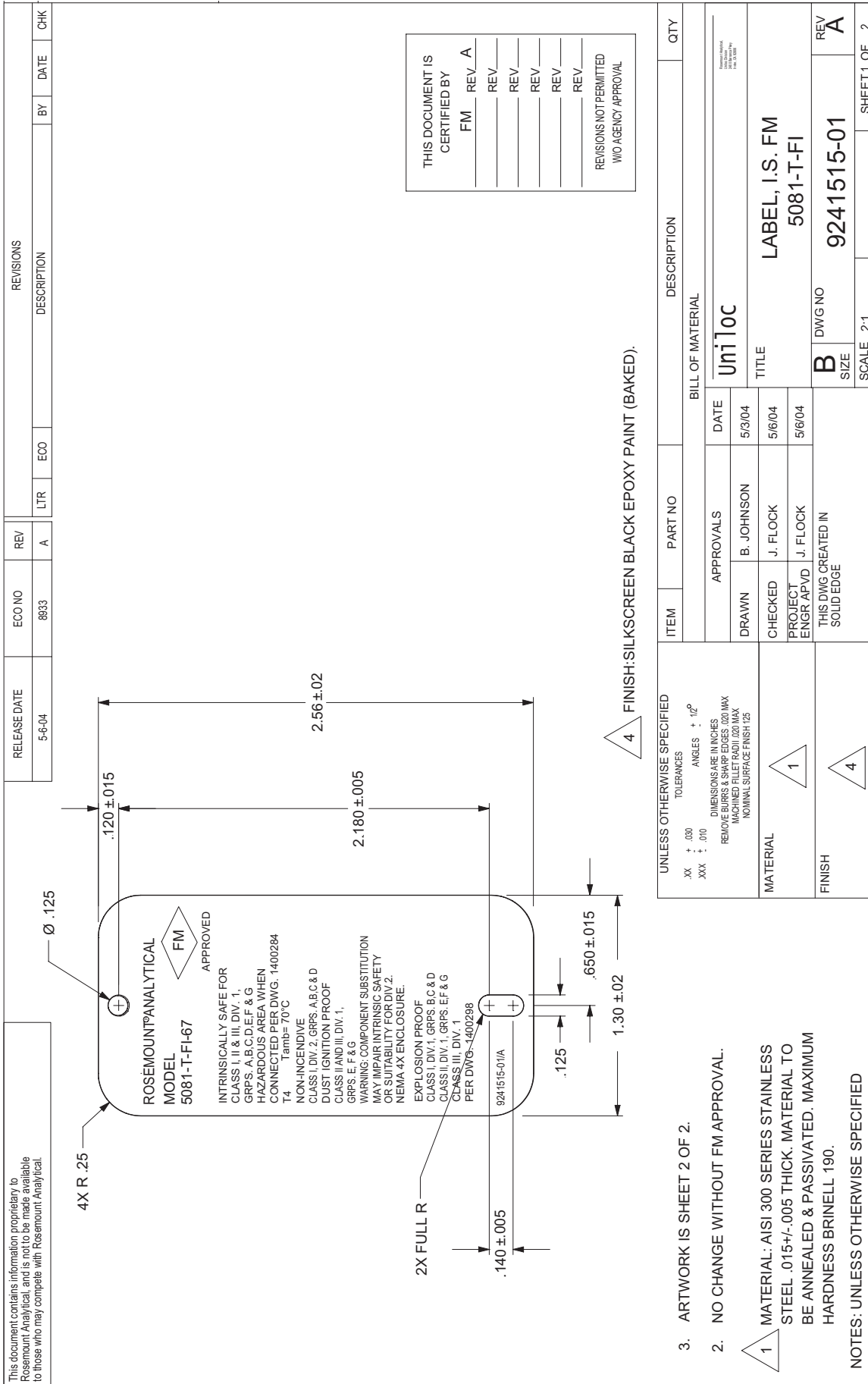

FIGURE 4-12. FM Intrinsically Safe Label for Model 5081-T-FI

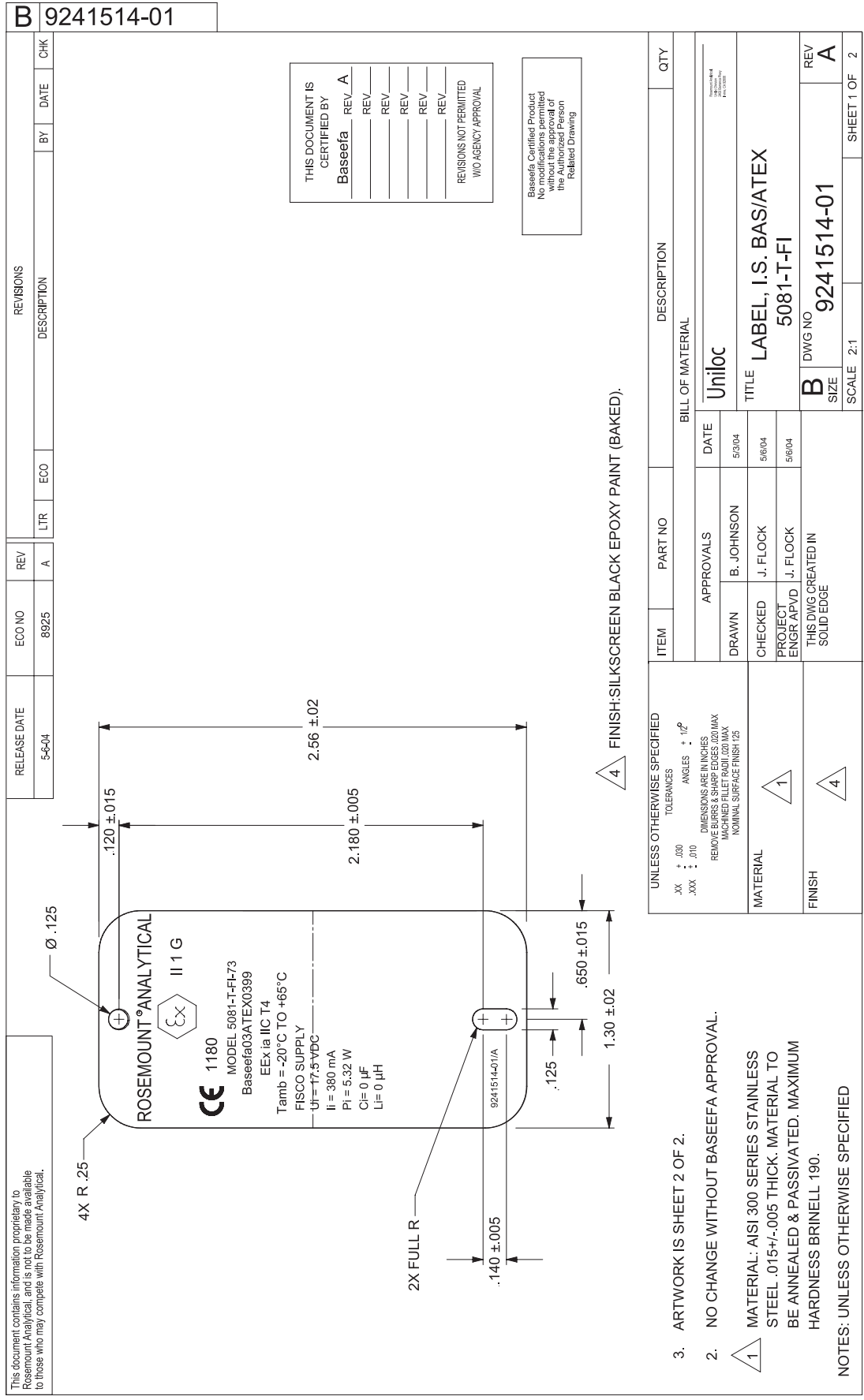

FIGURE 4-16. ATEX Intrinsically Safe Label for Model 5081-T-FI

SECTION 5.0 DISPLAY AND OPERATION

- 5.1 Displays
- 5.2 Infrared Remote Controller (IRC) - Key Functions
- 5.3 Quick Start for Model 5081-T-HT
- 5.4 Quick Start for Model 5081-T-FF
- 5.5 Menu Trees
- 5.6 Diagnostic Messages
- 5.7 Default Settings
- 5.8 Security
- 5.9 Using Hold

5.1 DISPLAYS

Figure 5-1 shows the process display screen, and Figure 5-2 shows the program display screen.

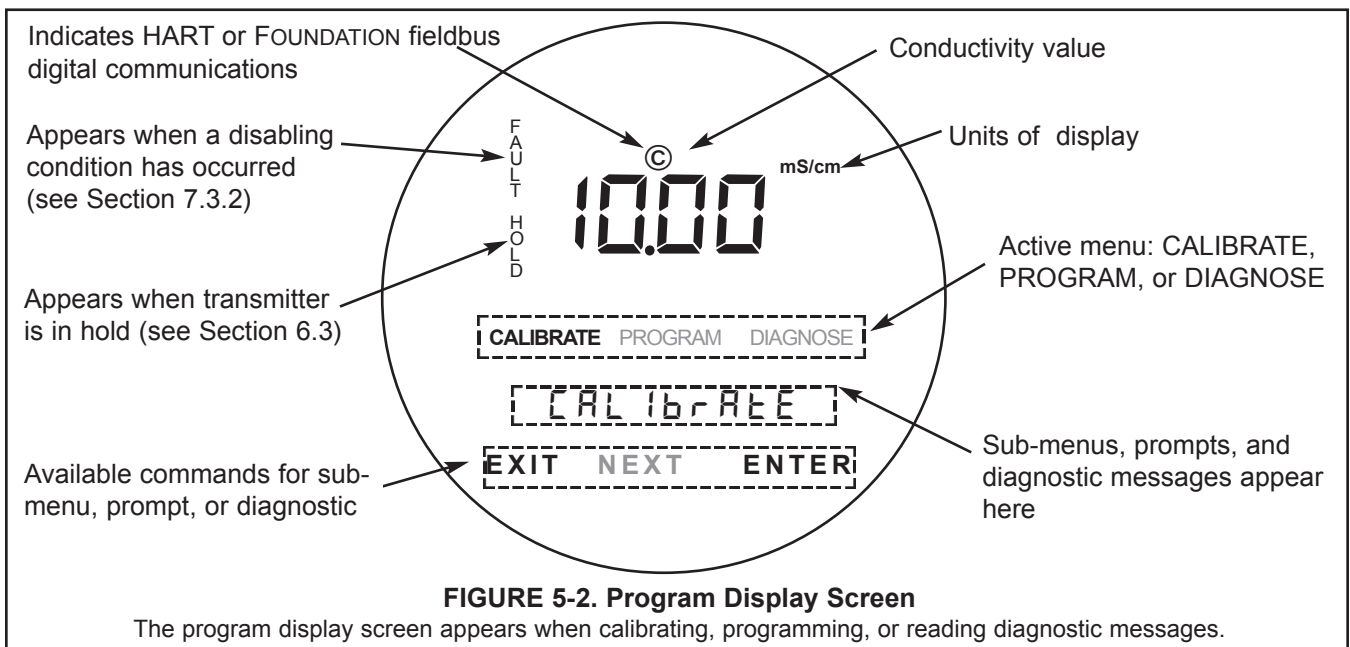
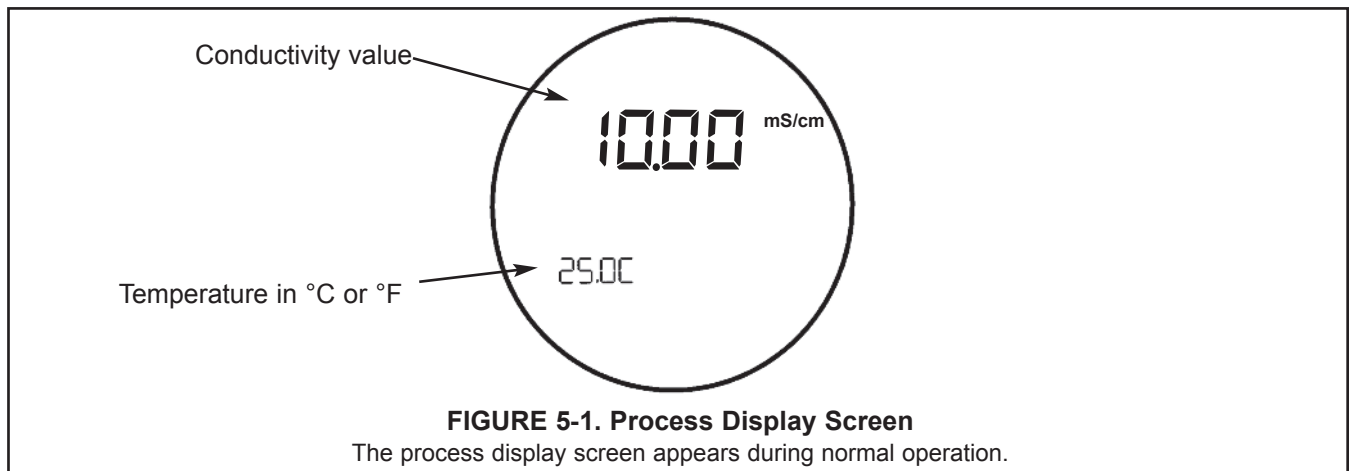

5.2 INFRARED REMOTE CONTROLLER (IRC) - KEY FUNCTIONS

The infrared remote controller is used to calibrate and program the transmitter and to read diagnostic messages. See Figure 5-3 for a description of the function of the keys.

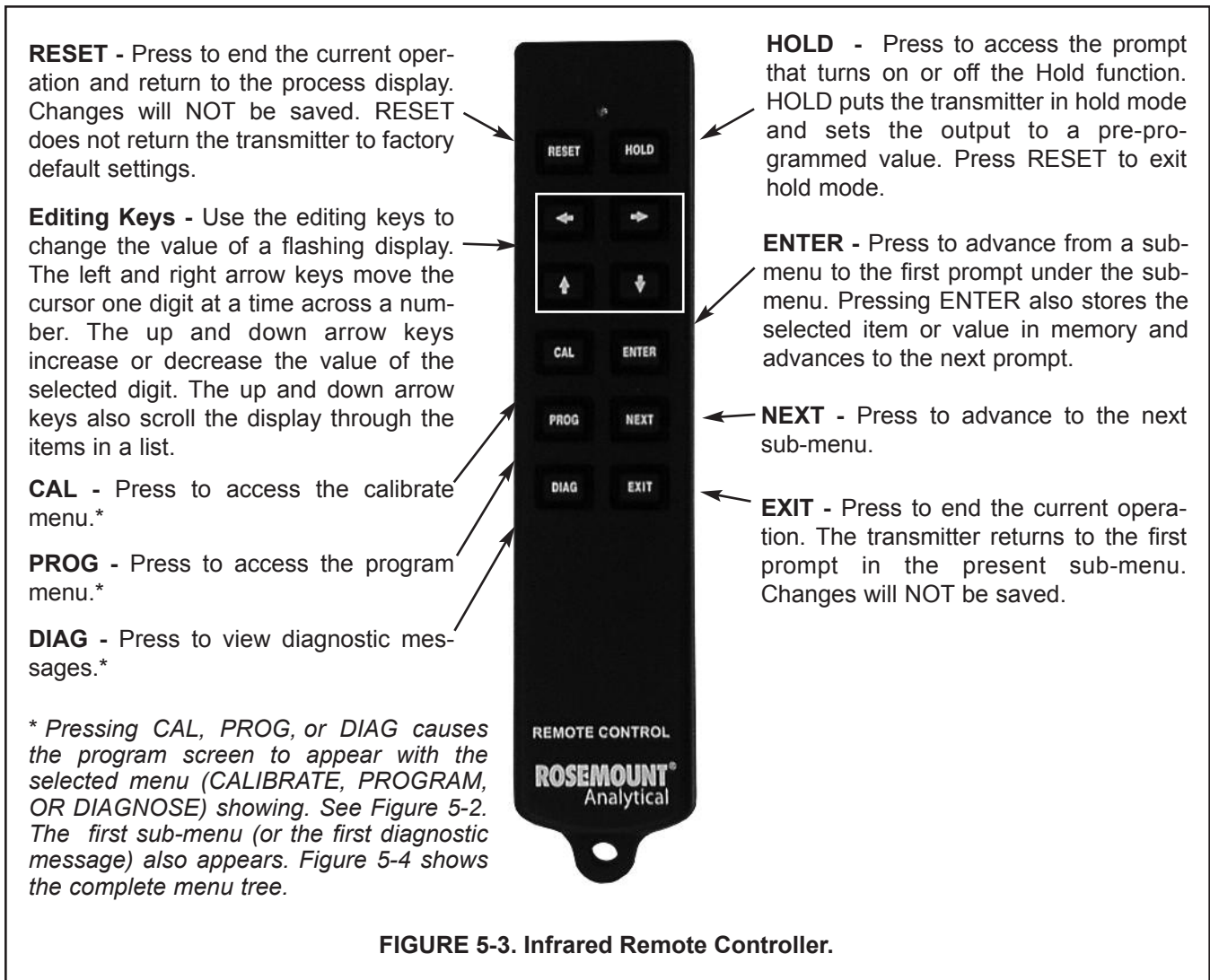

FIGURE 5-3. Infrared Remote Controller.

Hold the IRC within 6 feet of the transmitter, and not more than 15 degrees from horizontal to the display window.

5.3 QUICK START FOR MODEL 5081-T-HT (HART)

1. On the Remote, press PROG, NEXT, NEXT, ENTER.
2. Use the arrow buttons to select **COnduc** (conductivity), **nAOH** (Sodium Hydroxide 0-15%), **HCL** (Hydrochloric Acid 0-16%), **H2SO4L** (Sulfuric Acid 0-30%), **H2SO4H** (Sulfuric Acid 96-99.7%), or **CuSt** (custom curve) mode. Press ENTER. If you chose **CuSt**, continue with step 3. If you chose **COnduc** or one of the preprogrammed % concentration modes, skip step 3 and go to step 4.
3. If you selected **CuST**, you will see the Setup Custom screen. To move to the custom curve configuration menu, press ENTER. You will automatically return to this same Setup Custom screen after configuration is complete. To continue transmitter display programming, press NEXT in the Setup Custom screen.
4. Use the arrow keys to toggle temperature units between Celsius and Farenheit.
5. Press ENTER then RESET.
6. Press PROG, ENTER.
7. Use the arrow buttons to enter the 4 mA value. Press ENTER.
8. Use the arrow buttons to enter the 20 mA value. Press ENTER then RESET.
9. Press PROG, NEXT, ENTER.
10. Use the arrow key to toggle **t AutoO** to On or OFF to select using either the process temperature (**tAutoO** = On) or a manual temperature (**tAutoO** = OFF). Press ENTER. If you selected **t AutoO** = OFF, you will be prompted to enter the manual temperature; use the arrow keys, then press ENTER.
11. If you selected **CondUC** in step 2, you will see a **COMP** (Temperature Compensation type) screen. Use the arrow keys to select desired temperature compensation: **LinEAR** (linear) or **nOnE** (raw or uncompensated conductivity). Press ENTER. If you are in **LinEAR** mode, you can now enter a particular temperature slope (default is 2%/degC), then press ENTER to apply the slope.
12. Press RESET.
13. Press CAL, NEXT, NEXT, NEXT, ENTER.
14. Use the arrow buttons to enter the cell constant of the sensor. Press ENTER, then EXIT.
15. To "zero" the sensor in air, press CAL, NEXT, ENTER.
16. Hold the sensor in air to zero. Press ENTER, then EXIT.
17. If you are measuring % concentration (**nAOH**, **HCL**, **H2SO4L**, or **H2SO4H**) or custom curve (**CuSt**), quick start is complete; proceed to step 20.
18. If you are measuring conductivity (**CondUC**), then standardize the sensor by placing the sensor in a solution of known conductivity value. Press CAL, ENTER.
19. Use the arrow buttons to enter the current conductivity value of the solution. Press ENTER.
20. Press RESET.

To reset transmitter to factory default settings:

1. Press PROGRAM, NEXT, NEXT, NEXT, NEXT, NEXT. The screen should say "**dEFAULT**". Press ENTER.
2. Use the arrow keys to toggle between **nO** (retain your configuration and calibration settings) and **YES** (restore factory default settings to all variables).
3. Press ENTER, then EXIT.

5.4 QUICK START FOR MODEL 5081-T-FF/FI (FOUNDATION FIELDBUS)

1. On the Remote, press PROG, NEXT, ENTER.
2. Use the arrow buttons to select **COnduc** (conductivity), **nAOH** (Sodium Hydroxide 0-15%), **HCL** (Hydrochloric

Acid 0-16%), **H2SO4L** (Sulfuric Acid 0-30%), **H2SO4H** (Sulfuric Acid 95-99.99%), or **CuSt** (custom curve) mode. Press ENTER. If you chose **CuSt**, continue with step 3. If you chose **Conduc** or one of the preprogrammed % concentration modes, skip step 3 and go to step 4.

3. If you selected **CuST**, you will see the Setup Custom screen. To move to the custom curve configuration menu, press ENTER. You will automatically return to this same Setup Custom screen after configuration is complete. To continue transmitter display programming, press NEXT in the Setup Custom screen.
4. Use the arrow keys to toggle temperature units between Celsius and Fahrenheit.
5. Press ENTER then RESET.
6. Press PROG, ENTER.
7. Use the arrow key to toggle **t Auto** to On or OFF to select using either the process temperature (**tAuto** = On) or a manual temperature (**tAuto** = OFF). Press ENTER. If you selected **t Auto** = OFF, you will be prompted to enter the manual temperature; use the arrow keys, then press ENTER.
8. If you selected **CondUC** in step 2, you will see a **COMP** (Temperature Compensation type) screen. Use the arrow keys to select desired temperature compensation: **LinEAR** (linear) or **nOnE** (raw or uncompensated conductivity). Press ENTER. If you are in **LinEAR** mode, you can now enter a particular temperature slope (default is 2%/degC), then press ENTER to apply the slope.
9. Press RESET.
10. Press CAL, NEXT, NEXT, NEXT, ENTER.
11. Use the arrow buttons to enter the cell constant of the sensor. Press ENTER, then EXIT.
12. To "zero" the sensor in air, press CAL, NEXT, ENTER.
13. Hold the sensor in air to zero. Press ENTER, then EXIT.
14. If you are measuring % concentration (**nAOH**, **HCL**, **H2SO4L**, or **H2SO4H**) or custom curve (**CuSt**), quick start is complete; proceed to step 20.
15. If you are measuring conductivity (**CondUC**), then standardize the sensor by placing the sensor in a solution of known conductivity value. Press CAL, ENTER.
16. Use the arrow buttons to enter the current conductivity value of the solution. Press ENTER.
17. Press RESET.

To reset transmitter to factory default settings:

1. Press PROGRAM, NEXT, NEXT, NEXT. The screen should say "**dDEFAULT**". Press ENTER.
2. Use the arrow keys to toggle between **nO** (retain your configuration and calibration settings) and **YES** (restore factory default settings to all variables).
3. Press ENTER, then EXIT.

5.5 MENU TREE - Conductivity

The Model 5081-T transmitter has three menus: CALIBRATE, PROGRAM, and DIAGNOSE. Under the Calibrate and Program menus are several sub-menus. Figure 5-4 shows the complete menu tree for Model 5081-T-HT. Figure 5-5 shows the complete menu tree for Model 5081-T-FF.

5.6 DIAGNOSTIC MESSAGES

Whenever a warning or fault limit has been exceeded, the transmitter displays diagnostic messages to aid in troubleshooting. Diagnostic messages appear in the same area as the temperature/output readings in the process display screen (see Figure 5-2). The display alternates between the regular display and the diagnostic message. Figure 5-4 shows the diagnostic fault messages for conductivity for Model 5081-T-HT. Figure 5-4 shows the diagnostic fault messages for conductivity for Model 5081-T-FF. If more than one warning or fault message has been generated, the messages appear alternately.

See Section 10.0, Troubleshooting, for the meanings of the fault and warning messages.

5.7 DEFAULT SETTINGS

Table 5-1 shows the diagnostic fault messages for conductivity for Model 5081-T-FF. Table 5-2 shows the diagnostic fault messages for conductivity for Model 5081-T-HT.

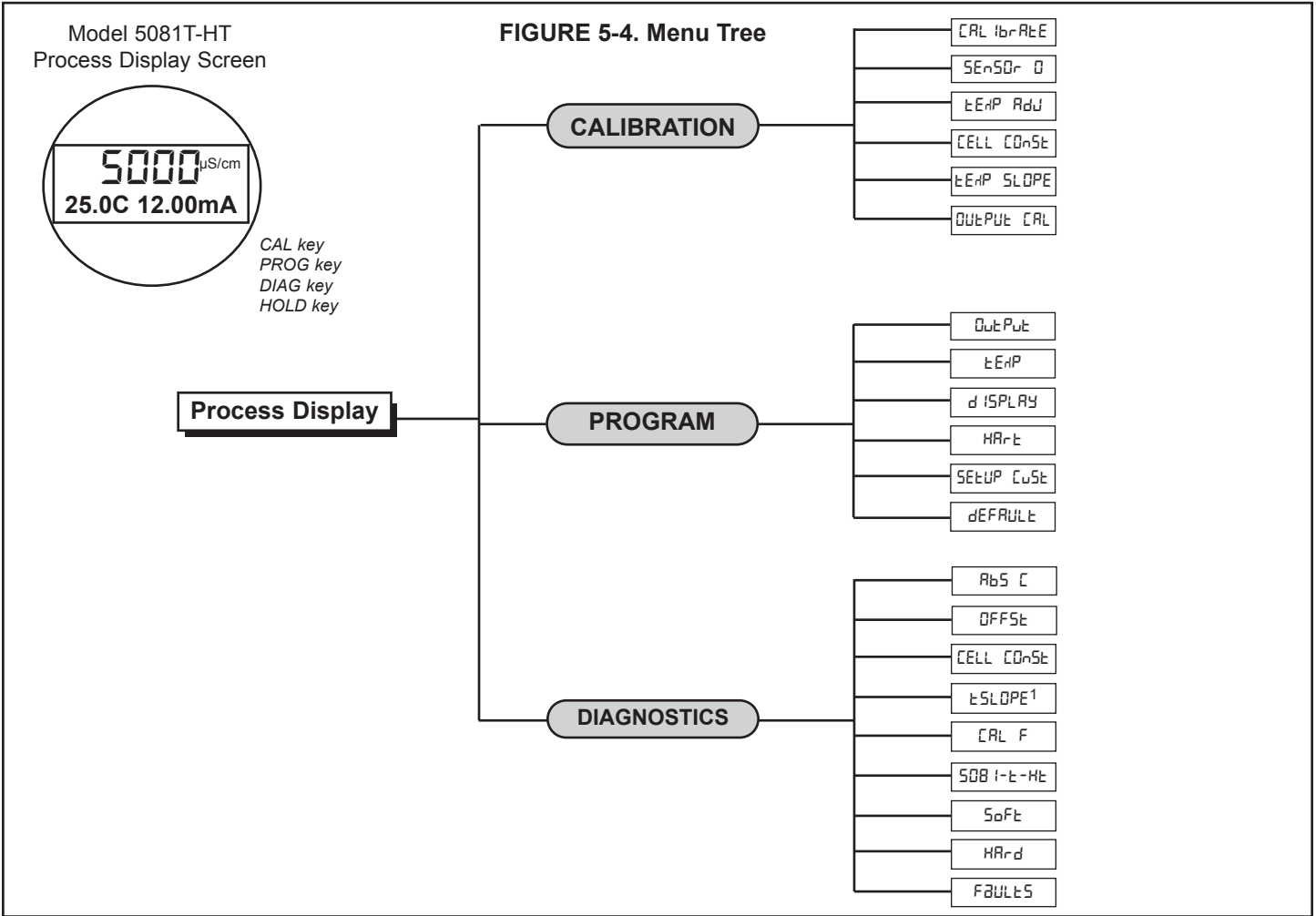

PROGRAM MENU MNEMONICS

OUtPUt	Current output menu header
4mA	4mA current output (setpoint)
20mA	20mA current output (setpoint)
HoLd	Current output on hold
FRULt	Fault condition current output setting
dPn	Current output dampening time
tESt	Current output test value
tEAPl	Temperature menu header
tRULt0	Automatic temperature compensation
tARn	Manual temperature compensation input
d ISPLAY	Display menu header
tYP	Conductivity measurement type
tEAPl	°C / °F toggle selection
OUtPUt	Current (mA) or percent of full scale display
COdE	Security code
OFFSt	Conductance Offset value

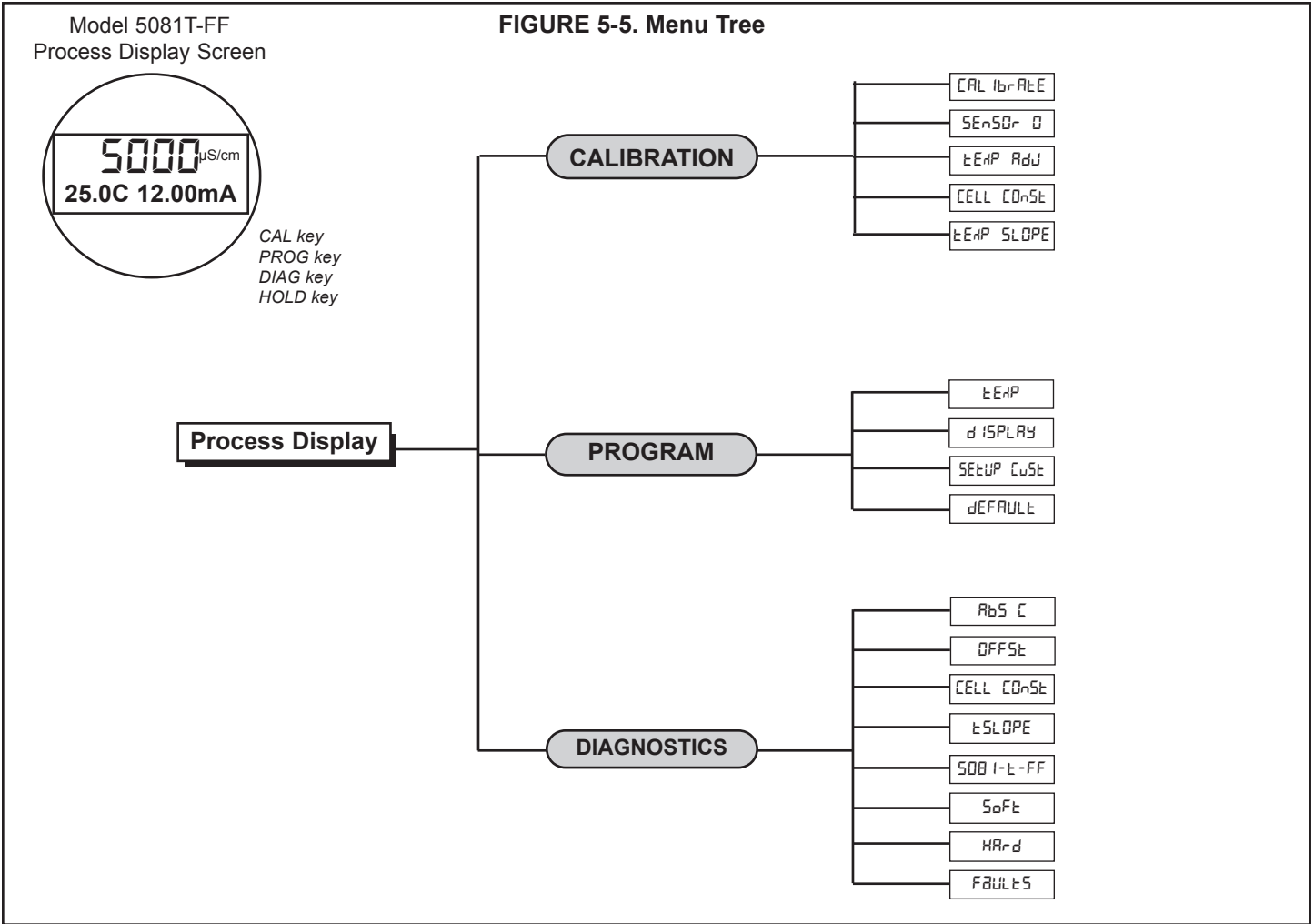

5.8 SECURITY

5.9.1 General. Use the programmable security code to protect program and calibration settings from accidentally being changed. The transmitter is shipped with the security feature disabled.

5.9.2 Entering the Security Code.



1. If calibration and program settings are protected with a security code, pressing PROG or CAL on the infrared remote controller causes the Id screen to appear.
2. Use the editing keys to enter the security code. Press ENTER .
3. If the security code is correct, the first sub-menu appears. If the security code is incorrect, the process display reappears.

5.9.3 Retrieving a Lost Security Code.

1. If the security code has been forgotten, enter 555 at the Id prompt and press ENTER . The transmitter will display the present code.
2. Press EXIT to return to the process display.
3. Press PROG or CAL . The Id screen appears.
4. Use the editing keys to enter the security code just shown; then press ENTER .
5. The first sub-menu under the selected menu will appear.

TABLE 5-1. Default Settings for Model 5081-T-FF/FI

<u>VARIABLE NAME</u>	<u>MNEMONIC</u>	<u>FACTORY SETTINGS</u>	<u>CUSTOMER SETTINGS</u>
Program Menu			
Temperature	ƒPƒP		
Auto temperature compensation	ƒQƒQ	on	_____
Manual temperature	ƒPƒn	25.0°C (overridden by auto)	_____
Temperature compensation algorithm	ƒQƒP (L nƒƒR or nQnE)	LInEAr	_____
Display			
	d .SPLƒƒ		
Measurement type	ƒYP (ƒonduƒ or nRQn or HƒL or H2504L or H2504H or ƒu5ƒ)	CondUC	_____
Temperature (°C or °F)	ƒPƒP	C	_____
Output (mA or %)	ouƒPuƒ	Cur	_____
Security Code	code	000	_____
Custom Curve			
	SEƒUP ƒu5ƒ		
Reference temperature	ƒ rƒF	25.0°C	_____
Range			
Measurement range	rRnSE	Auto	_____
Calibrate Menu			
Cell constant	ƒELL ƒon5ƒ	3.00	_____
Temperature slope	ƒEƒP SLOPE	2.000	_____
Diagnose Menu			
Diagnose		SAMPLE READINGS	
(Each segment displays the current value in the transmitter.)			
Absolute conductivity	Rb5	1000 µS	_____
Off Set	OFF5ƒ	0.0 µS	_____
Cell constant	ƒELL ƒQn5ƒ	3.00/cm	_____
Temperature slope	ƒSLoPE	2.000	_____
Software version	5oFƒ	A02.09	_____
Hardware version	HARd	01	_____
Show fault warnings	FƒULƒ5	none	_____

5.9 USING HOLD

During calibration, the sensor may be exposed to solutions having concentration outside the normal range of the process. To prevent false alarms and undesired operation of chemical dosing pumps, place the transmitter in hold during calibration. Activating hold keeps the transmitter output at the last value or sends the output to a previously determined value. See Section 7.2, Output Ranging, for details.

After calibration, reinstall the sensor in the process stream. Wait until readings have stabilized before deactivating Hold.

To activate or deactivate Hold:

1. Press **HOLD** on the remote controller.
2. The **HoLd** prompt appears in the display. Press **↻** or **↺** to toggle Hold between **On** and **OFF**.
3. Press **ENTER** to save.

TABLE 5-2. Default Settings for Model 5081-T-HT

<u>VARIABLE NAME</u>	<u>MNEMONIC</u>	<u>FACTORY SETTINGS</u>	<u>CUSTOMER SETTINGS</u>
Program Menu			
Output	OUTPUT	-	_____
4 mA	4 PA	0 µS	_____
20 mA	20 PA	20 mS	_____
Hold	hold	21 mA	_____
Fault	FAULT	22 mA	_____
Dampening	dPn	0 samples/second	_____
Test	TEST	04.00 mA	_____
Temperature			
Auto temperature compensation	TEMP	on	_____
Manual temperature	TEMP	25.0°C (overridden by auto)	_____
Temperature compensation algorithm	TEMP (LIN or NON)	LInEAR	_____
Display			
Measurement type	TEMP (CONDUC or NRMH or HCL or H2SO4L or H2SO4H or CUSL)	CondUC	_____
Temperature (°C or °F)	TEMP	C	_____
Output (mA or %)	OUTPUT	Cur	_____
Security Code	code	000	_____
Custom Curve			
Reference temperature	TEMP CUSL	25.0°C	_____
Range			
Measurement range	RANGE	Auto	_____
Calibrate Menu			
Cell constant	CELL CONST	3.00	_____
Temperature slope	TEMP SLOPE	2.000	_____
Output Calibration	OUTPUT CAL		_____
Diagnose Menu			
Diagnose		SAMPLE READINGS	
(Each segment displays the current value in the transmitter.)			
Absolute conductivity	ABS	1000 µS	_____
Off Set	OFFSET	0.0 µS	_____
Cell constant	CELL CONST	3.00/cm	_____
Temperature slope	TEMP SLOPE	2.000	_____
Software version	SOFT	A02.09	_____
Hardware version	HRID	01	_____
Show fault warnings	FAULTS	none	_____

SECTION 6.0 START-UP AND CALIBRATION

6.1 ACCESSING THE CALIBRATE MENU

The “Calibrate” menu is used to calibrate the transmitter to known temperature and conductivity values. This menu also contains the temperature calibration operation to establish the temperature slope.

Figure 6-1 illustrates the relationship between the Calibrate Menu and its sub-menus. Each sub-menu leads to a series of prompts that are used for calibration.

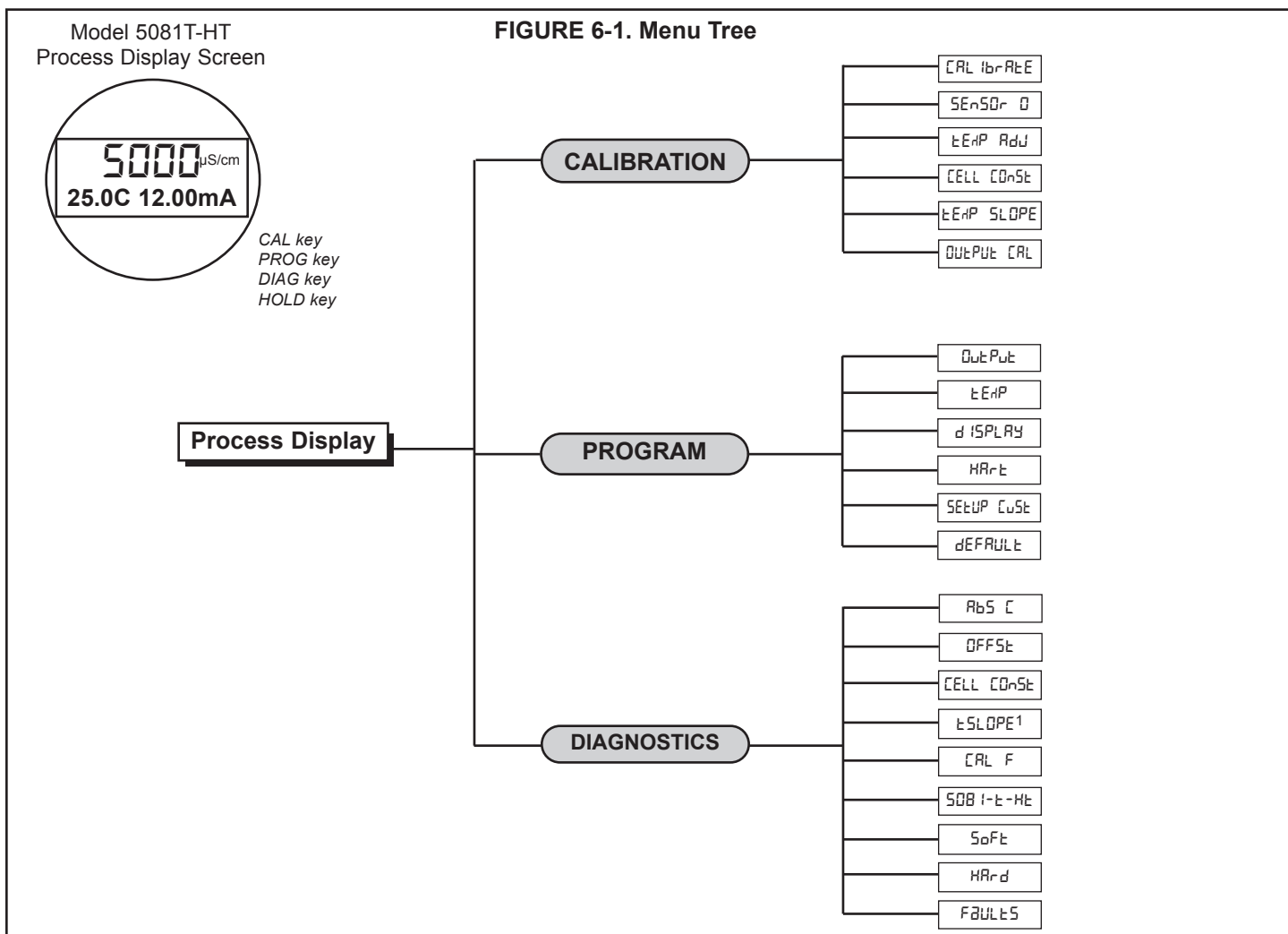

6.2 CALIBRATE MENU

To access the “Calibrate” menu, press the CAL key on the Infrared Remote Control. If security has been enabled, the secondary process display will be replaced with a prompt asking for the “Id”. Using the IRC editing keys, enter the “Id”. If the correct “Id” is entered, the **CALibrAtE** sub-menu will appear when ENTER is pressed.

If the **CALibrAtE** sub-menu does not appear when ENTER is pressed, see Section 5.8.3 (step 8) for procedure to find correct code.

6.2.1 Calibrate

1. With the sensor in a standard solution of known conductivity value, allow the temperature of the sensor to stabilize (10 min).
2. To access the **CALibrAtE** menu, press the CAL button on the IRC.
3. Press ENTER to access the **CAL** segment with flashing prompt.
4. Use the IRC editing keys to indicate the conductivity values of the standard solution on the screen.
5. Press ENTER then EXIT to enter the standard solution value and return to the main screen.

6.2.2 Sensor 0

From the main screen, press CAL, then press NEXT to enter the **SEnSOR 0** menu. Press ENTER to access the **SEnSOR 0** sub-menu. With the sensor attached and in air, press ENTER again to zero the sensor. Press EXIT to return to the **SEnSOR 0** sub-menu.

6.2.3 Temp Adj

1. Press NEXT and then ENTER to access the **tEMP** sub-menu with flashing prompt. With the sensor in any solution of known temperature, allow the temperature of the sensor to stabilize (10 min.). Use the editing keys of the IRC to change the displayed value as needed.
2. Press ENTER to standardize the temperature reading and return to the **tEMP AdJ** screen.

6.2.4 Cell Constant

1. When the **CALibrAtE** sub-menu has been accessed, press NEXT four (4) times and then ENTER to access the **CELL COnSt** menu segment with the flashing cell constant prompt.
2. Using the arrow keys on the IRC, enter your sensor’s cell constant as indicated on the sensor’s tag or specification sheet.
3. Press ENTER to save the cell constant into the transmitter memory and return to the **CELL COnSt** sub-menu.

Model 5081-T-HT

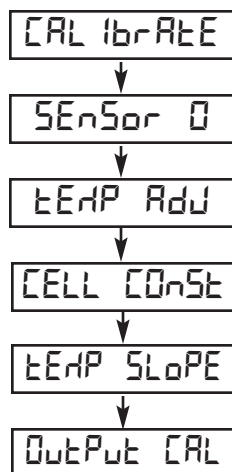

Model 5081-T-FF

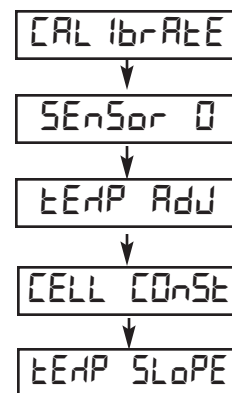

6.2.5 Temp Slope

1. Press NEXT to enter the **tEMP SLOPE** menu.

The correct temperature slope must be entered into the transmitter to ensure an acceptable process variable measurement under fluctuating process temperature conditions. Enter the slope in measured conductivity units per degree temperature change using the IRC's arrow keys. Press ENTER to enter the slope into memory; then press EXIT to return to the main screen.

2. If the temperature slope of the process is not known but you wish to approximate it, refer to the following guide and press ENTER to proceed on to **tEMP SLOPE** sub-menu with flashing prompt. Utilize the IRC editing keys to generate the desired slope value. Press ENTER then EXIT to return to the main screen.

Acids: 1.0 to 1.6% per °C

Bases: 1.8 to 2.2% per °C

Salts: 2.2 to 3.0% per °C

Water: 2.0% per °C

6.2.6 Output Cal

Although the transmitter outputs are calibrated at the factory, they can be trimmed in the field to match the reading from a standard current meter. Both the 4 mA and the 20 mA outputs can be trimmed. During output calibration the transmitter is in Hold. The output current will go to the value programmed in Section 7.2.

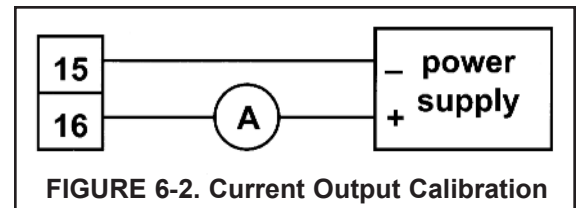

PROCEDURE

1. Wire an accurate milliammeter as shown in Figure 6-2.
2. Press CAL on the remote controller.
3. Press NEXT until the **OutPut CAL** submenu appears. Press ENTER.
4. Use the arrow keys to change the display to match the reading from the milliammeter. Press ENTER.
5. Use the arrow keys to change the display to match the reading from the milliammeter. Press ENTER. Press RESET to return to the main display.

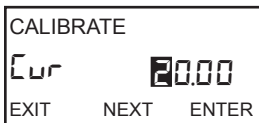
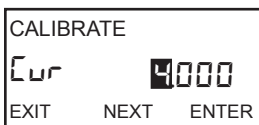
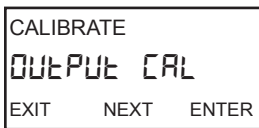

TABLE 6-1. CALIBRATE MENU MNEMONICS

CLIBRATE	Calibrate menu header
CL	Sensor calibration
TEMP SLOPE	Sub-menu header
ADJ SLOPE	Sub-menu header
TSLOPE	Slope adjustment %/°C
CELL CONST	Sub-menu header
SENSOR	Sub-menu header
SENSOR 0	Sensor "0" (performed in air)
TEMP ADJ	Sub-menu header
TEMP	Temperature adjustment °C/°F

SECTION 7.0 PROGRAMMING

- 7.1 General
- 7.2 Output
- 7.3 Temp
- 7.4 Display
- 7.5 HART
- 7.6 Setup Cust
- 7.7 Range
- 7.8 Default

7.1 GENERAL

This section describes how to do the following:

1. assign values to the 4 and 20 mA outputs (for 5081-T-HT only)
2. set the current generated by the transmitter during hold (for 5081-T-HT only)
3. set the current generated by the transmitter when a fault is detected (for 5081-T-HT only)
4. enable and disable automatic temperature correction
5. program the type measurement
6. program HART digital communications
7. set measurement range to automatic (default) or specific conductance ranges
8. reset all settings to factory default condition

Model 5081-T-HT

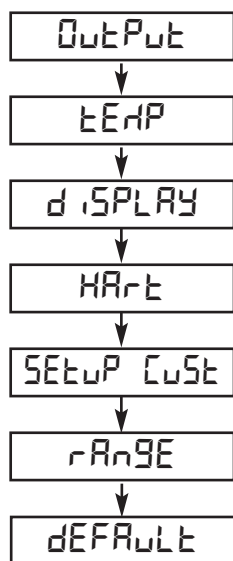

Model 5081-T-FF

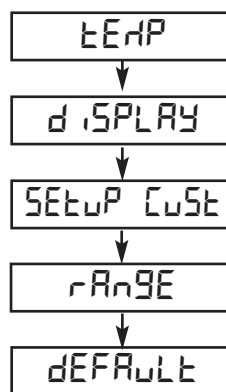

7.2 OUTPUT (5081-HT only)

7.2.1 Purpose

This section describes how to do the following:

1. assign values to the 4 and 20 mA outputs
2. set the output current generated during hold
3. set the output current generated when a fault is detected
4. control the amount of dampening on the output signal
5. generate a test current.

7.2.2 Definitions

1. **CURRENT OUTPUTS.** The transmitter provides a continuous 4 - 20 mA output directly proportional to the conductivity or resistivity.
2. **HOLD.** During calibration and maintenance the transmitter output may be outside the normal operating range. Placing the transmitter on hold prevents false alarms or the unwanted operation of chemical dosing pumps. The transmitter output can be programmed to remain at the last value or to generate any current between 3.80 and 22.00 mA. During hold, the transmitter displays the present concentration and temperature. The word HOLD appears in the display.
3. **FAULT.** A fault is a system disabling condition. When the transmitter detects a fault, the following happens:
 - a. The display flashes.
 - b. The words FAULT and HOLD appear in the main display.
 - c. A fault or diagnostic message appears in the display.
 - d. The output signal remains at the present value or goes to the programmed fault value. Permitted values are between 3.80 and 22.00 mA.
 - e. If the transmitter is in HOLD when the fault occurs, the output remains at the programmed hold value. To alert the user that a fault exists, the word FAULT appears in the main display, and the display flashes. A fault or diagnostic message also appears.
 - f. If the transmitter is simulating an output current when the fault occurs, the transmitter continues to generate the simulated current. To alert the user that a fault exists, the word FAULT appears in the display, and the display flashes.
4. **DAMPEN.** Output dampening smooths out noisy readings. But it also increases the response time of the output. To estimate the time (in minutes) required for the output to reach 95% of the final reading following a step change, divide the setting by 20. Thus, a setting of 140 means that, following a step change, the output takes about seven minutes to reach 95% of final reading. The output dampen setting does not affect the response time of the process display. The maximum setting is 255.
5. **TEST.** The transmitter can be programmed to generate a test current.

7.2.3 Procedure

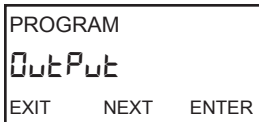

← 1. Press PROG on the remote controller. The **OutPut** submenu appears.

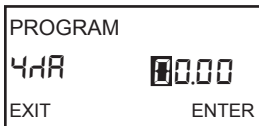

← 2. Press ENTER. The screen displays the **4 MA** prompt. Use the arrow keys to change the setting. Press ENTER to save.

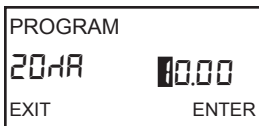

← 3. The screen displays the **20 MA** prompt. Use the arrow keys to change the setting. Press ENTER to save.

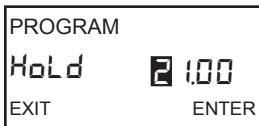

← 4. The screen displays the **HoLd** prompt. Use the arrow keys to change the setting to the output desired when the transmitter is in hold. The range is 3.80 to 22.00 mA. Entering 00.00 causes the transmitter to hold the output at the value it was when placed in hold. The hold setting overrides the fault setting. Press ENTER to save.

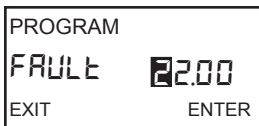

← 5. The screen displays the **FAULt** prompt. Use the arrow keys to change the setting to the output desired when the transmitter detects a fault. The range is 3.80 to 22.00 mA. Entering 00.00 causes the transmitter to hold the output at the value it was when the fault occurred. Press ENTER to save.

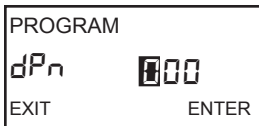

← 6. The screen displays the **dPn** prompt. Use the arrow keys to change the setting. The range is 0 to 255. Press ENTER to save.



← 7. The screen displays the **tESt** prompt. Use the arrow keys to enter the desired test current. Press ENTER to start the test. Press EXIT to end the test.

8. Press RESET to return to the process display.

7.3 TEMP

7.3.1 Purpose

This section describes how to do the following:

1. Enable and disable automatic temperature compensation
2. Set a manual temperature compensation value for conductivity measurements
3. Tell the transmitter the type of temperature element in the sensor

7.3.2 Definitions

1. **AUTOMATIC TEMPERATURE COMPENSATION.** Conductivity measurements are directly affected by temperature. A correction equation in the software automatically corrects for changes caused by temperature. In automatic temperature correction, the transmitter uses the temperature measured by the sensor for all calculations in which temperature is used.
2. **MANUAL TEMPERATURE COMPENSATION.** In manual temperature compensation, the transmitter uses the temperature entered by the user as the reference temperature for corrections of conductivity readings. It does not use the actual process temperature.

CAUTION

Changing the reference temperature from the default 25°C (77°F) can have large effects on the conductivity readings and will require different temperature slopes.

7.3.3 Procedure

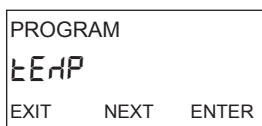

PROGRAM
TEMP
EXIT NEXT ENTER

1. Press PROG on the remote controller.

2. Press NEXT until the **tEMP** submenu appears. Press ENTER.

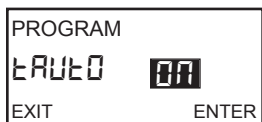

PROGRAM
tAuto ON
EXIT ENTER

3. The screen displays the **tAuto** (automatic temperature compensation) prompt. Press **3** or **6** to toggle between **On** and **OFF**. Press ENTER to save.



PROGRAM
tMAN 25.0
EXIT ENTER

4. If you disable tAuto, the **tMAN** prompt appears. Use the arrow keys to change the temperature to the desired value. To enter a negative number, press **4** or **2** until no digit is flashing. Then press **3** or **6** to display the negative sign. **The temperature entered in this step will be used in all measurements, no matter what the process temperature is.** Press ENTER to save.

5. Press RESET to return to the process display.

7.4 DISPLAY

7.4.1 Purpose

This section describes how to do the following:

1. Configure the transmitter to measure conductivity, resistivity, or set up a custom curve
2. Set the temperature units to °C or °F
3. Set the output to current or percent of full scale
4. Enter a security code.

7.4.2 Definitions

1. **MEASUREMENT.** The transmitter can be configured to measure conductivity in mS/cm or resistivity in MegOhms, or configured with a 3-5 point custom curve for special applications.
2. **OUTPUT CURRENT.** The transmitter generates a 4-20 mA output signal directly proportional to the conductivity or resistivity of the sample. The output signal can be displayed as current (in mA) or as percent of full scale.
5. **SECURITY CODE.** The security code unlocks the transmitter and allows access to all menus.

7.4.3 Procedure

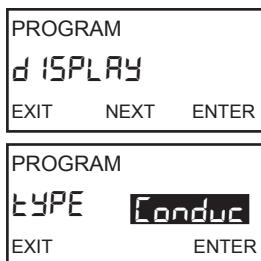

1. Press PROG on the remote controller.
2. Press NEXT until the **diSPLAy** submenu appears. Press ENTER.
3. Press **3** or **5** to display the desired measurement. Press ENTER to save.

COnduc	Conductivity
nAOH	Sodium Hydroxide 0-15%
HCL	Hydrochloric Acid 0-16%
H2SO4L	Sulfuric Acid 0-30%
H2SO4H	Sulfuric Acid 96-99.7%
CuSt	Custom Curve

4. **tEMP** will appear. Press **3** or **5** to display the desired temperature reading, **C** or **F**. Press ENTER.
5. **OUTPUt** will appear. Press **3** or **5** to display the desired 4-20 output value, **Cur** or **%**. Press ENTER.
6. **COdE** will appear. Using the arrow keys on the remote control, enter the desired 3-digit security code for accessing the Calibration, Program, and Diagnostic functions via the Remote Control handheld. Press ENTER. The **diSPLAy** mnemonic will appear.

7.5 HART

In multi-drop operation, polling addresses can be more conveniently set and debugging more conveniently performed using the infrared remote controller.

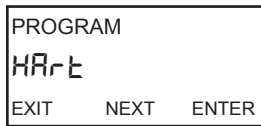

- ← 1. Press PROG on the infrared remote controller.
2. Press NEXT until the screen at left appears. Press ENTER.

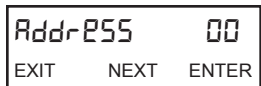

- ← 3. The HART menu tree is shown at left. Use the arrow keys to change settings. Press ENTER to store. Press NEXT to move to the next item on the menu.

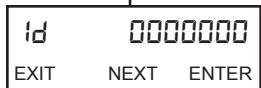
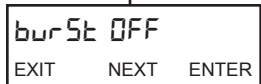
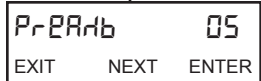

7.6 SETUP CUST

The Model 5081-T contains a curve fitting program that can create a second order curve for 3 to 5 user supplied data points. If only two points are entered, a straight line will be used. These points are from numerical data previously collected that is entered via the keypad. All data point must be approximately the same reference temperature.

Best results will be obtained by selecting data points that are representative of the typical operating range and are at least 5% different conductivity values. Plotting the graph of conductivity vs. concentration for the data points of interest before using this procedure is highly recommended. This will insure that unsuitable points (i.e. two concentrations with the same conductivity) and critical points (that best describe the curve) can be determined. All data points should be either on the rising side of the conductivity versus concentration curve or the falling side, but not both (i.e. both side of the conductivity maximum or minimum). Following these guideline will simplify the data entry procedure and provide optimum results.

The first point entered "COnd 1" should be at the normal operating condition. Other points, both above and below "COnd 1" can then be entered. Very nonlinear conductivity curves may need additional points to characterize these regions. Do not use the same data for more than one point and only use real data - do not interpolate.

NOTE

The default values for the custom curve are three data points, reference temperature of 25°C and a linear temperature slope of 2%/°C. This combination will yield the best results in most applications. If normal operation is over 40°C or under 10°C, the reference temperature should be changed to the normal process temperature. If the temperature slope at the reference temperature is known, it can be used.

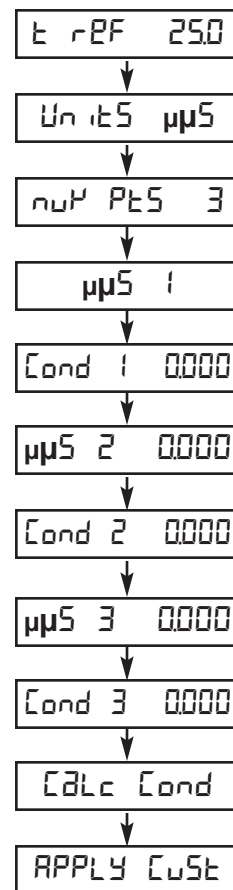

7.6.1 Procedure

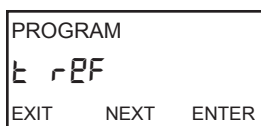

1. From the main menu, press PROG; then press NEXT four times. **SetUP CuSt** will appear.

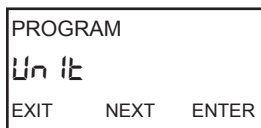

2. Press ENTER. **t rEF** will appear. If needed, change the reference temperature from the factory default 25°C (77°F) to a different reference temperature for the process. Press ENTER.

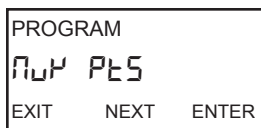

3. **UnIt** will appear. Press **3** or **6** to select the desired measurement units: μS (micro-Siemens), nS (milliSiemens), none (no units displayed), % (percent), or ppm (parts per million); then press ENTER.

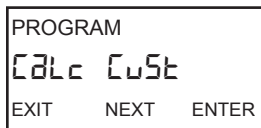

4. **NUM PtS** will appear. Press **3** or **6** to select the desired number of data points for a custom conductivity curve. Selecting 2 will generate a linear relationship for conductivity and concentration at the given reference temperature.

- a. Enter the concentration for Pt. 1 (displayed as **μS 1**). Press ENTER.
- b. Enter the known conductivity for Pt. 1 in μS/cm. Press ENTER.
- c. Complete this process for additional known data points. Press ENTER.

5. **CALC Cust** will appear. Press ENTER. **ProCESSInG** will appear briefly; then **APPLY CUSt** will appear. Press ENTER to enter the custom curve into memory and return to the **SetUP CuSt** screen.

The Custom curve will now be used to display and output all conductivity (or resistivity) measurements if **Cust** is selected in the Display menu for measurement type.

7.7 RANGE

7.7.1 Purpose

This section provides the steps to select automatic ranging or a specific fixed range of measurement. Five specific conductance ranges are selectable. Setting the Model 5081 to a fixed range reduces response time.

The following conductance ranges are available:

Setting	Measurement Range	Over Range Warning Limit
Auto	0uS to 1400mS	None
1400mS	550mS to 1400mS	None
550mS	200mS to 550mS	570mS
200mS	33mS to 200mS	207mS
33mS	3000uS to 33mS	34mS
3mS	0uS to 3000uS	3400uS

NOTE: The selection between automatic ranging or a specified fixed range of measurement range can ONLY be done using the IRC/Infrared Remote Controller. This selection cannot be done via HART or FOUNDATION Fieldbus hosts or configurators.

7.7.2 Procedure

1. Press **PROG**.
2. Press **NEXT** five times. **rAnGE** (range) will appear.
3. Press **ENTER**. The default setting **Auto** will appear. This indicates that Model 5081 is in auto ranging mode.
4. To set a fixed conductance range, press the down arrow key **⬇** until the desired measurement range appears. **1400mS**, **550mS**, **200mS**, **33mS** and **3mS** will appear when pressing the down arrow **⬇** successively.
5. When the desired range is reached, press **ENTER**. This disables auto ranging and limits the measurement to the selected range.
6. Press **NEXT** to move to the next Programming menu item.

7.8 DEFAULT

7.8.1 Purpose

This section describes how to erase ALL user-defined configuration settings and return the transmitter to factory default settings. All custom curve values and settings will be deleted.

7.8.2 Procedure

1. Press PROG on the remote controller.



2. Press NEXT until the **dEFAULT** appears in the display. Press ENTER.



3. Use **⬆** or **⬇** to toggle between **nO** and **yES**. With **yES** showing, press ENTER to return to factory default settings.

SECTION 8.0 FOUNDATION FIELDBUS OPERATION

This section covers basic transmitter operation and software functionality. For detailed descriptions of the function blocks common to all Fieldbus devices, refer to Fisher-Rosemount Fieldbus FOUNDATION Function Blocks manual, publication number 00809-001-4783.

Figure 8-1 illustrates how the pH/ORP signal is channelled through the transmitter to the control room and the FOUNDATION Fieldbus configuration device.

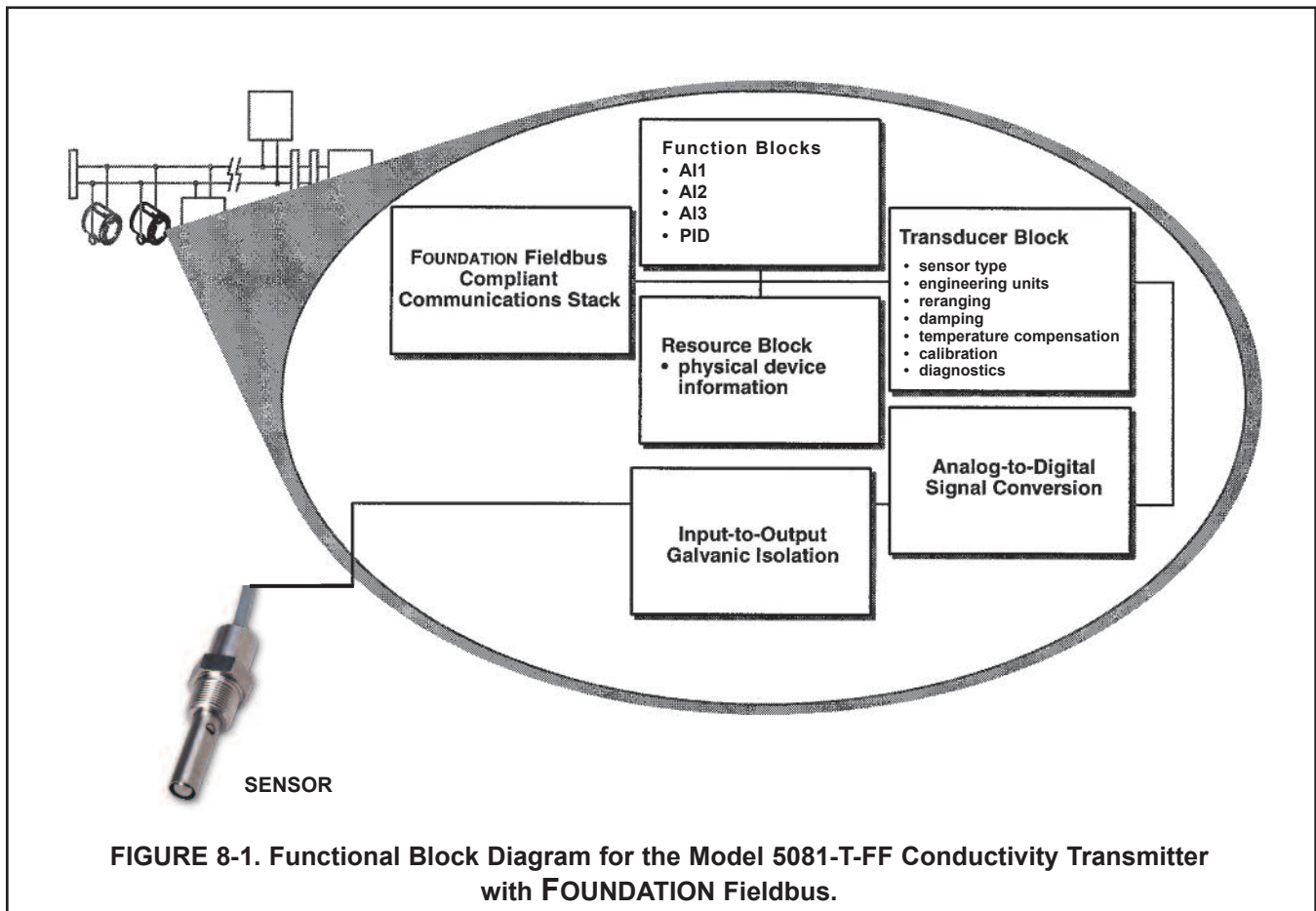

Software Functionality. The Model 5081-T software is designed to permit remote testing and configuration of the transmitter using the Fisher-Rosemount DeltaV Fieldbus Configuration Tool, or other FOUNDATION fieldbus compliant host.

Transducer Block. The transducer block contains the actual measurement data. It includes information about sensor type, engineering units, reranging, damping, temperature compensation, calibration, and diagnostics.

Resource Block. The resource Block contains physical device information, including available memory, manufacturer identification, type of device, and features.

FOUNDATION fieldbus Function Blocks. The Model 5081-T includes three Analog Input (AI) function blocks and one PID function block as part of its standard offering.

Analog Input. The Analog Input (AI) block processes the measurement and makes it available to other function blocks. It also allows filtering, alarming, and engineering unit change.

PID. The PID function block combines all of the necessary logic to perform proportional/integral/derivative (PID) control. The block supports mode control, signal scaling and limiting, feedforward control, override tracking, alarm limit detection, and signal status propagation.

SECTION 9.0 OPERATION WITH MODEL 375

9.1 Note on Model 375 or 475 Communicator

The Model 375 or 475 Communicator is a product of Emerson Process Management, Rosemount Inc. This section contains selected information on using the Model 375 or 475 with the Rosemount Analytical Model 5081-T-HT Transmitter. For complete information on the Model 375 or 475 Communicator, see the Model 375 or 475 instruction manual. For technical support on the Model 375 or 475 Communicator, call Emerson Process Management at (800) 999-9307 within the United States. Support is available worldwide on the internet at <http://rosemount.com>.

Note: Model 475 Communicator does not support FOUNDATION Fieldbus on Model 5081-T-FF.

9.2 Connecting the Communicator

Figure 9-1 shows how the Model 475 or 375 Communicator connects to the output lines from the Model 5081-T-HT Transmitter.



CAUTION

For intrinsically safe CSA and FM wiring connections, see the Model 375 instruction manual.

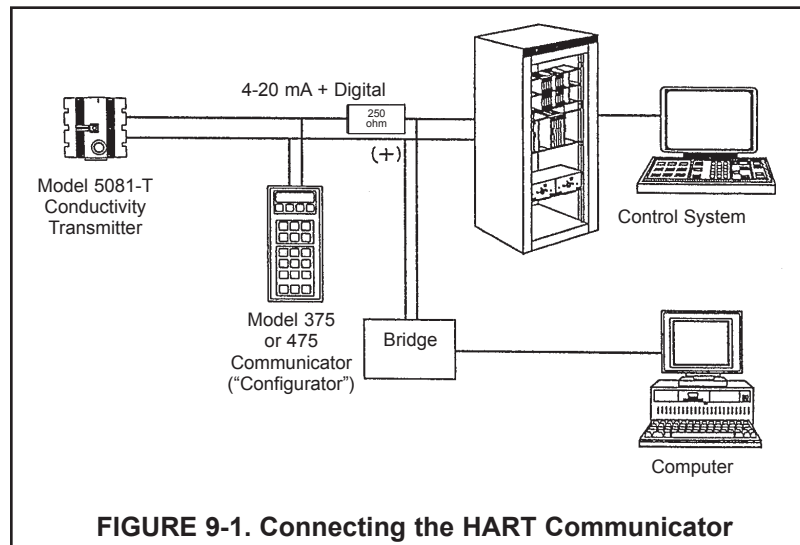

9.3 Operation

9.3.1 Off-line and On-line Operation

The Model 375 Communicator features off-line and on-line communications. On-line means the communicator is connected to the transmitter in the usual fashion. While the communicator is on line, the operator can view measurement data, change program settings, and read diagnostic messages. Off-line means the communicator is not connected to the transmitter. When the communicator is off line, the operator can still program settings into the communicator. Later, after the communicator has been connected to a transmitter, the operator can transfer the programmed settings to the transmitter. Off-line operation permits settings common to several transmitters to be easily stored in all of them.

9.3.2 Making HART related settings from the keypad

Calibrate	Hold
Program	Display

Output	Temp
Measurement	>>

Security	HART
	>>

DevID	PollAddr
Burst	Preamble

1. Press MENU. The main menu screen appears. Choose **Program**.
2. Choose >>.
3. Choose **HART**.
4. To display the device ID, choose **DevID**. To change the polling address, choose **PollAddr**. To make burst mode settings, choose **Burst**. To change the preamble count, choose **Preamble**.

9.3.3 Menu Tree

The menu tree for the Model 375 HART communicator is on the following page. The menu tree for the Model 375 FOUNDATION Fieldbus communicator immediately follows.

Note: Model 375 Communicator fully supports FOUNDATION Fieldbus on Model 5081-T-FF.

5081-C/T 475, 375 Menu Tree for HART communications

Device setup

Process variables

- Cond *
- Raw
- Conductance
- Temp
- Temp res
- View status

Diag/Service

Test device

- Loop test
- View status
- Master reset
- Fault history

Hold mode

Calibration

- Calibrate sensor
- Zero in air
- Zero in solution **
- Adjust temperature
- Calibrate input
- Cell constant
- Temp slope

D/A trim

Diagnostic vars

- Cond *
- Temp
- Cell constant
- Zero offset
- Soln offset **
- Temp slope ***
- Input cal factor

Basic setup

- Tag
- PV range values
 - PV LRV
 - PV URV
 - PV
 - PV % rng

FIGURE 9-2. 5081-C/T-HT HART/Model 375 Menu Tree (1 of 4)

Basic setup (continued)

Device information

Distributor
 Model
 Dev id
 Tag
 Date
 Physicl signl code
 Write protect
 Snsr text
 Descriptor
 Message
 Revision #'s
 Universal rev
 Fld dev rev
 Software rev
 Hardware rev

Detailed setup

Sensors

Main sensor

PV Type [Conductivity, Resistivity, 0-12% NaOH, 0-15% HCl, 0-25% H2SO4, 96-99.7% H2SO4, Custom]
 PV Snsr unit [uS/cm, mS/cm, mS/m, Mohm-cm, %, ppm, _]
 Cond unit [uS/cm, mS/cm, mS/m] ****
 Define curve ****
 View custom points ****
 Cell constant
 Temp comp type [Linear, Neutral salt, Cation, None/Off] *..
 Temp slope
 Ref temp ***, ****, *.

PV sensor type

Sensor information

LSL
 USL
 Min span

Temperature

ATC [On, Off]
 Man temp
 Temp unit [°C, °F]
 Temp snsr [RTD PT100, RTD PT1000]

Diag override (continued)

Offset error [ON, OFF]
 Zero warning [ON, OFF]
 Overage [ON, OFF]
 Sensor fail [ON, OFF]

FIGURE 9-2. 5081-C/T-HT HART/Model 375 Menu Tree (2 of 4)

Diag override (continued)
 RTD fail [ON, OFF]
 Sense line open [ON, OFF]
 Temp high/low [ON, OFF]

Signal condition
 LRV
 URV
 AO Damp
 % rng
 Xfer fnctn
 AO1 lo end point
 AO1 hi end pt

Output condition
 Analog output
 AO1
 AO Alm typ
 Fixed
 Fault
 Loop test
 D/A trim

 HART output
 PV is Cond
 SV is Temp
 TV is Raw
 Poll addr
 Burst option [PV, %range/current, Process vars/crnt]
 Burst mode [Off, On]
 Num req preams
 Num resp preams

Device information
 Distributor
 Model
 Dev id
 Tag
 Date
 Write protect
 Snsr text
 Descriptor
 Message
 Revision #'s
 Universal rev
 Fld dev rev
 Software rev
 Hardware rev

FIGURE 9-2. 5081-C/T-HT HART/Model 375 Menu Tree (3 of 4)

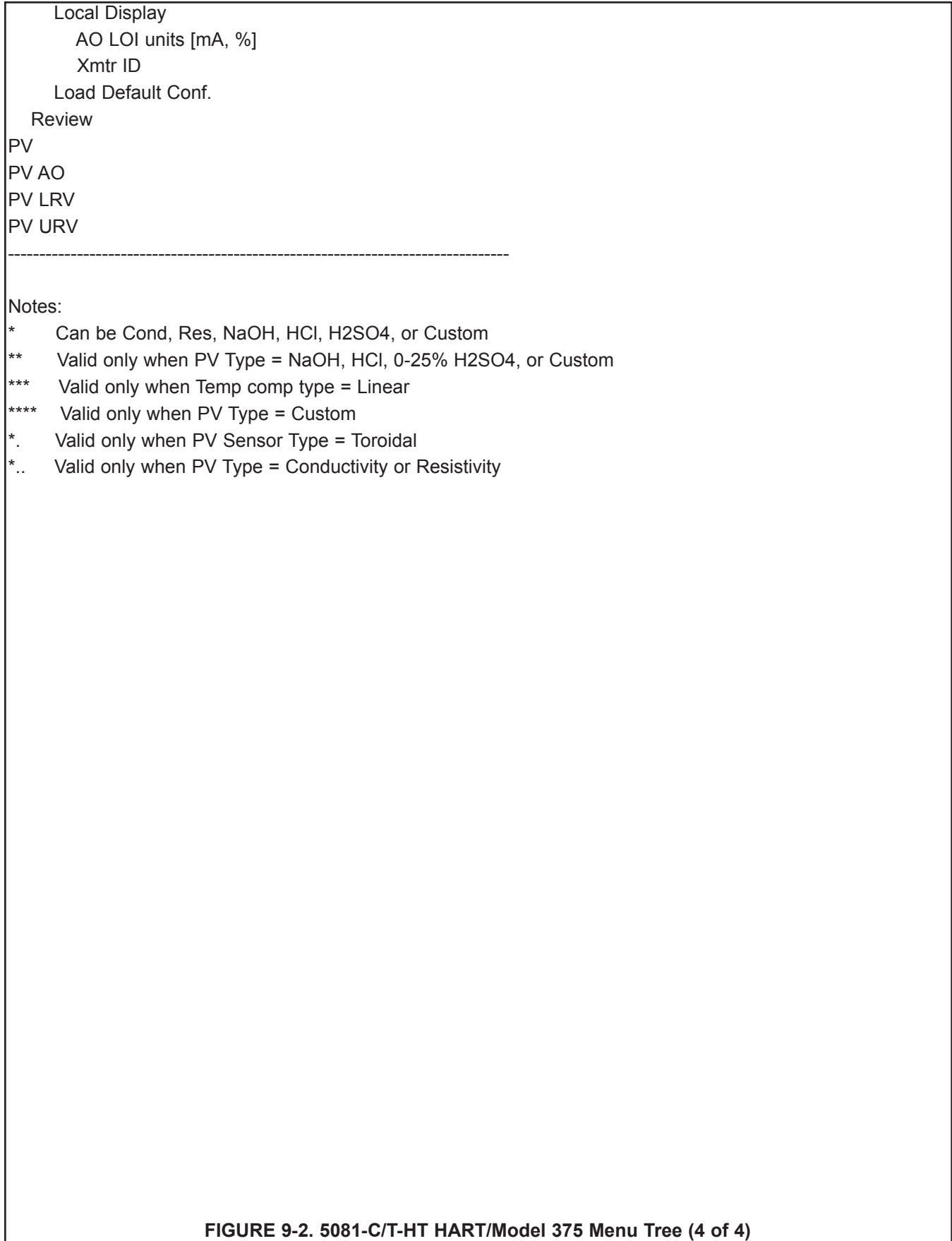

5081-C/T-FF/FI 375 Menu Tree	LIM_NOTIFY
-----	MAX_NOTIFY
RESOURCE	FAULT_STATE
Identification	SET_FSTATE [Uninitialized, OFF, SET]
MANUFACT_ID	CLR_FSTATE [Uninitialized, Off, Clear]
DEV_TYPE	ALARM_SUM: Disabled
DEV_REV	ACK_OPTION
DD_REV	Hardware
Characteristics Block Tag	MEMORY_SIZE
TAG_DESC	FREE_TIME
Hardware Revision	MIN_CYCLE_T
Software Revision String	HARD_TYPES
Private Label Distributor	NV_CYCLE_T
Final Assembly Number	FREE_SPACE
Output Board Serial Number	Options
ITK_VER	CYCLE_SEL
Status	CYCLE_TYPE
BLOCK_ERR	FEATURE_SEL
RS_STATE	FEATURES
FAULT_STATE	Download Mode
Summary Status	WRITE_LOCK
MODE_BLK: Actual	Start With Defaults
MODE_BLK: Target	Write Lock Definition
ALARM_SUM: Current	Plantweb Alerts
ALARM_SUM: Unacknowledged	Health Index
ALARM_SUM: Unreported	Recommended Action
Detailed Status	Fail Active
Process	Fail Mask
MODE_BLK.Actual	Maintenance Active
MODE_BLK.Target	Maintenance Mask
MODE_BLK.Permitted	Advisory Active
STRATEGY	Advisory Mask
ALERT_KEY	Methods
SHED_RCAS	Master reset
SHED_ROUT	Self test
GRANT_DENY: Grant	DD Version Info
GRANT_DENY: Deny	
Alarms	TRANSDUCER
WRITE_PRI	Status
CONFIRM_TIME	MODE_BLK: Actual

FIGURE 9-3. 5081-C/T-FF/FI Model 375 Menu Tree (1 of 10)

Transducer Error	Conductance offset
ST_REV	Solution/Conductivity offset
BLOCK_ERR	Input cal factor
Additional transmitter status	Temperature calibration offset
Fault history 0	Snsr Cal Meth
Fault history 1	Snsr Cal Date
Fault history 2	Temperature Compensation
Block Mode	Secondary value units
MODE_BLK: Actual	Sensor temperature compensation
MODE_BLK: Target	Sensor temp manual value
MODE_BLK: Permitted	Temp comp type
STRATEGY	Temperature slope
ALERT_KEY	Raw RTD ohms
Characteristics Block Tag	Sensor type temp
TAG_DESC	Custom Curve
Measurements	Reset transducer/Load factory defaults
Prim Val Type	Identification
Primary Val: Primary Val	Software revision level
Primary Val: Status	Hardware revision level
Primary Value Range: EU at 100%	LOI security code
Primary Value Range: EU at 0%	Sensor S/N
Secondary variable: Value	Final assembly number
Secondary variable: Status	AI blocks simulation
Raw RTD Ohms	AI1
Raw PV: Raw PV	AI2
Raw PV: Status	AI3
Conductance	Quick Config
Calibration	AI Channel
PV Cal	L_TYPE
Sensor Zero	XD_SCALE: EU at 100%
SV Cal	XD_SCALE: EU at 0%
Calibrate Meter	XD_SCALE: Units Index
Configuration	XD_SCALE: Decimal
Change PV Type	OUT_SCALE: EU at 100%
Sensor type conductivity	OUT_SCALE: EU at 0%
Prim Val Type	OUT_SCALE: Units Index
Conductivity unit	OUT_SCALE: Decimal
Diagnostic override	Common Config
Calibration Parameters	ACK_OPTION
Cell constant	ALARM_HYS

FIGURE 9-3. 5081-C/T-FF/FI Model 375 Menu Tree (2 of 10)

ALERT_KEY	BLOCK_ERR
HI_HI_LIM	FIELD_VAL: Status
HI_HI_PRI	FIELD_VAL: Value
HI_LIM	MODE_BLK: Target
HI_PRI	MODE_BLK: Actual
IO_OPTS	MODE_BLK: Permitted
L_TYPE	MODE_BLK: Normal
LO_LO_LIM	Out: Status
LO_LO_PRI	Out: Value
LO_LIM	PV: Status
LO_PRI	PV: Value
MODE_BLK: Target	Status
MODE_BLK: Actual	BLOCK_ERR
MODE_BLK: Permitted	Other
MODE_BLK: Normal	TAG_DESC
OUT_SCALE: EU at 100%	GRANT_DENY: Grant
OUT_SCALE: EU at 0%	GRANT_DENY: Deny
OUT_SCALE: Units Index	UPDATE_EVT: Unacknowledged
OUT_SCALE: Decimal	UPDATE_EVT: Update State
PV_FTIME	UPDATE_EVT: Time Stamp
Advanced Config	UPDATE_EVT: Static Rev
LOW_CUT	BLOCK_ALM: Unacknowledged
SIMULATE: Simulate Status	BLOCK_ALM: Alarm State
SIMULATE: Simulate Value	All
SIMULATE: Transducer Status	Characteristics: Block Tag
SIMULATE: Transducer Value	ST_REV
SIMULATE: Simulate En/Disable	TAG_DESC
ST_REV	STRATEGY
STATUS_OPTS	ALERT_KEY
STRATEGY	MODE_BLK: Target
XD_SCALE: EU at 100%	MODE_BLK: Actual
XD_SCALE: EU at 0%	MODE_BLK: Permitted
XD_SCALE: Units Index	MODE_BLK: Normal
XD_SCALE: Decimal	BLOCK_ERR
I/O References	PV: Status
AI Channel	PV: Value
Connectors	Out: Status
Out: Status	Out: Value
Out: Value	SIMULATE: Simulate Status
Online	SIMULATE: Simulate Value

FIGURE 9-3. 5081-C/T-FF/FI Model 375 Menu Tree (3 of 10)

SIMULATE: Transducer Status	LO_LIM
SIMULATE: Transducer Value	LO_LO_PRI
SIMULATE: Simulate En/Disable	LO_LO_LIM
XD_SCALE: EU at 100%	HI_HI_ALM: Unacknowledged
XD_SCALE: EU at 0%	HI_HI_ALM: Alarm State
XD_SCALE: Units Index	HI_HI_ALM: Time Stamp
XD_SCALE: Decimal	HI_HI_ALM: Subcode
OUT_SCALE: EU at 100%	HI_HI_ALM: Value
OUT_SCALE: EU at 0%	HI_ALM: Unacknowledged
OUT_SCALE: Units Index	HI_ALM: Alarm State
OUT_SCALE: Decimal	HI_ALM: Time Stamp
GRANT_DENY: Grant	HI_ALM: Subcode
GRANT_DENY: Deny	HI_ALM: Float Value
IO_OPTS	LO_ALM: Unacknowledged
STATUS_OPTS	LO_ALM: Alarm State
AI Channel	LO_ALM: Time Stamp
LOW_CUT	LO_ALM: Subcode
PV_FTIME	LO_ALM: Float Value
FIELD_VAL: Status	LO_LO_ALM: Unacknowledged
FIELD_VAL: Value	LO_LO_ALM: Alarm State
UPDATE_EVT: Unacknowledged	LO_LO_ALM: Time Stamp
UPDATE_EVT: Update State	LO_LO_ALM: Subcode
UPDATE_EVT: Time Stamp	LO_LO_ALM: Float Value
UPDATE_EVT: Static Rev	Alarm output: Status
UPDATE_EVT: Relative Index	Alarm output: Value
BLOCK_ALM: Unacknowledged	Alarm select
BLOCK_ALM: Alarm State	StdDev
BLOCK_ALM: Time Stamp	Cap StdDev
BLOCK_ALM: Subcode	PID1
BLOCK_ALM: Value	Quick Config
ALARM_SUM: Unacknowledged	ALERT_KEY
ALARM_SUM: Unreported	CONTROL_OP
ALARM_SUM: Disabled	DV_HI_LIM
ACK_OPTION	DV_LO_LIM
ALARM_HYS	GAIN
HI_HI_PRI	HI_HI_LIM
HI_HI_LIM	HI_LIM
HI_PRI	LO_LIM
HI_LIM	LO_LO_LIM
LO_PRI	OUT_SCALE: EU at 100%

FIGURE 9-3. 5081-C/T-FF/FI Model 375 Menu Tree (4 of 10)

OUT_SCALE: EU at 0%	SP: Status
OUT_SCALE: Units Index	SP: Value
OUT_SCALE: Decimal	SP_HI_LIM
PV_SCALE: EU at 100%	SP_LO_LIM
PV_SCALE: EU at 0%	Advanced Config
PV_SCALE: Units Index	BK_CAL_HYS
PV_SCALE: Decimal	FF_GAIN
RESET	FF_SCALE: EU at 100%
SP: Status	FF_SCALE: EU at 0%
SP: Value	FF_SCALE: Units Index
SP_HI_LIM	FF_SCALE: Decimal
SP_LO_LIM	SHED_OPT
Common Config	SP_RATE_DN
ALARM_HYS	SP_RATE_UP
ALERT_KEY	ST_REV
CONTROL_OPTS	STATUS_OPTS
DV_HI_LIM	STRATEGY
DV_LO_LIM	TRK_SCALE: EU at 100%
GAIN	TRK_SCALE: EU at 0%
HI_HI_LIM	TRK_SCALE: Units Index
HI_LIM	TRK_SCALE: Decimal
LO_LIM	TRK_VAL: Status
LO_LO_LIM	TRK_VAL: Value
MODE_BLK: Target	Connectors
MODE_BLK: Actual	BK_CAL_IN: Status
MODE_BLK: Permitted	BK_CAL_IN: Value
MODE_BLK: Normal	BK_CAL_OUT: Status
OUT_HI_LIM	BK_CAL_OUT: Value
OUT_LO_LIM	CAS_IN: Status
OUT_SCALE: EU at 100%	CAS_IN: Value
OUT_SCALE: EU at 0%	FF_VAL: Status
OUT_SCALE: Units Index	FF_VAL: Value
OUT_SCALE: Decimal	IN: Status
PV_FTIME	IN: Value
PV_SCALE: EU at 100%	OUT: Status
PV_SCALE: EU at 0%	OUT: Value
PV_SCALE: Units Index	TRK_IN_D: Status
PV_SCALE: Decimal	TRK_IN_D: Value
RATE	TRK_VAL: Status
RESET	TRK_VAL: Value

FIGURE 9-3. 5081-C/T-FF/FI Model 375 Menu Tree (5 of 10)

Online	BAL_TIME
BK_CAL_IN: Status	GRANT_DENY: Grant
BK_CAL_IN: Value	GRANT_DENY: Deny
BK_CAL_OUT: Status	UPDATE_EVT: Unacknowledged
BK_CAL_OUT: Value	UPDATE_EVT: Update State
BLOCK_ERR	UPDATE_EVT: Time Stamp
BYPASS	UPDATE_EVT: Static Rev
CAS_IN: Status	UPDATE_EVT: Relative Index
CAS_IN: Value	BLOCK_ALM: Unacknowledged
FF_VAL: Status	BLOCK_ALM: Alarm State
FF_VAL: Value	BLOCK_ALM: Time Stamp
GAIN	BLOCK_ALM: Subcode
IN: Status	BLOCK_ALM: Value
IN: Value	ALARM_SUM: Current
MODE_BLK: Target	ALARM_SUM: Unacknowledged
MODE_BLK: Actual	ALARM_SUM: Unreported
MODE_BLK: Permitted	ALARM_SUM: Disabled
MODE_BLK: Normal	ACK_OPTION
OUT: Status	HI_HI_ALM: Unacknowledged
OUT: Value	HI_HI_ALM: Alarm State
PV: Status	HI_HI_ALM: Time Stamp
PV: Value	HI_HI_ALM: Subcode
RCAS_IN: Status	HI_HI_ALM: Float Value
RCAS_IN: Value	HI_ALM: Unacknowledged
RCAS_OUT: Status	HI_ALM: Alarm State
RCAS_OUT: Value	HI_ALM: Time Stamp
ROUT_IN: Status	HI_ALM: Subcode
ROUT_IN: Value	HI_ALM: Float Value
ROUT_OUT: Status	LO_ALM: Unacknowledged
ROUT_OUT: Value	LO_ALM: Alarm State
SP: Status	LO_ALM: Time Stamp
SP: Value	LO_ALM: Subcode
TRK_IN_D: Status	LO_ALM: Float Value
TRK_IN_D: Value	LO_LO_ALM: Unacknowledged
TRK_VAL: Status	LO_LO_ALM: Alarm State
TRK_VAL: Value	LO_LO_ALM: Time Stamp
Status	LO_LO_ALM: Subcode
BLOCK_ERR	LO_LO_ALM: Float Value
Other	DV_HI_ALM: Unacknowledged
TAG_DESC	DV_HI_ALM: Alarm State

FIGURE 9-3. 5081-C/T-FF/FI Model 375 Menu Tree (6 of 10)

DV_HI_ALM: Time Stamp	OUT_SCALE: EU at 100%
DV_HI_ALM: Subcode	OUT_SCALE: EU at 0%
DV_HI_ALM: Float Value	OUT_SCALE: Units Index
DV_LO_ALM: Unacknowledged	OUT_SCALE: Decimal
DV_LO_ALM: Alarm State	GRANT_DENY: Grant
DV_LO_ALM: Time Stamp	GRANT_DENY: Deny
DV_LO_ALM: Subcode	CONTROL_OPTS
DV_LO_ALM: Float Value	STATUS_OPTS
Bias	IN: Status
Error	IN: Value
SP Work	PV_FTIME
SP FTime	BYPASS
mathform	CAS_IN: Status
structreconfig	CAS_IN: Value
UGamma	SP_RATE_DN
UBeta	SP_RATE_UP
IDeadBand	SP_HI_LIM
StdDev	SP_LO_LIM
Cap StdDev	GAIN
All	RESET
Characteristics: Block Tag	BAL_TIME
ST_REV	RATE
TAG_DESC	BK_CAL_IN: Status
STRATEGY	BK_CAL_IN: Value
ALERT_KEY	OUT_HI_LIM
MODE_BLK: Target	OUT_LO_LIM
MODE_BLK: Actual	BKCAL_HYS
MODE_BLK: Permitted	BK_CAL_OUT: Status
MODE_BLK: Normal	BK_CAL_OUT: Value
BLOCK_ERR	RCAS_IN: Status
PV: Status	RCAS_IN: Value
PV: Value	ROUT_IN: Status
SP: Status	ROUT_IN: Value
SP: Value	SHED_OPT
OUT: Status	RCAS_OUT: Status
OUT: Value	RCAS_OUT: Value
PV_SCALE: EU at 100%	ROUT_OUT: Status
PV_SCALE: EU at 0%	ROUT_OUT: Value
PV_SCALE: Units Index	TRK_SCALE: EU at 100%
PV_SCALE: Decimal	TRK_SCALE: EU at 0%

FIGURE 9-3. 5081-C/T-FF/FI Model 375 Menu Tree (7 of 10)

TRK_SCALE: Units Index	DV_LO_LIM
TRK_SCALE: Decimal	HI_HI_ALM: Unacknowledged
TRK_IN_D: Status	HI_HI_ALM: Alarm State
TRK_IN_D: Value	HI_HI_ALM: Time Stamp
TRK_VAL: Status	HI_HI_ALM: Subcode
TRK_VAL: Value	HI_HI_ALM: Float Value
FF_VAL: Status	HI_ALM: Unacknowledged
FF_VAL: Value	HI_ALM: Alarm State
FF_SCALE: EU at 100%	HI_ALM: Time Stamp
FF_SCALE: EU at 0%	HI_ALM: Subcode
FF_SCALE: Units Index	HI_ALM: Float Value
FF_SCALE: Decimal	LO_ALM: Unacknowledged
FF_GAIN	LO_ALM: Alarm State
UPDATE_EVT: Unacknowledged	LO_ALM: Time Stamp
UPDATE_EVT: Update State	LO_ALM: Subcode
UPDATE_EVT: Time Stamp	LO_ALM: Float Value
UPDATE_EVT: Static Rev	LO_LO_ALM: Unacknowledged
UPDATE_EVT: Relative Index	LO_LO_ALM: Alarm State
BLOCK_ALM: Unacknowledged	LO_LO_ALM: Time Stamp
BLOCK_ALM: Alarm State	LO_LO_ALM: Subcode
BLOCK_ALM: Time Stamp	LO_LO_ALM: Float Value
BLOCK_ALM: Sub Code	DV_HI_ALM: Unacknowledged
BLOCK_ALM: Value	DV_HI_ALM: Alarm State
ALARM_SUM: Current	DV_HI_ALM: Time Stamp
ALARM_SUM: Unacknowledged	DV_HI_ALM: Subcode
ALARM_SUM: Unreported	DV_HI_ALM: Float Value
ALARM_SUM: Disabled	DV_LO_ALM: Unacknowledged
ACK_OPTION	DV_LO_ALM: Alarm State
ALARM_HYS	DV_LO_ALM: Time Stamp
HI_HI_PRI	DV_LO_ALM: Subcode
HI_HI_LIM	DV_LO_ALM: Float Value
HI_PRI	Bias
HI_LIM	Error
LO_PRI	SP Work
LO_LIM	SP FTime
LO_LO_PRI	mathform
LO_LO_LIM	structreconfig
DV_HI_PRI	UGamma
DV_HI_LIM	UBeta
DV_LO_PRI	IDeadBand

FIGURE 9-3. 5081-C/T-FF/FI Model 375 Menu Tree (8 of 10)

StdDev	Finch Rec Ready Errors
Cap StdDev	Finch Rec FIFO Overrun Errors
Scheduling	Finch Rec FIFO Underrun Errors
Detail	Finch Trans FIFO Overrun Errors
Physical Device Tag	Finch Trans FIFO Underrun Errors
Address	Finch Count Errors
Device ID	Finch CD Errors
Device Revision	Cold Start Counts
Advanced	Software Crash Counts
Stack Capabilities	Spurious Vector Counts
FasArTypeAndRoleSupported	Bus/Address Error Counts
MaxDisapAddressesSupported	Program Exit Counts
MaxDlcepAddressesSupported	Finch Statistics 2
DlcepDeliveryFeaturesSupported	Scheduled Events
VersionOfNmSpecSupported	Missed Events
AgentFunctionsSupported	Max Time Error
FmsFeaturesSupported	MID Violations
Basic Characteristics	Schedule Resync
Version	Token Delegation Violations
BasicStatisticsSupportedFlag	Sum Of All Time Adjustments
DIOperatFunctionalClass	Time Adjustments
DIDeviceConformance	Time Updates Outside of K
Basic Info	Discontinuous Time Updates
SlotTime	Queue Overflow Statistics 1
PerDlPduPhIOverhead	Time Available
MaxResponseDelay	Normal
ThisNode	Urgent
ThisLink	Time Available Rcv
MinInterPduDelay	Normal Rcv
TimeSyncClass	Urgent Rcv
PreambleExtension	Time Available SAP EC DC
PostTransGapExtension	Normal SAP EC DC
MaxInterChanSignalSkew	Urgent SAP EC DC
Basic Statistics	Time Available Rcv SAP EC DC
Not Supported!	Normal Rcv SAP EC DC
Finch Statistics 1	Urgent Rcv SAP EC DC
Last Crash Description	Queue Overflow Statistics 2
Last RestartReason	Time Available SAP SM
Finch Rec Errors	Time Available Rcv SAP SM
Finch FCS Errors	Normal SAP Las

FIGURE 9-3. 5081-C/T-FF/FI Model 375 Menu Tree (9 of 10)

Normal Rcv SAP Las	ThisLink
Time Available SAP Src Sink	MinInterPduDelay
Normal SAP Src Sink	NumConsecUnpolledNodeId
Urgent SAP Src Sink	PreambleExtension
Time Available Rcv SAP Src Sink	PostTransGapExtension
Normal Rcv SAP Src Sink	MaxInterChanSignalSkew
Urgent Rcv SAP Src Sink	TimeSyncClass
Sys Q	
Link Master Parameters	
DlmeLinkMasterCapabilitiesVariable	
PrimaryLinkMasterFlagVariable	
BootOperatFunctionalClass	
NumLasRoleDeleg/Claim/DelegTokenHoldTimeout	
Link Master Info	
MaxSchedulingOverhead	
DefMinTokenDelegTime	
DefTokenHoldTime	
TargetTokenRotTime	
LinkMaintTokHoldTime	
TimeDistributionPeriod	
MaximumInactivityToClaimLasDelay	
LasDatabaseStatusSpduDistributionPeriod	
Current Link Settings	
SlotTime	
PerDlPduPhIOverhead	
MaxResponseDelay	
FirstUnpolledNodeId	
ThisLink	
MinInterPduDelay	
NumConsecUnpolledNodeId	
PreambleExtension	
PostTransGapExtension	
MaxInterChanSignalSkew	
TimeSyncClass	
Configured Link Settings	
SlotTime	
PerDlPduPhIOverhead	
MaxResponseDelay	
FirstUnpolledNodeId	

FIGURE 9-3. 5081-C/T-FF/FI Model 375 Menu Tree (10 of 10)

SECTION 10.0 DIAGNOSIS AND TROUBLESHOOTING

10.1 OVERVIEW

The Model 5081-T transmitters automatically monitor for fault conditions. The Diagnose Menu allows the current variable settings to be reviewed and shows fault messages indicating problems detected. Figure 10-1 illustrates the relationship between the Diagnose Menu and its sub-menus. The mnemonics are defined in Table 10-1.

10.1.1 TROUBLESHOOTING

- Step 1** Look for a diagnostic fault message on the display to help pinpoint the problem. Refer to Table 10-2 for an explanation of the message and a list of the possible problems that triggered it.
- Step 2** Refer to the Quick Troubleshooting Guide, Table 10-3, for common loop problems and the recommended actions to resolve them.

Step 3 Follow the step-by-step troubleshooting flow chart, offered in Figure 10-5, to diagnose less common or more complex problems.

10.1.2 DISPLAYING DIAGNOSTIC VALUES

The DIAG key on the IRC is used to access the Diagnosis Menu. The menu flow is shown in Figure 10-1 and the mnemonics are defined in Table 10-1.

The **FAuLts** sub-menu can be entered to show the last three faults/warnings. The most recent is displayed first; NEXT scrolls through the remaining faults. Pressing EXIT clears all fault/warnings and returns the **FAuLts** segment. Disconnecting the transmitter removes all fault messages from memory. The **nonE** message is displayed when no faults/warnings have occurred.

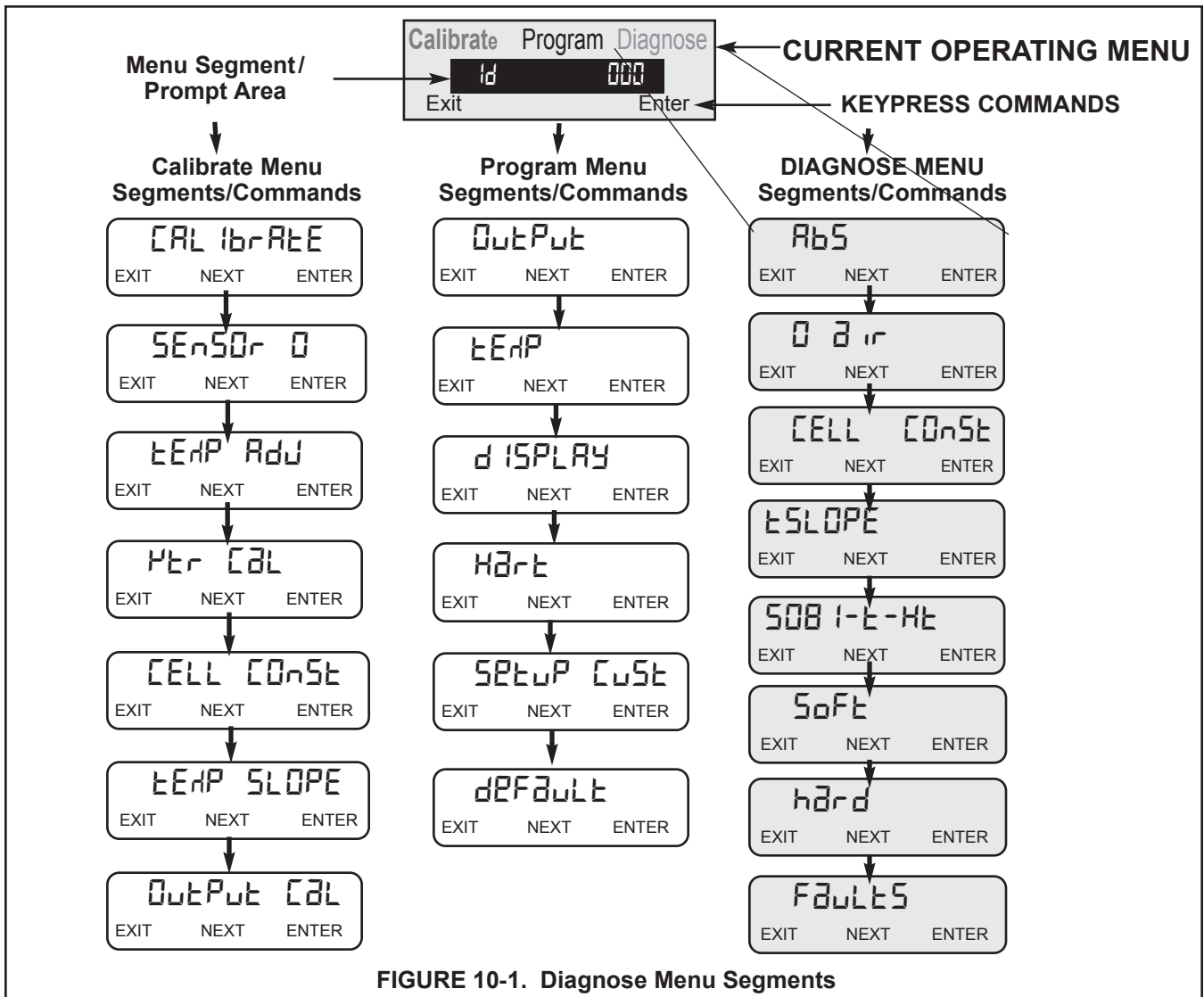

TABLE 10-1. Diagnostic Variables Mnemonics

AbS	Absolute conductivity ($\mu\text{S}/\text{cm}$ or mS/cm)
Q z ir	Sensor zero in air
CELL Const	Sensor cell constant
TSLOPE	Temperature slope in %/ °C
SOFT	Software version
Hard	Hardware version
FAULTS	Show fault messages
nonE	No fault messages in memory

10.2 FAULT CONDITIONS

Three classes of error conditions/problems are detected and differentiated between by the diagnostic program. System disabling problems are faults caused by failures in the loop or significant variations in the process. System non-disabling problems are warnings and deal with input or A to D conversion settings. The third class of detected problems are error messages and occur when the calibration limits are exceeded.

10.2.1 DISABLING FAULTS

1. Both FAULT and HOLD annunciation fields will become active (see Figure 10-3).
2. The process variable will flash at the rate of 1 second ON and 1 second OFF.
3. The appropriate fault message alternates with the normal Temperature/Current output display (see Figure 10-2).

4. The output current loop will be forced to the non-zero fault value entered in Step 3 of Section 7.2 or held at last value if fault value=0, if the transmitter is not in the TEST, HOLD, or Multidrop operational modes.
5. A 0-1 mA output signal is available for external use when system disability conditions are active. These conditions drive this output to 1 mA. Please contact factory for specific application information.

10.2.2 NON- DISABLING WARNINGS

When a **non-system-disabling** condition occurs, a warning message is displayed. The process variable does not flash. The appropriate message alternates with the Temperature/Current output display (see Figure 10-3).

If more than one fault exists, the display will sequence through each diagnostic message. This will continue until the cause of the fault has been corrected.

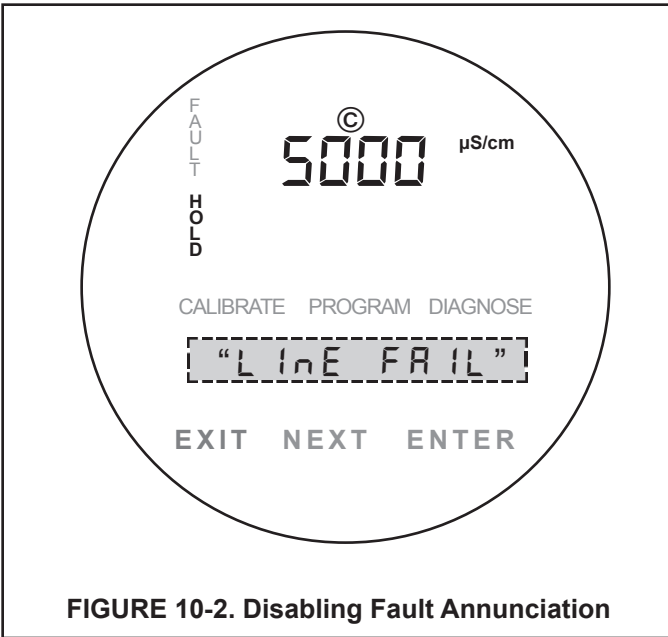

FIGURE 10-2. Disabling Fault Annunciation

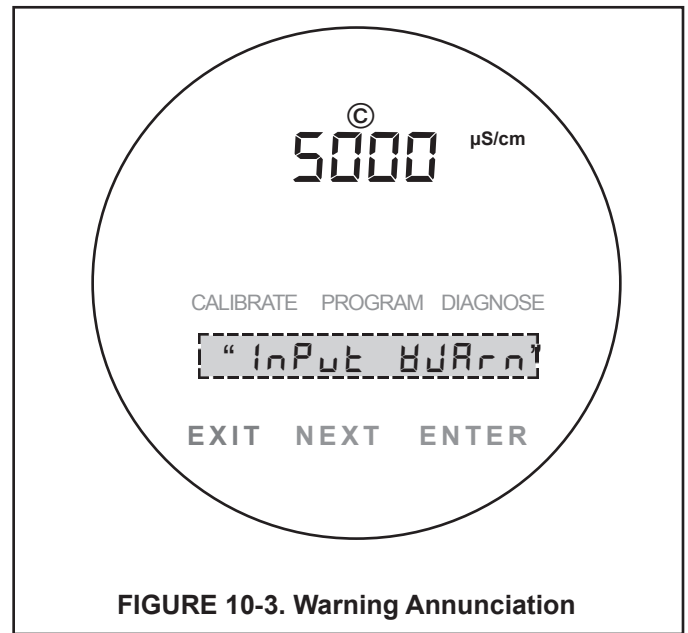

FIGURE 10-3. Warning Annunciation

10.3 DIAGNOSTIC MESSAGES

The Model 5081-T transmitter's diagnostics constantly monitor the conductivity loop for possible problems. If an operational problem is encountered, check the display for a fault or error message. These are displayed in the Temperature/Current output segment of the display. Note the message and refer to Table 10-2 for a description of possible problems that may have triggered the diagnostic message.

TABLE 10-2. Diagnostic Fault Messages.

Message	Description	Action
Faults		
TEMP LO	Temperature is too low.	Check wiring or sensor/process temp. Check RTD.
TEMP HI	Temperature is too high.	Check wiring or sensor/process temp. Check RTD.
RTD FAIL	The RTD sense line fault limits have been exceeded for the sensor.	Check wiring or Check Program/Temp menu setting to verify the 100-3 or 100-4 sensor type connected.
CPU FAIL	The CPU has failed during RAM or EEPROM verification.	Recycle. If persistent contact the factory.
FACIL FAIL	The transmitter has not been accurately factory calibrated.	Contact factory.
PROM FAIL	The PROM failed the check-sum test.	Contact factory.
CYCLE PWR	A wrong value was detected during power-up.	Recycle the power.
Warnings		
INPUT WARN	The compensated conductivity limit of 9999 ms/cm is exceeded.	Verify the conductivity range setting.
OVER RANGE	The current range setting has been exceeded.	Verify the 4 and 20 mA settings in the Program/output menu.
ADC Error	An analog to digital conversion error has occurred. (This may come up normally while readings are changing quickly)	Recycle the power.
Errors		
CAL Err or OFFSET Err	A calibration error has occurred between the standard and process.	Press RESET and repeat. Check calibration standards and unit configuration.
SLOPE Err	The limit for T-2 in a two point calibration has been exceeded.	Press RESET and repeat the calibrate/temp. slope menu setting.
0- Err	Sensor Zero limit has been exceeded	Press RESET and repeat the calibrate/sensor menu setting.
WRITE Err	An attempt to the write on the EEPROM has failed.	The jumper JP-1 on the CPU board has been removed.

10.4 QUICK TROUBLESHOOTING GUIDE

Table 10-3 identifies some of the more common symptoms and suggests actions to help resolve a problem. In general, wiring is the most common cause.

TABLE 10-3. Quick Troubleshooting Guide.

SYMPTOM	ACTION
Wrong temperature reading. Suspected temp. compensation problem.	Perform a temperature standardization. Verify sensor's RTD. Resistance vs. temp.; see Section 8.6 Temperature is out of range of sensor. Check wiring.
Display segments missing. Display inoperable.	Replace Display board.
Analyzer locks up; won't respond.	Replace PCB stack Press Reset. Check batteries in IRC.
Erratic displays.	Check sensors in process.
Transmitter won't respond to IRC key presses.	Verify and clean ribbon cable connection on CPU board. Check batteries in IRC.
Key press gives wrong selection.	Replace IRC. Check ribbon cable connection on CPU board.
Wrong or no current output.	Verify that output is not being overloaded; remove load; replace PCB stack.
No display or indicators.	Replace PCB stack.
"Excess Input"	Check sensor wiring.
"Reverse Input"	Perform sensor zero.
"Check sensor zero"	Analyzer will not zero. Place sensor in air and access zero routine.

10.4.1 FIELD TROUBLESHOOTING

When it is apparent by grab sample analysis that the transmitter is giving inaccurate readings, the following procedure should be followed.

- A. The sensor surfaces need to be totally wetted by the process and air bubbles must not be trapped in the vicinity of the electrodes. If air bubbles are found, the installation technique should be altered to eliminate this source of error.
- B. A quick visual inspection of the installation may identify the problem. Check to be sure that the transmitter is mounted securely and that its internal parts are properly connected. Next check all input and output wiring.
- C. If the previous two steps did not indicate the source of the problem, the next step is to isolate the problem to either the sensor or the transmitter.
- D. The first step in troubleshooting the sensor is to disconnect it from the transmitter, remove the sensor from the process and thoroughly dry the sensor electrodes. Refer to sensor manual for additional troubleshooting checks.
- E. To troubleshoot the transmitter independently of the sensor, use an appropriate resistor across the temperature input connectors and connect the conductivity inputs to resistance decade box. Refer to Figure 10-7 to reference the conductivity simulation values.

10.5 SYSTEMATIC TROUBLESHOOTING

If the Quick Troubleshooting Guide does not resolve the error, try the step-by-step approach offered in Figure 10-4.

Step 1 Follow the troubleshooting flow chart.

Step 2 Refer to the tests and instructions indicated by the flow chart to diagnose the problem.

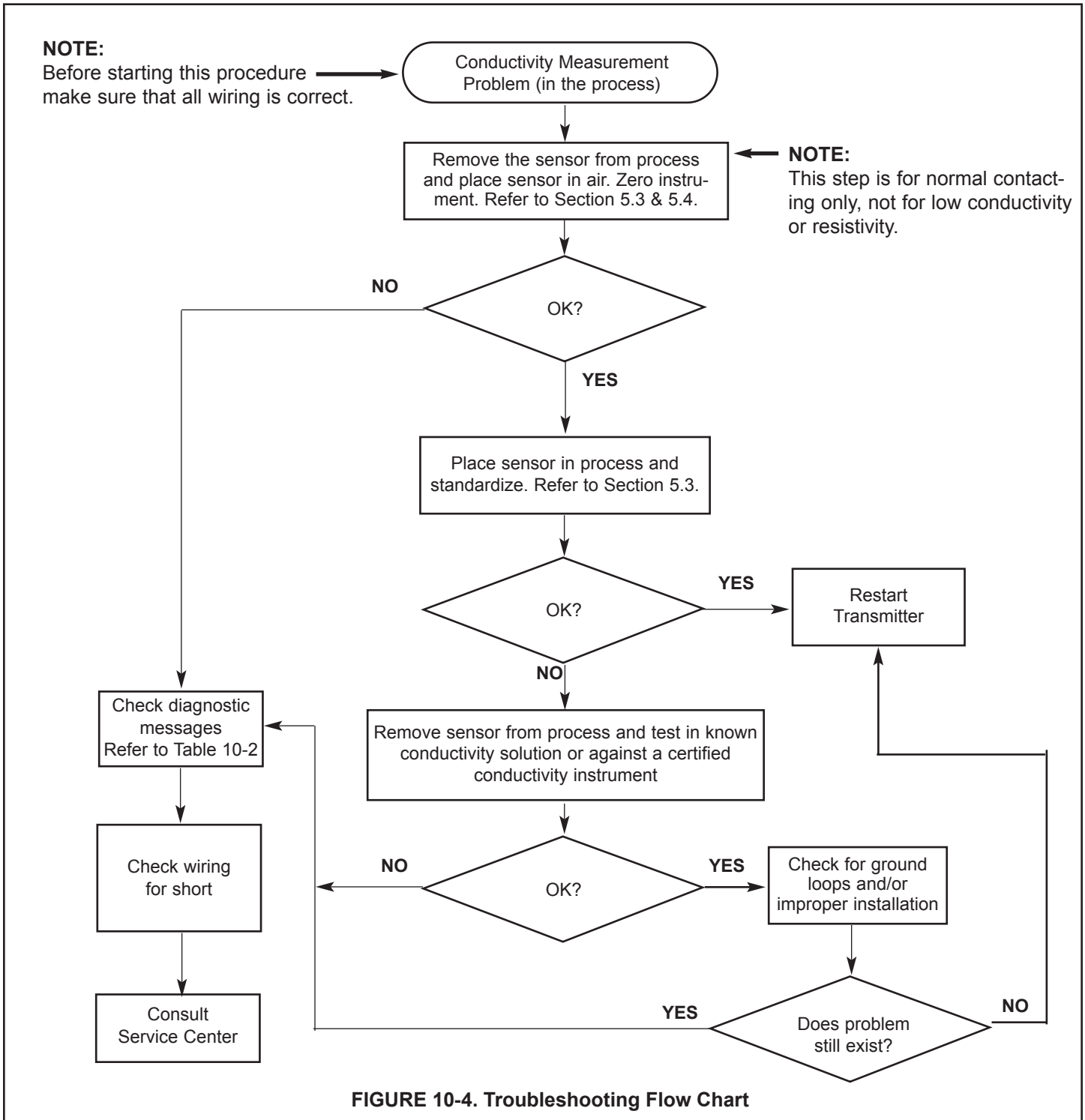

10.6 RTD RESISTANCE VALUES

Table 10-4 is a ready reference of RTD resistance values at various temperatures. These are used for test and evaluation of the sensor.

NOTE

Resistance values are read across the RTD element and are based on the manufacturer's stated values ($\pm 1\%$). Allow enough time for the RTD element in the sensor to stabilize to the surrounding temperature (10 min).

Table 10-4. RTD Resistance Values.

Temperature (°C)	Pt-100 Resistance (ohms)	Pt-1000 Resistance (ohms)
0	100.00	1000
10	103.90	1039
20	107.79	1078
25	109.62	1096
30	111.67	1117
40	115.54	1155
50	119.40	1194
60	123.24	1232
70	127.07	1271
80	130.89	1309
90	134.70	1347
100	138.50	1385

Use the following formula to determine the appropriate resistance value to use to simulate a conductivity value:

FORMULA:

$$\frac{\text{cell constant value} \times 1,000,000}{\text{desired simulated conductivity in } \mu\text{s/cm}} = \text{resistance in ohms}$$

EXAMPLE:

$$\frac{.01 \times 1,000,000}{10 \mu\text{s/cm}} = \text{use 1,000 ohm resistance}$$

FIGURE 10-5. Conductivity Determination

10.7 WARNING AND FAULT MESSAGES

The Model 5081-T transmitter continuously monitors the sensor and transmitter for conditions that cause erroneous measurements. When a problem occurs, the transmitter displays either a warning or fault message. A warning alerts the user that a potentially disabling condition exists. There is a high probability that the measurement is in error. A fault alerts the user that a disabling condition exists. If a fault message is showing, all measurements should be regarded as erroneous.

When a **WARNING** condition exists:

1. The main display reading remains stable; it does not flash.
2. A warning message appears alternately with the temperature and output readings in the second line of the display. See Section 10.3 for an explanation of the warning messages and suggested ways of correcting the problem.

When a **FAULT** exists:

1. The main display reading flashes.
2. The words **FAULT** and **HOLD** appear in the main display window.
3. A fault message appears alternately with the temperature and output readings in the second line of the display. See Section 10.3 for an explanation of the fault messages and suggested ways of correcting the problem.
4. The output current will remain at the present value or go to the programmed fault value. See Section 7.2 for details on how to program the current generated during a fault condition.
5. If the transmitter is in **HOLD** when the fault occurs, the output remains at the programmed hold value. To alert the user that a fault exists, the word **FAULT** appears in the main display, and the display flashes. A fault or diagnostic message also appears.
6. If the transmitter is simulating an output current when the fault occurs, the transmitter continues to generate the simulated current. To alert the user that a fault exists, the word **FAULT** appears in the display, and the display flashes.

10.8 TROUBLESHOOTING WHEN A FAULT OR WARNING MESSAGE IS SHOWING

Message	Explanation	See Section
OuEr rAnGE	Over range, measurement exceeds display limit	10.8.1
SEnSor FAIL	Bad sensor, sensor current is a large negative number	10.8.2
CAL Error	Calibration error, sensitivity (nA/ppm) is too high or too low	10.8.3
nEEd 0 CAL	Sensor needs re-zeroing, reading is too negative	10.8.4
rtd FAIL	Bad temperature reading	10.8.5
TEMP HI	Temperature reading exceeds 275°C when auto temp is selected	10.8.5
TEMP LO	Temperature reading is less than -25°C when auto temp is selected	10.8.5
SenSE OPEn	Sense line is not connected	10.8.6
OFFSEt Err	Zero offset during standardization exceeds programmed limit	10.8.7
FACT FAIL	Unit has not been factory-calibrated	10.8.8
CPU FAIL	Internal CPU tests have failed	10.8.9
ROM FAIL	Internal memory has failed	10.8.9
AdC Error	Analog to digital conversion failed	10.8.10

10.8.1 OuEr rAnGE and AMP FAIL.

These error messages appear if the sensor current is too high. Normally, excessive sensor current implies that the sensor is miswired or the sensor has failed.

1. Verify that wiring is correct and connections are tight. Be sure to check connections at the junction box if one is being used. See Section 3.0.
2. Replace the sensor membrane and electrolyte solution and clean the cathode if necessary. See the sensor instruction sheet for details.
3. Replace the sensor.

10.8.2 SEnSor FAIL.

Bad sensor means that the sensor current is a large negative number.

1. **SEnSor FAIL** may appear for a while when the sensor is first placed in service. Observe the sensor current (go to **SEnSor Cur** under the diagnostic menu). If the sensor current is moving in the positive direction, there is probably nothing wrong and the error message should soon disappear.
2. Verify that wiring is correct. Pay particular attention the anode and cathode connections.
3. Verify that the transmitter is configured for the correct measurement. Configuring the measurement sets (among other things) the polarizing voltage. Applying the wrong polarizing voltage to the sensor can cause a negative current.
4. Replace the sensor membrane and electrolyte solution and clean the cathode if necessary. See the sensor instruction sheet for details.
5. Replace the sensor.

10.8.3 CAL Error

At the end of the calibration step, the transmitter calculates the sensitivity in nA/ppm. If the sensitivity is outside the range normally expected, the transmitter displays the **CAL Error** message and the transmitter does not update the calibration. For assistance, refer to the troubleshooting section specific for the sensor.

10.8.4 nEEed 0 CAL

nEEed 0 CAL means that the concentration of the analyte is too negative.

1. Check the zero current (go to **0 CurrEnt** under the diagnostic menu). If the zero current is appreciably greater than the measurement current, the **nEEed 0 CAL** warning will appear.
2. Verify that the zero current is close to the value given in the calibration section for the analyte being determined.
3. Rezero the sensor. Refer to the calibration and troubleshooting sections for the sensor for more information.

10.8.5 rtd FAIL, TEMP HI, and TEMP LO

These messages usually mean that the RTD is open or shorted or there is an open or short in the connecting wiring.

1. Verify all wiring connections, including wiring in a junction box if one is being used.
2. Disconnect the RTD IN, RTD SENSE, and RTD RETURN leads or the thermistor leads at the transmitter. Be sure to note the color of the wire and where it was attached. Measure the resistance between the RTD IN and RETURN leads. For a thermistor, measure the resistance between the two leads. The resistance should be close to the value in the table in Section 10.6. If the temperature element is open or shorted, replace the sensor. In the meantime, use manual temperature compensation.

10.8.6 SenSE OPEn

Most Rosemount Analytical sensors use a Pt100 or Pt1000 in a three-wire configuration. The in and return leads connect the RTD to the measuring circuit in the analyzer. A third wire, called the sense line, is connected to the return lead. The sense line allows the analyzer to correct for the resistance of the in and return leads and to correct for changes in lead wire resistance with changes in ambient temperature.

1. Verify all wiring connections, including wiring in a junction box if one is being used.
2. Disconnect the RTD SENSE and RTD RETURN wires. Measure the resistance between the leads. It should be less than 5 Ω . If the sense line is open, replace the sensor as soon as possible.
3. The transmitter can be operated with the sense line open. The measurement will be less accurate because the transmitter can no longer compensate for lead wire resistance. However, if the sensor is to be used at approximately constant ambient temperature, the lead wire resistance error can be eliminated by calibrating the sensor at the measurement temperature. Errors caused by changes in ambient temperature cannot be eliminated. To make the error message disappear, connect the RTD SENSE and RETURN terminals with a jumper.

10.8.7 OFFSEt Err

The **OFFSEt Err** message appears if the zero offset (in mV) exceeds the programmed limit. Before increasing the limit to make the **OFFSEt Err** message disappear, check the following:

1. Verify that the reference meter is working properly and is properly calibrated.
2. Verify that the process sensor is working. Check its response in a solution of known conductivity.
3. If the transmitter is standardized against the conductivity determined in a grab sample, be sure to measure the conductivity before the temperature of the grab sample changes more than a few degrees.
4. Verify that the process sensor is fully immersed in the liquid. If the sensor is not completely submerged, it may not properly measure the conductivity of the process liquid.
5. Check the sensor for cleanliness. If the sensor looks fouled or dirty, clean it. Refer to the sensor instruction manual for cleaning procedures.

10.8.8 FACt FAIL

FACt FAIL means the unit has not been factory calibrated. Call the factory. The transmitter will probably need to be returned to the factory for calibration.

10.8.9 CPU FAIL and ROM FAIL

CPU FAIL means that the processing unit has failed internal tests. **ROM FAIL** means that the internal memory has failed.

1. Cycle the power. Leave the transmitter without power for at least 30 seconds before returning power to it.
2. If cycling the power fails to clear the error message, the CPU board probably needs replacing. Call the factory for assistance.

10.8.10 AdC Error

AdC Error means the analog to digital converter has failed.

1. Verify that sensor wiring is correct and connections are tight. Be sure to check connections at the junction box if one is being used. See Section 3.0.
2. Disconnect sensor(s) and simulate temperature and sensor input.
3. If the transmitter does not respond to simulated signals, the analog PCB has probably failed. Call the factory for assistance.

SECTION 11.0 MAINTENANCE

11.1 OVERVIEW

Maintenance consists of "Preventative" and "Corrective" measures.

11.2 PREVENTATIVE MAINTENANCE

11.2.1 Transmitter Maintenance. Transmitter maintenance consists of periodic calibration. A monthly calibration is a good starting maintenance schedule. This schedule can then be fine tuned to the site process.

11.2.2 Sensor Maintenance. Sensor maintenance consists of periodic cleaning of the electrode.

A weekly cleaning is a good starting maintenance schedule. This schedule can then be fine tuned to the site process.

11.2.3 Initiating HOLD Function For Maintenance. To place the transmitter into the Hold operational mode prior to servicing the sensor, press the **HOLD** key on the IRC (infrared remote control). The message field will respond with a message concerning the present hold condition. Press the IRC editing key to toggle to the **On** condition. Press ENTER to activate **HOLD** output.

Hold Mode will maintain the operating current output at the programmed value regardless of process changes. Refer to Section 7.2.3, step 4, for instructions on how to set this value.

Temperature/Current output segments change to indicate the current output level.

The section of the LCD reserved for hold annunciation (Refer to Figure 11-1) will display **HOLD** when the transmitter is in the Hold Mode.

To return transmitter to normal operation, press **HOLD** on the IRC again to access the hold toggling function.

Always calibrate after cleaning or replacing the sensor.

Press the IRC editing key to toggle to the **OFF** condition. Press ENTER to disengage the **HOLD** output function.

11.3 TRANSMITTER MAINTENANCE

Periodically clean the transmitter window with household ammonia or glass cleaner. The detector for the infrared remote controller is located behind the window at the top of the transmitter face. The window in front of the detector must be kept clean.

Most components of the transmitter are replaceable. Refer to Figure 11-2 and Table 11-1 on the following page for parts and part numbers.

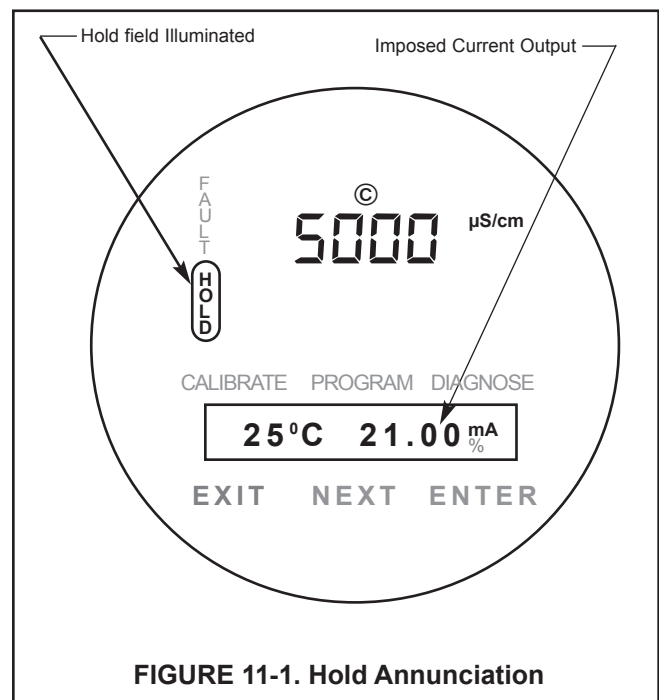

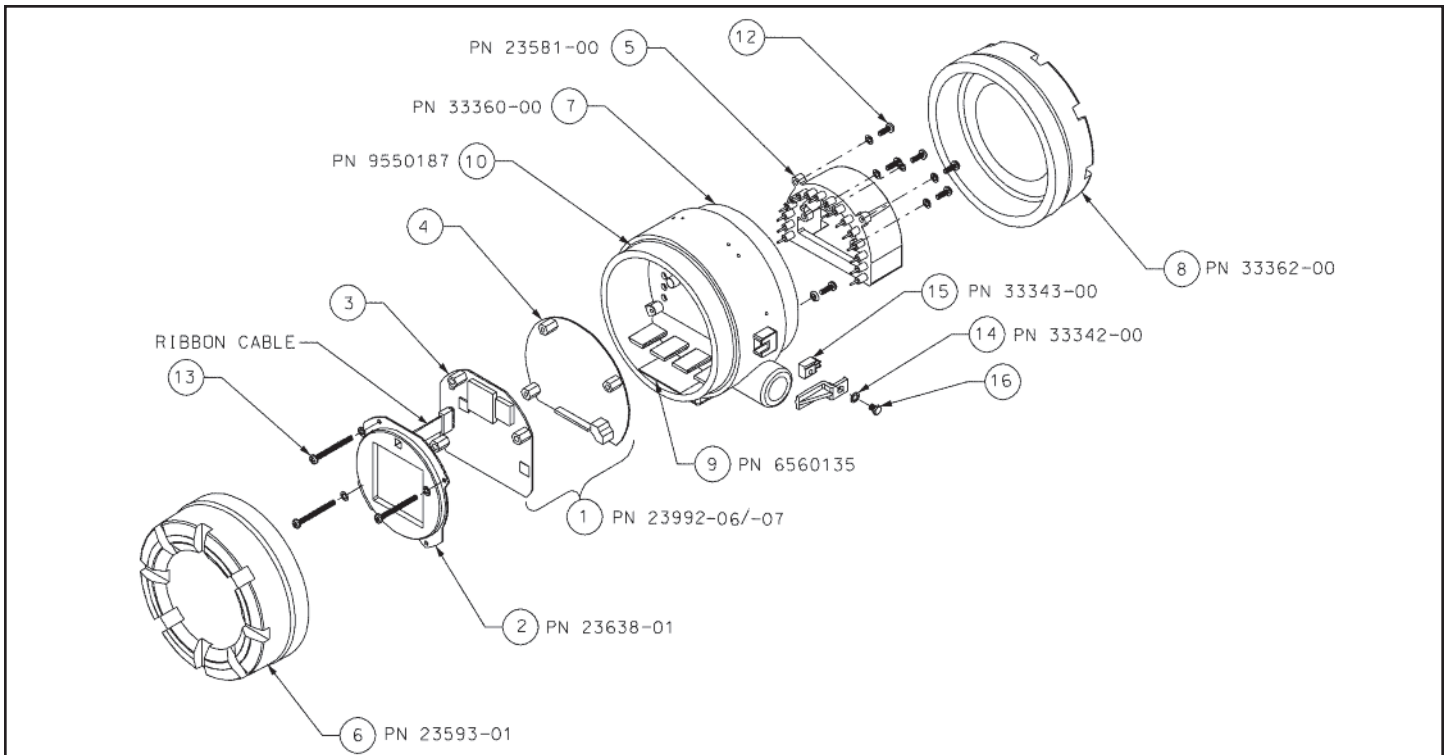

FIGURE 11-2. Exploded View of Model 5081-T Transmitter

Three screws (part 13 in the drawing) hold the three circuit boards in place. Removing the screws allows the display board (part 2) and the CPU board (part 3) to be easily removed. A ribbon cable connects the boards. The cable plugs into the CPU board and is permanently attached to the display board. A 16 pin and socket connector holds the CPU and analog (part 4) boards together. Five screws hold the terminal block (part 5) to the center housing (part 7), and the 16 pins on the terminal block mate with 16 sockets on the back side of the analog board. Use caution when separating the terminal block from the analog board. The pin and socket connection is tight.

TABLE 11-1. Replacement Parts for Model 5081-T Transmitter

Location in drawing	PN	Description	Shipping Weight
1	23992-06	PCB stack for 5081-T-HT consisting of the CPU (part 3) and analog (part 4) boards, display board is not included, CPU and analog boards are factory-calibrated as a unit and cannot be ordered separately	1 lb/0.5 kg
1	23992-07	PCB stack for 5081-T-FF consisting of the CPU (part 3) and analog (part 4) boards, display board is not included, CPU and analog boards are factory-calibrated as a unit and cannot be ordered separately	1 lb/0.5 kg
2	23652-01	LCD display PCB	1 lb/0.5 kg
5	33337-02	Terminal block	1 lb/0.5 kg
6	23593-01	Enclosure cover, front with glass window	3 lb/1.5 kg
7	33360-00	Enclosure, center housing	4 lb/1.5 kg
8	33362-00	Enclosure cover, rear	3 lb/1.0 kg
9	6560135	Desiccant in bag, one each	1 lb/0.5 kg
10	9550187	O-ring (2-252), one, front and rear covers each require an O-ring	1 lb/0.5 kg
12	note	Screw, 8-32 x 0.5 inch, for attaching terminal block to center housing	*
13	note	Screw, 8-32 x 1.75 inch, for attaching circuit board stack to center housing	*
14	33342-00	Cover lock	1 lb/0.5 kg
15	33343-00	Locking bracket nut	1 lb/0.5 kg
16	note	Screw, 10-24 x 0.38 inch, for attaching cover lock and locking bracket nut to center housing	*

NOTE: For information only. Screws cannot be purchased from Rosemount Analytical.
* Weights are rounded up to the nearest whole pound or 0.5 kg.

SECTION 12.0

THEORY OF OPERATION

12.1 OVERVIEW

This section is a general description of how the Model 5081-T Transmitter operates. This section is for those users who desire a greater understanding of the transmitter's operation.

12.2 CONDUCTIVITY

The conductivity sensor produces a "conductance signal" that is proportional to the conductivity of the process solution. The transmitter subtracts a baseline zero conductivity signal from the sensor signal and multiplies the result by the cell constant and the cell factor. This absolute conductivity is then corrected to the reference temperature (usually 25°C) using the process temperature measured by a RTD located in the conductivity sensor. In the "n SALT", "CAtion" and "rStvty" modes, the Model 5081-T automatically calculates the amount of correction needed.

In conductivity mode "LInEAR", the microprocessor also adjusts the amount of correction required for temperature compensation by means of a temperature slope adjustment. This slope may be adjusted between 0 to 5%/°C either manually via the Infrared Remote Control Keypad or automatically during bench or process calibration. This slope controls the amount of correction required in the temperature compensation circuit, and is specific to the process, giving you the most accurate conductivity reading possible.

12.3 HART COMMUNICATION

A MODAC (An application specific Integrated Circuit) is connected across the current loop to read and transmit the superimposed HART communications. The transmitter communicates via the HART protocol which uses an industry standard BELL 202 frequency shift keying (FSK) technique. This FSK signal is an AC signal, whose frequency is shifted higher or lower, depending upon the condition of the digital signal (High or Low). This communication conforms to the Rosemount HART® specification and is used to configure and interrogate the transmitter.

12.4 OUTPUT LOGIC

Normal transmitter operation specifies that the output tracks the process. However, the transmitter can be put into other modes of operation.

These modes are:

Fault Mode (in the event of a fault). Sets the transmitter output to the value set during configuration. (Between 3.80 and 22.00mA). This mode is over-ridden by the **HOLD** or **TEST** modes.

Hold Mode (manually placed in hold). Holds the output current to the value set during configuration. This value may be between 3.80 and 22.00 mA.

Hold mode supersedes the fault mode value. The current output measurement is "Frozen" while the transmitter is in the Hold Mode.

Test Mode (manually placed to test output). Can only be accessed through the Program menu, and is only active during the time the prompt is visible.

Output is set to the entered value and supersedes the Hold and Fault modes, if such exist.

Test mode also disables the normal timeout feature (2 minutes after the last keystroke is made) for 20 minutes.

Timeout. The display will normally timeout and default to the Main Display two (2) minutes after the last keystroke is made.

While the output is being tested, or if a 2-point calibration is being performed, the timeout is adjusted to 20 minutes.

If a custom curve is being programmed, no timeout will be applied.

SECTION 13.0 RETURN OF MATERIAL

13.1 GENERAL.

To expedite the repair and return of instruments, proper communication between the customer and the factory is important. Call 1-949-757-8500 for a Return Materials Authorization (RMA) number.

13.2 WARRANTY REPAIR.

The following is the procedure for returning instruments still under warranty:

1. Call Rosemount Analytical for authorization.
2. To verify warranty, supply the factory sales order number or the original purchase order number. In the case of individual parts or sub-assemblies, the serial number on the unit must be supplied.
3. Carefully package the materials and enclose your "Letter of Transmittal" (see Warranty). If possible, pack the materials in the same manner as they were received.
4. Send the package prepaid to:

Emerson Process Management
Rosemount Analytical
2400 Barranca Parkway
Irvine, CA 92606

Attn: Factory Repair

RMA No. _____

Mark the package: Returned for Repair

Model No. _____

13.1 NON-WARRANTY REPAIR.

The following is the procedure for returning for repair instruments that are no longer under warranty:

1. Call Rosemount Analytical for authorization.
2. Supply the purchase order number, and make sure to provide the name and telephone number of the individual to be contacted should additional information be needed.
3. Do Steps 3 and 4 of Section 13.2.

NOTE

Consult the factory for additional information regarding service or repair.

WARRANTY

Goods and part(s) (excluding consumables) manufactured by Seller are warranted to be free from defects in workmanship and material under normal use and service for a period of twelve (12) months from the date of shipment by Seller. Consumables, pH electrodes, membranes, liquid junctions, electrolyte, O-rings, etc. are warranted to be free from defects in workmanship and material under normal use and service for a period of ninety (90) days from date of shipment by Seller. Goods, part(s) and consumables proven by Seller to be defective in workmanship and / or material shall be replaced or repaired, free of charge, F.O.B. Seller's factory provided that the goods, parts(s), or consumables are returned to Seller's designated factory, transportation charges prepaid, within the twelve (12) month period of warranty in the case of goods and part(s), and in the case of consumables, within the ninety (90) day period of warranty. This warranty shall be in effect for replacement or repaired goods, part(s) and consumables for the remaining portion of the period of the twelve (12) month warranty in the case of goods and part(s) and the remaining portion of the ninety (90) day warranty in the case of consumables. A defect in goods, part(s) and consumables of the commercial unit shall not operate to condemn such commercial unit when such goods, parts(s) or consumables are capable of being renewed, repaired or replaced.

The Seller shall not be liable to the Buyer, or to any other person, for the loss or damage, directly or indirectly, arising from the use of the equipment or goods, from breach of any warranty or from any other cause. All other warranties, expressed or implied are hereby excluded.

IN CONSIDERATION OF THE STATED PURCHASE PRICE OF THE GOODS, SELLER GRANTS ONLY THE ABOVE STATED EXPRESS WARRANTY. NO OTHER WARRANTIES ARE GRANTED INCLUDING, BUT NOT LIMITED TO, EXPRESS AND IMPLIED WARRANTIES OF MERCHANTABILITY AND FITNESS FOR A PARTICULAR PURPOSE.

RETURN OF MATERIAL

Material returned for repair, whether in or out of warranty, should be shipped prepaid to:

**Emerson Process Management
Rosemount Analytical
2400 Barranca Parkway
Irvine, CA 92606**

The shipping container should be marked:

Return for Repair

Model _____

The returned material should be accompanied by a letter of transmittal which should include the following information (make a copy of the "Return of Materials Request" found on the last page of the Manual and provide the following thereon):

1. Location type of service, and length of time of service of the device.
2. Description of the faulty operation of the device and the circumstances of the failure.
3. Name and telephone number of the person to contact if there are questions about the returned material.
4. Statement as to whether warranty or non-warranty service is requested.
5. Complete shipping instructions for return of the material.

Adherence to these procedures will expedite handling of the returned material and will prevent unnecessary additional charges for inspection and testing to determine the problem with the device.

If the material is returned for out-of-warranty repairs, a purchase order for repairs should be enclosed.

EC Declaration of Conformity

We, Emerson Process Management, Blegistrasse 21, Barr, Switzerland CH 6341 declare under our sole responsibility that the product,

Model 5081-T-HT-60 Inductive Conductivity Transmitter, HART;
Model 5081-T-FF-60 Inductive Conductivity Transmitter, Fieldbus;
Model 5081-T-FI-60 Inductive Conductivity Transmitter, FISCO
manufactured by, Emerson Process Management, Rosemount Analytical

2400 Barranca Parkway, Irvine, California 92606 USA

to which this declaration relates, is in conformity with the provisions of the European Community directives, including the latest amendments, as listed below.

Assumption of conformity is based on the application of the harmonized standards.



(signature)

Andy Kemish
(name printed)

Vice President Analytical Europe
(function name printed)

October 1, 2012
(date of issue)

EMC Directive (2004/108/EC)

Model 5081-T-HT-60 Inductive Conductivity Transmitter, HART;
Model 5081-T-FF-60 Inductive Conductivity Transmitter, Fieldbus;
Model 5081-T-FI-60 Inductive Conductivity Transmitter, FISCO
Harmonized standard used: EN 61326-1: 2006

EC Declaration of Conformity

We, Emerson Process Management, Blegistrasse 21, Barr, Switzerland CH 6341 declare under our sole responsibility that the product,

Model 5081-T-HT-73 Inductive Conductivity Transmitter, HART;
Model 5081-T-FF-73 Inductive Conductivity Transmitter, Fieldbus;
Model 5081-T-FI-73 Inductive Conductivity Transmitter, FISCO

manufactured by, Emerson Process Management, Rosemount Analytical
2400 Barranca Parkway, Irvine, California 92606 USA

to which this declaration relates, is in conformity with the provisions of the European Community directives, including the latest amendments, as listed below.

Assumption of conformity is based on the application of the harmonized standards and, when applicable or required, a European Community notified body certification, as shown below.



(signature)

Andy Kemish
(name printed)

Vice President Analytical Europe
(function name printed)

October 2, 2012
(date of issue)

EMC Directive (2004/108/EC)

Model 5081-T-HT-73 Inductive Conductivity Transmitter, HART;
Model 5081-T-FF-73 Inductive Conductivity Transmitter, Fieldbus;
Model 5081-T-FI-73 Inductive Conductivity Transmitter, FISCO

Harmonized standard used: EN 61326-1: 2006

ATEX Directive (94/9/EC)

Provisions of the directive fulfilled by the equipment:

Equipment Group II, Category 1 G Ex ia IIC T4 Ga (-20°C ≤ Ta ≤ +65°C)

Model 5081-T-HT-73 Inductive Conductivity Transmitter, HART;
Model 5081-T-FF-73 Inductive Conductivity Transmitter, Fieldbus;
Model 5081-T-FI-73 Inductive Conductivity Transmitter, FISCO

Baseefa03ATEX0399X -- Intrinsically Safe Certificate

Harmonized standards used: EN 60079-0:2009 EN 60079-11:2007

Special condition for safe use:

The apparatus enclosure may contain light metals. The apparatus must be installed in such a manner as to minimize the risk of impact or friction with other metal surfaces.

ATEX Notified Body for EC Type Examination Certificate & Quality Assurance:

Baseefa [Notified Body Number: 1180], Rockhead Business Park, Staden Lane
Buxton, Derbyshire SK17 9RZ, United Kingdom

This page intentionally left blank.

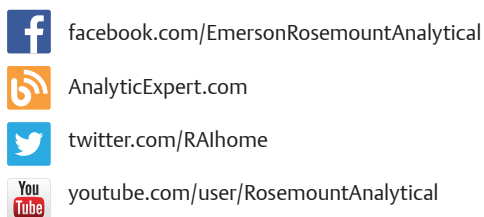

Credit Cards for U.S. Purchases Only.



Emerson Process Management

2400 Barranca Parkway
Irvine, CA 92606 USA
Tel: (949) 757-8500
Fax: (949) 474-7250
rosemountanalytical.com

© Rosemount Analytical Inc. 2015

©2015 Rosemount Analytical, Inc. All rights reserved.

The Emerson logo is a trademark and service mark of Emerson Electric Co. Brand name is a mark of one of the Emerson Process Management family of companies. All other marks are the property of their respective owners.

The contents of this publication are presented for information purposes only, and while effort has been made to ensure their accuracy, they are not to be construed as warranties or guarantees, express or implied, regarding the products or services described herein or their use or applicability. All sales are governed by our terms and conditions, which are available on request. We reserve the right to modify or improve the designs or specifications of our products at any time without notice.