



**Hewlett Packard**  
Enterprise

# **HPE Security ArcSight Data Platform Logger and ArcSight Logger**

Software Version: 6.3

Administrator's Guide

September 25, 2016

## Legal Notices

### Warranty

The only warranties for Hewlett Packard Enterprise products and services are set forth in the express warranty statements accompanying such products and services. Nothing herein should be construed as constituting an additional warranty. Hewlett Packard Enterprise shall not be liable for technical or editorial errors or omissions contained herein.

The information contained herein is subject to change without notice.

The network information used in the examples in this document (including IP addresses and hostnames) is for illustration purposes only.

HPE Security ArcSight products are highly flexible and function as you configure them. The accessibility, integrity, and confidentiality of your data is your responsibility. Implement a comprehensive security strategy and follow good security practices.

This document is confidential.

### Restricted Rights Legend

Confidential computer software. Valid license from Hewlett Packard Enterprise required for possession, use or copying. Consistent with FAR 12.211 and 12.212, Commercial Computer Software, Computer Software Documentation, and Technical Data for Commercial Items are licensed to the U.S. Government under vendor's standard commercial license.

### Copyright Notice

© Copyright 2016 Hewlett Packard Enterprise Development, LP

Follow this link to see a complete statement of copyrights and acknowledgements:

<https://www.protect724.hpe.com/docs/DOC-13026>

## Support

### Contact Information

<b>Phone</b>	A list of phone numbers is available on the HPE Security ArcSight Technical Support Page: <a href="https://softwaresupport.hpe.com/documents/10180/14684/esp-support-contact-list">https://softwaresupport.hpe.com/documents/10180/14684/esp-support-contact-list</a>
<b>Support Web Site</b>	<a href="https://softwaresupport.hpe.com">https://softwaresupport.hpe.com</a>
<b>Protect 724 Community</b>	<a href="https://www.protect724.hpe.com">https://www.protect724.hpe.com</a>

# Contents

- Chapter 1: Overview ..... 22
  - Introduction ..... 22
  - Logger Features ..... 23
    - Storage Configuration ..... 24
    - Receiver Configuration ..... 24
    - Analyzing Events ..... 25
    - Grouping Events ..... 26
    - Exporting Events ..... 26
    - Forwarder Configuration ..... 27
    - User Management ..... 27
    - Other Setup and Maintenance ..... 28
  - Deployment Scenarios ..... 28
    - Setting up Search Heads for Faster Peer Searches ..... 30
  - Centralized Management ..... 31
  - Running Logger on Encrypted Appliances ..... 31
  
- Chapter 2: User Interface and Dashboards ..... 32
  - Connecting to Logger ..... 32
  - Navigating the User Interface ..... 34
    - Menus, Take Me To, and Bar Gauges ..... 34
      - Take Me To Navigation Box ..... 34
      - Bar Gauges ..... 35
    - Server Clock, Current User, and Options Dropdown ..... 35
    - Logger Options ..... 36
      - Customizing the Maximum EPS ..... 37
      - Customizing the Logo ..... 37
      - Customizing the Start Page ..... 37
  - Summary ..... 38
    - Summary Dashboard Panels ..... 40
    - The Effect of Search Group Filters on the Summary Page ..... 40
    - Help, About, and Logout ..... 41
  - Dashboards ..... 41
    - Out-of-Box Dashboards ..... 42
      - The Monitor Dashboard ..... 43

Monitor Dashboard Summary Panel .....	44
Monitor Dashboard Receivers Panel .....	45
Monitor Dashboard Platform Panel .....	46
Monitor Dashboard Network Panel .....	47
Monitor Dashboard Logger Panel .....	48
Monitor Dashboard Forwarders Panel .....	49
Monitor Dashboard Storage Panel .....	49
The System Overview Dashboard .....	50
The Intrusion and Configuration Events Dashboard .....	52
Chart Drill-Down .....	53
The Login and Connection Activity Dashboard .....	53
Chart Drill-Down .....	54
The Event Count Dashboard .....	55
Chart Drill-Down .....	56
Custom Dashboards .....	56
Chart Drill-Down .....	58
Creating and Managing Custom Dashboards .....	58
Adding a Custom Dashboard .....	59
Editing a Custom Dashboard .....	59
Deleting a Custom Dashboard .....	60
Adding and Managing Panels in a Dashboard .....	60
Adding a Panel to a Dashboard .....	60
Editing a Dashboard Panel .....	62
Deleting a Dashboard Panel .....	63
Changing the Layout of a Dashboard .....	63
Setting a Default Dashboard .....	63
Chapter 3: Searching and Analyzing Events .....	65
The Process of Searching Events .....	65
Understanding Search Field Colors .....	68
Elements of a Search Query .....	69
Query Expressions .....	69
Indexed Search Portion of a Query .....	70
Keyword Search (Full-text Search) .....	70
Field-Based Search .....	71
Field-Based Search Expression Guidelines .....	74
Search Operator Portion of a Query .....	76
Time Range .....	76
Time Stamps in Logger .....	78

Fieldsets .....	79
Predefined Fieldsets .....	79
The User Defined Fields Field-Set .....	80
The Raw Event Field-Set .....	80
Custom Fieldsets .....	80
Constraints .....	84
Syntax Reference for Query Expressions .....	85
Using the Advanced Search Builder .....	90
Accessing the Advanced Search Builder .....	90
Nested Conditions .....	93
Alternate Views for Query Building in Search Builder .....	94
Search Analyzer .....	94
Performance Optimizations for Indexed Fields in Queries .....	95
Regex Helper Tool .....	96
Search Helper .....	98
Autocomplete Search .....	98
Opening Filters and Saved Searches via Autocomplete .....	100
Search History and Search Operator History .....	101
Examples, Usage, Suggested Next Operators, and Help .....	102
Searching for Events .....	102
Running a Search .....	103
Things You Should Know About Logger Searches .....	106
Searching Peers (Distributed Search) .....	107
Tuning Search Performance .....	108
Searching for Rare Field Values .....	109
Using Super-Indexed Fields to Increase Search Speed .....	109
The Search Results Display .....	112
Adjusting the Displayed Search Results .....	113
Canceling a Search in Progress .....	114
The Histogram .....	114
Displaying the Histogram .....	115
Mouse-Over .....	115
Histogram Drill Down .....	115
The Search Results Table .....	116
Additional Fields in the Search Results .....	116
User-Defined Fields .....	116
System-Defined Fields .....	117
Refining a Search from the Search Results Table .....	117
Viewing Raw Events .....	118

Changing the Displayed Search Results Using Field Sets .....	118
Multi-line Data Display .....	119
Auto Refresh Search Results .....	119
Chart Drill Down .....	120
The Field Summary Panel .....	121
Displaying the Field Summary Panel .....	122
Selected Fields List .....	122
Field Summary Drill Down .....	123
Discovering Fields in Raw Event Data .....	123
Refining and Charting a Search from Field Summary .....	124
Saving the Search Results .....	125
Example of a Quick Report in PDF Format (Search Results Export) .....	126
Exporting Search Results .....	126
Scheduling an Export Operation .....	129
Saving Queries (Creating Saved Searches and Saved Filters) .....	129
System Filters/Predefined Filters .....	131
Searching with Saved Queries .....	135
Scheduling Date and Time Options .....	136
Enriching Logger Data Through Static Correlation .....	138
Indexing .....	138
Full-Text Indexing (Keyword Indexing) .....	139
Field-Based Indexing .....	139
Superindexing .....	141
Viewing Alerts .....	141
Live Event Viewer .....	142
Chapter 4: Reporting .....	147
The Reports Home Page .....	147
Getting Started .....	149
The Reports Quick Access Menu .....	150
The Explorers .....	150
The Explorer Actions Menus .....	151
Category Explorer .....	153
Report Explorer .....	154
Query Explorer .....	155
Parameter Explorer .....	155
Favorites Explorer .....	156
Categories .....	157

System-defined Categories .....	157
Dashboards .....	161
Viewing Dashboards .....	162
Working with Available Dashboards .....	162
Designing Dashboards .....	163
What Items Can a Dashboard Include? .....	163
Creating a New Dashboard .....	163
Viewing Dashboards in the Dashboard Viewer .....	164
Removing an Existing Tab from the Dashboard Viewer .....	164
Deleting a Dashboard .....	165
Editing an Existing Dashboard .....	165
Selecting a Default Dashboard View for the Reports Home Page .....	165
Using Classic Dashboards .....	166
Viewing a Classic Dashboard .....	166
Designing Classic Dashboards .....	167
What Items Can a Classic Dashboard Include? .....	167
Creating a New Classic Dashboard .....	167
Placing Items on an Existing Dashboard .....	167
Dashboard Properties .....	168
Placing Dashboard Items on the Layout .....	168
Placing a Report on a Dashboard .....	168
Linking Widgets .....	170
Placing a Use Case on a Dashboard .....	171
Widget Properties for Use Cases .....	171
Placing an External Link on a Dashboard .....	172
Selecting a Dashboard View .....	172
Creating Widgets .....	173
Swapping Items on Widgets .....	174
Setting Classic Preferences .....	174
Widgets .....	175
The Widget Designer .....	175
Creating a New Widget .....	175
Deleting a Widget .....	178
Editing an Existing Widget .....	178
Placing Widgets in a Dashboard .....	178
Moving an Existing Widget within a Dashboard .....	178
Running, Viewing, and Publishing Reports .....	179
Best Practices .....	179
Finding Reports .....	179
Viewing Recently Run Reports .....	180

Task Options on Available Reports .....	180
Running and Viewing Reports .....	181
About the Pagination of Reports .....	181
About Running a Report .....	181
Running a Report Manually .....	182
Quick Run with Default Options or Run In Background Report Parameters .....	182
Selecting Device Groups, Storage Groups, Devices, or Peers .....	184
Run Report Parameters .....	185
Report File Formats .....	187
Publishing Reports .....	187
Add Report Job Settings .....	189
Report Delivery Options .....	189
Emailing a Report .....	190
Exporting and Saving a Report .....	191
Viewing the Output of a Published Report .....	191
Deleting Published Reports .....	191
Scheduled Reports .....	192
Viewing and Editing Scheduled Reports .....	192
Jobs Execution Status .....	193
Scheduling a Report .....	195
Designing Reports .....	196
Opening the Report Designer .....	197
Creating New Reports .....	198
Quick Start: Base a New Report on an Existing One .....	198
Designing New Reports (The Ad hoc Report Designer) .....	200
Toolbar Buttons .....	201
Report Components .....	201
Data Source .....	202
Creating a New Report .....	202
Fields .....	203
Filter .....	204
Group .....	206
Totals .....	207
Sort .....	208
Highlight .....	209
Matrix .....	209
Chart .....	211
Assigning Fields .....	212
Map .....	213
Adding a Map to a Report .....	214



Editing a Report .....	216
Private Reports .....	217
Running a Report While Designing It .....	217
Setting Access Rights on Reports .....	218
Determining What Access Rights to Give .....	218
Example: Giving a User Group Access Rights for a Report .....	218
Queries .....	219
How Search and Report Queries Differ .....	220
Overview of Query Design Elements .....	221
Creating a Copy of an Existing Query .....	221
Designing a New Query .....	222
Working with Steps .....	223
The Query Design Process .....	224
Steps .....	226
Data Source Step .....	227
Join Step .....	229
Union Step .....	230
Filter Step .....	230
Sort Step .....	230
Formula Fields Step .....	231
Dynamic Fields Step .....	231
External Task Step .....	232
Format Step .....	232
Parameters .....	233
Parameter Object Editor .....	234
Creating New Parameters .....	235
Setting Parameter Name, Data Type, and Default Values .....	235
Default Value for Date Type Parameter .....	236
Defining Input Type .....	237
Setting up Boolean Parameters .....	237
Setting Various Run Time Behaviors .....	237
Setting the Data Source List .....	238
Setting Multiple Default Values .....	239
Modifying a Parameter .....	239
Deleting a Parameter .....	239
Configuring Parameter Value Groups .....	240
Template Styles .....	242
Defining a New Template .....	243
Administration .....	243
Deploying a Report Bundle .....	243

Report Server Administration .....	245
Timeouts when Running Reports .....	245
Report Configuration .....	245
Report Categories .....	248
Adding a New Category .....	248
Deleting an Existing Category .....	250
Report Category Filters .....	250
Placing a System-defined Query or Parameter into a Category .....	251
Backup and Restore of Report Content .....	252
iPackager Utility .....	252
How iPackager Works .....	252
The iPackager Page .....	253
Actions Available from the iPackager .....	254
Selecting Entities .....	254
Adding Entity Objects to a Configuration File .....	255
Modifying Entity Object Properties .....	255
Opening an iPackager Configuration File .....	257
Deleting Entity Objects from a Configuration File .....	257
Deleting an iPackager Configuration File .....	257
Building the CAB File .....	257
Deploying a Repository (CAB) File .....	258
Chapter 5: Configuration .....	259
Search .....	260
Filters .....	260
Search Group Filters .....	263
Saved Searches .....	264
Scheduled Searches/Alerts .....	265
Adding a Scheduled Search or Scheduled Alert .....	267
Saved Search Alerts .....	271
Creating Saved Search Alerts (Scheduled Alerts) .....	272
Saved Search Files .....	274
Search Indexes .....	275
Guidelines for Field-Based Indexing .....	276
Search Options .....	277
Managing Fieldsets .....	281
Default Fields .....	281
Custom Fields .....	283
Running Searches .....	283
Lookup Files .....	284

Creating Lookup Files .....	285
Naming Lookup Files .....	285
Naming Fields in the Lookup File .....	285
Duplicate Values in the Lookup File .....	285
Lookup Capacity .....	286
Uploading Lookup Files .....	287
Managing Uploaded Lookup Files .....	288
Data .....	291
Devices .....	291
Device Groups .....	293
Receivers .....	294
Event Broker Receivers .....	295
File Based Receivers .....	296
Multi-line Receivers .....	296
Folder Follower Receivers .....	297
Using Source Types with File Follower Receivers .....	297
Working with Receivers .....	298
UDP, TCP, CEF UDP, and CEF TCP Receiver Parameters .....	301
Event Broker Receiver Parameters .....	302
File Receiver Parameters .....	303
Folder Follower Receiver Parameters .....	305
File Transfer Receiver Parameters .....	307
SmartMessage Receiver Parameters .....	309
Date and Time Specification .....	310
Source Types .....	311
Working with Source Types .....	312
Parsers .....	315
Using Parsers with Source Types .....	316
Using the Parse Command .....	316
Working with Parsers .....	317
Example: Creating an Extract Parser .....	319
Forwarders .....	321
Real Time Alerts .....	328
Creating Real Time Alerts .....	330
Logger Alert Types .....	332
Alert Triggers and Notifications .....	334
When are Alert events triggered? .....	334
Receiving Alert Notifications .....	334
Sending Notifications to E-mail Destinations .....	335
Setting Up Alert Notifications .....	336

Sending Notifications to Syslog and SNMP Destinations .....	336
SNMP Destinations .....	337
Syslog Destinations .....	337
Sending Notifications to ESM Destinations .....	338
ESM Destinations .....	339
Certificates .....	342
Forwarding Log File Events to ESM .....	343
Data Validation .....	344
Storage .....	347
Storage Groups .....	347
Storage Rules .....	349
Storage Volume .....	350
Event Archives .....	351
Guidelines for Archiving Events .....	353
Archiving Events .....	354
Daily Archive Settings .....	356
Archive Storage Settings .....	357
Loading and Unloading Archives .....	358
Indexing Archived Events .....	359
Scheduled Tasks .....	359
Scheduled Tasks .....	360
Currently Running Tasks .....	361
Finished Tasks .....	361
Filtering the Task List .....	362
Advanced Configuration .....	363
Retrieve Logs .....	364
Maintenance Operations .....	365
Required Permissions for Maintenance Mode .....	366
Entering and Exiting Maintenance Mode .....	367
Defragmenting the Logger Database .....	368
Defragmenting a Logger .....	369
Freeing Defragmentation Storage Space .....	371
Defragmenting Global Summary Persistence .....	372
Storage Volume Size Increase .....	374
About Increasing Storage Volume Size on a SAN Logger .....	374
Adding Storage Groups .....	375
Adding Fields to the Schema .....	377
Importing Schema Fields from Peers .....	379
Maintenance Results .....	383
Configuration Backup and Restore .....	383

Running a Configuration Backup .....	384
Scheduling Reoccurring Backups .....	386
Restoring from a Configuration Backup .....	387
Content Management .....	387
User Rights for Importing Content .....	388
Importing Content .....	389
User Rights for Exporting Content .....	389
Exporting Content .....	390
License Information .....	392
Trial Licenses .....	393
Data Volume .....	394
Daily Data Limit for Newly Upgraded Software Loggers .....	395
Standalone Logger Data Volume Page .....	395
ADP Logger Data Volume Page .....	396
Peer Nodes .....	397
Overview Steps for Configuring Peers .....	397
Guidelines for Configuring Peers .....	398
Authenticating Peers .....	399
Selecting a Peer Authentication Method .....	399
Authorizing a Peer .....	399
Adding and Deleting Peer Relationships .....	400
Adding a Peer .....	400
Deleting a Peer .....	403
Chapter 6: System Admin .....	404
System .....	404
System Locale .....	405
System Reboot .....	405
Network .....	406
System DNS .....	406
Hosts .....	407
NICs .....	407
Static Routes .....	409
Time/NTP .....	410
Impact of Daylight Savings Time Change on Logger Operations .....	412
SMTP .....	413
License & Update .....	413
Updating Your Logger License .....	414
Upgrading a Logger Appliance .....	414
Process Status .....	415

System Settings .....	415
SNMP .....	416
SNMP Metrics Supported .....	416
Configuration on the Logger Appliance .....	417
Configuration on the NMS .....	418
SSH Access to the Appliance .....	419
Logs .....	420
Audit Logs .....	420
Audit Forwarding .....	420
Storage .....	421
Remote File Systems .....	421
Managing a Remote File System .....	422
SAN .....	424
Managing a LUN .....	424
Restoring a SAN .....	426
Creating Multiple Paths to a LUN .....	427
Restoring Multipath on RMA or Factory Reset Loggers .....	429
RAID Controller/Hard Disk SMART Data .....	430
Security .....	430
SSL Server Certificate .....	430
Generating a Self-Signed Certificate .....	431
Generating a Certificate Signing Request (CSR) .....	432
Importing a Certificate .....	434
Enabling HTTP Strict Transport Security .....	434
SSL Client Authentication .....	435
Configuring Logger to Support SSL Client Authentication .....	436
Uploading Trusted Certificates .....	437
Uploading a Certificate Revocation List .....	437
FIPS 140-2 .....	438
FIPS Compliance .....	438
Enabling and Disabling FIPS Mode on Logger .....	439
Installing or Updating a SmartConnector to be FIPS-Compliant .....	440
Users/Groups .....	442
Authentication .....	442
Sessions .....	442
Local Password .....	443
Users Exempted From Password Expiration .....	445
Forgot Password .....	446
External Authentication .....	447
Local Password Authentication .....	448

Client Certificate Authentication .....	448
Client Certificate and Local Password Authentication .....	449
LDAP/AD and LDAPS Authentication .....	450
RADIUS Authentication .....	452
Local Password Fallback .....	453
Login Banner .....	454
User Management .....	454
Creating and Activating Users .....	455
Adding a User .....	455
Editing and Deleting Users .....	457
Activating Users .....	457
Setting Logger User Permissions .....	458
Reset a User's Password .....	458
Change My Password .....	459
User Groups .....	459
Managing User Groups .....	460
Creating a New User Group .....	460
Editing and Deleting User Groups .....	461
Other System Administration Information .....	462
Monitoring System Health .....	462
System Health Events .....	463
Using the Appliance Command Line Interface .....	465
Software Logger Command Line Options .....	468
Firewall Rules .....	469
Configuring the Firewall on Logger Appliance .....	470
Appendix A: Search Operators .....	471
cef (Deprecated) .....	471
chart .....	472
dedup .....	476
eval .....	477
extract .....	483
fields .....	485
head .....	486
keys .....	486
lookup .....	487
parse .....	492

rare .....	493
regex .....	494
rename .....	494
replace .....	495
rex .....	497
sort .....	500
tail .....	501
top .....	501
transaction .....	502
where .....	504
Appendix B: Using SmartConnectors to Collect Events .....	506
SmartMessage .....	506
Configuring a SmartConnector to Send Events to Logger .....	507
Configuring SmartConnectors to Send Events to Both Logger and an ArcSight Manager .....	507
Configuring SmartConnectors for Failover Destinations .....	508
Sending Events from ArcSight ESM to Logger .....	509
Appendix C: Using the Rex Operator .....	511
Syntax of the rex Operator .....	511
Understanding the rex Operator Syntax .....	511
Ways to Create a rex Expression .....	513
Creating a rex Expression Manually .....	513
Example rex Expressions .....	514
Appendix D: Logger Audit Events .....	517
Types of Audit Events .....	517
Information in an Audit Event .....	517
Platform Events .....	518
Application Events .....	525
Appendix E: Examples of System Health Events .....	544
Appendix F: Event Field Name Mappings .....	549



Appendix G: Logger Content .....	555
Reports .....	555
Device Monitoring .....	556
Anti-Virus .....	556
CrossDevice .....	557
Database .....	560
Firewall .....	560
IDS-IPS .....	561
Identity Management .....	562
Network .....	562
Operating System .....	563
VPN .....	564
Foundation .....	564
Configuration Monitoring .....	564
Intrusion Monitoring .....	566
Attackers .....	569
Resource Access .....	570
Targets .....	571
User Tracking .....	573
NetFlow Monitoring .....	574
Network Monitoring .....	574
Logger Administration .....	575
SANS Top 5 .....	576
1 - Attempts to Gain Access through Existing Accounts .....	576
2 - Failed File or Resource Access Attempts .....	576
3 - Unauthorized Changes to Users Groups and Services .....	577
4 - Systems Most Vulnerable to Attack .....	578
5 - Suspicious or Unauthorized Network Traffic Patterns .....	579
Parameters .....	581
IPAddress .....	581
categoryObjectParameter .....	582
commonlyBlockedPorts .....	582
destinationAddress .....	582
destinationPort .....	583
deviceGroupParameter .....	583
deviceProduct .....	583
deviceSeverityParameter .....	583
deviceVendor .....	584
dmBandwidthParameter .....	584
dmConfigurationParameter .....	584

dmLoginParameter .....	584
eventNameParameter .....	585
resourceTypeParameter .....	585
webPorts .....	585
zoneParameter .....	585
zones .....	586
System Filters .....	586
Queries .....	592
Access Events by Resource .....	592
Accounts Created By User Account .....	592
Accounts Deleted by Host .....	592
Accounts Deleted by User Account .....	593
Alert Counts by Device .....	593
Alert Counts by Port .....	593
Alert Counts by Severity .....	593
Alert Counts by Type .....	593
Alert Counts per Hour .....	593
Alerts from IDS .....	593
Anti-Virus Errors .....	593
Anti-Virus Updates-All-Failed .....	593
Anti-Virus Updates-All-Summary .....	594
Asset Startup and Shutdown Event Log .....	594
Attack Events By Destination .....	594
Authentication Errors .....	594
Bandwidth Usage by Hour .....	594
Bandwidth Usage by Protocol .....	594
Bottom Destinations .....	594
Bottom Sources .....	594
Bottom Targets .....	594
By User Account - Accounts Created .....	595
Common Account Login Failures by Source .....	595
Configuration Changes by Type .....	595
Configuration Changes by User .....	595
Connection Counts by User .....	595
Connections Accepted by Address .....	595
Connections Denied by Address .....	595
Connections Denied by Hour .....	595
Daily Bandwidth Usage .....	595
Daily Byte Count .....	596
Database Errors and Warnings .....	596

Denied Connections by Address .....	596
Denied Connections by Port .....	596
Denied Connections per Hour .....	596
Destination Counts by Device Severity .....	596
Destination Counts by Event Name .....	596
Device Configuration Changes .....	596
Device Configuration Events .....	596
Device Misconfigurations .....	597
Failed Anti-Virus Updates .....	597
Failed Login Attempts .....	597
Failed Logins by Destination Address .....	597
Failed Logins by Source Address .....	597
Failed Logins by User .....	597
Failed Res Access Events .....	597
Failed Resource Access .....	597
Firewall Traffic by Service .....	597
Hourly Bandwidth Usage .....	598
IDS Signature Destinations .....	598
IDS Signature Sources .....	598
Infected Systems .....	598
Least Common Accessed Ports .....	598
Least Common Events .....	598
Login Errors by User .....	598
Login Event Audit .....	598
Most Common Events .....	598
Most Common Events by Severity .....	599
Network-Device Critical Events .....	599
Network-Device Errors .....	599
Network-Device Events .....	599
Network-Device Interface Down Notifications .....	599
Network-Device Interface Status Messages .....	599
Network-Device SNMP Authentication Failures .....	599
Network-Top Device System Authentication Events .....	599
Number of Failed Logins .....	599
Password Change .....	600
Password Changes .....	600
Probes on Blocked Ports by Source .....	600
Resource Access by Users - Failures .....	600
Resource Access by Users - Success-Attempt .....	600
Source Counts By Destination .....	600
Source Counts by Destination Port .....	600

Source Counts by Device .....	600
Source Counts by Device Severity .....	600
Source Counts by Source Port .....	601
Source Port Counts .....	601
Successful Logins by Destination Address .....	601
Successful Logins by Source Address .....	601
Successful Logins by User .....	601
Target Attack Counts by Severity .....	601
Target Counts by Device Severity .....	601
Target Counts by Event Name .....	601
Target Counts by Source .....	601
Target Counts by Source Port .....	602
Target Counts by Target Port .....	602
Target Port Counts .....	602
Top 10 Talkers .....	602
Top 10 Types of Traffic .....	602
Top Alerts .....	602
Top Attack Sources .....	602
Top Attacker Details .....	602
Top Attacker Ports .....	602
Top Attackers .....	603
Top Bandwidth Hosts .....	603
Top Bandwidth Usage by Destination .....	603
Top Bandwidth Usage by Destination Port .....	603
Top Bandwidth Usage by Source .....	603
Top Destination IPs .....	603
Top Destination Ports .....	603
Top Destinations Across Firewalls .....	603
Top Destinations in IDS Events .....	603
Top Hosts by Number of Connections .....	604
Top IDS Attack Events .....	604
Top IDS Events .....	604
Top IDS and IPS Alerts .....	604
Top Machines Accessing the Web .....	604
Top Machines Traversing Firewall .....	604
Top Sources Detected by Snort .....	604
Top Sources Traversing Firewalls .....	604
Top Target IPs .....	604
Top Targets .....	605
Top User Logins .....	605
Top Users with Failed Logins .....	605

Top VPN Accesses by User .....	605
Top VPN Event Destinations .....	605
Top VPN Event Sources .....	605
Top VPN Events .....	605
Top Web Traffic .....	605
Update Summary .....	605
User Account Creations .....	606
User Account Deletions .....	606
User Account Modifications .....	606
User Activity .....	606
User Administration .....	606
User Password Changes .....	606
Users by Connection Count .....	606
VPN Connection Attempts .....	606
VPN Connection Failures .....	606
Virus Activity by Hour .....	607
Vulnerability Scanner Logs .....	607
Vulnerability Scanner Logs by Host .....	607
Vulnerability Scanner Logs by Vulnerability .....	607
Windows Events .....	607
Worm Infected System .....	607
Worm Infected Systems .....	607
Appendix H: Restoring Factory Settings .....	608
Before Restoring Your System .....	608
Restoring Your System .....	608
Restoring LX400 and Earlier Appliance Models .....	613
Appendix I: Logger Search From ArcSight ESM .....	616
Understanding the Integrated Search Functionality .....	616
Setup and Configuration .....	617
On ESM .....	618
On Logger .....	619
Supported Search Options .....	619
Guidelines .....	619
Searching on Logger From ArcSight Console .....	620
Send Documentation Feedback .....	623

# Chapter 1: Overview

This document provides information about the administration, configuration and use of version 6.3 of ArcSight Data Platform (ADP) Logger and standalone ArcSightLogger. It includes information on storage, receiver, and forwarder configuration; working with events; user management; and setup and maintenance considerations.

**Note:** Where there are no specific differences, all types of Logger are called *Logger* in this document. Where there are differences, the specific type of Logger is indicated.

- [Introduction](#) .....22
- [Logger Features](#) .....23
- [Deployment Scenarios](#) .....28
- [Centralized Management](#) .....31
- [Running Logger on Encrypted Appliances](#) .....31

## Introduction

Logger is a log management solution that is optimized for extremely high event throughput, efficient long-term storage, and rapid data analysis. Logger receives and stores events; supports search, retrieval, and reporting; and can optionally forward selected events. Logger compresses raw data, but can always retrieve unmodified data on demand for forensics-quality litigation data.

You can have a single, standalone Logger or as many as you need. As part of the *ArcSight Data Platform (ADP)*, Logger is managed by ArcSight Management Center (ArcMC). Multiple Loggers can work together to scale up to support extremely high event volume with search queries distributed across all Loggers.

Logger is available in the form factors: an appliance and software. The appliance-based solution is a hardened, dedicated, enterprise-class system that is optimized for extremely high event throughput, efficient long-term storage, and rapid data analysis. The software-based solution is similar in feature and functionality to the appliance-based solution, however, the software solution enables you to install ArcSightLogger on a supported platform of your choice. The software version is also available as a VMware VM.

An *event* consists of a receipt time, an event time, a source (host name or IP address), and an un-parsed message portion. Logger displays events in a tabular form, with fields that describe how Logger received the event.

## Analyze > Search page, displaying search results

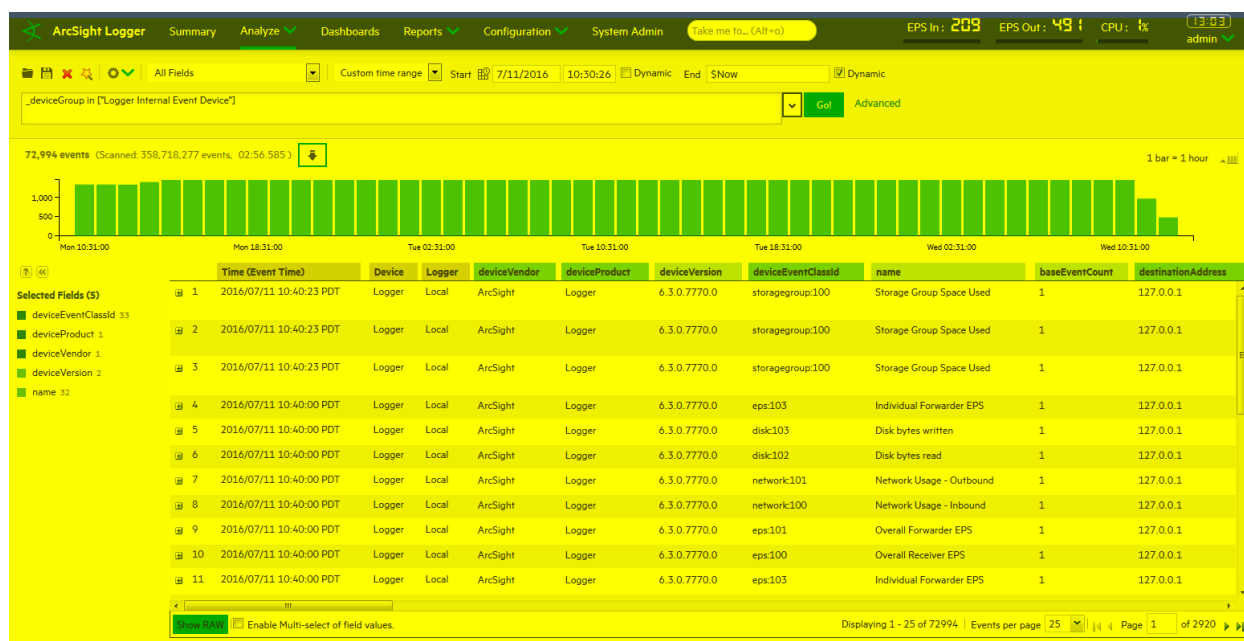

Similar to ArcSight Manager, Logger receives structured data in the form of normalized Common Event Format (CEF) events and unstructured data, such as syslog events. The file-type receivers configured on Logger only parse event time from an event. Although Logger is message-agnostic, it can do more with messages that adhere to the Common Event Format (CEF), an industry standard for the interoperability of event- or log-generating devices.

For more information about CEF, refer to the document "ArcSight CEF.". For a downloadable a copy of this guide, search for "ArcSight Common Event Format (CEF) Guide" in the [ArcSight Product Documentation Community on Protect 724](#).

Logger is available in the form factors: an appliance and software. The appliance-based solution is a hardened, dedicated, enterprise-class system that is optimized for extremely high event throughput, efficient long-term storage, and rapid data analysis. The software-based solution is similar in feature and functionality to the appliance-based solution, however, the software solution enables you to install ArcSight Logger on a supported platform of your choice. The software version is also available as a VMware VM.

## Logger Features

The following sections provide an overview of key Logger features with links to relevant sections of this guide.

- [Storage Configuration](#) .....24
- [Receiver Configuration](#) .....24
- [Analyzing Events](#) .....25

- [Grouping Events](#) ..... 26
- [Exporting Events](#) ..... 26
- [Forwarder Configuration](#) ..... 27
- [User Management](#) ..... 27
- [Other Setup and Maintenance](#) ..... 28

## Storage Configuration

Logger events can be stored locally on any Logger and remotely on Logger Appliance models that support Storage Area Network (SAN). SAN can be used for storing events on both types of Loggers; however, only one LUN can be used for storing events. Using a Network File System (NFS) as primary storage for events is not recommended.

The **Logger Appliance** includes onboard storage for events. Some Logger models include RAID 1 or RAID 5 storage systems. (See Logger specifications at <http://www8.hp.com/us/en/software-solutions/enterprise-security.html>.)

Events are stored compressed. You cannot configure the compression level.

An NFS or a CIFS system can be used for archiving Logger data such as event archives, Saved Searches, exported filters and alerts, and configuration backup information. You can also configure the Logger to read event data or log files from a CIFS host.

The storage volume, either external or local, can be divided into multiple storage groups, each with a separate retention policy. Two storage groups are created when Logger is first configured. New storage groups can be added later. A storage group's size can be increased or decreased and the retention policy defined for it can be changed.

For more information on storage strategy, refer to the Logger Installation Guide. For more information on event storage, see "[Storage](#)" on [page 347](#).

## Receiver Configuration

Logger receives events as syslog messages, encrypted SmartMessages, Common Event Format (CEF) messages, or by reading log files. Traditionally, syslog messages are sent using User Datagram Protocol (UDP), but Logger can receive syslog and CEF messages using the more reliable Transmission Control Protocol (TCP) as well.

Logger can also read events from text log files on remote hosts. Log files can contain one event per line or event messages that span multiple lines separated by characters such as newline (`\n`) or a carriage return (`\r`). Each event must include a timestamp. Logger can be configured to poll remote folders for new files matching a filename pattern. Once the events in the new file have been read, Logger can delete the file, rename it, or simply remember that it has been read. Logger can read remote files on network



drives using SCP, SFTP, or FTP protocol, or using a previously-established NFS or CIFS mount or, on some Logger Appliance models, a SAN.

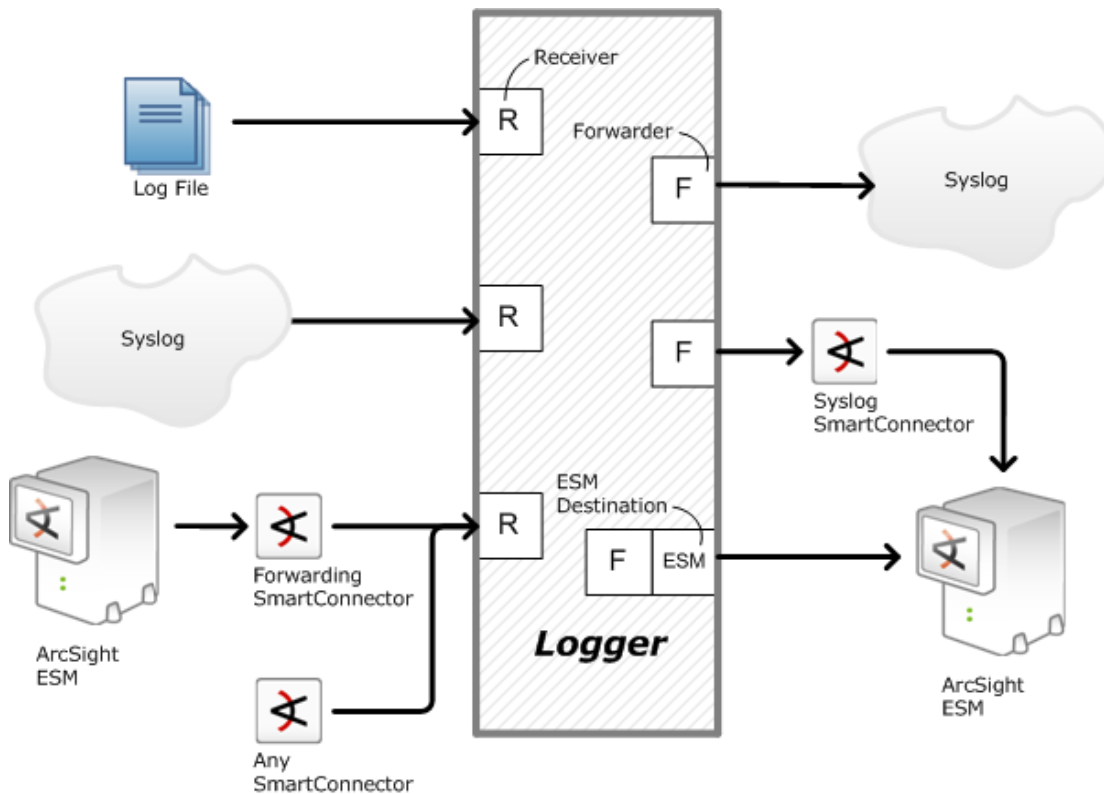

Logger may also receive events from an ArcSight Manager as CEF-formatted syslog messages. These events are forwarded to Logger through a special software component called an ArcSight Forwarding SmartConnector that converts the events into CEF-formatted syslog messages before sending them to Logger.

- For more information on setting up receivers, see ["Receivers" on page 294](#)
- For more information on setting up SmartConnectors, refer to the Logger Installation Guide.
- For more information on collecting events from ArcSight ESM, refer to the Logger Installation Guide.

## Analyzing Events

Events can be searched, yielding a table of events that match a particular query. Queries can be entered manually or automatically created by clicking on terms in the event table. Queries can be based on plain English keywords (full-text search), predefined fields, or specified as regular expressions. Logger supports a flow-based search language that allows you to specify multiple search commands in a pipeline format.

By default, a Logger queries only its primary data store even if peer Loggers are configured. However, you can configure it to distribute a query across peer Loggers of your choice.

Queries can be saved as a filter or as a saved search. Saved filters can be used to select events for forwarding or to filter for the same things later. A Saved Search is used to export selected events or to save results to a file, typically as a scheduled task.

The following topics provide more information about analyzing events:

- ["Searching for Events" on page 102](#)
- ["Saving Queries \(Creating Saved Searches and Saved Filters\)" on page 129](#)
- ["Filters" on page 260](#)
- ["Saved Searches" on page 264](#)
- ["Parsers" on page 315](#)

## Grouping Events

The combination of a source IP address and a Logger receiver is called a device. As events are received, devices are automatically created for each IP/receiver pair. Devices can also be created manually.

Devices can be categorized by membership in one or more device groups. While an incoming event belongs to one and only one device, it can be associated with more than one device group.

Storage rules associate a device group with a storage group. Storage rules are ordered by priority, and the first matching rule determines to which storage group an incoming event will be sent.

Device groups, devices, storage groups, and peer Loggers can each be used to filter events using Search Constraints, which can be specified interactively on the Analyze page as well as when creating filters or Saved Searches.

The following topics provide more information about grouping events:

- ["Event Archives" on page 351](#)
- ["Storage Rules" on page 349](#)
- ["Searching Peers \(Distributed Search\)" on page 107](#)

## Exporting Events

A Logger Appliance can export events to various sources. Events that match the current query can be exported locally, to an NFS mount, a CIFS mount, as a file or to a SAN, when the appliance supports SANs.

Events from a Software Logger can be exported locally to the Logger (to the `<install_dir>/data/logger` directory) or to the browser from which you connect to the Logger. The `<install_dir>/data/logger` directory can be mounted to an NFS or CIFS.

Events can be exported in Comma-Separated Values (CSV) format for easy processing by external applications or as a PDF file for generating a quick report. A PDF report includes a table of search

results and any charts generated for the results. Both raw (unstructured data) and CEF events (structured data) can be included in the PDF exported report.

Events in Common Event Format (CEF) have more columns defined, making the data more useful, but non-CEF events can be exported as well, if desired. The user can control which fields are exported.

Exports can be scheduled to run regularly by creating a Saved Search Job. First, a Saved Search is created, either manually or by saving a query on the Analyze page. A Saved Search can be based on an existing filter. A Saved Search Job combines one or more Saved Searches and a schedule with export options.

The following topics provide more information about exporting events:

- ["Exporting Search Results" on page 126](#)
- ["Time/NTP" on page 410](#)
- [" Scheduled Searches/Alerts" on page 265](#)

## Forwarder Configuration

Logger can send events (as they are received or past events) to other hosts using UDP or TCP, to a Logger Streaming SmartConnector, or to an ArcSight Manager. The events sent to a particular host can be filtered by a query that events must match. Outgoing syslog messages can be configured to either pass the original source IP and timestamp or to use Logger's "send time" and IP address.

Syslog messages can be sent to an ArcSight Manager using a syslog SmartConnector, but Logger can also send CEF events directly to an ArcSight Manager using its built-in SmartConnector. Logger can act as a funnel, receiving events at very high volumes and sending fewer, filtered events on to an ArcSight Manager, as depicted under ["Logger can act as a funnel, forwarding selected events to ArcSight Manager" on page 29](#).

The following topics provide more information about forwarding events:

- ["Forwarders" on page 321](#)
- ["ESM Destinations" on page 339](#)

## User Management

User accounts can be created by the Logger administrator to distinguish between different users of the system. User accounts inherit privileges from the User Group to which they belong. User Groups can have an enforced event filter applied to them, limiting the events that a specific user can see.

The following topics provide more information about user management:

- ["Users/Groups" on page 442](#)
- ["Change My Password" on page 459](#)
- ["Search Group Filters" on page 263](#)

## Other Setup and Maintenance

Logger configuration settings, such as receivers, filters, Saved Search jobs, and so on—everything except events—can be backed up as a configuration backup file to any disk and later restored.

Logs detailing Logger activity can be downloaded through the browser on demand, for debugging or other reasons. Other system information is available for viewing. Various system settings can be modified. Some require a system reboot or restart for the changes to take effect.

The Logger Appliance can be rebooted using controls in the user interface. For Software Logger, the Logger service and related processes can be restarted. Follow instructions in ["Software Logger Command Line Options" on page 468](#) to start, stop, or restart Software Logger.

The following topics provide more information about setup and maintenance:

- ["Configuration Backup and Restore" on page 383](#)
- ["Retrieve Logs" on page 364](#)
- ["Storage" on page 421](#)
- ["System" on page 404](#)
- ["License & Update" on page 413](#)
- ["Network" on page 406](#)

## Deployment Scenarios

Typically, Logger is deployed inside the perimeter firewall with a high degree of physical security to prevent tampering with the collected event information. Logger does not require other ArcSight products. It receives and forwards syslog and log file events created by a wide variety of hardware and software network products.

Logger also inter-operates with ArcSight Manager as shown in the following figures. A typical use of Logger is to collect firewall or other data and forward a subset of the data to ArcSight Manager for real-time monitoring and correlation, as shown below. Logger can store the raw firewall data for compliance or service-level agreement purposes.

**Logger can act as a funnel, forwarding selected events to ArcSight Manager**

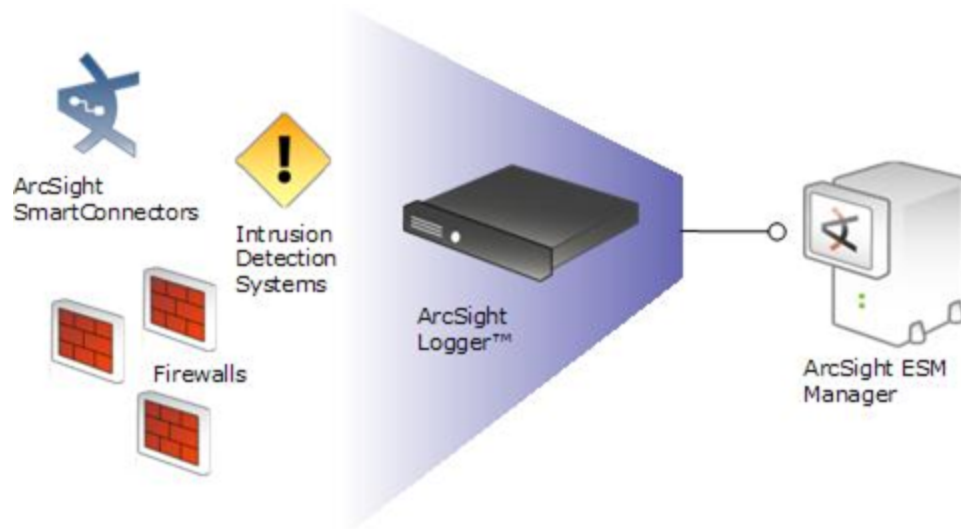

**Logger can store events sent by ArcSight Manager**

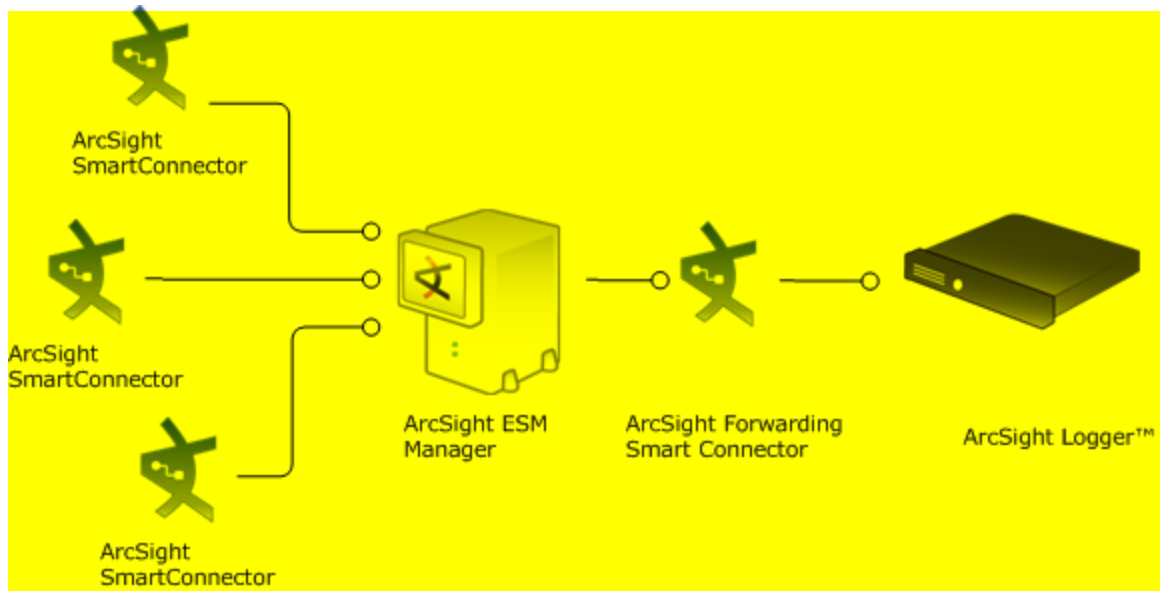

### Logger can store and forward filtered events in a hierarchical ArcSight Manager deployment

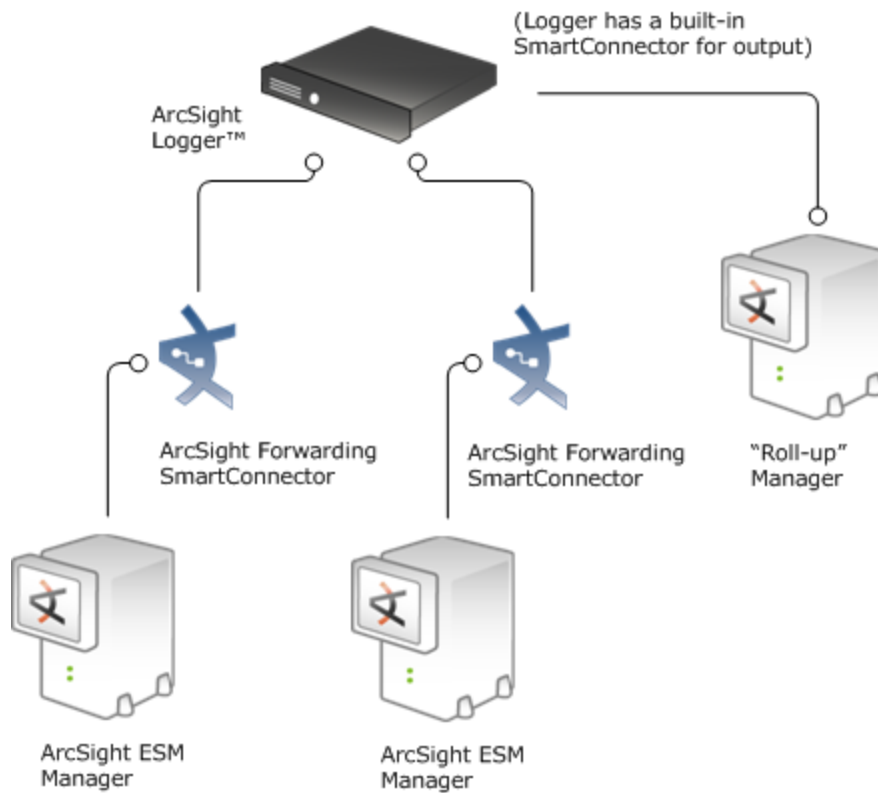

## Setting up Search Heads for Faster Peer Searches

If you have several peered Loggers and many users that need to search at the same time, you can set up your Loggers so that some of them are used for receiving, storing, and forwarding events, and others are used only for searching their peers.

A *node* is any peered Logger used for receiving, storing, and forwarding events. A *search head* is a peered Logger that is only used for searching. Search heads do not forward, receive, or store events. To take advantage of search heads, you must set up your architecture so that no data is sent to the Loggers that will be used as the search heads.

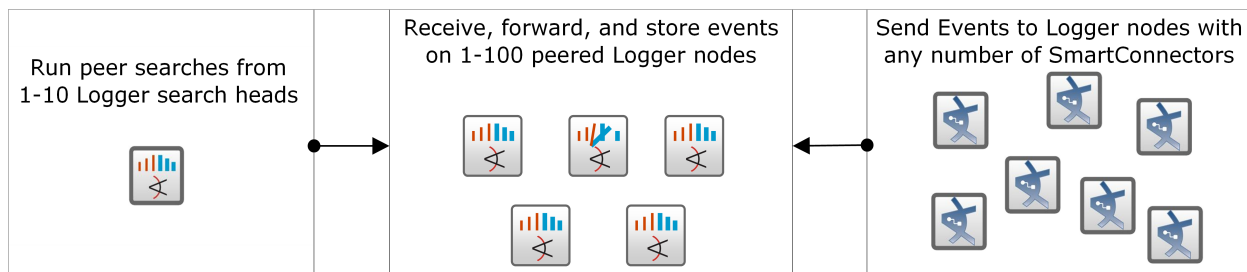

**Tip:** For best search speed, both nodes and search heads require a minimum of 16 GB Ram, with 32 GB recommended.

Once this configuration is in place, ten users can log in to the search head and run searches across ten specified nodes at the same time. You can scale this out to enable 100 users to run concurrent searches by setting up ten search heads.

## Centralized Management

HPEADP ArcSight Management Center (ArcMC) provides centralized management for Loggers and connectors with a single panel view of all managed ArcSight ADP products.

Using ArcMC, you can create or import configurations for managed products, and then rapidly push them to products of the same type across your network, ensuring consistent configuration for managed products with one action. You can perform a variety of remote management tasks, singly and in bulk, on Loggers, and connectors. Logger tasks you can perform using ArcMC include initial configuration, peer configuration, and user management.

For more information, consult your sales representative or refer to the ArcSight Management Center Administrator's Guide.

## Running Logger on Encrypted Appliances

Logger can run on encrypted hardware to help you to meet compliance regulations and privacy challenges by securing your sensitive data at rest.

You can encrypt your L7600 Logger Appliance by using HPE Secure Encryption, available from the [Server Management Software > HP Secure Encryption](#) web page. For instructions, refer to the HPE Secure Encryption Installation and User Guide, available in PDF and CHM formats through the Technical Support / Manuals link on that page.

L7600 Logger Appliances are encryption-capable. They come preinstalled with everything necessary for you to encrypt them using HP Secure Encryption. The length of time encryption takes depends on the amount of data on the server being encrypted. In our testing, a Gen 9 appliance with 7.5 TB of stored data took about 72 hours to encrypt. You can continue using Logger while the encryption runs. You may notice some performance degradation after encrypting your existing Logger appliance.

**Caution:** After encryption, you cannot restore your Logger to its previously unencrypted state.

# Chapter 2: User Interface and Dashboards

The following topics provide an overview of how to connect to Logger, and explores Logger's dashboards. Logger includes standard dashboards that display the real-time and historical status of receivers and forwarders as well as storage, CPU, and disk usage statistics. You can create your own dashboards for an all-in-one view of Logger information that is of interest to you.

- [Connecting to Logger](#) ..... 32
- [Navigating the User Interface](#) ..... 34
- [Summary](#) ..... 38
- [Dashboards](#) ..... 41
- [Setting a Default Dashboard](#) ..... 63

## Connecting to Logger

You can connect to Logger and log in with most browsers, including Chrome, Firefox and Internet Explorer. Refer to the Release Notes for a list of browsers supported in this release.

**To connect and log into Logger:**

1. Use the URL configured during Logger installation to connect to Logger through a supported browser.
  - For the Logger appliance, use `https://<hostname or IP address>`  
The End User License Agreement is displayed. Review and accept the EULA.
  - For Software Logger, use `https://<hostname or IP address>:<configured_port>`, where the hostname or IP address is the system on which the Logger software is installed, and `configured_port` is the port set up during the Logger installation, if applicable.

The Login screen displays.



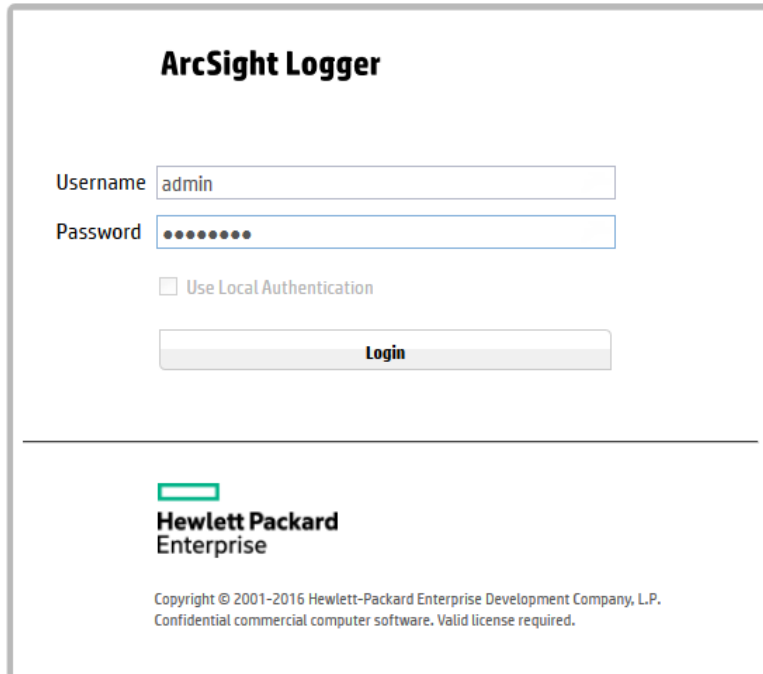

2. Enter your user name and password, and click **Login**. Use the following default credentials if you are connecting for the first time or have not yet changed the default credentials:

Username: **admin**

Password: **password**

- If login succeeds, the Summary page (Logger's default home page) is displayed. For information on the Summary page see ["Summary" on page 38](#).
- If login fails, the message Authentication Failed is displayed at the top of the login screen. Enter the correct username and password combination to try again.

**Note:** The first time you log in with the default user name and password, you will be required to change the password.

Depending on your system administration settings, the following options maybe also be available.

- **Forgot Password?:** A "Forgot Password?" link is displayed if your Logger is configured to show it. Click this link to change your password. For more information on the Forgot Password link, see ["Forgot Password" on page 446](#).
- **Use Local Authentication:** The "Use Local Authentication" checkbox is always displayed, but only becomes active when a login attempt fails. By default, this option is available only for the default admin. For more information on the Use Local Authentication option, see ["Local Password" on page 443](#).

# Navigating the User Interface

A navigation and information bar (navbar) runs across the top of every page in the user interface.

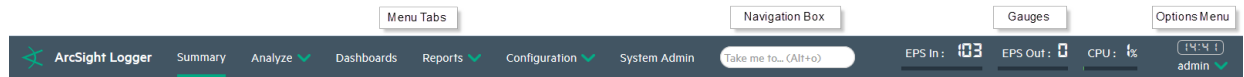

- [Menus, Take Me To, and Bar Gauges](#) ..... 34
- [Server Clock, Current User, and Options Dropdown](#) ..... 35
- [Logger Options](#) ..... 36

## Menus, Take Me To, and Bar Gauges

The Summary, Analyze, Dashboards, and Reports menu tabs provide access to various Logger functions and data stored on it.

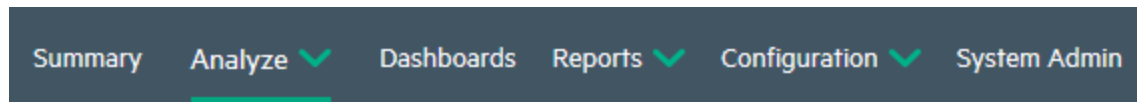

You can configure system settings and administrative functions in the Configuration and System Admin menus. For more information on each, refer to the sections below.

- The options available in the Summary menu are discussed in ["Summary" on page 38](#).
- The options available in the Dashboards menu are discussed in ["Dashboards" on page 41](#).
- The options available in the Analyze menu are discussed in ["Searching and Analyzing Events" on page 65](#).
- The options available in the Reports menu are discussed in ["Reporting" on page 147](#)
- The options available in the Configuration menu are discussed in ["Configuration" on page 259](#).
- The options available in the System Admin menu are discussed in ["System Admin" on page 404](#).

## Take Me To Navigation Box

To the right of the menu tabs, the **Take me to...** navigation box provides a quick and easy way to navigate to any location in the UI. The **Take me to...** feature enables you to navigate to any Logger feature simply by starting to type the feature's name.

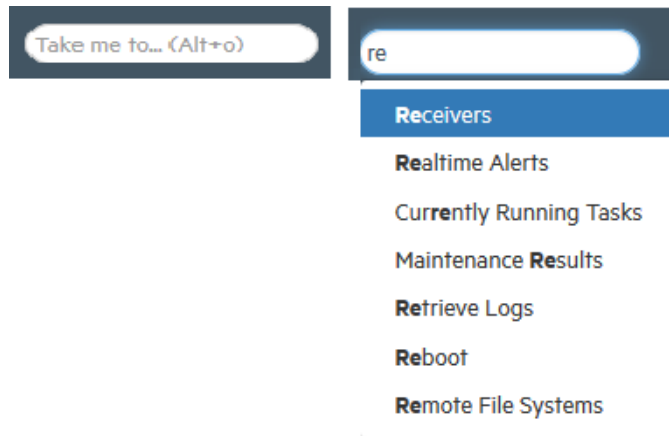

You can access the Take me to... navigation box by clicking in it or by using the Alt+o, Alt+p, or Ctrl+Shift +o hot keys. As you type, a list of features that match drops down. Click an item in the list or press enter to go to the specified feature.

You can open the help for the current page by typing help in the **Take me to...** search box.

## Bar Gauges

Bar gauges at the top right of the screen provide an indication of the throughput and CPU usage, which is available in more detail on the Monitor Dashboard discussed in ["Dashboards" on page 41](#).

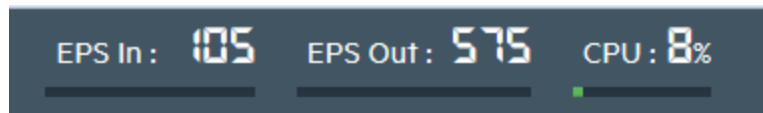

The range of the bar gauges can be changed on the Options page, as discussed in ["Logger Options" on the next page](#).

## Server Clock, Current User, and Options Dropdown

The server clock is shown to the right of the bar gauges, along with the currently logged-in user's name and the Options dropdown arrow.

The server clock displays the Logger server's system time. This may be different from the user's local time.

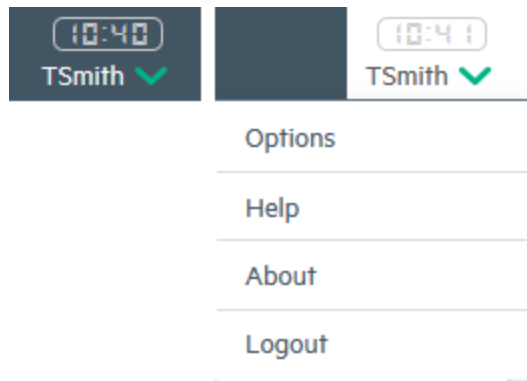

Below the clock is the login name of the current user. To the right of the user's login name is the dropdown arrow that you can use to open the "Logger Options" below and the "Help, About, and Logout" on page 41 options.

## Logger Options

When you click the Options drop-down arrow, you can access the Options page and the "Help, About, and Logout" on page 41 options as well.

The **Options** page enables you to set the default start page (home page) for all users and specific start pages for individual users and to upload a custom logo to display instead of the default logo.

### To access the Options page from any user interface page:

Click the down-arrow by your user name (👇) and then select **Options**.

A screenshot of the Options page configuration form. The form is titled 'Options' and is divided into two sections: 'System' and 'Personal'. Under 'System', there are three dropdown menus: 'EPS input rate bar gauge max' (set to 100K), 'EPS output rate bar gauge max' (set to 100K), and 'Default start page for all users' (set to Summary). Below these is a file upload section for 'Upload a logo (PNG file)' with a 'Browse...' button and the text 'No file selected.'. There is also a checkbox for 'Show default logo' which is checked. Under 'Personal', there is a dropdown menu for 'Default start page for admin' (set to Use default for all users). At the bottom of the form is a green 'Save' button.

## Customizing the Maximum EPS

You can set the maximum rate on the EPS In and EPS Out bar gauges from by using the **EPS Input rate bar gauge max** and **EPS output rate bar gauge max** dropdowns in the Options menu. If the event rate exceeds the specified maximum, the range is automatically increased.

## Customizing the Logo

The **Upload a logo (PNG file)** option in the Options menu enables you to replace the HPE ArcSight Logger logo with your custom logo. The logo must be in .png format. The recommended logo size is 150 X 30 pixels and the maximum file size is 1MB.

150 by 30 pixel logo:

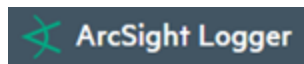

### To display a custom logo:

1. From the Options menu, click **Browse**, navigate to the logo you want to use, and click **Open**. The name of your logo is displayed by the browse button.
2. Then uncheck **Show default logo**. The custom logo will be displayed on the login page and on the menu bar.

### To display the default HPE ArcSight logo:

Check the **Show default logo** checkbox.

## Customizing the Start Page

### To set your own personal start page:

From the Personal section of the Options menu, select one of the start page options.

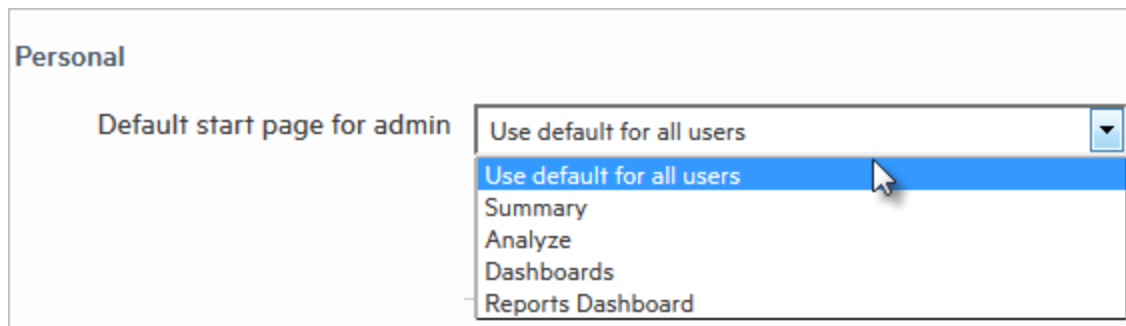



The **Default start page for all users** option indicates which user interface page is displayed after a user logs in. You can set the default start page (home page) for all users and specific start pages for individual users. Refer to the following table for information on how to configure a specific start page.

If you want to set...	Configure the...
The same start page for all users	<p>Default start page for all users option to the desired page.</p> <p>This is a global setting for your Logger. To override this setting, configure a different start page for specific users by using the Default start page for &lt;username&gt; option.</p> <p>When you set Default start page for all users option to Dashboards, the Monitor Dashboard is the default dashboard displayed for all users, except users who have configured other dashboards as their defaults, as described in <a href="#">"Setting a Default Dashboard" on page 63</a>.</p>
A different start page for specific users	<p>Default start page for &lt;username&gt; option to the desired page.</p> <p>This setting overrides the global Default start page for all users setting.</p> <p>When this option is set to "Use default for all users," the global default page (Default start page for all users) value is used for all users.</p>
<p>A specific dashboard for a specific user</p> <p>OR</p> <p>A specific dashboard for all users</p>	<p>Default start page for &lt;username&gt; option to Dashboards.</p> <p>The Monitor Dashboard is the default dashboard displayed for all users. However, if you want to display a different dashboard for one or more users, set the desired dashboard as the default when logged in as those users. For details, see <a href="#">"Setting a Default Dashboard" on page 63</a>.</p>

## Summary

Logger's default home page is the Summary page. (For information on how to use a different page as your home page, see ["Logger Options" on page 36](#).) The Summary page is a dashboard that provides summarized event information about your Logger in one screen. It enables you to gauge incoming events activity and the status of indexing. The events that are in Logger's primary storage (not aged out due to retention or archived data) are used to generate the summary information.

Logger's home page, the Summary page, displays data in four panels. Each panel is displayed in a donut chart by default. You can change the display setting for each panel by clicking the appropriate icon.

- Select  for a list.
- Select  for a column chart.
- Select  for a donut chart.

**Note:** Donut charts display an event total in the middle of the donut. This is the total number of events displayed in that chart. If the number of events is more than 1000, the event total is displayed using the appropriate standard metric prefix (k, M, G, T).

The panels on the Summary page can display up to 30 items. If there are more than 30, the panels display the top 30, by count.

### Logger's Home Page: The Summary Page

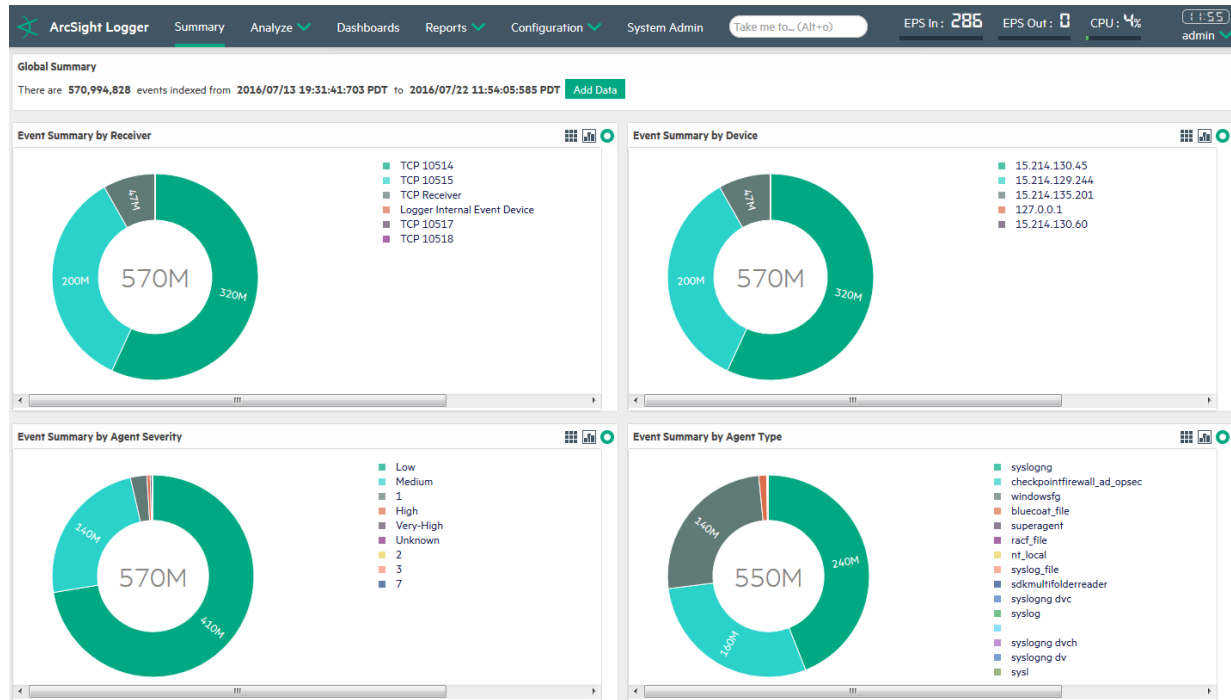

Hover your pointer over a column, donut slice, or over the item in the legend to display information about it. For even more details, you can drill down to view the events by a specific resource—receiver, device, agent severity, or agent type. To do so, click the column, donut slice, or list resource to search for those events. The Search page opens and the search box is automatically populated with the search that generated the information you clicked on the Summary page. The Start and End fields are populated with the time of oldest events stored on your Summary system (that have not aged out due to retention) and the current time, respectively.

For example, if you click Logger Internal Event Device under Event Summary by Receiver, the **Analyze > Search** page opens with the following query populated, and the search is run. If desired, you can further refine the search query to filter the search results to suit your needs. Click **Go!** to run the search again.

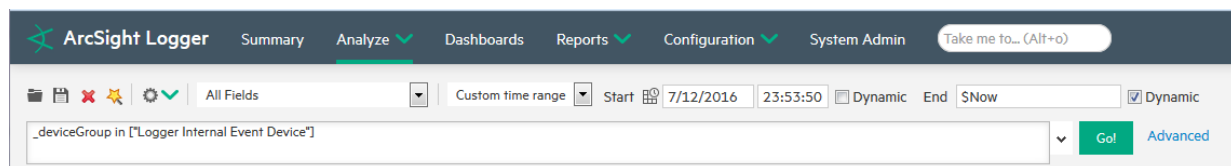

You cannot change or add other panels to the Summary page. If you need to display other information, you can create a custom Dashboard as described in "Dashboards" on page 41.

The information displayed on the Summary page is for your local Logger only, and does not include information about peer Loggers even if peers are configured.

## Summary Dashboard Panels

- **Global Summary:** The number of events indexed on your Logger during the time period displayed on the screen. This time period is dependent on the retention policy set on your Logger. The start is the time of the oldest event stored in the Logger since the Logger was restarted, that has not aged out due to retention; the end time is current time. The **Add Data** (  ) button at the top opens the Receivers page where you can add and manage the receivers that put log data into your Logger. For more information on managing receivers, see ["Receivers" on page 294](#).
- **Event Summary By Receiver:** The list of receivers configured on your Logger, the number of events received on each receiver (that are in Logger's primary storage, not aged out due to retention or archived data), and the timestamp of the last event received on each receiver. If a receiver is deleted, the summary information for it will continue to display until the events received on it age out from Logger's primary storage. However, the receiver name is changed to the receiver ID (a numerical string) associated with the deleted receiver.
- **Event Summary By Device:** A device is a named event source, comprising of an IP address (or hostname) and a receiver name. The Devices panel lists devices configured on your Logger, the number of events received on each device (that are in Logger's primary storage, not aged out due to retention or archived data), and the timestamp of the last event received on each device. If a device is deleted, the summary information for it will continue to display until the events received on it age out from Logger's primary storage. However, you cannot click the device name to view the events associated with the deleted device.
- **Event Summary By Agent Severity:** The list of severity levels of the incoming events from ArcSight SmartConnectors to your Logger, the number of events received of each severity level, and the timestamp of the last event received of each severity level. Only events in Logger's primary storage (not aged out due to retention or archived data) are considered when summarizing this information.
- **Event Summary By Agent Type:** The list of ArcSight SmartConnectors sending events to your Logger, the number of events received from each SmartConnector (for events that are in Logger's primary storage, not aged out due to retention or archived data), and the timestamp of the last event received from each SmartConnector. If a SmartConnector is deleted, the summary information for it will continue to display until the events received from it age out from Logger's primary storage.

## The Effect of Search Group Filters on the Summary Page

Search Group filters that enforce privileges on storage groups are applied to the content displayed on the Summary page. However, Search Group filters that enforce privileges on *device groups* are not applied. Therefore, the Summary page includes counts of events in device groups to which a user does not have privileges. However, if the user tries to drill down to view events, search results in accordance



with access privileges are returned as the search query is run on the Analyze page, which enforces all types of Search Group filters. Similarly, if a Search Group filter enforces privileges on both, storage groups and device groups, only the storage group enforcement is applied on the Summary page.

## Help, About, and Logout

When you click the Options drop-down arrow, you can access the following options and the "[Logger Options](#)" on page 36 page as well.

**To access the online help:** From any user-interface page, click the down-arrow by your user name  and then select **Help**.

**Tip:** The latest Logger documentation is available in Adobe Acrobat PDF format, through the [ArcSight Product Documentation Community on Protect 724](#).

**To access version information about your Logger:** From any user-interface page, click the down-arrow by your user name and then select **About**.

**To log out of Logger:** From any user interface page, click the down arrow by your user name and then select **Logout**. You will be returned to the Login screen.

**Tip:** Logging out is good security practice, to eliminate the chance of unauthorized use of an unattended Logger session. Logger automatically logs you out after a user-configurable length of time (15 minutes by default). To change this length of time, see "[Users/Groups](#)" on page 442.

**Caution:** Simply closing the browser window does not automatically log you out. Click the **Logout** link to prevent the possibility of a malicious user restarting the browser and resuming your Logger session.

## Dashboards

Dashboards are an all-in-one view of the Logger information of interest to you. You can select and view any of several out-of-box dashboards or create and display your own custom dashboard.

Each Logger dashboard contains one or more panels of these types:

- **Search Results:** Search Results panels display events that match the query associated with the panel.
- **Monitor:** Monitor panels display the real-time and historical status of various Logger components such as receivers, forwarders, storage, CPU, and disk.
- **Summary:** Summary panels display summarized event information about your Logger—the number of events received of a specific resource or field type, and the timestamp of the last event received for that resource or field type.

- [Out-of-Box Dashboards](#) ..... 42
- [Custom Dashboards](#) ..... 56

## Out-of-Box Dashboards

Logger comes with several out-of-box dashboards, described below. The Monitor dashboard is displayed by default unless you configure another dashboard to display as your default.

- The Event Count dashboard, described in "[The Event Count Dashboard](#)" on page 55, displays how many events each receiver or forwarder handled.
- The Intrusion and Configuration Events dashboard, described in "[The Intrusion and Configuration Events Dashboard](#)" on page 52, displays information about configuration changes and intrusions on your system.
- The Login and Connection Activity dashboard, described in "[The Login and Connection Activity Dashboard](#)" on page 53, displays information about login and connection activity on your system.
- The Monitor dashboard displays the Summary panel, which shows the status of CPU Usage, Event Flow, Receivers, Forwarders, and Storage Groups in a summarized view. The other panels available in this dashboard are Platform, Network, Logger, Receivers, Forwarders, and Storage. These views are described in detail in "[The Monitor Dashboard](#)" on the next page.

You cannot change or adjust the panels available in the out-of-box dashboards, except the System Overview dashboard (See "[The System Overview Dashboard](#)" on page 50). However, you can add specific Search Results panels to a custom dashboard, as described in "[Creating and Managing Custom Dashboards](#)" on page 58.

You can add also Monitor and Summary panels to it. These panels provide the same information available through the default Monitor dashboard and the default Summary dashboard, however in a modular form that enables you to choose specific views. (See "[Summary](#)" on page 38 for more information about default Summary dashboard.)

For example, if you want to view the EPS for the last 4 hours on all receivers, add the panel Type "Monitor Graph", and select "(Logger) All EPS Out-All EPS In - 4 hour" as the Graph, or if you want to view the EPS on Forwarders in a table form, select the "Monitor (Forwarders)" panel Type. Similarly, if you want to view only the summary information for receivers on your Logger, add the panel of Type "Summary (Receivers)". Besides the four Summary panels (Agent Severities, Agent Types, Receivers, and Devices), you can also create a user-defined Summary panel in which you can select *any indexed, non-time field* by which you want to categorize event summary. For example, if you want to add a Summary panel to display event summary categorized by "destinationAddress", you can add a panel of Type "Summary (User Defined)" for this field if it is indexed on your Logger.

You can also drill down on any of the resources listed in Monitor and Summary panels you add to view events by a specific resource or field value on the Analyze (Search) page. For example, you can click on a storage group in a Monitor panel to view its events in the last 24 hours, or you can click on an event name "Network Usage - Inbound" to view all events of that name in the last one hour. Additionally, you

can access the Configuration page for any of the resources listed in the Monitor panels to configure them. For example, if you want to configure a receiver, click the Configure link on top of the Monitor (Receiver) panel.

Search Group filters that restrict privileges on device groups are not enforced on *Summary panels*. Therefore, Summary panels include counts of events in device groups to which a user does not have privileges. However, if the user tries to drill down to view events, search results in accordance with access privileges are returned as the search query is run on the Analyze page, which enforces all types of Search Group filters. Similarly, if a Search Group filter enforces privileges on both, storage groups and device groups, only the storage group enforcement is applied on Summary panels.

Users can create both shared and private dashboards.

- Shared dashboards are visible to all users with the appropriate privileges.
- Private dashboards are visible only to the creator or users with "admin" privileges.
- Only the creator or users with "admin" privileges can edit or delete dashboards of either type.

A user accessing a shared dashboard must have privileges to view the information displayed in the dashboard; otherwise, the information to which they do not have the privileges is not displayed, and the associated panel displays a message that indicates the reason for the undisplayed information.

## The Monitor Dashboard

The Monitor Dashboard, displayed by default, contains the real-time and historical status of receivers, forwarders, and storage, CPU, and disk usage statistics. On Software Logger, the CPU and disk usage statistics indicate the total use of these resources on the system, not just the use of these resources by the Logger process.

The Monitor panels, available through a pull-down menu display Summary, Platform, Network, Logger, Receivers, Forwarders, and Storage information. You cannot change or adjust any of these out-of-box panels, but you can create your own dashboards to monitor the things in which you are most interested. For more information, see ["Creating and Managing Custom Dashboards" on page 58](#)

All monitor panels, except the Summary panel, include a pull-down menu for duration control. The summary panel has buttons instead. In both cases, you can choose one of the following time spans for historical data: 4 hours, 24 hours, 7 days, 30 days, 90 days, or 365 days. As you hover your pointer over the data, more details are displayed. In the case of dashboards that displays two fields, details of both are displayed, and a legend indicates the color that represents each field.

In these dashboards, events per second (e/s) are displayed using standard metric prefixes (k, M, G, T) for numbers over 1000. Numbers under 1000 are displayed as integers.

The System Overview dashboard provides a different view of these panels. See ["The System Overview Dashboard" on page 50](#) for more information about that view.

## Monitor Dashboard Summary Panel

The summary panel, displayed by default, shows the status of CPU Usage, Event Flow, Receivers, Forwarders, and Storage Groups in a summarized view.

### Monitor dashboard - Summary panel

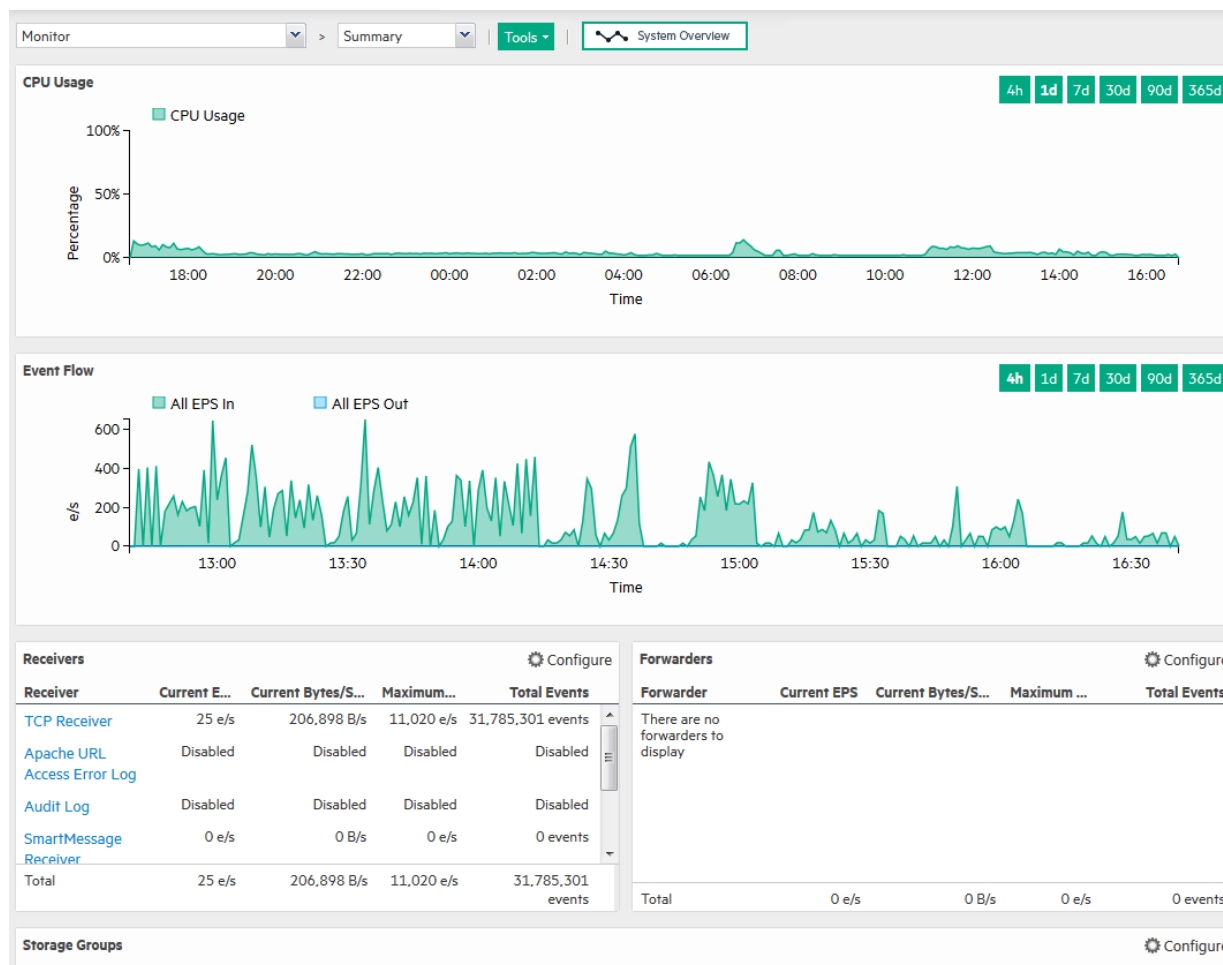

On the Summary panel, click on a Receiver, Forwarder, or Storage Group name to jump to the Search page and include the selected resource in the query.

Additionally, you can click **Configure** (⚙️ *Configure*) to open the Configuration page for Receivers, Forwarders, and Storage Groups.

**Note:** The total space allocated for a storage group includes a certain amount that has been set aside to ensure that the group can receive new events when it is almost full. As a result, the percentage of used space for a storage group never reaches 100% (as displayed on the Monitor > Summary panel). For Software Loggers installed using the Minimal setting, the maximum % Used

(On the Monitor > Summary panel) for each storage group reaches up to 66.33%. (Two storage groups of 3 GB each; 1 GB is set aside for new events in each group. After 2 GB of space has been used and the new events are being written to the last 1 GB, Logger automatically triggers retention and reclaims 1 GB of the used space. Thus, the % Used field for each storage group only reaches up to 66.33%.)

## Monitor Dashboard Receivers Panel

The Receivers monitor panel shows the total Events per Second (EPS) received and displays values for each configured receiver. The list of receivers includes all receivers known to the system, including those that are disabled. (To create a new receiver, or to enable or disable one, see ["Working with Receivers" on page 298.](#))

### Monitor dashboard - Receivers panel

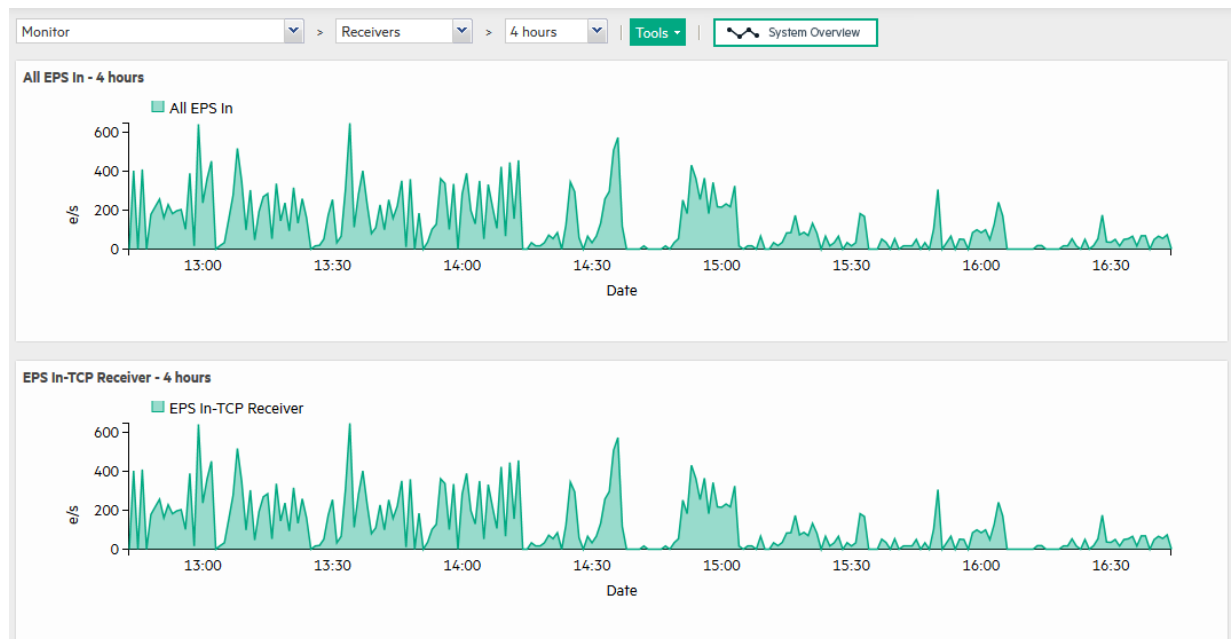

## Monitor Dashboard Platform Panel

The Platform monitor panel displays information about CPU usage, memory usage, bytes received and sent on the network, and raw disk reads and writes.

### Monitor dashboard - Platform panel

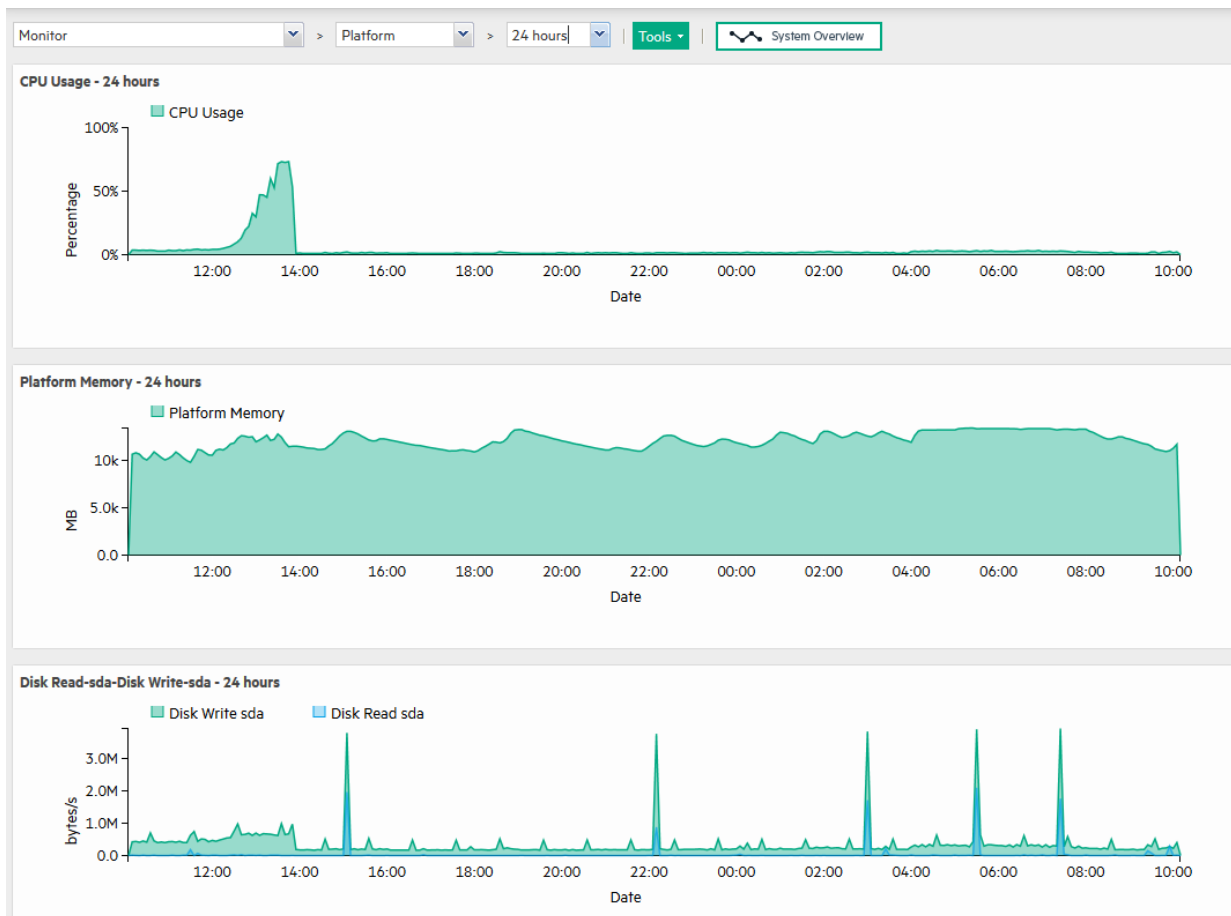

## Monitor Dashboard Network Panel

The Network monitor panel display a graph for each network interface card. (The number of network interface cards varies by the hardware model.) The graph displays the bytes transmitted, overlaid on the bytes received.

### Monitor dashboard - Network panel

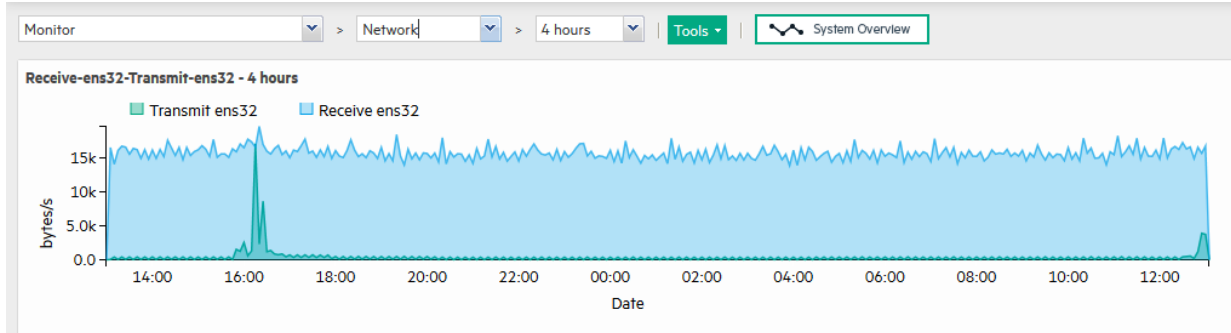

## Monitor Dashboard Logger Panel

The Logger monitor panel displays information about events, searches, and memory. JVM Memory Usage chart displays the memory used by the Logger's back-end server process. For example, this could be the memory used to perform the search after receiving the search query from the UI.

### Monitor dashboard - Logger panel

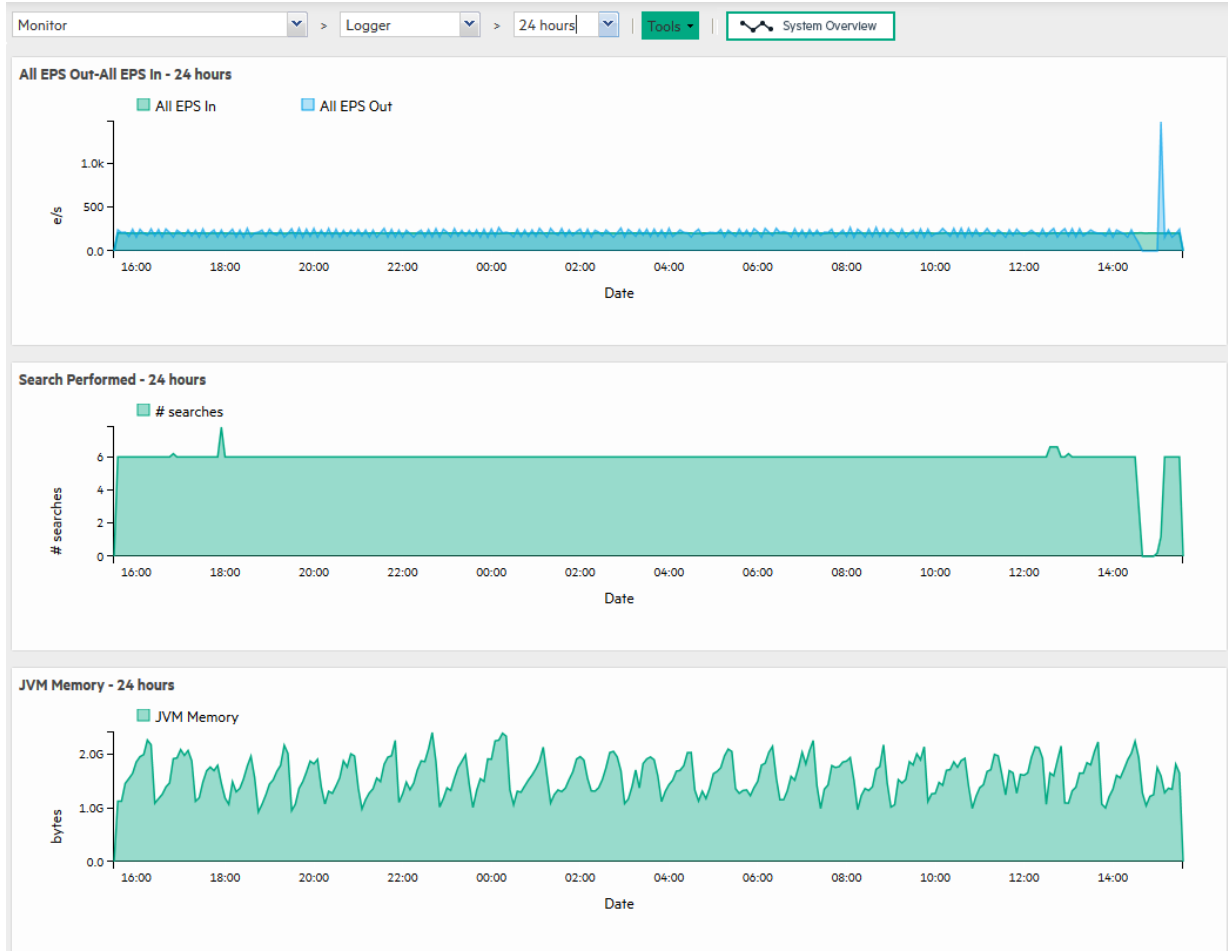



## Monitor Dashboard Forwarders Panel

The Forwarders monitor panel shows total Events per Second (EPS) sent and displays values for each configured forwarder. The list of forwarders includes all forwarders known to the system, including those that are disabled. To create a new forwarder, or to enable or disable one, see ["Forwarders" on page 321](#).

### Monitor dashboard - Forwarders panel

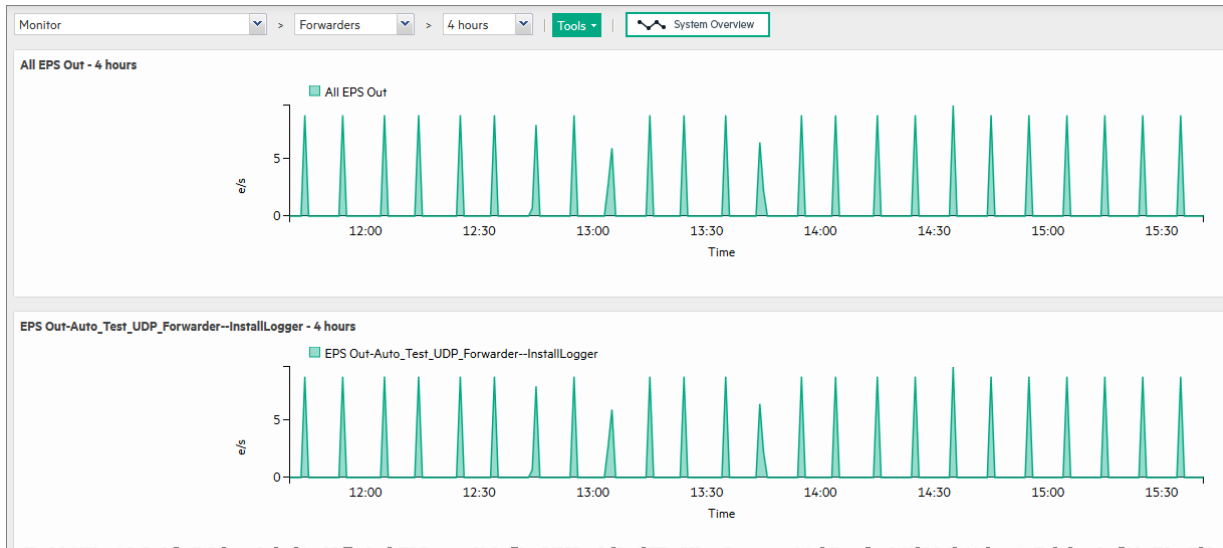

## Monitor Dashboard Storage Panel

The Storage monitor panel displays disk read and disk write information. The list of storage groups compares allocated and used space in each group. Space is used in 1 GB files so a 5 GB storage group appears 20% used as soon as it is set up. For more information about storage groups, see ["Storage Groups" on page 347](#).

### Monitor dashboard - Storage panel

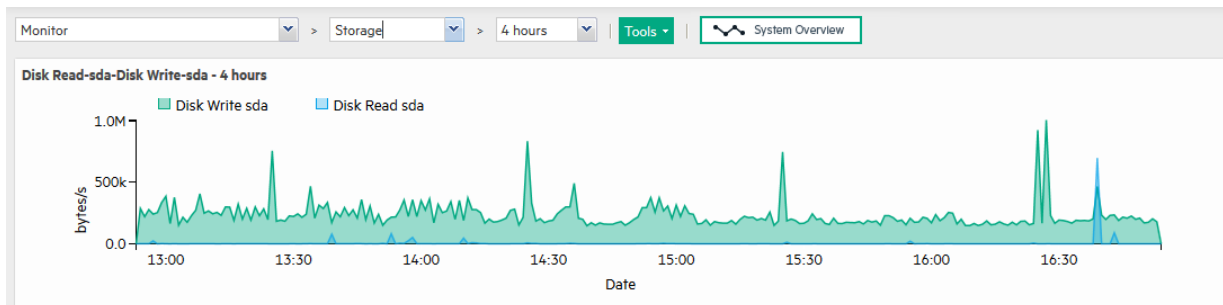

## The System Overview Dashboard

The System Overview dashboard provides an alternate view of several Monitor dashboard panels. This dashboard displays the CPU Usage, Platform Memory, Disk Read-sda, Disk Write-sda, Search Performed, Transmit-eth0, Receive-eth0, JVM Memory, All EPS In, and All EPS Out panels that you use to monitor your Logger. You can replace any of these panels with other Logger monitor panels to adjust the display to your needs.

To view the System Overview dashboard, open the Dashboards menu and click **System Overview** at the top of the Monitor Dashboard.

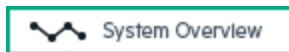

The System Overview dashboard displays.

### System Overview Dashboard, Light Background



The System Overview dashboard can be toggled between a dark or light background.

To change the background color, click the Switch Background icon (☾) in the top right.

## New Monitor Dashboard, Dark Background

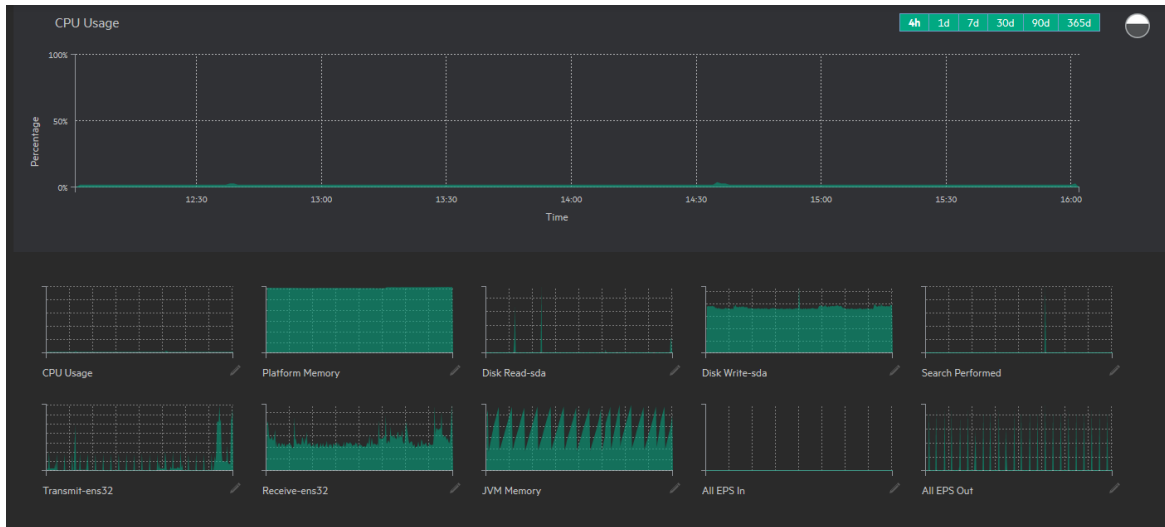



One Monitor panel is displayed in a large format at the top of the screen, the others are smaller and displayed in rows across the bottom.

- Click 4h, 1d, 7d, 30d, 90d, or 365d at the top of the large panel to adjust the displayed time range.
- Hover your pointer over a section on the large panel for more detail.
- Click a small panel on the bottom of the screen to move it to the large display at the top.
- You can display other monitor panels in place of the out-of-box panels.

**Note:** You can only display existing monitor panels; you cannot display search results or summary panels.

The Forwarder, Receiver and Storage panels available for display varies, based on your Logger configuration.

### To display a custom panel in place of one of the out-of-box panels:

1. Click the edit icon  next to the panel's name.
2. Start typing in the text box to see the list of available panels. For example, to display a receiver, start typing "re".
3. Click a panel in the list to select it, or click the cancel icon  to close the dialog without selecting another panel.

## The Intrusion and Configuration Events Dashboard

The Intrusion and Configuration Events dashboard displays information about the following types of configuration changes and intrusions on your system.

- Top Malicious Code Activity: displays the most active malicious code.
- Top Firewall Drops by Source: displays events in which traffic was dropped by a firewall.
- Configuration Changes by Product: shows products that have had their configurations modified.
- Windows Account Creations: shows user accounts created on Microsoft Windows operating systems.

### Intrusion and Configuration Events dashboard

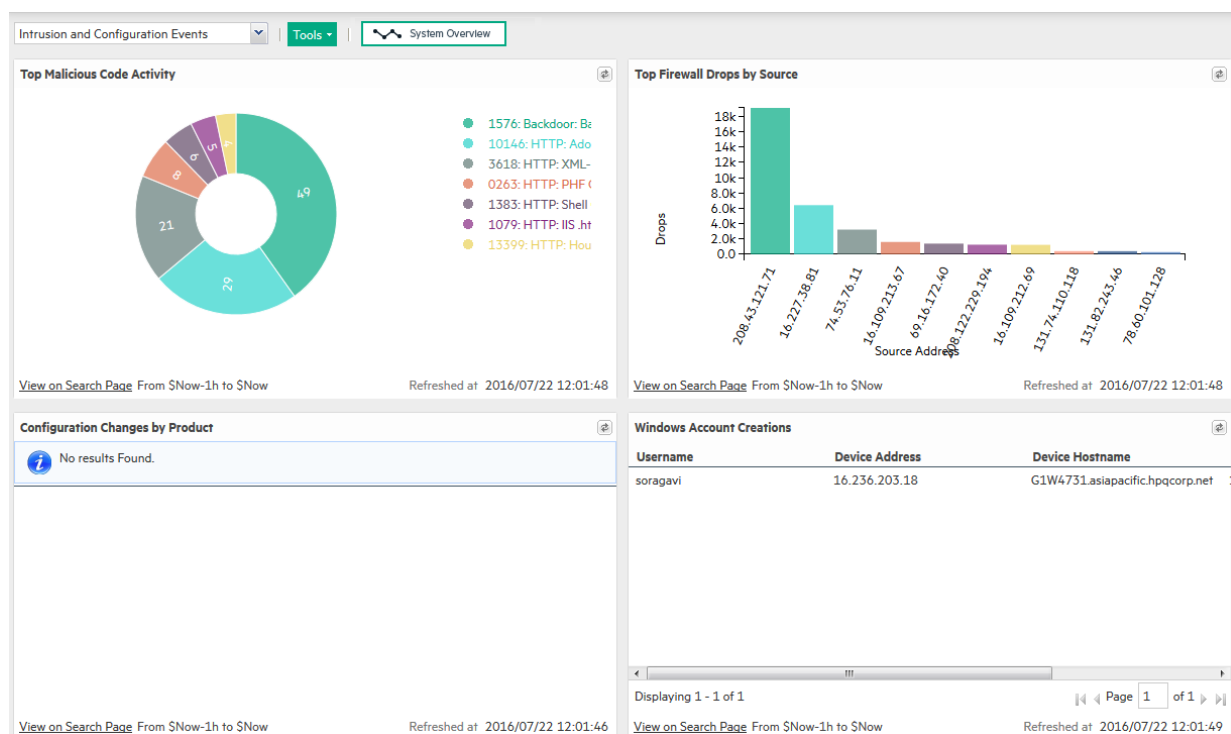

Each dashboard displays the search results of a Saved Search found in the standard system content along with the time and date the query was most recently refreshed.

While you cannot update the system content used in the out-of-box dashboard, you can then edit the search to meet your needs, save your changes, and use your new saved search in your own dashboard to find exactly what you are interested in. To create a new dashboard, follow the instruction in "[Creating and Managing Custom Dashboards](#)" on page 58.

**Note:** Dashboards that display charts are aggregated queries. Therefore, the entire search must complete before the chart is displayed. This can take some time if there are a large number of events.

- The dashboards are not automatically refreshed. Click refresh  to refresh the search results.
- Click **View on Search Page** to open the **Analyze > Search** page and run the Saved Search automatically.
- Click a chart value (a column, bar, or donut section) to drill down to events with specific field values. (Drill-down is not available for dashboards that display tables.)

## Chart Drill-Down

When you click on a chart value (a column, bar, or donut section), the query is rerun on the Analyze (Search) page with an additional WHERE operator clause that includes the field name and value you clicked on the chart.

The drill-down information includes a histogram and a table of the search results. You can drill down on the histogram for further information. For more information on drilling down on a histogram, see ["Histogram Drill Down" on page 115](#).

**Note:** The saved search query associated with the Search Results panel in the dashboard is not modified. If you need to return to the dashboard from the drill-down screen, use the Back function of your browser.

## The Login and Connection Activity Dashboard

The Login and Connection Activity dashboard displays information about the following types of login and connection activity on your system.

- **Top Failed Logins by Product:** displays the top failed logins sorted by device product.
- **Top Failed Logins by User:** displays the top failed logins sorted by user name.
- **SSH Authentications:** displays the users most frequently logging in or attempting to log in using SSH.
- **VPN Connections:** displays the users most frequently logging in or attempting to log in using a VPN connection.

### Login and Connection Activity Dashboard

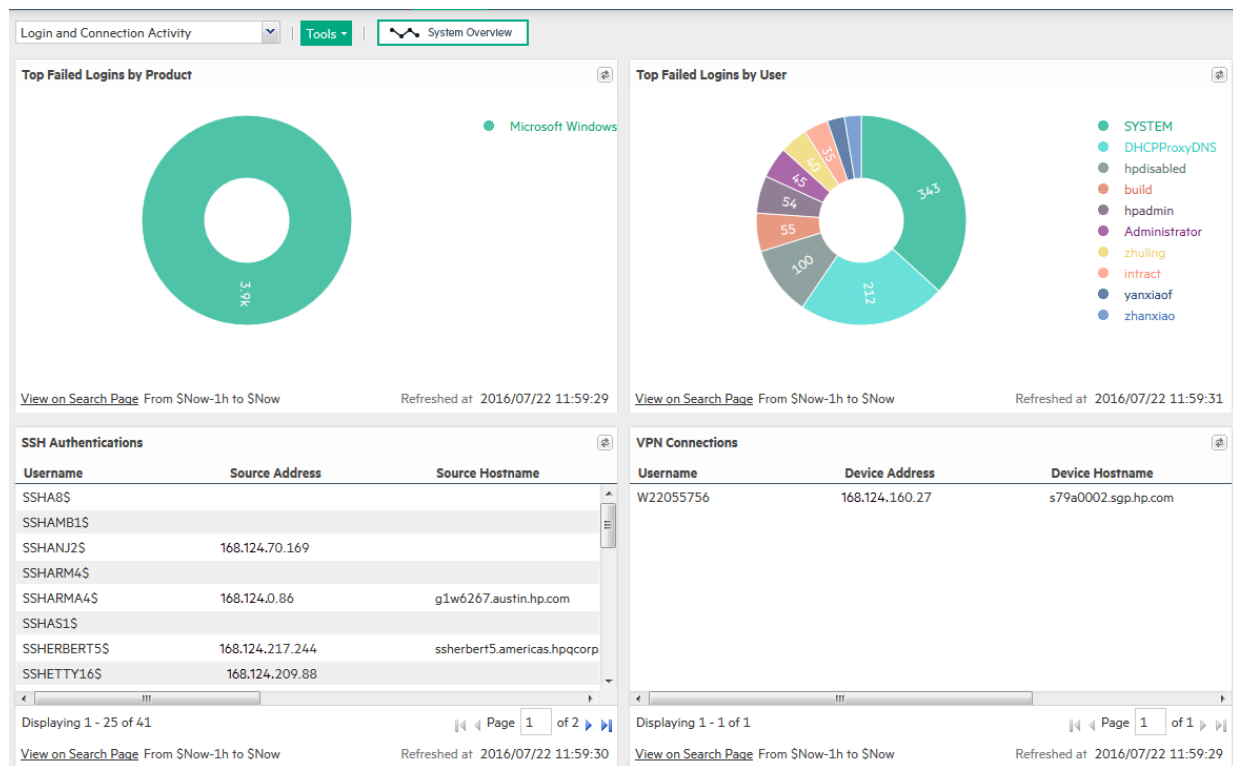

Each dashboard displays the search results of a Saved Search found in the standard system content along with the time and date the query was most recently refreshed.

While you cannot update the system content used in the out-of-box dashboard, you can then edit the search to meet your needs, save your changes, and use your new saved search in your own dashboard to find exactly what you are interested in. To create a new dashboard, follow the instruction in ["Creating and Managing Custom Dashboards"](#) on page 58.

**Note:** Dashboards that display charts are aggregated queries. Therefore, the entire search must complete before the chart is displayed. This can take some time if there are a large number of events.

- The dashboards are not automatically refreshed. Click refresh  to refresh the search results.
- Click **View on Search Page** to open the **Analyze > Search** page and run the Saved Search automatically.
- Click a chart value (a column, bar, or donut section) to drill down to events with specific field values. (Drill-down is not available for dashboards that display tables.)

## Chart Drill-Down

When you click on a chart value (a column, bar, or donut section), the query is rerun on the Analyze (Search) page with an additional WHERE operator clause that includes the field name and value you clicked on the chart.

The drill-down information includes a histogram and a table of the search results. You can drill down on the histogram for further information. For more information on drilling down on a histogram, see ["Histogram Drill Down" on page 115](#).

**Note:** The saved search query associated with the Search Results panel in the dashboard is not modified. If you need to return to the dashboard from the drill-down screen, use the Back function of your browser.

## The Event Count Dashboard

The Event Count dashboard displays information about the following types of event input and output activity on your system.

- **Individual Receivers:** displays the events received per receiver.
- **Individual Forwarders:** displays events forwarded per forwarder.
- **All Receivers:** displays the total events received by all receivers.
- **All Forwarders:** displays the total events forwarded by all forwarders.

### Event Count Dashboard

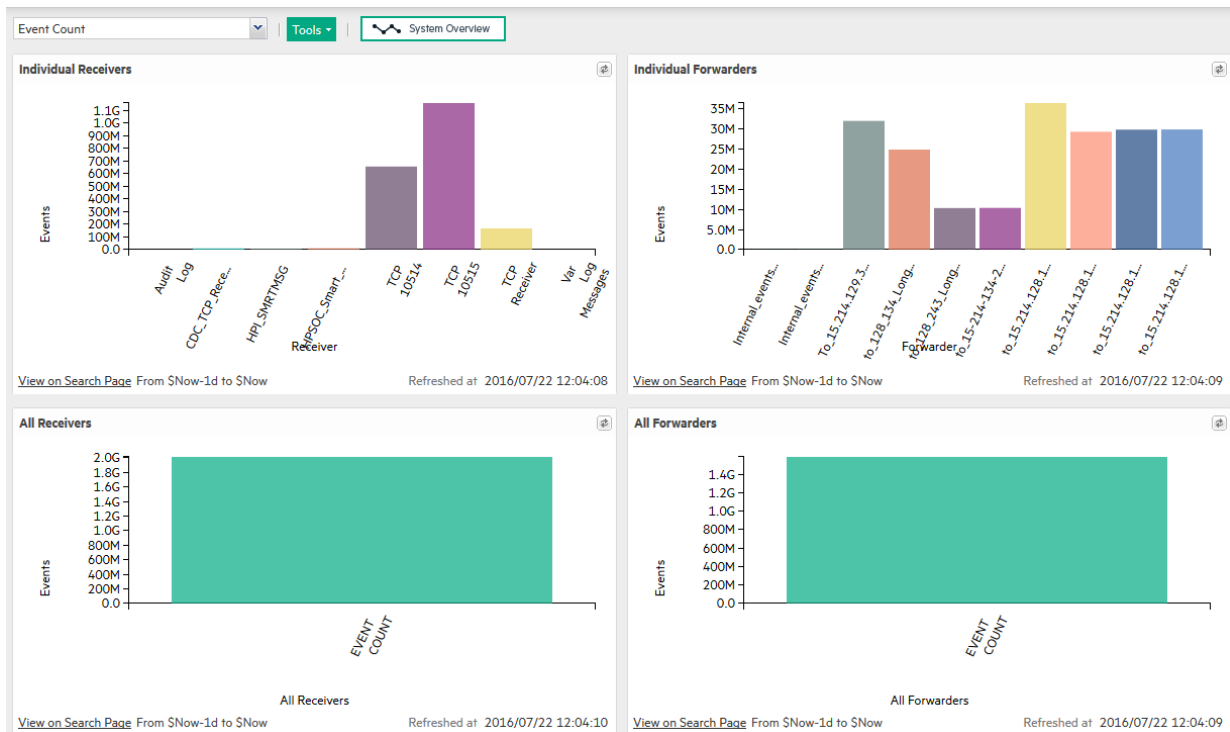

Each dashboard displays the search results of a Saved Search found in the standard system content along with the time and date the query was most recently refreshed.

While you cannot update the system content used in the out-of-box dashboard, you can then edit the search to meet your needs, save your changes, and use your new saved search in your own dashboard to find exactly what you are interested in. To create a new dashboard, follow the instruction in ["Creating and Managing Custom Dashboards" on page 58](#).

**Note:** Dashboards that display charts are aggregated queries. Therefore, the entire search must complete before the chart is displayed. This can take some time if there are a large number of events.

- The dashboards are not automatically refreshed. Click refresh  to refresh the search results.
- Click **View on Search Page** to open the **Analyze > Search** page and run the Saved Search automatically.
- Click a chart value (a column, bar, or donut section) to drill down to events with specific field values. (Drill-down is not available for dashboards that display tables.)

## Chart Drill-Down

When you click on a chart value (a column, bar, or donut section), the query is rerun on the Analyze (Search) page with an additional WHERE operator clause that includes the field name and value you clicked on the chart.

The drill-down information includes a histogram and a table of the search results. You can drill down on the histogram for further information. For more information on drilling down on a histogram, see ["Histogram Drill Down" on page 115](#).

**Note:** The saved search query associated with the Search Results panel in the dashboard is not modified. If you need to return to the dashboard from the drill-down screen, use the Back function of your browser.

## Custom Dashboards

A dashboard can contain a mix of Search Results, Monitor, and Summary panels. You can assemble various search queries that match events of interest to you, status of Logger resources such as receivers, forwarders, storage, CPU, and disk, or a combination of both on a single dashboard.

There is no limit on the number of Monitor and Summary panels you can add to a single dashboard; however, you can only add up to four Search Results panels.



## Sample Custom Dashboard

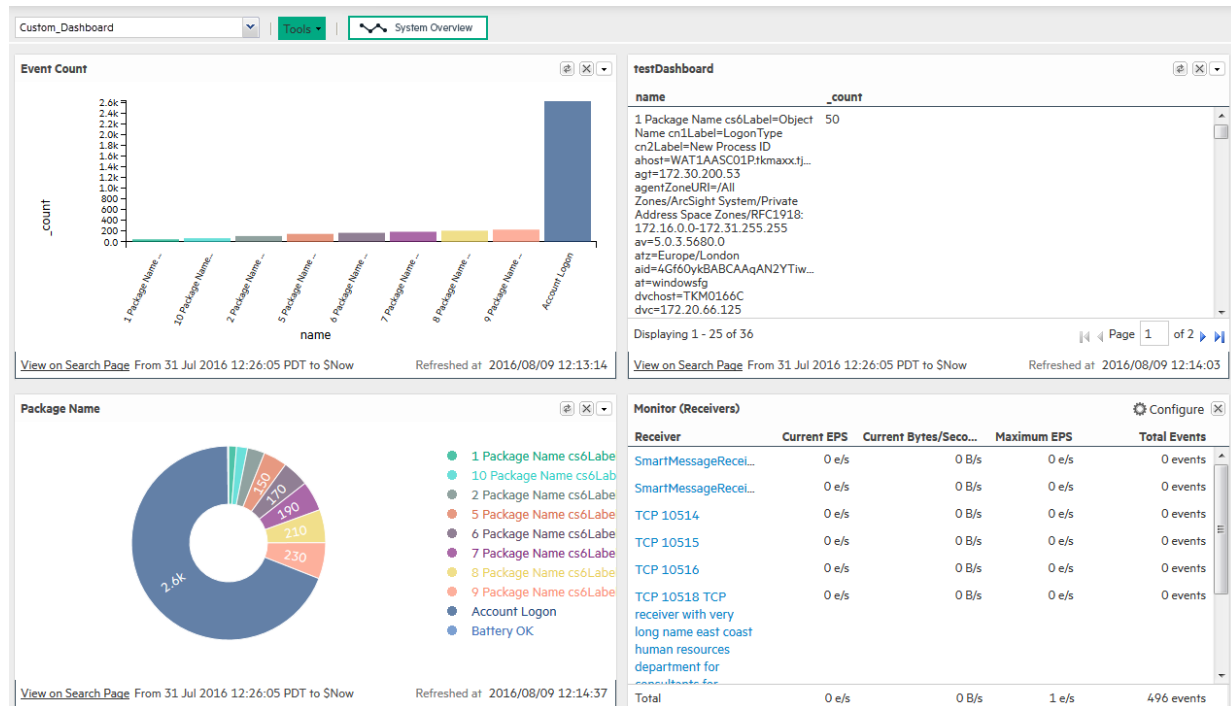

Each Search Results panel is associated with a saved search query. You can only associate saved search queries that contain an aggregation operator such as chart or top for this type of panel.

Click **View on Search Page** in the Search Results panels to go to the **Analyze > Search** page and view the event details; the panel query is automatically run and the search results are displayed.

Additionally, you can drill down from any chart to quickly filter down to events with specific field values. To do so, identify the value in the chart on a Search Results Chart panel and click it to drill down to events that match the value.

When you click on a chart value (a column, bar, or donut section), the query is rerun on the Analyze (Search) page with an additional WHERE operator clause that includes the field name and value you clicked on the chart.

**Note:** Dashboards that display charts are aggregated queries. Therefore, the entire search must complete before the chart is displayed. This can take some time if there are a large number of events.

- The dashboards are not automatically refreshed. Click refresh  to refresh the search results.
- Click **View on Search Page** to open the **Analyze > Search** page and run the Saved Search automatically.
- Click a chart value (a column, bar, or donut section) to drill down to events with specific field values. (Drill-down is not available for dashboards that display tables.)

## Chart Drill-Down

When you click on a chart value (a column, bar, or donut section), the query is rerun on the Analyze (Search) page with an additional WHERE operator clause that includes the field name and value you clicked on the chart.

The drill-down information includes a histogram and a table of the search results. You can drill down on the histogram for further information. For more information on drilling down on a histogram, see ["Histogram Drill Down" on page 115](#).

**Note:** The saved search query associated with the Search Results panel in the dashboard is not modified. If you need to return to the dashboard from the drill-down screen, use the Back function of your browser.

## Creating and Managing Custom Dashboards

The options displayed in the **Dashboards > Tools** menu vary depending on your permissions.

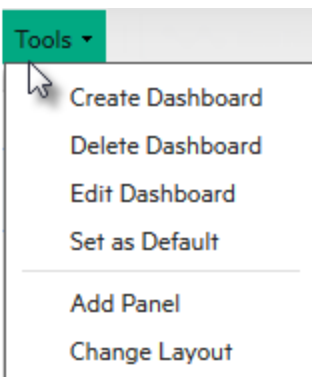

You need these privileges (in the Logger Rights group) to perform dashboard operations:

- Use and view dashboards
- Edit, save, and remove dashboards

With these permissions, you can create a dashboard (see ["Adding a Custom Dashboard" on the next page](#)), and add panels to the dashboard you created. (see ["Adding and Managing Panels in a Dashboard" on page 60](#)).

**Tip:** If you are adding a Search Results panel, the saved search must exist. If no saved searches exist, the Search Results panel option is not displayed.

## Adding a Custom Dashboard

### To add a dashboard:

1. Open the **Dashboards** menu.
2. Click the **Tools** pull-down menu and select **Create Dashboard**.
3. Enter a meaningful name for the dashboard in the **Name** field.
4. Select whether the dashboard **Type** is Private or Shared.

The private dashboards are only visible to the user who created them, and the shared dashboards are visible to all Logger users; however, they will not see the information to which they do not have privileges.

5. Click **Create**.

After creating the dashboard you must add panels to it, as described in ["Adding and Managing Panels in a Dashboard" on the next page](#).

## Editing a Custom Dashboard

The Edit Dashboard page allows you change the name and privacy settings for a custom dashboard. To add or edit dashboard panels, see ["Adding and Managing Panels in a Dashboard" on the next page](#).

The privacy options are:

- Private — Only you can see your dashboard.
- Shared — All Logger users can see your dashboard; however, they will not see the information to which they do not have privileges.

For example, if a user does not have privileges to a storage group and a panel in a Shared dashboard includes a query that accesses the events in that storage group, the panel will be blank when the user accesses the shared dashboard.

### To edit a dashboard:

1. Open the **Dashboards** menu.
2. Click the **Tools** pull-down menu and select **Edit Dashboard**.
3. If you want to change the name of the dashboard, enter a new name in the **Name** field.
4. If you want to change the privacy setting of the dashboard, select the appropriate setting from the **Type** pull-down menu, and click **Save**.
5. To add or edit dashboard panels, see ["Adding and Managing Panels in a Dashboard" on the next page](#).

## Deleting a Custom Dashboard

### To delete a dashboard:

1. Open the **Dashboards** menu.
2. Select the dashboard that you want to delete.
3. Click the **Tools** pull-down menu and select **Delete Dashboard**.
4. Click **Yes** to confirm your action in the confirmation message, or click **No** to exit without making a change.

## Adding and Managing Panels in a Dashboard

After you create a dashboard, you need to add panels to display the information you want to see. A dashboard can contain a mix of Search Results, Monitor, and Summary panels. There is no limit on the number of Monitor and Summary panels you add to a single dashboard; however, you can only add up to four Search Results panels for optimum performance.

Before you can add panels to a dashboard, you must first create the dashboard. See ["Creating and Managing Custom Dashboards" on page 58](#) for more information.

You can add the following types of panels:

- Search Results: Chart and Table
- Monitor: All four types available under the default Monitor dashboard
- Summary: All four types available under the default Summary dashboard and user-defined Summary panels.

## Adding a Panel to a Dashboard

### To add a panel to a dashboard:

1. Open the **Dashboards** menu.
2. Select the dashboard to which you want to add the panel.
3. Click the **Tools** pull-down menu and select **Add Panel**.
4. Configure these parameters and click **Add**.

Parameter	Description
Type	<p>Select the type of panel:</p> <ul style="list-style-type: none"> <li>• Search Results (Chart): Displays search results in a chart form.</li> <li>• Search Results (Table): Displays search results in a table form.</li> <li>• Monitor (Graph): Displays a graph of the selected resource.</li> <li>• Monitor (Forwarders): Displays forwarder information in a table form.</li> <li>• Monitor (Receivers): Displays receiver information in a table form.</li> <li>• Monitor (Storage Groups): Displays storage group information in a table form.</li> <li>• Summary (Agent Severities): Displays event summary categorized by agent severities configured on your Logger.</li> <li>• Summary (Agent Types): Displays event summary categorized by receivers configured on your Logger.</li> <li>• Summary (Receivers): Displays event summary categorized by receivers configured on your Logger.</li> <li>• Summary (Devices): Displays event summary categorized by devices configured on your Logger.</li> <li>• Summary (User Defined): Displays event summary categorized by the field you select when adding the panel.</li> </ul> <p><b>Note:</b> If no saved search queries exist on your Logger, the “Saved Search” panel types are not available as selections in the pull-down menu.</p>
Title	<p>Enter a meaningful name for the panel.</p> <p>A default name is present in this field, but you can change it.</p>
Graph	<p>Only applicable to Monitor Graph panels.</p> <p>Select the type of graph you want the panel to display. Some of the available options are CPU Usage - 4 hour, Platform Memory Usage - Daily, and Disk Read-Write - Weekly.</p>
Saved Search	<p><i>Only applicable to Search panels.</i></p> <p>Select the saved search query to use for searching events that will be displayed in the panel.</p>
Chart Type	<p><i>Only applicable to Search Result Chart panels.</i></p> <p>Type of chart to display matching events. You can select from:        Column, Bar, Donut, Area, Line, Stacked Column, Stacked Bar.        Default: Column</p>
Chart Limit	<p><i>Only applicable to Search Result Chart panels.</i></p> <p>Number of unique values to plot. Default: 10</p>
Field Name	<p><i>Only applicable to Summary (User Defined) panels.</i></p> <p>The event field name by which the event summary on a Summary panel will be categorized.        Default: agentSeverity</p>



## Editing a Dashboard Panel

Once you add a panel to a dashboard, whether you can edit it depends on the type of panel. You can edit the Search Results panels and the user-defined Summary panels; the Monitor panels and some of the Summary panels are not editable.

The following table lists the panels you can edit and what you can edit in them.

Action	Description
<b>All Panels</b>	
Delete	Removes a panel from a dashboard.
<b>Search Result Panels</b>	
Edit Panel	Change Title, associated saved search, Chart Type, or Chart Limit
Edit Saved Search	Access the Edit Saved search page to edit the associated saved search query
View on Search Page	Runs the panel's query on the Search Results page (Analyze > Search) and displays matching events on that page
Refresh	Refreshes the current contents of the panel. <b>Note:</b> All other panel types are automatically refreshed; therefore, an explicit refresh is not required for them.
<b>Summary Panels - User Defined</b>	
Edit Panel	Change Title or field name by which events are categorized.

### To edit a panel:

1. Open the **Dashboards** menu.
2. Select the dashboard that contains the panel you want to edit.
3. If you are editing a user-defined Summary panel:
  - a. Click the Edit () icon.
  - b. Edit the title, field name, or both.
4. If you are editing a Search Result panel:
  - a. Click the () icon.
  - b. Select **Edit Panel** if you want to edit the panel title, select a different saved search; or, if applicable, chart type or chart limit.
  - c. Select **Edit Saved Search** if you want to access the Edit Saved Search page (**Configuration | Search > Saved Searches**) to edit the saved search query.
5. Click **Save**.

## Deleting a Dashboard Panel

### To delete a panel from a dashboard:

You cannot delete panels from the default Monitor dashboard or the default Summary dashboard. However, Monitor and Summary panels added to the dashboards you created under the Dashboards menu option can be deleted.

1. Open the **Dashboards** menu.
2. Select the dashboard that contains the panel you want to delete.
3. Click the (✕) icon.
4. Click **Yes** to confirm your action in the confirmation message, or click **No** to exit without making a change.

## Changing the Layout of a Dashboard

### To change the layout of a dashboard:

You can only change the layout of the dashboards you create. The Monitor dashboard layout cannot be changed.

1. Open the **Dashboards** menu.
2. Select the dashboard that contains the panel you want to rearrange.
3. Click the **Tools** pull-down menu and select **Change Layout**.
4. Point your cursor in the blue band that shows the panel title and drag the panel to a different position.
5. Click **Save** after you rearrange the panels.

## Setting a Default Dashboard

When you set a dashboard as default, it is the default dashboard screen that displays when you navigate to the Dashboards menu. This setting is user-specific; therefore, your default dashboard can be different from that of another user.

The Summary page (accessible from the Summary navigation option in the top-level menu bar) is the default home page for all Logger users. That is, unless another page has been selected as your home page, the Summary page is displayed when you first log in.

You can configure Logger to display a specific dashboard as your home page, including one your created.

**To select a specific dashboard as your home page:**

1. Select the **Dashboard** option when configuring the Personal **Default start page for <username>**, following the instructions in "[Logger Options](#)" on page 36.
2. Open the **Dashboards** menu.
3. Select the dashboard that you want to configure as default.
4. Click the **Tools** pull-down menu and select **Select as Default**.
5. Click **Yes** to confirm your action in the confirmation message, or click **No** to exit without making a change.



# Chapter 3: Searching and Analyzing Events

When you want to analyze events matching specific criteria, include them in a report, or forward them to another system such as ArcSight ESM, you need to search for them. To search for events, you create queries. The queries you create can vary in complexity based on your needs. Queries can be simple search terms or they can be complex enough to match events that include multiple IP addresses or ports, and that occurred between specific time ranges from a specific storage group.

The following topics describe how to search for specific events in Logger. They discuss the methods available for search, how to query for events, how to save a defined query and the events that the query finds for future use. They also describe how to set up alerts to notify particular users when Logger receives events that match specified criteria.

- [The Process of Searching Events](#) ..... 65
- [Understanding Search Field Colors](#) ..... 68
- [Elements of a Search Query](#) ..... 69
- [Using the Advanced Search Builder](#) ..... 90
- [Search Analyzer](#) ..... 94
- [Regex Helper Tool](#) ..... 96
- [Search Helper](#) ..... 98
- [Searching for Events](#) ..... 102
- [The Search Results Display](#) ..... 112
- [Saving the Search Results](#) ..... 125
- [Saving Queries \(Creating Saved Searches and Saved Filters\)](#) ..... 129
- [Enriching Logger Data Through Static Correlation](#) ..... 138
- [Indexing](#) ..... 138
- [Viewing Alerts](#) ..... 141
- [Live Event Viewer](#) ..... 142

## The Process of Searching Events

The search process uses an optimized search language that allows you to specify multiple search commands in a pipeline format. In addition, you can customize the display of search results, view search results as charts, and so on.

The most straightforward way to run a search is to enter the keywords or information you are searching for (the query) in the Search text box, select the time range, and click **Go!** You can enter a simple keyword, such as, `hostA.companyxyz.com` or a complex query that includes Boolean expressions,

keywords, fields, and regular expressions. The system searches for data that matches the criteria you specified and displays the results in color-coded columns indicating its index status. For more information, see ["Understanding Search Field Colors" on page 68](#).

## Logger Search Page

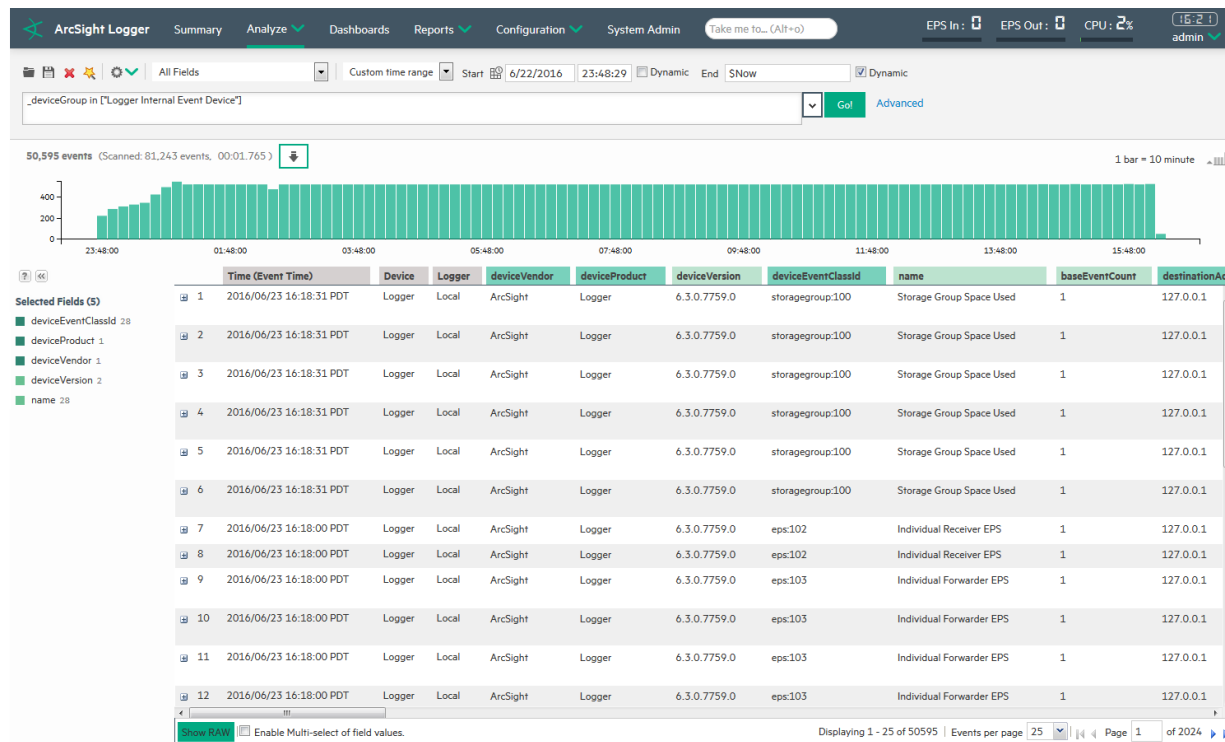

The search results are displayed in the table and as a histogram as soon as they are returned, even if the query has not finished scanning all data. For an example, see ["Simple Query Example" on the next page](#).

You can also add a chart to your search to display the most important information in a more meaningful fashion. Charts are not displayed until all the data is returned. For an example, see ["Chart Query Example Using a Chart" on the next page](#).

There are several convenient ways to enter a search query. You can type the query in the Search text box, use the Search Builder tool to create a query, click a field in the current search results, or use a previously saved query (referred to as a filter or saved search).

When you type a query, the Search Helper provides suggestions and possible matches to help you build the query expression. (See ["Search Helper" on page 98](#) for more information.)

In addition to typing the query in the Search text box, you can do the following:

- Create queries by using the Advanced Search tool. For more information, see ["Using the Advanced Search Builder" on page 90](#).
- Save queries and use them later. For more information, see ["Saving Queries \(Creating Saved Searches and Saved Filters\)" on page 129](#).

- Create new queries from the predefined queries that come with your system. For more information, see "System Filters/Predefined Filters" on page 131.

Although a search query can be as simple as a keyword, you will be better able to utilize the full potential of the search operation if you are familiar with all the elements of a query, as described in "Elements of a Search Query" on page 69.

## Simple Query Example

This example query finds events containing the word "Logger." Type Logger in the search box and then click **Go!**

The screenshot shows the ArcSight Logger search interface. At the top, there is a navigation bar with tabs for Summary, Analyze, Dashboards, Reports, Configuration, and System Admin. Below the navigation bar, there is a search box containing the text "Logger" and a "Go!" button. The search results are displayed as a bar chart and a table. The bar chart shows the distribution of events over time, with a peak around 12:35:00 and 20:35:00. The table below the chart lists the top 5 events, with columns for Time (Event Time), Device, Logger, deviceVendor, deviceProduct, deviceVersion, deviceEventClassId, and name.

	Time (Event Time)	Device	Logger	deviceVendor	deviceProduct	deviceVersion	deviceEventClassId	name
1	2016/08/04 10:17:52 PDT	Logger	Local	ArcSight	Logger	L7800	network:200	Number
2	2016/08/04 10:17:52 PDT	Logger	Local	ArcSight	Logger	L7800	memory:100	Platform
3	2016/08/04 10:17:52 PDT	Logger	Local	ArcSight	Logger	L7800	cpu:100	CPU Us
4	2016/08/04 10:16:27 PDT	Logger	Local	ArcSight	Logger	L7800	platform:230	Success
5	2016/08/04 10:15:10 PDT	Logger	Local	ArcSight	Logger	6.3.0.7800.0	storagegroup:100	Storage

## Chart Query Example Using a Chart

Aggregated search operators such as chart, top, and rare generate charts of search results. This example query finds events containing the word "Logger" and charts the top ten events by the contents of the name field. Type the following query in the search box and then click **Go!**

Logger | top deviceEventClassId

A chart similar to this one displays.

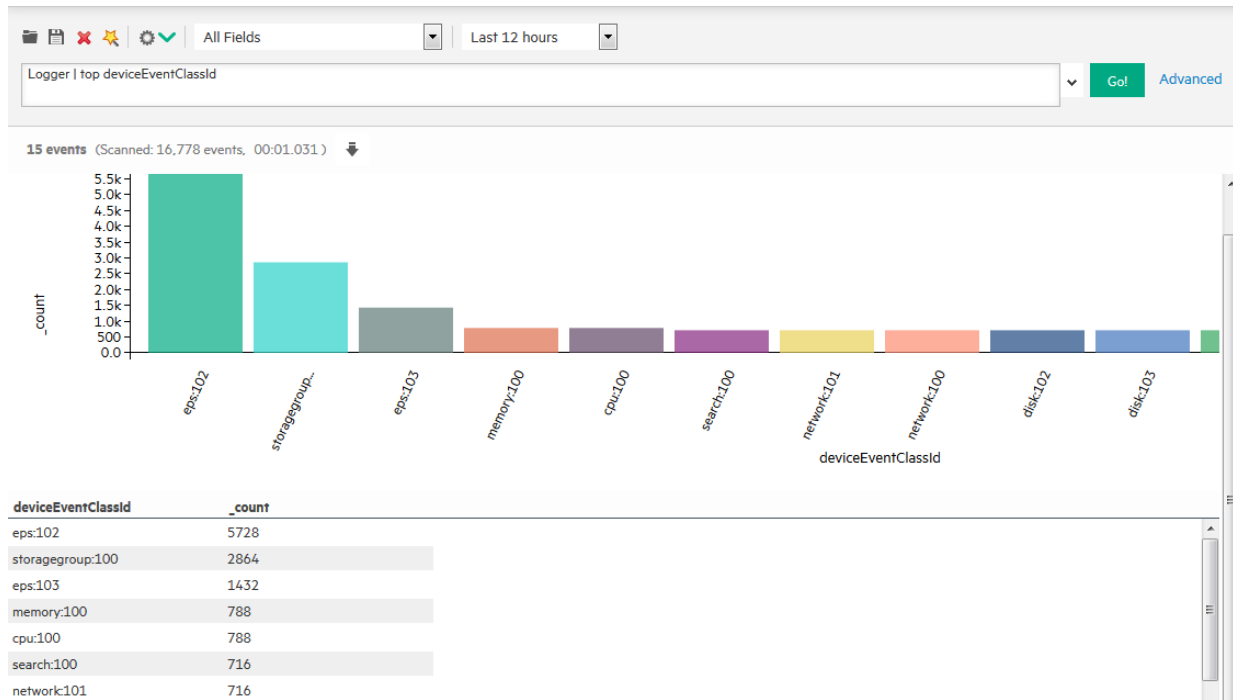

For more information on the search operators, see ["Search Operators" on page 471](#). For more information on creating and using charts, see ["Chart Drill Down" on page 120](#) and ["Refining and Charting a Search from Field Summary" on page 124](#).



## Understanding Search Field Colors

Each column in the Search Results table is color-coded to show what type of field it contains, and whether or not the field has been indexed. Colored column labels can help you refine your searches for the fastest results.

	Time (Event Time)	Device	Logger	deviceVendor	deviceProduct	deviceVersion	deviceEventClassId	name
1	2016/07/15 13:20:15 PDT	Logger	Local	ArcSight	Logger	L7780	platform:230	Successful login
2	2016/07/15 13:18:23 PDT	Logger	Local	ArcSight	Logger	L7780	network:200	Number of Apache Connections
3	2016/07/15 13:18:23 PDT	Logger	Local	ArcSight	Logger	L7780	memory:100	Platform Memory Usage

Field type icons will also display on Logger pages where search Fields are used, such as the Field set editor, the default Fields page, and search auto-complete.

Icon	Column Color	Field Type	Can Field be Indexed?
	Dark green	Super indexed	Indexed by default
	Green	Indexed	Indexed by default

Icon	Column Color	Field Type	Can Field be Indexed?
	Light green	Logger Common Event Format (CEF), including custom fields	Yes (indexable)
	Light gray	Metadata	No
	No color	Non-Logger CEF	No

## Elements of a Search Query

A simple search query consists of a query expression, a time range and a field set. An advanced Logger search query can also include constraints that limit the search to specific device groups, storage groups, and peer Loggers.

- [Query Expressions](#) .....69
- [Time Range](#) .....76
- [Fieldsets](#) .....79
- [Constraints](#) .....84
- [Syntax Reference for Query Expressions](#) .....85

## Query Expressions

A query expression is a set of conditions used to select events when a search is performed. An expression can specify a very simple term to match such as “login” or an IP address; or it can be more complex enough to match events that include multiple IP addresses or ports, and that occurred between specific time ranges from a specific storage group.

Specify the query in the Search text box by using the following syntax:

<Indexed Search> | <Search Operators>

The query expression is evaluated from left to right in a pipeline fashion. First, events matching the specified Indexed Search portion of the query are found. The search operator after the first pipe (“|”) character is then applied to the matched events followed by the next search operator, and so on to further refine the search results.

The search results table and the histogram display the events that match the query as they are found. As additional events are matched, the search results table and the histogram are refreshed. Certain search operators such as head and tail, require a query to finish running before search results can be displayed.

- The indexed search section of the query is described in ["Indexed Search Portion of a Query" on the next page](#).

- The search operator portion of the query is described in ["Search Operator Portion of a Query" on page 76](#).
- Additional points to take into consideration when writing queries are described in ["Things You Should Know About Logger Searches" on page 106](#).

## Indexed Search Portion of a Query

The Indexed Search section of the query uses fields to search for relevant data quickly and efficiently. You can use a search expression to specify keywords to search for in the event text or to search using field-based expressions in a Boolean format.

### Keyword Search (Full-text Search)

Keywords are simply the words you want to search for, such as failed, login, and so on. You can specify multiple keywords in one query expression by using Boolean operators (AND, OR, or NOT) between them. Boolean expressions can be nested, for example, ( John OR Jane ) AND Doe\*. If you need to search for the literal occurrence of AND, OR, or NOT (in upper-, lower-, or mixed case), enclose them in double quotes (“ ”) so the search engine does not interpret them as operators. For example, “and”, “Or”, and so on.

**Note:** Although the Boolean operators AND, OR, and NOT can be specified in upper-, lower-, or mixed case when used as an operator, HPE recommends that you use uppercase for ease of reading the query.

### Guidelines for Writing Keyword Search Expressions

Follow these guidelines when specifying keyword search expressions:

- Follow the requirements described in ["Syntax Reference for Query Expressions" on page 85](#).
- Additional points to take into consideration when writing queries are described in ["Things You Should Know About Logger Searches" on page 106](#).
- Keyword search is not case sensitive.
- Use Boolean operators (AND, OR, or NOT) to connect multiple keywords. If no Boolean operator is specified between two keywords, the AND operator is applied by default. Also, use the Boolean operators to connect keywords to fields you specify.
- Use double quotes (“ ”) to enclose a single word for an exact match. Otherwise, the word is treated as <search string>\*. For example, to search for log, type “log”. If you type log (without the double quotes), the search will match all words that begin with log; for example, log, logger, logging, and so on.
- When specifying Boolean operators (AND, OR, or NOT) as keywords, enclose them in double quotes (“ ”). For example, “AND”.

- Use the backslash (\) as an escape character for \, ", and \*. However, backslash will not escape these characters if the keyword is enclosed in double quotes.

The following table summarizes how special characters are treated in a keyword search.

### Using Special Characters in Keyword Searches

Character	Usage												
Space Tab Newline , ; ( ) [ ] { } "   *	You <b>cannot</b> specify keywords that contain the characters in the left column. Therefore, to search for a phrase such as <i>failed login</i> , enter "failed" AND "login".  <b>Note:</b> * is a valid character for wildcard character searches.												
= : / \ @ - ? # \$ & _ % > < !	To specify a keyword that contains any of the characters in the left column, enclose the keyword in <b>double quotes</b> (" "). You can also specify an asterisk (*) at the end of the keyword for an exact match.  Examples: <ul style="list-style-type: none"> <li>• "C:\directory"</li> <li>• "result=failed"</li> </ul>												
* asterisk	You can use the wildcard character asterisk (*) to search for keywords, however, the wildcard cannot be the leading character in the keyword. Therefore, the following usages are valid: <table border="1" data-bbox="402 974 1421 1083"> <tbody> <tr> <td>log*</td> <td>log\*</td> <td>"log**"</td> <td>log\\*</td> </tr> <tr> <td>log*app</td> <td>log*app</td> <td>log*app*app</td> <td></td> </tr> </tbody> </table> However, the following usages are not valid: <table border="1" data-bbox="402 1136 1421 1184"> <tbody> <tr> <td>*log</td> <td>*log*app*</td> <td></td> <td></td> </tr> </tbody> </table>	log*	log\*	"log**"	log\\*	log*app	log*app	log*app*app		*log	*log*app*		
log*	log\*	"log**"	log\\*										
log*app	log*app	log*app*app											
*log	*log*app*												

### Field-Based Search

The Logger schema contains a predefined set of fields. You can add fields that are relevant to the events you collect on your Logger to its schema. A field-based search can only contain fields in Logger's schema. ["Adding Fields to the Schema" on page 377](#).

The Logger indexing capability allows schema *fields* to be indexed. Logger's search operation and reports utilize the indexed fields to yield significant search and reporting performance gains. Although you can include both indexed and non-indexed fields to a search query, search and reporting performance will be much faster if all fields in a query are indexed. For more information and a list of fields you can index, see ["Indexing" on page 138](#). For discussion on field-based query performance, see ["Performance Optimizations for Indexed Fields in Queries" on page 95](#).

The field operators you can use in a query expression are listed in the table below. In addition to the field operators, you can use search operators, as discussed in ["Search Operator Portion of a Query" on page 76](#).

You can specify multiple field conditions in one query expression by using the listed operators between them. The conditions can be nested; for example, (name="John Doe" OR name="Jane Doe") AND message!="success".

**Note:** If a query includes the Boolean operator OR and the metadata identifiers (discussed in ["Constraints" on page 84](#)), the expression to be evaluated with OR must be enclosed in parentheses, as shown in this example:

```
(success OR fail) _storageGroup IN ["Default Storage Group"]
```

If the expression is not enclosed in parentheses, an error message displays.

Any literal operator in the table can be specified in upper-, lower-, or mixed case. To search for these words as literals in events, enclose them in double quotes (""). For example, message CONTAINS "Between".

- To determine the data type of a field, see ["Default Fields" on page 281](#).
- To determine the size of a custom field, see ["Custom Fields" on page 283](#).

### Using Operators in Field-Based Searches

Operator	Example	Notes
AND	name="Data List" AND message="Hello" AND 1.2.3.4	Valid for all data types.
OR	(name="TestEvent" OR message="Hello") AND type=2 AND 1.2.4.3	Valid for all data types.
NOT	NOT name="test 123"	Valid for all data types.
!=	destinationPort != 100 message!="failed login" message!=failed*login (* means wildcard) "test" message!=failed\*login (* is literal in this case)	Valid for all data types.
=	bytesIn = 32 message="failed login" message="failed*login" (* means wildcard)	Valid for all data types.  The size of each field in the schema is predetermined. If the string you are searching for is longer than the field-length, you should use a STARTSWITH rather than an = search, and include no more than the number of characters in the field size. To determine the size of a default field, see <a href="#">"Default Fields" on page 281</a> . To determine the size of a custom field, see <a href="#">"Custom Fields" on page 283</a> .



### Using Operators in Field-Based Searches, continued

Operator	Example	Notes
>*	bytesIn > 100	Valid for all data types.
<*	startTime < "\$Now - 1d"	* These operators evaluate the condition lexicographically. For example, deviceHostName BETWEEN AM AND EU searches for all devices whose names start with AM, AMA, AMB, AN, AO, AP and so on, up to EU. Therefore, any device whose name starts with AK, AL, and so on is ignored. Similarly, devices with names EUA, EUB, FA, GB, and so on will be ignored.
>=*	endTime >="01/13/2015 07:07:21"  endTime >="2015/13/01 00:00:00 PDT"  endTime >="Sep 10 2015 00:00:00 PDT"	
<=*	startTime <=" \$Now - 1d"	
IN*	priority IN [2,5,4,3]  destinationAddress IN ["192.0.2.4", "192.0.2.14"]  _deviceGroup IN ["DM1"]  _storageGroup NOT IN ["Internal Event Storage Group", "SG1"]  _peerLogger IN ["192.0.2.10", "192.0.2.11"]	
BETWEEN*	priority BETWEEN 1 AND 5	
STARTSWITH	message STARTSWITH "failed"	Valid for string (text) data types only.
ENDSWITH	message ENDSWITH "login"	Valid for string (text) data types only.

### Using Operators in Field-Based Searches, continued

Operator	Example	Notes
CONTAINS	message CONTAINS "foobar"	Valid for string (text) data types only.
IS	sessionId IS NULL sessionId IS NOT NULL	Valid for all data types.
INSUBNET	sourceAddress insubnet "192.0.2.*"  agentAddress insubnet "192.0.*.*" AND NOT deviceAddress insubnet "192.0.2.*"  agentAddress insubnet "192.0.2.1-192.0.2.24"  agentAddress insubnet "192.0.1.0-192.0.2.0" AND NOT deviceAddress insubnet "198.51.100.0/24"  agentAddress insubnet "192.0.*.*" AND NOT deviceAddress insubnet "192.0.2.*"  agentAddress insubnet "192.0.2.0/24" AND deviceAddress insubnet "198.51.100.0/24"  agentAddress insubnet "192.0.2.0/16" AND deviceAddress insubnet "198.51.100.*"	Filters IP addresses based on subnets in address fields such as sourceAddress, deviceAddress, and destinationAddress.  You can specify a subnet in one of the following ways: <ul style="list-style-type: none"> <li>• In CIDR notation: "address/prefix-length", such as 192.0.2.23/24,</li> <li>• As an address range: "address1-address2", such as 192.0.2.0-192.0.2.255.</li> <li>• As a wildcard expression where one or more asterisks replace data on the right-hand side of an address, such as 192.0.2.*.</li> </ul>

### Field-Based Search Expression Guidelines

Follow these guidelines when specifying field-based search expressions:

- Follow the requirements described in ["Syntax Reference for Query Expressions" on page 85](#).
- Addition points to take into consideration when writing queries are described in ["Things You Should Know About Logger Searches" on page 106](#).
- For faster searches, follow the recommendations in ["Searching for Rare Field Values" on page 109](#) and ["Tuning Search Performance" on page 108](#).
- By default, field-based search is case sensitive. You can change the sensitivity from the Field Search Options section of the [Configuration | Search > Search Options](#) page. For more information, see ["Search Options" on page 277](#).

- You can specify any predefined Logger schema field. For example, `cat = /Monitor/CPU/Usage`. For a complete list, see ["Indexing" on page 138](#).
- You can specify any custom field you have added to the schema. For example, `SSN=333-333-3333`. For more information about custom schema fields, see ["Adding Fields to the Schema" on page 377](#).
- You cannot specify user-defined fields created through a predefined or user-defined parser in the Indexed Search portion of a query. (The Indexed Search portion of a query is the expression before the first pipeline character.)
- A query expression (Indexed Search | Search Operators) is evaluated from left to right in a pipeline fashion. By design, a parser—predefined or user-defined—is applied to an event when the Search Operators are processed in a search query. Therefore, field creation when a parser is applied to an event occurs later than the Indexed Search stage. As a result, you cannot specify these fields in a field-based search query.

For example, the Apache Access Log parser creates the field `SourceHost`. You cannot specify the following query expression:

```
SourceHost="192.0.2.0"
```

However, you can use this field after the first pipeline, as shown in this example.

```
| where SourceHost="192.0.2.0"
```

Or, if you want to search only the Apache Access Logs for `SourceHost="192.0.2.0"`, you can specify this expression:

```
| where parser="Apache Access Log" and clientIP="192.0.2.0"
```

Additionally, you can run a full-text (keyword) search on `"192.0.2.0"`, as follows:

```
"123.456.789" | where SourceHost="192.0.2.0"
```

- If an event field contains data of an unexpected type (for example, a string when an integer is expected), the data is ignored. Therefore, search for that data value will not yield any results. For example, if the port field contains a value `8080A` (alphanumeric) instead of `8080` (numeric), the alphanumeric value is ignored. The data types of the schema fields are available from the [Configuration | Search > Default Fields page](#). For more information on how to view this information, see ["Default Fields" on page 281](#).
- For optimal search performance, make sure that event fields on ALL peers are indexed for the time range specified in a query. If an event field is indexed on one system but not on its peers for a specific time range, a distributed search will run slower on the peers. However, it will run at optimal speed on the local system. Therefore, the search performance in such a setup will be slow.
- For faster report generation, ALL fields of a report (including the fields being displayed in the report) need to be indexed. That is, in addition to the fields in the WHERE clause of the query, the fields in the SELECT clause also need to be indexed.

## Search Operator Portion of a Query

The *Search Operators portion of the query* enables you to further refine the data that matched the indexed search filter. See ["Search Operators" on page 471](#) for a complete list of search operators and examples of how to use them.

The `rex` search operator is useful for syslog events (raw or unstructured data) or if you want to extract information from a specific point in an event, such as the 15th character in an event. Other operators such as `head`, `tail`, `top`, `rare`, `chart`, `sort`, `fields`, and `eval` are applied to the fields you specify or the information you extract using the `rex` operator.

Prior to Logger 5.2, you needed to use a special search operator—`cef`—to extract CEF fields from CEF events (structured data) that matched the indexed search filter (the query portion before the first pipeline in the query expression) before you could use other search operators to act upon those fields. However, starting with Logger 5.2, you do not need to explicitly extract the CEF fields and then apply other search operators to those fields. You can specify the event fields directly in queries. The CEF operator has been deprecated as of Logger 5.2.

## Time Range

An event is timestamped with the receipt time when it is received on the Logger. **A search query uses the receipt time to search for matching events.**

Under most circumstances, the Logger receipt time is same as the event time. However, the event time and the Logger receipt time for an event can be different because there is usually a small lag between the time an event leaves a device and it is received at the Logger. If the device's clock is ahead or behind the Logger clock, the lag or lead can be significant.

A search operation requires you to specify the time range within which events would be searched. You can select from many predefined time ranges or define a custom time range to suit your needs.

When defining a time range for your query, be sure to take the information in ["Impact of Daylight Savings Time Change on Logger Operations" on page 412](#) into consideration.

**Predefined time range:** When you select a predefined time range such as "Last 2 Hours" or "Today", the time range is relative to the current time. For example, if you select "Last 2 Hours" at 2:00:00 PM on July 13th, events from 12:00:00 to 2:00:00 PM on July 13th will be searched. If you refresh your search results at 5:00:00 PM on the same day, the time window is recalculated. Therefore, events that match the specified criteria and occurred between 3:00:00 and 5:00:00 PM on July 13th are displayed.

**Custom time range:** You can specify a time range in a 24-hour format to suit your needs. For example, a custom time range is:

Start: 8/13/2015 13:36:30  
End: 8/13/2015 22:36:30

By default, the end time for a custom time range is the current time on your Logger and the start time is two hours before the current time.

You can also use variables to specify custom time ranges. For example, a dynamic date range might start at \$Now - 2h (two hours ago) and end at \$Now (the current time). The dynamic search is relative to when the query is run. Scheduled search operations use this mechanism to search through newer event data each time they are run.

The “Dynamic” field in the user interface enables you to specify the dynamic time, as shown in the following figure:

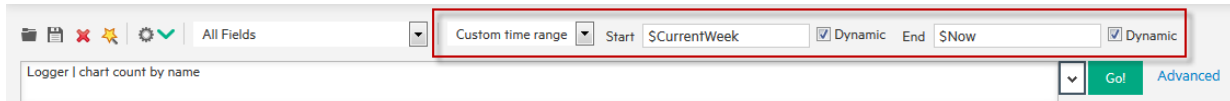

Following is a typical example of a dynamic search that limits results to the last two hours of activity:

Start: \$Now - 2h

End: \$Now

The syntax for dynamic search is:

<current\_period> [ +/- <units>]

Where <current\_period>, such as \$Now, either stands alone or is followed by either a plus ('+') or minus ('-') and a number of units, such as 2h for two hours. The <current\_period> always starts with a '\$' and consists of a word, case-sensitive, with no spaces, as shown in the table "Current Period" below. The <units> portion, if given, consists of an integer and a single, case-sensitive letter, as shown in the table "Units" below.

### Current Period

Period	Description
\$Now	The current minute
\$Today	Midnight (the beginning of the first minute) of the current day
\$CurrentWeek	Midnight of the previous Monday (or same as \$Today if today is Monday)
\$CurrentMonth	Midnight on the first day of the current month
\$CurrentYear	Midnight on the first day of the current year

### Units

Unit	Description
m (lowercase)	Minutes (Do not confuse with 'M', meaning months)
h	Hours

### Units, continued

Unit	Description
d	Days
w	Weeks
M (uppercase)	Months (Do not confuse with 'm', meaning minutes)

## Time Stamps in Logger

Events consist of a receipt time, event time, a source (host name or IP address), and an un-parsed message portion.

**Event Time** is the time the events are received by the Logger Receiver. Logger uses this field to find matching events when Searching and Reporting.

**Receipt Time** is the time the events are written to the Storage Group (disk). All events are timestamped with the receipt time when received on the Logger.

**Note:** Under most circumstances, the Logger receipt time is same as the event time. However, the event time and the Logger receipt time for an event may be different because there is a small lag between the time an event is received and when it is stored on the Logger. Other things may also cause some lag. For example, if event time parsing is enabled in file receiver, the receipt time may lag behind event time.

- Logger uses the receipt time field to find matching events when forwarding as well as for storage retention and archives.
- The Logger receipt time of an event is used to determine whether an event will be forwarded to a destination when a forwarder filter specifies a time range by which events are evaluated for forwarding.
- Logger uses the receipt time of an event to determine its archival day.
- Search results are sorted by the Logger event time.
- The histogram is based on the Logger event time.
- The default fields are automatically indexed. For the remaining fields, Logger uses the receipt time of an event and the time when a field was added to the index to determine whether that event will be indexed. If the receipt time of the event is equal to or later than the time when the field was added to the index, the event is indexed; otherwise, it is not.

In addition to the event time and the receipt time, you may see several other time stamps in Logger events, including the following:

**Agent Receipt Time** is the time the Connector received the event. Logger does not use this field, but you can search it.

**End Time** is the original time of the event on the device. Logger does not use this field, but you can search it.

**Manager Receipt Time** is the time the ESM received the event. Logger does not use this field, but you can search it.

## Fieldsets

A field set determines the fields that are displayed in the search results for each event that matched a search query. By selecting the field set, you select which fields you see in the search results. For information, see ["Changing the Displayed Search Results Using Field Sets" on page 118](#). You can use a predefined field set or create your own.

### Predefined Fieldsets

The system provides a number of predefined field sets.

**To view the list of available field sets:** Click the down-arrow in the Fields dialog box. The System Fieldsets list is displayed.

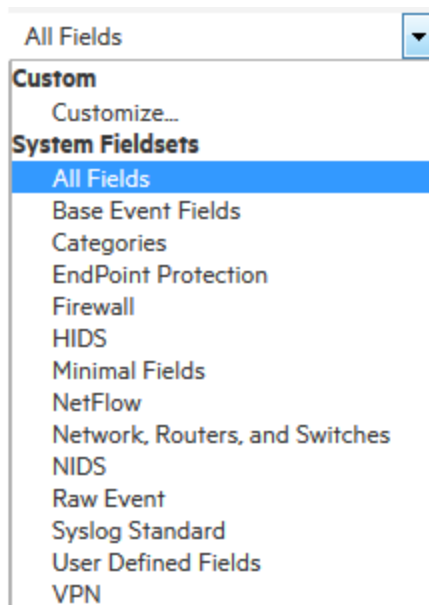

**To display the search results using a specific field set:** Click the field set from the drop-down list.

**Note:** Only fields available for matched events are displayed in a Search Results display (or the exported file). Therefore, even if you select the **All Fields** field set, you might not see all fields displayed in the search results, only the fields included in the events found by the search.

For more information about field sets, see ["Managing Fieldsets" on page 281](#).

## The User Defined Fields Field-Set

When you use a search operator that defines a new field, such as `rex`, `rename`, or `eval`, a new column for each field is added to the currently selected display. These newly defined fields are displayed by default. The **User Defined Fields** field set enables you to view only the newly defined fields.

## The Raw Event Field-Set

The **Raw Event** field set displays the whole raw syslog event in a column called `rawEvent`, with the event formatted to fit in the column.

Although the Raw Event field is most applicable for syslog events, you can also display the raw event associated with CEF events in the `rawEvent` column. To do so, make sure the connector that is sending events to the Logger populates the `rawEvent` field with the raw event.

**Note:** To see the raw events in the `rawEvent` column, enable the Search Option, "Populate `rawEvent` field for syslog events". See ["Search Options" on page 277](#) for more information.

## Custom Fieldsets

You can create your own field sets by selecting "Customize..." from the "Fields" pull-down menu.

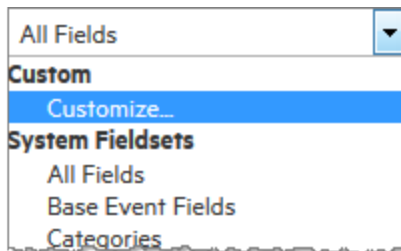

The user interface enables you to select and move event fields you want to include in a field set..



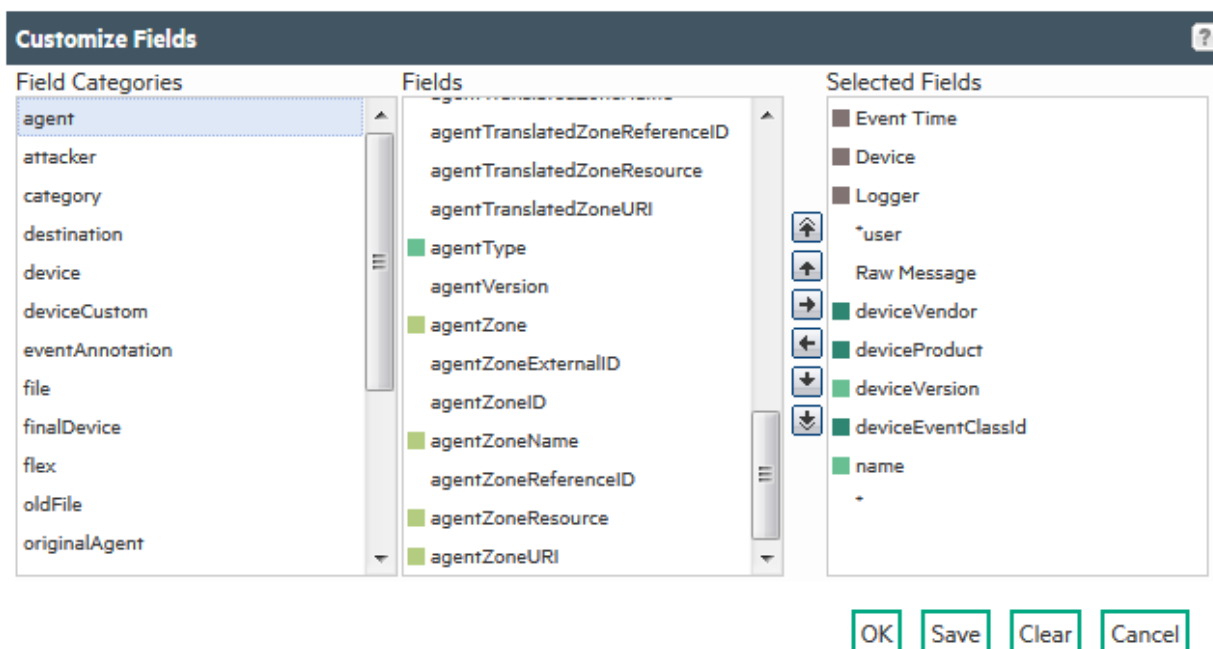

Use these buttons to create and edit a custom field set.



A wildcard field (“\*”) is available in the Fields list when you create a custom field set. This field includes all fields available in an event that are not individually listed in the custom field set definition. For example, for the following custom field set definition, the search results will list the fields before the asterisk (“\*”) first, followed by any other fields in an event. Lastly, the **deviceEventClassId** and **Name** fields will be listed.

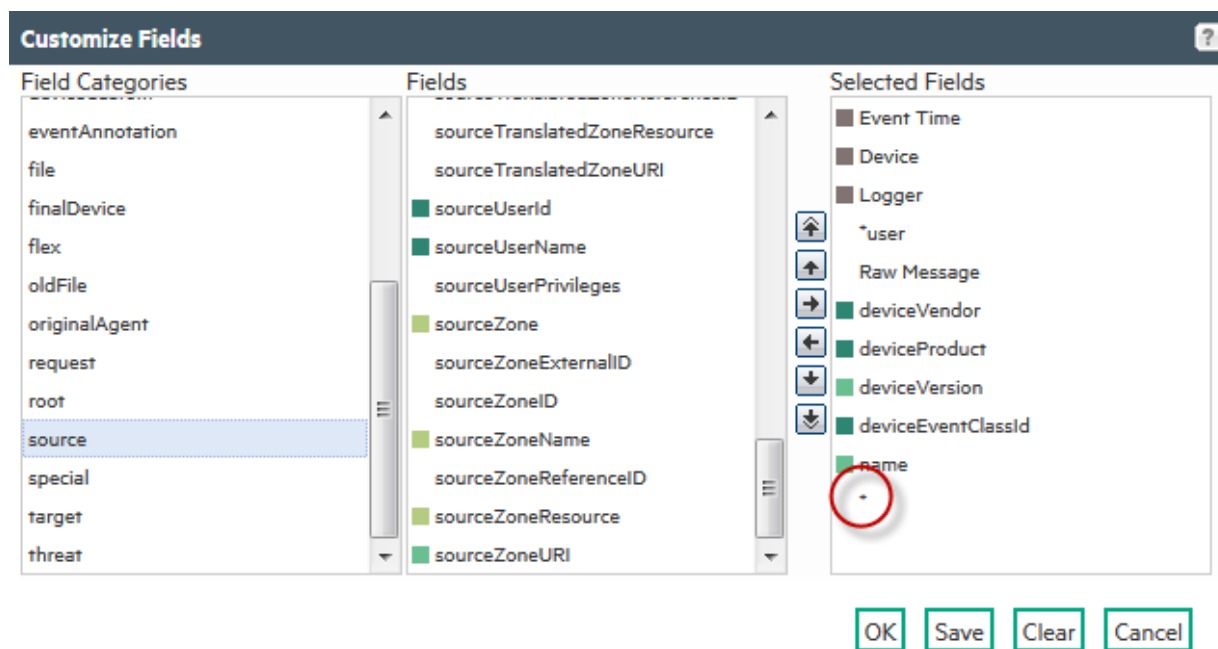

You can save the custom field set or use it only for the current session.

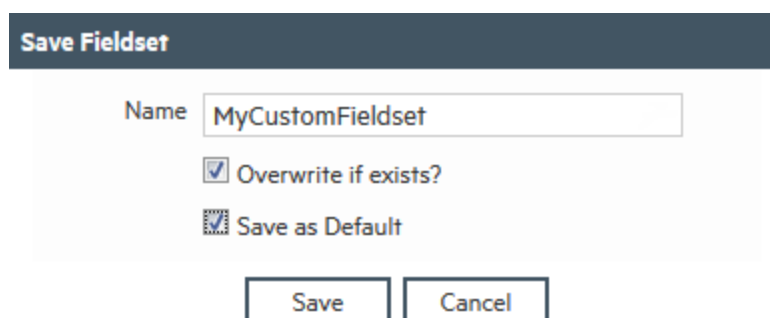

If you click **OK**, the field set appears in the Custom category. It is labeled as “Custom (not saved)” and is not visible to other users. It will remain available to you for this session. Once you log out of the current session, the temporary field set will be deleted. You can only have one temporary custom field set at a time.

If you click **Save**, the field set appears under the Shared Fieldsets category and is visible and available to the other users, as shown in the following figure. After a field set is saved, you can edit and delete it.

When saving a custom field set, you can specify it as the default for this system. If you do so, it is the default field set for all users on that system. If do not select it as the default, the field set is used only for your search results and does not affect other users connecting to the same system.

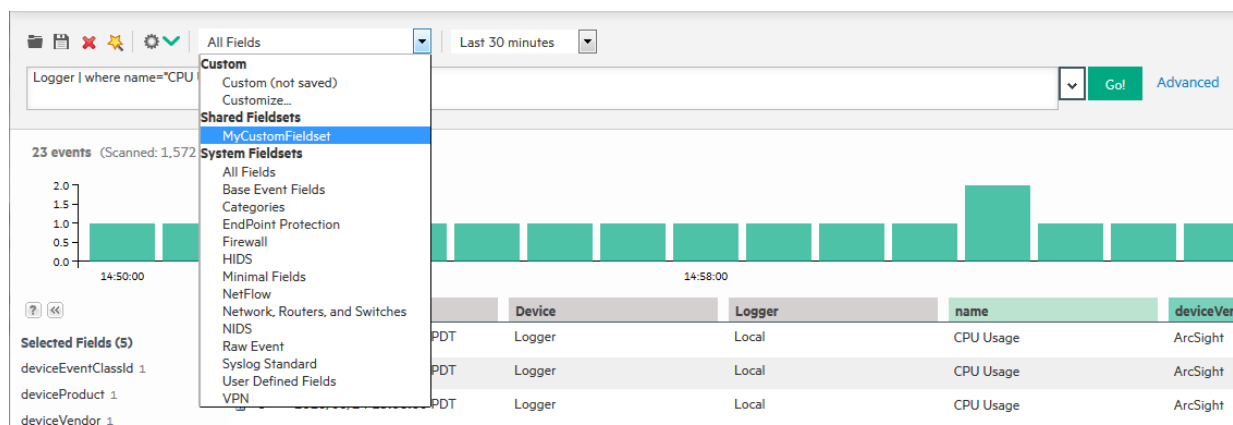

For information about deleting custom field sets, see ["Managing Fieldsets" on page 281](#)

**Note:** Field sets are not included in the saved filter definition.

The \*user field, shown below, controls the display of fields defined by search operators (rex, rename, extract, or eval) as well as the fields created when a parser is applied to an event. When \*user is included in the Selected Event Fields list of a custom field set, the created or defined fields are displayed.

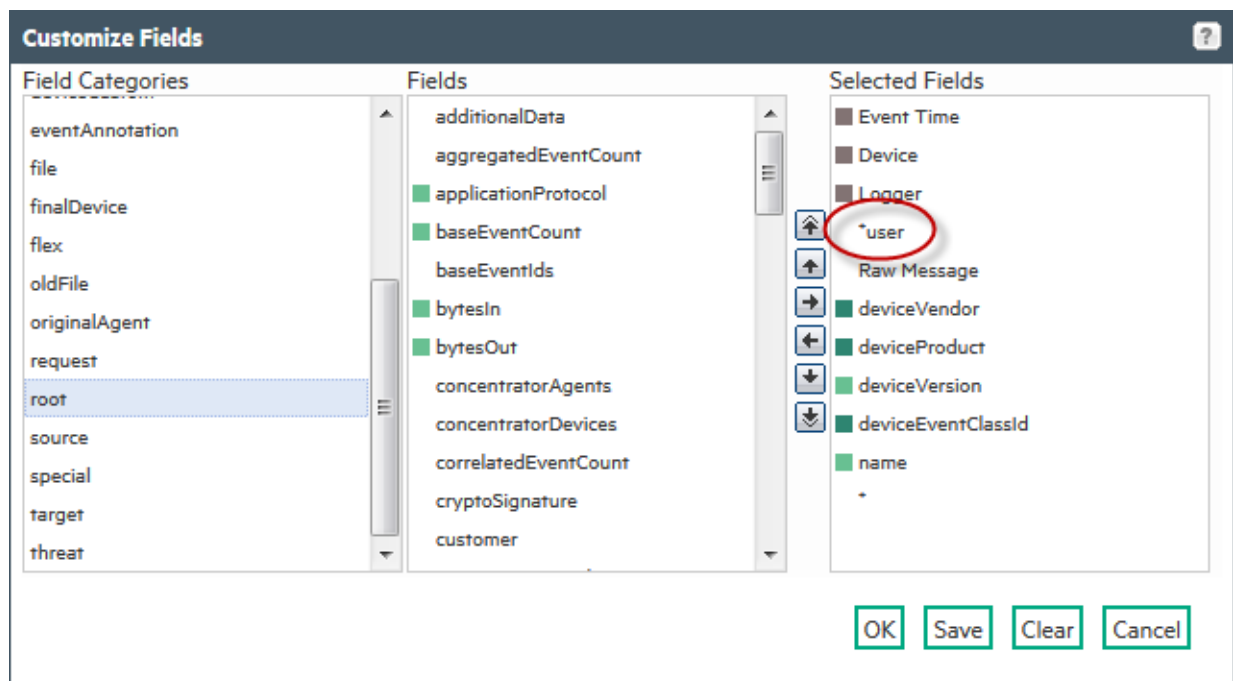

## Constraints

Using constraints in a query can speed up a search operation as they limit the scope of data that needs to be searched. Constraints enable you to limit a query to events from one or more of the following:

- Particular device groups
- Particular storage groups
- Specific peers

For example, you might want to search for events in the SG1 and SG2 storage groups on the local system only, or for events on specific peers.

For information about storage groups and peers, see ["Storage" on page 347](#), ["Device Groups" on page 293](#), and ["Peer Nodes" on page 397](#).

Follow these guidelines when specifying constraints:

- Use the following operators to specify constraints in a search query expression:

Metadata Identifier	Example
<code>_deviceGroup</code>	<code>_deviceGroup IN ["DM1", "HostA"]</code> where DM1 is a device group, while HostA is a device.  <b>Note:</b> You can use this field to specify individual devices, as shown in the example above.
<code>_storageGroup</code>	<code>_storageGroup IN ["Internal Event Storage Group", "SG1"]</code>
<code>_peerLogger</code>	<code>_peerLogger IN ["192.0.2.10", "192.0.2.11"]</code>

- If a query includes the Boolean operator OR and metadata identifiers, the expression to be evaluated with OR must be enclosed in parentheses, as shown in this example:

```
(success OR fail) _storageGroup IN ["Default Storage Group"]
```

If the expression to be evaluated with OR is not enclosed in parentheses, an error message is displayed on the user interface screen.

- When specifying multiple groups in a constraint, ensure that the group names are enclosed in square brackets; for example, `_storageGroup IN ["SGA", "SGB"]`.
- You can apply constraints to a search query by:
  - a. Typing the constraint in the Search text box

Once you type `"_s"` (for storage group), `"_d"` (for device group), or `"_p"` (for peer) in the Search text box, Search Helper automatically provides a drop-down list of relevant terms and operators from which you can select.

**Caution:** If a search query contains constraints and a regular expression, make sure that the

constraints are specified before the regular expression. For example, `_peerLogger IN [“192.0.2.10”] name contains abc | REGEX=“:\d31”`

- b. Selecting Storage Groups or peers from the Advanced Search tool. (To access the Advanced Search tool, click **Advanced Search** beneath the text box where you type the query.) For more information about the Advanced Search, see ["Using the Advanced Search Builder" on page 90](#).

## Syntax Reference for Query Expressions

To create valid and accurate query expressions, follow these requirements.

### Query Syntax Requirements

Behavior	Full Text Search	Field Search	Regular Expression
Case sensitivity	Insensitive  (Cannot be changed.)	Sensitive  (Can be changed using Tuning options. See <a href="#">"Search Options" on page 277</a> .)	Insensitive  (Can be changed using Tuning options. See <a href="#">"Search Options" on page 277</a> .)
Escape character	\  Use to escape \. You cannot escape any other character.	\  Use to escape \, ", and *.  Examples: <code>name=log\ger</code> (matches <code>log\ger</code> ) <code>name=logger\*</code> (matches <code>logger*</code> )	\  Use to escape any special character.  Example: To search for a term with the character "[": <code> REGEX= "logger\[</code>
Escaping wildcard character	Cannot search for *  Example: <code>log\*</code> is invalid	Can search for * by escaping the character  Example: <code>name=log\*</code> is valid	Can search for * by escaping the character  Example: <code>name=log\*</code> is valid

### Query Syntax Requirements, continued

Behavior	Full Text Search	Field Search	Regular Expression
Exact Match/Search string includes an operator or a special character	<p>Enclose keyword in double quotes; Otherwise, keyword treated as keyword*.</p> <p>Example:</p> <p>log (matches log, logging, logger, and so on)</p> <p>“log” (matches only log)</p> <p><b>Tip:</b> See the list of special characters that cannot be searched even when enclosed in double quotes, later in this table.</p>	<p>Enclose value in double quotes</p> <p>Example:</p> <p>message=“failed login”</p>	No special requirement.
Nesting, including parenthetical clauses, such as (a OR b) AND c	<p>Allowed</p> <ul style="list-style-type: none"> <li>Use Boolean operators to connect and nest keywords.</li> <li>Metadata identifiers (_storageGroup, _deviceGroup, and _peerLogger), but can only appear at the top level in a query expression). If the query contains a regular expression, the metadata identifiers need to precede the regular expression.</li> </ul>	<p>Allowed</p> <ul style="list-style-type: none"> <li>Use any operator listed in the <a href="#">"Field-Based Search" on page 71</a> section to connect and nest field search expressions.</li> <li>Metadata identifiers (_storageGroup, _deviceGroup, and _peerLogger), but can only appear at the top level in a query expression</li> </ul>	<p>Multiple regular expressions can be specified in one query using this syntax:</p> <pre>  REGEX= "&lt;REGEX1&gt;"   REGEX="&lt;REGEX2&gt;"   . . .</pre>

### Query Syntax Requirements, continued

Behavior	Full Text Search	Field Search	Regular Expression
Operators	<p>Upper-, lower-, or mixed case Boolean operators—AND, OR, NOT. If an operator is not specified, AND is used.</p> <p>To search for literal operator AND, OR, NOT, in an event, enclose them in double quotes. Example: “AND”, “OR”, “Not”</p> <div style="background-color: #f0f0f0; padding: 5px; border: 1px solid #ccc;"> <p><b>Note:</b> If a query includes the Boolean operator OR and the metadata identifiers (_storageGroup, _deviceGroup, and _peerLogger), the expression to be evaluated with OR must be enclosed in parentheses</p> </div> <p>Example:        (success OR fail) _storageGroup IN [“Default Storage Group”]</p>	<p>Use any operator listed in the <a href="#">"Field-Based Search" on page 71</a> section.</p> <ul style="list-style-type: none"> <li>Unless a value is enclosed between double quotes, a space between values is interpreted as an AND.            For example, name=John Doe is interpreted as John AND Doe.</li> <li>If an operator is not specified between multiple field expressions, AND is used.</li> <li>To search for literal operator, enclose the operator in double quotes.            Examples:  <pre>message STARTSWITH=“NOT” message=“LOGIN DID NOT SUCCEED”</pre> </li> <li>If a query includes the Boolean operator OR and the metadata identifiers (_storageGroup, _deviceGroup, and _peerLogger), the expression to be evaluated with OR must be enclosed in parentheses.            Example:  <pre>(success OR fail) _storageGroup IN [“Default Storage Group”]</pre> </li> </ul>	<p>  and the operators described in <a href="#">"Time Range" on page 76</a>.</p> <p>Use this operator to AND multiple regular expressions in one query expression.</p>

### Query Syntax Requirements, continued

Behavior	Full Text Search	Field Search	Regular Expression
Primary Delimiters: Space , ; ( ) [ ] } "   * > < !	You can search for keywords containing primary delimiters by enclosing the keywords in double quotes.  Examples: "John Doe" "Name=John Doe" "www.hp.com"	You can search for these characters. Enclose value in double quotes if value contains any of these characters.  Example: name="John*"	Cannot contain ^ in the beginning and \$ at the end as a matching character unless the regular expression you specify must look for an event that contains only the pattern you are specifying.  Special regular expression characters such as \ and ? need to be escaped.  Example:  REGEX= "^test\$" will search only for events containing the word test .
Secondary Delimiters: = . : / \ - ? # \$ & _ %	You can also search for keywords containing secondary delimiters once you have configured the full-text search options as described in <a href="#">"Search Options" on page 277</a> .  Example:  You can search for hpe.com in a URL http://www.hpe.com/apps by specifying hpe.com as the search string.	You can search for these characters. Enclose value in double quotes if value contains any of these characters.  Example: name="John"	<ul style="list-style-type: none"> <li>Cannot contain ^ in the beginning and \$ at the end as a matching character unless the regular expression you specify must look for an event that contains only the pattern you are specifying; for example,  REGEX= "^test\$" will search for events containing the word "test" (without quotes) only.</li> <li>Special regular expression characters such as \ and ? need to be escaped.</li> </ul>
Syntax	keyword1 boolean_operator keyword2 boolean_operator keyword3 ....	field_name operator field_value  (List of fields in the <a href="#">"Event Field Name Mappings" on page 549</a> section.)  (List of operators in the <a href="#">"Field-Based Search" on page 71</a> section.)	REGEX="<REGEX1>"   REGEX="<REGEX2>"   ...



### Query Syntax Requirements, continued

Behavior	Full Text Search	Field Search	Regular Expression
Tab Newline { " *	<p><b>Cannot search for these characters.</b></p> <p>Examples:            "John{Doe" is invalid</p>	<p>No restrictions.</p> <p>Enclose special character in double quotes. Escape the wildcard character and double quotes.</p> <p>Example:            name="John\* \"Doe"            (matches John* "Doe")</p>	<p>No restrictions.</p> <p>Special regular expression characters such as () [] {}"  , and * need to be escaped.</p>
Time format, when searching for events that occurred at a particular time	<p>No specific format. The query needs to contain the exact timestamp string. For example, "10:34:35".</p> <div style="background-color: #f0f0f0; padding: 5px; border: 1px solid #ccc;"> <p><b>Note:</b> The string cannot contain spaces. For example, "Oct 19" is invalid.</p> </div>	<p>Use this format to specify a timestamp in a query (<b>including double quotes</b>):</p> <p>"mm/dd/yyyy hh:mm:ss"</p> <p>Or</p> <p>"yyyy/mm/dd hh:mm:ss timezone"</p> <p>Or</p> <p>"MMM dd yyyy hh:mm:ss timezone"</p> <p>where            mm = month            dd = day            yyyy = year            hh = hour            mm = minutes            ss = seconds            timezone = EDT, CDT, MDT, PDT            MMM = First three letters of a month's name; for example, Jan, Mar, Sep, and so on.</p> <p>Use the &lt;= and &gt;= operators to narrow down the time range. Do not use = or !=.</p>	<p>No restrictions.</p>

### Query Syntax Requirements, continued

Behavior	Full Text Search	Field Search	Regular Expression
Wildcard	* Cannot be the leading character; only a suffix or in-between a keyword.  Examples: <ul style="list-style-type: none"> <li>*log is invalid</li> <li>log* is valid</li> <li>lo*g* is valid</li> </ul>	* Can appear anywhere in the value.  Examples: name=*log (searches for ablog, blog, and so on.)  name="\*log"  name=\*log  (both search for *log)	* Can appear anywhere.

## Using the Advanced Search Builder

The Advanced Search tool is a Boolean-logic conditions editor that enables you to build search queries quickly and accurately. The tool provides a visual representation of the conditions you are including in a query. You can specify keywords, field-based conditions, and regular expressions using this tool. You can also specify search constraints such as peers, device groups, and storage groups (see "[Constraints](#)" on page 84). This section describes how to use the tool.

- [Accessing the Advanced Search Builder](#) .....90
- [Nested Conditions](#) .....93
- [Alternate Views for Query Building in Search Builder](#) .....94

## Accessing the Advanced Search Builder

### To display the Advanced Search builder:

Click **Analyze > Search** to open the search page, and then click **Advanced Search**, to the right of the  button, as shown in the following figure.

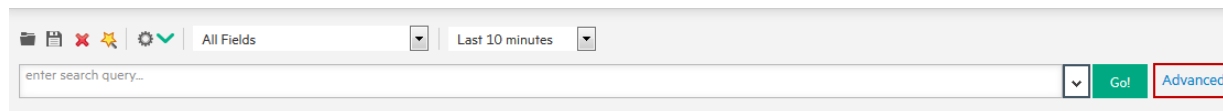

The Advanced Search builder is displayed, as follows:

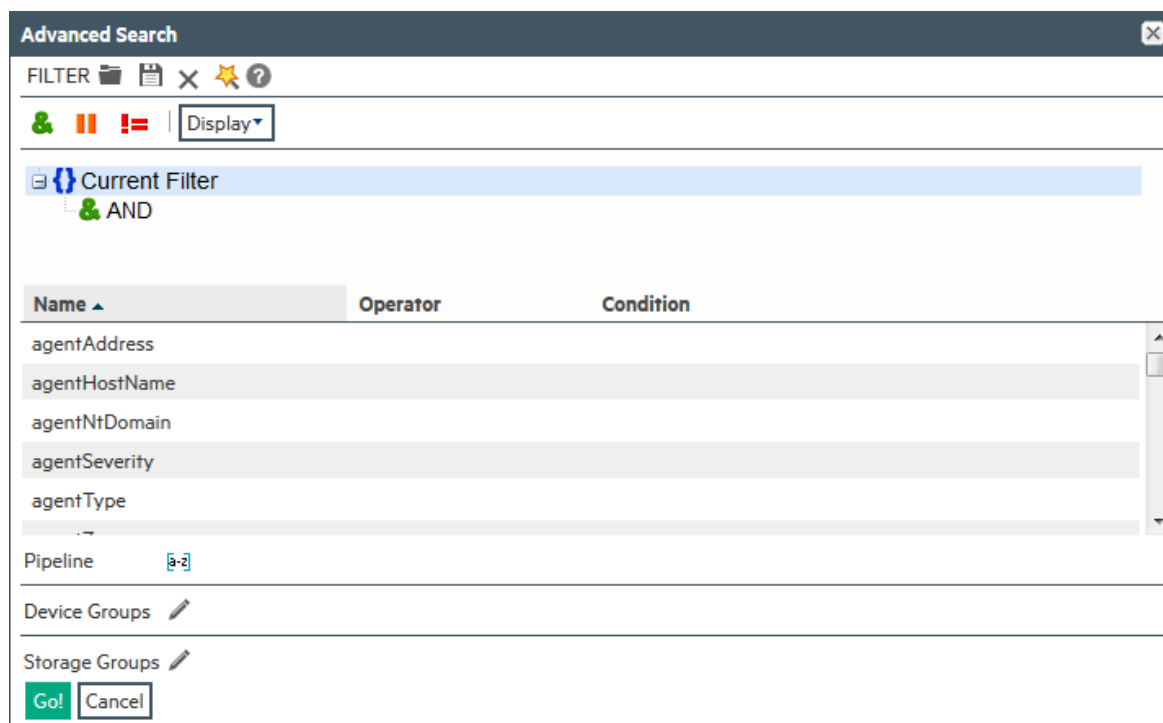

### To build a new search query in the Advanced Search builder:

1. Click **Analyze > Search** to open the search page, and then click **Advanced Search**.
2. Select the Boolean operator that applies to the condition you are adding from the top of Search Builder. You can select these operators:

Operator	Meaning
	AND
	OR
	NOT

3. If you want to load a system or saved filter, or a saved search, click the icon. Select the filter or the saved search from the displayed list and click **Load+Close**.

For more information, see ["Saving Queries \(Creating Saved Searches and Saved Filters\)" on page 129](#) and ["System Filters/Predefined Filters" on page 131](#).

4. To add a keyword (full-text search) or field condition:
  - a. Locate the field you want to add under the Name column.  
To specify a keyword (full-text search), use the **fullText** field under the Name column, as shown in the following figure.

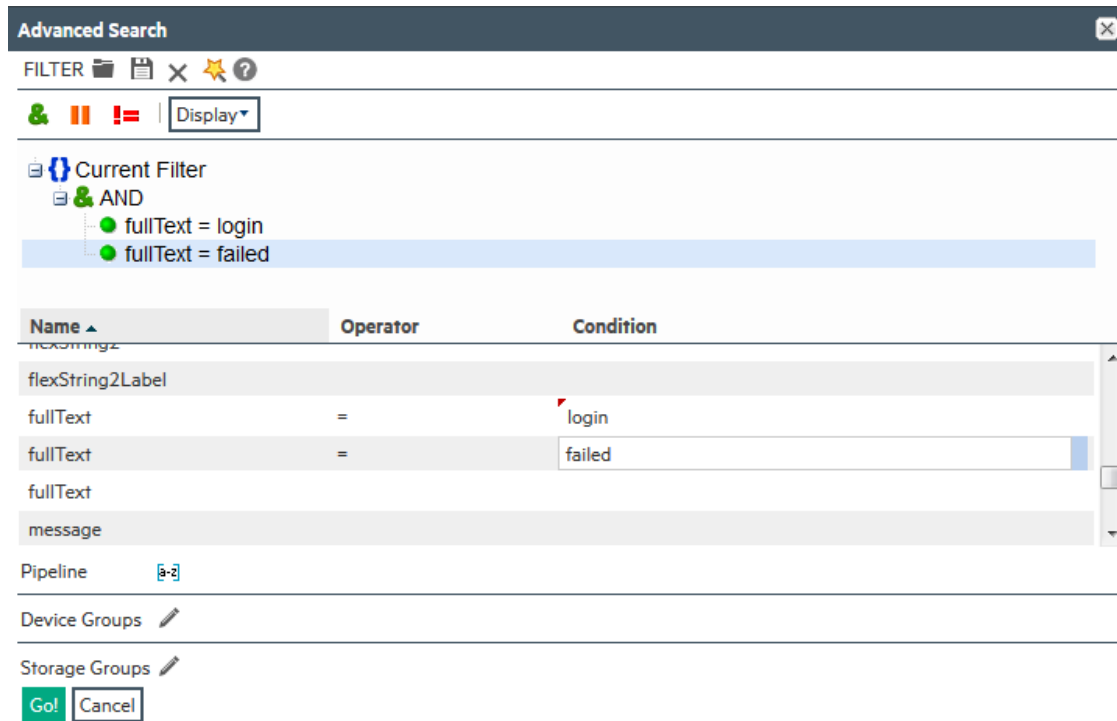

- b. Click the Operator column associated with the field, select the operator from the displayed list, and press **Enter**.
- c. Only operators applicable to a field are displayed in the list.
- d. In the Condition column associated with the field, enter a value and press **Enter**.  
To edit a condition, right click on the condition for a pull-down menu that enables you to edit, cut, copy, or delete the condition.

**Note:** You cannot specify a range of IP addresses. Therefore, to search for multiple IP addresses in a range, use the CONTAINS operator and wildcard characters in the Condition column; for example, enter 192.0.2.\*.

5. Repeat the steps above until you have added all the conditions.
6. If your search query will include a regular expression, type it in the Regex field.
7. If you want to constrain your search query to specific device groups, storage groups, and Loggers, click the  icon next to the constraint category. Select the relevant groups and Loggers. (To select multiple groups, hold the Ctrl-key down.)

You can specify devices or device groups in the Device Groups constraint.

The Logger constraint category is displayed only if Loggers are configured on your Logger.

If multiple values are selected for a constraint, those values are OR'ed together. For example, if you specify Device Group A, B, C, the query will find events in Device Group A, B, or C.

8. Click **Go**.  
The query is automatically displayed in the Search text box and is ready to be run.

OR

Click the  icon to save the query (referred as Saved Filter or a Saved Search) for a later use. For more information about saving queries, see ["Saving Queries \(Creating Saved Searches and Saved Filters\)" on page 129](#).

## Nested Conditions

You can create search queries with nested conditions in Search Builder. To do so, click the operator under which you want to nest the next condition and add the condition as described in ["Accessing the Advanced Search Builder" on page 90](#).

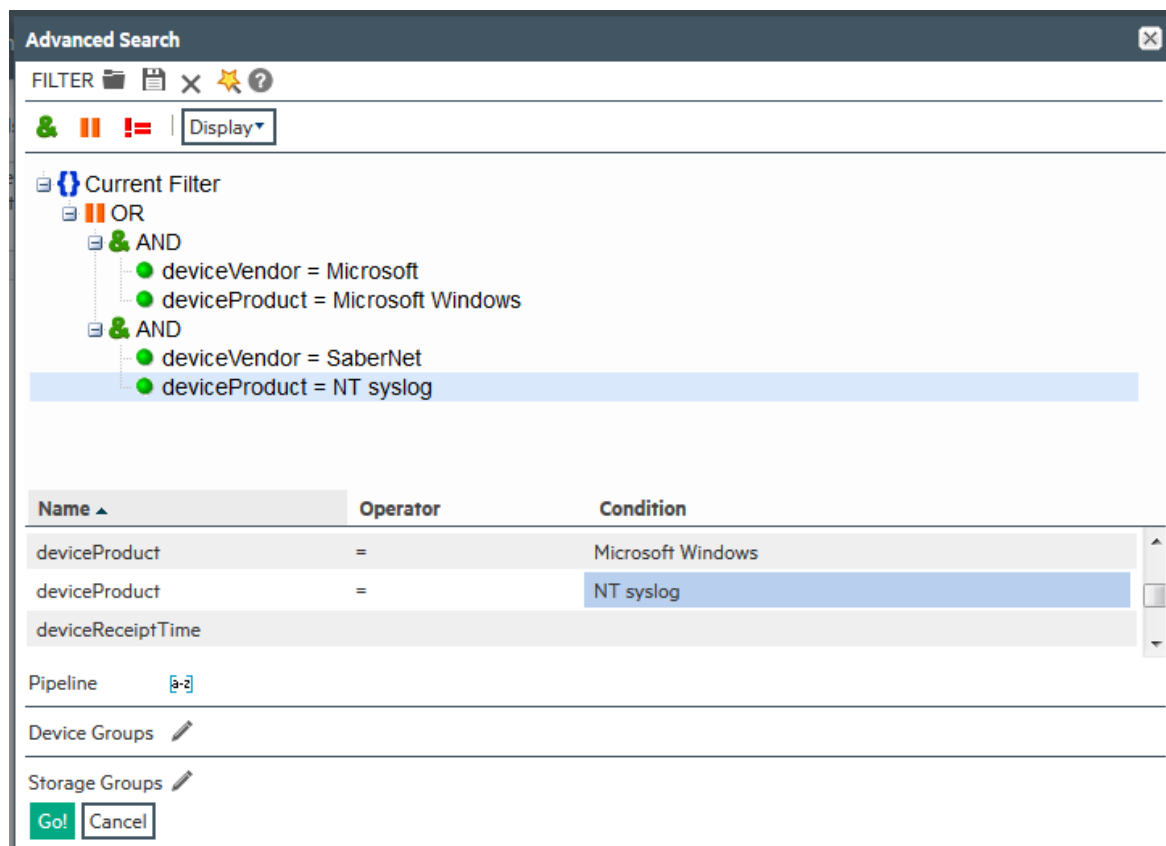

### To add a nested condition:

1. Select the new operator from the icons above the query.
2. Select a condition from the menu below the query.
3. Add an operator and a supported condition for the query, for example `deviceProduct = Microsoft`.
4. Click **Go!**

## Alternate Views for Query Building in Search Builder

By default, a tree view representation of the conditions is displayed, as shown in the previous figures in this section. You can change the view to a color-block scheme and the location where the fields you select are displayed. They can in the lower part of the screen or to the right of where conditions are displayed.

### To change views:

Click **Display** in the Search Builder tool and select the view of your choice.

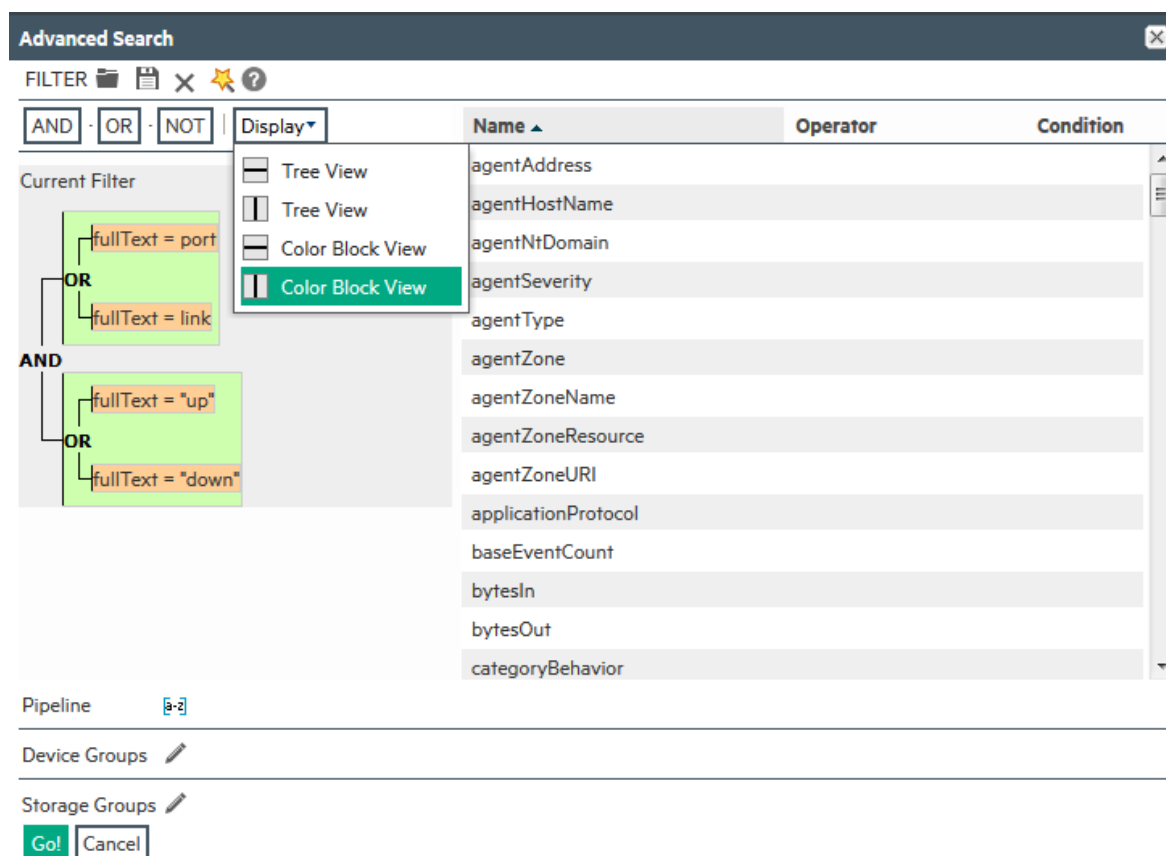

## Search Analyzer

A query's performance is dependent on many factors such as load on the system, size of data to be searched, indexed or non-indexed fields included in the query, the complexity of a query (a large number of conditions, wildcard characters, nesting), and so on.

The Search Analyzer tool analyzes a query to determine if any of the fields included in the query are non-indexed for the time range specified and thus affect the query's performance.

You can run this tool as needed; for example, if a query runs slower than expected. You can use Search Analyzer on a query after you have run it or while building a query using the Search Builder. Click  to access the Search Analyzer tool.

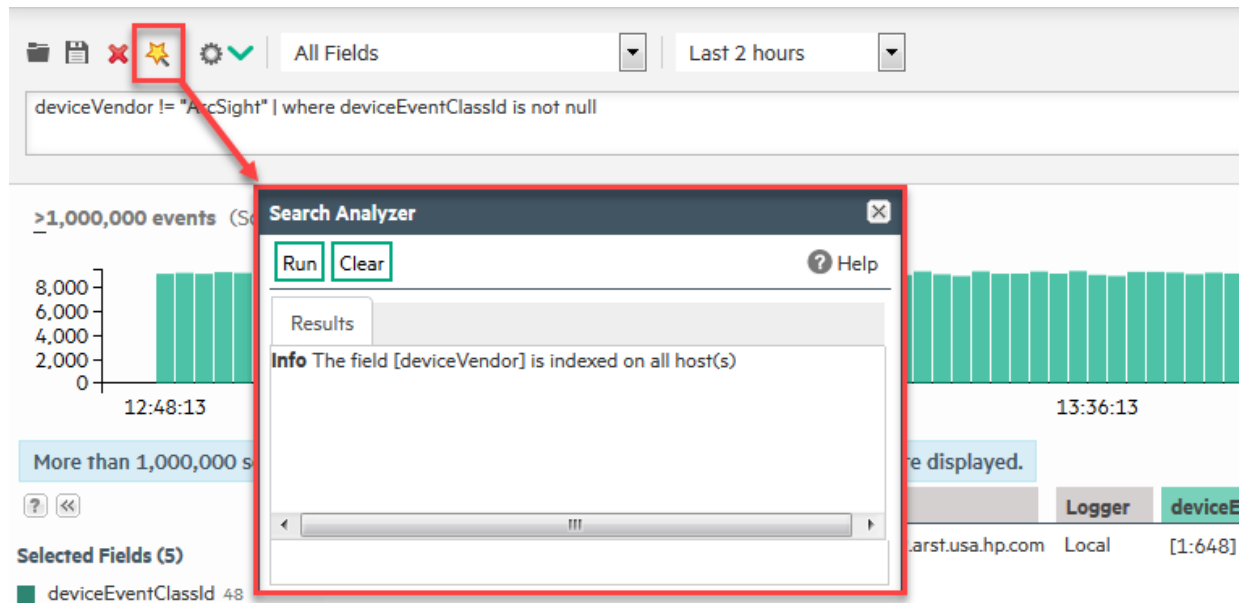

- [Performance Optimizations for Indexed Fields in Queries](#) .....95

## Performance Optimizations for Indexed Fields in Queries

Even though a search query includes indexed fields, you might not realize the performance gain you expect in these situations:

- When you include indexed and non-indexed fields in a query. Therefore, HPE recommends that you identify the fields that you will most commonly use in queries and index all those fields. See ["Understanding Search Field Colors" on page 68](#) to help you identify indexed and non-indexed fields within your query.
- When you include fields that are not super-indexed or field operators other than = in a needle-in-a-haystack search, your search speed may not see the expected performance increase for super-indexed fields. For fastest results when searching for rare values, be sure to follow the recommendations in ["Searching for Rare Field Values" on page 109](#).
- When you perform search on data in a time range in which a currently indexed field (included in the query) was non-indexed.

For example, you index the “port” field on August 13th at 2:00 PM. You run a search on August 14th at 1:00 PM to find events that include port 80 and occurred between August 11th and August 12th. The “port” field was not indexed between August 11th and the 12th; therefore, the query runs slower.

- When you include a field in your search query that Logger is in the process of indexing. Therefore, allow some time between adding a field to the index and using it in a search query.

- When a query that includes indexed field is performed on archived events, the query runs slower than when the data was not archived. This occurs because the index data on Logger is not archived with events. To improve the search speed of archived events, you can index them. For more information, see ["Indexing Archived Events" on page 359](#)



## Regex Helper Tool

The Regex Helper tool  enables you to create regular expressions that can be used with the rex pipeline operator to extract fields of interest from an event. (For information about rex, see ["Search Operator Portion of a Query" on page 76](#) or ["Using the Rex Operator" on page 511](#).) This tool not only simplifies the task of creating regular expressions for the rex operator but also makes it efficient and error free.

The tool, which is only available for non-CEF events (unstructured data), parses *raw syslog events* into fields and displays them as a list. You select the fields that you want to include in the rex expression of a query. The selected fields are automatically inserted in a search query as a rex expression.

### To use the tool, you need to perform the following steps:

**Note:** These steps are also depicted in the figure that follows the steps.

1. Enter a search query that finds events of interest to you. (For information about running a search, see ["Searching for Events" on page 102](#).)
2. Identify a syslog event that you want to analyze further. For example, in the shown figure, event #7 is the event we will analyze further.
3. Click the  icon (in the left-most column) for the identified event to expand it and display its raw event.
4. Click the  icon (next to the word **RAW**) to launch the Regex Helper tool.
5. Select the fields that you want to extract.



6. Click **OK**.

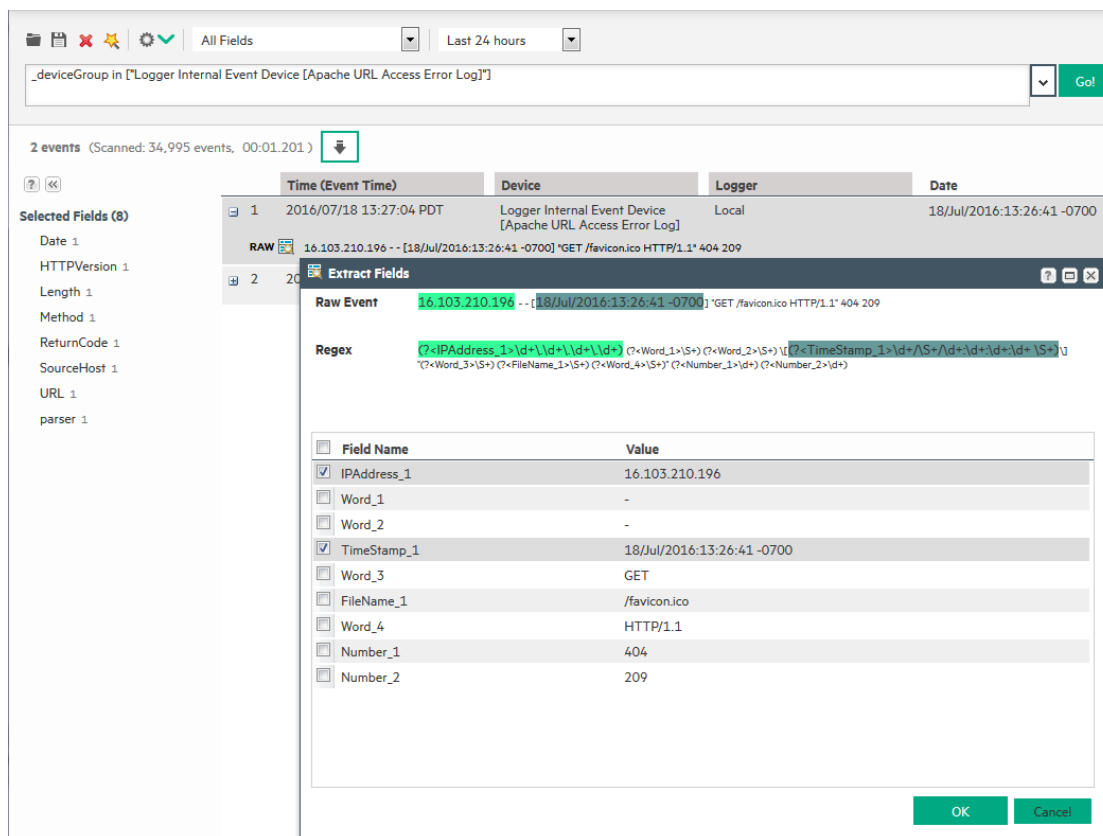

The rex expressions pertaining to the selected fields are automatically entered in the Search query box. In this example we want to extract the IP addresses from events. Therefore, the `IPAddress_1` field is selected in the Regex Helper tool. (The Regex Helper tool assigns incremental labels if a data type appears more than once in an event. For example, IP addresses are assigned `IPAddress_1`, `IPAddress_2`, `IPAddress_3`, and so on labels.)

Once the IP address is selected and you click **OK**, the rex expression that includes the regular expression for those IP addresses is displayed in the Search text box, as shown in the following example.

```
_deviceGroup in ["Logger Internal Event Device [Apache URL Access Error Log]"] | rex "(?<IPAddress_1>\d+\.\d+\.\d+\.\d+) \S+ \S+ \[(?<TimeStamp_1>\d+/\d+/\d+:\d+:\d+ \S+)\. *"
```

From this point, you can include additional pipeline operators in this query to create charts, identify the top five IP addresses, and so on. In the following example, the above query is modified to identify the top IP addresses.

```
_deviceGroup in ["Logger Internal Event Device [Apache URL Access Error Log]"] | rex "(?<IPAddress_1>\d+\.\d+\.\d+\.\d+) \S+ \S+ \[(?<TimeStamp_1>\d+/\d+/\d+:\d+:\d+ \S+)\. *" | top IPAddress_1
```

## Search Helper

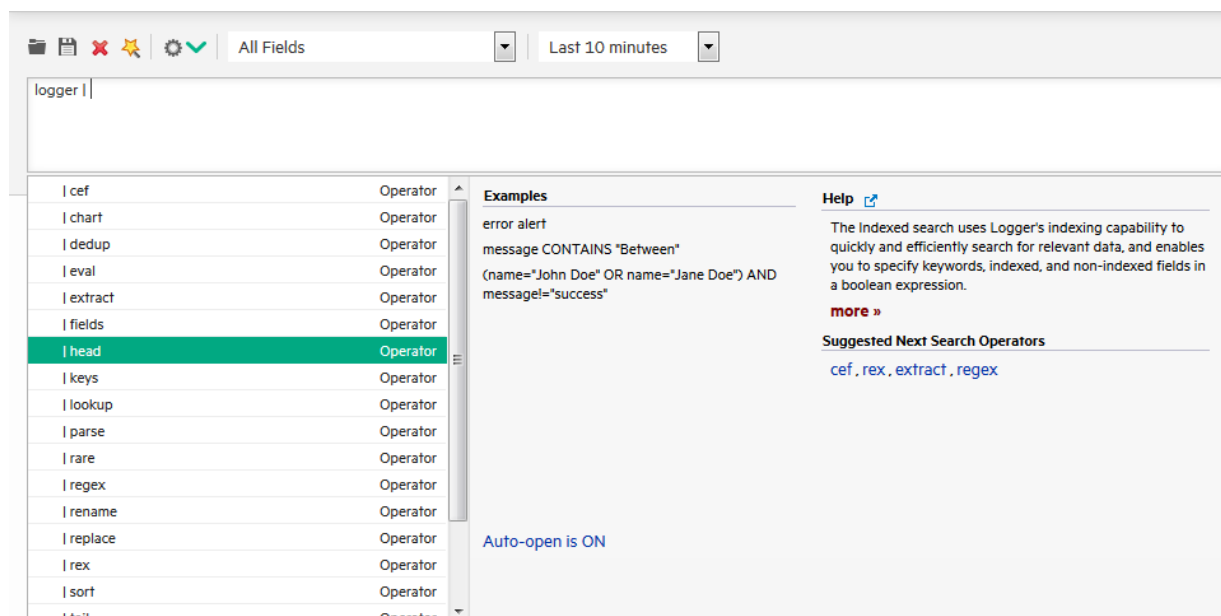

Search Helper is a search-specific utility that automatically displays relevant information based on the query currently entered in the Search text box.

Search Helper is available by default; if you do not want the Search Helper to display information automatically, click the “**Auto-open is ON**” link (in the Search Helper window). The link toggles to “**Auto-open is OFF**”. To access Search Helper once it has been turned off, click the down-arrow button to the right of the Search text box.

Search Helper displays auto-complete search functionality, a search history, a search operator history, a link to the help system, and suggested next operators.

- [Autocomplete Search](#) ..... 98
- [Opening Filters and Saved Searches via Autocomplete](#) ..... 100
- [Search History and Search Operator History](#) ..... 101
- [Examples, Usage, Suggested Next Operators, and Help](#) ..... 102

## Autocomplete Search

The autocomplete functionality provides full-text keywords and field suggestions based on the text currently entered in the Search box. The suggestions enable you to select keywords, fields, field values, search operators, or metadata terms from a list instead of typing them in, thus enabling you to build a query expression more quickly.

When you start typing, the suggestion list displays many types of entries, as displayed in the following image.

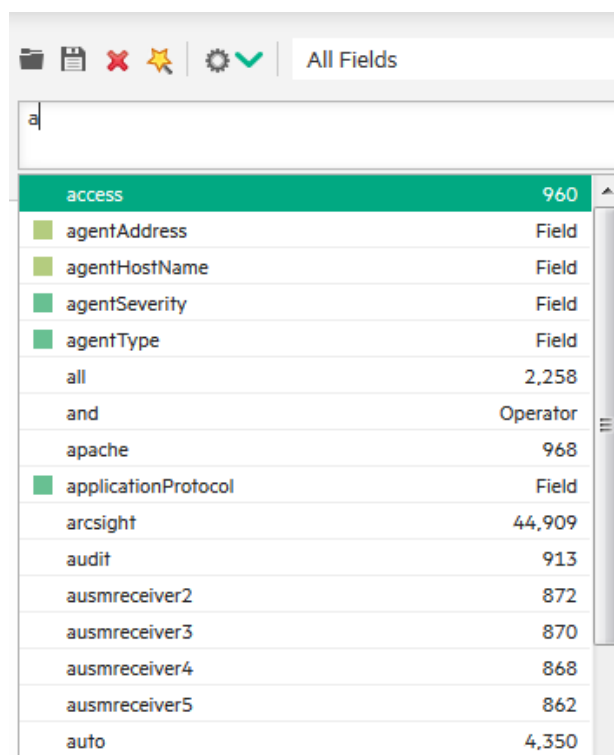

If the entered text is contained in both full-text keywords and schema fields, all of them are displayed in the suggested list.

If you type “|” (the pipeline character), the list of operators available on Logger are displayed.

The full-text keyword suggestions are obtained from the full-text keywords that are already indexed on your Logger.

If the Logger schema field is indexed, superindexed, or able to be indexed, an icon matching its index state displays to the left of the field name. See ["Understanding Search Field Colors" on page 68](#) for more information.

**Note:** System-defined fields are not available as fields in the auto-complete . For more information about system-defined fields and Logger searches, see ["Things You Should Know About Logger Searches" on page 106](#) and ["Additional Fields in the Search Results" on page 116](#).

The full-text keywords and field values display a count next to each suggestion that indicates the number of the instances of the keyword or field value stored on Logger.

The count represents the number of values stored for a field. The count is dependent on many factors and may not be exact. It does not indicate how many events might match the query. Many factors determine the number of event matches, including the time range, search constraints, and search operators for the query.

**Note:** The autocomplete suggestions and counts are based on data stored on the local system only. Counts are reset when the Logger restarts. Peer data is not included.

Search Group filters (that restrict privileges on storage and device groups) are not enforced on the autocomplete list. Therefore, the list includes keywords, fields, field values, and counts of events in storage and device groups to which a user might not have privileges.

When an archive is loaded back on Logger, the autocomplete list does not include the full-text keywords or field values that were available before the events were archived. This happens because summary data is not archived along with the event data. Therefore, when the event data is loaded back from an archive, the archive data is not included in the summary.

## Opening Filters and Saved Searches via Autocomplete

Logger 6.0 adds the autocomplete constants `$filter$` and `$ss$` to enable you to open Filters and Saved Searches directly from the search box.

If you type `$filter$` in the search box, the available Filters show up in the autocomplete. (Filters include only the query.) You can click a suggestion to select it or continue typing the filter name to narrow down the options. Once you select a filter from the autocomplete, Logger replaces the search box contents with the Filter definition.

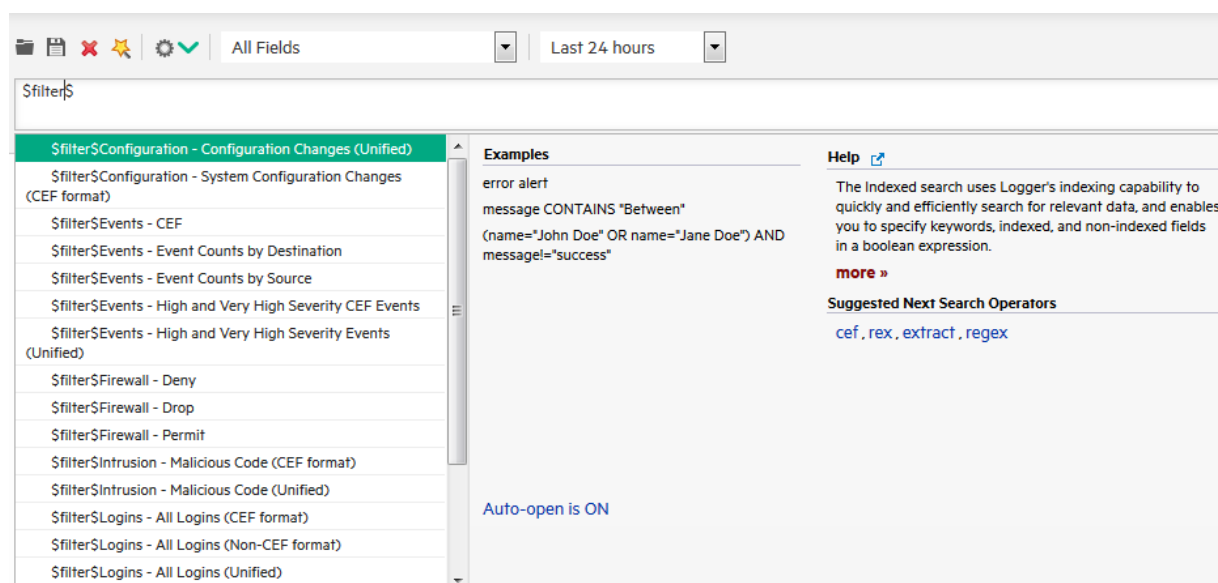

If you type `$ss$` in the search box, the available Saved Searches show up in the autocomplete. (Saved searches include the query, the start date/time, the end date/time, local only, and so on.) You can click a suggestion to select it or continue typing the saved search name to narrow down the options. Once you select a saved search from the autocomplete, Logger replaces the search box contents with the Saved Search definition.

### To use an autocomplete suggestion:

1. From the search autocomplete list, click the suggestion to move it up to the search box.
2. Click **Go!** to run that search, or continue typing to narrow your search further.

## Search History and Search Operator History

The **Search History** displays recently run queries that match the currently entered search. Click a recent query to run it again. To see the search history, start typing a search or click the down-arrow next to the **Go!** button.

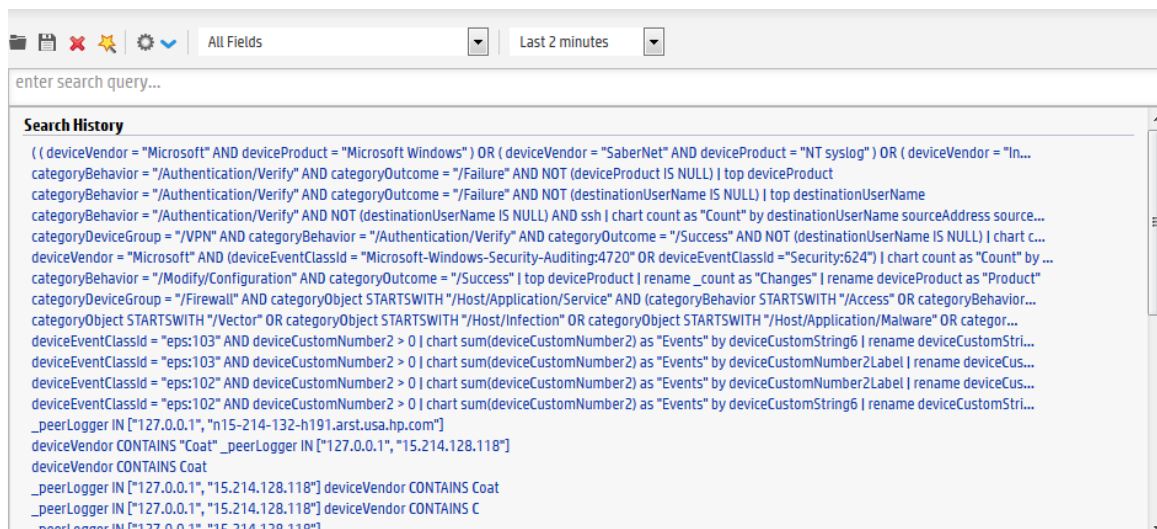

The **Search Operator History** displays the fields used previously with the search operator that is currently typed in the Search text box. The Search Operator History only displays if you have previously used the operator you have currently typed to perform searches on this system. Click the operator to add it to your search.

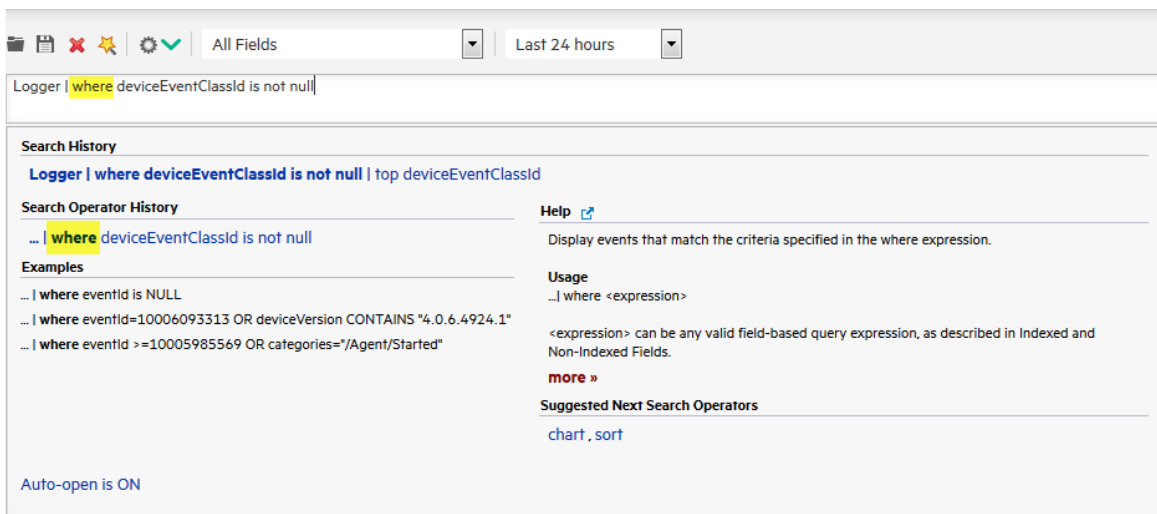

## Examples, Usage, Suggested Next Operators, and Help

The **Examples** section lists examples relevant to the latest query operator you have typed in the Search text box.

The **Usage** section provides the syntax for the search operator.

The **Suggested Next Operators** section provides a list of operators that generally follow the currently typed query. For example, if you type `logger |`, the operators that often follow are `rex`, `extract`, or `regex`. You can select one of the listed operators to automatically append to the currently typed query in the Search text box. This list saves you from guessing the next possible operators and manually typing them in.

The **Help** section provides context-sensitive help for the last-listed operator in the query that is currently typed in the Search text box. Additionally, if you click the  icon, Logger online Help launches.

## Searching for Events

The topics in this section explain how to search for events on Logger.

- [Running a Search](#) .....103
- [Things You Should Know About Logger Searches](#) .....106
- [Searching Peers \(Distributed Search\)](#) .....107
- [Tuning Search Performance](#) .....108
- [Searching for Rare Field Values](#) .....109

### Permissions and Prerequisites

Enable the following User Group permissions for Logger search users:

- Default Logger Search Group > Search > Search for events (local searches only)
- Default Logger Search Group > Search > Search for events on remote peers (for distributed searches)
- Default Logger Rights > Peers > View registered peers (to see peers)

Other permissions may also apply. See "[Setting Logger User Permissions](#)" on page 458 for information.

## Running a Search

You can use the options displayed on the search page to help create and run your search query.

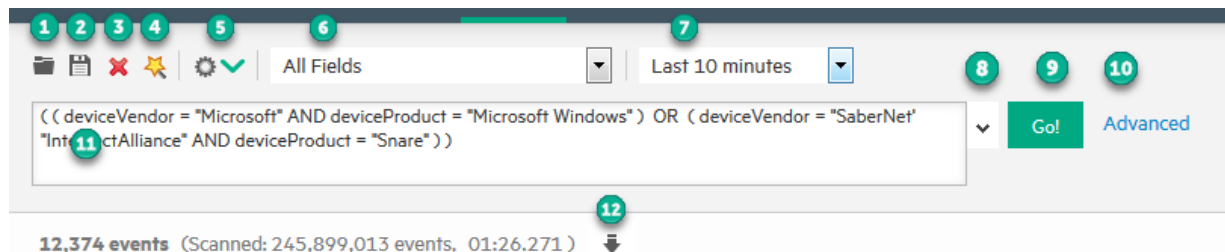

### Search Bar Legend

Option	Description	Option	Description
1	Load saved search or filter	7	Set time range
2	Save query	8	Open search history
3	Clear query	9	Start or cancel search
4	Open Search Analyzer	10	Open Advanced Search Builder
5	Update search options	11	Enter query
6	Select fieldset	12	Export search results

In addition to the options displayed on the search page, search options enable you to tune search operations to suit your environment. Those options are discussed in ["Search Options" on page 277](#).

**Note:** You cannot run concurrent searches in the same browser window. If you need to run more than one search at a time, use two different browsers or a browser with a plug-in that allows you to open different sessions.

### To search for events on Logger:

1. Open the **Analyze** menu and click **Search**.
2. Click the down-arrow to view and adjust the search options. Use the default values or change them suit your needs:

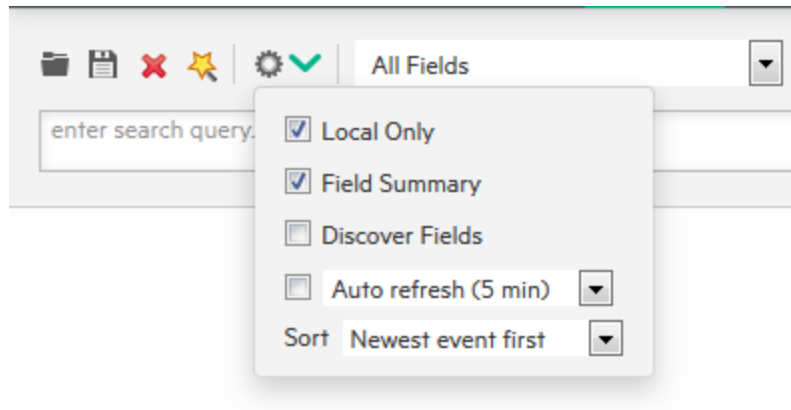

- **Local Only:** This option is only displayed when peers have been configured for your system. Local Only is checked by default. If you want to include peers in your search, uncheck the Local Only checkbox. If you do not see this checkbox, no peers have been configured on your Logger. See "[Searching Peers \(Distributed Search\)](#)" on [page 107](#) for more information.
  - **Field Summary:** Lists the selected CEF fields in the displayed events. By default, the selected fields include: deviceEventClassId, deviceProduct, deviceVendor, deviceVersion, and name; you can edit this list to suit your needs. Selecting this option enables the Discover Fields option. See "[The Field Summary Panel](#)" on [page 121](#) for more information about the Field Summary and Discover Fields options.
  - **Discover Fields:** Lists the non-CEF fields discovered in raw events. This option is only taken into consideration when Field Summary has been selected.
  - **Auto Refresh:** By default, the search results are not refreshed. Select this option to have the Search results auto refresh. You can select from the following refresh intervals: 30 seconds, 60 seconds, 2 minutes, 5 minutes, or 15 minutes.
  - **Sort :** Select Oldest Event First or Newest Event First, depending on how you want the search results to display.
3. **Fieldset:** By default, all fields (All Fields) are displayed in the search results. However, you can select another predefined field set or specify a customized field set. See "[Fieldsets](#)" on [page 79](#) for more information.

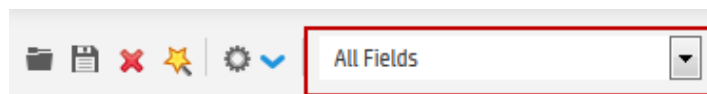

4. **Time Range:** By default, the query is run on the data received in the last ten minutes. Click the drop-down list to select another predefined time range or specify a custom time range. See "[Time Range](#)" on [page 76](#) for more information.

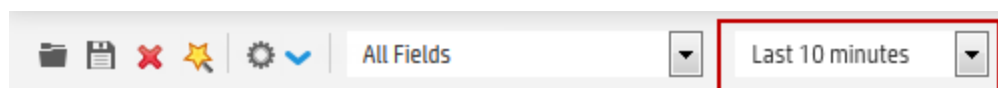



5. Specify a query expression in the Search text box using one or more of the following methods.



**Note:** Refer to ["Keyword Search \(Full-text Search\)" on page 70](#), ["Field-Based Search" on page 71](#), and ["Searching for Rare Field Values" on page 109](#) for instructions, exceptions, and invalid characters before you create a query expression.

- a. Type the query expression in the Search text box. For information about building a query expression, including lists of applicable operators, see ["Elements of a Search Query" on page 69](#).
- b. When you type a query, Logger's Search Helper enables you to quickly build a query expression by automatically providing suggestions, possible matches, and applicable operators. See ["Search Helper" on page 98](#) for more information.
- c. Use these guidelines to include various elements in a search query:
  - For a complete list of fields in Logger schema, see ["Field-Based Indexing" on page 139](#).
  - Metadata terms (`_storageGroup`, `_deviceGroup`, `_peerLogger`)  
Type `"_s"` (for storage group), `"_d"` (for device group), or `"_p"` (for Logger) in the Search text box to obtain a drop-down list of constraint terms and operators.
  - Regular expression term (`| REGEX=`)

**Note:** If your query expression includes multiple device groups and storage groups to which search should be constrained, make sure that the group names are enclosed in a square bracket; for example, `_storageGroup IN ["SGA", "SGB"]`.

- Click **Advanced** to use the Search Builder tool. (See ["Using the Advanced Search Builder" on page 90](#) for more information.) Also, use this option to specify device groups, storage groups, and Loggers to which search should be limited.
- d. Click the  icon to load a saved filter, a system filter, or a saved search. Select the filter or the saved search from the displayed list and click **Load+Close**.  
For more information, see ["Saving Queries \(Creating Saved Searches and Saved Filters\)" on page 129](#) and ["System Filters/Predefined Filters" on page 131](#).
6. Click **Go**.  
The search results are displayed in the bottom section of same screen in which you ran the search. For more information about how search results are displayed and various controls available within the user interface to use those results, see ["The Search Results Display" on page 112](#).  
You can also save the search you ran as a saved filter or saved search. Click the  icon to do so. For more information about a saved filter or a saved search, see ["Saving Queries \(Creating Saved Searches and Saved Filters\)" on page 129](#).

## Things You Should Know About Logger Searches

Take the following points into consideration when writing search queries.

- Values in the system-defined fields, which include Time, Device, Logger, parser, source, and sourceType, cannot be searched by either keyword or field based searches. These fields are system-defined and do not exist in the raw event text. Therefore, searching for data in these fields returns no result.

While the parser field includes only the name of the parser and is not searchable, the parser defines fields based on its associated source type, and those fields are searchable. See ["Additional Fields in the Search Results" on page 116](#) for more information.

**Note:** Fields that are not searchable are not highlighted by mousing over them in the search results and are not marked as fields in the auto-complete search. See ["Refining a Search from the Search Results Table" on page 117](#) and ["Autocomplete Search" on page 98](#) for more information.

- Null values are not included in the Search results. For example, when performing a search on event data such as NOT deviceCustomString1=bar, the search returns results that match deviceCustomString1 not equal to "bar", but does not return events where the deviceCustomString1 value is NULL. You must explicitly call out NULL values with <field> IS NOT NULL or <field> IS NULL.

**Note:** Logger can be configured to make NOT search conditions include NULL values, by setting the search option **Include NULL field value in NOT operator results** to yes. For more information, see ["Search Options" on page 277](#).

- Data contained within a string that has already been tokenized cannot be searched. Searchable keywords are determined by the set of delimiters used to parse the raw text string into searchable units called tokens. These delimiters are controlled on the **Configuration > Search Options** page.
  - Logger includes the following primary delimiters for use during full-text (keyword) search: space, tab, newline, comma, semi-colon, (, ), [, ], {, }, ", |, and \*. If only these primary delimiters are set to yes on the **Configuration > Search Options** screen and the raw event contains a string like this: dmz : 10 . 9 . 9 . 9 / 20, then that entire string would be a single, searchable keyword.
  - The **Configuration > Search Options** screen also enables you to use secondary delimiters when searching. If the secondary delimiters are also set to yes, the following list of delimiters would further tokenize the string: =, ., :, /, \, @, -, ?, #, &, \_, >, and <. As a result, if the raw event contains the string: dmz : 10 . 9 . 9 . 9 / 20, then the searchable keywords for this event, will be dmz, 10, 9, and 20.

See ["Search Options" on page 277](#) for more information on setting primary and secondary delimiters.

## Searching Peers (Distributed Search)

When you run a search query, by default, only your local Logger is searched for matching events. However, when specifying a query, you can select an option to run the search on the peer Loggers.

A user needs to belong to these user groups with the listed permissions set to perform peer searches and view their search results:

- Logger Search Group with “Search for events on remote peers” user right set (checked).
- Logger Rights Group with the “View registered peers” user rights set (checked).

### Follow these guidelines for searching across peers:

- Specify the peer Loggers to search, as described in ["Constraints" on page 84](#).
- Logger supports searching up to 100 peers in the same search.
- For best search performance and functionality, all peers must be on the latest version of Logger. Searches across peers are limited by the ability of the earliest version peer.
  - If an operator does not exist on a peer version, the query will not run on that peer.
  - Peers on earlier version will have the performance of that version, so search result for those peers will be returned more slowly.
- For best performance of non-pipeline searches, do not include the `regex`, `rex`, `parse`, `keys`, `transaction`, `extract`, or `lookup` search operators in the query.
- If the peer Loggers do not have the same storage or device group names, a search query operation skips searching for events for those groups on those peers.
- If there are custom schema fields in your Logger schema, those fields must exist on all peers. A search query containing those fields will not run across peers, and will return an error. See ["Adding Fields to the Schema" on page 377](#).
- When a Logger becomes unavailable during a search operation, error messages are displayed. The displayed message varies depending on the error detected. This is most likely because there is a problem with the network or the peer is down. In some cases it may be because there is an issue with the peering relationship. The error messages may still display for the search that was in progress even after the problem is fixed. However, you can ignore such messages if they go away when you run a new distributed search. For more information about peers, see ["Peer Nodes" on page 397](#).
- Using search heads enables faster peer searches for searches that use search operators, particularly aggregation operators, such as `chart`, `sort`, `top`. For best search performance when writing queries to be executed on a search head, specify all peers to be searched in the query and exclude the local Logger. See ["Setting up Search Heads for Faster Peer Searches" on page 30](#).

**Note:** Peer search speed improvements gained by using search heads apply only to searches run through the user interface. Using search heads does not improve the speed of scheduled searches or searches run through Logger Web Services.

### Example queries for searching across peers:

Search that sorts five fields:

```
_peerLogger IN ["peer1", "peer2", ...] | sort deviceEventCategory eventId  
deviceCustomNumber1 deviceCustomNumber2 deviceCustomNumber3
```

Search with field extraction:

```
_peerLogger IN ["peer1", "peer2", ...] | rex "(?<src_ip>\d{1,3}\.\d{1,3}\.\d  
{1,3}\.\d{1,3})"
```

Search evaluating a variable:

```
_peerLogger IN ["peer1", "peer2", ...] | eval (int)urllength=len(requestUrl)  
|sort urllength
```

Search with results grouped and counted as a top 50 list:

```
_peerLogger IN ["peer1", "peer2", ...] | and priority > 0 | top 50 name
```

Search for events with a long URL:

```
_peerLogger IN ["peer1", "peer2", ...] | eval n=len(requestUrl) | where n =  
"1023"
```

## Tuning Search Performance

Search performance depends on many factors and will vary from query to query. Some of factors that can affect search performance are listed below. To optimize search performance, ensure that you follow these recommendations:

- When searching for uncommon field values, use superindexing to narrow the range of data that needs to be searched, as described in ["Searching for Rare Field Values" on the next page](#).
- Enable field-based indexing for all fields that occur in your events. When events are indexed, Logger can quickly and efficiently search for relevant data. By default, a recommended set of fields are indexed on your Logger; you might need to add additional fields, as described in ["To add fields to the field-based index:" on page 275](#).
- Avoid specifying a time range that results in a query that needs to scan multi-millions of events.
- Limit the search to specific storage groups and peers.
- Reduce other load on the system when your query needs to run, such as scheduled jobs, large number of incoming events, and multiple reports being run.
- Before running a query, make sure all Loggers on which it will run support the query features.

For more information on improving search performance, refer to the [Logger Configuration and Tuning: Best Practices](#) guide.

## Searching for Rare Field Values

To enable you to quickly search common IP address, host name, and user name fields for rare field values; Logger creates superindexes on new data as it comes in. Searches written to take advantage of super-indexed fields will tell you very quickly if there are no hits and will return results more quickly than regular searches when there are very few hits. Therefore, they are excellent for fast needle-in-a-haystack searches. For more information, see "[Superindexing](#)" on page 141.

**Note:** Since superindexes are built on new data as it comes in, they only apply to data collected by Logger 5.5 or later. Any data brought forward from an upgrade from an earlier version of Logger will not be superindexed and will not exhibit this search speed improvement.

## Using Super-Indexed Fields to Increase Search Speed

To take advantage of superindexing and get the fastest search results, run an equal to (=) search, such as `sourceAddress=192.0.2.0`, and write the indexed search portion of your query to find uncommon values in the super-indexed fields listed in the table below.

### Super-indexed Fields

deviceEventClassId	deviceProduct	deviceVendor	destinationHostName
destinationPort	destinationAddress	destinationUserId	destinationUserName
deviceAddress	deviceHostName	sourceHostName	sourcePort
sourceAddress	sourceUserId	sourceUserName	

**Note:** Unlike the indexed fields discussed in "[Field-Based Indexing](#)" on page 139, you cannot add to the list of super-indexed fields.

Search on super-indexed fields only using the = operator, and only AND with non-super-indexed fields for fastest search performance. Superindexes speed up searches that use the equal to (=) operator in the indexed search portion of the query expression. They have no performance impact on searches that use greater than (>), less than (<), not equal to (!=), or other operators in the indexed search portion of the query. While Logger supports full-text search, search on fields that are not super-indexed, and searches that use operators such as >, less than <, !=, and so on; such searches may not provide the greatest search speed.

Using AND and OR with the = operator can be very powerful when searching super-indexed fields. However, to obtain the greatest search speed improvement, you must use them carefully. The table below provides examples to help you understand how to write queries that take advantage of the power of superindexing.

**Note:** To see the faster search results, all fields you use in your query must be indexed.

### Query Examples for Superindexing in Needle-in-a-Haystack Searches

Query	Does It Improve Search Speed?
arcsight (full text)	No difference.  This is a full text query, and so does not take advantage of super-indexed field-search speed improvements.
192.0.2.0 (full text that looks like a super-indexed field)	No difference.  While this could be an IP address, it is a full text search, not an = search against one of the super-indexed fields, and so does not take advantage of super-indexed field-search speed improvements.
sourceAddress = 192.0.2.0 (= on a super-indexed field)	The search speed is improved and the results return very quickly when there are no hits.  If Logger has not encountered 192.0.2.0 as a sourceAddress, it quickly returns the message "No results were found". If it has encountered that sourceAddress, the range of events to be searched is narrowed down.
sourceAddress = 192.0.2.0 OR sourceAddress = 192.0.2.2 (= using OR on super-indexed fields)	The search speed is improved and the results return very quickly when there are no hits.  If Logger has not encountered 192.0.2.0 or 192.0.2.2 as a sourceAddress, it quickly returns the message "No results were found". If it has encountered one or the other, the range of events to be searched is narrowed down.
sourceAddress = 192.0.2.0 AND destinationAddress = 192.0.2.2 (= using AND on super-indexed fields)	The search speed is improved and the results return very quickly when there are no hits.  If Logger has not encountered 192.0.2.0 as a sourceAddress, it quickly returns the message "No results were found".  Similarly, if Logger has not encountered 192.0.2.2 as a destinationAddress, it quickly returns the message "No results were found", even if it has encountered 192.0.2.0 as a sourceAddress.  If Logger has encountered both, the range of events to be searched is narrowed down.
sourceAddress != 192.0.2.0 (!= on a super-indexed field)	No difference.  Superindexing does not help with negations, so this query does not take advantage of super-indexed field-search speed improvements.
sourceAddress != 192.0.2.0 OR destinationAddress= 192.0.2.2 (!= using OR on Super-indexed fields)	No difference.  Since there is a negation on the sourceAddress and this is an OR condition, this query does not take advantage of super-indexed field-search speed improvements.

### Query Examples for Superindexing in Needle-in-a-Haystack Searches, continued

Query	Does It Improve Search Speed?
<code>sourceAddress != 192.0.2.0 AND destinationAddress = 192.0.2.2</code>  (!= using AND on Super-indexed fields)	<p>The search speed is improved and the results return very quickly when there are no hits.</p> <p>Since this is an AND condition, both conditions need to be true.</p> <p>Even though there is a negation on the <code>sourceAddress</code>, if Logger has not encountered a <code>destinationAddress</code> address of 192.0.2.2, this AND condition will never be satisfied. In that case, it quickly returns the message "No results were found".</p> <p>If Logger has encountered that <code>destinationAddress</code>, the range of events to be searched is narrowed down.</p>
<code>sourceAddress = 192.0.2.0 AND arcsight</code>  (= on super-indexed field AND full text)	<p>The search speed is improved and the results return very quickly when there are no hits.</p> <p>If Logger has not encountered a <code>sourceAddress</code> of 192.0.2.0, this AND condition will never be satisfied. In that case, it quickly returns the message "No results were found", even though there is a full text search.</p> <p>If Logger has encountered that <code>sourceAddress</code>, the range of events to be searched is narrowed down.</p>
<code>sourceAddress = 192.0.2.0 OR arcsight</code>  (= on super-indexed field OR full text)	<p>No difference.</p> <p>Regardless of whether Logger has encountered a <code>sourceAddress</code> of 192.0.2.0, the OR condition requires a full text search for "arcsight", so this query does not take advantage of super-indexed field-search speed improvements.</p>

### Query Examples for Superindexing in Needle-in-a-Haystack Searches, continued

Query	Does It Improve Search Speed?
name = "CPU Usage" AND sourceAddress = 192.0.2.0  (indexed field AND super-indexed field)	<p>The search speed is improved and the results return very quickly when there are no hits.</p> <p>Even though name is not one of the super-indexed fields, because the query uses an AND condition, Logger quickly returns the message "No results were found" if it has not encountered a sourceAddress of 192.0.2.0.</p> <p>If Logger has encountered that sourceAddress, the range of events to be searched is narrowed down.</p>
name = "CPU Usage" OR sourceAddress = 192.0.2.0  (indexed field OR super-indexed field)	<p>No difference.</p> <p>Even though sourceAddress is one of the super-indexed fields, because it is in an OR condition with name, which is not super-indexed, this query does not take advantage of super-indexed field-search speed improvements.</p>
sourceAddress = 192.0.2.0 AND (sourceHostName = myhost.com OR sourcePort = 80) AND (destinationAddress = 192.0.2.2 OR arcsight)  (super-indexed field AND (nested OR condition) AND (nested OR condition))	<p>Results return very quickly when there are no hits.</p> <p>If Logger has not encountered a sourceAddress of 192.0.2.0, the top level AND will never be true. It quickly returns the message "No results were found" in that case.</p> <p>If Logger has not encountered a sourceHostName of myhost.com AND it has not encountered a sourcePort of 80, then the OR condition will never be true. Thus the top level AND condition will never be true. It quickly returns the message "No results were found" in that case.</p> <p>If Logger cannot show that the above conditions are false, then there will be no difference in search speed.</p> <p>Even though destinationAddress is one of the super-indexed fields, because it is in an OR condition with a full-text search for "arcsight", the range of events to be searched cannot be narrowed down.</p>

## The Search Results Display

After you have initiated a search, the search results are displayed in the bottom section of the same screen in which you ran the search. A search operation can take time when millions of events need to be searched. When the first screen of events that match the specified conditions is available, Logger automatically pauses the search and displays the matched events.

Event data is categorized by field name and each field is displayed as a separate color-coded column. For example, the time when an event was received on the Logger (Event Time) is displayed in a gray-shaded column (■ indicating metadata) and labeled **Time (Event Time)**.

- [Adjusting the Displayed Search Results](#) ..... 113
- [Canceling a Search in Progress](#) ..... 114
- [The Histogram](#) ..... 114



- The Search Results Table ..... 116
- Additional Fields in the Search Results ..... 116
- Refining a Search from the Search Results Table ..... 117
- Viewing Raw Events ..... 118
- Changing the Displayed Search Results Using Field Sets ..... 118
- Multi-line Data Display ..... 119
- Auto Refresh Search Results ..... 119
- Chart Drill Down ..... 120
- The Field Summary Panel ..... 121

## Adjusting the Displayed Search Results

Search results are sorted by the Logger receipt time. The events are displayed either oldest first or newest first, depending on what you selected when you ran the search. If you want to change the sort order, you will need to rerun the search. To change the sort order, open the search options drop-down and in the Sort field select Oldest event first or Newest event first.

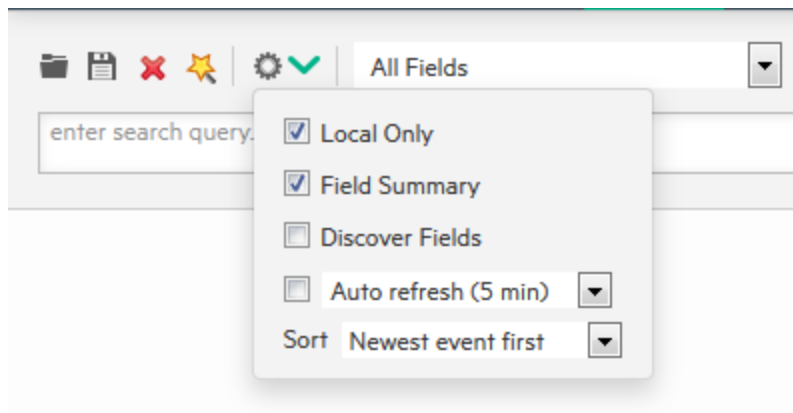

By default, 25 events are displayed on one screen. To change the number of events displayed per screen, open the Events per Page pop-up menu, located at the bottom of the search results, and select the number of events to display.

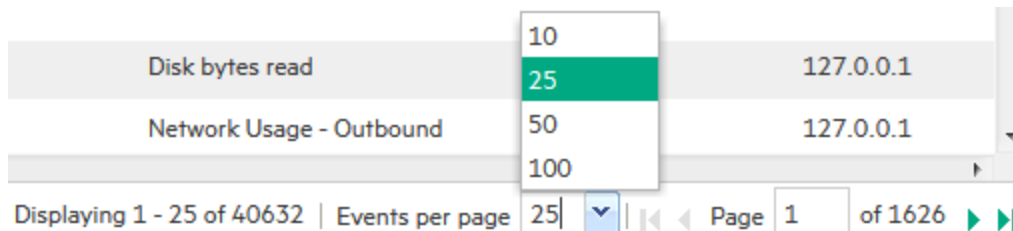

Some searches may return many pages of results. To move from page to page in the search results, click the appropriate arrow or type number of the page that you want to move to and then press Enter.

Each event is available in its raw form or parsed data. You can show or hide the raw event data from this page. See "[Viewing Raw Events](#)" on page 118 for details.

In addition to changing how the data is displayed, you can refine your search from the search results display. See "[Refining a Search from the Search Results Table](#)" on page 117 for details.

## Canceling a Search in Progress

While the search is in progress, the Go! button changes to Cancel—click Cancel to terminate the search early. When a query is running, search results are displayed as matching events are found. Therefore, when you click Cancel, any matching events found so far are displayed as the search results. This might be helpful in cases when the query needs to scan a large data set, but the search results displayed so far display the events you were looking for. You can further process the displayed (partial) results; for example, export the results, use the histogram to drill down in the results, or click on any text in the Search Results to add it to the query for further drill-down in the search results.

**Note:** If a query includes chart-able operators such as chart, rare, or top, and the query is terminated early, a chart of the partial results is not displayed. Additionally, if a query includes the head, tail, or sort operators, partial results are not generated.

## The Histogram

The Search Results page displays a histogram that provides a graphical representation of the events that match a search query. The histogram is based on the Logger receipt time of the events (similar to search queries that also use the Logger receipt time to search for events).

The X-axis represents event time and Y-axis represents the number of matching events, as shown in the following figure. The time distribution on the X-axis is determined automatically, based on the time range specified in the query.

**Note:** The time range on the X-axis might not match the time range specified in the search query because the start and end times on the X-axis are determined by the event times of the first and last matching events of the search query.

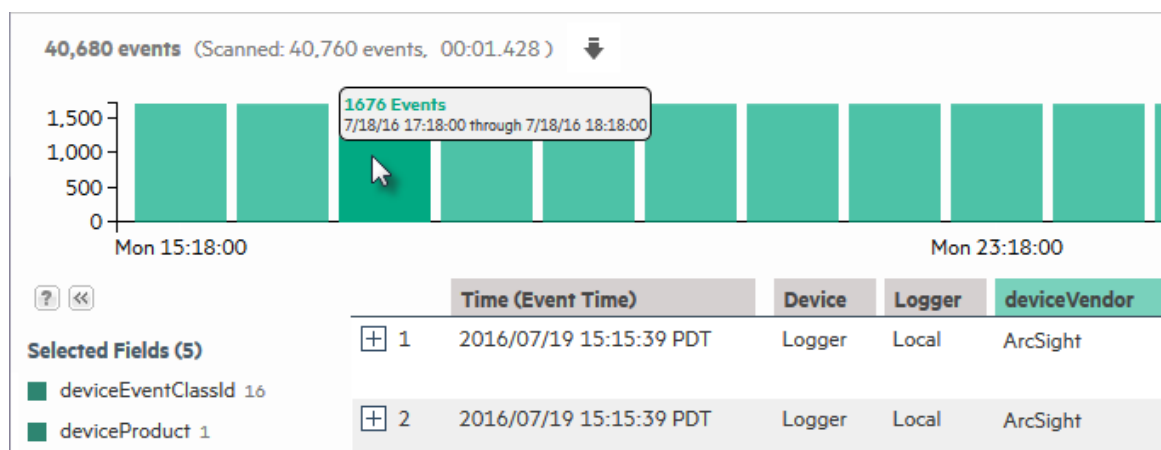

## Histogram showing mouseover details



A histogram is progressively built and displayed as events match a search query. If the search query needs to scan a large amount of data or a large time period, the histogram displayed initially might refresh multiple times while the query is running. To view the complete (and final) histogram of a search query, wait until the query has finished running (that is, the screen does not display the circular “waiting” icon anymore).

The first one million matching events are plotted on the histogram. If a search query matches more than one million events, an informational message is displayed on the screen. If you need to use the histogram view for event analysis for a search query that matches more than one million events, ArcSight suggests that you adjust the time range specified in your search query so that less than one million are matched. This will allow you to obtain a complete and meaningful histogram. You can also use a pipeline operator such as `top`, `head`, or `chart` to further refine search results so that the total number of hits is under one million events.

## Displaying the Histogram

You cannot disable the histogram; however, you can click the Histogram icon  above the upper-right corner of the histogram to hide it. To display a hidden histogram, click the  icon again.

## Mouse-Over

You can mouse-over any histogram bar to highlight it and view the number of matching events and the date and time period that the bar represents. For example, in the last figure, the highlighted bar represents 1,676 events from 5-6 p.m. on July 18th. The matching events listed below the histogram do not change, and the histogram continues to display all matching events.

## Histogram Drill Down

You can drill down to events in a specific time period by clicking the bar on the histogram that represents that time period. The bar you drilled down to is highlighted and the events matching that

time period are listed below the histogram. The histogram continues to display all of matching events, as shown in the following figure.

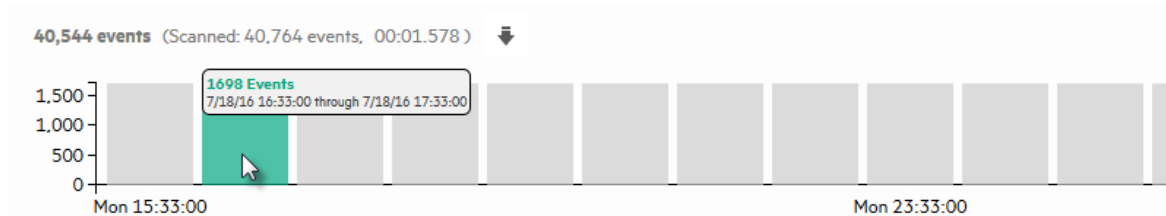

To deselect the time period, click the bar again. You can also select multiple consecutive bars on the histogram to view matching events in all of the selected time units.

## The Search Results Table

The search results table displays the number of events scanned, the number of events found, the index status of each event type, and how long the search took.

Below the histogram, events are shown in table form, one row per event. Terms that match your query are highlighted to make it easy to see why an event matched the query. As you roll the mouse over other terms in the events table, they highlight in green.

You can drill down into the displayed search results by clicking a green-highlighted term to add it to the current query. For example, if you search for “login” and roll over the word “fail” in the search results, “fail” will highlight in green. Click the word “fail” to change the query to “login AND fail.”

**Tip:** You can also highlight and copy text from any displayed column. This feature is handy when you need to copy an IP address or a URL. (Click and drag your cursor over it to select the text. Then, right-click to display the **Copy** option.)

By default, a Field Summary panel is displayed on the left side of the matched events. This section lists the fields that occur in matching events and the number of unique values for each in those events. For more information about Field Summary, see ["The Field Summary Panel" on page 121](#).

## Additional Fields in the Search Results

In addition to Logger's schema fields, you may see other types of fields in the Search results.

### User-Defined Fields

User-defined fields are created when a search query includes operators such as `rex`, `extract`, and `rename`. See ["Search Operators" on page 471](#) for information on these operators. These fields are displayed as additional columns in the All Fields view (of the System Fieldsets). To view only these columns, select **User Defined Fieldsets** from the System Fieldsets list.

## System-Defined Fields

When a search query matches events that were received from a defined source type and were parsed using a pre-defined or user-defined parser, the search results include a parser field, and may include fields for the source type, and source, depending on the setting in the Search Options page. For more information, see ["Search Options" on page 277](#).

System-defined fields contain no event data and are not searchable. See ["Things You Should Know About Logger Searches" on page 106](#) for more information.

Field	Description
parser	<p>Indicates whether or not an event was parsed, and if so, which parser was used.</p> <p><b>Note:</b> While the parser field itself is not searchable, the parser defines searchable fields based on its associated source type. These fields vary based on the source type. For more information, see <a href="#">"Parsers" on page 315</a>.</p> <p>If the event was parsed, this field contains the name of the parser. If the event was not parsed successfully, this field contains "Not parsed". If no parser is defined for the source type or if there is no source type, the field is blank.</p>
source type	<p>The type of file from which the event was received, as defined on the <b>Source Type</b> page (Configuration   Data &gt; Source Types). For more information, see <a href="#">"Source Types" on page 311</a>.</p> <p>If no source type was applied when the event was received, this field is blank. You can control whether this field is displayed from the Search Options page.</p>
source	<p>The name of the log file from which the event was received. For example, <code>/opt/mnt/testsoft/web_server.out.log</code>.</p> <p>If no source was applied when the event was received, this field is blank. You can control whether this field is displayed from the Search Options page.</p>

## Refining a Search from the Search Results Table

Use these shortcuts to select terms from the displayed search result columns or the raw events to refine your search query:



- Click a term in search results to add it to the search query, and rerun the search immediately.
- Flag the **Enable Multi-select of field values** checkbox ( [Enable Multi-select of field values.](#)) and then click multiple terms to add to the search query. When multiple terms are added, they are joined by AND operators. Click **Go!** to run the search.
- Ctrl+click to replace the entire search query with <field name> + "CONTAINS" + <selected term>, and rerun the search immediately.

- Alt or Shift + click the term in search results to add NOT to the term, and rerun the query, thus eliminating the events that match the term you selected.
- Add multiple NOT conditions by holding the Alt key and selecting terms in search results. When multiple conditions are added, they are joined by AND operators. If **Enable Multi-select of field values** is checked, click **Go!** to run the search. If it is not checked, the search runs when you click the term.
- Combine Ctrl+Alt, (or Ctrl+Shift) to replace the search query with NOT + <field name> + "CONTAINS" + <selected term>.

**Note:** Fields that are not searchable are not highlighted by mousing over them in the search results and cannot be clicked on to add to the search. For more information about what is searchable, see ["Things You Should Know About Logger Searches" on page 106](#), and ["Additional Fields in the Search Results" on page 116](#).

## Viewing Raw Events

Each event is available in its raw form or parsed data. By default, the parsed data is displayed.

- To view raw data for a single event, click the  icon to the left of the event.
- To view raw data for all displayed events, click **Show Raw** () at the bottom of the screen.

You can also view the Syslog raw events in a formatted column called rawEvent if you have enabled the "Populate rawEvent field for syslog events" option on the Search Options page, as discussed in ["Search Options" on page 277](#). See ["Predefined Fieldsets" on page 79](#) to learn more about displaying raw events.

## Changing the Displayed Search Results Using Field Sets

By default, the Search Results are displayed using the All Fields field set, which displays all fields contained in an event. Once you select another field set, it becomes your default view until you change it the next time. For a detailed discussion about field sets, see ["Fieldsets" on page 79](#).

If you view the Search Results using the Raw Event field set, remember these guidelines:

- Even though the rawEvent column displays the raw event, this column is not added to the Logger database and is not indexed. Therefore, you can only run a keyword (full-text) or regular expression to search on the event.
- You can use the Regex Helper tool to identify strings from the raw syslog events in the rawEvent column that you want to add to a query. (You cannot use the Regex Helper for CEF events displayed in the rawEvent column.) See ["Regex Helper Tool" on page 96](#) for details about the Regex Helper tool.

## Multi-line Data Display

An event field might span multiple lines separated by characters such as newline (\n) or carriage return (\r). For example,

```
0x0000: 0000 0100 0000 0000 0000 0000 0000 0000 .....  
0x0010: 0000 0000 0000 0000 0000 0000 0000 0000 .....  
0x0020: 0000 0000 0000 0000 0000 0000 0000 .....
```

The Logger user interface displays these in multi-line format and does not remove the line separators and collapse the message into one line.

## Auto Refresh Search Results

The Auto refresh feature executes the search over specified intervals, updating the search results if new events match the query. Set this option from the Search Options menu.

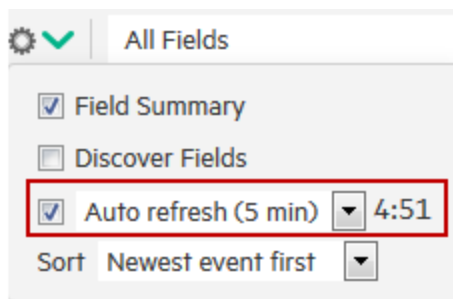

Depending on your needs, you can auto update the search results every:

- 30 seconds
- 60 seconds
- 2 minutes
- 5 minutes (default)
- 15 minutes

You can enable this option for a search operation before or after running it. Once you enable this option, the setting persists for all search operations until you explicitly disable it.

### To auto update search results:

1. Select Analyze > Search from the Navigation bar.
2. From the Search Options menu, check the **Auto refresh** box and select the refresh interval you want.

## Chart Drill Down

Aggregated search operators such as chart, top, and rare generate charts of search results. The chart drill down feature enables you to quickly filter down to events with specific field values. You identify the value on a search results chart and click it to drill down to events that match the value. For example, in the following chart, if you want to see events in which the device event class ID is eps 102, click the column labeled **eps:102** to display events shown in the second figure.

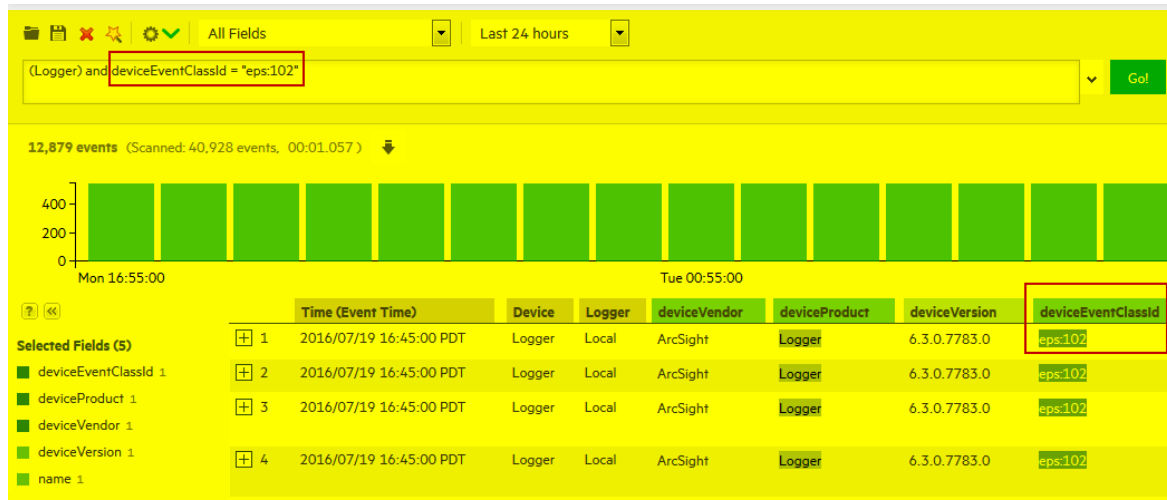
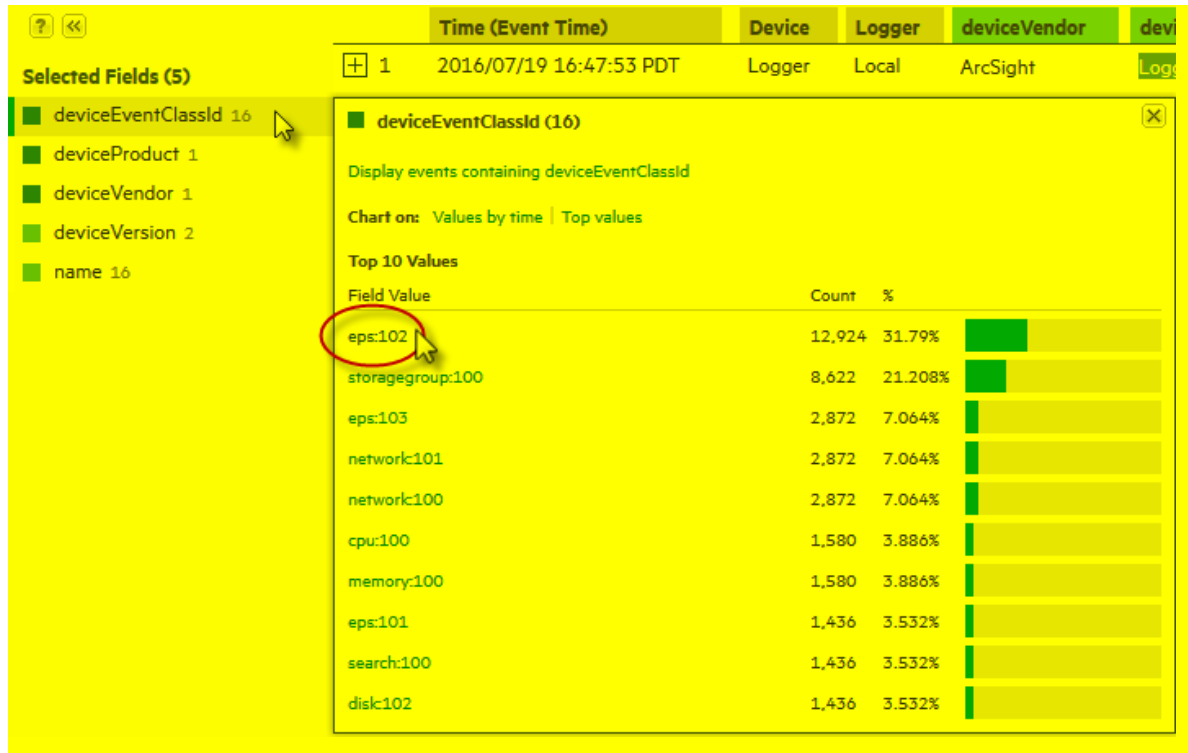



When you click on a chart value (a column, bar, or donut section), the existing search query is modified to include the WHERE operator with the field name and value, and automatically rerun. If you need to return to the original query from the drill-down screen, use the Back function of your browser.

## The Field Summary Panel

When a query is run, the Field Summary panel lists the CEF and non-CEF fields that occur in matching events and the number of unique values for each in those events. This panel is only displayed for queries that do not generate charts. If a peer search is performed, the summarized field values include counts from peer Loggers.

The Field Summary panel contains two sections: **Selected Fields** and **Discovered Fields**. The Selected Fields section lists the CEF fields, while the Discovered Fields section lists the non-CEF fields discovered in raw events.

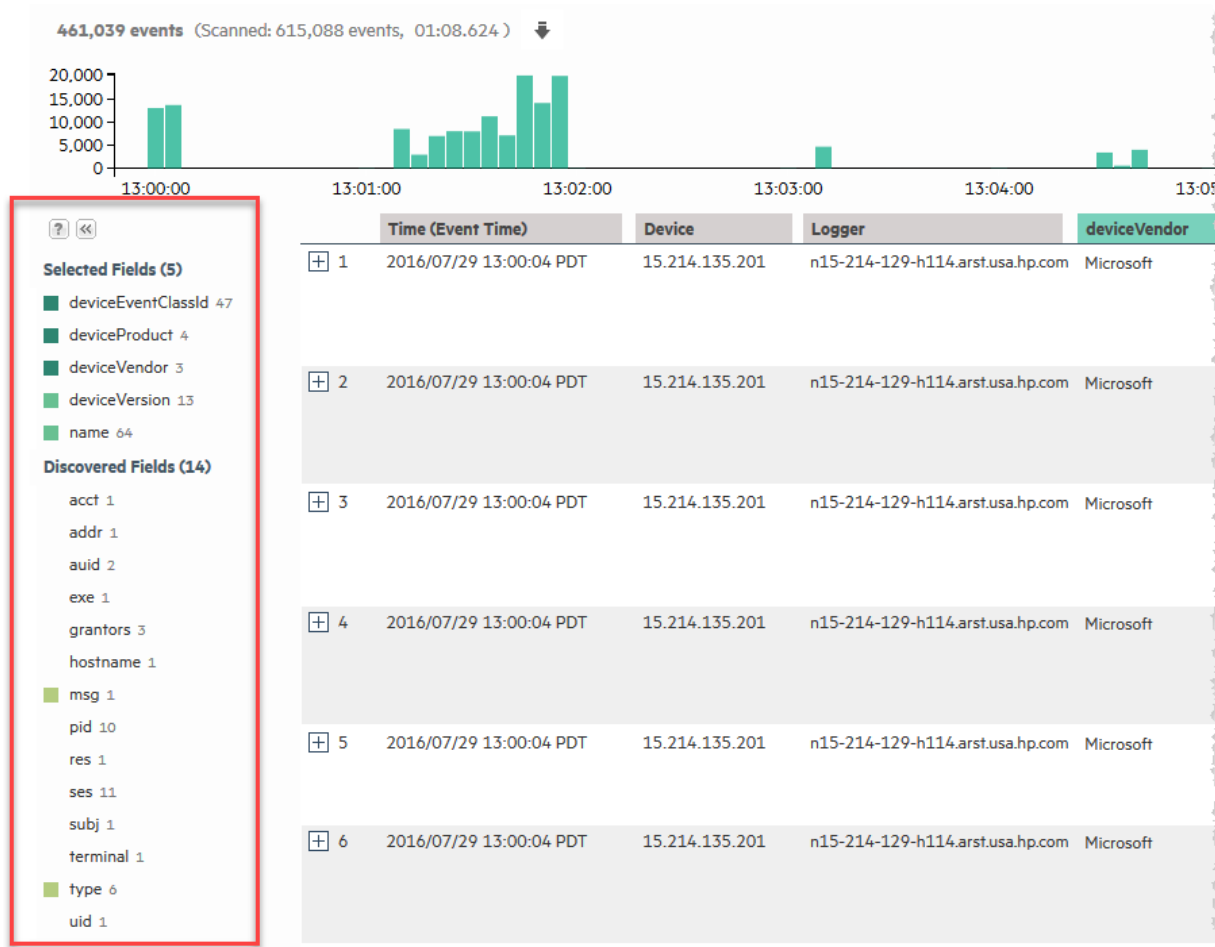

- [Displaying the Field Summary Panel](#) .....122
- [Selected Fields List](#) .....122
- [Field Summary Drill Down](#) .....123

- [Discovering Fields in Raw Event Data](#) ..... 123
- [Refining and Charting a Search from Field Summary](#) ..... 124

## Displaying the Field Summary Panel

By default, the Field Summary feature is enabled and the Discover Fields option is disabled. These options are controlled globally in the ["Search Options" on page 277](#), and locally with checkboxes in the search results display options. Selecting these options on the Analyze >Search page overrides the setting for these options on the Search Options page. For more information on the Discover Fields option, see ["Discovering Fields in Raw Event Data" on the next page](#).

You can display or hide the Field Summary panel by using the Fields Summary checkbox in the search results display options.

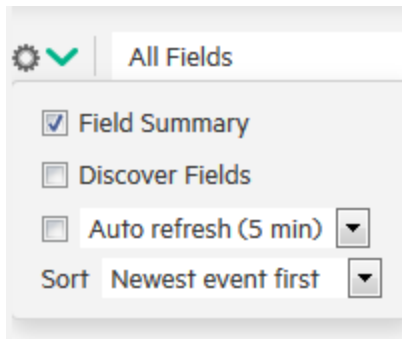

## Selected Fields List

By default, the Selected Fields list contains these fields: deviceEventClassId, deviceProduct, deviceVendor, deviceVersion, and name; you can edit this list to suit your needs. For both lists, by default, the top 10 values for each field are listed.

You can change the fields displayed in the Field Summary panel's Selected Fields list by changing the field-set. You can use one of the predefined fieldsets or create your own to include only the fields you need.

### To change the Selected Fields list:

1. Define or update an existing custom field set to include fields you want the Selected Fields list to contain. See ["Fieldsets" on page 79](#) for information on creating custom field sets.
2. Select the custom field set you defined to view search results.
3. After running a search query, if you select a different field set, the Field Summary panel displays the following message:

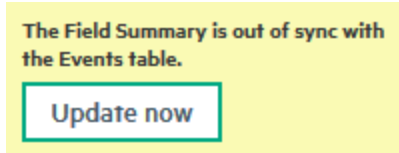

This message indicates that the fields listed in the Field Summary panel do not match the ones specified in the newly selected field set. To display the fields specified in the new field set, click **Update now**.

## Field Summary Drill Down

You can drill down on any of the listed fields or a specific value of the listed fields in the Fields Summary panel.

For example, you might want to view all events containing deviceEventClassId (specific field) or you might want to view events of deviceEventClassId "storagegroup:100" (specific value of a field).

For fields whose values are of type String, you can view all events, view the top 10, or create charts of the matching events. For fields whose values are of type Numeric, you can perform mathematical operations such as average, min, and max.

Every time you run a query or drill down on a specific field or value, a new query using the newly selected criteria is run and the Field Summary list is updated.

### To view drill down in the field summary:

1. Click Analyze | Search to open the search page.
2. Click the search options down arrow (▼) to configure the search display options and check **Field Summary**.
3. Run a search.
4. In the Field Summary list, click the field name you want more detail on.
5. The *<fieldname><number of values>* dialog box displays the top ten field values.
6. Optionally, click **Display events containing <fieldname>** to run a search that displays only those events.
7. Optionally, click a field value to run a search that displays only those events.
8. Optionally, create a chart of the results as discussed in ["Refining and Charting a Search from Field Summary" on the next page](#).

## Discovering Fields in Raw Event Data

The Field Summary feature can automatically discover non-CEF fields from a raw event if the Discover Fields is enabled. By default, the Discover Fields option is disabled.

If you need to enable the Discover Fields option for all searches on your Logger, change the default values (“No”) on the Search Options page (Configuration | Search > Search Options) to “Yes” for these options, as shown in the following figure.



The screenshot shows the 'Field Summary Options' section of the Search Options page. It contains two dropdown menus: 'Use Field Summary' is set to 'Yes' and 'Discover fields' is set to 'No'.

However, if you need to use the Discover Fields option occasionally—not for all searches—you can enable this option for one-time use on the user interface page from where you run the search query (Analyze > Search). To do so, click the **Discover Fields** checkbox in the search display options before running the query.

**Note:** Selecting these options on the Search page overrides the setting for these options on the Search Options page.

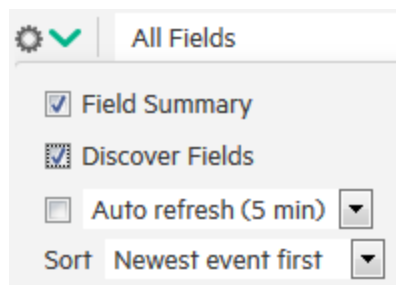

The screenshot shows the search display options menu. It includes a gear icon, a checkmark, and the text 'All Fields'. Below this, there are four options: 'Field Summary' (checked), 'Discover Fields' (checked), 'Auto refresh (5 min)' (unchecked), and 'Sort Newest event first' (selected).

**Tip:** To auto discover fields, the raw event must contain data in the “key=value” format, and none of these characters can be the first character of the “value”: comma, space, tab, and semicolon.

For each “key=value” pair found in a raw event, a new field of the name “key” is created. The Field Summary includes a summary of the values for all the new fields under the Discovered Fields section. The discovered fields are assigned the type “String” by default. The auto-discovery capability works only if at least 2,500 of the first 10,000 matching events contain “key=value” pairs. If this threshold is not met, auto discovery is automatically turned off. However, this threshold does not apply if there are less than 10,000 matching events; in that case, fields are discovered regardless.

## Refining and Charting a Search from Field Summary

When you click a field in the Field Summary, a dialog box labeled *<fieldname><number of values>* displays information about the field. From here, you can drill down to see more details and create a chart of the search results.

### To view field details from field summary:

1. Run a search and drill down to the data you are interested in, as described in ["Field Summary Drill Down"](#) on page 123.
2. To create a chart of the search results, click one of the Chart on values, such as **Values by time** or **Top values**.
3. The results display in a Result Chart and a Result Table.
4. In the Result Chart, click **Chart Settings** to adjust the chart.
5. Enter a useful **Chart Title**.
  - Select the **Chart Type** best suited to your data.
  - Set the **Display Limit**. The highest valid value is 100.
6. In the Result Table, you can use navigation buttons to move forward and backward through list of results, and refresh the search.

To create a PDF or CSV file containing the search results, click **Export Results**. For more information, see ["Exporting Search Results"](#) on the next page.

## Saving the Search Results

You can save the results of any search by exporting them in PDF or CSV format:

- PDF: Useful in generating a quick report of the search results. The report includes a table of search results and any charts generated for the results. Both raw (unstructured data) and CEF (structured data) events, can be included in the exported report.
- Comma-separated values (CSV) file: Useful for further analysis with other software applications. The report includes a table of search results. Charts cannot be included in this format.

Data for the following time fields is exported in human-readable format: deviceReceiptTime, startTime, endTime, agentReceiptTime. For example, 2015/03/21 20:22:09 PDT.

- [Example of a Quick Report in PDF Format \(Search Results Export\)](#) ..... 126
- [Exporting Search Results](#) ..... 126
- [Scheduling an Export Operation](#) ..... 129

## Example of a Quick Report in PDF Format (Search Results Export)

The following is an example of a quick report generated in PDF format. The chart is displayed first, followed by a table of matched events (not shown in this example). All generated charts (including stacked charts) can be exported.

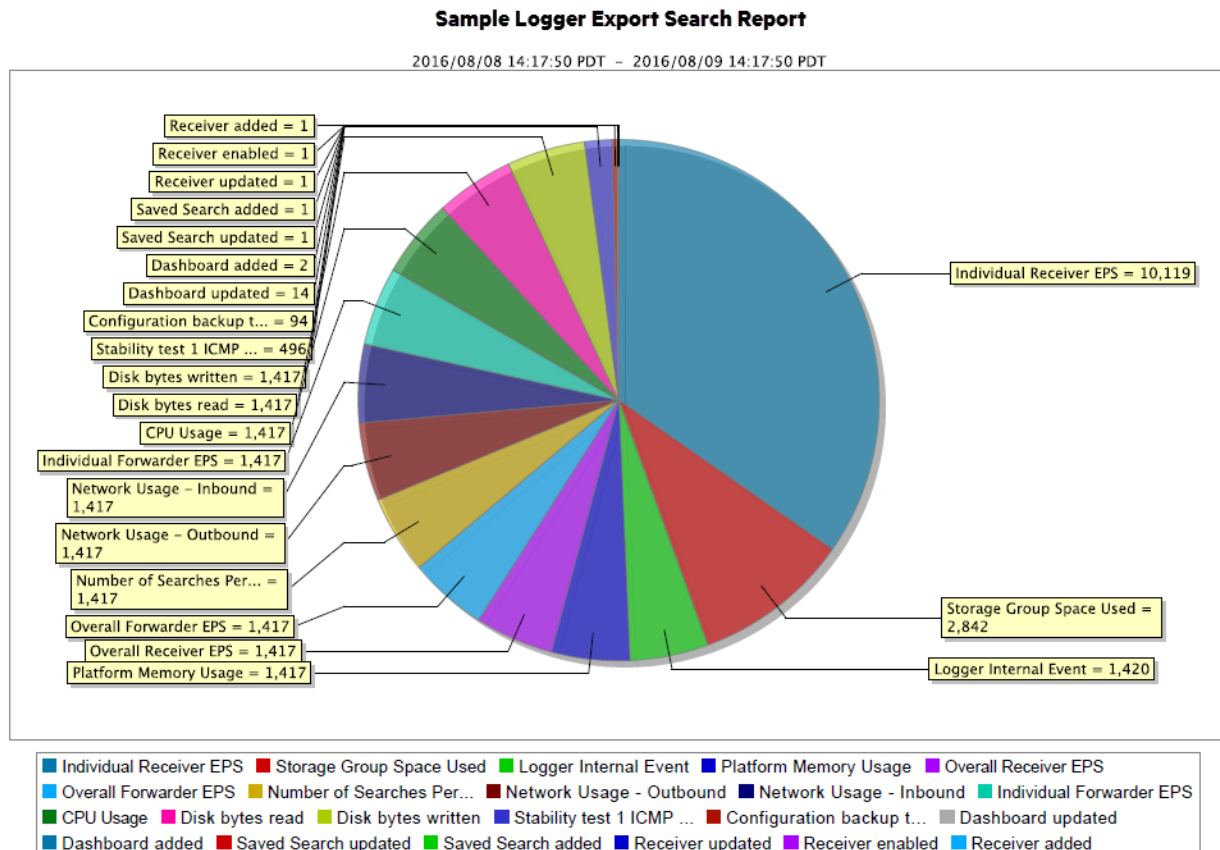

## Exporting Search Results

### To export the results of your search:

1. Run a search query from the **Analyze > Search** page or the **Analyze > Alerts** page.
2. Click the Export Results arrow  above the histogram.

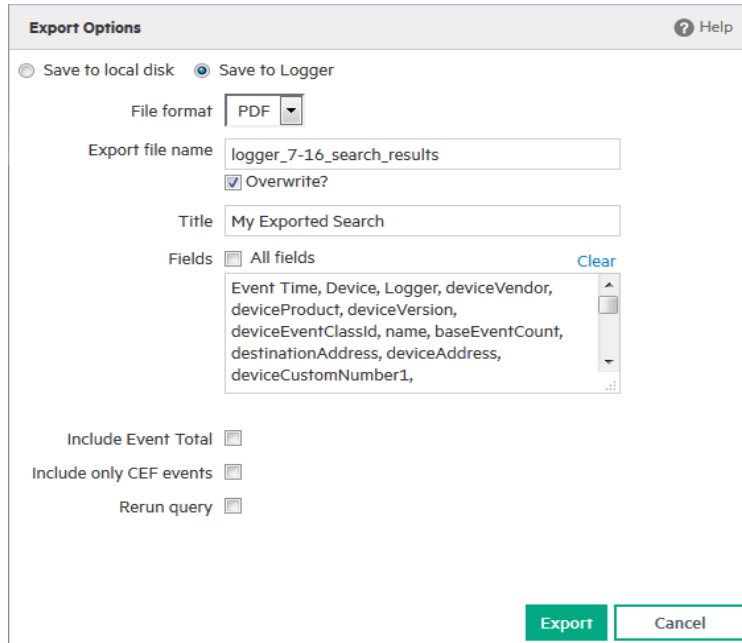

3. Select from the available options and then click **Export**. The displayed options change based on your selections.

Option	Description
Save to local disk	Select to save the file to a local system from which you are accessing Logger or is it sent to the browser for viewing or saving.
Export to remote location	Select to export the file On a Logger Appliance, the file is written to an NFS mount, a CIFS mount, or a SAN system. On Software Logger, data is always stored in the <install_dir>/data/logger directory. This directory can reside locally on the system running the Logger software, or on a remote storage system such as NFS or CIFS. <div style="background-color: #f0f0f0; padding: 5px;"><b>Note:</b> The Logger Appliance supports mounting through the user interface. Software Logger uses its filesystem, which can contain remote folders mounted through the operating system.</div>
Save to Logger	Select to write the file to Logger's local system.
File Format	Select <b>CSV</b> to produce a comma-separated values file. Select <b>PDF</b> to produce a report-style PDF that contains the search results in tables and charts. Charts are only included if the search query contains an operator that creates charts, such as chart, top, and so on.

Option	Description
Export file name	<p>(Available only when the “Export to remote location” option is selected)</p> <p>Specify the name of the file to which events will be exported.</p> <p>If a file of the specified name does not exist, it is created. If a file of the specified name exists and the Overwrite box is not checked, an error is generated. If the Overwrite box is checked, the existing file is overwritten.</p>
Title	<p>(Optional, available only when the File Format is “PDF”)</p> <p>Enter a meaningful name that appears on top of the PDF file. If no title is specified, “Untitled” is included.</p>
Fields	<p>Displays the list of event fields to be included in the exported file. By default, all fields are included.</p> <p>Enter fields or edit the displayed fields by deselecting All Fields.</p> <p>To export fields created as a result of <code>rex</code>, <code>extract</code>, <code>rename</code>, or <code>eval</code> operators, or field created when a parser is applied to an event, ensure that <code>*user</code> is selected in the Fields list.</p>
Chart Type (for PDF only)	<p>(Available only when a chart is available in search results)</p> <p>Select the type of chart to include in the PDF file. You can select from: Column, Bar, Donut, Area, Line, Stacked Column, Stacked Bar.</p> <p><b>Note:</b> If the Chart Type is different from the chart displayed on the Search Results screen, the value selected for this option overrides the one shown in the screen. Therefore, the exported PDF contains the chart you specify for this option and not the one shown on the screen.</p>
Chart Result Limit (for PDF only)	<p>(Available only when a chart is available in search results)</p> <p>Specify the number of unique values to plot. Default: 10</p> <p>If the configured Chart Result Limit is less than the number of unique values for a query, the top values equal to the Chart Result Limit are plotted. That is, if the Chart Result Limit is 5 and 7 unique values are found, the top 5 values will be plotted.</p>
Include Event Total	<p>Select to include the total number of events in the exported search results.</p>
Include Only CEF Events	<p>Select to include CEF events in the exported search results.</p>
Include Base Events (Available for Alerts only)	<p>Select to include base events in the exported search results.</p> <p><b>Tip:</b> The base events option is available ONLY when you Export the search results from the <b>Analyze &gt; Alerts</b> page.</p>
Rerun query	<p>Select to rerun the query before exporting the search results.</p>



## Scheduling an Export Operation

The time it takes to export search results is proportional to the number of events being exported. Therefore, for a large number of events, HPE recommends that you schedule the export operation to be performed at a later time by saving the query and time parameters as a Saved Search, and then scheduling a Saved Search Job. For more information about Saved Search jobs, including how to create a scheduled search, see "[Scheduled Searches/Alerts](#)" on page 265.

## Saving Queries (Creating Saved Searches and Saved Filters)

If you need to run the same search query regularly, you can save it in as a filter or as a saved search.

- Saving it as a filter saves the query expression, but does not save the time range or the field set information.
- Saving it as a saved search saves the query expression and the time range that you specified.
- [System Filters/Predefined Filters](#) .....131
- [Searching with Saved Queries](#) .....135
- [Scheduling Date and Time Options](#) .....136

### To save a query:

1. Define a query as described in "[Searching for Events](#)" on page 102 or "[Using the Advanced Search Builder](#)" on page 90.
2. Click the Save icon (📁) and enter a name for the query in the Name field, as shown in the following figure.

The screenshot shows a 'Save Query' dialog box. The title bar reads 'Save Query' and includes a 'Help' icon. The main area contains the following fields and options:

- Name:** A text input field containing 'MySavedQuery1'.
- Save as:** Radio buttons for 'Filter' and 'Saved Search'. 'Saved Search' is selected.
- Schedule it:** A checked checkbox with the text '(You can change the schedule settings later)'. This option is only visible when 'Saved Search' is selected.
- Type:** Radio buttons for 'Scheduled Search' and 'Scheduled Alert'. 'Scheduled Search' is selected.

At the bottom of the dialog are two buttons: 'Save' and 'Cancel'.

- In the Save as field, select whether you want to save this query as a Filter, as a Saved Search, or as a Dashboard panel.

If you select to save as a Saved Search, you can either keep the saved query as Saved Search or change it to a Scheduled Search or Schedule Alert by clicking the **Schedule it** Check box. (Queries with aggregation operators cannot be used in Saved Search Alerts.) For further information about Saved Search Alerts, see ["Saved Search Alerts" on page 271](#).

If the search query includes an aggregation operator such as chart or top, an option to save the query for a Dashboard panel is also displayed.

If you select the Dashboard panel option, dashboard options are displayed.

Enter the following parameters:

Parameter	Description
Title	Enter a meaningful name for the panel that will be added to the Dashboard.
Saved search	Select an existing saved search from the drop-down box that will be overwritten with this query.  OR  Select "New saved search" to create a new saved search query. Enter the new name in the text box.

Parameter	Description
Dashboard	Select an existing Dashboard from the drop-down box to which the Search Results panel will be added.  OR Select "New dashboard" to add the Search Results panel to a new Dashboard. Enter the name of the new Dashboard in the "Dashboard Name" field.
Panel type	Select the type of panel: <ul style="list-style-type: none"> <li>• Chart: Displays search results in a chart form</li> <li>• Table: Displays search results in a table form</li> <li>• Chart and Table: Adds two panels, one for displaying search results in the chart form and the other for displaying search results in the table form</li> </ul>
Chart type	Select the type of chart to display matching events. You can select from:  Column, Bar, Donut, Area, Line, Stacked Column, Stacked Bar.  Default: Column
Chart limit	<i>Only applicable to Search Result Chart panels.</i>  Specify the number of unique values to plot. Default: 10

4. Click **Save**.
5. If you selected Schedule it, you are asked if you'd like to edit the schedule setting now. Click **OK**. If you click **Cancel**, the Saved Search or Alert is not created.
6. Set the schedule options as appropriate. For details about these options, see ["Scheduling Date and Time Options" on page 136](#).
7. For Scheduled Saved Searches, select the desired options. For details about the parameters, see ["Search Job Options" on page 269](#).
8. For Scheduled Alerts, select the desired options. For details about the parameters, see ["Alert Job Options" on page 271](#).
9. Click **Save**.

## System Filters/Predefined Filters

Your Logger ships with a number of predefined filters, also known as system filters. These filters define queries for commonly searched events. For example, unsuccessful login attempts or the number of events by source. Filter queries are available as Unified queries and as Regular Expression queries. Unified queries can be used for searching and reporting while Regular Expression queries are for defining alerts and forwarders.

**Note:** To effectively use the Firewall or UNIX Server use case filters (listed in the following table), define device groups that include the firewall devices or UNIX servers that you are interested in and

then constrain your search to those device groups. If you do not create device groups specific to device types, the search results would match all Deny, Drop, or Permit events from all devices instead of only the firewall devices. Similarly, the “Unix-IO Errors and Warnings” filter would include IO errors and warnings from all devices and not only the UNIX servers.

The following is a list of all the system filters. For a description of each filter, see ["System Filters" on page 586](#).

To use a predefined system filter, follow instructions in ["Searching with Saved Queries" on page 135](#).

**Note:** Even though the filters in the System Alert category (listed in the last section of the following table) are displayed on the user interface of Software Logger, these filters do not apply to it.

### System Filters

Category	Unified Query Filters	Regular Expression Query Filters
<b>Login Status use case</b>	All Logins	All Logins (Non-CEF) All Logins (CEF format)
	Unsuccessful Logins	Unsuccessful Logins (Non-CEF) Unsuccessful Logins (CEF format)
	Successful Logins	Successful Logins (Non-CEF) Successful Logins (CEF format)
	Failed Logins	
<b>Configuration</b>	Configuration Changes	System configuration changes (CEF format)
<b>Events use case</b>	High and Very High Severity Events	High and Very High Severity CEF events
	Event Counts by Source	
	Event Counts by Destination	
		All CEF events
<b>Intrusion use case</b>	Malicious Code	Malicious Code (CEF format)
<b>Firewall use case</b>	Deny (Firewall Deny)	
	Drop (Firewall Drop)	
	Permit (Firewall Permit)	
<b>Network use case</b>	DHCP Lease Events	
	Port Links Up and Down	

### System Filters, continued

Category	Unified Query Filters	Regular Expression Query Filters	
	Protocol Links Up and Down		
<b>Connector System Status use case</b>	CPU Utilization by Connector Host		
	Disk Utilization by Connector Host		
	Memory Utilization by Connector Host		
<b>UNIX Server use case</b>	CRON related events		
	IO Errors and Warnings		
	PAM and Sudo Messages		
	Password Changes		
	SAMBA Events		
	SSH Authentications		
	User and Group Additions		
	User and Group Deletions		
<b>Windows Events use case</b>	Account Added to Global Group Account Added to Global Group (CEF)		
	Audit Policy Change Audit Policy Change (CEF)		
	Change Password Attempt Change Password Attempt (CEF)		
	Global Group Created Global Group Created (CEF)		
	Logon Bad User Name or Password Logon Bad User Name or Password (CEF)		
	Logon Local User Logon Local User (CEF)		
	Logon Remote User Logon Remote User (CEF)		

### System Filters, continued

Category	Unified Query Filters	Regular Expression Query Filters
	Logon Unexpected Failure Logon Unexpected Failure (CEF)	
	New Process Creation New Process Creation (CEF)	
	Pre-Authentication Failure Pre-Authentication Failure (CEF)	
	Special Privileges Assigned to New Logon Special Privileges Assigned to New Logon (CEF)	
	User Account Changed User Account Changed (CEF)	
	User Account Password Set User Account Password Set (CEF)	
	Windows Events (CEF)	
<b>System Alerts</b>	<p>The following filters search for specific internal alert events, which are written in CEF format to a special Internal Storage Group. <b>These filters are available for both search methods.</b> In addition to the following filters, you can define your own alerts based on the system health events listed in <a href="#">"System Health Events" on page 463</a>.</p> <p><b>Note:</b> Although these filters are displayed on Software Logger, these do not apply to it.</p>	
	CPU Utilization Above 90 Percent	CPU Utilization Above 90 Percent
	CPU Utilization Above 95 Percent	CPU Utilization Above 95 Percent
	Disk Failure	Disk Failure
	Root Partition Below 10 Percent	Root Partition Below 10 Percent
	Root Partition Below 5 Percent	Root Partition Below 5 Percent
	Device Configuration Changes	Device Configuration Changes
	Filter Configuration Changes	Filter Configuration Changes
	High CPU Temperature	High CPU Temperature
		Bad Fan

### System Filters, continued

Category	Unified Query Filters	Regular Expression Query Filters
	Power Supply Failure	Power Supply Failure
	RAID Controller Issue	RAID Controller Issue
	RAID Status Battery Failure	RAID Status Battery Failure
	RAID Status Disk Failure	RAID Status Disk Failure
	Storage Configuration Changes	Storage Configuration Changes
	Storage Group Usage Above 90%	Storage Group Usage Above 90%
	Storage Group Usage Above 95%	Storage Group Usage Above 95%
	Zero Events Incoming	Zero Events Incoming
	Zero Events Outgoing	Zero Events Outgoing

## Searching with Saved Queries

You can search using the Filters and Saved Searches that you create as well as the pre-defined system filters, explained in ["System Filters/Predefined Filters" on page 131](#).

### To use an existing query:

1. Open the **Analyze** menu and click **Search**.
2. Use one of these options to select the desired Filter, System Filter, or Saved Search.
  - Type `$filter$` or `$ss$` in the search text box and select a filter or a saved search from the dropdown list. See for more information, ["Opening Filters and Saved Searches via Autocomplete" on page 100](#).
  - Click the Load a Saved Filter icon () to view a list of all the saved filters and saved searches to display the Load Filter/Saved Search interface, as shown in the following figure.

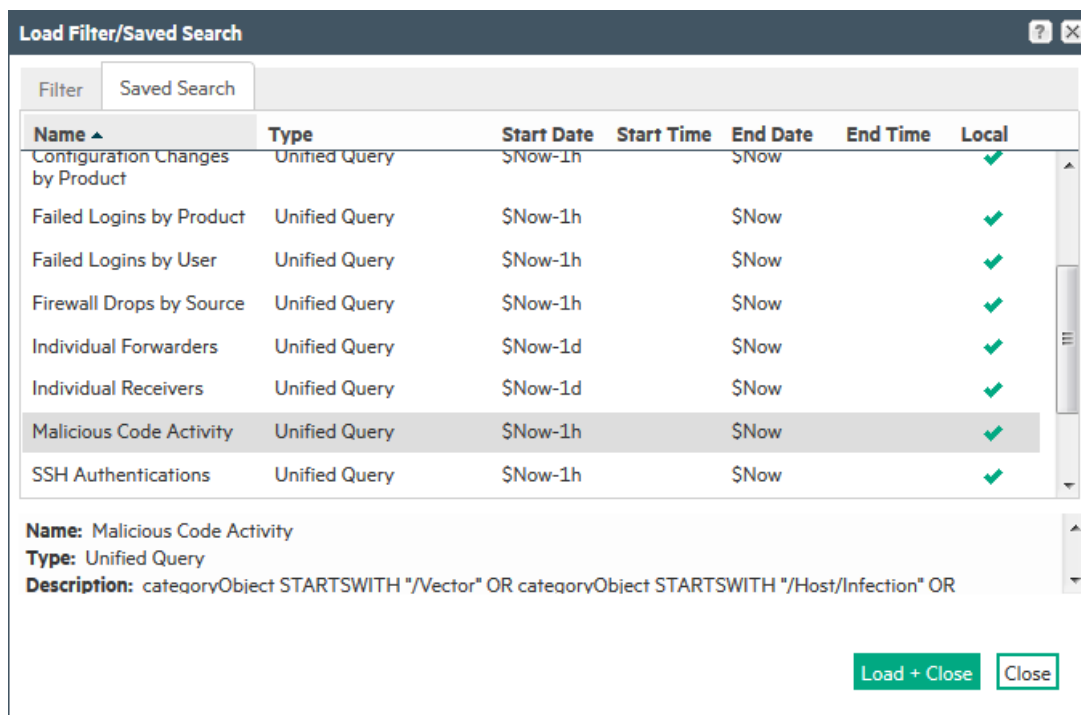

The Load Filter/Saved Search interface enables you to quickly locate the saved filters and the saved search queries. Click on any of the column names to sort information. To view details of a filter or a saved search, click its row. Details are displayed in the text box below.

To load a filter, select the filter or saved search you want to use and click **Load+Close**. The filter rows display the search query.

To load a saved query, open the **Saved Searches** page, select a search, and click **Load+Close**.

## Scheduling Date and Time Options

**Tip:** Make sure you are familiar with the information in ["Time/NTP" on page 410](#) before setting the schedule.

Choose Every Day, Days of Week, or Days of Month from the upper pull-down menu.

**Note:** When specifying multiple days, separate them with a comma. When specifying the time, use 24-hour format.

1. If **Every Day**, select one of the following options from the lower pull-down menu, and enter the necessary values:
  - **Hour of day:** (0-23) Enter the time you want the task to run (in 24 hour format) in the Hours field. Midnight is zero (0).



- **Every:** Select Hours or Minutes from the right-most pull-down menu and specify how frequently you want the task to run.
  - **Hours:** (1-23) Enter how frequently in hours you want the task to run. The result is every n hours every day.  
**Minutes:** (15-59) Enter how frequently in minutes you want the task to run. The result is every n minutes every day.
2. If **Days of Week**, select from the following options from the lower pull-down menu, and enter the necessary values:
- **Days:** (1-7) Enter the days of the week you want the task to run (Sunday=1, Monday=2, and so on).
  - **Hour of Day:** (0-23) Enter the time you want the task to run in the text field to the right. 0 is midnight.
  - **Every:** Select Hours or Minutes from the right-most pull-down menu and specify how frequently you want the task to run.  
**Hours:** (1-23) Enter how frequently in hours you want the task to run. The result is every n hours on the selected days.  
**Minutes:** (15-59) Enter how frequently in minutes you want the task to run. The result is every n minutes on the selected days.
3. If **Days of Month**, select from the following options from the lower pull-down menu, and enter the necessary values:
- **Days:** (1-31) Enter the day or days of the month you want the task to run.  
**Note:** The number of days in a month vary. Scheduled tasks will only run if the specified day exists for that month. Tasks scheduled on the 31st day of the month will not run in April, February, June, November, and September. Tasks scheduled on the 29th day of the month will only run in February during leap years.
  - **Hour of Day:** (0-23) Enter the time of day you want the task to run. (You cannot select Every for this option.)

### Examples:

- To run the scheduled job every 45 minutes of every day, select **Every Day** in the upper Schedule pull-down menu. Choose **Every** from the lower pull-down menu, enter **45** in the text box and select **Minutes**.
- To run the scheduled job every four hours on Tuesdays and Thursdays, select **Days of Week** from the upper Schedule pull-down menu and enter **3,5** as the **Days**. Then choose **Every** from the lower pull-down menu, enter **4** in the text box.
- To run the scheduled job on the 14th of each month at 3 AM, select **Days of Month** from the upper Schedule pull-down menu and enter **14** as the **Days**. Then choose **Hour of day** from the lower pull-

down menu and enter **3** in the text box. (To run the scheduled job at 3 AM and 3 PM, you would enter 3,15.)

## Enriching Logger Data Through Static Correlation

The lookup search operator enables you to augment data in Logger with data from an external file. This enables geo-tagging, asset tagging, user identification, and so on, through static correlation.

You can use the lookup operator to add information to your search results that is not part of the original data stored on Logger. You do this by creating an external file containing the data, uploading that Lookup file to Logger, and then using the lookup operator to create a join between Logger events and the uploaded Lookup file.

For example, if you want Logger search results to include which country source IP addresses are located in, you can create a file listing the IP addresses and countries and then upload that file to Logger as a Lookup file. After that, you can use the lookup operator to perform a join between the sourceAddress field in the Logger events and the IP address column in the Lookup file, and display the country in the search results.

- For information about creating Lookup files and uploading them to Logger, see "[Lookup Files](#)" on [page 284](#).
- For information on how to use the lookup operator when searching, see "[lookup](#)" on [page 487](#).

## Indexing

Once you have initialized Logger, it starts scanning events automatically and indexing them.

Logger's storage technology enables automatic indexing of events in these ways:

- Full-text indexing: Each event is tokenized and indexed. See "[Full-Text Indexing \(Keyword Indexing\)](#)" on the next page.
- Field-based indexing: Event fields are indexed based on a predetermined schema. See "[Field-Based Indexing](#)" on the next page.
- Superindexing: Certain event fields are super-indexed so that you can find rare field values quickly. See "[Superindexing](#)" on [page 141](#).

All events received after initialization are indexed for full-text search, a default set of fields is indexed for field-based search, and a default set of fields is superindexed for fast needle-in-a-haystack searches.

- [Full-Text Indexing \(Keyword Indexing\)](#) .....139
- [Field-Based Indexing](#) .....139
- [Superindexing](#) .....141

All events are timestamped with the receipt time when received on the Logger. The default fields are automatically indexed. For the remaining fields, Logger uses the receipt time of an event and the time when a field was added to the index to determine whether that event will be indexed. If the receipt time of the event is equal to or later than the time when the field was added to the index, the event is indexed; otherwise, it is not.

**Note:** Indexing information is not archived when the archive is created. You can choose to add indexing information to an archive after it has been created. For more information, see ["Indexing Archived Events" on page 359](#)

## Full-Text Indexing (Keyword Indexing)

For full-text indexing, each event (CEF or non-CEF) received on Logger is scanned and divided into keywords and stored on the Logger. The full-text search options control the manner in which an event is tokenized as described the Full-text Search Options section of the ["Search Options" on page 277](#).

## Field-Based Indexing

The field-based indexing capability allows for fields of events to be indexed. The fields are based on a predetermined schema. The Logger's reports and the field search method utilize these indexed fields to yield significant search and reporting performance gains.

Field-based indexing for a recommended set of fields is automatically enabled at Logger initialization time. You can add more fields to an index at any time. (See ["To add fields to the field-based index:" on page 275](#) for instructions.) Once a field has been added, you cannot remove it.

A list of the default index fields, along with their field descriptions is available from the Logger Configuration menu. For instructions on how to view the default Logger Schema fields, see ["Default Fields" on page 281](#).

**Note:** HPE strongly recommends that you index fields that you will be using in search and report queries.

The fields created when a predefined or user-defined rex parser parses the non-CEF events cannot be indexed using the field-based indexing capability. See ["Parsers" on page 315](#) for more information about rex parsers.

In addition to indexing the fields included in the field-based indexing list, Logger indexes event metadata fields—event time, Logger receipt time, and device address—for every event. The event metadata fields are also known as “internal” fields.

The following fields are available for indexing. The fields that Logger starts indexing automatically after Logger initialization are indicated in **bold** font.

In addition to the following fields, the requestUr1 field is available for search queries. However, this field **cannot** be indexed.

Index Fields		
agentAddress	deviceCustomDate2	flexDate1
agentHostName	deviceCustomDate2Label	flexDate1Label
agentNtDomain	<b>deviceCustomNumber1</b>	<b>filePath</b>
<b>agentSeverity</b>	deviceCustomNumber1Label	flexNumber1
<b>agentType</b>	<b>deviceCustomNumber2</b>	flexNumber1Label
agentZone	deviceCustomNumber2Label	flexNumber2
agentZoneName	<b>deviceCustomNumber3</b>	flexNumber2Label
agentZoneResource	deviceCustomNumber3Label	flexString1
agentZoneURI	<b>deviceCustomString1</b>	flexString1Label
<b>applicationProtocol</b>	deviceCustomString1Label	flexString2
<b>baseEventCount</b>	<b>deviceCustomString2</b>	flexString2Label
<b>bytesIn</b>	deviceCustomString2Label	message
<b>bytesOut</b>	<b>deviceCustomString3</b>	<b>name</b>
<b>categoryBehavior</b>	deviceCustomString3Label	<b>priority</b>
<b>categoryDeviceGroup</b>	<b>deviceCustomString4</b>	requestClientApplication
<b>categoryObject</b>	deviceCustomString4Label	requestContext
<b>categoryOutcome</b>	<b>deviceCustomString5</b>	requestMethod
<b>categorySignificance</b>	deviceCustomString5Label	requestUrlFileName
<b>categoryTechnique</b>	<b>deviceCustomString6</b>	requestUrlQuery
customerName	deviceCustomString6Label	sessionId
<b>destinationAddress</b>	<b>deviceEventCategory</b>	<b>sourceAddress</b>
destinationDnsDomain	<b>deviceEventClassId</b>	<b>sourceHostName</b>
<b>destinationHostName</b>	deviceExternalId	sourceMacAddress
destinationMacAddress	<b>deviceHostName</b>	<b>sourceNtDomain</b>
<b>destinationNtDomain</b>	deviceInboundInterface	<b>sourcePort</b>
<b>destinationPort</b>	deviceOutboundInterface	<b>sourceProcessName</b>
<b>destinationProcessName</b>	<b>deviceProduct</b>	sourceServiceName
<b>destinationServiceName</b>	deviceReceiptTime	sourceTranslatedAddress
destinationTranslatedAddress	deviceSeverity	<b>sourceUserId</b>

Index Fields		
destinationUserPrivileges	<b>deviceVendor</b>	<b>sourceUserName</b>
<b>destinationUserId</b>	<b>deviceVersion</b>	sourceUserPrivileges
<b>destinationUserName</b>	deviceZone	sourceZone
destinationZone	deviceZoneName	sourceZoneName
destinationZoneName	deviceZoneResource	sourcezoneResource
destinationZoneResource	<b>deviceZoneURI</b>	<b>sourceZoneURI</b>
<b>destinationZoneURI</b>	<b>endTime</b>	startTime
<b>deviceAction</b>	<b>eventId</b>	<b>transportProtocol</b>
<b>deviceAddress</b>	externalId	type
deviceCustomDate1	<b>fileName</b>	vulnerabilityExternalID
deviceCustomDate1Label		vulnerabilityURI

## Superindexing

In addition to full text and field based indexing, Logger and later creates superindexes for common IP address, host name, and user name fields. Superindexes enable Logger to quickly determine whether a particular field value has been stored on this Logger, and if it has, to narrow down the search to sections of data where that field value exists. Therefore, searches that can take advantage of superindexes return very quickly if there are no hits and return results more quickly than regular searches when there are very few hits.

- For information on how to use superindexes, see ["Searching for Rare Field Values" on page 109](#).
- A complete list of super-indexed fields is included in ["Using Super-Indexed Fields to Increase Search Speed" on page 109](#).

## Viewing Alerts

You can configure Logger to alert you by e-mail, an SNMP trap, or a Syslog message when a new event that matches a specific query is received or when a specified number of matches occur within a given time threshold. For more information, see ["Logger Alert Types" on page 332](#). In addition to receiving an alert via e-mail, an SNMP trap, or a Syslog message, you can view Alerts and the base events that triggered them on the **Analyze > Alerts page**.

Show  Within

Base Event Fields

Alerts 50 Status Paused  
 Page Start 2016/08/11 11:18:13 PDT Page End 2016/08/11 11:18:13 PDT

	Time (Event Time)	name	baseEventCount	deviceCustomNumber1	deviceCustomNumber2				
26	2016/08/11 11:18:13 PDT	CEF Alerts	1	3	1				
<b>Base Event (1 found)</b>									
Time (Event Time)	Device	Logger	deviceVendor	deviceProduct	deviceVersion	deviceEventClassId	name	agentAddress	agentHost
2016/08/11 11:18:12 PDT	n15-214-156-h219.arst.usa.hp.com [UDP Receiver]	Local	Snort	Snort	1.8	[1:2003]	MS-SQL Worm propagation attempt	192.168.21.138	cnaminenit
RAW CEF:0 Snort Snort 1.8 [1:2003] MS-SQL Worm propagation attempt High eventId=10005786480 mrt=1099218722851 proto=UDP categorySignificance=/Hostile categoryTime=1099452615848 eventAnnotationAuditTrail=1,1099452615848,System,Queued,,, eventAnnotationVersion=1 eventAnnotationEventId=10005786480 eventAnnotationFlags=0 eventAnnotationEndTime=1099218482000 eventAnnotationManagerReceipt									
27	2016/08/11 11:18:13 PDT	CEF Alerts	1	3	1				
<b>Base Event (1 found)</b>									
Time (Event Time)	Device	Logger	deviceVendor	deviceProduct	deviceVersion	deviceEventClassId	name	agentAddress	agentHost
2016/08/11 11:18:12 PDT	n15-214-156-h219.arst.usa.hp.com [UDP Receiver]	Local	Snort	Snort	1.8	[1:2004]	MS-SQL Worm propagation attempt OUTBOUND	192.168.21.138	cnaminenit
RAW CEF:0 Snort Snort 1.8 [1:2004] MS-SQL Worm propagation attempt OUTBOUND High eventId=10005786481 mrt=1099218722851 proto=UDP categorySignificance=/HostionModificationTime=1099452615848 eventAnnotationAuditTrail=1,1099452615848,System,Queued,,, eventAnnotationVersion=1 eventAnnotationEventId=10005786481 eventAnnotationFlags=0 eventAnnotationEndTime=1099218482000 eventAnnotationManagerReceipt									

To view Alerts, choose a predefined time range, such as “Last 2 hours” or “Today,” or choose “Custom Time Range” to reveal additional fields for specifying a time range manually. This aspect works like Search. Refer to ["Time Range" on page 76](#) for more detail.

When you create Alerts, you name them. Use the **Show** options to view only events associated with a particular Alert. The default is All Alerts.

Events that are labeled ‘Action Engine’ are Alert events. The events that triggered the alert are base events. You can also select whether to view the base events and which fields to view by using the **Base Event Fields:** option.

Like on the Search page, the **Go** button triggers the search, the **Export Results** button enables you to create a PDF or CSV file that contains the search results, and the **Auto Refresh** option determines whether and how frequently the displayed search results are updated.

## Live Event Viewer

The Live Event Viewer provides real-time view of the incoming events that match the criteria you specify. This functionality is useful in environments where the need to view an event quickly is important; for example, a financial institution might be interested in viewing a specific transaction type as soon as it occurs. Because the latency between the events arriving at Logger and the display time is quite less, events might not have been indexed on Logger before being displayed.

The Live Event Viewer composes of two tabs—Search Composer and Search Results. The Search Composer is for defining the search criteria and the Search Results tab displays the matching events in real time.

The following figure shows the Search Composer. If you specify more than one search term, the resulting query uses the AND operator to combine them. For example, if the first search term searches for “failure” and the second one **excludes** “admin,” the resulting query is “failure AND NOT admin.”

### Search Composer

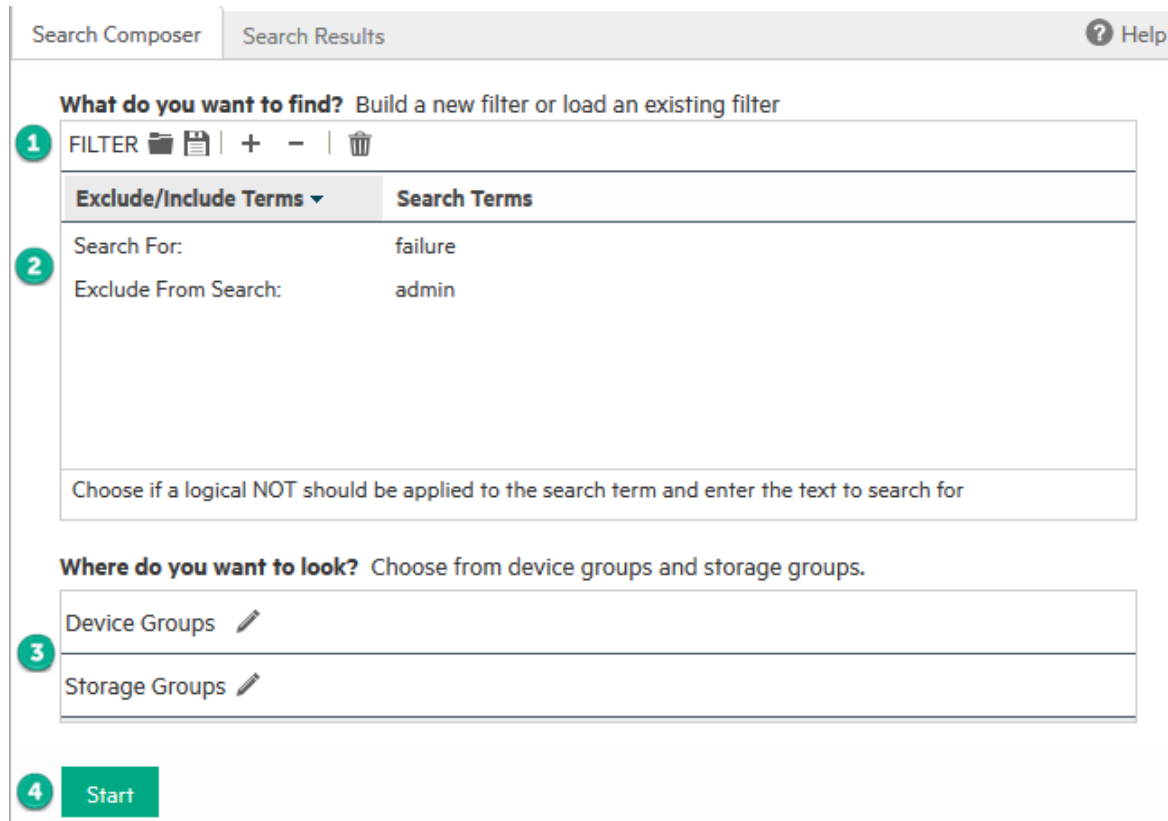

### Search Composer Legend

Feature	Description	Feature	Description
1	Load a saved filter Save the current filter Add a filter row Remove a filter row Remove all filters	3	Specify device groups Specify storage groups
2	Enter search criteria	4	Start or Stop Live Event Viewer

The Search Results tab provides the Play, Pause, Stop, Clear, and Export buttons that enable you to control the display in a manner similar to any electronic device, as shown in the following figure.

## Search Results Tab

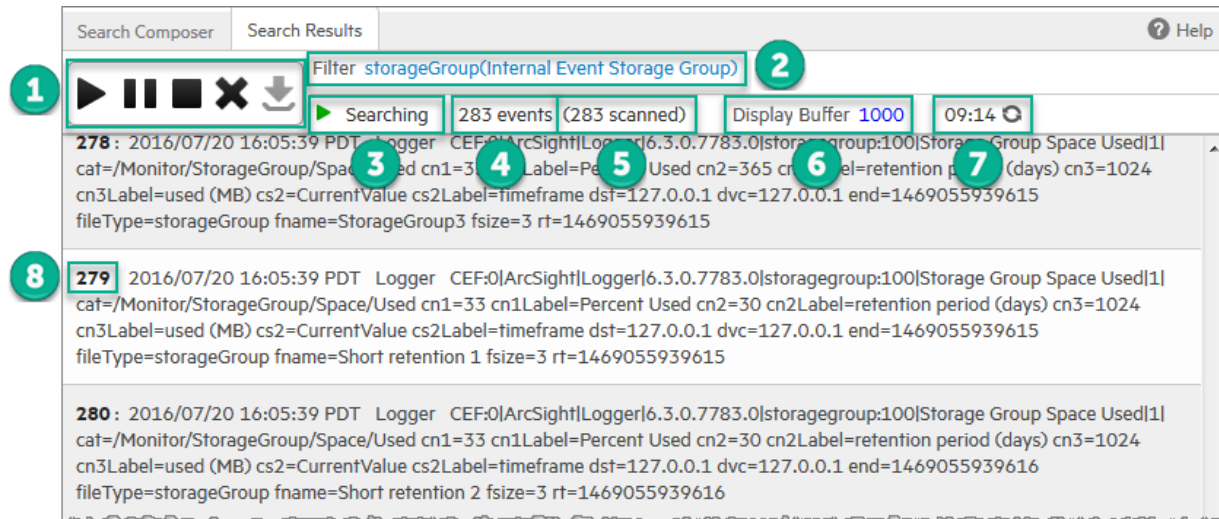

## Search Results Legend

Feature	Description	Feature	Description
1	Play / Pause / Stop / Delete / Export	5	Events scanned so far
2	Filter specified in Search Composer	6	Events display maximum
3	Current state	7	Search timer
4	Events found so far	8	Matching event number

The following list highlights the features of Search Results display:

- Events are displayed in the raw event format and not in the columnar, table form as displayed in the Search Results page (**Analyze > Search**) when you run a search query.
- A user can launch a maximum of one Live Event Viewer. There can be a maximum of five Live Event Viewers running on Loggr at any time.
- The regular expression search method is used to identify matching events. Therefore, you can specify regular expressions as the search term in the Search Composer.
- Buffer Size defines the maximum number of events displayed in the Viewer. By default, the Buffer Size is 1000; however, it can be set to any number between the range of 20 and 5000.
- By default, the search is run for 15 minutes and then stopped to preserve system resources. If you need to run the search for longer than 15 minutes, click the icon next to the countdown timer to reset the timer to 15 minutes.
- When you click Pause, the Search Results display is frozen. However, the search operation continues in the background and the new matching events are buffered until a maximum of 1000 events have







been buffered or the search timer, which continues to count down even when the Search Results display is frozen, reaches 00:00.

- If the timer has not reached 00:00, you can click Play to resume the paused search operation. When you click Play, the buffered events are displayed. The newly found events are appended to the previously found events on the Search Results display screen.
- When you click Stop, the search for matching events and the countdown of the search timer stop. When you click Play, the search is started afresh—the currently displayed events are cleared from the Search Results screen, the search timer is reset to 15 minutes, and the search starts again.
- You must stop the search operation to export the matching events.

### To launch a Live Event Viewer:

**Note:** Live Event Viewer is a resource-intensive application that can impact the overall performance of your Logger if run for a long period of time. Therefore, use this feature selectively and for short periods of time.

1. Open the **Analyze** menu and click **Live Event Viewer**.
2. In the Search Composer tab, enter the search terms or click the (  ) icon to select a saved filter.  
You can enter search terms that the event must contain (Search For:) or terms that the events must not contain (Exclude From Search:). Click the “Search For:” field to display a drop-down list from which you can select “Exclude From Search:”.  
If you specify more than one search term Logger uses the AND operator to combine them in the resulting search query.
  - To add additional search term click the (  ) icon.
  - To remove a search term, click the (  ) icon.
  - To remove all search terms, click the (  ) icon.
3. Enter constraints to limit your search to specific device groups, devices, or storage groups in the “Where do you want to look?” section. Click the (  ) icon to display a list from which you can choose the constraints.
4. Click **Start**.
5. The search results are automatically displayed in the Search Results display screen.

### To update the Live Event Viewer query:

1. In the Search Composer tab of the Live Event Viewer, update the search terms.
2. Click **Stop** first and then click **Start** to start search using the new search terms.

**To export Search Results display:**

1. Make sure you have stopped the Live Event Viewer. To do so, click the (■) icon in the Search Results display window.
2. Click the (↓) icon to open the Export Options window.
3. To export the displayed search results, select the Export options, as described in "[To export the results of your search:](#)" on page 126 Then click **Export**.

# Chapter 4: Reporting

Reporting is an essential tool for communicating the state of your network security to internal and external stakeholders. A *report* is a captured view or summary of events. Reports can be viewed from the Logger **Reports** page or exported for sharing in a variety of file formats.

**Note:** Reporting is not available before you have applied a license to your Logger. The trial license does not support Reporting. See ["Trial Licenses" on page 393](#).

The following topics describe how to create, run, and view reports in Logger. For information in about the out-of-box reports that come with your Logger, see ["Logger Content" on page 555](#).

- [The Reports Home Page](#) .....147
- [The Explorers](#) .....150
- [Categories](#) .....157
- [Dashboards](#) ..... 161
- [Widgets](#) .....175
- [Running, Viewing, and Publishing Reports](#) .....179
- [Scheduled Reports](#) .....192
- [Designing Reports](#) .....196
- [Queries](#) ..... 219
- [Parameters](#) .....233
- [Template Styles](#) .....242
- [Administration](#) ..... 243

## The Reports Home Page

**To access the Reports home page:**

1. From the Logger navigation bar, click **Reports | Dashboard**.

**To open the Reports home page from within the Reporting tool:**

1. From the Reports left panel, click **Dashboard**.

**Note:** If you have configured a dashboard to display as the Reports Home page, Logger opens the selected dashboard. If a dashboard has not been configured to display, you are redirected to the Recent Reports page.

At the top of the Reports home page, there are links for Dashboard Viewer, Dashboard Preferences, Widget Designer, Recent Reports, Jobs Execution Status, Classic Viewer, Classic Designer, and Classic Preferences.

[Dashboard Viewer](#) [Dashboard Preferences](#) [Widget Designer](#) [Recent Reports](#) [Jobs Execution Status](#) [Classic Viewer](#) [Classic Designer](#) [Classic Preferences](#)

- The **Dashboard Viewer** enables you to view your dashboards. You can use the buttons in the upper right corner of the Dashboard Viewer page to add a widget to the dashboard, save, edit, and subscribe the dashboard. For more information, see ["Dashboards" on page 161](#).
- The **Dashboard Preferences** link enables you to specify a default dashboard to display as your Reports home page, and to display multiple dashboards as tabs in the Reports home page. For more information, see ["Selecting a Default Dashboard View for the Reports Home Page" on page 165](#).
- The **Widget Designer** page enables you to create a widget displaying either a report or a web link. You can place the widget in the dashboard from the Dashboard Viewer page. For more information, see ["The Widget Designer" on page 175](#).
- The **Recent Reports** link lists the status of currently running, recently run, or accessed reports. By default, all reports except the completed scheduled reports are displayed. You can also use the **Filters** tab to restrict the reports displayed. For more information, see ["Viewing Recently Run Reports" on page 180](#).
- The **Jobs Execution Status** link displays a graphic summary of the execution status of all completed, succeeded, failed, and upcoming report run jobs. For more information, see ["Jobs Execution Status" on page 193](#).
- The **Classic Viewer**, **Classic Designer**, and **Classic Preferences** links enable the view, design and maintenance of dashboards created in pre-5.2 versions of Logger. See ["Using Classic Dashboards" on page 166](#) for more information.

Some Reports categories, such as Recent Reports and Jobs Execution Status, include subcategories. Click the  arrow next to a category to access its subcategories.

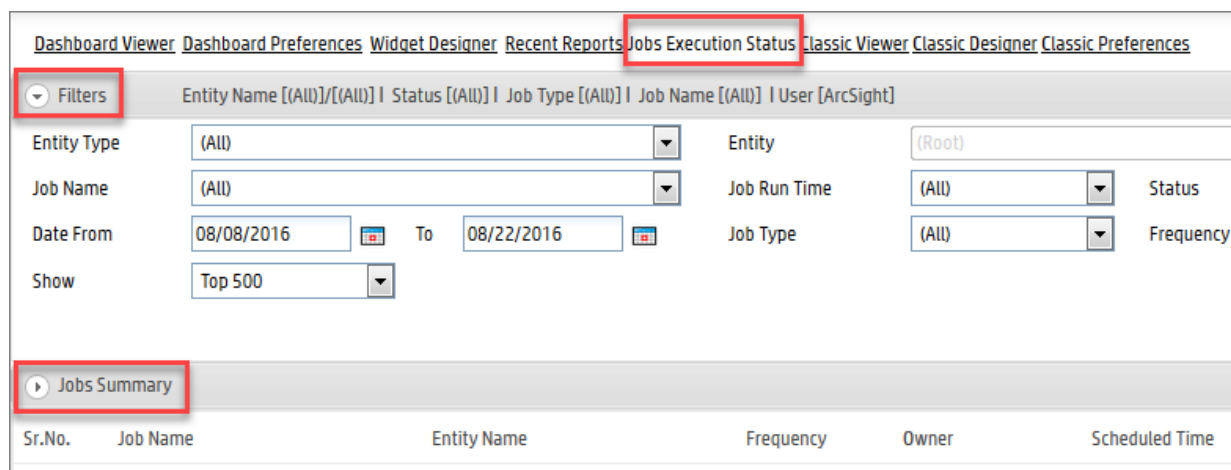

[Dashboard Viewer](#) [Dashboard Preferences](#) [Widget Designer](#) [Recent Reports](#) [Jobs Execution Status](#) [Classic Viewer](#) [Classic Designer](#) [Classic Preferences](#)

 Filters Entity Name [(All)]/[(All)] | Status [(All)] | Job Type [(All)] | Job Name [(All)] | User [ArcSight]

Entity Type [(All)] Entity [(Root)]  
Job Name [(All)] Job Run Time [(All)] Status  
Date From 08/08/2016 To 08/22/2016 Job Type [(All)] Frequency  
Show Top 500

 Jobs Summary

Sr.No.	Job Name	Entity Name	Frequency	Owner	Scheduled Time
--------	----------	-------------	-----------	-------	----------------

## Getting Started

You can get started with Logger reporting with any of the following:

- You can schedule any report to run once at a later date or on a specified frequency (such as daily or weekly). Monthly reports cannot be scheduled currently. To begin, see ["Scheduled Reports" on page 192](#).
- You can design a dashboard to show the things you are most interested in as your Reports Home page. To begin, see ["Designing Dashboards" on page 163](#).
- You can create reports to track information that you are interested in. To begin, see ["Designing Reports" on page 196](#)
- You can run, view, and publish the results of any type of report. To begin, see ["Running, Viewing, and Publishing Reports" on page 179](#).
- You can adjust the configuration on your report server. To begin, see ["Report Server Administration" on page 245](#).
- You can create a new query for use in reports, using the visual Query Object Editor. To begin, see ["Queries" on page 219](#).

## The Reports Quick Access Menu

All Logger Report pages include a left menu, for quick access to reporting features. It has the same options as the Reports menu in the navigation bar.

<p><b>Dashboard</b></p> <p>Scheduled Reports</p> <p><b>Navigation</b></p> <p>Category Explorer</p> <p>Report Explorer</p> <p>Query Explorer</p> <p>Parameter Explorer</p> <p>Favorites Explorer</p> <p><b>Design</b></p> <p>New Report</p> <p>Queries</p> <p>Parameters</p> <p>Parameter Value Groups</p> <p>Template Styles</p> <p><b>Administration</b></p> <p>Deploy Report Bundle</p> <p>Report Administration</p> <p>Report Category Filters</p> <p>Report Categories</p> <p>iPackager</p>	<ul style="list-style-type: none"><li>• The <b>Dashboard</b> link provides access to the reports Dashboard features.</li><li>• The <b>Scheduled Reports</b> link enables you to specify when to run your reports.</li><li>• The links listed under <b>Navigation</b> enable you to navigate to a category, report, query, parameter, or favorite item. You can select multiple objects in any of the Explorers and perform actions such as set access rights, copy, cut, paste or delete actions.</li><li>• The links listed under <b>Design</b> enable you to create a new report and create, view and configure any object of the Reporting tool.</li><li>• The links listed under <b>Administration</b> enable you to perform administrative reporting tasks.</li></ul>
---	--

## The Explorers

You can use the Explorers listed under the **Navigation** heading in the Reports quick access menu to navigate to a desired report, query, parameter, dashboard, dashboard widget, or favorite item.

### To navigate using the Explorers:

- Click a category to display the objects in that category.
- Click a category or an object in a category to perform an action on it.
- Some Reports categories, such as Recent Reports and Jobs Execution Status, include subcategories. Click the  arrow next to a category to access its subcategories.

The following Explorers are available:

- ["Category Explorer" on page 153.](#)
- ["Report Explorer" on page 154.](#)

- "Query Explorer" on page 155.
- "Parameter Explorer" on page 155.
- "Favorites Explorer" on page 156.

## The Explorer Actions Menus

The Explorers include context-sensitive **Actions** menus, which give quick access to tasks that are available for a selected report object.

### To access the Actions menu for an Explorer:

1. Select an Explorer from the Reports quick access menu. A menu displays to the right.
2. Select a subcategory from the **Root** menu. Another menu displays to the right.
3. Continue to select from the available options until you can select an individual item (such as a report or query). The **Actions** menu for that item opens to the right.

The list of items in the Actions menu depends on the Explorer context. The Actions menu for the Parameter Explorer, for example, displays a different set of actions from the Actions menu for the Query Explorer.

### Example

For example, to access the Actions menu for the Report Explorer:

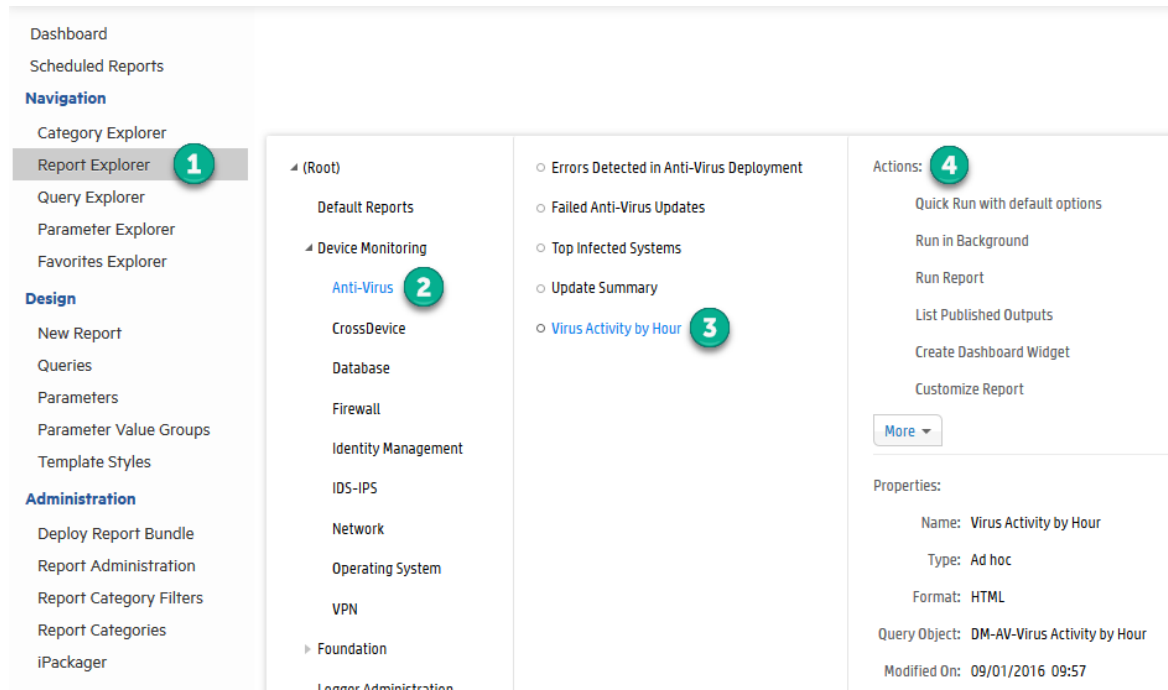

- 1 Click **Report Explorer** from the quick access menu. The list of report categories is displayed.
- 2 In the report categories list, click **Device Monitoring** to open the sub-menu, then click **Anti-Virus**. The list of Anti-Virus reports is displayed to the right of the category list.
- 3 From the list of Anti-Virus reports, select *Virus Activity by Hour*.
- 4 The **Actions** menu is displayed to the right of the reports list. The Actions menu includes items appropriate for running, viewing, or editing the *Virus Activity by Hour* report.



Reports also include a Properties section, with a description of the selected report.

**Properties:**

**Name:** Top Destination Ports

**Type:** Ad hoc

**Format:** HTML

**Query Object:** Top Destination Ports

**Modified On:** 08/04/2016 11:08

**Category:** Targets

**Public:** True

**Description:** This report displays a table of the top destination ports and the number of events for each port.

## Category Explorer

Reports and report objects, such as queries and parameters, can be organized and grouped based on their function. Such functional groups are called *categories*. For example, a report pertaining to a database can be stored under the Database category.

The Category Explorer lists all categorized reports and report objects. It comes with some pre-defined, commonly used categories. You can also add custom categories based on your requirements.

You can use the Category Explorer to display an overview of all reports, published reports only, Query Objects, Parameter Objects, Dashboards, Dashboard Widgets, Reports, and Saved Reports (published reports)

### To access objects from the Category Explorer:

1. From the Logger navigation bar, click **Reports**, then, under **Navigation**, click **Category Explorer**. The Repository pane opens to the right of the navigation pane and displays the available categories and objects.

2. Click the ▶ arrows to open available sub-menus.

For example, click the ▶ to open the **Root** menu. **Foundation**, the ▶ next to **Intrusion Monitoring**, and then click **Targets > Query Objects**.

The Category Explorer displays the Query Objects in the **Foundation > Intrusion Monitoring > Targets** category.

3. Click an object and then select an action to take by clicking a link in the Actions menu. If there are

actions you can take, available options will display in the actions pane. If there are no associated actions, the action pane will be grayed out.

For example, click **Target Counts by Device Severity** and then click **Edit Query Details**. The Query Object Editor opens, displaying the selected Query Object.

For a complete list and description of reports available on Logger, see ["Logger Content" on page 555](#).

## Report Explorer

The Report Explorer is the central location for viewing (publishing), running, or editing existing reports. For more information, see ["Running, Viewing, and Publishing Reports" on page 179](#).

**Note:** You cannot create a new report from the Report Explorer. To create a new report, click **New Report** under the **Design** section in the left pane. For more information, see ["Designing Reports" on page 196](#).

You can view, publish, and edit any type of report. For information on common reporting tasks available for all reports, see ["Task Options on Available Reports" on page 180](#).)

You can schedule any report to run once at a later date (an ad hoc report) or at a specified frequency (such as daily or weekly). For more on this, see ["Scheduled Reports" on page 192](#).

### To access reports from the Report Explorer:

1. From the Logger navigation bar, click **Reports**, then, under **Navigation**, click **Reports Explorer**. The **Reports** pane opens to the right of the navigation pane and displays the available report categories and reports.
2. Use the ► arrows and click the available links to navigate to the report you want to generate. For example, click the ► next to **Root**, the ► next to **Device Monitoring**, and then click **Anti-Virus**. The Report Explorer displays the reports in the **Device Monitoring > Anti-Virus** category.
3. Click a report, and then select an action to take by clicking the appropriate link in the Actions menu. For example, click **Top Infected Systems** and then, on the **Actions** menu, click **Run Report**.) The **Run Ad Hoc Report** dialog box opens, displaying the selected report.

For a complete list and description of reports available on Logger, see ["Logger Content" on page 555](#).

## Query Explorer

Queries comprise query objects (or parameters). You can use the Query Explorer to create new queries and view or edit existing queries.

### To access queries from the Query Explorer:

1. From the Logger navigation bar, click **Reports**, then, under **Navigation**, click **Query Explorer**. The Query Objects pane opens to the right of the navigation pane. It displays the existing categories under which you can find existing query objects and store newly created objects.
2. Navigate to the desired location using the ► arrows.

For example, click the ► next to **Root > SANS Top 5 > 5 - Suspicious or Unauthorized Network Traffic Patterns**.

The Query Explorer displays the query objects in the **SANS Top 5 > 5 - Suspicious or Unauthorized Network Traffic Patterns** category.

3. Click a query, and then select the action to take by clicking the appropriate link in the **Actions** menu.

For example, click **Top Ten Types of Traffic** and then click **More**.

## Parameter Explorer

Queries comprise parameters (or query objects). You can use the Parameter Explorer to create new parameters and view or edit existing parameters.

### To access parameters from the Parameter Explorer:

1. From the Logger navigation bar, click **Reports**, then, under **Navigation**, click **Parameter Explorer**. The Parameter Objects pane opens to the right of the navigation pane. It displays the existing categories under which you can find existing parameters and store newly created parameters.

Default parameters are shown in the right column.

2. Navigate to the desired location using the ► arrows.

For example, if you click **Parameter Explorer > Root**, the Parameter Explorer displays the parameters in the Root category.

3. Click a parameter in the right column, and then select the action to take by clicking a link in the **Actions** menu.

For example, click **deviceVendor** and then click **More**.

4. Click **Add to Favorites**. The selected object is added to the favorites list.

For a complete list of parameters available on Logger, see "[Parameters](#)" on page 581.

## Favorites Explorer

For quick access to frequently-used items, you can mark any report, query, parameter, dashboard, or dashboard widget as a favorite. An item marked as a favorite will be listed in the Favorites Explorer.

Any action that you can perform on an object from its own Explorer can be performed from the Favorites Explorer too. For example, you can run, save, or publish a report published from the Report Explorer. If you have marked the report as a Favorite, you can run, save, or publish it from the Favorites Explorer too.

Objects listed in the Favorites Explorer cannot be organized into categories.

### To add an object to your favorites list:

1. Navigate to the object in another Explorer. In the **Actions** menu, click **More**.

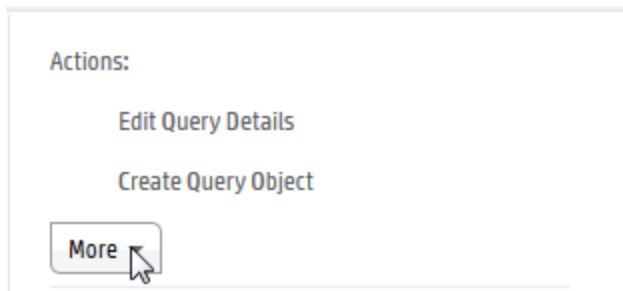

2. Click **Add to Favorites**.

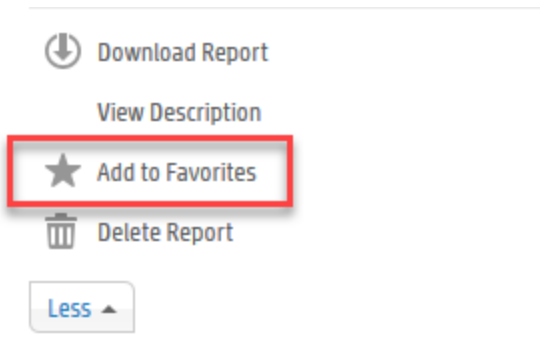

### To access an object from your favorites list:

1. From the Logger navigation bar, click **Reports**, then, under **Navigation**, click **Favorites Explorer**. The Favorites pane opens to the right of the navigation pane, displaying any favorites you have added.
2. Click the desired favorite and then select the action to take by clicking a link in the Actions menu.

## Categories

Reports, queries, and parameters can be organized and stored under categories for ease of access. You can create your own categories or edit the existing categories' properties by clicking on the **Report Categories** link in the left pane of the Reports Home page.

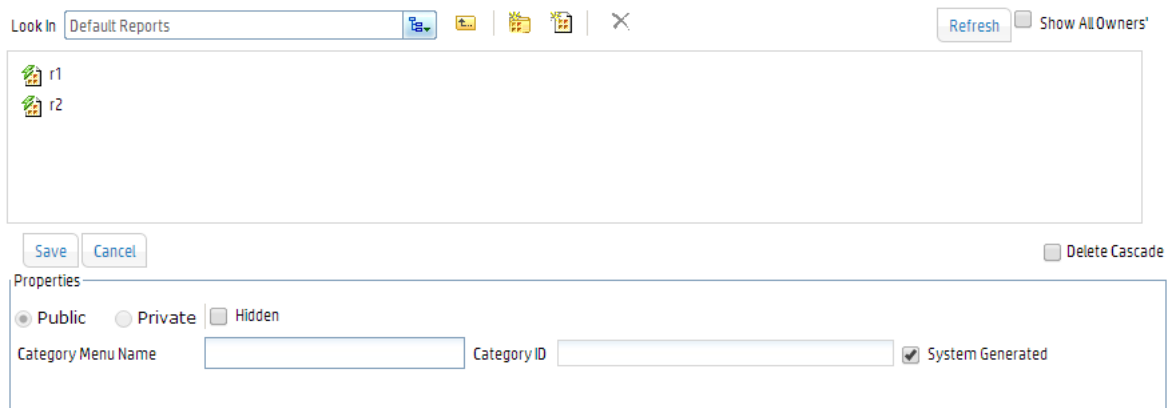

Objects in each category can be accessed by using the Category Explorer or the appropriate Explorer for that type of object. For more information, refer to the appropriate Explorer:

- ["Category Explorer" on page 153](#)
- ["Report Explorer" on page 154](#)
- ["Query Explorer" on page 155](#)
- ["Parameter Explorer" on page 155](#)
- ["Favorites Explorer" on the previous page](#)

For information on how to run, view, and publish reports, see ["Running, Viewing, and Publishing Reports" on page 179](#)

## System-defined Categories

The several categories, based on common areas of usage, come with your system. The **Default Reports** > **Saved Reports** category is for user-created reports. The other categories come with predefined reports ready for your use. For a complete list of reports in each category, access the category in the Report Explorer.

### Default Reports

User-generated reports are placed in this category.

## Device Monitoring

This category includes the following subcategories.

- **Anti-Virus:** Use this category to store reports, queries, parameters, dashboards, and dashboard widgets that provide information on anti-virus activity, such as the anti-virus update status, virus activity by hour, and top infected systems.
- **CrossDevice:** These reports provide information on functions that apply to multiple kinds of devices, such as failed login attempts, bandwidth usage by hosts, and accounts created by user.
- **Database:** The report in this category provides information on database errors and warnings.
- **Firewall:** These reports provide information on firewall activity, such as denied connections by port, address, and hour.
- **Identity Management:** This report provides information on the number of connections per user as reported by the Identity Management devices in your network.
- **IDS-IPS:** These reports provides information on activity involving Intrusion Detection Systems (IDS) and Intrusion Prevention Systems (IPS), such as alert count by device, port, severity, top alert destinations, worm-infected systems, and related metrics.
- **Network:** These reports provide information on activity involving network infrastructure, including interface status, device errors, and SNMP authentication failures.
- **Operating System:** These reports provide information on activity involving operating systems, such as login errors per user, user and user group creation, and modification events.
- **VPN:** These reports provide information on activity involving VPN connections, including authentication errors, connection information such as counts, accepted and denied by address, and related metrics.

**Tip:** More reports may be available for download as report packages on the HPE Customer Support site (SSO). (For information about deploying report packages, see "[Deploying a Report Bundle](#)" on page 243.)

## Foundation

This category includes the following subcategories.

- **Configuration Monitoring:** Logger provides reports that address configuration monitoring.
- **Intrusion Monitoring Reports:** Logger provides reports that address intrusion monitoring.  
For example, reports are provided to track password changes, firewall configuration events, firewall traffic, top attackers traversing firewalls, and so forth.
- **Intrusion Monitoring Reports:** Logger provides reports that address intrusion monitoring.  
For example, reports are provided to track password changes, firewall configuration events, firewall traffic, top attackers traversing firewalls, and so forth.
- **Netflow Monitoring:** Netflow Monitoring reports IP traffic information.

- Network Monitoring Reports: Network Monitoring reports describe activities on Virtual Private Networks.

## Logger Administration

This category includes Logger Administration tasks such as Daily Byte Count.

## SANS Top 5 Reports

Logger provides reports that address the SANS Top 5 log reports scenarios, all pre-built and available to run on-demand or schedule for a specified frequency.

The SANS Institute is a cooperative training, certification, and research organization with a focus on developing solutions for securing information against a variety of potential threats. SANS facilitates and supports a collaborative effort of a large number of security practitioners in various industries and sectors around the world to share experience, solutions, and resources related to information security.

**Note:** SANS stands for “SysAdmin, Audit, Network, Security”. More information is available on their Web site at [www.sans.org](http://www.sans.org)

The SANS Top 5 represents the current set of most critical log reports for a wide cross-section of the security community, and should be reviewed on a regular basis. This quote from the SANS Web site describes the strategy and focus of the SANS Top 5 Essential Log Reports:

*“The goal is to include reports that have the highest likelihood of identifying suspect activity, while generating the lowest number of false positive report entries. The log reports may not always clearly indicate the extent of an intrusion, but will at least give sufficient information to the appropriate administrator that suspect activity has been detected and requires further investigation.”*

The SANS Top 5 log reports cover the following five scenarios:

- 1 - Attempts to gain access through existing accounts
- 2 - Failed file or resource access attempts
- 3 - Unauthorized changes to users, groups and services
- 4 - Systems most vulnerable to attack
- 5 - Suspicious or unauthorized network traffic patterns

For a complete description of the SANS Top 5 log reports, see [www.sans.org/resources/top5\\_logreports.pdf](http://www.sans.org/resources/top5_logreports.pdf) or look for associated topics in SANS resources on their Web site.

The Logger SANS Top 5 Reports offered to address these threat scenarios are:

- SANS Top 5 - 1 Number of Failed Logins
- SANS Top 5 - 1 Top Users with Failed Logins
- SANS Top 5 - 2 Failed Resource Access by Users and Drilldown
- SANS Top 5 - 2 Failed Resource Access Events and Drilldown

- SANS Top 5 - 3 Password Changes
- SANS Top 5 - 3 User Account Creations, Deletions, and Modifications
- SANS Top 5 - 4 Vulnerability Scanner Logs by Host or by Vulnerability
- SANS Top 5 - 5 Alerts from IDS
- SANS Top 5 - 5 IDS Signature Destinations and Source
- SANS Top 5 - 5 Top 10 Talkers
- SANS Top 5 - 5 Top 10 Types of Traffic
- SANS Top 5 - 5 Top Destination and Target IPs
- SANS Top 5 - 1 Number of Failed Logins
- SANS Top 5 - 1 Top Users with Failed Logins
- SANS Top 5 - 2 Failed Resource Access by Users and Drilldown
- SANS Top 5 - 2 Failed Resource Access Events and Drilldown
- SANS Top 5 - 3 Password Changes
- SANS Top 5 - 3 User Account Creations, Deletions, and Modifications
- SANS Top 5 - 4 Vulnerability Scanner Logs by Host or by Vulnerability
- SANS Top 5 - 5 Alerts from IDS
- SANS Top 5 - 5 IDS Signature Destinations and Source
- SANS Top 5 - 5 Top 10 Talkers
- SANS Top 5 - 5 Top 10 Types of Traffic
- SANS Top 5 - 5 Top Destination and Target IPs

## Solution Reports

Any solution packages installed on the Logger are listed in separate report groups. Solution packages address specific compliance requirements or scenarios and are installed separately. Solutions Reports are available as add-on packages to Logger for specific compliance requirements or scenarios.

**Note:** You must log into Logger and open the Reports page at least once before installing any Solutions package.

The available solution packages include:

- ITGov (ISO 27002 & NIST 800-53 based reports)
- Payment Card Industry, (PCI based reports)
- SOX (Sarbanes-Oxley compliance reports)

For information on deploying Solutions Packages, see "[Deploying a Report Bundle](#)" on page 243. Once deployed, these solution reports are listed in categories under the Solution Reports report group. To access these reports (once deployed), click **Reports | Solutions Reports |<report category name>** on



the left menu, where <report category name> is the solution name, for example: Payment Card Industry.

For more information on report categories, including how to edit them, see ["Report Categories" on page 248](#).

## Dashboards

Dashboards display reporting data to provide a quick view of the latest information about network events. You can assemble various reports and external links onto a dashboard. However, you must place each report or link into its own widget and then place the widget in the dashboard. A dashboard can contain multiple widgets.

Placing reports on a dashboard gives you access to the most recently published results for those reports. Keep in mind, reports must be run and published in order for the results to be accessible on a dashboard viewer. If you schedule a report to run, publish, and save for a reasonable retention period (for example, one month), then those results will always be available for dashboard views.

For example, you can add one or more reports to a dashboard, and configure reports to *auto-refresh* on a specified interval (for example, every hour). The dashboard will access the latest published reports results, in this case, every hour.

If you have also *scheduled* the reports to run and publish every hour, your dashboard will show current results. This eliminates the need to manually run and view each report once per hour in order to retrieve the same information updates.

- [Viewing Dashboards](#) .....162
- [Designing Dashboards](#) .....163
- [Creating a New Dashboard](#) .....163
- [Viewing Dashboards in the Dashboard Viewer](#) .....164
- [Removing an Existing Tab from the Dashboard Viewer](#) .....164
- [Deleting a Dashboard](#) .....165
- [Editing an Existing Dashboard](#) .....165
- [Selecting a Default Dashboard View for the Reports Home Page](#) .....165
- [Using Classic Dashboards](#) .....166

**Note:** To view or edit Dashboards created in older versions of Logger, see ["Using Classic Dashboards" on page 166](#).

The process for configuring dashboards consists of these tasks:

1. Create a new dashboard. See "[Creating a New Dashboard](#)" on the next page for details.
2. Create one widget for every report or web link you want to display on the dashboard. See "[Creating a New Widget](#)" on page 175 for details.
3. Add the widgets to the dashboard. See "[Placing Widgets in a Dashboard](#)" on page 178 for details.
4. Optionally, you can configure the dashboard to display as a tab in the Dashboard Viewer. See "[Viewing Dashboards in the Dashboard Viewer](#)" on page 164 for details.

## Viewing Dashboards

If a dashboard is configured and selected for display, it is shown on the Dashboard Viewer page, and serves as the Reports Home page. If you are viewing other pages within the Reports page, click **Dashboard** on the left panel to return to the Dashboard Viewer (Reports Home page).

**Note:** If no dashboard is configured and selected for display, the default Reports home page shows an empty Dashboard Viewer.

Reports must be run and published first in order for the results to be accessible in a dashboard viewer. (Reports cannot be run from the Dashboard Viewer but may be viewed there.)

You can set a dashboard to auto-refresh at a certain interval, but auto-refreshing a dashboard simply updates the dashboard display with the most recently published results, not run the report. Use the dashboard refresh interval in conjunction with scheduled reports to ensure that report results are always published and retained long enough to be available to dashboards. For more information, see "[Designing Dashboards](#)" on the next page and "[Scheduled Reports](#)" on page 192.

The Dashboard Viewer page displays the all items placed on the dashboard. If the dashboard includes reports, reports will show current data from recently run reports.

Dashboards created in pre-5.2 Logger can be viewed and edited from the **Classic Viewer**, **Classic Designer**, and **Classic Preferences** links. See for information on how to view or edit dashboards created in pre-5.2 Loggers.

**Note:** Do **not** use these links to create new dashboards. Use the Dashboard Viewer link to create new Dashboards. See "[Designing Dashboards](#)" on the next page for details.

## Working with Available Dashboards

The set or subset of dashboards shown under **Available Dashboard(s)** is based on your user group status. For example, it is likely that a user with Administrative status will be able to see more or all dashboards than a user with fewer privileges.

## Designing Dashboards

Use the **Dashboard Viewer** page to create a new dashboard, name it, add items to it, and design the layout. You can design and save multiple dashboards, but only one at a time can be set as the default Dashboard Viewer for the Reports home page. Other dashboards can be saved for later use. Each dashboard can include multiple items (reports, use cases, and Web links).

To access the Dashboard Viewer, click the **Dashboard** link in the left pane.

### What Items Can a Dashboard Include?

The following information is available for placement on a dashboard. However, each report or Web Link must be placed inside a widget and the widget in turn is placed into the dashboard. A dashboard can contain one or more widgets containing either of the following:

- **Reports:** any report can be included. The dashboard will show the latest published version of the report. Reports must be published in order for the report data to be accessible to users on the Dashboard View. If no published results are available for a report on a dashboard, the Dashboard View will display a message indicating this. When the report is published, a refresh of the Dashboard view will display the report.
- **External Links:** any external URLs that you want included as a part of a particular Dashboard View.

## Creating a New Dashboard

The high-level steps to create a dashboard are described here. A detailed explanation of each of these steps is provided in the topics that follow. The Reports home page opens with the Dashboard Viewer open.

### To add a new dashboard:

1. In the navigation pane, click **Dashboard**. This opens a new empty dashboard tab with the name “Untitled”.
2. Click **Dashboard Options**  and pick **Switch to Edit Mode**.
3. To place items onto the dashboard, in the right corner, click **Add Widget**.

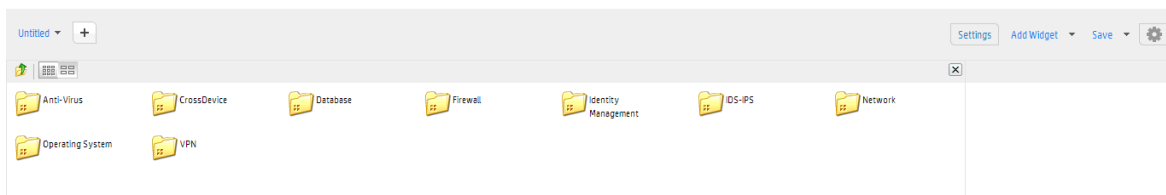

4. Select a widget and click-and-drag it onto the dashboard.

5. For each widget placed, specify Widget Properties, as needed.

**Note:** By default, a scroll bar is not available in the Dashboard for external links. To include a scroll bar, set the “Show Scrollbar” property to “Yes” in the Widget Properties section of “External Links” under Dashboard Items.

6. Click **Save** to save the dashboard.

Once saved, new dashboards become available in the **Dashboard Preferences** list of “Available Dashboard(s)”.

See ["Dashboards" on page 161](#) for information on how to display the new dashboard you just created or set the default display to a different dashboard.

## Viewing Dashboards in the Dashboard Viewer

### To open one or more dashboards as tabs in the Dashboard Viewer:

1. Click the **Dashboard Preferences** link on top of the Dashboard Viewer page.
2. In the Available Dashboards box, navigate to the dashboard that you want to display in a tab.
3. Click +. The dashboard name is displayed in the **Selected Dashboard** box.
4. Click **Save**.
5. Click the **Dashboard** link in the left panel to display the Dashboard Viewer. The dashboard you selected is displayed.

**Note:** The set or subset of dashboards shown under **Available Dashboard(s)** is based on your user group status and the selection status of Show All Owners' checkbox. A user with Administrative rights is able to see more or all dashboards than a user with fewer privileges. If you limit the view to only your dashboards, the list will not include dashboards designed by other users.

To access dashboards from all users (designers), select the **Show All Owners** checkbox.

To view only your dashboards, deselect this checkbox.

## Removing an Existing Tab from the Dashboard Viewer

### To remove an existing tab from the Dashboard Viewer without deleting the dashboard from its saved location:

1. Click the dashboard title, and then click **Delete**.
2. Click **OK** to confirm deletion.

## Deleting a Dashboard

You can delete an existing dashboard from the Dashboard Viewer.

### To delete the dashboard from the Dashboard Viewer:

1. Select the Dashboard, then click **Settings**.
2. Select **Switch to Edit Mode**.
3. In Edit Mode, select the down arrow next to the Dashboard title and click **Delete**.
4. In the Remove Tab dialog, check the **Remove this dashboard from saved location** checkbox and click **OK**.

## Editing an Existing Dashboard

### To modify an existing dashboard:

1. Click **Settings**, and then pick **Switch to Edit Mode**. Its current configuration is displayed and you can modify then save settings as needed.
2. The **Properties** area displays basic dashboard settings. To automatically refresh a dashboard at a regular interval, check the **Auto-refresh every** checkbox and specify the automatic refresh time in terms of minutes in **Min(s)**. Check the **Prompt on First Run** checkbox to display the **Input Parameter Form**, which shows the values of the Dashboard parameters before reports are run from the dashboard for the first time after they have been displayed on the dashboard.
3. The **Layout** area enables you to select panes for the dashboard.
4. The **Information** area displays Description, Scope and Location where the dashboard is saved.
5. The **Dashboard Parameters** area shows formatting parameters (Maximum Columns and Column Width).

## Selecting a Default Dashboard View for the Reports Home Page

If you have multiple dashboards open in tabs in the Dashboard Viewer, you can set one of the dashboards to display as the default dashboard for the **Reports** home page.

### To set a default dashboard:

1. Click the **Dashboard Preferences** link on top of the Dashboard Viewer page.
2. In the **Selected Dashboards** box, click the radio button corresponding to the dashboard that you would like to display as the default dashboard on the **Reports** home page. Click the up arrow to move that dashboard to the top of the list.
3. Click the **Save** button.
4. Click the Dashboard link in the left pane and your selected dashboard will show as the default tab (the first tab).

The **Dashboard Preferences** page has the following fields:

Field	Description
Show All Owners	To display all dashboards made by all the users in the Available Dashboard(s) box, check the Show All Owners' checkbox.
Available Dashboards	This box shows a list of all dashboards that are available for display in the Dashboard Viewer.
Selected Dashboards	Move the dashboards you want to display in the Dashboard Viewer from the Available Dashboards list to the Selected Dashboards box. Dashboards listed in this box will be displayed as tabs in the Dashboard Viewer.

## Using Classic Dashboards

This section is only applicable to existing dashboards that were created in versions of Logger **earlier than 5.2**. To create, edit or view new dashboards, follow the instructions in ["Dashboards" on page 161](#).

### Viewing a Classic Dashboard

To view the dashboard, click the **Classic Viewer** link on top of the Reports page. If no dashboard is configured and selected for display, the default Reports home page shows the **My Reports** page that lists the status of recently run or accessed reports.

### To set a dashboard as the default Dashboard View:

1. Open the dashboard in the Classic Designer.
2. Select the **Add to My Preferred List** checkbox.

The Classic Viewer page displays the contents of various items placed on the dashboard during the dashboard's design time. If the dashboard includes reports, reports will show current data from recently run reports.

Reports must be run and published first in order for the results to be accessible on a dashboard view. There are no options available to run reports from the Dashboard view. On a Dashboard view, you can view saved or published reports but not run them.

**Tip:** A refresh or auto-refresh on a dashboard simply updates the dashboard display with the most recently published results, but does not run the report. Use the dashboard refresh interval in conjunction with scheduled reports to ensure that report results are always published and retained long enough to be available to dashboards.

## Designing Classic Dashboards

Use the **Classic Designer** page to edit the dashboard, add items to it, and change the layout. Each dashboard can include multiple items (reports, use cases, and Web links).

### What Items Can a Classic Dashboard Include?

The following information is available for placement on a dashboard:

- **Reports:** any report can be included. The dashboard will show the latest published version of the report. Reports must be published in order for the report data to be accessible to users on the Dashboard View. If no published results are available for a report on a dashboard, the Dashboard View will display a message indicating this. When the report is published, a refresh of the Dashboard view will display the report.
- Common **Use Cases**, including a Report List, Saved Report List, Health Monitor, Recent Run Report List, Quick Job List, Schedule History, and Audit Log: These are provided as dashboard elements so that users access a use case without leaving the Dashboard View page.
- **External Links:** Any URLs that you want included as a part of a particular Dashboard View



### Creating a New Classic Dashboard

Do not use the Classic Designer page to create new dashboards. Create new dashboards using the **Dashboard Viewer** link. See "[Dashboards](#)" on page 161 for more information.

### Placing Items on an Existing Dashboard

To place an item on a dashboard, click the **Classic Preferences** link. In the **Widgets** provided in the Layout area, click-and-drag an item from the **Dashboard Items** list on the left into an empty widget to the right. Alternatively, click  next to the dashboard item you want to place the item on an empty widget.

You can also click-and-drag an item onto a currently occupied widget if you want to replace an item in a widget with a different one.

To add a new widget, click  (**Divide Widget Horizontally**) or  (**Divide Widget Vertically**) on a widget to split it into two widgets. The original widget remains and a new empty widget is placed on the dashboard layout.

For each item (widget) placed, specify Widget Properties, as needed.

By default, a scroll bar is not available in the Dashboard for external links. To include a scroll bar, set the “Show Scrollbar” property to “Yes” in the Widget Properties section of “External Links” under Dashboard Items.

## Dashboard Properties

The Dashboard Properties are described in the following table.

### Dashboard Properties Description

Property	Description
Name	Name of the dashboard
Description	Descriptive information about this dashboard

## Placing Dashboard Items on the Layout

Click the **Classic Designer** link on the **Reports** page. Reports, use cases, and external link objects are available under **Dashboard Items** (to the left of the Layout area).

To place a dashboard item, click to expand the menu for the type of item you want, click-and-drag an item onto a widget in the Layout area, and specify widget properties as needed. (Widget properties vary depending on the type of item you place on the dashboard.)

The following sections provide more detail on placing each type of dashboard item and setting appropriate widget properties.

### Placing a Report on a Dashboard

The following sections describe in detail how to place and configure reports on dashboards, including setting widget properties, report parameters, and dashboard parameters.

A dashboard can only be used to view results of previously saved, published reports. A refresh or auto-refresh on a dashboard simply updates the dashboard display with the most recently published results, but does not run the report.

Therefore, reports on dashboards must be run, saved, and published in order for the report data to be viewable on the Dashboard view. If a report on a dashboard has not been saved or published, its widget will display an error message on the Dashboard view the report data is not available to the dashboard.



### To place a report on a dashboard:

1. Under **Dashboard Items**, click **Reports** bar to expand the list of available reports.
2. If available, select a Reports submenu. (Different reports are displayed depending on the submenu you select.)

Optionally, select the **Saved Reports** checkbox to display a list of saved reports.

3. Select a category to view reports deployed in that category.
4. Click and drag the report to the widget in which you want to place the report. Alternatively, click  next to the dashboard item you want to place the item on an empty widget.  
The report name is displayed in the widget in the Layout area.
5. Set Widget Properties for the report.

The following table describes Widget Properties settings for Reports dashboard items.

**Note:** By default, a scroll bar is not available in the Dashboard for external links. To include a scroll bar, set the “Show Scrollbar” property to “Yes” in the Widget Properties section of “External Links” under Dashboard Items.

### Widget Properties for Reports on a Dashboard

Property	Description
Report Name	The name of the report that occupies this widget.
Refresh Interval (in minutes)	Report refresh will take place at the end of specified number of minutes. For example, if you want the report results to refresh every 15 minutes, set the Refresh Interval to 15.  <b>Note:</b> Reports must be run and published first in order for the results to be accessible on a dashboard view. A <i>refresh</i> or <i>auto-refresh</i> on a dashboard simply updates the dashboard display with the most recently published results, but does not run the report. Use the dashboard refresh interval in conjunction with scheduled reports to ensure that report results are always published and retained long enough to be available to dashboards. (See also, " <a href="#">Scheduled Reports</a> " on page 192.)
Format	Output format in which you want to view the report. Available options are: <ul style="list-style-type: none"><li>• HTML</li><li>• Acrobat PDF</li><li>• Interactive HTML</li></ul>

### Widget Properties for Reports on a Dashboard, continued

Property	Description
Auto Refresh	<p>Enables or disables auto-refresh option.</p> <ul style="list-style-type: none"><li>• Select <b>Yes</b> to refresh the reports at the Refresh Interval.</li><li>• Select <b>No</b> to view the report generated when dashboard was loaded for the first time.</li></ul> <p><b>Note:</b> Reports must be run and published first in order for the results to be accessible on a dashboard view. A <i>refresh</i> or <i>auto-refresh</i> on a dashboard simply updates the dashboard display with the most recently published results, but does not run the report. Use the dashboard refresh interval in conjunction with scheduled reports to ensure that report results are always published and retained long enough to be available to dashboards. (See also "<a href="#">Scheduled Reports</a>" on page 192.)</p>
Toolbar	<p>Specifies Toolbar settings.</p> <ul style="list-style-type: none"><li>• Select <b>Yes</b> to always show toolbar.</li><li>• Select <b>No</b> to never show the toolbar.</li><li>• Select <b>Multipage</b> to show the toolbar only for multi-page reports.</li></ul> <p>The Multipage setting is applicable to <b>HTML</b> and <b>Interactive</b> output formats.</p>
Instance Navigation	<p>Sets whether to include a report navigation feature on the dashboard.</p> <ul style="list-style-type: none"><li>• Select <b>Yes</b> to provide a pull-down menu that allows Dashboard users to select a saved report and view it.</li><li>• Select <b>No</b> if you do not want to provide this feature on the dashboard.</li></ul>
Link Widgets	<p>Click  to display the <b>Link Widget</b> dialog in which you can specify a link from any of the charts in the report in this widget to another widget.</p> <p>See "<a href="#">Linking Widgets</a>" below.</p>
Description	<p>Description of the widget.</p>

### Linking Widgets

You can link a widget that contains a report (although, not saved reports) to another widget. The widget that is the link target can contain a use case, a report, or external link.

#### To link a chart in a report to data in another widget:

1. Select a widget in which you want to provide a link. (The widget that is the link “source” must contain a report with a chart on it).
2. Under Widget Properties for the selected widget, click  to display the Link Widgets dialog in which you can specify a link from any of the charts in the report to another widget. (The widget that is the target of the link can contain a report, use case or external link.)
3. In the Link Widget dialog, select an Item (chart series) from the Item(s) and select (link) it to an item in one of the other Widgets.

4. Click  (add button) next to “Series” to add another row to specify another set of link information in the same report with a different widget/series combination.

To remove a row, click  (delete button) next to the row you want to remove.

5. Click **OK** to save the settings and close the dialog.

## Placing a Use Case on a Dashboard

The following sections describe in detail how to place and configure use cases on dashboards.

### To place a use case on a dashboard:

1. Under Dashboard Items, click **Use Cases** bar to expand the list of available use cases.
2. Click and drag a use case to the widget in which you want to place it. Alternatively, click  next to the dashboard item you want to place the item on an empty widget.

The use case name is displayed in the widget in the Layout area.

3. Set Widget Properties for the use case.

## Widget Properties for Use Cases

The following table describes Widget Properties settings for Use Case dashboard items.

### Widget Properties for Use Cases on a Dashboard

Property	Description
Name	The name of the use case that occupies this widget.
Refresh Interval (in minutes)	This is the time in minutes. The external link page is refreshed at the specified interval.
Auto Refresh	Enables or disables auto-refresh option. <ul style="list-style-type: none"><li>• Select <b>Yes</b> to refresh the use case as per Refresh Interval.</li><li>• Select <b>No</b> to execute only once, when the dashboard is loaded.</li></ul>
Show Scroll Bar	Select <b>Yes</b> to add a scroll bar if the use case does not fit in widget width.
Description	Description of the widget.
Category	This option is displayed when Report List, Saved Report List or Quick Job List is placed on widget. Select the category to carry out respective task (get a list of reports in selected category, display a list of saved reports or quick job lists for the selected report).
Report	This option is displayed when Saved Report List or Quick Job List is selected. Select the report for which saved report list or quick job list is to be viewed.

The use cases displayed in the list will depend on the permissions associated with your user group. Other properties are displayed based on the use case.

## Placing an External Link on a Dashboard

The following sections describe in detail how to place and configure an external link on a dashboard.

### To place a link on a dashboard:

1. Under **Dashboard Items**, click **External Links** bar to expand the list.
2. Click and drag an External Link URL object to the widget in which you want to place it.  
Alternatively, click  next to the dashboard item you want to place the item on an empty widget.  
The External Link URL object is displayed in the widget in the Layout area.
3. Set Widget Properties for the URL.

The following table describes Widget Properties settings for External Links dashboard items.

### Widget Properties for External Links on a Dashboard

Property	Description
Name	The name of the external link that occupies this widget.
Refresh Interval (in minutes)	This is the time in minutes. The use case page is refreshed at the specified interval.
Auto Refresh	Enables or disables auto-refresh option. <ul style="list-style-type: none"><li>• Select <b>Yes</b> to refresh the URL as per Refresh Interval.</li><li>• Select <b>No</b> to execute only once, when the dashboard is loaded.</li></ul>
Show Scroll Bar	Select <b>Yes</b> to display a scroll bar if external link does not fit in widget width.
Description	Description of the widget.
URL	Specify the URL for this widget.  If you want to add multiple Web pages to the dashboard, use a different widget for each URL.

## Selecting a Dashboard View

Once you have created one or more dashboards, you can select one of them as the default display for the Dashboard **View** page, which also serves as the Reports home page. Only one dashboard at a time can be displayed as the default dashboard view.

**Tip:** You must have at least one dashboard in order to set a preference for the Dashboard View.

You can also set a dashboard as the “Selected Dashboard” (default dashboard view) in the Dashboard Designer by enabling the **Add to my preferred list**, as described in ["Viewing a Classic Dashboard" on page 166](#).

### To select a default Dashboard View for the Reports home page:

1. Navigate to **Dashboard > Preferences**.
2. Select a dashboard from the Available Dashboard(s) list and click the right arrow button  to move it into the Select Dashboard(s) list for display. Only one dashboard can occupy the “Selected Dashboard(s)” list at any one time.
3. Click **Save** to save your preferences and display the selected dashboard.

### To remove or change the currently displayed dashboard:



1. Return to the **Classic Preferences** page.
2. Move the currently selected dashboard out of the Select Dashboard(s) list by selecting it and clicking the left arrow button .
3. Choose a different one to display if so desired (or none).
4. Click **Save** to save your preferences.

## Creating Widgets

Each dashboard item must be placed in its own widget for display on the dashboard.

Create new widgets using the **Widget Designer** link.

### To add a new widget:

To add a new widget, click  (Divide Widget Horizontally) or  (Divide Widget Vertically) on a widget to split it into two widgets. The original widget remains and a new empty widget is placed on the dashboard layout.

### To remove a widget:

To remove a widget, click **Remove Widget**, located on the top right corner on the widget you want to remove.

## Swapping Items on Widgets

You can swap items placed in widgets. To do this, click and drag the item to the widget where you want to place it.

Click and drag an item to a different widget to swap placement of the two items on the page.

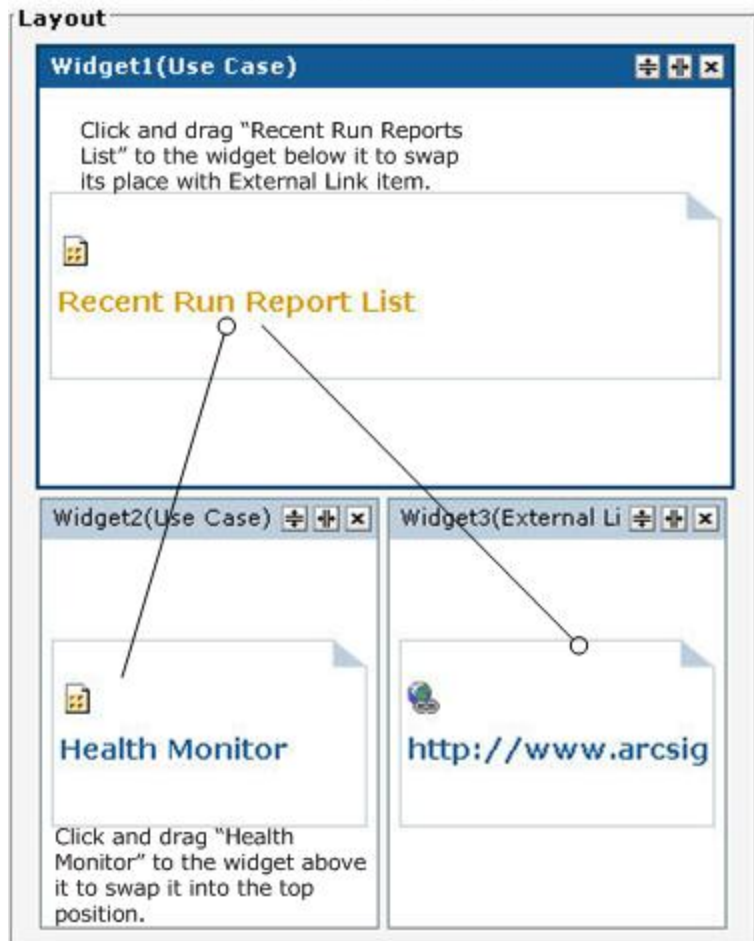

In the above example, the Recent Run Reports List item is swapped to the position of the External Link URL, which is then swapped with the Health Monitor item, which will end up at the top of the dashboard.

## Setting Classic Preferences

In the **Classic Preferences** page, you can specify the dashboard to be made available for viewing. Use the arrows to move the desired dashboards.

## Widgets

A *widget* is a mechanism for the display of data. After you have created a new dashboard, you will need to add one or more widgets to display your reports or web links. A widget is designed in the Widget Designer. Each dashboard item must be placed in its own widget for display on the dashboard. A widget can be placed on multiple dashboards.

- [The Widget Designer](#) ..... 175
- [Placing Widgets in a Dashboard](#) ..... 178
- [Moving an Existing Widget within a Dashboard](#) ..... 178

## The Widget Designer

The Widget Designer enables you to create a new widget, save a widget, edit a widget, or delete a widget. You can place a report or a web link (an external link) into a widget. Each widget can contain only one object.

### Creating a New Widget

To open the Widget Designer page and create a new widget, above the Dashboard Viewer, click **Widget Designer**.

On the **Widget Designer** page, you can choose what to place in the widget, a report, or a web link.

You cannot run reports from a Dashboard view. You can only view results of previously saved, published reports. A refresh or auto-refresh on a dashboard simply updates the dashboard display with the most recently published result, but does not run the report. Therefore, reports on dashboards must be run, saved, and published in order for the report data to be viewable on the Dashboard view. If a report on a dashboard has not been saved or published, its widget will display an error message on the Dashboard view the report data is not available to the dashboard.

Widget Name:

Contents:  Report  Web Link

---

Widget Contents

Report:

By Job:    Look in User's All Jobs

In Category:    User's Working Folder

---

Widget Properties

Report Format:

Viewer Toolbar:

Instance Navigation:

Auto Refresh:

Refresh Interval:   Min(s)  Sec(s)

Width:

Height:

### To create a Report widget:

Click the **Report** radio button on the Widget Designer page to place a report in the widget.

**Note:** You can only add reports that have already been run and published.

In your widget, you can include the last published instance of the following:

- *A report:* You need not make any selection in the Report field, By Job or In Category.
- *A specific report:* Navigate to the report in the Report field. You can leave the By Job and In Category fields blank.
- *A report executed by a specific scheduled report job:* Navigate to the job in the By Job field. You can leave the Report field and the In Category field blank.
- *A report deployed in a specific category and executed by a specific job:* From the In Category field, navigate to a category and navigate to a job in the By Job field.
- *Any of the reports from the jobs you own:* You own the jobs that you created or were created on your behalf. Check the **Look in User's All Jobs** checkbox.
- *Any of the reports deployed in your default category:* Check the **User's Working Folder** checkbox.



Specify the following widget properties:

Label	Description
Widget Name	Enter a name for the new widget to be created.
Report Format	Select the format in which you would like the report displayed.
Toolbar	Select whether you want a toolbar displayed and whether you want it displayed on all pages if this is a multi-page report.
Instance Navigation	Sets whether to include a report navigation feature on the dashboard. <ul style="list-style-type: none"> <li>Select <b>Yes</b> to provide a pull-down menu that enables Dashboard users to select a saved report and view it.</li> <li>Select <b>No</b> if you do not want to provide this feature on the dashboard.</li> </ul>
Auto Refresh	Set to <b>Yes</b> , if you want the report to refresh automatically after a certain interval, and then set the <b>Refresh Interval</b> parameter.
Refresh Interval	This is the time in minutes. Refresh will take place at the end of specified number of minutes. For example, if you want the report results to refresh every 15 minutes, set the Refresh Interval to 15.
Width	Select the width of the widget in pixels. You can select only whole numbers (no decimals allowed)
Height	Select the height of the widget in whole pixels (no decimals allowed)

### To create a Web Link widget:

Click the **Web Link** radio button on the **Widget Designer** page to place a web link in the widget.

Widget Name:

Contents:  Report  Web Link

---

Widget Contents

URL:   
e.g. <http://www.intellicus.com>

---

Widget Properties

Show Scrollbar:

Auto Refresh:

Refresh Interval:   Min(s)  Sec(s)

Width:

Height:

Specify the following properties:

Label	Description
URL	Specify the URL for the external link of the page that you want to display in the widget
Show Scrollbar	Select whether you want a scroll bar in the widget. By default, the scrollbar is visible.
Auto Refresh	By default, the web page will be automatically refreshed. Select No if you want to turn this feature off.
Refresh Interval	This is the time in minutes. Refresh will take place at the end of specified number of minutes. For example, if you want the web page to refresh every 15 minutes, set the Refresh Interval to 15.
Width	Select the width of the widget in pixels. You can select only whole numbers (no decimals allowed).
Height	Select the height of the widget in pixels. You can select only whole numbers (no decimals allowed).

## Deleting a Widget

To delete a widget, open the widget in the Widget Designer and click the **Delete** button on top of the Widget Designer page. When a dashboard uses a widget that is deleted, an error message explaining that the widget has been deleted is displayed in the widget on the dashboard.

## Editing an Existing Widget

Click the **Widget Designer** link to open it. Click the **Open** button on top of the Widget Designer page and select the widget that you want to edit. After editing it, click the **Save** button.

## Placing Widgets in a Dashboard

Reports and Web Link (external link) objects are available to be placed on a dashboard. However, these objects must first be placed in a widget and then the widget can be added to the dashboard.

1. With the report in Edit Mode, click the **Add Widget** button on the upper right corner of the empty dashboard page.
2. Navigate to the widget you want to place on the dashboard and click-and-drag it to the dashboard.
3. Repeat steps 1 and 2 to add more widgets.

## Moving an Existing Widget within a Dashboard

To move an existing widget on a dashboard, hover your mouse over the top boundary of the widget. The widget name bar will drop down. Click the widget name bar and drag it to move the widget to the desired location on the dashboard.

## Running, Viewing, and Publishing Reports

Reports are available under their respective categories. (See ["The Explorers" on page 150.](#))

You can run, view, and publish reports you create, as well as reports in categories for which the administrator has given you user access rights. You can run up to 5 ad hoc reports or up to 10 scheduled reports, concurrently.

**Tip:** There are no options available to run reports from a Dashboard viewer. On a Dashboard viewer, you can view saved or published reports, but not run them.

- [Best Practices](#) .....179
- [Finding Reports](#) .....179
- [Task Options on Available Reports](#) ..... 180
- [Running and Viewing Reports](#) .....181
- [Running a Report Manually](#) ..... 182
- [Publishing Reports](#) ..... 187
- [Report Delivery Options](#) ..... 189
- [Viewing the Output of a Published Report](#) ..... 191

### Best Practices

Logger is designed to process events while running a report, but event processing has priority. Running a complex report while the event processing system is under load will result in report timeout rather than dropped events.

To effectively manage demands for system resources, HPE recommends using the Scheduled Report feature so that reports run during periods of light load. If an ad hoc report must be run, run it when the system is not under load.

For information on working with scheduled reports, see ["Scheduled Reports" on page 192.](#)

If you are running a distributed report, also see the best practices discussed in ["Selecting Device Groups, Storage Groups, Devices, or Peers" on page 184.](#)

### Finding Reports

You can find reports on the following pages within the **Reports** page:

- Category Explorer
- Report Explorer

- Favorites Explorer (if you have marked the report as a Favorite)
- Scheduled Reports page (if the report you are looking for is a scheduled report and it has been run and published)
- The **Recent Reports** link on top of any Reports page.

## Viewing Recently Run Reports

To view the most recently run reports, click the **Recent Reports** link on top of the **Reports** page. Click on the radio button next to a report to select it.

[Dashboard Viewer](#) [Dashboard Preferences](#) [Widget Designer](#) [Recent Reports](#) [Jobs Execution Status](#) [Classic Viewer](#) [Classic Designer](#) [Classic Preferences](#)

Recent Reports

Sr.No.	Report Name	Category Name	Time Stamp
1	<input type="radio"/> Top Users with Failed Logins	1 - Attempts to Gain Access through	08/26/2016 16:02:59
2	<input checked="" type="radio"/> Database Errors and Warnings	Database	08/26/2016 16:02:17
3	<input type="radio"/> Traffic Statistics	Network Monitoring	08/26/2016 16:00:12
4	<input type="radio"/> User Administration	Operating System	08/26/2016 15:58:45

Report Execution Status



Filters Category Name [(All)] | Report Name [(All)] | Execution Type [(All)] | Status [(All)] | User [ArcSight/admin]

Select Report(s) (Root) Execution Type (All) Status (All)

Select Owner ArcSight admin

Date From 08/26/2016 To 08/26/2016 Refresh

Sr.No.	Report Name	Action	Execution Type	Completion Status	Completion Date
--------	-------------	--------	----------------	-------------------	-----------------

After you select a report, the **Run**  and the **Re-Run**  buttons are displayed in the top left corner. You can run the selected report using the same filter options as the original run by clicking the **Run** button, or you can run the selected report using different field values by clicking on the **Re-Run** button. See ["Run Report Parameters" on page 185](#) for details.

## Task Options on Available Reports

Your access to various reports and report options (view, publish, edit, etc.) depends the access rights associated with your user role and Logger Report Group affiliation. For example, depending on your access rights, you may have privileges to view some reports but not others, to view but not schedule or publish a report, or to view and schedule but not edit a report.

Access rights to report options are configured and managed with the **User/Groups** option on the **System Admin** page. For more information on setting permissions and on Logger Report Group management, see ["Setting Access Rights on Reports" on page 218](#).

The following sections describe details of running and viewing reports, setting report parameters on a report run, and the various options for working with report output.

## Running and Viewing Reports

To begin run and view reports, choose a report category in the Report Explorer, and then choose a report within the category. See ["Report Explorer" on page 154](#).

### About the Pagination of Reports

The default view option for the report results is **Multipage**. If Multipage is deselected in the **View Options** link, your report will be formatted as a single page. **HPE strongly recommends using the Multipage option for all reports.** Specifically, if a report will result in more than 826 records, using the Multipage option will ensure that the generated report is not blank. By default, PDF reports are set by default to use the Multipage option. However, if your PDF format report is blank, ensure that the Multipage option is still checked for that report.

If a report contains more columns than can be displayed horizontally using the default width specified in the report query, the report is paginated horizontally, such that additional columns are displayed on the following pages. For example, if a report contains 45 columns and only 5 can be displayed at once, the report would be paginated such that Page 1 displays columns 1 through 5, Page 2 displays columns 6 through 10, and so on. Consequently, if the report contained more rows than can be displayed vertically, the second group of rows would be displayed starting at Page 10.

Currently, Logger limits the number of pages for horizontal pagination to 10. As a result, if a report requires more than 10 pages to display all columns, complete report results may not be displayed. To view all columns of such reports, manually set the width of each column such that all columns fit in 10 or less pages in the report query (in the Query Object Editor).

### About Running a Report

Reports can be run from any of the following Explorers:

- Category Explorer

Click a category in the **Repository** column, click **Reports**, select a report in the **Reports** column and click **Quick Run with default options**, **Run in Background**, or **Run Report**. Then, set the parameters and click **Run Now**, **Run in Background**, or **Run** button depending upon what type of run you chose.

- Report Explorer

Click a category in the **Reports** column, select a report in the next column, and click the **Quick Run with default options, Run in Background, or Run Report buttons**. Then, set the parameters and click **Run Now, Run in Background, or Run** depending upon what type of run you chose.

- Favorites Explorer (if you have marked the Report as a Favorite)

Click on a report in the **Favorites** column and click **Quick Run with default options, Run in Background, or Run Report buttons**. Then, set the parameters and click **Run Now, Run in Background, or Run** depending upon what type of run you chose.

**Note:** Even if you selected **Run Report** initially, you can run a report in the background after setting the Run Report parameters.

The report output is displayed in the specified format (such as HTML or PDF).

At this point, the results of this report generation is available as a file for viewing only by you. If you close the file without saving or publishing it, the results are no longer available.

If you want to make the results of this run available for others, you need to publish it. To do this, leave the file open, click **Publish Report**, available in the button bar located on top of the report, and follow the steps in "[Publishing Reports](#)" on page 187.

For information about other delivery options available to you at this point, see "[Report Delivery Options](#)" on page 189.

## Running a Report Manually

### To run a report manually:

1. Click the Report Explorer in the left pane.
2. Click the category in which the report is stored.
3. Select the report.
4. Click the **Run Report, Quick Run with Default Options, or Run in Background** button.

## Quick Run with Default Options or Run In Background Report Parameters

When you click either the **Quick Run with default options** or the **Run in Background** button, the report will run with the data filters specified in the deployed report. Options are available to select additional filters on time frame and constraints, such as Device Groups, Storage Groups, Devices, and Peers.

You can also run a distributed report: a report that also includes matching events from the specified peers of a Logger. You select the peers on which the report should run in the Peers list, as shown in the following figure. If no peers are configured, the Peers list contains only the localhost IP address (127.0.0.1). However, if peers are configured, their IP addresses are listed.

Device Type : i

**Additional Filters**

Start   Dynamic

End   Dynamic

Scan Limit

Local Only

Use ctrl-click to select or deselect items

Device Groups	Storage Groups
There are no Device Groups to display	Default Storage Group Internal Event Storage Group
Devices	Peers (To include peers, uncheck Local Only)
Logger Internal Event Device Logger Internal Event Device [Apache URL Access Error Lo Logger Internal Event Device [Audit Log] Logger Internal Event Device [Var Log Messages]	There are no Peers to display

The following table describes Quick Run with default options or Run in Background report parameters.

**Quick Run with default options / Run in Background Report Parameters**

Option	Description
Start	Specify the starting point for the data gathering from the events database.  By default, the start time is specified with a <b>dynamic data expression</b> (\$Now - 2h).  You can modify the dynamic expression to specify a different dynamic start time, or disable <b>Dynamic</b> and use the calendar options to specify a fixed start time.
End	Specify the ending point for the data gathering that is some time after the starting point.  Keep in mind that large time spans can mean large amounts of data, which can affect system performance.  By default, the end time is specified with a <b>dynamic data expression</b> (\$Now).  You can modify the dynamic expression to specify a different dynamic end time, or disable <b>Dynamic</b> and use the calendar options to specify a fixed end time.

### Quick Run with default options / Run in Background Report Parameters, continued

Option	Description
Scan Limit	<p>Specify the number of events to scan.</p> <p>When you specify a scan limit, the number of events scanned for <i>manually</i> run reports is restricted to the specified limit. Doing so results in faster report generation and is beneficial in situations when you only want to process the latest N number of events in the specified time range instead of all the events stored in Logger.</p> <p>The scan limit is 100,000 by default. If you set the scan limit to 0 (zero), all events are scanned.</p> <p>This setting does not apply to the scheduled reports.</p>
Device Groups	Select any device groups on which to run the report query, if any. (See " <a href="#">Selecting Device Groups, Storage Groups, Devices, or Peers</a> " below.)
Storage Groups	Select any storage groups on which to run the report query. (See " <a href="#">Selecting Device Groups, Storage Groups, Devices, or Peers</a> " below.)
Devices	Select any devices on which to run the report query. (See " <a href="#">Selecting Device Groups, Storage Groups, Devices, or Peers</a> " below.)
Peers	Select the peer Loggers on which to run the report query. If no peers are configured on the Logger, this option only lists the localhost IP address (127.0.0.1). However, if peers are configured, their IP addresses are listed. (See " <a href="#">Selecting Device Groups, Storage Groups, Devices, or Peers</a> " below.)

## Selecting Device Groups, Storage Groups, Devices, or Peers

You can select or deselect items on Device Groups, Storage Groups, Devices, or Peers as a part of setting the Quick Run with default options or Run in Background parameters.

- Only highlighted (selected) items will be included in the report query when the report is run.
- To select an item, click on it. To select multiple items in a list, use Ctrl-Click. To deselect a currently selected item, use Ctrl-Click.
- If none of the storage groups, device groups, or devices are selected, all items are included in the report query. However, peers must be explicitly selected to run a report query on them. If none of the peers are selected, the query will only run on the local Logger.

- The selected items in the Device Groups, the Devices lists, and Peers are ORed in the report query, and these items are ANDed with the other selected items such as Storage Groups.

Follow these guidelines when you run a distributed report (a report on peer Loggers):

- You can run a distributed report in the Quick Run, Run in Background, Run, or Scheduled Reports mode.
- All Loggers on which you are running the distributed report must be running Logger 5.2 or later.
- If peer Loggers do not have identical storage or device group names, the report query skips searching for events for those groups on those peers.



- If you added custom schema fields to your Logger schema, those fields must exist on all peers. Otherwise, a query containing those fields will not run (when run across peers) and return an error. See ["Adding Fields to the Schema" on page 377](#).
- A user needs to belong to these user groups with the listed permissions set to run distributed reports:
  - a. Logger Search Group with "Search for events on remote peers" user right set (checked).
  - b. Logger Rights Group with the "View registered peers" user rights set (checked).
  - c. Logger Reports Group with "View, run, and schedule reports" rights set (checked) for specific reports or the global permission set to run all reports.

For more information on setting permissions, see ["Setting Access Rights on Reports" on page 218](#)

- If a peer is unavailable when a distributed report is run, an error message is displayed and the report is aborted. Similarly, if a peer becomes unavailable while a distributed report is running, the report will continue to run and displayed. However, the server log will contain exceptions indicating the cause.

Use the following best practices for optimal performance when running a distributed report:

- Avoid running a distributed report on a Wide Area Network (WAN) link.
- If you are running the report on a very large data set and the performance of the report is not optimal, reduce the size of the data set, and/or defragment the device..
- Ensure that all fields in the report query are indexed on all peer Loggers. The report query will run slower on the Logger on which the fields are not indexed.

Refer to the HPE Security Security ArcSight Logger Configuration and Tuning: Best Practices guide for more Logger best practices.

## Run Report Parameters

When you choose the **Run Report** link for a report, options are available to choose a file format, specify pagination, and to modify the data filter criteria for only this run of the report.

Run Ad hoc Report > **Configuration Changes by User**

Run Preview Run in Background

Select Filter Criteria **0 Selected**

Max. Rows:   Suppress Duplicates

Open	Field	Criteria	Use Field	Value	Close	Relation
<input type="checkbox"/>	<input type="text"/>	<input type="text"/>	<input type="checkbox"/>	<input type="text"/>	<input type="text"/>	<input type="text"/>
<input type="checkbox"/>	<input type="text"/>	<input type="text"/>	<input type="checkbox"/>	<input type="text"/>	<input type="text"/>	<input type="text"/>
<input type="checkbox"/>	<input type="text"/>	<input type="text"/>	<input type="checkbox"/>	<input type="text"/>	<input type="text"/>	<input type="text"/>

If you run the report without specifying any override run-time parameters here, the report is generated with the defaults specified at design time for this report. You can run a report in the background after specifying the Run Report parameters.

The following table describes **Run Report** parameters.

### Run Report Parameters

Option	Description
Report Format	<p>Specify a file type or “format” option of the output, and toggle on or off the Multipage option to generate a report as a multi-page or a single-page document. By default, Multipage is checked.</p> <p><b>Note: HPE strongly recommends using the Multipage option for all reports.</b> Specifically, if a report will result in more than 826 records, using the Multipage option will ensure that the generated report is not blank. By default, the reports generated in the PDF format are set to use the Multipage option. However, if your PDF format report is blank, ensure that the Multipage option is still checked for that report.</p> <p>For descriptions of report formats, see <a href="#">"Report File Formats" on the next page</a>.</p>
Select Filter Criteria	<p>Provides options to define filters, or modify default filters if any are already built in to the report.</p> <p>The filter expression is applied when the report runs, narrowing the focus of the report to the specified criteria.</p> <p>For example, you could set the filter criteria on a report on Top Password Changes to report only on password changes related to specified user names or involving specified IP addresses.</p> <p>For details on how to create these filters (with Field, Criteria, and Value fields), see <a href="#">"Filter" on page 204</a> in <a href="#">"Designing New Reports (The Ad hoc Report Designer)" on page 200</a>.</p> <p><b>Note:</b> Filter criteria defined at report run time applies only to this run of the report. Filters set in this way are not saved nor made available to other users. You can also set built-in, default filter criteria as a part of designing a report.</p>
Template	<p>Select the template to apply to this report. The templates pull-down menu shows supplied templates, and any custom templates you may have added. To include the start time, end time, scan limit, device group, storage group, and devices information (used to run a report) in a report, choose the <b>BlankWithHeader</b> template.</p> <p>See <a href="#">"Template Styles" on page 242</a> for more information on working with templates.</p>
View Options	<p>The default view option for the report results is Multipage. If you deselect the <b>Multipage</b> option, your report will be formatted as a single page. <b>HPE strongly recommends using the Multipage option for all reports.</b> You also have the option to download the report results as a zipped file. To do so, check the Download Zipped option.</p>

When you click **Run** on this first “Parameters” dialog, the same dialog is displayed as for a Quick Run with default option (or Run in Background) report where you can specify filters on timeframe and storage groups on which to run the report. (See ["Quick Run with Default Options or Run In Background](#)

[Report Parameters" on page 182](#) for details on this “Additional Filters” dialog. Clicking **Run Now** on this second dialog runs the report.

## Report File Formats

### Report file formats include:

- HTML (Web page format)
- PDF (Acrobat PDF)
- MS Excel
- Comma-separated (Delimiter-separated file. The delimiter is usually a comma.)
- MS Word
- Interactive HTML (iHTML)
- XML

For most formats, you can select the Multipage option by clicking on the **View Options** link. **HPE strongly recommends using the Multipage option for all reports.** (If this option is checked, the report results will be formatted for a multi-page report.)

The report formats made available to you depend on access rights associated with your user account. (See ["Setting Access Rights on Reports" on page 218](#) for more information.)

Some report formats require that the local machine has a separate viewer installed. For example, viewing reports in PDF format requires Adobe Reader.

## Publishing Reports

If you publish a report after you run it (["Running and Viewing Reports" on page 181](#)), the output results for that run of the report are saved for subsequent use.

You configure *scheduled reports* to publish after each scheduled run. The publish options for scheduled reports are the same as for *on-demand reports* described here. For more about scheduled reports, see ["Scheduled Reports" on page 192](#) and ["Scheduled Reports" on page 192](#) and ["Add Report Job Settings" on page 189](#).

### To publish a report:

1. In a generated report output file from running a report, click the **Publish Report**  button at the top of the page.

- In the **Publish** dialog, specify the report details. The following table describes the publish report options.

### Publish Report Settings

Option	Description
Report Format	Format of the report. To publish a zipped version of the file format, in click Options, then select <b>Publish Zipped File</b> .
Save In	Category under which to save the report. If you specify a category in the preferences, you can navigate to it. If you had not specified a category, the published report will be saved in the category in which the report resides.  <b>Note:</b> You cannot save a report in the root category.
Report Name	Name for this report on the published reports list.
Access	Select a value for access: <ul style="list-style-type: none"> <li>Public makes this report available to everyone.</li> <li>Private makes this report available to you only.</li> </ul>
Expires on	Date and time after which the report output is discarded (and, therefore, unavailable for viewing).  If you do not want the report results to expire (keep always available), then leave this field blank (that is, do not set a value for this field).

- Click **Publish**.

For information on how to view a published report, see ["Viewing the Output of a Published Report" on page 191](#).

## Add Report Job Settings

The following table describes the Add Report Job settings.

### Add Report Job Settings

Option	Description
Name	Name displayed on the Scheduled Jobs list.
Schedule	Set when and how often you want the report to run. For details about these options, see <a href="#">"Scheduling Date and Time Options" on page 136</a> .
Report Name	Select a report from the list, and click Go to load the report.  <b>Note:</b> You must click Go to load the selected report at the Report Name field before you save the scheduled report job.
Delivery Options	Depending on which delivery option you choose, the associated parameters are displayed. Select to enable or disable these options.  Both Email and Publish options for scheduled reports are the same as those provided after you run a report on demand.  Select a delivery option: <ul style="list-style-type: none"><li>• Email: For details on setting Email delivery options, see <a href="#">"Emailing a Report" on the next page</a>.</li><li>• Publish: For details on setting publishing options, see <a href="#">"Publishing Reports" on page 187</a>.</li></ul>
Report Format	Select a report format (Acrobat PDF, HTML, and so forth.)  For details on report formats, see <a href="#">"Report File Formats" on page 187</a> .
Report Parameters	You can either accept the default parameters, or modify them here. These are the same parameters that can be specified for an on-demand report run.  For information on specifying report parameters, see <a href="#">"Quick Run with Default Options or Run In Background Report Parameters" on page 182</a> .

## Report Delivery Options

When you run a report from the Report Explorer (as described in ["Running and Viewing Reports" on page 181](#)), many options are available for delivering the generated output.

The most common next step is to publish the resulting report (described in ["Publishing Reports" on page 187](#)), but you can also save the report output to a file, Email it to other users, refresh the results, change the output format, and so forth. Refreshing a Report

To re-run the report for an updated result set, click **Refresh**.

## Emailing a Report

You can send a report using email as either a Web link or an attachment. You can also configure these Email options on *scheduled reports*, as described in "[Scheduled Reports](#)" on page 192.

Before you can email a report, you must first set up SMTP for reports. Navigate to **Reports > Reports Administration** and configure the SMTP settings.

### To email a report:

1. In the Report Explorer, after you run a report, click **Email Report**  on top of the page.
2. Specify the following information about the email as shown in the table below.

#### Email Report Settings

Option	Description
Send Report As	Choose one of these: <ul style="list-style-type: none"><li>• To provide a link to the report in the body of the email, select <b>Link</b>.</li><li>• To send the report as an attachment to the email, click <b>Attachment</b>, and select a format for the attachment file.</li></ul>
Report Format	Select a format for the file to be attached to the email.
Options	Select the following options before attaching a report file to an email: <ul style="list-style-type: none"><li>• <b>Pagination:</b> Select whether you would like the report to display in a single page or multiple pages and whether you want horizontal breaks.</li><li>• <b>Download Zipped:</b> If selected, the file is zipped before being attached to email.</li><li>• <b>Include comments:</b> If selected, any comments added to the report are included.</li></ul>
Save In	You have the option to save the report in a location that you can specify here.  <b>Note:</b> You cannot save a report in the root category. Save it in one of the existing categories or create a new one.
To and CC	Specify email addresses to which to send the report.
Subject	Provide email subject header.
Message	For the body of the email, you can use the default message provided, modify it, or enter your own message.

3. Click **Email** to send the report.

## Exporting and Saving a Report

You can export a report to a file format of your choice and save it.

### To export and save a report:

1. Click the **Export** button or click one of the file format buttons on the published report top-level menu bar.
2. In the **Export Options** dialog, specify the Export Format and associated settings you want in the Export Options dialog. Depending on the Export Format you choose, other settings are displayed as appropriate.
3. Click **Generate**.

You can save the generated report as a file locally or elsewhere just as you would any other file.

## Viewing the Output of a Published Report

### To view the output of a published report:

1. In the Report Explorer, navigate to the report for which you want to view output results.
2. In the Actions menu, click **List Published Outputs**. The published outputs are displayed. You can use the Filters to search for a desired output result.

Saved Report List: Top Infected Systems

Filters Published Name Includes [ ] Report Name [./Anti-Virus]/[Top Infected Systems]

Published Name Includes [ ]

Updated Between [MM/dd/yyyy] and [MM/dd/yyyy]

Select Report [./Anti-Virus/Top Infected Systems] Orphan

Select Owner [ArcSight] [admin] Private Owned By [Selected User] Public Owned By [All]

[Search]

Anti-Virus

[Search] [Grid]

Sr.No.	File Name	Generated Time	Expiry Time
--------	-----------	----------------	-------------

## Deleting Published Reports

You can delete old instances of the report output that have accumulated over time from this page. To delete the report, select it and click the **Delete** button in the toolbar.

**Note:** Please be certain that you want to remove these old reports, and do so carefully.

## Scheduled Reports

You can schedule a reports to run as a scheduled job, either on a one-time basis, or at regular intervals (hourly, daily, and weekly). As part of scheduling a report job, you can set delivery options to email, save, or publish the resulting reports.

HPE recommends using the Scheduled Report feature in lieu of running on-demand (ad hoc) reports whenever possible, so that reports run during periods of light load. For more on this see "[Best Practices](#)" on page 179.

Time changes due at the beginning or end of Daylight Savings Time may affect your scheduled reports. For more information, see "[Impact of Daylight Savings Time Change on Logger Operations](#)" on page 412.

**Note:** If not completed, by default, a scheduled report times out in 4 hours.

- [Viewing and Editing Scheduled Reports](#) ..... 192
- [Scheduling a Report](#) ..... 195

## Viewing and Editing Scheduled Reports

Reports that are already scheduled are displayed on the Scheduled Reports page.

### To view scheduled reports:





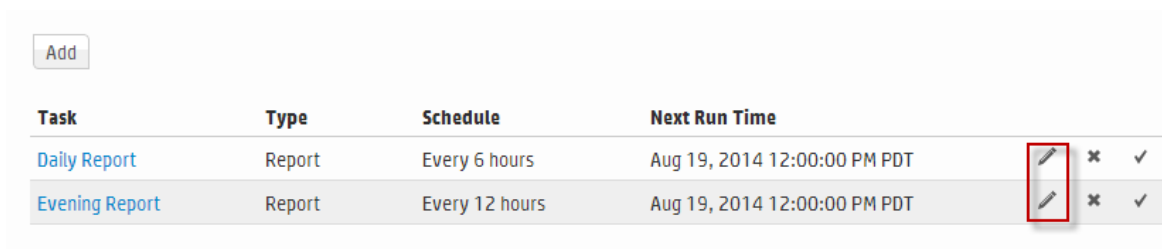

On the left pane, click **Scheduled Reports**.

**Note:** To view scheduled reports, a user must belong to a Logger Reports Group, a Logger Search Group, and a Logger Rights Group.

### To edit a scheduled report:

1. Click **Edit** next to the scheduled report job you want to edit.



Task	Type	Schedule	Next Run Time	
<a href="#">Daily Report</a>	Report	Every 6 hours	Aug 19, 2014 12:00:00 PM PDT	  
<a href="#">Evening Report</a>	Report	Every 12 hours	Aug 19, 2014 12:00:00 PM PDT	  



2. On the **Edit Job Report** page, modify the settings as needed, and then click **Save**.

**Edit Report Job**

Name: Daily Report

Schedule: Everyday, Every 6 Hours

Report Name: ../Anti-Virus/Failed Anti-Virus Updates

**Delivery Operations**

Email  Publish

Save In: User's Working Folder

File Name: Suffix Timestamp Format

Valid Upto: 1 Months After Generation

**Report Format**: ACROBAT PDF

**Delivery Options**

Pagination: Horizontal Breaks

Deliver Zipped File

Report Parameters: No Parameters

For details on how to specify these settings, see ["Scheduling a Report" on page 195](#).

**Note:** The job name is not editable once the scheduled report job is created. Other settings can be modified with an edit, and work the same way as on the Add a Report Job page described in ["Scheduling a Report" on page 195](#).

### To remove a scheduled report:

Click **Delete** next to the scheduled report job you want to remove.

**Tip:** Removing the report from Scheduled Reports list here deletes the *scheduled job*, not the report itself nor any instances of its previously published output.

## Jobs Execution Status

Click the **Jobs Execution Status** link at the top of the **Reports** page to display the **Jobs Execution Status** page. The page displays a graphic representation of the status of all executed jobs. The page has two panels: the **Jobs Summary** panel, and the **Filters** panel.

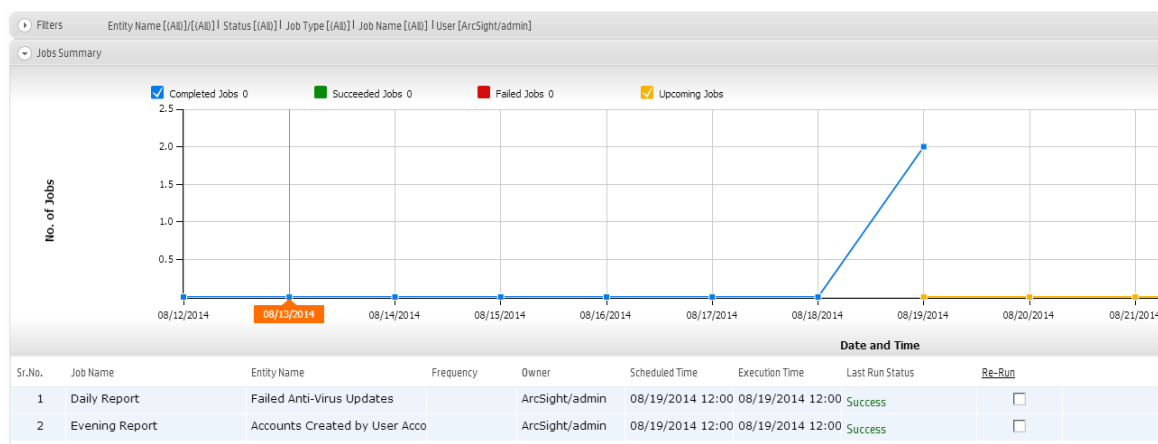

The **Jobs Summary** shows a graph indicating the number of executed jobs by day. Jobs are assigned a status as follows:

- Completed
- Succeeded
- Failed
- Upcoming

Select a Job Status button (for example, the **Failed Jobs** button) to display the jobs corresponding to that status in the graph.

**Note:** Upcoming jobs will not be displayed when the **Upcoming Jobs** status button is clicked. Only a blank list is shown.

Click a date to show jobs for that day in a pop-up.

Beneath the Jobs Summary is a table listing each job and its details.

Under **Filters**, you can filter the results of the Jobs Summary to show results matching a variety of criteria.

To create a filter, enter values for the criteria shown, and then click **Refresh**. (Next to the Filters label, the current filter is summarized in text format.) The results in the Jobs Summary include results that only match the filter criteria.

## Scheduling a Report

You can schedule a report to run daily at a specified time or every so many hours, or on specified days of week or month, at a specified time.

### To schedule a report:

1. Click **Scheduled Reports** on the Reports page left menu. The page shows the list of currently scheduled report jobs, if any.
2. Click **Add** to display the Add Report Job page.
3. Enter the report display name in the Scheduled Jobs list.
4. Use the pull-down menu next to **Report Name** to select a report, and then click the Select Entity checkmark to load the report.

**Add Report Job**

---

Name

Schedule

Hours (24 hour format)

**Report Name \***  

5. Use the schedule options to specify how frequently the report should run. For details about these options, see ["Scheduling Date and Time Options" on page 136](#).
6. Choose one or both delivery options under **Delivery Operations (Email, Publish)**. By default, only **Publish** is selected. Both Email and Publish options for scheduled reports are the same as those provided after you run a report on demand.
  - To keep the **Publish** option, select it and enter its associated parameters. For details on setting publishing options, see ["Publishing Reports" on page 187](#).
  - To include the **Email** option, select it and enter its associated parameters. For details on setting

email delivery options, see ["Emailing a Report" on page 190](#).

**Delivery Operations**

**Email**  **Publish**

Send Report As  Link  Attachment

Save In    User's Working Folder

File Name   Suffix Timestamp Format

To

Cc  Bcc

Subject

Message  
Hello, <BR><BR> You have received this automated email to let you know that report <%MENU\_NAME%> has been generated. Please click the following link to view the report

**Report Parameters**

7. Enter settings in the remaining fields based on the report you chose.
  - **Delivery Operations:** Depending on which delivery option you choose, the associated parameters are displayed. Select to enable or disable these options.
  - **Report Format:** Select a report format (Acrobat PDF, HTML, and so forth.) For details on report formats, see ["Report File Formats" on page 187](#).
  - **Report Parameters:** You can either accept the default parameters, or modify them here. These are the same parameters that can be specified for an on-demand report run. For information on specifying report parameters, see ["Quick Run with Default Options or Run In Background Report Parameters" on page 182](#).
8. Click **Save**.  
The report you added is scheduled, and now shows on the **Scheduled Reports** list.

## Designing Reports

You can use the Ad hoc Report Designer to design simple columnar reports, as well as mixed reports with embedded charts and matrices. For columnar reports, the Report Designer provides options for setting up filters, grouping, totals, and sort order to create a full-featured report.

- [Opening the Report Designer](#) .....197
- [Creating New Reports](#) .....198
- [Editing a Report](#) .....216
- [Setting Access Rights on Reports](#) ..... 218

## Opening the Report Designer

### To create a new report from scratch:

1. On the left menu bar, under **Design**, click **New Report**. The Ad hoc Report Designer will open with a new, blank report.

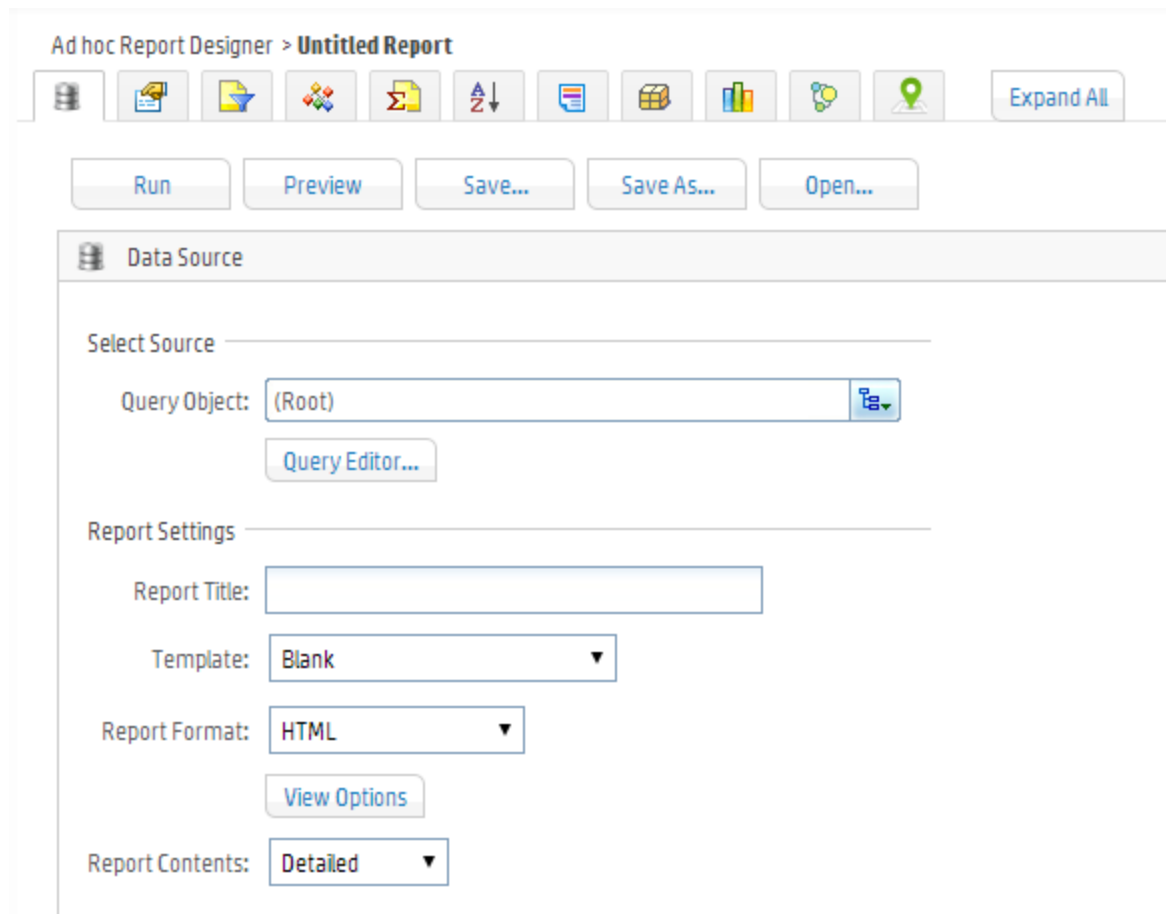

### To open the Report Designer to edit an existing report:

1. Browse to the report in the Report Explorer.
2. In the **Actions** menu, click **Customize Report**. The Ad hoc Report Designer will open with the selected report.

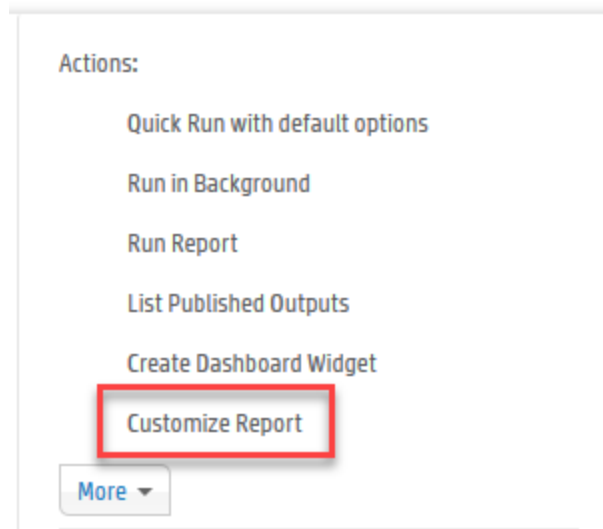

## Creating New Reports

If you are new to the Logger Report Designer, we recommend starting with an existing report as a basis for a new one, as described in ["Quick Start: Base a New Report on an Existing One"](#) below.

If you are starting a new report from scratch, or for more details on each of the settings in the Report Designer, see ["Designing New Reports \(The Ad hoc Report Designer\)"](#) on page 200.

- [Quick Start: Base a New Report on an Existing One](#) .....198
- [Designing New Reports \(The Ad hoc Report Designer\)](#) ..... 200
- [Filter](#) ..... 204
- [Group](#) .....206
- [Totals](#) ..... 207
- [Sort](#) ..... 208
- [Highlight](#) ..... 209
- [Matrix](#) .....209
- [Chart](#) ..... 211
- [Map](#) ..... 213

### Quick Start: Base a New Report on an Existing One

Since Logger ships with a variety of useful, pre-built reports for common security scenarios, you can use these not only to run as-is but also as templates for building new reports. If you are just beginning with the Report Designer, a good way to learn fast is to start with an existing report that has some of the features you want in your new report, save the original report under a new name, and then modify it.

**Caution:** Modifications to reports and other ArcSight-defined content may be overwritten without

warning when the content is upgraded. Do not modify ArcSight-defined content directly. Make modifications to a copy of any ArcSight-defined content as a general practice, and subsequent upgrades will not affect the modifications.

### To create a new report based on an existing report:

1. In the Report Explorer, browse to the report you want to use as a starting point.
2. In the **Actions** menu, click **Customize Report**.

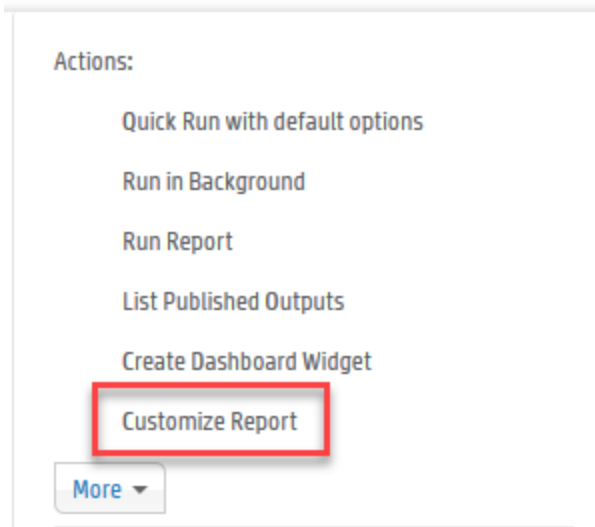

This opens the Report Designer with the report's properties filled in.

**Note:** Some reports, such as the ones obtained from ArcSight, or other custom developer sources, might not be editable. For such reports, the Customize Report link is disabled.

3. Click **Save As**. This displays the **Save Report Layout As** dialog for the selected report (and shows all reports stored in the same category as the one you selected).

4. In **Report Name**, enter a name for your report.

The screenshot shows a report configuration window. At the top, there is a navigation pane with a tree view containing: (Root), Device Monitoring, Operating System, and Login Errors by User. Below this, the 'Report Name' field contains 'Customized User Administration'. To the right of this field are 'Save' and 'Cancel' buttons, and an 'Options' button with a small upward-pointing arrow. Below the 'Report Name' field is the 'ID' field, which is empty. To the right of the 'ID' field is a checked checkbox for 'System Generated'. Below the 'ID' field are two radio buttons: 'Public' (selected) and 'Private'. Below these is a checked checkbox for 'Copy Access Rights'. Below the 'Copy Access Rights' checkbox is a text area for 'Description' containing the text: 'This report shows user and user group creations, modifications, and deletions.' At the bottom left of the text area, there is a small asterisk and the text '\*=Read Only'.

5. Click **Options**, and then enter values for the following:
  - **ID**: Enter a custom ID for the report, if desired. Alternatively, select System Generated to automatically generate one (selected by default).
  - **Public/Private**: select one. If public, everyone will have access to this report; if private, only you.
  - **Description**: Enter a description, if needed.
6. Click **Save**.
7. Click **OK** to confirm the save. Your new report is now shown under the category in which you saved it.
8. Select the report you just saved and click the **Customize Report** button to start modifying the new report to suit a specific scenario. (See the next section, "[Designing New Reports \(The Ad hoc Report Designer\)](#)" below.)

## Designing New Reports (The Ad hoc Report Designer)

To access the Report Designer to create a new report from scratch, under **Design**, click **New Report** link in the left panel. The **Ad hoc Report Designer** is displayed with a blank template.

The following sections explain how to use the Report Designer.













## Toolbar Buttons

The toolbar includes these buttons.

- Click **Run** to test the current version of the report.
- Click **Preview** to preview the report before saving it.
- Click **Save** to save the report.
- Click **Save As** to save it under a different name.
- Click **Open** to open another report in the Report Designer.

## Report Components

Report components can be accessed by the tabs at the top of the designer page:

Tab	Description
Data Source 	See <a href="#">"Data Source" on the next page</a> for more information.
Fields 	See <a href="#">"Fields" on page 203</a> for more information.
Filter 	See <a href="#">"Filter" on page 204</a> for more information.
Group 	See <a href="#">"Group" on page 206</a> for more information.
Totals 	See <a href="#">"Totals" on page 207</a> for more information.
Sort 	See <a href="#">"Sort" on page 208</a> for more information.
Highlight 	See <a href="#">"Highlight" on page 209</a> for more information.
Matrix 	See <a href="#">"Matrix" on page 209</a> for more information.
Chart 	See <a href="#">"Chart" on page 211</a> for more information.
Map 	See <a href="#">"Map" on page 213</a> for more information.
Expand All/ Collapse All 	Toggles the detail view.  Once expanded, you can also toggle visibility of an individual component in the Designer by clicking the component's title bar. For example, to toggle visibility of the <b>Highlighting</b> component, click the <b>Highlighting</b> title bar (above the <b>Create Matrix</b> title bar).

## Data Source

Every report is built on a base query. To select one for your report, under **Select Source**, in **Query Object**, browse to a query to use.

For instructions on how to view a list of the default search fields, see ["Default Fields" on page 281](#). For information about custom schema fields added to the default schema, see ["Adding Fields to the Schema" on page 377](#).

You can edit the selected query by clicking **Query Editor**. (For information on building new queries, see ["Queries" on page 219](#).)

## Creating a New Report

### To create a new report:

1. Under **Design**, click the **New Report** link in the left panel. The Ad hoc Report Designer is displayed with a blank template.

Report Settings

Report Title:

Template:

Report Format:

Report Contents:

2. Under **Report Settings**, enter or select values for each of the following settings:

#### General Report Design Settings

Option	Description
Report Title	Title of the report.
Template	Select the template to apply to this report. The templates pull-down menu shows supplied templates, and any custom templates you may have added. To include the start time, end time, scan limit, device group, storage group, and devices information (used to run a report) in a report, choose the "BlankWithHeader" template.  See <a href="#">"Template Styles" on page 242</a> for more information on working with templates.

### General Report Design Settings, continued

Option	Description
Report Format	Select the default format for the report. For information on available formats, see <a href="#">"Report File Formats" on page 187</a> .
Report Contents	Select whether report should detailed or summarized.

## Fields

Once you select a query to use in the report, the display fields it contains are shown in the **Available Fields** list. You can select which of these display fields you want to use in your report. You can edit the selected query by clicking on the **Query Editor** link. (For information on building new queries, see ["Queries" on page 219](#).)

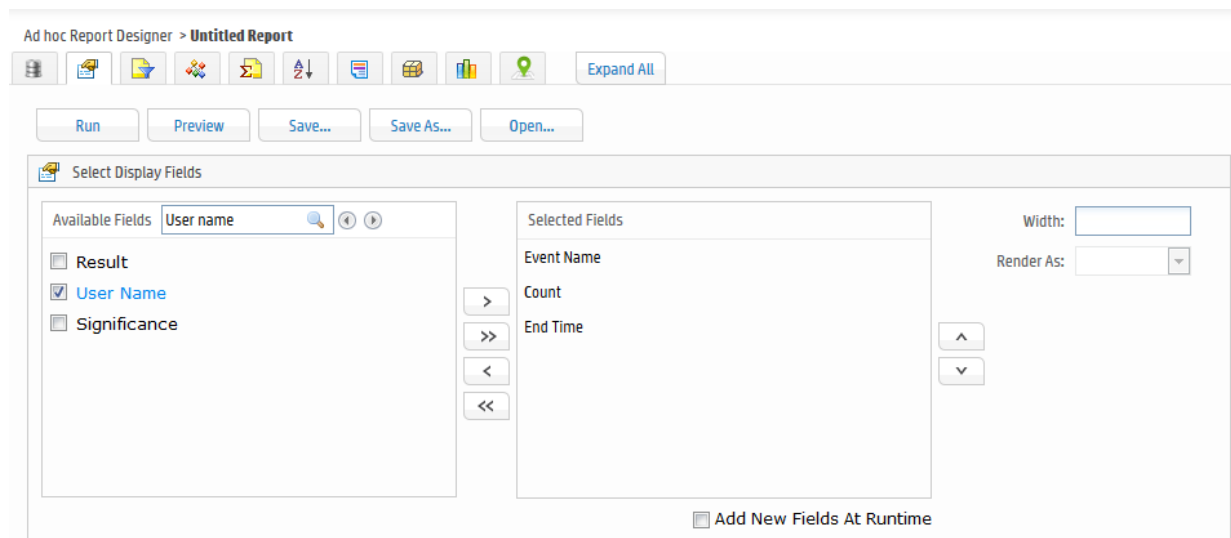

**Note:** In addition to the fields in the WHERE clause of the query, the fields in the SELECT clause also need to be indexed to yield faster report generation. For more information about indexing fields, see ["Indexing" on page 138](#).







Enter a title for the report in the **Report Title** field, and then select whether the report contents should be Detailed or Summarized in the **Report Contents** field. The report title is displayed at the top of a report.

Select the query you want to use for the report from the drop-down list located on top of the Select Display fields section. The Available Fields list is populated with the fields defined in the selected query.

Select the fields to use in the report by moving fields from **Available Fields** into the **Selected Fields** list.

**Note:** You must move at least some available fields to the **Selected Fields** list, or the report will not

run correctly





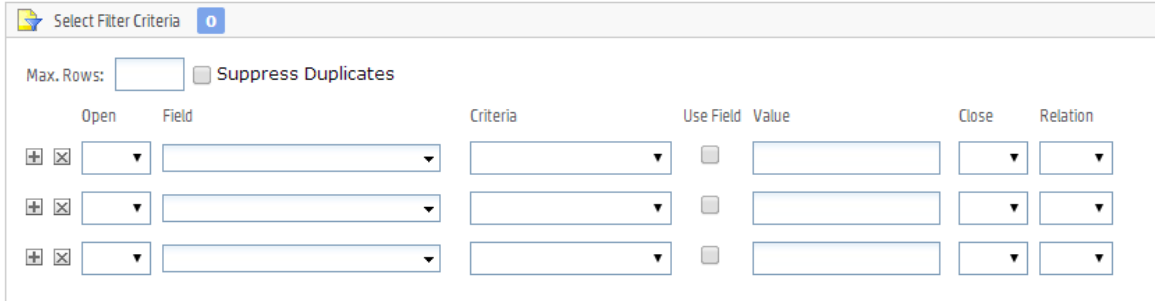

- Select a field in **Available Fields** and click  to move it into the **Selected Fields** list, or click  to add all fields.
- To deselect fields that you do not want in the report, select a field in the **Selected Fields** list and click  to move it back to the **Available Fields** list, or click  to deselect all fields.
- Use the move up  and move down  arrows to order the Selected Fields.

**Tip:** For information on how to create query objects for use in reports, see ["Queries" on page 219](#). All available queries, including new queries you create, show up in the pull-down menu in the Select Display Fields section of the Ad hoc Report Designer.

## Filter

Filter criteria are defined as part of a report design. When other users run the report, they receive the built-in filters by default. You can also set filter criteria and row limits on an ad hoc basis when you run a report. However, values set at run time are not built in to the report like those set at design time. Run-time parameters are only applicable to a particular report run and do not persist.





Open	Field	Criteria	Use Field	Value	Close	Relation
 	<input type="text"/>	<input type="text"/>	<input type="checkbox"/>	<input type="text"/>	<input type="text"/>	<input type="text"/>
 	<input type="text"/>	<input type="text"/>	<input type="checkbox"/>	<input type="text"/>	<input type="text"/>	<input type="text"/>
 	<input type="text"/>	<input type="text"/>	<input type="checkbox"/>	<input type="text"/>	<input type="text"/>	<input type="text"/>

If a report does include default filter criteria, users have the option to run the report with the defaults, or modify or remove the built-in filters at run time. For more information, see ["Run Report Parameters" on page 185](#).

You can set filters on the results of the base query with logical expressions to narrow the focus of the report results. For example, you could set the filter criteria on a report on Top Password Changes to report only on password changes related to specified user names or involving specified IP addresses.

You can limit the number of rows in a report by defining a Max. Rows value, or require filtering on one or more fields of your choice using the Mandatory option.

## Select Filter Criteria Options

Option	Description
<p>Maximum Rows (Max. Rows)</p>	<p>Specify the maximum number of rows in the report output. Results that push the number of rows beyond the Max. Rows limit you define will not be included in the report.</p> <ul style="list-style-type: none"> <li>• Selecting set Max. Rows and also specifying a grouping under <b>Set Grouping</b> (as described in <a href="#">"Group" on the next page</a>), may produce a different result than if you just specified Max. Rows without grouping.</li> <li>• Setting this field to 0 returns an unlimited number of rows.</li> <li>• Increasing the maximum rows for report may not always increase the number of rows returned by the report. If the query invoked by the report limits the number of rows returned, increasing the Max. Rows setting in the report has no affect. For example, if you edit the NIST IR Top 10 High Risk Events report and change the value in the Max. Rows column from 10 to 20, when the report is run report only 10 rows are returned. This is because the query invoked by the report is returning 10 rows. However, you can limit the number of rows returned by the report to a number less than the default value. For example, if the value of the Max. Rows field is changed from 10 to 5 for the NIST IR Top 10 High Risk Events report, this report returns 5 rows during run time.</li> <li>• You can increase the number of rows returned by editing the query and changing the number of rows returned by the query and change the number specified in the Max. Rows field of the report.</li> </ul>
<p>Field</p>	<p>The Fields will be populated with event data fields specified in the base query. (Fields will generally equate to columns in reports.)</p> <ol style="list-style-type: none"> <li>1. Select a field on which to filter.</li> <li>2. To add another field on which to filter, click  (Add Filter).</li> <li>3. To remove a filter, click  (Remove Filter).</li> </ol> <p>For instructions on how to view a list of the default search fields, see <a href="#">"Default Fields" on page 281</a>. For information about custom schema fields added to the default schema, see <a href="#">"Adding Fields to the Schema" on page 377</a>.</p> <p>Multiple filters with conditions set on different fields will be AND'ed together. Multiple filters with conditions set on the same field will be OR'ed together.</p> <p>For example, if you want to filter on events to return data based on a value/count (of rows or other) between 90 and 100, use the <b>Between</b> criteria to do this (for example, &lt;Field&gt; Between 90 and 100)</p> <p>Setting two filters on the same field with criteria <b>"Above 90"</b> and the other as "Below 90" would not give you the data you are looking for. Only one of these filters would be triggered.</p> <p>If the query you choose for this report has mandatory filtering, the "Select Filter Criteria" panel title and one or more fields are marked with a red asterisk. See details.</p>
<p>Criteria</p>	<p>Select a logical operator. (For example, Is, Is Not, Starts With, Ends With, Contains, and so forth.)</p> <p><b>Tip:</b> To make the query case-sensitive, select the Match Case option for your operator.</p>
<p>Value</p>	<p>Select a value to complete the conditional filter expression.</p>

## Group

Grouping brings together related report data into logical groups based on particular fields. The data can be arranged in ascending or descending order, and can display the selected field value, or a summary value. You can create different groups to display information in different ways.

To configure report groups, select **Reports | New Report**, then click **New Report** from the Design menu. The **Ad hoc Report Designer** page displays. Click the Group tab (  ) to open the **Select Grouping** menu.

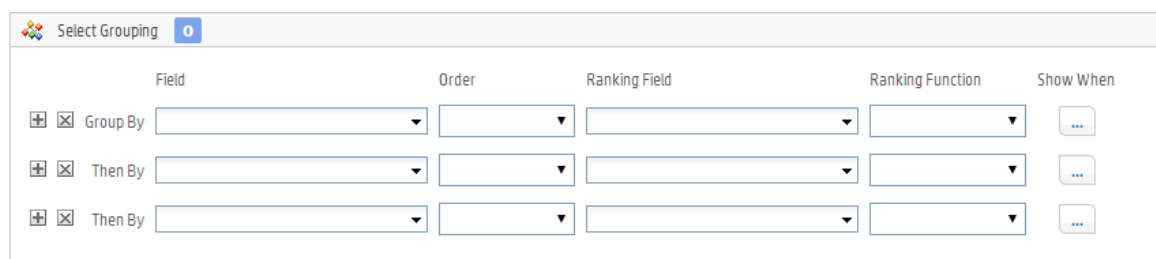

	Field	Order	Ranking Field	Ranking Function	Show When
<input type="checkbox"/> <input type="checkbox"/>	Group By				...
<input type="checkbox"/> <input type="checkbox"/>	Then By				...
<input type="checkbox"/> <input type="checkbox"/>	Then By				...

**Note:** A report that has a group defined can only display up to 100,000 lines.

**Example 1:** Let's say you create a group that displays "Total Sales" in descending order (Z to A). The total sales of "East Region" is 1000 units, and total sales of "West Region" is 1900 units. In the report, the "West Region" group detail will appear before "East Region" group details.

**Example 2:** If the report uses a query that includes a Date field, you can group results by date. You could add additional statements to group by "User Name", "Source Address", "Destination Address", and so forth, depending on what other fields are available in the report query.

**Note:** Selecting set Max. Rows under **Select Filter Criteria** (as described in ["Filter" on page 204](#)) and also specifying grouping may produce a different result than if you just specified Max. Rows without grouping.



See the table ["Add Report Job Settings" on page 189](#) for more information about report settings.

### To define a group:



1. From the **Group By** menu, select available options from the following menus to specify what event information should be groups, in what order, and under what conditions.

The **Group By** field is the primary field in the data group, organized by the ranking field, in ascending or descending order.

### Select Group By Fields

Option	Description
Field	<p>Select an option from the menu to make it the primary field in the report group. The <b>Field</b> menu is populated with event data fields specified in the base query.</p> <ul style="list-style-type: none"> <li>To add another grouping field, click  (Add Field).</li> <li>To remove a group-by field, click  (Delete Field).</li> </ul>
Order	<p>Select in what order you want the information to display.</p> <ul style="list-style-type: none"> <li>Ascending (0, 1, 2... or A-Z)</li> <li>Descending (2, 1, 0... or Z-A)</li> </ul>
Ranking Field Ranking Function	<p>Select a field to order by (Ranking Field) and the type of information you want the report to show (Ranking Function). Logger can group the data by date, number, and character.</p> <p>For example, if you select the query object "Login Errors by User," you can group the data by "User Name", in "Ascending" order, with "Error" as the ranking field, and "Count" as the ranking function.</p> <p>This allows you to see users with the highest number of errors listed at the top of the data group section of the report.</p>
Show When	Use this menu if you want information to display when more detailed criteria are met.

- If you want to include secondary groups, populate the **Then By** fields. For example, if your report uses a query that reports on password changes and includes a "User Name" field, you might want to sub-group the results for each date by "User Name".



Use the  (Add Field) and  (Remove Field) buttons to add or remove **Then By** fields for sub-groups.

The report will generate records organized and grouped in the order you selected.

**Tip:** Alternatively, you can specify only a sort order (instead of groups). See also, ["Sort" on the next page](#).

## Totals

Σ Select Totals 0

	Field	Function	Level
+ 	<input style="width: 90%;" type="text"/>	<input style="width: 90%;" type="text"/>	<input style="width: 90%;" type="text"/>
+ 	<input style="width: 90%;" type="text"/>	<input style="width: 90%;" type="text"/>	<input style="width: 90%;" type="text"/>
+ 	<input style="width: 90%;" type="text"/>	<input style="width: 90%;" type="text"/>	<input style="width: 90%;" type="text"/>

You can specify the summary (total) fields. You can apply a summary on any of the following levels:

- Report
- Page
- Group

### To specify summary details:

1. From **Field**, select the field that will be processed to calculate summary information.
2. On the same row, from **Function**, select the summary function.
3. On the same row, from **Level**, select the level at which you want the summary.

**Note:** If a Total is applied to a field that is not already in the Selected Fields list, that field is automatically added to the Selected Fields list.

## Sort

	Field	Criteria
+ -	Sort By	
+ -	Then By	
+ -	Then By	

If you do not want grouped report results (as described in a "[Group](#)" on page 206) but you do expect sorted results, then specify a sort (instead of a grouping).

**Note:** A report that has a sort order defined can only display up to 100,000 lines.

You can have up to three levels of sorting.

### To specify a sort order:

1. In **Field**, select the field on which you want to sort the report.
2. In **Criteria** (in the same row), select the sort criteria.
3. If desired, provide values in the "Then By" rows to specify more sorting criteria.



## Highlight

A report can include multiple levels of highlighting for specified fields. Highlighted items can serve as visual alerts on generated reports when specified set conditions are satisfied.

Highlighting 0 Selected

Highlight Using Style

When Open Field Level Function Criteria Use Field Value Close Relation

### To set up a highlight:

1. In **Highlight**, select the field that should be highlighted. Select **Entire Row** to highlight an entire record.
2. In **Using Style**, select the style to be applied to highlight it.
3. Select **Alert** checkbox to receive a visual alert on report viewer.
4. In **Field**, select the fields to evaluate for highlight (alert).
5. In **Level**, select the level at which the selected field should be evaluated:
  - DETAIL evaluates each row (record)
  - REPORT evaluates at the end of report
  - Respective groups evaluate at the end of each group
  - PAGE evaluates at the end of the page
6. When REPORT or PAGE is selected in Level, select a Function to be applied.
7. Select **Criteria** and specify its **Value**.  
Click  (Remove Condition) on the left of the criteria entry to delete an entry. Click  (Add Condition) to add another entry.

## Matrix

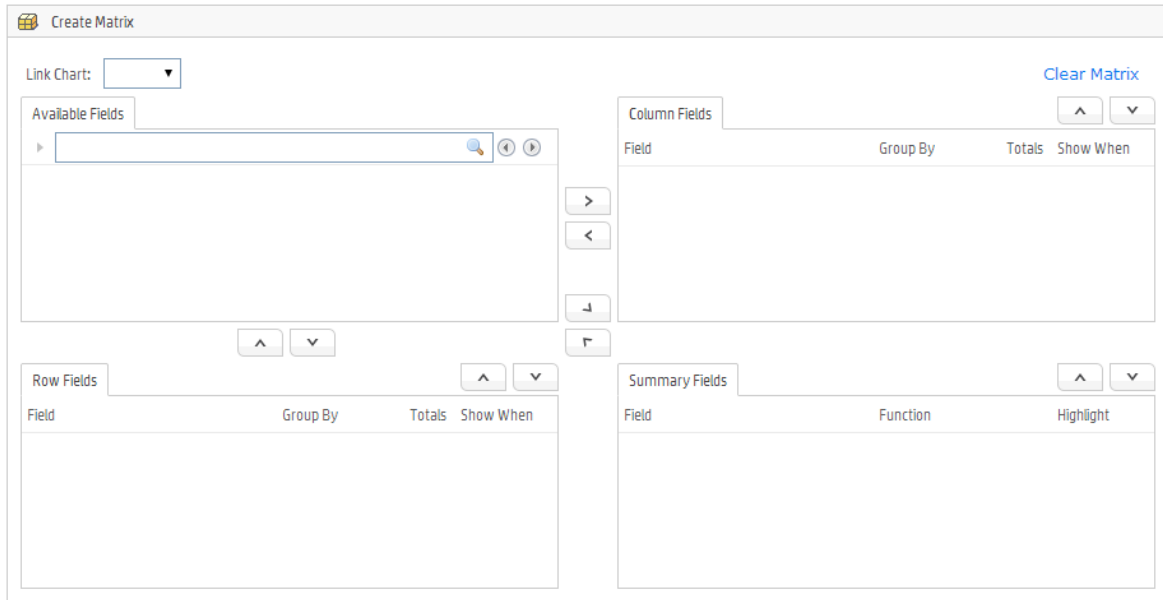

You might choose to include a matrix in your report, since it presents a summary of data. Make sure that the appropriate query object is selected (under **Select Display Fields**).







### To create a matrix:

1. To place a field in Row or Column, click the field and drag it to the **Row Fields** or **Column Fields** boxes.
2. To place a field as a cell (summary), click the field and drag into the **Summary Fields** box.
3. Select a **Function** from the pull-down menu provided for a field placed in **Summary Fields**.
4. Optionally, for numeric or date fields in columns or rows, specify a **Group By** function in the pull-down menu provided.
5. Optionally, for fields in columns or rows, check the **Totals** checkbox to view a row or column.

Select a field and click padding-right: 0px; to add that field to the matrix as one of the **Column Fields**. Select a field in Column Fields and click  to remove it from the matrix.

Select a field and click  to add that field to the matrix as one of the **Row Fields**. Select a field in Row Fields and click  to remove it from the matrix.

Select a field and click  to add that field to the matrix as one of the **Summary Fields**. Select a field in Summary Fields and click  to remove it from the matrix.

To move a field up or down, select the field and click  (Move up) or  (Move down), to move the field in the respective direction.

To remove all settings and contents of the current matrix, click **Clear Matrix**.

## Chart

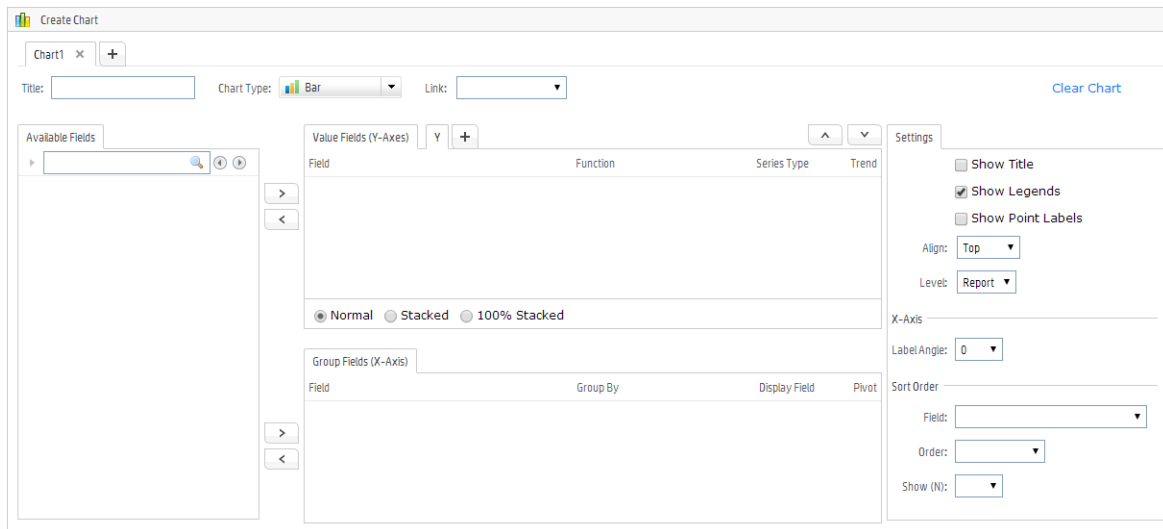

For pictorial representation of summary data, you can add a chart to your report. Make sure that the appropriate query object is selected (under **Select Display Fields**).



### To create a chart, specify values for the following:

Setting	Description
Title	Title of the chart.
Chart Type	Select a chart type from the drop-down list.
Link	Choose to link the chart to either report fields or a matrix.
Available Fields	Available Fields are drawn from the report query. Using the > button, assign these fields to Value Fields (Y-axes on the chart) or Group Fields. See "Assigning Fields" on the next page.
Settings	<ul style="list-style-type: none"> <li>• <b>Show Title:</b> if selected, the chart title displays.</li> <li>• <b>Show Legends:</b> if selected, the chart will show legends for each field.</li> <li>• <b>Show Point Labels:</b> if selected, a label is shown with the number of matches for a value of a field in a chart.</li> <li>• <b>Align:</b> Select an alignment for chart placement.</li> <li>• <b>Level:</b> Select a level from which to draw data for the chart: <ul style="list-style-type: none"> <li>◦ <b>Report:</b> Data will be plotted with data from entire report</li> <li>◦ <b>Page:</b> Data will be plotted with data from the page where the chart is located)</li> </ul> </li> </ul>
Sort Order	Select a sort order for the chart.

## Assigning Fields

You can set value and sort fields for a chart.

### To Set Value Fields (Y-Axis):

1. Click and drag the Field in **Value Fields (Y-Axis)** box, or use the  button (Add field) to add the selected field.
2. Select summary function for the field.
3. To select a different chart type, click the button on the right to open a box with chart types. Select the type you need. Follow steps 1 through 3 above for each attribute to be placed as series. To reposition fields, select a field and click  (Move up) or  (Move down) as needed.

### To Set Group Fields (X-Axis):

1. Click and drag the field in **Group Fields (Y-Axis)** box, or use the  button (Add field) to add the selected field.
2. Select the method to group (for Numeric or date type).

You can specify groups in numeric fields. For example, to have groups of 10, specify 10 in Groups box.

You can specify groups in date fields. From the drop-down box select from Day, Week (Sunday to Saturday), Month, Quarter (Jan-Mar, Apr - Jun, Jul - Sep, Oct - Dec), Year.

**Tip:** To remove fields from Value fields (Y-Axis) or Group Fields (X-Axis), drag them out of the respective box or use the  button (Remove field) on selected fields.

To remove all settings and contents of the current chart, click **Clear Chart**.

## Map

Your report can include a GIS (Geographic Information System) map based on your data.

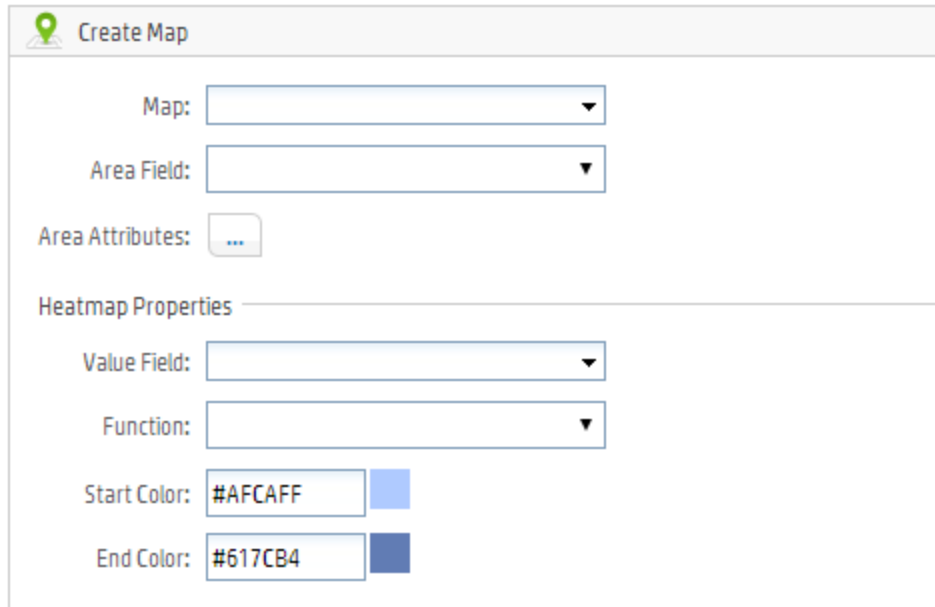

The screenshot shows a 'Create Map' configuration panel. At the top is a 'Map:' dropdown menu. Below it is an 'Area Field:' dropdown menu. To the right of 'Area Field:' is an 'Area Attributes:' button with three dots. A horizontal line separates the top section from the 'Heatmap Properties' section. Under 'Heatmap Properties', there is a 'Value Field:' dropdown menu, followed by a 'Function:' dropdown menu. Below these are two color pickers: 'Start Color:' with the hex code #AFCAFF and a light blue swatch, and 'End Color:' with the hex code #517CB4 and a dark blue swatch.

The GIS map can include a heat map, which highlights by color the areas of most activity that you specify.

**Note:** In the context of a GIS heat map, *heat* refers to activity level.

A map includes the following parameters:

### Map Parameters

Parameter	Description and Values
Map	Select the map name for initial loading of data. For example, if you want to depict a map of US states, then select “USA - Regions”.
Area Field	This is the value used to group map data. Select an area based on the initial selection of value for Map.
Area Attributes	Click an area of the map to see an informational balloon. Set values for the following attributes in the balloon display. <ul style="list-style-type: none"><li>• <b>Prefix:</b> the prefix caption value for the field</li><li>• <b>Field:</b> the value of the field</li><li>• <b>Function:</b> the aggregation summary for the field</li><li>• <b>Suffix:</b> the suffix caption for the field</li><li>• <b>As Title:</b> if selected, this line appears as a title bar in the balloon.</li></ul>

### Map Parameters, continued

Parameter	Description and Values
Heatmap Properties - Value Field	Select the value field by which the heatmap is calculated.
Function	Select the aggregation summary for the field by which the heatmap is calculated.
Start Color	Select a color representing the lowest value of the value field.
End Color	Select a color representing the highest value of the value field. All in-between colors will be assigned values automatically by an even distribution.

### Adding a Map to a Report

You can create a GIS map reflecting the values of a field in a query. This map can be included in a report. When adding a map to a report you must select a GIS-enabled field a map type, as described in the steps below. The map displays in interactive HTML (iHTML) format.

#### To add a map to a report:

1. In the navigation pane, under **Design**, click **Queries** to open the Query Object Editor.
2. Click **Open** to browse to and open an existing query, or, alternatively, create a new query to use in the report. (If creating a new query, specify the query as discussed in ["Designing a New Query" on page 222.](#))
3. In the **Transformation** workspace, click the **Format** step.
4. On the **Properties** tab, select the field to add to the map.
5. In the field details, select **GIS Enabled**. The field that you select must contain GIS classification data such as country names, state, or city names.

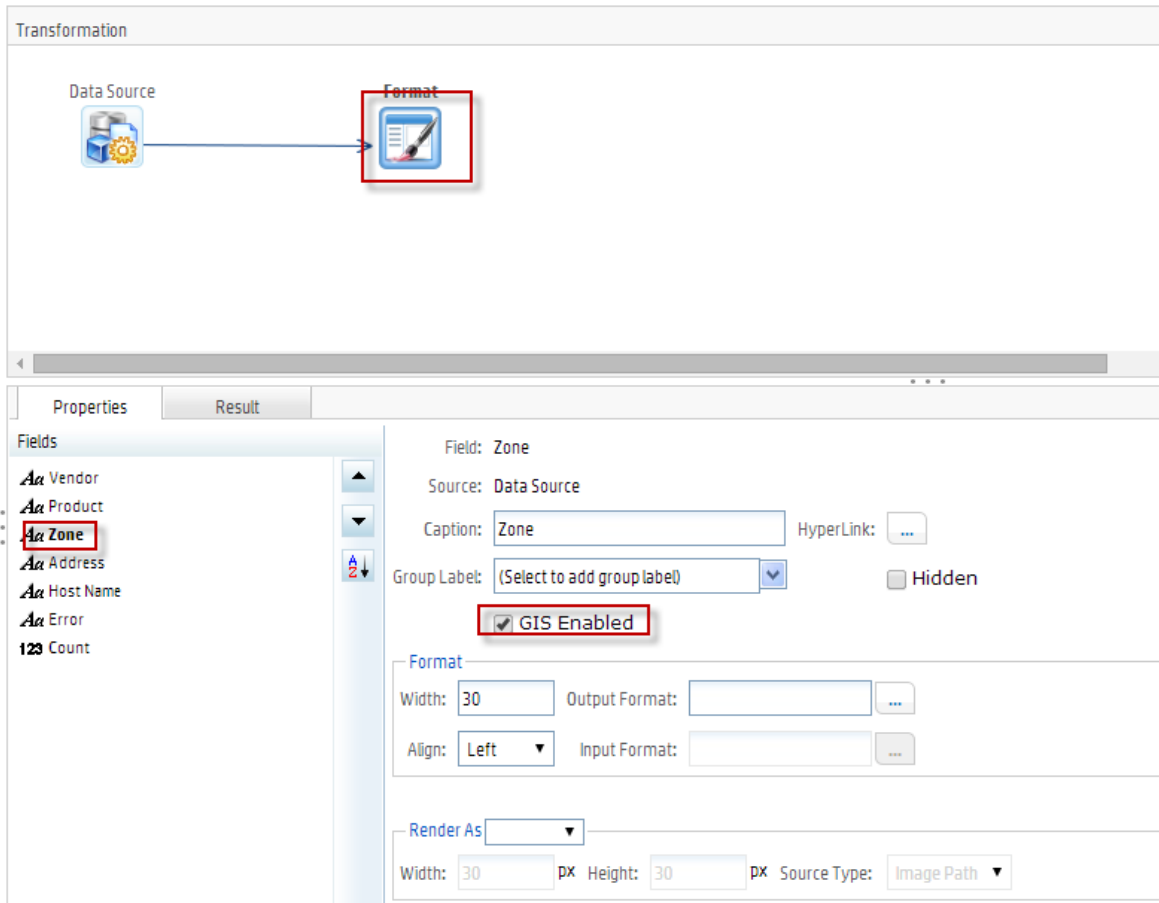

6. In the toolbar, click **Save** to save the modified query object.
7. In the navigation pane, under Design, click **New Report**. The Ad hoc Report Designer opens.
8. In **Data Source**, browse to and select the query object in which you previously GIS enabled the field.
9. Under **Report Settings**, in **Format**, select iHTML from the drop-down list.
10. Click the **Map** tab. 
11. In **Map**, select a map type from the drop-down list.
12. In **Area Field**, select the field you enabled for GIS earlier.

Create Map

Map: World - Countries

Area Field: Zone

Area Attributes: ...

Heatmap Properties

Value Field:

Function:

Start Color: #AFCAFF

End Color: #517CB4

13. Click **Area Attributes**. In the **Attributes** dialog, select a field to display in the information balloon, as described in the table "Map Parameters" on page 213.
14. Under **Heatmap Properties**, in **Value Field**, select the field from which the map is to derive its values from, to populate the map.
15. For **Start** and **End Color**, select two colors from the palette to display the range of values on the map. For example, a lighter color on the map would indicate a lower value, while a darker color would represent a higher value.
16. Make any additional edits to the report as needed, and then run the report.

## Editing a Report

You can use the Report Designer to edit existing user-designed reports. (The supplied reports are not editable.)

### To edit an existing report:

1. Browse to the report in the Report Explorer.
2. In the **Actions** menu, click **Customize Report**. This displays the Report Designer for the selected report.



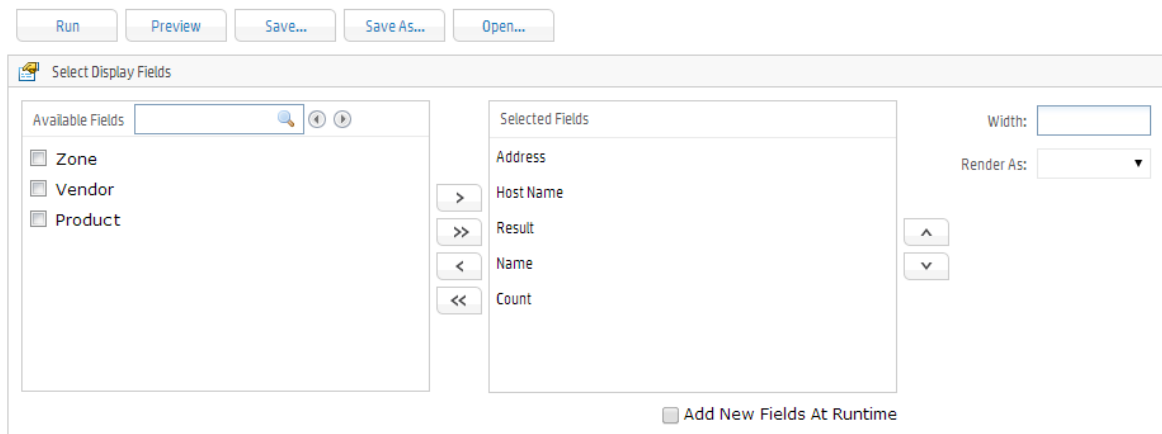

3. Modify the report as needed (using the settings described in ["Creating New Reports" on page 198](#)).
4. (Optional) Before saving the report, you can run it to ensure that the changes you expected in the report output suit your needs. To do so, click **Run**. (For more information see, ["Running a Report While Designing It" below](#)).
5. Click **Save**.

See also ["Quick Start: Base a New Report on an Existing One" on page 198](#).

## Private Reports

If you have access rights to view, run, and schedule all reports, you can create **private** reports. If you do not have permissions to edit a **public** report that you want to modify but you do have permissions to create private reports, then you can save the public report as a private one and edit the private report.

For more about publishing a report as public or private, see ["Publish Report Settings" on page 188](#). For more about access rights for reports, see ["Setting Access Rights on Reports" on the next page](#).

## Running a Report While Designing It

While editing or designing a report in the Ad hoc Report Designer, you can run it before saving it to ensure that the output meets expectations.

### To run a report while designing it:

1. With the report open in the Ad hoc Report Designer, click **Run**.
2. Edit the report parameters as needed.
3. Click **Run Now**. The report is displayed using the parameter values you set.

The Ad hoc Report Designer is useful in adding formatting and display elements to a report definition and viewing the output with those elements before saving the report definition. For example, you can specify a sort pattern or add a chart to a report.

## Setting Access Rights on Reports

Administrators can set access rights on various report categories, reports, and report options (such as view, publish, and edit) based on user roles and Logger Report Group affiliation. For example, you can grant users privileges to view some reports but not others, to view but not schedule or publish a report, or to view and schedule but not edit a report.

Access rights are given at the folder level. If you want to give access only to specific reports, you can put them in their own folder and give access to it. Access rights on report options are configured and managed with the User/Groups option on the Logger System Admin page. For more information on System Admin User/Group management, see ["Setting Logger User Permissions" on page 458](#).

## Determining What Access Rights to Give

When setting access rights for a user or group, be sure to give the user all the necessary permissions. In order to access a particular child node, users need access rights to all higher nodes in that branch of the tree.

To determine the necessary rights for a report, open the report tree to that report.

**Note:** In order to access a particular child node, users need access rights to all higher nodes in that branch of the tree.

### Example: Giving a User Group Access Rights for a Report

Suppose you want to give a Group the rights to view, run, and schedule, but not to change the Attackers reports. To determine the necessary rights, scan the report tree and note the nodes. You will then need to navigate to the System Admin menu to set the rights.

#### **To view Attackers Report tree and determine the necessary rights to access it:**

1. Click **Reports** in the menu bar.
2. Click **Report Explorer** in the **Navigation** section on the left panel.
3. In the **Reports** list, navigate to the group of reports you want to give access to. For the example, click **Foundation > Intrusion Monitoring > Attackers**.
4. In the **Reports** list, navigate to the group of reports you want to give access to. For the example, click **Foundation > Intrusion Monitoring > Attackers**.
5. Make a note of each node you open.

Now that you know the nodes you need to give access rights to, you can set them from the System Admin menu.

### To create a new User Group and give it Logger Reports Rights:

1. Click **System Admin** in the menu bar.
2. Click **Use Management** in the **Users/Groups** section on the left panel.
3. Open the **Groups** tab, and click **Add**.
4. Type in a Name for the group and add a description.
5. Select **Logger Reports** from the Group Type drop down menu.
6. Click the arrow to display the list of Logger Reports Rights.
7. Click **Clear All** to remove all permissions.
8. Click the box next to each permission you want to give the user group.

For the example, you noted Foundation, Intrusion Monitoring, and Attackers, and you wanted to give the rights to view, run, and schedule these reports. Therefore, put a mark in the box next to each of the following access rights:

```
Report folder [Attackers]: view, run, and schedule reports
Report folder [Foundation]: view, run, and schedule reports
Report folder [Intrusion Monitoring]: view, run, and schedule reports
```

9. Click **Save and Edit Membership**.
10. Click **Add** in the **Edit Group Membership** dialog.
11. Put a mark in the box for the user you want to add to the group, and click **OK**.
12. Log in as a member of the group you created and test whether you can perform the desired functions. For the example, the user should be able to view, run, and schedule the Attackers reports only.

## Queries

Query objects (which comprise queries bundled with additional metadata) are used as the basis for designing reports.

**Note:** Some queries may require parameters. We recommend first designing all needed parameter objects before creating the query object that will use those parameter objects.

For information on developing parameter objects, see ["Parameters" on page 233](#).

To view a query object, in the navigation pane, click **Query Explorer**. You can then browse queries by category. Click ► to toggle visibility of each category and drill down. See ["Query Explorer" on page 155](#).

Logger Reporting provides a set of pre-built queries, which are used as the basis for the System-defined Reports and Solutions Reports to address common security use cases (as described in ["The Explorers" on page 150](#)).

### To search for an existing query by name or other criterion:

1. In the navigation pane, under **Design**, click Queries.
2. On the toolbar, click Open.
3. Click **Search**. 
4. In the criteria dialog, select the criteria for your search.
5. Click **Search**. All queries matching your criteria are returned.

For instructions on how to view a list of the default search fields, see ["Default Fields" on page 281](#). For information about custom schema fields added to the default schema, see ["Adding Fields to the Schema" on page 377](#).

You can use a provided query object as is, as the basis for your own reports, or design new query objects on the Query Object List page. You can use existing query objects as a starting point for new ones.

**Note:** Reports that directly invoke SQL queries can use the standard insubnet SQL function as follows: `insubnet( "subnet string", address_column )`

**Caution:** Modifications to reports and other ArcSight-defined content may be overwritten without warning when the content is upgraded. It is not good practice to modify ArcSight-defined content directly.

Make modifications to a copy of any ArcSight-defined content as a general practice, and subsequent upgrades will not affect the modifications.

This topic explains how to design new query objects (either from scratch or based on existing ones).

- [How Search and Report Queries Differ](#) .....220
- [Overview of Query Design Elements](#) .....221
- [Creating a Copy of an Existing Query](#) .....221
- [Designing a New Query](#) .....222

## How Search and Report Queries Differ

Even though a search and a report query both perform the same function (finding events that match specific conditions) the two queries are distinct in these ways:

- You use Logger's Query Object Editor to create a report query.
- You use the Logger's Search UI to create a search query. The query can be specified using plain English keywords, field names, or regular expressions. See ["Searching for Events" on page 102](#) for more information.

However, report queries and field name queries can utilize indexed fields to expedite the underlying search.

## Overview of Query Design Elements

To create a new query object, you need to specify a query name, define a data transformation, and save it. The data source for Logger Report queries is always the Logger databases, so there is no need to specify this as part of the query object.

Optionally, you can specify formulas, set field properties, define transformations, define formatting, define field groups, provide hyperlinking, define lookup values, and build mandatory filtering into the query.

## Creating a Copy of an Existing Query

### To use an existing query object as the basis for a new one:

1. In the **Query Explorer**, click on a category and select the name of the query that you want to copy from the query list.
2. On the **Actions** menu, click **More** to expand the menu.
3. Click **Copy Query Object**.

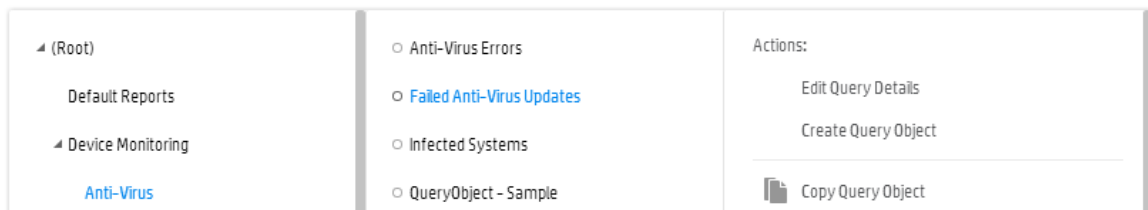

4. In the list of categories, right-click the category name under which you want to place the copied query, and select **Paste**.

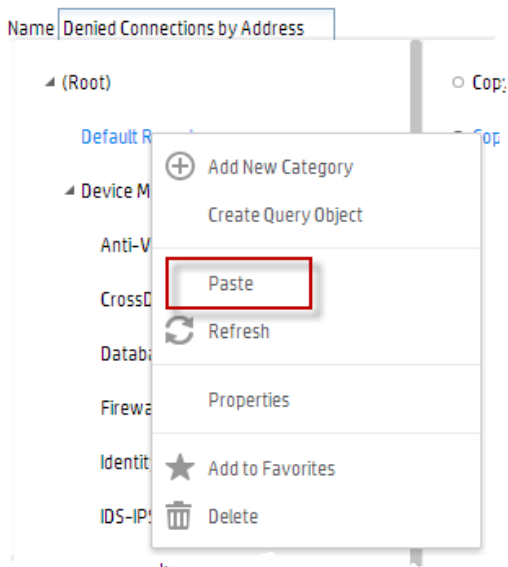

A temporary version of the new query object is created with the same contents as the original and the same name pre-fixed with “Copy of.”

## Designing a New Query

A query object represents a data transformation, which comprises a set of steps (elements) to produce the final output. A step can be a data source, a sort, a filter, an output, or other element. You design a query interactively using the Query Object Editor.

The Query Object Editor is shown here. Highlighted are the **Steps** list and the **Transformation** workspace.

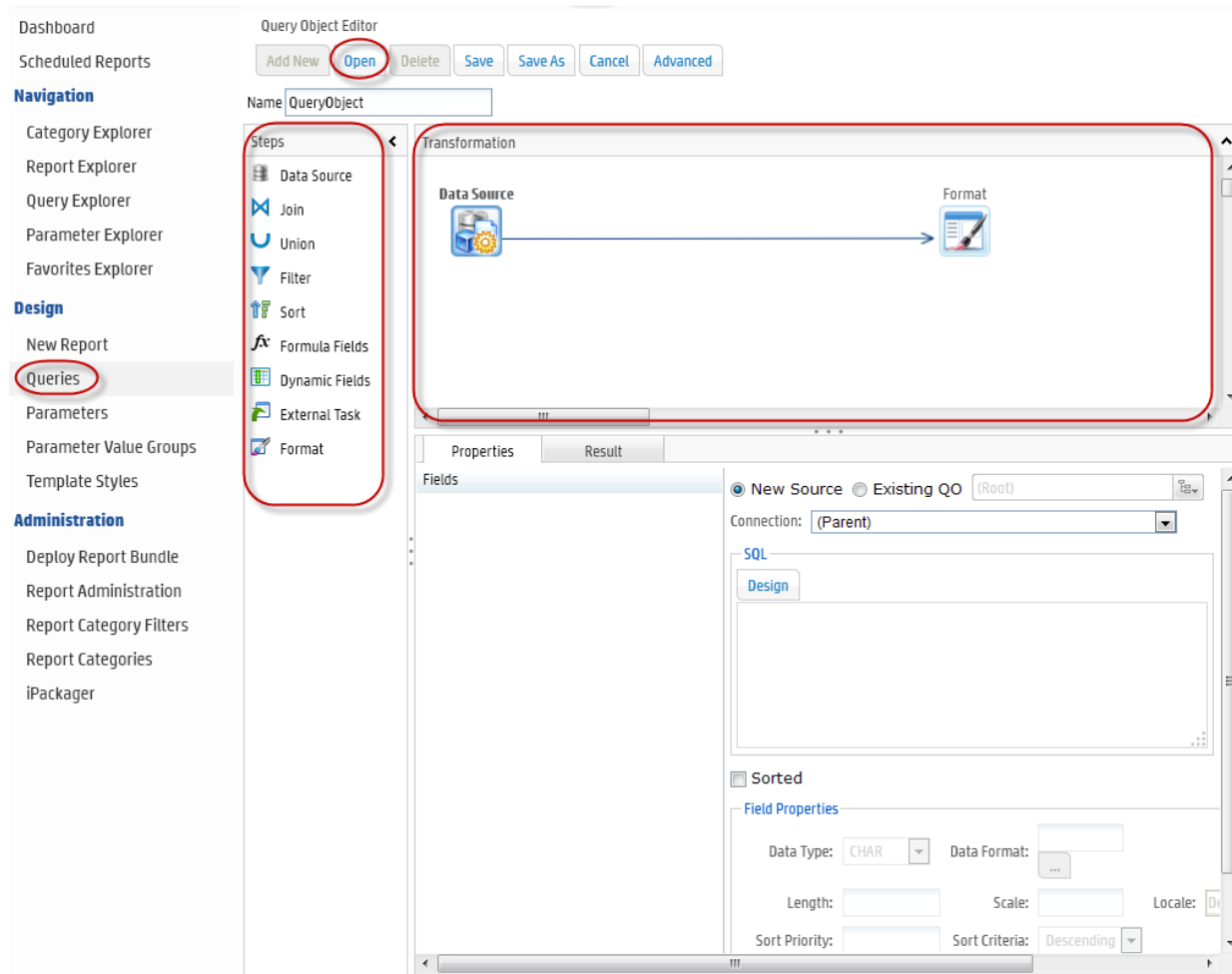

To create a transformation, you drag query elements (steps) from the **Steps** list to the **Transformation** workspace, linking them in the sequence in which they will be evaluated. Then, you specify properties for each Step.

## Working with Steps

- To add a Step to a query, drag it from the list to the **Transformation** workspace.
  - a. To specify properties for a Step, select the Step, then enter values for it in the **Properties** tab. Values for Steps are listed in ["Steps" on page 226](#)
  - b. To see the results of a Step after you've added it, click the **Results** tab.
  - c. To link one Step to another, in the **Transformation** workspace, select the Step. Holding your

mouse button down, drag and draw an arrow (link) to the linked Step.

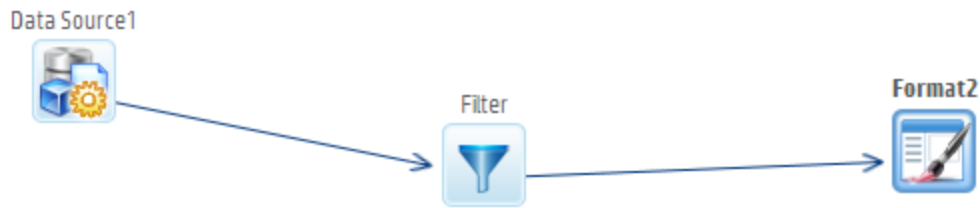

- To add a Step between two linked steps, drag and drop the step on the link.
- To rename a Step, right-click it and choose **Rename Step**. Then enter a new name.
- To delete a link or a Step, right-click on the item, then choose **Delete Link** or **Delete Step**.

## The Query Design Process

You design a query visually in the **Transformation** workspace.

### To design a query:

1. In the navigation menu, under **Design**, click **Queries**. The Query Object Editor opens.
2. In **Name** field, specify a unique name for this query object.

Name

3. In the **Transformation** workspace, drag and drop the required steps for the query from the **Steps** menu into the desired sequence. (By default, the **Transformation** window already includes a Data Source and Format step.)

For example, to add a sort to the transformation, drag a Sort element from the **Step** list to the Transformation field and drop it on a link.



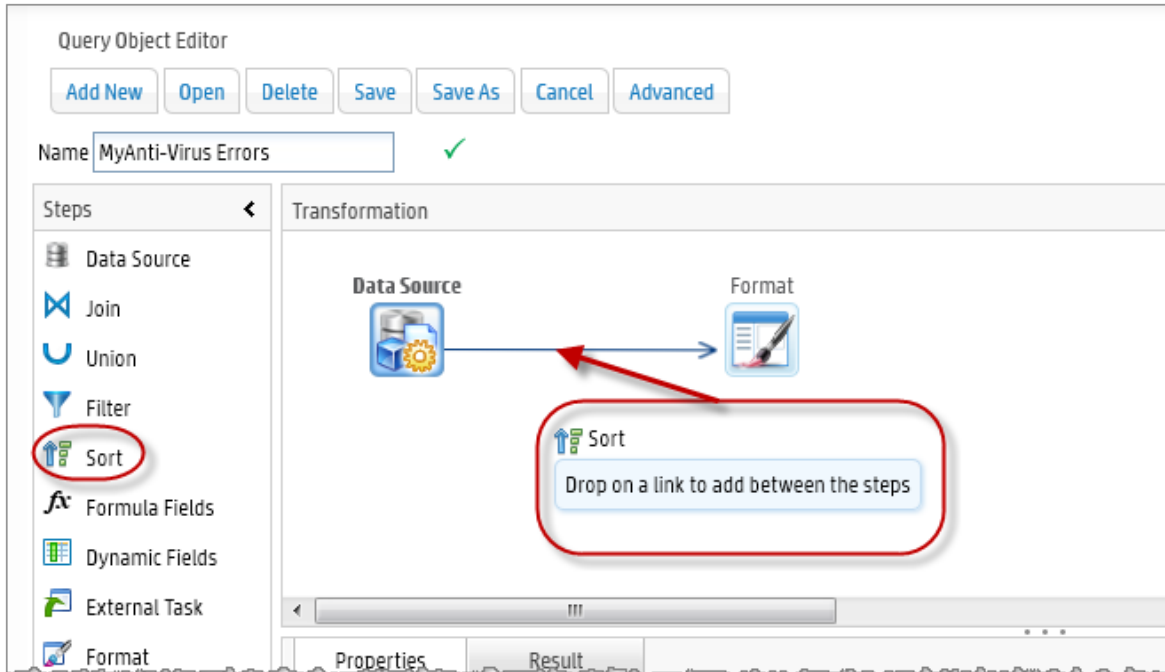

Then, in the **Properties** tab, select a field to sort by.

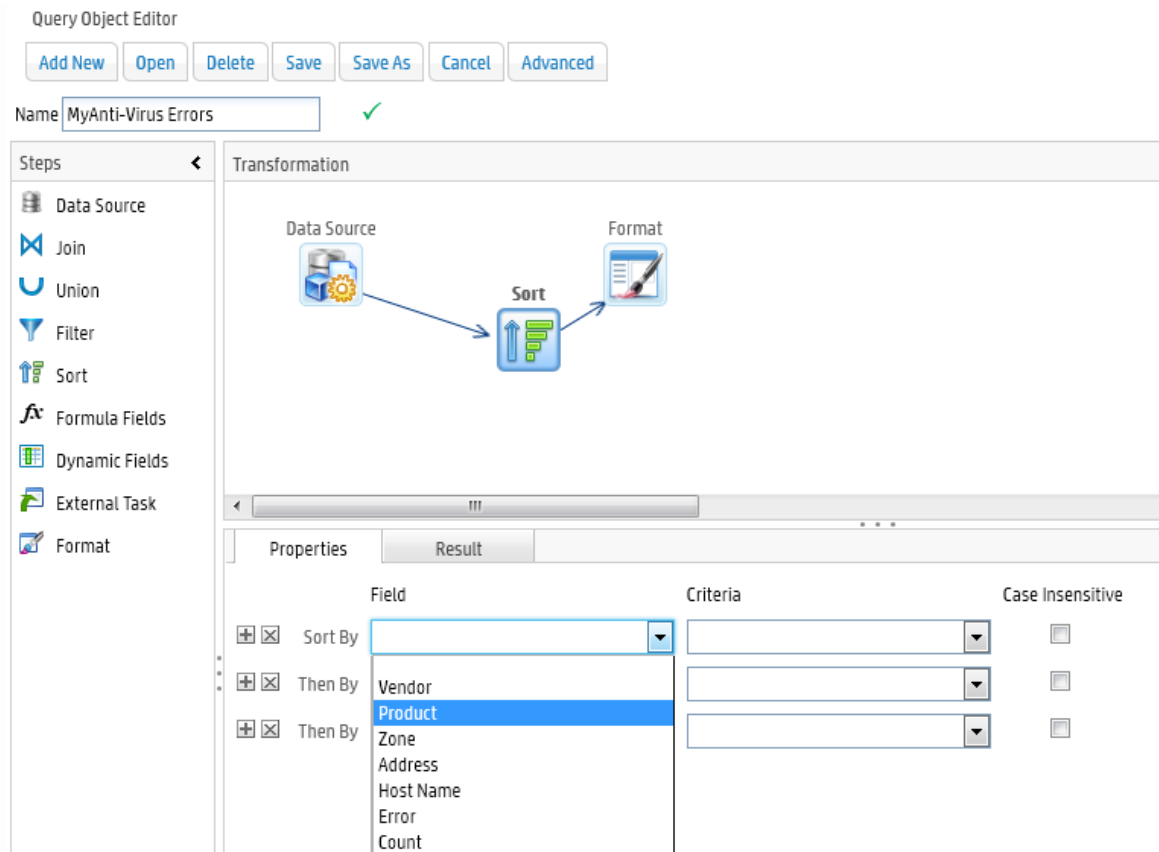

4. Optionally, in the toolbar click **Advanced**, then set any advanced properties for the query object.
5. Click **Save**.

**Note:** A blank (empty) query object is displayed when this page is opened, and the **Add New** button on the toolbar is disabled until the blank query object is saved. After saving, you can add a new query object by clicking **Add New**.

## Steps

A *step* is an element of a transformation, used in the construction of query objects. To use a step, drag it from the **Steps** menu to the **Transformation** window. The behavior of a step depends on the properties you assign to it on the **Properties** tab. You can check the results of a step on the data on the step's **Result** tab.

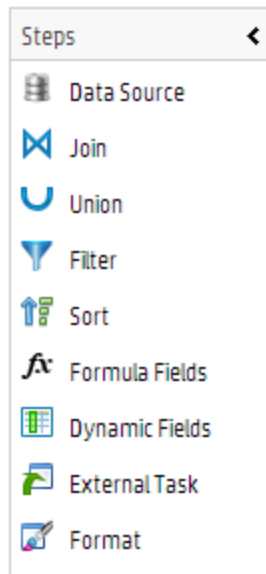

The following steps are available for use in the Query Object Editor:

### Steps

Step	Description
Data Source	Brings data into the query object. You must have at least 1 data source. For more information, see <a href="#">"Data Source Step" on the next page</a> .
Join	Joins two inputs. For more information, see <a href="#">"Join Step" on page 229</a> .
Union	Appends one input to another. For more information, see <a href="#">"Union Step" on page 230</a> .
Filter	Applies pre-defined filters and sets lookup values. For more information, see <a href="#">"Filter Step" on page 230</a> .
Sort	Sets sorting criteria. For more information, see <a href="#">"Sort Step" on page 230</a> .
Formula Fields	Enables addition of calculated fields populated at runtime. For more information, see <a href="#">"Formula Fields Step" on page 231</a> .

## Steps, continued

Step	Description
Dynamic Fields	Add or remove fields to the query object at runtime. For more information, see <a href="#">"Dynamic Fields Step" on page 231.</a>
External Task	Call standard and custom 3rd party procedures. For more information, see <a href="#">"External Task Step" on page 232.</a>
Format	Lists all fields provided by the query object. Generally, the format step is the last one in the transformation workflow. For more information, see <a href="#">"Format Step" on page 232.</a>

## Data Source Step

A Data Source Step brings data into the query object from the Logger database or an existing query object. A query can have multiple Data Source Steps.

The screenshot shows the Transformation tool interface. At the top, a workflow diagram shows a 'Data Source' step followed by a 'Format' step. Below this, the 'Properties' tab is active, showing the configuration for the 'Data Source' step. The 'Fields' list on the left includes: Reporting Device, Type, User Name, Source Zone, Source Address, Source Host Name, Destination Zone, Destination Address, Destination Host Name, Result, and End Time. The main configuration area has 'New Source' selected, with 'Connection' set to '(Parent)'. The 'SQL' tab is active, displaying the following query:

```
SELECT IF( events.arc_categoryDeviceGroup = '/Application', IF( events.arc_categoryObject LIKE '/Host/Application/Database%', '/Database', IF( events.arc_categoryObject = '/IDS/Host/Antivirus', '/Anti-Virus', IFNULL( events.arc_categoryDeviceGroup, '' ) ) ) "Reporting Device", events.arc_name "Type", events.arc_destinationUserName "User Name", events.arc_sourceZoneURI "Source Zone", events.arc_sourceAddress "Source Address",
```

Below the SQL editor, the 'Sorted' checkbox is checked. The 'Field Properties' section shows: Data Type: CHAR, Data Format: (empty), Length: 200, Scale: 0, Locale: Default, Sort Priority: (empty), Sort Criteria: Descending, and a Qualified Name field.

A data source step has the following properties:

### Data Source Step Properties

Property	Description
New Source/ Existing QO	Choose whether to use the Logger database or existing Query Object.
Connection	<p>Select either <i>parent</i> or the name of a connection.</p> <ul style="list-style-type: none"> <li>• <i>Parent</i>: data is fetched from the connection specified at the Query Object level, or falls back to the default connection configured for the user.</li> <li>• <i>Connection name</i>: data is fetched only from the specified connection.</li> </ul>
SQL	<p>A complete SQL statement designed with the SQL Designer. Only visible if the Logger database is the data source.</p> <p>The SQL Designer enables you to design SQL statements by dragging and dropping tables (on the Design tab) or by typing the complete SQL (Edit tab).</p> <p>When using the Query Editor, be sure to use the appropriate SQL syntax for your data type. For example, to call a string data type, you must enclose the string with single quotes, as in the query below.</p> <pre>select arc_deviceVendor from events where lower(arc_deviceVendor) = 'arcsight'</pre>
Sorted	If selected, the data is sorted.
Field Properties	The Field Properties sub-menu (when enabled) allows you to configure the properties of the selected field. See the <a href="#">"Field Properties Sub-menu" below</a> for a description of these properties.

### Field Properties Sub-menu

Property	Values	Comments
Data Type	CHAR, NUMBER, DATE, BINARY	Select the data type of the incoming data.
Data Format	Format String	Specify the format of the incoming data. This is useful only if the Date or IP Address type data are incoming in CHAR fields, but need to be converted to Date and Number types for further use.
Database Time Zone	Select Time zone from the list	<p>Specify the time zone in which the incoming date data is stored. This is useful only if date time data needs to be converted to other time zone data based on reporting requirement.</p> <p>For example when incoming GMT data should be converted to another time zone in the report, specify that the incoming data is <b>GMT</b>. The output format is generally specified in the <a href="#">Format Step</a> or in user preferences.</p>

Property	Values	Comments
Length/Precision	Enter	Enter the length of field for Char data types, and the precision or length of field for the Number data type.
Scale	Enter	Enter the Scale or number of digits after the decimal point.
Locale	Select from menu	Select the language/ country in which the incoming date data is stored.
Sort Priority	Number 0-N	If the data is sorted on multiple fields, then specify the sort priority number of this field. Primary sort field should be the lowest number.
Sort Criteria	Ascending/ Descending	Specify sort as either ascending or descending order.
Qualified Name	Enter	This name helps by providing a field name for SQL clauses such as WHERE and ORDER BY.  It can also be used to resolve field name ambiguity when the same field comes from different tables or expressions.

## Join Step

A Join Step joins two inputs. A Join Step has the following properties:

### Join Step Properties

Property	Description
Select All Fields	If enabled, all fields from both sources will be available in the output of this step. If deselected, you can select which fields will be available in the output.
Join Type	Select from one of the following join types: <ul style="list-style-type: none"> <li>• Inner Join</li> <li>• Left Outer</li> <li>• Right Outer</li> <li>• Full Outer</li> </ul>
Join Conditions	Forms the Join Key.

## Union Step

A Union Step appends one input to another. A Union Step has the following properties:

### Union Step Properties

Property	Description
Union Type	Select either Sorted or Unsorted.
Remove Duplicate Rows	If selected, each row in the result will be distinct.
Column	Enter the name of a column. Click to rename the column. Click to add a column Click to delete the column.

## Filter Step

A Filter step will apply pre-defined filters and set lookup values. A Filter step has the following properties:

### Filter Step Properties

Property	Description
Ad hoc filters	To apply one or more ad hoc filters, under <b>Select Filter Criteria</b> , enter the <b>Field Name, Criteria</b> , and <b>Value</b> . Click <b>+</b> to add more filters or click <b>X</b> to delete one.
Lookup Values	If enabled, a list of lookup values is provided to the end user to easily choose values to apply a filter.
Mandatory	If enabled, then any reports using this Query Object must apply the filter on the selected field.
Hide	If enabled, the field will be hidden from the end user in the list of fields that can be filtered on.

## Sort Step

A Sort step sets sorting criteria. A Sort step has the following properties:

### Sort Step Properties

Property	Description
Field	Select a field from the list on which to sort. You can add multiple fields for the sort using <b>Sort by</b> and <b>Then by</b> lines.
Criteria	Sorting criteria, either ascending or descending order.

### Sort Step Properties, continued

Property	Description
Case Insensitive	If enabled, then case is ignored for sorting. (ABC would be the same level as abc).
Hide	If enabled, the field not be seen by the end user in the list of fields that can be filtered on.

### Formula Fields Step

A Formula Fields step enables you to add calculated fields populated at run time. These calculated fields are generally based on existing fields.

To add a formula field, click **+**. Then specify values for the field as follows:

#### Formula Fields Properties

Property	Description
Name	Name and caption of the field.
Return Type	Data type of the formula field (Number, Char, or Date).
Length/ Precision	<ul style="list-style-type: none"> <li>Length of field for Char data type</li> <li>Precision or length of field for Number data type.</li> </ul>
Scale	Scale or number of digits after decimal point.
Formula	<p>Formula, using JavaScript syntax. To create a formula, you can use field names and define variables.</p> <ul style="list-style-type: none"> <li>A formula can include an if construct as well as nested if and logical operators.</li> <li>To include more than one statement in a formula, use a semicolon (;) to separate them.</li> </ul> <p>Example: For a formula field named TotalAmount,</p> <pre>var total ; if (unitprice &lt; 10 ) {total = unitprice*quantity;} else {total = unitprice;} TotalAmount = total;</pre>

### Dynamic Fields Step

A Dynamic Fields step can add fields to, or remove fields from, a query object at runtime. Dynamic fields can be added by pivoting data from a single data source, or dynamically fetching metadata for field properties.

- **Dynamic Mapping** takes each field from the metadata result set and maps it to Query Object Field Properties. The primary mappings are **Field ID**, **Field Name**, **Caption**, and **Data Type**.
- **Pivoting** converts normalized, name-value paired data into flattened tabular data. The Pivot tab includes these fields.

- **Pivot Columns:** specifies which column has field ID and which column has value.
- **Select Grouping:** specifies grouping fields, which when grouped on, the normalized data converts to a flat table.

## External Task Step

An external task step enabled you to call standard and custom third-party processes. Logger includes the following pre-configured external tasks:

- **Java Row Processor:** for processing of Java rows
- **R Job:** for R Analytics Server scripts (See the table "[R Job Parameters](#)" below for the properties)
- **Hive Job:** for Hive scripts
- **Pig Job:** for Pig scripts
- **Custom Map Reduce Job:** for custom map reduce scripts

### R Job Parameters

Property	Description
Server IP	IP address of R server
Plot Type	If Format Type is an image format, select a plot type from the drop-down list
Format Type	Select a format type
Model File	Location of the R model file
No. of Images	If Format Type is an image format, enter the number of images in the output
Script	R script file name
Validate	Click to validate the R job

## Format Step

A Format Step is the last step in the workflow, and lists all fields provided by the Query Object. A Format Step includes these parameters:

### Format Step Parameters

Property	Description
Field	Original name of field.
Source	Step in which this field originated.
Caption	The end user will see the field by this name.
Hyperlink	Drilldown detail or hyperlink URL.



### Format Step Parameters, continued

Property	Description
Group Label	To assign this field to an existing group, select the group name from the drop-down list. To create a new group, type the new group name.
Hidden	If selected, the field will be invisible to users for the reporting process.
GIS Enabled	The selected field must contain GIS classification data such as country names, state, or city names. A GIS Enabled field will appear in the selection list for the grouping option in the <b>GIS Mapping</b> dialog and the <b>Area</b> field and the <b>Heat Map Properties &gt; Value</b> fields on the <b>Create Map</b> dialog. For more information, see <a href="#">"Map" on page 213</a> .
<b>Format properties</b>	
Width	The default width of this field when dragged onto a report. Valid values 1-100.
Output Format	Enter a format string. The field value will be formatted using the format string. Useful for date and number formatting. (If you need to decide the format string at runtime, select <b>Apply Locale Default</b> .)
Align	Field alignment (left, center, right) when assigned to a report.
Input Format	Enter a format string. The string determines the prompting format for the value of this field in Ad hoc filters. Useful in prompting date or IP values in the desired format.
User Time Zone	Time zone for the display of report data. The Report Server calculates the difference between Database Time Zone and User Time Zone, and does time conversion. To decide time zone at runtime, select <code>SYS_USER_TZ</code> .

#### To define a Format Step:

1. From the **Fields** list, select the field for which you want to define an input format. (The selected field is bold.)
2. Select the appropriate format and provide necessary values for that format.

#### To designate a mandatory filtering field:

From the **Fields** list, select a field you want as a mandatory filtering field.

Click the **Mandatory** checkbox to the right of the Fields list.

Other fields can be selected or deselected using the **Mandatory** checkbox.

## Parameters

Reports retrieve data by running pre-built query objects. If a query needs a value at report run time, it uses built-in, run-time parameters. At report run time, the user is prompted to provide values for run-time parameters as a prerequisite for running the report. The report is then generated based on the user-provided values for those parameters.

Parameters are stored on the server, and therefore can be used in one or more report and query objects.

**Note:** We recommend first designing all needed parameter objects before creating the query object that will use those parameter objects. (For information on creating queries, see "Queries" on page 219.)

- [Parameter Object Editor](#) .....234
- [Configuring Parameter Value Groups](#) .....240

## Parameter Object Editor

To view and work with Logger Report parameters, under **Design**, click **Parameters** in the Reports left pane or click **Parameter Explorer** and click on a category, select a parameter, and click the **Edit Parameter Details** button to open the Parameter Object Editor.

- [Creating New Parameters](#) ..... 235
- [Modifying a Parameter](#) ..... 239
- [Deleting a Parameter](#) .....239

## Creating New Parameters

### To create a new parameter:

1. In the Parameter Object Editor, click the **Add New** button located at the top left.
2. Specify values for the new parameter. (Details are given in the topics below.)

**Caution:** The parameter name must be unique amongst all parameters in the system.

3. After providing all required values, click **Save**.
4. The parameter is added to the Parameters list.

**Note:** A blank (empty) parameter object is displayed when this page is opened, and the **Add New** button on the toolbar is disabled until the blank parameter object is saved. After saving, you can add a new parameter object by clicking **Add New**.

## Setting Parameter Name, Data Type, and Default Values

Specify the parameter unique ID, display name, data type, size, format, and default value as described in the table below.

### Parameter Name, Data Type, and Default Values

Option	Description
Name	Provide a name to uniquely identify this parameter. This name should be unique amongst all parameters in the system.
Prompt	Parameter name displayed to the user at report run time.
Data Type	Specify type of value the user must provide at report run time: <ul style="list-style-type: none"><li>• CHAR - Value may include alphabetical characters, numbers and special characters.</li><li>• NUMBER - Value may include digits and decimal points</li><li>• DATE - A date or part of a date, like day, month, or year</li><li>• BOOLEAN (For more information, see <a href="#">"Setting up Boolean Parameters" on page 237.</a>)</li></ul>

### Parameter Name, Data Type, and Default Values, continued

Option	Description
Size	<p>Specify number of characters or digits this parameter should accept.</p> <p><b>Note:</b> This is only applicable to CHAR and NUMBER data types, not for BOOLEAN or DATE parameters.</p>
Format	<p>Select the appropriate format in which user should provide value for this parameter. Click  to open a <b>Data Format</b> dialog box. Based on the format you have selected, a format string is displayed in the entry box.</p>
Default Value	<p>Specify a default value that is appropriate in most cases to provide for this parameter at report run time.</p> <p>The default value will be automatically selected at report run time. The user can change the default value, if needed. If the user does not change it, the report will run using the default value you specify here for this parameter.</p>

### Default Value for Date Type Parameter

For a date type parameter, the **Default Value** field provides a pull-down menu and a calendar. Click the calendar icon  to provide an explicit date, or select one of these dynamic variable values from the pull-down menu:

- CURRENT\_DATE
- MONTH\_START\_DATE
- YEAR\_START\_DATE

You can also set a default date that is *relative* to any of the above three dynamic variable dates.

For example, to set a default date as 3 days after CURRENT\_DATE, specify  
CURRENT\_DATE + 3.

To set a default date as 5 days before MONTH\_START\_DATE, specify  
MONTH\_START\_DATE - 5.

To provide a value that is relative to a dynamic variable, select one of the dynamic variables, then type a suffix to it in the Default Value field by adding + or - and the number.

At report run time, a parameter with a Date format will display with the default date set here.

## Defining Input Type

The parameter *input type* describes the style of interface provided to users at report run time in which to enter a value for this parameter. Choose from **Text Box**, **Combo**, or **Option** as described below.

**Note:** In the Reports Designer, changing the parameter type TextBox to another type causes an error. If you need to change the parameter type to TextBox, do not edit an existing parameter, delete that parameter and add a new one.

### Input Type

Option	Description
Text Box	Select <b>Text Box</b> input type if you want the user to type the value for the parameter.
Combo	Select <b>Combo</b> if you want the user to select one value or multiple values from a pull-down menu. Select the <b>Multi Select</b> checkbox so that user can select multiple values from the box. See " <a href="#">Setting Multiple Default Values</a> " on page 239 to configure other settings for this option.
Option	Select <b>Option</b> if you want the user to select values represented as options. Select the <b>Multi Select</b> checkbox to have value options in the form of checkboxes. Keep the <b>Multi Select</b> checkbox deselected to have options in the form of radio buttons.

## Setting up Boolean Parameters

Parameters that have a Boolean data type are represented to the user as checkboxes (the input type) and have only two states:

- Checked (chosen at run time)
- Unchecked (deselected at run time)

### To set up a BOOLEAN parameter:

1. Select **Data Type** as BOOLEAN.
2. In the **Values** area, select an option:
  - a. **Checked:** Specify the value to be passed when the user selects this option at run time.
  - b. **Unchecked:** Specify the value to be passed when the user does not select this option at run time.

## Setting Various Run Time Behaviors

You can specify a variety of options on how the parameter will look and act at report run time. These options are generally related to the input type, and further define acceptable user input values, whether the parameter will be displayed or hidden, which values can be searched, and so forth.

## Parameter Options

Option	Description
Mandatory	Select this checkbox if you want to require the user to specify a value for this parameter at report run time.
Visible	Select this checkbox if you want the parameter to be displayed on the input form at report run time.  Keep this deselected if the value for this parameter is populated from another report or if you want the parameter to use the default value in all cases.
Restrict to List	This setting is applicable for parameters with Input Type of <b>Combo</b> . select the <b>Restrict to List</b> checkbox here to force user input of a parameter value from the available run-time options only.  If <b>Restrict to List</b> is <i>not selected</i> in the parameter definition you create here, the user can specify a value or can select values from available options.
Pass Values Using Tables	This setting is applicable for <b>Multi Select</b> . Select this checkbox when you want to pass parameter values through a table. This is done especially when the number of values that can be passed (total number of bytes of selected values) as part of the SQL is more than allowed.
Enable	
Forced	Select this checkbox if you want to restrict parameter values to a pre-specified list of values.

## Setting the Data Source List

Specify values for **Check box**, **Combo**, and **Option** input type. Values can be predefined only.

### To Set Predefined Values:

1. In the **Display Name** field, specify the value to be displayed to the user at run time.
2. In the **Value** field, specify the value to pass as a filter.
3. Click  (**Add**) to add the display name to the list.

(To delete an option from the list, select the value and click .)

4. Repeat these steps for each option.
5. Select the **Display Parameter Name** checkbox if you want to provide the user with the option of adding the parameter as a control on a report.

Once selected, the **Display Parameter Name** field is auto-filled with the parameter display name that can be selected for use on a report. The name displayed on the report is the one specified in the **Prompt** field.

**Tip:** The **Display Parameter Name** settings have no effect when the Parameter Object is used in an ad hoc report.

## Setting Multiple Default Values

If you selected **Combo** Input Type (as described in ["Defining Input Type" on page 237](#)), you need to define the following settings in the Parameter editor:

- **Maximum Selectable Values:** Specify the maximum number of values that can be selected or provided for a parameter.
- **Enclosed By:** Specify the character to use to enclose the set of values. This will depend on the database.
- **Separator:** Specify the character to use to separate the two values. This will depend on the database.
- **Select Default Values:** Specify the number of default values to display at report run time. You can choose from the following:
  - a. **Selected:** Only values for the selected parameters are displayed.
  - b. **All:** Values for all parameters are displayed.
  - c. **None:** No default values are defined.

## Modifying a Parameter

### To modify a parameter:

1. On the **Reports** right panel menu, click **Parameter Explorer** to display the Parameter Object list.
2. Browse to the parameter you want to modify.
3. In the **Actions** menu, click **Edit Parameter Details**.
4. Edit the parameter as needed (using the settings described in ["Creating New Parameters" on page 235](#)) and click **Save**.

**Note:** Only custom parameters can be modified, not supplied parameters, since supplied parameters are required for use in system Reports and Solution pack add-ons.

## Deleting a Parameter

### To delete a parameter:

1. On the **Reports** left panel, click **Parameter Explorer** to display the Parameters Object list.
2. Browse to the parameter you want to modify.
3. In the **Actions** menu, click **Delete**.
4. Click **Yes** to confirm deletion.

**Note:** Only custom parameters can be removed, not supplied parameters, since supplied

parameters are required for use in foundation Reports and Solution pack add-ons.

## Configuring Parameter Value Groups

Some reports may require users to provide multiple run-time values that would be easier to select if they were grouped. For example, a report that requires a user to select more than one country name might be a good candidate for parameter value groups. Users might find it difficult to select a few country names from a single, long list of countries.

As an alternative, the query designer could create parameter value groups for the Americas, Europe, Asia, Africa, and so forth. Each parameter value group would contain lists of countries belonging to those continents or areas. At report run time, when the user selects a group, values belonging to the group are pre-selected. Users do not have to manually select countries in parameter groups for every report run. Selections are saved from one report run to the next.

Using parameter value groups as a part of your query design strategy can save users time and reduce error at report run time.

To view and work with Logger Report parameter value groups, under **Design**, click **Parameter Value Groups** on the Reports left panel.

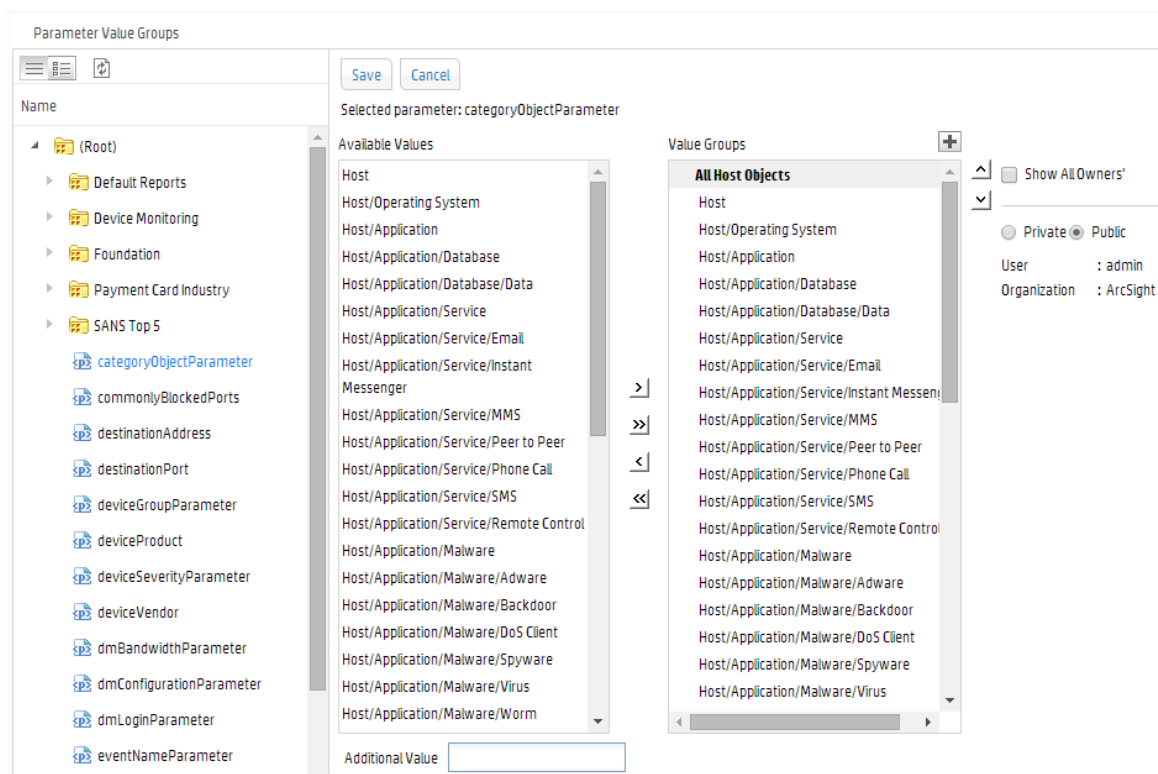





The following table describes the options on the **Parameter Value Groups** page.



### Parameter Value Groups





Option	Description
Name	Lists all the parameter objects.
Available Values	Lists available values for the selected parameter.
Value Groups	Lists groups created and the values selected within a group. An icon is displayed on the left of a Private group.
Show All Owners	If selected, displays groups created by all users.
Option buttons: Private Public	Select <b>Private</b> to list the groups you have set for you only. Select <b>Public</b> if you wish to list the groups you have set for everyone.

### To create a group:

1. Click  (Add Group) next to the **Value Groups** box. A group is created and listed under Value Groups with a default name (based on the currently selected parameter in Parameters list).
2. In the Value Groups list, edit the new group name as needed. (Double-click the name to edit it, if it is not already in edit mode.) Double-click the name again to set it, or click outside the box.
3. Add the values you want in the group by selecting a value in **Available Values** list and clicking  (Add value to selected group) button. The selected value is added to the selected group in the Value Groups list.
4. Repeat the previous step for each value you want to add to the group.

If a value that you want to add to a group is not listed in Available Values list, specify the value in **Additional Value** field (under Available Values) press Return key. The custom value is added to the currently selected group.



Select an Available Value and click  to add all the values to the selected group in Value Groups, click  to remove the selected value from Value Groups, and click  to remove all the values from Value Groups box.

Select a group and click up  and down  arrows to move the selected group up or down. Select a value and click up  and down  arrows to move the selected value up or down (within the group).

5. Click **Save**.

**Note:** If the name of a group is changed by a user, the values under that group will be removed from the **Selected Values** group of that user's preferences.

### To create a tree view parameter:

1. Click the leaf node and click the right arrow  button.
  - To select all values in a branch (only for a multi-select parameter), click the branch and click the  button.
  - To make changes in name of a group, double-click the group name to make it editable. Specify a new name and click outside the box.
  - To delete a group, click  in the title of group you want to delete, and then click the **Save** button to save the changes.

## Template Styles

Logger reports use a style file (.sty) to generate report output in a specified format. The style file defines the look and feel, arrangement, and orientation of the report output.

You can modify any of the style files from the Logger Reports Template Styles page or you can define a new style to suit your needs.

**Note:** A report layout file (.in1) defines factors like paper size, static controls, and headers and footers to include in a report. You can define your own layout files. See ["Defining a New Template" on the next page](#) for more information.

To view and work with Logger Report template styles, under Design, click **Template Styles** on the Reports left menu bar.

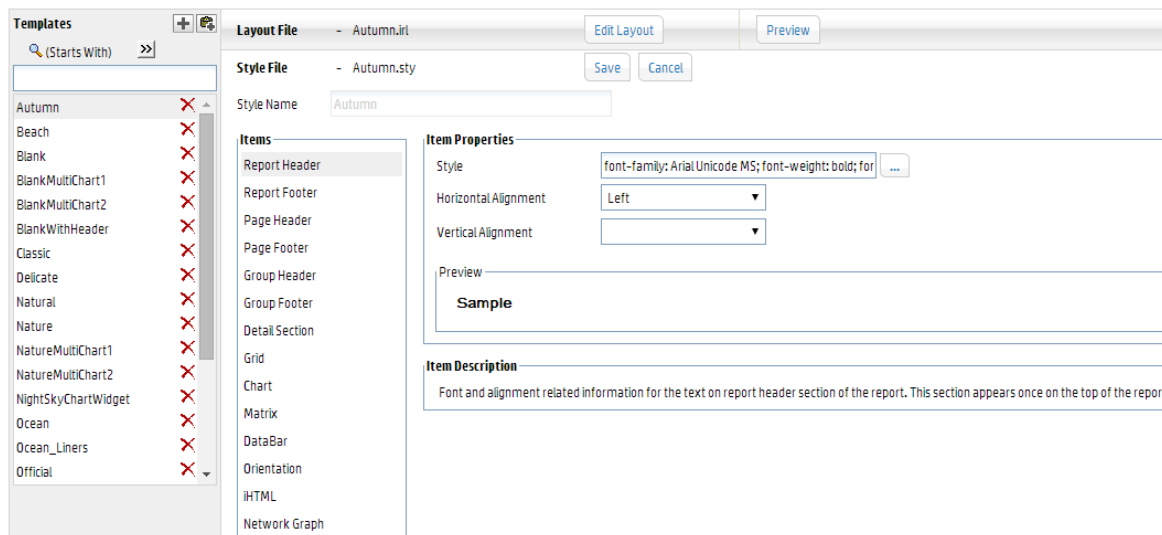

## Defining a New Template

Before creating a new template, you may want to check whether there is an existing one that meets your needs.

To search for an existing template, do one of the following:

- Enter the first few letters with which the template name begins (if the **Starts With** search criteria is selected) in the text box above the list of existing templates.
- Enter a word or part of a word that the template name contains (if the **Contains** search criteria is selected) in the text box above the list of existing templates.

### To define a new template:

1. Under Design, click **Template Styles** on the Reports left menu bar.
2. Click the  icon in the right panel.
3. Define the Items and Item Properties for the template.
4. If you want to define or change the report layout file, click **Edit Layout**.

**Tip:** You will need to edit the layout of the report to include a header or footer in a report. After clicking Edit Layout, click “Report Header” (to include a header) or “Page Footer” (to include a footer) to select that section. Click **Insert > Layout Control >** *select an option from the sub-menu.*

5. Click **Save**.

## Administration

This section discusses Logger report administration. It discusses how to deploy report bundles, configure report server settings, administer report categories and category filters, and manage report packages.

## Deploying a Report Bundle

You might obtain additional sets of reports from ArcSight to address new security scenarios, add packaged solutions, or enhance your current coverage with updated reports. You can use the **Deploy Report Bundle** page to load and deploy packages of new reports onto your Logger system.

On the **Reports** page left panel menu, click the **Deploy Repository Bundle** link to start.

Deploy Repository Bundle

Step 1:(Upload & View Cab Information)

Step 2:(Deploy Objects On Report Server)

A report package (or CAB file) can contain several types of reporting resources, including:

- Categories and reports
- Organization information
- Portal properties and server properties
- Parameter objects
- Query objects
- Ad hoc report templates
- Printer settings
- Database connections

### To upload and deploy report package:

1. In the entry box provided under Step 1, specify the reports package file name and with its full path. Click **Browse** to locate the file.
2. Click **Upload**.  
The content is uploaded and information is displayed about the included categories and reports. (A legend is provided below these steps).
3. If you want to create log of the deployment process, select the **Create Log File** option.
4. Click **Deploy** to continue with the deployment process, or click **Cancel** to discontinue with deployment process.)

Status information is displayed about the objects in the package being deployed.

A legend is displayed just below the **Deploy** button. Information about each of the components in the package is displayed in respective tabs.

**Note:** Overwrite behaviors are determined when the package was created.

For example, protocol on whether or not an object in the deployed package will overwrite an existing object on the system, and under what circumstances, is determined at package creation time. Therefore, these settings on package deployment are not available to you at

deploy time.

A log file will be created if the **Create Log File** checkbox was selected.

The content of the deployed reports package is available on the respective Logger Reports pages.

Solution Reports will be listed under **Solution Reports** on the left panel menu. For more information about these types of reports, see ["Solution Reports" on page 160](#).

## Report Server Administration

Logger Reporting provides a default configuration for the report server. If you do not modify the report server, reports will run with the default settings.

### Timeouts when Running Reports

There are two timeouts that can affect long running reports.

- The *client timeout* is 1 hour. If an ad hoc report takes more than an hour to run, it will time out. Use a scheduled report instead.
- The *default database connection timeout* for scheduled reports is 4 hours. If a scheduled report takes more than 4 hours to run, you can increase the database connection timeout from the Report Configuration pane.

## Report Configuration

### To view or modify the report server configuration:

1. Click **Reports** in the navigation bar.
2. Click **Report Administration** under Administration. The **Report Configuration** dialog is displayed.

Report Configuration

Database Connection TimeOut (seconds) i

Data Source Fetch Size (rows per fetch)

Log Level

SMTP Server

E-Mail From Address

Job Error Mail To

Host URL

Sign Document  [Manage Certificates](#)

Sign Document Formats

Sign Document Operations

Sign Document On Page

Sign Document Location Corner

3. When you have finished entering the report configuration settings, click **Save**.

The following table describes the report configuration settings.

### Report Configuration

Option	Description
Database Connection Timeout (seconds)	<p>Time in seconds after which the database connection will be closed, if not used for that many seconds.</p> <p>Valid values include any integer greater than zero.</p> <p>Default: <b>14400</b></p> <p>Example: If DATABASE_CONNECTION_TIMEOUT is set to 50, the report server will close the connection to a database if there is no communication between the report server and database server for 50 seconds.</p>
Data Source Fetch Size (rows per fetch)	<p>Specifies the number of records to be fetched from the data source at one time (in one "read").</p> <p>A valid value is any positive integer.</p> <p>Default: <b>50</b></p> <p>Example: DATA_SOURCE_FETCH_SIZE=50</p>

### Report Configuration, continued

Option	Description
Log Level	<p>Sets the level of criticality to be considered for logging.</p> <p>Valid values are DEBUG, INFO, WARN, ERROR, FATAL.</p> <p>Default: <b>ERROR</b></p> <p>Example: LOG_LEVEL=ERROR</p>
SMTP Server	<p>Sets the server IP address or domain name (as IP or URL) used to email scheduled reports. All email communications, such as notifications and report delivery, are sent by Logger Reporting using this email server.</p> <p>Example: SMTP_SERVER=127.0.0.1</p> <p>For information on Logger's SMTP settings, see <a href="#">"SMTP" on page 413</a>.</p>
Email from Address	<p>Sets the sender's address in emails originating from the Logger Reporting system.</p> <p>Example: loggeradmin@companyxyz.com</p>
Job Error Mail To	<p>Email address to receive job error messages, when generated. To include multiple addresses, separate them by commas.</p>
Host URL	<p>Host URL (URL to the Logger application) sent as part of Logger Reporting Emails.</p> <p>Syntax: HOST_URL=[Host URL](String)</p> <p>Default: <b>https://&lt;logger_hostname&gt;/logger/report</b></p> <p>Example: HOST_URL=https://loggerA.xyz.com/logger/report</p>
Sign Document	<p>Enable or disable the digital signing of reports. Options are Enable and Disable.</p> <p>Default is <b>Disable</b>.</p> <p>An administrator with correct permissions can browse and upload signature files. This can be done at global, organization or user level. When the Sign Document property is enabled, then these signatures are applied to the documents. See <a href="#">"Certificates" on page 342</a>.</p>
Sign Document Formats	<p>Currently, <b>PDF</b> is the only supported format for signatures.</p>
Sign Document Operations	<p>Enter what types of report operations should have a signature applied. Options are View, Email, Publish, Upload, Print, or All.</p> <p>Default is <b>ALL</b></p>
Sign Document on Page	<p>Choose on which page the signature should appear. Options are First and Last.</p> <p>Default is <b>Last</b>.</p>
Sign Document Location Corner	<p>Choose on which page corner the signature should appear. Options are Right Top, Right Bottom, Left Top, Left Bottom.</p> <p>Default is <b>Left Bottom</b>.</p>

## Report Categories

The Category Explorer comes with some System-defined commonly used categories. You can edit them as needed.

### To navigate to an existing report category:

1. Click **Reports** on the top-level menu bar.
2. Click **Report Categories** in the **Administration** section in the left pane. The **Deploy Reports and Categories** displays available categories.

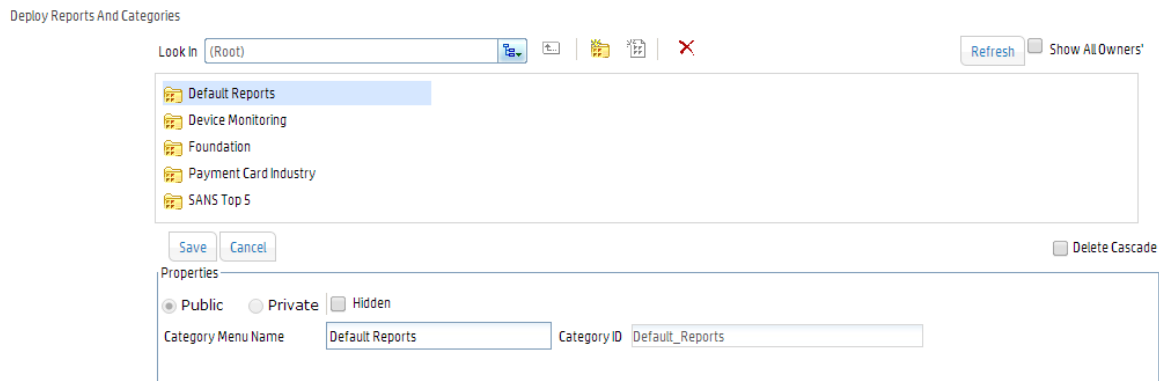

3. Click the navigation tree button (  ) next to the **Look In** field, and navigate through the tree to the desired location.

For this example, navigate to **Root > Foundation** and double click **Intrusion Monitoring**.

The **Deploy Reports and Categories** dialog displays the subcategories and reports in that category.

4. Click the report you want to access.

For this example, click **Device Interface Down Notifications**.

The **Deploy Reports and Categories** dialog displays the properties and Default output format of the report you selected.

## Adding a New Category

In addition to using the existing report categories, you can create additional categories to meet your business needs.

### To add a custom category:

1. Click **Report Categories** in the **Administration** section in the left pane.  
The Deploy Reports and Categories displays the available categories. A toolbar across the top of the page displays buttons for the available actions.



2. Click **Add New Category** .
3. Define the properties for the new category and click the **Save** button.

Property	Used for...
Public	Setting this as <b>Public</b> makes the category available to everyone
Private	Setting this as <b>Private</b> make the category available to you only
Hidden	Select the <b>Hidden</b> checkbox to hide the display of this category in the Report Explorer. It will still be displayed in other Explorers.
Category Menu Name	Name of the Category
Category ID	<b>Category ID</b> should be unique across all the categories. By default, the Category ID is auto-generated by the system. To specify the Category ID manually, deselect the <b>System Generated</b> checkbox and specify the category ID.
System Generated	To specify the Category ID manually, deselect the <b>System Generated</b> checkbox and specify the category ID.
Delete Cascade	You can delete a category only if it is empty. To delete a category including its contents, check the <b>Delete Cascade</b> checkbox.

**Note:** Once set, Category ID and scope (Public / Private options) cannot be changed.

4. You can optionally add a report to the category. To do so, double-click any category to open it and click the **Add New Report**  button. Define the following properties in the Properties box:



Property	Used for...
Public	Setting this as <b>Public</b> makes the report available to everyone
Private	Setting this as <b>Private</b> make the report available to you only
Hidden	Check the <b>Hidden</b> checkbox, if you do not want to display this report in any of the dialogs and pages (except in the Report Explorer). Mark a report as hidden to stop users from directly accessing it.
Report File	An existing data file from which a report is generated. See <a href="#">"Report File Formats" on page 187</a> .
Report Name	The <b>Report Name</b> has to be unique within a category
Report ID	A unique ID for the report that is auto-generated by the system by default when you run and publish the report. To manually enter an ID of your choice, deselect the <b>System Generated</b> checkbox and enter an ID in the <b>Report ID</b> field.
Design Mode	Text in <b>Design Mode</b> indicates if the report was designed using Studio (Web Studio or Desktop Studio) or ad hoc Report Wizard.

Property	Used for...
Deployment Type	A report deployed as Read Only cannot be modified and uploaded with same name. A report deployed as Custom can be modified and uploaded with the same name.
Output Format	<b>Output Formats</b> in which this report can be generated. Formats not selected here will not be available for this report.
System Generated	To specify a Report ID manually, deselect the <b>System Generated</b> checkbox and specify the Report ID.

## Deleting an Existing Category

You can delete a category only if it is empty.

### To delete an empty category:

1. Click **Reports** on the top-level menu bar.
2. Click **Report Categories** in the **Administration** section in the left pane.  
The Deploy Reports and Categories displays the available categories. A toolbar across the top of the page displays icons for the available actions.
3. Click the tree button () next to the **Look In** field, and navigate through the tree to the desired category.
4. Select the category click the **Delete** () button to delete the selected category.

### To delete a category and its contents:

Click the **Report Categories** link in the left pane, select the category, check the **Delete Cascade** checkbox and click the **Delete Selected Category** () button.

**Note:** If you attempt to delete a category that is not empty, and the **Delete Cascade** checkbox is deselected, a message Failed to delete the category is displayed on top left of the page.

## Report Category Filters

A Search Group filter can be optionally assigned to each report category. Assigning a Search Group filter to a report category means that all the reports in the category will only process events returned by this filter.

### To assign a search group filter to a report category:

1. Create the filter that you would like to apply to every report in a given category. See ["Filters" on page 260](#) for the details of creating a filter of type Search Group.
2. Open the **Reports** page.

3. In the menu, under **Administration**, click **Report Category Filters**.
4. The new search group filter are displayed in the pull-down menu associated with each category. Select the desired filter for each category.
5. Click **Save**.

### To remove a search group filter from a report category:

1. Open the **Reports** page. In the menu, under Administration, click **Report Category Filters**.
2. In the pull-down menu associated with the report category from which you want to remove the filter, select **None**.
3. Click **Save**.

### Placing a System-defined Query or Parameter into a Category

You can place a pre-defined query or parameter into a category. Use the cut/paste feature to do so because cutting and pasting will preserve its ID.

### To cut and paste a query/parameter:

1. Click the **Query Explorer** or **Parameter Explorer** link (depending on what you want to place in the category) in the left pane.
2. Click on the pre-defined query/parameter you want to move.
3. Click the **Cut Query Object/Cut Parameter Object**  button on the side button bar.
4. Click the category name under which you would like to place this query/parameter.

**Note:** You cannot save a report in the root category. Save it in one of the existing subcategories, or create a new category.

Click the **Paste**  button on the side button bar.

5. Do not *copy* and paste a query or parameter to place it in a category. Doing so will give the query or parameter a new ID and render it unusable to reports or other existing objects that are using it. Use *cut* and paste, instead.

You can schedule any report to run once at a later date or on a specified frequency (such as daily or weekly). Monthly reports cannot be scheduled currently. For more on this, see ["Scheduled Reports" on page 192](#).

You can run, publish, and save the results of any type of report. For information on these common reporting tasks available on all reports, see ["Running, Viewing, and Publishing Reports" on page 179](#) and ["Task Options on Available Reports" on page 180](#).)

## Backup and Restore of Report Content

You can back up and restore report content. For more information about this feature, see ["Configuration Backup and Restore" on page 383](#).

## iPackager Utility

The iPackager utility enables you to package reports and report objects residing in Logger. This package can be later imported to a different Logger installation. If you own multiple Loggers, you can use the packages to configure reporting features on them. This method eliminates the need to configure reporting features for each Logger.

**Note:** The iPackager utility requires administrator privileges.

### To access the iPackager utility:

Open the iPackager page in one of the following ways:

- Click **Reports** from the top navigation bar, and click **iPackager** from the Administration section.
- Click **iPackager** from the Administration section of the Reports quick access menu.

## How iPackager Works

The iPackager enables you to first create a configuration (.conf) file, in which you can collect (import) the references for all the entity objects that you want to include in the package. You can save the configuration file and edit it at any time. Once you are satisfied with the contents of the .conf file, you can build the package into a CAB file. Data can be imported from multiple report servers and packaged in a single CAB.

**Note:** You can open only one .conf file in iPackager at a time.

When iPackager opens a .conf file, it checks for the availability of the objects already imported in the .conf file. If any of the objects already imported are not found on the report server, it is indicated on the tree view. The CAB file cannot be built until the missing object is replaced, or the object is removed from the .conf file.

## The iPackager Page

The iPackager page consists of three panes that are located to the right of the quick access menu on the Reports page—Entity Type, Select Entities, and Selection Summary.

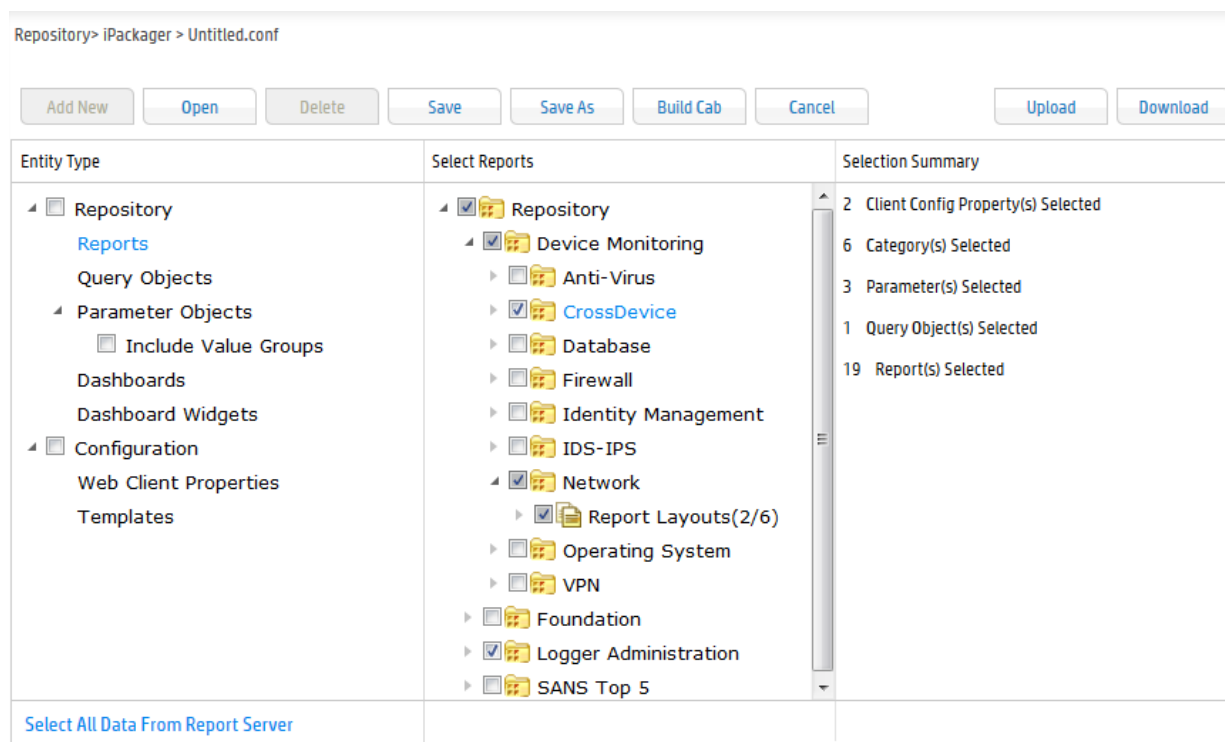

- The **Entity Type** pane displays the repository objects available in the report server. These contents are displayed in a tree view, and checking or unchecking the object will add or remove the object entities in the .conf file.
- The **Select Entities** pane displays a list of selected object entities available and selected. The pane title will vary with the entities you select. Checking or unchecking the entity will add or remove it from the .conf file.
- The **Selection Summary** is the area where you can view the summarized details of your selected objects and entities.

Messages and information display above the menu buttons.

## Actions Available from the iPackager

The following actions can be performed from within the iPackager:

Action	Description
Add New	Creates a new configuration (.conf) file.
Open	Opens an existing .conf file in iPackager.
Delete	Deletes the selected .conf file.
Save	Saves the currently open .conf file.
Save As	Saves the .conf file that is currently open under a new name.
Build CAB	Initiates the process of building a CAB file.
Cancel	Cancels the operation.
Upload	Uploads the .conf file to a web server.
Download	Downloads the .conf file from a web server to the browser's default download folder.

## Selecting Entities

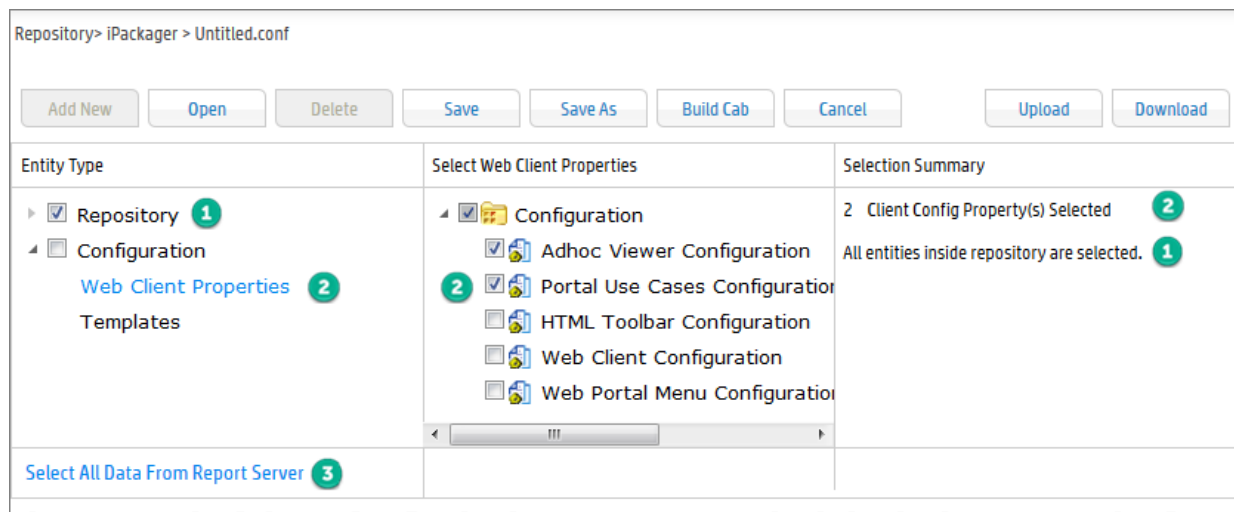

You can select entity objects with different levels of granularity:

- 1 To select all the entities within a repository, click the check box for the entity type. The Selection Summary pane displays "All entities inside <repository name> are selected."
- 2 To select a subset of a repository, open ( ▶ ) the entity type and select an entity sub-type from the open list. The Select Entities pane displays available entity objects. After you've made your selection, the Selection Summary page displays the number and type of entities you select.

**3** To select all the entities from the report server, click "Select All Data From Report Server" at the bottom of the Entity Type pane. The Selection Summary pane displays "All data from report server is selected." Click "Deselect Complete Data" to revert the selection.

## Adding Entity Objects to a Configuration File

You can import entity object references from a report server into a .conf file.

**Note:** Only references to the entities will be imported. The actual components will be imported during the creation of the CAB file.

### To add entity object references to a .conf file:

1. Select the entity objects you want to import. See ["Actions Available from the iPackager" on the previous page](#).
2. Click **Save** or **Save As** to open the Save Configuration File dialog box.
3. Enter a name for the configuration file.
4. Click **Save**. If successful, a confirmation message displays at the top of the page.



**Note:** The **Add New** button is now available, which clears the entity selection panes for a new configuration file.

## Modifying Entity Object Properties

You can modify the properties for entity objects in an open .conf file.

### To modify an entity object property:

1. Click **Open** to open an existing .conf file.
2. Select the entity types to open the object you would like to modify.
3. From the Select Entity pane, right-click the object and click **Properties** from the popup menu.

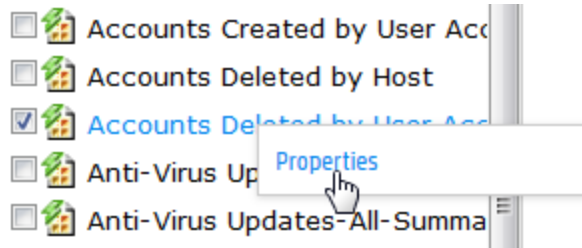

The Properties dialog box displays for the object. Each object displays its own default properties.

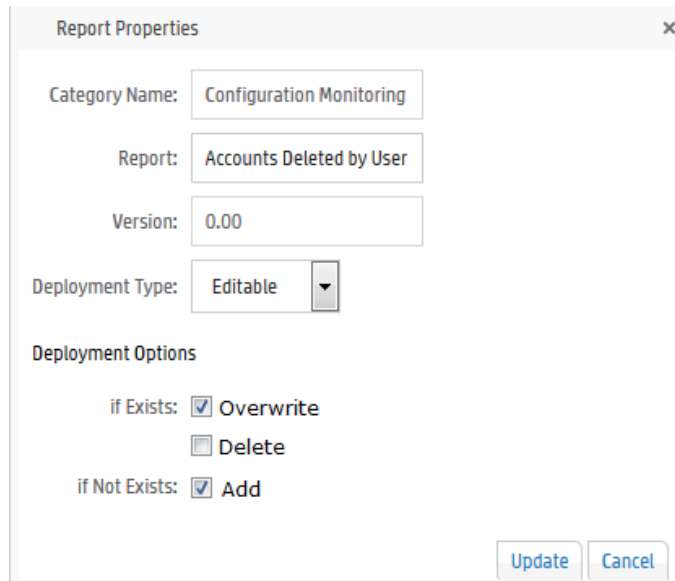

Object names are pre-populated with the object name from the report server. You can change the name of the object. If you change the name here, the object is packaged with the new name, but its original name on the report server will not change.

In addition, all objects have some variation of the following Deployment Options:

- If Exists:
  - Overwrite — While importing, if the component is found in the package, replace the one in package with the one on the report server.
  - Delete — While importing, if the component is found in the package, delete it.
  - Cascade Delete (Category folders only) — Delete the category folder, even if it contains reports.
- If Not Exists:
  - Add — While importing, if the component is not found in the package, add it to the package.



## Opening an iPackager Configuration File

### To open an existing .conf file in iPackager:

1. Click **Open** in the iPackager toolbar. The Open Configuration File dialog opens.
2. Select an available configuration file.
3. Click **Open**.

## Deleting Entity Objects from a Configuration File

### To delete an entity object within a .conf file:

1. Open the .conf file in iPackager.
2. Open the repository that contains the entity object.
3. Deselect the check box for the object.
4. Click **Save**.

## Deleting an iPackager Configuration File

### To delete a .conf file:

1. Open the .conf file in iPackager.
2. Click **Delete**.
3. On the warning dialog, click **Yes** to confirm the deletion.

## Building the CAB File

When you issue command to build the CAB file, the actual objects specified in the references in your open .conf file are actually picked up from the respective locations and a CAB file is built. This CAB file will contain all the objects.

If any of the information saved in the .conf file is not available at the right source while building the CAB, then you will see an error message and the CAB building process stops. You will need to fix any errors before rebuilding the CAB file.

### To build the CAB file:

1. Click **Build CAB**.
2. On the **Build Properties** dialog, enter a name for the file.
3. Optionally, enter information in the **Author**, **Company**, **Version**, and **Comment** fields.

4. Click **Build and Download**. The Build Status window displays the status. To halt the process, click **Cancel Build**.
5. When the CAB file is complete, follow the prompts to view the objects included in the file.

## Deploying a Repository (CAB) File

**Caution:** When deploying a CAB file from a source Logger to a target Logger, if the categories being imported do not have identical names and IDs on both Loggers, the deployment will fail.

Should you encounter this issue, rename the conflicting category in the target Logger or the source Logger (you will need to recreate the CAB file if you do this on the source Logger) such that the category has a unique name or ID. Then, redeploy the CAB file.

### To deploy a CAB file:

1. In the Reports navigation pane, click **Deploy Report Bundle**.

Deploy Repository Bundle

Step 1:(Upload & View Cab Information)

Step 2:(Deploy Objects On Report Server)

Create Log File

2. Click **Browse** to select the CAB file, and click **Upload**.
3. Click **Deploy**. The CAB file is deployed.

# Chapter 5: Configuration

The following topics describe how to create and manage receivers, forwarders, devices, device groups, SmartConnectors, and filters. Receivers, devices, and other resources created by one user are visible to all other users, although subject to user group privileges. Resources are shared by all sessions.

- [Search](#) .....260
- [Data](#) .....291
- [Storage](#) .....347
- [Scheduled Tasks](#) .....359
- [Advanced Configuration](#) .....363

You can access these configuration options in the Logger UI from the Configuration dropdown menu or by starting to type the feature name in the Take Me To... text box and clicking it in the dropdown list.

Configuration ▼
System Admin

Search	Data	Storage	Advanced
Filters	Devices	Storage Groups	Retrieve Logs
Search Group Filters	Device Groups	Storage Rules	
		Storage Volume	Maintenance Operations
Saved Searches	Receivers		Maintenance Results
Scheduled Searches/Alerts	Source Types	Event Archives	
Saved Search Files	Parsers	Daily Archive Settings	Configuration Backup
		Archive Storage Settings	
Search Indexes	Forwarders		Import Content
Search Options	Realtime Alerts	<b>Scheduled Tasks</b>	Export Content
Fieldsets	SNMP Destinations	Scheduled Tasks	
Default Fields	Syslog Destinations	Currently Running Tasks	License Information
Custom Fields	ESM Destinations	Finished Tasks	Data Volume
Running Searches	Certificates		
			Peer Nodes
Lookup Files	Data Validation		Peer Authorization

## Search

The options in the **Configuration | Search** category enable you to manage how search works on your Logger.

- [Filters](#) ..... 260
- [Search Group Filters](#) ..... 263
- [Saved Searches](#) ..... 264
- [Scheduled Searches/Alerts](#) ..... 265
- [Saved Search Files](#) ..... 274
- [Search Indexes](#) ..... 275
- [Guidelines for Field-Based Indexing](#) ..... 276
- [Search Options](#) ..... 277
- [Managing Fieldsets](#) ..... 281
- [Default Fields](#) ..... 281
- [Custom Fields](#) ..... 283
- [Running Searches](#) ..... 283
- [Lookup Files](#) ..... 284

## Filters

You can create search filters to save specific queries so that you can easily use them again. Filters are similar to saved searches. However, filters save the query only, while saved searches save the time range information in addition to the query.

Your system comes with a set of predefined search filters. For more information about these filters, see ["System Filters/Predefined Filters" on page 131](#). You can add new filters and edit the existing ones from the Filters page.

**Filters**

Type of Filter

**Add**

Name	Category	Type	Query	Creator	Last Editor	
Configuration - Configuration Changes (Unified)	System	Unified Query	categoryBehavior = "/Modify/Configuration" AND categoryOutcome = "/Success"	SystemFilters-6.3	SystemFilters-6.3	
Configuration - System Configuration Changes (CEF format)	System	Regular Expression	cef.0.*categoryBehavior=/Modify/Configuration:AND: categoryOutcome=/Success	SystemFilters-6.3	SystemFilters-6.3	
CustomRegexFilterQuery1	Shared	Regular Expression	cef.0.*categoryBehavior=/Authentication/Verify	admin	admin	
CustomSearchGroupFilter1	Search Group	Regular Expression	cef.0.*categoryBehavior=/Authentication/Verify:AND: categoryOutcome=/Success	admin	admin	
CustomUnifiedFilter1	Shared	Unified Query	categoryBehavior = "/Modify/Configuration" AND categoryOutcome = "/Success"	admin	admin	

The following categories of filters are displayed on the Filters page.

- **Shared:** Shared search filters are user-created and are visible to all users. Once created, any user can use a shared search filter to search for events.
- **Search Group:** Search group filters provide an access control mechanism to limit the events that users in a particular user group can see. Search group filters can also be used to limit the events processed by a category of reports (see ["Report Category Filters" on page 250](#)). The query for these filters can only contain regular expressions. For more information, see ["Search Group Filters" on page 263](#).  
You must have admin-level privileges to create or edit search group filters. See ["Users/Groups" on page 442](#) for more information on Logger user rights and how to administer them.
- **System:** A set of pre-defined filters, known as system filters, come with your system. For more information about system filters, see ["System Filters/Predefined Filters" on page 131](#).

Search filters can have one of two different types of query:

- **Unified Query:** Unified Query (Unified) search queries specify keywords and fields.
- **Regular Expression:** Regular Expression (Regex Query) search queries specify a regular expression. Regular expression based search filters are useful for creating real time alerts, which accept only regex queries.

### To create a filter:

1. From the navigation bar Configuration menu, select **Filters** to open the Filter page.
2. Click **Add**. The Add Filter page displays.
3. Enter a name for the new filter in the Name field. Filter names are case-sensitive.
4. Select one of the following options:
  - If you are creating a shared filter, select **Unified** or **Regex Query**.
  - If you are creating a Search Group filter, select **Search Group**.

**Note:** Only administrator users can create Search Group filters. See ["Users/Groups" on page 442](#) for more information on Logger user rights and how to administer them.

5. Click **Next**.
6. If you selected Unified or Regex Query method in the previous step, enter the query for the new filter.
  - For Unified queries:  
When you type a query, Logger's Search Helper enables you to quickly build a query expression by automatically providing suggestions, possible matches, and applicable operators. See ["Search Helper" on page 98](#) for more information.  
OR  
Click **Advanced Search** to use the Search Builder Tool to create the query. For details about using the Search Builder Tool, see ["Using the Advanced Search Builder" on page 90](#).
  - For Regex queries: Enter the regular expression in the Query text box.
7. Click **Save**.

**Note:** If you created a Search Group filter, make sure that you associate it to a user group, as described in ["Search Group Filters" on the next page](#).

### To create a filter by copying an existing one:

1. From the navigation bar Configuration menu, select **Filters** to open the Filter page.
2. Locate the filter that you want to copy from the list of filters. Click the Copy icon ().  
A new filter with the name "Copy of <filtername>" is created.
3. Change the name of the filter and edit the query for the new filter if necessary.
4. Click **Save**.

### To edit a filter:

1. From the navigation bar Configuration menu, select **Filters** to open the Filter page.
2. Find the filter that you want to edit and click the Edit icon () on that row.
3. Change the information in the form and click **Save**.

### To delete a filter:

1. From the navigation bar Configuration menu, select **Filters** to open the Filter page.
2. Find the filter that you want to delete and click the Delete icon () on that row.
3. Confirm the delete.

## Search Group Filters

The Search Group Filters manage the association of User Groups with Search Group Filters. Search Group Filters can be used to restrict events in the following two ways:

- **Restrict the events processed by a Report Category:** A Search Group Filter can be associated directly with a Report Category. This association provides a way to restrict the events processed by all the reports in a Report Category.

When a Search Group filter is used to restrict the events processed by a Report Category, you do not need configure the Search Group in the Search Group Filters page as described below. After adding a filter of type "Search Group", you can go directly to the Reports Category Filters page under the Reports menu and select the filter for the Report Category. For more information, see "[Report Category Filters](#)" on page 250.

- **Restrict the events visible by members of a user group:** A Search Group Filter can be associated with a user group (of type Logger Search). This association means that all members of the user group only see events that match the Search Group Filter. User groups (described in more detail later in this chapter) provide a way of assigning privileges to a specified set of users.

### Search Group Filters Page

**Search Group Filters**

You may assign a search filter to a search group that will be appended to all searches performed by users in that search group.

To create a new search group filter, you must first go to the [Filters](#) page and add a new filter of type Search Group.

Name	Filter	Description	
<a href="#">Default Logger Search Group</a>	NONE	The default search group allows both local and distributed searches.	

**Tip:** The User Group of type Default Logger Search Group is listed in the Name column and the associated filter is listed in the middle column.

Users who belong to a User Group that does not have a Search Group Filter will see all events.

To add, edit, or delete Search Group Filters, see "[Filters](#)" on page 260. To add, edit, or delete User Groups, see "[Users/Groups](#)" on page 442 for more information on Logger user rights and how to administer the. Only users that are members of a System Admin group can assign Search Group Filters.

### To associate a Search Group Filter with a User Group:

1. If the User Group that you want to associate with the Search Group Filter does not exist, create a new User Group of type Search Group. For instructions, see "[Users/Groups](#)" on page 442.
2. If the Search Group Filter you want to associate with the User Group does not exist, create a filter of type Search Group. For instructions, see "[To create a filter:](#)" on page 261. When creating the filter, from the **Type** pull-down menu select the **Search Group** option.











3. From the navigation bar Configuration menu, select **Search Group Filters**.
4. Find the User Group in the Search Group Filters table. Click the Edit icon (✎).
5. Select a filter from the pulldown list. (Only Search Group type filters are listed.)
6. Click **Save**.

## Saved Searches

A saved search, like a search filter, recalls a specific query. However, in addition to the query, a saved search saves the time range and the field set to display in the search results. Saving the time range supports scheduled searches and reports. You can schedule a Saved Search to run at a specific interval. A scheduled Saved Search can be also configured to generate an alert. For more information, see "[Scheduled Searches/Alerts](#)" on the next page.

The Saved Searches page displays all Saved Searches and supports adding, editing, and deleting Saved Searches. You can add a saved search here or directly from the Search page.

### Saved Search Page

Saved Searches						
<a href="#">Add</a>						
Name	Start	End	Type	Query	Creator	
<a href="#">StorageGroupSavedSearch</a>	\$CurrentWeek	\$Now	Unified Query	(success OR fail) _storageGroup IN ["Default Storage Group"]	admin	  
<a href="#">SavedSearchLogger</a>	\$CurrentWeek	\$Now	Unified Query	deviceProduct=Logger	admin	  
<a href="#">MySavedQuery1</a>	\$CurrentWeek	\$Now	Unified Query	Logger and deviceEventClassId = memory:100	admin	  
<a href="#">Windows Account Creations</a>	\$Now-1h	\$Now	Unified Query	deviceVendor = "Microsoft" AND (deviceEventClassId = "Microsoft-Windows-Security-Auditing:4720" OR deviceEventClassId = "Security:624")   ch...	System-6.3	

For information on how to save a search from the Search page, see "[Saving Queries \(Creating Saved Searches and Saved Filters\)](#)" on page 129.

For information on how to use the saved searches created on this page, see "[Searching with Saved Queries](#)" on page 135.

### To add a Saved Search:

1. Open the **Configuration | Search** menu and click **Saved Searches**.
2. Click **Add** and enter the following parameters:



Parameter	Description
Name	A name for this Saved Search. This name will be used for exported output files, with the Saved Search date and time appended.
Start Time	Absolute date and time of earliest possible event. Alternatively, check <b>Dynamic</b> to specify the start time relative to the time when the Saved Search job is run.
End Time	Absolute or Dynamic date and time of latest possible event, as described above.
Query Terms	Enter the query in the text field or select one or more Filters from the list below the text field.  When you type a query, Logger's Search Helper enables you to quickly build a query expression by automatically providing suggestions, possible matches, and applicable operators. See " <a href="#">Search Helper</a> " on page 98 for more information.
Local Search	Check this box to limit the Saved Search to the local Logger box. If the Local Search box is left unchecked, the Saved Search will include all Peer Loggers as well as the local Logger.

3. Click **Save** to add the new Saved Search, or **Cancel** to quit.

### To edit a Saved Search:

1. Open the **Configuration | Search** menu and click **Saved Searches**.
2. Find the Saved Search that you want to edit and click the Edit icon (✎) on that row.
3. Change the information in the form and click **Save**.

### To delete a Saved Search:

1. Open the **Configuration | Search** menu and click **Saved Searches**.
2. Find the Saved Search that you want to delete and click the Delete icon (✖) on that row.
3. Confirm the delete.

## Scheduled Searches/Alerts

You can schedule a Saved Search to run at a specific interval. A scheduled Saved Search can be configured to generate an alert. The results of a scheduled search are written to a file, as described in "[Saved Search Files](#)" on page 274. The results of a scheduled Alert are sent to a specified destination.

The Scheduled Searches/Alerts page displays a list of currently scheduled Saved Searches and Alerts. From here you can add a new Scheduled Search or Alert and manage existing ones. For more information about scheduled Saved Search Alerts, see "[Saved Search Alerts](#)" on page 271.

**Note:** Before you schedule a Saved Search Alert, you must have created at least one Saved Search. Saved searches used in Alerts cannot contain aggregation operators such as chart or top.

### To add an new Scheduled Search or Alert:

You can add a new Scheduled Search or Alert from the Configuration menu or directly from the search results page.



- To set up a Scheduled Search Alert from the search results page (**Analyze > Search**), see ["Creating Saved Search Alerts \(Scheduled Alerts\)" on page 272](#).
- To set up a Scheduled Search from the search results page (**Analyze > Search**), follow the instruction in ["Saving Queries \(Creating Saved Searches and Saved Filters\)" on page 129](#), set the Type to **Scheduled Search** and select the **Schedule it** option.
- To set up a Scheduled Search or Alert from the configuration menu (**Configuration | Search > Scheduled Searches/Alerts**), see ["Adding a Scheduled Search or Scheduled Alert" on the next page](#).

### To see list of the existing Scheduled Searches and Alerts:

Open the **Configuration | Search** menu and click **Scheduled Searches/Alerts**.

A list of the current Scheduled Searches and Alerts is displayed.



### To edit a existing Scheduled Search or Alert:

1. Open the **Configuration | Search** menu and click **Scheduled Searches/Alerts**.
2. Locate the Scheduled Search/Alert that you want to edit and click the Edit icon () on that row.
3. Click the Edit icon () and update the parameters as needed. For details about the settings, see ["To set up a Scheduled Search or Alert from the Scheduled Searches/Alerts page:" on the next page](#).
4. Click **Save** to update the Scheduled Search/Alert or **Cancel** to abandon your changes.

### To remove a Scheduled Search or Alert:

1. Open the **Configuration | Search** menu and click **Scheduled Searches/Alerts**.
2. Identify the Scheduled Search/Alert that you want to remove, and click the Remove icon () on that row.
3. Click **OK** to confirm the removal, or click **Cancel** to keep the Scheduled Search/Alert.

### To enable or disable a Scheduled Search or Alert

1. Open the **Configuration | Search** menu and click **Scheduled Searches/Alerts**.
2. Identify the Scheduled Search/Alert that you want to enable.
3. Click the associated icon ( or ) to enable or disable the alert.

### To view triggered Alerts:

See ["Viewing Alerts" on page 141](#).

## Adding a Scheduled Search or Scheduled Alert

You can schedule a Saved Search or an Alert to run at any time. Before you schedule a Saved Search or Alert to run, you must have created or saved at least one Saved Search. See "[Saving Queries \(Creating Saved Searches and Saved Filters\)](#)" on page 129.

You can add a new Scheduled Search or Alert from the Configuration menu or directly from the search results page.

- To set up a Scheduled Search Alert from the search results page (Analyze > Search), see "[Creating Saved Search Alerts \(Scheduled Alerts\)](#)" on page 272.
- To set up a Scheduled Search from the search results page (Analyze > Search), follow the instruction in "[Saving Queries \(Creating Saved Searches and Saved Filters\)](#)" on page 129, set the Type to **Scheduled Search** and select the **Schedule it** option.

### **To set up a Scheduled Search or Alert from the Scheduled Searches/Alerts page:**

1. Open the Configuration | Search menu and click **Scheduled Searches/Alerts**.
2. Click **Add**. A screen like the following is displayed.

### Add Scheduled Search/Alert

---

Name

Schedule    Hours (24 hour format)

Job type

Saved Searches

- All Receivers
- All Forwarders
- Configuration Changes by Product
- Failed Logins by Product
- Failed Logins by User
- Firewall Drops by Source
- Individual Forwarders
- Individual Receivers
- Malicious Code Activity
- SSH Authentications

Use ctrl-click to select or deselect items

#### Search Result Export Options

Export Options  Export to remote location  Save to Logger

File format

Export directory name

Fields  All fields

Include Event Total

Include only CEF events

Delete files after  days

3. Enter the following parameters:

Parameter	Description
Name	A name for this Scheduled Search.
Schedule	Set when and how often you want the report to run. For details about these options, see <a href="#">"Scheduling Date and Time Options"</a> on page 136.

Parameter	Description
Job Type	Select <b>Search</b> to schedule a Saved Search. Select <b>Alert</b> to schedule a Saved Search Alert.
Saved Searches	Select from the list of saved searches. If none of the saved searches suits your needs, click the <b>Saved Searches</b> page to define a new search. Then come back to this page to schedule it. For more information about defining a Saved Search query, see <a href="#">"Saved Searches" on page 264</a> . You can use Ctrl+click to select and remove items from the list.  <b>Note:</b> When multiple saved searches are specified in one scheduled search job, the resulting file contains the number of hits for each saved search and not the actual events.  <b>Note:</b> You can only select one Saved Search for each Alert you configure.  <b>Note:</b> Aggregation operators such as chart and top cannot be included in the search query for Scheduled Alerts. Saved searches that contain aggregation operators are not displayed in the selection list after you specify searches you have created are not displayed in the selection list for Saved Search Alerts.

4. If you selected the job type Search, specify the Search Result Export Options

**Search Job Options**

Parameter	Description
Export Options	For the Logger Appliance: Select from one of these options: <ul style="list-style-type: none"> <li>Export to remote location: The file is written to an NFS mount, a CIFS mount, or a SAN system location that you specify.</li> <li>Save to Logger: The file is saved to the Logger's onboard disk. If the file is saved locally, you can use the Saved Search Files (<a href="#">"Saved Search Files" on page 274</a>) feature to access those files.</li> </ul> For Software Logger, the only available option is "Save to Logger," which is preselected for you.  <b>Tip:</b> The Logger Appliance supports mounting through the user interface. Software Logger uses its filesystem, which can contain remote locations mounted through the operating system.
File Format	Select a format for the exported search results. <ul style="list-style-type: none"> <li>CSV, for comma-separated values file.</li> <li>PDF, for a report-style file that contains search results as charts and in tables. You must specify a title for the report in the Title field. If the search query contains an operator that creates charts such as chart, top, and so on, charts are included in the PDF file. In that case, you can also set the Chart Type and Chart Result Limit fields. These fields are described later in this table.</li> </ul>
Remote Location	This field is only available on the Logger Appliance. Use the dropdown to select an existing Remote File System location. If there are none, a link to the Remote File System location page is displayed.

### Search Job Options, continued

Parameter	Description
Export Directory Name	<p>For the Logger Appliance, select the directory where the search results will be exported from the pull-down menu.</p> <p>For Software Logger, enter the directory path in this field, which can be a path to a local directory or to a mount point on the machine on which Software Logger is installed.</p> <p>By default, all saved searches are stored in <code>/opt/arcsight/logger/userdata/logger/user/logger/data/savedsearch</code>.</p> <p><b>Tip:</b> To group your searches in folders, indicate a subdirectory in which to store them.</p> <p>If a directory of the specified name does not exist, it is created. If a directory of the specified name exists and the Overwrite box is not checked, an error is generated. If the Overwrite box is checked, the existing directory contents are overwritten.</p>
Title	<p>(Optional) Enter a title to appear at top of the PDF file. If no title is specified, the default "Untitled" is used.</p> <p><b>Tip:</b> This field becomes available when you select the PDF output format.</p>
Fields	<p>A list of event fields that will be included in the exported file. By default, all listed fields are included.</p> <p>Deselect All Fields to the view and edit the list of fields. Click Clear to remove the listed fields.</p>
Chart Type (for PDF only)	<p>Type of chart to include in the PDF file. You can select from: Column, Bar, Donut, Area, Line, Stacked Column, Stacked Bar.</p> <p><b>Note:</b> This option overrides the Chart Type displayed on the Search Results screen.</p> <p>(If the search query includes an operator that creates a chart, this field is meaningful; otherwise, it is ignored.)</p>
Chart Result Limit (for PDF only)	<p>The maximum number of unique values to include on the chart. The default is 10.</p> <p>(If the search query includes an operator that creates a chart, this field is meaningful; otherwise, it is ignored.)</p> <p>If the configured Chart Result Limit is less than the number of unique values for a query, the top values equal to the Chart Result Limit are plotted. That is, if the Chart Result Limit is 5 and 7 unique values are found, the top 5 values will be plotted.</p>

### Search Job Options, continued

Parameter	Description
Include Event Total	Check this box to include an event count with the Saved Search, or a total when more than one Saved Search is specified.
Include only CEF Events	Check this box to include only Common Event Format (CEF) events. Uncheck the box to include all events in the output.  For more information about CEF, refer to the document "ArcSight CEF." For a downloadable a copy of this guide, search for "ArcSight Common Event Format (CEF) Guide" in the <a href="#">ArcSight Product Documentation Community on Protect 724</a> .
Delete Files After	Specify how many days to keep the saved search results.

- If you selected the job type Alert, specify the Alert Options

### Alert Job Options

Parameter	Description
Match count	Number of events that should be matched in Threshold number of seconds for an alert to be triggered.
Threshold (sec)	Number of seconds within which the "Match count" events should be matched for an alert to be triggered.
Notification destinations are optional. If none is specified, a notification is not sent.	
Email address(es)	(Optional) A comma-separated list of email addresses to which the alert will be sent
SNMP destination	(Optional) An SNMP destination to which the alert will be sent. For more information, see <a href="#">"SNMP Destinations" on page 337</a> .
Syslog destination	(Optional) A syslog server address to which the alert will be sent.  For more information, see <a href="#">"Syslog Destinations" on page 337</a> .
ESM Destination	(Optional) An ArcSight Manager address to which the alert will be sent. For more information, see <a href="#">"Sending Notifications to ESM Destinations" on page 338</a> .

- Click **Save** to add the new Scheduled Search/Alert, or Cancel to quit.
- Once a Scheduled Search is created, enable it as described in ["To enable or disable a Scheduled Search or Alert" on page 266](#).

## Saved Search Alerts

This section describes Saved Search Alerts. Saved Search Alerts are based on the search queries that you have saved on Logger. For detailed information about Saved Search queries, see ["Saved Searches" on page 264](#).

**Note:** For information on Real Time Alerts, see ["Real Time Alerts" on page 328](#). For information on alerts in general, see ["Logger Alert Types" on page 332](#).

For each Saved Search Alert, you configure a match count, threshold, destination, and a schedule at which the alert will be triggered (if specified number of matches occurs within the specified threshold). If the new Alert will send notifications to an email, SNMP, or Syslog Destination, set up the destination before creating the Alert.

See ["Static Routes" on page 409](#), ["Receiving Alert Notifications" on page 334](#), and ["Setting Up Alert Notifications" on page 336](#) for more information. Audit events for alerts are only written to the Internal Storage Group and not forwarded to ESM Destinations by default. If you need to forward these audit events to ESM, please contact customer support for assistance.

**Note:** This change only applies to audit events generated for alerts; other audit events are can be sent to ESM Destinations.

**Note:** To ensure system performance, a maximum of 200 alerts are allowed per saved search alert job. Therefore, if a saved search alert job triggers more than 200 alerts, only the first 200 alerts are sent out for that job iteration; the rest are not sent. Additionally, the job is aborted so it does not trigger more alerts for that iteration and the status for that job is marked "Failed" in the Finished Tasks page (**Configuration** | **Scheduled Tasks** > **Finished Tasks**). The job runs as scheduled at the next scheduled interval and alerts are sent out until the maximum limit is reached.

This limit does not exist on the real-time alerts.

## Creating Saved Search Alerts (Scheduled Alerts)

This section describes how to schedule Saved Searches to run as Scheduled Alerts. For information on creating Real Time Alerts, see ["Creating Real Time Alerts" on page 330](#). For a description of the types of alerts, see ["Logger Alert Types" on page 332](#).

You can schedule a Saved Search to run at any time. Before you schedule a Saved Search Alert, you must have created at least one Saved Search.

**Note:** Saved searches used in Alerts cannot contain aggregation operators such as chart or top. See ["Saving Queries \(Creating Saved Searches and Saved Filters\)" on page 129](#) for more information.

You can add a new Scheduled Search or Alert from the Configuration menu or directly from the search results page.

- To set up a Scheduled Search Alert from the search results page (**Analyze** > **Search**), see ["Creating Saved Search Alerts \(Scheduled Alerts\)" above](#).



- To set up a Scheduled Search from the search results page (**Analyze > Search**), follow the instruction in ["Saving Queries \(Creating Saved Searches and Saved Filters\)" on page 129](#), set the Type to **Scheduled Search** and select the **Schedule it** option.
- To set up a Scheduled Search or Alert from the configuration menu (**Configuration | Search > Scheduled Searches/Alerts**), see ["Adding a Scheduled Search or Scheduled Alert" on page 267](#).

**To set up a Saved Search Alert from the search results page:**

1. Run a search, as described in ["Searching for Events" on page 102](#).
2. Click the Save icon () and enter the following settings.

Parameter	Description
Name	A name for the query you are saving.
Save as	To enable the Scheduling option, select Saved Search.
Schedule it	Click to schedule now or leave blank to schedule later.
Type	Select whether you want to schedule a Search or an Alert. Scheduled searches run on a predetermined schedule and export results to a pre-specified location. Scheduled alerts run a search on a predetermined schedule but only generate an alert if the specified number of events within the specified threshold is found. Select Scheduled Alert to create an Alert.

3. Click **Save**.  
If you checked the "Schedule it" setting in the previous step, you are prompted to choose if you want to edit the schedule. If you click **OK**, the Edit Scheduled Search page is displayed, as shown in the next step. If you click **Cancel**, the search is saved but it is not scheduled to run.
4. The Edit Scheduled Search/Alert page enables you to define a schedule for the saved search job and alert options. Select the desired options, and click **Save**. For details about the parameters, see ["Alert Job Options" on page 271](#).

**Edit Scheduled Search/Alert**

Name: SavedSearchLogger job

Schedule: Every day (dropdown), Every (dropdown), 4 (input), Hours (dropdown)

Job type: Alert (dropdown)

Saved Searches: SavedSearchLogger (list)

Alert Options:

Match count: 4 (input)

Threshold (sec): 60 (input)

Email address(es): (input)

SNMP destination: NONE (dropdown)

Syslog destination: NONE (dropdown)

ESM destination: NONE (dropdown)

Save (button) Cancel (button)

5. After creating the Scheduled Alert, enable it as described in "To enable or disable a Scheduled Search or Alert" on page 266.



## Saved Search Files

Access Saved Search results that were saved to Logger with the Saved Search Files command. Saved Search Files can be retrieved (streamed to the browser) or deleted. Click Refresh to update the list of files.

### Saved Search Files page

**Saved Search Files**

Refresh (button)

Name	Last Modified	Size	State	Error Message
<a href="#">Export_save_query.pdf</a>	Jun 15, 2016 10:27:22 AM PDT	1.22 MB	Exported	 

### Access the saved search results:

1. Open the **Configuration | Search** menu and click **Saved Search Files**. The files containing the search results are displayed.
2. To download and open a file, click a link in the Name column or click the **Retrieve** icon in the row.

## Search Indexes

You can add fields to the field-based index at any time. However, **once a field has been added to the index, you cannot remove it.**

### Prerequisites

Users must be assigned to the following User Groups to access this feature:

- Default Logger Rights Group
- Default System Admin Group

See "[Setting Logger User Permissions](#)" on page 458 for more information.

**Caution** Before adding any fields to the index, make sure you are familiar with the information in "[Guidelines for Field-Based Indexing](#)" on the next page.

### To add fields to the field-based index:

1. Open the **Configuration | Search** menu and click **Search Indexes**.
2. Select the fields from the Indexable Fields list.

**Edit Search Index**

**Important**

Once a field is indexed, it cannot be changed. Significantly exceeding ArcSight's default recommended indexed fields could result in performance degradation in certain situations. If you need to exceed the default number of fields, only index those additional fields which are necessary for your environment.

---

To add indexed fields, select one or more fields below

Indexable fields

- agentAddress
- agentHostName
- agentNtDomain
- agentZoneURI
- customerName
- destinationDnsDomain
- destinationMacAddress
- destinationTranslatedAddress
- destinationUserPrivileges
- deviceCustomDate1
- deviceCustomDate1Label
- deviceCustomDate2
- deviceCustomDate2Label
- deviceCustomNumber1Label
- deviceCustomNumber2Label
- deviceCustomNumber3Label
- deviceCustomString1Label

Use ctrl-click to select or deselect items

Indexed fields

- deviceVendor
- deviceProduct
- deviceVersion
- deviceEventClassId
- name
- agentSeverity
- agentType
- applicationProtocol
- baseEventCount
- bytesIn

All recommended fields have already been indexed

Full text indexing is enabled

**Apply Changes**

3. To select multiple fields at the same time, hold the Ctrl key down and click on the fields.
4. Click **Apply Changes**.

## Guidelines for Field-Based Indexing

Make sure you are familiar with these guidelines before you index any fields:

- Events are indexed by the fields in the “Indexed fields” list (on the Search Indexes page) and the default event metadata fields—event time, Logger event, and device address.

- You can index up to 123 fields on Logger. This number includes the custom schema fields you may have added to your Logger.
- Once a field has been added to the index, it cannot be undone.
- Only users belonging to a System Admin Group can add fields to index.
- After you add a field to the index, Logger might not immediately start indexing on that field. Therefore, allow some time between adding a field and using it in the search query. If Logger is in the process of indexing on a field and you use that field to run a search query, the search performance for that operation will be slower than expected.
- If an event field contains data of unexpected type (for example, a string when an integer is expected), the data is ignored. Therefore, search for that data value will not yield any results. For example, if the port field contains a value 8080A (alphanumeric) instead of 8080 (numeric), the alphanumeric value is ignored.
- For faster report generation, ALL fields of a report (including the fields being displayed in the report) need to be indexed. That is, in addition to the fields in the WHERE clause of the query, the fields in the SELECT clause also need to be indexed.
- For optimal search performance, make sure that event fields on ALL peers are indexed for the time range specified in a query. If an event field is indexed on a Logger but not on its peers for a specific time range, a distributed search will run slower on the Loggers. However, it will run at optimal speed on the local Logger. Therefore, the search performance in such a setup will be slow.
- Although the requestUrl field is available for search and report queries, it cannot be indexed. Including this field in such queries will result in the query running slower than a search performed on indexed data.

## Search Options

### Prerequisites

Users must be assigned to the following User Groups to access this feature:

- Default Logger Rights Group
- Default System Admin Group

See ["Setting Logger User Permissions" on page 458](#) for more information.

The search options on this page support internationalization (i18n) choices. To adjust these options, open the **Configuration | Search** menu and click **Search Options**.

### Edit Search Options

**Most users shouldn't need to adjust these settings**

---

**Field Search Options**

Case sensitive

Include NULL field value in NOT operator results

**Full-text Search Options**

Use primary delimiters

Use secondary delimiters

**Regular Expression Search Options**

Case sensitive

Unicode case sensitive

Check for canonical equality

**Search Display Options**

Populate rawEvent field for syslog events

Show source and sourceType fields

**Field Summary Options**

Use Field Summary

Discover fields

### Modifying Logger search options:

The following table lists the advanced search options you can view and configure.

**Note:** Several of the options on this screen will require you to reboot your Logger Appliance or restart your Software Logger.

Option	Description
<b>Field Search Option</b>	
Case sensitive	<p>Default: <b>Yes</b></p> <p>Controls whether to differentiate between upper- and lower-case characters during a search. When this option is set to No, searching for "login" will find "login," "Login," and "LOGIN".</p> <p>You must reboot the Logger Appliance/restart the Software Logger for this change to take effect.</p> <p><b>Notes:</b></p> <ol style="list-style-type: none"> <li>1. Setting this option to <b>No</b> may affect query performance.</li> <li>2. Changing the case-sensitivity only applies to the local Logger. Peer Loggers will continue to use their own settings.</li> <li>3. Full-text search (keyword search) is case insensitive. You cannot change its case sensitivity.</li> </ol>
Include NULL field value in NOT operator results	<p>Default: <b>No</b></p> <p>Setting this option to <b>Yes</b> causes queries using the NOT operator to return events where the field value matches the filter criteria or is NULL.</p> <p>The default, <b>No</b>, causes queries using the NOT operator to only return events where the field value matches the filter criteria.</p> <p>You must reboot the Logger Appliance/restart the Software Logger for this change to take effect.</p>
<b>Full-text Search Options</b>	
Use primary delimiters	<p>Default: <b>Yes</b></p> <p>Controls whether primary delimiters are applied to an event to tokenize it for indexing.</p> <p>A primary delimiter tokenizes an event for indexing. For example, an event "john doe the first" is tokenized into "john" "doe" "the" "first" using the "space" primary delimiter.</p> <p>The primary delimiters are: space, tab, newline, comma, semi-colon, ( ) [ ] { } “   *</p>
Use secondary delimiters	<p>Default: <b>No</b></p> <p>Controls whether secondary delimiters are applied to an event to further tokenize a token created by a primary delimiter thus enabling searches that can match a part of a primary token.</p> <p>For example, you can search for "hpe.com" in http://www.hpe.com.</p> <p>The secondary delimiters are: period, = : / \ @ - ? # &amp; _ &gt; &lt;</p>
<b>Regular Expression Search Options</b>	
Case sensitive	<p>Default: <b>No</b></p> <p>See <a href="#">"Case sensitive" above</a>.</p> <p>You must reboot the Logger Appliance/restart the Software Logger for this change to take effect.</p>

Option	Description
Unicode case sensitive	<p>Default: <b>No</b></p> <p>Controls whether events in languages other than English should be compared in a case-sensitive way.</p> <p><b>Caution:</b> HPE strongly recommends that you do not change this option.</p> <p>You must reboot the Logger Appliance/restart the Software Logger for this change to take effect.</p>
Check for canonical equality	<p>Default: <b>No</b></p> <p>Controls whether events in languages other than English should be compared using locale-specific algorithms.</p> <p><b>Caution:</b> HPE strongly recommends that you do not change this option.</p> <p>You must reboot the Logger Appliance/restart the Software Logger for this change to take effect.</p>
<b>Search Display Options</b>	
Populate rawEvent field for syslog events	<p>Default: <b>No</b></p> <p>Controls whether raw events are displayed in a formatted column called rawEvent using the Raw Event field set. This option applies to syslog events only. If you want to view the raw events associated with CEF events, you do not need to configure this setting. Instead, configure the connector that is sending events to Logger to populate the rawEvent field with the raw event.</p> <p><b>Note:</b> Even though the rawEvent column displays the raw event, this column is not added to the Logger database and is not indexed. Therefore, you can only run a keyword (full-text) or regular expression search on the event.</p>
Show Source and SourceType fields	<p>Default: <b>No</b></p> <p>Controls whether the Source and SourceType fields are included in the Field Summary and query results.</p> <p>You must reboot the Logger Appliance/restart the Software Logger for this change to take effect.</p> <p><b>Note:</b> Setting this option to <b>Yes</b> can impact query performance.</p>
<b>Field Summary Options</b>	
Use Field Summary	<p>Default: <b>Yes</b></p> <p>Controls the whether the Field Summary panel is included in the search results by default. Regardless of the default, you can change the setting on-the-fly by using the Fields Summary checkbox on the Search screen.</p>
Discover Fields	<p>Default: <b>No</b></p> <p>Controls whether the Field Summary feature automatically detects non-CEF fields in raw events. Regardless of the default, you can change the setting on-the-fly by using the Discover Fields checkbox on the Search screen.</p> <p>This field is hidden if Use Field Summary is set to No.</p>



## Managing Fieldsets

You can view the predefined fieldsets and the ones you have created on the Fieldsets page (**Configuration | Search > Fieldsets**).

Fieldsets		
Name	Type	Fields
Network Routers, and Switches	System	Event Time, deviceVendor, deviceProduct, name, deviceEventClassId, sourceAddress, sourceHostName, sourcePort, destinationAddress, destinationHostName, destinationPort, transportProtocol, deviceAction, deviceSeverity, deviceAddress, deviceHostName, deviceCustomNumber2Label, deviceCustomNumber2, deviceCustomString2Label, deviceCustomString2, deviceCustomString3Label, deviceCustomString3, deviceCustomString5Label, deviceCustomString5, deviceCustomString6Label, deviceCustomString6, categoryDeviceGroup, categoryBehavior, categoryObject, categoryOutcome, categorySignificance, *user, Raw Message
NIDS	System	Event Time, deviceVendor, deviceProduct, name, deviceEventClassId, sourceAddress, sourceHostName, sourcePort, destinationAddress, destinationHostName, destinationPort, fileName, deviceCustomString2Label, deviceCustomString2, deviceCustomString3Label, deviceCustomString3, deviceCustomString4Label, deviceCustomString4, deviceCustomString5Label, deviceCustomString5, deviceCustomNumber1Label, deviceCustomNumber1, deviceAddress, deviceHostName, deviceSeverity, categoryDeviceGroup, categoryBehavior, categoryObject, categoryOutcome, categorySignificance, *user, Raw Message
VPN	System	Event Time, deviceVendor, deviceProduct, name, deviceEventClassId, message, deviceAction, sourceAddress, sourceTranslatedAddress, sourceHostName, destinationAddress, destinationHostName, transportProtocol, deviceAddress, deviceHostName, deviceSeverity, sourceUserName, destinationUserName, deviceCustomNumber1Label, deviceCustomNumber1, deviceCustomNumber2Label, deviceCustomNumber2, deviceCustomNumber3Label, deviceCustomNumber3, deviceCustomString1Label, deviceCustomString1, deviceCustomString2Label, deviceCustomString2, deviceCustomString3Label, deviceCustomString3, deviceCustomString4Label, deviceCustomString4, deviceCustomString5Label, deviceCustomString5, deviceCustomString6Label, deviceCustomString6, bytesIn, bytesOut, deviceInboundInterface, deviceOutboundInterface, categoryDeviceGroup, categoryBehavior, categoryObject, categoryOutcome, categorySignificance, *user, Raw Message

In this list of fieldsets, \*user indicates user-created fields. An asterisk (\*) at the end of the list of fields indicates that more fields are included than are listed.

If you have “Edit, save, and remove fieldsets” privileges, you can delete your custom fieldsets from this screen.

**Note:** You can only delete the field sets you create, and not the predefined ones available on Logger.

### To delete a custom field set:

1. Open the **Configuration | Search** menu and click **Fieldsets**.
2. Identify the field set you want to delete and click the Delete icon (✕).
3. Confirm the deletion.

## Default Fields

The Logger schema comes with a set of predefined fields. Some of these fields are already indexed for improved search speed and efficiency. You can add custom fields to Logger's schema and index them for field-based search. A field-based search can only use fields in the schema.

**Note:** The size of each field in the schema is predetermined. If the string you are searching for is longer than the field-length, you should use a STARTSWITH rather than an = search, and include no more than the number of characters in the field size. For more information, see “Field-based Search” on page 1.

The Default Fields page (**Configuration | Search > Default Fields**) displays the predefined fields included in the schema. It includes the Display Name, Type, Length, and Field Name for each default field. To view information on existing custom fields, see ["Custom Fields" on the next page](#).

## Prerequisites





Users must be assigned to the following User Groups to access this feature:

- Default Logger Rights Group
- Default System Admin Group

See ["Setting Logger User Permissions" on page 458](#) for more information.



## To view the default schema fields:

1. From the Configuration menu under Search, click **Default Fields**.

Default Fields					
Display Name	Type	Length	Field Name		indexed
agentAddress	TEXT	16	agt		-
agentHostName	TEXT	40	ahost		-
agentNtDomain	TEXT	40	agentNtDomain		-
 agentSeverity	TEXT	-	agentSeverity		Indexed
 agentType	TEXT	16	at		Indexed
agentZone	TEXT	200	agentZone		-
agentZoneName	TEXT	50	agentZoneName		-
agentZoneResource	TEXT	100	agentZoneResource		-
agentZoneURI	TEXT	2048	agentZoneURI		-
 applicationProtocol	TEXT	40	app		Indexed
 baseEventCount	LONG	-	cnt		Indexed

2. The Default Fields page displays the default schema fields. You can sort the fields by clicking the column headers.

Logger displays the Index status of each field in two ways:

- The **Indexed** column shows indexed and superindexed fields.
- The **Display Name** field includes a light green icon () for indexed fields, and a dark green icon () for superindexed fields. Non-indexed fields have no icon.

## Custom Fields

You can view the custom fields that have been added to the Logger schema under Configuration | Search > **Custom Fields**.

Custom Fields						
Display Name	Type	Length	Field Name	Actual Field Name	Creator	Created
DoubleField1	DOUBLE	-	DoubleField1	ad.DoubleField1.r	admin	Jul 12, 2016 9:36:11 AM PDT
Peer_Field	TEXT	25	MytextField	ad.MytextField	admin	Jul 12, 2016 9:35:40 AM PDT

This page lists all custom schema fields that have been saved. You can view the alphabetical list of fields, but cannot edit or delete them. For detailed information about custom fields, see ["Adding Fields to the Schema" on page 377](#).

## Running Searches

When a search initiated as a result of any of the following operations is in-progress, the Running Searches page (**Configuration | Search > Running Searches**) displays the currently running process.

- A manual search on local or peer Logger (**Analyze > Search**)
- A scheduled search (**Configuration | Search > Saved Search**)
- A saved search alert (**Configuration | Search > Scheduled Searches/Alerts**)
- A search export, with the “Rerun query” option checked (**Analyze > Search > Export Results**)

The table shows the session ID, user who started the tasks, the date and time that the task started, the number of hits, the number of scanned events, the elapsed time, and the query.

Running Searches							
<input type="button" value="Refresh"/>							
Session ID	User	Start	Hits	Scanned	Elapsed	Query	
0	admin	Jul 21, 2016 3:52:25 PM PDT	0	22,508,626	06:13.667	receiver = "UDP Receiver"	✕
6	admin	Jul 21, 2016 3:58:26 PM PDT	77	129,784	00:12.378	Logger	✕

Once a task finishes, the task's entry on the Running Searches page is removed. (The task entry is removed upon page refresh, either when you refresh the browser page or when you navigate away from this page and come back to it.)

You might need to end a currently running search task when it is taking too long to run, or appears to be stuck and slowing the overall Logger performance.

**Note:** You must have admin user privileges to end a running search process. See ["Setting Logger User Permissions"](#) on page 458 for more information on Logger user rights and how to administer them.

### To view the currently running searches:

Open the **Configuration | Search** menu and click **Running Searches**. Any searches that are currently running are displayed.

### To end a currently running search:

1. Open the **Configuration | Search** menu and click **Running Searches**.
2. To end a search process, click the **✕** icon for the task.

## Lookup Files

Lookup files are used by the lookup search operator to enrich Logger data during a search. After you upload a valid Lookup file to Logger, you can use that Lookup file in a lookup search command.

The Lookup Files page displays the uploaded Lookup files.

### Lookup Files

[Add](#)

Name	Schema	Row count	Schedule	
<a href="#">deviceVendor_dept_org_status_protocol</a>	Write down	12	None	
<a href="#">SL_Lookup</a>	ip, host, status, protocol	7	None	

- For information on when to use the lookup operator, see ["Enriching Logger Data Through Static Correlation"](#) on page 138.
- For information on how to use the lookup operator when searching, see ["lookup"](#) on page 487.

## Creating Lookup Files

Lookup files must be in CSV format with the Lookup field names as the first row. (A Lookup field is an individual column in the Lookup file.) Each row in the table is loaded sequentially and the first row is treated as the definition of the columns in the table. Any subsequent row that does not contain the same number of comma-separated values as the first row will be skipped during the search by the Lookup operator. If a search using the Lookup operator needs to skip one or more rows, a warning message displays on the search page. HP recommends that you check the table with a tool such as Microsoft Excel to make sure that each row has the same number columns as the header row before uploading it as a lookup file.

**Tip:** For more information on the CSV format your lookup files need to follow, refer to RFC 4180.

## Naming Lookup Files

The Lookup filenames can contain only alphanumeric characters and underscore, and must NOT begin with a number. Do not include +, -, or \* in the filename. These characters are reserved for the Lookup command.

Creating a short and meaningful Lookup filenames make it easy to identify Lookup fields in the output. To help differentiate them from Logger fields, fields from the Lookup file are appended with the first six characters of the Lookup file name when displayed in the search results.

As an example, look at the following search:

```
lookup _table_20160608 ip as src output hostname
```

In this example, "\_table\_" will be appended to the Lookup field "hostname". The date (20160608) will not be included. The name displayed in the search results will be "hostname\_table\_" because only the first six characters of the Lookup file name are appended.

## Naming Fields in the Lookup File

Lookup fieldnames can contain only alphanumeric characters and underscore, and must NOT begin with a number. Do not include +, -, or \* in the fieldname. These characters are reserved for the Lookup command.

## Duplicate Values in the Lookup File

When there are multiple rows with identical values in a Lookup column, the lookup operation only uses the first row that matches and ignores any subsequent matches.

When using Logger exported search results as Lookup file, you can use "dedup" operator to remove the duplicate values in the fields that will be used as Lookup fields. For more information on duplication in

Lookup fields, see the lookup operator "[lookup](#)" on page 487. For more information on the dedup operator, see "[dedup](#)" on page 476.

## Lookup Capacity

- The maximum size Lookup file that can be uploaded is 50 MB (uncompressed or compressed)
- The maximum disk space allocated for storing Lookup files is 1 GB. This is the cap on overall disk space allowed for storing all Lookup files.
- Maximum number of Lookup entries is 5,000,000 (A Lookup entry is an individual comma-separated value in the Lookup file.)

For example, if a Lookup file has four columns and ten rows, the total number of lookup entries is  $4 \times 10 = 40$ . When such a Lookup file is used in the search, all of its entries will be loaded into memory. It is worth noting that the maximum number of rows loaded for lookup varies depending on the number of columns in the Lookup file.

For example, if a Lookup file contains 500 columns, the maximum number of rows allowed for lookup will be  $5,000,000 / 500 = 10,000$  rows, and any subsequent rows will not be used. On the other hand, if the table has only four columns, the maximum number rows allowed for lookup will be  $5,000,000 / 4 = 1,250,000$  rows.

When exporting Logger search results to use them as Lookup files, uncheck **All Fields** and export only the fields you need.

**Export Options** Help

Save to local disk  Save to Logger

File format: PDF

Title: ExportSearchtoLocalPDF

Fields:  All fields Clear

Event Time, Device, Logger, deviceVendor, deviceProduct, deviceVersion, deviceEventClassId, name, agentAddress, agentHostName, agentType, agentZoneURI, baseEventCount, categoryBehavior

Include Event Total

Include only CEF events

Rerun query

**Export** **Cancel**

Since there is an overall limit of 5 million lookup entries, exporting only the necessary fields will reduce the number of rows loaded for lookup.

## Uploading Lookup Files

Click **Add** on the Lookup Files page to upload a Lookup file in .csv, .zip, or .gz format. You can upload an individual Lookup file from your local desktop or schedule a lookup file to be uploaded regularly from a location accessible to Logger.

Uncompressed files (files uploaded in .csv format) will be compressed into .zip format and stored with the name you specified (<name> .zip.) Compressed files will be uploaded and stored in their original compression format with the name you specified (<name> .zip or <name> .gz.) Upload compressed Lookup files (.zip or .gz) when possible. This saves upload time and loads more information for the same upload file size. You can only include one Lookup file in .csv format in each .zip or .gz file.

For information on how to use the Lookup operator when searching, see ["lookup" on page 487](#).

### To add a Lookup file:

1. Open the **Configuration | Search** menu and click **Lookup Files**.
2. Click **Add**. The Add Lookup File page opens.

#### Add Lookup File

The screenshot shows a form titled "Add Lookup File". It contains the following fields and controls:

- Name:** A text input field containing the value "deviceVendor\_dept\_org\_status\_protocol".
- File Location:** A dropdown menu with "Local" selected.
- Lookup File:** A "Browse..." button followed by the text "ImportedLookupFile.csv".
- Buttons:** "Save" and "Cancel" buttons at the bottom.

3. Enter a meaningful name for the Lookup file. This name can contain only alphanumeric characters and underscore, and must NOT begin with a number. Do not include +, -, or \* in the name. These characters are reserved for the lookup command.
4. Select where to access the Lookup file.
  - Select **Local** to browse to a location on your local machine and upload the file one time only.
  - Select **On Logger** to enter a path on the Logger's server. If you select this option, you can choose to set up a regular update schedule.

The available options change based on your selection.

5. Specify the Lookup file's location:



- If you selected **Local**, click **Browse**, navigate to the desired .csv, .zip or .gz file, and then click **Open**.
- If you selected **On Logger**, specify the absolute path and file name on the Logger system. For example, if the file is in the /opt folder on your Logger you could specify /opt/lookup.csv. The lookup file must already exist in this location. The user Logger was installed with must have read permissions on the lookup file itself and on the directory you specify here.

**Note:** The Logger Appliance supports mounting through the user interface. Software Logger uses its file system, which can contain remote folders mounted through the operating system.

6. If you selected **On Logger**, specify how often to upload the Lookup file.
  - To upload the Lookup file only once, check **One time only**.
  - To schedule the Lookup file to be uploaded now and at regularly scheduled interval, remove the checkmark by **One time only** and then use the schedule options to specify how frequently to update the lookup file. For details about these options, see "[Scheduling Date and Time Options](#)" on page 136.
7. Click **Save**. After the Lookup file is uploaded, it will be displayed in the list of Lookup files. If you specified a schedule, the Lookup process will look in the specified location at the indicated time and upload the new version (if there is one).

## Managing Uploaded Lookup Files

After you upload a Lookup file, you can view it, edit it or delete it by using the icons at the end of the row for that file.

Lookup Files			
<a href="#">Add</a>			
Name	Schema	Row count	Schedule
<a href="#">deviceVendor_dept_org_status_protocol</a>	Write down	12	None   
<a href="#">SL_Lookup</a>	ip, host, status, protocol	7	None   

To view an uploaded Lookup file:

1. Open the **Configuration | Search** menu and click **Lookup Files**.
2. Find the Lookup file you want to view, click the view icon () or the Lookup file's name.  
This view only shows a few rows. The entire file may not be displayed.



**Note:** The Schedule field is only displayed if the Lookup file has been scheduled for update.

#### View Lookup Files

<b>Name</b>	SL_Lookup																																
<b>Schedule</b>	None																																
<b>Schema</b>	ip, host, status, protocol																																
<b>Row Count</b>	7																																
<b>Preview</b>	<table><thead><tr><th>ip</th><th>host</th><th>status</th><th>protocol</th></tr></thead><tbody><tr><td>15.214.133.124</td><td>hacker.com</td><td>reported</td><td>TCP</td></tr><tr><td>15.252.64.240</td><td>flash.com</td><td>reported</td><td>TCP</td></tr><tr><td>15.252.64.240</td><td>flash.com</td><td>reported</td><td>UDP</td></tr><tr><td>15.252.64.240</td><td>flash.com</td><td>watched</td><td>UDP</td></tr><tr><td>15.199.224.251.</td><td>p2p.org</td><td>alert</td><td>TCP</td></tr><tr><td>15.252.64.242</td><td>fakeips.com</td><td>ok</td><td>TCP</td></tr><tr><td>15.252.64.248</td><td>staffit.com</td><td>unknown</td><td>UDP</td></tr></tbody></table>	ip	host	status	protocol	15.214.133.124	hacker.com	reported	TCP	15.252.64.240	flash.com	reported	TCP	15.252.64.240	flash.com	reported	UDP	15.252.64.240	flash.com	watched	UDP	15.199.224.251.	p2p.org	alert	TCP	15.252.64.242	fakeips.com	ok	TCP	15.252.64.248	staffit.com	unknown	UDP
ip	host	status	protocol																														
15.214.133.124	hacker.com	reported	TCP																														
15.252.64.240	flash.com	reported	TCP																														
15.252.64.240	flash.com	reported	UDP																														
15.252.64.240	flash.com	watched	UDP																														
15.199.224.251.	p2p.org	alert	TCP																														
15.252.64.242	fakeips.com	ok	TCP																														
15.252.64.248	staffit.com	unknown	UDP																														
	<input type="button" value="Done"/>																																

3. Click **Done** to return to the list of Lookup files. You cannot edit the file from here. If you need to change something, follow the steps under "[To edit a Lookup file:](#)" below.

#### To delete a Lookup file:

1. Open the **Configuration | Search** menu and click **Lookup Files**.
2. Find the Lookup file you want to remove, click the Remove icon (✖) on that row and then click **OK**.

**Note:** Attempting to remove a Lookup file that is still being used in a current search session will result in an error message. The file will not be deleted. To quickly clear such files from the search cache so that they can be removed, run a search that does NOT use the lookup operator. This closes the lookup search session and ensures that the Lookup file is no longer in use. Once the session is closed, you can remove the Lookup file.

#### To edit a Lookup file:

1. Open the **Configuration | Search** menu and click **Lookup Files**.

2. Find the Lookup file you want to edit, click the Edit icon (✎) on that row and then click **OK**. The Edit Lookup File page opens.

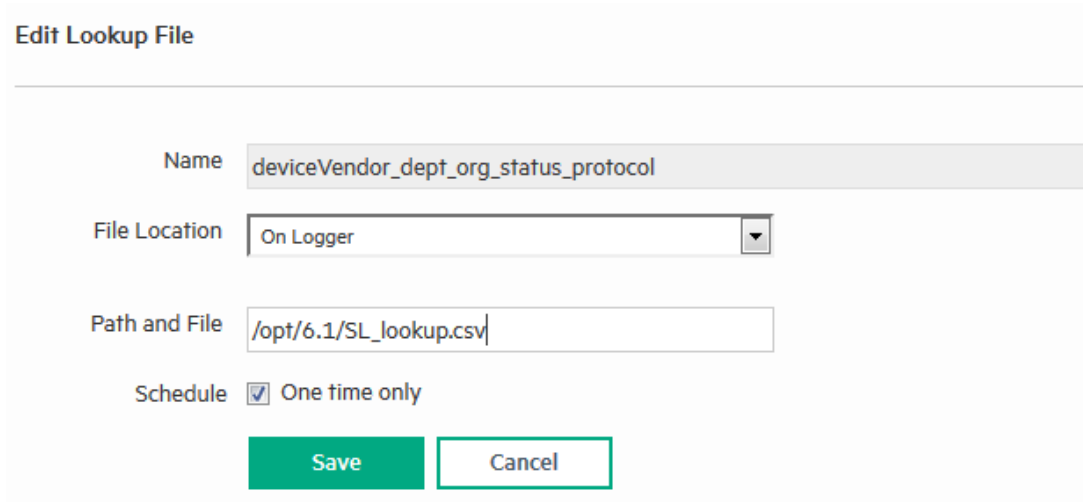

**Edit Lookup File**

Name

File Location

Path and File

Schedule  One time only

You can upload a new version of the Lookup file, schedule a lookup update, or change the existing update schedule.

3. Select where to access the Lookup file.
  - Select **Local** to browse to a location on your local machine and upload the file one time only.
  - Select **On Logger** to enter a path on the Logger's server. If you select this option, you can choose to set up a regular update schedule.

The available options change based on your selection.

4. Specify the Lookup file's location.
  - If you selected **Local**, click **Browse**, navigate to the desired .csv, .zip or .gz file, and then click **Open**.
  - If you selected **On Logger**, specify the absolute path and file name on the Logger system. For example, if the file is in the /opt folder on your Logger you could specify /opt/lookup.csv. The lookup file must already exist in this location.

**Note:** The Logger Appliance supports mounting through the user interface. Software Logger uses its file system, which can contain remote folders mounted through the operating system.

5. If you selected **On Logger**, specify how often to upload the Lookup file.
  - To upload the Lookup file only once, check **One time only**.
  - To schedule the Lookup file to be uploaded now and at regularly scheduled interval, remove the checkmark by **One time only** and then select a schedule. For scheduling information, see ["Scheduling Date and Time Options" on page 136](#).

6. Click **Save**. After the Lookup file is uploaded, it will be displayed in the list of Lookup files. If you specified a schedule, the Lookup process will look in the specified location at the indicated time and upload the new version (if there is one).

## Data

The options in the **Configuration | Data** category enable you to control the data going in and out of your Logger.

- [Devices](#) ..... 291
- [Device Groups](#) ..... 293
- [Receivers](#) ..... 294
- [Source Types](#) ..... 311
- [Parsers](#) ..... 315
- [Forwarders](#) ..... 321
- [Real Time Alerts](#) ..... 328
- [SNMP Destinations](#) ..... 337
- [Syslog Destinations](#) ..... 337
- [Sending Notifications to ESM Destinations](#) ..... 338
- [ESM Destinations](#) ..... 339
- [Certificates](#) ..... 342
- [Forwarding Log File Events to ESM](#) ..... 343
- [Data Validation](#) ..... 344

## Devices

A device is a named event source, comprising of an IP address (or hostname) and a receiver name. Two receivers can receive events from the same IP address, so IP address alone is insufficient to identify a device. Event source is the device that directly sends the event to Logger. When an event is sent through a SmartConnector, the event source is the system on which the SmartConnector is running and not the device that sent the event to the SmartConnector.

Devices can be added to device groups, and device groups can be referenced in filters and queries.

Receivers perform *autodiscovery* by automatically creating a device for each source IP address. Devices created by autodiscovery are named for their hostname, or if the hostname cannot be determined, their IP address.

The Devices page displays all defined devices and includes controls to add, edit, or delete them.

## Devices page

Devices

[Add](#)

Name	IP Address	Receiver	Creator	Last Editor
Logger Internal Event Device	127.0.0.1	Not Applicable	System	System
Logger Internal Event Device [Apache URL Access Error Log]	127.0.0.1	Apache URL Access Error Log	System	
Logger Internal Event Device [Var Log Messages]	127.0.0.1	Var Log Messages	System	
n15-214-194-h65.arst.usa.hp.com [AusmReceiver1]	15.214.194.65	AusmReceiver1	System	
n15-214-194-h65.arst.usa.hp.com [AusmReceiver101]	15.214.194.65	AusmReceiver101	System	

**Maximum number of devices that can be defined on Logger:** No limit.

Autodiscovery creates devices automatically, but you can also define them manually.

### To define a device:

1. Open the **Configuration | Data** menu and click **Devices**.  
A display similar the "Devices page" above appears.
2. Click **Add**.
3. Enter a name, an IP address, and select a receiver for the new device.
4. Click **Save** to add the new device, or **Cancel** to abandon it.

One reason for editing a device is to replace the default name created by autodiscovery (the IP address or hostname) with a more meaningful one.

### To edit a device:

1. Open the **Configuration | Data** menu and click **Devices**.  
A display similar the "Devices page" above appears.
2. Locate the device that you want to edit and click the Edit icon () on that row.
3. Change the Name or IP address for the device.
4. Click **Save** to update the device group, or **Cancel** to abandon your changes.

### To delete a device:

1. Open the **Configuration | Data** menu and click **Devices**.  
A display similar the "Devices page" above appears.
2. Locate the device that you want to delete and click the Remove icon () on that row.  
Deleting a device does not block the source IP address from sending events. If new events are received, autodiscovery recreates the device.
3. Confirm the deletion by clicking **OK**, or click **Cancel** to retain the device.

## Device Groups

Device groups allow you to categorize named source IP addresses called devices. The Device Groups page lists all device groups with edit and delete icons and includes the ability to create new device groups.

**Tip:** Device groups can be associated with storage rules that define in which storage groups where from specific devices are stored. Doing so enables you to retain event data from different sources for different lengths of times (because you can define different retention policies on different storage groups). For more information about storage rules, see ["Storage Rules" on page 349](#).

**Tip:** There is no maximum number of device groups that can be created on Logger.

### To create a device group:

1. Open the **Configuration | Data** menu and click **Device Groups**.
2. Click **Add**. A display similar to that shown below appears.

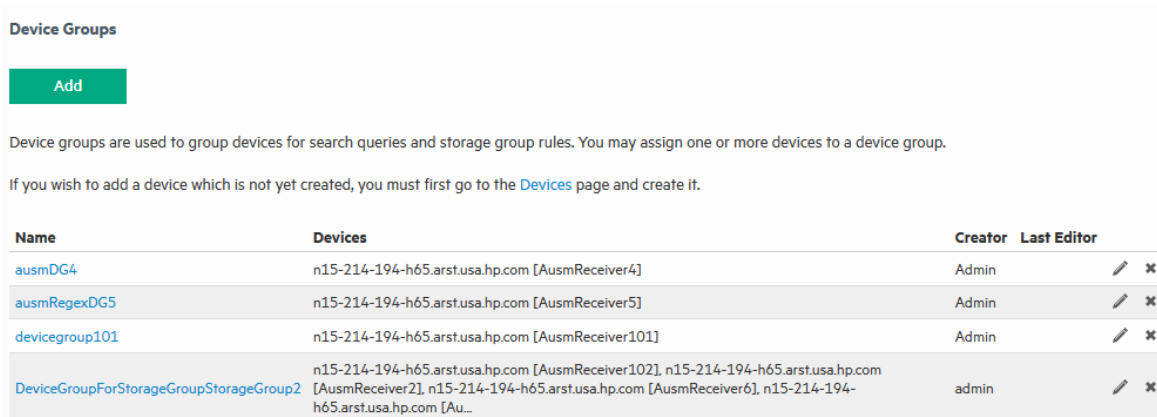

The screenshot shows the 'Device Groups' page. At the top, there is a green 'Add' button. Below it, a text block explains that device groups are used for search queries and storage group rules, and that new devices must be created on the 'Devices' page. A table lists existing device groups with columns for Name, Devices, Creator, and Last Editor.

Name	Devices	Creator	Last Editor
ausmDG4	n15-214-194-h65.arst.usa.hp.com [AusmReceiver4]	Admin	
ausmRegexDG5	n15-214-194-h65.arst.usa.hp.com [AusmReceiver5]	Admin	
devicegroup101	n15-214-194-h65.arst.usa.hp.com [AusmReceiver101]	Admin	
DeviceGroupForStorageGroupStorageGroup2	n15-214-194-h65.arst.usa.hp.com [AusmReceiver102], n15-214-194-h65.arst.usa.hp.com [AusmReceiver2], n15-214-194-h65.arst.usa.hp.com [AusmReceiver6], n15-214-194-h65.arst.usa.hp.com [Au...	admin	

3. Enter a name for the new device group. Click to select devices from the list. Press and hold the **Ctrl** key when clicking to add additional devices to the selection. To select a range of devices, click to select the first device, then press and hold the **Shift** key while clicking the last device.
4. Click **Save** to create the new device group, or **Cancel** to abandon it.

### To edit a device group:

1. Open the **Configuration | Data** menu and click **Device Groups**.
2. Locate the device group that you want to edit and click the Edit icon () on that row.
3. Change the Name, add, or remove devices from the selection. Ctrl-Click devices that are not selected to select them, or Ctrl-Click selected devices to remove them from the selection.
4. Click **Save** to update the device group, or **Cancel** to abandon your changes.

### To delete a device group:

1. Open the **Configuration | Data** menu and click **Device Groups**.
2. Locate the device group that you want to delete and click the Remove icon (✕) on that row. Deleting a device group does not affect the set of devices.
3. Confirm the deletion by clicking **OK**, or click **Cancel** to retain the device group.

## Receivers

Logger can receive text events, either sent through the network or read from a file. From the Receivers page, you can set up and configure the receivers that will capture event data, and populate each event with information about its origin. Some receivers capture streaming events transmitted over the network by devices, applications, services, and so on. Other types of receivers monitor individual files for events or monitor files selected from a directory tree, based on a pattern you specify. Since receivers can only receive events of a single source type, you should set up separate receivers for each type of log file.

To start receiving events, direct your event sources to the default receivers. For more information about the default receivers, refer to the Logger Installation guide.

Receiver types include UDP, TCP, SmartMessage, and three types of file based receivers, File Transfer, File Receiver, and Folder Follower Receiver.

Before the receiver can receive data, the port it is listening on must be opened through the firewall. For more information, see ["Firewall Rules" on page 469](#).

You can configure the following types of receivers:

- **UDP Receiver:** UDP receivers listen for User Datagram Protocol messages on the port you specify. Logger comes pre-configured with a UDP Receiver on port 514 or 8514, enabled by default. For Software Loggers, this port may vary based on the port numbers available at installation time.
- **CEF UDP Receiver:** UDP receivers that receive events in Common Event Format.
- **TCP Receiver:** TCP receivers listen for Transmission Control Protocol messages on the port you specify. Logger comes pre-configured with a TCP receiver on port 515 or 8515, enabled by default. For Software Loggers, this port may vary based on the port numbers available at installation time.
- **CEF TCP Receiver:** TCP receivers that receive events in Common Event Format.
- **Event Broker Receiver:** Event Broker receivers are consumers for the Event Broker's publish-subscribe messaging system. They subscribe to event topics and receive events in Common Event Format (CEF) from Event Broker.
- **Folder Follower Receiver:** Folder follower receivers actively read the log files in a specified directory as they are updated. If the source directory contains different types of log files, you can create a receiver for each type of file that you want to monitor. Logger comes pre-configured with folder follower receivers for Logger's Apache Access Error Log, the system Messages Log, and Audit Log (when auditing is enabled). You must enable these receivers in order to use them.

- **File Transfer:** File Transfer receivers read remote log files using SCP, SFTP, or FTP protocol. These receivers can read single- or multi-line log files. You can schedule the receiver to read a file or batch of files periodically.

**Note:** Be aware of the following when setting up file transfer receivers.

- The SCP, SFTP, and FTP file transfer receivers depend on the FTP (File Transfer Protocol) SCP (Secure Copy Protocol) and SFTP (SSH file transfer protocol) clients installed on your system. Ensure that the appropriate client is installed on the system before you create the receiver.
  - The SCP and SFTP protocols on Logger Appliances are not FIPS compliant.
- **SmartMessage Receiver:** SmartMessage receivers listen for encrypted messages from ArcSight SmartConnectors. Logger comes pre-configured with a SmartMessage receiver with the name "SmartMessage Receiver." To use this receiver to receive events from a SmartConnector, set the **Receiver Name** to be "SmartMessage Receiver" when configuring the SmartConnector's destination. For more information on SmartConnectors, see ["Using SmartConnectors to Collect Events" on page 506](#).

## Event Broker Receivers

Event Broker receivers connect to ArcSight Data Platform Logger and ArcSight Event Brokers and consume all events for the topics that they subscribe to. Loggers receiving events from the Event Broker can be part of a pool of Loggers for balanced distribution and redundancy. The events will be distributed among Loggers in the pool in a round-robin fashion. If one Logger in the pool is down, the events will be sent to one of the others.

You can configure multiple Loggers with Event Broker receivers that subscribe to the same Event Topic List and belong to the same Consumer Group. Each Logger Event Broker receiver in the group will receive events from a different subset of partitions in the topic. The Event Broker will balance the partitions between all Event Broker receivers configured in the same Consumer Group.

The events are published to the Event Broker by ArcSight Data Platform Logger and ArcSight SmartConnector. When configuring your SmartConnector to send data to an Event Broker receiver, use the "Event Broker (CEF Kafka)" destination.

For more information about ArcSight Data Platform Logger and ArcSight Event Broker, refer to the ArcSight Data Platform Logger and ArcSight Event Broker User's Guide, available for download from the [ArcSight Product Documentation Community on Protect 724](#).

For more information about SmartConnectors, refer to the SmartConnector User's Guide, available for download from the [ArcSight Product Documentation Community on Protect 724](#).

For more information about Kafka, refer to the [Kafka documentation](#).

## File Based Receivers

File based receiver types include File Receivers, File Transfer Receivers, and Folder Follower Receivers. You can set them up as multiline receivers, and configure them to use source types with associated parsers to extract data from captured events.

**Note:** When a receiver cannot read the file it logs from, such as when the file or folder is deleted or renamed, Logger records a message in `current/arcsight/logger/logs/logger_receiver.log`

## Multi-line Receivers

TCP and UDP receivers interpret line break characters, such as `\r` or `\n`, as the end of the event. If the input event contains embedded `\r` or `\n` characters, the event will be treated as more than one event. If your events span more than one line, you may want to use a multi-line receiver. Multi-line receivers include the File Transfer, File Receiver, and Folder Follower Receivers.

A multi-line receiver can read events that span more than one line, such as a server log. You could set up the receiver to handle stack traces reported in the log by reading the entire stack trace as a single event instead of reading each line separately.

When creating a multi-line receiver, you must specify a regular expression that the receiver should use to detect the start of a new event in the log file. Each new event starts where the characters in the log file match the regular expression.

For example, in the following log file, each event starts with a timestamp embedded within square brackets (`[yy-MM-dd HH:mm:ss.SSS]`); therefore, you can use this regular expression to identify each event:

```
^\[\d+-\d+-\d+ \d+:\d+:\d+,\d+\].*
```

```
[2016-06-06 13:11:26,824][INFO][I18N]Locale has not been chosen by the user.  
[2016-06-06 13:11:26,824][ERROR][DirectConnection$ReadChannel]  
java.io.IOException: end of communication channel  
    at com.arcsight.logger.distributed.DirectConnection.a(DirectConnection.java:39)  
    at com.arcsight.logger.distributed.DirectConnection.access$200(DirectConnection.java:19)  
    at com.arcsight.logger.distributed.DirectConnection$ReadChannel.run(DirectConnection.java:85)  
    at java.util.concurrent.ThreadPoolExecutor$Worker.runTask(ThreadPoolExecutor.java:886)  
    at java.util.concurrent.ThreadPoolExecutor$Worker.run(ThreadPoolExecutor.java:908)  
    at java.lang.Thread.run(Thread.java:619)
```

- For multi-line file receivers and file transfer receivers, the regular expression that identifies the beginning of a new event must be specified in the receiver's *Multiline Event Starts With* field.
- For multi-line folder follower receivers, the regular expression that identifies the beginning of a new event must be specified in the *Multiline Event Starts With* field of the **source type** associated with that receiver, rather than in the receiver itself.



For information on creating and using receivers, see ["Working with Receivers" on the next page](#). For information on creating and using source types, see ["Source Types" on page 311](#).

## Folder Follower Receivers

When you want to monitor active files as they are updated, use a folder follower receiver. After you set up a folder follower receiver and enable it, it will monitor the specified files in that directory and continuously upload new events to the system. Folder follower receivers recognize file rotation.

### **Overview of the steps to monitor a directory:**

1. Determine the types of logs you need to monitor.
2. Determine whether the out-of-box source types or source type/parser pairs will satisfy your needs. For more information, see ["Source Types" on page 311](#), and ["Parsers" on page 315](#).

If so, proceed to the next step.

If not, create the parsers and source types that you need.

- a. Select an appropriate parser or set of parser for the log files in the directory you want to follow. If the out-of-box parsers do not provide what you need, create appropriate parsers.
  - b. Assign a source type for each parser. If the out-of-box source types do not provide what you need, create appropriate source types.
3. Create the folder follower receivers required to monitor the logs in the directory, selecting the source type you chose or created, above. For more information, see ["Working with Receivers" on the next page](#).
  4. Enable the receivers.
  5. Optionally, to forward log file events, set up and configure one or more forwarders. For more information, see ["Forwarders" on page 321](#).

## Using Source Types with File Follower Receivers

Logger uses the parser associated with the source type you select for a receiver to extract fields and their respective values from the received events. These fields are parsed at search time. For more information on using source types and parsers, see ["Source Types" on page 311](#), and ["Parsers" on page 315](#).

When creating a file follower receiver, you must select a source type appropriate to monitor a specific type of log file. After you select the source type for the file follower receiver, ensure that the parser associated with it works with your source files.

Events from different versions of the same source type can be in different formats. Similarly, events from different source types of the same vendor might be formatted differently. Therefore, if the source type of your source file does not exactly match the specifications of your source type, the associated parser will not parse events correctly, and the search results will not display any parsed fields.

To confirm whether the source type has a valid parser for your source type, after you have set up the receiver, check whether the incoming events are parsed. To determine this, run a search and review the “parser” field in the search results. The parser used in the search will be displayed in the parser column of the search results. If the event was parsed, this field contains the name of the parser. If the event was not parsed successfully, this field contains “Not parsed.” If no parser is defined for the source type or if there is no source type, the field is blank.

## Working with Receivers

Several receivers come set up on your system. You can add other receivers as needed. The maximum number of receivers that you can create is limited by system resources—memory, CPU, disk input/output and possibly network bandwidth. The receiver ports available on your system may vary from the image shown.

Before the receiver can receive data, the port it is listening on must be opened through the firewall. For more information, see ["Firewall Rules" on page 469](#).

### Receivers page

**Receivers**

[Add](#)

Once you enable the Apache URL Access Error Log receiver, Logger will start storing entries from the <install\_dir>/userdata/logs/apache/http\_error\_log file.

Logger can also store entries from the messages and audit.log files in the /var/log/\* folders. Before enabling the receivers for these files, consult the Logger Administrators guide for details.

Name	Type	IP Address	Port	
<a href="#">Apache URL Access Error Log</a>	Folder Follower Receiver			
<a href="#">Audit Log</a>	Folder Follower Receiver			
<a href="#">AusmReceiver1</a>	TCP Receiver	All	30001	
<a href="#">AusmReceiver101</a>	CEF TCP Receiver	All	30101	

Before creating a receiver of type File Receiver:

- For the Logger Appliance, set up a Network File System mount. See ["Storage" on page 347](#).
- For Software Logger, the file system from which the log files will be read needs to be mounted on the system on which you have installed Logger.

**Note:** Before creating a receiver of type File Transfer, ensure that the appropriate SCP, SFTP, and FTP client is installed on your system.

The Logger Appliance supports mounting through the user interface. Software Logger uses its file system, which can contain remote folders mounted through the operating system.

### To create a receiver:

1. Open the **Configuration | Data** menu and click **Receivers**.  
The ["Receivers page" on the previous page](#) displays the current receivers and their status. You can sort the fields by clicking the column headers.
2. Click **Add**.
3. Enter a name for the new receiver. SmartMessage receiver names are used when configuring the associated ArcSight SmartConnectors.
4. Choose the receiver type. Select UDP Receiver, TCP Receiver, CEF UDP Receiver, CEF TCP Receiver, File Receiver, Folder Follower Receiver, File Transfer, or SmartMessage Receiver.

**Note:** The receiver type cannot be changed after the receiver is created.

5. Click **Next** to edit receiver parameters.  
The fields displayed in the Edit Receiver dialog box vary according to the type of Logger and the type of receiver.
6. Fill in the appropriate fields. Refer to the following tables for field descriptions.
  - ["UDP, TCP, CEF UDP, and CEF TCP Receiver Parameters" on page 301](#)
  - ["Event Broker Receiver Parameters" on page 302](#)
  - ["File Receiver Parameters" on page 303](#)
  - ["Folder Follower Receiver Parameters" on page 305](#)
  - ["File Transfer Receiver Parameters" on page 307](#)
  - ["SmartMessage Receiver Parameters" on page 309](#)
7. The **Enable** checkbox is flagged by default, so that the receiver will be enabled immediately after you create. If you do not want to enable the receiver now, click the checkbox to remove the flag. You can enable it later.
8. Click **Save**.

### To enable or disable a receiver:

**Note:** Before enabling the following preconfigured folder follower receivers for Software Logger, ensure that the files are readable by the non-root user that you installed with or specified during installation.

- `/var/log/messages`
- `/var/log/audit/audit.log`

1. Open the **Configuration | Data** menu and click **Receivers**.

The "Receivers page" on page 298 displays the current receivers and their status. You can sort the fields by clicking the column headers.

2. Locate the receiver that you want to enable or disable.
  - If the receiver is currently disabled, click the Disabled icon (🚫) to enable it.
  - If the receiver is currently enabled, click the Enabled icon (✅) to disable it.

**Tip:** Wait a few minutes after enabling a receiver before disabling it. Likewise, wait before enabling a receiver that has just been disabled. Background tasks initiated by enabling or disabling a receiver can produce unexpected results if they are interrupted.

### To edit a receiver:

1. Open the **Configuration | Data** menu and click **Receivers**.

The "Receivers page" on page 298 displays the current receivers and their status. You can sort the fields by clicking the column headers.

2. Locate the receiver that you want to update and click the Edit icon (✎) on that row.

The fields displayed in the Edit Receiver dialog box vary according to the type of Logger and the type of Receiver.

3. Edit the appropriate fields. Refer to the following tables for field descriptions.
  - "UDP, TCP, CEF UDP, and CEF TCP Receiver Parameters" on the next page
  - "Event Broker Receiver Parameters" on page 302
  - "File Receiver Parameters" on page 303
  - "Folder Follower Receiver Parameters" on page 305
  - "File Transfer Receiver Parameters" on page 307
  - "SmartMessage Receiver Parameters" on page 309

4. Flag the **Enable** checkbox to have the receiver immediately enabled, or remove the flag from the checkbox to enable the receiver later.
5. Click **Save**.

### To delete a receiver:

1. Open the **Configuration | Data** menu and click **Receivers**.

The "Receivers page" on page 298 displays the current receivers and their status. You can sort the fields by clicking the column headers.

2. Locate the receiver that you want to delete and click the Remove icon (✖) on that row.
3. Click **OK** to confirm the delete.

## UDP, TCP, CEF UDP, and CEF TCP Receiver Parameters

Fill in the following fields when creating or editing UDP Receivers, TCP Receivers, CEF UDP Receivers, and CEF TCP Receivers.

Parameter	Description
Name	Enter the name of the Receiver, used for reporting and status monitoring.
IP/Host	Select one of the available network connections for the receiver to listen to, or select <b>All</b> to listen on both network connections.  <b>Note:</b> If localhost (127.0.0.1) appears in the list, it means that the Logger hostname has not been configured. To configure the hostname, see <a href="#">"Network" on page 406</a> .
Port	For the Logger Appliance: <ul style="list-style-type: none"> <li>The default UDP Receiver is pre-configured on port 514.</li> <li>For SmartMessage receivers, configure the SmartConnector for port 443.</li> </ul> For Software Logger: <ul style="list-style-type: none"> <li>If you installed Software Logger as a root user, you can use any available port. The default UDP Receiver is pre-configured on port 514. If that port is not available, then the next higher available port is chosen.</li> <li>If you installed Software Logger as a non-root user, you can only use a port numbers greater than 1024. The default UDP Receiver is pre-configured on port 8514. If that port is not available, then the next higher available port is chosen.</li> </ul>
Encoding	Select a character encoding, such as US-ASCII, Big5, or EUC-KR, from the pulldown list. CEF UDP, CEF TCP, and SmartMessage receivers must use US-ASCII or UTF-8 encoding.
Source Type	Select from the pull-down list of log file types, including: <ul style="list-style-type: none"> <li>Apache HTTP Server Access</li> <li>Apache HTTP Server Error</li> <li>Juniper Steel-Belted Radius</li> <li>Microsoft DHCP Log</li> <li>IBM DB2 Audit</li> <li><i>More options...</i></li> </ul> Additionally, you can define your own source types, based on the needs of your company. See <a href="#">"Source Types" on page 311</a> .  A receiver can only receive events of a single source type. Set up separate receivers for each type of log file.  <b>Note:</b> CEF TCP and CEF UDP receivers are set to the CEF source type, and cannot be changed. Currently, there is no parser associated with the CEF source type.  Associating Source types with TCP and UDP receivers was introduced in Logger 5.3 SP1. When upgrading, TCP and UDP receivers from earlier releases are set to the "Other" source type.

## Event Broker Receiver Parameters

Fill in the following fields when creating or editing Event Broker receivers.

Parameter	Description
Name	<p>Enter the name of the Event Broker receiver.</p> <p>This is a required field.</p>
Event broker host(s) and port	<p>Enter a list of host/port pairs to use for establishing the initial connection to the Event Broker Kafka cluster.</p> <p>This is a required field.</p> <p>Valid Values: Should be in the following format: host1:port1, host2:port2,...</p> <p><b>Note:</b> The hostname needs to be resolvable. Be sure to configure a DNS and add the appropriate hosts. See <a href="#">"Network" on page 406</a> for more information.</p>
Event Topic List	<p>Enter the event topics the receiver should subscribe to.</p> <p>This is a required field.</p> <p>Valid Values: Comma separated list of event topics. Event topic names are case sensitive.</p>
Retrieve Event from Earliest Offset	<p>Set to true to retrieve the earliest offset of this partition. (Retrieves all existing events as well as new incoming events.)</p> <p>Set to false to retrieve the latest offset. (Only retrieves new incoming events.)</p> <p>This option is only used in initial configuration.</p> <p>The default is true.</p>
Consumer Group	<p>Enter a name that uniquely identifies the Consumer Group this receiver belongs to.</p> <p>When multiple Loggers have Event Broker receivers that subscribed to the same topic and belong to the same Consumer Group, each Logger in the group will receive events from a different subset of partitions in the topic. The Event Broker will balance the partitions between all Logger configured in the same Consumer Group.</p> <p>This is a required field.</p>

Parameter	Description
Use SSL/TLS	<p>Select true to enable SSL/TLS encryption. HPE Security ArcSight recommends that you set this option to true. If you select false, information sent via this receiver will in plain text.</p> <p>Default: false</p> <p>When set to true, you must provide the <b>Event Broker CA or Self-Signed Certificate File Location</b>.</p>
Event Broker CA or Self-Signed Certificate File Location	<p>Required if use SST/TLS is true.</p> <p>If the certificate is the Certificate Authority (CA) signed, specify the location of the Java KeyStore (JKS) truststore that contains the CA certificate (CA root that signed the Event Broker certificate.)</p> <p>If the Event Broker certificate is self-signed, the location of the JKS truststore of the self-signed certificate.</p>
Enable	Check this box to enable the receiver.

## File Receiver Parameters

Fill in the following fields when creating or editing File Receivers.

Parameter	Description
Name	Enter the name of the receiver, used for reporting and status monitoring.
RFS Names	<p>Select from the pulldown list of NFS or CIFS mount names. The list also includes attached SANs on Logger models that support SAN.</p> <p>To mount NFS volumes, see <a href="#">"Storage" on page 421</a>. To mount CIFS shares, see <a href="#">"Storage" on page 421</a>. For more information about SAN, see <a href="#">"SAN" on page 424</a>.</p>
Folder	<p>Choose "Local" and then specify the directory on your Logger where the remote file system is mounted in the "Folder" field.</p> <p>To mount a remote file system on the system on which you have installed Logger, see its operating system's documentation.</p>
Source Type	<p>Select from the pulldown list of log file types, including:</p> <ul style="list-style-type: none"> <li>• Apache HTTP Server Access</li> <li>• Apache HTTP Server Error</li> <li>• Juniper Steel-Belted Radius</li> <li>• Microsoft DHCP Log</li> <li>• IBM DB2 Audit</li> <li>• <i>More options...</i></li> </ul> <p>Additionally, you can define your own source type, based on the needs of your enterprise. See <a href="#">"Source Types" on page 311</a>.</p> <p>A receiver can only receive events of a single source type. Set up separate receivers for each type of log file.</p>

Parameter	Description
Wildcard (regex)	<p>A regular expression (regex) describing the log files to read.</p> <p>This is a regular expression, not a typical file wildcard like <code>“*. *”</code>.</p> <p>The default is <code>.*</code>, meaning all files.</p> <p>Examples:</p> <p>To include all files ending with <code>.process</code>, you could use: <code>.*\.process</code></p> <p>To monitor only <code>*.properties</code> files, you could use: <code>.*\.properties</code></p> <p>To include only <code>.log</code> files with eight digit filenames, you could use: <code>\d{8}\.log</code></p> <div style="background-color: #f0f0f0; padding: 5px;"> <p><b>Note:</b> Uploading any type of data other than text, including binary files such as <code>.zip</code> or <code>.bin</code>, may prevent Logger from functioning correctly. Use caution when pulling everything from a directory by specifying <code>.*</code> in the Regex field, as you could inadvertently include binary files.</p> </div>
Mode	<p>Select one of the following:</p> <ul style="list-style-type: none"> <li>• Delete - delete the log file once it has been processed</li> <li>• Rename - rename the log file once it has been processed. The file is named by appending the Rename Extension.</li> <li>• Persist - Logger remembers which files have been processed and only processes them once.</li> </ul>
Rename extension	The suffix to append to log files that have been processed.
Character encoding	Select a character encoding, such as US-ASCII, Big5, or EUC-KR, from the pulldown list. CEF UDP, CEF TCP, and SmartMessage receivers must use US-ASCII or UTF-8 encoding.
Delay after seen	<p>Number of seconds to wait after a source file is first seen until it is processed. This allows the entire file to be copied to Logger or (in the case of File Receiver) copied to the remote file system, before processing begins.</p> <p>The default is <b>10 seconds</b>.</p> <div style="background-color: #f0f0f0; padding: 5px;"> <p><b>Note:</b> For File Transfer Receivers, this parameter should be set to a larger value if large files are expected. The default, 10 seconds, does not allow enough time for a large file, such as 1 GB.</p> </div>
Event Time Locale	Select a locale from the pulldown list, such as English (United States), Chinese (Hong Kong), Chinese (Taiwan), and so on.
Date/time zone	<p>Required if the timestamp in the log file does not specify a time zone.</p> <p>For File Transfer and File Receivers, this parameter is ignored if either Date/time format or Date/time location regex are blank.</p> <p>On appliance Loggers you can see the time zone configured on the Logger <b>System Admin   System   Network &gt; Time/NTP</b> tab. Software Loggers use the system time.</p>



Parameter	Description
Event Time Location	<p>A regular expression describing which characters represent the timestamp in the log file. For example:</p> <pre>.*\[(.*?)\].*</pre> <p>This regular expression specifies that the timestamp is found inside the first set of square brackets on each line. The first capturing group (the part of the regex in parentheses) is that part that is then parsed using the Date/time format.</p> <p>The default is no timestamp.</p>
Event Time Format	<p>Required if the log file contains timestamps in the same format for each event. If not specified (or if the Date/time location regex is blank), each event in the file will be stamped with the date that the file itself was first seen by Logger (not its file system timestamp).</p> <p>See <a href="#">"Date and Time Specification" on page 310</a> for a list of formats.</p> <p>The default is no timestamp.</p>
Multiline Event Starts With	<p>A regular expression that specifies the start of a new event in a log file. Specify this expression to enable the receiver to read multi-line log files. Each new event starts at the point where the regular expression is matched to the characters in the log file. For example,</p> <pre>^\[d+-\d+-\d+ \d+:\d+,\d+].*</pre> <p>This regular expression matches timestamps such as:</p> <pre>[2010-12-06 13:09:46,818]</pre> <p>When this field is left blank, each line in the log file is treated as a single event.</p> <p>The default is each line in the log file is a single event.</p>

## Folder Follower Receiver Parameters

Fill in the following fields when creating or editing Folder Follower Receivers.

Parameter	Description
Name	Enter the name of the receiver, used for reporting and status monitoring.
Local Folder	Specify the local folder to process. On the Logger Appliance, this field is only available if you select "Local" for the Mount Name.

Parameter	Description
Source Type	<p>Select from the pulldown list of log file types, including:</p> <ul style="list-style-type: none"><li>• Apache HTTP Server Access</li><li>• Apache HTTP Server Error</li><li>• Juniper Steel-Belted Radius</li><li>• Microsoft DHCP Log</li><li>• IBM DB2 Audit</li><li>• <i>More options...</i></li></ul> <p>Additionally, you can define your own source type, based on the needs of your company. See <a href="#">"Source Types" on page 311</a>.</p> <p>A receiver can only receive events of a single source type. Set up separate receivers for each type of log file.</p>
Wildcard (regex)	<p>A regular expression (regex) describing the log files to read.</p> <p>This is a regular expression, not a typical file wildcard like <code>"*.log"</code>.</p> <p>The default is <code>.*</code>, meaning all files.</p> <p>Examples:</p> <p>To include all files ending with <code>.process</code>, you could use:</p> <pre>.*\.process</pre> <p>To monitor only <code>*.properties</code> files, you could use:</p> <pre>.*\.properties</pre> <p>To include only <code>.log</code> files with eight digit filenames, you could use:</p> <pre>\d{8}\.log</pre> <p><b>Note:</b> Uploading any type of data other than text, including binary files such as <code>.zip</code> or <code>.bin</code>, may prevent Logger from functioning correctly. Use caution when pulling everything from a directory by specifying <code>.*</code> in the Regex field, as you could inadvertently include binary files.</p>

Parameter	Description
Blacklist (regex)	<p>A regular expression (regex) describing the name of the log files to ignore. Files are not monitored if they match this expression.</p> <p>This is a regular expression, not a typical file wildcard like *.*.</p> <p>Example:</p> <p>To exclude files that end in .txt, you could use: .*\.txt</p> <p>To monitor all files except *.txt, you could use: Wildcard: .* Blacklist: .*\.txt</p>
Character encoding	Select a character encoding, such as US-ASCII, Big5, or EUC-KR, from the pulldown list. CEF UDP, CEF TCP, and SmartMessage receivers must use US-ASCII or UTF-8 encoding.
Date/time zone	<p>Required if the timestamp in the log file does not specify a time zone.</p> <p>For File Transfer and File Receivers, this parameter is ignored if either Date/time format or Date/time location regex are blank.</p> <p>You can see the time zone configured on the Logger <b>System Admin   System   Network &gt; Time/NTP</b> tab.</p> <p>Software Loggers use the system time.</p>

## File Transfer Receiver Parameters

Fill in the following fields when creating or editing File Transfer Receivers.

Parameter	Description
Name	Enter the name of the receiver, used for reporting and status monitoring.
Protocol	Select SCP, SFTP or FTP protocol.
Port	The port number for the receiver. The default port is 22.
IP/Host	<p>Select one of the Logger's network connections for the receiver to listen to, or select All to listen on both network connections.</p> <p><b>Note:</b> If localhost (127.0.0.1) appears in the list, it means that the Logger hostname has not been configured. To configure hostname, see <a href="#">"Network" on page 406</a>.</p>
User	Enter a user on the host with privileges to view and read the source log files. If the protocol is FTP, you can specify the special user, "anonymous."
Password	Enter the password of the specified User. The password must not be empty, even in the case of anonymous FTP (although in this case, the password will be ignored.)

Parameter	Description
File path	<p>Enter the path and the name of the log file(s) to be read. You can use wild cards like ? and * (for example, *.log or Log-?.?.txt) in the path name and the file name. Separate directories with forward slashes (/).</p> <p>Separate multiple file specifications with commas.</p> <p>Example: /tmp/SyslogData/syslog.log.gz, /security/logs/*/, /security/log?/admin/special/</p> <div style="background-color: #f0f0f0; padding: 5px; border: 1px solid #ccc;"> <p><b>Note:</b> Uploading any type of data other than text, including binary files such as .zip or .bin, may prevent Logger from functioning correctly. Be sure that any directories you specify do not include binary files. Use caution when pulling everything from a directory by specifying *, as you could inadvertently include binary files.</p> </div>
Schedule	<p>Specify when and how often you want the File Transfer to run. If no schedule is specified, the File Transfer will occur just once. For scheduling information, see <a href="#">"Scheduling Date and Time Options" on page 136</a>.</p>
Zip Format	<p>Choose gzip, zip, or none.</p>
Source Type	<p>Select from the pulldown list of log file types, including:</p> <ul style="list-style-type: none"> <li>• Apache HTTP Server Access</li> <li>• Apache HTTP Server Error</li> <li>• Juniper Steel-Belted Radius</li> <li>• Microsoft DHCP Log</li> <li>• IBM DB2 Audit</li> <li>• More options...</li> </ul> <p>Additionally, you can define your own source type, based on the needs of your enterprise. See <a href="#">"Source Types" on page 311</a>.</p> <p>A receiver can only receive events of a single source type. Set up separate receivers for each type of log file.</p>
Character encoding	<p>Select a character encoding, such as US-ASCII, Big5, or EUC-KR, from the pulldown list. CEF UDP, CEF TCP, and SmartMessage receivers must use US-ASCII or UTF-8 encoding.</p>
Delay after seen	<p>Enter the number of seconds to wait after a source file is first seen until it is processed. This allows the entire file to be copied to Logger or (in the case of File Receiver) copied to the remote file system, before processing begins.</p> <p>The default is 10 seconds.</p> <p>For File Transfer Receivers, this parameter should be set to a larger value if large files are expected. The default, 10 seconds, does not allow enough time for a large file, such as 1 GB.</p>
Event Time Locale	<p>Select a locale from the pulldown list, such as English (United States), Chinese (Hong Kong), Chinese (Taiwan), and so on.</p>

Parameter	Description
Date/time zone	<p>Enter the date/time zone. For more information, see <a href="#">"Date and Time Specification" on the next page</a>.</p> <p>Required if the timestamp in the log file does not specify a time zone.</p> <p>For File Transfer and File Receivers, this parameter is ignored if either Date/time format or Date/time location regex are blank.</p> <p>You can see the time zone configured on the Logger System Admin   System   Network &gt; Time/NTP tab.</p> <p>Software Loggers use the system time.</p>
Event Time Location	<p>A regular expression describing which characters represent the timestamp in the log file. For example:</p> <pre>.*\[(. *?)\].*</pre> <p>This regular expression specifies that the timestamp is found inside the first set of square brackets on each line. The first capturing group (the part of the regex in parentheses) is that part that is then parsed using the Date/time format.</p> <p>The default is no timestamp.</p>
Event Time Format	<p>Required if the log file contains timestamps in the same format for each event. If not specified (or if the Date/time location regex is blank), each event in the file will be stamped with the date that the file itself was first seen by Logger (not its file system timestamp).</p> <p>See <a href="#">"Date and Time Specification" on the next page</a> for a list of format specifiers.</p> <p>The default is no timestamp.</p>
Multiline Event Starts With	<p>A regular expression that specifies the start of a new event in a log file. Specify this expression to enable the receiver to read multi-line log files. Each new event starts at the point where the regular expression is matched to the characters in the log file. For example,</p> <pre>^\[\d+-\d+-\d+ \d+:\d+,\d+].*</pre> <p>This regular expression matches timestamps such as:</p> <pre>[2010-12-06 13:09:46,818]</pre> <p>When this field is left blank, each line in the log file is treated as a single event.</p> <p>The default is each line in the log file is a single event.</p>

## SmartMessage Receiver Parameters

Fill in the following fields when creating or editing SmartMessage Receivers.

Parameter	Description
Name	Enter the name of the receiver, used when configuring an associated ArcSightSmartConnector.
Encoding	Select a character encoding, such as US-ASCII, Big5, or EUC-KR, from the pulldown list. CEF UDP, CEF TCP, and SmartMessage receivers must use US-ASCII or UTF-8 encoding.

## Date and Time Specification

To specify the date and time format so that it can be parsed from a file receiver, (File Receiver, Folder Follower Receiver, or File Transfer), refer to the table "[Date/Time Format Specification](#)" below.

Internally, Logger uses a common Java method called SimpleDateFormat. Sophisticated uses of SimpleDateFormat, as described in Java sources, will work with Logger. Pattern letters are usually repeated, as their number determines the exact presentation.

The following examples show how date and time patterns are interpreted in the U.S. locale. The given date and time are July 4th 2013, at 12:08:56 local time, in the "U.S. Pacific Time" time zone.

### Date/Time Examples

Source	Date and Time Pattern
2013.07.04 AD at 12:08:56 PDT	yyyy.MM.dd G 'at' HH:mm:ss z
Wed, Jul 4, '13	EEE, MMM d, "yy
12:08 PM	h:mm a
12 o'clock PM, Pacific Daylight Time	hh 'o'clock' a, zzzz
0:08 PM, PDT	K:mm a, z
2013.July.04 AD 12:08 PM	yyyyy.MMMMM.dd GGG hh:mm aaa
Wed, 4 Jul 2013 12:08:56 -0700	EEE, d MMM yyyy HH:mm:ss Z
130704120856-0700	yyMMddHHmmssZ
2013-07-04T12:08:56.235-0700	yyyy-MM-dd'T'HH:mm:ss.SSSZ

### Date/Time Format Specification

Symbol	Meaning	Presentation	Examples
G	Era designator	(Text)	AD
y	Year	(Number)	2013 or 13
M	Month in year (1-12)	(Month)	July or Jul or 07
w	Week in year (1-52)	(Number)	39
W	Week in month (1-5)	(Number)	2
D	Day in year (1-366)	(Number)	129
d	Day in month (1-31)	(Number)	10
E	Day in week	(Text)	Tuesday or Tue
F	Day in week of month		
a	Am/pm marker	(Text)	AM or PM

### Date/Time Format Specification, continued

Symbol	Meaning	Presentation	Examples
H	Hour in day (0-23)	(Number)	0
k	Hour in day (1-24)	(Number)	24
K	Hour in am/pm (0-11)	(Number)	0
h	Hour in am/pm (1-12)	(Number)	12
m	Minute in hour (0-59)	(Number)	30
s	Second in minute (0-59)	(Number)	55
S	Millisecond (0-999)	(Number)	978
z	Time zone	(Text)	Pacific Standard Time, or PST, or GMT-08:00
Z	Time zone	(RFC 822)	-0800 (indicating PST)

## Source Types

Source types identify the kind of event that comes from a specific data source. For example, an event could come from an Apache access log, a simple syslog, or the log of an application you created. You can use parsers to parse event data from a specified source type.

Once events are associated with a source type, if the source type is associated with a parser, the events are parsed by that parser when you run a search that matches those events. The search result displays the matching parsed event fields in columns, similar to the CEF events. (Use the "User Defined Fields" field set to view these events.) For more information, see ["Parsers" on page 315](#).

The source of the event, the source type, and the parser will be displayed in the column list of the search results if any row is fetched from a search that contains a non-CEF source type.

### Prerequisites

Users must be assigned to the following User Groups to access this feature:

- Default Logger Rights Group
- Default System Admin Group

See ["Setting Logger User Permissions" on page 458](#) for more information.

The following columns are displayed in the search results when a source type is used:

- **Source:** The name of the log file from which the event was received.  
For example, `/opt/mnt/testsoft/web_server.out.log`. If no source was applied when the event was received, this field is blank. You can control whether this field is displayed from the Search Options page. See ["Search Options" on page 277](#) for how to set this option.

- **Source Type:** The type of file from which the event was received, as defined on the Source Type page (**Configuration | Data > Source Types**). If no source type was applied when the event was received, this field is blank. You can control whether this field is displayed from the Search Options page. See "[Search Options](#)" on page 277 for how to set this option.
- **Parser:** If the event was parsed, this field contains the name of the parser. If the event was not parsed successfully, this field contains "Not parsed." If no parser is defined for the source type or if there is no source type, the field is blank.

## Working with Source Types

Logger provides a number of source types with pre-configured parsers. Additionally, you can define new source types and assign parsers to them. This lets you choose the set of fields you want to extract for a given kind of event. Only one parser can be associated with a source type, however, multiple source types can be associated with a parser. Out-of-box source types cannot be edited or deleted, but you can copy them to make similar source types to meet your needs. You can edit or delete custom source types, as desired. The source types available on your Logger may vary from the image below.

### Source Types page

Source Types						
Add						
Name	Description	Parser	Event Time Location	Event Time Format	Multiline Event Starts With	Locale
VMWare_ESX	VMWare ESX Syslog	VMWare_ESX	.*(w{3}s\d+\s\d:\d:\d\d:\d\d).*	MMM dd HH:mm:ss		English (United States)
TippingPoint_SMS	Tipping Point SMS 2.5 Syslog	TippingPoint_SMS				English (United States)
syslog	Simple Syslog	syslog	.*(w{3} \d\d \d\d:\d:\d\d:\d\d).*	MMM dd HH:mm:ss		English (United States)
Other	legacy Other					English (United States)

The following source types have associated parsers:

Source type	Description
Apache_access	Apache Access Log
Apache_error	Apache Error Log
audit_log	Syslog for Audit Log files
Bluecoat_proxy	Bluecoat Proxy SG
Cisco_PIX	Cisco PIX
IBM_DB2	IBM DB2 9.x Audit Log
Juniper_NSM	Juniper NSM 2009 Syslog



Source type	Description
logger_syslog	Syslog for syslog files on Logger Appliance
Microsoft_DHCP	Microsoft DHCP for 2008 v6 log files
syslog	Simple Syslog
TippingPoint_SMS	Tipping Point SMS 2.5 Syslog
VMware_ESX	VMware ESX Syslog

Logger can forward an event to ESM by using a Connector forwarder, which then forwards it to a Streaming Connector. This connector normalizes the event and forwards it to ESM.

If you need forward events to ESM by using a Connector forwarder, you must choose one of the following source types:

Source Type	
Apache HTTP Server Access	Juniper Steel-Belted Radius
Apache HTTP Server Error	Microsoft DHCP Log
IBM DB2 Audit	Other

### To add a source type:

1. Open the **Configuration | Data** menu and click **Source Types**.  
The "[Source Types page](#)" on the previous page displays the current source types. You can sort the fields by clicking the column headers.
2. Click **Add**.

- Fill in the fields to define the source type:

### Source Type Fields

Field	Description
Name	The name of the source type.
Description	A description of the source type.
Parser	The parser you want to associate with this source type. If the parser you need does not appear in the drop-down list, you can add one. For information on how to add a parser, see <a href="#">"Parsers" on the next page</a> .
Event Time Location	<p>A regular expression describing the timestamp in the log file. For example:  <code>.*\[(.*)\].*</code></p> <p>This expression specifies that the timestamp is found inside the first set of square brackets on each line. The first capturing group (the part of the regex in parentheses) is the part that is then parsed using the Date/time format.</p> <p>You can specify that there is no timestamp in the log file with <code>'</code>.</p>
Event Time Format	<p>A regular expression describing the date and time format in the log file. For example,  <code>dd/MMM/yyyy:HH:mm:ss Z</code></p> <p>You can specify that there is no timestamp in the log file with <code>'</code>.</p> <p>For more information about event time, see <a href="#">"Time Range" on page 76</a> and <a href="#">"Date and Time Specification" on page 310</a>.</p>
Multiline Event Starts With	A regular expression describing how to recognize when adjacent lines are of the same event or when a new event starts. For example if each event starts with the date in the format, yy-MM-dd HH:mm:ss.SSS you could use <code>(\d+-\d+-\d+ \d+:\d+:\d+.\d+)</code> to indicate the start of a new event.
Locale	Select a locale from the pulldown list, such as English (United States), Chinese (Hong Kong), Chinese (Taiwan), and so on. This is locale of the data Logger should find in the file.

- Click **Save**.

### To edit a source type:

- Open the **Configuration | Data** menu and click **Source Types**.  
The ["Source Types page" on page 312](#) displays the current source types. You can sort the fields by clicking the column headers.
- Locate the source type that you want to update and click the Edit icon (✎) on that row.

**Note:** The Edit icon (✎) is not available for out-of-box source types. You can copy the source type and make a similar one instead.

- Edit the fields as appropriate.  
See the table ["Source Type Fields" above](#) for field details.
- Click **Save**.

5. Disable and then re-enable any receivers that use this source type.

**Note:** Changes in source type are not reflected in the associated receivers until you have re-enabled them.

### To copy a source type:

1. Open the **Configuration | Data** menu and click **Source Types**.  
The "[Source Types page](#)" on page 312 displays the current source types. You can sort the fields by clicking the column headers.
2. Locate the source type that you want to copy and click the Copy icon () on that row.
3. Enter a name for the new source type and edit the fields as appropriate.  
See the table "[Source Type Fields](#)" on the previous page for field details.
4. Click **Save**.

### To delete a source type:

1. Open the **Configuration | Data** menu and click **Source Types**.  
The "[Source Types page](#)" on page 312 displays the current source types. You can sort the fields by clicking the column headers.
2. Locate the source type that you want to delete and click the Remove icon () on that row.

**Note:** The Remove icon () is not available for out-of-box source types. You can only remove source types that you added.

3. Click **OK** to confirm the removal.

## Parsers

Parsers enable you to extract and manipulate raw events (non-CEF data) from different sources in your network environment. Once you have parsed event fields, you can easily search for data, chart it, and perform other operations on it. One user with in-depth knowledge of the events can create the parser, and then all users who look at those events will get the benefit of that work.

Parsers provide you with a simple way to read events. Instead of looking at raw event data and trying to figure out what it means, you can use a parser to extract portions of non-CEF events into fields. However, the fields created by the parser are available only for search operations, and are not added to the Logger schema.

You can use a parser either of the following ways:

- **Use the parser with a source type:** You can associate the parser with a source type to extract any set of fields in any kind of event. For more information, see "[Source Types](#)" on page 311.

- **Use the parse command in a search:** During a search, you can use the parse command to extract fields from events and use other search operators (such as where, chart, top, and so on) to further refine the search or manipulate the data in the fields. This is particularly useful for IT operations and other customers who need to extract and manipulate raw event data.

## Prerequisites

Users must be assigned to the following User Groups to access this feature:

- Default Logger Rights Group
- Default System Admin Group

See ["Setting Logger User Permissions" on page 458](#) for more information.

## Using Parsers with Source Types

Logger provides a number of pre-configured parsers with associated source types. You can also define new parsers and associate them with source types. Only one parser can be associated with a source type, however, multiple source types can use the same parser. Out-of-box parsers cannot be edited or deleted, but you can copy them to make a similar parser to meet your needs. You can edit or delete custom parsers as desired.

### Parsers page

Parsers			
<a href="#">Add</a>			
Name	Parser Type	Description	Definition
VMWare_ESX	Rex Parser	VMWare ESX Syslog Parser	(?<Module>\S+?vmware-hostd Hostd Fdm DCUI vmkwarning jumpstart dhclient-uw- d+ esxupdate Vpxalvodblauthd cims plsfcblnssquery vmkernel watchdog- S+ dhclient VMware\ init syslogd\s[\d\ ]+\(\{(?<PID>\d+\})\}+?(?<message>.*))
TippingPoint_SMS	Rex Parser	Tipping Point SMS 2.5 Syslog Parser	(?<timestamp>\w{3} \d+ \d:\d:\d\d)? (?<host>[\w\d\ ]+)? (?<actionType>\d)\t(?<appSeverity>\d)\t(?<policyUUID>\w+-\w+-\w+-\w+-\w+)\t(?<signatureUUID>\w+-\w+-\w+-\w+-\w+)\t(?<message>["\t ]+)\t(?<applied>\d+)\t(?<protocol>\w+)\t(?<srcip>...)
syslog	Rex Parser	Simple Syslog Parser for syslog files on Linux	(<(?<priority>\d+)>)?(?<timestamp>\w{3}\s*\w{0,3}\s*\d+ \d{0,4}\s?\S{8})\s*(?<DeviceHostName>[": ]*)?(?<message>.*)

## Using the Parse Command

The parse command can be used to invoke a parser on any non-CEF events that are returned by a search. It applies the definition of the parser, such as the regular expression of a rex parser, to each event. Then it adds the fields that are extracted by that regular expression to the fields that are being passed through. For a REX parser, this is functionally the same as having a rex command with the same regular expression as the definition of the parser, so you can think of a REX parse command as invoking a saved rex expression.

For more information about the parse command, see ["parse" on page 492](#). For information about searching in general, see ["Searching and Analyzing Events" on page 65](#).

## Working with Parsers

You can define two types of parsers—a REX parser or an Extract parser. Before adding the parser, you need to define the query you want to use for parsing events.

For a Rex parser, one way to do this is to use the rex search operator to test and adjust a regular expression until it returns the desired fields from the events that you want it to handle. Then copy the rex expression and paste it into the parser's **Definition** field. For an Extract parser, use the extract operator. For more information about the search operators, see ["parse" on page 492](#), ["rex" on page 497](#), and ["extract" on page 483](#).

The parser used in a search will be displayed in the Parser column of the search results. If the event was parsed, this field contains the name of the parser. If the event was not parsed successfully, this field contains "Not parsed." If no parser is defined for the source type or if there is no source type, the field is blank.

### Prerequisites

Users must be assigned to the following User Groups to access this feature:

- Default Logger Rights Group
- Default System Admin Group

See ["Setting Logger User Permissions" on page 458](#) for more information.

### To add a parser:

1. Open the **Configuration | Data** menu and click **Parsers**.

The Parsers page, shown in ["Parsers page" on the previous page](#), displays the current parsers. You can sort the fields by clicking the column headers.

2. Click **Add**.
3. Enter a name for the parser.
4. Choose the Parser Type from the drop-down list.
5. Click **Save**.

The fields display in the **Edit Parser** dialog box according to the type of parser.

6. Fill in the fields for the parser.

### Parser Fields

Field	Description
Name	The name of the parser. Enter a new name if you want to change the existing name.
Description	A meaningful description of the purpose of the parser.
<b>Rex parsers only</b>	
Definition	The rex expression that you want to use to parse events.
<b>Extract parsers only</b>	
Pair Delimiter	The characters separate key/value pairs within an event. Enter only the separator characters, for example: \\ ,
Key/Value Delimiter	The characters that separate the key from the value. Enter only the delimiter character, for example: =
Fields	The list of field names to use when parsing events. Enter the field names, separated by comma (,). For example, to parse events like: foo=abc , bar=xyz , baz=def Enter: foo,bar ,baz

7. Click **Save**.

### To edit a parser:

1. Open the **Configuration | Data** menu and click **Parsers**.

The Parsers page, shown in "[Parsers page](#)" on page 316, displays the current parsers. You can sort the fields by clicking the column headers.

2. Locate the parser that you want to update and click the Edit icon (✎) on that row.

**Note:** The Edit icon (✎) is not available for out-of-box parsers. You can copy the parser and make a similar one instead.

3. Edit the parser fields as appropriate.

The fields displayed in the Edit Parser dialog box according to the type of parser. Parser fields are documented in the table "[Parser Fields](#)" above.

4. Click **Save**.

### To copy a parser:

1. Open the **Configuration | Data** menu and click **Parsers**.  
The Parsers page, shown in "[Parsers page](#)" on page 316, displays the current parsers. You can sort the fields by clicking the column headers.
2. Locate the parser that you want to copy and click the Copy icon () on that row.  
The fields displayed in the Edit Parser dialog box according to the type of parser.
3. Enter a name for the new parser and edit the fields as appropriate.  
Parser fields are documented in the table "[Parser Fields](#)" on the previous page, above.
4. Click **Save**.

### To delete a parser:

1. Open the **Configuration | Data** menu and click **Parsers**.  
The Parsers page, shown in "[Parsers page](#)" on page 316, displays the current parsers. You can sort the fields by clicking the column headers.
2. Locate the parser that you want to delete and click the Remove icon () on that row.

**Note:** The Remove icon () not available for out-of-box parsers. You can only remove parsers that you added.

3. Click **OK** to confirm the removal.

**Tip:** Be cautious when deleting a parser. Logger doesn't warn you when you modify or delete a parser that is associated with a Source Type.

## Example: Creating an Extract Parser

Suppose you want to create a parser to find the contents of the INT, MAC, DST, and SRC fields of a log like the one below.

```
Jul 12 14:30:31 n15-214-128-h92 kernel: IN=eth2  
MAC=00:24:e8:60:cb:82:00:50:56:92:2a:d5:08:00 SRC=192.0.2.9 | DST=192.0.2.2  
LEN=52 TOS=0x00 PREC=0x00 TTL=128 ID=21408 DF PROTO=TCP SPT=56978 DPT=443  
WINDOW=8192 RES=0x00 SYN URGP=0  
Jul 12 14:30:31 n15-214-128-h92 kernel: IN=eth2 |  
MAC=00:24:e8:60:cb:82:00:50:56:92:2a:d5:08:00 | SRC=192.0.2.9 | DST=192.0.2.2  
LEN=52 TOS=0x00 PREC=0x00 TTL=128 ID=21408 DF PROTO=TCP SPT=56978 DPT=443  
WINDOW=8192 RES=0x00 SYN URGP=0  
Jul 12 14:30:31 n15-214-128-h92 kernel: IN=eth2 |  
MAC=00:24:e8:60:cb:82:00:50:56:92:2a:d5:08:00 | SRC=192.0.2.9 | DST=192.0.2.2
```

```
LEN=52 TOS=0x00 PREC=0x00 TTL=128 ID=21408 DF PROTO=TCP SPT=56978 DPT=443  
WINDOW=8192 RES=0x00 SYN URGP=0
```

In this sample log, the field values are indicated with an equal sign (=), and fields are delimited by pipe (|) and colon (:). You could use the following query to search for the contents of the IN, MAC, DST, and SRC fields.

```
extract pairdelim= "|:" kvdelim= "=" fields= "IN,MAC,DST,SRC"
```

The following steps describe how to make an extract parser using that query.

### To create an example extract parser:

1. Open the Configuration | Data menu and click **Parsers**.
2. Click **Add**. The Add Parser dialog box opens.

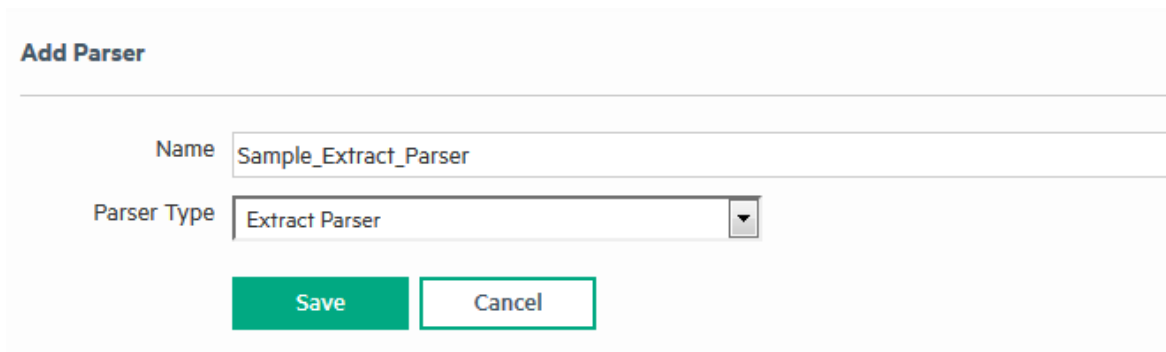

**Add Parser**

Name

Parser Type

3. Enter a Name and select the Parser Type. For the example, enter:  
Name: Sample\_Extract\_Parser  
Parser Type: Extract Parser
4. Click **Save**. The Edit parser dialog box opens.

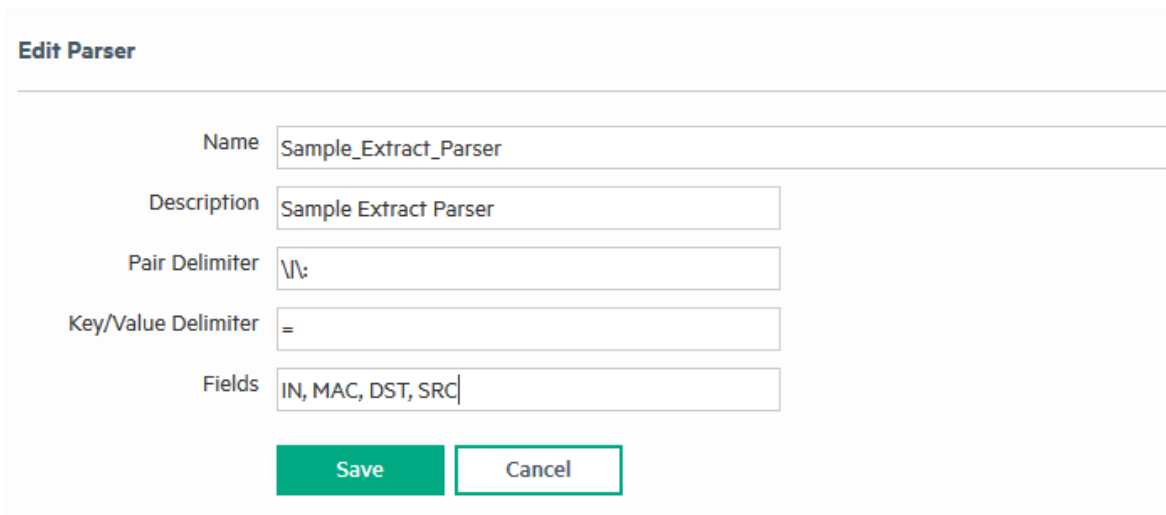

**Edit Parser**

Name

Description

Pair Delimiter

Key/Value Delimiter

Fields

5. Enter the Pair Delimiter, Key value, and Fields for the parser. For the example, enter:



Pair Delimiter: \ | \ :  
Key/Value Delimiter: =  
Fields: INT, MAC, DST, SRC

**Note:** You need to escape the pipe (|) and the colon (: ) with a backslash (\).

- Click **Save**. The Parsers page displays the new parser.

Name	Parser Type	Description	Definition	
Sample_Extract_Parser	Extract Parser	Sample Extract Parser	pair delimiter [ :] key/value delimiter [=] fields [IN, MAC, DST, SRC]	
Apache_access	Rex Parser	Apache Access Log Parser	(?<SourceHost>\S+)[\s-]+(?<Identity>\S+)?[\s-]+[(?<Date>.+?)\]\s+\" (?<Method>\S+)\s+(?<URL>.*?)\s+(HTTP/(?<HTTPVersion>.*?))?\s+(? <ReturnCode>\d+)\s+-(?<Length>\d+)?	
Apache_error	Rex Parser	Apache Error Log Parser	\S+ \S+ \d{1,2} [\d.] + \d{4}\)\s+[(?<severity>[a-z]*) \s+(\[client\s+(?<clientIp>[\d.]*)\]\s+File\s+does\s+not\s+exist: \s+(?<filename>\S+))?(?<message>.*)	

## Forwarders

Forwarders send all events, or events that match a particular filter, on to a particular host or destination such as ArcSight Manager.

The ability to define a different filter for each forwarder allows Logger to divide traffic among several destinations. For example, because Logger can handle much higher event rates than ArcSight Manager, Logger might be used to forward events to a number of ArcSight Managers. Forwarder filters make it possible to split the flow between the Managers, using one forwarder for each Manager. Additionally, forwarding enables you to send a subset of events to other destinations for further processing while maintaining all events on Logger for long-term storage.

## Forwarders page

**Forwarders**

Type of Filter

[Add](#)

Name	Type	Type of Filter	IP/Host	Port	Query				
<a href="#">Auto_Test_TCP_Forwarder--InstallLogger</a>	TCP Forwarder	Regular Expression	15.214.194.65	5001	NONE				
<a href="#">Auto_Test_UDP_Forwarder--InstallLogger</a>	UDP Forwarder	Regular Expression	15.214.194.65	5000	NONE				
<a href="#">tcpAndUdpForwarderDisabled-TCPForwarder</a>	TCP Forwarder	Regular Expression	15.214.194.65	6015	NONE				
<a href="#">tcpAndUdpForwarderDisabled-UDPForwarder</a>	UDP Forwarder	Regular Expression	15.214.194.65	6014	NONE				

The forwarding filter is a query that searches for matching events, optionally within a time range. You can create two types of forwarder filters—**continuous** and **time-range bound**.

- A **continuous** filter constantly evaluates the incoming events and forwards the matching ones to the specified destination.
- A **time-range bound** filter uses a time range in addition to the specified condition to determine whether an event should be forwarded to the destination. If the event falls within the specified time range and matches the specified condition, it is forwarded; otherwise, it is not. The Logger receipt time of an event is used to determine whether an event will be forwarded to a destination when a forwarder filter specifies a time range by which events are evaluated for forwarding. Once a forwarder has forwarded all events within a time range, it does not forward any more events.

A forwarder only forwards events from the Logger that it is configured on; it cannot forward events from peers.

A forwarder's operation can be paused and resumed at any point in time. When a forwarder resumes operation, forwarding resumes from the last checkpoint that was established before the forwarding operation was paused.

You can also disable and re-enable a forwarder. When you re-enable a forwarder, all previously established checkpoints are removed and forwarding starts over again as per the forwarder configuration—forwarders with continuous filters start from the current time, while forwarders with time-range bound filters start from beginning of the configured time range.

Forwarder types include UDP Forwarder, TCP Forwarder, Connector Forwarder, and ArcSight ESM Forwarder:

- **UDP Forwarder** UDP forwarders forward events by using the User Datagram Protocol.
- **TCP Forwarder:** TCP forwarders forward events by using the Transmission Control Protocol.
- **Connector Forwarder:** Connector forwarders send events to the Logger Streaming Connector.
- **ArcSight ESM CEF Forwarders:** ArcSight ESM CDF forwarders send Common Event Format (CEF) events to an ESM Destination. The built-in connector on Logger is used to forward these events to

ESM.

**Note:** In order to create an ArcSight Data Platform Logger and ArcSight ESM forwarder, you must first create an ESM Destination. See ["ESM Destinations" on page 339](#) for more information.

As a best practice, do not add more than ten regular expression forwarders. Even though each additional forwarder improves the forwarding rate, the relation is not proportional. In high EPS (events per second) situations or situations where other resource-intensive features are running in parallel (alerts, reports, and several search operations) and the forwarding filter is complex, adding too many forwarders may reduce performance because forwarders have to compete for the same Logger resources besides competing for the same built-in connector for forwarding.

You can specify a regular expression or an indexed search query (Unified Query) for the filter. Doing so enables you to take advantage of the indexing technology to quickly and efficiently search for events to forward.

**Note:** Unified query-based forwarders forward events once they have been indexed. Therefore, these forwarders can exhibit “bursty” behavior because indexing occurs in batches on Logger. You might notice the bursty behavior in the EPS out bar gauge (on top of the Logger interface screen)—the bar gauge will display high EPS level as a burst of data is forwarded and then drop back to normal level.

### To create a forwarder:

1. Open the **Configuration | Data** menu and click **Forwarders**.
2. Click **Add** to display the following form.

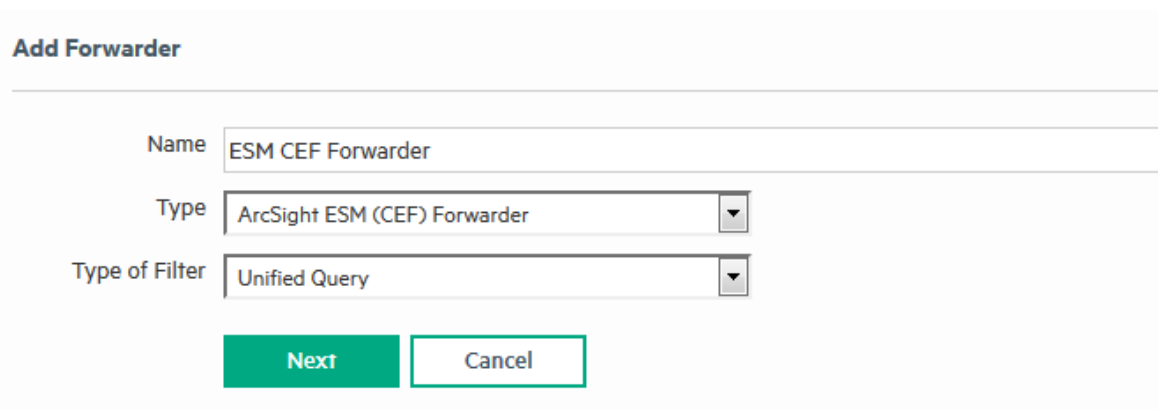

**Add Forwarder**

Name

Type

Type of Filter

3. Enter a name for the new forwarder and choose the forwarder type appropriate for your need: UDP Forwarder, TCP Forwarder, Connector Forwarder, or ArcSight ESM (CEF) Forwarder type.
4. Select the type of forwarding filter you want this forwarder to use—**Unified** or **Regular Expression**. Select “Unified” if you want to specify an indexed search query or “Regular Expression” to specify a regular expression query.

- Click **Next**.
- Enter additional type-specific information as described in the following table.

### Forwarder Parameters

Parameter	Forwarder Types	Description
Name	All	The name that you entered in the previous screen is displayed automatically. If you want to change the name, make the change on this screen.
Query	All	<p>Enter the query that will be used to filter events that the forwarder will forward, or select a filter from the Filters list.</p> <p>Forwarder queries can be constrained by device groups and storage groups, but not by Peers.</p> <p>If you selected Unified Query in the previous screen, enter an indexed search query that includes full-text and field-based indexed fields. You can click the Advanced Search link to access the Search Builder tool to build an indexed query. (See <a href="#">"Accessing the Advanced Search Builder" on page 90</a> for more information.)</p> <p><b>Tip:</b> The unified query you specify must follow the following guidelines, or you will not be able to save the query or the forwarder.</p> <p>Queries in the following format are valid; no other formats are allowed.</p> <pre>(full-text terms   field search)*   regex</pre> <p>That is, the query must only contain full-text (keyword) and field-based query elements; it cannot contain any aggregation search operators, or operators that process the searched data further to refine the search. For example, chart, sort, eval, top, and so on.</p> <p>Therefore, this is a valid query:</p> <pre>failed message CONTAINS "failed device"</pre> <p>However, this is an invalid query:</p> <pre>failed message CONTAINS "failed device"   sort deviceEventCategory</pre> <p>The query can contain the regex operator after a pipeline character ( ). Therefore, this is a valid query for a forwarder:</p> <pre>failed message CONTAINS "failed device"   regex deviceEventCategory = "fan"</pre> <p><b>Tip:</b> All search terms (except the "regex" portion) in a query must be indexed. If a query contains full-text (keyword) terms, full-text indexing must be enabled. Similarly, if the query contains a field, field-based indexing must be enabled and the specified field must be indexed.</p> <p>If you selected Regular Expression in the previous screen, specify a regular expression in this text box. See <a href="#">"Searching for Events" on page 102</a>.</p>

### Forwarder Parameters, continued

Parameter	Forwarder Types	Description
Filters	All	<p>Instead of specifying a unified query, you can select a filter from the Filters list. The Filters list contains all saved filters and predefined system filters on your Logger. Select a filter that meets the validity guidelines described in <a href="#">"Query" on the previous page</a>. Otherwise, the user interface will display an error when you save the forwarder definition.</p> <p>You can only select one unified query filter per forwarder. However, You can select multiple filters for a regular expression-based forwarder.</p> <p>Similarly, when creating a regular expression-based filter, select a filter from this list.</p>
Filter by time range	All	<p>If you are creating a continuous filter, which continuously evaluates incoming events and forwards the matching ones, skip this parameter. In this case, the query is run continuously and forwarding continues until you pause it.</p> <p>If you are creating a time range bound filter, check this box to specify a time range of events that the forwarder will forward. If you enter a time range, the forwarder sends events that are within that time range and stops.</p> <p>When you check this box, the Start and End dates and Time fields are displayed. Start must be earlier than End. Specifying a time in the future changes that field to the current time. For example, specifying a Start of the current day at 7 AM and an End of current day at 7 PM will produce events with timestamps from 7 AM to the time the filter is saved (that is, earlier than 7 PM).</p>
Source Type	Connector	<p>Select from the pull-down list of log file types, including:</p> <ul style="list-style-type: none"> <li>• Apache HTTP Server Access</li> <li>• Apache HTTP Server Error</li> <li>• IBM DB2 Audit</li> <li>• Juniper Steel-Belted Radius</li> <li>• Microsoft DHCP Log</li> <li>• Others...</li> </ul> <p><b>Note:</b> The Source type must be the same in receiver, forwarder, and SmartConnector. See <a href="#">"Forwarding Log File Events to ESM" on page 343</a>.</p> <p>A receiver can only receive events of a single source type. Set up separate receivers for each type of log file.</p>
Preserve Syslog Timestamp	UDP, TCP	<p>Set to true to preserve the syslog timestamp. The default is true. In this case, the timestamp is the original receipt time of the event.</p> <p>If set to false, original timestamp is replaced with Logger's receipt time.</p>

### Forwarder Parameters, continued

Parameter	Forwarder Types	Description
Preserve Original Syslog Sender	UDP, TCP	Set to true to send the event as-is, without inserting Logger's IP address in the hostname (or equivalent) field of the syslog event. The default is true.  If set to false, Logger's information is inserted in the hostname (or equivalent) field of the syslog event.
IP/Host	UDP, TCP, Connector	The IP address or host name of the destination that will the receive forwarded events.  <b>Note:</b> You cannot configure a Logger forwarder to send data to the same system on which it is configured.
Port	UDP, TCP, Connector	The port on the destination that will receive the forwarded events.  The default port is 514.
Connection Retry Timeout	TCP, Connector, ESM	The time, in seconds, to wait before retrying a connection. The default is 5 seconds.
ESM Destination	ESM	An existing ESM Destination that will receive the forwarded events. (For more information, see <a href="#">"ESM Destinations" on page 339.</a> )

7. Flag the **Enable** checkbox to have the forwarder immediately enabled. If you choose not to enable the forwarder now, you can enable it later.
8. Click **Save**.

### To edit a forwarder:



1. Open the **Configuration | Data** menu and click **Forwarders**.
2. Locate the forwarder you want to edit.
3. If the forwarder is enabled, click the **Enabled** icon (✓) to disable it.
4. Click the **Edit** icon (✎).

The following screen shows the Edit Forwarder screen for a regular expression based forwarder. The Edit Forwarder screen for a Unified Query forwarder lists the Unified Query based filters and the Query text box only allows you to specify one query.

## Specifying Query Terms, Filters, and other forwarder parameters

**Edit Forwarder**

Name

Query !    

Filters

- Configuration - System Configuration Changes (CEF format)
- Events - CEF
- Events - High and Very High Severity CEF Events
- Intrusion - Malicious Code (CEF format)
- Logins - All Logins (CEF format)
- Logins - All Logins (Non-CEF format)
- Logins - Successful Logins (CEF format)
- Logins - Successful Logins (Non-CEF format)
- Logins - Unsuccessful Logins (CEF format)
- Logins - Unsuccessful Logins (Non-CEF format)

Use ctrl-click to select or deselect items

Filter by time range

Preserve Syslog Timestamp

Preserve Original Syslog Sender

IP/Host

Port

Connection Retry Timeout

Enable

5. Edit the information in the form, as described in the table "Forwarder Parameters" on page 324.
6. Flag the **Enable** checkbox to have the forwarder immediately enabled. If you choose not to enable the forwarder now, you can enable it later.
7. Click **Save**.

### To delete a forwarder:

1. Open the **Configuration | Data** menu and click **Forwarders**.
2. Locate the forwarder that you want to delete.
3. If the forwarder is enabled, click the Enabled icon (✓) to disable it.
4. Click the Remove icon (✕).
5. Click **OK** to confirm the delete.

### To pause a forwarder:

1. Open the **Configuration | Data** menu and click **Forwarders**.
2. Locate the forwarder that you want to pause.
3. Click the Running icon (  ) to pause the forwarder.

### To resume a forwarder:

1. Open the **Configuration | Data** menu and click **Forwarders**.
2. Locate the forwarder whose operation you want to resume.
3. Click the Paused icon (  ) to resume forwarder operation.

### To disable a forwarder:

1. Open the **Configuration | Data** menu and click **Forwarders**.
2. Click **Event Output** in the left panel.
3. Locate the forwarder that you want to disable.
4. Click the Enabled icon (  ) to disable it.

### To enable or re-enable a forwarder:

**Tip:** Wait a few minutes to disable a forwarder that was just enabled. Likewise, wait before enabling a forwarder that has just been disabled. Background tasks initiated by enabling or disabling a forwarder can produce unexpected results if they are interrupted.

1. Open the **Configuration | Data** menu and click **Forwarders**.
2. Locate the forwarder that you want to enable or re-enable.
3. Click the Disabled icon (  ).

## Real Time Alerts

This section describes Real Time Alerts. For information on Saved Search Alerts, see ["Saved Search Alerts" on page 271](#). For a description of the types of alerts, see ["Logger Alert Types" on page 332](#).

You can set up real time alerts that will be triggered by specified events or event patterns, and optionally, send notifications to previously configured destinations such as an email address or an SNMP server. Event patterns are specified events that occur above a particular frequency (a threshold number of events in a specified period). For example, you could create alert that is generated when five events from a specific device contain the word “unauthorized” within a five-minute interval.

Additionally, alerts can also be generated for internal events such as storage capacity warnings or, on some Logger Appliance models, CPU temperature warnings.



To create an Alert, you will need to specify a query or filter, event aggregation values (Match count and Threshold), and (optional) one or more notification destinations. If the new Alert will send notifications to an email, SNMP, or Syslog Destination, set up the destination before creating the Alert. See "[Static Routes](#)" on page 409, "[Receiving Alert Notifications](#)" on page 334, and "[Setting Up Alert Notifications](#)" on page 336 for more information.

Audit events for alerts are only written to the Internal Storage Group and not forwarded to ESM Destinations by default. If you need to forward these audit events to ESM, please contact customer support for assistance.

**Note:** This change only applies to audit events generated for alerts; other audit events are can be sent to ESM Destinations.

Logger comes with predefined filters with commonly needed event patterns so that you can use to quickly create the alerts you need. You can also create new filters that to find specific event patterns of interest.

### To see a list of the configured Real Time Alerts:







1. Open the **Configuration | Data** menu and click **Alerts**.  
The Realtime Alert list is displayed.

#### Realtime Alerts

Realtime Alerts

[Add](#)



If you are looking for scheduled alerts, you can find them on the [Scheduled Searches/Alerts](#) page.

Name	Email Destination(s)	SNMP Destination	Syslog Destination	ESM Destination	Query	
<a href="#">NolncomingEvents realtime alert</a>		NONE	NONE	NONE	cef:0.*cat=/Monitor/Receiver/EPs/All.*cn1=0.*:AND:storageGroup(Internal Event Storage Group)	  
<a href="#">UnsuccessfulLogins realtime alert</a>		NONE	NONE	NONE	login auth(?:fail succe start from) authenticat userauth password ["a-zA-Z]su.*(?:succeeded pts) sshd.*session sudo(?:52[89] 53[0-7,9] 540 552)	  

### To add a Real Time Alert:

See "[Creating Real Time Alerts](#)" on the next page.

### To enable or disable a Real Time Alert:

1. Open the **Configuration | Data** menu and click **Alerts**.
2. Locate the Alert that you want to disable or enable. Click the associated icon ( or ) to enable or disable the Alert.

**Note:** A maximum of 25 alerts can be enabled at one time. To enable an additional alert, you will need to disable a currently enabled alert.

If you have the maximum number of alerts enabled, and the receiver EPS is higher than 30k, you may see some slow-down in receiver EPS to prevent slower search times.

### To edit a Real Time Alert:

1. Open the **Configuration | Data** menu and click **Alerts**.
2. Locate the Alert that you want to edit and click the Edit icon (✎) on that row.

A screen similar to the "Add Realtime Alert dialog box" below is displayed. Only alphanumeric characters can be used in an Alert name.

### To remove a Real Time Alert:

1. Open the **Configuration | Data** menu and click **Alerts**.
2. Locate the Alert that you want to remove and click the Remove icon (✖) on that row.
3. Confirm the deletion by clicking **OK**, or click **Cancel** to retain the Alert.

### To view triggered alerts:

See "Viewing Alerts" on page 141.

## Creating Real Time Alerts

This section describes how to create Real Time Alerts. For information on Saved Search Alerts, see "Creating Saved Search Alerts (Scheduled Alerts)" on page 272. For a description of the types of alerts, see "Logger Alert Types" on page 332.



### To create a Real Time Alert:

1. Open the **Configuration | Data** menu and click **Alerts**.
2. Click **Add**. The Add Realtime Alert dialog box is displayed.

#### **Add Realtime Alert dialog box**

### Add Realtime Alert

Name

Query    

Filters

- Configuration - System Configuration Changes (CEF format)
- Events - CEF
- Events - High and Very High Severity CEF Events
- Intrusion - Malicious Code (CEF format)
- Logins - All Logins (CEF format)
- Logins - All Logins (Non-CEF format)
- Logins - Successful Logins (CEF format)
- Logins - Successful Logins (Non-CEF format)
- Logins - Unsuccessful Logins (CEF format)
- Logins - Unsuccessful Logins (Non-CEF format)

Use ctrl-click to select or deselect items

Match count

Threshold (sec)

Email address(es)

SNMP destination

Syslog destination

ESM destination

3. Enter a name for the new Alert, specify a query, or select an available Filter from the list. Events that match this query are candidates for the Alert.
4. You can edit the search filter query to meet your needs. Alphanumeric characters and spaces are acceptable, however, some special characters such as % and & are not.

For more information on Filters, see ["Filters" on page 260](#).

**Tip:** To test the validity of an alert query, use the **Search** user interface. Enter the query in the Search text box in the following format:

Real time Alert: | regex "regex expression"

Scheduled saved alert: \_deviceGroup IN ["192.0.2.3 [TCPC]"] name="\*[4924TestAlert]\*" AND ("192.0.\*" OR categoryBehavior CONTAINS Stop)

If the query is valid, cut and paste the regular expression between the double quotes (“ ”) in the **Query** text box on the Add Alert page.

5. Enter **Match count** and **Threshold** values. If the number of candidate events equals or exceeds the Match count within the Threshold number of seconds, the Alert will be triggered.

If you want to be notified when any event matches the filter (for example, for an internal event such as High CPU Temperature), enter a Match count of 1 and a Threshold of 1.

**Note:** To maintain an optimal size of an alert event, the event does not contain event IDs of all the triggering events if you specify **Match count of 101 or higher**. As a result, the `baseEventCount` field in the event does not reflect the true number of matching events for such alert events.

Triggering events are truncated in multiples of 100. Therefore, if you specify a Match count of 101, only one event is included in the alert event and the `baseEventCount` field value is 1. Similarly, if you specify a Match count of 720, only 20 events are included and the `baseEventCount` field value is 20.

6. Enter notification destinations. Enter any combination of:
  - One or more e-mail addresses, separated by commas
  - An SNMP Destination—for more information, see ["SNMP Destinations" on page 337](#).
  - A Syslog Destination—for more information, see ["Syslog Destinations" on page 337](#).
  - An ArcSight Manager—for more information, see ["Sending Notifications to ESM Destinations" on page 338](#).

7. Click **Save**.

When you create an alert, it is in disabled state. Enable it using the instructions in ["To enable or disable a Real Time Alert:" on page 329](#).

## Logger Alert Types

Logger provides two types of alerts:

- Real time alerts search continually and automatically send notifications if specified criteria are found. For more information, see ["Real Time Alerts" on page 328](#).
- Saved Search Alert search at a scheduled interval and send notifications if specified criteria are found. For more information, see ["Saved Search Alerts" on page 271](#).

The following table compares the two types of alerts.

Real Time Alerts	Saved Search Alerts
<p>No limit on the number of alerts that are defined.</p> <p>A maximum of 25 alerts can be enabled at any time.</p>	<p>Any number of alerts can be defined. All defined alerts are enabled and effective, however, a maximum of 50 alerts can run concurrently.</p>
<p>No limit on the number of configured e-mail destinations; however, you can only set one SNMP, one Syslog, and one ESM Destination.</p>	<p>No limit on the number of configured e-mail destinations; however, you can only set one SNMP, one Syslog, and one ESM Destination.</p>
<p>Only regular expression queries can be specified for these alerts.</p>	<p>Queries for these alerts are defined using the flow-based search language that allows you to specify multiple search commands in a pipeline format, including regular expressions.</p> <p>Aggregation operators such as chart and top cannot be included in the search query.</p>
<p>Alerts are triggered in real time. That is, when specified number of matches occurs within the specified threshold, an alert is immediately triggered.</p>	<p>These alerts are triggered at scheduled intervals. That is, when a specified number of matches occurs within the specified threshold, an alert is triggered at the next scheduled time interval.</p>
<p>To define a real time alert, you specify a query, match count, threshold, and one or more destinations.</p> <p>A time range is not associated with the queries defined for these alerts. Therefore, whenever the specified number of matches occurs within the specified threshold, an alert is triggered.</p>	<p>To define a Saved Search Alert, you specify a Saved Search (which is a query with a time range), match count, threshold, and one or more destinations.</p> <p>A time range (within which events should be searched) is specified for the query associated with these alerts. Therefore, specified number of matches within the specified threshold (in minutes) must occur within the specified time range. You can also use dynamic time range (for example, \$Now-1d, \$Now, and so on).</p> <p>For example, if a Saved Search query has these start and end times:</p> <ul style="list-style-type: none"> <li>• Start Time: 5/11/2010 10:38:04</li> <li>• End Time: 5/12/2010 10:38:04</li> </ul> <p>And, the number of matches and threshold are the following:</p> <ul style="list-style-type: none"> <li>• Match count: 5</li> <li>• Threshold: 3600</li> </ul> <p>This will trigger an alert whenever five events occur within one hour between May 11th, 2016 10:38:04 AM and May 12th, 2016 10:38:04.</p>

## Alert Triggers and Notifications

An alert is triggered if a specified number of matches occurs within the specified threshold (time interval in seconds). When an alert is triggered, Logger creates an alert event containing the triggering events or event IDs, and sends notification through previously configured destinations—e-mail addresses, SNMP server, Syslog server, and ArcSight Manager.

By default, only alert notifications sent to e-mail destinations include all matching events that triggered the alert. You can configure your Logger to include matched events for SNMP, Syslog, and ESM Destinations as well. However, that kind of configuration is only possible through the command-line interface of the Logger; therefore, please contact customer support for instructions.

### When are Alert events triggered?

You also specify a time window and a number of matching events. When that number of matching events is detected within the time window, an alert event is triggered.

Logger resets the count after detecting 100 matching events. Therefore, all events that occur in the time window will not necessarily be recorded in an alert. For example, if you configure the alert to be sent when there are 20 matching events in two minutes, and 152 events occur within two minutes, you will get seven alerts, and 12 matching events will not be included in any alert. In this situation, the following alert events are triggered:

- Alert one has 20 matching events.
- Alert two has 40 matching events.
- Alert three has 60 matching events.
- Alert four has 80 matching events.
- Alert five has 100 matching events (1-100).
- Alert six has 20 matching events (101-120).
- Alert seven has 40 matching events (101-140).

The remaining 12 events are being held, waiting to meet the threshold of 20 more events in a two-minute interval.

### Receiving Alert Notifications

In order to receive notification from an alert, set up the alert to be sent to a previously configured destination, such as an e-mail address, SNMP server, Syslog server, and ArcSight Manager.

By default, only alerts to e-mail destinations include all matched events that triggered the alert. You can configure your Logger to include matched events for SNMP, Syslog, and ESM Destinations as well. However, such a configuration is only possible through the command-line interface of the Logger; therefore, please contact customer support for instructions.

For information on how to configure destinations, see ["ESM Destinations" on page 339](#), ["SNMP Destinations" on page 337](#), and ["Syslog Destinations" on page 337](#). To configure e-mail destinations, see ["Static Routes" on page 409](#), as well.

**Note:** Audit events for alerts are only written to the Internal Storage Group and not forwarded to ESM by default. If you need to forward these audit events to ESM destinations, please contact customer support for assistance. This only applies to audit events generated for alerts; other audit events can be sent to ESM destinations.

## Sending Notifications to E-mail Destinations

When you send notifications for an alert via e-mail, the e-mail message contains both the trigger alert information and the matched (base) events.

The following is an example of the trigger alert information:

Alert event match count [1], threshold [10] sec

And the matched event:

Event Time [Tue May 11 16:46:49 PST 2016]

Event Receipt Time [Tue May 11 16:46:50 PST 2016]

Event Device Address [192.0.2.1]

Event Content [May 11 10:31:20 localhost

```
CEF:0|NetScreen|Firewall/VPN||traffic:1|Permit|Low| eventId=590 msg=start_
time=\ "2016-05-11 15:25:02" duration\=15 policy_id\=0 service\=SSH proto\=6
src zone\=Trust dst zone\=Untrust action\=Permit sent\=656 rcvd\=680
src\=192.0.2.4 dst\=192.0.2.5 src_port\=54759 dst_port\=22 translated
ip\=192.0.2.2 port\=54759 app=SSH proto=TCP in=680 out=656
categorySignificance=/Normal categoryBehavior=/Access
categoryDeviceGroup=/Firewall categoryOutcome=/Success
categoryObject=/Host/Application/Service art=1165861874880 cat=Traffic Log
deviceSeverity=notification act=Permit rt=1165861874880 shost=n111-
h046.qa.arcsight.com src=192.0.2.4 sourceZoneURI=/All Zones/System
Zones/Private Address Space/RFC1918: 192.0.2.0-192.255.255.255
sourceTranslatedAddress=192.0.2.2 sourceTranslatedZoneURI=/All Zones/System
Zones/Public Address Space/192.0.2.0-192.0.255.255 spt=54759
sourceTranslatedPort=54759 dst=192.0.2.10 destinationZoneURI=/All
Zones/System Zones/Private Address Space/RFC1918: 192.0.2.0-192.255.255.255
dp]
```

## Setting Up Alert Notifications

### To set up alerts notifications:

1. Configure the Logger's SMTP with the desired e-mail address destination (see ["Static Routes" on page 409](#)) or create an SNMP Destination (see ["SNMP Destinations" on the next page](#)) or Syslog Destination (see ["Syslog Destinations" on the next page](#)).

Number of destinations per alert:

- E-mail: Multiple, each separated by a comma.
  - SNMP: One
  - Syslog: One
2. Create a query to find the events of interest; save the query as a filter. See ["Saving Queries \(Creating Saved Searches and Saved Filters\)" on page 129](#).

**Note:** Only regular expressions can be used in queries specified for alerts.

3. Create an Alert that uses the new filter and specify match count and threshold (see ["Saved Searches" on page 264](#).)
4. Enable the new Alert.

## Sending Notifications to Syslog and SNMP Destinations

When configuring Logger to send alerts to SNMP and Syslog destinations, you should be familiar with this information:

- Logger supports SNMP v2c and v3.
- Unlike an e-mail alert, a trigger alert is sent separately from the alert that contains the matched (base) events that triggered the alert.
- All SNMP alerts are sent as SNMP traps; therefore, trigger alerts and their associated matched (base) events are received as SNMP traps on an SNMP destination. The SNMP trap includes the trigger event, but it does not include the events that caused the alert to trigger (matched events). The trigger event does include the event IDs of all the matched events. You can use the event IDs in the trigger alert to identify the associated matched events.

**Note:** Non-CEF events do not contain event IDs. If you need to associate such base events with their trigger alert, send such events to Logger through a connector.

- SNMP uses UDP to send packets. As a result, the order in which alerts arrive at an SNMP destination is not guaranteed.
- When Syslog events are sent using UDP, the order in which the trigger alert and matched events arrive is not guaranteed.



## SNMP Destinations

SNMP Destinations describe how Alert notifications should be sent using Simple Network Management Protocol (SNMP). Set up SNMP Destinations before creating Alerts that will use them. Before configuring SNMP destinations, you should be familiar with the information in ["Sending Notifications to Syslog and SNMP Destinations" on the previous page.](#)

### To add an SNMP Destination:

1. Open the **Configuration | Data** menu and click **SNMP Destinations**.
2. Click the **Add** button.
3. Enter parameters:

Parameter	Description
SNMP Destination Name	A name for this destination.
Connector Name	The SmartConnector name.
Connector Location	The physical location of the SmartConnector machine. If you do not want to specify a location, enter "None."
Logger Location	Optional comment describing Logger's physical location.
SNMP Host	Host name or IP address.
SNMP Port	162, by default.
Community Name	SNMP community name.

4. Click **Save** to create the new SNMP Destination.

### To remove an SNMP Destination:

1. Open the **Configuration | Data** menu and click **SNMP Destinations**.
2. Locate the SNMP Destination that you want to remove and click the Remove icon (✕) on that row.
3. Confirm the deletion by clicking **OK**, or click **Cancel** to retain the SNMP Destination.

## Syslog Destinations

Syslog Destinations describe how Alert notifications should be sent using the comparatively simple syslog protocol. You need to set up Syslog Destinations before creating Alerts that will use them. Before configuring Syslog destinations, you should be familiar with the information in ["Sending Notifications to Syslog and SNMP Destinations" on the previous page.](#)

### To add a Syslog Destination:

1. Open the **Configuration | Data** menu and click **Syslog Destinations**.
2. Click the **Add** button.
3. Enter parameters:

Parameter	Description
Name	A name for this destination.
Type	UDP or TCP Syslog. <b>Note:</b> This choice cannot be edited later.

4. Click **Next**. Enter the secondary parameters:

Parameter	Description
Name	The name for the destination.
Type	This is the value you entered in the previous screen. This value cannot be changed.
Ip/Host	Host name or IP address.
Port	Port (default is 514).
Connection Retry Timeout	(Only for TCP Syslog Destinations) The time, in seconds, to wait before retrying a connection. The default is 5 seconds.

5. Click **Save** to create the new Syslog Destination.

### To edit a Syslog Destination:

1. Open the **Configuration | Data** menu and click **Syslog Destinations**.
2. Click the Edit icon (✎). You can edit the parameters of the Syslog Destination except its type.
3. Click **Save** to make the changes, or **Cancel** to return to the Syslog Destination table.

### To remove a Syslog Destination:

1. Open the **Configuration | Data** menu and click **Syslog Destinations**.
2. Locate the Syslog Destination that you want to remove and click the Remove icon (✖) on that row.
3. Confirm the deletion by clicking **OK**, or click **Cancel** to retain the Syslog Destination.

## Sending Notifications to ESM Destinations

ESM Destinations describe how Alert notifications should be sent to an ArcSight Manager. Set up ESM destinations before creating Alerts that will use them.

If an ArcSight Manager uses a signed SSL certificate, you will need to load it on the Logger.

**Note:** Audit events for alerts are only written to the Internal Storage Group and not forwarded to ESM by default. If you need to forward the audit events generated for alerts to ESM, please contact customer support for assistance.

### To setup Logger to send alerts to an ArcSight Manager:

1. If the ArcSight Manager uses a certificate, copy the server SSL certificate file from an ArcSight Console or other component that is already communicating with the target Manager, and upload the certificate file to Logger, as described ["Uploading a Certificate to the Logger:" on page 342.](#)

**Note:** You cannot import the cacerts file, which is a repository of trusted certificates, to the Logger. Instead, you need to import specific SSL certificate files.

2. Create an ESM Destination, as described in ["To create an ESM Destination:" on page 341.](#)

## ESM Destinations

An ESM Destination establishes a trusted connection between Logger and an ArcSight Manager so that you can forward events and alerts in Common Event Format (CEF) from the Logger to the Manager using Logger's built-in SmartConnector.

The CEF events are already normalized or categorized. For more information about CEF, refer to the document "Implementing ArcSight CEF". For a down-loadable copy of this guide, search for "ArcSight Common Event Format (CEF) Guide" in the [ArcSight Product Documentation Community on Protect 724.](#)

Logger can forward these types of events to an ArcSight Manager:

- Syslog events to an ArcSight Syslog SmartConnector that is connected to an ArcSight Manager
- Common Event Format (CEF) events directly to an ArcSight Manager using Logger ESM Destinations. An ESM Destination appears as a SmartConnector to an ArcSight Console.
- Events received by file receivers where the type specified is not Other. Such events are forwarded using the ArcSight Streaming SmartConnector.

**Maximum ESM Destinations:** As many destinations as are allowable on the SmartConnectors you are using. However, for performance reasons, HPE ArcSight Data Platform Logger and ArcSight recommends that you create no more than two ESM Destinations pointing to a single ArcSight Data Platform Logger and ArcSight Manager. (One should suffice in most cases.)

**Note:** Do not use basic aggregation for Logger's built-in SmartConnector because it is resource intensive. (Basic aggregation is set using the **Enable Aggregation (in seconds)** field from the ArcSight Console.) Instead, follow these steps on the ArcSight Console to configure field-based aggregation:

1. Ensure that Processor > Enable Aggregation (in seconds) is set to **Disabled**, to disable basic aggregation.
2. Right-click the connector and select **inspect/edit/**.

For additional details about configuring field-based aggregation, refer to the ArcSight SmartConnector *User's Guide*.

### To setup Logger to forward events to an ArcSight Manager:

1. Copy the server SSL certificate file from an ArcSight Console or other component that is already communicating with the target Manager, and upload the certificate file to Logger, as described ["Uploading a Certificate to the Logger:" on page 342](#).

If your Logger operates in FIPS mode, a valid and current (non-expired) server SSL certificate file from the ArcSight Manager is required on the Logger; otherwise, the forwarder will not forward events to it.

**Note:** You cannot import the cacerts file, which is a repository of trusted certificates, to the Logger. Instead, you need to import specific SSL certificate files.

2. Create an ESM Destination, as described in ["To create an ESM Destination:" on the next page](#).
3. Create an ESM forwarder that refers to this ESM Destination. (See ["Forwarders" on page 321](#)).

#### ESM Destinations page

**Add ESM Destination**

Name	<input type="text" value="n185-h129"/>
Connector Name	<input type="text" value="n185-h129"/>
Connector Location	<input type="text" value="/All Connectors/Devices"/>
Logger Location	<input type="text"/>
IP/Host	<input type="text" value="n185-h129"/>
Port	<input type="text" value="8443"/>
User Name	<input type="text" value="UserName"/>
Password	<input type="password" value="••••••••"/>

### To create an ESM Destination:

Make sure you have loaded the certificate file for ArcSight Manager as described in ["Uploading a Certificate to the Logger:" on the next page](#) before adding it as a destination on the Logger. If the certificate file does not exist on the Logger, you will not be able to create an ESM Destination.

1. Open the **Configuration | Data** menu and click **ESM Destinations**.
2. Click **Add**. The ESM Destinations page is displayed.
3. Enter the following parameters:

Parameter	Description
Name	The name for this ESM Destination.
Connector Name	The SmartConnector name.
Connector Location	The physical location of the SmartConnector machine. If you do not want to specify a location, enter "None."
Logger Location	The physical location of the Logger. If you do not want to specify a location, enter "None."
IP or Host	The ArcSight Manager to which the forwarder will direct events.  <b>Note:</b> Make sure the name or IP address you specify in this field is exactly the name or IP address configured on the ArcSight Manager. If the two names or IP addresses do not match, you will not be able to set up an ESM Destination successfully.
Port	Typically 8443.
User Name	The name of an existing User of the ArcSight Manager with administrator privileges.
Password	The password for the Login user.  This password cannot contain the special characters percent (%), equal to (=), semicolon (;), double quote ("), single quote ('), less than (<), or greater than (>).  <b>Caution:</b> While ArcSight Manager allows these special characters in passwords, Logger does not. If the ArcSight Manager user's password contains those characters, you will need to change the password in ArcSight Manager before configuring this password.

4. Click **Save**.

**Tip:** If you receive the following error when adding a new ESM Destination, make sure the host name you specified in the IP or Host field *exactly matches* the name configured on the ArcSight Manager.

There was a problem: Failed to add destination

Additionally, if the ArcSight Manager is configured using a host name instead of IP address, make sure you add the ArcSight Manager host name and IP address in the Logger's hosts file (**System Admin > Network > Hosts**).

### To delete an ESM Destination:

1. Open the **Configuration | Data** menu and click **ESM Destinations** (or click **Alerts** and then open the **ESM Destinations** page if you are deleting an ESM Destination for forwarding Alerts.)
2. Locate the ESM Destination that you want to delete and click the Delete icon (✖) on that row.
3. Confirm the deletion by clicking **OK**, or click **Cancel** to retain the ESM Destination.

## Certificates

### Uploading a Certificate to the Logger:

Upload a valid server SSL certificate file for the ArcSight Manager that you are establishing as a Logger destination for forwarding events and alerts.

If your Manager *does not* have FIPS 140-2 mode enabled, you can obtain a certificate file for your Manager in these ways:

- From the Manager's keystore
- From the ArcSight Console's truststore
- From the truststore of one of the SmartConnectors that communicates with the Manager

Use the `keytoolgui` utility to export a Manager's certificate as described in the "Using Keytoolgui to Export Certificate" procedure in the ArcSight ESM *Administrator's Guide*. For detailed information about keystore, truststore, their locations on the Manager, ArcSight Console, and the SmartConnectors, see the ArcSight ESM *Administrator's Guide*.

Once you have exported a certificate for your Manager, copy it to the machine from which you connect to your Logger.

If your Manager *has* FIPS 140-2 mode enabled, run this command to export the Manager's certificate from the Manager's `<ARCSIGHT_HOME>/bin` directory:

```
arcsight runcertutil -L -n managerkey -r -d <ARCSIGHT_HOME>/config/jetty/nssdb -o <absolute_path_to_manager.cert>
```

This command generates the `manager.cert` file, the Manager's certificate, in the location that you specified in the above command.

**Note:** By default, the `manager.cert` file will be exported to your `<ARCSIGHT_HOME>` directory if you do not specify the absolute path to the `manager.cert` file destination.

### To upload a certificate file for an ESM Destination:

1. Make sure you have copied the Manager certificate to the machine from which you connect to your Logger.
2. Open the **Configuration | Data** menu and click **Certificates**.
3. Click **Add** to display the following screen.

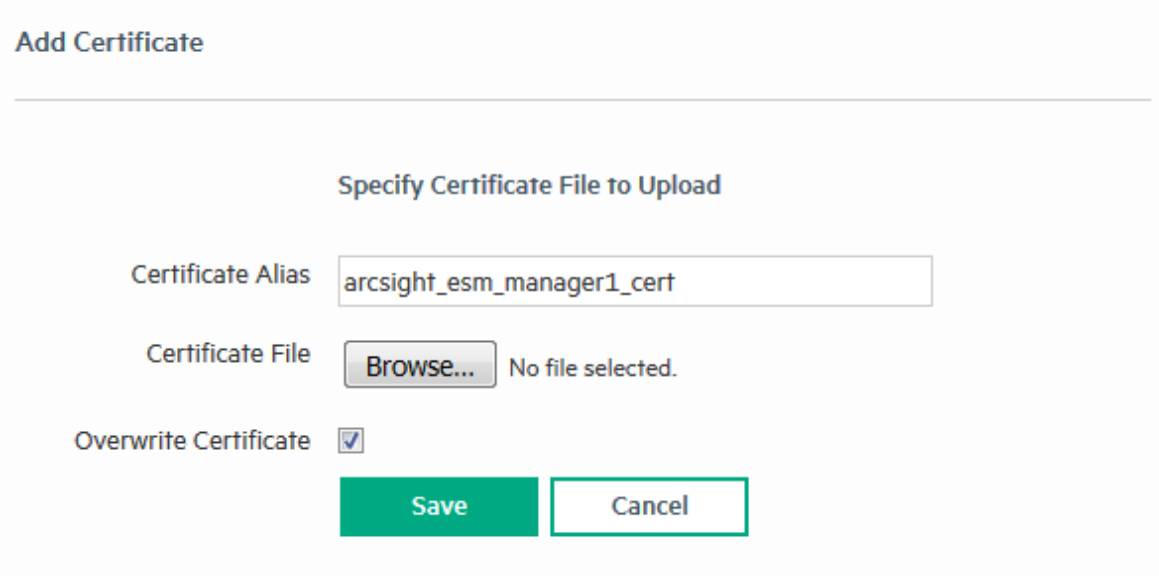

**Add Certificate**

---

**Specify Certificate File to Upload**

Certificate Alias

Certificate File  No file selected.

Overwrite Certificate

4. Enter an alias for the certificate file. This name is used to easily identify a certificate file. For example, arcsight\_esm\_manager1\_cert.
5. Click **Browse** to locate the Manager Certificate file you copied.
6. Check the “Overwrite Certificate” box if you want this certificate to overwrite an existing certificate with the same alias.
7. Click **Save**.

## Forwarding Log File Events to ESM

Logger can read events from a log file and forward those events to a Logger streaming SmartConnector that sends the events on to ArcSight Manager.

To forward log file events to ESM, configure the receiver, forwarder, and SmartConnector to accept the same source type (as described in ["Working with Source Types" on page 312](#)).

**Note:** The receiver, forwarder, and SmartConnector must all be configured with **the same Source Type value** to successfully forward log file events from Logger to ArcSight ESM.

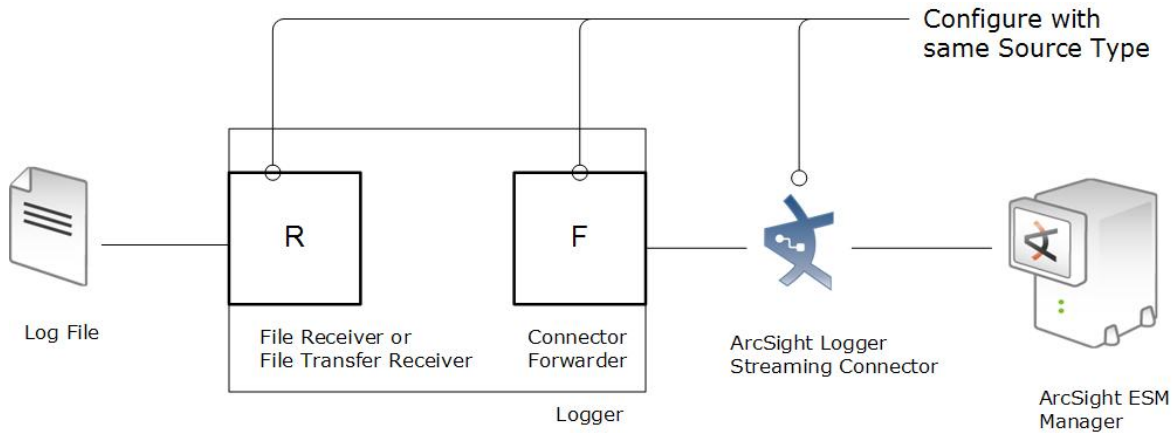

Unlike events that Logger receives, such as syslog, SmartMessage, or CEF, log file events must be parsed to determine event timestamp. Therefore, if you need forward events to ESM by using a Connector forwarder, you must choose one of the following source types for the receiver:

Source Type	
Apache HTTP Server Access	Microsoft DHCP Log
Apache HTTP Server Error	Other
IBM DB2 9.x Audit Log	Tipping Point SMS 2.5 Syslog
IBM DB2 Audit	VMware ESX Syslog
Juniper Steel-Belted Radius	

## Data Validation

The data validation screen enables you to perform audit-quality validation on your Logger data files. From here, you can check the hash value of all data files within specified time range to validate the data. This feature is only available to administrators. See ["Users/Groups" on page 442](#) for more information on Logger user rights and how to administer them.

The data validation process uses the SHA1 hash algorithm to compute the hash value for the data files in the specified time range and compares it to the pre-computed value to determine the integrity of the data file. Each data file contains up to 1 GB of data; the hash value is computed once the data file is full. If a data file is not full yet, its validation result cannot be computed.

### Prerequisites

Users must be assigned to the following User Groups to access this feature:

- Default Logger Rights Group
- Default System Admin Group

See ["Setting Logger User Permissions" on page 458](#) for more information.



## To validate data on Logger:

1. Open the **Configuration | Data** menu and then click **Data Validation**.

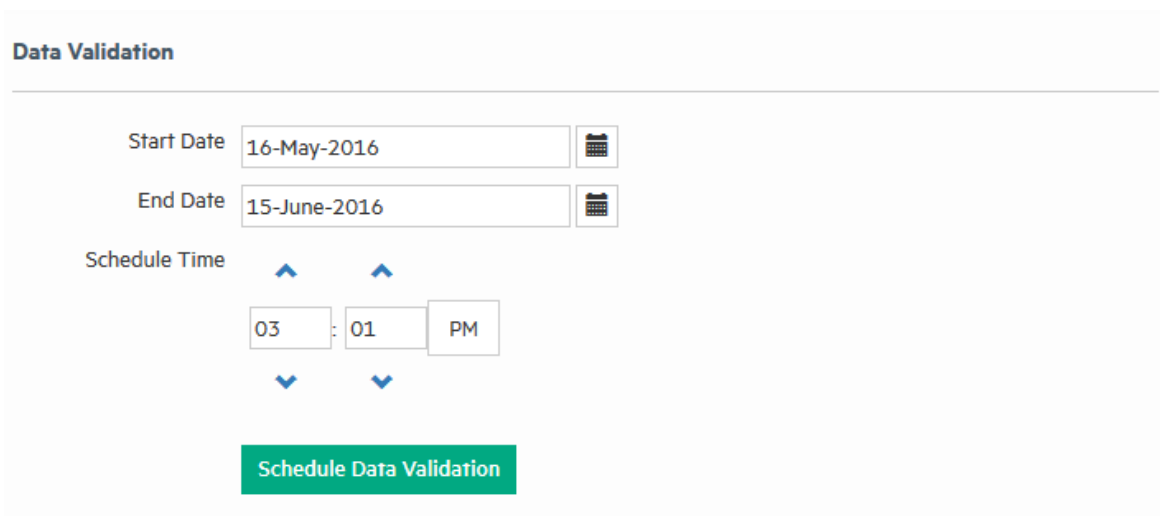

The screenshot shows the 'Data Validation' configuration page. It features two date input fields: 'Start Date' with the value '16-May-2016' and 'End Date' with the value '15-June-2016'. Below these is a 'Schedule Time' section with three input boxes: '03', '01', and 'PM'. The '03' and '01' boxes have up and down arrows above and below them, respectively. A green button labeled 'Schedule Data Validation' is positioned at the bottom of the form.

2. Specify the range of data you want to validate in the **Start Date** and **End Date** fields.
3. Specify the time you want to run the validation by using the up and down-arrows on the **Schedule Time** fields.
4. Check the **Email Me Validation Results** checkbox to have Logger send an email letting you know the validation result as soon as the validation process is complete. Logger sends this to the email address stored for the logged-in user.

**Note:** If the **Email Me** option is not available, Logger's SMTP server has not been configured. Logger's system administrator may be able to enable this feature. For more information, see ["SMTP" on page 413](#).

5. Click **Schedule Data Validation**.

**Note: You cannot cancel a Data Validation in progress.** The data validation process can take a long time for large amounts of data. Therefore you should schedule the process to run during off-peak hours, and narrow down the time range to include only the data you are interested in.

Once the data validation process is complete, each data file in the specified time range is displayed along with its Validation Result. If the email checkbox was selected, an email with the subject, "Data Validation results from Logger <logger host name>" is sent to the email address stored for the logged-in user.

**Data validation result generated on 15-Jun-2016** [Export](#)

---

Start Date 11-Jun-2016  
End Date 14-Jun-2016  
Number of corrupt files 0  
Number of intact files 0  
Number of files without a hash 4

---

<b>Data File</b>	<b>? Validation Result</b>	All
/opt/softlogger/data/logger/Arcsight_Data_4	Hash unavailable	
/opt/softlogger/data/logger/Arcsight_Data_6	Hash unavailable	
/opt/softlogger/data/logger/Arcsight_Data_8	Hash unavailable	
/opt/softlogger/data/logger/Arcsight_Data_10	Hash unavailable	

To view the validation results:

- Click the down-arrow in the **Validation Result** dropdown to select the type of result that you want to see. You can select All, Corrupt, Intact, or Hash Unavailable.

OR

- Click **Export** to download a spreadsheet containing the validation data.

The following table describes the possible validation results:

<b>Displayed Value</b>	<b>Value in Exported File</b>	<b>Description</b>
Intact	True	The hashes match; the data is intact.
Corrupt	False	The hashes do not match; the data has been changed or become corrupt.
Hash unavailable	N/A	The file has no hash; the data could not be validated. This is most likely because the data file is not yet full or the data file was created by an older version of Logger.

**Note:** If the system is upgraded to Logger 6.0, data from the earlier version will have a status of N/A. This is because no data validation hash value was stored when the data was created. However, in the case of future upgrades, hash validation data will be kept, and you will be able to validate the data after an upgrade.

## Storage

The options in the **Configuration | Storage** category enable you to manage how data is stored in Logger. Different storage groups support the implementation of multiple retention policies. Each group can have a different policy, and storage rules determine which storage group is used for events from specific device groups. For more information, refer to the *Logger Installation Guide*.

- [Storage Groups](#) ..... 347
- [Storage Rules](#) ..... 349
- [Storage Volume](#) ..... 350
- [Event Archives](#) ..... 351
- [Guidelines for Archiving Events](#) ..... 353
- [Archiving Events](#) ..... 354
- [Daily Archive Settings](#) ..... 356
- [Archive Storage Settings](#) ..... 357
- [Loading and Unloading Archives](#) ..... 358
- [Indexing Archived Events](#) ..... 359

## Storage Groups

Storage Groups support multiple retention policies by defining a maximum size (Allocated (GB)) and number of days (Maximum Age) to retain events. Once events are older than the specified Maximum Age or there are more events than the storage group will hold (as specified by Allocated size), the oldest events are deleted at the next retention cycle. The retention process triggers periodically on Logger, therefore, events might not be deleted immediately when events gets older than maximum age or the storage group size exceeds the allocated size.





Logger can have a maximum of 6 storage groups—two that pre-exist on your Logger (Internal Storage Group and Default Storage Group) and four that you can create. You can add the additional storage groups (up to the maximum of six) at any time.

HPE recommends that you create the four additional storage groups in addition to the two that pre-exist, so that you have five storage groups available for event storage and one for Logger's internal events.

To add additional storage groups, follow the instructions in ["Adding Storage Groups" on page 375](#).

**Once a storage group is created, it cannot be deleted;** however its size can be increased or decreased any time. If you are decreasing the size of the storage group and the new size is lesser than the currently used space on the storage group, you will need to delete data to achieve the new size. In this situation, the Logger UI guides you to delete sufficient data.

## Storage Groups page

Storage Groups						
Name	Maximum Age (Days)	Allocated (GB)	Used (GB)	Creator	Last Editor	
Default Storage Group	365	30	19	admin	admin	
Internal Event Storage Group	365	3	1	System	System	
SG1	30	97	18	admin	admin	
SG2	30	97	65	admin	admin	
SG3	30	97	3	admin	admin	

### To edit (including resizing) a storage group:

1. Open the **Configuration | Storage** menu and then click **Storage Groups**.  
The Storage Groups page displays the available storage groups.
2. Identify the storage group you want to modify and click the associated **Edit** icon (). The Storage Groups page displays the Edit <Storage Group Name> Storage Group pane.

#### Edit Default Storage Group

**Important:**

Please be aware that if you reduce the maximum age from the current value you will lose all events that are older than the new maximum age.

Reducing the maximum storage group age may take a few minutes to complete.

Maximum Age (Days)	<input type="text" value="180"/>
Allocated (GB)	<input type="text" value="3"/>
Used (GB)	<input type="text" value="1"/>
<input type="button" value="Save"/> <input type="button" value="Cancel"/>	

3. Change the name of the storage group, or increase or decrease Maximum Age or Allocated size.

**Note:** The names of the Internal Storage Group and Default Storage Group cannot be modified.

**If you are reducing the size of the storage group** and the new size is smaller than the current size indicated the **Used (GB)** field on the Edit Storage Group page, Logger displays a message indicating that reducing storage group size in this situation will require you to delete existing data.

#### **If you choose to delete data to reduce the storage group size, follow these steps:**

- a. Set the **Maximum Age** value to the number indicated in the message. Doing so triggers the deletion of events.
- b. Refresh the Edit Storage Group screen. When the **Used (GB)** value is less than or equal to the

storage group size you want to set, go to the next step. Otherwise, keep refreshing the screen periodically.

**Note:** The Used (GB) value changes as data are deleted, which can take some time. Therefore, you need to wait before proceeding to the next step.

- c. Set the **Allocated (GB)** value to suit your needs.
- d. If you wish, restore the **Maximum Age** setting (that you changed in Step a) to the original value.

If you choose *not* to delete data, go to the next step to exit the procedure.

**Note:** If there is sufficient space to reduce the storage group size, you can change it without modifying the Maximum Age value (to modify the retention policy to delete data).

4. Click **Save** to store the changes, or **Cancel** to quit.

## Storage Rules

Storage rules create a mapping between device groups and storage groups. Doing so enables you to store events from specific sources to a specific storage group. You can configure these storage groups with different retention policies, and thus retain event data based on the source of incoming events. For example, all events from firewall devices can be subject to a short retention period. To accomplish this, manually assign the firewall devices to a device group and then create a storage rule that maps the device group to a storage group with the desired short retention period.

**Tip:** Events that are not subject to any storage rule are sent to the Default Storage Group.

Before you add a storage rule, make sure that the storage group to which you want to store the events and the device group that contains the devices whose events you want to store exist. For information on how to create device groups, see ["Device Groups" on page 293](#).

Logger allows you to create up to 40 storage rules. If you create additional rules, an error might be generated.

### To add a storage rule:

1. Open the **Configuration | Storage** menu and then click **Storage Rules**.
2. Click **Add**. The Add Storage Rule page displays.

**Add Storage Rule**

---

Storage Group

Device Group

Priority

3. Enter the following parameters:

Parameter	Description
Storage Group	Select a storage group from the drop-down list. The storage groups must already be set up before any storage rules are added.
Device Groups	Select a device to associate with the storage group.  <b>Note:</b> If you want to include events from more than one device in the storage group, create a Device Group which contains all the Logger Devices you want and then select that Device Group for the Storage Rule.
Priority	An integer that indicates the new rule's priority. The number must be unique for each storage rule. The smaller the number, the higher the rule's priority.

4. Click **Save** to add the new storage rule, or **Cancel** to quit.

### To edit or reorder a storage rule:

1. Open the **Configuration | Storage** menu and then click **Storage Rules**.
2. Find the storage rule that you want to edit and click the Edit icon (✎) on that row.
3. Change the information in the form—for example, change the priority value to reposition the storage rule in the table—and click **Save**.

### To delete a storage rule:

1. Open the **Configuration | Storage** menu and then click **Storage Rules**.
2. Find the storage rule that you want to delete and click the Remove icon (✖).
3. Click **OK** to confirm the delete.

## Storage Volume

The Storage Volume page displays the mount location and current storage volume settings.

### To view the existing storage volume settings:

1. Select **Storage Volume Settings** from the navigation bar Configuration | Storage menu.

Storage path is configured to `/opt/arcsight/data/logger`. To increase the Storage Volume size, go to the System Maintenance page. You must have admin-level privileges to perform this operation.

#### Storage Volume Settings

**Allocated (GB)** 583

**Status** Ready

### To increase the Storage Volume size:

See "[Storage Volume Size Increase](#)" on page 374 for full details. You must have admin-level privileges to perform this operation. See "[Users/Groups](#)" on page 442 for more information on Logger user rights and how to administer them.

## Event Archives

Event Archives enable you to save the events for any day in the past, *not including the current day*. Archive Storage Settings must be configured before Event Archives can be created. Archive Storage Settings specify the location to which event archives will be written.

**Caution:** Ensure that both Configuration Backups (for configuration settings) and Event Archives (for data) run on a regular basis and are stored in a remote location. In the event of catastrophic failure, you will need to restore the most recent Configuration Backup and Event Archive. For information on Configuration Backups, see "[Configuration Backup and Restore](#)" on page 383.

- For Logger Appliances, the location needs to be an NFS mount, CIFS mount, or SAN, which is configured using the Logger user interface.
- For Software Loggers, the location is a directory (either local or a mount point that you have already established on the Logger host).

Events in each storage group are archived separately. That is, one archive file is created for each storage group, for each day. In addition, you can bulk archive events—that is, specify a range of dates to archive events in a single archive operation.

Archiving events from each storage group to a separate archive location enables you to keep data in specific storage groups longer than others. You need to specify these locations when you configure the

Archive Storage Settings before archiving any events, as shown in the following figure. This figure is from a Logger Appliance. The **Mount Location** field is not available on a Software Logger.

- For Logger Appliances, the path you specify in the Archive Path field is appended to the path specified in the Mount Location.
- On a Software Logger, you need to enter a complete path where the archive file will be written in the Archive Path field. This path could be a local directory or a mount point that is already established on the machine on which the Logger software is installed. The **Mount Location** field is not available on a Software Logger.

Logger uses the receipt time of an event to determine its archival day. For example, an event with a timestamp of 11:55:00 PM on December 7 is received at 12:01:00 AM on December 8 on the Logger. This event is archived in the archive file created for December 8th and not December 7th. When an archive operation occurs, one archive file per storage group is created at the location specified in **Archive Storage Settings**. Each archive file contains events from 12:00:00 AM to 11:59:59 PM for a single storage group of any given day. When you specify a range of dates, one archive file per storage group, for each specified day is created.

You can archive events in two ways: **manually** and **scheduled**. When archiving events manually, you specify the start and end dates of the event archive, and the storage groups that should be archived. This operation occurs once for the specified date range. When scheduling event archives, you specify the time at which the archive operation should occur every day and select the storage groups that should be included.

**Note:** You cannot set event archives to start at 1 AM for scheduled archives. This restriction is by design to account for the Daylight Savings Time (DST) changes.

When Logger starts archiving, it proceeds sequentially through the various storage groups, as listed on the **Daily Task Settings** page (for scheduled archives) or the **Add Event Archives** page (for manual archives).

Once the events have been archived, they are not deleted from the local storage until the events (and their related indexing information) age out due to the configured retention policy. These events continue to be included in search operations until they age out.

Once events that have been archived are deleted from Logger's local storage, they are not included in search operations. To include such events in search operations, you must load the archive in which those events exist back to the Logger. When an Event Archive is loaded, its events are included in searches, but the archive itself remains on the remote storage.

When events are archived, index information for those events is not archived. Therefore, when event archives are loaded, indexes are not available. As a result, a search query that runs on archived events (that have been loaded on Logger) is slower than when the data was not archived because the index data for the archived data is not available. You can choose to index an archive's events. This process can take some time. After this indexing process completes, search will run at the regular speed on events in the indexed archive.



**Caution:** Archives take a long time to index and searches may be slower while indexing is taking place. Only index the archives you need.

The source type information (if associated with an event) is preserved when the event is archived. For information on creating and using source types, see ["Source Types" on page 311](#).

## Guidelines for Archiving Events

- Be sure to run configuration backups as well as event archives regularly, and to store them in a remote location. In the event of catastrophic failure, you will need to restore the most recent configuration backup and event archive. For information on configuration backups, see ["Configuration Backup and Restore" on page 383](#).
- If you need to archive a large number of events (in the order of tens of GB), HPE recommends that you archive during the off-peak hours to prevent impacting the performance of your Logger.
- Multiple archiving operations such as loading, unloading, archiving, and deletion of archives can occur simultaneously. Therefore, you can initiate the loading of an existing archive, while an archive operation is in progress.

**Tip:** Only one manual archive job can run at a time. However, a scheduled archiving operation can run in parallel with a manual job.

- You cannot re-archive the events that have already been archived. If you try to do so, the Logger reports an error.
- Do not move the archived files from their archive location. The archives that have been moved from the originally archived location cannot be loaded on to the Logger. If you need to delete the archives, use the Logger user interface to do so.
- If an archive job fails, you need to initiate it manually. To do so, delete the failed archive and archive it manually. To be notified of a failed archive, configure an alert for this audit event: **Event Archive Failed**. For more information about this event, see ["Logger Audit Events" on page 517](#). For more information about configuring alerts, see ["Saved Searches" on page 264](#).
- If a Logger Appliance goes down while an archive operation is in progress, you need to re-initiate the archive operation for only the storage groups that were not archived when the operation failed. The status of such storage groups is marked "Failed" in the Status column on the Event Archives page. For example, you archive the event data of 12/1/16, which consists of events from four storage groups "Default", "Internal", "Short-Term", and "Long-Term". The appliance goes down after the events from the "Default" and "Internal" groups have been successfully archived, and the events from "Short-Term" are being archived. The status of the "Short-Term" storage group on the Event Archives page will display "Failed", while the status of the "Default" and "Internal" groups will display "Archived". (The status of the "Long-Term" storage group will not be displayed.) In this case, you need to manually re-initiate the archive for the "Short-Term" and "Long-Term" storage groups.

**Note:** In the above example, the status of the “Long-Term” storage group is not displayed on the Event Archives page after the failure occurs because archival of this group was never initiated during that archive operation.

If an archive operation fails, make sure you determine the storage groups that could not be archived and re-initiate the archival for all of those groups manually.

- You can cancel an in-progress archive operation that was manually initiated at any time using the **Cancel** link that displays on top of the Event Archives page.

## Archiving Events

To save events for a particular day, you need to add an Event Archive. The table in the Event Archives page shows the current archives and their status.

Event Archives

<input type="checkbox"/>	Name	Day	Month	Year	Storage Group	Status	Index Status	Mount	Mount Path	Archive Size
<input type="checkbox"/>	Filter: All	Filter: All	Filter: All	Filter: All	Filter: All	Filter: All	Filter: All	Filter: All	Filter: All	
<input checked="" type="checkbox"/>	Test 629 Archive [2016-06-29] [Default Storage Group]	29	6	2016	Default Storage Group	Archived	None	Local	/opt/mnt/Archive_NFS/Archive_135_208	1GB
<input type="checkbox"/>	Test 629 Archive [2016-06-29] [Internal Event Storage Group]	29	6	2016	Internal Event Storage Group	Archived	None	Local	/opt/mnt/Archive_NFS/Archive_135_208	1GB
<input checked="" type="checkbox"/>	Test 629 Archive [2016-06-29] [Test Storage group 1]	29	6	2016	Test Storage group 1	Archived	None	Local	/opt/mnt/Archive_NFS/Archive_135_208	-
<input type="checkbox"/>	Test 629 Archive [2016-06-29] [Test Storage group 2]	29	6	2016	Test Storage group 2	Archived	None	Local	/opt/mnt/Archive_NFS/Archive_135_208	-

An archive storage location must be established on the Logger before you can archive its events. This is a one-time configuration. To establish an archive storage location, see "[Archive Storage Settings](#)" on [page 357](#).

### To add an Event Archive:

- Open the **Configuration | Storage** menu and then click **Event Archives**.
- Click **Add** in the Event Archives page.

**Add Event Archive**

An event archive contains 24 hours of event data for a given day. To archive only one day, the start and end dates should be the same.

After clicking save, the events will start to be archived. Since this process may take a while you may monitor the progress on the Event Archives page.

---

Name

Each archive file contains events from 12:00:00 a.m. to 11:59:59 p.m. for a single storage group of any given day.

When the Start and End dates are different, one archive file per storage group, for each specified day is created.

Start Date

End Date

Storage Groups

- Default Storage Group
- Internal Event Storage Group
- Test Storage group 1
- Test Storage group 2
- Test Storage group 3
- Test Storage group 4

3. Enter a meaningful name in the **Name** field for the new Event Archive and specify the **Start** and **End** dates in the format m/dd/yy, where m is month number, dd is the day of the month (with a leading zero if necessary), and yy is the two-digit year number.

When the Start and End dates are different, one archive file per storage group, for each specified day is created. For example, if you specify the following Start and End dates:

Start Date: 8/12/15

End Date: 8/13/15

**Note:** If a day's events have already been archived, you will not be able to archive them again. If you try to archive the same day's events twice, Logger will display a message with the already archived day or dates. If you are archiving a range of dates and some of them have been archived, the archive process will complete, skipping any days already archived, and a message will display the already archived dates.

And, if you configure both storage groups—**Internal Event Storage Group** and **Default Storage Group**, four archive files will be created as a result of this archive operation—two files per storage group for the specified two days.

The Event Archives table (under the Event Archives page) lists the archives by an alias in this format: <archive\_name> [<yyyy-m-dd>] [<storage\_group\_name>].

4. Select the names of storage groups that need to be included in the archive.
5. Click **Save** to start archiving events, or **Cancel** to quit.

**Note:** You can cancel an in-progress archive operation at any time using the **Cancel** link that displays on top of the Event Archives page.

### To delete an Event Archive:

1. Open the **Configuration | Storage** menu and then click **Event Archives**.
2. Click the checkboxes in the left-most column to select the event archives that you want to delete.
3. Click **Remove** from the top of the screen to delete the selected archives.
4. Confirm the deletion by clicking **OK**, or click **Cancel** to retain the Event Archive.

## Daily Archive Settings

You can schedule a daily event archive and specify what hour of the day it should run. Scheduled event archives that have finished running appear on the archive list on the Event Archives page. Only one scheduled event archive can run at a time; however, it can run in parallel with a manually scheduled archive.

### Daily Archive Settings

The previous day's events will be automatically archived daily at 10:00 PM

Time For Daily Archive To Start

Storage Groups

- Default Storage Group
- Internal Event Storage Group
- Short retention 1
- Short retention 2
- StorageGroup2
- StorageGroup3

Make sure you are familiar with the information in "[Time/NTP](#)" on page 410 before you schedule an event archive.

### To schedule a daily event archive:

1. Open the **Configuration | Storage** menu and then click **Daily Archive Settings**.
2. Select a time from the **Time For Daily Archive to Start** list.

**Tip:** Scheduled archives must start on the hour. Midnight and 1:00 AM are not on the list to allow your Logger to receive all of the previous day's events.

3. Select the storage groups whose events should be included in the scheduled archive.
4. Click **Save** to schedule daily event archive, or click on another page to cancel.

## Archive Storage Settings

On the Logger Appliance, Event Archives are saved to a specific NFS or CIFS mount point, or SAN. For the Software Logger, event archives are saved to the specified directory, which can be a path to a local directory or to a mount point on the machine on which the Software Logger is installed. To establish a mount point, see your system's operating system documentation.

### To perform Archive Storage Setting setup:

1. If you are using the Logger Appliance, create the NFS or CIFS mount point. (See ["Storage" on page 421](#) and ["Remote File Systems" on page 421](#).)

If you are using Software Logger and intend to use an NFS or CIFS mount point, ensure that the external storage point is mounted on the machine on which Logger is installed. See your system's operating system documentation for more information.

2. Open the **Configuration | Storage** menu and then click **Archive Storage Settings**.
3. Specify a mount location and an archive path for each storage group. You can specify a different path for each storage group, thus enabling the Logger to archive events to a different location for each storage group.
  - For Logger Appliances, choose the name of an NFS mount, CIFS mount, or SAN mount point for the **Mount Location** field. This drop-down list contains the names you specified when creating the NFS, CIFS, or SAN mount points (**System Admin > Storage > Remote File Systems**).  
For example, if the mount location you selected refers to the path /opt/ARCHIVES, and the archive directory in that location is archivedir, then specify archivedir in the **Archive Path** field.
  - For Software Loggers, the **Mount Location** field does not exist. You need to enter a complete path where the archive file will be written in the **Archive Path** field. This path could be a local directory or a mount point that is already established on the machine on which the Logger software is installed.  
For example, you could specify /opt/ARCHIVES/archivedir.

**Note:** You must configure settings for all storage groups on the Archive Storage Settings page even if you do not intend to archive all of them.

**Archive Storage Settings**

Storage Group Default Storage Group  
Archive Path /opt/mnt/Archive\_NFS/Archive\_135\_208

Storage Group Internal Event Storage Group  
Archive Path /opt/mnt/Archive\_NFS/Archive\_135\_208

Storage Group Test Storage group 1  
Archive Path /opt/mnt/Archive\_NFS/Archive\_135\_208

Save

4. Click **Save**.

## Loading and Unloading Archives

Archived events must be loaded back on Logger before they can be included in a search operation. When an Event Archive is loaded, its events are included in searches, but the archive itself remains on the remote storage. When an Event Archive is unloaded, it is available for loading, but its events are not included in searches. You can unload a loaded archive if you no longer need to include it in your search operations.

Archive indexes are loaded and unloaded with the archive. See ["Indexing Archived Events" on the next page](#) for more information.

**Note:** Even though an archive has been created, you cannot load an archive for data that is still in current storage. That is, loading the archive will fail if that data has not already passed its retention date and been aged out of current storage. [Earlier Logger versions \(release 6.0 and below\) do allow you to load and search on an active Archive, but HPE does not recommend it.](#)

### To load or unload an Event Archive:

1. Open the **Configuration | Storage** menu and then click **Event Archives**.
2. Click the checkboxes in the left-most column to select the event archives that you want to load or unload.
3. Click **Load** or **Unload** from the top of the screen to load or unload the selected archives.

**Note:** If you index an archive while the archive is loaded, the archive will be automatically reloaded after the index is created.

## Indexing Archived Events

Although Index data is not stored when the events are archived, you can build an index for existing archives. After creation, the index will be located in the same root of current archive and in the newly created subdirectory name with “Index” postfix.

Searching for events in loaded archives that do not have indexes is slower than searching events that still exist in current storage. Indexing an archive will increase performance when searching the archived data. After indexing an archive searching on events in that archive will be as fast as searches in local storage.

If you index an archive while that archive is already loaded, the archive will be automatically reloaded once the index had been created.

**Tip:** The tmp directory and the archive directory must both be writable and have enough space for the index to be created.

### To index an Event Archive:

1. Open the **Configuration | Storage** menu and then click **Event Archives**.
2. Click the checkboxes in the left-most column to select the event archives that you want to index.

**Caution:** Archives take a long time to index and searches may be slower while indexing is taking place. Only index the archives you need.

3. Click **Index** from the top of the screen to index the selected archives.

**Tip:** You cannot cancel the indexing once it is in progress, but you can cancel indexing of archives in the pending queue. To cancel indexing, click the checkboxes in the left-most column and select event archives with the Indexing Status of **Pending**. Then click **Cancel Index**.

**Note:** If indexing fails, check the log for the cause of failure. After you fix the problem, try indexing again.

## Scheduled Tasks

Scheduled tasks are jobs that are programmed to happen automatically. Job types include Configuration Backup, File Transfer, Event Archive, and Saved Search. The options in the **Configuration | Scheduled Tasks** category enable you to manage the scheduled tasks.

Make sure you are familiar with the information in ["Time/NTP" on page 410](#) that can impact a scheduled task.

- [Scheduled Tasks](#) ..... 360
- [Currently Running Tasks](#) ..... 361
- [Finished Tasks](#) ..... 361

## Scheduled Tasks

Scheduled Tasks can be created for the following activities:

- Saved Searches (See "[Scheduled Searches/Alerts](#)" on page 265.)
- File Receivers and File Transfer Receivers (See "[Receivers](#)" on page 294.)
- Event Archives (See "[Archiving Events](#)" on page 354.)
- Configuration Backups (See "[Configuration Backup and Restore](#)" on page 383.)
- Lookup File Updates (See "[Lookup Files](#)" on page 284.)

The Scheduled Tasks page displays the list of scheduled jobs. Some tasks can be managed from this screen. The available management options, which may include edit, enable, disable and delete, are displayed at the right end of the column.

A drop-down list at the top of the page lets you display all scheduled tasks (**All**), or only tasks of a specific type.

### Scheduled Tasks page

The screenshot shows the 'Scheduled Tasks' page. At the top, there is a section titled 'Scheduled Tasks' with a filter dropdown menu labeled 'Filter by Job Type' set to 'Scheduled Archive'. Below the filter is a 'Refresh' button. Underneath is a table with the following data:

Task	Type	Schedule	Next Run Time
Daily Event Archiving Task	Scheduled Archive	Daily at 11:00	Jun 2, 2016 11:00:00 AM PDT

### To view Scheduled Tasks:

1. From the Configuration menu under Scheduled Tasks, click **Scheduled Tasks**.
2. Filter the list by selecting a specific type of Scheduled Task from the drop-down list, or select **All**.
3. Click **Refresh** to update the list of tasks.

### To delete a Scheduled Task:

1. From the Configuration menu under Scheduled Tasks, click **Scheduled Tasks**.
2. Locate the Scheduled Task that you want to delete and click the Remove icon (✕) on that row.



3. Confirm the deletion by clicking **OK**, or click **Cancel** to retain the Scheduled Task.

## Currently Running Tasks

The Currently Running Tasks page displays the Scheduled Tasks that are running right now. The table shows task name, type, and the date and time that the task started.

### Prerequisites

Users must be assigned to the following User Groups to access this feature:

- Default Logger Rights Group
- Default System Admin Group

See "[Setting Logger User Permissions](#)" on page 458 for more information.

### To view tasks that are running now:

1. From the Configuration menu under Scheduled Tasks, click **Currently Running Tasks**.
2. Click **Refresh** to update the list of tasks.
3. Filter the list by selecting a specific type of Scheduled Task from the drop-down list, or select **All**.

## Finished Tasks

The Finished Tasks page displays the Scheduled Tasks that have finished running. The Finished Tasks page acts like a log of all Scheduled Task runs, with the most recently finished tasks on top.

Finished Tasks					
Last 24 hours	Job Type	All	Job Result	All	<b>Filter</b>
Text Search					
Total: 4 Page 1 of 1					
Name	Type	Start	End	Result	Status
Peer Authorization Expiration Enforcer	PeerAuthorizationExpiration	Jul 22, 2016 12:00 AM, PDT	Jul 22, 2016 12:00 AM, PDT	Passed	daily peer authorization expiration enforcement completed
scheduled daily vacuum	ScheduledVacuum	Jul 22, 2016 12:00 AM, PDT	Jul 22, 2016 12:00 AM, PDT	Passed	scheduled vacuum for [2016-07-22] completed
scheduled TTL Retention	ScheduledVacuum	Jul 22, 2016 12:01 AM, PDT	Jul 22, 2016 12:01 AM, PDT	Passed	scheduled TTL Retention for [2016-07-22] completed
scheduled aggregation information maintenance	AggregateInfoMaintenance	Jul 22, 2016 12:10 AM, PDT	Jul 22, 2016 12:10 AM, PDT	Passed	scheduled Aggregation information maintenance for [2016-07-22] completed
Total: 4 Page 1 of 1					

### To View Finished Tasks:

From the Configuration menu under Scheduled Tasks, click **Finished Tasks**.

## Filtering the Task List

You can filter the task list by time or duration, job type, task result, or by text search. By default, the task list displays the finished tasks for the last 24 hours, displaying 20 entries per page.

**Tip:** Click **Filter** at any time to update the Finished Tasks list.



### Filtering finished tasks by time

1. From the first filter menu, select one of the following options, or leave the default:
  - **Last 24 hours** (the default) — Returns completed tasks for the previous 24 hours.
  - **Last 7 Days** — Returns completed tasks for the previous seven days.
  - **30 days** — Returns completed tasks for the previous 30 days.
  - **Custom Time Range** — Returns completed tasks for a custom date and time range. See ["Filtering finished tasks by a specific date and time"](#) below.
2. Optionally, click **Filter** to see your results, or add more filtering criteria.

### Filtering finished tasks by a specific date and time

When you select Custom Time Range, the Date and Time fields display.

**Finished Tasks**

Custom time range ▼	Start Date	04/18/2016		Time	01:01:01
	End Date	04/25/2016		Time	23:59:59

1. Enter a date in the **Start Date** field. You can enter the dates in mm/dd/yyyy format, or click the calendar icon () to select a date. Do the same for the **End Date** field.
2. Optionally, enter a start and end time from the **Time** menus. You can enter the times in hh:mm:ss format, or accept the default start time of 00:00:00 and end time of 23:59:59.
3. Optionally, click **Filter** to see your results, or add more filtering criteria.

### Filtering finished tasks by job type or task result

Optionally, select from the list of job types and job results to further narrow your search criteria. Click **Filter** to see your results, or add more filtering criteria.

**Finished Tasks**

Last 30 days Job Type Aggregate Info Maintenance Job Result Passed **Filter**

Text Search

### Filtering finished tasks by text search

Optionally, enter a text word or phrase in the text search field to return a list of tasks containing the text. As you type, matching text will be highlighted. Click **Filter** to see your results.

**Finished Tasks**

Last 30 days Job Type All Job Result All **Filter**

co

Total: 53 Page 1 of 3 ▶

Name	Type	Start	End
Configuration Backup	ConfigBackup	May 25, 2016 03:15 PM, PDT	May 25, 2016

## Advanced Configuration

The options in the **Configuration | Advanced** category enable you to manage the advanced tasks. Most of these tasks require administrator privileges.

- [Retrieve Logs](#) ..... 364
- [Maintenance Operations](#) ..... 365
- [Maintenance Results](#) ..... 383
- [Configuration Backup and Restore](#) ..... 383
- [Content Management](#) ..... 387
- [License Information](#) ..... 392
- [Data Volume](#) ..... 394
- [Peer Nodes](#) ..... 397

## Retrieve Logs

Logger records some audit and debug information, including details of any issues that occur. These system logs (not be confused with the event logs), are like the "black box" on an airliner. If something goes wrong, the logs can be helpful. Customer support may ask you to retrieve logs as part of an incident investigation. If so, follow the steps below and provide the resulting .zip file to customer support.

When retrieving logs, you have the option to sanitize the log files by obfuscating the IP addresses, hostnames, and email addresses. However, sanitizing adds extra time to log retrieval. Each sanitized IP address, hostname, and email address is replaced by the symbols xxx . xxx . xxx . xxx (for IP addresses), sanitized@email (for emails) and sanitized . host . name (for hostnames).

### Retrieve Logs page

#### Retrieve Logs

---

Download retrieved logs **143 MB (Wed Jun 15 14:35:12 PDT 2016)**

Do not sanitize logs (fastest)

Remove IP addresses

Remove IP addresses, hostnames and email addresses (slowest)

List of the host name suffixes to be removed (sanitized) from host names and email addresses. For example, to remove all host names and email addresses that end with hp.com, specify hp.com.

**Retrieve Logs**

### To retrieve Logger system logs:

1. Open the **Configuration | Advanced** menu and then click **Retrieve Logs**.
2. Select the Log Retrieval options to use when creating the Log file.

- If you select **Do not sanitize logs (fastest)**, then all IP addresses, hostnames and email addresses will be kept in the log file.
- If you select **Remove IP addresses**, all IP addresses in the log will be obfuscated. You cannot specify individual IP addresses.
- If you select **Remove IP addresses, hostnames and email addresses**, you must specify the suffixes of the hostnames and email addresses in the text box.

Separate multiple suffixes with comma, space, or line-break. For example, to obfuscate all hostnames and email addresses that end with hp.com and gmail.com, you could specify the following:

```
hp.com, gmail.com
```

All IP addresses, hostnames, and email addresses with the specified suffixes will be obfuscated. Specifying individual email addresses like name@hp.com is not supported. Individual email addresses and their suffixes will be ignored.

3. Click Retrieve Logs. The page will display a progress bar while the logs are being retrieved.
4. When the collection is complete, the system log files have been compressed into a single zip file. A link to this file is displayed on the Log Retrieval page. Click the link to download the file.

## Maintenance Operations

Certain operations on Logger, such as database defragmentation, extending the storage volume size, adding storage groups, and adding additional schema fields, require that Logger be in a maintenance state—a state in which operations related to data on the Logger are not running. Maintenance mode enables you to place the Logger in such a state. When a Logger is in maintenance mode:

- Events are not processed
- Reports are not generated
- Search cannot run
- Scheduled jobs do not run

**Tip:** You cannot place a Logger in maintenance mode directly. A Logger can enter maintenance mode only to perform an operation that requires it to be in that mode.

**Caution:** Do not restart/reboot a Logger in Maintenance Mode from the command line. Use the restart link on the Maintenance page:

Logger is in Maintenance Mode. You may [restart](#) Logger at any time to resume normal operation.

## Required Permissions for Maintenance Mode

Logger users who will be performing operations that require it to be in maintenance mode must have the “Enable Maintenance Mode” privilege checked (**System Admin > User Management > Groups tab > System Admin Group**). See ["Users/Groups" on page 442](#) for more information on Logger user rights and how to administer them.

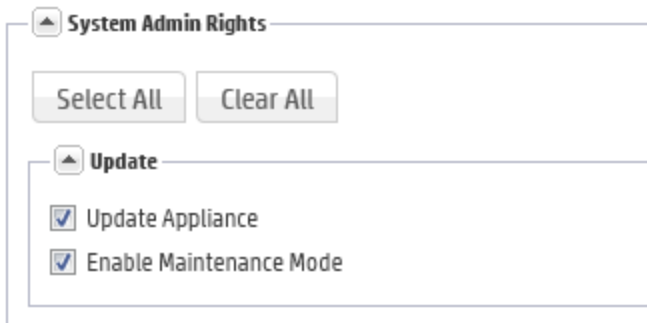

When a Logger is in maintenance mode, users with the “Enable Maintenance Mode” privilege see this UI message:

**Not Allowed**

**Another user has placed Logger in maintenance mode.**

**During this time, only maintenance operations may be performed by that user.**

**Although it is not recommended, you may [restart](#) Logger to resume normal operation.**

You can [refresh](#) this page or report the problem to your Administrator

For all other users, the log-in screen displays this message:

**Not Allowed**

**Another user has placed Logger in maintenance mode.**

**During this time, only maintenance operations may be performed by that user.**

You can [refresh](#) this page or report the problem to your Administrator

## Entering and Exiting Maintenance Mode

### To Enter Maintenance Mode:

1. From the **Configuration | Advanced** menu, click **Maintenance Operations**. The Maintenance Operations panel displays the available options.

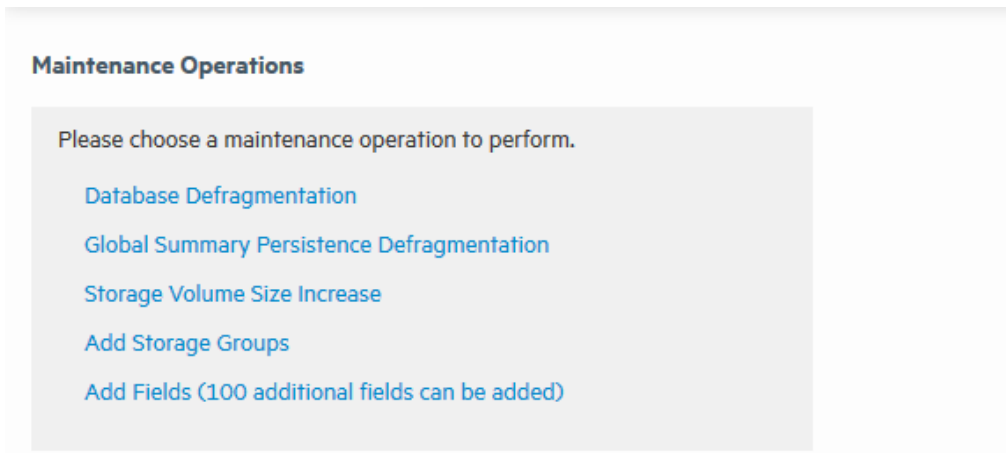

2. Click an option on the Maintenance Operations panel. A confirmation window displays for that option.

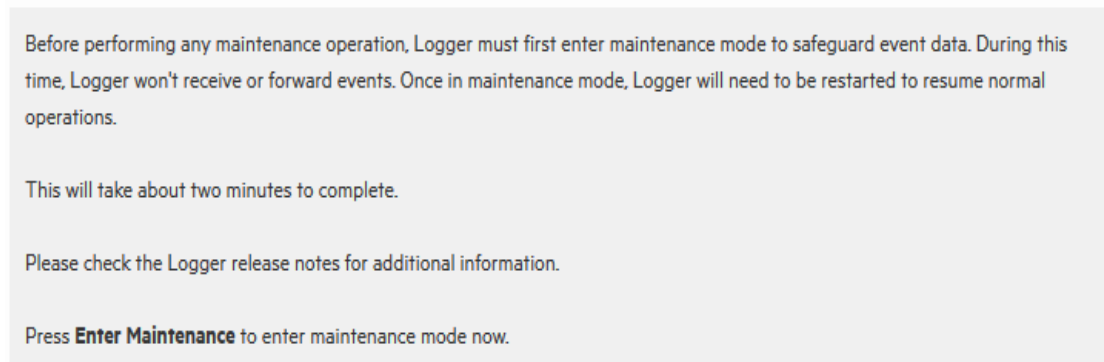

**Enter Maintenance**

3. Click **Enter Maintenance** and follow the instructions for the maintenance operation you selected:
  - "Defragmenting the Logger Database" on the next page
  - "Defragmenting Global Summary Persistence" on page 372
  - "Storage Volume Size Increase" on page 374
  - "Adding Storage Groups" on page 375
  - "Adding Fields to the Schema" on page 377

### To Exit Maintenance Mode:

1. Reboot the the Logger Appliance or restart the Software Logger using the link on the Maintenance Mode page.

**Caution:** Do not restart/reboot a Logger in Maintenance Mode from the command line. Use the restart link on the Maintenance page:

Logger is in Maintenance Mode. You may [restart](#) Logger at any time to resume normal operation.

## Defragmenting the Logger Database

Logger's database can become fragmented over time. Frequent retention tasks can exacerbate this issue. The following symptoms appear on a Logger when the database should be defragmented:

- Slow search and reporting  
For example, even a search operation over the last two minutes of data is slow.
- Long pauses in the receiver and forwarder operations

You can defragment a Logger that exhibits these symptoms. Make sure that you have read the following guidelines before starting the defragmentation process.

### Guidelines for Database Defragmentation

Ascertain that the Logger symptoms are not due to issues related to network infrastructure, such as network latency or unexpected load on the Logger.

The Logger system needs to be placed in maintenance mode before defragmentation can begin. As a result, most processes on the Logger are stopped—no events are processed or scheduled jobs run, and most user interface operations are unavailable. For more information about maintenance mode, see ["Maintenance Operations" on page 365](#).

A minimum amount of free disk space is required on your system to run database defragmentation. The utility automatically checks for the required free space and displays a message if it doesn't have sufficient disk space.

**Tip:** Although you can defragment as needed, if you are using this utility too often (such as on a system that was defragmented over the last few days), contact customer support for guidance.

If the defragmentation process fails at any point, the Logger returns to the same state that it was in before you started defragmentation:

You can safely reboot the Logger Appliance and restart the process from the beginning. For the Software Logger, restart the Logger process as described in ["Process Status" on page 415](#).



## Required Permissions

You can perform this process only if you have the “**Enable Maintenance Mode**” privilege set to **Yes** in the **System Admin Rights** list for the System Admin Group to which you are assigned. To set, navigate to **System Admin > User Management > Groups tab > Manage Groups** page, select a System Admin Group and click **Add** or **Edit**.

See ["Users/Groups" on page 442](#) for more information on Logger user rights and how to administer them.

## Defragmenting a Logger

### To defragment a Logger:

1. Open the **Configuration | Advanced** menu and then click **Maintenance Operations**.  
The Maintenance Operations panel, described in ["Maintenance Operations" on page 365](#), displays the available options.
2. Click **Database Defragmentation**.
3. Click **Enter Maintenance** so that the Logger can enter maintenance mode.

A minimum amount of free storage is required for the database defragmentation process to proceed. Therefore, Logger performs a check to determine free storage when entering maintenance mode.

**Database Defragmentation**

Logger is ready to perform the database defragmentation. There is sufficient free storage to perform this operation. (Required free storage: 0.79 MB, available free storage: 11.04 GB)

Please check the Logger Release Notes for additional information.

This should take approximately 0 seconds.

Press **Begin Defragmentation** to begin.

Logger is in Maintenance Mode. You may [restart](#) Logger at any time to resume normal operation.

**Begin Defragmentation**

4. Click **Begin Defragmentation**.
  - If the required storage is not found, follow the instructions found in ["Freeing Defragmentation Storage Space" on page 371](#).
  - If the required amount of free storage is found and Logger successfully enters maintenance mode, the following screen is displayed.

## Begin Database Defragmentation

### Database Defragmentation

Logger is ready to perform the database defragmentation. There is sufficient free storage to perform this operation. (Required free storage: 0.79 MB, available free storage: 11.04 GB)

Please check the Logger Release Notes for additional information.

This should take approximately 0 seconds.

Press **Begin Defragmentation** to begin.

Logger is in Maintenance Mode. You may [restart](#) Logger at any time to resume normal operation.

**Begin Defragmentation**

**Note:** On the Software Logger, the following Database Defragmentation screens instruct you to click **Restart** to resume normal operation when Logger is in maintenance mode. When you click restart, only the Logger service and its related processes are started on the machine on which the Software Logger is installed.

5. The defragmentation process starts. A progress indicator shows the status of defragmentation, as shown in the example below. HPE recommends that you do not attempt any operation on the Logger until defragmentation has completed.

Once defragmentation is complete, the Logger reboots automatically. This exits maintenance mode.

### Database Defragmentation

Database defragmentation is in progress. Upon completion Logger will restart automatically.

Logger is in Maintenance Mode. You may [restart](#) Logger at any time to resume normal operation.

 Restarting...

## Freeing Defragmentation Storage Space

If the required storage is not found, Logger prompts you to free sufficient space:

You can choose from one of the following options:

- **Manual Deletion**

**Note:** The Manual Deletion option is not available on L7x00 Loggers.

A text file is automatically created on your Logger that lists the files you can safely delete. On the Logger appliance, this file is located in

```
/opt/arcsight/logger/user/logger/defragmentation/filelist.txt
```

On Software Loggers, this file is located in <install\_dir>/current/arcsight/logger/user/logger/defragmentation/filelist.txt.

The files are listed in descending order of size in the text file. You can delete sufficient number of files to free up storage. However, **do not** delete the files before contacting customer support for instructions and guidance.

Follow these steps to proceed:

- a. Leave the message screen without taking any action.
- b. Contact customer support for instructions on deleting files listed in the text file.
- c. After deleting sufficient number of files, resume the Database Defragmentation process from the message screen. To resume, click **Recheck** to check whether sufficient storage is now available for defragmentation to proceed.

If sufficient storage is found, the "[Begin Database Defragmentation](#)" on the previous page is displayed. Click **Begin Defragmentation** to proceed further.

If sufficient storage is still not found, a message displayed. Choose from the listed options to create additional space.

**Note:** If you need to exit the defragmentation process without creating sufficient storage, click **Reboot**.

- **Delete Database Indices**

Logger automatically deletes a sufficient number of database indices, starting with the largest index, to free up the required amount of storage. If sufficient space becomes available after deleting database indices, defragmentation proceeds further automatically.

However, if sufficient storage is not available even after dropping database indices, follow these steps to proceed:

- a. Click **Manual Deletion**.

**Note:** The Manual Deletion option is not available on L7x00 Loggers.

A text file is created on your Logger that lists the files you can safely delete. The files are listed in descending order of size in a text file.

- b. Click **Reboot**.  
Logger exits the maintenance mode.
- c. Contact customer support for instructions on manually deleting the files.  
You can delete sufficient number of files to free up storage.
- d. After deleting the files, restart the defragmentation process as described in "[To defragment a Logger:](#)" on page 369.

**Note:** If the defragmentation process fails or is aborted at any time, Logger must recover those indices. Although the recovery process is automatic, it can take at least a few hours to complete. You will not lose any data during this process.

- **Reboot**

The database defragmentation process is aborted and Logger returns to the state it was in before you started the defragmentation utility.

## Defragmenting Global Summary Persistence

There is a known issue with the Global Summary Persistence functionality. This feature was designed to persist the statistics reported in the global summary section of Logger through a reboot. In some environments, disk space may be affected due to this feature.

Global Summary Persistence is disabled in this release. No action should be necessary in most cases. However, if you have just upgraded from Logger 5.3, you should defragment the Global Summary Table as soon as possible. Make sure that you have read the following guidelines before starting the defragmentation process.

### Guidelines for Defragmenting Global Summary Persistence

- The Logger system needs to be placed in maintenance mode before Global Summary Persistence defragmentation can begin. As a result, most processes on the Logger are stopped—no events are processed or scheduled jobs run, and most user interface operations are unavailable. For more information about maintenance mode, see "[Maintenance Operations](#)" on page 365.
- A minimum amount of free disk space is required on your system to run Global Summary Persistence defragmentation. The utility automatically checks for the required free space and displays a message if sufficient disk space is not found.
- If the defragmentation process fails at any point, the Logger returns to the same state that it was in before you started defragmentation. You can safely reboot the appliance or restart the Software Logger process and try again.
  - a. Reboot the Logger Appliance as described in "[System Reboot](#)" on page 405.
  - b. For the Software Logger, restart the Logger process as described in "[Process Status](#)" on page 415.

## Required Permissions

You can perform this process only if you have the “Enable Maintenance Mode” privilege set to Yes (**System Admin > User/Groups > Manage Groups > System Admin Group**). See ["Users/Groups" on page 442](#) for more information on Logger user rights and how to administer them.

### To defragment for the Global Summary Persistence issue:

1. Open the **Configuration | Advanced** menu and then click **Maintenance Operations**.  
The Maintenance Operations panel, described in ["Maintenance Operations" on page 365](#) displays the available options.
2. Click **Global Summary Persistence Defragmentation**.
3. Click **Enter Maintenance** so that the Logger can enter maintenance mode.

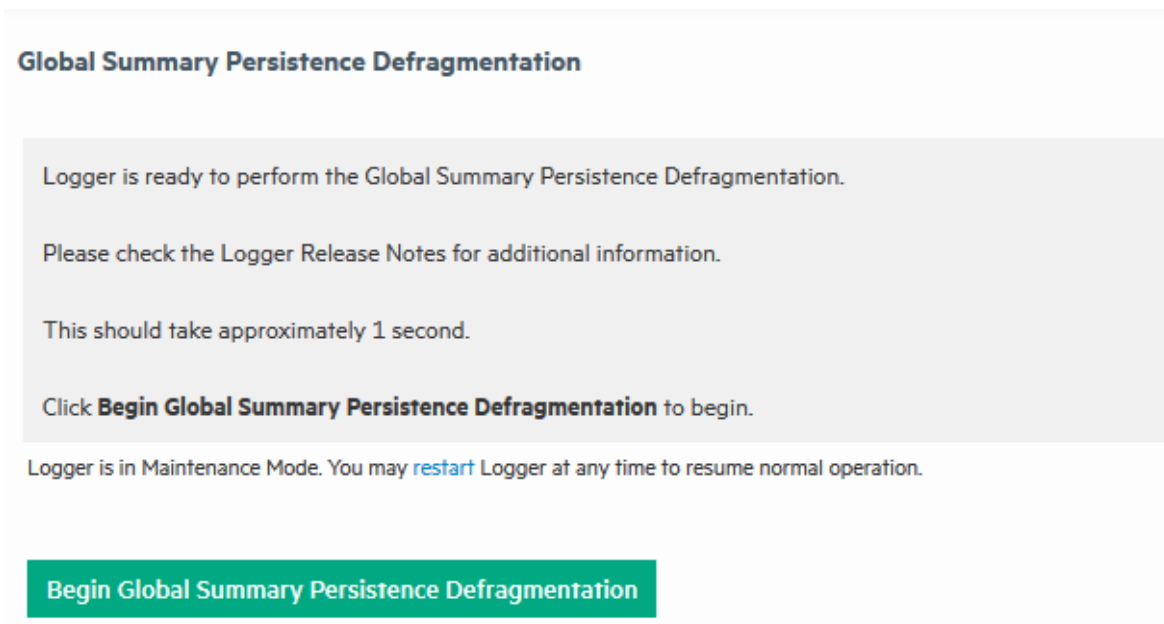

**Global Summary Persistence Defragmentation**

Logger is ready to perform the Global Summary Persistence Defragmentation.

Please check the Logger Release Notes for additional information.

This should take approximately 1 second.

Click **Begin Global Summary Persistence Defragmentation** to begin.

Logger is in Maintenance Mode. You may [restart](#) Logger at any time to resume normal operation.

**Begin Global Summary Persistence Defragmentation**

4. Click **Begin Global Summary Persistence Defragmentation** to start the defragmentation process.
5. The defragmentation process starts. A progress indicator shows the status of defragmentation. HPE recommends that you do not attempt any operation on the Logger until defragmentation has completed.  
Once defragmentation is complete, the Logger reboots or restarts. This automatically exits maintenance mode.

**Note:** On Software Loggers, only the Logger service and its related processes are restarted.

## Storage Volume Size Increase

You can extend the storage volume size you established during initialization at any time. Once extended, the volume size cannot be reduced. The Logger interface guides you about current and the maximum value to which you can increase the size.

**Note:** For the “Storage Volume Size Increase” operation to show as an option under the System Maintenance operations (**Configuration | Advanced > Maintenance Operations**), you need to belong to the System Admin group (with “Enable Maintenance Mode” privilege enabled) and the Logger Rights group. See ["Users/Groups" on page 442](#) for more information on Logger user rights and how to administer them.

### About Increasing Storage Volume Size on a SAN Logger

Logger cannot detect a resized LUN. Therefore, if you change the LUN size after it has been mounted on a Logger, the new size is not recognized by Logger. As a result, you can only increase the size of a storage volume to the LUN size that was initially mounted on the Logger.

You should make your initial LUN size as large as possible before mounting. The following examples illustrate storage volume increase on a SAN Logger.

Initial LUN Size	LUN Resized	Current Storage Volume Size	Storage Volume Size Increase Allowed
4 TB	No	1 TB	Yes, up to 4 TB
4 TB	No	4 TB	No
8 TB	No	4 TB	Yes, up to 8 TB
2 TB	8 TB	1 TB	Yes, only up to 2 TB
4 TB	8 TB	1 TB	Yes, only up to 4 TB
8 TB	8 TB	4 TB	Yes, up to 8 TB

#### To increase the size of a storage volume:

1. Select **Configuration | Maintenance Operations** from the navigation bar.  
The Maintenance Operations page displays the available options. See ["Maintenance Operations" on page 365](#).
2. Click **Storage Volume Size Increase**.
3. Click **Enter Maintenance** so that the Logger can enter maintenance mode.

### Storage Volume Size Increase

Before performing any maintenance operation, Logger must first enter maintenance mode to safeguard event data. During this time, Logger won't receive or forward events. Once in maintenance mode, Logger will need to be restarted to resume normal operations.

This will take about two minutes to complete.

Please check the Logger release notes for additional information.

Press **Enter Maintenance** to enter maintenance mode now.

Enter Maintenance

4. While entering the maintenance mode, Logger performs a check to determine if the storage volume size can be increased and by what amount. If the storage volume can be increased, then enter the new size and click **OK**.

**Note:** On the Software Logger, the following Storage Volume Size Increase screens instruct you to click **restart** to resume normal operation when Logger is in maintenance mode. When you click restart, only the Logger service and its related processes are restarted.

If sufficient space is not found to increase the storage volume, the following message is displayed. Click **Reboot** to restart Logger and exit maintenance mode.

### Storage Volume Size Increase

Sufficient free space is not available to increase the storage volume size.

To restore normal Logger operation, click **Restart**.

Logger is in Maintenance Mode. You may [restart](#) Logger at any time to resume normal operation.

Restart

## Adding Storage Groups

In addition to the two storage groups that exist on your Logger by default, you can add up to four additional storage groups. You can add storage groups at any time if the following conditions are met:

- The maximum allowed six storage groups do not exist on your Logger already.
- The storage volume contains spare storage space that can be allocated to the storage groups you will add.

**Tip:** If you do not have sufficient space in the storage volume to add another storage group and the existing groups have free space, consider reducing the size of existing storage groups to make space available for the storage groups you want to add. Alternatively, increase the size of your existing storage volume, as described in "[Storage Volume Size Increase](#)" on page 374.

The Logger must be in maintenance mode when adding storage groups. When you add a storage group, Logger automatically checks to ensure that the storage group size you specified is greater than the minimum size required (5 GB) and less than the amount of space available in the storage volume.

Once you have added storage groups and rebooted your Logger to exit the maintenance mode, remember to configure the Archive Storage Settings for the groups you just added so that event archives are created for them.

### To add a storage group:

1. Open the **Configuration | Advanced** menu and then click **Maintenance Operations**.

The Maintenance Operations panel, described in "[Maintenance Operations](#)" on page 365

displays the available options.

2. Click **Add Storage Groups**.

A maximum of six storage groups can exist on Logger. Therefore, you can add up to four storage groups in addition to the two that exist by default on Logger.

If the maximum number of allowed storage groups **do not** exist on Logger, a screen prompts you to enter maintenance mode, as described in the next step.

If all six storage groups exist on Logger or sufficient space does not exist in the storage volume to add additional group, a message is displayed on your screen and the Logger cannot enter maintenance mode.

3. Click **Enter Maintenance** so that the Logger can enter maintenance mode.

For more information about maintenance mode, see "[Maintenance Operations](#)" on page 365.



- Once Logger enters maintenance mode, the following Add Storage Groups page is displayed.

**Add Storage Groups**

The storage volume has 5 GB left of unallocated space.

Logger is in Maintenance Mode. You may [restart](#) Logger at any time to resume normal operation.

Name	Maximum Age (Days)	Allocated (GB)	Used (GB)	Creator	Last Editor
Default Storage Group	180	7	1	admin	admin
Internal Event Storage Group	365	3	1	System	System

---

Name

Maximum Age (Days)

Allocated (GB)

**Add**

This screen also lists information about the existing storage groups and the amount of space remaining in the storage volume.

- Enter the following information.

Parameter	Description
Name	Choose a name for the storage group.
Maximum Age (Days)	Specify the number of days to retain events. Events older than this number of days are deleted.
Maximum Size (GB)	Enter a maximum event data size, in GB.

- Click **Add**.

The storage group is added to your Logger. If your Logger has not reached the maximum allowed six storage groups, you can click **Add** to add more storage groups. However, if the maximum number has been reached, the Add button is not displayed. If you do not want to add more storage group, go to the next step.

- To apply your changes and exit maintenance mode, reboot your Logger Appliance or restart Software Logger.

## Adding Fields to the Schema

The Logger schema contains a predefined set of fields. A field-based query can contain only these fields. Additionally, you can index only these fields for faster search operations. For instructions on how to view the default Logger schema fields, see ["Default Fields" on page 281](#).

Prior to Logger 5.2, if your log analysis needs required you to search on a field that is currently not present in the Logger schema, you did not have a way of adding it to the schema yourself. Starting with Logger 5.2, you can add additional fields to the Logger schema. That is, you can insert fields in your Logger schema Storage that are relevant to the events you collect on your Logger, thus enabling you to search

and report using these fields. Additionally, you can index the fields you add so that the search and report queries that use these fields run faster. For example, a financial institution might want to add credit card numbers or social security numbers to the schema.

You can add up to 100 custom schema fields on Logger. You can also import custom fields from a peer Logger. However, the total number of added and imported fields cannot exceed the maximum allowed 100 fields.

You can index up to 123 fields on Logger. Therefore, the number of custom schema fields you can index will depend on the number of default fields you currently have indexed on your Logger.

The events that contain custom fields must be in CEF format (key-value pairs) for Logger to process them. Therefore, you will need to either use a SmartConnector that generates additional data or define an ArcSight FlexConnector to collect and parse events containing custom fields from the event source, convert them into CEF format, and forward them to the Logger.

Logger can only process events from FlexConnectors written using connector build 5.0.0.5560 or later. For details about designing FlexConnectors, see the ArcSight FlexConnector Developer's Guide.

**Note:** Logger cannot process the additional fields data received in CEF version 0 from a FlexConnector, and assumes a NULL value for such fields when they are present in a CEF version 0 event. As a result, you cannot search on these fields or index them. However, these fields are displayed in the UI display when you select "\*" in the field set because the interface displays information contained in the raw event. Therefore, if Logger receives "ad.callnumber=5678", the Logger UI will display a column, ad.callnumber, with value 5678. However, a search on "5678" will not return this event in the search results.

You need to be in maintenance mode to add or import custom schema fields. The process of adding or importing schema fields involves an add or import operation followed by a save operation. The add or import operation adds the specified fields but does not write them to the Logger schema. You can edit or delete the added or imported fields at this point. Once you save these fields, the fields are written to the schema. From this point on, these fields cannot be edited or deleted. Therefore, carefully review the fields you are adding to the schema before saving them.

**Note:** For the "Add Fields" operation to show as an option under the System Maintenance operations (**Configuration | Advance > Maintenance Operations**), you need to belong to the System Admin group (with "Enable Maintenance Mode" privilege enabled) and the Logger Rights group. See ["Users/Groups" on page 442](#) for more information on Logger user rights and how to administer them.

You need to specify the following information to add a custom schema field:

- **Display name** — A meaningful name for the field. This name is displayed as the column header name for the field and is the one you specify in a search query. For example, SocialSecurityNumber.
- **Type** — The type of data this field will contain. The available options are Double, BigInt, DateTime, Text.

The following table describes each data type.

Type	Description
Double	Use to store decimal numbers or fractions.  Numbers from -1.79769313486231570E+308 through -4.94065645841246544E-324 for negative values, and  4.94065645841246544E-324 through 1.79769313486231570E+308 for positive values.
BigInt	Use to store whole numbers.  Numbers from -2 <sup>63</sup> through 2 <sup>63</sup> - 1, or -9,223,372,036,854,775,808 through 9,223,372,036,854,775,807.
DateTime	Use to store both dates and time or only dates.
Text	Use to store any characters. You can store a maximum of 255 characters per field.

- **Length** — This field is only relevant when the Type specified is **Text**. This field specifies the maximum number of characters allowed in the value of the field when the data type is Text. This field is only relevant when the Type specified is **Text**. This field specifies the maximum number of characters allowed in the value of the field when the data type is Text.
- **Field name** — The field name that you want to add to the Logger schema. Typically, this is an abbreviated version of the **Display** name. For example, SSN.

## Importing Schema Fields from Peers

If your Logger is a peer of another Logger, you can import the custom fields added to the peer's schema. You specify the peer from which you want to import fields in the user interface screen. Fields can be imported if the following conditions are met:

- A field of the same Display name and Field name does not exist on the Logger to which you are importing schema fields. If conflicting fields exist, they are still imported but are flagged in the user interface screen. You cannot save the imported fields to schema until you resolve the conflicts.
- A maximum of 100 custom fields has not been reached on the importing Logger. If there are more fields than can be imported, only the first N until the allowed maximum is reached will be imported.

The custom schema fields contained in a search query must exist on all peers on which the query is run. Otherwise, the query will not run and return an error.

### To add or import custom schema fields:

1. Open the **Configuration | Advanced** menu and then click **Maintenance Operations**.  
The Maintenance Operations panel, described in "[Maintenance Operations](#)" on page 365 displays the available options.

2. Click **Add Fields (100 additional fields can be added)**.

You can add a maximum of 100 custom fields to Logger schema. The number in the “Add Fields” link reflects the number of custom fields you can add. This number decreases as you add fields to Logger schema.

3. Click **Enter Maintenance** so that the Logger can enter maintenance mode.
4. Once Logger enters maintenance mode, the Add Fields page is displayed.

**Add Fields**

Logger is ready for adding new fields. You can add up to **99** additional fields.  
The fields in "Ready to save" status are not in logger schema yet. Click Save to write these fields to the schema.

Logger is in Maintenance Mode. You may [restart](#) Logger at any time to resume normal operation.

Display Name	Type	Length	Field Name	Actual Field Name	Creator	Created	Status
DoubleField1	DOUBLE	-	DoubleField1	ad.DoubleField1.r	admin	Jun 22, 2016 6:52:22 AM PDT	<span>🚧</span> Ready for save <span>✎</span> <span>✕</span>

You can import fields from peer Loggers. Make sure this Logger is configured as the peer of the Logger from which you want to import fields.

Display Name:

Type:

Field Name:

You can add fields manually or import them from a peer Logger.

### To manually add fields:

1. After entering Maintenance Mode, click **Add a New Field**, if it is not selected.
2. Enter a meaningful name in the **Display Name** field.

The display name is the one you specify in a search query and is the column header for the field in search results. For example, SocialSecurityNumber. It is not added to the Logger schema.

Follow these guidelines when specifying a display name:

- The display name must be unique; that is, another field (custom or Logger schema) of the same display name must not already exist on the Logger.
- Only ASCII characters are allowed. That is, no native Chinese or Japanese characters are accepted in this field.
- The display name can contain up to 100 alphanumeric and underscore characters.

**Note:** To be valid, the display name must not *start* with "arc\_" or an underscore.

3. Select a data type for the field from the **Type** pull-down menu. The available options are Double, BigInt, DateTime, Text. See ["Adding Fields to the Schema" on page 377](#) for more information.

4. In the **Length** field, enter the maximum number of characters allowed in the value of the field *when the data type is Text*. This field is only available when the Type specified is Text. You can specify from 1 to 255 characters in this field.

5. Enter a name in the **Field** name field.

This is the name that will be added to the Logger schema. Typically, this is an abbreviated version of the Display name. For example, SSN.

Follow these guidelines when specifying a Field name:

- This is a required field.
- The field name must be unique; that is, a custom field of the same Field name must not already exist on the Logger.
- Only ASCII characters are allowed. That is, no native Chinese or Japanese characters are accepted in this field.
- The field name can contain up to 40 characters and can contain alphanumeric, hyphen, and underscore characters. The underscore ( `_` ) is used as an escape character for the actual field name. Therefore, if you include an underscore in the field name, the actual field name will contain a double underscore ( `__` ).

Once you enter a name in this field, a prefix and a suffix is automatically added to it, and the resulting name is displayed in the Actual Field Name field, as shown in the following figure. This field displays the way the field name you entered earlier will be stored on Logger. The prefix, “ad.”

6. Click **OK**.

The field you added is displayed in the upper section of the Add Fields form, as shown in the following figure. This field is not saved yet (in “Ready to Save” state) and you can edit or delete it. Once you click Save, the field is added to the schema and cannot be changed or deleted.

**Add Fields**

Logger is ready for adding new fields. You can add up to **98** additional fields.

The new fields were added successfully. [Restart](#) the Logger for changes to take effect.

Logger is in Maintenance Mode. You may [restart](#) Logger at any time to resume normal operation.

Display Name	Type	Length	Field Name	Actual Field Name	Creator	Created	Status
DoubleField1	DOUBLE	-	DoubleField1	ad.DoubleField1.r	admin	Jun 22, 2016 6:52:22 AM PDT	Saved
TextField1	TEXT	10	TextField1	ad.TextField1	admin	Jun 22, 2016 6:55:02 AM PDT	Saved

---

You can import fields from peer Loggers. Make sure this Logger is configured as the peer of the Logger from which you want to import fields.

Display Name

Type

Field Name

7. Repeat the steps above to add additional fields.
8. Review the added fields and make any edits (✎) or deletions (✖), if necessary.

**Caution:** The next step commits the added fields to Logger's schema. This process is irreversible; that is, once the fields are written to Logger's schema, they cannot be edited or deleted. If you exit this process without saving, the fields you were adding are not remembered and your changes are lost.

9. Click **Save** to commit the added fields and write them to your Logger's schema.

### To import fields from a peer:

1. After entering Maintenance Mode, click **Import Fields From Peers**, if it is not selected.
2. Select the peer from which you want to import the fields from the **Peer Host Name** drop-down list.
3. Click **OK** in the bottom right corner of the screen.

If there are no conflicting fields, all fields from the peer are imported successfully.

If there are conflicts, the conflicting fields are displayed ahead of the ones that were imported successfully. The Status column describes the reason for the conflict. You must fix the listed issues before you can save these fields to the schema. Use the edit (✎) or delete (✖) icons at the end of the row to make changes or delete the added fields.

**Add Fields**

Logger is ready for adding new fields. You can add up to **97** additional fields.  
The fields in "Ready to save" status are not in logger schema yet. Click Save to write these fields to the schema.

Another field of the same display name, "testBigInt", exists. Enter another display name.

Logger is in Maintenance Mode. You may [restart](#) Logger at any time to resume normal operation.

Display Name	Type	Length	Field Name	Actual Field Name	Creator	Created	Status
testBigInt	BIGINT	-	testBigInt	ad.testBigInt.i	admin	Jul 7, 2016 1:06:53 PM PDT	⚠ Ready for save ✎ ✖
testDouble	DOUBLE	-	testDouble	ad.testDouble.r	admin	Jul 7, 2016 1:07:32 PM PDT	⚠ Ready for save ✎ ✖
testText	TEXT	255	testText	ad.testText	admin	Jul 7, 2016 1:07:18 PM PDT	⚠ Ready for save ✎ ✖

---

You can import fields from peer Loggers. Make sure this Logger is configured as the peer of the Logger from which you want to import fields.

Display Name:

Type:

Field Name:

If there are more fields than can be imported, only the first N until the allowed maximum (100) is reached will be imported.

**Caution:** The imported fields are not committed to Logger's schema yet. The next step

commits them. This process is irreversible; that is, once the fields are written to Logger's schema, they cannot be edited or deleted.

If you exit this process without saving, the fields you were adding are not remembered and your changes are lost.

4. Click **Save** to commit the added fields and write them to your Logger's schema. Restart Logger to put the changes into effect.

If you added fields from a peer Logger, be sure to add the same fields to any other peers.

To view the custom schema fields, see "[Custom Fields](#)" on page 283.

## Maintenance Results

You can check the status of a maintenance operation on the Maintenance Results page.

To access the Maintenance Results page (as shown in the example below), open the **Configuration | Advanced** menu and then click **Maintenance Results**.

### Maintenance Results

Status	Operation	Start	End	Message	Creator
Success	Add Storage Groups	Jul 6, 2016 2:43:31 PM PDT		Added Storage Group [sg2]	admin
Failure	Add Storage Groups	Jul 6, 2016 2:43:16 PM PDT		Failed attempting to add Storage Group [sg2]	admin
Success	Add Storage Groups	Jul 6, 2016 2:43:04 PM PDT		Added Storage Group [sg1]	admin

## Configuration Backup and Restore

By default, Logger does not back up any content. However, you can configure it to back up the following content to a remote system:

- All non-event data (Except Lookup files)
- Reports content only

You can back up this content on ad-hoc basis or schedule it to run periodically. The content is saved to the backup location in a single `.tar.gz` format file.

**Caution:** Ensure that Configuration Backups (for configuration settings) and Event Archives (for data) run on a regular basis and are stored in a remote location. You should also store a copy of your license. In the event of catastrophic failure, you will need to restore the most recent Configuration Backup, Event Archives, and license. For information on Event Archives, see "[Event Archives](#)" on page 351.

You can use the backed-up content to:

- Restore a Logger that is not functioning as expected or that has been reset to its factory defaults.
- Copy content from one Logger to another.

**Caution:** When you restore content to a Logger, the existing content on it is deleted or overwritten.

The following table lists the information included in the backup when you back up all non-event data and reports-only data.

All non-event data backup includes...	Reports-only backup includes...
<p>System information</p> <p>License *</p> <p>Logs</p> <p>Global settings</p> <p>User and group information</p> <p>All configuration settings</p> <p>Existing filters and saved searches</p> <p>Logger Monitor settings</p> <p>The following Reports content:</p> <ul style="list-style-type: none"> <li>• Queries, Reports, Parameters, Parameter Value Groups, Dashboards</li> <li>• Templates</li> </ul> <p><b>Note:</b> Lookup files are not included in configuration backups.</p>	<p>The following Report content only:</p> <ul style="list-style-type: none"> <li>• Queries, Reports, Parameters, Parameter Value Groups, Dashboards</li> <li>• Templates</li> </ul>

## Running a Configuration Backup

Follow these steps to create and run a backup of your Logger configuration information.

**Configuration Backup**

Restore

Name	Schedule	IP/Host	Transfer File Using	
Configuration Backup	Thursday at 22:00		CP	



**To run a configuration backup or to edit the configuration backup settings:**

1. Open the **Configuration | Advanced** menu and then click **Configuration Backup**.
2. Click the (✎) icon and enter the following parameters:

### Edit Configuration Backup

---

Transfer File Using

Port

IP/Host

User

Password

Remote directory

Schedule  One time only

Days of week  Days

Hour of day  Hours (24 hour format)



Backup content

Parameter	Description
Transfer File Using	<ul style="list-style-type: none"> <li>• Select <b>SCP</b> to transfer the file to a remote host.</li> <li>• Select <b>CP</b> to copy the file to location on Logger.</li> </ul> The available options change depending on what you select.
Port (SCP Only)	The port on which the Logger should connect to the remote system.
IP/Host (SCP Only)	The IP address or hostname of the remote system.
User (SCP Only)	A user on the remote system with write privileges on the backup folder (specified in Remote Directory, below).
Password (SCP Only)	Password for the user. The password cannot contain these characters: % = ; " ' < >

Parameter	Description
Mount location (Appliance only)	Select a mount location that has previously added on the appliance.
Remote Directory	The location in which to save the configuration backup files. The remote directory name cannot contain spaces. <b>Note:</b> The Logger Appliance supports mounting through the user interface. Software Logger uses its file system, which can contain remote folders mounted through the operating system.
Schedule	Schedule when and how often the Backup is run. <ul style="list-style-type: none"><li>• If you leave the default <b>One Time Only</b> checkbox enabled, other fields are hidden and the configuration backup occurs just once (ad-hoc), when you click <b>Save</b>.</li><li>• If you disable the <b>One Time Only</b> checkbox, you can use the schedule options to specify how frequently the configuration backup should run. See "<a href="#">Scheduling Reoccurring Backups</a>" below.</li></ul>
Backup Content	Whether to backup all non-event data or only the report content. <ul style="list-style-type: none"><li>• Select <b>All</b> for all non-event data</li><li>• Select <b>Report Content Only</b> for only the report content.</li></ul>

3. Click **Save**. The configuration backup you set up is displayed on the Configuration Backup page.

**Note:** If you chose to run the backup **One Time Only**, the configuration backup is run right away. Otherwise, it is scheduled to run at the specified time.

4. Once you have created one or more configuration backups, you can take the following optional actions from the Configuration Backup page:
  - a. Click **Restore** to begin restoring your configuration backup. See "[Restoring from a Configuration Backup](#)" on the next page.
  - b. Click the associated edit icon (✎) or the name of the backup file to change your configuration backup parameters.
  - c. If the backup file you want is disabled, click the  icon to enable it (✓).
  - d. If a backup file you want is enabled, click the  icon to disable it (.

## Scheduling Reoccurring Backups

When scheduling reoccurring backups, set the scheduling options as described in "[Scheduling Date and Time Options](#)" on page 136.

## Restoring from a Configuration Backup

Make sure you are familiar with these guidelines before you restore a backup file on Logger:

- When you restore content to a Logger, the existing content on it is deleted or over-written.  
Logger restores the specific environment settings that were current at the time the backup was taken. Any configuration settings that were updated between the time of the backup and the time of the restoration are lost. This includes the license file.
- You must restore the content to the same version of Logger that was used to create the backup file.
- You must restore to the same form of Logger (Software, Appliance, or VMware.)
- For Appliance Loggers, the Logger Appliance model must be the same as the one used to create the backup file.
- For Software Loggers and Loggers on VMware, the operating system that Logger is running must be the same as the one used to create the backup file.
- Since the current license will be over-written by the backup, retain a copy of the existing license to re-apply after the Restore is complete, if appropriate.

### To restore from a configuration backup:

1. Open the **Configuration | Advanced** menu and then click **Configuration Backup**.
2. Click **Restore**.  
The **Upload Configuration Backup** option displays on the Configuration Backup page. You will see a message that after restoring the configuration, Logger will need to be restarted.
3. Click **Browse** to locate the backup file.
4. Click **Submit** to start the restore process.
5. When the restore process is complete, you will be prompted to reboot your Logger:
  - a. Logger Appliance—When the restore process is complete, you will be redirected to the **System Admin > System > System Reboot** page. Select Reboot and click **Reboot**. See "[System Reboot](#)" on page 405.
  - b. Software Logger—When the restore process is complete, you will be prompted to reboot your system. See "[Software Logger Command Line Options](#)" on page 468.

**Tip:** You may need to upload a new license or re-apply a copy of the license in place before the backup.

## Content Management

Depending on their rights, users can export Alerts, Dashboards, Fieldsets, Filters, Parsers, Saved Searches, and Source Types from a Logger to a file, and then import that content onto another Logger

or re-import it onto that same Logger, as a backup. For information on the user rights necessary to import or export a particular type of content, instructions, and guidelines for importing and exporting Logger content, see ["User Rights for Exporting Content" on the next page](#) and ["User Rights for Importing Content" below](#).

Content import and export is useful in these situations:

- When you want to make a backup of Logger content. If your Logger becomes unavailable or is reset to its factory defaults, you can quickly restore its content by importing the saved content.
- When multiple Loggers with the same content need to be installed in your network, you need to configure only one Logger. Subsequent Loggers can be deployed by importing the first Logger's content on them, thus reducing deployment time.
- When you want to add content from one Logger to the content on another.

The **Export** function saves the content from a Logger to a storage location on your network or to the local disk of the computer from which you connect to the Logger. When you need to use that content for any of the situations described previously, simply import the saved content.

## User Rights for Importing Content

The content you are able to import depends on your user rights. If you have any of the following rights, the **Import Content** dialog box is available:

- Logger Rights > **Filters**: Edit, save, and remove shared filters.
- Logger Rights > **Forwarders and Alerts**: Edit, save, and remove forwarders and alerts.

**Note:** While this Logger right enables you to edit, save, and remove both forwarders and alerts, you can only import alerts, but not forwarders.

- Logger Rights > **Dashboards**: Edit, save, and remove dashboards.  
If the user has the dashboard save right but does not have the saved search save right, then the dashboards using search results panels will not be imported (A warning message will indicate which dashboards are skipped).
- Logger Rights > **Saved Search**: Edit, save, and remove saved search.
- **System Admin**: For parsers and source types, the user can be assigned to any System Admin group. If the user is not an admin, then Parsers and Source Types are not importable.

See ["Users/Groups" on page 442](#) for more information on Logger user rights and how to administer them.

Even if you see the **Import** page, you may not be able to import all of the content types. If you do not have the associated user rights, then you cannot import that type of content, and will get a warning message instead.

## Importing Content

Make sure you are familiar with these guidelines before importing Logger content:

- If an object with the same name exists on the importing system, the object being imported is named `<ObjectName> [import]`. For example, an imported alert is named `ALertName [import]` and an imported filter is named `FilterName [import]`.  
If an object with the name `<ObjectName> [import]` already exists on the importing Logger (from a previous import procedure), the object being imported is named `<ObjectName> [import]` `[import]`.
- Be sure to set the alert destinations (SNMP, Syslog, ESM Destination, and SMTP servers) for alerts you import, because this information is not included in the exported content.
- Content Export and Import assumes that the importing Logger has the same configuration setup as the exporting Logger. The Logger you are importing your content to must have the same configuration setup, such as devices, device groups, storage groups as the exporting Logger. If it does not imported content that relies on that configuration cannot be used.

### To import content from another Logger:

1. Open the **Configuration | Advanced** menu and then click **Import Content**.

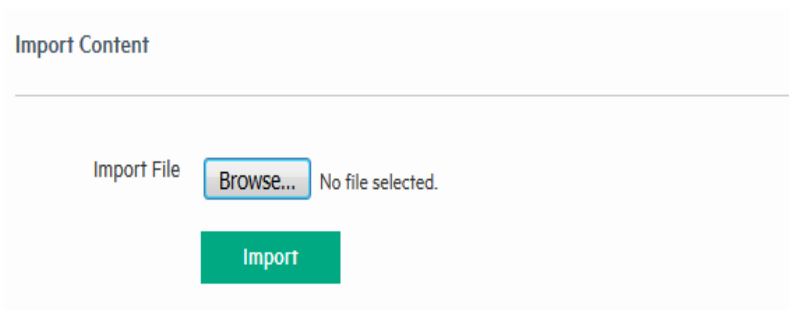

Import Content

Import File  No file selected.

2. Click **Browse** to locate the file  
The file must reside on a local or remote drive accessible to the system whose browser you are using to access Logger's user interface.
3. Click **Import**.

## User Rights for Exporting Content

The content you are able to export depends on your user rights. If you have any of the following rights, the **Export** page discussed in ["Exporting Content" on the next page](#) is available:

- Logger Rights > **Filters**: Use and view shared filters.
- Logger Rights > **Forwarders and Alerts**: View forwarders and alerts.

**Note:** While this Logger right enables you to view both forwarders and alerts, you can only export alerts, but not forwarders.

- Logger Rights > **Dashboards:** Use and view dashboards.  
If the user has the dashboard read right but does not have the saved search read right, then dashboards having search results panels are not available for selection from the Content to Export dialog box.
- Logger Rights > **Fieldsets:** View fieldsets.
- Logger Rights > **Saved Search:** View saved search.
- **System Admin:** For parsers and source types, the user can be assigned to any System Admin Group. If the user is not an admin, then Parsers and Source Types are not exportable.  
See "[Users/Groups](#)" on page 442 for more information on Logger user rights and how to administer them.

Even if you see the **Export** page, you may not be able to export all of the content types. If you do not have one of the above user rights, then the corresponding content type is not available in the **Content to Export** dialog box.

## Exporting Content

Make sure you are familiar with these guidelines before exporting Logger content:

- The exported content is in XML format in a gzip file. For example, `allfilters.xml.gz`.
- The folder on the remote file system to which you are exporting Logger content needs to exist before you can export content to it.
- When exporting alerts, the query associated with the alert, match count, threshold, and status are included in the export. The export does not include e-mail, SNMP, ESM Destination information, or syslog destination information. Since alert destination (SNMP, Syslog, ESM Destination, and SMTP servers) information is not exported, you will need to set this information for alerts you import.
- When exporting dashboards, the content of any saved searches used in the exported dashboards is also exported.
- When exporting source types, the content of the parsers used in the exported source types is also exported.

## To export Logger content:

1. Open the **Configuration | Advanced** menu and then click **Export Content**.

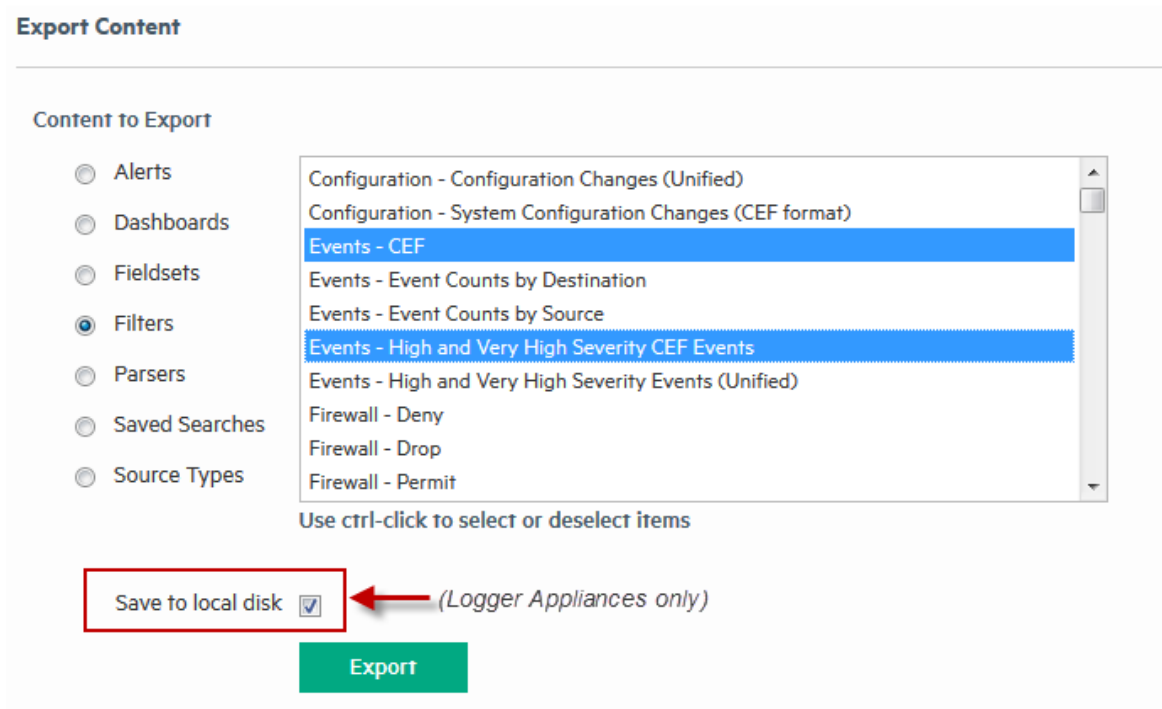

2. Select the radio button for the type of content that you want to export. The available objects menu changes with the type of content you select.
3. Select the objects to export from the menu.  
To select one object, click its name. To select multiple objects, hold the Ctrl key down and click the names.
4. For Software Loggers, click **Export**. The content will be saved according to your browser settings. If you are using a Logger Appliance, continue to the next step.
5. For Appliance Loggers, choose where to save the exported content. **Save to local disk** is the default option.

To save on the local disk of the computer from which you connect to the Logger, leave **Save to local disk** checked.

### To export to a remote location:

- a. Uncheck **Save to local disk** to display options for exporting to a remote file system.

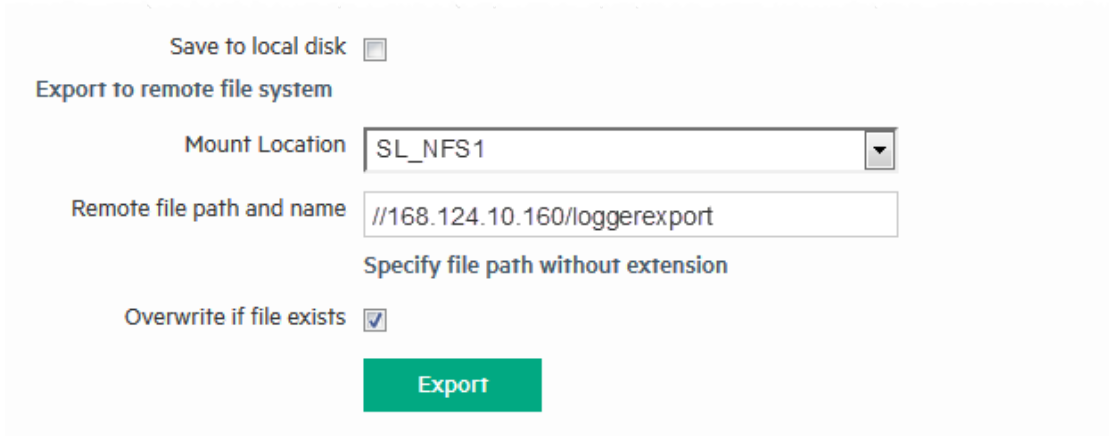

The screenshot shows a configuration panel for exporting to a remote file system. At the top, there is a checkbox labeled "Save to local disk" which is unchecked. Below this, the section "Export to remote file system" is active. It contains a "Mount Location" dropdown menu with "SL\_NFS1" selected. Underneath is a text input field for "Remote file path and name" containing "//168.124.10.160/loggerexport". A note below the input field says "Specify file path without extension". At the bottom of the form, there is a checkbox for "Overwrite if file exists" which is checked, and a green "Export" button.

- b. Select the location to which you want to export the content in the **Mount Location** field. If the location you want is not in the drop-down list, you need to add it. For information about adding a network storage location, see "[Storage](#)" on page 421.
- c. In the **Remote file path and name** field, enter the folder location in which the exported contents file will be created at the Mount Location you specified in the previous step. The folder location you specify in this step must already exist on the Mount Location. It is not created by the Logger.

**Note:** Specify the filename without using an extension.

6. Click **Overwrite if file exists** if you want to overwrite a file with the same name as the exported contents file in the folder location that you specified in the previous step.
7. Click **Export**.

## License Information

The License Information page (**Configuration | Advanced > License Information**) provides information about the currently applied license, as shown in the following example.



### License Information

#### License

Customer: ArcSight Internal License Key  
Expiration date: 2016/12/31  
Activation date: 2016/06/15  
Creation date: 2016/06/16  
Logger features: Enabled  
Connector appliance features: Disabled

#### Logger features

Alerting: Enabled  
Local storage: Enabled  
Reporting: Enabled  
SAN storage: Disabled  
Peering: Enabled

#### Logger limits

Devices: Unlimited  
EPS incoming: 100,000  
Daily data: 500GB  
Maximum capacity: 12TB  
Maximum violations: 5  
Violation days: 30

## Trial Licenses

ArcSight Data Platform Logger and ArcSight Logger both come with a trial license that you can use for a 90 day evaluation period. After the evaluation period is over, you will not be able to access any Logger features until you apply a valid license.

**Caution:** Immediately after upgrading your Logger to version 6.3, you will have only a trial license, and will be subject to the trial license limitations until you apply your standalone ArcSight Logger or ArcSight Data Platform (ADP) Logger license. For more information, see ["Data Volume" on the next page](#).

The trial license gives you access to the following:

- All Logger features except Reporting.
- 5 GB per day ingested data volume. (Software Loggers only.)
- 90 GB Storage Volume. (For upgraded systems, the license will display 90 GB, but the Storage Volume on your Logger will not be lowered to that limit.)

Please upload your new license as soon as possible. To upload a new license, open **System Admin** in the menu bar, and then click **License & Update** in the **System** section. For instructions, see ["Updating Your Logger License" on page 414](#).

Depending on whether your license entitles you to management by ArcMC, you can update the trial license with either a standalone ArcSight Loggerlicense or an ADP license. (ADP Loggers are managed by ArcMC.) After you upload either license, the Reporting feature is enabled, and the licensed daily data volume and storage volume are increased to the capacity of the license.

The ingested daily data volume of your Logger is displayed on the Data Volume page under **Configuration | Advanced > Data Volume**. You can view your daily data limit and other license information in Logger under **Configuration | Advanced > License Information** and under **System Admin > System > License & Update**.

## Data Volume

The Data Volume page (**Configuration | Advanced > Data Volume**) shows the amount of data stored on your Software Logger for each of the last 30 days.

The data volume restriction function measures the daily data for the previous 24 hours at 00:00:00 UTC and posts that information on the Data Volume page. The time this functions uses is independent of the Logger's local time.

The type of license you have affects how the data volume restriction function works and what is displayed on the Data Volume page.

- For trial Loggers, standalone ArcSight Loggers, and all newly upgraded Loggers, the data volume restriction function adds the sum of the sizes of the events received on a given day to compute the ingested daily data volume (the amount of data that comes into Logger per day). Logger compares that value against the daily data limit in the license. If this limit is exceeded, Logger continues to collect and store events, so that no events are lost. However, if the daily data limit is exceeded on more than five days in a 30-day sliding window, all search-related features are disabled.

**Caution:** The disabled search features include forwarders as well as all searching and reporting functionality.

- For ADP Loggers, ArcMC manages the license restrictions, and the data volume restriction function does not disable searching, forwarding, and reporting. Refer to the ArcMC Administrator's Guide for more information.

For information on the trial and standalone Logger Data Volume page, see ["Standalone Logger Data Volume Page" below](#). For information on the ADP Logger Data Volume page, see ["ADP Logger Data Volume Page" on the next page](#).

## Daily Data Limit for Newly Upgraded Software Loggers

Logger 6.3 implements a new type of license file. Immediately on upgrade to Logger 6.3, this new type of license is in effect. A trial Logger license, with the trial license limitations, is in place until you upload your 6.3 standalone ArcSight Logger or ArcSight Data Platform (ADP) Logger license. For more information, see ["Trial Licenses" on page 393](#).

Until you update to the full license, the daily data limit is *5 GB per day*. Logger displays a "Licensed Data Volume Limit Exceeded" warning banner each day you exceed 5 GB daily data limit.

**Caution:** If the data limit has been exceeded six times in 30 days, you cannot use any search-related features until the listed 30 days have five or fewer violations. The disabled search-related features include forwarders as well as all searching and reporting functionality.

Apply the full license by following the instructions in ["License & Update" on page 413](#).

## Standalone Logger Data Volume Page

**This topic applies to standalone ArcSight Loggers, newly upgraded Loggers, and Trial Loggers.**

On standalone and trial Software Loggers, the Data Volume page (**Configuration | Advanced > Data Volume**) displays the daily ingested data volume, the licensed GB per day, and the number of license violations that have occurred. There is a limit of five data volume license violations in a 30 day period. Logger displays a "Licensed Data Volume Limit Exceeded" warning banner when your incoming data volume is greater than this limit.

**Note:** Logger comes with a 90-day trial license. *During the trial period, the licensed daily data limit is 5 GB per day.* For more information see ["Trial Licenses" on page 393](#). To increase this limit, apply a license by following the instructions in ["License & Update" on page 413](#).

In the data volume chart, a vertical line indicates your licensed daily data volume, a green bar indicates you are below 90% of your license limit for that day, a yellow bar indicates that you have reached 90% of your license limit for that day, and a red bar indicates that you have exceeded your license limit for that day. Below the chart, the number of violations, maximum allowed violations, and licensed GB per day are listed and the table displays the data ingested for each of the past 30 days.

**Caution:** If the data-limit has been exceeded six times in 30 days, you cannot use any search-related features until the listed 30 days have five or fewer violations. The disabled search-related features include forwarders as well as all searching and reporting functionality.

You can view your daily data limit and other license information on Logger under **Configuration | Advanced > License Information** and under **System Admin > System > License & Update**.

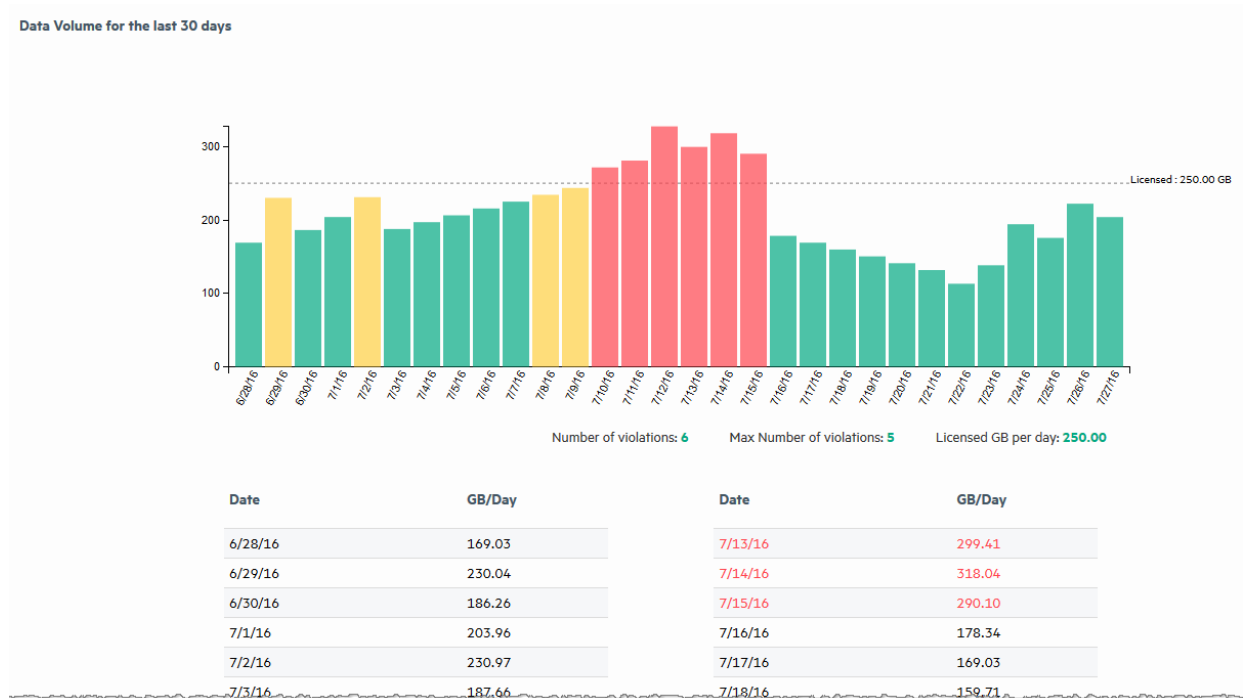

## ADP Logger Data Volume Page

**This topic applies to ADP Loggers only.**

On ADP Software Loggers, the Data Volume page (**Configuration | Advanced > Data Volume**) displays the daily ingested data volume the management status of the Logger.

**Note:** ADP Loggers are managed by ArcMC, therefore the data volume restrictions for standalone Loggers do not apply.

In the Data Volume chart, a green bar indicates that the Logger was managed by ArcMC for that day and an orange bar indicates the Logger was unmanaged for that day. Below the chart, the number days unmanaged, maximum allowed unmanaged days, and last managed day are listed, and the table displays the data ingested for each of the past 30 days.

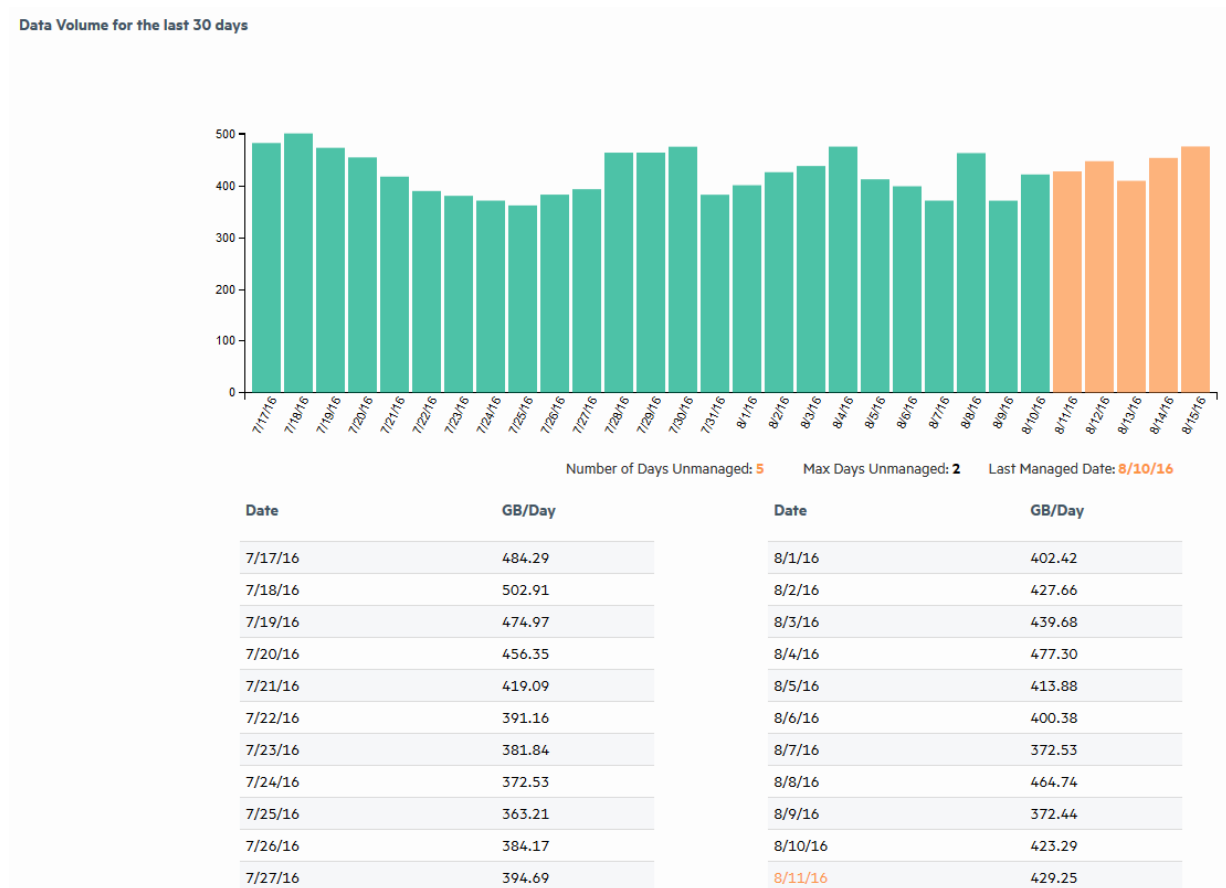

## Peer Nodes

Logger can establish peer relationships with one or more Loggers or ArcSight Managers to enable distributed searches. To search other Loggers or Managers, you must define one or more peers.

When two systems peer with each other, one initiates the relationship. The initiator sends credentials to authenticate itself to the target system. If the authentication succeeds, a peer relationship is established between the two systems.

## Overview Steps for Configuring Peers

### The following steps are required to set up peer relationships:

1. Determine which Manager or Logger will initiate the peer relationship. Manager or Logger A is the initiator in this example, and Logger B is the target.
2. Decide on a peer authentication method, based on the information in ["Selecting a Peer Authentication Method"](#) on page 399.
  - To authenticate with a user name and password:  
Determine which user name and password Manager or Logger A should to use to authenticate

itself when peering with B, or set up a user, as described in ["Users/Groups" on page 442](#).

- To authenticate with an Authorization ID and Code:  
On Manager or Logger B, generate an Authorization ID and Code for A to use to authenticate itself when peering with B. For instructions, see ["Authorizing a Peer" on the next page](#).
- 3. On Manager or Logger A, add the authentication information from B, as described in ["Adding a Peer" on page 400](#).
  - If authenticating with a user name and password, use the user name and password that you determined.
  - If authenticating with an Authorization ID and Code, use the Authorization ID and Code that you generated.

## Guidelines for Configuring Peers

Consider these guidelines when configuring peers:

- Logger 6.3 can peer with ESM 6.8c, ESM 6.5c, and Logger 5.3 and above.
- You can configure a maximum of 100 peers for a Logger.
- The system time and date on each Manager or Logger in the peer relationship must be set correctly for its time zone. HPE recommends that you configure your system to synchronize its time with an NTP server regularly.
- If the remote Logger is configured for SSL Client authentication (SSL/CAC Authentication), you must configure an authorization ID and code on the initiator Logger.
- There are no special authentication requirements for FIPS-enabled Loggers. Such Loggers can use any of the allowed authentication methods.
- Peers cannot be edited, however you can delete and re-add a peer.
- If you are running distributed searches (searches across peers), follow these additional guidelines:
  - a. A user must belong to the Logger Search User Group with "Search for events on remote peers" privilege set to **Yes** and the Logger Rights Group with "View registered peers" privilege set to **Yes**. See ["Searching Peers \(Distributed Search\)" on page 107](#).
  - b. Users performing search operations on peers have the same privileges on the peer that they have on the Logger they are logged into. For example, User A is restricted by a search group filter to only search for events in which deviceVendor is set to "Cisco." When User A performs a search operation across Logger A's peers, the same constraint (to search events where deviceVendor = "Cisco") is applied on all peers.
- If you are running distributed reports (reports across peers), see ["Running a Report Manually" on page 182](#).
- When user name and password are used for authenticating to a remote peer, changes to the user name and password after the peer relationship is established do not affect the relationship. However,

if you delete the peer relationship or it breaks for other reasons, you will need to provide the changed credentials to re-establish the relationship.

## Authenticating Peers

Authentication happens only once, at the time the peer relationship is created. The authorization to use peer services is implicit each time a remote system receives peer requests from a system that previously authenticated as a peer.

You can authenticate a peer in one of two ways:

- **Peer Authorization ID and Code:** These credentials are generated on one Manager or Logger and used on another to configure peering between the two. When generating the Authorization ID and Code, enter the IP address of the Manager or Logger you will use to initiate peering in the Peer Authorization page of the one you want to peer with. The IP address is used to generate a unique ID and code that can be used only for peering from that address. Therefore, this method is more secure than using a user name and password.

**Note:** HP ArcSight recommends using Peer Authorization ID and Code for authentication.

- **User name and password:** A user name and password already configured on the target system is used for authentication.

## Selecting a Peer Authentication Method

- When using a user name and password to configure peering, you must use the user password for local authentication, even if your system is configured to use LDAP or RADIUS authentication.
- If the peer Manager or Logger is configured for SSL Client authentication (CAC), you must configure an Authorization ID and Code on the target Manager or Logger. You cannot use a user name and password.
- FIPS-enabled systems are not limited to a specific authentication method.

## Authorizing a Peer

Use the following procedure to generate the Authorization ID and Code on the target Manager or Logger with which you want to establish a peer relationship. (Manager or Logger B in the example in ["Peer Nodes" on page 397](#).) After that, use the ID and Code on the initiating Manager or Logger when configuring the peer relationship (Manager Logger A in that example).

### **To generate the Authorization ID and Code to use when configuring a peer relationship:**

1. Open the **Configuration | Advanced** menu and click **Peer Authorizations**.
2. Click **Add**.

3. Enter the hostname or IP address and port for the Manager or Logger you want to peer with this system.
4. Click **Save**.  
The authorization ID and authorization code display. Copy this information and use it on the other Manager or Logger when adding this system as a peer.
5. Click **Done** to return to the Peer Authorization list.

## Adding and Deleting Peer Relationships

The **Peer Nodes** page displays the current peer relationships. From here, you can add and delete peers.

### Adding a Peer

Adding a peer creates a peer relationship between two Loggers, two ArcSight Managers, or a Logger and a Manager. Once added, you can delete a peer, but you cannot edit it. See "[Guidelines for Configuring Peers](#)" on page 398 for more information.

Adding a peer on a Logger is a bi-directional process. That is, when Logger A adds peer access for Logger B, Logger B automatically adds peer access for Logger A. Similarly, if you delete the peer access for B on A, the peer access for A is automatically deleted on B.



### To add a peer:

1. Open the **Configuration | Advanced** menu and click **Peer Nodes**.

**Add Peer Node**

---

Peer Hostname/IP

Peer Port

Peer Login Credentials  
 Peer Authorization Credentials

Peer User Name

Peer Password

In most cases, the fields below will be pre-populated for you, and you do not need to change them. In the event that you need to change these fields, please consult the [Logger Administrator's Guide](#) for specific instructions.

Local Hostname/IP

Local Port

2. Click **Add** and enter the following parameters.

Parameter	Description
Peer Hostname/IP	Enter the target Manager or Logger's hostname or IP address.
Peer Port	Use the port configured when installing or initially configuring the target system. See <a href="#">"Guidelines for Configuring Peers" on page 398</a> . By default, this is Port 443 for the Logger Appliances.
Peer Login Credentials	Select <b>Peer Login Credentials</b> for password-based authentication.
Peer Authorization Credentials	OR Select <b>Peer Authorization Credentials</b> to use an Authorization ID and Code. <ul style="list-style-type: none"> <li>On systems using local or RADIUS authentication, you can use either authentication method, although peer Authorization ID and Code are recommended.</li> <li>On systems using SSL Client Authentication (CAC), Authorization ID and Code is the only way to authenticate a peer. You cannot use a user name and password. (See <a href="#">"SSL Client Authentication" on page 435</a>.)</li> <li>FIPS-enabled systems are not limited to a specific authentication method.</li> </ul>
<b>If you selected Peer Login Credentials...</b>	
Peer User Name	Enter a user name already configured on the target system.
Peer Password	Enter the password for the user specified in the Peer User Name field.
<b>If you selected Peer Authorization Credentials...</b>	
Peer Authorization ID	Enter the authorization ID generated on the target Manager or Logger. (See <a href="#">"To generate the Authorization ID and Code to use when configuring a peer relationship:" on page 399</a> for more information.)
Peer Authorization Code	Enter the authorization code generated on the target Manager or Logger. (See <a href="#">"To generate the Authorization ID and Code to use when configuring a peer relationship:" on page 399</a> for more information.)
<b>Other Fields</b> These fields need to be updated in rare circumstances.	
Local Hostname/IP	In most cases, the value in this field matches the IP address or host name you use to connect to this Logger from your browser, and you do not need to do anything. However, if the IP address does not match (for example, when the Logger is behind a VPN concentrator), change the value to match the IP address or host name with which you connect to this Logger.
Local Port	In most cases, the value in this field matches the port in your browser when you logged into this system (the initiating Manager or Logger), and you do not need to do anything. However, if the port here does not match the port in the IP address, (for example, when the Manager or Logger is behind a VPN concentrator), change the value to match the port in the IP address in your browser.

3. Click **Save** to add the new Logger, or **Cancel** to quit.

## Deleting a Peer

Deleting a peer removes the peer relationship between two Loggers or two ArcSight Managers, or a Manager and a Logger. You can perform this process from either peer.

### To delete a peer:

1. Open the **Configuration | Advanced** menu and click **Peer Nodes**.
2. Locate the peer you want to delete the peer relationship to and click the Delete icon ( **x** ) on that row.
3. Confirm the deletion by clicking **OK**, or click **Cancel** to retain the Peer.

# Chapter 6: System Admin

System Administration tools enable you to create and manage users and user groups, and to configure security settings, SMTP, and other system settings.

**Note:** Some System Administration topics apply to Software Loggers, some to Logger appliances, and some to both types of Logger. The type of Logger to which the topic applies is noted at the top of each System Administration topic.

The following subjects are covered in this section:

- System .....404
- Logs .....420
- Storage .....421
- Security .....430
- Users/Groups .....442
- Other System Administration Information .....462

## System

**This topic applies to both Software Logger and the Logger Appliance.**

From the **System** tab, you can configure system-specific settings.

- System Locale .....405
- System Reboot .....405
- Network .....406
- SMTP .....413
- License & Update .....413
- Process Status .....415
- System Settings .....415
- SNMP .....416
- SSH Access to the Appliance .....419

## System Locale

**This topic applies to both Software Logger and the Logger Appliance.**

The System Locale setting ensures that the user interface displays information such as date, time, numbers, and messages in the format and language appropriate for the selected country.

The System Locale is configured during the Logger installation process. Once configured it cannot be changed.

### To view the System Locale:

1. Click **System Admin** from the top-level menu bar.
2. Click **System Locale** in the **System** section. The **System Locale Setting** dialog box displays the Locale.

## System Reboot

**This topic applies to Logger Appliances only.**

You can reboot or shutdown your appliance. For related information for Software Logger, see ["Software Logger Command Line Options" on page 468](#)

### To reboot or shutdown your system:

1. Click **System Admin** from the top-level menu bar.
2. Click **System Reboot** in the **System** section.
3. Select from the following options:

Button	Description
Reboot	Your system reboots in about 60 seconds. The reboot process normally takes 5-10 minutes, during which time the system is unavailable.
Reboot in 5 Minutes	Your system reboots after a 5-minute delay. The reboot process normally takes 5-10 minutes, during which time the system is unavailable.
Shutdown	Automatically shuts down (powers off) the system.

Each of the above actions can be canceled. "Reboot" and "Shutdown" allow for cancellation within **60 seconds**. "Reboot in 5 Minutes" can be canceled within **300 seconds**.

4. Click **Reboot**, **Reboot in 5 Minutes**, or **Shutdown** to execute the chosen action.

**Caution:** During reboot, Logger is not able to receive events. Events may be lost while Logger reboots, unless SmartConnectors are used. SmartConnectors cache events when destinations like Logger are temporarily unavailable.

## Network

**This topic applies to Logger Appliances only.**

On the Logger Appliance, you can configure the DNS, Hosts, NICs, static routes, and system time settings from the **Network** menu. For Software Loggers, these are configured through the operating system.

- [System DNS](#) ..... 406
- [Hosts](#) ..... 407
- [NICs](#) ..... 407
- [Static Routes](#) ..... 409
- [Time/NTP](#) ..... 410



## System DNS

**This topic applies to Logger Appliances only.**

The **System DNS** tab enables you to edit the DNS settings and to add DNS search domains.

### To change DNS settings:

1. Click **System Admin** from the top-level menu bar.
2. Click **Network** in the **System** section.
3. In the **System DNS** tab, enter new values for the IP address of the primary and secondary DNS servers, or edit the list of search domains.

To add a new domain, click the  icon. To remove a domain, click the  icon. To change the search order of domains, select a domain name, and click the up or down arrow until the domain is in the desired position.

4. Click **Save**.
5. Click **Restart Network Service** to put the changes into effect.

## Hosts

**This topic applies to Logger Appliances only.**

The **Hosts** tab enables direct editing of your system's `/etc/hosts` file. You can enter data in the **System Hosts** text box or import it from a local file.

### To change the Hosts information:

1. Click **System Admin** from the top-level menu bar.
2. Click **Network** in the **System** section, and then click the **Hosts** tab.
3. In the **System Hosts** text box, enter hosts information (one host per line) in this format:

<IP Address> <hostname1> <hostname2> <hostname3>

To import information from a file, click **Import from Local File**, and locate the text file on the computer from which you are accessing your system.

4. Click **Save**.

## NICs

**This topic applies to Logger Appliances only.**

The **NICs** tab enables you to set the IP addresses for the network interface cards (NICs) on your system. Additionally, you can configure the hostname and default gateway for your system.

### To set or change the NICs settings:

1. Click **System Admin** from the top-level menu bar.
2. Click **Network** in the **System** section.
3. In the **NICs** tab, enter the following settings. To edit the IP address, subnet mask, or speed/duplex of an NIC, select the NIC and click **Edit** above the NIC Name list.

Setting	Description
Default Gateway	The IP address of the default gateway.
Hostname	<p>The network host name for this system. Make sure that your DNS can resolve the host name you specify to your system's IP address. Performance is significantly affected if DNS cannot resolve the host name.</p> <p>This name must be identical to the domain specified in the Certificate Signing Request, described in <a href="#">"Generating a Certificate Signing Request (CSR)" on page 432</a>.</p> <p><b>Note:</b> If you previously used a self-signed or CA-signed certificate on this system and are now changing its host name, you must regenerate a new self-signed certificate or CSR. A new certificate ensures that the connectors in FIPS mode which communicate with your system are able to validate the host name. For more information about generating a CSR, see <a href="#">"Generating a Certificate Signing Request (CSR)" on page 432</a>.</p>
Automatically route outbound packets (interface homing)	<p>When this option is enabled (checked box), the response packets are sent back on the same system interface on which the request packets had arrived. Enabling this option can improve performance as the routing decisions do not need to be made (using the default gateway information and static routes) to send packets out from your system. If you have static routes configured, they are ignored when this feature is enabled.</p> <p>When this feature is disabled (unchecked box), the static routes (if configured) are used to determine the interface through which the response packets should leave your system.</p> <p>If you configure only one network interface, this setting does not provide any additional benefit.</p>



Setting	Description
IP Address	<p>The IP address for each network interface card (NICs) in your system. These IP addresses should be on separate subnets to avoid confusion and to allow load balancing between receivers and forwarders.</p> <p><b>Add NIC Alias</b></p> <p>You can create an alias for any listed NIC. To do so:</p> <ol style="list-style-type: none"> <li>Highlight the NIC for which you want to create an alias.</li> <li>Click <b>Add</b>.</li> <li>Create an alternative IP address for the alias.</li> <li>Click <b>Save</b>.</li> </ol> <p>You can identify the alias from its original by an appended colon alongside a digit indicating the number of aliases you have created on a particular NIC.</p> <p><b>Note:</b> You cannot alter the speed of an IP alias.</p> <p>You can create as many aliases as you choose.</p>
Subnet Mask	The subnet mask associated with the IP address you entered for an NIC.
Speed/Duplex	<p>Choose a speed and duplex mode, or let your system determine the network speed automatically:</p> <ul style="list-style-type: none"> <li>• Auto (recommended)</li> <li>• 10 Mbps - Half Duplex</li> <li>• 10 Mbps - Full Duplex</li> <li>• 100 Mbps - Half Duplex</li> <li>• 100 Mbps - Full Duplex</li> <li>• 1Gbps - Full Duplex</li> </ul>

- Click **Save**.
- Click **Restart Network Service** to put the changes into effect.

## Static Routes

**This topic applies to Logger Appliances only.**

You can specify static routes for the NICs on your system.

### To add, edit, or delete a static route:

- Click **System Admin** from the top-level menu bar.
- Click **Network** in the **System** section.
- In the **Static Routes** tab:

- To add a new static route, click **Add**.
- To edit or delete an existing route, select the route first, then click **Edit** or **Delete**.

When adding or editing a static route, you need to configure these settings.

Setting	Description
Type	Whether the static route is to a Network or a Host
Destination	The IP address for the static route destination
Subnet Mask	The subnet mask if you specify a network as the destination
Gateway	The IP address of the gateway for the route

4. Click **Save**.

## Time/NTP

### **This topic applies to Logger Appliances only.**

You do not need to configure the time, date, or time zone for a Software Logger. Software Loggers use the operating system's settings for the time and time zone.

The **Time/NTP** tab enables you to configure system time, date, local timezone, and NTP servers. HPE strongly recommends using an NTP server instead of manually configuring the time and date on your system.

Precise timestamping of events is also critical for accurate and reliable log management. The times displayed for Logger operations such as searches, reports, and scheduled jobs are in the Logger's local time zone.

### **To set or change the system time, date, or time zone manually:**

1. Click **System Admin** from the top-level menu bar.
2. Click **Network** in the **System** section.
3. In the **Time/NTP** tab, configure these settings.



Setting	Description
Current Time Zone	<p>The time zones appropriate to your system's location. To change this setting, click <b>Change Time Zone...</b></p> <p>Local times zones follow the Daylight Savings Time (DST) rules for that area. Greenwich Mean Time (GMT) + and - time zones are DST-agnostic.</p> <p>For example, the America/Los Angeles time zone varies by an hour compared with GMT when DST goes into and out of effect.</p> <ul style="list-style-type: none"><li>• Pacific Standard Time (PST) = GMT-8</li><li>• Pacific Daylight Time (PDT) = GMT-7</li></ul>
Current Time	<p>The current date and time at the system's location. To change this setting, click <b>Change Date/Time...</b></p>

4. The Time Zone change requires that you reboot the appliance. However, the Current Time change takes effect immediately.

**Caution:** If you manually set the date and time settings and are also using an NTP service, the date and time entered manually cannot be more than 16 minutes ahead of or behind the time that the NTP server is providing. If the manually entered time is more than 16 minutes different from the NTP server time, then the NTP service will fail to start.

### To configure your system as an NTP server or for using an NTP server for your system:

1. Click **System Admin** from the top-level menu bar.
2. Click **Network** in the **System** section.
3. Click the **Time/NTP** tab.
4. Under **NTP Servers**, configure these settings.

To add a new NTP server, click the  icon. To remove a server, click the  icon. To change the order in which the NTP servers should be used, select a server and click the up or down arrow until the NTP server is in the desired position.

Setting	Description
Enable as an NTP server	Check this setting if this system should be used as an NTP server.
NTP Servers	<p>Enter the host name of an NTP server. For example, time.nist.gov.</p> <p>HPE recommends using at least two NTP servers to ensure precise time on your system. To enter multiple NTP servers, type one server name per line.</p> <p>Once you add servers to this list, you can click the <b>“Click to Test”</b> link to verify if the servers that you added are reachable from your system.</p> <ul style="list-style-type: none"><li>• An ArcSight system can serve as an NTP server for any other ArcSight system.</li><li>• If System A serves as an NTP server for System B, System B needs to list System A in its NTP Servers list.</li><li>• Use the <b>Test Servers</b> button to verify the status of the servers entered into the <b>NTP Servers</b> box.</li></ul>

5. Click **Save**.

**Tip:** You may need to scroll down to view the **Save** button and **Restart NTP Service**.

6. Click **Restart NTP Service** to put the changes into effect.

## Impact of Daylight Savings Time Change on Logger Operations

### **This topic applies to both Software Logger and the Logger Appliance.**

To search for events that occur between 1 a.m. to 2 a.m. when the time change due to the end of Daylight Savings Time (DST) takes place in the fall, (time is set back one hour), specify a start time of 12:59:59 or earlier and end time of 2:00:01 or later to ensure that all events are returned.

To search for events that occur between 1 a.m. to 2 a.m. when the time change due to the start of Daylight Savings Time (DST) takes place in the spring (time is set ahead one hour), specify an end time of 2:00:01 or later to ensure that all events are returned.

Scheduled operations on Logger such as reports, event archives, and file transfers are also impacted when system time is adjusted on the Logger at the start and end of the US Daylight Savings Time period (DST).

Operations scheduled for the hour lost at the start of DST (for example, on March 9, 2015) are not run on the day of time adjustment. Similarly, operations scheduled for the hour gained at the end of the DST (for example, on November 2, 2015) are run at standard time instead of DST time.

Examples:

- A report scheduled to run at 1 a.m. DST on November 2, 2015 will run at 1 a.m. standard time, which is an hour later than the DST time on that day.
- A report scheduled to run at 2 a.m. on November 2, 2015 will run at 2 a.m.; however, due to time adjustment, an hour later than it ran on the previous day (November 1, 2015).
- A report scheduled to run at 2 a.m. on March 9, 2015 will not run.

## SMTP

**This topic applies to both Software Logger and the Logger Appliance.**

Your system uses the Simple Mail Transfer Protocol (SMTP) setting to send email notifications such as alerts and password reset emails.

### To add or change SMTP settings:

1. Click **System Admin** from the top-level menu bar.
2. Click **SMTP** in the **System** section and enter values for these settings.

Setting	Description
Primary SMTP Server	The IP address or hostname of the SMTP server that will process outgoing email.
Backup SMTP Server	The IP address or hostname of the SMTP server that will process outgoing email in case the primary SMTP server is unavailable.
Outgoing Email Address	The email address that will appear in the From: field of outbound email.

3. Click **Save**.

**Note:** Be sure to configure your reports to use the same SMTP settings. For instructions, see ["Report Server Administration" on page 245](#).

## License & Update

**This topic applies to both Software Logger and the Logger Appliance.**

This page displays license information, the version of the components, and the elapsed time since Logger was last rebooted (Logger Appliance) or restarted (Software Logger).

On this page, you can apply a new license to your Logger. You can also update a Logger Appliance from here. However, to upgrade Software Logger, you must install an upgrade package. Refer to the Release Notes for the upgrade version for instructions.

To view details of your current license, open **Configuration** from the top-level menu bar, and then click **License Information**. For details, see ["License Information" on page 392](#).

## Updating Your Logger License

### To update your Logger license:

1. Redeem your license on the Software Entitlements Portal, then download the license file to a computer from which you can connect to Logger. For more information, refer to the software delivery confirmation email you received from HPE.
2. From the computer to which you downloaded the update file, log in to Logger using an account with administrator (upgrade) privileges.
3. Click **System Admin** from the top-level menu bar.
4. Click **License & Update** in the **System** section.
5. Browse to the license file you downloaded earlier, and click **Upload Update**. The Update in Progress page displays the update progress.

Once the update has completed, the **Update Results** page displays the update result (success/failure). A reboot or restart is not required.

After applying a new license, you may need to increase your Storage Volume. See ["Storage Volume Size Increase" on page 374](#) for instructions.

**Note:** After upgrade or when converting a trial Logger to the full version, be sure to increase the Storage Volume to take advantage of your full licensed capacity.

## Upgrading a Logger Appliance

**Caution:** Immediately after upgrading your Logger to version 6.3, you will have only a trial license, and will be subject to the trial license limitations until you apply your standalone ArcSightLogger or ArcSight Data Platform (ADP) Logger license. Please upload your new license as soon as possible. For instructions, see ["Updating Your Logger License" above](#).

### To upgrade Logger appliance:

1. Download the update file from the Software Entitlements Portal, to a computer from which you can connect to Logger. For more information, refer to the software delivery confirmation email you received from HPE.
2. From the computer to which you downloaded the update file, log in to Logger using an account with administrator (upgrade) privileges.
3. Click **System Admin** from the top-level menu bar.
4. Click **License & Update** in the **System** section.
5. Click **Browse** to locate the file.

6. Click **Upload Update**. The **Update in Progress** page displays the update progress.
7. Once the update has completed, the Update Results page displays the update result (success/failure) and whether the update requires a reboot or restart. If it does, the Logger reboots/restarts automatically.

## Process Status

**This topic applies to both Software Logger and the Logger Appliance.**

The **Process Status** page lists all processes related to your system and enables you to view the details of those processes and start, stop, or restart them.

### To view the Process Status page:

1. Click **System Admin** from the top-level menu bar.
2. In the **System** section, click **Process Status**. A list of Logger processes display.

**Tip:** In this context, the "processors" listed in the **Processes** table refers to forwarders.

3. On the **Process Status** dialog, to toggle the view of the details of a process, click the  icon to the left of the process name.

To start, stop, or restart a process, select the process and click **Start**, **Stop**, or **Restart** at the top of the process list.

## System Settings

**This topic applies to Software Loggers only.**

If you did not select Logger to start as service during the installation process, you can do so using the **System Settings** page. When you select this option Logger will use a service called `arc_sight_logger`, enabled to run at levels 2, 3, 4, and 5.

### To configure Logger to start as a service:

1. Click **System Admin** from the top-level menu bar.
2. Click **System Settings** in the left panel.
3. From under **Service Settings**, choose the appropriate option:
  - **Start as a Service**
  - **Do not start as a Service**
4. Click **Save**.

## SNMP

### **This topic applies to Logger Appliances only.**

You can use SNMP (Simple Network Management Protocol) to monitor the health of your appliance. Logger appliance supports SNMP v2c and SNMP v3.

You can configure SNMP polling and notifications (traps):

- If you configure SNMP polling, a manager station can query the SNMP agent residing on Logger. The information retrieved provides detailed information at the hardware and Operating System level.
- If you configure and SNMP destination, Logger can send notifications for the set of events below. These notifications differ from the ones sent by Alerts. (For more information on using Alerts to send event information as SNMP notifications, see ["Real Time Alerts" on page 328](#) and ["SNMP Destinations" on page 337](#).) Instead of a notification being for a generic event, the new notifications are specific to a single event, making more easily understood by a Network Management System (NMS) such as HP NMMi.

## SNMP Metrics Supported

### **Hardware**

Logger supports polling and notifications for the following hardware parameters.

- CPU Usage
- Memory Usage
- Disk Almost Full
- Fan Failure
- Power Supply Failure
- Temperature Out of Range
- Ethernet Link Down

### **Logger application**

The following notifications are defined in the ARCSIGHT - EVENT - MIB.

- Login attempt failed
- Password change attempt failed
- User account locked
- Reboot command launched
- Manual backup failed



- Scheduled backup failed
- Enable FIPS mode successful
- Disable FIPS mode successful
- Enable FIPS mode failed
- Disable FIPS mode failed

## Configuration on the Logger Appliance

### To configure SNMP polling:

1. In the main menu bar, click **System Admin**.
  2. In the navigation tree, under **System**, click **SNMP**. The SNMP Poll Configuration tab displays.
  3. **Status:** Select **Enabled** or **Disabled**.
  4. **Port:** Enter a port number. The default is 161 (UDP) but can be any available port.
  5. **SNMP Version:** Select **V2c** or **V3**. The default is V2c.
    - **V2c** — Enter the following value:
      - Community String:** 6–128 alphanumeric, underscore ( \_ ), and dash ( - ) characters.
    - **V3** — Enter values for the following fields:
      - Username:** 4–16 alphanumeric, lower-case characters. The user name must begin with an alphabetic character and may include underscores.
      - Authentication Protocol:** Select **MD5** or **SHA**.
      - Authentication Passphrase:** Enter a password consisting of 4–256 characters.
      - Privacy Protocol:** Select **DES** or **AES128**.
      - Privacy Passphrase:** Enter a password consisting of 4–256 characters.
- Note:** To be valid, the values for Poll Configuration and Trap Configuration must match.
6. **System Name:** Enter a name for the system you want to poll.
  7. **Point of Contact:** Enter a valid notification contact.
  8. **Location:** Enter a location for the system you want to poll.
  9. Click **Save**.
  10. Configure the firewall to open the SNMP port, see ["Firewall Rules" on page 469](#).

If an SNMP destination is configured, Logger can send notifications for a limited set of events (see ["SNMP Metrics Supported" on the previous page](#)).

SNMP notifications differ from those sent by SmartConnectors, which are for a generic ArcSight event. The notifications listed here are specific to a single event, making them easier for understanding by a network management system like HP NMMi.

### To configure the destination for SNMP notifications:

1. In the main menu bar, click **System Admin**.
  2. In the navigation tree, under **System**, click **SNMP**. The SNMP Poll Configuration tab displays.
  3. Select the **SNMP Destination** tab to open the SNMP Trap Configuration menu.
  4. **Status**: Select **Enabled** or **Disabled**.
  5. **NMS IP Address**: Enter the IP address of the Network Management System (NMS) host.
  6. **Port**: Enter a port number. The default is 162 (UDP) but can be any available port.
  7. **SNMP Version**: Select **V2c** or **V3**. The default is V2c.
    - **V2c** — Enter the following value:  
**Community String**: 6–128 alphanumeric, underscore (\_), and dash (-) characters.
    - **V3** — Enter values for the following fields:  
**Username**: 4–16 alphanumeric, lower-case characters. The user name must begin with an alphabetic character and may include underscores.  
**Authentication Protocol**: Select **MD5** or **SHA**.  
**Authentication Passphrase**: Enter a password consisting of 4–256 characters.  
**Privacy Protocol**: Select **DES** or **AES128**.  
**Privacy Passphrase**: Enter a password consisting of 4–256 characters.
- Note**: To be valid, the values for Poll Configuration and Trap Configuration must match.
8. Click **Save**.

## Configuration on the NMS

1. Download ArcSight MIB file and other standard Net-SNMP MIB files using following URLs:
  - [https://<system\\_name\\_or\\_ip>/platform-service/ARCSIGHT-EVENT-MIB.txt](https://<system_name_or_ip>/platform-service/ARCSIGHT-EVENT-MIB.txt)
  - [https://<system\\_name\\_or\\_ip>/platform-service/DISMAN-EVENT-MIB.txt](https://<system_name_or_ip>/platform-service/DISMAN-EVENT-MIB.txt)
  - [https://<system\\_name\\_or\\_ip>/platform-service/HOST-RESOURCES-MIB.txt](https://<system_name_or_ip>/platform-service/HOST-RESOURCES-MIB.txt)
  - [https://<system\\_name\\_or\\_ip>/platform-service/IF-MIB.txt](https://<system_name_or_ip>/platform-service/IF-MIB.txt)
  - [https://<system\\_name\\_or\\_ip>/platform-service/UCD-SNMP-MIB.txt](https://<system_name_or_ip>/platform-service/UCD-SNMP-MIB.txt)
2. Load the MIB.
3. Configure the node (appliance) in the NMS (or MIB browser) according to the protocol used, either v2c or v3.

## MIB Contents

The standard MIB files contain the following types of notifications:

Module	Notification Types
DISMAN-EVENT-MIB	Event triggers and actions for standard network management.
IF-MIB	Objects for network interfaces.
IP-MIB	IP and ICMP implementations.
HOST-RESOURCES-MIB	Standard hardware parameters.

## SSH Access to the Appliance

**This topic applies to Logger Appliances only.**

**Note:** SSH access to Software Logger is controlled through the operating system.

When you report an issue to customer support that requires them to access your appliance for troubleshooting and diagnostics in situations such as an upgrade failure, unresponsive appliance, and so on, they will direct you to enable SSH access on it.

By default, SSH access (known as Support Login in previous releases) to your appliance is disabled. (This also includes Loggers upgraded to version 6.0 from previous versions.) However, you can select one of these options in the appliance's user interface to enable SSH:

- **Enabled:** SSH access is always enabled.
- **Enabled, only for 8 hours:** SSH access is disabled automatically eight hours after it was enabled.
- **Enabled, only during startup/reboot:** SSH access is enabled during the time the appliance reboots and is starting up. It is disabled once all processes on the appliance are up and running. This option provides a minimal period of SSH access for situations such as when the appliance does not start successfully after a reboot.

For optimal security, you should set a strong password for the root account. In addition, leave SSH access disabled and enable it only when necessary, such as for troubleshooting purposes.

**Note:** If SSH is disabled on your appliance, you can still access its console if you have it setup for remote access using the HP ProLiant Integrated Lights-Out (iLO) Advanced remote management card. For more information, refer to the Logger Installation Guide.

### Enabling or Disabling SSH Access

**To enable or disable SSH access:**

1. Click **System Admin** from the top-level menu bar.
2. Click **SSH** in the **System** section.

3. On the SSH Configuration dialog, select an SSH configuration.
4. Confirm the new SSH configuration for it to take effect.

Once you have enabled SSH access on your appliance, follow these steps to connect to it using SSH.

## Connecting to Your Appliance Using SSH

### Connecting to your appliance using SSH:

1. Connect to the appliance as “root” using an SSH client.
2. At the password prompt, type the root password and press **Enter**.

## Logs

### This topic applies to both Software Logger and the Logger Appliance.

Your system can generate audit logs at the application and platform levels. Use the Logs sub-menu to search audit logs.

## Audit Logs

Your system's audit logs are available for viewing. Audit logs, as Common Event Format (CEF) audit events, can be sent to ArcSight ESM directly for analysis and correlation. For information about forwarding audit events, see "[Audit Forwarding](#)" below.

### To view audit logs:

1. Click **System Admin** from the top-level menu bar.
2. Click **Audit Logs** in the **Logs** section.
3. Select the date and time range for which you want to obtain the log.
4. (Optional) To refine the audit log search, specify a string in the **Description** field and a user name in the **User** field. When a description string is specified, only logs whose Description field contains the string are displayed. Similarly, when a user is specified, only logs whose User field contains the username are displayed.
5. Click **Search**.

## Audit Forwarding

You can forward audit events to an ArcSight ESM for correlation and analysis. For a list of audit events that you can forward, see "[Application Events](#)" on page 525.

### To forward audit events to specific ESM destinations:

1. Click **System Admin** from the top-level menu bar.
2. Click **Audit Forwarding** in the **Logs** section.
3. Select destinations from the **Available Destinations** list and click the right arrow icon (→) to move the selected destination to the **Selected Destinations** list.

You can select multiple destinations at the same time and move them, or you can move all available destinations by clicking the (→) icon.

The destinations are ESM destinations that you configure on the ESM Destinations page (**Configuration**>**Data**>**ESM Destinations**).

4. Click **Save Settings**.

## Storage

### This topic applies to Logger Appliances only.

Use the **Storage** sub-menu to add an NFS mount or a CIFS mount, or SAN (if applicable) and to view the status of the hard disk array (RAID) controller and specific system processes.

- [Remote File Systems](#) .....421
- [SAN](#) .....424
- [RAID Controller/Hard Disk SMART Data](#) .....430

## Remote File Systems

### This topic applies to Logger Appliances only.

Your system can mount Network File System (NFS) and CIFS (Windows) shares. As a result, it can read log files and event data from UNIX, Linux, Windows remote hosts, and any Network Attached Storage (NAS) solutions based on these operating systems. In addition, you can use the NFS and CIFS mounts for archiving data such as events, exported filters and alerts, and saved searches. Loggers with Storage Area Network (SAN) capability can also interface with a SAN.

Logger appliance supports NFSv4. However, using a NFS for primary storage of Logger events is not recommended. Using a CIFS share for primary storage is not supported.

- [Managing a Remote File System](#) .....422

## Managing a Remote File System

### This topic applies to Logger Appliances only.

Make sure the following requirements are met before you mount a share.

File System Type	Requirements
CIFS (Windows)	<ul style="list-style-type: none"><li>• A user account that has access to the shared drive exists on the Windows system.</li><li>• The folder to which you are establishing the mount point is configured for sharing.</li></ul>
NFS	<ul style="list-style-type: none"><li>• Grant your ArcSight system read and write permission on the NFS system.</li><li>• The account used for mounting must use the numeric ids 1500 for <code>uid</code>, or 750 for <code>gid</code>.</li></ul>

### To add a Remote File System mount:

1. Click **System Admin** from the top-level menu bar.
2. Click **Remote File Systems** in the **Storage** section in the left panel.  
The **Remote File Systems** table is displayed.
3. Click **Add** from the top left side of the page and enter values for the following fields in the resulting form.

Parameter	Description
Select File System Type	Whether you want to mount an NFS or a CIFS share.
<b>NFS Settings</b>	
Name	A meaningful name for the mount point. This name is used locally on your system to refer to the mount point, and needs to be specified when configuring archive settings for data that will be stored on the share.  <b>Tip:</b> The mount name cannot contain spaces.
Hostname / IP Address	The name or IP address of the host to which you are creating the mount.
Remote Path (for NFS)	The folder on the remote host that will act as the root of the network file system mount. For example, <code>/public/system_logs</code> .  Make sure that only this system can write to the location you specify in this field. If multiple systems (or other systems) mount this location and write to it, data on this location will be corrupted.

Parameter	Description
Mount Options	<p>AutoFS options. For example, ro for read-only from the remote host, rw for read-write, or hard to keep retrying until the remote host responds.</p> <p><b>Note:</b> Even if you configure rw permission at your mount point, read-write permission is not granted to the remote host if the host is configured to allow read-only access.</p>
Description	A meaningful description of the mount point.
<b>CIFS Settings</b>	
Name	<p>Name is used locally on your system to refer to the mount point, and needs to be specified when configuring archive settings for data that will be stored on the share.</p> <p><b>Note:</b> The mount name can include alpha-numeric, dash (-), and underscore (_) characters. It must begin with an alpha-numeric character.</p>
Location	<p>Enter the share name in one of the following ways:</p> <ul style="list-style-type: none"> <li>Share name in this format:  <code>&lt;IP Address&gt; or &lt;Hostname&gt;:&lt;share_name&gt;</code>                      For example, <code>198.0.2.160:myshare</code>                      This folder needs to be configured for sharing. (Typically, to configure a Windows folder for sharing, right click on the <b>folder name &gt; Properties &gt; Sharing.</b>) <p><b>Caution:</b> When mounting from a Windows Server 2008 in cluster, you must use the Hostname and <b>not</b> the IP address for a successful mount.</p> <li>UNC path:                      For example, <code>//198.0.2.160/myshare</code></li> </li></ul>
Mount Options	<p>AutoFS options. For example, ro for read-only from the remote host, rw for read-write, or hard to keep retrying until the remote host responds.</p> <p><b>Note:</b> Even if you configure rw permission at your mount point, read-write permission is not granted to the remote host if the host is configured to allow read-only access.</p>
Description	A meaningful description of the mount point.
<b>Credentials for CIFS</b>	
Username	<p>The name of the user account with read-write privileges to the Windows share. Make sure the username is prefixed with the domain information. For example, <code>tahoe\arcsight</code>.</p>
Password	The password for the user name specified above.

4. Click **Add**.

All mount points are created under `/opt/mnt`.

### To edit a Remote File System mount:

**Note:** You cannot edit a mount point if it is in use. The **Edit** link is displayed only if the mount point can be edited.

If you rename a mount point, access to the archives that were made using the original name is lost until you revert the mount point name to the original name.

1. Click **System Admin** from the top-level menu bar.
2. Click **Remote File Systems** in the **Storage** section in the left panel.
3. Select the mount point you want to edit, and click **Edit** from the top left side of the page.
4. Change the field values.
5. Click **Save**.

### To delete a Remote File System mount:

**Note:** You cannot delete a mount point that is in use. The **Delete** link is displayed only if the mount point can be deleted.

1. Click **System Admin** from the top-level menu bar.
2. Click **Remote File Systems** in the **Storage** section in the left panel.
3. Select the mount point you want to delete, and click **Delete** from the top left side of the page.

## SAN

### This topic applies to Logger Appliances only.

Some models of the Logger Appliance include the ability to connect to a Storage Area Network (SAN). SANs contain Logical Units (LUNs), identified by their World Wide Name.

- [Managing a LUN](#) ..... 424
- [Restoring a SAN](#) ..... 426
- [Creating Multiple Paths to a LUN](#) ..... 427
- [Restoring Multipath on RMA or Factory Reset Loggers](#) ..... 429

## Managing a LUN

### This topic applies to Logger Appliances only.

A LUN can be in "available," "attached," or "detached" state, which determines what actions are available within Logger.



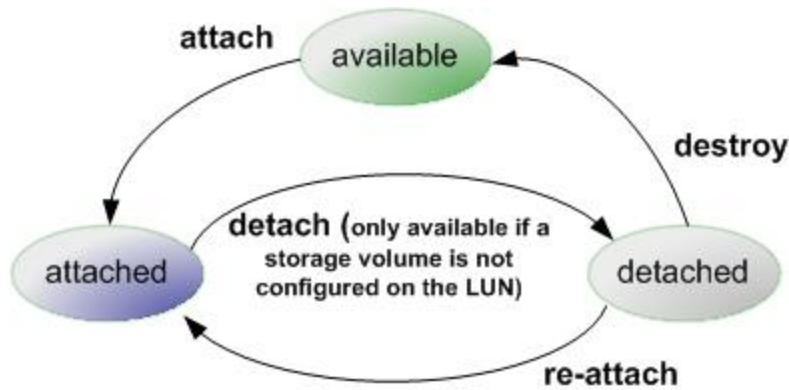

The following table summarizes the LUN states and possible actions.

Attachment Status	Actions	Description
available	attach	LUNs detected on a SAN are initially available for attachment.
attached	detach	Attached LUNs can be accessed by Logger.  The “ <b>detach</b> ” action is only available if a storage volume has not been configured on the LUN. Once a storage volume has been configured, you cannot “ <b>detach</b> ” the LUN unless you follow the factory reset instructions, described in <a href="#">"Restoring Factory Settings" on page 608</a> .
detached	re-attach destroy	When an attached LUN is detached, its data is preserved, but it cannot be accessed by Logger. To make it available again, use the “ <b>re-attach</b> ” action. The “ <b>destroy</b> ” action releases the LUN back to the “ <b>available</b> ” state.  When you detach, the only action available immediately is “ <b>re-attach</b> ”. The “ <b>destroy</b> ” state takes a few minutes to appear because it takes a few minutes for the LUN to detach on the system.  Destroying a LUN puts it into a state in which a subsequent attach will erase any data stored on the LUN. If a LUN is accidentally destroyed, customer support may be able to recover the data, provided there has been no subsequent attempt to attach the LUN.

Logger can attach to only one LUN at a time for primary storage. You can attach an additional LUN for event archiving, configuration backup, and export.

The L7500-SAN has two HBAs. This enables you to use one for multipathing and one for event archival, configuration backup, and export. For information about multipathing, see ["Creating Multiple Paths to a LUN" on page 427](#).

### To attach a LUN:

1. Click **System Admin** from the top-level menu bar.
2. Click **SAN** in the **Storage** section in the left panel.
3. Under **SAN Configuration**, locate and select the LUN in the LUN Name List.
4. Click **Attach** from the top left of the SAN Configuration page. If you do not see the **Attach** menu

option, no LUNs can be attached to the Logger at this time.

**Note:** You can attach a LUN only if the LUN is in the "Available" status.

The LUN's Attachment Status will change to "Attached" when the LUN is ready for use.

### To detach a LUN:

1. Click **System Admin** from the top-level menu bar.
2. Click **SAN** in the **Storage** section in the left panel.
3. In the LUN Name List, locate the LUN to be detached.
4. Click **Detach** from the top left of the SAN Configuration page. If you do not see the Detach menu option, no LUNs can be detached from the Logger at this time.

**Note:** You cannot detach a LUN if a storage volume is configured on it.

### To re-attach a LUN:

1. Click **System Admin** from the top-level menu bar.
2. Click **SAN** in the Storage section in the left panel.
3. In the LUN Name List, locate the LUN to be re-attached. The LUN must be in the **Detached** state.
4. Click **Re-attach** from the top left of the SAN Configuration page.  
If you do not see the Re-attach menu option, no LUNs can be re-attached from the Logger at this time.

### To destroy a LUN:

1. Click **System Admin** from the top-level menu bar.
2. Click **SAN** in the **Storage** section in the left panel.
3. In the LUN Name List, locate the LUN to be destroyed. The LUN must be in the 'detached' state.
4. Click **Destroy** in the top left corner of the SAN Configuration page.

**Caution:** Destroying a Logical Unit (LUN) that has been detached, puts that LUN into a state in which a subsequent attach will erase any data stored on the LUN. If a LUN is accidentally destroyed, customer support may be able to recover the data, provided there has been no subsequent attempt to attach the LUN.

## Restoring a SAN

### This topic applies to Logger Appliances only.

You can restore a SAN to either the Logger to which it was formerly attached, or to a new Logger (in the case of disaster recovery).

### To restore a SAN:

1. With Logger powered off, attach the SAN physically.
2. Turn on Logger.
3. Restore the configuration to Logger. HPE recommends backing up the configuration regularly so that a backup file will be available for this purpose. If no backup file is available, skip this step and manually add receivers, forwarders, users, and so on, after the SAN has been restored. For more information, see "[Configuration Backup and Restore](#)" on page 383.
4. Enable SSH access to your Logger (see "[SSH Access to the Appliance](#)" on page 419).
5. Contact customer support at <https://softwaresupport.hpe.com/>.
6. Customer support will log in remotely, stop all Logger processes, and migrate the internal database to the SAN.
7. When customer support has finished, reboot Logger.

## Creating Multiple Paths to a LUN

### This topic applies to Logger Appliances only.

The HBA card on your Logger has two ports. You can connect both of those ports to the same LUN. Using those ports to create two different paths between the Logger and the LUN (multipathing) reduces the possibility of a single point of failure causing the LUN to become unavailable.

**Note:** Although any SAN vendor that supports multipathing can work with Logger, ArcSight specifically tests with HPE 3PAR SANs.

Logger provides a default multipath configuration as a starting point. However, make sure that you consult your SAN documentation for information specific to your environment.

A multipath user interface (UI) is available by default on Logger models that support SAN. However, you must connect the LUN to both HBA ports and configure multipath configuration in the UI for it to function. Once enabled, **multipath cannot be disabled** on Logger.

You do not need to enable multipath in order to connect to two different LUNs on different SANs, since there are no duplicate paths. To connect to two different LUNs on the same SAN, or to have two connections to the same LUN, you must configure multipathing. Otherwise, the OS will see duplicate paths to the same LUN, and will be unable to resolve which path to use.

To enable multipath for a new Logger installation, configure multipathing before attaching the LUN.

## Enabling Multipath

### To enable multipath:

1. Ensure that a LUN is **not** attached to the Logger, as described in ["SAN" on page 424](#).
2. Click **System Admin** from the top-level menu bar.
3. Click **Multipath** in the **Storage** section in the left panel.
4. Select a SAN multipathing configuration from the pull-down menu.
5. If you chose **Custom**, or if the displayed configuration does not meet your needs, customize the parameters.
6. Click **Test** to ensure that the configuration you chose or the changes you made are valid.  
If the test fails, make additional changes, or click **Reset** to start over.
7. Click **Save**.

When you configure multipath SAN connectivity to the appliance, you must also make sure that the `multipathd` service is configured to start on boot.

### To verify that the `multipathd` service is configured to start on boot:

1. Run `chkconfig --list multipathd`  
Make sure `#:on` is shown for your run level. The current run level can be displayed with the `'runlevel'` command.
2. If the service is not enabled, do so with:  
`chkconfig multipathd on`
3. Reboot the appliance or start the multipath daemon with:  
`/sbin/service multipathd start`

**Note:** Be sure to also configure any vendor-specific multipath configuration accordingly in the `/etc/multipath.conf` file.

To convert a single path LUN to multipath:

### To convert a single path LUN to multipath:

1. Upgrade your Logger Appliance to version 5.1 or later.
2. After a successful upgrade, connect to your Logger using SSH, as described in the ArcSight Logger Administrator's Guide.
3. Run these commands:  
`cd /opt/arcsight/aps/mpath`

```
./mpath_prepare.sh
```

4. Connect the second fiber cable to the second port on the HBA card.
5. Create the `multipath.conf` file for your SAN.

The contents of this file will vary depending on your SAN vendor and configuration. The Logger user interface includes a default multipath configuration for EMC CLARiiON SANs that can be used as a starting point to populate the `multipath.conf` file. However, consult your SAN documentation for information specific to your setup and environment.

To view the default multipath configuration for EMC CLARiiON SAN, connect to the Logger UI, go to System Admin > Multipath, copy the configuration from the UI, and then paste the copied configuration in the `/opt/arcSight/aps/mpath/multipath.conf` file.

6. Run this test command:

```
./mpath_test.sh <path_to_your_multipath.conf >
```

Review the output of the test command to ensure that multipath devices that will be created are listed at the bottom of the output.

7. If test output is not correct, repeat the steps "[Create the multipath.conf file for your SAN.](#)" above and "[Run this test command:](#)" above until the multipath devices are correctly listed.
8. Run this command:

```
./mpath_enable.sh <path_to_your_multipath.conf >
```

9. Reboot your appliance.

## Restoring Multipath on RMA or Factory Reset Loggers

### **This topic applies to Logger Appliances only.**

If you need to restore Logger to its last working state—running version 5.1 or later, with multipath enabled—from 5.0 Patch 3 or earlier, be sure to upgrade your system to Logger 5.1 or later before attaching the LUN.

This could happen in either of the following situations:

- You received a new system that is running Logger 5.0 Patch 3 or earlier after you RMA'd the system to ArcSight.
- You restored the system to its factory default settings, and that reset the Logger version to 5.0 Patch 3 or earlier.

If you will be restoring the configuration of the Logger from a backup, ensure that the Logger is first running the version that matches the backup, perform the restoration, and then complete the upgrade to the desired version. See "[Restoring Factory Settings](#)" on page 608 for more information.

## RAID Controller/Hard Disk SMART Data

**This topic applies to Logger Appliances only.**

You can view information about the RAID controller or hard disk SMART data in the General Controller Information screen. This information is not needed during normal system operations, but it can be helpful for diagnosing specific hardware issues. Due to the redundant nature of RAID storage, a single drive failure will not disable your system. Instead, performance degrades. Use this report to determine whether a performance issue is caused by a disk failure. Customer support can also use this information to diagnose problems.

**To view the General Controller Information screen:**

1. Click **System Admin** from the top-level menu bar.
2. Click **RAID Controller** in the **Storage** section in the left panel.
3. The information displayed depends on the hardware model of your system. Click the arrows to toggle the information displays.

## Security

**This topic applies to both Software Logger and the Logger Appliance.**

Security settings enable you to configure SSL server certificates, enable and disable FIPS (Federal Information Processing Standards) mode on your system, and configure SSL client authentication for client certificate and Common Access Card (CAC) support.

**Tip:** For steps on how to create a user DN, see ["Creating and Activating Users" on page 455](#), and refer to the section "Use Client DN" in the parameters table.

- [SSL Server Certificate](#) ..... 430
- [SSL Client Authentication](#) ..... 435
- [FIPS 140-2](#) ..... 438

## SSL Server Certificate

**This topic applies to both Software Logger and the Logger Appliance.**

Your system uses Secure Sockets Layer (SSL) technology to communicate securely over an encrypted channel with its clients, such as SmartConnectors, when using the SmartMessaging technology and other ArcSight systems. Your system ships with a self-signed certificate so that an SSL session can be

established the first time you use the appliance. For more information on this option, see ["Generating a Self-Signed Certificate" below](#).

Although a self-signed certificate is provided for your use, HPE strongly recommends using a certificate authority (CA) signed certificate. Additionally, ensure that the root certificate of the CA that signed your system's certificate is trusted on the SmartConnector. If the CA's root certificate is not trusted on the SmartConnector, follow instructions in ["Installing or Updating a SmartConnector to be FIPS-Compliant" on page 440](#).

To facilitate obtaining a CA-signed certificate, your system can generate a Certificate Signing Request. Once a signed certificate file is available from the CA, it can be uploaded to your system for use in a subsequent authentication. For detailed instructions, see ["Generating a Certificate Signing Request \(CSR\)" on the next page](#).

Your system generates an audit event when the installed SSL certificate is going to expire in less than 30 days or has already expired. The event with Device Event Class ID "platform:407" is generated periodically until you replace the certificate with one that is not due to expire within 30 days.

- [Generating a Self-Signed Certificate](#) ..... 431
- [Generating a Certificate Signing Request \(CSR\)](#) ..... 432
- [Importing a Certificate](#) ..... 434
- [Enabling HTTP Strict Transport Security](#) ..... 434

## Generating a Self-Signed Certificate

**This topic applies to both Software Logger and the Logger Appliance.**

Your appliance ships with a self-signed certificate so that an SSL session can be established the first time you connect. This type of certificate does not require signing from another entity and can be used immediately.

### To generate a self-signed certificate:

1. Click **System Admin** from the top-level menu bar.
2. Click **SSL Server Certificate** from the **Security** section in the left panel to display the **Generate Certificate/Certificate Signing Request** page.
3. Click the **Generate Certificate** tab.
4. From the **Enter Certificate Settings** field, enter new values for the following fields:

Parameter	Description
Country	A two-letter country code, such as 'US' for the United States.
State/Province	State or province name, such as 'California.'
City/Locality	City name, such as 'Sunnyvale'.

Parameter	Description
Organization Name	Company name, governmental entity, or similar overall organization.
Organizational Unit	Division or department within the organization.
Hostname	<p>The host name or IP address of this system.</p> <p>When specifying the host name, make sure that this name matches the name registered in the Domain Name Service (DNS) server for the system. On the Logger Appliance, this name must be identical to the host name specified in "NICs" on <a href="#">page 407</a>.</p> <p><b>Note:</b> If the host name or IP address of this system changes in the future, you must generate a new self-signed certificate or CSR. Once a new certificate is obtained, you must upload it to ensure that the connectors (in FIPS mode) which communicate with the system are able to validate the host name.</p>
Email Address	The email address of the administrator or contact person for this CSR.
Private Key Length	Select the length (in bits) of the private key: <b>1024</b> , <b>2048</b> , <b>4096</b> , or <b>8192</b> .

Use the first two buttons to generate a CSR or a self-signed certificate. The **View Certificate** button is only used to view the resulting certificate.

Button	Description
Generate CSR	Click to generate a Certificate Signing Request (CSR).
Generate Certificate	Click to generate a self-signed certificate.
View Certificate	Click to view the generated certificate.

- Click the **Generate Certificate** button to generate the self-signed certificate.

**Note:** The Apache server restarts while generating the certificate. You may get an error communicating to the web server while this is happening. This is expected behavior, and communication is automatically restored once Apache is back up.

- Click **Ok** to confirm generation.
- Click the **View Certificate** button to view the PEM-encoded self-signed certificate.

## Generating a Certificate Signing Request (CSR)

**This topic applies to both Software Logger and the Logger Appliance.**

Generating a Certificate Signing Request (CSR) is the first step to obtain a certificate signed by a 3rd party Certificate Authority (CA), for example, VeriSign. The resulting CSR must be sent to a CA, such as VeriSign, which responds with a signed certificate file. The CSR must be generated on the system for which you are requesting a certificate. That is, you cannot generate a CSR for System A on System B or use a third-party utility for generation.



### To generate a certificate signing request:

1. Click **System Admin** from the top-level menu bar.
2. Click **SSL Server Certificate** from the **Security** section in the left panel to display the **Generate Certificate/Certificate Signing Request** page.
3. Click the **Generate Certificate** tab.
4. From the **Enter Certificate Settings** field, enter new values for the following fields:

Parameter	Description
Country	A two-letter country code, such as 'US' for the United States.
State / Province	State or province name, such as 'California.'
City / Locality	City name, such as 'Sunnyvale'.
Organization Name	Company name, governmental entity, or similar overall organization.
Organizational Unit	Division or department within the organization.
Hostname	The host name or IP address of this system.  When specifying the host name, make sure that this name matches the name registered in the Domain Name Service (DNS) server for the system. For Logger Appliances, this name must be identical to the host name specified in "NICs" on page 407.  <b>Note:</b> If the host name or IP address of this system changes in the future, you must generate a new self-signed certificate or CSR. Once a new certificate is obtained, you must upload it to ensure that the connectors (in FIPS mode) which communicate with the system are able to validate the host name.
Email Address	The email address of the administrator or contact person for this CSR.
Private Key Length	Select the length (in bits) of the private key: <b>1024</b> , <b>2048</b> , <b>4096</b> , or <b>8192</b> .

5. Use the first two buttons to generate a CSR or a self-signed certificate. The **View Certificate** button is only used to view the resulting certificate.

Button	Description
Generate CSR	Click to generate a Certificate Signing Request (CSR).
Generate Certificate	Click to generate a self-signed certificate.
View Certificate	Click to view the generated certificate.

6. Choose **Generate CSR** to generate a certificate signing request.
7. If the CSR was successfully generated, a pop-up window is shown, enabling you to either download the CSR file or to copy/paste its content.

To copy/paste, copy all the lines (inclusive) from -----BEGIN CERTIFICATE REQUEST-----  
to -----END CERTIFICATE REQUEST-----.

8. Send the CSR file to your certificate authority to obtain the CA-signed certificate.
9. Once the CA-signed certificate file is obtained, continue on to ["Importing a Certificate" below](#) below.

## Importing a Certificate

**This topic applies to both Software Logger and the Logger Appliance.**

After you have obtained a certificate from your certificate authority (CA), you can follow the steps below to import it onto your system.

### To import a certificate:

1. Click **System Admin** from the top-level menu bar.
2. Click **SSL Server Certificate** under the **Security** section in the left panel.
3. Click the **Import Certificate** tab.
4. Click the **Browse** button to locate the signed certificate file on your local file system.

**Note:** The imported certificate must be in Privacy Enhanced Mail (PEM) format.

5. Click **Import and Install** to import the specified certificate.
6. If using **HTTPS** and depending on your browser, you may need to close and restart the browser for the new certificate to take effect. If you are unsure of your browser's requirements, close and restart it.

## Enabling HTTP Strict Transport Security

HTTP Strict Transport Security (HSTS) is a simple and widely supported standard to ensure that browsers always connect to a website over HTTPS. Using it, you can remove the need for the insecure practice of redirecting users from `http://` to `https://` URLs.

Connecting to the Logger Web UI requires an HTTPS URL:

- `https://<hostname or IP address>` for Logger Appliances.
- `https://<hostname or IP address>:<configured_port>` for Software Loggers.

However, you may accidentally try to connect to Logger over HTTP instead of HTTPS, leaving you vulnerable to a man-in-the-middle attack. You can leverage Logger's support for HSTS to ensure that your browser always connects to Logger over HTTPS.

## To enable HSTS:

1. On Logger, generate a Certificate Signing Request (CSR). See ["Generating a Certificate Signing Request \(CSR\)" on page 432](#) for the steps to generate the CSR.
  - Do not use a self-signed certificate.
  - Do use the fully-qualified domain name (FQDN) when creating the certificate, for example, `n192-0-2-h24.server.yourco.com`.
2. Have the CSR signed by a Certificate Authority(CA), such as Verisign, who will return the CA-signed certificate back to you.
3. Import the CA-signed certificate into Logger. See ["Importing a Certificate" on the previous page](#) for the steps to import the certificate.
4. In the browser, import the CA-signed certificate in your browser's trust store. Refer to your browser's help for instructions on importing a trusted certificate.

For example, in Firefox 47.x, you would select **Options** from the  menu, click **Advanced**, click the **Certificates** tab, click **View Certificate**, click the **Authorities** tab, and click the **Import** button.

5. Close and restart the browser. You should now be able to connect to Logger using the following HTTP addresses:
  - `http://<Logger FQDN>` for Logger Appliances.
  - `http://<Logger FQDN>:<configured_port>` for Software Loggers.

**Note:** Be sure to use the Logger FQDN and not an IP address or hostname in the URL.

## SSL Client Authentication

### This topic applies to both Software Logger and the Logger Appliance.

Your system supports client authentication using SSL certificates. SSL client authentication is a form of two-factor authentication that can be used *as an alternate* or *in addition to* local password authentication. As a result, your system can be configured for SmartCards, such as Common Access Card (CAC) based authentication. CAC is a standard identification card for active duty members of the Uniformed Services, Selected Reserve, DOD civilian employees, and eligible contractor personnel.

**Note:** CAC is a form of client certificate authentication. Information on client certificate authentication applies to CAC.

Your system also supports LDAPS authentication. The SSL certificate for the LDAPS server must be uploaded into the trusted store. After uploading the SSL certificate, the `aps` process must be restarted (**System Admin > Process Status > aps > Restart**).

- [Configuring Logger to Support SSL Client Authentication](#) ..... 436

- [Uploading Trusted Certificates](#) ..... 437
- [Uploading a Certificate Revocation List](#) ..... 437

## Configuring Logger to Support SSL Client Authentication

**This topic applies to both Software Logger and the Logger Appliance.**

Perform the following steps to configure Logger to support SSL client authentication.

### To configure Logger to support SSL client:

On the Logger:

1. If the Logger uses the default signed certificate it shipped with from ArcSight, replace it with a *FIPS-compliant*, signed SSL server certificate. Follow instructions at "[Uploading Trusted Certificates](#)" on the next page to load the certificate.

**Caution:** All SSL client certificates used for authentication must be FIPS-compliant (that is, hashed with FIPS-compliant algorithms) even if FIPS is not enabled on your Logger.

2. Enable client certificate authentication, as described in "[Client Certificate Authentication](#)" on page 448.
3. Choose one of the following:
  - If the client certificates are **CA-signed**, upload the root certificate of the authority who signed the certificates that will be used for authenticating clients, as described in "[Uploading Trusted Certificates](#)" on the next page.
  - If the client certificates used to authenticate with Logger are signed by different CAs, make sure you upload root certificates of **all** CAs.
  - If the client certificates are **self-signed**, upload the public portion of the client certificate.
4. Configure a user name for each user who will be connecting to the Logger using a client certificate, as described in "[User Management](#)" on page 454.
5. (Optional) Upload a certificate revocation list (CRL), as described in "[Uploading a Certificate Revocation List](#)" on the next page.
6. (Optional) If this Logger is configured to use **only** SSL Client Authentication, make sure this Logger's Authorization ID and Code are appropriately configured on other Loggers that with it. For more information, see "[Peer Nodes](#)" on page 397.

On the Client (Web browser):

Configure your browser to provide the SSL client certificate when accessing Logger. (Upload the private key in PKCS 12 format in your browser.)

## Uploading Trusted Certificates

**This topic applies to both Software Logger and the Logger Appliance.**

A trusted certificate is used to authenticate users that log in to your system. Uploading a trusted certificate is required if you are using LDAPS authentication. The trusted certificate is used to authenticate the remote LDAPS server. The certificate needs to be in Privacy Enhanced Mail (PEM) format.

### To upload a trusted certificate:

1. Click **System Admin** from the top-level menu bar.
2. Click **SSL Client Authentication** in the **Security** section in the left panel.
3. On the **Trusted Certificates** tab, click **Browse** to find the trusted certificate on your local file system.
4. Click **Upload**. The trusted certificate is uploaded and listed in the **Certificates in Repository** list. To view details about a trusted certificate, click the link displayed in the Certificate Name column. To delete a trusted certificate, select the certificate and click **Delete**.

## Uploading a Certificate Revocation List

**This topic applies to both Software Logger and the Logger Appliance.**

A certificate revocation list (CRL) is a computer-generated record that identifies certificates that have been revoked or suspended before their expiration dates. To support CAC, you need to upload a CRL file to your ArcSight system. The CRL file needs to be in PEM format.

### To upload a CRL file:

1. Click **System Admin** from the top-level menu bar.
2. Click **SSL Client Authentication** in the **Security** section in the left panel.
3. In the **Certificate Revocation List** tab, click **Browse** to find the CRL file on your local file system.
4. Click **Upload**. The CRL is uploaded and listed in the **Certificate Revocation** list.

To view details about a CRL, click the link displayed in the **Issuer Name** column.

To delete a CRL file, select it and click the **Delete** button.

**Note:** To enable client certificate authentication, see ["Client Certificate Authentication" on page 448](#).

## FIPS 140-2

**This topic applies to both Software Logger and the Logger Appliance.**

Your system supports the Federal Information Processing Standard 140-2 (FIPS 140-2). FIPS 140-2 is a standard published by the National Institute of Standards and Technology (NIST) and is used to accredit cryptographic modules in software components. The US Federal government requires that all IT products dealing with Sensitive, but Unclassified (SBU) information meet these standards.

- [FIPS Compliance](#) ..... 438
- [Enabling and Disabling FIPS Mode on Logger](#) ..... 439
- [Installing or Updating a SmartConnector to be FIPS-Compliant](#) ..... 440

## FIPS Compliance

If your system needs to be FIPS 140-2 compliant, you can enable FIPS. Once you do so, the system uses the cryptographic algorithms defined by the NIST for FIPS 140-2 for all encrypted communication between its internal and external components.

**Note:** To be fully FIPS 140-2 compliant, all components of your Logger deployment need to be in FIPS 140-2 mode. For example, if you enable FIPS 140-2 on your Logger but the SmartConnectors that send events to it are not running in FIPS 140-2 mode, your deployment is not fully FIPS 140-2 compliant.

In a typical deployment, your Logger will communicate with the following components. To be fully FIPS-compliant, all of these components should be FIPS-enabled:

- SmartConnectors that send events to the Logger: FIPS mode is supported on SmartConnectors running version 4.7.5.5372 and later. Follow instructions in ["Installing or Updating a SmartConnector to be FIPS-Compliant" on page 440](#) to ensure that your connector is FIPS-compliant.
- Logger forwarders, such as ArcSight Managers to which Logger forwards events and alerts: The system to which your FIPS-compliant Logger forwards events should be FIPS-compliant as well. Additionally, you need to import that system's SSL server certificate on the Logger so that Logger can communicate with it.

If you forward events and alerts to an ArcSight Manager, it needs to run ESM 4.0 SP2 or later to enable FIPS 140-2 on it. For more information, see the ArcSight ESM Installation and Configuration Guide for the ESM version you are running. Additionally, follow instructions in ["ESM Destinations" on page 339](#) to complete configuration of this setup.

- Loggers: Logger automatically uses FIPS 140-2 compliant algorithms. Therefore, no action is required on Logger, except enabling FIPS as described in this section. When enabling FIPS on a Software Logger, make sure that the machine on which Logger is installed is used exclusively for Logger.

**Note:** Enabling FIPS 140-2 on Software Logger does not make the system on which it is installed FIPS 140-2 compliant. Consult your system's documentation to determine the requirements for making the entire system FIPS 140-2 compliant.

- A Logger must use a CA-signed certificate if it is a destination of a software-based SmartConnector. Additionally, ensure that the root certificate of the CA that signed Logger's certificate is trusted on the SmartConnector. If the CA's root certificate is not trusted on the SmartConnector, follow instructions in "[Installing or Updating a SmartConnector to be FIPS-Compliant](#)" on the next page.

## Enabling and Disabling FIPS Mode on Logger

**This topic applies to both Software Logger and the Logger Appliance.**

You can enable or disable FIPS mode on Logger to suit your needs; however, you will need to reboot (Logger Appliance) or restart (Software Logger) before the new mode will be effective.

Things to be Aware of When Enabling FIPS Mode on Logger:

- Your Logger must be set up with a CA-signed SSL certificate. For more information, see "[SSL Server Certificate](#)" on page 430.
- A Logger, even when in non-FIPS mode, must use a CA-signed certificate if it is software-based SmartConnector. Additionally, ensure that the root certificate of the CA that signed Logger's certificate is trusted on the SmartConnector. If the CA's root certificate is not trusted on the SmartConnector, follow instructions in "[Installing or Updating a SmartConnector to be FIPS-Compliant](#)" on the next page.
- Once FIPS is enabled on your Logger, the SmartMessage receiver (if configured) stops receiving events from non-FIPS connectors if those connectors are not running version 4.7.5.5372 or later. Make sure you have the correct connectors.

### To enable or disable FIPS mode:

**Note:** Make sure you are familiar with the configuration requirements on your Logger as described in "[Things to be Aware of When Enabling FIPS Mode on Logger](#):" above.

1. Click **System Admin** from the top-level menu bar.
2. Click **FIPS 140-2** in the Security section in the left panel.
3. Click **Enable** or **Disable** for the Select FIPS Mode option.
4. Click **Save**.
5. Do one of the following:
  - Use the following command to restart Software Logger:  
`<install_dir>/current/arcsight/logger/bin/loggerd restart`
  - Reboot your Logger Appliance.

The FIPS Status Table shows which processes and components of the Logger are FIPS-enabled.

## Installing or Updating a SmartConnector to be FIPS-Compliant

**This topic applies to both Software Logger and the Logger Appliance.**

The information in this section is same as that in the ArcSight Installing FIPS-Compliant SmartConnectors document except that the information in that document is generally applicable, while information in this section is in the context of Logger.

FIPS mode is supported on SmartConnectors running version 4.7.5.5372 or later.

If you are...	Then...
Installing a new SmartConnector to send events to a Logger in FIPS-compliant mode	Follow the installation prompts. No additional steps are necessary.
Updating a SmartConnector to be FIPS-compliant and the SmartConnector is <b>not</b> running version 4.7.5.5372 or later.	<ol style="list-style-type: none"><li>1. Upgrade the SmartConnector to a FIPS-supported version. Follow instructions in the SmartConnector User's Guide to upgrade the SmartConnector.</li><li>2. Create an <code>agent.properties</code> file (see <a href="#">Step 2a</a>, below). No additional steps are necessary.</li></ol>
Updating a SmartConnector to be FIPS-compliant and the SmartConnector is running version 4.7.5.5372 or later.	Create an <code>agent.properties</code> file (see <a href="#">Step 2a</a> , below). No additional steps are necessary.

### To make a SmartConnector FIPS-compliant:

1. Follow device configuration steps provided in the SmartConnector's configuration guide (available from the HPE Customer Support site (SSO) at <https://softwaresupport.hp.com>), then follow the installation procedure through installation of the core Connector software (SmartConnector Installation Step 2).

At Step 3 of the Connector setup, click **Cancel** to exit the setup. You must then configure the NSS DB, which is necessary for installing the connector in FIPS-compliant mode.

Once the NSS DB is configured, continue to the next step.

2. To enable FIPS Mode on the SmartConnector:
  - a. Create an `agent.properties` file at the following location if it does not exist already:

`$ARCSIGHT_HOME/current/user/agent`

- b. Enter the following property, then save and close the file.

```
fips.enabled=true
```

3. Import Logger's certificate on the SmartConnector:
  - a. In a command window on your SmartConnector machine, from `$ARCSIGHT_HOME/current/bin`, enter the following command to turn off FIPS mode:



```
./arcsight runmodutil -fips false -dbdir $ARCSIGHT_
HOME/current/user/agent/nssdb.client
```

- b. Export the Logger certificate file and import it to the SmartConnector's NSS DB as follows:

- Export Logger's certificate file from the browser you use to connect to it. Refer to your browser's Help for instructions. For example, to export a Logger's certificate file on Firefox v.44, click  to open the **Options** menu, then select **Advanced > Certificates > View Certificates > Servers > your Logger Appliance** and click **Export...** Save the certificate file with a .crt or .cer extension.
- Copy the certificate file you exported in the previous step (in this example, **loggercert.crt**) to the \$ARCSIGHT\_HOME/current/bin directory on the SmartConnector. From \$ARCSIGHT\_HOME/current/bin, enter the following:

```
./arcsight runcertutil -A -n mykey -t "CT,C,C" -d $ARCSIGHT_
HOME/current/user/agent/nssdb.client -i bin/loggercert.crt
```

- c. Enter the following command to re-enable FIPS mode that you turned off in Step 1:

```
./arcsight runmodutil -fips true -dbdir $ARCSIGHT_
HOME/current/user/agent/nssdb.client
```

- d. Ensure that the SmartConnector can resolve the name specified in the CN value of the Logger certificate's *Subject*: field. If the name is not resolvable, add it to the SmartConnector system's **Hosts** file.
- e. If you are installing a new SmartConnector, continue to the next step.

If you are updating your SmartConnector to be FIPS-compliant, ensure that the Connector's Logger destination host name is same as the CN value in the certificate's *Subject* field, and **exit this procedure**.

4. To return to the SmartConnector configuration wizard, enter the following from \$ARCSIGHT\_HOME/current/bin:

```
./arcsight connectorsetup
```

5. When prompted whether you want to start in Wizard Mode, click **Yes**.

The **Destination** selection window is again displayed. Return to **Installation Step 4** of your **SmartConnector Configuration Guide** to continue the Connector configuration.

**Note:** When configuring the connector, ensure that the connector's Logger destination host name is same as the CN value in the certificate's **Subject**: field.

For the remainder of the configuration process, see the Configuration Guide for the SmartConnector you are installing. The specific configuration guide provides information about how to configure the device for event collection, specific installation parameters required during the configuration process, and a table of vendor-specific field mappings to ArcSight events.

# Users/Groups

**This topic applies to both Software Logger and the Logger Appliance.**

Use the **Users/Groups** sub-menu to configure users and user groups, and to set authentication options.

- [Authentication](#) ..... 442
- [Login Banner](#) ..... 454
- [User Management](#) ..... 454

## Authentication

**This topic applies to both Software Logger and the Logger Appliance.**

**Authentication Settings** enable you to specify the settings and policies for user log in sessions, password rules and lockouts, and external authentication options.

- [Sessions](#) ..... 442
- [Local Password](#) ..... 443
- [Users Exempted From Password Expiration](#) ..... 445
- [Forgot Password](#) ..... 446
- [External Authentication](#) ..... 447

## Sessions

**This topic applies to both Software Logger and the Logger Appliance.**

The **Session** tab lets you specify the maximum number of simultaneous sessions for a single user account, and the length of time after which a user session is automatically logged out or a user account disabled. By default, a single user account can have up to 15 simultaneous active sessions, and a user account is logged out after 15 minutes of inactivity.

### To change session settings:

1. Click **System Admin** from the top-level menu bar.
2. Click **Authentication** in the **Users/Groups** section.

3. On the **Sessions** tab, update the parameters described in the following table.

Parameters	Description
Max Simultaneous Logins/User	The maximum number of simultaneous sessions allowed for a single user account. The default is <b>15 sessions</b> .
Logout Inactive Session After	The length of time, in minutes, after which an inactive session is automatically ended. The default is <b>15 minutes</b> .
Disable Inactive Account After	The number of days after which an inactive user account is disabled. The default is <b>0</b> , meaning the account is never disabled.

4. Click **Save** to make the changes, or click another tab to cancel.

## Local Password

**This topic applies to both Software Logger and the Logger Appliance.**

The **Local Password** tab enables you to set password policies, such as the minimum and maximum number of characters and other password requirements.

**Tip:** For better security, if the configured authentication method is "Local Password", ensure that the Account Lockout policy is enabled.

### To change the password settings:

1. Click **System Admin** from the top-level menu bar.
2. Click **Authentication** in the **Users/Groups** section.
3. Choose the **Local Password** tab.

Use the parameters described in the following table to customize your password settings.

Parameter	Description
<b>Lockout Account</b>	
Enable Account Lockout	Select the checkbox to enable user accounts to be locked out as defined by the following settings. By default, the policy is <b>disabled</b> .  <b>Note:</b> You should enable this if you will be using the "Local Password" authentication method.
Lockout Account After	Number of failed login attempts after which a user account is locked out. The default is <b>3</b> .
Remember Failed Attempts For	The length of time, in minutes, for which a failed login attempt is remembered. The default is <b>1</b> .

Parameter	Description
Lockout Account For	The length of time, in minutes, for which a locked out account cannot be unlocked. The default is <b>15</b> .
<b>Password Expiration</b>	
Enable Password Expiration	Select the checkbox to enable user passwords to expire as defined by the following settings. By default, the policy is <b>disabled</b> .
Password Expires in	Number of days after which the password expires. The default is <b>90</b> .
Notify User	Number of days before expiration to notify the user. Select this option to allow users to update their password before expiration. The default is <b>5</b> .
Users Exempted From Password Expiration Policy	Click the link to set the users whose password should never expire. For information on how to use this feature, see " <a href="#">Users Exempted From Password Expiration</a> " on the next page.
<b>Password Strength Rules</b>	
Enforce Password Strength	Select the checkbox to enforce password policy as defined by the following settings. By default, the policy is <b>disabled</b> .
Minimum Length	Minimum number of characters that a password must contain. The default is <b>10</b> .
Maximum Length	Maximum number of characters that a password can contain. The default is <b>20</b> .
<b>Password Character Rules</b>	
Password character rules define additional character requirements to ensure password strength.	
Numeric	Minimum number of numeric characters (0-9) in a password. The default is <b>2</b> .
Uppercase	Minimum number of uppercase characters (A-Z) in a password. The default is <b>0</b> .
Special	Minimum number of non-digit and non-letter characters that are required in a password. The default is <b>2</b> .

Parameter	Description
Lowercase	Minimum number of lowercase characters (a-z) in a password. The default is <b>0</b> .
Password Must be At Least N Characters Different From Old Password	Minimum number of characters by which the new password must differ by from the previous one. The default is <b>2</b> .
Include "Forgot Password" link on Login Screen	<ul style="list-style-type: none"><li>• Select the checkbox to enable users to reset their local password using a "Forgot Password" link on the login page. By default, the option is <b>disabled</b>.</li><li>• An SMTP server must be configured on the system, and the username must have a correct email address for this feature to work successfully.</li><li>• If an SMTP server is not set, you will not be able to reset the password because the email containing the temporary password cannot be sent.</li><li>• An email address must be specified in the user settings for the user name. The temporary password is sent to that email address. If no email address is specified or if the email address is incorrect, the user will not receive the email.</li></ul> <p>For information on how to use this feature, see <a href="#">"Forgot Password" on the next page</a>.</p>

4. Click **Save** to save the changes, or click another tab to cancel.

## Users Exempted From Password Expiration

**This topic applies to both Software Logger and the Logger Appliance.**

Even though you have set a password expiration policy for most users, you may want to have a user whose password does not expire automatically.

### To exempt a user from the password expiration policy:

1. Click **System Admin** from the top-level menu bar.
2. Click **Authentication** in the **Users/Groups** section.
3. Choose the **Local Password** tab, and then click **Users Exempted From Password Expiration Policy**.
4. The **Exempt Users From Password Expiration** page is displayed.
5. Select users from the **Non-exempted Users** list and click the right arrow icon  to move the selected users to the **Exempted Users** list. Do the reverse to remove users from the list of exempted users.

You can select multiple users at the same time and move them over. Or you can move all users by clicking the  icon.

6. Click **Save** to save the policy or **Cancel** to exit.

## Forgot Password

**This topic applies to both Software Logger and the Logger Appliance.**

This feature enables users to reset their own password from a **Forgot Password?** link accessible from the login screen. Logger sends the user a temporary password to the email address on file.

This feature is disabled by default. To enable it, go to **System Admin > Authentication > Local Password** tab, scroll down to the bottom of the page, and check **Include "Forgot Password" link on Login Screen** and click **Save**.

The next time a user logs in, the link is enabled.

An SMTP server must be configured in order to use this feature. For more details on how to enable it, see "[Local Password](#)" on page 443.

**Tip:** The temporary password is valid until the time specified in the email. The default is five hours. If you do not log in within the specified time, only an administrator can reset the password to generate another temporary password.

### To reset your password:

1. On the Login dialog box, click the **Forgot Password** link.

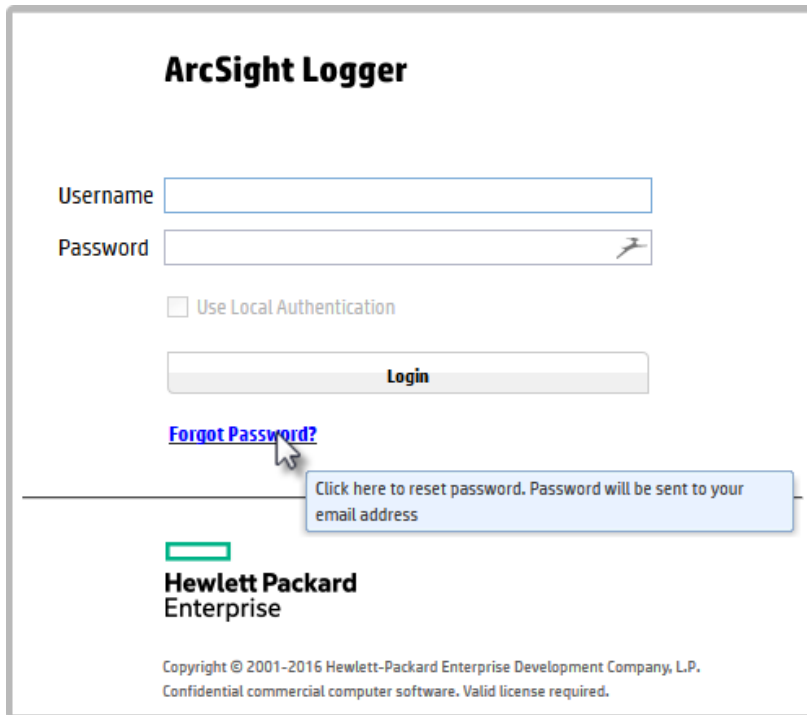

2. The Reset Password screen displays.

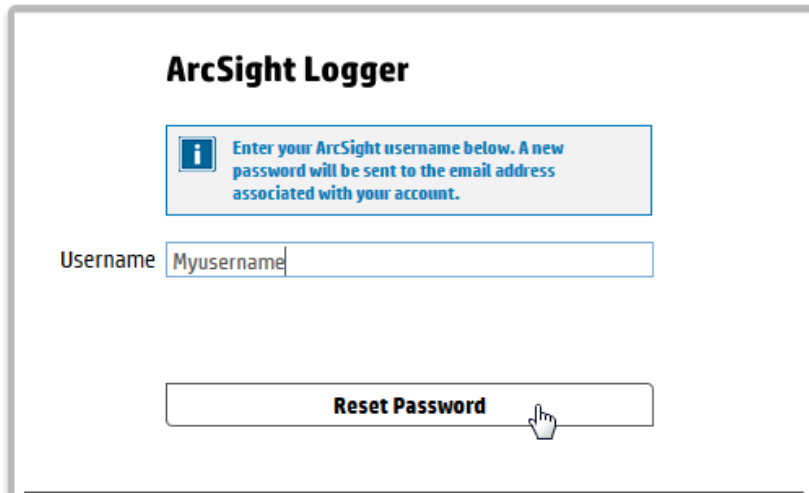

3. Enter a user name on the Reset Password screen.
4. Click **Reset Password**.  
An automated email with a temporary password is sent to the email address specified for that user. After logging in with the temporary password, Logger redirects you to the Change Password page, where you can reset your password.

## External Authentication

**This topic applies to both Software Logger and the Logger Appliance.**

Besides providing a local password authentication method, your system supports Client Certificate/CAC, LDAP, and RADIUS authentication. It is not possible to enable all authentication methods simultaneously.

### To enable external authentication:

1. Click **System Admin** from the top-level menu bar.
2. Click **Authentication** in the Users/Groups section.
3. Click the **External Authentication** tab.
4. Select an authentication method from the menu.
5. Click **Save**.

**Note:** CAC is a form of client certificate authentication. Information on client certificate authentication applies to CAC.

## Local Password Authentication

**This topic applies to both Software Logger and the Logger Appliance.**

Local Password Authentication is the default authentication method. It implements the local password policies set in the **Local Password** tab. For more information, see ["Local Password" on page 443](#).

### To configure local password authentication:

1. Click **System Admin** from the top-level menu bar.
2. Click **Authentication** in the **Users/Groups** section.
3. Choose the **ExternalAuthentication** tab.
4. From the pull-down menu, choose **Local Password Authentication**
5. Click **Save**.

## Client Certificate Authentication

**This topic applies to both Software Logger and the Logger Appliance.**

This authentication method requires that users authenticate using a client certificate. For each client certificate, a user account with a Distinguished Name (DN) matching the one in the client certificate must exist on your system.

**Caution:** All SSL client certificates used for authentication must be FIPS-compliant (hashed with FIPS-compliant algorithms) even if FIPS is not enabled on your system.

### To configure client certificate authentication:

1. Click **System Admin** from the top-level menu bar.
2. Click **Authentication** in the **Users/Groups** section.
3. Choose the **External Authentication** tab.
4. From the pull-down menu, choose **Client Certificate**.
5. **Allow Local Password Fallback** provides two options:
  - **Allow Local Password Fallback for Default Admin Only**  
Select this option to allow the default admin user to log in using only a username and password if the client certificate is not available or invalid. This privilege is restricted to the default admin user only—other users must have a valid client certificate to gain access to the system. This option is enabled by default.
  - **Allow Local Password Fallback for All Users**



Select this option to allow all users to log in using their local user name and password if their client certificate is invalid or unavailable.

For more information, see "[Local Password Fallback](#)" on page 453.

6. Click **Save**.

## Client Certificate and Local Password Authentication

### **This topic applies to both Software Logger and the Logger Appliance.**

This authentication method requires that users authenticate using an SSL client certificate and a valid local password. *Local Password* refers to the password associated with the user credentials created in **User Management** in the **Users/Groups** section. See "[Creating and Activating Users](#)" on page 455 for details.

A user account on your system must be defined with a Distinguished Name (DN) that matches the one in the client certificate.

For instructions on how to create a user DN, see "[Creating and Activating Users](#)" on page 455 and refer to the section called "Use Client DN" in the parameters table.

**Caution:** All SSL client certificates used for authentication must be FIPS-compliant (hashed with FIPS-compliant algorithms) even if FIPS is not enabled on your system.

### **To configure client certificate and password authentication:**

1. Click **System Admin** from the top-level menu bar.
2. Click **Authentication** in the **Users/Groups** section.
3. Choose the **External Authentication** tab.
4. From the pull-down menu, choose **Client Certificate AND Local Password**.
5. **Allow Local Password Fallback** provides two options:
  - **Allow Local Password Fallback for Default Admin Only**  
This option, always enabled, enables the default admin user to log in using only a username and password.
  - **Allow Local Password Fallback for All Users**  
This option is always disabled. You cannot enable it when using the **Client Certificate AND Local Password** authentication method.  
For more information, see "[Local Password Fallback](#)" on page 453.
6. Click **Save**.

## LDAP/AD and LDAPS Authentication

### **This topic applies to both Software Logger and the Logger Appliance.**

This authentication method authenticates users against an LDAP server. Even when LDAP is enabled, each user account must exist locally on your system. Although the user name specified locally can be different from the one specified on the LDAP server, the Distinguished Name (DN) specified for each user account must match the one in the LDAP server.

**Tip:** For steps on how to create a user DN, see ["Creating and Activating Users" on page 455](#), and the parameter ["Use Client DN" on page 456](#)."

## LDAP Authentication

### **To set up LDAP authentication:**

1. Click **System Admin** from the top-level menu bar.
2. Click **Authentication** in the **Users/Groups** section.
3. Choose the **ExternalAuthentication** tab.
4. From the pull-down menu, choose **LDAP**.
5. **Allow Local Password Fallback** provides two options:
  - **Allow Local Password Fallback for Default Admin Only**  
Select this option to allow the default admin user to log in using only a username and password if LDAP authentication fails. This privilege is restricted to the default admin user only—all others must be authenticated by LDAP. This option is enabled by default.
  - **Allow Local Password Fallback for All Users**  
Select this option to allow all users to log in using their local user name and password if LDAP authentication fails.

For more information, see ["Local Password Fallback" on page 453](#).

**LDAP Server** has the following parameters:

Parameter	Description
Server Hostname[:port] (optional)	(Optional) Enter the host name or IP address and port of the LDAP server in the following format:  ldap://<hostname or IP address>:<port> ldaps://<hostname or IP address>:<port> Additional steps are required for the use of LDAPS. See .
Backup Server Hostname[:Port] (optional)	(Optional) Enter the backup LDAP server to use if the primary server does not respond. If the server returns an authentication failure (bad password, unknown username, etc), then the backup server is not tried. The backup server is tried only when the primary server has a communication failure.  Use the same format as the primary server to specify the host name and port.
Request Timeout	The length of time, in seconds, to wait for a response from the LDAP server. The default is <b>10</b> .

6. When finished, click **Save**.

## LDAPS Authentication

### To set up LDAP Over SSL authentication:

1. Verify that an SSL certificate for the LDAPS server has been uploaded into the trusted store.
2. Follow the steps for "[To set up LDAP authentication:](#)" on the previous page.
3. Enter the URL for the LDAPS server(s), starting with ldaps : //.
4. From the System Admin **System** menu, click **Process Status**.
5. From the Processes table, select **aps**.
6. Click **Restart**.

**Caution:** You must restart the aps process, or attempts to authenticate through LDAPS will fail.

## RADIUS Authentication

**This topic applies to both Software Logger and the Logger Appliance.**

This authentication method enables users to authenticate against a RADIUS server. Even when RADIUS authentication is enabled, each user account must exist locally on your system. The username must match the one in the RADIUS server, although the password can be different. A user must present a valid username and (RADIUS) password to be successfully authenticated.

### To configure RADIUS authentication settings:

1. Click **System Admin** from the top-level menu bar.
2. Click **Authentication** in the **Users/Groups** section.
3. Choose the **External Authentication** tab.
4. From the pull-down menu, choose **RADIUS**.
5. **Allow Local Password Fallback** provides two options:
  - **Allow Local Password Fallback for Default Admin Only**  
Select this option to allow the default admin user to log in using only a username and password if RADIUS authentication fails. This privilege is restricted to the admin user only—all others must be authenticated by RADIUS. This option is enabled by default.
  - **Allow Local Password Fallback for All Users**  
Select this option to allow all users to log in using their local user name and password, if RADIUS authentication fails. For more information, see "[Local Password Fallback](#)" on the next page.

6. **Update the RADIUS Server** parameters as necessary:

Parameter	Description
Server Hostname[:port]	Enter the host name and port of the RADIUS server.
Backup Server hostname [:port] (optional)	<b>(Optional)</b> Enter the backup RADIUS server to use if the primary server does not respond. If the server returns an authentication failure (bad password, unknown username, etc), then the backup server is not tried. The backup server is tried only when the primary server has a communication failure.  Use the same format as the primary server to specify the host name and port.
Shared Authentication Secret	Enter a RADIUS passphrase.
NAS IP Address	The IP address of the Network Access Server (NAS).
Request Timeout	The length of time, in seconds, to wait for a response from the RADIUS server (in seconds). The default is <b>10</b> .
Retry Request	Number of times to retry a RADIUS request. The default is <b>1</b> .
RADIUS Protocol	Use the pull-down menu to choose a protocol option. The default is <b>None</b> .

7. Click **Save**.

## Local Password Fallback

**This topic applies to both Software Logger and the Logger Appliance.**

You can use this feature to log in using your local user name and password if the external authentication (Certificate, LDAP, or RADIUS) fails, if you forgot your password to the authentication server, or if the authentication server is not available.

The **Use Local Authentication** feature enables the default admin to log in even when the remote authentication server is not available, by adding a **Use Local Authentication** checkbox to the login screen. Out-of-box, this option is enabled only for the default administrator. However, it is possible to allow local password fallback for all users. For example, you could configure the RADIUS authentication method to allow users to log in using local authentication instead of RADIUS should they fail to authenticate to any configured external RADIUS servers.

For information on how to allow local password fallback for all users for all users, see ["Client Certificate Authentication" on page 448](#), ["LDAP/AD and LDAPS Authentication" on page 450](#), or ["RADIUS Authentication" on the previous page](#).

### To log in when authentication fails:

1. On the **ArcSight Logger Login** dialog, select the **Use Local Authentication** checkbox.

**Note:** This option is only available to the default admin unless it has been enabled for other

users.

2. Enter your user name and password and click **Login**.

## Login Banner

**This topic applies to both Software Logger and the Logger Appliance.**

You can customize the message on the login screen to suit your needs. The text you enter in the Content field is displayed above the Username and Password fields on the login screen. In addition, you can enter a confirmation message that the user must click to enable the **Username** and **Password** fields.

You must have the “Configure Login Settings” permission enabled for your user account to edit the login banner.

### To customize the login banner:

1. Click **System Admin** from the top-level menu bar.
2. Click **Login Banner** in the **Users/Groups** section.
3. Enter the text you want to display as the login banner in the **Content** field.  
You can enter only unformatted text in this field; however, you can apply standard HTML tags to display formatted text. Loading images in this field is not allowed.
4. (Optional) Enter text in the **Confirmation** field.  
If you enter text in this field, the text will be accompanied by a checkbox that the user must click to enable the Username and Password fields. For example, if you enter “Are you sure?”, “Do you want to proceed?”, or “I agree” in this field, the user must click the checkbox in order to log in.
5. Click **Save**.

## User Management

**This topic applies to both Software Logger and the Logger Appliance.**

The **Users** and **Groups** tabs enable you to manage users and user groups on your system. User groups are a way to enforce access control to various sections of your system.

- [Creating and Activating Users](#) ..... 455
- [Setting Logger User Permissions](#) ..... 458
- [Reset a User's Password](#) ..... 458
- [Change My Password](#) ..... 459
- [User Groups](#) ..... 459

- [Managing User Groups](#) .....460

## Creating and Activating Users

**This topic applies to both Software Logger and the Logger Appliance.**

Open the **Users** tab to manage the users that can log in to your system. You can add a new user, edit user information, or delete a user at any time. You must have the appropriate System Admin group rights to perform these functions.

### Adding a User

**To add a new user:**

1. Click **System Admin** from the top-level menu bar.
2. Click **User Management** in the **Users/Groups** section in the left panel.
3. In the **Users** tab, click **Add**.

4. Enter the following parameters.

Parameter	Description
<b>Credentials</b>	
Login	The user's login name.
Password	The user's password.
Confirm Password	Reenter the users' password.
<b>Contact Information</b>	
Use Client DN	<p>If you enabled SSL client certificate or LDAP authentication, click this link to enter user's the Distinguished Name (Certificate Subject) information. The Distinguished Name should be similar to this format:</p> <p>CN=UserA,OU=Engg Team,O=ArcSight\, Inc.,            L=Cupertino,C=US,ST=California</p> <p>To determine the DN, use this URL to display the certificate:</p> <p>https://&lt;hostname or IP address&gt;/platform-service/DisplayCertificate</p> <p>OR</p> <p>Obtain the DN information for a user from the browser that the user will open to connect to the system. For example, in Firefox, click Tools &gt; Options &gt; Advanced &gt; Encryption &gt; View Certificates &gt; Your Certificates &gt; <i>Select the certificate</i> &gt; View.</p>
First Name	The user's first name.
Last Name	The user's last name.
Email	The user's email address.
Phone Number	(Optional) The user's phone number.
Title	(Optional) The user's title.
Department	(Optional) The user's department.
Fax	(Optional) The user's fax number.
Alternate Number	(Optional) The user's alternate phone number.
Notes	(Optional) Other information about the user.
<b>Assign to Groups</b>	
<p>This setting controls the privileges a user has on this Logger. Select the groups to which this user belongs. See <a href="#">"Setting Logger User Permissions" on page 458</a>.</p>	
System Admin	Permissions to all System Admin operations.



Parameter	Description
Logger Rights	Permissions to read and edit all logger operations except System Admin.
Logger Report	Permissions to view, run, schedule, edit, and delete all reports.
Logger Search	Permissions to run both local and distributed searches.

5. Click **Save and Close**.

## Editing and Deleting Users

### To edit a user:

1. Click **System Admin** from the top-level menu bar.
2. Click **User Management** in the **Users/Groups** section in the left panel.
3. In the **Users** tab, select the user (or users) you want to edit.
4. Click **Edit**.
5. Update the user information as necessary.
6. Click **Save User**.

### To delete a user:

1. Click **System Admin** from the top-level menu bar.
2. Click **User Management** in the **Users/Groups** section in the left panel.
3. In the **Users** tab, select the user (or users) you want to delete.
4. Click **Delete** from the top left side of the page.

**Caution:** Deleting a user will also delete all of that user's reports.

## Activating Users

### To activate a user:

1. Click **System Admin** from the top-level menu bar.
2. Click **User Management** in the **Users/Groups** section in the left panel.
3. In the **Users** tab, select the user (or users) that you want to activate.
4. Choose **Edit**.
5. Check the **Active** box.
6. **Save** the changes.

## Setting Logger User Permissions

Logger installs with a default Administrator user, who has full permissions to create other users and assign them access permissions. When users require a specific set of permissions, you can create a custom User Group with those permissions. To do this, see ["Creating a New User Group" on page 460](#).

### To assign Logger permissions to a user:

1. Click **System Admin** from the Logger navigation bar.
2. From the User/Groups menu, click **User Management**. The Manage Users page opens.
3. Select the check box for the user to whom you want to assign privileges.
4. Click **Edit**. The Edit User page opens.
5. From the Assign to Groups section, select one option from each group type. For new users, the default selection is "Unassigned." A user must be a member of at least one User Group to use Logger.

The screenshot shows the 'Assign to Groups' section of the Logger interface. It contains four dropdown menus for assigning permissions:

- System Admin: Unassigned
- Logger Rights: Default Logger Rights Group
- Logger Report: Unassigned
- Logger Search: Default Logger Search Group

A tooltip points to the 'Logger Search' dropdown with the text: "Select one group from each group type". Below the dropdowns is a 'Notes' section.

6. Click **Save and Close**.

## Reset a User's Password

### This topic applies to both Software Logger and the Logger Appliance.

The Reset Password feature enables you to reset a user's password without knowing their password. If you are using an SMTP-configured server and have permissions to create and update users, you can reset a user's password by clicking the **Reset Password** button. An automated email is sent to the user with the new password string.

An SMTP server must be configured for the automated email containing the temporary password to be sent. If an SMTP server is not configured, the password will not be reset because an email cannot be sent.

### To reset a user's password:

1. Click **System Admin** from the top-level menu bar.
2. Click **User Management** in the **Users/Groups** section in the left panel.

3. In the **Users** tab, select the user (or users) whose passwords you want to reset.
4. Click **Reset Password** from the top left side of the page.

The user must use the temporary string to log in within the time specified in the email. If the user does not log in within the specified time, the account becomes deactivated. If the account has been deactivated, the admin must re-activate it before resetting the password.

## Change My Password

**This topic applies to both Software Logger and the Logger Appliance.**

You can use the **Change Password** menu to change your password. This feature is available to all users for changing their passwords, unlike the Reset Password feature that enables a system administrator to reset the password of users without knowing the password. Passwords are subject to the password policy specified by the Admin user.

### To change your password:

1. Click **System Admin** from the top-level menu bar.
2. Click **Change Password** in the **Users/Groups** section in the left panel to display the **Change Password for <User Name>** page.
3. Enter the Old Password, the New Password, and enter the New Password a second time to confirm.
4. Click **Change Password**.

## User Groups

**This topic applies to both Software Logger and the Logger Appliance.**

User groups define privileges to specific functions on your system and serve to enforce access control to these functions. For example, if you want User A to be able to run searches but not reports, assign that user to the Search group but not to the Reports group.

User groups are organized by the following types: System Admin, Read Only System Admin, Logger Rights, Logger Search, and Logger Reports. Each type has a pre-defined, default user group in which all privileges for the type are enabled. To authorize a subset of the privileges for a specific group type, create a new user group and enable only the privileges you want to provide for that group. Then, assign restricted users to the newly created group.

### System Admin Group

The System Admin Group controls the system administration operations for your system, such as configuring network information, setting storage mounts, installing SSL certificates, and user management.

## Read Only System Admin Group

In addition to the default System Admin Group that enables all system administration rights (privileges), a Read Only System Admin Group is available on your system. Users assigned to this group can view System Admin settings, but cannot change them.

Refer to your system's user interface for a complete list of privileges available to this group.

## Logger Rights Group

The Logger Rights Group controls the Logger application operations for your system, such as viewing the Logger dashboards and configuring all the settings in the Configuration menu (including event archives, storage groups, alerts, filters, and scheduling tasks.)

Refer to your system's user interface for a complete list of privileges available to this group.

## Logger Search Group

The Logger Search Group controls local and peer searches through the following privileges:

- Search for events
- Search for events on remote peers

If the group is configured to allow users to run local and peer searches, users assigned to this group can perform those operations. Conversely, if the group is configured to prevent users from running local and peer searches, users assigned to this group cannot perform those operations.

## Logger Reports Group

The Logger Reports group controls all report operations on Logger such as run, edit, delete, schedule, and view published reports.

Refer to your system's user interface for a complete list of privileges available to this group.

## Managing User Groups

**This topic applies to both Software Logger and the Logger Appliance.**

### Creating a New User Group

#### **To create a new user group:**

1. Click **System Admin** from the top-level menu bar.
2. Click **User Management** in the **Users/Groups** section in the left panel.
3. Click the **Groups** tab.
4. Click **Add**.

5. Define the new group:
  - a. In the **Group Name** field, provide a name for the group.
  - b. In the **Description** field, provide a description for the group.
  - c. From the Group Type drop-down box, select the group type.
  - d. Click the down arrow icon () next to the group type name to view and select privileges that you want to assign to the users in this group.
6. Click **Save and Close** to save the settings of the group, or click **Save and Edit Membership** to add users to this group.

## Editing and Deleting User Groups

### To edit a user group:

1. Click **System Admin** from the top-level menu bar.
2. Click **User Management** in the **Users/Groups** section in the left panel.
3. Click the **Groups** tab.
4. Select the group that you want to edit, and click **Edit**.
5. Update the user group information.

If you need to edit the group's membership:

- a. Click **Save and Edit Membership** to display the Edit Group Membership page.
  - b. Click **Add** from the top left of the Edit Group Membership page.
  - c. Select users you want to add. By default, you can add only users who do not belong to other groups of the type that you are editing. To add such users, click **Show users that belong to other <group\_type> groups**.  
When you add a user who belongs to another group of the same group type as the one you are updating, that user is automatically removed from the previous group.
  - d. Click **OK**.
  - e. Click **Back to Group List**.
6. Click **Save and Close**.

### To delete a user group:

1. Click **System Admin** from the top-level menu bar.
2. Click **User Management** in the **Users/Groups** section in the left panel.
3. Click the **Groups** tab.
4. Select the group (or groups) that you want to delete.
5. Click **Delete** at the top left side of the page.

## Other System Administration Information

**This topic applies to both Software Logger and the Logger Appliance.**

This section contains information related to system administration that you will need to fully administer your Logger, including starting and stopping Software Logger, system health events, and SNMP polling.

- [Monitoring System Health](#) ..... 462
- [System Health Events](#) ..... 463
- [Using the Appliance Command Line Interface](#) ..... 465
- [Software Logger Command Line Options](#) ..... 468
- [Firewall Rules](#) ..... 469
- [Configuring the Firewall on Logger Appliance](#) ..... 470

## Monitoring System Health

**This topic applies to both Software Logger and the Logger Appliance.**

You can monitor your Logger's health in these ways:

- By using a pre-defined system filter, as listed in ["System Filters/Predefined Filters"](#) on page 131. The pre-defined system health filters are based on the system health events listed in ["System Health Events"](#) on the next page.
- By searching for system health events in Logger's Internal Storage Group, as listed in ["System Health Events"](#) on the next page. If a pre-defined system health filter does not suit your needs, you can create alerts based on the system health events.
- By polling system health events (Logger Appliance only), as explained in ["SNMP"](#) on page 416. You can poll system health information from your system by using SNMP version 2c or 3 from any standard network management system.

### **To set up notification of system health events:**

1. Configure the Logger's SMTP settings (see ["SMTP"](#) on page 413) or create an SNMP Destination (see ["SNMP Destinations"](#) on page 337) or Syslog Destination (see ["Syslog Destinations"](#) on page 337).
2. Create an Alert that uses one or more System Alert Filters or define a query that searches for the system health events in Logger's Internal Storage Group, and specify match count and threshold (see ["Logger Alert Types"](#) on page 332).
3. Enable the new Alert.

## System Health Events

**This topic applies to both Software Logger and the Logger Appliance.**

The following table lists the system health events that Logger generates. These events are also referred to as Logger Internal Events because they are stored in Logger's Internal Storage Group. See ["Examples of System Health Events" on page 544](#) for examples of these events.

The pre-defined System Filters that provide system health status are based on some of these events. If a pre-defined filter does not suit your needs, create an alert using one of these events.

Starting with Logger 5.1, the format in which system health events are generated was changed to provide more meaningful information. These changes include:

- Addition of new events (for example, Current and Voltage).
- Instead of referring to all system health events as Logger Internal Event in the name field, meaningful names are used (for example, Fan OK, Temperature OK).
- Three severity levels for each event have been added to the `agentSeverity` field—1 (OK), 5 (Degraded), and 8 (Severe).
- The `deviceCustomString` and `deviceCustomStringLabel` field mappings have changed. Refer to a specific event to see the changes.
- Device Event Class ID (`deviceEventClassId`) and Device Event Category (`deviceEventCategory`) of the events have changed. An updated list is available in the following table.
- All hardware-related events are classified as `hardware : nnn` events, where `nnn` is a three-digit number that identifies the hardware component (for example, `hardware : 13x` identifies the fan events.)

Keep the following in mind when working with System Health Events.

- The sensor names in each event are hardware specific; therefore, they are not consistent across various Logger platforms. Use the event name (`Name`) and status (`CustomString3`) fields to determine the status of a sensor. The raw status (`CustomString4`), location (`CustomString5`), and sensor name (`CustomString6`) fields are for informational use when diagnosing a hardware problem and are not consistent across appliance types.
- HPE recommends that you develop custom alerts for certain System Health Events to prevent users from being alerted too often. Some of the conditions that your system alerts on may be self-clearing or warnings that you do not want to be alerted about until a specific number of warnings have been generated.

## System Health Events for Both Types of Logger

Group	Device Event Category	Device Event Class ID
CPU	/Monitor/CPU/Usage	cpu:100
Disk	/Monitor/Disk/Read	disk:102
	/Monitor/Disk/Write	disk:103
EPS	/Monitor/Receiver/EPS/All	eps:100
	/Monitor/Receiver/EPS/Individual	eps:102
	/Monitor/Forwarder/EPS/All	eps:101
	/Monitor/Forwarder/EPS/Individual	eps:103
Memory	/Monitor/Memory/Usage/Platform	memory:100
Network	/Monitor/Network/Usage/In	network:100
	/Monitor/Network/Usage/Out	network:101
Search	/Monitor/Search/Performed	search:100
Storage Group	/Monitor/StorageGroup/Space/Used	storagegroup:100
	<p><b>Note:</b> The size of the storage group, indicated by the “fsize” field is in GB.</p>	

## System Health Events for Logger Appliances Only

Group	Device Event Category	Device Event Class ID
Battery	/Monitor/Sensor/Battery/OK	hardware:121**
	/Monitor/Sensor/Battery/Degraded	hardware:122**
	/Monitor/Sensor/Battery/Failed	hardware:123**
Current (Electrical)	/Monitor/Sensor/Current/OK	hardware:101**
	/Monitor/Sensor/Current/Degraded	hardware:102**
	/Monitor/Sensor/Current/Failed	hardware:103**
Disk	/Monitor/Disk/Space/Remaining/Root	disk:101
Fan	/Monitor/Sensor/Fan/OK	hardware:131
	/Monitor/Sensor/Fan/Degraded	hardware:132
	/Monitor/Sensor/Fan/Failed	hardware:133



Group	Device Event Category	Device Event Class ID
Power Supply	/Monitor/Sensor/PowerSupply/OK	hardware:141
	/Monitor/Sensor/PowerSupply/Degraded	hardware:142
	/Monitor/Sensor/PowerSupply/Failed	hardware:143
RAID	/Monitor/RAID/Controller/OK	raid:101
	/Monitor/RAID/Controller/Degraded	raid:102
	/Monitor/RAID/Controller/Failed	raid:103
	/Monitor/RAID/BBU/OK	raid:111
	/Monitor/RAID/BBU/Degraded	raid:112
	/Monitor/RAID/BBU/Failed	raid:113
	/Monitor/RAID/Disk/OK	raid:121
	/Monitor/RAID/Disk/Rebuilding	raid:122
	/Monitor/RAID/Disk/Failed	raid:123
Temperature	/Monitor/Temperature/OK	hardware:151
	/Monitor/Temperature/Degraded	hardware:152
	/Monitor/Temperature/Failed	hardware:153
Voltage	/Monitor/Sensor/Voltage/OK	hardware:111**
	/Monitor/Sensor/Voltage/Degraded	hardware:112**
	/Monitor/Sensor/Voltage/Failed	hardware:113**

**Note:** In the table, the notation \*\* indicates an event generated only on older non-HP model appliances.

## Using the Appliance Command Line Interface

### **This topic applies to Logger Appliances only.**

The Logger appliance CLI enables you to start and stop the appliance as well as issue commands for the Logger application.

Use one of the following methods to connect to the appliance Command Line Interface (CLI):

- Log into HP ProLiant Integrated Lights-Out (iLO) and launch the remote console feature. For more information, refer to the Logger Installation Guide.
- Connect a keyboard and monitor to the ports on the rear panel of the appliance.

- Connect a terminal to the serial port on the appliance using a null modem cable with DB-9 connector. The serial port expects a standard VT100-compatible terminal: **9600 bps, 8-bits, no parity, 1 stop bit (8N1), no flow control.**

Once you are connected to the CLI, a Login prompt displays.

The following commands are available at the CLI prompt:

Category	Command	Description
<b>System Commands</b>		
	exit	Logout
	halt	Stop and power down the Logger Appliance
	help	Opens the command line interface help
	reboot	Reboot the Logger Appliance
<b>Admin Commands</b>		
	show admin	Show the default administrator user's name
<b>Authentication Commands</b>		
	reset authentication	Reset to local authentication
<b>Config Commands</b>		
	show config	Show host name, IP address, DNS, and default gateway for the Logger
<b>Date Commands</b>		
	show date	Show the date and time currently configured on the Logger
	set date	Set the date and time on Logger. The date/time format is yyyyMMddhhmmss. Example date: 20101219081533
<b>Default Gateway Commands</b>		
	set defaultgw <IP> [nic]	Set the default gateway for one or all network interfaces
	show defaultgw [nic]	Display the default gateway for all or the specified network interface
<b>DNS Commands</b>		
	show dns	Show the currently configured DNS servers on the Logger
	set dns <sd> <ns> set dns <sd1>,<sd2> <ns1> <ns2>	Set DNS name server(s). sd=search domain, ns = name server  You can add up to three name servers and six search domains.  <b>Note:</b> When using multiple search domains, separate them with a comma, but no space. When using multiple name servers separate them with a space but no comma.

Category	Command	Description
<b>Hostname Commands</b>		
	show hostname	Show the currently configured hostname on the Logger
	set hostname <host>	Set Logger's host name
<b>IP Commands</b>		
	show ip [nic]	Show the IP addresses of all or the specified network interface
	set ip <nic> <IP> [prefix] [netmask]	Set Logger's IP address for a specific network interface
<b>NTP Commands</b>		
	set ntp <ntp server> <ntp server> <ntp server> ...	<p>Sets the NTP server addresses. This entry over writes the current NTP server setting.</p> <p>You can specify as many NTP servers as you like. If you specify multiple NTP servers, they are each checked in turn. The time given by the first server to respond is used.</p> <p>Example:</p> <pre>logger&gt; set ntp ntp.arcsight.com time.nist.gov 0.rhel.pool.org</pre>
	show ntp	<p>Show the current NTP server setting.</p> <p>Example:</p> <pre>logger&gt; show ntp ntp.arcsight.com time.nist.gov 0.rhel.pool.org</pre>
<b>Password Commands</b>		
	set password	Set the password the current user's account
<b>Process Commands</b>		
	restart process	Restart a process
	start process	Start a process
	status process	Show process status
	stop process	Stop a process
<b>SSL Certificate Commands</b>		
	show sslcert	Show the currently loaded SSL certificate on Logger
	reset sslcert	Creates and installs a new self-signed certificate with the original default information, then restarts the HTTPS server.
	diag sslcert	Display the SSL session information
<b>Status Commands</b>		
	show status	Show the Logger configuration

## Software Logger Command Line Options

### This topic applies to Software Loggers only.

The `loggerd` command enables you to start or stop the Logger software running on your machine. In addition, the command includes a number of subcommands that you can use to control other processes that run as part of the Logger software.

**Note:** If your Logger is installed to run as a system service, you can use your operating system's service command to start, stop, or check the status of a process on Logger.

```
<install_dir>/current/arcsight/logger/bin/loggerd  
{start|stop|restart|status|quit}
```

```
<install_dir>/current/arcsight/logger/bin/loggerd {start <process_name> |  
stop <process_name> | restart <process_name>}
```

To view the processes that can be started, stopped, or restarted with `loggerd`, click **System Admin** from the top-level menu bar. Then, under **System**, pick **Process Status**. The processes are listed on the right under **Processes**.

The following table describes the subcommands available with `loggerd` and their purpose.

Command	Purpose
<code>loggerd start</code>	Start all processes listed under the System and Process sections. Use this command to launch Logger.
<code>loggerd stop</code>	Stop processes listed under the Process section only. Use this command when you want to leave <code>loggerd</code> running but all other processes stopped.
<code>loggerd restart</code>	This command restarts processes listed under the Process section only.  <b>Note:</b> When the <code>loggerd restart</code> command is used to restart Logger, the status message for the "aps" process displays this message:  Process 'aps' Execution failed.  After a few seconds, the message changes to:  Process 'aps' running.
<code>loggerd status</code>	Display the status of all processes.
<code>loggerd quit</code>	Stops all processes listed under the System and Process sections. Use this command to stop Logger.

Command	Purpose
<code>loggerd start &lt;process_name&gt;</code>	Start the named process. For example, <code>loggerd start apache</code>
<code>loggerd stop &lt;process_name&gt;</code>	Stop the named process. For example, <code>loggerd stop apache</code>
<code>loggerd restart &lt;process_name&gt;</code>	Restart the named process. For example, <code>loggerd restart apache</code>

## Firewall Rules

**This topic applies to both Software Logger and the Logger Appliance.**

Before Logger can receive data, some ports must be opened through the firewall.

- For Software Logger, you are responsible for setting up the firewall. After you first install or upgrade to Logger 6.3, configure the firewall to be open only for the ports described in ["Default Inbound Ports" below](#), and any other ports required for your configuration.

**Caution:** HPE ArcSight strongly recommends that you configure your firewall so that only the required ports are open.

- For the Logger Appliance, the firewall is preconfigured. HPE ArcSight provides a script you can use to update the firewall. See ["Configuring the Firewall on Logger Appliance" on the next page](#) for more information.

**Tip:** Be sure to update the firewall configuration whenever you add or remove any service that requires an open port for incoming traffic, such as a Logger receiver or SNMP polling.

You can configure the firewall on your Logger as you would on any server, by white-listing the appropriate ports in `iptables` (for CentOS and RHEL 6.X) or `firewalld` (for CentOS and RHEL 7.X).

### Default Inbound Ports

Service	Logger Appliance	Software Logger root install	Software Logger non-root install
SSH	22/TCP	--	--
HTTPS	443/TCP	443/TCP	9000/TCP *
ArcMC agent	7913/TCP	7913/TCP	7913/TCP
NTP	123/UDP	--	--
UDP receiver	514/UDP *	514/UDP *	8514/UDP *
TCP receiver	515/TCP *	515/TCP *	8515/UDP *

\* Configured port may vary.

## Configuring the Firewall on Logger Appliance

### **This topic applies to Logger Appliances only.**

Your Logger Appliance includes a script that you can use to configure the firewall. This script looks at your current Logger configuration and decides what ports to keep open. Alternatively, you can configure the firewall on your Logger as you would on any server, by white-listing the appropriate ports in `iptables` (for CentOS and RHEL 6.X) or `firewalld` (for CentOS and RHEL 7.X).

When called without arguments, the `/usr/sbin/arcfirewall` script displays the ports that it will keep open, but takes no action to alter the firewall configuration. To alter firewall configuration, use the `--set` option.

### **To preview the list of ports the script would open:**

1. Log into the appliance as root.
2. Run the following command:  
`/usr/sbin/arcfirewall.`

The script displays the ports that it would open if run with the `--set` option.

### **To configure the firewall:**

1. Log into the appliance as root.
2. Run the following command:  
`[root@myserver ~]# /usr/sbin/arcfirewall --set.`

The script configures the firewall leaving only the necessary ports open.

# Appendix A: Search Operators

The following topics describe the operators you can specify in the Search box (**Analyze > Search**) and give examples of their use.

Aggregation operators return the combined results of more than one field, and include chart, head, keys, rare, sort, tail, top.

- [cef \(Deprecated\)](#) ..... 471
- [chart](#) ..... 472
- [dedup](#) ..... 476
- [eval](#) ..... 477
- [extract](#) ..... 483
- [fields](#) ..... 485
- [head](#) ..... 486
- [keys](#) ..... 486
- [lookup](#) ..... 487
- [parse](#) ..... 492
- [rare](#) ..... 493
- [regex](#) ..... 494
- [rename](#) ..... 494
- [replace](#) ..... 495
- [rex](#) ..... 497
- [sort](#) ..... 500
- [tail](#) ..... 501
- [top](#) ..... 501
- [transaction](#) ..... 502
- [where](#) ..... 504

## cef (Deprecated)

*Prior to Logger 5.2, you needed to use the cef operator to extract CEF fields from CEF events that matched the indexed search filter (the query portion before the first pipeline in the query expression) before you could use other search operators to act upon those fields. However, starting with Logger 5.2, you do not need to explicitly extract the CEF fields and then apply other search operators to those fields. You can specify the event fields directly in queries.*

Extracts values for specified fields from matching CEF events. If an event is non-CEF, the field value is set to NULL.

### Synopsis

```
...| cef <field1> <field2> <field3> ...
```

### Usage Notes

If multiple fields are specified, separate each field name with a white space or a comma.

To identify the name of a CEF field, use the Search Builder tool (click Advanced Search under the Search text box), which lists the names of all fields alphabetically.

The extracted fields are displayed as additional columns in the All Fields view (of the System Fieldsets).

To view only the extracted columns, select **User Defined Fieldsets** from the System Fieldsets list.

### Examples

```
...| cef categorySignificance agentType
```

```
...| cef deviceEventCategory name
```

## chart

Displays search results in a chart form of the specified fields.

### Synopsis

```
...| chart count by <field1> <field2> <field3> ... [span [<time_<br>field>]=<time_bucket>]
```

```
...| chart {{sum | avg | min | max | stdev | perc<N>} (<field>)}+ by<br><field1>, <field2>, <field3> ...[span [<time_field>]= <time_bucket>]
```

```
...| chart {<function> (<field>)} as <new_column_name> by <field> [span<br>[<time_field>]=<time_bucket>]
```

where <field>, <field1>, <field2>are the names of the field that you want to chart. The fields can be either event fields available in the Logger schema or a user-defined fields created using the rex or eval operator prior in the query.

<time> is the bucket size for grouping events. Use d for day, h for hour, m for minute, s for seconds. For example, 2h, 5d, 1m. (See Usage Notes for details.)

<function> is one of these: count, sum, avg (or mean), min, max, stdev, percN



<new\_column\_name> is the name you want to assign to the column in which the function's results are displayed. For example, Total.

<N> is the percentile, and so can be a number between 0 and 100, inclusive.

**Deprecated:** The following deprecated usage contains “\_count”. The recommended usage, as shown above, is “count”.

```
...| chart _count by <field1> <field2> <field3> ...
```

## Usage Notes

By default, a column chart is displayed. Other chart types you can select from: bar chart, line chart, donut chart, area chart, stacked column, or stacked bar.

To change the chart settings (including its type), click  in the upper right corner of the Result Chart frame of the screen. You can change these settings:

- **Title:** Enter a meaningful title for the chart.
- **Type:** Column, Bar, Donut, Area, Line, Stacked column, Stacked Bar. The last two types create stacked charts in which multiple values are plotted in a stack form. These charts are an alternate way of representing multi-series charts, which are described below.
- **Display Limit:** Number of unique values to plot. Default: 10  
If the configured Display Limit is less than the number of unique values for a query, the top values equal to the specified Display Limit are plotted. That is, if the Display Limit is 5, and seven unique values are found, only the top five values will be plotted.

All chart commands except “count by” accept only *one field* in the input. The specified field must contain numeric values.

If multiple fields are specified, separate the field names with a white space or a comma.

You can click on a charted value to quickly filter down to events with specific field values. For more information, see ["Chart Drill Down" on page 120](#).

## Percentile Function

The perc<N> function returns the <N> percentile. <N> can be a number between 0 and 100, inclusive.

```
...| chart perc by field list" (with no specified <N>) returns all results generated by ... |  
chart count by field list.
```

```
...| chart perc50 by field list returns the median value of all the results generated by ... |  
chart count by field list.
```

```
...| chart perc90 by field list returns the 90 percentile value of all the results generated by  
...| chart count by field list.
```

The percentile value is derived based on the increasing order of the field values. The derived value of string fields rely on alphabetical order (ASCII value).

## Aggregation Functions

**Note:** Aggregation functions only work on numeric fields. The specified fields must contain numeric values. If a field you specify is of the wrong data type, you will receive an error message like the following: "java.lang.NumberFormatException".

If an aggregation function such as `count`, `sum`, or `avg` is specified, a chart of the aggregated results is displayed along with the tabular results of the aggregation operation in a Results Table. For example, for the aggregation function `sum(deviceCustomNumber1)`, the `sum_deviceCustomNumber1` column in the Results Table displays the sum of unique values of the `deviceCustomNumber1` field.

If this field had two unique values 1 and 20, occurring 2 times each, the `sum_deviceCustomNumber1` column displays sum of those two values.

The mathematical operators `avg` and `mean` are identical.

You can include multiple functions in the same `chart` command. When doing so, separate each function with a comma, as shown in this example:

```
...| chart count, sum(deviceCustomNumber3) by deviceEventClassId
```

When you include multiple functions, one column per function is displayed in the search Results Table. The Results Chart, however, plots the chart for the field specified in the "by" clause.

You can use the "as `new_column_name`" clause to name any column resulting from the aggregation functions, as shown in this example:

```
...| chart sum(deviceCustomNumber3) as TotalStorage, avg(deviceCustomNumber3) as AverageStorage by deviceCustomNumber3
```

Once defined, the newly defined column can be used in the pipeline as any other field. For example,

```
...| chart sum(deviceCustomNumber3) as TotalStorage, avg(deviceCustomNumber3) as AverageStorage by deviceCustomNumber3 | eval UpdatedStorage = TotalStorage + 100
```

When you export the search results of a chart operator, the newly defined column name (using the `chart function as new_column_name` command) is preserved.

## Multi-Series Charts

A multi-series chart can plot the values of multiple aggregation functions in a single chart. If you include multiple aggregation functions in a `chart` command, Logger generates a multi-series chart that plots the values of the specified aggregation functions along the Y-axis, as illustrated in ["Example Two" on page 476](#). Multi-series charts can be any of the chart types except Donuts= charts. For example, you can

choose to plot a multi-series chart as a stacked chart—Stacked column or Stacked Bar—in which multiple values are plotted in a stack form.

## The Span Function

In addition to grouping events by the Logger schema fields (or the ones defined by the `rex` or `eval` operators), the `span` function provides an additional way to group events by a time field (such as `EventTime` or `deviceReceiptTime`) and a time bucket. In the following example, `deviceReceiptTime` is the time field and `5m` (5 minutes) is the time bucket:

```
...| chart count by deviceEventCategory span (deviceReceiptTime) = 5m
```

If a time field is not specified for the `span` function, `EventTime` is used as the default. For example, the following query uses `EventTime` by default:

```
...| chart count by deviceEventCategory span = 5m
```

By default, the `chart` command displays the first 10 unique values. If the `span` function creates more than 10 unique groups, not all of them will be displayed. If you want to view all of the unique groups, increase the `Display Limit` value under `Chart Settings`. (Click in the upper right corner of the `Result Chart` frame of the screen.)

Grouping with `span` is useful in situations when you want to find out the number of occurrences in a specific time span.

If you want to find out the total number of incoming bytes every 5 minutes on a device, you can specify a span of `5m`, as shown in this example:

```
...| chart sum(deviceCustomNumber1) span=5m
```

The above example assumes that `deviceCustomNumber1` field provides the incoming bytes information for these events.

The `span` field can be used for grouping in conjunction with or without the event fields that exist in Logger schema or user-defined fields using the `rex` or `eval` operators. When a `span` field is specified in conjunction with an event field, the unique sets of all those fields is used for grouping. The following example uses `deviceCustomNumber3` and `deviceAddress` in conjunction with `span` to find out the number of events (using `deviceCustomNumber3`) from a specific source (using `deviceAddress`) in one hour:

```
...| chart sum(deviceCustomNumber3) by deviceAddress span=1h
```

When `span` is included in a query, search results are grouped by the specified time bucket. For example, if `span=5m`, the search results will contain one row for each 5-minute span. If there are no events within a specific 5-minute span, that row will be empty.

Additionally, the `span` function assumes a 24-hour day, all year long. If `span=1d` or `24h`, on the day of daylight savings time change, the event time indicated by the `span_eventTime` field in the search results will be different from the previous day by one hour. On the day when there are 23 hours in a day (in

March), the span bucket will still include events from the last 24 hours. Similarly, on the day when there are 25 hours in the day (in November), the span bucket will include events from the last 24 hours.

## Example One

Use the default chart setting (Column Chart) to specify multiple fields. In this example, a count of unique groups of deviceEventCategory and name fields is displayed and plotted.

```
... | chart count by deviceEventCategory name
```

## Example Two

Include average and sum in a chart command, to generate a multi-series chart that plots the values of these functions along the Y-axis in a single chart. You can display a multi-series chart as a stacked chart—Stacked column or Stacked Bar—in which multiple values are plotted in a stack, by changing the

### **Chart Settings.**

# dedup

Removes duplicate events from search results. That is, events that contain the same value in the specified field. The first matching event is kept, and the subsequent events with the same value in the specified field are removed.

## **Synopsis**

```
... | dedup [N] <field1>,<field2>, ... [keepevents=(true|false)] [keepempty=(true|false)]
```

N is an optional number that specifies the number of duplicate events to keep. For example, “dedup 5 deviceEventClassId” will keep the first five events containing the same deviceEventClassId values for each deviceEventClassId, and remove the events that match after the first five have been kept.

Default: **1**.

field1, field2 is a field or a comma-separated field list whose values are compared to determine duplicate events. If a field list is specified, the values of the unique sets of all those fields are used to remove events. For example, if name and deviceCustomNumber1 are specified, and two events contain “Network Usage - Outbound” and “2347896”, only the first event is kept in the search results.

keepevents specifies whether to set the fields specified in the field list to NULL or not. When this option is set to True, the values are set to NULL and events are not removed from search results. However, when this option is set to False, duplicate events are removed from the search results. Default: False.

keepempty specifies whether to keep events in the search results whose specified fields contain NULL values. When this option is set to True, events with NULL values are kept, however if this option is set to False, events with NULL values are removed. Default: False.

## Example One

To view events from unique devices:

```
... | dedup deviceAddress
```

## Example Two

To view unique deviceEventClassId events from unique devices:

```
... | dedup deviceEventClassId deviceAddress
```

## Example Three

To view the className in events with Java exceptions in the message field:

```
exception | <rex_expression> | dedup 5 className
```

In the example above, <rex\_expression> is not shown in detail; however this expression extracts the class name in a field called className, which the dedup operator acts upon.

# eval

Displays events after evaluating the result of the specified expression. The expression can be a mathematical, string, or Boolean operation and is evaluated when the query is run. The resulting value of the expression is assigned to a field name (specified in the expression). Once a new field has been defined by the eval operator in a query, this field can be used in the query for further refining the search results (see ["Example Three" on page 482](#) below, in which a new field "Plus" is defined by the eval operator; this field is then used by the sort operator.)

## Synopsis

```
...|eval <type> <newField>=function([<field>|<value>]*)
```

Where:

<newField> is a derived field displayed in the search results.

<type> is the datatype of the new field and can be int, bigint, long, float or double. If you do not include a data type, the default is string. Including a <type> is optional; include when you need some data type other than string. For example, if you do not include a type, the sort will be alphabetical. If you want to sort numerically, make <type> one of the number data types. The datatype you specify should match the data that will be displayed in the <newField>, according to standard datatype definitions. The temporary field is not part of the Logger schema and its data type does not have to match the Logger schema data type of <field>.

<function> is one of these: `abs(X)`, `case(X,"Y",...)`, `ceil(X)`, `ceiling(X)`, `exp(X)`, `floor(X)`, `if(X,Y,Z)`, `isfalse(X)`, `istrue(X)`, `len(X)`, `ln(X)`, `log(X)`, `lower(X)`, `tolower(X)`, `mod(x,y)`, `rand()`, `replace(X,Y,Z)`, `round(X)`, `sqrt(X)`, `substr(X,Y,Z)`, `sum(x,y,z,...)`, `trim(X)`, `ltrim(X)`, `rtrim(X)`, `upper(X)`, `toupper(X)`, `urldecode(X)`.

**Note:** These functions are described in detail in the usage notes below.

<field> is the name of the field that you want to evaluate. It can be either an event field available in the Logger schema or a user-defined field created using the `rex` or `eval` operator earlier in the query.

<value> can be a string or a number.

### Operators supported for eval expressions

Operation	Symbol
Addition, Subtraction	<code>+</code> , <code>-</code>
Multiplication, Division	<code>*</code> , <code>/</code>
Boolean And, Or, Not	<code>&amp;&amp;</code> , <code>  </code> , <code>!</code>
Equal, Not Equal	<code>==</code> , <code>!=</code>
Less Than, Greater Than	<code>&lt;</code> , <code>&gt;</code>
Less Than or Equal, Greater Than or Equal	<code>&lt;=</code> , <code>&gt;=</code>
Modulus, Power	<code>%</code> , <code>^</code>
Unary Plus, Unary Minus	<code>+x</code> , <code>-x</code>

### Usage Notes

Typically, a `cef` or `rex` operator (to extract fields from matching events) precedes the `eval` operator, as shown in the examples below. However, you can use the `eval` operator on a field that has been defined by a previous `eval` operator in a query.

Keep the following in mind when working with `eval` functions:

- Functions can accept either the literal value of a string or a field.
- To indicate that `X` is a literal string, surround it with double quotes ("`X`"). If there are no double quotes, the function assumes that `X` is a field.
- The derived value of string fields rely on alphabetical order (ASCII value).

### Functions supported for eval operations

Function	Description	Example
abs(X)	Takes a number, X, and returns its absolute value.	The function assigns the evaluated value to the new field. If the value of X is 3 or -3, the function assigns the evaluated value of 3 to the field absnum.  ...   eval absnum=abs(number)
case(X,"Y",...)	Takes pairs of arguments, X and Y.  The X arguments are Boolean expressions that are evaluated from first to last. When case encounters the first X expression that evaluates to true, it returns the corresponding Y. Subsequent arguments are ignored. If none are true, it returns NULL.	The following example returns outcome =Success or outcome =Failure, depending on whether deviceCustomNumber1 is 200.  ...   eval outcome=case (deviceCustomNumber1== 200, "Success", deviceCustomNumber1 != 200, "Failure")
ceil(X), ceiling(X)	Rounds a number, X, up to the next highest integer.	The following example returns n=2.  ...   eval n=ceil(1.9)
exp(X)	Takes a number, X, and returns eX.	The following example returns y=e3.  ...   eval y=exp(3)
floor(X)	Rounds a number, X, down to the nearest whole integer.	The following example returns 1.  ...   eval n=floor(1.9)
if(X,Y,Z)	Takes three arguments. The first argument, X, must be a Boolean expression. If X evaluates to TRUE, the result is the second argument, Y. If X evaluates to FALSE, the result evaluates to the third argument, Z.	The following example looks at the values of deviceCustomNumber1 and returns outcome=Succeeded if outcome=200, otherwise returns outcome=Failed.  ...   eval outcome=if (deviceCustomNumber1 == 200, "Succeeded", "Failed")
isfalse(X)	Checks whether expression X is false. Returns true if expression X is false, otherwise returns false.  <b>Note:</b> If X > 0, results are false. If X <=0, results are true.	The following example returns true because 4+4 is not equal to 9.  ...   eval newField = isfalse(4+4==9)

### Functions supported for eval operations, continued

<p>istrue(X)</p>	<p>Checks whether expression X is true. Returns true if expression X is true, otherwise returns false.</p> <p><b>Note:</b> If <math>X &gt; 0</math>, results are true, if <math>X \leq 0</math>, results are false.</p>	<p>The following example returns true because 8 is greater than 0.</p> <pre>...   eval newField = istrue(8)</pre>
<p>len(X)</p>	<p>Returns the character length of a string, X.</p>	<p>The following example returns the length of (field). If the field is 256 characters long, it returns <math>n=256</math>,</p> <pre>...   eval n=len(field)</pre> <p>The following example returns <math>n=3</math>. (abc is a literal string, surrounded by double quotes.)</p> <pre>...   eval n=len("abc")</pre>
<p>ln(X)</p>	<p>Takes a number, X, and returns its natural log.</p>	<p>The following example returns the natural log of the value of "bytes". If "bytes" contains 100, it returns 4.605170186.</p> <pre>...   eval lnBytes=ln(bytes)</pre>
<p>log(X)</p>	<p>Evaluates the log of number X with base 10.</p>	<p>The following example returns 4.</p> <pre>...   eval num=log(10000).</pre>
<p>lower(X) tolower(X)</p>	<p>Takes a string argument, X, and returns the lowercase version.</p>	<p>The following example returns the value of the field username in lowercase. If the username field contains FRED BROWN, it returns name=fred brown.</p> <pre>...   eval name=lower("username")</pre>
<p>mod(X,Y)</p>	<p>Returns the modulo of X and Y. (<math>X\%Y</math>; the remainder of X divided by Y.)</p>	<p>The following example returns 5.</p> <pre>...   eval newField = mod(25,10)</pre>
<p>rand()</p>	<p>Returns a random number between 0 and 1, inclusively.</p>	<p>The following example might return a number like 0.56789.</p> <pre>...   eval newField = rand()</pre>
<p>replace(X,Y,Z)</p>	<p>Returns a string formed by substituting string Z for every occurrence of regex string Y in string X. The third argument, Z, can also reference groups that are matched in the regex.</p>	<p>The following example replaces instances of the value "ArcSight" with the value "HP" in the deviceVendor field.</p> <pre>...   eval n=replace(deviceVendor, "ArcSight", "HP")</pre>



**Functions supported for eval operations, continued**

<p>round(X)</p>	<p>Rounds X to the nearest integer.</p>	<p>The following example returns 1.  <code>...   eval n=round(1.4)</code></p> <p>The following example returns 2.  <code>...   eval n=round(1.5)</code></p>
<p>sqrt(X)</p>	<p>Takes one numeric argument, X, and returns its square root.</p>	<p>The following example returns 3.  <code>...   eval n=sqrt(9)</code></p>
<p>substr(X,Y,Z)</p>	<p>This function returns a new string that is a substring of string X. The substring begins with the character at index Y and extends up to the character at index Z-1.</p> <div data-bbox="467 772 769 995" style="background-color: #f0f0f0; padding: 5px;"> <p><b>Note:</b> The index is a number that indicates the location of the characters in string X, from left to right, starting with zero.</p> </div>	<p>The following example returns "g".  <code>...   eval n=substr("ArcSight",5,6)</code></p> <p>The following example returns "cSig".  <code>...   eval n=substr("ArcSight",2,6)</code></p> <p>The following example returns "ght".  <code>...   eval n=substr("ArcSight",5,8)</code></p> <p>The following example returns "ArcSight".  <code>...   eval n=substr("ArcSight",0,8)</code></p> <p>The following example returns "Sight".  <code>...   eval n=substr("ArcSight",3,8)</code></p> <p>The following example returns "Arc".  <code>...   eval n=substr("ArcSight",0,3)</code></p>
<p>sum(X,Y,Z,...)</p>	<p>Adds all the numbers together.</p>	<p>The following example returns the sum of the values in the baseEventCount, deviceCustomNumber1, and deviceCustomNumber2 fields.  <code>...   eval newnum = sum(baseEventCount, deviceCustomNumber1, deviceCustomNumber2)</code></p>

### Functions supported for eval operations, continued

<p>trim(X) ltrim(X) rtrim(X)</p>	<p>trim(X) removes all spaces from both sides of the string X.</p> <p>ltrim(X) removes all spaces from the left side of the string X.</p> <p>rtrim(X) removes all spaces from the right side of the string X.</p>	<p>For the sake of the example, assume that X is a literal string and _ represents any number of space characters.</p> <p>The following example returns trimmed="string_". ...   eval trimmed=ltrim("_string_")</p> <p>The following example returns trimmed="_string". ...   eval trimmed=rtrim("_string_")</p> <p>The following example returns "string". ...   eval trimmed=trim("_string_")</p>
<p>upper(X) toupper(X)</p>	<p>Takes one string argument and returns the uppercase version.</p>	<p>The following example returns the value of the field username in uppercase. If username contains fred brown, it returns name=FRED BROWN.</p> <p>...   eval name=upper("username")</p>
<p>urldecode(X)</p>	<p>Takes one URL string argument X and returns the unescaped or decoded URL string.</p>	<p>The following example returns "http://www.hp.com/download?r=header".</p> <p>...   eval n=urldecode("http%3A%2F%2Fwww.hp.com%2Fdownload%3Fr%3Dheader")</p>

### Example One

If the Category Behavior is “Communicate”, then assign the value “communicate” to a new field “cat”; otherwise, assign the value “notCommunicate” to it.

```
_storageGroup IN ["Default Storage Group"] | cef categoryBehavior | eval
cat=if(categoryBehavior== "/Communicate", "communicate", "notCommunicate")
```

### Example Two

Append the word, “END”, at the end of extracted event name. For example, if event name is “Logger Internal Event”, after the eval operation it is “Logger Internal EventEND” and is assigned to a new field, “fullname”.

```
logger | cef msg name | eval fullname=name + "END"
```

### Example Three

Add 100 to the value of bytes In and assign it to a new field, “Plus”. Then, sort the values assigned to “Plus” in ascending order.

```
_storageGroup IN ["Default Storage Group"] | cef bytesIn bytesOut name | eval
Plus=bytesIn +100 | sort Plus
```

## Example Four

Find the longest URLs from the vendor ArcSight.

```
deviceVendor = ArcSight |eval (int)urllength=len(requestUrl) |sort urllength
```

## extract

Extracts key value pairs from raw events.

### Synopsis

```
...| extract [pairdelim="<delimiters>"] [kvdelim="<delimiters>"] [maxchars=<n>]  
fields="key1,key2,key3..."
```

Where:

- `pairdelim` is a delimiter (or a list of delimiters) that separates one key-value pair from another key-value pair in an event. By default, semi colon, pipe, and comma (; | ,) are used.
- `kvdelim` is a delimiter (or a list of delimiters) that separates a key from its value. By default, "=".
- `maxchars` is the maximum number of characters in an event that would be scanned for extracting key value pairs. By default, 10240.
- `fields` is a key (or a list of comma-separated keys) whose values you want to display in the search results.

For example, if you want to display the Name Age, and Location values from this event:

```
Name:Jane | Age:30 | Location:LA
```

extract the "Name", "Age", and "Location" keys and list them in the `fields` list.

### Understanding How the Extract Operator Works

The key represents a field in the raw event and its value consists of the characters that appear after the key until the next key in the event. The following raw event is used to illustrate the concept:

```
[Thu Jul 30 01:20:06 2009] [error] [client 69.63.180.245] PHP Warning:  
memcache_pconnect() [pconnect</a>]: Can't connect to 10.4.31.4:11211
```

To extract the URL from the above event, you can define these key-pair delimiters, which separate the key-value pairs in the event:

- Greater than sign (>)
- Square bracket ([)

And, define this key delimiter, which separates the key from its value:

- Equal to sign (=)

Thus, the following command will extract the URL:

```
... | extract pairdelim= ">\" kvdelim= "=" fields="<a href"
```

The key value pairs in the event will be: [`<a href= 'function.memcache-pconnect' >`

The key in the event will be: `<a href`

The extracted URL will be: `'function.memcache-pconnect'`

## Usage Notes

This operator only works on raw events. That is, you cannot extract key value pairs from CEF events or the fields defined by the rex operator.

You can specify the `pairdelim` and `kvdelim` delimiters in the `extract` operator command to extract keys and their values. However, if you want to determine the key names that these delimiters will generate, use the `keys` operator as described in ["keys" on page 486](#). The `keys` operator can only be used to determine keys; you cannot pipe those keys in the `extract` operator. That is, `...| keys | extract fields=field1` is incorrect.

The keys specified in the fields list can be used further in the pipeline operations. For example, `...| extract pairdelim= "|" kvdelim= ":" fields= "count" | top count`

If none of the specified `pairdelim` characters exists in an event, the event is not parsed into key value pairs. The whole event is skipped. Similarly, if the specified `kvdelim` does not exist, values are not separated from the keys.

To specify double quotes (") as the delimiter, enter it within the pair of double quotes with backslash (\) as the escape character. For example, `"=\"`. Similarly, use two backslashes to treat a backslash character literally. For example, `\"`.

## Example

```
... | extract pairdelim= "|" kvdelim= ":" fields= "Name,Age,Location"
```

Extracts values from events in this format:

Name:Jane | Age:30 | Location:LA

## fields

Includes or excludes specified fields from search results.

### Synopsis

```
... | fields [(+ | -)] <field>+
```

Where:

- + includes only the specified field or fields in the search results. This is the default.
- excludes only the specified field or fields from the search results.

### Usage Notes

Typically, the <field> list contains event fields available in the Logger schema or user-defined fields created using the rex operator prior in the query, as shown in the examples below. However, fields might also be defined by other operators such as the eval operator.

The + and - can be used in the same expression when multiple fields are specified. For example:

```
| fields + name - agentType
```

**Tip:** A complete field name must be specified for this operator; wildcard characters in a field name are not supported.

When this operator is included in a query, select **User Defined Fieldsets** from the System Fieldsets list to view the search results.

### Example One

```
... | fields - agentType + categorySignificance
```

### Example Two

```
... | fields - name
```

## head

Displays the first <N> lines of the search results.

### Synopsis

```
... | head [<N>]
```

<N> is the number of lines to display. Default: **10**, if <N> is not specified.

### Usage Notes

When this operator is included in a query, the search results cannot be previewed. That is, the query must finish running before search results are displayed.

### Example

```
... | head
```

## keys

Identifies keys in raw events based on the specified delimiters.

### Synopsis

```
... | keys [pairdelim= "<delimiters>"] [kvdelim= "<delimiters>"] [limit=<n>]
```

Where:

- `pairdelim` is a delimiter (or a list of delimiters) that separates one key-value pair from another key-value pair in an event. By default, semi colon, pipe, and comma (;|,) are used.
- `kvdelim` is a delimiter (or a list of delimiters) that separates a key from its value. By default, "=".
- `limit` is the maximum number of key value pairs to find. There is no default or maximum number for this parameter.

### Usage Notes

This operator only works on raw events. That is, you cannot identify key value pairs from CEF events or fields defined by the rex operator.

Although this operator is not required to determine keys, it is recommended that you use it to first determine the keys whose values you want to obtain using the extract operator. This operator

returns aggregated results. Therefore, the search results list the keys found in the matching events and their counts.

The keys operator can only be used to determine keys; you cannot pipe those keys in the extract operator. That is, `| keys | extract fields=field1` is incorrect.

If a key value is blank (or null), it is ignored and not counted toward the number of hits.

For example, for the following event data:

```
Date=3/24/2011 | Drink=Lemonade  
Date=3/23/2011 | Drink=  
Date=3/22/2011 | Drink=Coffee
```

**Search Query:** `keys pairdelim= "|" kvdelim= "="`

**Search Result:** Date, 3 hits and Drink, 2 hits

If none of the specified `pairdelim` characters exists in an event, the event is not parsed into key value pairs. The whole event is skipped. Similarly, if the specified `kvdelim` does not exist, values are not separated from the keys.

To specify double quotes (") as the delimiter, enter it within the pair of double quotes with backslash (\) as the escape character. For example, `"=\|"`. Similarly, use two backslashes to treat a backslash character literally. For example, `"\\"`.

## Example One

```
...| keys pairdelim= "|" kvdelim= "="
```

Identifies keys (Date and Drink) in event of this format:

```
Date=3/24/2011 | Drink=Lemonade.
```

## Example Two

```
...| keys pairdelim= "," kvdelim= ">="
```

Identifies keys (Path and IPAddress) in the event of this format:

```
Path>c:\usr\log, IPAddress=1.1.1.1
```

# lookup

Returns an augmented or filtered set of events based on whether they have identical values in the corresponding fields in an uploaded Lookup file.

Before you can use this operator, you must upload a Lookup file to Logger. You can add a Lookup file by uploading a CSV file from the **List Lookup** configuration page.

- For information on when to use the lookup operator, see ["Enriching Logger Data Through Static Correlation" on page 138](#).
- For information about creating Lookup files and uploading them to Logger, see ["Lookup Files" on page 284](#).

## Synopsis

```
... | lookup [+/-/*] lookupTableName externalField1 [as loggerField1] [,  
externalField2 [as loggerField2] ...] [output [ * | externalField1,  
externalField2... ] ]
```

The plus sign (+) selects events where the value in the Lookup field (loggerField1, loggerField2) is identical with that in the uploaded Lookup file (externalField1, externalField2). When the output clause is used, it augments the search results with the specified output columns from in the uploaded Lookup file. + is the default lookup operator. If you do not specify +, -, or \*, + is used.

### Logger Events "AND" External Events

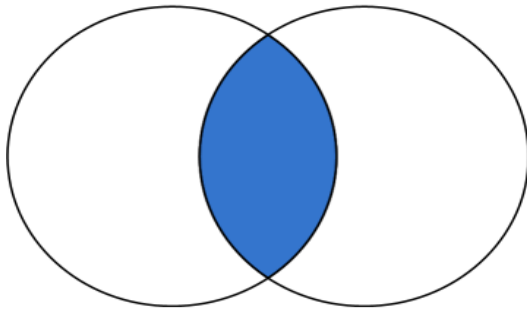

When a Lookup field value matches multiple rows in the uploaded Lookup file, only the first matched row is used. Logger displays an alert message indicating that the Lookup field contains multiple matches in the Lookup file, and that only the first match is included.

The minus sign (-) selects events where the value in the Lookup field is not in the uploaded Lookup file. When you do a lookup with negation, the results will not display the external fields in the UI fields. The output clause is not applicable for negative lookup. This is because the negative lookup **excludes** matches from the uploaded lookup file.

### Logger Events "NOT IN" External Events

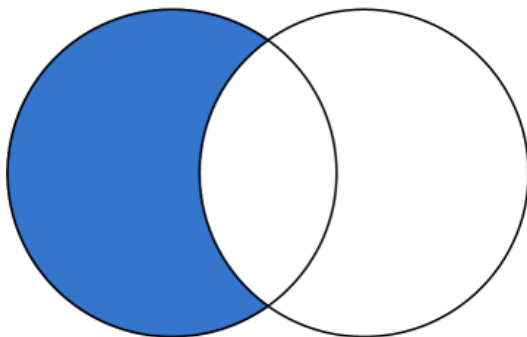



The asterisk (\*) includes all events regardless of whether they are in the uploaded Lookup file. (Performs a left-outer join between the Logger events table and the Lookup file.) When the output clause is used, the output fields will be empty (null) for Logger events that do not have a match in the Lookup file.

#### Logger Events "LEFT JOIN" External Events

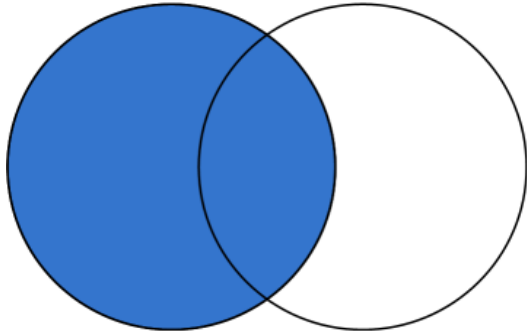

If +, -, or \* is not provided, the default is +.

loggerField1 and loggerField2 are valid field names in Logger search results.

externalField1 and externalField2 are valid column names from the Lookup file.

loggerField1 as externalField1 looks up values between loggerField1 in Logger search results and externalField1 in the uploaded Lookup file.

In the first lookup operator in a search pipeline, loggerField1, must be a valid field name in a Logger event, otherwise, this field can be a Logger field or a search-generated field in the search results from the previous pipeline operator.

loggerField1 as externalField1, loggerField2 as externalField2 performs value lookup on multiple fields between Logger search results and uploaded Lookup file.

[output [ \* | externalField1, externalField2...]] if you specify one or more external fields, augments the search results with the indicated fields. If you use output \*, all fields from uploaded Lookup file are added. When the output clause is not used, no fields from uploaded Lookup file are added to the search results.

#### Usage Notes

**The lookup operator supports specific date/time formats.** Logger event fields can be of three different data types, string, integer, and date/time. The lookup operator converts values in the Lookup fields to a value of the same data type as the corresponding Logger event field.

The lookup operator supports the following formats for date/time fields:

```
MM/dd/yyyy HH:mm:ss z  
MM/dd/yyyy HH:mm:ss  
yyyy/MM/dd HH:mm:ss z  
dd/MMM/yyyy HH:mm:ss Z
```

```
dd MMM yyyy HH:mm:ss z
yyyy-M-d H:mm:ss
yyyy-MM-dd'T'HH:mm:ss
yyyy-MM-dd'T'HH:mm:ssZ
```

**Logger allows about 1GB system memory for all lookup searches.** Running multiple lookup searches simultaneously on large lookup tables could use up the 1GB memory. When this limit is reached, some lookup searches may run more slowly or may time out. If a user starts a lookup search when other lookup searches are running and the memory is full, Logger will display a message that suggests that the user runs the lookup search after the current lookup searches finish and the memory is released.

**Choose Lookup fields that have unique values in the uploaded Lookup file.** The lookup operation only uses the first row that matches and ignores any subsequent matches. Therefore, it is best to have unique values in the lookup column and avoid having duplicate matches ignored.

As an example, look at the following search.

```
| lookup testLU deviceVendor output status
```

where the Lookup file "testLU" contains four rows with same deviceVendor value, "ArcSight", as shown below.

#### testLU

deviceVendor	dept	org
ArcSight	sales	HPE
ArcSight	marketing	HPE
BlueCoat	sales	BlueCoatINC
ArcSight	engineering	HPE
ArcSight	marketing	ESP

When the lookup operation finds duplicates in the Lookup field, ("deviceVendor=ArcSight" in testLU and "deviceVendor=ArcSight" in the Logger events table), the search results use only the first entry, "status\_testLU=ok" to augment the matching Logger event, while subsequent matches, such as "status\_testLU=alert", are NOT used.

**Tip:** In some rare situations, a blank page may be returned after you upload a Lookup File from the Add Lookup File page. If this happens, refresh the page manually. After the refresh, you are returned to the loading page and the process tries to load the Lookup File again. Since the file was already uploaded, you get an error message. You can safely ignore the error.

### Using IP Addresses in Lookup Files

The Lookup process automatically determines whether the Lookup file consists of IP addresses, and if so treats them as IP addresses rather than strings. When performing a search using a Lookup file,

Logger checks the first ten rows of each Lookup column to determine whether it contains only IP addresses.

- If a Lookup column contains only IP addresses in the first ten rows, Logger assumes that the rest of rows in that column contain IP addresses.

**Note:** Including non-IP address data later in the same column may cause an exception.

- If the first ten rows contain strings that are not IP addresses, Logger uses the field type of the corresponding Logger event column to determine the data type.
- If the Lookup process determines that it's an IP address lookup based on the above rule, the search will find matching IP addresses in any equivalent IP address format.

For example, if your Lookup column has some things that are not IP addresses in the first ten rows:

- Searching for the string “2001:db8:250:0:0:fefe:0:1” would find only events where the target field is the exact string “2001:db8:250:0:0:fefe:0:1”
- Searching for the string “192.168.10.100” would find only events where the target field is the exact string “192.168.10.100”.

Whereas, if your Lookup file has only IP addresses in the first ten rows:

- Searching for the address “192.0.2.010” could find events with addresses such as: “192.0.2.010” and “192.0.2.10”.

## Example One

The following example looks up events where the sourceAddress comes from the IP address listed in a lookup file named “maliciousIP” under the column named “ip”.

```
lookup maliciousIP ip as sourceAddress
```

## Example Two

The following example looks up access events with a sourcePort different from the sourcePort in day\_x, where day\_x is the lookup file generated from the exported Logger events on a day before.

```
access | lookup - day_x sourcePort
```

## parse

Applies the named parser to the matching events of a search query.

### Synopsis

```
... | parse <parser_name>
```

Where <parser\_name> is the name of the parser to use. For information on how to create a parser, see ["Working with Parsers" on page 317](#).

**Tip:** The parser must exist before it can be used in a query.

The parse operator is useful in parsing the non-CEF (unstructured textual) data stored on Logger and parsing it into specific fields according to the parser's definition.

Once parsed into fields, this data can be used further in search operations. For example, the following parse operator parses the events using a user-defined parser "Web Server Access Logs" such that "username", "login\_status", "num\_attempts" fields are created.

You can use these created fields further in a pipeline query to display the top 10 user names that resulted in the maximum failed login attempts and the number of attempts they made.

```
... | parse Web Server Access Log | where login_status = "failed" | top  
username num_attempts
```

Because the parser definitions are rex or extract expressions, they create additional fields to contain values that match the specified expression. These fields are displayed in the Search Results just like the results of any rex or extract expression. Therefore, in the above example, three additional fields will be added to the Search Result: username, login\_status, num\_attempts.

An additional field called "parser" is also added to the Search Results when the parse operator is used in a search query.

This field contains the name of the parser when the parser is able to parse one or more fields specified in the definition for the matching events. If the event was not parsed successfully, if no parser is defined for the source type, or if there is no source type, this field displays, this field contains "Not parsed". Similarly, the field contains the value "not parsed" when the parser definition is not able to parse any fields of the matching event.

### Example

You can also use this field to find out events that were successfully parsed or did not parse:

```
... | parse Web Server Access Log | where parser = "not parsed"
```

## Usage Notes

**When to use the parse operator:** When non-CEF events are received through TCP or UDP receivers on Logger, they are not associated with a source type and thus a parser definition. Therefore, such events are not parsed automatically. Similarly, non-CEF events stored on Logger version 5.2 or earlier are not parsed since the parser feature did not exist in those versions. If you need such events parsed when they match a query, use the parse operator.

When an event for which a defined source type exists on Logger is parsed through the parse operator, it can result in the creation of multiple user-defined fields—through the parser associated with the source type and through the parser you specified in the parser pipeline command. If both parsers create unique field names, all those fields are created when a query that matches the event is run. If the parsers specify one or more same name fields, the field names specified in the parse operator parser take precedence as this parser is applied last.

## Example

```
...| parse Web Server Access Log | where url CONTAINS “.org” | top url
```

## rare

Lists the search results in a tabular form of the least common values for the specified field. That is, the values are listed from the lowest count value to the highest.

When multiple fields are specified, the count of unique sets of all those fields is listed from the lowest to highest count.

## Synopsis

```
...| rare <field1> <field2> <field3> ...
```

Sorts the matching results from least to most common for the specified fields.

## Usage Notes

Typically, the <field> list contains event fields available in the Logger schema or user-defined fields created using the rex or eval operators prior in the query, as shown in the examples below. However, fields might also be defined by other operators such as the eval operator.

A chart of the search results is automatically generated when this operator is included in a query. You can click on a charted value to quickly filter down to events with specific field values. For more information, see ["Chart Drill Down" on page 120](#).

If multiple fields are specified, separate the field names with a white space or a comma.

## Example

```
... | rare deviceEventCategory
```

## regex

Selects events that match the specified regular expression.

### Synopsis

```
... | regex <regular_expression>
```

OR

```
... | regex <field> (=|!=) <regular_expression>
```

### Usage Notes

Regular expression pattern matching is case insensitive.

The first usage (without a field name) is applied to the raw event. While the second usage (with a field name), is applied to a specific field.

If you use the second usage (as shown above and in the second example, below), either specify an event field that is available in the Logger schema or a user-defined field created using the `rex` or `eval` operators.

## Examples

```
... | regex "failure"
```

```
... | regex deviceEventCategory != "fan"
```

## rename

Renames the specified field name.

### Synopsis

```
... | rename <field> as <new_name>
```

Where:

- `<field>` is the name of an event field that is available in the Logger schema or a user-defined field created using the `rex` or `eval` operator.

- <new\_name> is the new name you want to assign to the field.

## Usage Notes

An additional column is added to the search results for each renamed field. The field with the original name continues to be displayed in the search results in addition to the renamed field. For example, if you rename `deviceEventCategory` to `Category`, two columns are displayed in the search results: `deviceEventCategory` and `Category`.

You can include the wildcard character, `*`, in a field name. However, you must enclose the field that contains a wildcard character in double quotes (`"`). For example:

```
...| rename "*IPAddress" as "*Address"
```

OR

```
...| rename "*IPAddress" as Address
```

If a field name includes a special character (such as `_`, a space, `#`, and so on), it should be included in double quotes (`"`) in the rename operator expression. For example:

```
...| rename src_ip as "Source IP Address"
```

If the resulting field of a rename operation includes a special character, it must be enclosed in double quotes (`"`) whenever you use it in the pipeline operator expression. For example,

```
...| rename src_ip as "Source IP Address" | top "Source IP Address"
```

The internal field names (that start with `"_raw"`) cannot be renamed.

The renamed fields are valid only for the duration of the query.

The resulting field of a rename operation is case sensitive. When using such a field in a search operation, make sure that you use the same case that was used to define the field.

When you export the search results of a search query that contains the rename expression, the resulting file contains the renamed fields.

## Example

```
...| rename src_ip as IPAddress
```

```
...| rename src_ip as "Source IP Address"
```

# replace

Replaces the specified string in the specified fields with the specified new string.

## Synopsis

```
<orig_str> with <new_str> [in <field_list>]
```

Where:

- <orig\_str> is the original string you want to replace.
- <new\_str> is the new string you want to replace with.
- <field\_list> is the optional, however highly recommended.

## Usage Notes

**Tip:** Even though the field list is optional for this command, HPE strongly recommends that you specify the fields on which the replace operator should act in this command.

If you skip the field list, the replace operator acts on the fields that have been either explicitly defined using the cef, rex, and eval operators preceding the replace command, or any fields that were used in other operator commands that preceded the replace operator command.

For example, the replace command acts on deviceEventCategory in all of the following cases and replaces all instances of “EPS” with “Events”:

```
...| replace *EPS* with *Events* in deviceEventCategory  
...| cef deviceEventCategory | replace *EPS* with *Events*  
...| top deviceEventCategory | replace *EPS* with *Events*
```

An additional column of the same name is added to the search results for each field in which string is replaced. The column with the original value continues to be displayed in the search results in addition to the column with replaced values. For example, if you replace “err” with “Error” in the “message” column, an additional “message” column is added to the search results that contains the modified value.

If you want to replace the entire string, specify it in full (as it appears in the event). For example, “192.168.35.3”.

If you want to replace a part of the string, include wildcard character (\*) for the part that is not going to change.

For example, if the original string (the string you want to replace) is “192.168\*”, only the 192.168 part in an event is replaced. The remaining string is preserved. As a result, if an event contains 192.168.35.3, only the first two bytes are replaced. The rest (35.3) will be preserved. Similarly, if the event contains 192.168.DestIP, DestIP will be preserved. However, if the event contains the string 192.168, it will not be replaced.

If both, the original and the new strings contain wildcard characters, the number of wildcard characters in the *original* string must match the number of wildcard characters in the *new* string.

```
...| replace “*.168.*” with “*.XXX.*”
```



If the original or the new string includes a special character such as / or ?, enclose the string in double quotes (“”):

```
...| replace “/Monitor” with Error
```

You can replace multiple values for multiple fields in a single operation by separating each expression with a comma (,). Note that you must specify the field list after specifying the “with” expression for all values that you want to replace, as shown in the following example:

```
...| replace "Arc*" with HP, "cpu:100" with EPS in deviceVendor,  
deviceEventClassId
```

The original string is case-insensitive. Therefore, the string “err” will replace an event that contains “Err”.

### Example One

Replace any occurrence of “a” with “b” but the characters preceding “a” and succeeding it are preserved.

```
...| replace *a* with *b*
```

### Example Two

Replace any occurrence of “a” with “b” without retaining any characters preceding or succeeding “a”.

```
...| replace *a* with b in name
```

## rex

Extracts (or capture) a value based on the specified regular expression or extract and substitute a value based on the specified “sed” expression. The value can be from a previously specified field in the query or a raw event message.

### Synopsis

```
... | rex <regular_expression containing a field name>
```

Or

```
... | rex field = <field> mode=sed “s/<string to be  
substituted>/<substitution value>”
```

### Understanding How Extraction Works

When the value is extracted based on a regular expression, the extracted value is assigned to a field name, which is specified as part of the regular expression. The syntax for defining the field name is ?<fieldname>, where `fieldname` is a string of alphanumeric characters. Using an underscore (“\_”) is not recommended.

For example, use the following event to illustrate the power of rex.

```
[Thu Jul 30 01:20:06 2009] [error] [client 69.63.180.245] PHP Warning: Can't connect to 10.4.31.4:11211
```

If you want to extract any IP address from the above event and assign it to a field called `IP_Address`, specify the following rex expression:

```
| rex "(?<IPAddress>\d{1,3}\.\d{1,3}\.\d{1,3}\.\d{1,3})"
```

However, if you wanted to extract the IP address after the word "client" from the following event and assign it to a field called `SourceIP`, you will need to specify a start and end point for IP address extraction, so that the second IP address in the event is not captured. The starting point in this event can be `[client` and the end point can be `]`. Thus, the rex expression will be:

```
| rex "\[client (?<SourceIP>[^\]]*)"
```

In this rex expression `?<SourceIP>` is the field name defined to capture IP address and `client` specifies the text or point in the event AFTER which data will be extracted. The `[^\]]*` expression will match every character that is not a closing right bracket, therefore, for our example event, the expression will match until the end of the first IP address and not the second IP address that appears after the word "to" in the event message.

## Understanding How Substitution Works

When the rex operator is used in sed mode, you can substitute the values of extracted fields with the values you specify. For example, if you are generating a report of events that contain credit card numbers, you might want to substitute the credit card numbers to obfuscate the real numbers.

The substitution only occurs in the search results. The actual event is not changed.

In the following example, the credit card numbers in the `CCN` field are substituted with "xxxx", thus obfuscating sensitive data:

```
| rex field=CCN mode=sed "s/*/xxxx/g"
```

The `/g` at the end of the command indicates a global replace, that is, all occurrences of the specified pattern will be replaced in all matching events. If `/g` is omitted, only the first occurrence of the specified pattern in each event is replaced.

Multiple substitutions can be performed in a single command, as shown in the following example. In this example, the word "Authentication" is substituted with "xxxx" globally (for all matching events), the first byte of the agent address that start with "192" is substituted with "xxxx" and an IP address that starts with "10" is substituted with "xxxx".

```
| rex field=msg mode=sed "s/Authentication/xxxx/g" | rex field=agentAddress mode=sed "s/192/xxxx/g" | rex field=dst mode=sed "s/10.*/xxxx/g"
```

## Usage Notes

A detailed tutorial on the rex operator is available at ["Using the Rex Operator" on page 511](#).

A Regex Helper tool is available for formulating regular expressions of fields in which you are interested. The Regex Helper parses an event into fields. Then, you select the fields that you want to include in the rex expression. The regular expression for those fields is automatically inserted in the Search box. For detailed information on the Regex Helper tool, see ["Regex Helper Tool" on page 96](#).

The extracted values are displayed as additional columns in the All Fields view (of the System Fieldsets). To view only the extracted columns, select **User Defined Fieldsets** from the System Fieldsets list. In the above example, an additional column with heading "SourceIP" is added to the All Fields view; IP address values extracted from events are listed in this column.

If you want to use other search operators such as fields, sort, chart, and so on to refine your search results, you must first use this operator to extract those fields.

### Example One

The following example extracts name and social security number from an event that contains data in name: John ssn:123-45-6789 format and assigns them to Name and SSN fields:

```
... | rex "name: (?<Name>.*) ssn: (?<SSN>.*)"
```

### Example Two

The following example extracts URLs from events and displays the top 10 of the extracted URLs:

```
... | rex "http://(?<URL>[^\ ]*)" | top URL
```

### Example Three

The following example substitutes the last four digits of social security numbers extracted in the first event with xxxx:

```
... | rex field=SSN mode=sed "s/-\d{4}/-xxxx/g"
```

## sort

Sorts search results as specified by the sort criteria.

### Synopsis

```
... | sort [<N>] ((+ | -) field)+
```

Where:

- The plus sign (+) sorts the results by specified fields in ascending order. This is the default.
- The minus sign (-) sorts the results by specified fields in descending order.
- <N> keeps the top N results, where N can be a number between 1 and 10,000. Default: 10,000.

### Usage Notes

Typically, the <field> list contains event fields available in the Logger schema or user-defined fields created using the rex operator prior in the query. However, fields might also be defined by other operators such as the eval operator.

Sorting is based on the data type of the specified field.

When multiple fields are specified for a sort operation, the first field is used to sort the data. If there are multiple same values after the first sort, the second field is used to sort within the same values, followed by third field, and so on. For example, in the example below, first the matching events are sorted by “cat” (device event category). If multiple events have the same “cat”, those events are further sorted by “eventId”.

When multiple fields are specified, you can specify a different sort order for each field. For example, | sort + deviceEventCategory - eventId.

If multiple fields are specified, separate the field names with a white space or a comma.

Sorting is case-sensitive. Therefore, “Error:105” will precede “error:105” in the sorted list (when sorted in ascending order).

When a sort operator is included in a query, only the top 10,000 matches are displayed. This is a known limitation and will be addressed in a future Logger release.

When this operator is included in a query, the search results are not previewable. That is, the query must finish running before search results are displayed.

### Example

```
... | sort deviceEventCategory eventId
```

## tail

Displays the last <N> lines of the search results.

### Synopsis

```
...| tail [<N>]
```

Where:

<N> is the number of lines to display. Default: **10**, if <N> is not specified.

### Usage Notes

When this operator is included in a query, the search results cannot be previewed. That is, the query must finish running before search results are displayed.

### Example

```
... | tail 5
```

## top

Lists the search results in a tabular form of the most common values for the specified field. That is, the values are listed from the highest count value to the lowest.

### Synopsis

```
...| top [<N>] <field1> <field2> <field3> ...
```

<N> limits the matches to the top n values for the specified fields. Default: 500, if <N> is not specified.

### Usage Notes

The fields can be either event fields available in the Logger schema or user-defined fields created using the `rex` or `eval` operators prior in the query. If multiple fields are specified, separate the field names with a white space or a comma.

When multiple fields are specified, the count of unique sets of all those fields is listed from the highest to lowest count.

A chart of the search results is automatically generated when this operator is included in a query. You can click on a charted value to quickly filter down to events with specific field values. For more information, see ["Chart Drill Down" on page 120](#).

To limit the matches to the top  $n$  values for the specified fields, specify a value for  $n$ .

The value you specify overrides the default value of 500. For example, the following query:

```
... | top 1000 deviceEventCategory
```

charts the events with the 1000 most common values in the deviceEventCategory field.

**Note:** When a chart displays too many events, it can be difficult to read. Therefore, the number of events returned is limited to 500 by default. If you need to change that default number, please contact Customer Support.

## Examples

```
... | top deviceEventCategory
```

```
... | top 5 categories
```

# transaction

Groups events that have the same values in the specified fields.

## Synopsis

```
... | transaction <field1> <field2>... [maxevents=<number>] [maxspan=<number>  
[s|m|h|d]] [maxpause=<number>[s|m|h|d]] [startswith=<reg_exp>]  
[endswith=<reg_exp>]
```

Where:

`field1`, `field2` is a field or a comma-separated field list whose values are compared to determine events to group. If a field list is specified, the values of the unique sets of all those fields are used to determine events to group. For example, if `host` and `portNum` are specified, and two events contain “hostA” and “8080”, the events are grouped in a transaction.

`maxevents` specifies the maximum number of events that can be part of a single transaction. For example, if you specify 5, after five matching events have been found, additional events are not included in the transaction. Default: 1000

`maxspan` specifies the limit on the duration of the transaction. That is, the difference in time between the first event and all other events in a transaction will never be more than the specified `maxspan` limit. For example, if you specify `maxspan=30s`, the event time of all events within the transaction will be at most 30 seconds more than the event time of the first event in the transaction. Default: Unlimited

`maxpause` specifies the length of time by which consecutive events in a transaction can be apart. That is, this option ensures that events in a single transaction are never more than the `maxpause` value from the previous event in the transaction. Default: Unlimited

`startswith` specifies a regular expression that is used to recognize the beginning of a transaction. For example, if a transaction operator includes `startswith= "user [L|l]ogin"`, all events are scanned for this regular expression. When an event matches the regular expression, a transaction is created, and subsequent events with matching fields are added to the transaction.

**Note:** The regular expression is applied to the raw event, not to a field in an event.

`endswith` specifies a regular expression that is used to recognize the end of an existing transaction. That is, an existing transaction is completed when an event matches the specified "endswith" regular expression. For example, if a transaction operator includes `endswith= "[L|l]ogout"`, any event being added to a transaction is checked, and if the regular expression matches the event, the transaction is completed.

**Note:** The regular expression is applied to the raw event, not to a field in an event.

## Usage Notes

Several of the above options specify conditions to end a transaction. Therefore, when multiple end conditions are specified in a transaction operator, the first end condition that occurs will end the transaction even if the other conditions have not been satisfied yet. For example, if `maxspan` is reached but `maxevents` has not been reached, or if the `endswith` regular expression is matched but `maxevents` has not been reached.

## Understanding How the Transaction Operator Works

A transaction is a set of events that contain the same values in the specified fields. The events may be further filtered based on the options described above, such as `maxspan`, `maxpause`, and so on. In addition to grouping events, the transaction operator adds these fields to each event: `transactionid`, `duration`, and `eventcount`. These fields are displayed in the Search Results as separate columns.

A `transactionid` is assigned to each transaction when the transaction completes. Transaction IDs are integers, assigned starting from 1 for the transactions (set of events) found in the current query. All events in the same transaction will have the same transaction ID.

If an event does not belong to any transaction found in the current query, it is assigned the transaction ID 0. For example, in a transaction operator with a `startswith` regular expression, if the first event in the pipeline does not match the regular expression, that event is not part of the transaction, and is assigned transaction ID 0.

The `duration` is the time in milliseconds of the duration of a transaction, which is the difference between the event time of the last event in the transaction and the first event in the transaction. The `duration` field for all events in a transaction is set to the `duration` value of the transaction.

The `eventcount` displays the number of events in a transaction.

### Example One

To view source addresses accessed within a 5-minute duration:

```
... | transaction sourceAddress maxspan=5m
```

### Example Two

To group source addresses by source ports and view 5 events per group:

```
...| transaction sourceAddress sourcePort maxevents=5
```

### Example Three

To group users and URLs they accessed within a 10-minute duration:

```
... | transaction username startswith= "http://" maxspan=10m
```

### Example Four

To view login transactions from the same session ID and source address in a 1-hour duration:

```
... | transaction sessionID sourceAddress maxspan=1h startswith= "user  
[L|l]ogin"
```

## where

Displays events that match the criteria specified in the "where" expression.

### Synopsis

```
...| where <expression>
```

<expression> can be any valid field-based query expression, as described in ["Indexed Search Portion of a Query" on page 70](#).

### Usage Notes

<expression> can only be a valid field-based query expression. Arithmetic expressions or functions are not supported.



## Examples

... | where eventId is NULL

... | where eventId=10006093313 OR deviceVersion CONTAINS "4.0.6.4924.1"

... | where eventId >=10005985569 OR categories= "/Agent/Started"

# Appendix B: Using SmartConnectors to Collect Events

Similar to ArcSight Manager, Logger leverages the ArcSight SmartConnectors to collect events. SmartConnectors can read security events from heterogeneous devices on a network (such as firewalls and servers) and filter events of interest (and optionally aggregate them) and send them to a Logger receiver. Logger can receive structured data in the form of normalized Common Event Format (CEF) events from the SmartConnectors.

The following topics give basic information. For details on a specific Connector, refer to the documentation for that Connector.

- [SmartMessage](#) .....506
- [Configuring a SmartConnector to Send Events to Logger](#) ..... 507
- [Configuring SmartConnectors to Send Events to Both Logger and an ArcSight Manager](#) ..... 507
- [Configuring SmartConnectors for Failover Destinations](#) .....508
- [Sending Events from ArcSight ESM to Logger](#) .....509

## SmartMessage

SmartMessage is an ArcSight technology that provides an efficient secure channel for Common Event Format (CEF) events between ArcSight SmartConnectors and Logger.

**Caution:** SmartMessage and FIPS require SmartConnector 4.7.5 or later. If you do not have the current build, download the latest from the HPE ArcSight web site.

Older SmartConnectors will work with Logger, but may not support SmartMessage or FIPS.

SmartMessage provides an end-to-end encrypted secure channel using secure sockets layer (SSL). One end is an ArcSight SmartConnector, receiving events from the many devices supported by ArcSight SmartConnectors. The other end is a SmartMessage receiver on Logger.

**Note:** The SmartMessage secure channel uses SSL protocol to send encrypted events to Logger. This is similar to, but different from, the encrypted binary protocol used between SmartConnectors and ArcSight Manager.

## Configuring a SmartConnector to Send Events to Logger

Logger comes pre-configured with a SmartMessage Receiver. To use it to receive events from a SmartConnector, you must configure the SmartConnector as described below. You can also create new SmartMessage receivers and configure the SmartConnectors with these newly created receivers. When configuring a SmartConnector, be sure to specify the correct receiver name.

### To configure a SmartConnector to send events to Logger:

1. Install the SmartConnector component using the SmartConnector User's Guide as a reference. Specify Logger as the destination instead of ArcSight ESM or a CEF file.

**Note:** Refer to the documentation that came with your SmartConnector for instructions.

2. Specify the required parameters. Enter the Logger hostname or IP address and the name of the SmartMessage receiver. These settings must match the receiver in Logger that listen for events from this connector.
  - To use the preconfigured receiver, specify **SmartMessage Receiver** as the Receiver Name.
  - To use SmartMessage to communicate between an ArcSight SmartConnector and a Logger Appliance, configure the SmartConnector to use port 443.
  - To communicate between an ArcSight SmartConnector and Software Logger, configure the SmartConnector to use the port configured for the Software Logger.
  - For unencrypted CEF syslog, enter the Logger hostname or IP address, the desired port, and choose UDP or TCP output.

## Configuring SmartConnectors to Send Events to Both Logger and an ArcSight Manager

You can configure a SmartConnector to send CEF syslog output to Logger and send events to an ArcSight Manager at the same time.

For more information about CEF, refer to the document "ArcSight CEF." For a downloadable a copy of this guide, search for "ArcSight Common Event Format (CEF) Guide" in the [ArcSight Product Documentation Community on Protect 724](#).

1. Install the SmartConnector normally. Register the SmartConnector with a running ArcSight Manager and test that the SmartConnector is up and running.

2. Start the SmartConnector configuration program again using the `$ARCSIGHT_HOME/current/bin/runagentsetup` script (or `arcsight agentsetup -w`).
3. Select **I want to add/remove/modify ArcSight Manager destinations**, then choose **Add new destination**.
4. Choose **Logger** and specify the requested parameters. Restart the SmartConnector for changes to take effect.

## Configuring SmartConnectors for Failover Destinations

SmartConnectors can be configured to send events to a secondary, failover, destination when a primary connection fails.

### To configure a failover destination, follow these steps:

1. Configure the SmartConnector for the primary Logger as described above. The transport must be raw TCP in order to detect the transmission errors that trigger failover.
2. Edit the `agent.properties` file in the directory `$ARCSIGHT_HOME/current/user/agent`, where `$ARCSIGHT_HOME` is the root directory where the SmartConnector component was installed.  
Add this property: `transport.types=http,file,cefsyslog`  
Delete this property: `transport.default.type`.
3. Start the SmartConnector configuration program again using the `$ARCSIGHT_HOME/current/bin/runagentsetup` script (or `arcsightagentsetup -w`).
4. Choose **I want to add/remove/modify** and, with the primary Logger selected, choose **Modify**. Then select **Add failover destination**.
5. Enter information for the secondary Logger.
6. Restart the SmartConnector for the changes to take effect.
7. For more information about installing and configuring ArcSight SmartConnectors, refer to the ArcSight SmartConnector User's Guide, or specific SmartConnector Configuration Guides, available from the [ArcSight Product Documentation Community on Protect 724](#).

## Sending Events from ArcSight ESM to Logger

The ArcSight Forwarding SmartConnector can read events from an ArcSight Manager and forward them to Logger as CEF-formatted syslog messages.

**Note:** The Forwarding SmartConnector is a separate installable file, named similar to this:

ArcSight-4.x.x.<build>.x-SuperConnector-<platform>.exe

Use build 4810 or later for compatibility with Logger.

### To configure the ArcSight Forwarding SmartConnector to send events to Logger:

1. Install the SmartConnector component normally, but cancel the installation when the SmartConnector Wizard asks whether the target Manager uses a demo certificate.



When the first screen of the SmartConnector Configuration Wizard appears, asking about a demo certificate, click **Cancel**.

2. Confirm that you want to exit, then click **Done** to dismiss the Install Wizard. This will install the SmartConnector, but leave it un-configured.
3. Create a file called **agent.properties** in the directory `$ARCSIGHT_HOME/current/user/agent`, where `$ARCSIGHT_HOME` is the root directory where the SmartConnector component was installed. This file should contain a single line:

```
transport.default.type=cefsyslog
```

4. Start the SmartConnector configuration program again using the `$ARCSIGHT_HOME/current/bin/runagentsetup` script (or `arcsight agentsetup -w`).
5. Specify the required parameters for CEF output. Enter the desired port for UDP or TCP output.

**Tip:** These settings will need to match the receiver you create in Logger to listen for events from ArcSight ESM.

Parameter	Description
Ip/Host	IP or host name of the Logger
Port	514 or another port that matches the receiver
Protocol	UDP or Raw TCP
ArcSight Source Manager Host Name	IP or host name of the source ArcSight Manager
ArcSight Source Manager Port	8443 (default)
ArcSight Source Manager User Name	A user account on the source Manager with sufficient privileges to read events
ArcSight Source Manager Password	Password for the specified Manager user account
SmartConnector Name	A name for the ESM to Logger connector (visible in the Manager)
SmartConnector Location	Notation of where this connector is installed
Device Location	Notation of where the source Manager is installed
Comment	Optional comments

To configure the Forwarding SmartConnector to send CEF output to Logger and send events to another ArcSight Manager at the same time, see ["Configuring SmartConnectors to Send Events to Both Logger and an ArcSight Manager" on page 507](#).

For more information about CEF, refer to the document "ArcSight CEF." For a downloadable a copy of this guide, search for "ArcSight Common Event Format (CEF) Guide" in the [ArcSight Product Documentation Community on Protect 724](#).

# Appendix C: Using the Rex Operator

The rex operator is a powerful operator that enables you to extract information that matches a specified regular expression and assigns it to a field, whose field name you specify. You can also specify an optional start point and an end point in the rex expression between which the information matching the regular expression is searched.

When a rex expression is included in a search query, it must be preceded by a basic search query that finds events from which the rex expression will extract information. For example:

```
failed | rex "(?<srcip>[^\ ]\d{1,3}\.\d{1,3}\.\d{1,3}\.\d{1,3})"
```

The following topics describe the rex search operator in detail.

- [Syntax of the rex Operator](#) .....511
- [Ways to Create a rex Expression](#) ..... 513
- [Example rex Expressions](#) ..... 514

## Syntax of the rex Operator

```
| rex "text1(?<field1>text2regex)"
```

Where:

- **text1:** The text or point in the event AFTER which information extraction begins. The default is the beginning of the event.
- **text2:** The text or point in the event at which information extraction ends.
- **field1:** The name of the field to which the extracted information is assigned.
- **regex:** The pattern (regular expression) used for matching information to be extracted between **text1** and **text2**.

**Tip:** If you are an experienced regular expression user, see the Note in the next section for a quick understanding of how rex enables you to capture named input and reference it for further processing.

## Understanding the rex Operator Syntax

Extract all information *after* **text1** and until **text2** that matches the specified **regex** (regular expression) and assign to **field1**.

- **text1** and [**text2**] can be any points in an event—start and end of an event, specific string in an event (even if the string is in the middle of a word in the event), a specific number of characters from

the start or end of an event, or a pattern.

- To specify the next space in the event as text2, enter [^ ].

This is interpreted as “not space.” Therefore, entering a “not” results in the capture to stop at the point where the specified character, in this case, a space, is found in the event.

- To specify [text2] to be the end of the line, enter [^\$].

This is interpreted as "not end of line." Therefore, when an end-of-line in an event is encountered, the capture will stop at that point. The [^\$] usage only captures one character if it is not an end-of-line character. However, by specifying [^\$]\* in a rex expression, the usage captures all characters until end-of-line.

You can also specify .\* to capture all characters in an event instead of [^\$]. Examples in this document, however, use [^\$].

- Any extra spaces within the double quotes of the rex expression are treated literally.
- The characters that need to be escaped for rex expressions are the same as the ones for regular expressions. Refer to a regular expressions document of your choice to obtain a complete list of such characters.
- Information captured by a rex expression can be used for further processing in a subsequent rex expression as illustrated in the following example in which an IP address is captured by the first rex expression and the network ID (assuming the first three bytes of the IP address represent it) to which the IP address belongs is extracted from the captured IP address:

```
logger | rex "(?<srcip>[^ ]\d{1,3}\.\d{1,3}\.\d{1,3}\.\d{1,3})" | rex  
field=srcip "(?<netid>\d{1,3}\.\d{1,3}\.\d{1,3})"
```

**Note:** If you are an experienced regular expression user, you can interpret the rex expression syntax as follows:

```
rex "(?<field1>regex)"
```

where the entire expression in the parentheses specifies a named capture. That is, the captured group is assigned a name, which can be referenced later for further processing. For example, in the following expression “srcip” is the name assigned to the capture.

```
failed | rex "(?<srcip>[^ ]\d{1,3}\.\d{1,3}\.\d{1,3}\.\d{1,3})"
```

Once named, use “srcip” for further processing as follows:

```
failed | rex "(?<srcip>[^ ]\d{1,3}\.\d{1,3}\.\d{1,3}\.\d{1,3})" | top  
srcip
```



## Ways to Create a rex Expression

You can create a rex expression in two ways:

- Manually: Follow the syntax and guidelines described in this appendix to create a rex expression to suit your needs.
- Regex Helper: Use the Regex Helper tool, as described in ["Regex Helper Tool" on page 96](#). This tool not only simplifies the process, it also makes it less error prone and more efficient.

### Creating a rex Expression Manually

Start with a simple search that finds the events that contains the information in which you are interested. Once the events are displayed, identify a common starting point in those events that precedes the information.

For example, say you want to extract the client IP address, which always appears after the word “[client” in the following event:

```
[Thu Jul 30 01:20:06 2009] [error] [client 69.63.180.245] PHP Warning:  
memcache_pconnect() [pconnect</a>]: Can't connect to 10.4.31.4:11211
```

Therefore, “[client” is the starting point. A good end point is the “]” after the last byte of the client IP address. Now, we need to define the regular expression that will extract the IP address. Because in this example, only the client IP address appears after the word “client”, we use “\*” as the regular expression, which means “extract everything”. (We could be more specific and use `\d{1,3}\.\d{1,3}\.\d{1,3}\.\d{1,3}` for the IP address.) We assign the extracted IP address to a field name “clientIP”. We are almost ready to create a rex expression, except that we need to escape the “[” and “]” characters in the expression. The escape character to use is “\”.

Now, we are ready to create the rex expression to extract the IP address that appears after the word “client” in the event shown above:

```
| rex "\[client(?<clientip>[^\]]*)"
```

## Example rex Expressions

This section contains several sample examples for extracting different types of information from an event. The specificity of the information extracted increases with each example. Use these examples as a starting point for creating rex expressions to suit your needs. Also, use the Regex Helper tool that simplifies rex expression creation.

The following event examples illustrate how different rex expressions extract information.

### Example One

The following rex example uses this event for illustration:

```
2010/07/01 13:46:00 PDT      unknown      Local      ArcSight      Logger      4.5.0.4836.0      eps:100
CEF:0|ArcSight|Logger|4.5.0.4836.0|eps:100|Logger Internal Event|1| cat=/Monitor/Receiver/All/EP5 cs2=SinceLastMonitorEvent cnt=1 dvc=192.168.36.3 cs1=Events/s
2010/07/01 13:46:00 PDT      unknown      Local      ArcSight      Logger      4.5.0.4836.0      eps:100
CEF:0|ArcSight|Logger|4.5.0.4836.0|eps:100|Logger Internal Event|1| cat=/Monitor/Forwarder/All/EP5 cs2=SinceLastMonitorEvent cnt=1 dvc=192.168.36.3 cs1=Events/s
```

- Capture matching events from the left of the pipeline and assign them to the field message. The entire event is assigned to the message field.

```
| rex "(?<message>[^\$]*)"
```

This expression extracts the entire event (as shown above), starting at the word “CEF:0”.

- Specifying the starting point as number of characters from the start of an event instead of a specific character or word

```
| rex "[a-zA-Z0-9:\.\s]{16}(?<message>[^\$]*)"
```

This expression starts extracting after 16 **consecutive** occurrences of the characters specified for text1—alphanumeric characters, colons, periods, or spaces. Although the first 16 characters of the first event are CEF:0|ArcSight|L, the extraction does not begin at “Logger|4.5.0...” because the pipeline character is not part of the characters we are matching, but this character is part of the beginning of the event. Therefore, the first 16 consecutive occurrences are “Logger Internal” As a result, information starting at the word Event is extracted from our example event.

- Extract a specified number of characters instead of specifying an end point such as the next space or the end of the line

```
| rex "[a-zA-Z0-9:\.\s]{16}(?<message>[^\$]{5})"
```

This expression only extracts the word “Event.” (See the previous sample rex expression for a detailed explanation of the reason extraction begins at the word “Event”.)

- Extract everything after “CEF:0|” into the message field. Then, pipe events for which the message field is not null through another rex expression to extract the IP address contained in the matching events and assign the IP addresses to another field, msgip. Only display events where msgip is not null.

```
| rex "CEF:0\|(?<message>[^\$]*)" | where message is not null | rex "dvc=(?[^\ ]\d{1,3}\.\d{1,3}\.\d{1,3}\.\d{1,3})" | where msgip is not null
```

**Note:** The colon (: ) and equal sign (=) characters do not need to be escaped; however, pipe (|) characters must be escaped. The characters that need to be escaped for rex expressions are the same as the ones for regular expressions. Refer to a regular expressions document of your choice to obtain a complete list of such characters.

This expression extracts the device IP address from the event.

## Example Two

The following rex example uses this event for illustration:

```
Nov 10 03:04:24 192.168.20.114 192.168.20.113 [REDACTED];C007:4D28:Evi7Packets:Line 16;"New Group", "My [REDACTED] 150", "11/10/2005 11:02:05.000", "21561", "11/10/2005 11:02:05.000", "3106004", "generator", "1", "192.168.20.111", "http:80", "192.168.20.112", "32771", "tcp", "Alert", "47302", "47285", "RPC Incomplete Segment", "0", "0", "00:00:00:00:00:00", "00:00:00:00:00:00"
```

- Extract the first two IP addresses from an event and assign them to two different fields, IP1 and IP2.

```
| rex "(?<IP1>[^\$]\d{1,3}\.\d{1,3}\.\d{1,3}\.\d{1,3})" | rex "\d{1,3}\.\d{1,3}\.\d{1,3}\.\d{1,3}(?<IP2>[^\$]\d{1,3}\.\d{1,3}\.\d{1,3}\.\d{1,3})"
```

This expression extracts the first and second IP addresses in the above event.

Because the two IP addresses are right after one another in this event, you can also specify the extraction of the two IP addresses in a single rex expression as follows:

```
| rex "(?<IP1>[^\$]\d{1,3}\.\d{1,3}\.\d{1,3}\.\d{1,3})(?<IP2>[^\$]\d{1,3}\.\d{1,3}\.\d{1,3}\.\d{1,3})"
```

**Note:** Do not enter any spaces in the expression.

- Building on the previous example, add a new field called Ignore. Assign the value “Y” to this field if the two IP addresses extracted in the previous example are the same and assign the value “N” if the two IP addresses are different. Then, list the top IP1 and IP2 combinations for events for which Ignore field is “N”.

```
| rex "(?<IP1>[^\$]\d{1,3}\.\d{1,3}\.\d{1,3}\.\d{1,3})" | rex "\d{1,3}\.\d{1,3}\.\d{1,3}\.\d{1,3}(?<IP2>[^\$]\d{1,3}\.\d{1,3}\.\d{1,3}\.\d{1,3})" | eval Ignore=if(IP1==IP2,"Y","N") | where Ignore="N" | top IP1 IP2
```

**Note:** The eval command uses a double equal sign (==) to equate the two fields.

- Information captured by a rex expression can be used for further processing in a subsequent rex expression as illustrated in the following example. The first IP address is captured by the first rex expression and the network ID (assuming the first three bytes of the IP address represent it) to which the IP address belongs is extracted from the captured IP address:

```
logger | rex "(?<srcip>[^\ ]\d{1,3}\.\d{1,3}\.\d{1,3}\.\d{1,3})" | rex  
field=srcip "(?<netid>\d{1,3}\.\d{1,3}\.\d{1,3})"
```

## Example Three

The following rex example uses this event for illustration:

```
127.0.0.1 - name [10/Oct/2010:13:55:36 -0700] "GET /apache_pb.gif HTTP/1.0"  
200 2326 "http://www.example.com/start.html" "Mozilla/4.08 [en] (Win98; I  
;Nav)"
```

- Extract all URLs from events and generate a chart of the URL counts, excluding blank URLs. (The events contain the URL string in “http://” format.)

```
| rex "http://(?<customURL>[^\ ]*)" | where customURL is not null | chart  
count by customURL | sort - customURL
```

**Note:** The meta character “/” needs to be enclosed in square brackets [ ] to be treated literally.

## Example Four

The following rex example uses this event for illustration:

1	2010/04/06 22:11:46 CDT 10.0.10.222 [Raw_Syslog] Local	root
RAW	Feb 25 14:03:24 beach login(pam_unix)[123]: session closed for <b>jsdr</b> root	
2	2010/04/06 22:11:46 CDT 10.0.10.222 [Raw_Syslog] Local	sysadmin
RAW	Feb 25 14:03:24 beach sshd(pam_unix)[123]: authentication failure; logname= uid=0 euid=0 tty=ssh ruser= rhost=123.123.123.123 <b>jsdr</b> =sysadmin	
3	2010/04/06 22:11:46 CDT 10.0.10.222 [Raw_Syslog] Local	p4admin
RAW	Feb 25 14:03:24 beach sshd(pam_unix)[123]: session closed for <b>jsdr</b> p4admin	
4	2010/04/06 22:11:46 CDT 10.0.10.222 [Raw_Syslog] Local	sysadmin
RAW	Feb 25 14:03:24 beach sshd(pam_unix)[123]: session opened for <b>user</b> sysadmin by (uid=500)	

- Extract the first word after the word “user” (one space after the word) or “user=”. The word “user” is case-insensitive in this case, and must be preceded by a space character. That is, words such as “ruser” and “suser” should not be matched.

```
| rex "\s[u|U][s|S][e|E][r|R][\s|=](?<CustomUser>[^\ ]*)"
```

# Appendix D: Logger Audit Events

You can forward the Logger audit events, which are in Common Event Format (CEF), to ArcSight ESM directly for analysis and correlation. Use the Audit Forwarding feature (as described in "[Audit Forwarding](#)" on page 420) to forward the events.

For more information about CEF, refer to the document "ArcSight CEF". For a downloadable a copy of this guide, search for "ArcSight Common Event Format (CEF) Guide" in the [ArcSight Product Documentation Community on Protect 724](#).

The following topics describe Logger's audit events:

- [Types of Audit Events](#) ..... 517
- [Information in an Audit Event](#) ..... 517
- [Platform Events](#) ..... 518
- [Application Events](#) ..... 525

## Types of Audit Events

Two types of audit events are generated on Logger and available for Audit Forwarding to ArcSight ESM.

- "[Platform Events](#)" on the next page, which are related to the Logger hardware/system.
- "[Application Events](#)" on page 525, which are related to Logger functions and configuration changes on it.

Both types of events are stored in the Logger Internal Storage Group. As a result, these events can be searched using the Logger Search UI. For example, you can search for this platform event:

"/Platform/Authentication/Failure/Password"

## Information in an Audit Event

A Logger audit event (in CEF format) contains information about the following prefix fields:

- Device Event Class ID
- Device Severity
- Message
- Device Event Category—(keyName for this CEF extension is "cat")

For example:

```
Sep 19 08:26:10 zurich CEF:0|ArcSight|Logger|3.5.0.13412.0|logger:500|Filter
added|2| cat=/Logger/Resource/Filter/Configuration/Add
msg=Filter [Regex Query Test] has been added
```

## Platform Events

The following table lists the information contained in audit events related to the Logger platform. All events include the following fields.

- `duser`—UserName
- `duid`—User ID
- `src`—IP address of client
- `dst`—IP address of appliance
- `cat`—Device Event Category
- `cn1`—Session number
- `cn1label`—Session

Additional fields (if applicable) are listed in the following table.

Device Event Class ID	Sev.	Device Event Category (cat)	Message	Additional Fields
platform:200	5	/Platform/Authentication/PasswordChange/Failure	Failed password change	
platform:201	7	/Platform/Authentication/Failure	Failed login attempt	
platform:202	5	/Platform/Authentication/PasswordChange	Password changed	cs1: Affected User Id cs2: Affected User Login cs3: Affected User Full Name
platform:203	7	/Platform/Authentication/InactiveUser/Failure	Login attempt by inactive user	
platform:213	7	/Platform/Configuration/Global/AuditEvents	Audit forwarding modified	cs1: Audit Forwarders
platform:220	5	/Platform/Certificate/Install	Installed certificate	cs1: Network Protocol
platform:221	7	/Platform/Certificate/Mismatch	Certificate mismatch failure	cs1: Network Protocol

Device Event Class ID	Sev.	Device Event Category (cat)	Message	Additional Fields
platform:222	1	/Platform/Certificate/Request	Created certificate signing request	cs1: Certificate Signing Request cs2: Network Protocol
platform:224	5	/Platform/Certificate/Regenerate	Re-generate self-signed certificate	cs1: Certificate Signing Request cs2: Network Protocol
platform:226	7	/Platform/Update/Failure/CorruptPackage	Uploaded update file damaged or corrupt	cs1: Error cs2: fname cs3: fsize
platform:227	5	/Platform/Update/Applied	Update installation success	cs1: Update Name cs2: Is Reboot Required
platform:228	7	/Platform/Update/Failure/Installation	Update installation failure	cs1: Error cs2: Update Name
platform:230	3	/Platform/Authentication/Login	Successful login	
platform:234	7	/Platform/Authentication/Failure/LOCKED	Failed login attempt (LOCKED)	
platform:239	3	/Platform/Authentication/Logout	User logout	
platform:240	3	/Platform/Authorization/Groups/Add	Added user group	cn2: Current Number of Users cn3: Current Number of User Rights cs1: Affected Group Name cs2: Affected Group Id flexNumber1: Old Number of Users flexNumber2: Old Number of User Rights
platform:241	3	/Platform/Authorization/Groups/Update	Updated user group	cn2: Current Number of Users cn3: Current Number of User Rights cs1: Affected Group Name cs2: Affected Group Id flexNumber1: Old Number of Users flexNumber2: Old Number of User Rights

Device Event Class ID	Sev.	Device Event Category (cat)	Message	Additional Fields
platform:242	5	/Platform/Authorization /Groups/Membership /Update/Clear	Removed all members from group	
platform:243	3	/Platform/Authorization /Groups/Membership/Update	Modified user group membership	
platform:244	3	/Platform/Authorization /Groups/Delete	Deleted user group	cs1: Affected Group Name cs2: Affected Group Id
platform:245	3	/Platform/Authorization /Users/Add	Added user	cs1: Affected User Id cs2: Affected User Login cs3: Affected User Full Name
platform:246	3	/Platform/Authorization /Users/Update	Updated user	cs1: Affected User Id cs2: Affected User Login cs3: Affected User Full Name
platform:247	3	/Platform/Authorization/Users /Delete	Deleted user	cs1: Affected User Id cs2: Affected User Login cs3: Affected User Full Name
platform:248	3	/Platform/Authentication /Logout/SessionExpiration	Session expired	
platform:249	7	/Platform/Authentication /AccountLocked	Account locked	
platform:250	5	/Platform/Storage/RFS /Add	Added remote mount point	cs1: RFS Mount Name cs2: RFS Mount Host and Remote Path
platform:251	5	/Platform/Storage/RFS /Edit	Edited remote mount point	cs1: RFS Mount Name cs2: RFS Mount Host and Remote Path
platform:252	7	/Platform/Storage/RFS /Failure	Failed to create remote mount point	cs1: Server cs2: Remote Directory cs3: Mount Name cs4: Mount Type cs5: Username
platform:253	5	/Platform/Storage/RFS /Remove	Removed remote mount point	cs1: RFS Mount Name cs2: RFS Mount Host and Remote Path



Device Event Class ID	Sev.	Device Event Category (cat)	Message	Additional Fields
platform:254	5	/Platform/Storage/SAN /Destroy	Destroyed SAN Logical Unit	cs1: Volume label
platform:255	5	/Platform/Storage/SAN /Attach	Attached SAN Logical Unit	cn2: Volume size (in MB) cs1: Volume label cs2: World-wide Name cs3: Filesystem type
platform:256	7	/Platform/Storage/SAN /Detach	Detached SAN Logical Unit	cs1: Storage unit details
platform:259	5	/Platform/Storage/SAN /Reattach	Reattached SAN Logical Unit	cs1: Volume label cs2: Filesystem type
platform:260	5	/Platform/Configuration /Network/Route/Update	Static route modified	cs1: Destination cs2: Subnet cs3: Gateway
platform:261	5	/Platform/Configuration /Network/Route/Remove	Static route removed	cs1: Destination cs2: Subnet cs3: Gateway
platform:262	5	/Platform/Configuration /Time	Appliance time modified	cs1: Old Date/Time cs2: New Date/Time cs3: Old Time Zone cs4: New Time Zone
platform:263	5	/Platform/Configuration /Network	NIC settings modified	cs1: NIC cs2: IP Address cs3: Netmask cs4: Speed
platform:264	5	/Platform/Configuration /Network/NTP	NTP server settings modified	cs1: NTP Servers cs2: Is Appliance NTP Server
platform:265	5	/Platform/Configuration /Network/DNS	DNS settings modified	
platform:266	5	/Platform/Configuration /Network/Hosts	Hosts file modified	cs1: Difference from previous hosts file
platform:267	5	/Platform/Configuration /SMTP	SMTP settings modified	cs1: EMail Address cs2: SMTP Server cs3: Backup SMTP Server
platform:268	5	/Platform/Configuration /Network/Route/Add	Static route added	cs1: Destination cs2: Subnet cs3: Gateway

Device Event Class ID	Sev.	Device Event Category (cat)	Message	Additional Fields
platform:270	5	/Platform/Authorization /Users/Inactive/Disable	Inactive user disabled	cs1: User Login deviceCustomDate1: Date Last Active
platform:280	7	/Appliance/State/Reboot /Initiate	Appliance reboot initiated	
platform:281	3	/Appliance/State/Reboot /Cancel	Appliance reboot canceled	
platform:282	7	/Appliance/State/ Shutdown	Appliance poweroff initiated	
platform:284	5	/Platform/Storage/ Multipathing/Enable	Enabled SAN Multipathing	cs1: Multipath Configuration
platform:285	5	/Platform/Storage/ Multipathing/Disable	Disabled SAN Multipathing	
platform:300	5	/Platform/Certificate /Install	Installed trusted certificate	cs1: Certificate details
platform:301	5	/Platform/Certificate /Revocation/Install	Installed certificate revocation list	cs1: CRL details
platform:302	5	/Platform/Certificate/Delete	Deleted trusted certificate	cs1: Certificate details
platform:303	5	/Platform/Certificate/ Revocation/Delete	Deleted certificate revocation list	cs1: CRL details
platform:304	7	/Platform/Certificate/ Install/Failure	Failed installing trusted certificate	cs1: Error cs2: File Size cs3: File Name
platform:305	7	/Platform/Certificate/ Revocation/Install/Failure	Failed installing certificate revocation list	cs1: Error cs2: File Size cs3: File Name
platform:306	5	/Platform/Process/Start	Start process	cs1: Process Name
platform:307	5	/Platform/Process/Stop	Stop process	cs1: Process Name
platform:308	5	/Platform/Process/Restart	Restart process	cs1: Process Name
platform:310	5	/Platform/Configuration /FIPS/Enable	Enabled FIPS mode	
platform:311	7	/Platform/Configuration /FIPS/Disable	Disabled FIPS mode	
platform:312	7	/Platform/Configuration /WebServer/CipherStrength	Web server cipher strength changed	cs1: New Value cs2: Old Value

Device Event Class ID	Sev.	Device Event Category (cat)	Message	Additional Fields
platform:320	3	/Appliance/State /Shutdown/Cancel	Appliance poweroff canceled	
platform:371	5	/Platform/Service/Restart	Restarted OS service	cs1: Service Name
platform:400	2	/Platform/Diagnostics /Command	Ran diagnostic command	cs1: Diagnostic Command
platform:407	7	/Platform/Certificate /SSL/Expiration	SSL certificate expiration warning	cs1: Issuer cs2: Subject deviceCustomDate1: Expiration Date
platform:408	5	/Appliance/State/Startup	Appliance startup completed	deviceCustomDate1: Startup Date
platform:409	3	/Platform/Configuration /LoginBanner	Configure login warning banner	cs1: Acknowledgment Prompt cs2: Banner Text
platform:410	5	/Platform/Configuration /Network	Network settings modified	cs1: Gateway cs2: Multi-homing cs3: Hostname
platform:411	5	/Platform/Authentication /PasswordChange	Automated Password Reset	cn2: User ID cs1: User Login
platform:412	3	/Platform/Configuration /Locale	Set Locale	cs1: Locale
platform:440	3	/Platform/Configuration/ SNMP	SNMP configuration modified	cn2: Port Number cn3: Refresh Interval cs1: SNMP Enabled cs2: Community String cs3: Listen Address(es)
platform:460	3	/Platform/Network/Alias/Add	NIC alias added	cs1: NIC cs2: IP Address cs3: Netmask
platform:462	3	/Platform/Network/Alias /Remove	NIC alias removed	cs1: NIC cs2: IP Address cs3: Netmask
platform:500	5	/Platform/Authorization /Groups/Membership /Remove	Remove member from group	cs1: Affected Group Name cs2: Affected User Login cs3: Affected Group Id cs4: Affected User Id

Device Event Class ID	Sev.	Device Event Category (cat)	Message	Additional Fields
platform:501	5	/Platform/Authorization /Groups/Membership/Add	Group member added	cs1: Affected Group Name cs2: Affected User Login cs3: Affected Group Id cs4: Affected User Id
platform:502	5	/Platform/Authorization /Users/Groups/Remove	User removed from group	cs1: Affected Group Name cs2: Affected User Login cs3: Affected Group Id cs4: Affected User Id
platform:503	5	/Platform/Authorization /Users/Groups/Add	User added to group	cs1: Affected Group Name cs2: Affected User Login cs3: Affected Group Id cs4: Affected User Id
platform:530	5	/Platform/Configuration /Authentication/Sessions /Success	Authentication Session settings successfully changed.	cn2: New Value cn3: Old Value cs1: Parameter Changed
platform:540	5	/Platform/Configuration /Authentication/Password /Lockout/Success	Password Lockout settings successfully updated.	cn2: New Value cn3: Old Value cs1: Parameter Changed
platform:550	5	/Platform/Configuration /Authentication/Password /Expiration/Success	Password Expiration settings successfully updated.	cn2: New Value cn3: Old Value cs1: Parameter Changed
platform:560	5	/Platform/Configuration /Authentication/Password /Validation/Success	Password Validation settings successfully updated.	cn2: New Value cn3: Old Value cs1: Parameter Changed
platform:570	5	/Platform/Configuration /Authentication/Password /AutomatedPasswordReset /Success	Password Automated Password Reset setting successfully updated.	cs1: Parameter Changed cs2: New Value cs3: Old Value
platform:580	5	/Platform/Configuration /Authentication/Certificate /Success	Client Certificate authentication settings successfully changed.	cs1: Parameter Changed cs2: New Value cs3: Old Value

Device Event Class ID	Sev.	Device Event Category (cat)	Message	Additional Fields
platform:590	5	/Platform/Configuration /Authentication/RADIUS /Success	RADIUS authentication settings successfully changed.	cs1: Parameter Changed cs2: New Value cs3: Old Value
platform:600	5	/Platform/Configuration /Authentication/LDAP/ Success	LDAP authentication settings successfully changed.	cs1: Parameter Changed cs2: New Value cs3: Old Value
platform:610	5	/Platform/Configuration /Authentication/Global /Success	Global Authentication settings successfully changed.	cs1: Parameter Changed cs2: New Value cs3: Old Value

## Application Events

The following table lists the information contained in audit events related to various Logger functions and configuration changes on it. The Severity for all Logger application events is **2**.

Device Event Class ID	Device Event Category (cat)	Message	Additional Fields
<b>Alerts</b>			
logger:610	/Logger/Component /Alert/Configuration /Add	Alert [name] has been added	fname=AlertName duser=UserName duid=userId cs4=sessionIdfile cs4Label=Session ID fileType=forwarderType dvc=syslogOrSnmpIpAddr dvchost=syslogOrSnmpHostName cn1Label=Syslog or SNMP Destination Port cn1=syslogOrSnmpPort cs1Label=Filter cs1=filter cs2Label=Email Destination(s) cs2=emailAddresses

Device Event Class ID	Device Event Category (cat)	Message	Additional Fields
logger:611	/Logger/Component /Alert/Configuration /Delete	Alert [name] has been deleted	fname=AlertName duser=UserName duid=userId cs4=sessionIdfile cs4Label=Session ID fileType=forwarderType dvc=syslogOrSnmpIpAddr dvchost=syslogOrSnmHostName cn1Label=Syslog or SNMP Destination Port cn1=syslogOrSnmpPort cs1Label=Filter cs1=filter cs2Label=Email Destination(s) cs2=emailAddresses
logger:612	/Logger/Component /Alert/Configuration /Update	Alert [name] has been updated	fname=AlertName duser=UserName duid=userId cs4=sessionIdfile cs4Label=Session ID fileType=forwarderType dvc=syslogOrSnmpIpAddr dvchost=syslogOrSnmpHostName cn1Label=Syslog or SNMP Destination Port cn1=syslogOrSnmpPort cs1Label=Filter cs1=filter cs2Label=Email Destination(s) cs2=emailAddresses
logger:613	/Logger/Component /Alert/Configuration /Enable	Alert [name] has been enabled	fname=AlertName duser=UserName duid=userId cs4=sessionIdfile cs4Label=Session ID fileType=forwarderType dvc=syslogOrSnmpIpAddr dvchost=syslogOrSnmpHostName cn1Label=Syslog or SNMP Destination Port cn1=syslogOrSnmpPort cs1Label=Filter cs1=filter cs2Label=Email Destination(s) cs2=emailAddresses

Device Event Class ID	Device Event Category (cat)	Message	Additional Fields
logger:614	/Logger/Component/Alert/Configuration/Disable	Alert [name] has been disabled	fname=AlertName duser=UserName duid=userId cs4=sessionIdfile cs4Label=Session ID fileType=forwarderType dvc=syslogOrSnmpIpAddr dvchost=syslogOrSnmpHostName cn1Label=Syslog or SNMP Destination Port cn1=syslogOrSnmpPort cs1Label=Filter cs1=filter cs2Label=Email Destination(s) cs2=emailAddresses
logger:615	/Logger/Alert/Configuration/Sent	Alert [name] has been sent	fname=AlertName duser=UserName duid=userId cs4=sessionIdfile cs4Label=Session ID fileType=forwarderType dvc=syslogOrSnmpIpAddr dvchost=syslogOrSnmpOr EsmHostName cn1Label=Syslog Or SNMP Or ESM Destination Port cn1=syslogOrSnmpOrEsmPort cs1Label=Filter cs1=filter cs2Label=Email Destination(s) cs2=emailAddresses
<b>Certificates</b>			
logger:643	/Logger/Component/Certificate/Configuration/Add	Certificate [name] has been added	fname=alias duser=UserName duid=userId cs4=sessionId cs4Label=Session ID fileType=Certificate
logger:650	/Logger/Component/Certificate/Configuration/Delete	Certificate [name] has been deleted	fname=alias duser=UserName duid=userId cs4=sessionId cs4Label=Session ID fileType=Certificate

<b>Device Event Class ID</b>	<b>Device Event Category (cat)</b>	<b>Message</b>	<b>Additional Fields</b>
logger:651	/Logger/Component/ Certificate/Configuration /Update	Certificate [name] has been updated	fname=alias duser=UserName duid=userId cs4=sessionId cs4Label=Session ID fileType=Certificate
<b>Configuration Backup</b>			
logger:660	/Logger/Component/ ConfigBackup /Configuration/Update	Configuration backup has been updated	fname=Configuration Backup duser=UserName duid=userId cs4=sessionId cs4Label=Session ID fileType=Configuration Backup
logger:661	/Logger/Component/ ConfigBackup /Configuration/Enable	Configuration backup has been enabled	fname=Configuration Backup duser=UserName duid=userId cs4=sessionId cs4Label=Session ID fileType=Configuration Backup
logger:662	/Logger/Component/ ConfigBackup /Configuration/Disable	Configuration backup has been disabled	fname=Configuration Backup duser=UserName duid=userId cs4=sessionId cs4Label=Session ID fileType=Configuration Backup
logger:665	/Logger/Component /ConfigBackup /Configuration/Backup	Configuration backup succeeded. Transfer process finished.	fname=Configuration Backup fileType=Configuration Backup fpath=path ToBackupFile fsize=fileSizeInByte
<b>ESM Destinations</b>			



Device Event Class ID	Device Event Category (cat)	Message	Additional Fields
logger:640	/Logger/Component/EsmDestination/Configuration/Add	ESM destination [name] has been added	fname=esmDestinationName duser=UserName duid=userId cs4=sessionIdfile cs4Label=Session ID fileType=ESM Destination fileId=esmDestinationId dvc=esmDestinationIp dvchost=esmDestinationHost cn1Label=ESM Destination Port cn1=esmDestinationPort cs1Label=Connector Name cs1=connectorName cs2Label=Connector Location cs2=connectorLocation cs3Label=Logger Location cs3=loggerLocation
logger:641	/Logger/Component/EsmDestination/Configuration/Delete	ESM destination [name] has been deleted	fname=esmDestinationName duser=UserName duid=userId cs4=sessionId file cs4Label=Session ID fileType=ESM Destination fileId=esmDestinationId dvc=esmDestinationIp dvchost=esmDestinationHost cn1Label=ESM Destination Port cn1=esmDestinationPort cs1Label=Connector Name cs1=connectorName cs2Label=Connector Location cs2=connectorLocation cs3Label=Logger Location cs3=loggerLocation
<b>Forwarders</b>			

Device Event Class ID	Device Event Category (cat)	Message	Additional Fields
logger:605	/Logger/Component/Forwarder/Configuration/Add	Forwarder [name] has been added	fname=forwarderName duser=UserName duid=userId cs4=sessionIdfile cs4Label=Session ID fileType=forwarderType dvc=forwarderIpAddr dvchost=forwarderHostName cn1Label=Forwarder Port cn1=forwarderPort cs1Label=Forwarder Filter cs1=forwarderFilter
logger:606	/Logger/Component/Forwarder/Configuration/Delete	Forwarder [name] has been deleted	fname=forwarderName duser=UserName duid=userId cs4=sessionIdfile cs4Label=Session ID fileType=forwarderType dvc=forwarderIpAddr dvchost=forwarderHostName cn1Label=Forwarder Port cn1=forwarderPort cs1Label=Forwarder Filter cs1=forwarderFilter
logger:607	/Logger/Component/Forwarder/Configuration/Update	Forwarder [name] has been updated	fname=forwarderName duser=UserName duid=userId cs4=sessionIdfile cs4Label=Session ID fileType=forwarderType dvc=forwarderIpAddr dvchost=forwarderHostName cn1Label=Forwarder Port cn1=forwarderPort cs1Label=Forwarder Filter cs1=forwarderFilter

Device Event Class ID	Device Event Category (cat)	Message	Additional Fields
logger:608	/Logger/Component/Forwarder/Configuration/Enable	Forwarder [name] has been enabled	fname=forwarderName duser=UserName duid=userId cs4=sessionIdfile cs4Label=Session ID fileType=forwarderType dvc=forwarderIpAddr dvchost=forwarderHostName cn1Label=Forwarder Port cn1=forwarderPort cs1Label=Forwarder Filter cs1=forwarderFilter
logger:609	/Logger/Component/Forwarder/Configuration/Disable	Forwarder [name] has been disabled	fname=forwarderName duser=UserName duid=userId cs4=sessionIdfile cs4Label=Session ID fileType=forwarderType dvc=forwarderIpAddr dvchost=forwarderHostName cn1Label=Forwarder Port cn1=forwarderPort cs1Label=Forwarder Filter cs1=forwarderFilter
logger:663	/Logger/Component/Forwarder/Configuration/Pause	Forwarder [name] has been paused	fname=forwarderName duser=UserName duid=userId cs4=sessionIdfile cs4Label=Session ID fileType=forwarderType dvc=forwarderIpAddr dvchost=forwarderHostName cn1Label=Forwarder Port cn1=forwarderPort cs1Label=Forwarder Filter cs1=forwarderFilter

Device Event Class ID	Device Event Category (cat)	Message	Additional Fields
logger:664	/Logger/Component/Forwarder/Configuration/Resume	Forwarder [name] has been resumed	fname=forwarderName duser=UserName duid=userId cs4=sessionIdfile cs4Label=Session ID fileType=forwarderType dvc=forwarderIpAddr dvchost=forwarderHostName cn1Label=Forwarder Port cn1=forwarderPort cs1Label=Forwarder Filter cs1=forwarderFilter
<b>Receivers</b>			
logger:600	/Logger/Component/Receiver/Configuration/Add	Receiver [name] has been added	fname=receiverName duser=UserName duid=userId cs4=sessionIdfile cs4Label=Session ID fileType=receiverType dvc=receiverIpAddr dvchost=receiverHostName cn1Label=Receiver Port cn1=receiverPort
logger:601	/Logger/Component/Receiver/Configuration/Delete	Receiver [name] has been deleted	fname=receiverName duser=UserName duid=userId cs4=sessionIdfile cs4Label=Session ID fileType=receiverType dvc=receiverIpAddr dvchost=receiverHostName cn1Label=Receiver Port cn1=receiverPort
logger:602	/Logger/Component/Receiver/Configuration/Update	Receiver [name] has been updated	fname=receiverName duser=UserName duid=userId cs4=sessionIdfile cs4Label=Session ID fileType=receiverType dvc=receiverIpAddr dvchost=receiverHostName cn1Label=Receiver Port cn1=receiverPort

Device Event Class ID	Device Event Category (cat)	Message	Additional Fields
logger:603	/Logger/Component/Receiver/Configuration/Enable	Receiver [name] has been enabled	fname=receiverName duser=UserName duid=userId cs4=sessionIdfile cs4Label=Session ID fileType=receiverType dvc=receiverIpAddr dvchost=receiverHostName cn1Label=Receiver Port cn1=receiverPort
logger:604	/Logger/Component/Receiver/Configuration/Disable	Receiver [name] has been disabled	fname=receiverName duser=UserName duid=userId cs4=sessionIdfile cs4Label=Session ID fileType=receiverType dvc=receiverIpAddr dvchost=receiverHostName cn1Label=Receiver Port cn1=receiverPort
<b>SNMP Destinations</b>			
logger:644	/Logger/Component/SnmpDestination/Configuration/Add	SNMP destination [name] has been added	fname=snmpDestinationName duser=UserName duid=userId cs4=sessionIdfile cs4Label=Session ID fileType=SNMP Destination fileId=snmpDestinationId dvc=snmpDestinationIp dvchost=snmpDestinationHost cn1Label=SNMP Destination Port cn1=snmpDestinationPort cs1Label=Connector Name cs1=connectorName cs2Label=Connector Location cs2=connectorLocation cs3Label=Logger Location cs3=loggerLocation

Device Event Class ID	Device Event Category (cat)	Message	Additional Fields
logger:645	/Logger/Component/SnmpDestination/Configuration/Delete	SNMP destination [name] has been deleted	fname=snmpDestinationName duser=UserName duid=userId cs4=sessionIdfile cs4Label=Session ID fileType=SNMP Destination fileId=snmpDestinationId dvc=snmpDestinationIp dvchost=snmpDestinationHost cn1Label=SNMP Destination Port cn1=snmpDestinationPort cs1Label=Connector Name cs1=connectorName cs2Label=Connector Location cs2=connectorLocation cs3Label=Logger Location cs3=loggerLocation
<b>Syslog Destinations</b>			
logger:647	/Logger/Resource/SyslogDestination/Configuration/Add	Syslog destination [name] has been added	fname=syslogDestinationName duser=UserName duid=userId cs4=sessionIdfile cs4Label=Session ID fileType=Syslog Destination fileId=syslogDestinationId dvc=syslogDestinationIp dvchost=syslogDestinationHost cn1Label=Syslog Destination Port cn1=syslogDestinationPort
logger:648	/Logger/Component/SyslogDestination/Configuration/Delete	Syslog destination [name] has been deleted	fname=syslogDestinationName duser=UserName duid=userId cs4=sessionIdfile cs4Label=Session ID fileType=Syslog Destination fileId=syslogDestinationId dvc=syslogDestinationIp dvchost=syslogDestinationHost cn1Label=Syslog Destination Port cn1=syslogDestinationPort

Device Event Class ID	Device Event Category (cat)	Message	Additional Fields
logger:649	/Logger/Component /SyslogDestination /Configuration/Update	Syslog destination [name] has been updated	fname=syslogDestinationName duser=UserName duid=userId cs4=sessionIdfile cs4Label=Session ID fileType=Syslog Destination fileId=syslogDestinationId dvc=syslogDestinationIp dvchost=syslogDestinationHost cn1Label=Syslog Destination Port cn1=syslogDestinationPort
<b>Archives</b>			
logger:520	/Logger/Resource /Archive/Configuration /Add	Archive [archiveName] has been added	fname=archiveName duser=UserName duid=userId cs4=sessionIdfile cs4Label=Session ID fileType=EventArchive fileId=archiveId
logger:521	/Logger/Resource /Archive/Configuration /Delete	Archive [archiveName] has been deleted	fname=archiveName duser=UserName duid=userId cs4=sessionIdfile cs4Label=Session ID fileType=EventArchive fileId=archiveId
logger:523	/Logger/Resource /Archive/Configuration /Load	Archive [archiveName] has been loaded	fname=archiveName duser=UserName duid=userId cs4=sessionIdfile cs4Label=Session ID fileType=EventArchive fileId=archiveId
logger:524	/Logger/Resource /Archive/Configuration /Unload	Archive [archiveName] has been unloaded	fname=archiveName duser=UserName duid=userId cs4=sessionIdfile cs4Label=Session ID fileType=EventArchive fileId=archiveId

<b>Device Event Class ID</b>	<b>Device Event Category (cat)</b>	<b>Message</b>	<b>Additional Fields</b>
logger:525	/Logger/Resource /Archive/Configuration /Archive	Archive [archiveName] has been archived	fname=archiveName duser=UserName duid=userId cs4=sessionIdfile cs4Label=Session ID fileType=EventArchive fileId=archiveId
logger:526	/Logger/Resource /Archive/Add	Event archive settings added	fname=archiveName duser=UserName duid=userId cs4=sessionIdfile cs4Label=Session ID fileType=EventArchive fileId=archiveId
logger:527	/Logger/Resource /Archive/Update	Daily archive task settings updated	fname=archiveName duser=UserName duid=userId cs4=sessionIdfile cs4Label=Session ID fileType=EventArchive fileId=archiveId
logger:528	/Logger/Resource /Archive/Failed	Event archive failed	fname=archiveName duser=UserName duid=userId cs4=sessionIdfile cs4Label=Session ID fileType=EventArchive fileId=archiveId
<b>Dashboards</b>			
logger:580	/Logger/Resource /Dashboard /Configuration/Add	Dashboard [name] has been added	fname=dashboardName duser=UserName duid=userId cs4=sessionIdfile cs4Label=Session ID fileType=Dashboard fileId=DashboardId rt=receiptTime



<b>Device Event Class ID</b>	<b>Device Event Category (cat)</b>	<b>Message</b>	<b>Additional Fields</b>
logger:581	/Logger/Resource /Dashboard /Configuration/Add	Dashboard [name] has been deleted	fname=dashboardName duser=UserName duid=userId cs4=sessionIdfile fileType=Dashboard fileId=DashboardId rt=receiptTime
logger:582	/Logger/Resource /Dashboard /Configuration/Update	Dashboard [name] has been updated	fname=dashboardName duser=UserName duid=userId cs4=sessionIdfile cs4Label=Session ID fileType=Dashboard fileId=DashboardId rt=receiptTime
<b>Devices</b>			
logger:510	/Logger/Resource /Device/Configuration /Add	Device [deviceName] has been added	fname=deviceName duser=UserName duid=userId cs4=sessionIdfile cs4Label=Session ID fileType=Device fileId=deviceId
logger:511	/Logger/Resource /Device/Configuration /Delete	Device [deviceName] has been deleted	fname=deviceName duser=UserName duid=userId cs4=sessionIdfile cs4Label=Session ID fileType=Device fileId=deviceId
logger:512	/Logger/Resource /Device/Configuration /Update	Device [deviceName] has been updated	fname=deviceName duser=UserName duid=userId cs4=sessionIdfile cs4Label=Session ID fileType=Device fileId=deviceId
<b>Filters</b>			

<b>Device Event Class ID</b>	<b>Device Event Category (cat)</b>	<b>Message</b>	<b>Additional Fields</b>
logger:500	/Logger/Resource/Filter/Configuration/Add	Filter [filterName] has been added	fname=filterName duser=UserName duid=userId cs4=sessionIdfile cs4Label=Session ID fileType=Filter fileId=filterId
logger:501	/Logger/Resource/Filter/Configuration/Delete	Filter [filterName] has been deleted	fname=filterName duser=UserName duid=userId cs4=sessionIdfile cs4Label=Session ID fileType=Filter fileId=filterId
logger:502	/Logger/Resource/Filter/Configuration/Update	Filter [filterName] has been updated	fname=filterName duser=UserName duid=userId cs4=sessionIdfile cs4Label=Session ID fileType=Filter fileId=filterId
<b>Groups</b>			
logger:513	/Logger/Resource/Group/Configuration/Add	Group [groupName] has been added	fname=groupName duser=UserName duid=userId cs4=sessionIdfile cs4Label=Session ID fileType=Group fileId=groupId
logger:514	/Logger/Resource/Group/Configuration/Delete	Group [groupName] has been deleted	fname=groupName duser=UserName duid=userId cs4=sessionIdfile cs4Label=Session ID fileType=Group fileId=groupId
logger:515	/Logger/Resource/Group/Configuration/Update	Group [groupName] has been updated	fname=groupName duser=UserName duid=userId cs4=sessionIdfile cs4Label=Session ID fileType=Group fileId=groupId

Device Event Class ID	Device Event Category (cat)	Message	Additional Fields
<b>Peer Loggers</b>			
logger:550	/Logger/Resource /PeerLogger /Configuration/Add	Peer Logger [name] has been added	fname=Name duser=UserName duid=userId cs4=sessionIdfile cs4Label=Session ID fileType=Peer Logger fileId=LoggerId
logger:551	/Logger/Resource /PeerLogger /Configuration/Delete	Peer Logger [name] has been deleted	fname=Name duser=UserName duid=userId cs4=sessionIdfile cs4Label=Session ID fileType=Peer Logger fileId=LoggerId
logger:570	/Logger/Resource /Peer/Authorizations /Configuration/Add	Peer Logger authorization [name] has been added	fname=Name duser=UserName duid=userId cs4=sessionIdfile cs4Label=Session ID fileType=Peer Logger Authorization
logger:571	/Logger/Resource /PeerLogger /Authorizations /Configuration/Delete	Peer Logger authorization [name] has been deleted	fname=Name duser=UserName duid=userId cs4=sessionIdfile cs4Label=Session ID fileType=Peer Logger Authorization fileId=LoggerId
<b>Parsers</b>			
logger:590	/Logger/Resource /ParserDescription /Configuration/Add	Parser Description [name] has been added	fileType=Parser Description duid=1 cs4=sessionIdfile cs4Label=Session ID duser=UserName rt=receiptTime fname=parserName

<b>Device Event Class ID</b>	<b>Device Event Category (cat)</b>	<b>Message</b>	<b>Additional Fields</b>
logger:591	/Logger/Resource/ParserDescription/Configuration/Delete	Parser Description [name] has been deleted	fileType=Parser Description cs4=sessionIdfile duser=UserName fileId=ParserID 710 duid=1 cs4Label=Session ID rt=receiptTime fname=parserName
logger:592	/Logger/Resource/ParserDescription/Configuration/Update	Parser Description [name] has been updated	fileType=Parser Description cs4=sessionIdfile duser=UserName fileId=ParserID duid=1 cs4Label=Session ID rt=receiptTime fname=parserName
<b>Saved Searches</b>			
logger:540	/Logger/Resource/SavedSearch/Configuration/Add	Saved search [name] has been added	fname=savedSearchName duser=UserName duid=userId cs4=sessionIdfile cs4Label=Session ID fileType=Saved Search fileId=savedSearchId
logger:541	/Logger/Resource/SavedSearch/Configuration/Delete	Saved search [name] has been deleted	fname=savedSearchName duser=UserName duid=userId cs4=sessionIdfile cs4Label=Session ID fileType=Saved Search fileId=savedSearchId
logger:542	/Logger/Resource/SavedSearch/Configuration/Update	Saved search [name] has been updated	fname=savedSearchName duser=UserName duid=userId cs4=sessionIdfile cs4Label=Session ID fileType=Saved Search fileId=savedSearchId
<b>Source Types</b>			

<b>Device Event Class ID</b>	<b>Device Event Category (cat)</b>	<b>Message</b>	<b>Additional Fields</b>
logger:596	/Logger/Resource/ SourceType /Configuration/Add	Source Type [name] has been added	cs4=sessionIdfile fileType=Source Type duid=1 cs4Label=Session ID duser=UserName rt=receiptTime fname=SourceTypeName
logger:597	/Logger/Resource /SourceType /Configuration/Delete	Source Type [name] has been deleted	fileType=Source Type cs4=sessionIdfile duser=UserName fileId=SourceTypeId duid=1 cs4Label=Session ID rt=receiptTime fname=SourceTypeName
logger:598	/Logger/Resource /SourceType /Configuration/Update	Source Type [name] has been updated	fileType=Source Type cs4=sessionIdfile duser=UserName fileId=1SourceTypeId duid=1 cs4Label=Session ID rt=receiptTime fname=SourceTypeName
<b>Storage Groups</b>			
logger:530	/Logger/Resource/ StorageGroup /Configuration/Add	Storage group [storageGroupName] has been added	fname=storageGroupName duser=UserName duid=userId cs4=sessionIdfile cs4Label=Session ID fileType=Storage Group fileId=storageGroupId
logger:532	/Logger/Resource/ StorageGroup /Configuration/Update	Storage group [storageGroupName] has been updated	fname=storageGroupName duser=UserName duid=userId cs4=sessionIdfile cs4Label=Session ID fileType=Storage Group fileId=storageGroupId
<b>Storage Rules</b>			

<b>Device Event Class ID</b>	<b>Device Event Category (cat)</b>	<b>Message</b>	<b>Additional Fields</b>
logger:533	/Logger/Resource/StorageRule/Configuration/Add	Storage rule [name] has been added	fname=storageRuleName duser=UserName duid=userId cs4=sessionIdfile cs4Label=Session ID fileType=Storage Rule
logger:535	/Logger/Resource/StorageRule/Configuration/Update	Storage rule [name] has been updated	fname=storageRuleName duser=UserName duid=userId cs4=sessionIdfile cs4Label=Session ID fileType=Storage Rule
<b>Storage Volume</b>			
logger:536	/Logger/Resource/StorageVolume/Configuration/Add	Storage volume [name] has been added	fname=storageVolumeName duser=UserName duid=userId cs4=sessionIdfile cs4Label=Session ID fileType=Storage Volume fileId=storageVolumeld
<b>Search</b>			
logger:680	/Logger/Search/Index/Update	Search indices have been added OR Search index has been added	cs4=sessionId fileType=Search Index Configuration duser=UserName msg=Search index has been added cn1=1 duid=1 cs4Label=Session ID rt=receiptTime cn1Label=No. of fields added

Device Event Class ID	Device Event Category (cat)	Message	Additional Fields
logger:690	/Logger/Search/Options/Update	Search options have been updated	cs6=false cs7=true cs4=sessionId cs5=false cs2=false cs3=false cs1=true cs8=false cs1Label=Field Search Case Sensitivity duid=1 cs7Label=Field Summary cs8Label=Field Summary Field Discovery cs6Label=Display options raw Event cs3Label=Regex Search Unicode Case Sensitivity fileType=Search Options duser=UserName cs5Label=Regex Search Canonical Equality Check cs4Label=Session ID rt=receiptTime cs2Label=Regex Search Case Sensitivity
logger:710	/Logger/Search/Canceled	Search session [sessionID] has been canceled by [user]	cs1Label=Session ID duid=1 cs1=sessionIdfile duser=UserName rt=receiptTime
<b>Maintenance Mode</b>			
logger:700	/Logger/Server/MaintenanceMode/Enter	Maintenance mode entered	fname=Maintenance Mode duser=UserName duid=userId cs4=sessionId cs4Label=Session ID fileType=Maintenance Mode

## Appendix E: Examples of System Health Events

The following table provides examples of system health events generated on Logger. These examples are intended to help you understand the format and various fields of the generated events.

**Note:** You can set up Alerts to be triggered to let you know when system health events are generated. For more information, see ["Saved Searches" on page 264](#).

The table includes information on the following system health event classes:

Device Event Class: ID	Example
<b>cpu</b>	
cpu:100	CEF:0 ArcSight Logger 5.1.0.5780.0 cpu:100 CPU Usage 1  cat=/Monitor/CPU/Usage cn1=3 cn1Label=Percent Usage cs2=CurrentValue cs2Label=timeframe dst=192.0.2.6 dvc=192.0.2.6 end=1302739080014 rt=1302739080014
<b>disk</b>	
disk:101	CEF:0 ArcSight Logger 5.1.0.5803.0 disk:101 Root Disk Space Remaining 1  cat=/Monitor/Disk/Space/Remaining/Root cn1=99 cn1Label=Percent Available cs2=CurrentValue cs2Label=timeframe cs3=Ok cs3Label=Status cs4=Ok cs4Label=Raw Status cs5=Root cs5Label=Location cs6=Disk/Space/Remaining/Root cs6Label=Sensor Name dst=192.0.2.6 dvc=192.0.2.6 end=1303927171790 rt=1303927171790
disk:102	CEF:0 ArcSight Logger 5.1.0.5780.0 disk:102 Disk bytes read 1  cat=/Monitor/Disk/Read cn1=373524 cn1Label=Kb Read cs2=SinceStartup cs2Label=timeframe cs6=c0d0 cs6Label=Partition Name dst=192.0.2.6 dvc=192.0.2.6 end=1302743760036 rt=1302743760036
disk:103	CEF:0 ArcSight Logger 5.1.0.5780.0 disk:103 Disk bytes written 1  cat=/Monitor/Disk/Write cn1=24474998 cn1Label=Kb Written cs2=SinceStartup cs2Label=timeframe cs6=c0d0 cs6Label=Partition Name dst=192.0.2.6 dvc=192.0.2.6 end=1302743760038 rt=1302743760038
<b>eps</b>	
eps:100	CEF:0 ArcSight Logger 5.1.0.5780.0 eps:100 Overall Receiver EPS 1  cat=/Monitor/Receiver/All/EPS cn1=0 cn1Label=EPS cs2=SinceLastMonitorEvent cs2Label=timeframe dst=192.0.2.6 dvc=192.0.2.6 end=1302733680034 rt=1302733680034
eps:101	CEF:0 ArcSight Logger 5.1.0.5780.0 eps:101 Overall Forwarder EPS 1  cat=/Monitor/Forwarder/All/EPS cn1=0 cn1Label=EPS cs2=SinceLastMonitorEvent cs2Label=timeframe dst=192.0.2.6 dvc=192.0.2.6



Device Event Class: ID	Example
eps:102	CEF:0 ArcSight Logger 6.1.0.0.1 eps:102 Individual Receiver EPS 1  cat=/Monitor/Receiver/EPS/Individual cn1=0 cn1Label=EPS cn2=0 cn2Label=EVENT COUNT cs1=TCP cs1Label=Receiver Type cs2=SinceLastMonitorEvent cs2Label=timeframe cs3=up cs3Label=STATUS cs6=TCP Receiver cs6Label=Receiver name dst=192.0.2.6 dvc=192.0.2.6 end=1420620420064 rt=1420620420064
eps:103	CEF:0 ArcSight Logger 6.1.0.0.1 eps:103 Individual Forwarder EPS 1  cat=/Monitor/Forwarder/EPS/Individual cn1=0 cn1Label=EPS cn2=0 cn2Label=EVENT COUNT cs1=TCP cs1Label=Forwarder Type cs2=SinceLastMonitorEvent cs2Label=timeframe cs3=up cs3Label=STATUS cs6=TCP Forwarder cs6Label=Forwarder name dst=192.0.2.6 dvc=192.0.2.6 end=1420620420064 rt=1420620420064
<b>hardware</b>	
hardware:101	CEF:0 ArcSight Logger 5.1.0.5784.0 hardware:101 Electrical (Current) OK 1  cat=/Monitor/Sensor/Current/Ok cs1=0.80 Amps cs1Label=Raw Value cs2=CurrentValue cs2Label=timeframe cs3=Ok cs3Label=Status cs4=ok cs4Label=Raw Status cs5=10.2 (Power Supply) cs5Label=Location cs6=Current 2 cs6Label=Sensor Name dst=192.0.2.5 dvc=192.0.2.5 end=1303937520837 rt=1303937520837
hardware:102	CEF:0 ArcSight Logger 5.1.0.5776.0 hardware:102 Electrical (Current) Degraded 5  cat=/Monitor/Sensor/Current/Degraded cs1=126 Watts cs1Label=Raw Value cs2=CurrentValue cs2Label=timeframe cs3=Degraded cs3Label=Status cs4=Inc cs4Label=Raw Status cs5Label=Location cs6=Power Meter cs6Label=Sensor Name dst=192.0.2.4 dvc=192.0.2.4 end=1302817019262 rt=1302817019262
hardware:103	CEF:0 ArcSight Logger 5.1.0.5776.0 hardware:103 Electrical (Current) Failed 8  cat=/Monitor/Sensor/Current/Failed cs1=126 Watts cs1Label=Raw Value cs2=CurrentValue cs2Label=timeframe cs3=Failed cs3Label=Status cs4=Icr cs4Label=Raw Status cs5Label=Location cs6=Power Meter cs6Label=Sensor Name dst=192.0.2.4 dvc=192.0.2.4 end=1302817019262 rt=1302817019262
hardware:111	CEF:0 ArcSight Logger 5.1.0.5780.0 hardware:111 Electrical (Voltage) OK 1  cat=/Monitor/Sensor/Voltage/Ok cs1=State Deasserted cs1Label=Raw Value cs2=CurrentValue cs2Label=timeframe cs3=Ok cs3Label=Status cs4=ok cs4Label=Raw Status cs5=3.1 (Processor) cs5Label=Location cs6=VCORE cs6Label=Sensor Name dst=192.0.2.6 dvc=192.0.2.6 end=1302819047959 rt=1302819047959
hardware:112	CEF:0 ArcSight Logger 5.1.0.5780.0 hardware:112 Electrical (Voltage) Degraded 5  cat=/Monitor/Sensor/Voltage/Degraded cs1=State Deasserted cs1Label=Raw Value cs2=CurrentValue cs2Label=timeframe cs3=Degraded cs3Label=Status cs4=Inc cs4Label=Raw Status cs5=3.1 (Processor) cs5Label=Location cs6=VCORE cs6Label=Sensor Name dst=192.0.2.6 dvc=192.0.2.6 end=1302819047959 rt=1302819047959
hardware:113	CEF:0 ArcSight Logger 5.1.0.5780.0 hardware:113 Electrical (Voltage) Failed 8  cat=/Monitor/Sensor/Voltage/Failed cs1=State Deasserted cs1Label=Raw Value cs2=CurrentValue cs2Label=timeframe cs3=Failed cs3Label=Status cs4=Icr cs4Label=Raw Status cs5=3.1 (Processor) cs5Label=Location cs6=VCORE cs6Label=Sensor Name dst=192.0.2.6 dvc=192.0.2.6 end=1302819047959 rt=1302819047959

Device Event Class: ID	Example
hardware:121	CEF:0 ArcSight Logger 5.1.0.5803.0 hardware:121 Battery OK 1  cat=/Monitor/Sensor/Battery/Ok cs1=cs1Label=Raw Value cs2=CurrentValue cs2Label=timeframe cs3=Ok cs3Label=Status cs4=ok cs4Label=Raw Status cs5=7.1 (System Board) cs5Label=Location cs6=CMOS Battery cs6Label=Sensor Name dst=192.0.2.6 dvc=192.0.2.6 end=1303937972008 rt=1303937972008
hardware:122	CEF:0 ArcSight Logger 5.1.0.5803.0 hardware:122 Battery Degraded 5  cat=/Monitor/Sensor/Battery/Degraded cs1=cs1Label=Raw Value cs2=CurrentValue cs2Label=timeframe cs3=Degraded cs3Label=Status cs4=Inc cs4Label=Raw Status cs5=7.1 (System Board) cs5Label=Location cs6=CMOS Battery cs6Label=Sensor Name dst=192.0.2.6 dvc=192.0.2.6 end=1303937972008 rt=1303937972008
hardware:123	CEF:0 ArcSight Logger 5.1.0.5803.0 hardware:123 Battery Failed 8  cat=/Monitor/Sensor/Battery/Degraded cs1=cs1Label=Raw Value cs2=CurrentValue cs2Label=timeframe cs3=Failed cs3Label=Status cs4=lcr cs4Label=Raw Status cs5=7.1 (System Board) cs5Label=Location cs6=CMOS Battery cs6Label=Sensor Name dst=192.0.2.6 dvc=192.0.2.6 end=1303937972008 rt=1303937972008
hardware:131	CEF:0 ArcSight Logger 5.1.0.5780.0 hardware:131 Fan OK 1  cat=/Monitor/Sensor/Fan/Ok cs1=29.01 unspecified cs1Label=Raw Value cs2=CurrentValue cs2Label=timeframe cs3=Ok cs3Label=Status cs4=Inc cs4Label=Raw Status cs5=7.1 (System Board) cs5Label=Location cs6=Fan Block 1 cs6Label=Sensor Name dst=192.0.2.1 dvc=192.0.2.1 end=1302823237825 rt=1302823237825
hardware:132	
hardware:133	CEF:0 ArcSight Logger 5.1.0.5780.0 hardware:133 Fan Failure 8  cat=/Monitor/Sensor/Fan/Failed cs1=29.01 unspecified cs1Label=Raw Value cs2=CurrentValue cs2Label=timeframe cs3=Failed cs3Label=Status cs4=lcr cs4Label=Raw Status cs5=7.1 (System Board) cs5Label=Location cs6=Fan Block 1 cs6Label=Sensor Name dst=192.0.2.1 dvc=192.0.2.1 end=1302823237825 rt=1302823237825
hardware:141	CEF:0 ArcSight Logger 5.1.0.5803.0 hardware:141 Power Supply OK 1  cat=/Monitor/Sensor/PowerSupply/Ok cs1=cs1Label=Raw Value cs2=CurrentValue cs2Label=timeframe cs3=Ok cs3Label=Status cs4=ok cs4Label=Raw Status cs5=10.1 (Power Supply) cs5Label=Location cs6=Status cs6Label=Sensor Name dst=192.0.2.6 dvc=192.0.2.6 end=1303938572149 rt=1303938572149
hardware:142	
hardware:143	CEF:0 ArcSight Logger 5.1.0.5776.0 hardware:143 Power Supply Failed 8  cat=/Monitor/Sensor/PowerSupply/Failed cs1=0 Watts cs1Label=Raw Value cs2=CurrentValue cs2Label=timeframe cs3=Failed cs3Label=Status cs4=lcr cs4Label=Raw Status cs5=10.2 (Power Supply) cs5Label=Location cs6=Power Supply 2 cs6Label=Sensor Name dst=192.0.2.4 dvc=192.0.2.4 end=1302817019263 rt=1302817019263
hardware:151	CEF:0 ArcSight Logger 5.1.0.5776.0 hardware:151 Temperature OK 1  cat=/Monitor/Sensor/Temperature/Ok cs1=17 degrees C cs1Label=Raw Value cs2=CurrentValue cs2Label=timeframe cs3=Ok cs3Label=Status cs4=ok cs4Label=Raw Status cs5=64.1 (Unknown (0x40)) cs5Label=Location cs6=Temp 1 cs6Label=Sensor Name dst=192.0.2.4 dvc=192.0.2.4 end=1302823560051 rt=1302823560051
hardware:152	

Device Event Class: ID	Example
hardware:153	
<b>memory</b>	
memory:100	CEF:0 ArcSight Logger 5.1.0.5780.0 memory:100 Platform Memory Usage 1  cat=/Monitor/Memory/Usage/Platform cn1=2757 cn1Label=MB Used cs2=CurrentValue cs2Label=timeframe dst=192.0.2.6 dvc=192.0.2.6 end=1302797940018 rt=1302797940018
<b>network</b>	
network:100	CEF:0 ArcSight Logger 5.1.0.5780.0 network:100 Network Usage - Inbound 1  cat=/Monitor/Network/Usage/In cn1=41837428 cn1Label=Bytes Received cs2=SinceStartup cs2Label=timeframe cs6=eth0 cs6Label=Interface Name dst=192.0.2.6 dvc=192.0.2.6 end=1302733620026 rt=1302733620026
network:101	CEF:0 ArcSight Logger 5.1.0.5780.0 network:101 Network Usage - Outbound 1  cat=/Monitor/Network/Usage/Out cn1=158442791 cn1Label=Bytes Sent cs2=SinceStartup cs2Label=timeframe cs6=eth0 cs6Label=Interface Name dst=192.0.2.6 dvc=192.0.2.6 end=1302733620028 rt=1302733620028
<b>raid</b>	
raid:101	CEF:0 ArcSight Logger 5.1.0.5780.0 raid:101 RAID Controller OK 1  cat=/Monitor/RAID/Controller/Ok cs1=Type: RAID-5 cs1Label=Raw Value cs2=CurrentValue cs2Label=timeframe cs3=Ok cs3Label=Status cs4=Optimal cs4Label=Raw Status cs5=RAIDController/Configuration cs5Label=Location cs6=RAIDController/Configuration cs6Label=Sensor Name dst=192.0.2.6 dvc=192.0.2.6 end=1302886250104 rt=1302886250104
raid:102	CEF:0 ArcSight Logger 5.1.0.5780.0 raid:102 RAID Controller Degraded 5  cat=/Monitor/RAID/ControllerDegraded cs1=Type: RAID-5 Critical Disks: 0 Failed Disks: 0 cs1Label=Raw Value cs2=CurrentValue cs2Label=timeframe cs3=Degraded cs3Label=Status cs4=Degraded cs4Label=Raw Status cs5=RAIDController/Configuration cs5Label=Location cs6=RAIDController/Configuration cs6Label=Sensor Name dst=192.0.2.6 dvc=192.0.2.6 end=1302826128482 rt=1302826128482
raid:103	
raid:111	CEF:0 ArcSight Logger 5.1.0.5776.0 raid:111 RAID BBU OK 1  cat=/Monitor/RAID/BBU/Ok cs1=Battery/Capacitor Count: 1 cs1Label=Raw Value cs2=CurrentValue cs2Label=timeframe cs3=Ok cs3Label=Status cs4=OK cs4Label=Raw Status cs5=RAIDController/Battery/bbu cs5Label=Location cs6=RAIDController/Battery/bbu cs6Label=Sensor Name dst=192.0.2.4 dvc=192.0.2.4 end=1302890169285 rt=1302890169285
raid:112	CEF:0 ArcSight Logger 5.1.0.5780.0 raid:112 RAID BBU Degraded 5  cat=/Monitor/RAID/BBU/Degraded cs1=Fully Charged: false Remaining Time Alarm: false Remaining Capacity Alarm: false Over Charged: false isSOHGood: true cs1Label=Raw Value cs2=CurrentValue cs2Label=timeframe cs3=Degraded cs3Label=Status cs4=Degraded cs4Label=Raw Status cs5=RAIDController/Battery/bbu cs5Label=Location cs6=RAIDController/Battery/bbu cs6Label=Sensor Name dst=192.0.2.6 dvc=192.0.2.6 end=1302820608015 rt=1302820608015

<b>Device Event Class: ID</b>	<b>Example</b>
raid:113	
raid:121	CEF:0 ArcSight Logger 5.1.0.5780.0 raid:121 RAID Disk OK 1  cat=/Monitor/RAID/DISK/Ok cs1=Port: 1  Box: 1 Bay: 1 Size: 500 GB Serial Number: 9SP24JD5 cs1Label=Raw Value cs2=CurrentValue cs2Label=timeframe cs3=Ok cs3Label=Status cs4=OK cs4Label=Raw Status cs5=Port: 1  Box: 1 Bay: 1 Serial Number: 9SP24JD5 cs5Label=Location cs6=RAIDController/Port/p0 cs6Label=Sensor Name dst=192.0.2.1 dvc=192.0.2.1 end=1302849041777 rt=1302849041777
raid:122	CEF:0 ArcSight Logger 5.1.0.5776.0 raid:122 RAID Disk Rebuilding 5  cat=/Monitor/RAID/DISK/Rebuilding cs1=Port: 2  Box: 1 Bay: 1 Size: 1 TB Serial Number: WMATV6348517 cs1Label=Raw Value cs2=CurrentValue cs2Label=timeframe cs3=Rebuilding cs3Label=Status cs4=Rebuilding cs4Label=Raw Status cs5=Port: 2  Box: 1 Bay: 1 Serial Number: WMATV6348517 cs5Label=Location cs6=RAIDController/Port/p0 cs6Label=Sensor Name dst=192.0.2.4 dvc=192.0.2.4 end=1302826980530 rt=1302826980530
raid:123	CEF:0 ArcSight Logger 5.1.0.5780.0 raid:123 RAID Disk Failed 8  cat=/Monitor/RAID/DISK/Failed cs1=Port: 1  Box: 1 Bay: 2 Size: 500 GB Serial Number: 9SP23M08 cs1Label=Raw Value cs2=CurrentValue cs2Label=timeframe cs3=Failed cs3Label=Status cs4=Failed cs4Label=Raw Status cs5=Port: 1  Box: 1 Bay: 2 Serial Number: 9SP23M08 cs5Label=Location cs6=RAIDController/Port/p1 cs6Label=Sensor Name dst=192.0.2.1 dvc=192.0.2.1 end=1302826358346 rt=1302826358346
<b>search</b>	
search:100	CEF:0 ArcSight Logger 5.1.0.5780.0 search:100 Number of Searches Performed 1  cat=/Monitor/Search cn1=0 cn1Label=Number of Searches cs2=SinceStartup cs2Label=timeframe dst=192.0.2.6 dvc=192.0.2.6 end=1302741300026 rt=1302741300026
<b>storagegroup</b>	
storagegroup:100	CEF:0 ArcSight Logger 5.1.0.5803.0 storagegroup:100 Storage Group Space Used 1  cat=/Monitor/StorageGroup/Space/Used cn1=1 cn1Label=Percent Used cn2=7 cn2Label=retention period (days) cn3=1024 cn3Label=used (MB) cs2=CurrentValue cs2Label=timeframe dst=192.0.2.6 dvc=192.0.2.6 end=1303928072008 fileType=storageGroup fname=Default Storage Group fsize=1534 rt=1303928072008

# Appendix F: Event Field Name Mappings

The nomenclature for field names depends on the function area of the Logger. The following table provides the mapping between these types of names.

- **Database Name:** Field name created in the database when you index this field. There will be no database name for a field if you have not indexed it. This field name is used when creating a SQL query for generating a report.
- **Search Results:** Field name displayed in the search results when your search returns data in this field.
- **CEF Field Name:** The key or field name as defined in Implementing ArcSight CEF. For a downloadable a copy of this guide, search for "ArcSight Common Event Format (CEF) Guide" in the [ArcSight Product Documentation Community on Protect 724](#).
- **Reports:** Field name displayed in a report containing data from this field.

Database Name	Search Results	CEF Field Name	Reports
arc_agentAddress	agentAddress	agt	Agent Address
arc_agentHostName	agentHostName	ahost	Agent Host Name
arc_agentNtDomain	agentNtDomain	agentNtDomain	Agent NT Domain
arc_agentSeverity	agentSeverity	Severity	Severity
arc_agentType	agentType	at	Agent Type
arc_agentZone	agentZone	agentZone	Agent Zone
arc_agentZoneName	agentZoneName	agentZoneName	Agent Zone Name
arc_agentZoneResource	agentZoneResource	agentZoneResource	Agent Zone Resource
arc_agentZoneURI	agentZoneURI	agentZoneURI	Agent Zone URI
arc_applicationProtocol	applicationProtocol	app	Application Protocol
arc_baseEventCount	baseEventCount	cnt	Base Event Count
arc_bytesIn	bytesIn	in	Bytes In
arc_bytesOut	bytesOut	out	Bytes Out
arc_categoryBehavior	categoryBehavior	categoryBehavior	Category Behavior
arc_categoryDeviceGroup	categoryDeviceGroup	categoryDeviceGroup	Category Device Group

Administrator's Guide  
Appendix F: Event Field Name Mappings

Database Name	Search Results	CEF Field Name	Reports
arc_categoryObject	categoryObject	categoryObject	Category Object
arc_categoryOutcome	categoryOutcome	categoryOutcome	Category Outcome
arc_categorySignificance	categorySignificance	categorySignificance	Category Significance
arc_categoryTechnique	categoryTechnique	categoryTechnique	Category Technique
arc_customerName	customerName	customerName	Customer Name
arc_destinationAddress	destinationAddress	dst	Destination Address
arc_destinationDnsDomain	destinationDnsDomain	destinationDnsDomain	Destination DNS Domain
arc_destinationHostName	destinationHostName	dhost	Destination Host Name
arc_destinationMacAddress	destinationMacAddress	dmac	Destination Mac Address
arc_destinationNtDomain	destinationNtDomain	dntdom	Destination NT Domain
arc_destinationPort	destinationPort	dpt	Destination Port
arc_destinationProcessName	destinationProcessName	dproc	Destination Process Name
arc_destinationServiceName	destinationServiceName	destinationServiceName	Destination Service Name
arc_destinationTranslatedAddress	destinationTranslatedAddress	destinationTranslatedAddress	Destination Translated Address
arc_destinationUserId	destinationUserId	duid	Destination User ID
arc_destinationUserName	destinationUserName	duser	Destination User Name
arc_destinationUserPrivileges	destinationUserPrivileges	dpriv	Destination User Privileges
arc_destinationZone	destinationZone	destinationZone	Destination Zone
arc_destinationZoneName	destinationZoneName	destinationZoneName	Destination Zone Name
arc_destinationZoneResource	destinationZoneResource	destinationZoneResource	Destination Zone Resource

Database Name	Search Results	CEF Field Name	Reports
arc_destinationZoneURI	destinationZoneURI	destinationZoneURI	Destination Zone URI
arc_deviceAction	deviceAction	act	Device Action
arc_deviceAddress	deviceAddress	dvc	Device Address
arc_deviceCustomDate1	deviceCustomDate1	deviceCustomDate1	Device Custom Date 1
arc_deviceCustomDate1Label	deviceCustomDate1Label	deviceCustomDate1Label	Device Custom Date 1 Label
arc_deviceCustomDate2	deviceCustomDate2	deviceCustomDate2	Device Custom Date 2
arc_deviceCustomDate2Label	deviceCustomDate2Label	deviceCustomDate2Label	Device Custom Date 2 Label
arc_deviceCustomNumber1	deviceCustomNumber1	cn1	Device Custom Number 1
arc_deviceCustomNumber1Label	deviceCustomNumber1Label	cn1Label	Device Custom Number 1 Label
arc_deviceCustomNumber2	deviceCustomNumber2	cn2	Device Custom Number 2
arc_deviceCustomNumber2Label	deviceCustomNumber2Label	cn2Label	Device Custom Number 2 Label
arc_deviceCustomNumber3	deviceCustomNumber3	cn3	Device Custom Number 3
arc_deviceCustomNumber3Label	deviceCustomNumber3Label	cn3Label	Device Custom Number 3 Label
arc_deviceCustomString1	deviceCustomString1	cs1	Device Custom String 1
arc_deviceCustomString1Label	deviceCustomString1Label	cs1Label	Device Custom String 1 Label
arc_deviceCustomString2	deviceCustomString2	cs2	Device Custom String 2
arc_deviceCustomString2Label	deviceCustomString2Label	cs2Label	Device Custom String 2 Label
arc_deviceCustomString3	deviceCustomString3	cs3	Device Custom String 3

Administrator's Guide  
Appendix F: Event Field Name Mappings

Database Name	Search Results	CEF Field Name	Reports
arc_ deviceCustomString3Label	deviceCustomString3Label	cs3Label	Device Custom String 3 Label
arc_deviceCustomString4	deviceCustomString4	cs4	Device Custom String 4
arc_ deviceCustomString4Label	deviceCustomString4Label	cs4Label	Device Custom String 4 Label
arc_deviceCustomString5	deviceCustomString5	cs5	Device Custom String 5
arc_ deviceCustomString5Label	deviceCustomString5Label	cs5Label	Device Custom String 5 Label
arc_deviceCustomString6	deviceCustomString6	cs6	Device Custom String 6
arc_ deviceCustomString6Label	deviceCustomString6Label	cs6Label	Device Custom String 6 Label
arc_deviceEventCategory	deviceEventCategory	cat	Device Event Category
arc_deviceEventClassId	deviceEventClassId	Signature ID	Signature Id
arc_deviceExternalId	deviceExternalId	deviceExternalId	Device External Id
arc_deviceHostName	deviceHostName	dvchost	Device Host Name
arc_deviceInboundInterface	deviceInboundInterface	deviceInboundInterface	Device Inbound Interface
arc_deviceOutboundInterface	deviceOutboundInterface	deviceOutboundInterface	Device Outbound Interface
arc_deviceProduct	deviceProduct	Device Product	Device Product
arc_deviceReceiptTime	deviceReceiptTime	rt	Device Receipt Time
arc_deviceSeverity	deviceSeverity	deviceSeverity	Device Severity
arc_deviceVendor	deviceVendor	Device Vendor	Device Vendor
arc_deviceVersion	deviceVersion	Device Version	Device Version
arc_deviceZone	deviceZone	deviceZone	Device Zone
arc_deviceZoneName	deviceZoneName	deviceZoneName	Device Zone Name
arc_deviceZoneResource	deviceZoneResource	deviceZoneResource	Device Zone Resource



Database Name	Search Results	CEF Field Name	Reports
arc_deviceZoneURI	deviceZoneURI	deviceZoneURI	Device Zone URI
arc_endTime	endTime	end	End Time
arc_eventId	eventId	eventId	Event Id
arc_externalId	externalId	externalId	External Id
arc_fileName	fileName	fname	File Name
arc_filePath	filePath	filePath	File Path
arc_flexDate1	flexDate1	flexDate1	Flex Date 1
arc_flexDate1Label	flexDate1Label	flexDate1Label	Flex Date 1 Label
arc_flexNumber1	flexNumber1	flexNumber1	Flex Number1
arc_flexNumber1Label	flexNumber1Label	flexNumber1Label	Flex Number 1 Label
arc_flexNumber2	flexNumber2	flexNumber2	Flex Number 2
arc_flexNumber2Label	flexNumber2Label	flexNumber2Label	Flex Number 2 Label
arc_flexString1	flexString1	flexString1	Flex String 1
arc_flexString1Label	flexString1Label	flexString1Label	Flex String 1 Label
arc_flexString2	flexString2	flexString2	Flex String 2
arc_flexString2Label	flexString2Label	flexString2Label	Flex String 2 Label
arc_message	message	msg	Message
arc_name	name	Name	Name
arc_priority	priority	priority	Priority
arc_requestClientApplication	requestClientApplication	requestClientApplication	Request Client Application
arc_requestContext	requestContext	requestContext	Request Context
arc_requestMethod	requestMethod	requestMethod	Request Method
arc_requestUrl	requestUrl	request	Request URL
arc_requestUrlFileName	requestUrlFileName	requestUrlFileName	Request URL File Name
arc_requestUrlQuery	requestUrlQuery	requestUrlQuery	Request URL Query
arc_sessionId	sessionId	sessionId	Session Id

Administrator's Guide  
Appendix F: Event Field Name Mappings

Database Name	Search Results	CEF Field Name	Reports
arc_sourceAddress	sourceAddress	src	Source Address
arc_sourceHostName	sourceHostName	shost	Source Host Name
arc_sourceMacAddress	sourceMacAddress	smac	Source Mac Address
arc_sourceNtDomain	sourceNtDomain	sntdom	Source NT Domain
arc_sourcePort	sourcePort	spt	Source Port
arc_sourceProcessName	sourceProcessName	sproc	Source Process Name
arc_sourceServiceName	sourceServiceName	sourceServiceName	Source Service Name
arc_sourceTranslatedAddress	sourceTranslatedAddress	sourceTranslatedAddress	Source Translated Address
arc_sourceUserId	sourceUserId	suid	Source User Id
arc_sourceUserName	sourceUserName	suser	Source User Name
arc_sourceUserPrivileges	sourceUserPrivileges	spriv	Source User Privileges
arc_sourceZone	sourceZone	sourceZone	Source Zone
arc_sourceZoneName	sourceZoneName	sourceZoneName	Source Zone Name
arc_sourceZoneResource	sourcezoneResource	sourceZoneResource	Source Zone Resource
arc_sourceZoneURI	sourceZoneURI	sourceZoneURI	Source Zone URI
arc_startTime	startTime	start	Start Time
arc_transportProtocol	transportProtocol	proto	Transport Protocol
arc_type	type	type	Type
arc_vulnerabilityExternalID	vulnerabilityExternalID	vulnerabilityExternalID	Vulnerability External Id
arc_vulnerabilityURI	VulnerabilityURI	vulnerabilityURI	Vulnerability URI

# Appendix G: Logger Content

The following topics provide information about the out-of-box Logger reports:

- [Reports](#) .....555
- [Parameters](#) .....581
- [System Filters](#) .....586
- [Queries](#) .....592

## Reports

Logger provides the reports described in the tables below. In the Logger UI, these reports are listed in categories, accessible through the Category Explorer (in the left pane). For example, the "Top Infected Systems" report is listed in the Anti-Virus category, which is listed in the parent category called [Device Monitoring](#).

The reports contain hyperlinks that drill down to other reports. For example, the report "Most Common Events" displays a field called Count. Clicking on the Count field drills down to the report [Target Attack Counts by Severity](#), which provides additional detail information, as shown in the following figure. The drill-down relationship between reports is shown in the tables below.

Severity	Name	Count
<a href="#">Very-High</a>	SMB: WinLogon DoS	2089
<a href="#">Very-High</a>	IRC: Trojan.IrcBounce Command Channel	70
<a href="#">Very-High</a>	Snort Alarm [1:2404:5]	58
<a href="#">Very-High</a>	Host is DOWN	41
<a href="#">Very-High</a>	ids syn attack	26
<a href="#">Very-High</a>	RCRS/POP3_INVALID_ARG_TO_QUIT	16

Severity	Target Zone	Target Address	Count
Very-High	/All Zones/ArcSight System/Private Address Space Zones/RFC1918: 10.0.0.0-10.255.255.255	10.0.0.10	57
Very-High	/All Zones/ArcSight System/Private Address Space Zones/RFC1918: 10.0.0.0-10.255.255.255	10.156.106.101	25
Very-High	/All Zones/ArcNet Zones/sj2.west.arcnet.com - internal	10.0.112.187	10
Very-High	/All Zones/ArcSight System/Private Address Space Zones/RFC1918: 10.0.0.0-10.255.255.255	10.0.0.10	10
Very-High	/All Zones/ArcSight System/Private Address Space Zones/RFC1918: 172.16.0.0-172.31.255.255	172.16.5.157	8

Logger provides the following top-level categories:

- [Device Monitoring](#) .....556

- [Foundation](#) .....564
- [Logger Administration](#) .....575
- [SANS Top 5](#) .....576

## Device Monitoring

This category provides a device or application based view on events.

The following categories are located under the Device Monitoring category:

- [Anti-Virus](#) .....556
- [CrossDevice](#) .....557
- [Database](#) .....560
- [Firewall](#) .....560
- [IDS-IPS](#) .....561
- [Identity Management](#) .....562
- [Network](#) .....562
- [Operating System](#) .....563
- [VPN](#) .....564

## Anti-Virus

This is a sub-category of the Device Monitoring category, focusing on events related to Anti-Virus systems.

The Anti-Virus category is located under the following path.

Device Monitoring\Anti-Virus

The Anti-Virus category reports are listed in the following table.

### Anti-Virus

Report	Description	Drill Down	Parameters
Errors Detected in Anti-Virus Deployment	This report shows a summary of information on the anti-virus errors, including the Anti-Virus product information, host details, error information, and the number of errors.	none	none
Failed Anti-Virus Updates	This report displays a table with the Device Vendor, Device Product Target Zone Name, Target Host Name, Target Address, and Minute(EndTime).	none	none

### Anti-Virus, continued

Report	Description	Drill Down	Parameters
Top Infected Systems	This report displays summaries of the systems reporting the most infections.	none	none
Update Summary	This report shows a summary and details of anti-virus update activity.	none	none
Virus Activity by Hour	This report shows malware activity by hour.	none	none

## CrossDevice

This is a sub-category of the Device Monitoring category. It provides information on events that are similar across devices, e.g., logins, start up and shut down, etc.

The CrossDevice category is located under the following path.

Device Monitoring\CrossDevice

The CrossDevice category reports are listed in the following table.

### CrossDevice

Report	Description	Drill Down	Params
Bandwidth Usage by Hour	This report shows the network bandwidth usage per hour by device type. Note that the bandwidth values are based on all reported traffic, including traffic within the network, as well as traffic to and from internal and external sources. There is a parameter allowing the limitation of the devices to one of the following: Firewalls, Network Equipment, or VPNs. By default, the parameter is set to all devices and applications that report data.	The Reporting Device field drill downs to the <a href="#">Bandwidth Usage by Hour</a> report.  This report drills down to itself.	none
Bandwidth Usage by Protocol	This report shows all the protocols sorted by bandwidth usage, by device type. Note that the bandwidth values are based on all reported traffic, including traffic within the network, as well as traffic to and from internal and external sources. There is a parameter allowing the limitation of the devices to one of the following: Firewalls, Network Equipment, or VPNs. By default, the parameter is set to all devices and applications that report data.	The Reporting Device field drill downs to the <a href="#">Bandwidth Usage by Protocol</a> report.  This report drills down to itself.	none
By User Account - Accounts Created	This report shows all newly created accounts that were reported to Logger.	none	none

### CrossDevice, continued

Report	Description	Drill Down	Params
Configuration Changes by Type	This report shows recent configuration changes that were reported to Logger.	The Reporting Device field drill downs to the <a href="#">Configuration Changes by Type</a> report.  This report drills down to itself.	none
Configuration Changes by User	This report shows recent configuration changes that were reported to Logger.	The Reporting Device field drill downs to the <a href="#">Configuration Changes by User</a> report.  This report drills down to itself.	none
Failed Login Attempts	This report shows authentication failures from login attempts by hour. There is a parameter allowing the limitation of the devices to one of the following: Database, Firewalls, Identity Management systems, Network Equipment, Operating Systems, or VPNs. By default, the parameter is set to all devices and applications that report data.	The Reporting Device field drill downs to the <a href="#">Failed Login Attempts</a> report.  This report drills down to itself.	none
Failed Logins by Destination Address	This report shows authentication failures from login attempts by destination address. There is a parameter allowing the limitation of the devices to one of the following: Database, Firewalls, Identity Management systems, Network Equipment, Operating Systems, or VPNs. By default, the parameter is set to all devices and applications that report data.	The Reporting Device field drill downs to the <a href="#">Failed Logins by Destination Address</a> report.  This report drills down to itself.	none
Failed Logins by Source Address	This report shows authentication failures from login attempts by source address. There is a parameter allowing the limitation of the devices to one of the following: Database, Firewalls, Identity Management systems, Network Equipment, Operating Systems, or VPNs. By default, the parameter is set to all devices and applications that report data.	The Reporting Device field drill downs to the <a href="#">Failed Logins by Source Address</a> report.  This report drills down to itself.	none
Failed Logins by User	This report shows authentication failures from login attempts by user. There is a parameter allowing the limitation of the devices to one of the following: Database, Firewalls, Identity Management systems, Network Equipment, Operating Systems, or VPNs. By default, the parameter is set to all devices and applications that report data.	The Reporting Device field drill downs to the <a href="#">Failed Logins by User</a> report.  This report drills down to itself.	none

**CrossDevice, continued**

Report	Description	Drill Down	Params
Login Event Audit	This report shows all authentication events. There is a parameter allowing the limitation of the devices to one of the following: Database, Firewalls, Identity Management systems, Network Equipment, Operating Systems, or VPNs. By default, the parameter is set to all devices and applications that report data.	The Reporting Device field drill downs to the <a href="#">Login Event Audit</a> report.  This report drills down to itself.	none
Password Changes	This report shows all password changes that were reported to Logger.	The Reporting Device field drill downs to the <a href="#">Password Changes</a> report.  This report drills down to itself.	none
Successful Logins by Destination Address	This report shows successful authentication events by destination addresses. There is a parameter allowing the limitation of the devices to one of the following: Database, Firewalls, Identity Management systems, Network Equipment, Operating Systems, or VPNs. By default, the parameter is set to all devices and applications that report data.	The Reporting Device field drill downs to the <a href="#">Successful Logins by Destination Address</a> report.  This report drills down to itself.	none
Successful Logins by Source Address	This report shows successful authentication events by source addresses. There is a parameter allowing the limitation of the devices to one of the following: Database, Firewalls, Identity Management systems, Network Equipment, Operating Systems, or VPNs. By default, the parameter is set to all devices and applications that report data.	The Reporting Device field drill downs to the <a href="#">Successful Logins by Source Address</a> report.  This report drills down to itself.	none

## CrossDevice, continued

Report	Description	Drill Down	Params
Successful Logins by User	This report shows successful authentication events by user. There is a parameter allowing the limitation of the devices to one of the following: Database, Firewalls, Identity Management systems, Network Equipment, Operating Systems, or VPNs. By default, the parameter is set to all devices and applications that report data.	The Reporting Device field drill downs to the <a href="#">Successful Logins by User</a> report.  This report drills down to itself.	none
Top Bandwidth Hosts	This report shows the top hosts, sorted by bandwidth usage. Note that the bandwidth values are based on all reported traffic, including traffic within the network, as well as traffic to and from internal and external sources. There is a parameter allowing the limitation of the devices to one of the following: Firewalls, Network Equipment, or VPNs. By default, the parameter is set to all devices and applications that report data.	none	none
Top Hosts by Number of Connections	This report shows a summary of the number of connections by the top hosts. There is a parameter allowing the limitation of the devices to one of the following: Firewalls, Network Equipment, or VPNs. By default, the parameter is set to all devices and applications that report data.	The Reporting Device field drill downs to the <a href="#">Top Hosts by Number of Connections</a> report.  This report drills down to itself.	none

## Database

This is a sub-category of the Cross Device category, focusing on database events.

The Database category is located under the following path.

Device Monitoring\Database

The Database category reports are listed in the following table.

### Database

Report	Description	Drill Down	Parameters
Database Errors and Warnings	This report shows recent database errors and warnings.	none	none

## Firewall

This is a sub-category of the Device Monitoring category, focusing on firewall events.

The Firewall category is located under the following path.

Device Monitoring\Firewall



The Firewall category reports are listed in the following table.

### Firewall

Report	Description	Drill Down	Parameters
Denied Connections by Address	This report shows a summary and details of inbound and outbound connections denied by Firewall devices.	none	none
Denied Connections by Port	This report shows a summary and details of inbound and outbound ports denied by Firewall devices.	none	none
Denied Connections per Hour	This report shows a summary and details of inbound and outbound connections denied by Firewall devices on an hourly basis.	none	none

### IDS-IPS

This is a sub-category of the Device Monitoring category, focusing on Intrusion Detection System and Intrusion Prevention System events.

The IDS-IPS category is located under the following path.

Device Monitoring\IDS-IPS

The IDS-IPS category reports are listed in the following table.

### IDS-IPS

Report	Description	Drill Down	Parameters
Alert Counts by Device	This report shows counts of IDS and IPS alerts.	none	none
Alert Counts by Port	This report shows count of IDS and IPS alerts by destination port.	none	none
Alert Counts by Severity	This report shows count of IDS and IPS alerts by agent severity.	none	none
Alert Counts by Type	This report shows the count of IDS and IPS alerts by type (category technique).	none	none
Alert Counts per Hour	This report shows the count of IDS and IPS alerts for each hour.	none	none
Top Alert Destinations	This report shows the top destinations of IDS and IPS alerts.	none	none

### IDS-IPS, continued

Report	Description	Drill Down	Parameters
Top Alerts from IDS and IPS	This report shows the top alerts coming from Intrusion Detection Systems (IDS) and Intrusion Prevention Systems (IPS).	none	none
Top Alert Sources	This report shows the top sources of IDS and IPS alerts.	none	none
Worm Infected Systems	This report shows a list of systems that have been infected by a worm.	none	none

## Identity Management

This is a sub-category of the Device Monitoring category, focusing on Identity Management system events.

The Identity Management category is located under the following path.

Device Monitoring\Identity Management

The Identity Management category reports are listed in the following table.

### Identity Management

Report	Description	Drill Down	Parameters
Connection Counts by User	This reports shows count information about connections for each user reported by Identity Management devices.	none	none

## Network

This is a sub-category of the Device Monitoring category, focusing on network devices such as routers and switches.

The Network category is located under the following path.

Device Monitoring\Network

The Network category reports are listed in the following table.

### Network

Report	Description	Drill Down	Parameters
Device Critical Events	This report shows information regarding critical events on network devices. These critical events could be indications of hardware failure, resource exhaustion, configuration issues, or attacks.	none	none
Device Errors	This report shows information regarding error events on network devices. These critical events could be indications of hardware failure, resource exhaustion, configuration issues, or attacks.	none	none
Device Events	This report shows information regarding events on network devices. These critical events could be indications of hardware failure, resource exhaustion, configuration issues, or attacks.	none	none
Device Interface Down Notifications	This report shows a table displaying the network devices that report a down link.	none	none
Device Interface Status Messages	This report shows the network devices reporting link status changes.	none	none
Device SNMP Authentication Failures	This report shows information regarding network device SNMP failures.	none	none

## Operating System

This is a sub-category of the Device Monitoring category, focusing on operating system events.

The Operating System category is located under the following path.

Device Monitoring\Operating System

The Operating System category reports are listed in the following table.

### Operating System

Report	Description	Drill Down	Parameters
Login Errors by User	This report shows the details of failed logins for each username (time, event name, source, and destination).	none	none
User Administration	This report shows user and user group creations, modifications, and deletions.	none	none

## VPN

This is a sub-category of the Device Monitoring category, focusing on virtual private network events.

The VPN category is located under the following path.

Device Monitoring\VPN

The VPN category reports are listed in the following table.

### VPN

Report	Description	Drill Down	Parameters
Authentication Errors	This report shows errors generated by a VPN connection attempt. The address is the IP address of the VPN connection source. This report can be used to see which users are having difficulties using or setting up their VPN clients.	none	none
Connection Counts by User	This report shows count information about VPN connections for each user. Details of each user's connection counts are provided, including connection count and systems accessed.	none	none
Connections Accepted by Address	This report shows successful VPN connection data.	none	none
Connections Denied by Address	This report shows denied VPN connection data.	none	none
Connections Denied by Hour	This report shows denied VPN connection data for each hour.	none	none

## Foundation

This category covers a broad range of events, from security and perimeter defense to network bandwidth usage and configuration events.

The following categories are located under the Foundation category:

- [Configuration Monitoring](#) .....564
- [Intrusion Monitoring](#) .....566
- [NetFlow Monitoring](#) .....574
- [Network Monitoring](#) .....574

## Configuration Monitoring

This category covers configuration changes to systems and applications.

The Configuration Monitoring category is located under the following path.

Foundation\Configuration Monitoring

The Configuration Monitoring category reports are listed in the following table. There are no parameters.

### Configuration Monitoring

Report	Description	Drill Down
Accounts Created by User Account	This report details the successfully created accounts created on network hosts. The table includes the timestamp of when the account was created, the created account name (Destination User Name), the name of the user creating the account (Source User Name), the account creation event name, and the zone and host name of the device on which the account was created.	none
Accounts Deleted by Host	This report provides a listing of user deletions, ordered by Customer, Zone, and System.	none
Accounts Deleted by User Account	This report displays a table showing the date, the deleted user name, the user name that deleted the account, the account deletion event name, and the zone and host name of the system from which the account was deleted.	none
Anti-Virus Updates-All-Failed	This report displays a table with the Device Vendor, Device Product Target Zone Name, Target Host Name, Target Address and Minute(EndTime), of all failed anti-virus update events.	none
Anti-Virus Updates-All-Summary	This report displays a table showing the Target Zone Name, Target Host Name, Target Address, Device Vendor, Device Product, Category Outcome and the sum of the Aggregated Event Count of all anti-virus events.	none
Asset Startup and Shutdown Event Log	This report provides a listing of the system startup and shutdown events.	none
Device Configuration Changes	This report shows a table of events related to successful device configuration modification events. The information provided includes the Device Group, the Zone, Address and Host Name, the Configuration Event name, the User ID and Name making the change, and the hour the change was made. Clicking on a device entry in the Device Group column will bring up a new report, Device Configuration Changes Drilldown, which will show only configuration events for that particular device type.	The Device Group field drill downs to the <a href="#">Device Configuration Changes</a> report.  This report drills down to itself.
Device Configuration Events	This report shows a table of events related to various device configuration modification events, whether successful or not. The information provided includes the Device Group, the Zone, Address and Host Name, the Configuration Event name, the User ID and Name making the change, and the hour the change was made. Clicking on a device entry in the Device Group column will bring up a new report, Device Configuration Events Drilldown, which will show only configuration events for that particular device type.	The Device Group field drill downs to the <a href="#">Device Configuration Events</a> report.  This report drills down to itself.

### Configuration Monitoring, continued

Report	Description	Drill Down
Device Misconfigurations	This report shows a table of events related to device configuration checks. The information provided includes the Device Group, the Zone, Address and Host Name, the Misconfiguration name, and the count of the number of misconfigurations found. Clicking on a Device Group entry will run the Device Misconfigurations Drilldown report, focusing on the device type that was clicked.	The Device Group field drill downs to the <a href="#">Device Misconfigurations</a> report.  This report drills down to itself.
Password Changes	This report displays a table of user accounts having their passwords changed. The table shows the time the password was changed, the user name of the account with the new password, the zone and address of the system on which the password was changed, and the zone and address from which the change originated.	none
Vulnerability Scanner Logs by Host	This report shows Vulnerability Scanner Logs grouped by Zone and Host IP Address.	none
Vulnerability Scanner Logs by Vulnerability	This report shows Vulnerability Scanner Logs grouped by Vulnerability IDs and Names.	none

## Intrusion Monitoring

This is a sub-category of the Foundation category, focusing on security, perimeter defense, resource access and user tracking events.

The Intrusion Monitoring category is located under the following path.

Foundation\Intrusion Monitoring

The Intrusion Monitoring category reports are listed in the following table. There are no parameters.

### Intrusion Monitoring

Report	Description	Drill Down
Firewall Traffic by Service	This report displays a table showing the Port, transport protocol, application protocol, and the number of events reported by firewalls.	none
Least Common Events	This report displays all events in the time period selected and orders them by the sum of the aggregated event count in ascending order. The columns are hyperlinked for convenience. The Event Name column will bring up the Bottom Destinations report using the same time frame. The Count column will bring up the Bottom Sources report using the same time frame.	The Event Name field drill downs to the <a href="#">Bottom Destinations</a> report.  The Count field drill downs to the <a href="#">Bottom Sources</a> report.
Most Common Events	This report displays the 200 most common events within the time range specified. The event name is hyperlinked to drilldown to the Destination Counts by Event Name report, which will show destination information for the event selected. The Count field will bring up the Source Counts by Destination Port report, which will include information about all sources by destination port.	The arc_name field drill downs to the <a href="#">Destination Counts by Event Name</a> report.  The SUM(events.arc_baseEventCount) field drill downs to the <a href="#">Source Counts by Destination Port</a> report.
Most Common Events by Severity	This report displays a table showing the Severity, event name and count of events in descending order.	The Severity field drill downs to the <a href="#">Source Counts by Device Severity</a> report.  The Count field drill downs to the <a href="#">Destination Counts by Device Severity</a> report.
Probes on Blocked Ports by Source	This report displays a table of events showing the source zone, address and host name, the transport protocol, the destination port, and the count of events where the destination port is in the list of commonly blocked ports. The query uses the commonlyblockedPorts parameter, which can be edited to include other ports (please make a copy of the report, the query, and the parameter, and modify your version as updates to the Foundation Content may overwrite your changes).	none

### Intrusion Monitoring, continued

Report	Description	Drill Down
SecurityDash BoardRpt	This custom report displays a table showing the source address, category behavior, destination address and event ID.	none
SecurityDB Report	This custom Security Dashboard report displays two charts and a table. The first chart shows the number of events by source address. The second chart shows the number of events by destination address. The table shows the counts of events for each source and destination.	none
Top IDS Attack Events	This report displays a table showing the top events from IDS systems, with the IDS Event name, the type of IDS, and the count of each IDS event where the category significance is Compromise or Hostile.	none
Top IDS Events	This report displays a table showing the top events from IDS systems, with the IDS Event name, the type of IDS, and the count of each IDS event.	none
Top Machines Traversing Firewall	This report displays the source zone, address and hostname, and number of events reported by firewalls.	none
Top Web Traffic	This report displays a table showing the hour, source zone, address and host name, the web port and the count of events where the destination port is listed in the webPorts parameter.	none
Windows Events	This report displays a table showing the device zone, address and host name, the device event ID, the source user ID, user name and NT domain, the destination user ID, user name and NT domain, the behavior, outcome and event type, and the count of events of each type reported by any Microsoft operating system.	none
Worm Infected Systems	This report displays a table showing the Zone Name, Host Name and Address of systems exhibiting symptoms of being infected by a worm.	none

The following categories are located under Intrusion Monitoring:

- [Attackers](#) .....569
- [Resource Access](#) .....570
- [Targets](#) .....571
- [User Tracking](#) .....573



## Attackers

This is a sub-category of the Intrusion Monitoring category, focusing on events based on source or attacker information.

The Attackers category is located under the following path.

Foundation\Intrusion Monitoring\Attackers

The Attackers category reports are listed in the following table. There are no parameters.

### Attackers

Report	Description	Drill Down
Bottom Sources	This report displays the Source Zone Names, Source Addresses and event Count ordered by the sum of the base event counts in ascending order. Clicking on the hyperlink for the Count column will bring up the Bottom Targets report. It is the target of the Least Common Events report's Count column.	The Count field drill downs to the <a href="#">Bottom Targets</a> report.
Source Counts by Destination	This report displays a table showing the destination zone and address, the source zone and the number of each event for a specific destination zone and address where the category significance is Compromise or Hostile.	<p>The Destination Zone field drill downs to the <a href="#">Source Counts by Destination</a> report.</p> <p>The Destination Address field drill downs to the <a href="#">Source Counts by Destination</a> report.</p> <p>The Source Count field drill downs to the <a href="#">Attack Events by Destination</a> report.</p> <p>This report drills down to itself.</p>
Source Counts by Destination Port	This report displays a table showing the Destination Port, the source zone and address, and the number of events for each port.	none
Source Counts by Device	This report displays a table showing the device zone and address, the source zone and address, and the number of each event where the category significance is Compromise or Hostile.	none
Source Counts by Device Severity	This report displays a table showing the Severity, source zone and address, and the number of events at that severity.	none
Source Counts by Source Port	This report displays a table showing the Source Port, source zone and address, and a count of events where the category significance is Compromise or Hostile.	none

## Attackers, continued

Report	Description	Drill Down
Source Port Counts	This report displays a table showing the Source Port, Event Name and count of the events where the category significance is Compromise or Hostile.	none
Top 10 Talkers	This report displays a table of the Top 10 systems generating events, showing the Source zone and address, as well as the number of events from that system.	none
Top Attacker Detail	This report displays a table showing the severity, attacker zone and address, the target zone and address, and the count of events for a specified source zone and address where the category significance is Compromise or Hostile.	none
Top Attacker Details	This report displays the Severity, Attacker Zone, Attacker Address, Target Zone, Target Address and Count of events where the Category Significance of the event is compromise or hostile, ordered by the event count in descending order. This report is the target of the Top Attackers report's Attacker Address column.	none
Top Attacker Ports	This report displays a table showing the Attacker Port, Transport Protocol and the count of events where the category significance is Compromise or Hostile.	none
Top Attackers	This report shows the Attacker Zone Names, Attacker Addresses and Count of events where the Category Significance of the events is compromise or hostile, in descending order of the sum of the base event count. This report has hyperlinks that will run reports showing more information base on the field selected. The Attacker Zone column will run the Top Attack Sources report. The Attacker Address will run the Top Attacker Details report. The Count column will run the Top Targets report.	The Attacker Address field drill downs to the <a href="#">Top Attacker Details</a> report.  The Count field drill downs to the <a href="#">Top Targets</a> report.
Top Attack Sources	This report displays the Attacker Zone and Count of events where the Category Significance of the event is compromise or hostile, ordered by the event count in descending order. This report has a hyperlink in the Attacker Zone column that will run the Top Attackers report.	The Attacker Zone field drill downs to the <a href="#">Top Attackers</a> report.
Top Sources Detected by Snort	This report displays a table showing the source zone, address and host name and the number of events detected by Snort.	none
Top Sources Traversing Firewalls	This report displays a table of the source zone, address and host name, as well as the count of events, where the event was reported by a firewall device.	none

## Resource Access

This is a sub-category of the Intrusion Monitoring category, focusing on protected resources.

The Resource Access category is located under the following path.

Foundation\Intrusion Monitoring\Resource Access

The Resource Access category reports are listed in the following table. There are no parameters.

### Resource Access

Report	Description	Drill Down
Access Events by Resource	This report displays a table showing the Resource Type, the zone and address, the access event, the outcome and the number of times this has happened over the time period selected. Clicking on a resource type will run the Access Events by Resource Drilldown report showing the events for the selected resource type.	The Resource Type field drill downs to the <a href="#">Access Events by Resource</a> report.  This report drills down to itself.
Least Common Accessed Ports	This report displays a table showing the Destination Port, the Transport Protocol and a count of the events for that port where the transport protocol is TCP or UDP.	none
Resource Access by Users - Failures	This report displays a table showing the Resource Type, the User ID and Name, Destination zone and address, the Access Event and number of failed attempts to access a given resource. Clicking on an entry in the Resource Type column will bring up the Resource Access by Users - Failures Drilldown report, which will show all related events for that resource type.	The Resource Type field drill downs to the <a href="#">Resource Access by Users - Failures</a> report.  This report drills down to itself.
Resource Access by Users - Successes-Attempts	This report displays a table showing the Resource Type, Outcome, destination user ID and name, destination zone and address, the access event name and the number of such events. The Resource Type column is hyperlinked so that clicking on a resource type will run the Resource Access by Users - Successes-Attempts Drilldown report, showing only events for the selected resource type.	The Resource Type field drill downs to the <a href="#">Resource Access by Users - Successes-Attempts</a> report.  This report drills down to itself.
Top Machines Accessing the Web	This report displays a table showing the source zone, address and host name, the destination port and the number of events where the destination port is in the webPorts parameter list.	none

### Targets

This is a sub-category of the Intrusion Monitoring category, focusing on events based on destination or target information.

The Targets category is located under the following path.

Foundation\Intrusion Monitoring\Targets

The Targets category reports are listed in the following table. There are no parameters.

### Targets

Report	Description	Drill Down
Attack Events by Destination	This report displays a table showing the destination zone and address, the source zone and address, the event name and the number of each event for a specific destination zone and address where the category significance is Compromise or Hostile.	The Destination Zone field drill downs to the <a href="#">Attack Events by Destination</a> report. The Destination Address field drill downs to the <a href="#">Attack Events by Destination</a> report. This report drills down to itself.
Bottom Destinations	This report displays the Destination Zone Names, Destination Addresses and event Count ordered by the sum of the base event counts in ascending order. It is the target of the Least Common Events report's Event Name column.	none
Bottom Targets	This report shows the Target Zone Names, Target Addresses and Count of events where the Category Significance of the events is compromise or hostile, in ascending order of the sum of the base event count. This report is the target of the Bottom Sources report's Count column.	none
Destination Counts by Device Severity	This report displays a table showing the Severity, target zone and address, and the number of events for each severity.	none
Destination Counts by Event Name	This report displays a table showing the event name, the target zone and address, and the number of events for each destination.	none
Target Attack Counts by Severity	This report displays a table showing the Severity, the target zone and the number of events where the event has a category significance of Compromise, Hostile or Suspicious.	none
Target Counts by Event Name	This report displays a table showing the event name, target zone and address, and the number of time that event has occurred where the category significance is Compromise or Hostile.	none
Target Counts by Severity	This report displays a table showing the Severity, the target zone and address, and the number of events where the event has a category significance of Compromise, Hostile or Suspicious.	none
Target Counts by Source	This report displays a table showing the Source zone and address, the target zone and address, and the number of events where the event has a category significance of Compromise, Hostile or Suspicious.	none

### Targets, continued

Report	Description	Drill Down
Target Counts by Source Port	This report displays a table showing the Source Port, the count of events for that port, with the destination zone and address, where the category significance is Compromise or Hostile.	none
Target Counts by Target Port	This report displays a table showing the Destination Port, the number of events for each port, and the target zone and address for events with category significance of Compromise or Hostile.	none
Target Port Counts	This report displays a table showing the Target Port, the number of events for that port, and the target zone and address of events where the category significance is Compromise or Hostile.	none
Top Destination Ports	This report displays a table of the top destination ports and the number of events for each port.	none
Top Destinations Across Firewalls	This report displays a table of the destination zone, address and host name, as well as the count of events, where the event was reported by a firewall device.	none
Top Destinations in IDS Events	This report displays a table showing the Destination zone, address and host name, as well as the count of event going to each host, for all events coming from an IDS.	none
Top Targets	This report displays the Target Zone, Target Address and Count of events where the Category Significance of the event is compromise or hostile, ordered by the event count in descending order. This report is the target of the Top Attackers report's Count column.	none

### User Tracking

This is a sub-category of the Intrusion Monitoring category, focusing on events based on user information.

The User Tracking category is located under the following path.

Foundation\Intrusion Monitoring\User Tracking

The User Tracking category reports are listed in the following table. There are no parameters.

### User Tracking

Report	Description	Drill Down
Common Account Login Failures by Source	This report displays a table of the Resource Type, Attacker Address, Attacker Asset Name, Attacker NT Domain, Attacker User ID, Attacker User Name, Attacker Zone Name and the sum of the Aggregated Event Count.	none
Number of Failed Logins	This report displays a table showing the number of failed logins for each hour covered by the report time-range.	none
Top User Logins	This report displays a table showing the NT Domain, the user ID and name, and the number of successful logins.	none
Top Users with Failed Logins	This report displays a table showing the user ID and name, time (by minute) and the number of failed login attempts.	none
User Activity	This report displays a table of events, showing the source user ID and user name, the destination user ID and user name, the time of the event, the event name and the result (success, attempt, failure).	none

## NetFlow Monitoring

This is a sub-category of the Foundation category, focusing on NetFlow data.

The NetFlow Monitoring category is located under the following path.

Foundation\NetFlow Monitoring

The NetFlow Monitoring category reports are listed in the following table.

### NetFlow Monitoring

Report	Description	Drill Down
Daily Bandwidth Usage	This report displays a chart and a table to show the bandwidth usage by day.	none
Hourly Bandwidth Usage	This report displays a chart and a table to show the bandwidth usage by hour.	none
Top Bandwidth Usage by Destination	This report displays a chart and a table to show the bandwidth usage by destination address.	none
Top Bandwidth Usage by Destination Port	This report displays a chart and a table to show the bandwidth usage by destination port.	none
Top Bandwidth Usage by Source	This report displays a chart and a table to show the bandwidth usage by source address.	none

## Network Monitoring

This is a sub-category of the Foundation category, focusing on network bandwidth and status events.

The Network Monitoring category is located under the following path.

Foundation\Network Monitoring

The Network Monitoring category reports are listed in the following table. There are no parameters.

### Network Monitoring

Report	Description	Drill Down
Top VPN Accesses by User	This report displays a table showing the source user ID and name, and the count of events for VPN access, authorization or authentication events.	none
Top VPN Event Destinations	This report displays a table showing the VPN destination zone, address and host name, and the count of events for that host, reported by the VPN device, excluding modification events.	none
Top VPN Events	This report displays a table showing the VPN event name, source zone and address, destination zone and address, and the count of events for that event reported by the VPN device, excluding modification events.	none
Top VPN Event Sources	This report displays a table showing the VPN source zone, address and host name, and the count of events for that source, reported by the VPN device, excluding modification events.	none
Traffic Statistics	This report displays two charts and a table. The first chart shows the bytes in and out by hour. The second chart shows the bytes in and out by device. The table shows the hour, firewall zone and address, the transport protocol and the bytes in and out.	none
VPN Connection Attempts	This report displays a table showing the source hostname, source user name, destination zone, address and host name, destination user ID and user name and the count of events where the VPN access, authorization or authentication event did not result in failure.	none
VPN Connection Failures	This report displays a table showing the VPN device zone, address and host name, the VPN event, the source user ID, host name and user name, the destination zone, address, host name and user name, and the count of each event, where the VPN device reports and access, authorization or authentication failure.	none

## Logger Administration

This category covers Logger administration tasks. The Logger Administration category reports are listed in the following table.

### Logger Administration

Report	Description	Drill Down	Params
Daily Byte Count	This report displays a daily count of bytes from events that have been received from connectors.	none	none

## SANS Top 5

This category covers the SANS Top 5 Essential Log Reports (<http://www.sans.org/security-resources/top5-logreports.pdf>). Each of the sub-categories addresses one of the 5 areas.

The following categories are located under the SANS Top 5 category:

- 1 - Attempts to Gain Access through Existing Accounts .....576
- 2 - Failed File or Resource Access Attempts .....576
- 3 - Unauthorized Changes to Users Groups and Services .....577
- 4 - Systems Most Vulnerable to Attack .....578
- 5 - Suspicious or Unauthorized Network Traffic Patterns .....579

### 1 - Attempts to Gain Access through Existing Accounts

This is a sub-category of the SANS Top 5 Essential Log Reports. It addresses attempts to gain access to a system through existing accounts.

The 1 - Attempts to Gain Access through Existing Accounts category is located under the following path.

SANS Top 5\1 - Attempts to Gain Access through Existing Accounts

The 1 - Attempts to Gain Access through Existing Accounts category reports are listed in the following table.

#### 1 - Attempts to Gain Access through Existing Accounts

Report	Description	Drill Down	Params
Number of Failed Logins	This report, based on the SANS Top 5 Essential Log Reports, section 1 - Attempts to Gain Access Through Existing Accounts, displays a table showing the number of failed logins for each hour covered by the report time-range.	none	none
Top Users with Failed Logins	This report, based on the SANS Top 5 Essential Log Reports, section 1 - Attempts to Gain Access Through Existing Accounts, displays a table showing the user ID and name, the time and the number of attempts to login to a system during that minute.	none	none

### 2 - Failed File or Resource Access Attempts

This is a sub-category of the SANS Top 5 Essential Log Reports. It addresses failed file or resource access attempts.

The 2 - Failed File or Resource Access Attempts category is located under the following path.

SANS Top 5\2 - Failed File or Resource Access Attempts



The 2 - Failed File or Resource Access Attempts category reports are listed in the following table.

## 2 - Failed File or Resource Access Attempts

Report	Description	Drill Down	Params
Failed Resource Access by Users	This report, based on the SANS Top 5 Essential Log Reports, section 2 - Failed File or Resource Access Attempts, displays a table showing the Resource Type, the User ID and Name, Destination zone and address, the Access Event and number of failed attempts to access a given resource. Clicking on an entry in the Resource Type column will bring up the SANS Top 5 -2- Failed Resource Access by Users Drilldown report, which will show all related events for that resource type.	The Resource Type field drill downs to the <a href="#">Failed Resource Access by Users</a> report.  This report drills down to itself.	none
Failed Resource Access Events	This report, based on the SANS Top 5 Essential Log Reports, section 2 - Failed File or Resource Access Attempts, displays a table showing the Resource Type, the User ID and Name, Destination zone and address, the Access Event and number of failed attempts to access a given resource. Clicking on an entry in the Resource Type column will bring up the SANS Top 5 -2- Failed Resource Access Events Drilldown report, which will show all related events for that resource type.	The Resource Type field drill downs to the <a href="#">Failed Resource Access Events</a> report.  This report drills down to itself.	none

## 3 - Unauthorized Changes to Users Groups and Services

This is a sub-category of the SANS Top 5 Essential Log Reports. It addresses unauthorized changes to users, groups and services.

The 3 - Unauthorized Changes to Users Groups and Services category is located under the following path.

SANS Top 5\3 - Unauthorized Changes to Users Groups and Services

The 3 - Unauthorized Changes to Users Groups and Services category reports are listed in the following table.

### 3 - Unauthorized Changes to Users Groups and Services

Report	Description	Drill Down	Params
Account Modifications	This custom report, based on the SANS Top 5 Essential Log Reports, section 3 - Unauthorized Changes to Users, Groups and Services, displays a chart and a table. The chart shows the top user account modifications. The table shows the source user name, source zone and address, destination user name, destination zone and address, the modification event, and the date of the modification.	none	none
Password Changes	This report, based on the SANS Top 5 Essential Log Reports, section 3 - Unauthorized Changes to Users, Groups and Services, displays a table showing the user name, source zone and address, destination zone and address, and the date of password change events.	none	none
User Account Creations	This report, based on the SANS Top 5 Essential Log Reports, section 3 - Unauthorized Changes to Users, Groups and Services, displays a table showing the source user name, the source zone and address, the destination user name, the destination zone and address, the modification event name and the date of the account creation.	none	none
User Account Deletions	This report, based on the SANS Top 5 Essential Log Reports, section 3 - Unauthorized Changes to Users, Groups and Services, displays a table showing the source user name, the source zone and address, the destination user name, the destination zone and address, and the time when a user account was deleted.	none	none
User Account Modifications	This report, based on the SANS Top 5 Essential Log Reports, section 3 - Unauthorized Changes to Users, Groups and Services, displays a table showing the source user name, the source zone and address, the destination user name, the destination zone and address, the modification event name, and the date of the account modification.	none	none

### 4 - Systems Most Vulnerable to Attack

This is a sub-category of the SANS Top 5 Essential Log Reports. It addresses the systems that are most vulnerable to attack.

The 4 - Systems Most Vulnerable to Attack category is located under the following path.

SANS Top 5\4 - Systems Most Vulnerable to Attack

The 4 - Systems Most Vulnerable to Attack category reports are listed in the following table.

#### 4 - Systems Most Vulnerable to Attack

Report	Description	Drill Down	Params
Vulnerability Scanner Logs by Host	This report, based on the SANS Top 5 Essential Log Reports, section 4 - Systems Most Vulnerable to Attack, displays a table showing the system zone and address, the vulnerability ID and name, and the number of times that vulnerability has been reported for that system.	The arc_destinationAddress field drills down to the <a href="#">Vulnerability Scanner Logs by Host</a> report.  This report drills down to itself.	none
Vulnerability Scanner Logs by Vulnerability	This report, based on the SANS Top 5 Essential Log Reports, section 4 - Systems Most Vulnerable to Attack, displays a table showing the vulnerability ID and name, the zone and address, and the number of times that vulnerability has been reported for that system.	The arc_destinationAddress field drills down to the <a href="#">Vulnerability Scanner Logs by Host</a> report.  This report drills down to itself.	none

#### 5 - Suspicious or Unauthorized Network Traffic Patterns

This is a sub-category of the SANS Top 5 Essential Log Reports. It addresses suspicious or unauthorized network traffic patterns.

The 5 - Suspicious or Unauthorized Network Traffic Patterns category is located under the following path.

SANS Top 5\5 - Suspicious or Unauthorized Network Traffic Patterns

The 5 - Suspicious or Unauthorized Network Traffic Patterns category reports are listed in the following table.

#### 5 - Suspicious or Unauthorized Network Traffic Patterns

Report	Description	Drill Down	Params
Alerts from IDS	This report, based on the SANS Top 5 Essential Log Reports, section 5 - Suspicious or Unauthorized Network Traffic Patterns, displays a table showing the device vendor and product, the device event ID, the IDS signature name and the number of times that signature was reported.	none	none
IDS Signature Destinations	This report, based on the SANS Top 5 Essential Log Reports, section 5 - Suspicious or Unauthorized Network Traffic Patterns, displays a table showing the destination zone and address, the device vendor and product and the count of events reported for the address by the IDS.	none	none

## 5 - Suspicious or Unauthorized Network Traffic Patterns, continued

Report	Description	Drill Down	Params
IDS Signature Sources	This report, based on the SANS Top 5 Essential Log Reports, section 5 - Suspicious or Unauthorized Network Traffic Patterns, displays a table showing the destination zone and address, the device vendor and product, and the count of each event.	none	none
Top 10 Talkers	This report, based on the SANS Top 5 Essential Log Reports, section 5 - Suspicious or Unauthorized Network Traffic Patterns, displays a table showing the source zone and address, and the number of events coming from each address.	none	none
Top 10 Types of Traffic	This report, based on the SANS Top 5 Essential Log Reports, section 5 - Suspicious or Unauthorized Network Traffic Patterns, breaks down the traffic by the Application Protocol, Port number and Transport Protocol, where at least one of the three must be available and the bytes in or bytes out are available. The count is bases on the number of base events, presuming that each event with these conditions represents a packet of some type.	none	none
Top Alerts from IDS	This report, based on the SANS Top 5 Essential Log Reports, section 5 - Suspicious or Unauthorized Network Traffic Patterns, displays a chart and a table. The chart shows the top 10 alerts from IDSes. The table shows the Signature ID, the signature name, the device vendor and the number of times that signature was reported.	none	none
Top Destination IPs	This report, based on the SANS Top 5 Essential Log Reports, section 5 - Suspicious or Unauthorized Network Traffic Patterns, displays a table showing the target zone and address and the count of events for each destination address.	none	none
Top IDS Signature Destinations	This report, based on the SANS Top 5 Essential Log Reports, section 5 - Suspicious or Unauthorized Network Traffic Patterns, displays a chart and a table. The chart shows the top signature destinations by address. The table shows the destination zone and address, the device vendor and product, and the count of events to that host.	none	none
Top IDS Signature Sources	This report, based on the SANS Top 5 Essential Log Reports, section 5 - Suspicious or Unauthorized Network Traffic Patterns, displays a chart and a table. The chart shows the top signature sources by address. The table shows the source zone and address, the device vendor and product, and the count of events by that host.	none	none
Top Target IPs	This report, based on the SANS Top 5 Essential Log Reports, section 5 - Suspicious or Unauthorized Network Traffic Patterns, displays a table showing the target zone and address, and the number of IDS event reported for that address where the category significance is Compromise or Hostile.	none	none

## Parameters

Some reports invoke queries that prompt for field values during report runtime. The values entered for these fields are passed to the query using parameters. To change the value of the parameter that is passed to the query, you can enter a new value when prompted by the report during runtime or you can change the default value of the parameter. SQL wildcards are supported values for parameters; for example, the % wildcard character matches one or more characters. For more information about parameters, see ["Parameters" on page 233](#).

Logger reports invoke queries that use the following parameters:

• IPAddress .....	581
• categoryObjectParameter .....	582
• commonlyBlockedPorts .....	582
• destinationAddress .....	582
• destinationPort .....	583
• deviceGroupParameter .....	583
• deviceProduct .....	583
• deviceSeverityParameter .....	583
• deviceVendor .....	584
• dmBandwidthParameter .....	584
• dmConfigurationParameter .....	584
• dmLoginParameter .....	584
• eventNameParameter .....	585
• resourceTypeParameter .....	585
• webPorts .....	585
• zoneParameter .....	585
• zones .....	586

## IPAddress

When a report invokes a query that expects the IPAddress parameter as input, the IP Address prompt is displayed during report runtime with a default value of %.

This is a single value character type (CHAR) parameter that takes an IP address, such as 192.168.35.5.

This parameter is used with the LIKE keyword in the WHERE clause of an SQL query. See the Foundation \ Intrusion Monitoring \ Attackers \ Top Attacker Details query object for an example of a query using this parameter.

## categoryObjectParameter

When a report invokes a query that expects the `categoryObjectParameter` parameter as input, the Resource Type prompt is displayed during report runtime with a default value of  `'/Host/Application/Database', '/Host/Application/Database/Data', '/Host/Application/Service/Email', '/Host/Resource/File'`.

This is a multiple value character type (CHAR) parameter that allows the selection of one or more Category Object URIs, such as `Host/Application/Database`.

This parameter is used with the IN keyword in the WHERE clause of an SQL query. See the Foundation \\ Intrusion Monitoring \\ Resource Access \\ Access Events by Resource query object for an example of a query using this parameter.

## commonlyBlockedPorts

When a report invokes a query that expects the `commonlyBlockedPorts` parameter as input, the Blocked Ports prompt is displayed during report runtime with all default values listed in the Combo Source panel.

This is a multiple value number type (NUMBER) parameter that allows the selection of one or more listed port numbers, such as `135,139`.

This parameter is used with the IN keyword in the WHERE clause of an SQL query. See the Foundation \\ Intrusion Monitoring \\ Probes on Blocked Ports query object for an example of a query using this parameter.

## destinationAddress

When a report invokes a query that expects the `destinationAddress` parameter as input, the Destination IP Address prompt is displayed during report runtime with a default value of `%`.

This is a single value character type (CHAR) parameter that takes an IP address, such as `192.168.35.5`.

This parameter is used with the LIKE keyword in the WHERE clause of an SQL query. See the Foundation \\ Intrusion Monitoring \\ Attackers \\ Source Counts by Destination query object for an example of a query using this parameter.

## destinationPort

When a report invokes a query that expects the `destinationPort` parameter as input, the Destination Port prompt is displayed during report runtime with a default value of `80`.

This is a single value number type (NUMBER) parameter that allows the entry of one port number, such as `80`.

## deviceGroupParameter

When a report invokes a query that expects the `deviceGroupParameter` parameter as input, the Category Device Group prompt is displayed during report runtime with a default value of `'/Firewall','/IDS','/IDS/Host','/IDS/Host/Antivirus','/IDS/Host/File Integrity','/IDS/Network','/IDS/Network/Traffic Analysis','/Network Equipment','/Network Equipment/Router','/Network Equipment/Switches','/VPN'`.

This is a multiple value character type (CHAR) parameter that allows the selection of one or more Category Object URIs, such as `Host/Application/Database`.

This parameter is used with the `IN` keyword in the `WHERE` clause of an SQL query. See the Foundation \\ Configuration Monitoring \\ Device Configuration Changes query object for an example of a query using this parameter.

## deviceProduct

When a report invokes a query that expects the `deviceProduct` parameter as input, the Device Product prompt is displayed during report runtime with a default value of `%`.

This is a single value character type (CHAR) parameter that takes a string, such as `Snort`.

This parameter is used with the `LIKE` keyword in the `WHERE` clause of an SQL query. See the Foundation \\ Configuration Monitoring \\ Vulnerability Scanner Logs by Host query object for an example of a query using this parameter.

## deviceSeverityParameter

When a report invokes a query that expects the `deviceSeverityParameter` parameter as input, the Device Severity prompt is displayed during report runtime with a default value of `%`.

This is a single value character type (CHAR) parameter that takes a string, such as `High`.

This parameter is used with the `LIKE` keyword in the `WHERE` clause of an SQL query. See the Foundation \\ Intrusion Monitoring \\ Attackers \\ Source Counts by Device Severity query object for an example of a query using this parameter.

## deviceVendor

When a report invokes a query that expects the `deviceVendor` parameter as input, the Device Vendor prompt is displayed during report runtime with a default value of %.

This is a single value character type (CHAR) parameter that takes a string, such as Snort.

This parameter is used with the LIKE keyword in the WHERE clause of an SQL query. See the Foundation \\ Configuration Monitoring \\ Vulnerability Scanner Logs by Host query object for an example of a query using this parameter.

## dmBandwidthParameter

When a report invokes a query that expects the `dmBandwidthParameter` parameter as input, the Device Type prompt is displayed during report runtime with a default value of all.

This is a single value character type (CHAR) parameter that allows the selection of predefined value, such as Firewall.

This parameter is used with the LIKE keyword in the WHERE clause of an SQL query. See the Foundation \\ Configuration Monitoring \\ Vulnerability Scanner Logs by Host query object for an example of a query using this parameter.

## dmConfigurationParameter

When a report invokes a query that expects the `dmConfigurationParameter` parameter as input, the Device Type prompt is displayed during report runtime with a default value of all.

This is a single value character type (CHAR) parameter that allows the selection of predefined value, such as Firewall.

This parameter is used with the LIKE keyword in the WHERE clause of an SQL query.

## dmLoginParameter

When a report invokes a query that expects the `dmLoginParameter` parameter as input, the Device Type prompt is displayed during report runtime with a default value of all.

This is a single value character type (CHAR) parameter that allows the selection of predefined value, such as Firewall.

This parameter is used with the LIKE keyword in the WHERE clause of an SQL query. See the Device Monitoring \\ CrossDevice \\ Failed Login Attempts query object for an example of a query using this parameter.



## eventNameParameter

When a report invokes a query that expects the `eventNameParameter` parameter as input, the Event Name prompt is displayed during report runtime with a default value of %.

This is a single value character type (CHAR) parameter that takes a string, such as `Connector Raw Event Statistics`.

This parameter is used with the LIKE keyword in the WHERE clause of an SQL query. See the Foundation \ In intrusion Monitoring \ Targets \ Destination Counts by Event Name query object for an example of a query using this parameter.

## resourceTypeParameter

When a report invokes a query that expects the `resourceTypeParameter` parameter as input, the Resource Type prompt is displayed during report runtime with a default value of `/Host/Application/Database`.

This is a single value character type (CHAR) parameter that takes a string, such as `/Host/Application/Database`.

This parameter is used with the LIKE keyword in the WHERE clause of an SQL query.

## webPorts

When a report invokes a query that expects the `webPorts` parameter as input, the Web Ports prompt is displayed during report runtime with all default values listed in the Combo Source panel.

This is a multiple value number type (NUMBER) parameter that allows the selection of one or more listed port numbers, such as `80,443`.

This parameter is used with the IN keyword in the WHERE clause of an SQL query. See the Foundation \ In intrusion Monitoring \ Top Web Traffic query object for an example of a query using this parameter.

## zoneParameter

When a report invokes a query that expects the `zoneParameter` parameter as input, the Zone prompt is displayed during report runtime with a default value of %.

This is a single value character type (CHAR) parameter that takes an IP address, such as /All Zones/ArcSight System/Private Address Space Zones/RFC1918: 10.0.0.0-10.255.255.255.

This parameter is used with the LIKE keyword in the WHERE clause of an SQL query. See the Foundation \ In intrusion monitoring \ Attackers \ Top Attacker Details query object for an example of a query using this parameter.

## ZONES

When a report invokes a query that expects the zones parameter as input, the Zone prompt is displayed during report runtime with a default value of %.

This is a multiple value character type (CHAR) parameter that allows the selection of one or more Category Object URIs, such as /All Zones/ArcSight System/Private Address Space Zones/RFC1918: 10.0.0.0-10.255.255.255, /All Zones/ArcSight System/Private Address Space Zones/RFC1918: 192.168.0.0-192.168.255.255.

This parameter is used with the IN keyword in the WHERE clause of an SQL query. See the Foundation \ In intrusion monitoring \ Attackers \ Source Counts by Destination query object for an example of a query using this parameter.

## System Filters

Logger provides the system filters listed in the following table.

### Filters

Filter	Type	Description
Configuration - Configuration Changes (Unified)	Unified Query	This filter looks for events categorized as configuration changes events.
Configuration - System Configuration Changes (CEF format)	Regular Expression	This filter looks for events categorized as configuration changes events. It is a Regular Expression filter and can be used to create alerts.
Events - CEF	Regular Expression	This filter looks for all CEF formatted events. It is a Regular Expression filter and can be used to create alerts.
Events - Event Counts by Destination	Unified Query	This filter looks for all CEF events that have a destination address and shows a chart.
Events - Event Counts by Source	Unified Query	This filter looks for all CEF events that have a source address and shows a chart.
Events - High and Very High Severity CEF Events	Regular Expression	This filter looks for CEF events with a high or very high severity. It is a Regular Expression filter and can be used to create alerts.

### Filters, continued

Filter	Type	Description
Events - High and Very High Severity Events (Unified)	Unified Query	This filter looks for CEF events with a high or very high severity.
Firewall - Deny	Unified Query	This filter looks for events with deny or shun.
Firewall - Drop	Unified Query	This filter looks for drop events that are not database related.
Firewall - Permit	Unified Query	This filter looks for events that have the word permit.
Intrusion - Malicious Code (CEF format)	Regular Expression	This filter looks for CEF events categorized to indicate malicious code. It is a Regular Expression filter and can be used to create alerts.
Intrusion - Malicious Code (Unified)	Unified Query	This filter looks for CEF events categorized to indicate malicious code.
Logins - All Logins (CEF format)	Regular Expression	This filter looks for CEF events categorized as authentication events. It is a Regular Expression filter and can be used to create alerts.
Logins - All Logins (Non-CEF format)	Regular Expression	This filter looks for non-CEF format events with words indicating it is an authentication event. It is a Regular Expression filter and can be used to create alerts.
Logins - All Logins (Unified)	Unified Query	This filter looks for CEF events categorized as authentication events.
Logins - Failed Logins	Unified Query	This filter looks for failure events related to logins, user authentication and user authorization.
Logins - Successful Logins (Non-CEF format)	Regular Expression	This filter looks for events with keywords indicating a successful login attempt. It is a Regular Expression filter and can be used to create alerts.
Logins - Successful Logins (CEF format)	Regular Expression	This filter looks for CEF events categorized as successful login events. It is a Regular Expression filter and can be used to create alerts.
Logins - Successful Logins (Unified)	Unified Query	This filter looks for CEF events categorized as successful login events.
Logins - Unsuccessful Logins (Non-CEF format)	Regular Expression	This filter looks for failure events related to logins, user authentication and user authorization. It is a Regular Expression filter and can be used to create alerts.
Logins - Unsuccessful Logins (CEF format)	Regular Expression	This filter looks for failure events related to logins, user authentication and user authorization. It is a Regular Expression filter and can be used to create alerts.
Logins - Unsuccessful Logins (Unified)	Unified Query	This filter looks for failure events categorized as login events.

### Filters, continued

Filter	Type	Description
Network - DHCP Lease Events	Unified Query	This filter looks for DHCP lease related events.
Network - Port Links Up and Down	Unified Query	This filter looks for port or link status messages.
Network - Protocol Links Up and Down	Unified Query	This filter looks for protocol status messages.
SystemAlert - CPU Utilization Above 90% (CEF format)	Regular Expression	This filter looks for internal events indicating that CPU utilization is above 90%. It is a Regular Expression filter and can be used to create alerts.
SystemAlert - CPU Utilization Above 90% (Unified)	Unified Query	This filter looks for internal events indicating that CPU utilization is above 90%.
SystemAlert - CPU Utilization Above 95% (CEF format)	Regular Expression	This filter looks for internal events indicating that CPU utilization is above 95%. It is a Regular Expression filter and can be used to create alerts.
SystemAlert - CPU Utilization Above 95% (Unified)	Unified Query	This filter looks for internal events indicating that CPU utilization is above 95%.
SystemAlert - Device Configuration Changes (CEF format)	Regular Expression	This filter looks for internal events indicating a Logger configuration change. It is a Regular Expression filter and can be used to create alerts.
SystemAlert - Device Configuration Changes (Unified)	Unified Query	This filter looks for internal events indicating a Logger configuration change.
SystemAlert - Filter Configuration Changes (CEF format)	Regular Expression	This filter looks for internal events indicating a Logger filter change. It is a Regular Expression filter and can be used to create alerts.
SystemAlert - Filter Configuration Changes (Unified)	Unified Query	This filter looks for internal events indicating a Logger filter change.
SystemAlert - High CPU Temperature (CEF format)	Regular Expression	This filter looks for internal events indicating potential CPU over-heating. It is a Regular Expression filter and can be used to create alerts.
SystemAlert - High CPU Temperature (Unified)	Unified Query	This filter looks for internal events indicating potential CPU over-heating.
SystemAlert - Bad Fan (CEF format)	Regular Expression	This filter looks for Logger appliance internal events related to fan failure. It is a Regular Expression filter and can be used to create alerts.
SystemAlert - Power Supply Failure (CEF format)	Regular Expression	This filter looks for internal events indicating that a power supply has failed. It is a Regular Expression filter and can be used to create alerts.

### Filters, continued

Filter	Type	Description
SystemAlert - Power Supply Failure (Unified)	Unified Query	This filter looks for internal events indicating that a power supply has failed.
SystemAlert - RAID Status Battery Failure (CEF format)	Regular Expression	This filter looks for internal events indicating that the RAID battery backup unit (BBU) has failed. It is a Regular Expression filter and can be used to create alerts.
SystemAlert - RAID Status Battery Failure (Unified)	Unified Query	This filter looks for internal events indicating that the RAID battery backup unit (BBU) has failed.
SystemAlert - Disk Failure (CEF format)	Regular Expression	This filter looks for Logger appliance internal events indicating a disk failure. It is a Regular Expression filter and can be used to create alerts.
SystemAlert - Disk Failure (Unified)	Unified Query	This filter looks for Logger appliance internal events indicating a disk failure.
SystemAlert - RAID Controller Issue (CEF format)	Regular Expression	This filter looks for internal events indicating that a RAID disk has failed. It is a Regular Expression filter and can be used to create alerts.
SystemAlert - RAID Controller Issue (Unified)	Unified Query	This filter looks for internal events indicating that a RAID disk has failed.
SystemAlert - Root Partition Free Space Below 5% (Unified)	Unified Query	This filter looks for internal events indicating that the root partition disk free space is below 5%.
SystemAlert - Root Partition Free Space Below 10% (Unified)	Unified Query	This filter looks for internal events indicating that the root partition disk free space is below 10%.
SystemAlert - Root Partition Free Space Below 10% (CEF format)	Regular Expression	This filter looks for internal events indicating that the root partition disk free space is below 10%. It is a Regular Expression filter and can be used to create alerts.
SystemAlert - Root Partition Free Space Below 5% (CEF format)	Regular Expression	This filter looks for internal events indicating that the root partition disk free space is below 5%. It is a Regular Expression filter and can be used to create alerts.
SystemAlert - Storage Configuration Changes (CEF format)	Regular Expression	This filter looks for Logger internal events related to changes of the storage configuration. It is a Regular Expression filter and can be used to create alerts.
SystemAlert - Storage Configuration Changes (Unified)	Unified Query	This filter looks for Logger internal events related to changes of the storage configuration.
SystemAlert - Storage Group Usage Above 90% (CEF format)	Regular Expression	This filter looks for Logger internal events indicating that the storage group usage is above 90%. It is a Regular Expression filter and can be used to create alerts.
SystemAlert - Storage Group Usage Above 90% (Unified)	Unified Query	This filter looks for Logger internal events indicating that the storage group usage is above 90%.

### Filters, continued

Filter	Type	Description
SystemAlert - Storage Group Usage Above 95% (CEF format)	Regular Expression	This filter looks for Logger internal events indicating that the storage group usage is above 95%. It is a Regular Expression filter and can be used to create alerts.
SystemAlert - Storage Group Usage Above 95% (Unified)	Unified Query	This filter looks for Logger internal events indicating that the storage group usage is above 95%.
SystemAlert - Zero Events Incoming (CEF format)	Regular Expression	This filter looks for Logger internal events indicating that the no events are being received by Logger. It is a Regular Expression filter and can be used to create alerts.
SystemAlert - Zero Events Incoming (Unified)	Unified Query	This filter looks for Logger internal events indicating that the no events are being received by Logger.
SystemAlert - Zero Events Outgoing (CEF format)	Regular Expression	This filter looks for Logger internal events indicating that the no events are being forwarded by Logger. It is a Regular Expression filter and can be used to create alerts.
SystemAlert - Zero Events Outgoing (Unified)	Unified Query	This filter looks for Logger internal events indicating that the no events are being forwarded by Logger.
SystemStatus - CPU Utilization by Connector Host	Unified Query	This filter looks for SmartConnector system health events and charts the CPU utilization by host.
SystemStatus - Disk Utilization by Connector Host	Unified Query	This filter looks for SmartConnector system health events and charts the disk utilization by host.
SystemStatus - Memory Utilization by Connector Host	Unified Query	This filter looks for SmartConnector system health events and charts the memory utilization by host.
Unix - CRON related events	Unified Query	This filter looks for events with the cron keyword.
Unix - IO Errors and Warnings	Unified Query	This filter looks for I/O events with error or warning keywords.
Unix - PAM and Sudo Messages	Unified Query	This filter looks for events with the keywords PAM or sudo.
Unix - Password Changes	Unified Query	This filter looks for events related to password changes.
Unix - SAMBA Events	Unified Query	This filter looks for events related to SAMBA.
Unix - SSH Authentications	Unified Query	This filter looks for SSH authentication events.
Unix - User and Group Additions	Unified Query	This filter looks for events related to adding users or groups.

### Filters, continued

Filter	Type	Description
Unix - User and Group Deletions	Unified Query	This filter looks for events related to deleting users or groups.
Windows - Account Added to Global Group	Unified Query	This filter looks for non-CEF events related to adding a Windows account to a Global Group.
Windows - Account Added to Global Group (CEF)	Unified Query	This filter looks for CEF events related to adding a Windows account to a Global Group.
Windows - Audit Policy Change	Unified Query	This filter looks for non-CEF events related to Windows Audit Policy changes.
Windows - Audit Policy Change (CEF)	Unified Query	This filter looks for CEF events related to Windows Audit Policy changes.
Windows - Change Password Attempt	Unified Query	This filter looks for non-CEF events related to Windows password changes.
Windows - Change Password Attempt (CEF)	Unified Query	This filter looks for CEF events related to Windows password changes.
Windows - Global Group Created	Unified Query	This filter looks for non-CEF events related to the creation of Windows global groups
Windows - Global Group Created (CEF)	Unified Query	This filter looks for CEF events related to the creation of Windows global groups.
Windows - Logon Bad User Name or Password	Unified Query	This filter looks for non-CEF events related to Windows logon failures.
Windows - Logon Bad User Name or Password (CEF)	Unified Query	This filter looks for CEF events related to Windows logon failures.
Windows - Logon Local User	Unified Query	This filter looks for non-CEF events related to Windows logons to the local system.
Windows - Logon Local User (CEF)	Unified Query	This filter looks for CEF events related to Windows logons to the local system.
Windows - Logon Remote User	Unified Query	This filter looks for non-CEF events related to Windows logons to a remote system.
Windows - Logon Remote User (CEF)	Unified Query	This filter looks for CEF events related to Windows logons to a remote system.
Windows - Logon Unexpected Failure	Unified Query	This filter looks for non-CEF events related to Windows logons with an unexpected failure.
Windows - Logon Unexpected Failure (CEF)	Unified Query	This filter looks for CEF events related to Windows logons with an unexpected failure.
Windows - New Process Creation	Unified Query	This filter looks for non-CEF events related to the creation of new Windows processes.

### Filters, continued

Filter	Type	Description
Windows - New Process Creation (CEF)	Unified Query	This filter looks for CEF events related to the creation of new Windows processes.
Windows - Pre-Authentication Failure	Unified Query	This filter looks for non-CEF events related to failures with Windows pre-authentication.
Windows - Pre-Authentication Failure (CEF)	Unified Query	This filter looks for CEF events related to failures with Windows pre-authentication.
Windows - Special Privileges Assigned to New Logon	Unified Query	This filter looks for non-CEF events related to logons for accounts with special privileges (power user or administrator-like accounts).
Windows - Special Privileges Assigned to New Logon (CEF)	Unified Query	This filter looks for CEF events related to logons for accounts with special privileges (power user or administrator-like accounts).
Windows - User Account Changed	Unified Query	This filter looks for non-CEF events related to user account changes.
Windows - User Account Changed (CEF)	Unified Query	This filter looks for CEF events related to user account changes.
Windows - User Account Password Set	Unified Query	This filter looks for non-CEF events related to user account password changes.
Windows - User Account Password Set (CEF)	Unified Query	This filter looks for CEF events related to user account password changes.
Windows - Windows Events (CEF)	Unified Query	This filter looks for all CEF events that are generated by Microsoft Windows.

## Queries

This content contains the following queries:

### Access Events by Resource

This query has no input parameters.

### Accounts Created By User Account

This query has no input parameters.

### Accounts Deleted by Host

This query has no input parameters.



## Accounts Deleted by User Account

This query has no input parameters.

## Alert Counts by Device

This query has no input parameters.

## Alert Counts by Port

This query has no input parameters.

## Alert Counts by Severity

This query has no input parameters.

## Alert Counts by Type

This query has no input parameters.

## Alert Counts per Hour

This query has no input parameters.

## Alerts from IDS

This query has no input parameters.

## Anti-Virus Errors

This query has no input parameters.

## Anti-Virus Updates-All-Failed

This query has no input parameters.

## Anti-Virus Updates-All-Summary

This query has no input parameters.

## Asset Startup and Shutdown Event Log

This query has no input parameters.

## Attack Events By Destination

This query has no input parameters.

## Authentication Errors

This query has no input parameters.

## Bandwidth Usage by Hour

This query has no input parameters.

## Bandwidth Usage by Protocol

This query has no input parameters.

## Bottom Destinations

This query has no input parameters.

## Bottom Sources

This query has no input parameters.

## Bottom Targets

This query has no input parameters.

## By User Account - Accounts Created

This query has no input parameters.

## Common Account Login Failures by Source

This query has no input parameters.

## Configuration Changes by Type

This query has no input parameters.

## Configuration Changes by User

This query has no input parameters.

## Connection Counts by User

This query has no input parameters.

## Connections Accepted by Address

This query has no input parameters.

## Connections Denied by Address

This query has no input parameters.

## Connections Denied by Hour

This query has no input parameters.

## Daily Bandwidth Usage

This query has no input parameters.

## Daily Byte Count

This query has no input parameters.

## Database Errors and Warnings

This query has no input parameters.

## Denied Connections by Address

This query has no input parameters.

## Denied Connections by Port

This query has no input parameters.

## Denied Connections per Hour

This query has no input parameters.

## Destination Counts by Device Severity

This query has no input parameters.

## Destination Counts by Event Name

This query has no input parameters.

## Device Configuration Changes

This query has no input parameters.

## Device Configuration Events

This query has no input parameters.

## Device Misconfigurations

This query has no input parameters.

## Failed Anti-Virus Updates

This query has no input parameters.

## Failed Login Attempts

This query has no input parameters.

## Failed Logins by Destination Address

This query has no input parameters.

## Failed Logins by Source Address

This query has no input parameters.

## Failed Logins by User

This query has no input parameters.

## Failed Res Access Events

This query has no input parameters.

## Failed Resource Access

This query has no input parameters.

## Firewall Traffic by Service

This query has no input parameters.

## Hourly Bandwidth Usage

This query has no input parameters.

## IDS Signature Destinations

This query has no input parameters.

## IDS Signature Sources

This query has no input parameters.

## Infected Systems

This query has no input parameters.

## Least Common Accessed Ports

This query has no input parameters.

## Least Common Events

This query has no input parameters.

## Login Errors by User

This query has no input parameters.

## Login Event Audit

This query has no input parameters.

## Most Common Events

This query has no input parameters.

## Most Common Events by Severity

This query has no input parameters.

## Network-Device Critical Events

This query has no input parameters.

## Network-Device Errors

This query has no input parameters.

## Network-Device Events

This query has no input parameters.

## Network-Device Interface Down Notifications

This query has no input parameters.

## Network-Device Interface Status Messages

This query has no input parameters.

## Network-Device SNMP Authentication Failures

This query has no input parameters.

## Network-Top Device System Authentication Events

This query has no input parameters.

## Number of Failed Logins

This query has no input parameters.

## Password Change

This query has no input parameters.

## Password Changes

This query has no input parameters.

## Probes on Blocked Ports by Source

This query has no input parameters.

## Resource Access by Users - Failures

This query has no input parameters.

## Resource Access by Users - Success-Attempt

This query has no input parameters.

## Source Counts By Destination

This query has no input parameters.

## Source Counts by Destination Port

This query has no input parameters.

## Source Counts by Device

This query has no input parameters.

## Source Counts by Device Severity

This query has no input parameters.



## Source Counts by Source Port

This query has no input parameters.

## Source Port Counts

This query has no input parameters.

## Successful Logins by Destination Address

This query has no input parameters.

## Successful Logins by Source Address

This query has no input parameters.

## Successful Logins by User

This query has no input parameters.

## Target Attack Counts by Severity

This query has no input parameters.

## Target Counts by Device Severity

This query has no input parameters.

## Target Counts by Event Name

This query has no input parameters.

## Target Counts by Source

This query has no input parameters.

## Target Counts by Source Port

This query has no input parameters.

## Target Counts by Target Port

This query has no input parameters.

## Target Port Counts

This query has no input parameters.

## Top 10 Talkers

This query has no input parameters.

## Top 10 Types of Traffic

This query has no input parameters.

## Top Alerts

This query has no input parameters.

## Top Attack Sources

This query has no input parameters.

## Top Attacker Details

This query has no input parameters.

## Top Attacker Ports

This query has no input parameters.

## Top Attackers

This query has no input parameters.

## Top Bandwidth Hosts

This query has no input parameters.

## Top Bandwidth Usage by Destination

This query has no input parameters.

## Top Bandwidth Usage by Destination Port

This query has no input parameters.

## Top Bandwidth Usage by Source

This query has no input parameters.

## Top Destination IPs

This query has no input parameters.

## Top Destination Ports

This query has no input parameters.

## Top Destinations Across Firewalls

This query has no input parameters.

## Top Destinations in IDS Events

This query has no input parameters.

## Top Hosts by Number of Connections

This query has no input parameters.

## Top IDS Attack Events

This query has no input parameters.

## Top IDS Events

This query has no input parameters.

## Top IDS and IPS Alerts

This query has no input parameters.

## Top Machines Accessing the Web

This query has no input parameters.

## Top Machines Traversing Firewall

This query has no input parameters.

## Top Sources Detected by Snort

This query has no input parameters.

## Top Sources Traversing Firewalls

This query has no input parameters.

## Top Target IPs

This query has no input parameters.

## Top Targets

This query has no input parameters.

## Top User Logins

This query has no input parameters.

## Top Users with Failed Logins

This query has no input parameters.

## Top VPN Accesses by User

This query has no input parameters.

## Top VPN Event Destinations

This query has no input parameters.

## Top VPN Event Sources

This query has no input parameters.

## Top VPN Events

This query has no input parameters.

## Top Web Traffic

This query has no input parameters.

## Update Summary

This query has no input parameters.

## User Account Creations

This query has no input parameters.

## User Account Deletions

This query has no input parameters.

## User Account Modifications

This query has no input parameters.

## User Activity

This query has no input parameters.

## User Administration

This query has no input parameters.

## User Password Changes

This query has no input parameters.

## Users by Connection Count

This query has no input parameters.

## VPN Connection Attempts

This query has no input parameters.

## VPN Connection Failures

This query has no input parameters.

## Virus Activity by Hour

This query has no input parameters.

## Vulnerability Scanner Logs

This query has no input parameters.

## Vulnerability Scanner Logs by Host

This query has no input parameters.

## Vulnerability Scanner Logs by Vulnerability

This query has no input parameters.

## Windows Events

This query has no input parameters.

## Worm Infected System

This query has no input parameters.

## Worm Infected Systems

This query has no input parameters.

# Appendix H: Restoring Factory Settings

The following topics describe how to restore your appliance to its original factory settings by overwriting the current files with an image of the original system.

**Caution:** Restoring an appliance to its original factory settings **irrevocably deletes all event data** and some configuration settings.

- [Before Restoring Your System](#) .....608
- [Restoring Your System](#) .....608

## Before Restoring Your System

Note the following cautions and guidelines before you restore to factory settings.

When restoring the configuration of the Logger from a backup, first ensure that the appliance is restored, then complete the upgrade to the desired version.

After restoring, you can restore backups of your data and configuration settings.

### Logger With Multipath SAN Enabled

If your Logger is running version 5.1 or later and multipath SAN is enabled, AND you encounter one of these situations:

- You have returned a system to HPE and received a new system that is either running Logger 5.0 Patch 3 or earlier;
- You restored the system to its factory default settings, which resets the Logger version to 5.0 Patch 3 or earlier

You must upgrade your system to Logger 5.1 or later *before* attaching the LUN, in order to restore your Logger to its last working state—running version 5.1 or later, with multipath enabled.

## Restoring Your System

Instructions for performing a factory reset vary by the appliance model. Refer to the appropriate section for your appliance.



## Restoring LX500 and Later Appliance Models

You can restore LX500 or LX600 model appliances to their original factory settings by using the built-in System Restore utility.

### To restore an LX500 or LX600 appliance:

1. Attach a keyboard, monitor, and mouse directly to the appliance or, if your appliance is configured for remote access through iLO, you can use that functionality to access the appliance console. (For information on how to set up the Logger Appliance for remote access, refer to the Logger Installation Guide.) You will see something like the following image.

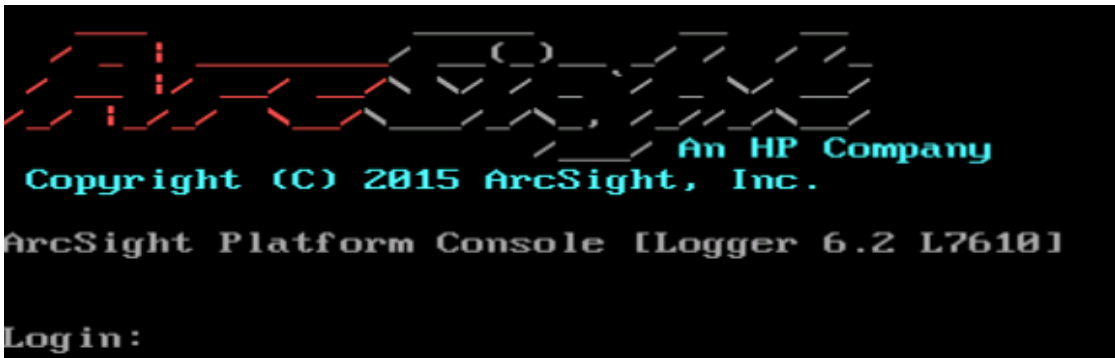

2. Log into the appliance with your username and password.
3. At the command prompt, type `reboot`, and then press Enter.
4. As the system reboots, messages scroll by. As soon as a message like the following appears on the screen, press any key on your keyboard.

Press any key to enter the menu

Booting Red Hat Enterprise Linux <version> in N seconds...

This message is displayed for a very short time. Make sure you press a key on your keyboard quickly; otherwise, the appliance will continue to boot normally. You need to press the key after the BIOS is done booting but before the OS boots.

If the OS starts booting, you will see something like the screen capture below. You'll need to try again in that case.



5. The session viewer window opens.



Use the mouse or arrow keys to select **System Restore L<XXXX>** and press **Enter**.

6. System Restore automatically detects and displays the archive image. The image is named following the pattern YYYY-MM-DD\_LXX00\_L<XXXX>.ar*i*, where YYYY-MM-DD is the date, LXX00 is the appliance version and L<XXXX> is the appliance build number.
7. Press **F1** (auto-select) to automatically map the Source Image, displayed in the top panel, to the Target Disk, displayed in the bottom panel. The restore image name is displayed in the right-most column.
8. Optionally, press **F10** (VERIFY) to check the archive for damage before performing the restore. Once the archive has been verified, press Enter to continue.
9. Press **F2** (RESTORE) to begin the restore process. A dialog box asks whether you want to restore. Press **y** to proceed with the restore or **n** to cancel.
10. Progress bars show the status of the restoration.

**Caution:** Do not interrupt or power-down the appliance during the restore process. Interrupting the restore process may force the system into a state from which it cannot be recovered.

11. When the restore process is complete, press F12 to reboot the appliance. A dialog box asks whether you want to reboot. Press **y** to proceed with the reboot.

## Restoring LX400 and Earlier Appliance Models

You can restore LX400 and earlier appliances to the original factory settings by using the built-in Acronis True Image software.

### To restore LX400 and earlier appliances:

1. Attach a keyboard, monitor, and mouse directly to the appliance or, if your appliance is configured for remote access through iLO, you can use that functionality to access the appliance console. (For information on how to set up the Logger Appliance for remote access, refer to the Logger Installation Guide.) You will see something like the following image.

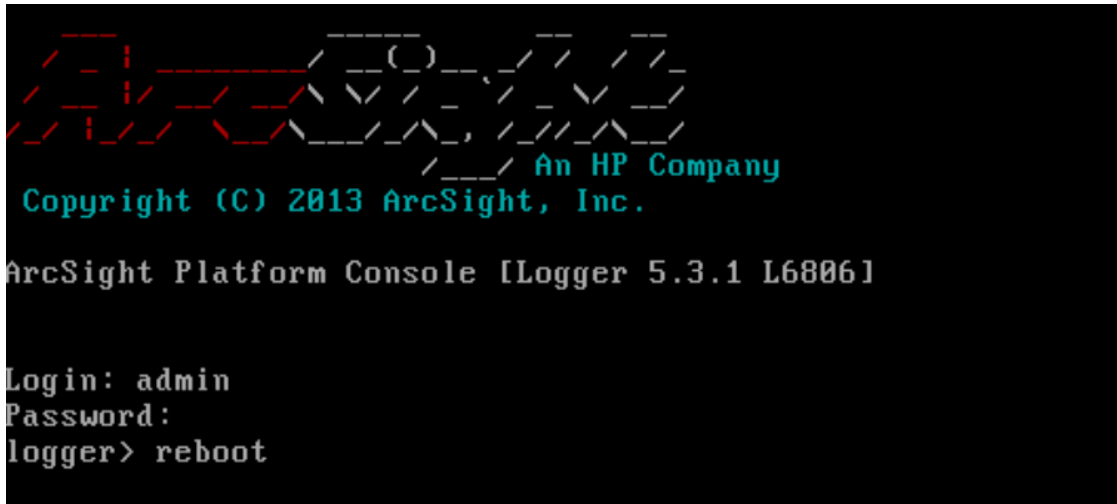

2. Log into the appliance, type `reboot` at the command prompt, and then press Enter.
3. As the system reboots, messages scroll by. As soon as a message like the following appears on the screen, press any key on your keyboard.

Press any key to enter the menu

Booting Red Hat Enterprise Linux <version> in N seconds...

This message is displayed for a very short time. Make sure you press a key on your keyboard quickly; otherwise, the appliance will continue to boot normally. You need to press the key after the BIOS is done booting but before the OS boots.

If the OS boots, you will see something like the screen capture below. You'll need to try again in that case.



- The session viewer opens.

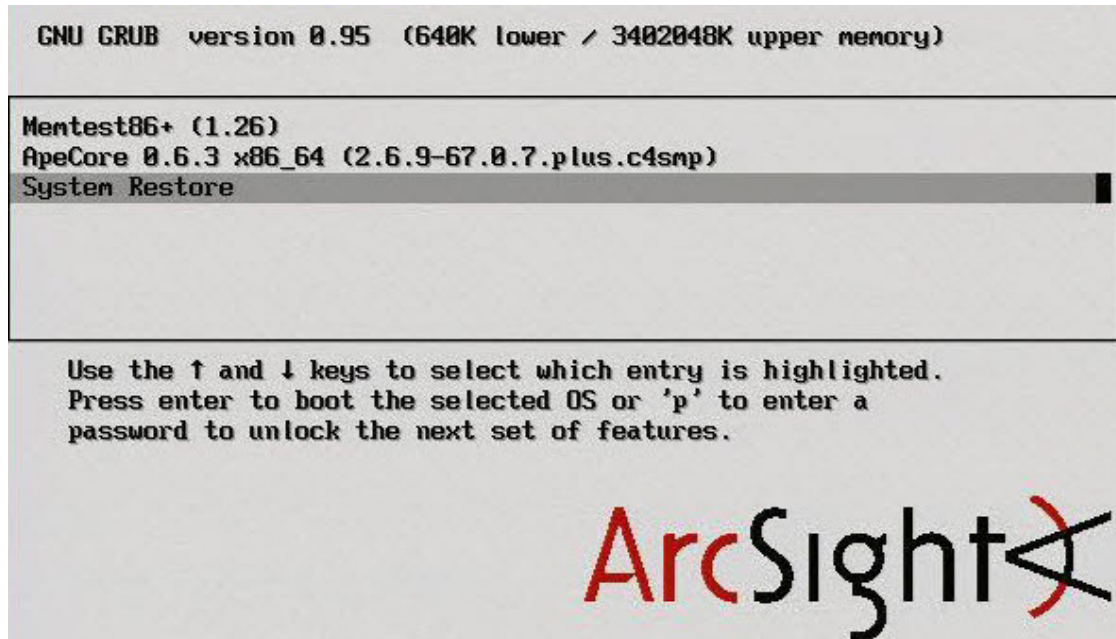

Use the mouse or arrow keys to select **System Restore** and press **Enter**.

- In the **Acronis True Image Echo Server** dialog box, select **Recovery** from the **Pick a Task** list and then press Enter.
- When the Restore Data Wizard starts, click **Next** to continue.
- On the Welcome to the Restore Data Wizard page, click **Next** to continue.
- On the **Backup Archive Selection** page, select **Acronis Secure Zone** and click **Next**. You will have a chance to review the choices you make on this page and the wizard pages that follow before initiating the restore process.
- On the **Restoration Type Selection** page, select **Restore disks or partitions** and click **Next**. Only choose other options if specifically directed to do so by customer support.
- On the **Partition or Disk to Restore** page, select the entire drive, labeled **cciss/c0d0** or **sda** (depending on the appliance model) and click **Next**.
- On the **NT Signature selection for image restoration** page, select how you want the NT signature for the restored disk to be processed and click **Next**.
- On the **Restored Hard disk Location** page, select the drive to restore (**cciss/c0d0** or **sda**) and click **Next**.
- On the **Non-empty Destination Hard Disk Drive** page, select **Yes, I want to delete all partitions on the destination hard disk drive before restoring** and click **Next**.
- On the **Next Selection** page, select **No, I do not** and click **Next** (there are no other partitions or disks to restore).
- On the **Restoration Options** page, select **Validate backup archive for the data restoration process** if you want to validate the archive before resetting the appliance. Select **Reboot the**

**computer automatically after the restoration is finished** if you want to reboot the appliance automatically. Click **Next**.

16. Review the checklist of operations to be performed and click **Proceed** to begin factory reset. Click **Back** to revisit previous pages.

**Caution:** Do not interrupt or power-down the Logger Appliance during the restore process. Interrupting the restore process may force the system into a state from which it cannot be recovered.

Progress bars show the status of the current operation and the total progress.

17. When you see a message indicating that the data was restored successfully, click **OK**.  
If you specified automatic reboot, the appliance reboots when the restore is complete. Otherwise, reboot manually.

## Restoring LX400 and Earlier Appliance Models

You can restore LX400 and earlier appliances to the original factory settings by using the built-in Acronis True Image software.

### To restore LX400 and earlier appliance models:

1. Attach a keyboard, monitor, and mouse directly to the appliance or, if your appliance is configured for remote access through iLO, you can use that functionality to access the appliance console. (For information on how to set up the Logger Appliance for remote access, refer to the Logger Installation Guide.) You will see something like the following image.

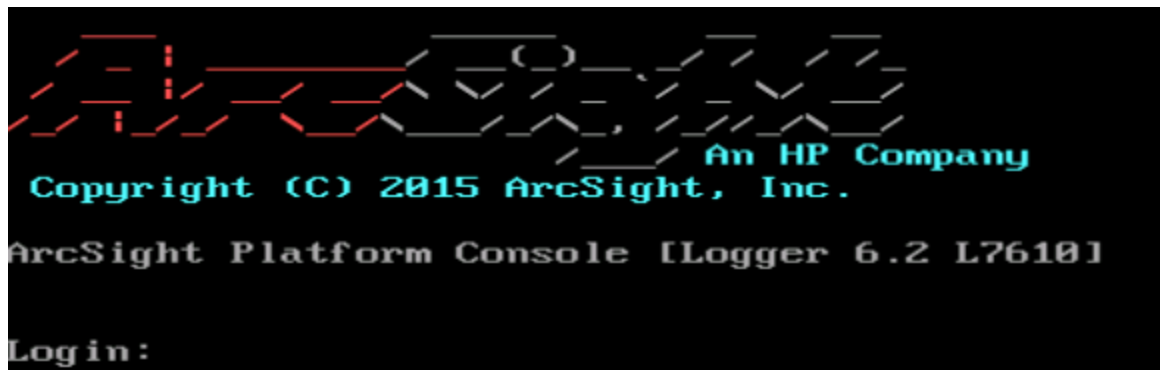

2. Log into the appliance, type `reboot` at the command prompt, and then press Enter.
3. As the system reboots, messages scroll by. As soon as a message like the following appears on the screen, press any key on your keyboard.

Press any key to enter the menu

Booting Red Hat Enterprise Linux <version> in N seconds...

This message is displayed for a very short time. Make sure you press a key on your keyboard quickly; otherwise, the appliance will continue to boot normally. You need to press the key after the BIOS is done booting but before the OS boots.

If the OS boots, you will see something like the screen capture below. You'll need to try again in that case.



4. The session viewer opens.

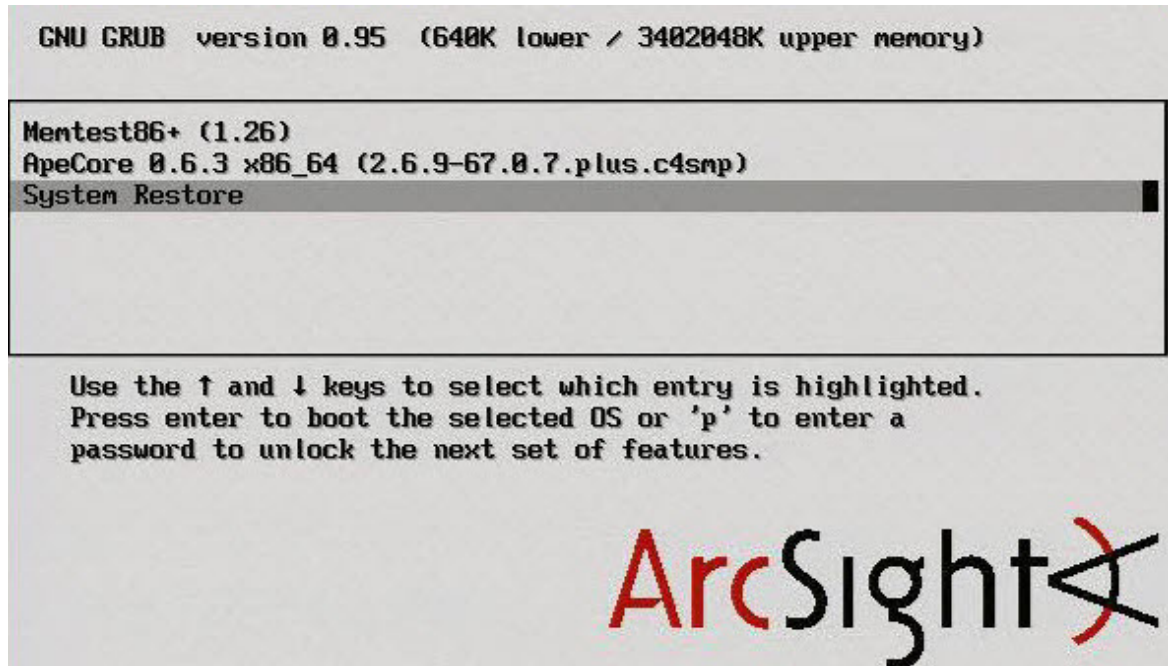

Use the mouse or arrow keys to select **System Restore** and press **Enter**.

5. In the **Acronis True Image Echo Server** dialog box, select **Recovery** from the **Pick a Task** list and then press Enter.
6. When the Restore Data Wizard starts, click **Next** to continue.
7. On the Welcome to the Restore Data Wizard page, click **Next** to continue.
8. On the **Backup Archive Selection** page, select **Acronis Secure Zone** and click **Next**. You will have a chance to review the choices you make on this page and the wizard pages that follow before initiating the restore process.
9. On the **Restoration Type Selection** page, select **Restore disks or partitions** and click **Next**. Only choose other options if specifically directed to do so by customer support.
10. On the **Partition or Disk to Restore** page, select the entire drive, labeled **cciss/c0d0** or **sda** (depending on the appliance model) and click **Next**.
11. On the **NT Signature selection for image restoration** page, select how you want the NT signature for the restored disk to be processed and click **Next**.

12. On the **Restored Hard disk Location** page, select the drive to restore (**cciss/c0d0** or **sda**) and click **Next**.
13. On the **Non-empty Destination Hard Disk Drive** page, select **Yes, I want to delete all partitions on the destination hard disk drive before restoring** and click **Next**.
14. On the **Next Selection** page, select **No, I do not** and click **Next** (there are no other partitions or disks to restore).
15. On the **Restoration Options** page, select **Validate backup archive for the data restoration process** if you want to validate the archive before resetting the appliance. Select **Reboot the computer automatically after the restoration is finished** if you want to reboot the appliance automatically. Click **Next**.
16. Review the checklist of operations to be performed and click **Proceed** to begin factory reset. Click **Back** to revisit previous pages.

**Caution:** Do not interrupt or power-down the Logger Appliance during the restore process. Interrupting the restore process may force the system into a state from which it cannot be recovered.

Progress bars show the status of the current operation and the total progress.

17. When you see a message indicating that the data was restored successfully, click **OK**.  
If you specified automatic reboot, the appliance reboots when the restore is complete. Otherwise, reboot manually.

# Appendix I: Logger Search From ArcSight ESM

If you have ArcSight Logger and ArcSight ESM deployed in your network infrastructure, you can perform a Logger search operations from ArcSight Command Center or the ArcSight Console.

If you are running ESM 6.5c or later, you can use the search functionality provided by the ArcSight Command Center. For information on this feature, refer to the ArcSight Command Center User’s Guide. For ESM 6.0c and earlier versions, you can perform a Logger search from your ArcSight Console.

The following topics discuss how use the integrated search functionality from the ArcSight Console.

- [Understanding the Integrated Search Functionality](#) ..... 616
- [Setup and Configuration](#) ..... 617
- [Supported Search Options](#) ..... 619
- [Guidelines](#) ..... 619
- [Searching on Logger From ArcSight Console](#) ..... 620

## Understanding the Integrated Search Functionality

**Tip:** If you are using ESM 6.5c and above, you can search from ArcSight Command Center in addition to the ArcSight Console described here. Refer to the ArcSight Data Platform Logger and ArcSight Command Center User's Guide for details.

There are several ways to perform a search operation on Logger from an ArcSight Console:

- Search: a regular search operation in which you can specify search options.
- Quick search: a search operation based on field and value you select in an ArcSight Console active channel; you are not prompted for any search options.

To run a Logger search, right click on an event in an active channel of the ArcSight Console to display a menu to select a search method—Logger Search or Logger Quick Search.

If you select Logger Search, you need to select search options such as Event Name, Destination, Source, and so on, and the Logger Appliances on which the search should be run (if there are multiple Logger Appliances). If you select Logger Quick Search, you are not prompted to specify any search options because the search is run on the field you had clicked on.

The search results are displayed in the ArcSight Console, as shown in the following figure:

**Note:** This figure is from ESM 5.x. In ESM 6.x, the results are displayed in a separate browser window.



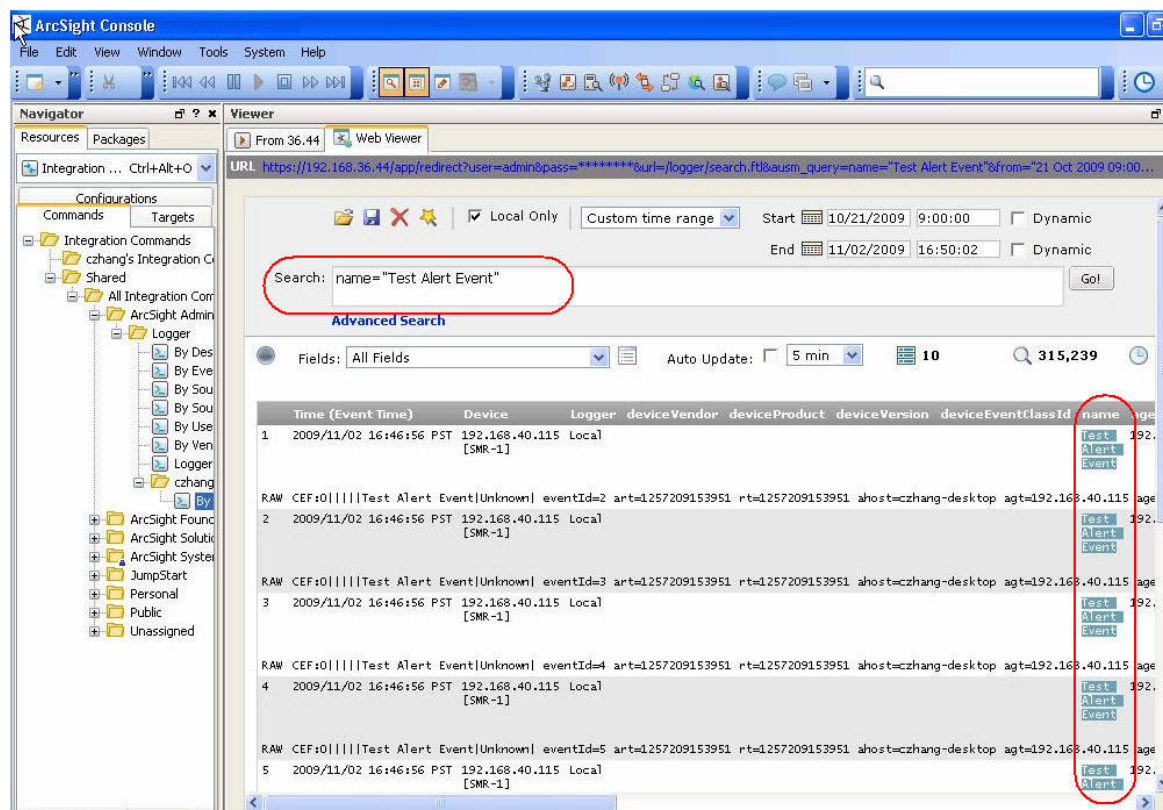

Before you can run a search operation on Logger from ArcSight Console, you need to set up parameters in the ArcSight Console that are used to authenticate the user who performs the search. Authentication can be done via Basic Authentication (user name and password) or a One Time Password (OTP). This option makes the user authentication between Logger and ArcSight Console highly secure.

By default, a Logger search from the ArcSight Console uses the OTP method to authenticate. However, if Logger or ArcSight Console is not running a release that supports the OTP option, an error message is displayed and basic authentication is used.

## Setup and Configuration

The following table lists the minimum and recommended versions that Logger and ArcSight Console must be running.

Option	Requirement
Recommended	Logger 6.2 ESM 6.8  <b>Tip:</b> To verify the latest supported ESM release, refer to ArcSight Product Documentation on <a href="#">HPE ArcSight Protect 724</a> .
Minimum	Logger 5.1 ESM 5.0 SP1 Patch 2

## On ESM

Follow these instructions to set up and configure ArcSight Manager to run integrated search operations:

1. Ensure that the ArcSight Manager is running one of the recommended versions.
2. Follow instructions in the ArcSight ESM User's Guide to set up ArcSight Console for integrated searches on Logger. When setting up a user for Logger access (as described in the "Set Up Users for Logger Access" section of the User's Guide), specify the following integration parameters.

Parameter	Type	Value	Targets
OTPPassword	Password	●●●●●●●●	Logger Appliance 1
LoggerHost	Text	192.168.36.29	Logger Appliance 1
OTPUser	Text	logger_user	Logger Appliance 1
LoggerPort	Text	443	Logger Appliance 1
LoggerUser	Text	logger_user	Logger Appliance 1
LoggerPassword	Password	●●●●●●●●	Logger Appliance 1

Parameter	Description
<b>For a Logger Appliance Target</b>	
LoggerUser	The user account for a Logger Appliance target.
LoggerPassword	The password for LoggerUser.
LoggerHost	The IP address of the Logger host.
LoggerPort	443
<b>For a Software Logger Target</b>	
OTPUser	The user account for one-time password (OTP) authentication. This account must exist on the Logger.

Parameter	Description
OTPPassword	The password for OTPUser.
LoggerHost	The IP address of the Logger host.
LoggerPort	The Logger port number you assigned it during installation.

The ArcSight ESM User's Guide is available from the [ArcSight Product Documentation Community on Protect 724](#).

## On Logger

### Make sure:

1. Your Logger is one of the recommended versions.
2. The Logger user name is the one you specified while creating an integration parameter (in) on the ArcSight Console.

## Supported Search Options

You can select from the following search options when running a Logger search (not Quick Search) from the ArcSight Console:

- By Destination
- By Event Name
- By Source
- By Source and Destination
- By User
- By Vendor and Product

Additionally, if multiple Loggers are configured on your ArcSight Console, you can select the one on which the integrated search should be run.

## Guidelines

Make sure you are aware of the following guidelines about Logger Search when it is run from ArcSight Console:

- A field-based search query is used to perform search on the Logger.
- Only searches from an active channel of an ArcSight Console is supported; searches from other ESM resources are not supported.

- Only one search option per search operation is supported. That is, you cannot select by both Event Name and By Destination for one search operation. For multiple search options, see ["Supported Search Options" on the previous page](#).

- You can run the search operation on only one Logger at a time. That is, you cannot select multiple Loggers from the menu list on ArcSight Console.

Additionally, even if a Logger peers with other Loggers, integrated search runs only on the local Logger that you select from the menu list on ArcSight Console.

- The one-time password (OTP) authentication is available for use only when Logger is running 5.1 or later and ArcSight Console is running 5.0 SP1 Patch 2 or later.

If OTP cannot be used, the searches run from the ArcSight Console display a message that a single-use session token could not be negotiated, thus regular authentication will be used. Click **OK**. LoggerUser and LoggerPassword is then used to authenticate.

## Searching on Logger From ArcSight Console

You can perform two types of searches on Logger from ArcSight Console—Quick search, and regular search. Follow the steps for the type of search you want to run.

### Running a Quick Search:

To run a Quick Search on Logger (as described in ["Understanding the Integrated Search Functionality" on page 616](#)):

1. Right click on the event field in an active channel of the ArcSight Console.
2. From the menu list, select **Integration Commands>Logger Quick Search**, as shown in the

following figure.

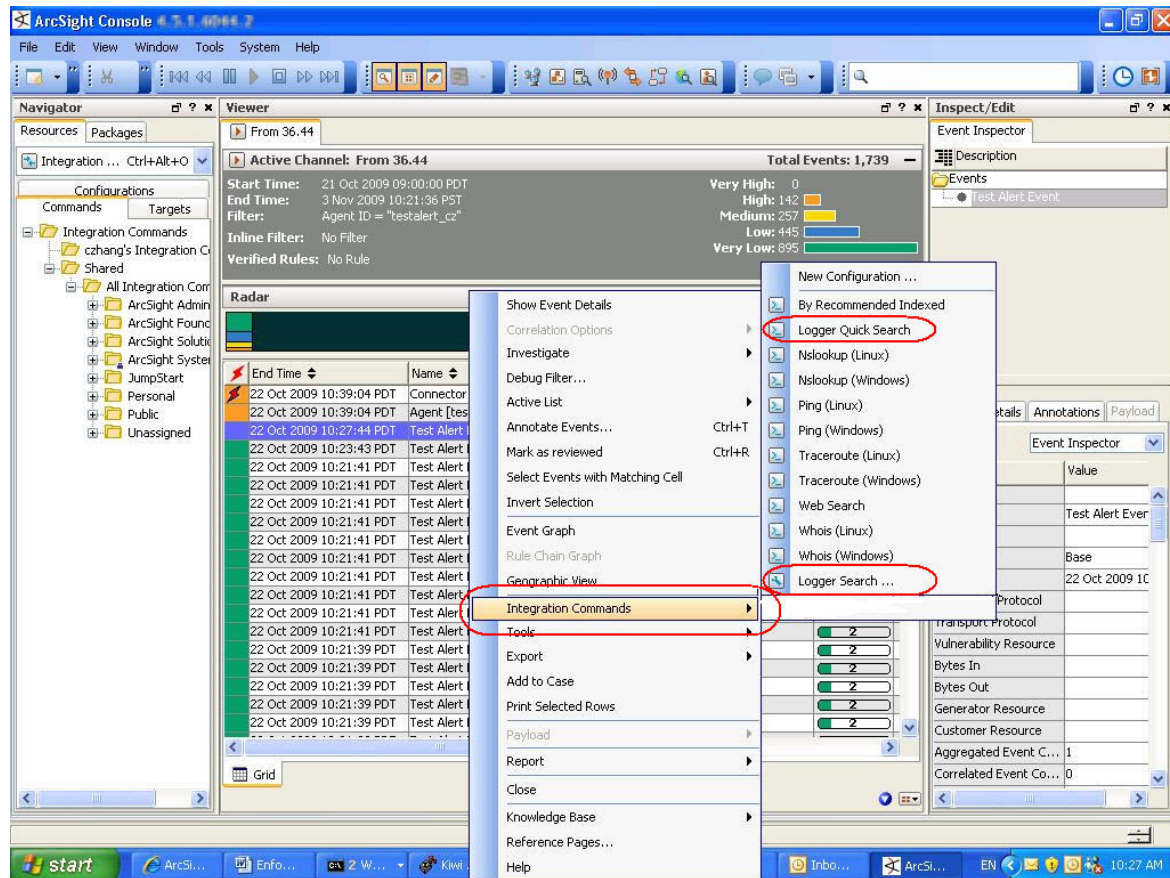

## Running a Regular Search:

To run a regular **Search** (in which you specify search options):

1. Right click on any field of an event in an active channel of the ArcSight Console.
2. From the menu list, select **Integration Commands > Logger Search > Select Search Options**, as shown in the following figure.

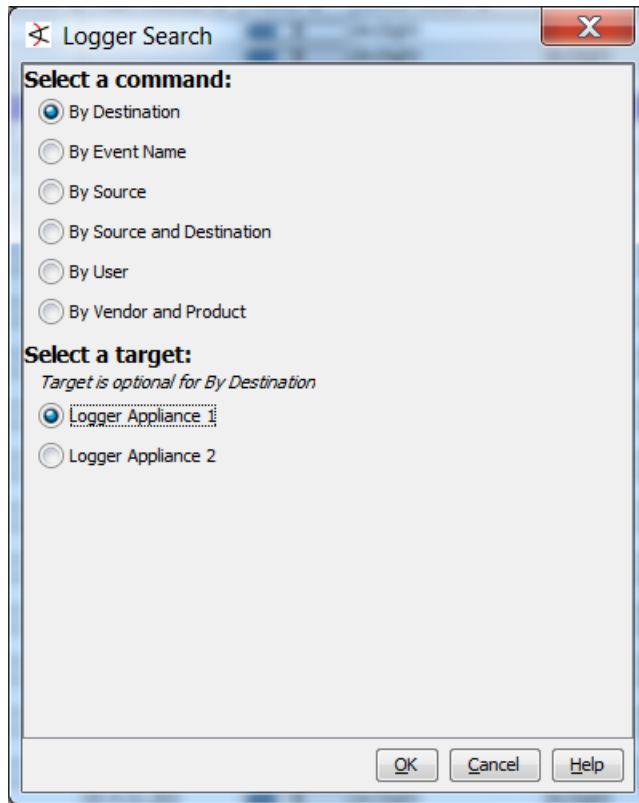

3. Click **OK** to run the search or **Cancel** to quit.
  - a. If Logger or ArcSight Console is not running a release that supports the OTP option, an error message is displayed indicating that a single-use session token was not negotiated and basic authentication will be used instead.
  - b. If that option is acceptable, click **OK** to proceed.

The search results are displayed in the ArcSight Console Web Viewer.

# Send Documentation Feedback

If you have comments about this document, you can [contact the documentation team](#) by email. If an email client is configured on this system, click the link above and an email window opens with the following information in the subject line:

## **Feedback on Administrator's Guide (Logger 6.3)**

Just add your feedback to the email and click send.

If no email client is available, copy the information above to a new message in a web mail client, and send your feedback to [arc-doc@hpe.com](mailto:arc-doc@hpe.com).

We appreciate your feedback!