

AEROTECNICA COLTRI®

www.aerotecnicacoltri.com



USE AND MAINTENANCE MANUAL

MCH-6

High pressure compressors for pure breathing air and technical gases

MCH-6

HIGH PRESSURE COMPRESSORS FOR PURE BREATHING AIR AND TECHNICAL GASES

IMPORTANT



**BEFORE USING THE COMPRESSOR READ THIS
MANUAL CAREFULLY**

The MCH6 is designed for filling SCUBA or SCBA tanks one at a time. The compressor was not engineered or manufactured for continuous duty filling of storage tanks or cascade storage systems of any kind.

AEROTECNICA COLTRI®

Via Colli Storici, 177

25010 SAN MARTINO DELLA BATTAGLIA (BRESCIA) ITALY

Tel. +39 030 9910301 Fax. +39 030 9910283

www.coltrisub.it www.coltrisub.com

coltrisub@coltrisub.it

Dear Customer,

Thank you for choosing an **AEROTECNICA COLTRI** compressor. This manual is provided together with the compressor to aid you in the use of the machine and ensure that your work produces the best possible results.

Please read all the instructions and information provided on the following pages. Ensure that the manual is at the disposal of the personnel who will be using/managing the compressor and carrying out any maintenance on it.

Should you require any clarification, when using the compressor for the first time or at any other time it is used, please remember that **AEROTECNICA COLTRI** is at your complete disposal.

Should you need to contact us our fax number is: **+39 030 9910283**

For routine or unscheduled maintenance note that **AEROTECNICA COLTRI** international technical service is able to provide you with assistance and spare parts as and when required.

To ensure that your requests are dealt quickly, the following information is provided:

Manufacturer's data: **AEROTECNICA COLTRI SpA**

Via Colli Storici, 177

25010 SAN MARTINO DELLA BATTAGLIA (BRESCIA) - ITALY

Telefono : +39 030 9910301 - +39 030 9910297

Fax +39 030 9910283

<http://www.coltrisub.it> - <http://www.coltrisub.com>

e-mail: coltrisub@coltrisub.it

DECLARATION **CE** OF CONFORMITY
Italian DPR 459 of 24th July 1996, appendix II, part A

It is hereby declared that the machine model:

MCH - 6

Serial n° _____ year _____

complies with

the provisions of Italian DPR 459/96 as per EEC directives 89/392, 93/44 and 93/68

according to
the specifications of the following harmonized standards:

EN 292-1 ('91) - EN 292-2 ('91) - EN 60204-1 ('92) - ISO 3746 - ISO 11202

and also complies with

the provisions of Italian Dlgs 476/92 as per EEC directives 89/336 and 92/31 according to
the specifications of the following harmonized industrial environment standards:

EN 50081-2 (August 1993)

EN 50082-2 (March 1995)

DESENZANO DEL GARDA, date _____

**Chairman of the Board of
Directors**
Carlo Coltri



This manual is the property of AEROTECNICA COLTRI SpA. Reproduction, whole or partial, is forbidden.

QUICK GUIDE

WARNING



- This guide is intended only as a rapid introduction to use of the compressor.
- This guide is not meant to replace the use and maintenance manual.
- This compressor must not be used before reading the entire use and maintenance manual.

Preliminary tasks:

- Position the compressor in the selected area (see section "5").
- If necessary connect the air intake extension (see section "5.3.2").
- Check the oil level; if the compressor is new fill the oil sump with the oil supplied with the compressor (see section "7.6").

For compressors with combustion engines:

- Check fuel level and top up if necessary (see section "7.7").

For compressors with electric motors:

- Connect the electric motor to the mains power socket (see section "5.3.3").
- For compressors equipped with a three-phase electric motor, check that the cooling fan rotates in the direction indicated by the arrow on the cover; if it turns the other way invert two of the three phases on the mains power (see section "6.1.2").
- Check the safety valve is working (see section "7.9").

- Switch on the compressor with the fill valve 1 connected to the closed bottle 2 and the condensate outlets 3 closed and check that free drainage of the safety valve occurs when the value on the gauge is the same as the calibration value of the valve (see section 6.3.1).

Bottle refill (see section "6.5"):

- fit the hose connector 1 on the bottle connector 2 (closed) (A);
- open the condensate discharge valve 3 on the separator (B);
- start the compressor (C);
- close the discharge (B);
- open the tank valve 4 (A);
- discharge the condensate every 10-15 minutes of use (B).

When refill is complete:

- close the bottle valve 4 (A);
- open the condensate discharge valve 3 and let all the air bleed out (B);
- switch off the compressor (C);
- disconnect the coupling 1 from the bottle (A).

Maintenance:

- After the first 5 working hours change the oil again (see section "7.6.3").
- Check the lubricating oil level every 5 hours (see section "7.6.2").
- Change the lubricating oil every 50 hours (see section "7.6.3").
- Periodically change the air intake filter (see section "7.8").
- Check the safety valve at every refill (see section "7.9").
- Periodically change the active carbon filters/molecular sieve (see section "7.12").
- Periodically change the hoses (see section "7.13").

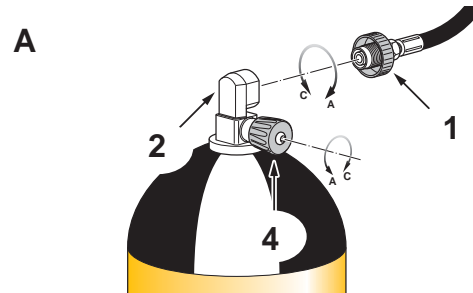

Model: MCH-6/EM

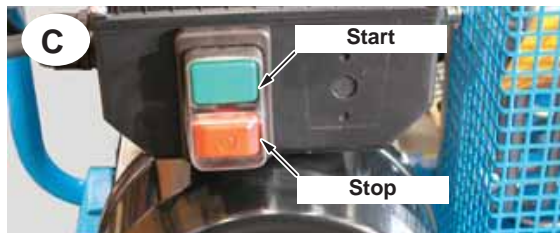

Model: MCH-6/ET

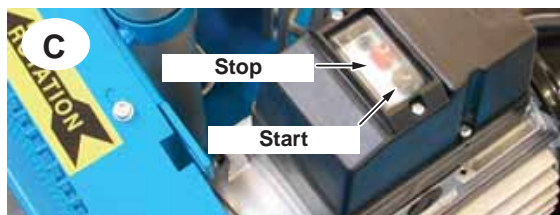

Model: MCH-6 SH e MCH-6 SR

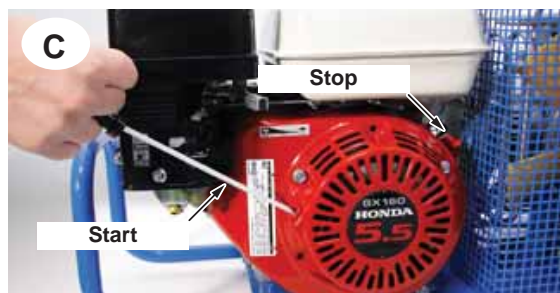

CONTENTS

CHAPTER 1 – GENERAL	10
1.1 Preliminary information	10
1.2 Required operator training	10
1.3 Important information for the user	11
1.4 Foreword	12
1.5 Warranty	12
1.6 Assistance	13
1.7 Responsibility	14
1.8 Purpose of the machine	14
1.9 Where the machine may be used	17
1.10 Running in and testing the compressor	17
1.10.1 Tightening torque values	17
CHAPTER 2 – BASIC INFORMATION ON THE COMPRESSOR	18
2.1 Description of the compressor	18
2.2 Identification the compressor	18
2.3 General instructions	18
CHAPTER 3 – SAFETY REGULATIONS	20
3.1 General safety rules	20
3.1.1 Know the compressor	20
3.1.2 Protective clothing	20
3.1.3 Emergency equipment	20
3.1.4 Checks and maintenance	20
3.2 General precautions	21
3.2.1 Important safety information	22
3.2.2 Accident prevention	23
3.2.3 Using safety	23
3.2.4 Residual risk zones	24
3.3 Safety info labels: location	25
3.3.1 Safety info labels: description	26
3.4 General safety regulations	28
3.4.1 Care and maintenance	28
3.4.2 Fire extinguishers and first aid	29
3.5 Maintenance precautions	29
3.5.1 Warning signs	29
3.5.2 Tools	29
3.5.3 Personnel	29
3.5.4 Keeping the compressor clean	30
3.5.5 Periodic replacement of essential safety parts	30
CHAPTER 4 – TECHNICAL DATA	31
4.1 Technical characteristics	31
4.1.1 Crankcase, crankshaft, cylinder, pistons	31
4.1.2 Valves	31
4.1.3 Safety valves	31
4.1.4 Cooling pipes, lubrication	31

CONTENTS

4.1.5 Frame, guards	31
4.1.6 Machine parts	32
4.2 Technical characteristics	33
4.2.1 MCH-6/SH - MCH-6/SH COMPACT	33
4.2.2 MCH-6/SR - MCH-6/SR COMPACT	34
4.2.3 MCH-6/EM - MCH-6/EM MINICOMPACT	35
4.2.4 MCH-6/EM COMPACT - MCH-6/EM COMPACT (3Kw special version)	36
4.2.5 MCH-6/ET - MCH-6/ET COMPACT - MCH-6/ET MINICOMPACT	37
4.3 Pressure circuit	38
CHAPTER 5 – HANDLING AND INSTALLATION	39
5.1 Unpacking	39
5.2 Handling	39
5.3 Installation	39
5.3.1 Positioning	40
5.3.2 Air intake extension connection	41
5.3.3 Electrical connection (MCH-6 / EM and MCH-6 / ET only)	41
CHAPTER 6 – USING THE COMPRESSOR	42
6.1 Preliminary checks before using for the first time	42
6.1.1 Filling with lubricating oil	42
6.1.2 Checking for proper electrical connection	42
6.2 Checks to be run at the start of each working day	43
6.2.1 Lubricating oil level check	43
6.2.2 Checking that the refill flex hoses are in good condition	43
6.2.3 Fuel level check	43
6.2.4 Storing technical documentation	44
6.3 Preliminary tasks	44
6.3.1 Safety valve checks	44
6.4 Starting and shutting down	45
6.4.1 Starting and shutting down with internal combustion engine	45
6.4.2 Starting and shutting down with electric motor	47
6.4.3 Automatic shutdown with pressure switch	47
6.5 Tank refill	48
CHAPTER 7 – MAINTENANCE	50
7.1 Foreword	50
7.2 General regulations	50
7.3 Unscheduled work	51
7.4 Schedule maintenance table	51
7.5 Troubleshooting	51
7.6 Checking and changing the lubricating oil	52
7.6.1 Oil table	52
7.6.2 Checking the oil level	52
7.6.3 Changing the lubricating oil	53
7.7 Checking fuel level and topping up	54
7.8 Changing the intake filter	55

CONTENTS

7.9 Checking the safety valve	56
7.10 Condensate discharge	56
7.11 Transmission belts	57
7.11.1 Checking transmission belt tension/changing belts	57
7.12 Active carbon filters / molecular sieve	58
7.12.1 Filter replacement frequency calculation table	58
7.12.2 Changing the active carbon filters / molecular sieve	58
7.13 Changing the flex hoses	59
CHAPTER 8 – STORAGE	60
8.1 Stopping the machine for a brief period	60
8.2 Stopping the machine for a long period	60
CHAPTER 9 – DISMANTLING AND PUTTING OUT OF SERVICE	61
9.1 Waste disposal	61
9.2 Dismantling the compressor	62
CHAPTER 10 – INSTRUCTIONS FOR EMERGENCY SITUATIONS	62
10.1 Fire	62
CHAPTER 11 – SAFETY STANDARDS	63
11.1 Foreword	63
11.1.1 Definitions	64
11.2 General standards	67
11.2.1 Accident prevention	69
11.2.2 Personal Protection Equipment (PPE)	71
11.3 Regulations for lifting and handling the machine	73
11.4 Delivery regulations	74
11.5 Storage	75
11.6 Regulations for use	76
11.6.1 Residual risks	78
11.6.2 Purpose of the compressor	79
11.6.3 Limitations of use	80
11.7 Maintenance regulations	81
CHAPTER 12 – MAINTENANCE REGISTER	85
12.1 Assistance service	85
12.2 Scheduled maintenance	85
12.3 Using the compressor under heavy-duty conditions	85
12.4 The Customer Care Centre	85
12.5 Scheduled maintenance registry coupons	86
CHAPTER 13 - NOTES	89

1 - GENERAL

1.1 PRELIMINARY INFORMATION

Do not destroy or modify the manual and update it with inserts published by producer only.

Machine type: High pressure compressor for breathing air and/or technical gases
Revision n°: 02
Edition: 03/2008
Model: MCH-6

Manufacturer's data: **AEROTECNICA COLTRI SpA**
Via Colli Storici, 177
25010 SAN MARTINO DELLA BATTAGLIA (BRESCIA) - ITALY
Tel : +39 030 9910301 - +39 030 9910297
Fax +39 030 9910283
<http://www.coltrisub.it> - <http://www.coltrisub.com>
e-mail: coltrisub@coltrisub.it

Appendices

- Internal combustion engine use and maintenance manual

1.2 REQUIRED OPERATOR TRAINING

This manual must be read carefully:

- all compressor operators / maintenance personnel must read this entire manual with due care and attention and observe the instructions/information contained herein.
- company owners must ensure that the operator has the required training for operation of the compressor and that he/she has read the manual.

1.3 IMPORTANT INFORMATION FOR THE USER

The information/instructions for compressor use contained in this manual only concern the:

AEROTECNICA COLTRI Mod. MCH-6.

The instruction manual must be read and used as follows:

- read this manual carefully; treat it as an essential part of the compressor;
- the instruction manual must be kept where it can readily be consulted by compressor operators and maintenance staff;
- keep the manual for the working life of the compressor;
- make sure updates are incorporated in the manual;
- make sure the manual is given to other users or subsequent owners in the event of resale;
- keep the manual in good condition and ensure its contents remain undamaged;
- do not remove, tear or re-write any part of the manual for any reason;
- keep the manual protected from damp and heat;
- if the manual is lost or partially damaged and its contents cannot be read it is advisable to request a copy from the manufacturer.

Important: you must understand the following symbols and their meaning.
They highlight essential information:

IMPORTANT

Refers to additional information or suggestions for proper use of the compressor.



DANGER

Refers to dangerous situations that may occur during use of the compressor: aims to ensure worker safety.



WARNING

Refers to dangerous situations that may occur during use of the compressor: aims to prevent damage to objects and the compressor itself.



1.4 FOREWORD

The regulations/instructions for use contained in this manual constitute an essential component of the supplied compressor.

These regulations/instructions are intended for an operator who has already been trained to use this type of compressor. They contain all the information necessary and essential to safety and efficient, proper use of the compressor.

Before beginning work, read the following suggestions carefully:

- 1) before using the compressor, gain familiarity with the tasks to be completed and the admissible working position;
- 2) the operator must always have the instruction manual to hand;
- 3) program all work with due care and attention;
- 4) you must have a detailed understanding of where and how the compressor is to be used;
- 5) before starting work make sure that safety devices are working properly and that their use is understood; in the event of any doubts do not use the compressor;
- 6) observe the warnings given in this manual with due care and attention;
- 7) constant and careful preventive maintenance will always ensure a high level of safety when using the compressor. Never postpone repairs and have them carried out by specialised personnel only; use only original spare parts.

1.5 WARRANTY

IMPORTANT



The materials supplied by AEROTECNICA COLTRI SpA are covered by a 1 year warranty, the validity of which begins when the compressor is put into service as proven by the delivery document.

AEROTECNICA COLTRI SpA shall repair or replace those parts it acknowledges to be faulty during the warranty period.

In replacing the faulty part AEROTECNICA COLTRI SpA shall not be liable for any other expenses sustained by the dealer or his customer such as presumed damage (present or future), lost earnings or fines.

Routine and unscheduled maintenance must be carried out in compliance with the instructions contained in this manual. Should the required work not be covered by the manual or assistance be required you are advised to contact AEROTECNICA COLTRI SpA in writing, even where agreements have already been made on the phone.

AEROTECNICA COLTRI SpA cannot be held liable for any delays or failure to execute work.

AEROTECNICA COLTRI SpA cannot be held liable for any damage or malfunctions caused by work carried out on the compressor by unauthorised personnel.

AEROTECNICA COLTRI SpA guarantees that its compressors are free from defects design, workmanship and the used materials for a period of 1 year starting from the date of delivery of the compressor; should the customer note any flaws and/or defects he must report them, in writing, to **AEROTECNICA COLTRI SpA** within 8 days of their discovery otherwise the warranty shall be rendered null and void.

The warranty only covers flaws and faults that occur where the compressor is used properly in compliance with the instructions contained in this manual and where periodic maintenance is carried out.

The warranty does not cover faults caused by improper use of the compressor, exposure to atmospheric agents (rain etc.) or damage during transport; all materials subject to wear and those subject to periodic maintenance are not covered by the warranty and are to be paid for by the customer in full; in any event the warranty is rendered null and void if the compressor is tampered with or if work is carried out on it by personnel who have not been authorised by **AEROTECNICA COLTRI SpA**.

A compressor that has been acknowledged as faulty on account of flaws in design, workmanship or used materials shall be repaired or replaced free of charge by **AEROTECNICA COLTRI SpA** at its plant in San Martino della Battaglia (BRESCIA); costs regarding transport, delivery of spare parts and any materials subject to wear shall be met by the customer.

Should warranty-covered work need to be carried out on the customer's premises, travel and accommodation costs for personnel sent by **AEROTECNICA COLTRI SpA** shall be met by the customer.

The act of taking delivery of machines and/or faulty components or the sending of technicians to assess the presumed defects and/or flaws reported by the customer does not in itself imply acknowledgement that the defect is covered by warranty.

Repairs and/or replacements made by **AEROTECNICA COLTRI SpA** during the warranty period do not in any way prolong the latter itself.

Acknowledgement that a defect is covered by warranty does not in itself mean that **AEROTECNICA COLTRI SpA** is in any way liable to award compensation.

AEROTECNICA COLTRI SpA cannot be held liable for any other direct or indirect damages

imputable to compressor defects and flaws (loss of production or earnings etc.) except in cases where serious negligence is demonstrated.

1.6 ASSISTANCE

AEROTECNICA COLTRI SpA technicians are at your disposal for all routine/unscheduled maintenance work.

Please forward your request for assistance to **AEROTECNICA COLTRI SpA** by sending a fax or email to:

Fax. +39 030 9910283
e-mail coltrisub@coltrisub.it

1.7 RESPONSIBILITY

AEROTECNICA COLTRI spa considers itself exonerated from any responsibility or obligation regarding injury or damage caused by:

- failure to observe the instructions contained in this manual that concern the running, use and maintenance of the compressor;
- violent actions or incorrect manoeuvres during use or maintenance of the compressor;
- modifications made to the compressor without prior written authorisation from **AEROTECNICA COLTRI spa**;
- incidents beyond the scope of routine, proper use of the compressor.

In any case, should the user impute the incident to a defect of the compressor, he/she must demonstrate that the damage has been a major and direct consequence of this "defect".

WARNING



Maintenance and repairs must only be carried out using original spare parts.

AEROTECNICA COLTRI spa cannot be held liable for any damages caused by failure to observe this rule.

The compressor is guaranteed as per the contractual agreements made at the time of sale.

Failure to observe the regulations and instructions for use contained in this manual shall render the warranty null and void.

1.8 PURPOSE OF THE MACHINE

The compressor mod. MCH-6 has been designed and built for the purpose of obtaining excellent quality breathing air by drawing it from the surrounding environment. The air, free from any harmful fumes, is passed through an intake filter and, after the filtration cycle, is stored in bottles constructed to contain air at high pressure.

The MCH-6 can also be used to obtain other non-breathable gases for industrial use such as:

- Nitrogen
- Helium
- Nitrox 40% max O₂

Any other use is inappropriate: the manufacturer cannot be held liable for any personal injury or damage to objects / the machine itself caused by improper use.

DANGER

- Use only tested, certified bottles: do not exceed the working pressure indicated on them.
- Aspirate unpolluted air.
Use the compressor in areas free from dust, risk of explosion, corrosion and fire.
- It is forbidden to use the compressor with an internal combustion engine indoors. Make sure that air intakes are a long way from fume exhausts.
- Improper use could have serious consequences for the user.
- Do not disconnect the hose from the fittings or the clamp when under pressure.
- Change the air purification filters regularly as described in section “7.12.2 Changing the active carbon filters”.
- Drain the condensate regularly as illustrated in section “7.10 Condensate discharge”.
- The power lead plug must be disconnected:
 - if there is a problem during use
 - before carrying out any cleaning or maintenance tasks.
- Never pull the plug out by tugging the lead. Make sure the lead is not bent at a sharp angle and that it does not rub against any sharp edges. Use of extensions is not recommended.
- Never run the compressor when:
 - the power lead is damaged;
 - there is evident damage;
 - the covers/guards are removed.
- All routine and unscheduled maintenance tasks must be carried out with the compressor at standstill, the electrical power supply disconnected and the pumping circuit depressurised.
- After switching off the compressor wait about 30 minutes before carrying out any maintenance tasks so as to prevent burns.
- The high pressure flex hose that connects to the bottle (also called the refill hose) must be in good condition, especially in the areas near the fittings.
The plastic sheath that covers the pipe must not show any signs of abrasion otherwise damp could get in, corrode the steel braid and weaken it.
The hose must be changed periodically (yearly) or when it shows signs of wear.
Failure to observe this rule could seriously endanger the users' safety.
Make sure the minimum bending radius of the hose is no less than 250 mm.

To ensure maximum working efficiency, **AEROTECNICA COLTRI** has constructed the compressor with carefully selected components and materials.

The compressor is tested prior to delivery.

Continued compressor efficiency over time will also depend on proper use and maintenance as per the instructions contained in this manual.

All the components, connections and controls used in its construction have been designed and built to a high degree of safety so as to resist abnormal strain or in any case a strain greater than that indicated in the manual. Materials are of the finest quality; their introduction and storage in the company and their utilisation in the workshop are controlled constantly so as to prevent any damage, deterioration or malfunction.

DANGER

- Before carrying out any work on the compressor each operator must have a perfect understanding of how the compressor works, know how to use the controls and have read the technical information contained in this manual.
 - It is forbidden to use the compressor under conditions / for purposes other than those indicated in this manual and AEROTECNICA COLTRI cannot be held liable for breakdowns, problems or accidents caused by failure to observe this rule.
 - Check that the fittings provide a proper seal by wetting them with soapy water: eliminate any leaks.
 - Do not attempt to repair high pressure hoses by welding them.
 - Do not empty the bottles completely, not even during winter storage, so as to prevent damp air getting in.
 - It is forbidden to tamper with, alter or modify, even partially, the systems and equipment described in this instruction manual, especially as safety guards and safety symbols are concerned.
 - It is also forbidden to carry out work in any way other than that described or to neglect the illustrated safety tasks.
 - The safety information and the general information given in this manual are highly important.
-

1.9 WHERE THE MACHINE MAY BE USED

The compressor mod. MCH-6 has been designed and built for the purpose of obtaining excellent quality breathing air by drawing it from the surrounding environment. The air, which must be free from any harmful fumes, is passed through an intake filter and, after the filtration cycle, is stored in bottles constructed to contain air at high pressure.

The compressor must only be used in environments having the characteristics described in the following table.

AREA OF MACHINE USE: ESSENTIAL DATA TABLE		
Temperature ambience	(°C) / (°F)	min.+5°C - Max.+45°C / min.+41°F - Max.+113°F
Air humidity	(%)	max.80%
Tolerated weather conditions	rain	None
	hail	
	snow	
Max tilt angle (bank)	%	6

Check that the area in which the compressor is to be positioned is adequately ventilated: good air exchange with no dust and no risk of explosion, corrosion or fire.

If ambient temperatures exceed 45°C air conditioning will be required.

Make sure that lighting in the area is sufficient to identify every detail (such as the writing on the info plates/stickers); use artificial lighting where daylight on its own is insufficient.

1.10 RUNNING IN AND TESTING THE COMPRESSOR

Each compressor is carefully run and tested prior to delivery.

A new compressor must nevertheless be used with caution during the first 5 working hours so as to complete proper running in of its components.

If the compressor is subject to an excessive workload during initial use, its potential efficiency will be prematurely compromised and functionality soon reduced. During the running in period proceed as follows:

- after starting let the compressor run on empty for 5-6 minutes.

After the first 5 hours carry out - in addition to the scheduled maintenance - the following tasks:

- change the compressor oil;
- check and adjust nuts and bolts.

1.10.1 Tightening torque values

The table shows tightening torques for bolts or hexagonal-head screws or socket screws lubricated with grease, except for specific cases indicated in the manual. Pipe connections (swivel nuts) should be finger tight plus an additional 1/2 turn.

Tightening torque values	
Thread	Max. torque
M6 - 1/4"	10Nm (7ft-lbs)
M8 - 5/16"	25Nm (18ft-lbs)
M10 - 3/8"	45Nm (32ft-lbs)
M12 - 1/2"	75Nm (53ft-lbs)
M14 - 9/16"	120Nm (85ft-lbs)
M16 - 5/8"	200Nm (141ft-lbs)

6 bolt and 4 bolt torque sequence

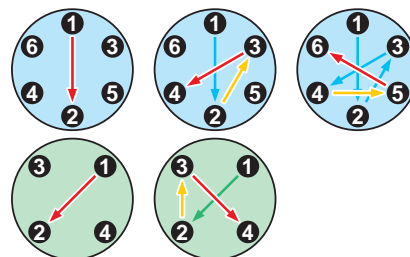

2 - BASIC INFORMATION OF THE COMPRESSOR

2.1 DESCRIPTION OF THE COMPRESSOR

High pressure compressor for breathing air and technical gases.

Compatible process gases:

- Nitrogen
- Helium
- Nitrox 40% max O₂



2.2 IDENTIFICATION THE COMPRESSOR

Each compressor has an identification label attached to its frame.

AEROTECNICA COLTRI SpA <small>Via Colli Storici 177 25010 DESENZANO D/G (BS) ITALY Tel. 030/9910301-9910297 Fax. 030/9910283</small>		
MODEL	MCH-6	
TYPE	PORTABLE	
S/N.	0226	
YEAR	2005	

2.3 GENERAL INSTRUCTIONS

WARNING



- This manual must be read carefully before transporting, installing, using or carrying out any maintenance on the compressor.
- It must be preserved carefully in a place known to compressor users, managers and all transport/installation/maintenance/repair/final dismantling personnel.
- This manual indicates the purposes for which the compressor can be used and gives instructions for its transport, installation, assembly, adjustment and use. It also provides information on maintenance tasks, ordering spare parts, residual risks and staff training.

WARNING

- It should be born in mind that the use and maintenance manual can never replace proper experience; some maintenance jobs are particularly difficult and in this regard the manual only offers general guidelines on the most important tasks, which must be carried out by personnel with proper training (e.g. acquired during training courses run by the manufacturer).
- This manual is an integral part of the compressor and must be stored in a suitable container near the compressor until its final demolition. If the manual is lost or damaged a copy can be requested from the manufacturer.
- Make sure all users have understood the regulations for use and the meaning of the symbols on the compressor.
- Observance of these technical instructions can prevent accidents: instructions have been drawn up in compliance with EEC Machinery Directive 89/392 and subsequent amendments.
- In any case always observe national safety regulations.
- Do not remove or damage guards, labels or notices, especially those required by law.
- The adhesives attached to the compressor are there for safety purposes. They must be replaced if they become illegible.
- This manual reflects the technical knowledge available at the time the compressor was sold and cannot be considered inadequate simply because updated at a later time on the basis of new experience.
- The manufacturer reserves the right to update products and manuals, without any obligation to update preceding products or manuals except in exceptional circumstances.
- To request or receive any updates or additions to this use and maintenance manual (which shall be considered an integral part of the manual) apply via the contact numbers given on section “1.6 Assistance”.
- Should you have any other queries or suggestions as to how to improve the manual please contact the manufacturer.
- Should you sell the compressor AEROTECNICA COLTRI invites you to provide us with the details of the new owner so that any new additions to the manual can be sent on.

3 - SAFETY REGULATIONS

3.1 GENERAL SAFETY RULES

3.1.1 Know the compressor

The compressor must only be used by qualified personnel. They must have an understanding of the arrangement and function of all the controls, instruments, indicators, warning lights and the various info plates/labels.

3.1.2 Protective clothing

All operators must use accident prevention items such as gloves, hard hat, eye goggles, accident prevention shoes and ear defenders against noise.



3.1.3 Emergency equipment

Make sure a first aid cabinet and a CO2 fire extinguisher are near the compressor. Keep the extinguisher fully loaded. Use according to standards in force.



3.1.4 Checks and maintenance

Apply a sign with the legend "WORK IN PROGRESS" on all sides of the compressor.

Inspect the compressor carefully every day it is used as per the check list given in this manual.

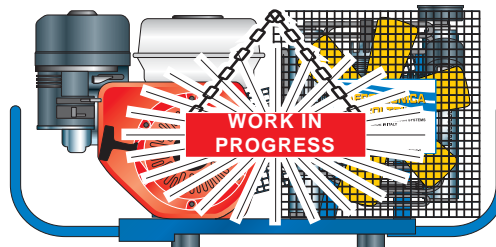

3.2 GENERAL PRECAUTIONS

- The EEC Machinery Directive 89/392 provides the following definitions (appendix 1, 1.1.1):

«**DANGEROUS ZONE**»: any zone inside and/or near a machine in which the presence of an exposed person constitutes a risk for his/her security and health.

«**EXPOSED PERSON**»: any person wholly or partially inside a dangerous zone.

«**OPERATOR**»: the person(s) charged with the task of installing, running, maintaining, cleaning, repairing and transporting the machine.

IMPORTANT



- Before carrying out any task or operation with the compressor it is compulsory to read and follow the instructions given in the use and maintenance manual. Doing so during work is too late: improper use or an erroneous manoeuvre could cause serious damage or injury.
- The employer must provide workers with detailed information on the risk of accident, especially risks deriving from noise, use of safety devices and the general accident prevention regulations provided for by international laws or standards or national standards within the country of use.
All operators must observe both international accident prevention standards and the national ones relevant to the country of use.
Bear in mind that the European Union has issued directives concerning worker health and safety: these include EEC directives 89/391, 89/686, 89/654, 89/655, 89/656, 86/188, 92/58 and 77/576 which all employers are legally obliged to comply with.
- Before carrying out any work on the compressor each operator must have a perfect understanding of how the compressor works, know how to use the controls and have read the technical information contained in this manual.

WARNING



It is forbidden to tamper with or replace compressor parts without obtaining prior authorisation from AEROTECNICA COLTRI.

The use of accessories, tools, materials subject to wear or spare parts other than those recommended by the manufacturer and/or illustrated in this manual can constitute a source of danger to operators and/or damage the machine.

Any modification to the compressor that has not been expressly authorised by AEROTECNICA COLTRI shall exonerate the manufacturer from any civil or penal liability.

ATTENZIONE



Should the compressor be used where the daily noise exposure level is greater than 80 dBA, the employer must apply all the relevant worker health and safety measures.

Where necessary operators must use personal protection such as ear defenders.

IMPORTANT

- Removing or tampering with any safety device is strictly forbidden.
- All installation, routine or unscheduled maintenance work must be carried out with the compressor at standstill and disconnected from the electrical power supply.
- Once the compressor has been cleaned the operator must

check for any worn, damaged or loose parts; in this case seek assistance from the maintenance technician.

It is especially important to check that flex hoses or other parts subject to wear are in good condition. Check also for any leaking of oil or other dangerous substances. If such situations arise it is forbidden to restart the compressor before the situation is resolved. If these problems are observed at the end of the refilling the operator must, before leaving the machine unattended, place a sign on the compressor indicating that maintenance work is in progress and that it must not be restarted.

- Never place hands or introduce screwdrivers, keys or other tools into moving parts.
- Never clean with flammable fluids.
- Periodically check the info plates/labels and restore/replace them where necessary.
- The workplace must be kept clean, tidy and free from objects that might hinder movement.
- Operators must avoid carrying out “awkward” tasks in uncomfortable positions that might cause imbalance.
- Operators should be aware of the risk of entrapment caused by clothes or hair getting caught up in moving parts; wear a cap to contain long hair.
- Necklaces, bracelets and rings can also be a source of danger.
- Workplace lighting must be adequate for the work in progress. Insufficient or excessive lighting can generate risks.
- Always observe the instructions, accident prevention regulations and the warnings contained in this manual.

3.2.1 Important safety information

technical regulations in force concerning compressors for the production of high pressure breathing air. The laws, regulations, standards and directives in force for such machines have been complied with.

Materials, parts, production procedures and quality controls all comply with the strictest safety and reliability standards.

Using the compressor for the purposes described in this manual, handling it with due diligence and carrying out maintenance and overhauls according to proper working practices will ensure long lasting performance and functionality.

3.2.2 Accident prevention

The manufacturer cannot be held liable for accidents that occur during use of the compressor as a result of the user's non-observance of the laws, regulations, standards and directives in force for high pressure compressors.

The compressor has been designed for use in weather conditions as refer to "1.9 Where the machine may be used".

3.2.3 Using safety

The manufacturer cannot be held liable for malfunction or damage if the compressor:

- is used for purposes other than that for which its is intended;
- is not handled or maintained according to the instructions specified in this manual;
- is not periodically and continually maintained as instructed or if non-original spare parts are used;
- machine parts are modified or replaced without written authorisation from the manufacturer, especially where the efficiency of safety devices has been reduced or eliminated;
- where it is used outside the admissible temperature range.

3.2.4 Residual risk zones

DANGER



In some compressor zones there remain residual risks that were not possible to eliminate at the design stage or for which safety guards could not be provided without compromising the functionality of the MCH-6. To prevent accidents all operators must be aware of the residual risks on this compressor.

Residual risk zones:

- 1 Danger of polluting the produced air due to the possibility of mixing exhaust fumes or lubricating oil vapours with the compressed air being produced.
- 2 Electrical dangers. Use the machine with suitable insulation, especially against water and humidity.
- 3 Dangers derived from use of internal combustion engine: Observe instruction in the relevant engine manual.
- 4 Heat-related dangers in exhaust pipe and compressor zone. Use the machine with suitable safety devices and after switching off the machine wait 30 minutes for the machine to cool down before carrying out maintenance work.
- 5 Danger deriving from noise emitted by the compressor.
- 6 Fire risk.
- 7 Risk of being crushed or dragged in the transmission belt zone.
- 8 Danger of impact/abrasion with the cooling fan.
- 9 Danger of direct contact with operator if hose breaks during bottle refill.

MCH-6 with internal combustion engine

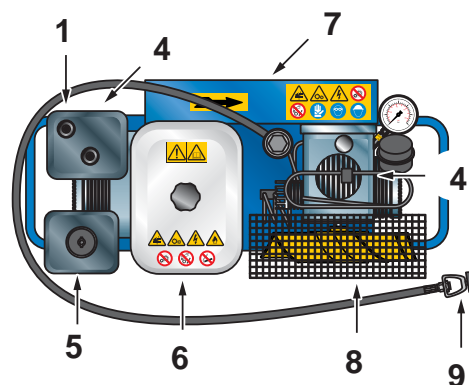
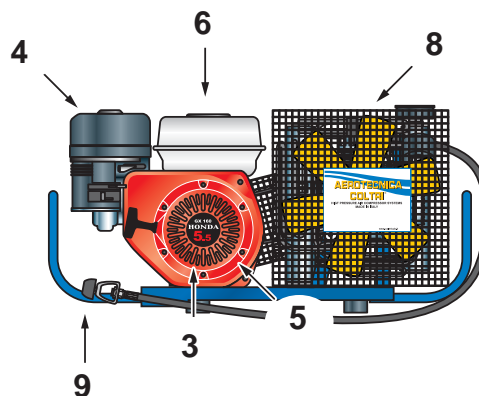

MCH-6 with electric motor

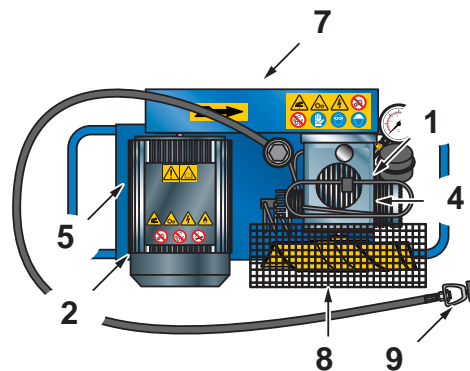

3.3 SAFETY INFO LABELS: LOCATION

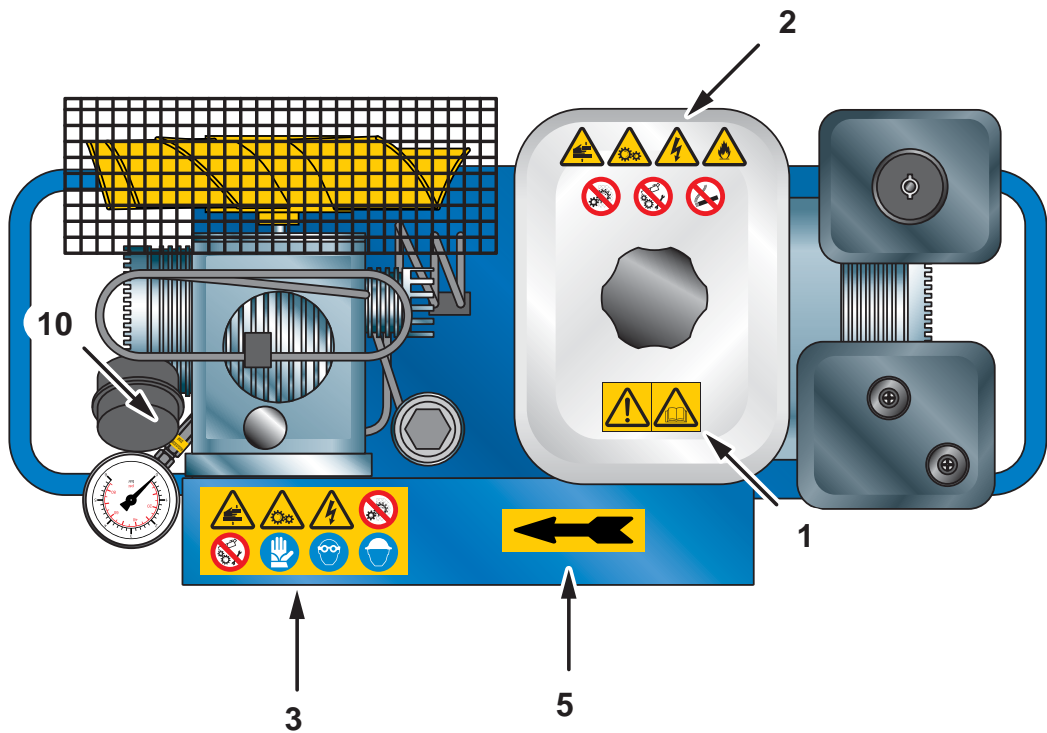
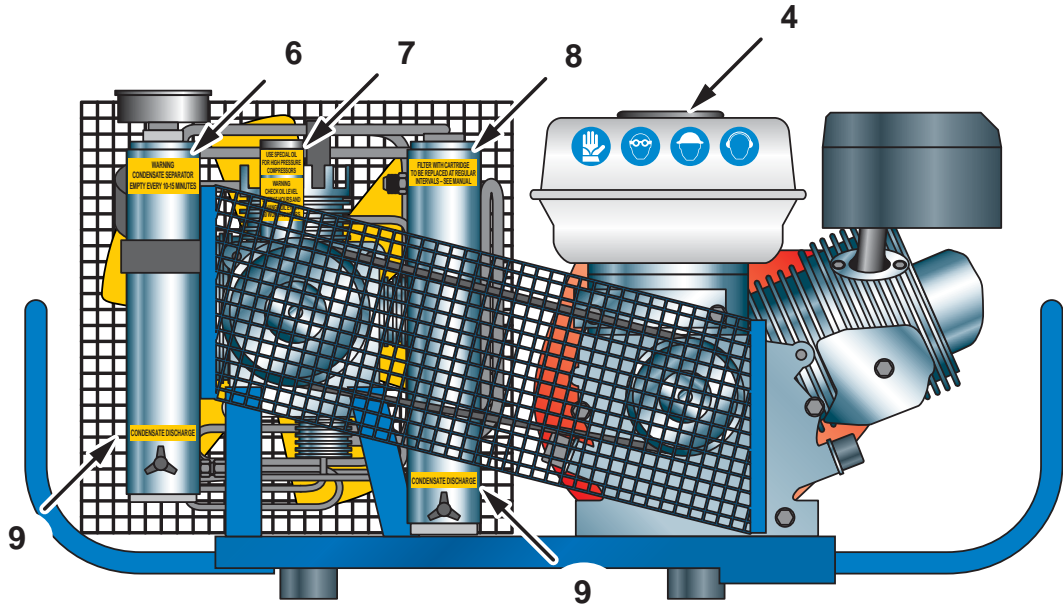

3.3.1 Safety info labels: description

1

- a Warning info plates about the dangers that derive from a lack of knowledge about the compressor and its functions and the consequent risks.
- b Read the use and maintenance manual carefully before using the compressor.

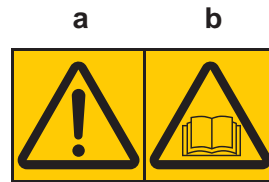

2

- a Hands at risk of being crushed in transmission belt zone
- b Moving parts in transmission belt and cooling zone fan
- c Live wires: risk of electric shock
- d Risk of fire associated with fuel or flammable liquids
- e Forbidden to remove covers/guards
- f Forbidden to lubricate mechanical parts when they are moving: compressor must be switched off before any maintenance/lubrications tasks are carried out on it.
- g Smoking forbidden near compressor owing to presence of fuels/flammable liquids.

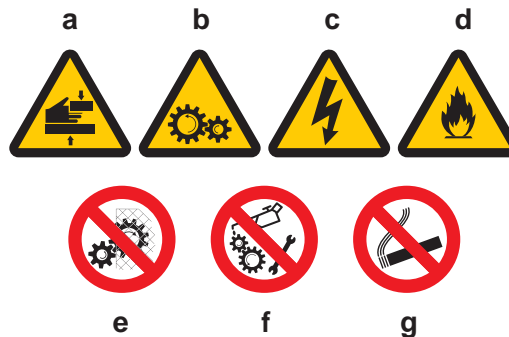

3

- a Hands at risk of being crushed in transmission belt zone
- b Moving parts in transmission belt and cooling zone fan
- c Live wires: risk of electric shock
- d Forbidden to remove covers/guards
- e Forbidden to lubricate mechanical parts when they are moving: compressor must be switched off before any maintenance/lubrications tasks are carried out on it.
- f Safety gloves must be worn.
- g Safety goggles must be worn.
- h Hard hat must be worn.



4

- a Safety gloves must be worn
- b Safety goggles must be worn
- c Hard hat must be worn
- d Ear defenders must be worn

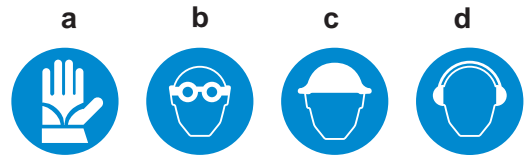

5

- a Cooling fan direction of rotation info label.
When using the machine for the first time check that the fan rotates in the direction indicated by the arrow.
If, on a three-phase electric motor compressor, the fan rotates against the direction of the arrow invert two of the three phases on the main power lead.

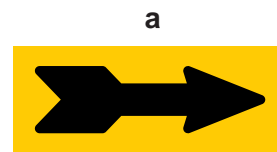

6

- a Condensate separator info label.
Indicates that the condensate must be emptied via the drain valves every 10-15 minutes.



IMPORTANT

Except for version with automatic condensate discharge.



7

- a Special oil info plate
Indicates that only special oils must be used for high pressure compressors.
To choose the right oil see section "7.6.1 Oil table".
- b Oil level check info plate
Check lubricating oil level every 5 working hours and change it every 50 working hours.
For information on how to check see "7.6.2 Checking the oil level".
For information on how to change the oil see "7.6.3 Changing the lubricating oil".

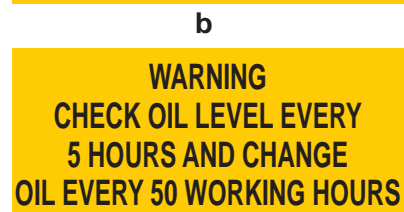

<p>a Cartridge change info label Filter with active carbon molecular sieve cartridge. To change the filter refer to “7.12.1 Filter replacement frequency calculation table” and “7.12.2 Changing the active carbon filters”.</p>	8	<p>a</p> <p>FILTER WITH CARTRIDGE TO BE REPLACED AT REGULAR INTERVALS – SEE MANUAL</p>
<p>a Condensate discharge info plate Indicates position of condensate discharge valve. To discharge the condensate see “7.10 Condensate discharge”.</p>	9	<p>a</p> <p>CONDENSATE DISCHARGE</p>
<p>a Safety valve info plate The safety valve is calibrated by the manufacturer to 225-300-330 bar. To check the safety valve refer to “7.9 Checking the safety valve”.</p>	10	<p>a</p> <p>SAFETY VALVE 225 BAR</p> <p>SAFETY VALVE 300 BAR</p> <p>SAFETY VALVE 330 BAR</p>

IMPORTANT

Should the safety valve fail to work properly contact the AEROTECNICA COLTRI technical assistance service.



3.4 GENERAL SAFETY REGULATIONS

3.4.1 Care and maintenance

Damage and accidents are often caused by maintenance errors, such as:

- no oil,
- insufficient cleaning,
- compressed air circuit inefficiency (flex hoses damaged, loose pipes, screws etc.).

Maintenance work must be carried out with due care and attention: your safety depends on it.

Never postpone repairs.

Repairs must only be carried out by specialised or authorised personnel.

Always observe the following safety regulations, even when you become completely familiar with working procedures:

- Keep the compressor and the surrounding area clean at all times.
- Before starting work check that safety devices/guards are in good working order.
- Make sure no-one is in the compressor danger zone. Interrupt work if anyone is in the danger zone and tell them to leave.
- Never leave the machine unattended when it is on.

3.4.2 Fire extinguishers and first aid

- Check that a fire extinguisher is present. Make sure all personnel know where it is.
- Periodically check that extinguishers are full and operators know how to use them.
- The location of the first aid cabinet must be known.
- Check the first aid cabinet periodically to make sure it contains disinfectant, bandages, medicines etc.
- Fire drills must be known.
- Make sure a phone number for emergency medical assistance is kept nearby.

IMPORTANT

The provision of a fire extinguisher is the responsibility of the owner of the compressor.



3.5 MAINTENANCE PRECAUTIONS

3.5.1 Warning signs

Before doing any maintenance work, stop the engine/motor and make sure the compressed air system is depressurised. If other people start the engine or act on the control pushbuttons/keys while maintenance work is in progress there is a risk of serious injury or death. To avoid these dangers always place warning signs around the compressor before carrying out maintenance.

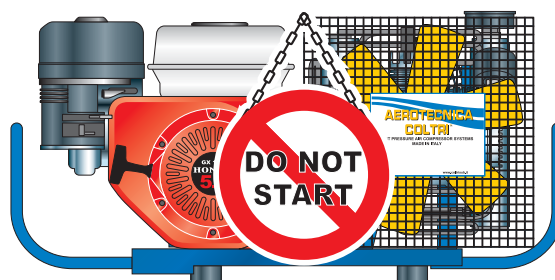

3.5.2 Tools

Use only manufacturer-recommended tools; do not use worn, damaged, poor quality or improvised tools as they can cause injury.

WARNING

The manufacturer cannot be held liable for any damage or injury caused by the use of tools that are not prescribed or modified without authorisation.



3.5.3 Personnel

The routine maintenance tasks described in this manual must only be carried out by trained, authorised personnel. For component maintenance/revision tasks not covered by this manual please contact **AEROTECNICA COLTRI**.

3.5.4 Keeping the compressor clean

Oil and grease stains, scattered tools or broken pieces constitute a danger to personnel as they may cause slips and falls. Always keep the compressor and the surrounding work area clean and tidy.

Clean the compressor with a pressurised hot water or steam jet and commercially available detergents. Do not use diesel, petrol or solvents as the former leave an oily film that causes dust to stick while solvents (even where weak) damage the paintwork and can lead to rust.

If the water jet gets inside the electrical parts it could, in addition to oxidising the contacts, prevent the machine being started or even cause a sudden, unexpected start.

For this reason never use water or steam jets on sensors or connectors.

3.5.5 Periodic replacement of essential safety parts

Periodically check the following components, which are important for fire prevention:

- compressed air system: main compressed air circuit delivery hoses;
- bottle refill system: flex hoses for bottle refill.

Even though they may appear to be in good condition, these components must be periodically replaced with new ones. Over time these components tend to deteriorate.

Should any of these parts prove to be faulty, replace or repair them ahead of schedule.

4 - TECHNICAL DATA

4.1 TECHNICAL CHARACTERISTICS

4.1.1 Crankcase, crankshaft, Cylinders, Pistons

The crankcase is made of aluminium alloy, the flanges with the ball bearings that support the crankshaft are oil-sealed against the crankcase by way of a splash guard.

The crankshaft and connecting rods rotate on roller and ball bearings only. The four connecting rods are mounted on the crankshaft with a single crank angle.

The first and second stage cylinders are made of cast iron and feature traditional multiple sealing rings. The third stage cylinder is in tempered steel with carbon-graphite sealing rings.

The fourth stage cylinder is in tempered steel with a lapping coupling, without sealing rings.

4.1.2 Valves

First stage valves are of the lamellar type; the second, third and fourth stage valves are of the diaphragm type with tempered recovery spring.

4.1.3 Safety valves

The safety valve is pre-adjusted during assembly of the compressor and prevents it being damaged in the event of a malfunction. The max pressure, as a function of the valve, as follows:

225 Bar - (3200 PSI)

300 Bar - (4300 PSI)

330 Bar - (4700 PSI)

WARNING



It is strictly forbidden to carry out any adjustments to the valve to raise its trigger pressure.

Tampering with the safety valve can cause serious damage and renders the warranty null and void.

4.1.4 Cooling pipes, lubrication

The cooling tubes are made of stainless steel.

Lubrication is by oil mist via the sunk shank of the second stage connecting rod.

4.1.5 Frame, guards

The compressor is mounted on a welded steel frame that has been painted with epoxy resins. The cooling fan and the trapezoidal transmission belt are protected by steel guards.

Stainless steel frame available on request.

4.1.6 Machine parts

Description:

- 1 Frame
- 2 Pressure gauge
- 3 Hose
- 4 Refill valve
- 5 Internal combustion engine
- 6 Compressor
- 7 Oil filler cap
- 8 Air filter
- 9 Safety mesh
- 10 Anti-vibration devices
- 11 Cooling fan
- 12 Belt
- 13 Active carbon air filter
- 14 Electric motor
- 15 Fuel tank
- 16 Internal combustion engine air filter
- 17 Internal combustion engine exhaust pipe

MCH-6 with internal combustion engine

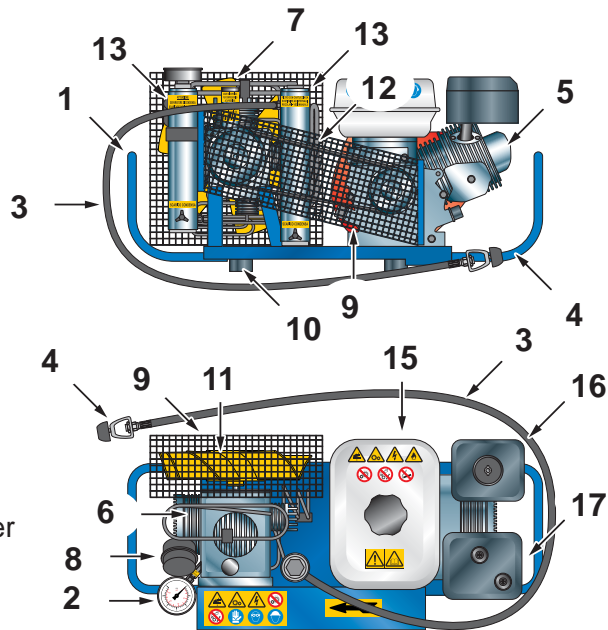

MCH-6 / COMPACT with internal combustion engine

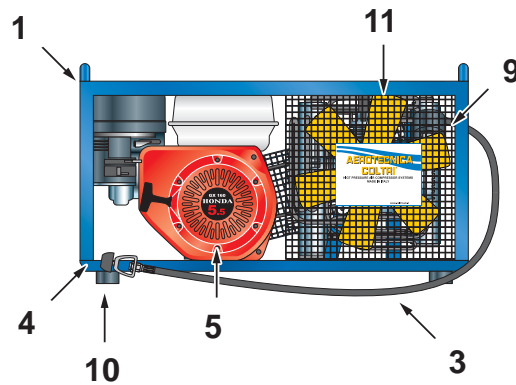

MCH-6 with electric motor

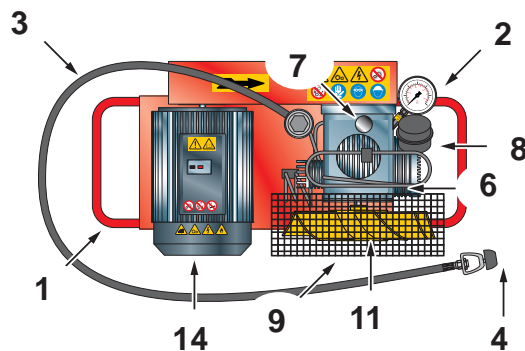

4.2 TECHNICAL CHARACTERISTICS

4.2.1 MCH-6 / SH - MCH-6 / SH COMPACT

Model: **MCH-6 / SH**

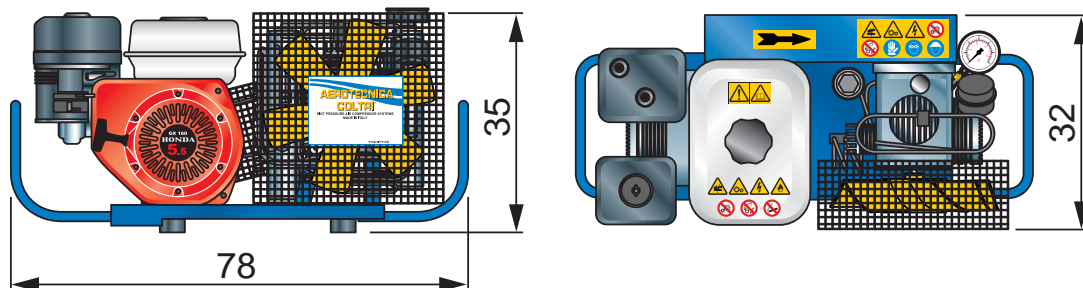

Model: **MCH-6 / SH COMPACT**

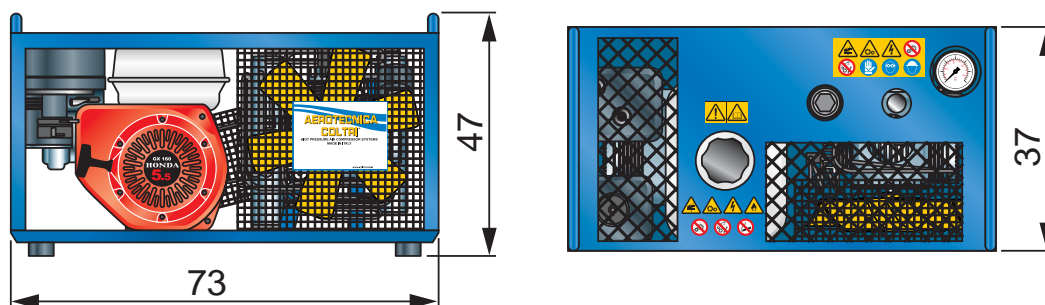

		MCH-6/SH	MCH-6/SH Compact
Engine		Honda Petrol	Honda Petrol
Engine power	(kW)	4	4
	(HP)	5,5	5,5
Engine rpm	(rpm)	3600	3600
Pumpin Unit	(rpm)	2800	2800
Pressure 1 st stage	(bar)/(PSI)	3,5 / 50	3,5 / 50
Pressure 2 nd stage	(bar)/(PSI)	13 / 190	13 / 190
Pressure 3 rd stage	(bar)/(PSI)	65 / 940	65 / 940
Working pressure	(bar)	225-300-330	225-300-330
	(PSI)	3200-4300-4700	3200-4300-4700
Delivery rate	(l/min)	100	100
	m ³ /h	6	6
	CFM	3,5	3,5
Refill time 10l	(min)	20	20
Noise level (ISO 3746)	(dB)	87	87
Dry weight	(Kg)	37	47,3
	(lb)	81,7	104
Dimensions	(mm)	780x350x320	730x470x370
	(inches)	30,7x13,7x12,5	28,7x18,5x14,5

4.2.2 MCH-6 / SR - MCH-6 / SR COMPACT

Model: **MCH-6 / SR**

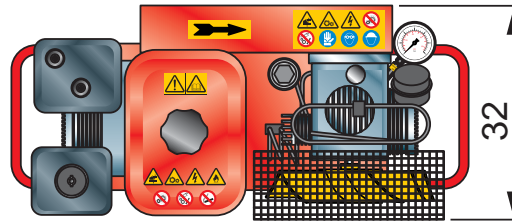
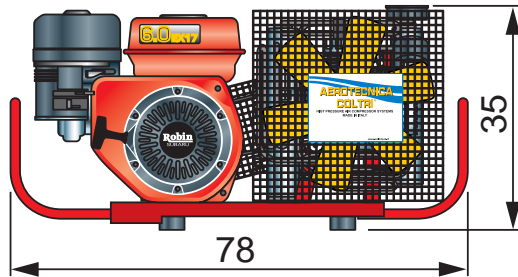

Model: **MCH-6 / SR COMPACT**

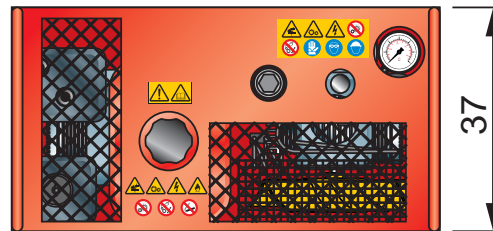
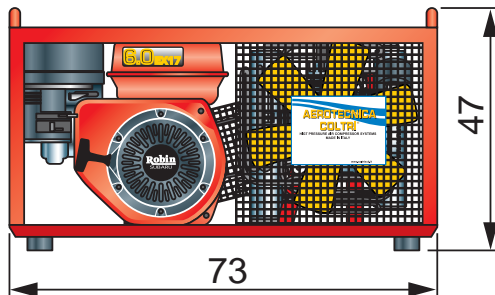

	MCH-6/SR	MCH-6/SR Compact
Engine	Robin-Subaru Petrol	Robin-Subaru Petrol
Engine power (kW)	4,4	4,4
(HP)	6	6
Engine rpm (rpm)	3600	3600
Pumpin Unit (rpm)	2800	2800
Pressure 1 st stage (bar)/(PSI)	3,5 / 50	3,5 / 50
Pressure 2 nd stage (bar)/(PSI)	13 / 190	13 / 190
Pressure 3 rd stage (bar)/(PSI)	65 / 940	65 / 940
Working pressure (bar)	225-300-330	225-300-330
(PSI)	3200-4300-4700	3200-4300-4700
Delivery rate (l/min)	100	100
(m ³ /h)	6	6
(CFM)	3,5	3,5
Refill time 10l (min)	20	20
Noise level (ISO 3746) (dB)	87	87
Dry weight (Kg)	37	54,8
(lb)	81,7	121
Dimensions (mm)	780x350x320	730x470x370
(inches)	30,7x13,7x12,5	28,7x18,5x14,5

4.2.3 MCH-6/EM - MCH-6/EM MINICOMPACT

Model: **MCH-6 / EM**

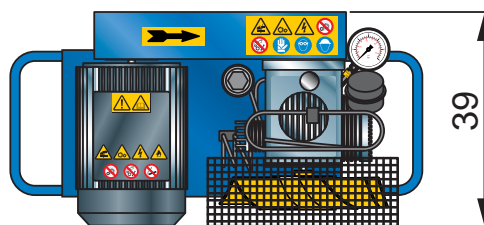
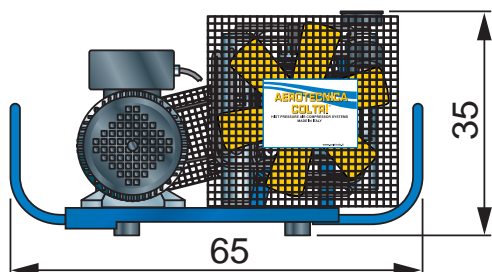

Model: **MCH-6 / EM MINICOMPACT**

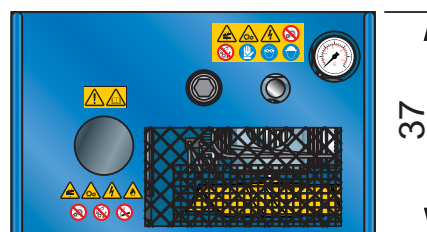
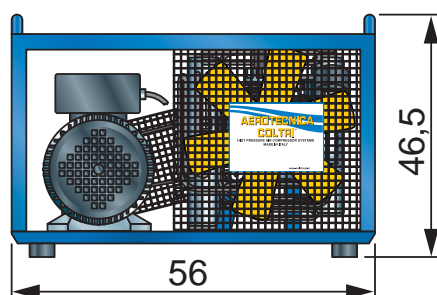

	MCH-6/EM			MCH-6/EM MiniCompact		
	Single-phase electric			Single-phase electric		
Engine						
Engine power (kW)	2,2			2,2		
(HP)	3			3		
Engine rpm (rpm)	2800	3400		2800	3400	
Voltage (V)	230	115	230	230	115	230
Frequency (Hz)	50	60	60	50	60	60
Absorption (A)	14	29	14	14	29	14
Pumpin Unit (rpm)	2250			2250		
Pressure 1 st stage (bar)/(PSI)	3,5 / 50			3,5 / 50		
Pressure 2 nd stage (bar)/(PSI)	13 / 190			13 / 190		
Pressure 3 rd stage (bar)/(PSI)	65 / 940			65 / 940		
Working pressure (bar)	225-300			225-300		
(PSI)	3200-4300			3200-4300		
Delivery rate (l/min)	80			80		
m ³ /h	4,8			4,8		
CFM	2,8			2,8		
Refill time 10l (min)	25			25		
Noise level (ISO 3746) (dB)	87			87		
Dry weight (Kg)	39,5			46		
(lb)	87			101		
Dimensions (mm)	650x350x390			560x46,5x370		
(inches)	25,5x13,7x15,3			22,5x18,3x14,5		

4.2.4 MCH-6/EM COMPACT - MCH-6/EM COMPACT(3Kw Special version)

Model: **MCH-6 / EM COMPACT**

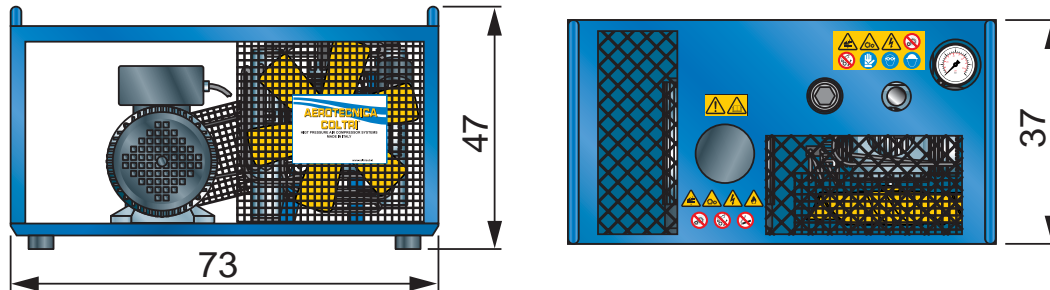

	MCH-6/EM Compact			MCH-6/EM Compact (special version 3Kw)
	Single-phase electric			Single-phase electric
Engine				
Engine power (kW)	2,2			3
(HP)	3			4
Engine rpm (rpm)	2800	3400		2800
Voltage (V)	230	115	230	230
Frequency (Hz)	50	60	60	50
Absorption (A)	14	29	14	18
Pumpin Unit (rpm)	2250			2800
Pressure 1 st stage (bar)/(PSI)	3,5 / 50			3,5 / 50
Pressure 2 nd stage (bar)/(PSI)	13 / 190			13 / 190
Pressure 3 rd stage (bar)/(PSI)	65 / 940			65 / 940
Working pressure (bar)	225-300			225-300
(PSI)	3200-4300			3200-4300
Delivery rate (l/min)	80			100
m ³ /h	4,8			6
CFM	2,8			3,5
Refill time 10l (min)	25			20
Noise level (ISO 3746) (dB)	87			87
Dry weight (Kg)	57,1			57,1
(lb)	126			126
Dimensions (mm)	730x470x370			730x470x370
(inches)	28,7x18,5x14,5			28,7x18,5x14,5

4.2.5 MCH-6/ET - MCH-6/ET COMPACT - MCH-6/ET MINICOMPACT

Model: **MCH-6 / ET**

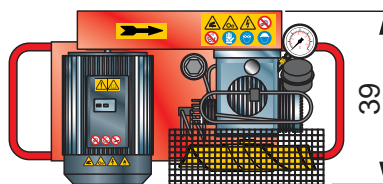
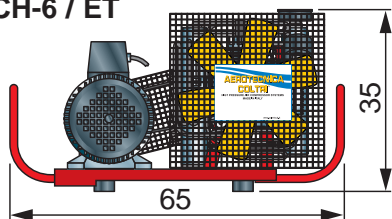

Model: **MCH-6 / ET COMPACT**

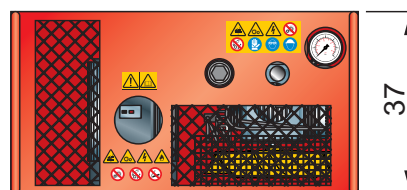
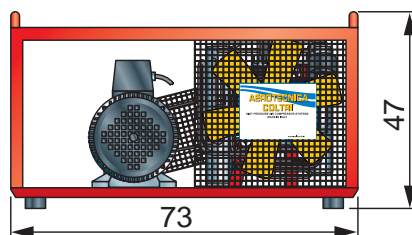

Model: **MCH-6 / ET MINICOMPACT**

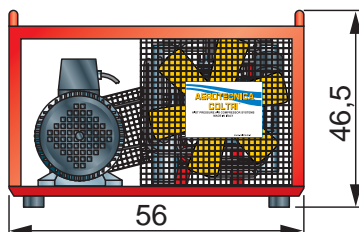

	MCH-6/ET				MCH-6/ET Compact				MCH-6/ET MiniCompact			
	three-phase electric				three-phase electric				three-phase electric			
Engine												
Engine power (kW)	3				3				3			
(HP)	4				4				4			
Engine rpm (rpm)	2800	3400	2800	3400	2800	3400	2800	3400	2800	3400	2800	3400
Voltage (V)	230	400	230	400	230	400	230	400	230	400	230	400
Frequency (Hz)	50	50	60	60	50	50	60	60	50	50	60	60
Absorption (A)	11,5	6,7	11,5	6,7	11,5	6,7	11,5	6,7	11,5	6,7	11,5	6,7
Pumpin Unit (rpm)	2800				2800				2800			
Pressure 1 st stage (bar)/(PSI)	3,5 / 50				3,5 / 50				3,5 / 50			
Pressure 2 nd stage (bar)/(PSI)	13 / 190				13 / 190				13 / 190			
Pressure 3 rd stage (bar)/(PSI)	65 / 940				65 / 940				65 / 940			
Working pressure (bar)	225-300-330				225-300-330				225-300-330			
(PSI)	3200-4300-4700				3200-4300-4700				3200-4300-4700			
Delivery rate (l/min)	100				100				100			
m ³ /h	6				6				6			
CFM	3,5				3,5				3,5			
Refill time 10l (min)	20				20				20			
Noise level (ISO 3746) (dB)	81,7				81,7				81,7			
Dry weight (Kg)	39				56,7				45,5			
(lb)	85				125				100			
Dimensions (mm)	650x350x390				730x470x370				560x465x370			
(inches)	25,5x13,7x15,3				28,7x18,5x14,5				22,5x18,3x14,5			

4.3 PRESSURE CIRCUIT

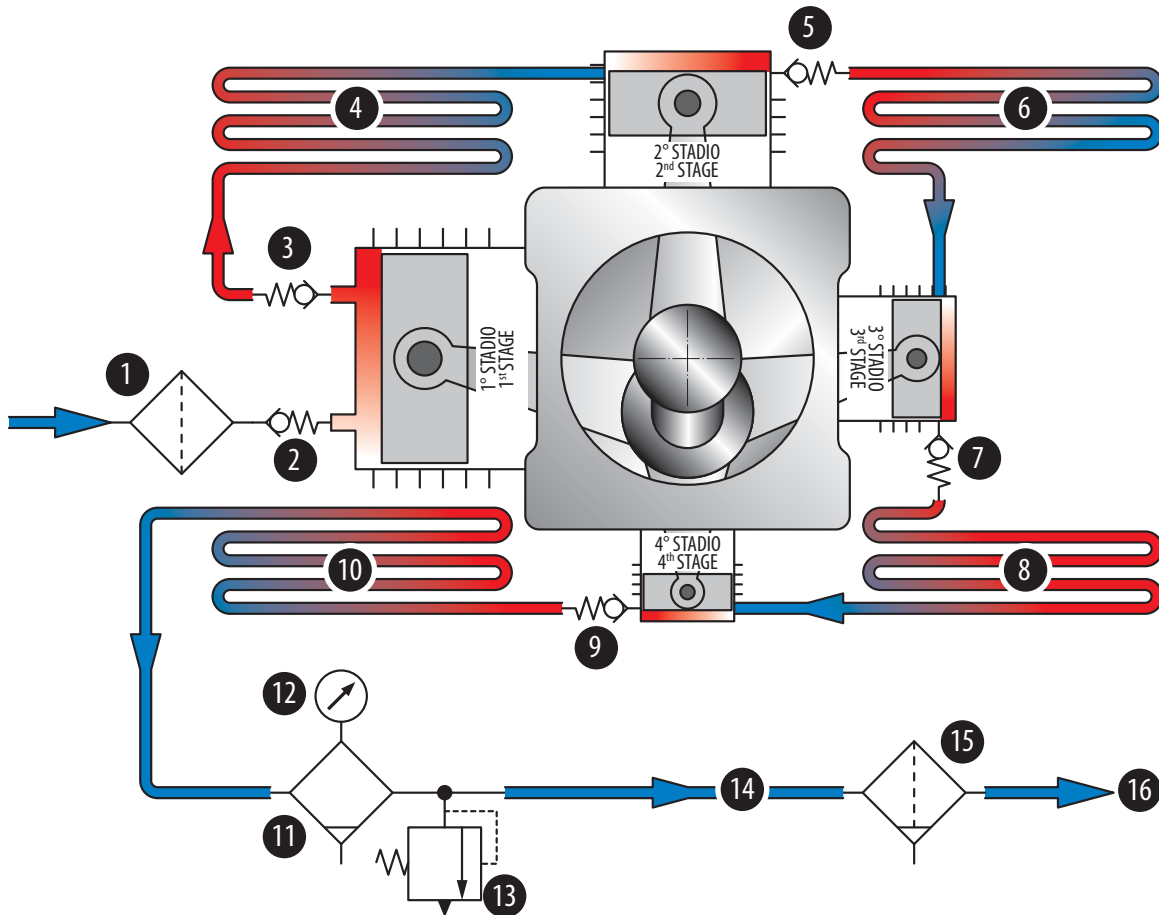

- | | |
|---|---|
| 1 Intake filter | 9 Outlet valve 4 th stage |
| 2 Intake valve 1 st stage | 10 Final cooling pipe |
| 3 Outlet valve 1 st stage | 11 Condensate separator |
| 4 Cooling pipe 1 st -2 nd stage | 12 Pressure gauge |
| 5 Outlet valve 2 nd stage | 13 Safety valve |
| 6 Cooling pipe 2 nd -3 rd stage | 14 Cooling pipe separator/ filter |
| 7 Outlet valve 3 rd stage | 15 Active carbon air filter/molecular sieve |
| 8 Cooling pipe 3 rd -4 th stage | 16 Flex hose |

5 - HANDLING AND INSTALLATION

5.1 UNPACKING

The MCH-6 compressor is sent fully assembled, packed in a cardboard box to simplify handling and transport.

The box containing the compressor must be moved according to the instructions shown on the box itself.

The machine is supplied with the following as standard:

- use and maintenance manual
- engine use and maintenance manual
- lubricating oil (5 litres).

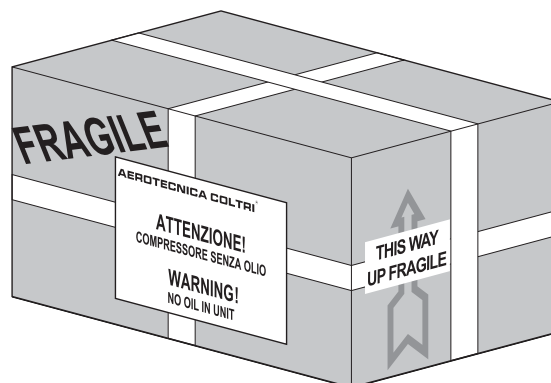

5.2 HANDLING

After separating the compressor from its packaging it can be transported to the designated placement area.

Transfer will require the use of a fork-lift or transpallet (of suitable load-bearing capacity). To lift the compressor use the carry handles (a).

If the compressor is to be lifted manually make sure the task is done by two workers, once again using the carry handles (a).

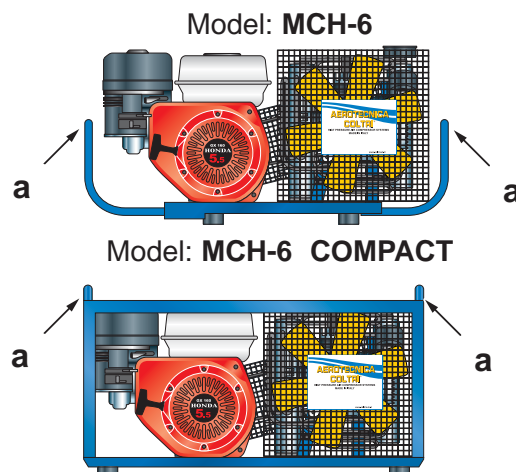

IMPORTANT

Proceeding with the utmost care when lifting, transferring and positioning the compressor.



WARNING

Manual lifting of the compressor requires at least two workers and in any case no individual worker should lift more than 30 Kg.



5.3 INSTALLATION

WARNING

Before proceeding with the installation tasks described below, read Chapter 3 "SAFETY REGULATIONS" carefully.



5.3.1 Positioning

- Position the compressor in the designated area and check it is level. For compressor dimensions please consult section 4.2 “Technical characteristics”.
- Check that the area in which the compressor is to be positioned is adequately ventilated: good air exchange (more than one window), no dust and no risk of explosion, corrosion or fire.
- If ambient temperatures exceed 45°C air conditioning will be necessary.
- Position the compressor no closer than 1 m to surrounding walls; the gap between compressor and ceiling should be at least 1.5 m. These distances ensure proper compressor operation and proper cooling of the pumping unit.
- Make sure that lighting in the area is sufficient to identify every detail (such as the writing on the info labels); use artificial lighting where daylight is on its own insufficient.

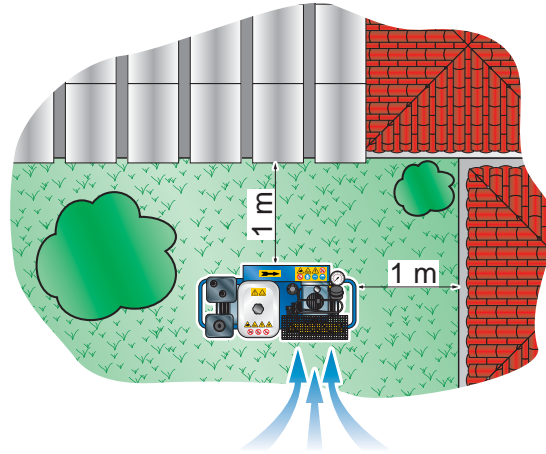
**WARNING**

Compressors of the MCH-6 series with internal combustion engines must only be installed outdoors.



5.3.2 Air intake extension connection

If the compressor is installed in an area without the necessary ventilation requisites described in section 5.3.1 "Positioning", it will be necessary to install an air intake extension leading in from outdoors or a place with the cited ventilation requisites.

- The extension, supplied as an optional, must be connected to the intake connector.
- Remove the intake filter (a)
- Attach the fitting (b)
- Connect the extension pipe (c) to the fitting (b).
- Fit the intake filter (a) on the other end of the extension pipe.
- Position the end of the extension with the air intake filter in a properly ventilated area sheltered from weather and exhaust fumes.
- Point the air intake against the wind.
- Check that there are no kinks or breaks along the pipe. If it is damaged replace it.

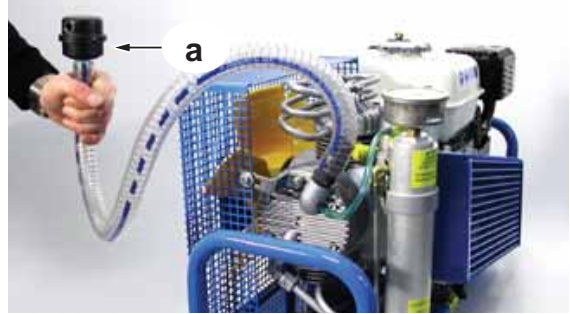

WARNING



Use only a flexible pipe with internal steel braiding reinforcement so as to prevent kinks and a consequent reduction of cross-section.

5.3.3 Electrical connection (MCH-6/EM and MCH-6/ET only)

The compressor is delivered together with power lead.

To connect up to the power supply just insert the plug in the mains power socket.

Check that the data on the compressor ID plate is compatible with mains power supply, especially as regards rated current and voltage.

The mains power system must have an efficient ground (earth); check that the earth resistance value complies with the protection / operational requirements of the compressor electrical system.

WARNING



Before inserting the plug, check that the electrical system complies with the standards in force in the country of installation. A proper earth (ground) system is an essential safety requisite. An efficient compressor ground (earth) system is an essential compressor safety requisite.

DANGER



Check that the characteristics of the mains power are compatible with those of the compressor.

6 - USING THE COMPRESSOR

6.1 PRELIMINARY CHECKS BEFORE USING FOR THE FIRST TIME

The operator must check that the compressor is supplied with:

- use and maintenance manual;
- use and maintenance manual of internal combustion engine (where applicable);

If the compressor is sold on the customer/user must provide the purchaser with a complete, undamaged use and maintenance manual.

6.1.1 Filling with lubricating oil

At the time of delivery the compressor does not contain lubricating oil; this is supplied together with the compressor in cans contained in the packaging.
For filling instructions see section "7.6.3 Changing the lubricating oil".

6.1.2 Checking for proper electrical connection

Check for proper connection of electrical phases by checking that the cooling fan rotates in the direction indicated on the label (a) on the fan cover.

If the direction of rotation is not as indicated by the arrow it will be necessary to disconnect the electrical power supply and invert two of the three phases on the main power lead.

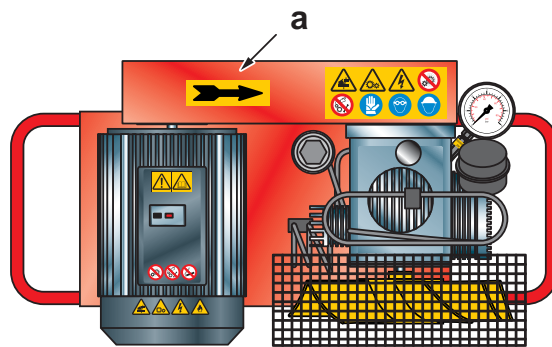

DANGER



Before carrying out this task disconnect the compressor from the mains power supply.

Do not invert or disconnect the ground (earth) wire (yellow/green).

The MCH6 is designed for filling SCUBA or SCBA tanks one at a time. The compressor was not engineered or manufactured for continuous duty filling of storage tanks or cascade storage systems of any kind.

6.2 CHECKS TO BE RUN AT THE START OF EACH WORKING DAY

Inspect the exterior of the compressor (couplings, pipes, pneumatic components etc.) and check for any oil leaks.

6.2.1 Lubricating oil level check

Check the lubricating oil level by removing the cap (a) and seeing if the level is within acceptable limits (i.e. between min. and max.). Replace the cap (a).

Note that an excessive quantity of oil can cause infiltrations in the cylinders and leave deposits on the valves while too low a level prevents proper lubrication and could cause engine seizure.

If the oil level is not within the minimum and maximum limits top up or drain as described in section “7.6.3 Changing the lubricating oil”.

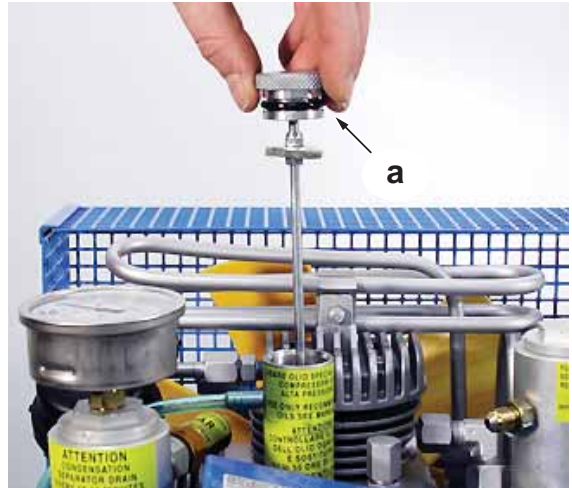

6.2.2 Checking that the refill flex hoses are in good condition

Inspect the refill hoses and make sure there are no cuts, holes, abrasions, leaks etc. If necessary replace with new hoses.

6.2.3 Fuel level check

To check the fuel level unscrew the cap (a), check that there is fuel and re-close the cap (a).

If a top-up is necessary refer to “7.7 Checking fuel level and topping up”.

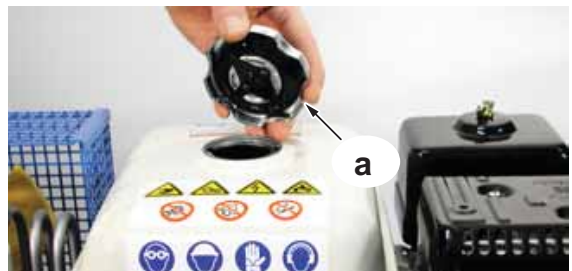

DANGER



When topping up the fuel level make sure you do not spill any fuel as this could cause a fire. If fuel is spilt it must be wiped up immediately.

The fuel is flammable: therefore, never use naked flames when refuelling and do not use materials that can generate sparks. Use protective gloves when topping up the fuel level.

Always make sure the fire extinguisher is at hand when topping up the fuel level.

6.2.4 Storing technical documentation

The use and maintenance manual and its appendices must be stored carefully and must always be kept where they can be accessed easily for immediate consultation.

WARNING



The use and maintenance manual is an integral part of the compressor and must always be handed over in the event of a change of ownership.

6.3 PRELIMINARY TASKS

6.3.1 Safety valve checks

Check that safety valve is working properly by starting the compressor with the end valve closed: this will raise circuit pressure fast and trip the valves when their pressure setting is reached.

The safety valve is pre-adjusted to 225 bar (3200 PSI), or 300 bar (4300 PSI) or 330 bar (4700 PSI).

Check that the bottles to be refilled are in good condition: they must have been tested by the relevant authorities (stamped and/or certified). Run a visual check on the exterior.

Check that the refill hose and relevant fitting are in good condition.

After being refilled do not empty the bottles completely, not even during winter storage or long periods of inactivity: this will stop humidity getting in.

IMPORTANT



Tampering with the safety valve to increase the pressure setting is strictly forbidden. Tampering with the safety valve can seriously damage the compressor, cause serious injury to personnel and renders the warranty null and void.

DANGER



Should bottles show evident signs of internal/external corrosion, do not refill them even if they have been tested.

WARNING



Use only tested bottles (as proven by a test stamp and/or certificate). The working and bottle refill pressures are shown on the bottles themselves. It is forbidden to refill them at a pressure greater than that indicated.

IMPORTANT



Should the safety valve fail to work properly contact the AEROTECNICA COLTRI assistance service.

6.4 STARTING AND SHUTTING DOWN

6.4.1 Starting and shutting down with internal combustion engine

IMPORTANT

These tasks must be carried out by qualified personnel who have been trained to use the compressor.



Before starting the compressor read the attached engine use and maintenance manual carefully.

Before starting the engine open the condensate discharge points to prevent a "strained" start.

- shift the fuel lever (a) to ON.
- if the engine is cold shift the air lever (b) to the closed position.
- if the engine is hot the choke (b) must be in the open position.
- shift the accelerator lever (c) about a 1/3 of the way from its minimum position.
- turn the shutdown switch to the ON position.
- gently pull the starter handle (d) until the cord is taut then tug it sharply.
- re-accompany the handle gently back to its original position to prevent damage to the start mechanism.
- repeat the procedure if necessary.
- if the air lever was in the closed position at the start gradually shift it to the open position as the engine warms up.

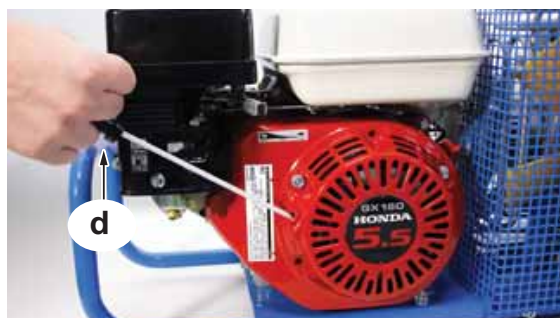
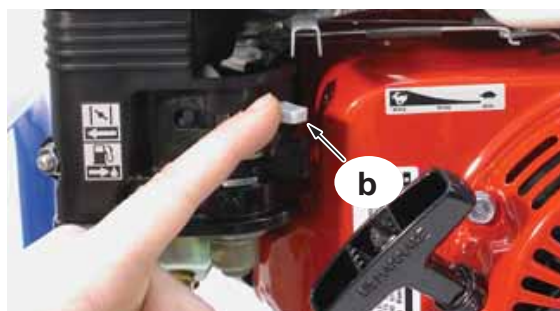

- to stop the engine in the event of an emergency turn the shutdown switch (e) to the OFF position.
- to stop the engine under routine working conditions shift the accelerator lever to MIN.
- turn the shutdown switch (e) to the OFF position.
- shift the fuel valve lever (a) to OFF.

**WARNING**

Carbon monoxide is a toxic gas: Breathing it can cause loss of consciousness and death. Avoid areas or actions that will expose people to carbon monoxide.

6.4.2 Starting and shutting down with electric motor

IMPORTANT

These tasks must be carried out by qualified personnel who have been trained to use the compressor.



Before starting the engine open the condensate discharge points to prevent a “strained” start.

- check the voltage and that there is a proper earth contact.
- connect the compressor up to the mains power supply.
- press the start pushbutton (a), ON position.
- close the condensate discharge points.

To switch the motor off again press the start pushbutton (b), OFF position (red pushbutton).

Model: MCH-6/EM

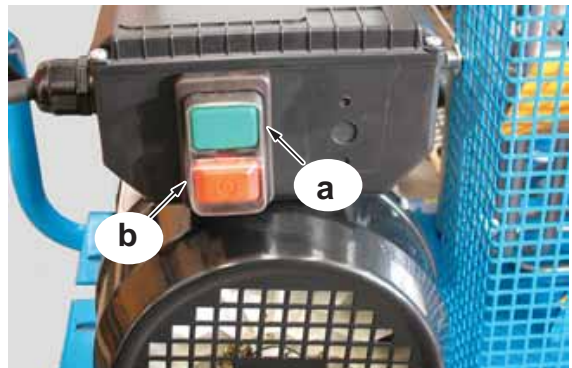

Model: MCH-6/ET

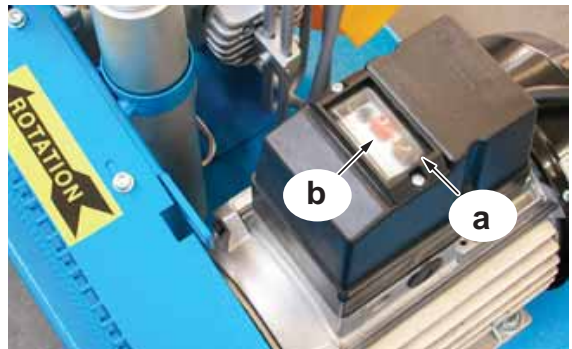

IMPORTANT

For models with three-phase electric motor check that the direction of rotation of the electric motor is as indicated by the arrow on the cover (if it is not refer to “6.1.2 Checking for proper electrical connection”).



6.4.3 Automatic shutdown with pressure switch

The compressor can be equipped with a pressure switch (a) so that it shuts down automatically when it reaches the pressure set by the manufacturer.

When the set pressure is reached the compressor stops.

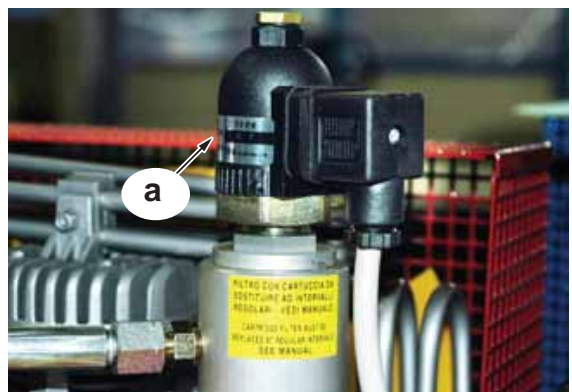

6.5 TANK REFILL

IMPORTANT



During refill the operator must be in the work area (see “4.1.7 Noise level”).

It is advisable, during the bottle refill phase, to submerge the bottles in cold water so as to reduce the pressure drop.

WARNING



During bottle refill those not involved in the refill procedure must maintain a safety distance of at least 3 metres. Also, it is forbidden to disconnect the hoses from the fittings or the fill valve while the machine is under pressure.

The available bottle refill connectors are:

<p>DIN 230 Cod.: 6-05-024 optional(*)DIN/INT REDUCER Cod.: RE100350</p>		1 - STANDARD
<p>INT / YOKE Cod.: 6-05-025</p>		
<p>DIN 300 Cod.: 6-05-024/300</p>		
<p>ITALIAN CONNECTOR FOR FIRE MAN SCBA Cod.: 06-05-023</p>		
<p>BC DIN 230 Cod.: SC000470 optional(*)DIN/INT REDUCER Cod.: RE100350</p>		2 - ON REQUEST
<p>BC DIN 300 USA Cod.: SC000460/SP</p>		
<p>BC DIN 300 Cod.: SC000460</p>		
<p>BC ITALIAN CONNECTOR FOR FIRE MAN SCBA Cod.: SC000475</p>		
<p>BC INT Cod.: SC000450</p>		

To refill bottles with standard connectors (1):

- Fit the hose connector (g) to the bottle valve (b).
- Screw in the fixing knob (h) until it is completely tightened.
- Start the compressor.
- Open the valve (e) by rotating it anticlockwise.
- When the refill has been completed shut the compressor down.
- Close the valve (e) by rotating it clockwise.
- Open the condensate drain valves (i) (see "7.10 Condensate discharge") until all the residual air in the compressor has been expelled.
- Unscrew the fixing knob (h) by rotating it anticlockwise.
- Disconnect the bottle coupling.

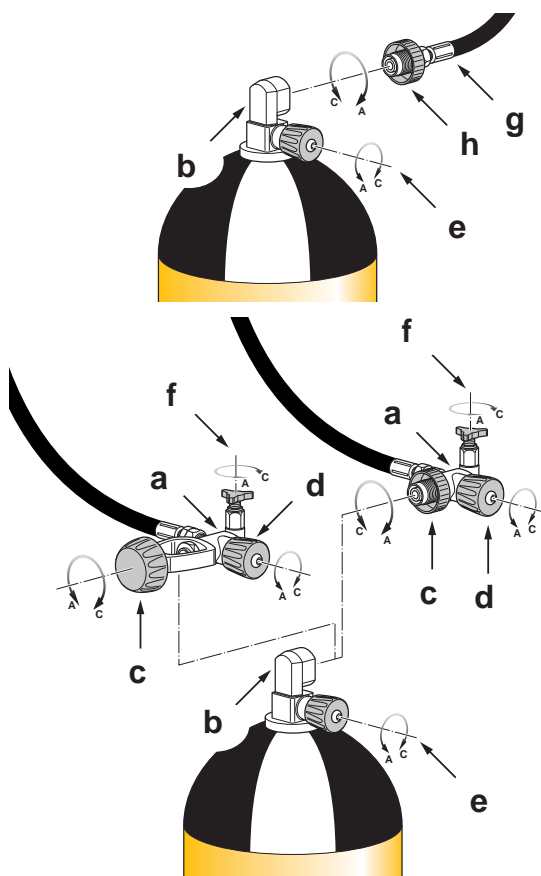
**To refill bottles with BC connectors (2):**

- Fit the hose connector (a) to the bottle valve (b).
- Screw in the fixing knob (c) until it is completely tightened.
- Check that the bleed valve (f) is closed by rotating it clockwise.
- Open the valve (d) by rotating it anticlockwise.
- Start the compressor.
- Open the valve (e) by rotating it anticlockwise.
- When the refill has been completed shut the compressor down.
- Close valves (d) and (e) by rotating them clockwise.
- Open the bleed valve (f) by rotating it anticlockwise until all the residual air in the fitting has been expelled.
- Unscrew the fixing knob (c) by rotating it anticlockwise.
- Disconnect the bottle coupling.

**WARNING**

Use only tested bottles (as proven by a test stamp and/or certificate). The working and bottle refill pressures are shown on the bottles themselves. It is forbidden to refill them at a pressure greater than that indicated.

IMPORTANT

If an emergency situation arises during refill, press the stop pushbutton (see "6.4 Starting and shutting down"). The compressor is nevertheless equipped with a safety system that shuts it down automatically when:

- The pressure setting on the pressure switch has been reached.
- The electrical power supply is temporarily cut.
- The electric motor overload device is tripped.

Following an emergency shutdown always make sure the cause of the emergency has been eliminated before proceeding with another refill.

7 - MAINTENANCE

WARNING

Maintenance tasks must only be carried out by the AEROTECNICA COLTRI Customer Assistance Service or qualified personnel.

DANGER

All maintenance tasks must be carried out with the compressor off and the power lead unplugged from the mains socket.

7.1 FOREWORD

To obtain the best possible performance from the compressor and ensure a long working life for all its parts it is essential that personnel follow the use and maintenance instructions with extreme diligence.

It is thus advisable to read the information below and consult the manual every time an inconvenience arises.

For further information please contact our assistance centre:

Contact the AEROTECNICA COLTRI SpA Maintenance Service Centre

Tel. +39 030 99 10 297

Fax. +39 030 99 10 283

e-mail: coltrisub@coltrisub.it

7.2 GENERAL REGULATIONS

- Proper preservation of the compressor requires thorough cleaning.
- This type of refill station, designed and built according to the most advanced technological criteria, requires only minimum preventive and routine maintenance.
- Before carrying out any maintenance tasks, run checks and/or controls on the compressor, switch off the compressor, remove the plug from the mains socket.
- The residual pressure present in the compressor (pumping circuit) must be released.
- During disassembly and re-assembly of the compressor, always use suitable wrenches/tools so as not to damage the relevant components.
- Loosen stiff parts with a copper or plastic mallet.
- When refitting parts make sure they are clean and lubricated sufficiently.
- Compressor maintenance tasks must only be carried out by authorised personnel and recorded in the chapter "12 Maintenance register" of this manual.

7.3 UNSCHEDULED WORK

Involves repair and/or replacement of the mechanical parts of one or more compressor components: this work normally needs doing only after some years of use. If substantial modifications are made, the manufacturer cannot be held liable for any dangers that might arise.

This work must be carried out by the assistance centre.

7.4 SCHEDULED MAINTENANCE TABLE

Maintenance	Every refill	Every 5hours	Every 25hours	Every 30hours	Every 50hours	Every 100hours	Every year	Every 300hours
Lubricating oil level check		○			●		●	
Belt wear and tension				○				●
Air intake filter			○			●	●	
Fitting/hose leak check			○					
Safety valve check	○							
Refill hose check	○							●

○ Checking and cleaning

● Change

7.5 TROUBLESHOOTING

Problem	Cause	Solution
- The electric motor does not start	• Phase missing	• Check fuses or condenser
- Rotation speed and flow rate decrease	• Motor power too low • The belt slips	• Check the motor and the line • Restore proper belt tension
- The flow rate diminishes without rpm decreasing	• Valves not working • 4th stage piston worn • Fittings loose / leaking seals • Intake filter clogged • Intake extension kinked • Piston or piston rings worn	• Contact technical assistance • Contact technical assistance • Check for leaks with soapy water and eliminate them • Replace filter • Straighten, use stiffer pipe • Contact technical assistance
- Air smells of oil	• Cartridge filter exhausted • Piston rings worn	• Replace • Contact technical assistance
- Compressor overheats	• Direction of rotation wrong • Cooling tubes dirty • Incomplete valve closure (causing overload of another stage)	• Correct direction of rotation • Contact technical assistance • Contact technical assistance

7.6 CHECKING AND CHANGING THE LUBRICATING OIL

After putting the compressor into service the lubricating oil must be changed after the first 5 (five) working hours.

The lubricating oil must be changed every 50 hours working hours or annually.

IMPORTANT

The compressor must be placed on a solid surface with a tilt of no more than 5°.



DANGER



Do not carry out these tasks if the compressor has only just shut down; wait for the compressor to cool.

Any oil spilt during the oil/filter change could cause personnel to slip; wear protective garments and anti-slip footwear and remove any traces of oil immediately.

Both oil and filter are classified as special wastes and must therefore be disposed of in compliance with the anti-pollution laws in force.

All maintenance work must be carried out with the compressor OFF and the power supply lead unplugged from the mains socket.

7.6.1 Oil table

Sump capacity	litres / Quart	0,3
Recommended oils		COLTRI OIL CE750

7.6.2 Checking the oil level

The oil level must be checked every 5 working hours of the compressor.

The oil level must be between the minimum and the maximum shown on the dipstick (a).

If the oil level is above the maximum level:

- position a recipient under the drain valve (b) so that the oil flows into the exhausted oil recipient;
- open the drain valve (b) and let the oil flow out until the oil level returns within the max. and min. limits shown on the dipstick (a);
- close the drain valve (b).

If the oil level is below the minimum level:

- top up with oil until the level returns within the max. and min. limits on the dipstick (a);
- close the top-up plug (c) by exerting a slight pressure on it.

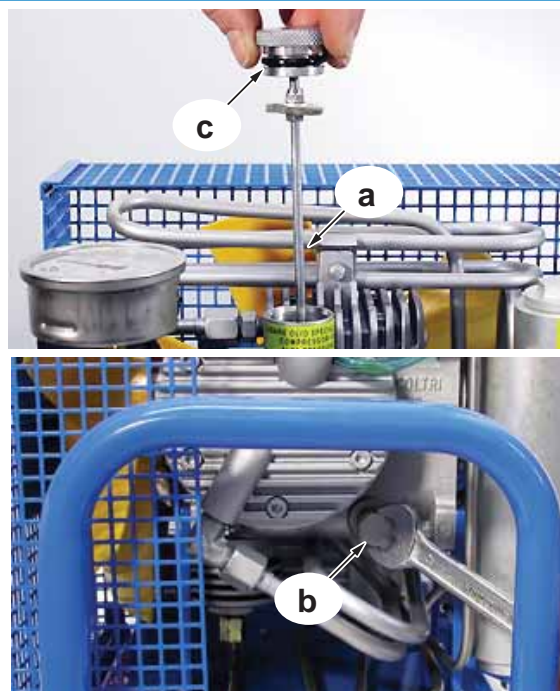

7.6.3 Changing the lubricating oil

The lubricating oil must be changed after the first 5 working hours (running in) then every 50 working hours or annually. Every time the lubricating oil is changed the oil filter must be changed too.

To change the oil proceed as described:

- position a recipient under the drain plug (b) so that the oil flows into the exhausted oil recipient (recipient capacity of at least 1 litre required).
- remove the push-lock plug (c).
- open the plug (b) and let all the oil flow out.
- close the drain plug (b).
- open the air vent (d).
- fill the oil sump with 0.3 litres of oil from top oil plug (see "7.6.1 Oil table").
- close the air vent (d).
- close the oil top-up plug (c).
- switch on the compressor and run it depressur area for 30 seconds.
- switch off the compressor and wait 5 minutes.
- check the oil level (a); if it is not between the min. and max. limits on the dipstick (a) proceed with the tasks described in paragraph "7.6.2 Checking the oil level".

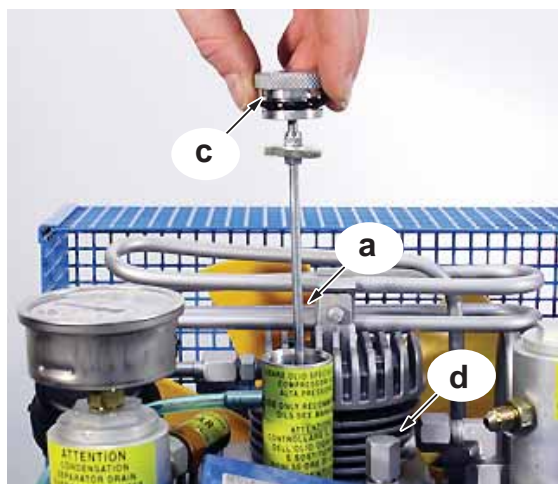

7.7 CHECKING FUEL LEVEL AND TOPPING UP

IMPORTANT

Before carrying out any work on the engine consult the attached engine use and maintenance manual.



The fuel level must be checked at the start of every working day.

To check the fuel level:

- unscrew the cap (a);
- check that there is fuel inside the tank (b).
- re-tighten the cap (a).

To top up the fuel level:

- unscrew the cap (a);
- top up with fuel: do not fill to the brim of the tank (b) but leave a space for expansion.
- re-tighten the cap (a).

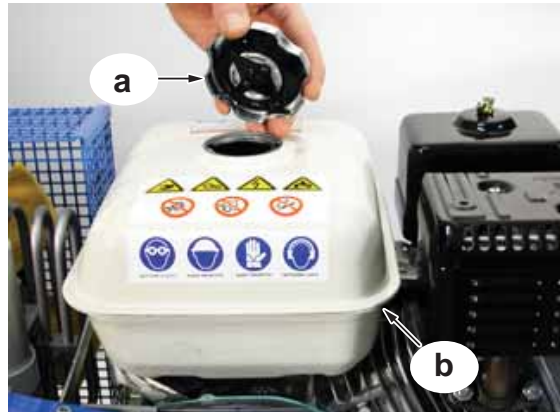

DANGER



When topping up the fuel level make sure you do not spill any fuel as this could cause a fire. If fuel is spilt it must be wiped up immediately.

The fuel is flammable: therefore, never use naked flames when refuelling and do not use materials that can generate sparks.

Use protective gloves when topping up the fuel level.

Always make sure the fire extinguisher is at hand when topping up the fuel level.

7.8 CHANGING THE INTAKE FILTER

After putting the compressor into service the intake filter must be changed after the first 50 working hours. The air filter must then be changed every 100 working hours or annually.



DANGER



Do not carry out these tasks if the compressor has only just shut down; wait for the compressor to cool. All maintenance work must be carried out with the compressor OFF and the power supply lead unplugged from the mains socket.

The air intake filter must be changed every 100 working hours or annually.

To change the filter proceed as follows:

- turn the air filter cover (a) by rotating it clockwise;
- remove the air filter cartridge (b);
- replace the cartridge with a new one;
- re-close the cover (a): screw it back on anti-clockwise.



IMPORTANT



If the compressor is used in a dusty environment the filter change interval should be reduced to every 50 hours.

7.9 CHECKING THE SAFETY VALVE

The final safety valve protects bottles from being filled with air at too high a pressure; the valve setting is made at the time of testing the compressor.

The safety valve must be tested every time bottles are refilled.

After attaching the coupling to the bottle start the compressor with the bottle valves closed. Once you have checked, using the gauge, that the safety valve trips properly at maximum working pressure, open the valves and start the refill.

IMPORTANT

Should the safety valve fail to operate properly contact the AEROTECNICA COLTRI technical assistance service.



7.10 CONDENSATE DISCHARGE

Condensation accumulates in the condensate separator; the condensate must be discharged every 10-15 minutes of compressor use.

To discharge the condensate open the drain valves (a) and (b) in sequence and collect the condensate in an appropriate recipient.

Close the valves.

For compressors with automatic condensate discharge the condensate must be collected at the discharge point (c) in appropriate recipients.

Every **250 hours** it is necessary to replace the **SINTERED FILTER** inside the solenoid valve fitting (d).

Condensate must be disposed of according to the instructions shown in section "9.1 Waste disposal".

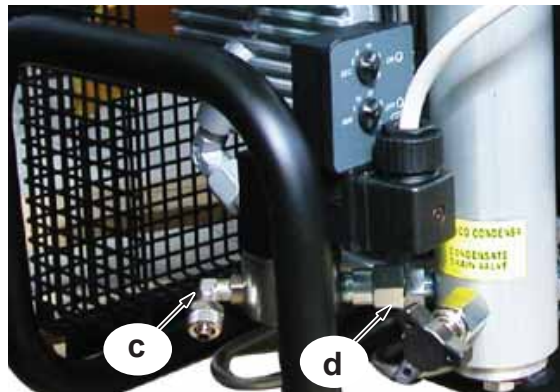
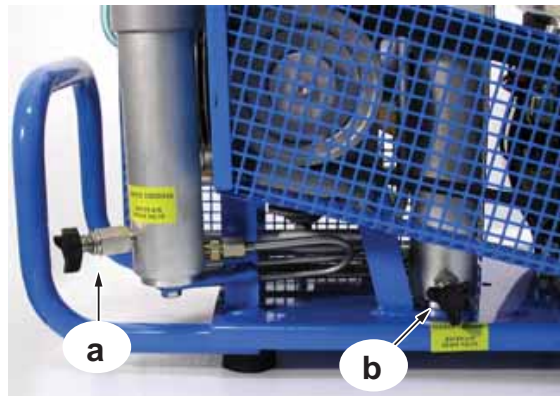

DANGER

Do not carry out these tasks if the compressor has only just shut down; wait for the compressor to cool.



7.11 TRANSMISSION BELT

Belt tension must be checked monthly.

The transmission belts must be replaced every 500 working hours of the compressor.

DANGER



Do not carry out these tasks if the compressor has only just shut down; wait for the compressor to cool.

All maintenance work must be carried out with the compressor OFF and the power supply lead unplugged from the mains socket.

7.11.1 Checking transmission belt tension / changing belts

The transmission belt must be replaced annually or every 500 working hours of the compressor.

To check belt tension remove the cover (a) by removing the fixing screws (b) and exert a pressure of approximately 10 Kg on the belt (c); check that the belt does not flex by more than 1 cm with respect to its original position.

Should it flex more than this:

- loosen the engine fixing screws (d).
- loosen the cooling fan cover fixing screw (e).
- if the belt is worn or close to its scheduled time for replacement change it with a new one (f).
- remove the belt (c).
- withdraw the engine by about 5 mm.
- fix the screws (d).
- tighten the cooling fan cover fixing screw (e).
- re-fit the belt (c).
- re-check belt tension.
- re-fit the cover (a).

If the tension of the new belt still fails to comply with the necessary requisites contact **AEROTECNICA COLTRI** assistance service.

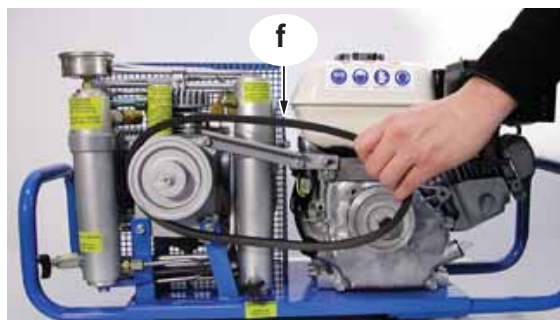
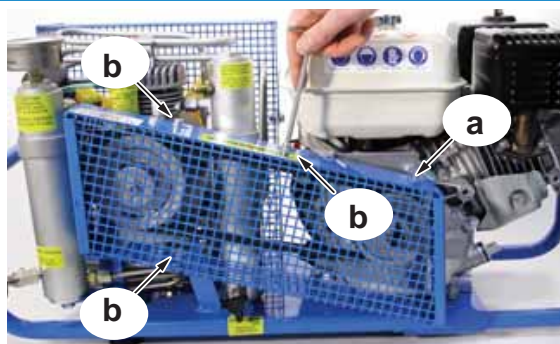
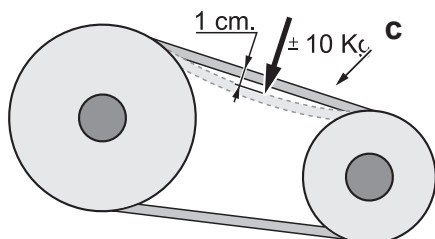

7.12 ACTIVE CARBON FILTER / MOLECULAR SIEVE

The active carbon filter must be replaced at intervals calculated on the basis of the characteristics of the environment in which the compressor is located. To calculate these intervals refer to the table below.

The filter must nevertheless be replaced before the air becomes malodorous.

IMPORTANT



If the compressor is used in an environment where CO (exhaust fumes) may be present it is compulsory to use CO-fixing filters; these can be supplied on request.

IMPORTANT



For compressors used in the USA and CANADA the use of LAWRENCE FACTOR filtration cartridges is recommended.

DANGER



Do not carry out these tasks if the compressor has only just shut down; wait for the compressor to cool.
All maintenance work must be carried out with the compressor OFF and the power supply lead unplugged from the mains socket. Depressurise the entire compressor circuit before carrying out any maintenance tasks.

7.12.1 Filter replacement frequency calculation table

Temp. (°C)	Temp. (°F)	Correction factor	Filter duration (hours)	N° bottles by 15l Recharge 0-200bar	
				80 l/min	100 l/min
50	122	0,2	(35x0,2)=7	11	14
40	104	0,34	(35x0,34)=12	19	24
30	86	0,57	(35x0,57)=20	32	40
20	68	1	35	56	70
10	50	1,20	(35x1,20)=42	67	84
5	41	1,40	(35x1,40)=49	78	98
0	32	1,60	(35x1,60)=56	90	112

7.12.2 Changing the active carbon filters / molecular sieve

To change the active carbon filters (b) proceed as follows:

- vent all the compressed air inside the circuit.
- unscrew the filter cap (a).
- remove the active carbon filter cartridge (b) and replace it with a new one.
- change the O-ring (c) on the cap (a) every time the filter is changed.
- close the filter cap (a).

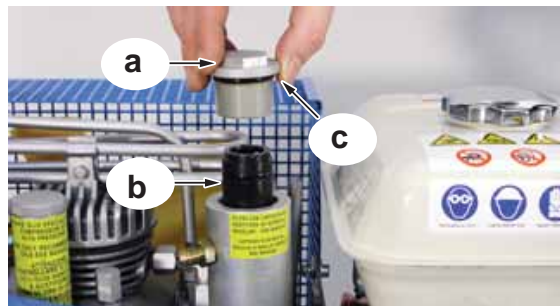

WARNING



The active carbon filters are classified as special waste: they must be disposed of in compliance with the anti-pollution standards in force.

7.13 CHANGING THE FLEX HOSES

IMPORTANT



The hoses must be changed periodically (every 3 years yearly or ever 300 hours) or when they show signs of abrasion/wear/damage. The bending radius of the hoses must not be less than 250 mm.

DANGER



Do not carry out these tasks if the compressor has only just shut down; wait for the compressor to cool.

All maintenance work must be carried out with the compressor OFF and the power supply lead unplugged from the mains socket. Vent the air from the compressor before carrying out any maintenance tasks.

Tank refill pressure is very high; therefore, before refilling the tanks check that the hoses are perfectly connected and in good condition. Check also that the valves on any unused hoses are closed properly so as to prevent the dangers that derive from hose whiplash.

When the tanks are being refilled unauthorised personnel must remain at a distance of at least 3 metres.

It is strictly forbidden to disconnect the hoses from the fittings or refill valve when the machine is under pressure.

To change the bottle refill hose proceed as follows:

- disconnect the bottle refill hoses by unscrewing the fitting (a) at its extremity (17 mm wrench).
- replace the old hose with a new one.
- screw the hose onto the connector (a).
- use a dynamometric wrench to tighten the hoses on the compressor with a torque of 15 Nm.



8 - STORAGE

Should the compressor not be used, it must be stored in a dry sheltered area at an ambient temperature of between 0 °C and 40 °C.

Store the compressor away from sources of heat, flames or explosive.

8.1 STOPPING THE MACHINE FOR A BRIEF PERIOD

If you do not intend to use the compressor for a brief period proceed with general cleaning.

8.2 STOPPING THE MACHINE FOR A LONG PERIOD

If you do not intend to use the compressor for a long period, extract the active carbon filter cartridge.

Run the compressor for a few minutes without actually filling bottles so as to flush out all the residual condensate. Stop the compressor, disassemble the intake filter, restart the compressor and spray a few drops of oil into the air intake hole so that a light film of lubricant is aspirated and penetrates the interior of the compressor. Stop the compressor and refit the air intake filter. Clean the external parts: eliminate any moisture, salt or oil deposits. Protect the compressor from dust and water by storing it in a clean, dry place.

Switch off the machine via the main switch and remove the plug from the mains power socket.

Proceed with a thorough general clean of all machine parts.

During machine downtimes it is advisable to run the compressor for 20 minutes every 15 days.

9 - DISMANTLING AND PUTTING OUT OF SERVICE

Should you decide not to use the compressor or any of its parts any longer you must proceed with its dismantling and putting out of service.

These tasks must be carried out in compliance with the standards in force.

WARNING

Should the compressor, or a part of it, be out of service its parts must be rendered harmless so they do not cause any danger.



WARNING

Bear in mind that oil, filters or any other compressor part subject to differentiated waste collection must be disposed of in compliance with the standards in force.



9.1 WASTE DISPOSAL

Use of the compressor generates waste that is classified as special. Bear in mind that residues from industrial, agricultural, crafts, commercial and service activities not classified by quality or quantity as urban waste must be treated as special waste.

Deteriorated or obsolete machines are also classified as special waste.

Special attention must be paid to active carbon filters as they cannot be included in urban waste observe the waste disposal laws in force where the compressor is used.

Bear in mind that it is compulsory to record loading/unloading of exhausted oils, special wastes and toxic-harmful wastes that derive from heavy/light industry processes.

Exhausted oils, special wastes and toxic-harmful waste must be collected by authorised companies.

It is especially important that exhausted oils be disposed of in compliance with the laws in the country of use.

9.2 DISMANTLING THE COMPRESSOR

IMPORTANT

Disassembly and demolition must only be carried out by qualified personnel.



Dismantle the compressor in accordance with all the precautions imposed by the laws in force in the country of use. Before demolishing request an inspection by the relevant authorities and relative report.

Disconnect the compressor from the electrical system.

Eliminate any interfaces the compressor may have with other machines, making sure that interfaces between remaining machines are unaffected.

Empty the tank containing the lubricating oil and store in compliance with the laws in force.

Proceed with disassembly of the individual compressor components and group them together according to the materials they are made of: the compressor mainly consists of steel, stainless steel, cast iron, aluminium and plastic parts.

Then scrap the machine in compliance with the laws in force in the country of use.

IMPORTANT

At every stage of demolition observe the safety regulations contained in this manual carefully.



10 - INSTRUCTIONS FOR EMERGENCY SITUATIONS

10.1 FIRE

In the event of fire use a CO₂ extinguisher in compliance with the relevant standards in force.

Contact the fire brigade.

11 - SAFETY STANDARDS

11.1 FOREWORD

WARNING



The purpose of the manual supplied with the machine is to provide the operators with information concerning the use and maintenance of the machine within the health and safety limits as laid down by the regulations in force. The manual does not intend to instruct the staff on the working methods, but to explain the principles on which the machine is based.

Art. 1 The use of the machine is limited to qualified staff who have specific knowledge of the product to be made.

Art. 2 Any points not specified concerning the machine operation and maintenance should be understood to refer to "specialized operations" and as such can only be carried out by a technician from **AEROTECNICA COLTRI**.

Art. 3 Additional manuals are enclosed concerning devices or optionals supplied by other companies.

Art. 4 The manuals should be kept in a dry place and protected against atmospheric agents that could damage the contents.

Art. 5 The manual must be kept until the machine is finally dismantled. If the machine should change ownership, the manual must be passed on to the new owner.

Art. 6 If the manual supplied should be lost or damaged, a request for a copy should be sent to the manufacturer stating the machine identification details given on the machine registration plate.

Art. 7 Before starting any work on the machine, every operator must be perfectly aware of the machine operation and its controls. Furthermore, the operator must have read and understood all the technical information contained in this manual and in the manual enclosed concerning the internal-combustion engine (if available).

Art. 8 All the precautions listed in the instruction manual must be adopted.

Art. 9 The safety information is of particular importance, as well as the general information given in this booklet and in the instruction manual.

Art. 10 The instructions, the accident prevention regulations and the warnings contained in this booklet and in the instruction manual must always be complied with.

ONLY FOR COMPRESSORS WITH PETROL ENGINES

Art. 11 For petrol-fuelled machines, the instruction booklet enclosed supplied by the engine manufacturer, should be followed with the greatest of care.

11.1.1 Definitions

Here below is a list of the most important definitions that appear in this booklet and in the operating and maintenance manual.

DANGER ZONES

Any zone inside and/or near the machine in which the presence of an exposed person represents a risk for the health and safety of that person.



EXPOSED PERSON

Any person either completely or partially in a danger zone.



OPERATOR

The person or people in charge of the operation, the maintenance, the cleaning, the repairing and the transport of a machine.



QUALIFIED STAFF

The term Qualified Staff refers to members of staff who are familiar with the methods of installation, assembly, repair and operation of the machine and who have a specific technical qualification.

For example:

1. A technical background that authorizes them to operate in accordance with the safety standards concerning the dangers represented by the presence of electricity, circuits under pressure, etc.
2. A technical background or a specific training concerning the safe use and maintenance of the machine.
3. A training in basic first aid measures.



Manufacturer

The machine manufacturer, whose name, trademark, address and CE mark is stated on the machine, is identified as:

AEROTECNICA COLTRI SpA

Registered office:

Via Rio Ponale, 7 - 25010 Rivoltella di Desenzano D/Garda - BRESCIA - ITALY

Factory:

Via Colli Storici, 177 - 25010 San Martino della Battaglia - BRESCIA - ITALY

Tel. 030 9910297 - 9910301

Fax 030 9910283

e-mail: coltrisub@coltrisub.it

Internet: <http://www.coltrisub.it>

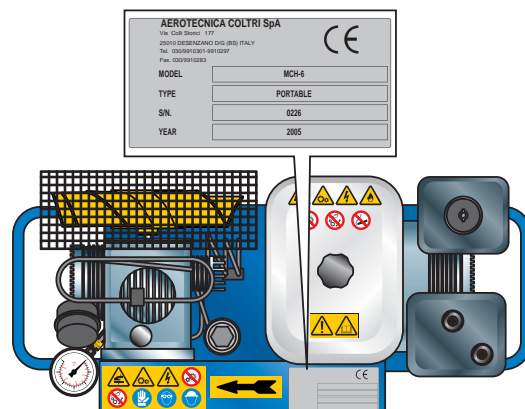
**Machine**

In this specific case, the compressor complete with hoses and respective attachments.

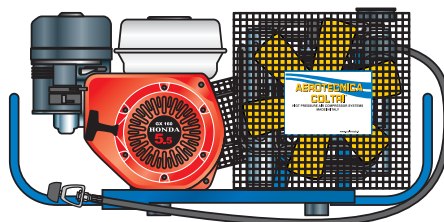
**Buyer**

The legitimate owner of the machine (customer).

**Residue Risks**

This term refers to all those dangers that could not be eliminated during the machine design phase as suitable countermeasures would have compromised the machine operation.

Potential danger dont manifest.



Danger

The heading is used in the instruction manual when failure to comply with the regulations or tampering with the parts may cause serious injury to people (permanent disablement or even death).

**Caution**

The heading is used in the instruction manual when failure to comply with the instructions may cause slight injury to people, damage to the machine or other parts connected with it or to the surrounding area.

**Foreign Bodies**

Reference is made to all those objects, tools, materials, etc. present on site and which have nothing to do with the operation described.

**Acoustic Pressure Level**

This indicates the noise level emitted by the machine during operation and measured at the operator's station.

**Hose**

This is the technical term used to identify the flexible high pressure pipe connected to the cylinder.



11.2 GENERAL STANDARDS

The recommendations given below are based mainly on the observance of some regulations general.

AEROTECNICA COLTRI invites the operators and all the exposed staff to put the regulations listed below into practice.

Art. 12

The machine must be used and undergo the maintenance procedures as described in the operating and maintenance manual and according to the instructions given as each circumstance arises.



Art. 13

The staff who has to work on the machine must receive suitable instruction in the form of training courses.



Art. 14

The electrical connection of the machine must always be provided with an earthing in order.



Art. 15

It is strictly forbidden to place combustible material near the machine.

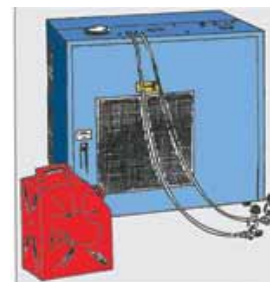

Art. 16

It is strictly forbidden to intervene on any part of the machine unless it has come to a complete standstill.

The operations must only be carried out when the mains power supply switch has been turned off, the power supply to the machine has been cut off and all the residue pressures have been discharged.

Only then may the mechanics and workers carry out maintenance and repair work.

Art. 17

The position that the operator must keep during the machining phase is shown in the operating and maintenance manual.

**Art. 18**

The machine must not be started up when:

- the electric cable is damaged;
- the machine has been dropped and shows signs of damage;
- the protective guards are missing.

Art. 19

The electric plug must be taken out of the socket:

- in the event of problems during operation;
- before every cleaning or maintenance operation;
- after use.

Art. 20

Never remove the plug by pulling the cable. Make sure that the cable is not bent and that it does not run past sharp corners.

Extension leads should not be used.

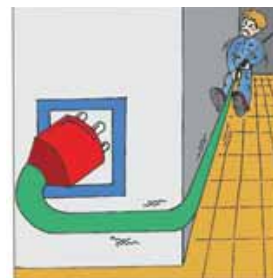
**Art. 21**

Do not deactivate the safety devices or ignore the signals, alarms or warnings whether they are given automatically or by means of signs fitted on the machine.

Art. 22

Do not operate the machine without the safety guards.

**Art. 23**

Any waste from the machining work, left over grease or scraps must be disposed of according to specific national regulations through authorized disposal companies.

Oil and grease must not be discharged into drainpipes or drainholes.

**Art. 24**

Do not place hands or put screwdrivers, keys or other tools on the moving parts.

11.2.1 Accident prevention

Art. 25

It must be strictly prohibited for the operator or an outside person to get close to the machine when it is moving; it is especially forbidden to clean, oil and grease the parts and elements by hand or carry out any adjustment, maintenance or repair work on them.

The purchaser is responsible for reminding workers of this regulation by means of clearly visible notices.

**Art. 26**

Every so often check the condition of the rating plates and replace them if necessary.

Art. 27

The machines may only be started-up under the supervision of a person in charge selected by the purchaser.

Before start-up, this person in charge must ensure that there are no workers near the machines and that all the safety devices for the moving parts have been switched on. It is also this person's duty to check that all the alarm devices are in perfect working order.

Art. 28

Access to the operating areas and the crossing of the same must be strictly forbidden to any unauthorized person.

The customer is responsible for reminding the workers of this regulation with suitable means and carefully placed notices in order to surround the potentially dangerous areas.

**Art. 29**

Any breakdowns or problems that may arise during operation may only be looked into if the operators are not put under any danger.

**Art. 30**

Any staff authorized to approach the machines when in operation, must wear suitable clothing to protect the body.

**Art. 31**

Before carrying out any maintenance operation, the machine must be cut off from the power supply. In order to avoid any danger that may arise due to the machine being switched on accidentally which could injure the operator and damage the machine, place a warning sign on the mains power supply switch saying, **"WARNING: SWITCH TURNED OFF DUE TO MAINTENANCE WORK IN PROGRESS"**.

Art. 32

The machine's earthing system must be checked periodically and at least once every two years to ensure that it is in good working order.

Art. 33

Before connecting the electric motors to the power supply, check that the mains voltage corresponds to that for which the machine has been designed.



Art. 34

Before operating the machine, the appointed staff in charge must undergo a medical to certify their suitability for such work.

**Art. 35**

Any workers or maintenance staff prone to fainting must not work on the machine.

**Art. 36**

The refill hose must be in good condition especially in the area of the pipe fittings.

Art. 37

The plastic sheath covering the pipe must not show signs of abrasion otherwise, if dampness penetrates the pipe it could corrode the steel plait and reduce its level of resistance.

11.2.2 Personal Protection Equipment (PPE)

The employer must provide all the operators with detailed information concerning the risk of injury and especially the risks deriving from the noise and about the protective clothing provided and of the general accident prevention regulations laid down by the laws or by the international or national regulations in force in the country where the machine is to be used.

All operators must comply with the international accident prevention laws and those of the country where the machine is to be used in order to avoid possible accidents.

It is important to remember that the European Community has issued some directives concerning the safety and health of workers and amongst these, the following should be borne in mind 89/391/CEE, 89/686/CEE, 89/654/CEE, 89/655/CEE, 89/656/CEE, 86/188/CEE, 92/58/CEE and 77/576/CEE. The employer is required to comply with these directives and to make sure they are followed by his workers.

Art. 38

During the machine operation and maintenance, it is essential to use special accident prevention clothing.



Art. 39

If an environmental analysis of the work area should show an emission of dust above that provided for by local regulations, a suitable mask must be worn to protect the respiratory tracts.

**Art. 40**

The operators, maintenance staff and any members of staff likely to operate and/or pass near by the machine, must be careful of the risks of catching clothes and/or long hair in the moving parts. Long hair should be kept under a cap.

It is prohibited to wear chains, bracelets and rings that may be dangerous.

**Art. 41**

The area in which the operator works must not only be kept clear of any foreign objects, but a non-slip treatment must be given to the floor too (at the customer's expense). Alternatively, it is possible to use non-slip flooring.

**Art. 42**

Workers must always wear rubber-soled, steel-toed work shoes.

**Art. 43**

In those cases where the level of acoustic pressure (noise) emitted by the machine is higher than the minimum permitted safety level (see operating manual) it is essential to use ear defenders or earplugs.



11.3 REGULATIONS FOR LIFTING AND HANDLING THE MACHINE

Art. 44

To lift the machines, use hoists of a capacity suitable for the weight of the machine.

Art. 45

Before lifting each load, check that the sections of the slinging are larger than the minimum permitted limit. Check that the ropes are in perfect condition and that they are correctly secured.

Art. 46

Do not use protruding parts as attachment points.

Art. 47

Do not use the projecting parts as attachment points.

**Art. 48**

Make sure there are no people or foreign bodies within the operating radius of the machine.

Art. 49

When the machine is moved, care should be taken not to exceed the permitted inclines or speeds. Do not bang the load.

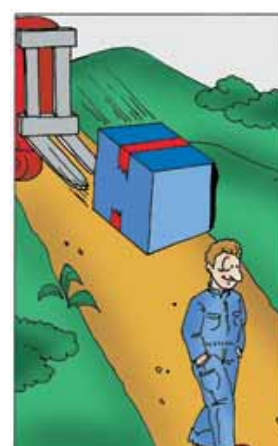

Art. 50

Do not rest any other material on top of the machines or the packing.

Art. 51

Particular care must be taken when anchoring the load on the means of transport so that the slings do not crush or bend the edges of the unit and do not scratch the machine paintwork.

Fit wooden wedges or protective corner pieces on the corners. Special care must be taken to ensure that the loads and their parts are in a horizontal position.

**Art. 52**

Crates and packs supplied with the machine may be lifted by hand if they weigh less than approx. 30 Kg.



11.4 DELIVERY REGULATIONS

Art. 53

When the machine is delivered, check that there are no damaged or missing parts.

If this is not the case, contact the forwarding agent or the manufacturer.

**Art. 54**

Check that the goods supplied correspond with the order specifications.



Art. 55

Check that the machine components and the packing were not damaged during transportation.

**Art. 56**

The buyer will not have to repair any damaged packing.

Art. 57

When the machine is delivered, the operator must read the operating manual very carefully and adhere to the information given, paying particular attention to the Chapter "SAFETY REGULATIONS".



11.5 STORAGE

Art. 58

If the machines are not installed straightaway for immediate use, they should be stored in a covered area that is preferably dry and clean, away from sources of heat and vibration that could compromise the delicate parts or the instrumentation.

Art. 59

The packed material may normally be stored in a closed environment for up to three years as long as the temperature does not drop below 10°C or exceed 50°C and the level of humidity is not greater than 70%. (For other limits, the packing must be purpose-made).

The filtering cartridge must be replaced after this period.

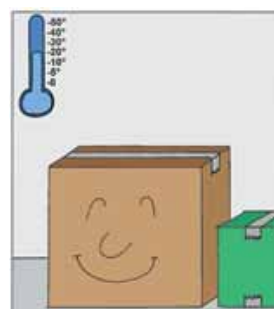
**Art. 60**

To unpack the machine, remove the top lid or open the upper edges.

Art. 61

Having removed the packaging, the machines and their components must be moved using suitable means and equipment appropriate for this purpose.

Art. 62

Do not empty the cylinders or the filters completely even during winter storage. This will prevent damp air from getting inside.

11.6 REGULATIONS FOR USE

As far as accident prevention is concerned, apart from the general provisions of the law in force with which all the workers should be familiar and which should be abided by, the operators and the maintenance staff must also follow all the instructions set out below and mentioned as each circumstance arises in the chapters and relative paragraphs of the manuals supplied.

Art. 63

The staff, who as a result of their activity or the environment in which they work are at risk from injuries to their sight, their hearing or to their limbs, must use protective goggles (transparent or dark lenses), ear defenders, thick gloves, safety shoes and helmet.



Art. 64

Operatore must avoid carrying out unsafe procedures in uncomfortable positions in which their sense of balance may be compromised.

Art. 65

It is prohibited to climb on the machine.



Art. 66

The work place must be suitably lit for the operations to be carried out. Insufficient or excessive lighting may be hazardous.

Art. 67

The safety devices and other means of protection must not be removed or altered without having obtained prior authorization.

If the safety devices have to be removed, the workshop foreman and the head of the safety office (if there is one) must be informed so that suitable measures are taken in order to highlight and reduce the risk of any danger that may result.

The safety guard and safety devices must be put back in place as soon as the reasons for which their temporary removal was necessary have been resolved.

Art. 68

If any digging has to be done or if the passages near the machines have to be blocked, suitable means of protection and notices must be provided.

Art. 69

No worker must enter or remain within the areas marked or enclosed. If work has to be carried out in this area, specific agreements must be made with the staff responsible for the machinery.

**Art. 70**

If the power supply to particular machines and/or plants has to be switched off in order to carry out repair work, check that the person responsible actually switches the power supply off.

Check that there is an interlock to stop other people from starting up the unit in question.

A warning must be given of the operation in progress by means of suitable notices.

Furthermore, the regulations and the notices put up inside the factory must be followed.

Art. 71

Workers should not carry out operations on their own initiative or which are not of their competence and that may jeopardize their own safety and that of others.

Art. 72

It is strictly forbidden to block the passageways in the vicinity of the machines with materials of any kind. In the case of absolute necessity, ask for authorization from the workshop foreman and provide suitable warning of the obstacle.

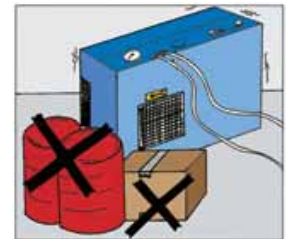
**Art. 73**

It is forbidden to clean, oil or grease the components and parts of the machine when they are moving. If such an operation should be necessary, it must be carried out using suitable equipment and with the utmost care.

**Art. 74**

It is prohibited to carry out any repair or adjustment operation on moving parts.

The operations must be carried out with the machine turned off. Consequently, the main power supply switch must be turned off and blocked in this position to ensure that the machine remains still.

Fix a notice to the switch bearing the message, "WORK IN PROGRESS".



Art. 75

Personal clothing which may present a hazard to personal safety because of the type of work carried out, must not be worn in the work place.

Therefore, clothes worn at work must not be loose-fitting or of the type that may be caught up in parts of the machine.

Always use the means of protection and the clothes as prescribed.

**Art. 76**

Once the machine has been cleaned, the operator must check that there are no worn, damaged or loose parts. If such parts should be found, ask for the maintenance technician to intervene.

11.6.1 Residual risks**a)**

Dangers of an electrical nature. Use the machine with suitable electrical safety devices, especially in the presence of water or humidity.

ONLY FOR COMPRESSORS WITH PETROL OR DIESEL ENGINES**b)**

Risk of polluting the air produced because the exhaust fumes or lubricating oil vapours may mix with the compressed air produced.

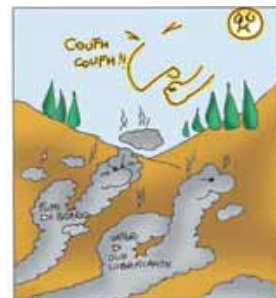
**c)**

Dangers deriving from the use of an internal-combustion engine. The enclosed operating and maintenance manual concerning the engine should be followed very carefully.

d)

Danger of burning in the area near the exhaust pipe and around the compressor.

Use the machine with suitable protection guards and wait about 30 minutes after turning the engine off before carrying out any maintenance work.



11.6.2 Purpose of the compressor

Art. 77

The compressor has been designed to obtain the highest quality breathable air which is taken from the surrounding environment, the harmful fumes are eliminated by means of a special suction filter and after the filtering cycle, the air is fed into cylinders suitable for containing high pressure air.

Art. 78

When refilling the cylinders, it is compulsory for people not involved with the work to maintain a distance of at least three metres.

Art. 79

Only use duly inspected and tested cylinders and do not exceed the operating pressure shown on the same.



Art. 80

When filling the cylinders, it is advisable to immerse them in cold water in order to reduce the reduction in pressure when the cylinders cool down.

Particular care must be given during these operations to the residue hazards described in the Operating Manual.

Art. 81

Do not remove the hose from the attachments or from the clamp when it is under pressure.



Art. 82

At each use, check the operation of the overpressure valve by starting up the compressor with the end valves turned off so that the pressure rises quickly in the circuit and the valve comes into operation at the set pressure.

Art. 83

For compressors that do not have an automatic discharge of the condensate, it is advisable every 15/20 minutes during normal operation of the compressor, to drain off the condensate produced by turning on the condensate discharge valve on the separator.

The discharge of vapourized water emulsified with lubricating oil should be considered normal during refilling and the quantity of such water depends on the percentage of humidity present in the air. Before and after every refill, drain off any residue condensate leaving the compressor to run idle for a few seconds with the drain valve turned on.

Art. 84

Make sure that the minimum radius of curvature of the hose is not less than 250 mm.

Art. 85

Particular care must be given to the soundness of the flexible pipes and the other parts subject to wear. Furthermore, care must be taken that there is no leakage of oil or other harmful substances.

If such situations should arise, it is forbidden for the operator to start the machine up again until the problems have been solved.

Art. 86

If the operator or person in charge of maintenance should find a fault on the machine (for example after a refill), before going away, they must place a sign on the machine to show that maintenance operations are in progress and that it must not be started up.

**Art. 87**

It is forbidden to use the machine under conditions or for purposes other than those described in the manual and **AEROTECNICA COLTRI** cannot be held responsible for any faults, problems or damage caused by a failure to comply with these indications.

11.6.3 Limitations of use

Art. 88

Take in air that is neither foul nor polluted. Use the machine in environments where there is no dust or risk of explosion, corrosion or fire.

Art. 89

Some components have characteristics that are of importance for personal safety: therefore, only original spare parts must be used.

Art. 90

It is forbidden to use petrol, diesel or electrically operated compressors on board boats.

ONLY FOR COMPRESSORS WITH PETROL OR DIESEL ENGINES

Art. 91

It is extremely dangerous and therefore absolutely forbidden to flame-cut or flame or electric-weld pipes or recipients that contain or have contained inflammable liquids (for example tanks of petrol or diesel-fuelled compressors).

In case of doubt, do not proceed with the operation and wash the part with non-flammable solvente (wear a protective face mask during washing); it is also forbidden to carry out welding or cutting operations in places which, owing to their position, may present a fire hazard.



Art. 92

Use petrol-fuelled compressors outdoors.
It is forbidden to use compressors in closed environments. Make sure that the air intake is away from exhaust fumes of an internal-combustion engine and follow the paragraph entitled "Position" in the Instruction Manual.

**Art. 93**

Make sure that the air intake is away from exhaust fumes given off by internal-combustion engines.

11.7 MAINTENANCE REGULATIONS

Art. 94

All the routine and additional maintenance operations must be carried out with the compressor at a standstill, with the power supply turned off and with the pump circuit depressurized. For models with an internal-combustion engine, turn the engine off.

Art. 95

During maintenance or the replacement of parts of the pneumatic system, particular care must be given to avoid the introduction or insertion of foreign bodies in the circuit, even small parts, as they could cause operating problems and compromise the safety of the machine.

**Art. 96**

When the maintenance work has been completed and before starting up the machine, check that the pieces that have been replaced and/or the tools used for the repair/maintenance work, have been removed from the machine. Check that all the safety devices have been fitted and are in good condition. Make sure that all the graphic signs and safety warnings are applied, in good condition and legible.

Art. 97

Before every operation, the maintenance technician must stop the machine and make sure that it cannot be started again without his authorization.
Only in this way can the operator be sure that the machine will not be started up again accidentally while the maintenance staff are in a position of risk.

Art. 98

Care should be taken with the maintenance of the electric motor. The danger is signalled by a "Danger voltage" sign.

**Art. 99**

Avoid carrying out any maintenance operation with bare hands.

Art. 100

Cases may arise where the maintenance technician has to check the successful outcome of the operations carried out or has to pinpoint faults while the machine is in operation or even during working operations.

In these circumstances, precise and irrevocable instructions must be given so that:

- the operator who is at the machine controls and the maintenance technician can see each other so that they can communicate together in an easy and clear way.
- The operator must act according to the instructions given to him by the maintenance technician.
- The maintenance operations must be carried out under adequate lighting.
- Before going from a standstill to setting a part in motion, the maintenance technician must move to a position of safety and approach the moving parts only when he is sure that his instructions have been correctly understood by the operator.

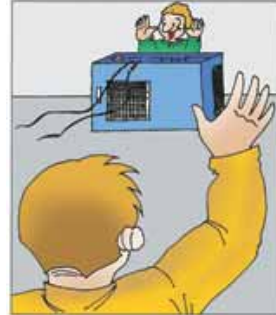
**ONLY FOR COMPRESSORS WITH PETROL OR DIESEL ENGINES**

- For all the maintenance and lubrication operations concerning internal-combustion engines, the instructions in the manual enclosed, supplied by the engine manufacturer, must be closely followed.

Art. 101

The frequency of the maintenance operations as stated must be complied with.

Art. 102

The maintenance technician must keep a register of all the operations carried out.

**Art. 103**

The hose must be replaced periodically (yearly) or when it shows signs of wear. Failure to comply with this regulation could place the operators at serious risk.

Art. 104

Check the tightness of the pipe fittings by wetting them with water and soap and eliminate any leakages.



Art. 105

Do not repair high pressure pipes by welding.

**Art. 106**

Replace the air purification filters regularly as described in the Instruction Manual.

Art. 107

Drain off the condensate regularly as described in the Instruction Manual.

ONLY FOR COMPRESSORS WITH PETROL OR DIESEL ENGINES**Art. 108**

Never top up the tanks of petrol-fuelled machines when they are running.

**Art. 109**

The machine must be at a standstill with the switchboards cut off when it is cleaned.

**Art. 110**

It is forbidden to use inflammable fluids for cleaning operations.

Art. 111

It is forbidden to tamper with or replace parts of the machine unless expressly authorized by **AEROTECNICA COLTRI**

Art. 112

Use of accessories, tools, expendable materials or spare parts other than those recommended by the manufacturer and/or described in this manual, may present a hazard to the operator and/or damage the machine.

Art. 113

To guarantee an optimum performance from the machine, only original **AEROTECNICA COLTRI** spare parts must be used to replace parts of the machine.

**Art. 114**

Any operation carried out to modify the machine without the express authorization of **AEROTECNICA COLTRI** will relieve the manufacturing company of any civil or penal liability.

12 - MAINTENANCE REGISTER

12.1 ASSISTANCE SERVICE

Customers continue to receive assistance after the purchase of a compressor. To this end **AEROTECNICA COLTRI** has created an assistance network covering the entire country.

IMPORTANT



Our qualified technicians are at your disposal at any time to carry out maintenance work or repairs; we use only original spare parts so as to ensure quality and reliability.

12.2 SCHEDULED MAINTENANCE

The scheduled maintenance programme is designed to keep your compressor in perfect working order.

Some simple tasks, described in this manual, can be carried out directly by the customer; others, instead, require that the work be carried out by trained personnel. For the latter we recommend you always contact our assistance network.

This section provides a simple tool with which to request assistance and register completed scheduled maintenance work.

Start-up and maintenance checks/tasks, once completed by our qualified technician, are registered in this maintenance chapter by way of an official stamp, signature and inspection date; the number of working hours is also registered.

The maintenance schedules/coupons easily let you know when our assistance service should be contacted to carry out work.

12.3 USING THE COMPRESSOR UNDER HEAVY-DUTY CONDITIONS

Where compressors are used in particularly difficult conditions (high levels of pollution, presence of solid particulate in suspension etc.), scheduled maintenance tasks must be carried out more frequently as per the advice given by our assistance network.

12.4 THE CUSTOMER CARE CENTRE

Our qualified technicians are constantly in contact with the head offices of our company where there is an assistance network coordination and support centre, better known as the **Customer Care Centre**.

To contact us:

Telephone: **+39 030 9910301**
+39 030 9910297
Fax: **+39 030 9910283**
E-mail: **coltrisub@coltrisub.it**

12.5 SCHEDULED MAINTENANCE REGISTRY COUPONS

Type of work and notes	Date
.....	_____
	'Assistance' service stamp
	_____ _____ _____
	Maintenance technician's signature

Type of work and notes	Date
.....	_____
	'Assistance' service stamp
	_____ _____ _____
	Maintenance technician's signature

Type of work and notes	Date
.....	_____
	'Assistance' service stamp
	_____ _____ _____
	Maintenance technician's signature

Type of work and notes	Date
.....	_____ _____
	'Assistance' service stamp
	Maintenance technician's signature

Type of work and notes	Date
.....	_____ _____
	'Assistance' service stamp
	Maintenance technician's signature

Type of work and notes	Date
.....	_____ _____
	'Assistance' service stamp
	Maintenance technician's signature

Type of work and notes	Date
.....	 _____
	'Assistance' service stamp
	Maintenance technician's signature

Type of work and notes	Date
.....	 _____
	'Assistance' service stamp
	Maintenance technician's signature

Type of work and notes	Date
.....	 _____
	'Assistance' service stamp
	Maintenance technician's signature



AEROTECNICA COLTRI®

AEROTECNICA COLTRI Spa
Via Colli Storici, 177
25010 SAN MARTINO DELLA BATTAGLIA (BS) ITALY
Tel. +39 030 9910301
Fax. +39 030 9910283
www.coltrisub.it
www.coltrisub.com
coltrisub@coltrisub.it

www.coltrisub.com