

MEMS Motion Handling and Assembly Guide

PURPOSE AND SCOPE

This document provides preliminary information and general guidelines for handling and assembling InvenSense Micro Electro-Mechanical Systems (MEMS) motion sensors.

MANUFACTURING RECOMMENDATIONS

ASSEMBLY GUIDELINES AND RECOMMENDATIONS

Surface Mount Packages

MEMS (Micro Electro-Mechanical Systems) motion sensors are generally sensitive to mechanical stress coming from the PCB. Minimize PCB stress by following these design rules:

When using MEMS components in plastic packages, PCB mounting and assembly can cause package stress. Package stress in turn can affect the output offset over a wide range of temperature. This stress is caused by the mismatch between the Coefficient of Linear Thermal Expansion (CTE) of the package material and the PCB. Traces connected to pads should be as symmetric as possible. Maximizing symmetry and balance for pad connection will help with component self-alignment and will lead to better control of solder paste reduction after reflow.

Any material used in the surface-mount assembly process of the MEMS product should be free of restricted RoHS elements or compounds. Pb-free solders should be used for assembly.

Offset shift may exist after the MEMS motion sensor being mounted onto the PCB board. It depends on individual applications to decide what degree of offset shift they may tolerate. For best consistency, it is recommended to do an on-board calibration after the accelerometer is soldered. Additional information is available upon request.

Exposed Die Pad Precautions

InvenSense products have very low active and standby current consumption. The exposed die pad is not required for heat sinking, and should not be soldered to the PCB. Failure to adhere to this rule can induce performance changes due to package thermo-mechanical stress. There is no electrical connection between the pad and the CMOS.

Trace Routing

Routing traces or vias under the device package is not recommended. Routed active signals may harmonically couple with the MEMS sensor devices, compromising the sensor's performance. To avoid harmonic coupling do not route active signals in non-shielded signal planes directly below, or above the sensor package in cabling or adjacent PCB. Note: For best performance, design a ground plane under the sensor to reduce PCB signal noise from the board on which the sensor is mounted. If the sensor is stacked under an adjacent PCB board, design a ground plane directly above the sensor device to shield active signals from the adjacent PCB board.

Component Placement

Do not place large insertion components such as keyboards or push buttons, connectors, or shielding boxes at a distance of less than 2 mm from the MEMS motion sensor. This is to prevent mechanical stress or large thermal sink/source to the adverse of sensor performance. Maintain generally accepted industry design practices for component placement near the device to prevent noise coupling and thermo-mechanical stress, avoiding the neighborhood of any vibration sources like vibrator, speaker, buzzer, and etc.

TABLE OF CONTENTS

PURPOSE AND SCOPE	1
MANUFACTURING RECOMMENDATIONS	1
ASSEMBLY GUIDELINES AND RECOMMENDATIONS	1
SURFACE MOUNT PACKAGES	1
EXPOSED DIE PAD PRECAUTIONS	1
TRACE ROUTING	1
COMPONENT PLACEMENT	1
TABLE OF CONTENTS	2
COMPONENT PLACEMENT PRESSURE AND PICK-AND-PLACE VELOCITY	3
PCB MOUNTING AND CROSS-AXIS SENSITIVITY	3
PCB MOUNTING OPTICAL INSPECTION.....	3
PCB DESIGN GUIDELINES AND RECOMMENDATIONS.....	3
MEMS HANDLING INSTRUCTIONS	4
TAPE AND REEL HANDLING INSTRUCTIONS	4
ESD CONSIDERATIONS.....	5
REFLOW SPECIFICATION	5
STORAGE SPECIFICATIONS.....	6
PACKAGE MARKING SPECIFICATION	6
TAPE & REEL SPECIFICATION	7
REEL & PIZZA BOX LABEL	10
PACKAGING	10
REPRESENTATIVE SHIPPING CARTON LABEL	12
REVISION HISTORY	13
COMPLIANCE.....	14
ENVIRONMENTAL COMPLIANCE	14
DRC COMPLIANCE	14
COMPLIANCE DECLARATION DISCLAIMER.....	14
GENERAL.....	14

Component Placement Pressure and Pick-and-Place Velocity

Use a typical pick-and-place machine with reflow equipment like oven. Avoid any manual soldering process. [Machines should be set up to slow down both the pick and the place operations, as much possible, to help minimize any shock impact to the device.](#) Especially we recommend staying below the following mounter parameters as listed below to minimize the mechanical impact force on the MEMS Motion Sensor. Sharp or sudden impacts should be avoided.

- Mounter transfer max speed: 50 cm/s
- Mounter max force: 480 gf or 4.7 N

PCB Mounting and Cross-Axis Sensitivity

Orientation errors of the gyroscope and accelerometer mounted on the PCB can cause cross-axis sensitivity in which one gyro or accel responds to rotation or acceleration about another axis, respectively. For example, the X-axis gyroscope may respond to rotation about the Y or Z axes. The orientation mounting errors are illustrated in the figure below.

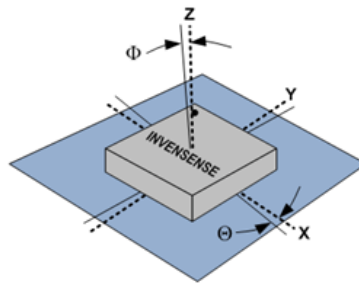

Package Gyro & Accel Axes (-----) Relative to PCB Axes (——) with Orientation Errors (Θ and Φ)

The table below shows the cross-axis sensitivity as a percentage of the specified gyroscope or accelerometer’s sensitivity for a given orientation error, respectively.

Cross-Axis Sensitivity vs. Orientation Error

Orientation Error (θ or Φ)	Cross-Axis Sensitivity ($\sin\theta$ or $\sin\Phi$)
0.0°	0.00%
0.5°	0.87%
1.0°	1.75%

The product specifications for cross-axis sensitivity include the effect of the die orientation error with respect to the package.

Note: Please refer to the data sheet for actual orientation of the axis with respect to package.

PCB MOUNTING OPTICAL INSPECTION

For production efficiency, multiple qualified assembly suppliers and lead frame vendors may be used on any given device. Therefore, variations in lead frame color or reflectivity can occur. It is recommended to use a higher illumination source for optical inspection before PCB mounting.

PCB DESIGN GUIDELINES AND RECOMMENDATIONS

It is recommended to design the PCB pad layout with Non-Solder Mask Defined pads (NSMD), rather than Solder Mask Defined (SMD) pads. NSMD pads have several advantages over SMD pads. They provide a tighter tolerance for copper etching, provide a larger copper pad area, and allow the solder to anchor to the edges of the copper pads, which improves solder joint reliability. Design the PCB pad land sizes to match the component pad sizes listed in the package dimensions section. Set the solder mask aperture to a minimum of 0.05 mm larger than the component solder pad per edge with blocked areas (as shown below on the left), or with individually outlined pads (as shown below on the right).

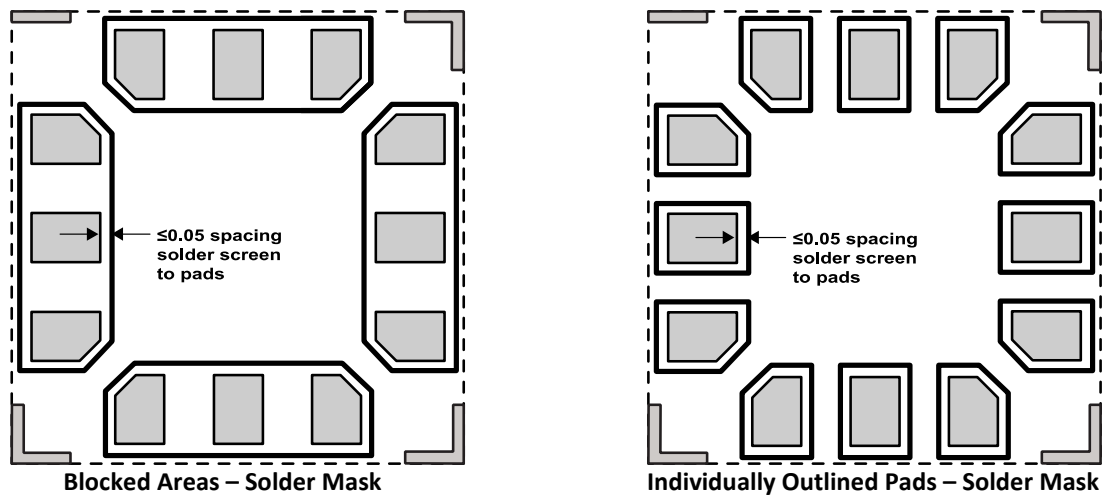

MEMS HANDLING INSTRUCTIONS

Unlike conventional IC products in similar packages, MEMS devices contain moving micromechanical structures. Therefore, MEMS devices require different handling precautions than conventional ICs prior to mounting onto PCBs.

InvenSense products have been qualified to a shock tolerance of 10,000g. Furthermore, the products are shipped in cushioned packaging to protect them from potential damage induced by normal handling and shipping.

- Do not drop individually packaged sensors, or trays of sensors. Components placed in trays could be subject to *g*-forces in excess of 10,000g if dropped.
- PCBs that incorporate mounted sensors should not be separated by manually snapping apart. This could also create *g*-forces in excess of 10,000g.
- Do not clean MEMS sensors in ultrasonic baths. Ultrasonic baths can induce MEMS damage if the bath energy causes excessive drive motion through resonant frequency coupling.
- Do not open and remove MEMS devices from the moisture barrier bag until you are ready to use them. The moisture barrier bag provides good protection to the MEMS sensors during storage and transfer.
- If any devices are dropped inadvertently during any handling, those devices should not be used.

TAPE AND REEL HANDLING INSTRUCTIONS

InvenSense devices are shipped in tape and reels. They are packaged to protect them from potential damage induced by normal handling and shipping. These are handling guidelines for the tape and reels populated with MEM's motion devices

- Tape and reels (with devices) should not be dropped at any time or un-reeled manually.
- Precautions should be taken to minimize the amount of vibration that tape and reels (with devices) are subjected to while in pick and place machines.
- The slowest settings possible should be used on pick and place machines during SMT process.
- Tape and reels should be kept in packaging as long as possible, until ready to use on pick and place machines
- Any carts used for internal transportation of tape and reels (with devices) should be padded with bumpers and have shock absorbing features.

ESD CONSIDERATIONS

Establish and use (Electrostatic Damage) ESD-safe handling precautions when unpacking and handling ESD-sensitive devices.

- Store ESD sensitive devices in ESD safe containers until ready for use. The Tape-and-Reel moisture-sealed bag is an ESD approved barrier. The best practice is to keep the units in the original moisture sealed bags until ready for assembly.
- InvenSense products are qualified to meet at least 250V ESD-MM (Machine Model). Restrict all device handling to ESD protected work areas that measure less than 200V static charge. Ensure that all workstations and personnel are properly grounded to prevent ESD.

REFLOW SPECIFICATION

Qualification Reflow: InvenSense products are qualified in accordance with IPC/JEDEC J-STD-020D.1. This standard classifies proper packaging, storage and handling in order to avoid subsequent thermal and mechanical damage during the solder-reflow attachment phase of PCB assembly.

The qualification preconditioning process specifies a sequence consisting of a bake cycle, a moisture soak cycle (in a temperature humidity oven), and three consecutive solder reflow cycles, followed by functional device testing.

The peak-solder reflow classification temperature requirement for package qualification is (260°C +5°C/-0°C) for lead-free soldering of components measuring less than 1.6 mm in thickness. The qualification profile and a table explaining the set-points are shown below.

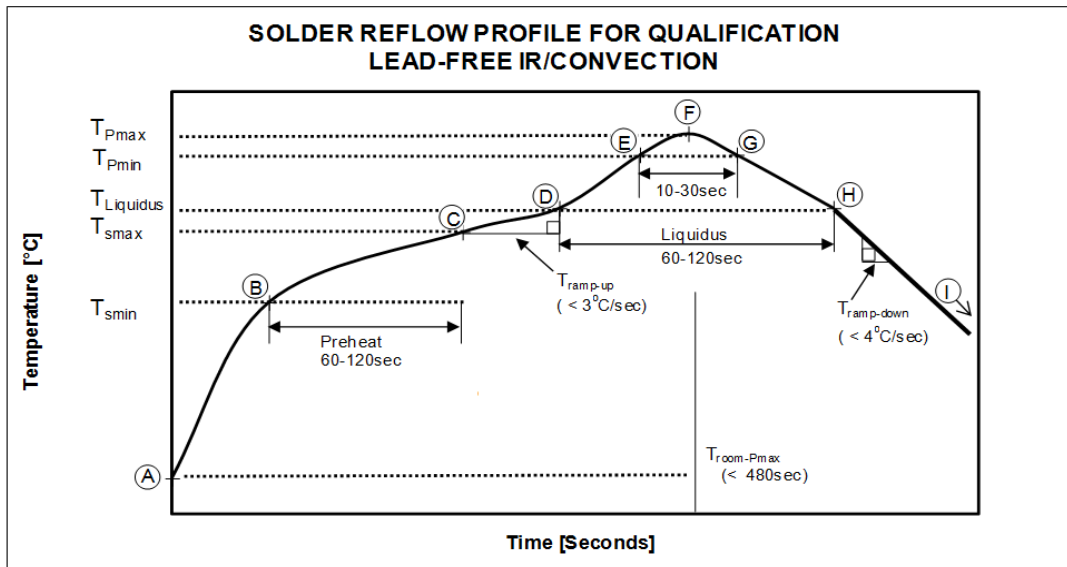

Temperature Set Points Corresponding to Reflow Profile Above

Step	Setting	CONSTRAINTS		
		Temp (°C)	Time (sec)	Max. Rate (°C/sec)
A	T_{room}	25		
B	T_{Smin}	150		
C	T_{Smax}	200	$60 < t_{BC} < 120$	
D	$T_{Liquidus}$	217		$r_{(TLiquidus-TPmax)} < 3$
E	T_{Pmin} [255°C, 260°C]	255		$r_{(TLiquidus-TPmax)} < 3$
F	T_{Pmax} [260°C, 265°C]	260	$t_{AF} < 480$	$r_{(TLiquidus-TPmax)} < 3$
G	T_{Pmin} [255°C, 260°C]	255	$10 < t_{EG} < 30$	$r_{(TPmax-TLiquidus)} < 4$
H	$T_{Liquidus}$	217	$60 < t_{DH} < 120$	
I	T_{room}	25		

Notes: Customers must never exceed the Classification temperature ($T_{Pmax} = 260^{\circ}C$).
All temperatures refer to the topside of the package, as measured on the package body surface.

STORAGE SPECIFICATIONS

InvenSense products conform to the storage specifications of IPC/JEDEC J-STD-020D.1 Moisture Sensitivity Level (MSL) 3.

After opening moisture-sealed bag	168 hours -- Storage Conditions: Ambient ≤30°C at 60%RH
-----------------------------------	---

PACKAGE MARKING SPECIFICATION

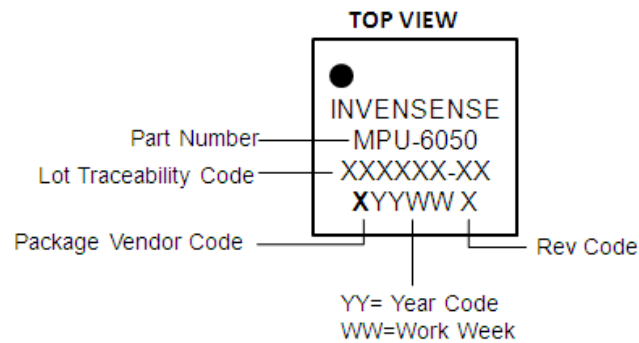

4x4 Package Marking Specification (shown for device MPU-6050 as an example)

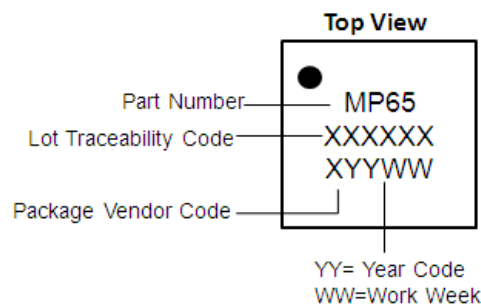

3x3 Package Marking Specification (shown for device MPU-6500 as an example)

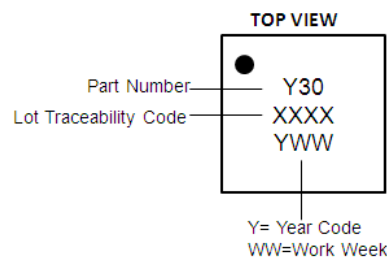

2.3x2.3 Package Marking Specification (shown for device IDG-2030 as an example)

TAPE & REEL SPECIFICATION

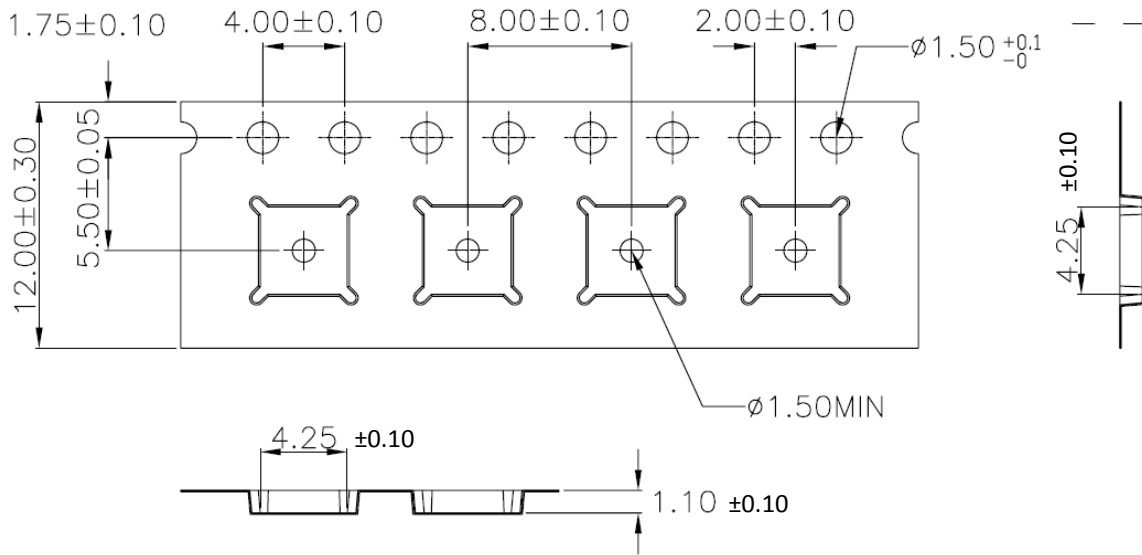

4x4 Tape Dimensions

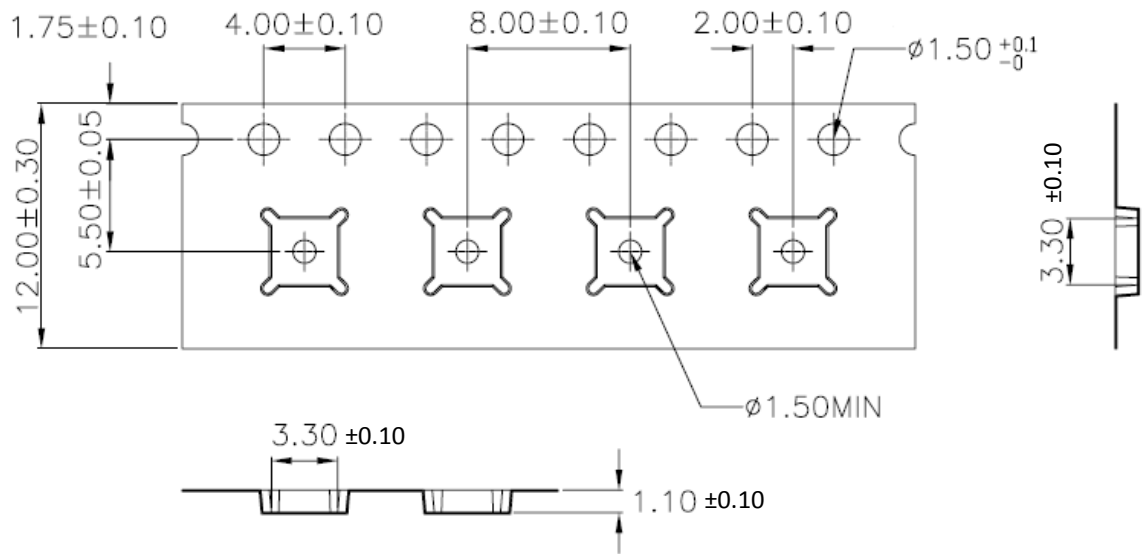

3x3 Tape Dimensions (for package height 0.9)

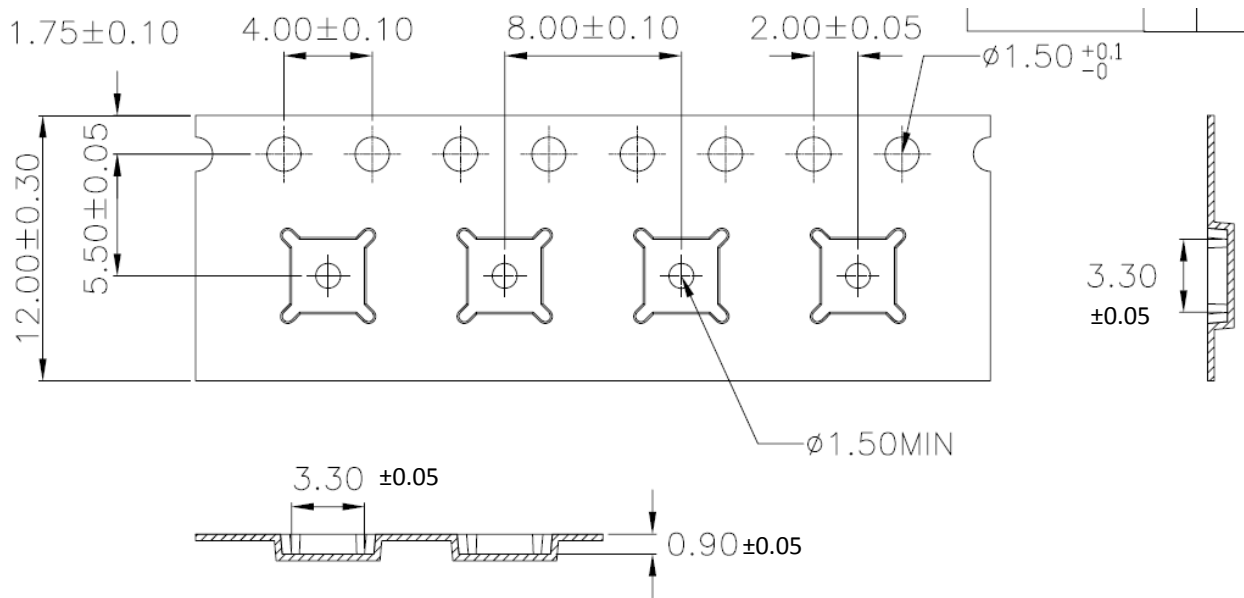

3x3 Tape Dimensions (for package height 0.75)

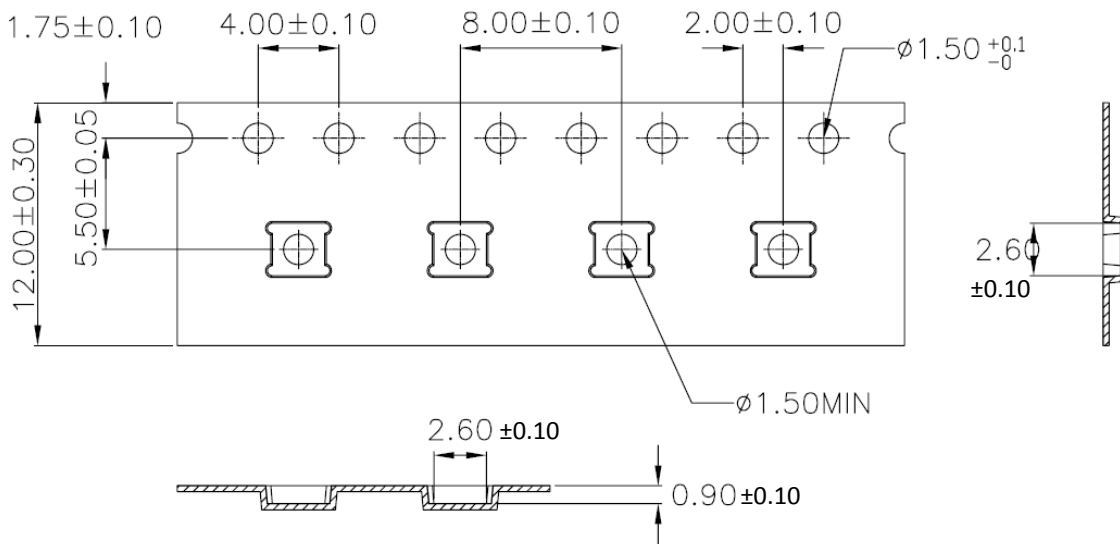

2.3x2.3 Tape Dimensions

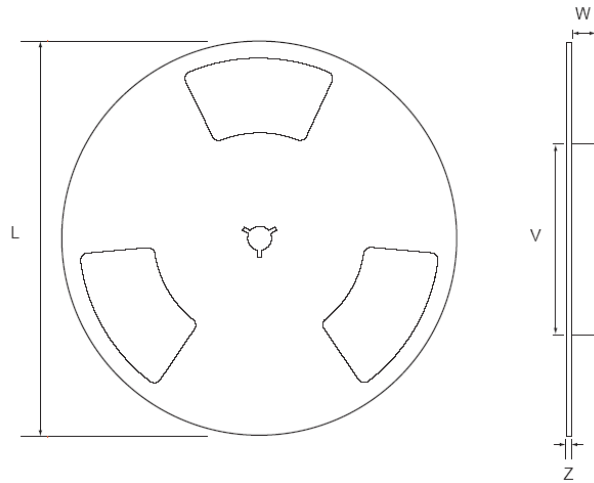

Reel Outline Drawing

Reel Dimensions and Package Size

PACKAGE SIZE (mm)	REEL (mm)			
	L	V	W	Z
4x4,3x3,2.3x2.3	330	102	12.8	2.3

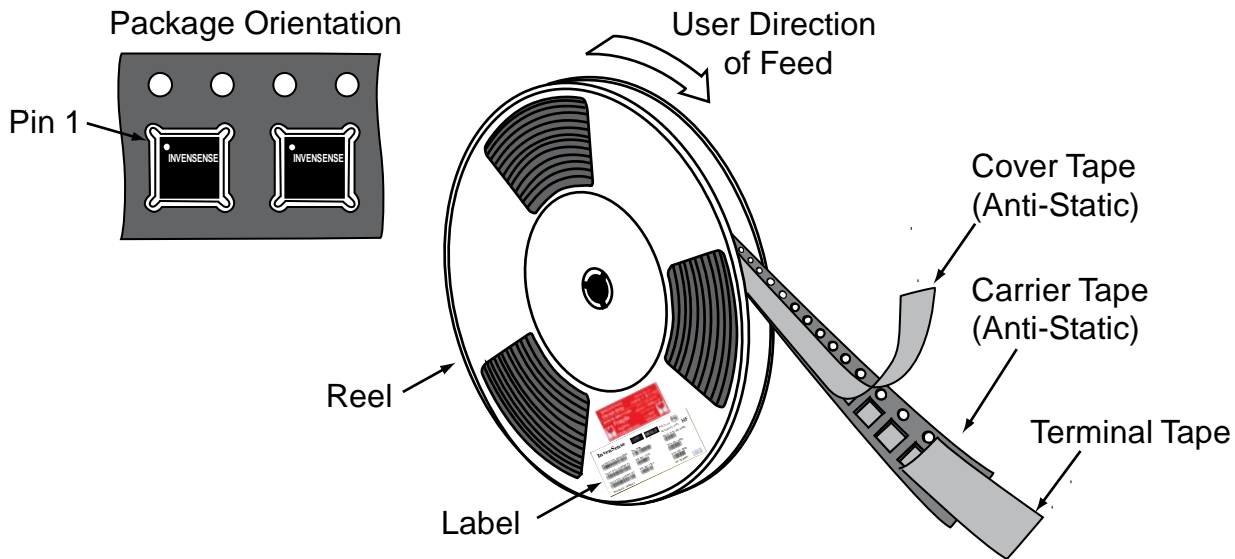

Tape and Reel – Package Orientation

Reel Specifications

Quantity Per Reel	5,000
Reels per Box	1
Boxes Per Carton (max)	5
Pcs/Carton (max)	25,000

REEL & PIZZA BOX LABEL

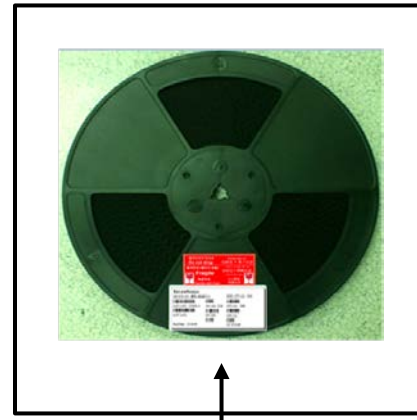
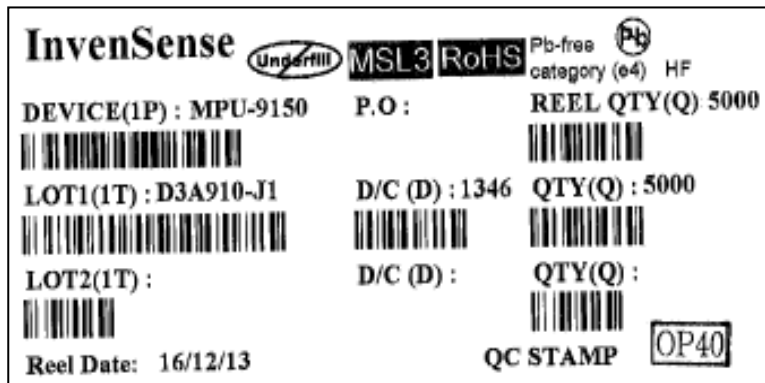

Barcode Label (MPU-9150 as an example)

Location of Label on Reel

PACKAGING

Improved packing → Front :550 empty tape



→ End: 550 empty tape

→ Strip foam

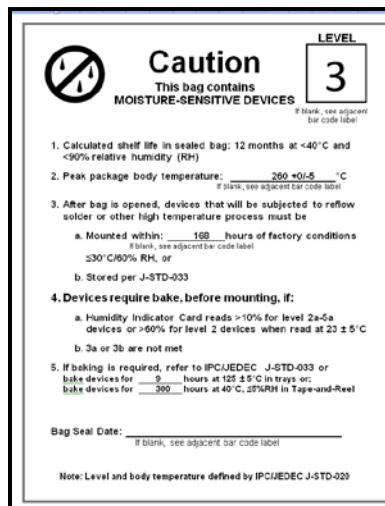

MSL 3 Label



Current



New

Reel now packed for shipping in bubble wrap and pizza box



Caution Label



ESD Label



Pizza Box



Pizza Boxes Placed in Foam-Lined Shipper Box



Outer Shipper Label

REPRESENTATIVE SHIPPING CARTON LABEL

E4		InvenSense		Delivery Name NO:	
				405010	
From:		Ship To:			
InvenSense Taiwan Ltd. 1F,9 Prosperity 1st Road,Hsinchu Science Park, Hsinchu City,30078,Taiwan TEL:+886 3 6686999 FAX:+886 3 6686777		AVNET INTERNIX K.K. AVNET INTERNIX K.K.,59-10, Takakura-cho,Hachioji,,Tokyo,192- 0033,JP			
SUPP PROD ID: MPU-9150					
LOT#: D3A910-J1		LOT#:			
QTY: 10273		QTY:	0		
LOT#: D3A598-J1		LOT#:			
QTY: 4727		QTY:	0		
LOT#:		LOT#:			
QTY: 0		QTY:	0		
LOT#:		LOT#:			
QTY: 0		QTY:	0		
Total Quantity/Carton:		Weight : (KG)			
15000		4.54			
Pb-free		Shipping Carton:	Category (e4)	HF	
		1	1		
MSL3	RoHS		OF		

Outer Shipping Carton Label (MPU-9150 as an example)

REVISION HISTORY

Revision Date	Revision	Description
10/16/2013	1.0	Initial Release
01/13/2014	2.0	Revised sections 3.1.5, 3.3, 3.7, 3.8, 3.9, and 3.11.
02/11/14	2.1	Modified document format and updated shipping label.
05/29/14	2.2	Added tape and reel handling guidelines, updated 3x3mm tape and reel spec, updated packaging section for reels
07/07/14	2.3	Revised 3x3mm tape and reel spec to add tolerances
11/06/14	2.4	Added section on PCB Mounting Optical Inspection section
11/17/2014	2.5	Updated Storage Specifications

COMPLIANCE

ENVIRONMENTAL COMPLIANCE

InvenSense products are RoHS and Green compliant.

InvenSense products are in full environmental compliance as evidenced by our Materials Declaration Data Sheets (MDS). The MDS report, along with support documentation consisting of Material Safety Data Sheets (MSDS) and analytical reports for each homogeneous element of the product are available upon request.

DRC COMPLIANCE

InvenSense products use materials that comply with DRC (Democratic Republic of the Congo) Conflict-Free Smelter and Mines requirements to meet the SEC implementation of Dodd–Frank Section 1502.

COMPLIANCE DECLARATION DISCLAIMER

InvenSense believes this compliance information to be correct but cannot guarantee accuracy or completeness. Conformity documents for the above component constitutes are on file. InvenSense subcontracts manufacturing and the information contained herein is based on data received from vendors and suppliers, which has not been validated by InvenSense.

GENERAL

This information furnished by InvenSense is believed to be accurate and reliable. However, no responsibility is assumed by InvenSense for its use, or for any infringements of patents or other rights of third parties that may result from its use. Specifications are subject to change without notice. InvenSense reserves the right to make changes to this product, including its circuits and software, in order to improve its design and/or performance, without prior notice. InvenSense makes no warranties, neither expressed nor implied, regarding the information and specifications contained in this document. InvenSense assumes no responsibility for any claims or damages arising from information contained in this document, or from the use of products and services detailed therein. This includes, but is not limited to, claims or damages based on the infringement of patents, copyrights, mask work and/or other intellectual property rights.

This information furnished by InvenSense is believed to be accurate and reliable. However, no responsibility is assumed by InvenSense for its use, or for any infringements of patents or other rights of third parties that may result from its use. Specifications are subject to change without notice. InvenSense reserves the right to make changes to this product, including its circuits and software, in order to improve its design and/or performance, without prior notice. InvenSense makes no warranties, neither expressed nor implied, regarding the information and specifications contained in this document. InvenSense assumes no responsibility for any claims or damages arising from information contained in this document, or from the use of products and services detailed therein. This includes, but is not limited to, claims or damages based on the infringement of patents, copyrights, mask work and/or other intellectual property rights.

Certain intellectual property owned by InvenSense and described in this document is patent protected. No license is granted by implication or otherwise under any patent or patent rights of InvenSense. This publication supersedes and replaces all information previously supplied. Trademarks that are registered trademarks are the property of their respective companies. InvenSense sensors should not be used or sold in the development, storage, production or utilization of any conventional or mass-destructive weapons or for any other weapons or life threatening applications, as well as in any other life critical applications such as medical equipment, transportation, aerospace and nuclear instruments, undersea equipment, power plant equipment, disaster prevention and crime prevention equipment.

InvenSense, Inc products described in this document are protected by patents in the United States. The following web page is provided to serve as notice under AIA Sec. 16; 35 U.S.C. 287(a).

Patent: www.invensense.com/patents.html

©2014 InvenSense, Inc. All rights reserved. InvenSense, MotionTracking, MotionProcessing, MotionProcessor, MotionFusion, MotionApps, DMP, AAR, and the InvenSense logo are trademarks of InvenSense, Inc. Other company and product names may be trademarks of the respective companies with which they are associated.



©2014 InvenSense, Inc. All rights reserved.