

277

SERVICE MANUAL



# FISHER

# MT-6250

Linear Motor  
Quartz Locked PLL  
Direct Drive Turntable  
(EUROPE)



*The first name in high fidelity*

277

## TABLE OF CONTENTS

Specifications . . . . .	3
Introduction. . . . .	4
Drive System . . . . .	5
Drive System (Continued) . . . . .	6
Drive Signal Generation & Turn On. . . . .	7
Quartz-Lock System/Speed Detection and Servo Control/ Motor Speed Control and Phase Comparator. . . . .	8
Electromagnetic Braking System/Stroboscope/Power Supply. . . . .	9
Block Diagram-Quartz Lock Reference Signal and Strobe Circuits. . . . .	10
Electrical Adjustments and Procedure . . . . .	11
Electrical Adjustments (Continued)/Mechanical Adjustments/ Mounting The Cartridge . . . . .	12
Motor P.C.Board/Power Supply P.C.Board . . . . .	13
Parts List (Motor P.C.B. Assy & Power Supply P.C. Assy) . . . . .	14
Exploded View of Turntable (1). . . . .	15
Exploded View of Turntable (2). . . . .	16
Parts List-(Packing, Accessories, Cabinet, Turntable) . . . . .	17
Parts List-(Continued) . . . . .	18
Parts List-(Continued) . . . . .	19
Point to Point Wiring Diagram . . . . .	20
Schematic Diagram . . . . .	21,22
Semiconductor Lead Identification. . . . .	23

**Nominal Specifications for Information Only.**

<b>TURNTABLE</b>	<b>MT-6250</b>
Motor	120 pole Linear Quartz Phase Locked Loop
Drive System	Direct
Wow & Flutter (WRMS)	0.03 %
Rumble (DIN 45539B)	-70 dB
Speed Variation	0 % (Quartz lock on)
Speed Control Range	±6 % (Quartz lock off)
Tracking Force Range	0.6 - 3.5 grams
Tracking Force Adjustment	Calibrated Counterweight
Platter Diameter	12-15/16"
Platter Weight	2.2 lbs.
Strobe Light	Yes
Record Speed Selector	33/45 rpm
Auto Function	
Stop	Yes
Reject	Yes
Automatic	
Tone Arm Return at End of Record	Yes
Manual Function	
Start	Yes
Stop	Yes
Tone Arm Data	
Resonance	<10 Hz
Balance Adjustment	Counterweight
Effective Length	222 mm
Shape	S-Form
Bearing Type	
Horizontal	Thrust
Friction Sensitivity	0.15 gram
Vertical	Pivot
Friction Sensitivity	0.2 gram
Max. Tracking Error	±1.5°
Anti Skate Control	Calibrated Adjustable
Cueing	Viscous Damped
Overhang Indicator	Yes
<b>GENERAL</b>	
Power Requirements	110/220V 50/60 Hz 3.5 Watts
Weight	18.7 lbs.
Dimensions (WxDxH)	17-3/4"x14-1/4"x6-1/2"
Base Finish	Walnut grain vinyl

Because Fisher products are subject to continuous improvement, Fisher reserves the right to modify, change, or alter any design or specifications without notice and without incurring any obligation. Fisher reserves the right to make changes and improvements upon its products without any obligation to install such changes upon any of its products previously manufactured.

# INTRODUCTION

In the past a variety of turntable platter drive systems have been employed. All these systems involved deceleration because the motor speed was always considerably higher than the playing speed required for the turntable platter. A complicated system of worm gears, idler wheels, pulleys and belts had to be used to reduce the speed.

The disadvantage of any coupling (transmission) between the motor and the turntable platter is that it does add a certain amount of wow, flutter and rumble. If a direct coupling exists between the motor shaft and the turntable platter, if the motor shaft becomes in fact the drive shaft, the platter speed is the motor speed and that can be maintained within very narrow tolerances, and almost complete elimination of vibration can be achieved.

The FISHER MT-6250 direct drive turntable employs a very unique linear motor drive system, very different from some of the other direct-drive turntables on today's market.

If a comparison is made, the most obvious difference is the utmost simplicity of the FISHER MT-6250; and since this is an electromechanical device, simplicity translates into long-term stability and reliability.

Some of the most outstanding features of this unique drive system are that the turntable platter is the rotor of the motor, that there are no electrical connections to the rotor, that the rotor has no armature windings and that all the complicated electronic circuitry is in a stationary (nonmoving) position on a single P.C.Board mounted into the turntable base.

The linear motor used in the MT-6250 moves and accelerates upon the application of a 3-phase drive signal at a frequency of either 33 1/3 Hz or 45 Hz to 3 stator field coils. The 3-phase drive signal produces a progressively changing magnetic field in the stator windings. This magnetic field will attract and repel (or pull and push) the respective magnetic poles of the rotor magnets and thus cause the platter to rotate. Inertia causes the rotor to turn past the exact position of North Pole and South Pole alignment, and at this instant the magnetic field advances or rotates, thus pulling and pushing the rotor again in the same direction.

One other significant difference between the FISHER MT-6250 and other turntables is the number of magnetic rotor poles used. The motor speed is directly related to the number of poles in a motor, which can be calculated by using the following equation.

$$\text{RPM} = \frac{120 \times f}{p}$$

RPM = Revolutions/minute  
f = supply frequency  
p = number of poles  
120 = constant

## DRIVE SYSTEM

The turntable platter is the rotating part (the rotor) of the motor. It is mounted on a spindle and the spindle is mounted into a precision bearing. There are no other moving parts connected to the drive system. The only exception is the shut-off mechanism which engages only in the reject mode or at the end of a record.

A band 14 mm wide and 2 mm thick, made of rubber ferrite material, is bonded to a 210 mm diameter rim on the inside of the turntable platter. 120 individual poles, 60 bar magnets, are printed onto the ferrite band through permanent magnetization at equal intervals of 5.5 mm around the entire circumference. The magnetic flux density of the rotor magnets is approximately 600 Gauss.

The stator of the motor consists of three field coils connected in a three-phase star configuration, their respective sawtooth-shaped pole pieces, and of three sensing coils needed to produce the 120° 3-phase drive signal. The field coils are physically located under the platter on one side of the turntable base in a circular pattern facing the permanent magnet ferrite band on the rotor. The physical gap between the pole pieces and the rotor magnets is 1 mm. The mechanical arrangement is such that the 3 field coils with their pole pieces, subdivided into 25 sawtooth-shaped sections with a mechanical separation of 3° 15' for each, are always directly opposite a rotor section that contains 25 of the 120 magnetic poles. Only 81.25° of the total circular area is occupied by the stator. This is sufficient to develop a starting torque of 600 gr-cm and for the rotor to reach the operational speed of 33 1/3 rpm after approximately 1 second.

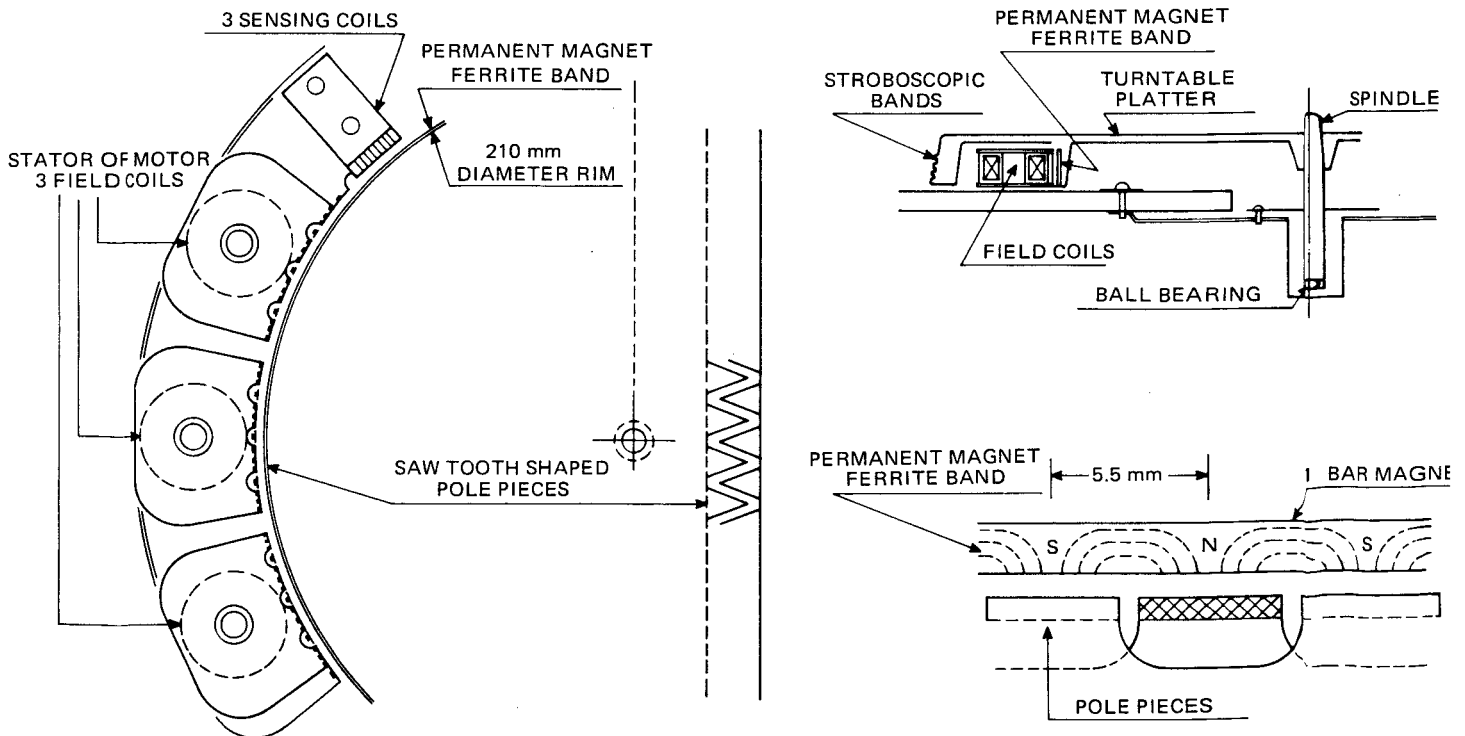

## DRIVE SYSTEM (Continued)

According to the above, a 30 pole motor connected to a 33 1/3 Hz supply would turn at a speed of 133 1/3 rpm. A 120 pole motor will turn at 33 1/3 rpm.

As the number of poles is increased, the speed of the motor is electrically reduced and the torque of the motor increased, provided the same electrical power source is used to drive the motor. The turntable has its own regulated power supply for the electronic circuits and a servo locked frequency generator to power the linear motor. This makes it completely immune to power line voltage variations.

### BLOCK DIAGRAM LINEAR MOTOR

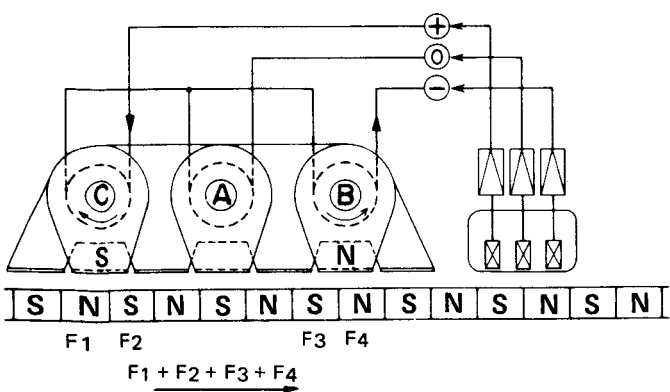
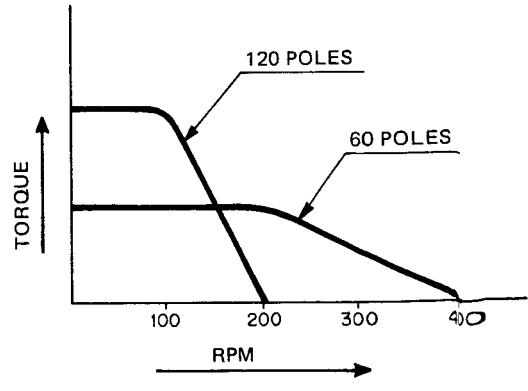
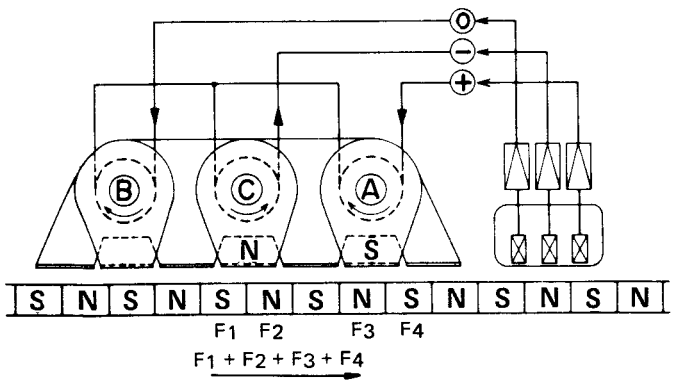
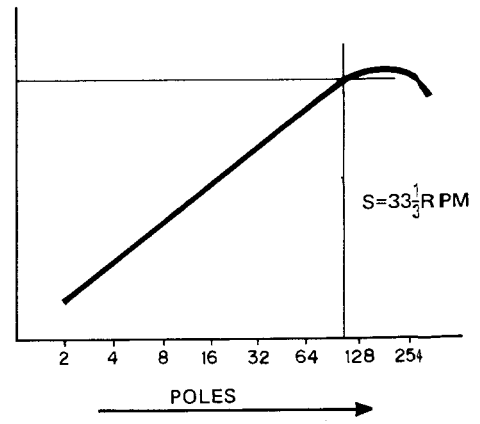
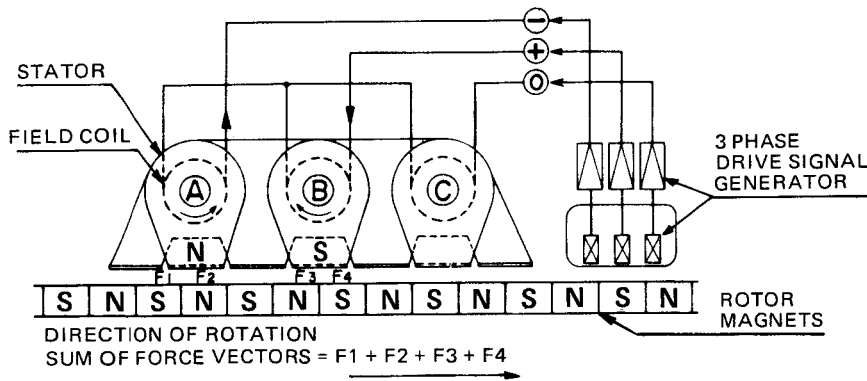

## DRIVE SIGNAL GENERATION

A 60 kHz sinewave signal is generated by an LC oscillator circuit. The 60 kHz signal is then fed to the 3 sensing coils. The inductance of the 3 sensing coils is varied through the rotation of the rotor magnets passing the sensing coils. The nominal value of the inductance of the sensing coils is approximately 1 mH; but since the coils are physically located in a very strong rotating magnetic field, magnetic saturation of the cores in the sensing coils occurs, and the effective inductance alternates between the nominal value and less than 10 % of the nominal value. The amplitude of the 60 kHz signal current flowing through the sensing coils is also varied at a frequency equal to the rotational speed of the platter. This phenomenon of variable inductance is exploited and very effectively used to AM modulate the 60 kHz carrier of the frequency generator. The AM modulation is adjusted to approximately 50 %.

There is a spacing of 3.8 mm between the 3 sensing coils. This arrangement will produce a 120° phase difference between the three modulating signals at the coils.

The three AM modulated signals are then demodulated, and the recovered 3-phase sinewave signal at a frequency of 33 1/3 Hz for 33 1/3 rpm and 45 Hz for 45 rpm is the actual drive signal for the linear motor.

The drive signal is further processed by 3 constant current drive amplifiers, consisting of 3 operational amplifiers (IC's) and 3 complementary symmetry output stages. The amplifier output signals are then connected to the 3 stator field coils.

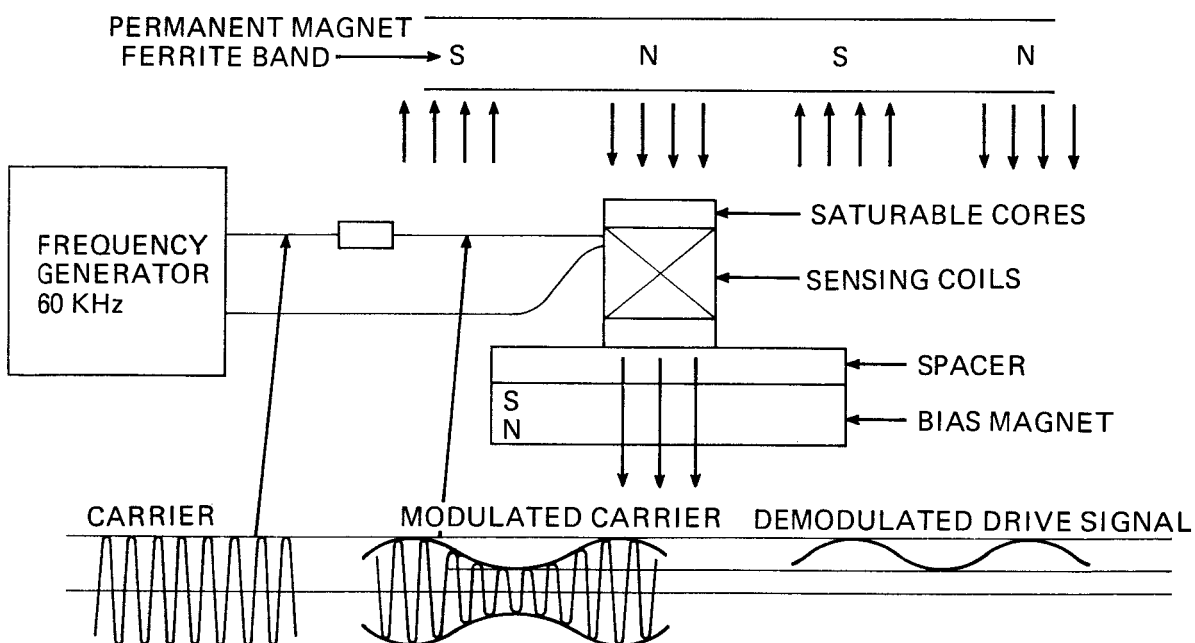

## TURN-ON

The turntable electronic circuits are switched on with an AC power switch.

The linear motor is turned on by a microswitch connected mechanically to the shut-off mechanism of the tonearm. At the very first instant after turn-on, the output signal of the 60 kHz frequency generator is unmodulated and its amplitude is approximately 6 V pp. This carrier signal is rectified and fed through the 3 amplifiers to the 3 stator field coils. As soon as the platter has started to turn, the servo control circuits will reduce the carrier amplitude to approximately 1 V pp which will at this time also contain the amplitude modulation produced by the sensor coils. As soon as the correct speed is reached, the magnetic field produced by the field coils will run synchronous with the rotor magnets.

## QUARTZ-LOCK SYSTEM

Two integrated circuits and some external components contain all the circuit elements required for the quartz phase-locked loop system and the stroboscope.

The heart of the system is the reference quartz crystal and the MSM 5810 integrated circuit which contains the oscillator circuit components, frequency dividers and a phase comparator. The quartz oscillator which operates at a frequency of 7.3728 MHz provides a stable reference signal which is immune to influences of ambient temperature and fluctuations of the power line voltage. The quartz oscillator signal is divided by a number of series connected counters contained in IC's MSM 5810 and M53290P down to frequencies of 106 2/3 Hz or 144 Hz (drive signal for strobe lamp circuits) and 66 2/3 Hz or 90 Hz (reference signal for phase comparator) corresponding to the standard speeds of the turntable platter of 33 1/3 RPM or 45 RPM respectively.

The speed selection switches are connected to a control input on MSM 5810 integrated circuit. Depending on the selected speed, the frequency divide ratio of one of the internal counters is changed upon the application of a control voltage of either 0V DC at 33 1/3 RPM or +5V DC at 45 RPM.

## SPEED DETECTION AND SERVO CONTROL

The control voltage for the servo amplifier is derived from the speed sensing coils monitoring the actual speed of the turntable platter. The passing rotor magnets induce a signal in the speed control sensing coils which corresponds exactly to the speed of the rotor. The frequency of this signal is 33 1/3 Hz at 33 1/3 RPM and 45 Hz at 45 RPM, and it varies with the speed of the rotor. This signal is the drive signal for the servo amplifier which consists of a high gain operational amplifier, an amplitude limiter to make it immune to amplitude variations, a pulse shaping circuit and a frequency doubler to increase its speed and thus decrease the response time of the control circuits. The signal at the output of the servo amplifier is connected either to the phase comparator of the quartz lock circuits or the frequency to voltage convertor and the differential comparator for manual "speed control" operation.

The servo loop is closed by connecting the output of the differential amplifier or the output of the phase comparator through the phase lock switch to a low pass filter and a regulator transistor to the 60 kHz oscillator circuit.

Precise servo action is instantaneous and is maintained at all times regardless of mode of operation, "phase locked" or "manual speed control."

## MOTOR SPEED CONTROL AND PHASE COMPARATOR

The output of the frequency doubler is connected to one input of the phase comparator contained in the MSM 5810 integrated circuit. The output of the standard reference signal derived from the quartz oscillator is connected to the other input of the phase comparator. The phase comparator detects phase lead or phase lag (time difference between the two signals) by means of the built-in phase logic, even if the frequencies of the two signals are not identical. Any phase difference between the standard reference signal and the signal from the speed detection circuits will produce a control voltage at the output of the phase comparator.

The control voltage is amplified and then connected through the quartz lock switch to the frequency generator control circuits. The speed of the linear motor is controlled by varying the high frequency carrier amplitude of the frequency generator. Any change in the carrier amplitude of the frequency generator will affect the amplitude of the motor drive signal.

With the phase lock switch in the OFF position the turntable speed can be varied by  $\pm 6\%$  or set for  $\square$  deviation with the built-in quartz controlled stroboscope. Once the quartz lock switch is ON, the speed control is automatically phase-locked to the quartz reference signal.



## ELECTROMAGNETIC BRAKING SYSTEM

The electromagnetic brake is activated either at the end of a record by the tonearm microswitch or when the speed selector is switched from 45 RPM to 33 1/3 RPM.

The speed sensing coils are also utilized as a signal source for the electromagnetic braking system. The signal induced into the speed sensing coils by the rotor magnets is amplified by integrated circuit NJM 4558 (IC-102A/IC-102B). The output signal of the integrated circuit NJM 4558 is used to bias switching diodes connected to the positive inputs of the linear motor drive amplifiers.

With the brake switch in the OFF position the negative inputs of the integrated circuits NJM 4558 (IC-102A/IC-102B) have a higher voltage than the positive inputs and the output voltages are approximately 1.5 volts. This will not provide enough bias voltage to forward-bias the switching diodes.

With the brake switch in the ON position the switching diodes (D-107, D-108 and D-109) will be forward biased (conducting) and the input signals of the linear motor drive amplifiers will be shunted.

The brake switching circuit consists of two input transistors, one of which is connected to the tonearm microswitch and the other to the speed selector switch. The two input transistors provide the drive signal for the switching transistor.

The time constant of the brake switch is adjusted for 0.8 seconds. This is the time required for the turntable platter to reach 33 1/3 RPM when switched from 45 RPM or for the platter to come to a complete stop after the tonearm microswitch has been activated.

## STROBOSCOPE

The strobe neon lamp drive signal is a square wave pulse with a 20% duty cycle. The frequency of the drive signal is switched simultaneously with the turntable speed. There are 96 black bars on the turntable platter outside rim. The bars will be synchronized with the strobe light (at standstill) at the two selected speeds when the quartz lock switch is ON, or when the pitch control is adjusted for zero deviation with the quartz lock switch OFF.

## POWER SUPPLY

The MT-6250 is isolated from the power line by a power transformer. One high voltage power supply (140V) is used for the neon strobe lamp, and one low voltage regulated power supply (25V) is used to power the electronic circuitry and the drive amplifiers of the linear motor.

## BLOCK DIAGRAM—QUARTZ LOCK REFERENCE SIGNAL AND STOROBO CIRCUITS

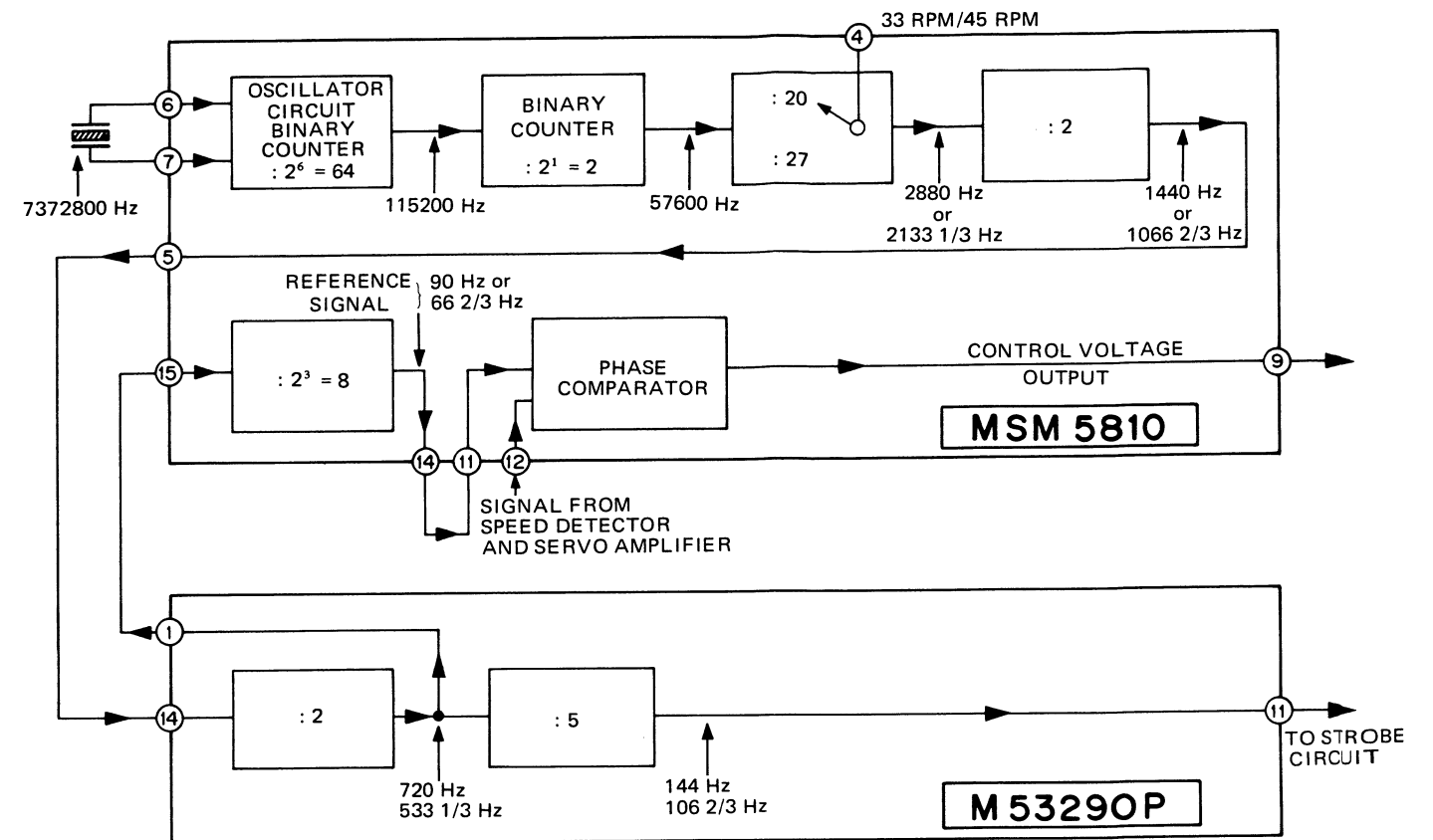

## BLOCK DIAGRAM

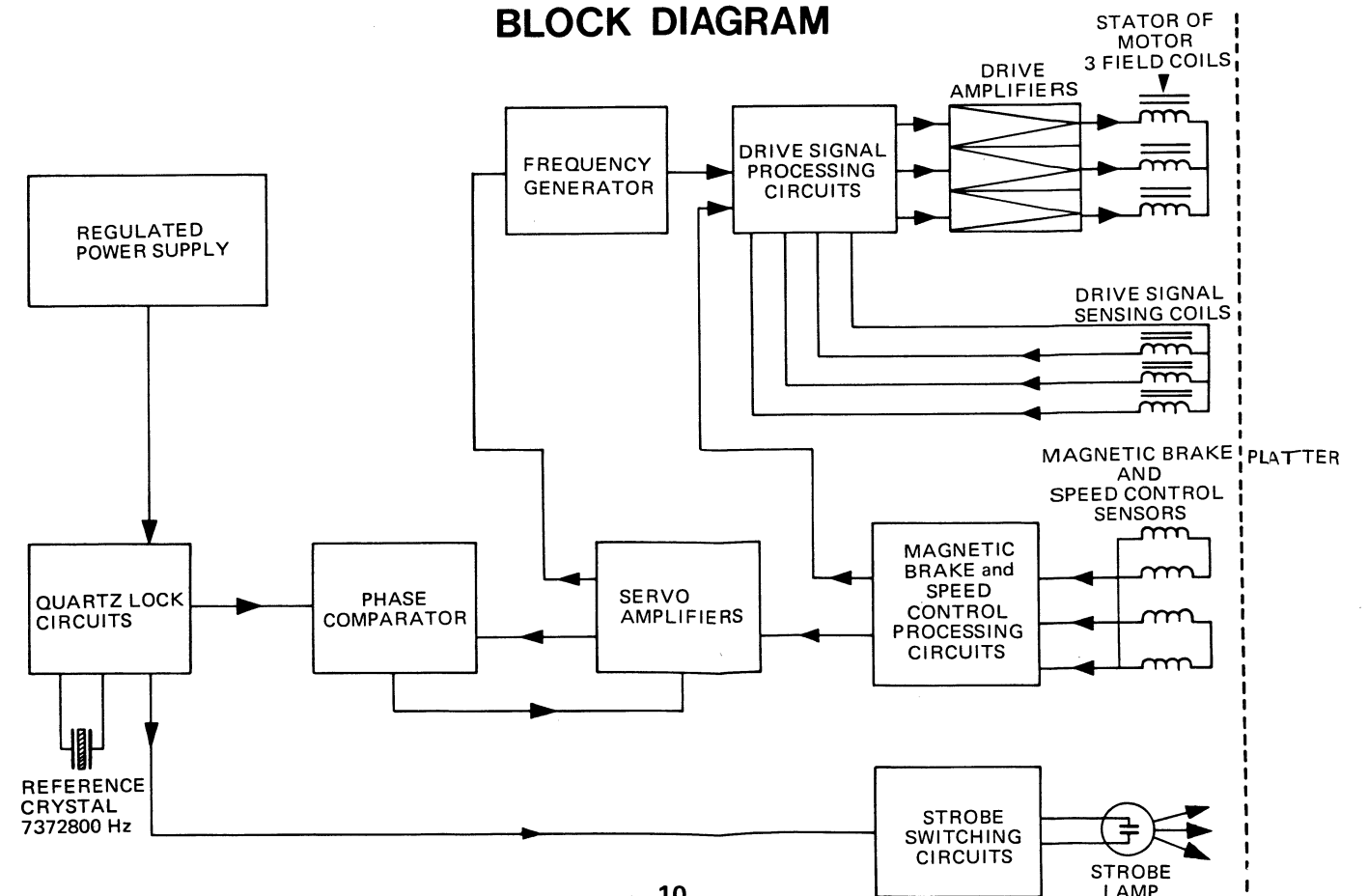

## ELECTRICAL ADJUSTMENTS AND PROCEDURE

Although the adjustments below are performed at the factory, be sure to recheck each adjustment whenever the printed circuit boards are removed and repaired.

### 1. DC Balance Adjustment

- Remove the turntable platter. (The unit can be placed vertically.)
- Remove the tonearm from the tonearm rest and move it to a position which corresponds approximately to the center of the modulated grooves of an LP record.
- On the main P.C.Board connect a DC VTVM between test points (TP-1) and Pin No. 7 and subsequently between test point (TP-1) and Pin No. 10. Adjust first VR105 and then VR106 for minimum DC voltage. The value measured should be less than 10 mV DC.

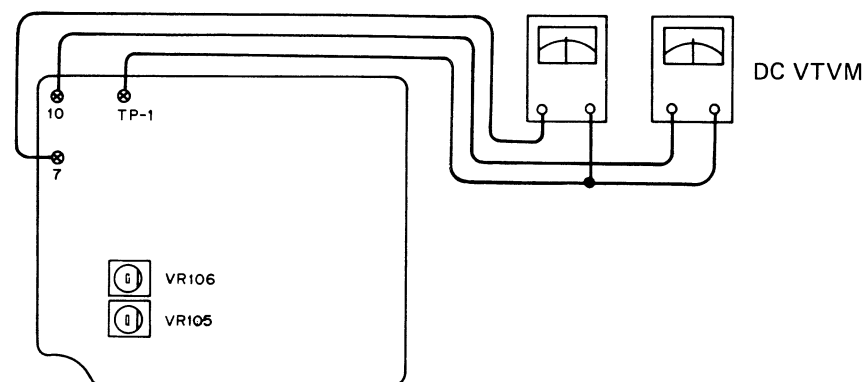

### 2. Speed Adjustment

- Place the unit horizontally and set the pitch control knobs (VR301, VR302) to their mechanical center positions.
- Set the speed selector to 33 1/3 RPM and place the tonearm on the test record. Adjust VR101 for zero deviation by observing the stroboscope, then set the speed selector to 45 RPM and adjust VR102 for zero deviation by observing the stroboscope.

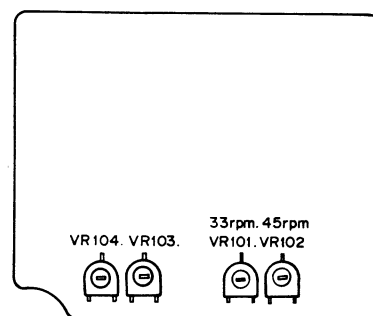

### 3. Rumble Balance

- Place the turntable on a solid (non-vibrating) surface. Connect the turntable audio cables to an RIAA equalized preamplifier and a low pass filter (0 dB = 315 Hz and -18 dB/octave above 315 Hz). Connect an AC VTVM to the output of the low pass filter.
- Place a rumble test record with unmodulated grooves on the turntable. Set the turntable speed to 45 RPM and the quartz lock to "OFF." Set the stylus tracking pressure to 2 grams and place the tonearm on the unmodulated grooves of the test record.
- Set VR103 and VR104 to their mechanical center position. Adjust carefully VR103 and VR104 until the AC VTVM indicates minimum.

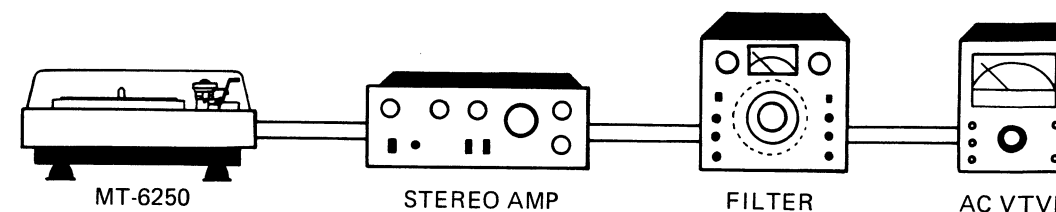

## MECHANICAL ADJUSTMENTS

### TO NEARM HEIGHT ADJUSTMENT

Loosen the tonearm height adjusting screw (65) and adjust the height by sliding the support arm (58) and secure the screw.

### TO NEARM LIFT POSITION ADJUSTMENT (Return point)

Turn screw (A) clockwise to move outwards, and counterclockwise to move inwards.

## MOUNTING THE CARTRIDGE

- Carefully mount cartridge according to maker's instructions. DO NOT tighten mounting screws.
- Connect the 4 colored wires in the cartridge shell to cartridge terminals. It is important that connections be made correctly. That is, colors of wires and cartridge terminals be matched.

White = Left output  
 Blue = Left ground  
 Red = Right output  
 Green = Right ground

- Plug cartridge shell into tone arm and tighten the cartridge shell ring by turning it counterclockwise (See Fig. 2)
- Move the tone arm over the overhang indicator (Bubble) and adjust cartridge until the stylus point is located exactly above the overhang indicator (red center ring of Bubble). Fix cartridge in this location by TIGHTENING the mounting screws. (See Fig. 3)

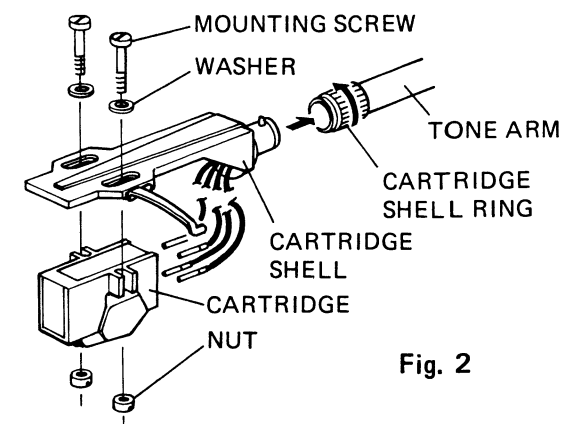

Fig. 2

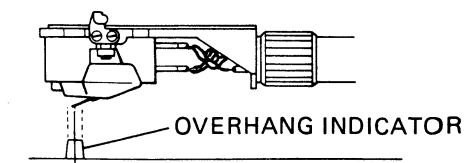
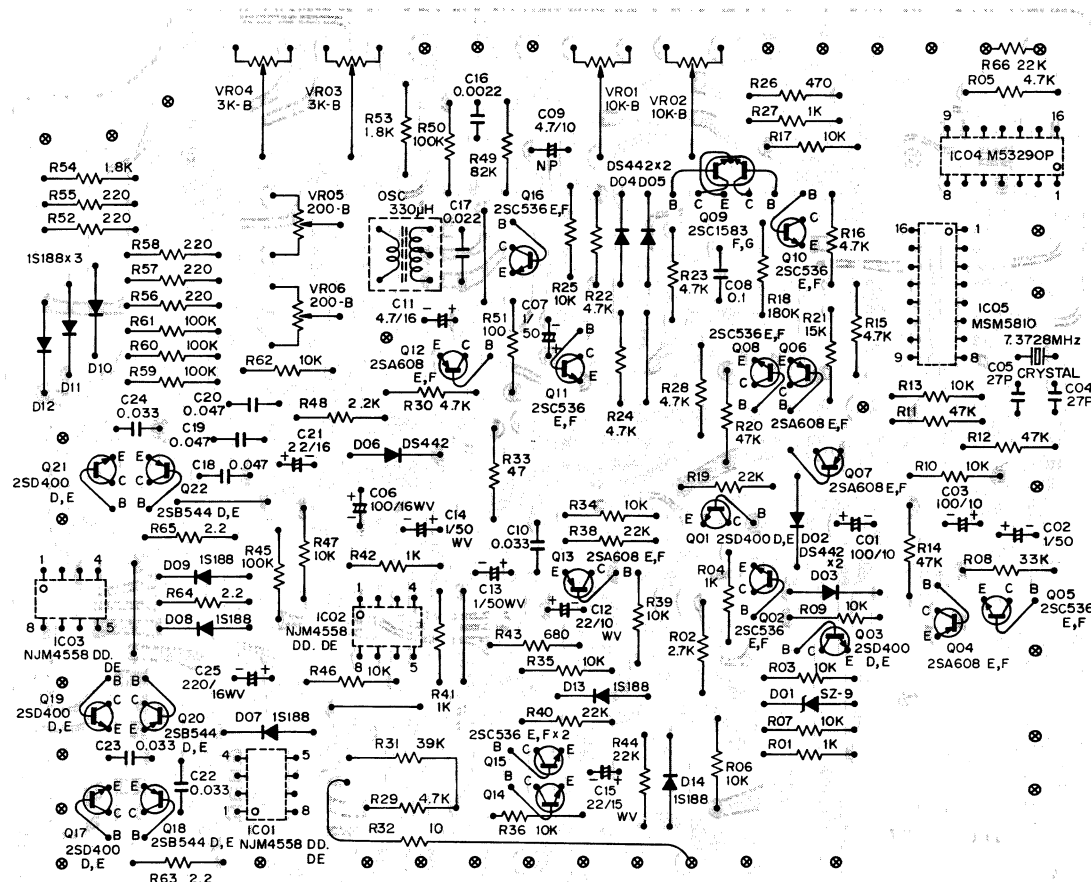
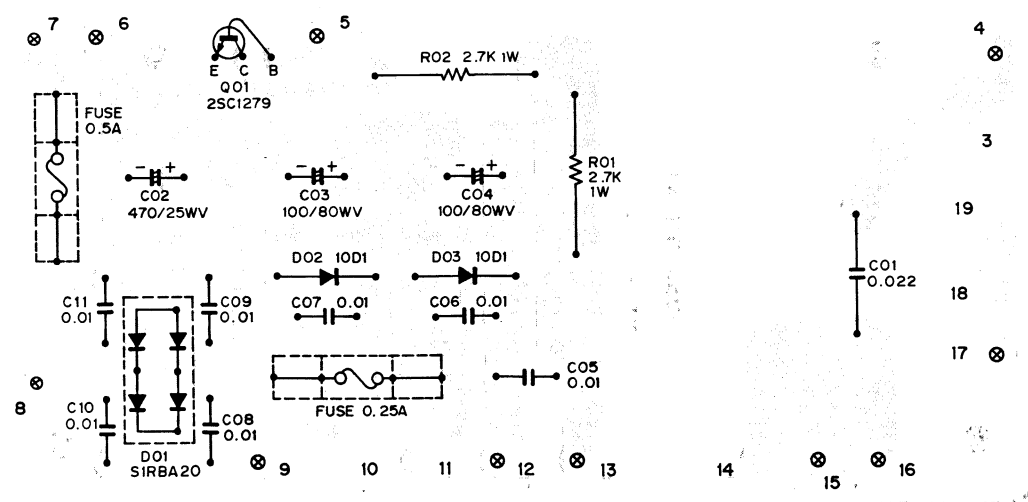

Fig. 3

## MOTOR P.C.BOARD (BOTTOM VIEW)



## POWER SUPPLY P.C.BOARD (BOTTOM VIEW)



### MOTOR P.C.B. Assy 1310 4001 92000

Ref. No.	Parts Number	Description
	4 2252 00010	Crystal (7.3728 MHz)
	4 2589 20900	OSC Coil (330 μH)
VR01,02	4 2229 24820	VR 10k-B
VR03,04	4 2222 00100	Semi-Fixed VR 3k
VR05,06	4 2229 26070	VR 200

#### CAPACITORS

C01	C1ARE-107A	Electrolytic 100 μF 10V
C02	C1HRE-105A	Electrolytic 1 μF 50V
C03	C1ARE-107A	Electrolytic 100 μF 10V
C04,05	C1HCSK270SL	Ceramic 27 pF 50V ±10%
C06	C1CRE-107A	Electrolytic 100 μF 16V
C07	C1HRE-105A	Electrolytic 1 μF 50V
C08	C1HFAM104A	Mylar 0.1 μF 50V ±20%
C09	C1ARE-475A	Electrolytic 4.7 μF 10V
C10	C1HFAM333A	Mylar 0.033 μF 50V ±20%
C11	C1CRE-475A	Electrolytic 4.7 μF 16V
C12	C1ARE-226A	Electrolytic 22 μF 10V
C13,14	C1HRE-105A	Electrolytic 1 μF 50V
C15	C1ARE-220A	Electrolytic 22 μF 10V
C16	C1HFAM222A	Mylar 0.022 μF 50V ±20%
C17	C1HFAM223A	Mylar 0.022 μF 50V ±20%
C18,19	C1HFAM473A	Mylar 0.047 μF 50V ±20%
C20		
C21	C1CRE-226A	Electrolytic 22 μF 16V
C22,23	C1HFAM333A	Mylar 0.033 μF 50V ±20%
C24		
C25	C1CRE-227A	Electrolytic 220 μF 16V

#### SEMICONDUCTORS

D01	202 5 3000 00910	Diode, SZ-9
D02,03	205 5 9040 44210	Diode, SD-442
04,05,06		
D07,08	202 5 9110 18820	Diode, 1S-188FM1
09,10		
11,12		
13,14		
IC01,02	IJJ-NJM558D	IC, NJM4558D-E
03		
IC04	IMM-M53290P	IC, M53290P
IC05	IPP-MSM5810	IC, MSM5810
Q01,03	203 5 6900 40050	TR 2SD400E
17,19		
21		
Q02,05	203 5 5000 53660	TR 2SC536
08,10		
11,14		
15,16		
Q04,06	203 5 7200 60860	TR 2SA608F
07,12		
13		
Q9	TMM-2SC1583-G	TR 2SC-1583 G
Q18,20	203 5 6860 54450	TR 2SB544E-MP
22		

#### RESISTORS

R01	R2EDZJ102APA	Carbon 1k 1/4W ±5%
R02	R2EDZJ272APA	Carbon 2.7k 1/4W ±5%
R03	R2EDZJ103APA	Carbon 10k 1/4W ±5%
R04	R2EDZJ102APA	Carbon 1k 1/4W ±5%
R05	R2EDZJ472APA	Carbon 4.7k 1/4W ±5%
R06,07	R2EDZJ103APA	Carbon 10k 1/4W ±5%

## PARTS LIST

### RESISTORS

R08	R2EDZJ333APA	Carbon 33k 1/4W ±5%
R09,10	R2EDZJ103APA	Carbon 10k 1/4W ±5%
R11,12	R2EDZJ473APA	Carbon 47k 1/4W ±5%
R13	R2EDZJ103APA	Carbon 10k 1/4W ±5%
R14	R2EDZJ473APA	Carbon 47k 1/4W ±5%
R15,16	R2EDZJ472APA	Carbon 4.7k 1/4W ±5%
R17	R2EDZJ103APA	Carbon 10k 1/4W ±5%
R18	R2EDZJ184APA	Carbon 180k 1/4W ±5%
R19	R2EDZJ223APA	Carbon 22k 1/4W ±5%
R20	R2EDZJ473APA	Carbon 47k 1/4W ±5%
R21	R2EDZJ153APA	Carbon 15k 1/4W ±5%
R22,23	R2EDZJ472APA	Carbon 4.7k 1/4W ±5%
24		
R25	R2EDZJ103APA	Carbon 10k 1/4W ±5%
R26	R2EDZJ471APA	Carbon 470 1/4W ±5%
R27	R2EDZJ102APA	Carbon 1k 1/4W ±5%
R28,29	R2EDZJ472APA	Carbon 4.7k 1/4W ±5%
30		
R31	R2EDPJ393A	Carbon 39k 1/4W ±5%
R32	R2EDZJ100A	Carbon 10 1/4W ±5%
R33	R2EDZJ470APA	Carbon 47 1/4W ±5%
R34,35	R2EDZJ103APA	Carbon 10k 1/4W ±5%
36		
R38	R2EDZJ223APA	Carbon 22k 1/4W ±5%
R39	R2EDZJ103APA	Carbon 10k 1/4W ±5%
R40	R2EDZJ223APA	Carbon 22k 1/4W ±5%
R41,42	R2EDZJ102APA	Carbon 1k 1/4W ±5%
R43	R2EDZJ681APA	Carbon 680 1/4W ±5%
R44,66	R2EDZJ223APA	Carbon 22k 1/4W ±5%
R45	R2EDZJ104APA	Carbon 100k 1/4W ±5%
R46,47	R2EDZJ103APA	Carbon 10k 1/4W ±5%
R48	R2EDZJ222PAA	Carbon 2.2k 1/4W ±5%
R49	R2EDZJ823APA	Carbon 82k 1/4W ±5%
R50	R2EDZJ104APA	Carbon 100k 1/4W ±5%
R51	R2EDZJ101APA	Carbon 100 1/4W ±5%
R52	R2EDZJ221APA	Carbon 220 1/4W ±5%
R53,54	R2EDZJ182APA	Carbon 1.8k 1/4W ±5%
R55,56	R2EDZJ221APA	Carbon 220 1/4W ±5%
57,58		
R59,60	R2EDZJ104APA	Carbon 100k 1/4W ±5%
61		
R62	R2EDZJ103APA	Carbon 10k 1/4W ±5%
R63,64	R2EDSJ2R2A	Carbon 2.2 1/4W ±5%
65		

### POWER SUPPLY P.C.B. Assy 1310 4001 00140

Ref. No.	Parts Number	Description
	4 2349 21320	Fuse 0.25AT
	4 2349 21420	Fuse 0.5A

#### CAPACITORS

C01	C2EHRM223A	Metalized Paper 0.022 μF 250V ±20%
C02	C1ERE-477A	Electrolytic 470 μF 25V
C03,04	4 2239 20840	Electrolytic 100 μF 80V -10,+50%
C05,06	C2HYDP103A	Ceramic 0.01 μF 500V +100,-0%
07,08,09,10,11		

#### SEMICONDUCTOR

D01	DDD-S1RBA20	Diode Bridge SIRBA20
D02,03	DCC-10D1	Diode, 10D1
Q01	TNN-2SC1279S	TR 2SC1279S

#### RESISTORS

R01,02	R3AXB272A	Oxide Metal Film 2.7k 1W ±5%
--------	-----------	------------------------------



**PARTS LIST**

Ref. No.	Parts No.	Description
<b>PACKING</b>		
	131 6 1139 67001	Box Corrugate-EXP
	131 6 2119 01362	Bag Polyethylene-EXP (Set)
	131 6 2119 01470	Bag Polyethylene-EXP (AC Cord & Phono Lead)
	131 6 2119 01690	Bag Polyethylene-EXP (Lid)
	131 6 2519 01300	Bag Polyethylene IND (Weight)
	131 6 3009 19520	Pad (Bottom Turntable)
	131 6 3009 19980	Pad (Top)
	131 6 3009 25550	Pad (Left & Right)
<b>ACCESSORIES</b>		
	131 6 2519 07400	Bag Polyethylene IND
	131 6 2719 10801	Bag Fan
	131 6 4119 68201	Explanatory Booklet
	131 6 4159 14700	Guarantee Certificate
	131 6 4519 15200	Guarantee Card
	131 6 2519 07400	Bag Polyethylene IND
	134 0 9905 00100	Set Screws
	134 2 4201 12900	Screw M2.6, L=6
	134 2 4201 12901	Screw M2.6, L=10
	134 2 4201 12902	Screw M2.6, L=12
	134 2 4201 12903	Screw M2.6, L=18
	134 2 4202 11301	Nut
	134 2 4203 01803	Washer (Nylon, 2.6x5x0.5t)
	134 2 4119 10700	Sub Weight
		For using the Cartridge
<b>CABINET</b>		
1	131 0 1003 12500	Leg Assy (Plate Bottom)
2	131 0 2002 14203	Hinge Assy (Cabinet)
3	131 2 1101 37001	Cabinet
4	131 2 1105 19900	Plate Bottom
	131 0 2022 90140	Lid Assy
5	131 2 1107 19801	Lid
6	131 2 2904 12300	Pad Lid
7	131 2 1310 22106	Name Plate (Lid)
8	131 2 1301 16801	Badge
9	131 2 1310 28715	Name Plate (Cabinet Rear)
10	131 2 1407 11400	Cover Decorate (Motor Assy)
11	131 2 6113 28600	Shelter
12	131 2 2108 01400	Hinge (Lid)
13*	131 2 4203 19400	Washer (4.1x24x1.6t)
14	131 2 1503 11501	Decorate Sign (Overhang Indicator)
*	131 2 4202 12904	Nut (M4x13)
		4 - 4
*	131 2 4202 11900	Push Nut
		14 - 3
*	131 3 1204 01404	Screw, Flat Head 4.0x14
		15 - 4
*	131 2 4201 18600	Screw (M4x12)
		10 - 6
*	106 3 1103 10802	Screw, Round Head Wood +3.1x8
		9 - 2
*	106 3 1103 10801	Screw, Round Head Wood +3.1x8
		15 - 7
Ref. No.	Parts No.	Description
<b>CABINET</b>		
*	106 3 1103 11302	Screw, Round Head Wood +3.1x13
		2 - 6, 4 - 8, 16 - 2
*	101 3 1204 01005	Screw, Flat Head 4.0x10
		12 - 4
*	134 3 1104 00003	Nut, Hex Head 4.0
		104 - 3
*	102 3 2603 01801	Screw, Button Head Tapping
		3x18 4 - 8
*	101 3 1604 01205	Screw, Binding Head 4.0x12
		104 - 3
*	102 3 2003 00603	Screw, Binding Head Tapping
		3.0x6 10 - 2
*	131 2 4203 18800	Washer
		104 - 3
*	131 2 4203 84208	Washer Plain 4.2x10x1.0
		104 - 3
<b>TURNTABLE</b>		
15*	134 2 2101 12900	Unit Plate
16*	131 2 3101 47601	Metal Mount (Line Cord)
17*	131 2 3608 10300	Cramp Wire (Phone Cord Cramp)
18*	131 2 3608 12401	Cramp Wire
19*	131 2 3608 12405	Cramp Wire
20*	131 2 3608 12700	Cramp Wire
21*	131 2 3608 13200	Cramp Wire
22*	131 2 3617 16500	Metal Mount Transformer
23*	131 2 4108 10300	Spindle Pulley (Metal Mount Transformer)
24*	131 2 6103 14700	Cover Shield
25	131 2 6111 14200	Bushing (Line Cord)
26	131 2 6111 15800	Bushing (Phono Cord)
27	134 2 2901 10700	Adapter EP
28	134 2 2902 00305	Pin Adapter EP
29	134 2 5202 10900	Rubber Cushion (Tone Arm Assy)
30	134 2 5202 11800	Rubber Cushion (Metal Mount Transformer)
31	131 2 3614 17101	Mount Pring C.Board (Power & Motor P.C.B.)
*	131 2 4202 12900	Flange Nut (Nut, Hex Head 3.0x10)
		28 - 1
*	102 3 1203 00802	Screw, Pan Head Tapping
		3.0x8 18 - 1
*	102 3 2203 00601	Screw, Button Head Tapping
		3.0x6 20 - 7, 24 - 1, 22 - 2
*	102 3 2203 01202	Screw, Button Head Tapping
		3.0x12 31 - 8
*	131 2 4203 83202	Washer, Plain 3.2x10x1.0
		19 - 4, 22 - 2
*	131 2 4203 83201	Washer, Plain 3.2x10x0.5
		22 - 4
32	134 0 5001 12800	Turntable Assy
33	134 0 9902 11103	Assembly Plan (Spindle T.T. Assy)
*	131 2 4201 13507	Screw (Pan Head 3.x10)
		33 - 3
*	131 2 4203 83200	Washer, Plain 3.2x8x0.5
		33 - 3
34*	131 2 4108 10300	Spindle Pulley (Return Plate Spring)

**PARTS LIST**

Ref. No.	Parts No.	Description
<b>TURNTABLE</b>		
35	134 0 6022 12010	Plate PU Fix Assy (Tone Arm Assy)
36*	134 2 2403 17200	Angle Mount
37	134 2 2902 00304	Pin Adapter EP (Gear Cycling)
38	134 2 4106 21800	Shaft (Reject Lever)
39	134 2 4106 21900	Shaft (Return Plate)
40	134 2 4106 22000	Shaft (Return Arm)
41	134 2 4107 12600	Collar
42	134 2 4108 20300	Plate
43	134 2 4110 11300	Gear Cycling
44	134 2 4112 00100	Rod
45	134 2 4122 10800	Trip
46	134 2 4122 11300	Trip
47	134 2 4123 12900	Return Arm
48	134 2 4123 15900	Arm
49	134 2 4208 14100	Spacer
50	134 2 5101 20501	Spring (Plate PU Fix Assy)
51	134 2 5101 20800	Spring (Return Plate)
52	134 2 5101 28600	Spring (Unit Plate)
53	134 2 4106 22100	Shaft (Return Plate)
54	134 2 4106 22100	Shaft (Gear Cycling)
*	104 3 1203 00002	Nut, Hex Head 3.0
		54 - 1, 35 - 1, 39 - 1
*	104 3 1104 00003	Nut, Hex Head 4.0
		39 - 1
*	131 2 4220 10502	Ring Snap
		45 - 1
*	108 3 1103 00007	Ring E 3.0
		49 - 1, 40 - 1
*	108 3 1104 00006	Ring E 4.0
		45 - 1, 49 - 1, 105 - 1
A	101 3 1103 02501	Screw, Pan Head 3.0x25
		35 - 1
*	131 2 4201 15104	Screw M3.0x10
*	102 3 1203 00602	Screw, Pan Head Tapping
		3.0x6 36 - 1
*	102 3 1203 01602	Screw, Pan Head Tapping
		3.0x16 107 - 1
*	102 3 1203 00802	Screw, Pan Head Tapping
		3.0x8 43 - 1
*	102 3 2203 00601	Screw, Button Head Tapping
		3.0x6 52 - 1
*	103 3 1103 02011	Bolt, Hex Head 3x20
		107 - 1
*	131 2 4203 38200	Washer, Plain 3.2x8x0.5
		52 - 1
*	105 3 1203 00002	Washer, Spring 3.0
		54 - 1, 53 - 1, 40 - 1, 107 - 1
*	105 3 1204 00001	Washer, Spring 4.0
		53 - 1
*	131 2 4203 83202	Washer, Plain 3.2x10x1.0
		54 - 1
*	131 2 4203 84500	Washer, Plain 4.5x10x0.8
		53 - 1
*	131 2 4203 86000	Washer, Plain 6.5x14x1.0
		53 - 1
*	131 2 4203 84501	Washer,
		53 - 1
55	131 2 1407 10800	Cover, Decorate (Base Pick-up)
56	131 2 1601 37500	Knob (Lifter Assy)
Ref. No.	Parts No.	Description
<b>TURNTABLE</b>		
57	131 2 2904 11500	Pad Lid (Cushion Lifter)
58	131 2 4201 16102	Screw (Support Arm)
59	131 2 4201 16300	Screw, (IFC Arm)
60	134 0 6017 10900	Lifter Assy
60-1	134 2 4120 17400	Lever
60-2	134 2 4124 11500	Cam
60-3	134 2 5102 13800	Spring Mounting
*	108 3 1102 00000	Ring E 2.0
*	131 2 4203 83200	Washer, Plain 3.2x8x0.5
61	134 0 6031 11600	Armrest Assy
62	134 2 1601 13801	Knob
63	134 2 3201 11900	Base Pick-up
64	134 2 4108 18200	Plate (Base Pick-up)
65	134 2 4116 12800	Spindle Lifting (Base Pick-up)
66	134 2 4123 15101	Arm (Anti Skate Knob)
67	134 2 4213 10800	Washer Bowl (Lifter Spring)
68	134 2 5101 27100	Spring (IFC Arm)
69	134 2 5101 26500	Spring (Spindle Lifting)
70	134 2 5103 10500	Spring Plate (Base Pick-up)
71	134 2 5205 11300	Cushion (Base Pick-up)
72	134 2 3310 11001	Support Arm
73	134 2 3310 11002	Support Arm (Spindle Lifting)
74	134 2 5205 11101	Cushion (Support Arm)
*	104 3 1102 60000	Nut, Hex Head 2.6
		61 - 1
*	108 3 1102 00000	Ring E 2.0
		65 - 1
*	102 3 1203 01002	Screw, Pan Head Tapping
		3.0x10 63 - 3
*	102 3 1203 00802	Screw, Pan Head Tapping
		3.0x8 64 - 2
*	131 2 4201 16300	Screw,
		66 - 1
*	102 3 1203 00602	Screw, Pan Head Tapping
		3.0x6 70 - 1
*	131 2 4203 83201	Washer, Plain 3.2x10x0.5
		65 - 1
*	131 2 4203 18900	Washer 5x8x0.8t
		66 - 1
75	4 2312 01050	Push Switch Power
76	4 2312 00750	Push Switch Quartz
77	4 2312 00760	Push Switch Speed Select
78	131 0 4006 14400	Cord Assy (Housing)
78-1	D00-SLP-231B-	SLP-231 B (Quartz Lamp)
79	131 2 4202 12904	Nut (Housing)
80	131 2 4203 19300	Washer (Speed Select Knob)
81	131 2 6308 17600	Filter (Housing)
82	134 0 1016 29300	Panel Decorate Assy
83	134 2 1404 11500	Housing (Cabinet)
84	131 0 1001 47000	Knob Assy
85	134 0 1001 12700	Knob Assy (Volume 33/44 rpm)
86	134 2 1601 15400	Knob (Quartz On Off SW)
87	134 2 1601 15500	Knob (Power & Quartz Knob)
88	134 2 2106 10900	Holder (Filter)
89*	134 2 2403 18700	Angle Mount (Unit Plate)
90*	134 2 2601 10200	Angle Switch (Quartz)
91*	134 2 2601 10400	Angle Switch (Power)
92*	134 2 4106 21800	Shaft (Angle Mount)

# PARTS LIST

Ref. No.	Parts No.	Description
<b>TURNTABLE</b>		
93	134 2 4120 16800	Reject Lever (Angle Mount)
94	134 2 5101 27400	Spring (Reject Lever)
95	134 2 5101 29100	Spring (Speed Select Knob)
*	104 3 1203 00002	Nut, Hex Head 3.0
	93 - 1	
*	131 2 4220 10503	Ring Snap
	84 - 4	
*	131 2 4220 10507	Ring Snap
	87 - 1	
*	131 2 4201 18500	Screw
	92 - 2, 93 - 2	
*	101 3 1103 00602	Screw, Pan Head 3.0x6
	89 - 2, 90 - 2, 91 - 2, 92 - 2, 76 - 2, 77 - 2	
*	102 3 2203 00601	Screw, Button Head Tapping 3.0x6
	78 - 2, 83 - 3, 88 - 1	
*	102 3 1203 01002	Screw, Pan Head Tapping 3.0x10
	93 - 1	
*	101 3 1103 00802	Screw, Pan Head 3.0x8
	102 - 1	
*	101 3 1103 01602	Screw, Pan Head 3.0x16
	93 - 1	
*	131 2 4203 83200	Washer, Plain 3.2x8x0.5
	101 - 1	
*	105 3 1203 00002	Washer, Spring 3.0
96	C1HYDZ103A--	Ceramic 0.01 $\mu$ F 50V +80,-20%
97	131 0 4004 15001	Wire Shield Assy
99	134 0 4001 06500	Tone Arm Assy
99-1	134 0 4002 10402	Arm Head Assy
99-2	134 0 4003 01500	Weight Assy Without Cartridge
*	134 2 4202 11502	Nut
	98 - 1	
*	134 2 4203 02301	Washer
	98 - 1	
*	102 3 2203 00601	Screw, Button Head Tapping 3x6
	100 - 1	
100	4 2379 21500	Terminal Lug 1-4P
101	4 2319 21993	Switch Micro (Return Plate)
102	4 2439 20526	Line Cord
103	4 6129 20792	Neon Lamp
104	134 0 5011 00700	Motor Assy (Linear Quartz Lock)
*	104 3 1104 00003	Nut, Hex Head 4.0
	104 - 3	
*	101 3 1604 01205	Screw, Binding Head 4.0x12
	104 - 3	
*	131 2 4203 18800	Washer
	104 - 3	
*	131 2 4203 84208	Washer, Plain 4.2x10x1.0
	104 - 3	
105	4 2512 04320	Power Transformer
106 (VR01)	4 2229 25280	VR 1kB (45 rpm)

Ref. No.	Parts No.	Description
<b>TURNTABLE</b>		
107	4 2229 27010	VR 2kB (33 rpm)
(VR02)		
108*	131 0 4001 00140	Power Supply P.C.B. Assy
109*	131 0 4001 92000	Motor P.C.B. Assy
110	134 2 6102 14600	Mat Turntable
111	134 2 6103 11201	Plate Decorate T.T
112	4 2312 01020	Slide Switch

NOTE: \* Asterisk indicates not a service part. The numbers for screws, nuts, and washers, shown in Description, correspond with Ref. Nos. of the parts using these screws, nuts and washers.

Example: 3 - 2

3 means Ref. No.  
2 means Q'ty.

# POINT TO POINT WIRING DIAGRAM

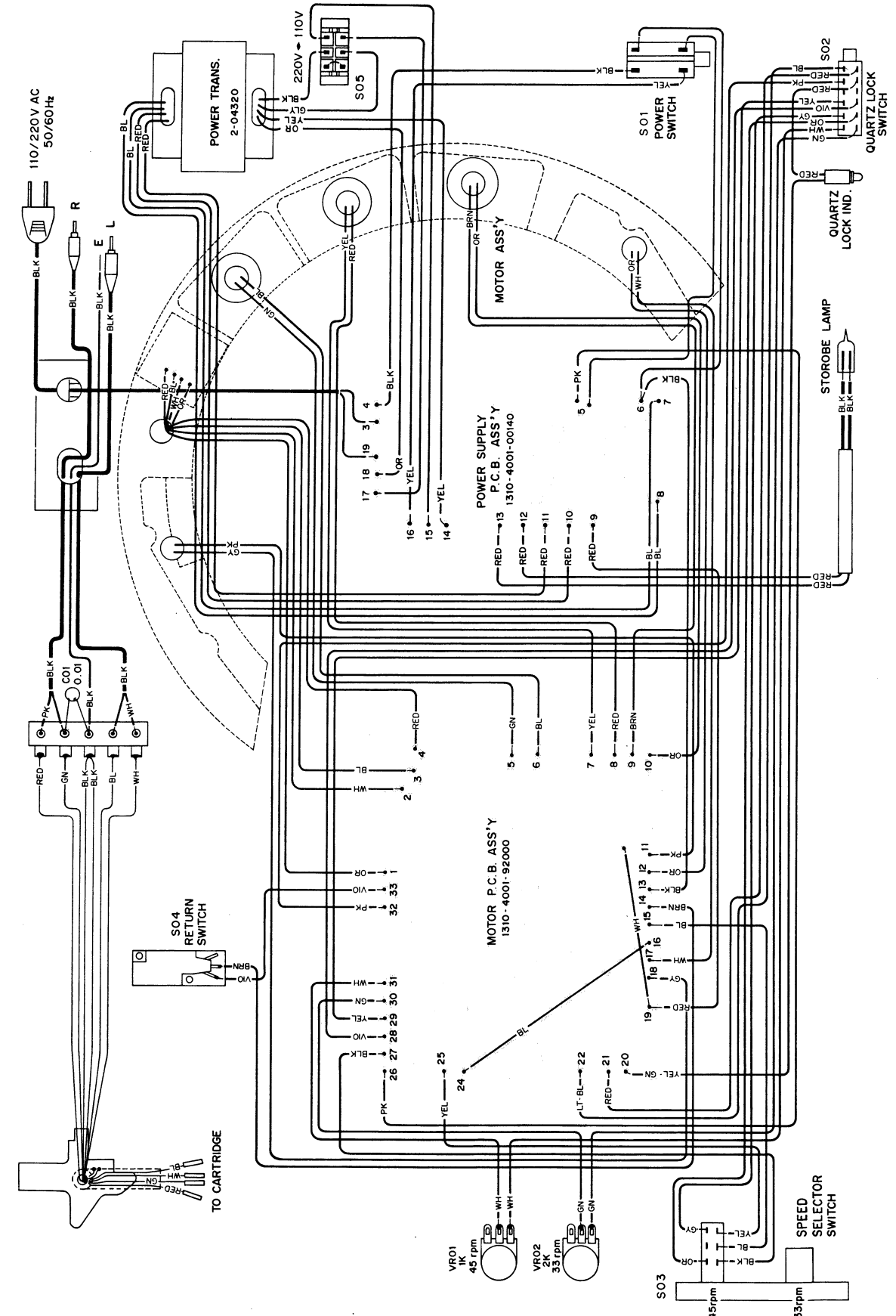



# SCHEMATIC DIAGRAM

## IC NJM 4558D EQUIVALENT CIRCUIT

**NOTE:**

1. LINE VOLTAGE ISOLATION TRANSFORMER SET TO 110/220V AC FOR ALL VOLTAGE MEASUREMENTS.
2. ALL VOLTAGES ARE ±20%, UNLESS OTHERWISE NOTED XXXDC DENOTES DC VOLTAGE MEASURED WITH DC VTVM TO CHASSIS.
3. ALL CAPACITOR VALUES ARE MICROFARAD UNLESS OTHERWISE NOTED.
4. ALL RESISTOR VALUES ARE OHMS, ±5%, 1/4 WATT UNLESS OTHERWISE NOTED.

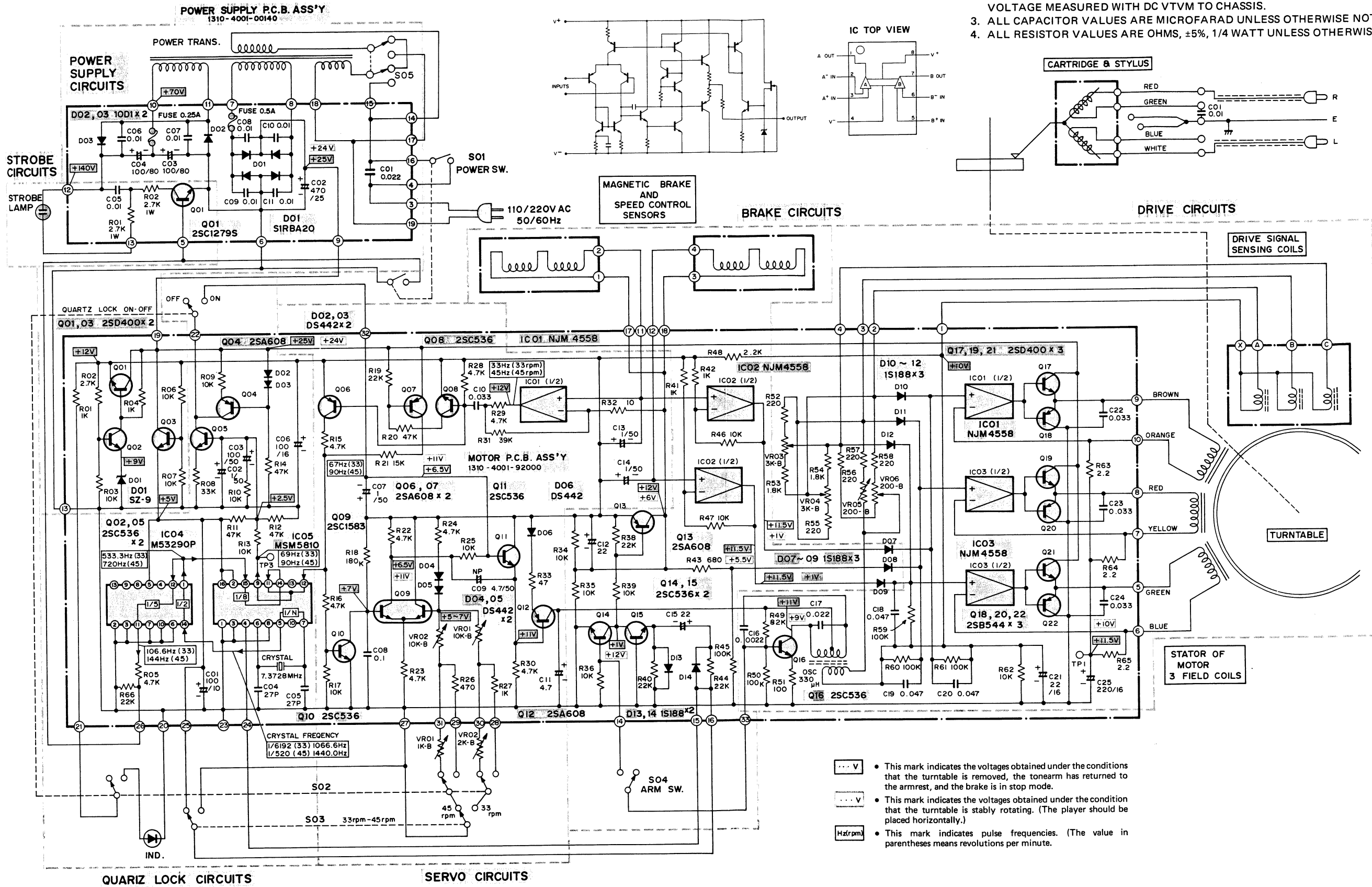

- ⋯ V • This mark indicates the voltages obtained under the conditions that the turntable is removed, the tonearm has returned to the armrest, and the brake is in stop mode.
- ⋯ V • This mark indicates the voltages obtained under the condition that the turntable is stably rotating. (The player should be placed horizontally.)
- Hxrpm • This mark indicates pulse frequencies. (The value in parentheses means revolutions per minute.)

# SEMICONDUCTOR LEAD IDENTIFICATION

## INTEGRATED CIRCUITS (PLASTIC CASE)

16 PIN  
DUAL IN-LINE

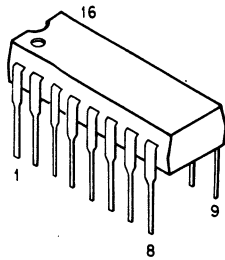

- MSM5810

14 PIN  
DUAL IN-LINE

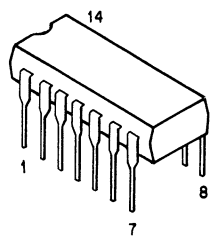

- M53290P

8 PIN  
DUAL IN-LINE

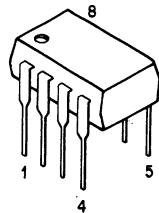

- NJM4558D

## BI-POLAR TRANSISTORS (PLASTIC CASE)

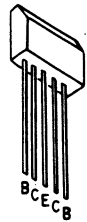

- 2SC1583

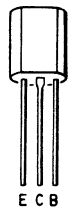

- 2SD400E
- 2SB544E



- 2SC536
- 2SA608
- 2SC1279S

## DIODES

### DIODE SYMBOL

Anode  Cathode

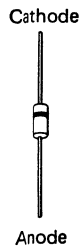

- DS-442
- IS-188
- 10D1

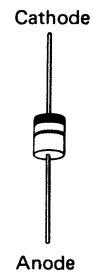

- SZ-9

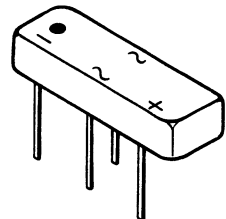
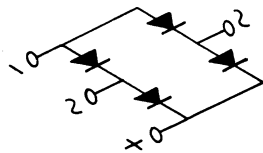

- S1RBA20



 **FISHER**

Service und Auslieferungslager:  
FISHER HiFi Europa, Vertriebs-GmbH  
Schönstraße 80, 8000 München 90  
Telefon 089/652011

Verwaltung und Verkauf:  
FISHER HiFi Europa, Vertriebs-GmbH  
Widenmayerstraße 25, 8000 München 22  
Telefon 089/224851, Telex 5-24033 D

Wenden Sie sich bitte mit technischen  
Fragen an diese Adresse

PRINTED IN JAPAN

78/Jun. WM-3021