**User's
Manual**

**MX100
Standard Software**



vigilantplant.®

Thank you for purchasing the MX100 Data Acquisition Unit.

This user's manual contains useful information about the functions and operating procedures of the MX100 Standard Software and lists the handling precautions of the software. To ensure correct use, please read this manual thoroughly before beginning operation.

After reading the manual, keep it in a convenient location for quick reference whenever a question arises during operation.

The following five manuals relating to the MX100 Data Acquisition Unit (hereinafter the "MX100") are provided in addition to this one. Read them along with this manual.

The MX100 Data Acquisition Unit User's Manual (IM MX100-01E), MX100 Data Acquisition Unit Operation Guide (IM MX100-02E), and this manual (IM MX180-01E) are all available on the MX100 Manual CD-ROM.

Manual Title	Manual No.	Description
MX100 Data Acquisition Unit User's Manual	IM MX100-01E	Describes the functions, installation, wiring procedures, handling precautions, and other information about MX100.
MX100 Data Acquisition Unit Operation Guide	IM MX100-02E	Describes concisely the handling of the MX100 and the basic operations of the MX100 Standard Software.
Precautions on the Use of the MX100/MW100 Data Acquisition Unit	IM MX100-71E	Summarizes the usage precautions of the MX100/MW100.
MX100/MW100 Data Acquisition Unit Installation and Connection Guide	IM MX100-72E	Describes concisely the installation and wiring procedures of the MX100/MW100.
Control of pollution caused by MX100/MW100 products	IM MX100-91C	Describes control of pollution caused by the product.

Notes

- **This manual describes the MX100 Standard Software, release number "R3.03.01." You can check the release number by choosing About from the Help menu of the Standard Software.**
- The contents of this manual are subject to change without prior notice as a result of continuing improvements to the software's performance and functions. The figures given in this manual may differ from those that actually appear on your screen.
- Every effort has been made in the preparation of this manual to ensure the accuracy of its contents. However, should you have any questions or find any errors, please contact your nearest YOKOGAWA dealer.
- This user's manual does not cover the handling and operating procedures of Windows.
- Copying or reproducing all or any part of the contents of this manual without YOKOGAWA's permission is strictly prohibited.

Trademarks

- DAQMASTER is a registered trademark of Yokogawa Electric Corporation.
- Microsoft and Windows are registered trademarks or trademarks of Microsoft Corporation in the United States and/or other countries.
- Adobe and Acrobat are registered trademarks or trademarks of Adobe Systems Incorporated.
- Company and product names that appear in this manual are registered trademarks or trademarks of their respective holders.
- The company and product names used in this manual are not accompanied by the registered trademark or trademark symbols (® and ™).

Revisions

- 1st Edition: May, 2003
- 2nd Edition: November, 2004
- 3rd Edition: February, 2008
- 4th Edition: March 2012

Terms and Conditions of the Software License

NOTICE - PLEASE READ CAREFULLY BEFORE USE

Thank you very much for purchasing this medium containing a software program and related documentation provided by Yokogawa Electric Corporation (hereinafter called "Yokogawa"), and the program contained, embedded, inserted or used in the medium (hereinafter called the "Yokogawa Software Program").

By opening this package or plastic wrapping (hereinafter called "Package") enclosing the Yokogawa Software Program, you acknowledge that you understand and agree to the "Terms and Conditions of the Software License" (hereinafter called "Terms and Conditions") which is written in the documentation and separately attached. Accordingly, the Terms and Conditions bind you.

The Yokogawa Software Program and its related documentation including ownership of copyright shall remain the exclusive property of Yokogawa or those third parties from whom sublicensed software in the Yokogawa Software Program is licensed.

Yokogawa hereby grants you permission to use the Yokogawa Software Program on the conditions that you agree to the Terms and Conditions before you open the Package and/or install it in or onto a computer.

IF YOU DO NOT AGREE TO THE TERMS AND CONDITIONS, YOU CANNOT OPEN THE PACKAGE, AND MUST IMMEDIATELY RETURN IT TO YOKOGAWA OR ITS DESIGNATED PARTY.

Terms and Conditions of the Software License

Yokogawa Electric Corporation, a Japanese corporation (hereinafter called "Yokogawa"), grants permission to use this Yokogawa Software Program (hereinafter called the "Licensed Software") to the Licensee on the conditions that the Licensee agrees to the terms and conditions stipulated in Article 1 hereof.

You, as the Licensee (hereinafter called "Licensee"), shall agree to the following terms and conditions for the software license (hereinafter called the "Agreement") based on the use intended for the Licensed Software.

Please note that Yokogawa grants the Licensee permission to use the Licensed Software under the terms and conditions herein and in no event shall Yokogawa intend to sell or transfer the Licensed Software to the Licensee.

Licensed Software Name: MX100 Standard Software (Model MX180)

Number of License: 1

Article 1 (Scope Covered by these Terms and Conditions)

- 1.1 The terms and conditions stipulated herein shall be applied to any Licensee who purchases the Licensed Software on the condition that the Licensee consents to agree to the terms and conditions stipulated herein.
- 1.2 The "Licensed Software" herein shall mean and include all applicable programs and documentation, without limitation, all proprietary technology, algorithms, and know-how such as a factor, invariant or process contained therein.

Article 2 (Grant of License)

- 2.1 Yokogawa grants the Licensee, for the purpose of single use, non-exclusive and non-transferable license of the Licensed Software with the license fee separately agreed upon by both parties.
- 2.2 The Licensee is, unless otherwise agreed in writing by Yokogawa, not entitled to copy, change, sell, distribute, transfer, or sublicense the Licensed Software.
- 2.3 The Licensed Software shall not be copied in whole or in part except for keeping one (1) copy for back-up purposes. The Licensee shall secure or supervise the copy of the Licensed Software by the Licensee itself with great, strict, and due care.
- 2.4 In no event shall the Licensee dump, reverse assemble, reverse compile, or reverse engineer the Licensed Software so that the Licensee may translate the Licensed Software into other programs or change it into a man-readable form from the source code of the Licensed Software. Unless otherwise separately agreed by Yokogawa, Yokogawa shall not provide the Licensee the source code for the Licensed Software.
- 2.5 The Licensed Software and its related documentation shall be the proprietary property or trade secret of Yokogawa or a third party which grants Yokogawa the rights. In no event shall the Licensee be transferred, leased, sublicensed, or assigned any rights relating to the Licensed Software.
- 2.6 Yokogawa may use or add copy protection in or onto the Licensed Software. In no event shall the Licensee remove or attempt to remove such copy protection.
- 2.7 The Licensed Software may include a software program licensed for re-use by a third party (hereinafter called "Third Party Software", which may include any software program from affiliates of Yokogawa made or coded by themselves.) In the case that Yokogawa is granted permission to sublicense to third parties by any licensors (sub-licensor) of the Third Party Software pursuant to different terms and conditions than those stipulated in this Agreement, the Licensee shall observe such terms and conditions of which Yokogawa notifies the Licensee in writing separately.
- 2.8 In no event shall the Licensee modify, remove or delete a copyright notice of Yokogawa and its licensor contained in the Licensed Software, including any copy thereof.

Article 3 (Restriction of Specific Use)

- 3.1 The Licensed Software shall not be intended specifically to be designed, developed, constructed, manufactured, distributed or maintained for the purpose of the following events:
 - a) Operation of any aviation, vessel, or support of those operations from the ground;;
 - b) Operation of nuclear products and/or facilities;;
 - c) Operation of nuclear weapons and/or chemical weapons and/or biological weapons; or
 - d) Operation of medical instrumentation directly utilized for humankind or the human body.
- 3.2 Even if the Licensee uses the Licensed Software for the purposes in the preceding Paragraph 3.1, Yokogawa has no liability to or responsibility for any demand or damage arising out of the use or operations of the Licensed Software, and the Licensee agrees, on its own responsibility, to solve and settle the claims and damages and to defend, indemnify or hold Yokogawa totally harmless, from or against any liabilities, losses, damages and expenses (including fees for recalling the Products and reasonable attorney's fees and court costs), or claims arising out of and related to the above-said claims and damages.

Article 4 (Warranty)

- 4.1 The Licensee shall agree that the Licensed Software shall be provided to the Licensee on an "as is" basis when delivered. If defect(s), such as damage to the medium of the Licensed Software, attributable to Yokogawa is found, Yokogawa agrees to replace, free of charge, any Licensed Software on condition that the defective Licensed Software shall be returned to Yokogawa's specified authorized service facility within seven (7) days after opening the Package at the Licensee's expense. As the Licensed Software is provided to the Licensee on an "as is" basis when delivered, in no event shall Yokogawa warrant that any information on or in the Licensed Software, including without limitation, data on computer programs and program listings, be completely accurate, correct, reliable, or the most updated.
- 4.2 Notwithstanding the preceding Paragraph 4.1, when third party software is included in the Licensed Software, the warranty period and terms and conditions that apply shall be those established by the provider of the third party software.

Terms and Conditions of the Software License

- 4.3 When Yokogawa decides in its own judgement that it is necessary, Yokogawa may from time to time provide the Licensee with Revision upgrades and Version upgrades separately specified by Yokogawa (hereinafter called "Updates").
- 4.4 Notwithstanding the preceding Paragraph 4.3, in no event shall Yokogawa provide Updates where the Licensee or any third party conducted renovation or improvement of the Licensed Software.
- 4.5 THE FOREGOING WARRANTIES ARE EXCLUSIVE AND IN LIEU OF ALL OTHER WARRANTIES OF QUALITY AND PERFORMANCE, WRITTEN, ORAL, OR IMPLIED, AND ALL OTHER WARRANTIES INCLUDING ANY IMPLIED WARRANTIES OF MERCHANTABILITY OR FITNESS FOR A PARTICULAR PURPOSE ARE HEREBY DISCLAIMED BY YOKOGAWA AND ALL THIRD PARTIES LICENSING THIRD PARTY SOFTWARE TO YOKOGAWA.
- 4.6 Correction of nonconformity in the manner and for the period of time provided above shall be the Licensee's sole and exclusive remedy for any failure of Yokogawa to comply with its obligations and shall constitute fulfillment of all liabilities of Yokogawa and any third party licensing the Third Party Software to Yokogawa (including any liability for direct, indirect, special, incidental or consequential damages) whether in warranty, contract, tort (including negligence but excluding willful conduct or gross negligence by Yokogawa) or otherwise with respect to or arising out of the use of the Licensed Software.

Article 5 (Infringement)

- 5.1 If and when any third party should demand injunction, initiate a law suit, or demand compensation for damages against the Licensee under patent right (including utility model right, design patent, and trade mark), copy right, and any other rights relating to any of the Licensed Software, the Licensee shall notify Yokogawa in writing to that effect without delay.
- 5.2 In the case of the preceding Paragraph 5.1, the Licensee shall assign to Yokogawa all of the rights to defend the Licensee and to negotiate with the claiming party. Furthermore, the Licensee shall provide Yokogawa with necessary information or any other assistance for Yokogawa's defense and negotiation. If and when such a claim should be attributable to Yokogawa, subject to the written notice to Yokogawa stated in the preceding Paragraph 5.1, Yokogawa shall defend the Licensee and negotiate with the claiming party at Yokogawa's cost and expense and be responsible for the final settlement or judgment granted to the claiming party in the preceding Paragraph 5.1.
- 5.3 When any assertion or allegation of the infringement of the third party's rights defined in Paragraph 5.1 is made, or when at Yokogawa's judgment there is possibility of such assertion or allegation, Yokogawa will, at its own discretion, take any of the following countermeasures at Yokogawa's cost and expense.
- a) To acquire the necessary right from a third party which has lawful ownership of the right so that the Licensee will be able to continue to use the Licensed Software;
 - b) To replace the Licensed Software with an alternative one which avoids the infringement; or
 - c) To remodel the Licensed Software so that the Licensed Software can avoid the infringement of such third party's right.
- 5.4 If and when Yokogawa fails to take either of the countermeasures as set forth in the preceding subparagraphs of Paragraph 5.3, Yokogawa shall indemnify the Licensee only by paying back the price amount of the Licensed Software which Yokogawa has received from the Licensee. THE FOREGOING PARAGRAPHS STATE THE ENTIRE LIABILITY OF YOKOGAWA AND ANY THIRD PARTY LICENSING THIRD PARTY SOFTWARE TO YOKOGAWA WITH RESPECT TO INFRINGEMENT OF THE INTELLECTUAL PROPERTY RIGHTS INCLUDING BUT NOT LIMITED TO, PATENT AND COPYRIGHT.

Article 6 (Liabilities)

- 6.1 If and when the Licensee should incur any damage relating to or arising out of the Licensed Software or service that Yokogawa has provided to the Licensee under the conditions herein due to a reason attributable to Yokogawa, Yokogawa shall take actions in accordance with this Agreement. However, in no event shall Yokogawa be liable or responsible for any special, incidental, consequential and/or indirect damage, whether in contract, warranty, tort, negligence, strict liability, or otherwise, including, without limitation, loss of operational profit or revenue, loss of use of the Licensed Software, or any associated products or equipment, cost of capital, loss or cost of interruption of the Licensee's business, substitute equipment, facilities or services, downtime costs, delays, and loss of business information, or claims of customers of Licensee or other third parties for such or other damages. Even if Yokogawa is liable or responsible for the damages attributable to Yokogawa and to the extent of this Article 6, Yokogawa's liability for the Licensee's damage shall not exceed the price amount of the Licensed Software or service fee which Yokogawa has received. Please note that Yokogawa shall be released or discharged from part or all of the liability under this Agreement if the Licensee modifies, remodels, combines with other software or products, or causes any deviation from the basic specifications or functional specifications, without Yokogawa's prior written consent.
- 6.2 All causes of action against Yokogawa arising out of or relating to this Agreement or the performance or breach hereof shall expire unless Yokogawa is notified of the claim within one (1) year of its occurrence.
- 6.3 In no event, regardless of cause, shall Yokogawa assume responsibility for or be liable for penalties or penalty clauses in any contracts between the Licensee and its customers.

Article 7 (Limit of Export)

Unless otherwise agreed by Yokogawa, the Licensee shall not directly or indirectly export or transfer the Licensed Software to any countries other than those where Yokogawa permits export in advance.

Article 8 (Term)

This Agreement shall become effective on the date when the Licensee receives the Licensed Software and continues in effect unless or until terminated as provided herein, or the Licensee ceases using the Licensed Software by itself or with Yokogawa's thirty (30) days prior written notice to the Licensee.

Article 9 (Injunction for Use)

During the term of this Agreement, Yokogawa may, at its own discretion, demand injunction against the Licensee in case that Yokogawa deems that the Licensed Software is used improperly or under severer environments other than those where Yokogawa has first approved, or any other condition which Yokogawa may not permit.

Article 10 (Termination)

Yokogawa, at its sole discretion, may terminate this Agreement without any notice or reminder to the Licensee if the Licensee violates or fails to perform this Agreement. However, Articles 5, 6, and 11 shall survive even after the termination.

Article 11 (Jurisdiction)

Any dispute, controversies, or differences between the parties hereto as to interpretation or execution of this Agreement shall be resolved amicably through negotiation between the parties upon the basis of mutual trust. Should the parties fail to agree within ninety (90) days after notice from one of the parties to the other, both parties hereby irrevocably submit to the exclusive jurisdiction of the Tokyo District Court (main office) in Japan for settlement of the dispute.

Article 12 (Governing Law)

This Agreement shall be governed by and construed in accordance with the laws of Japan. The Licensee expressly agrees to waive absolutely and irrevocably and to the fullest extent permissible under applicable law any rights against the laws of Japan which it may have pursuant to the Licensee's local law.

Article 13 (Severability)

In the event that any provision hereof is declared or found to be illegal by any court or tribunal of competent jurisdiction, such provision shall be null and void with respect to the jurisdiction of that court or tribunal and all the remaining provisions hereof shall remain in full force and effect.

Contents

Terms and Conditions of the Software License	iii
Chapter 1 Before Using the Software	
1.1 Functional Explanation of the MX100 Standard Software.....	1-1
1.2 System Requirements.....	1-4
1.3 Setup Procedures of the MX100 Standard Software	1-5
1.4 Starting and Exiting Software Programs	1-8
Chapter 2 Integration Monitor	
2.1 Connecting and Disconnecting the MX100.....	2-1
2.2 Configuring the System, Setting the Write Mode of the CF Card, and Formatting the CF Card.....	2-9
2.3 Setting the Acquisition Conditions of the Measured/Computed Data.....	2-14
2.4 Setting the Measurement Conditions (Setting the Measurement Channels)	2-19
2.5 Setting Computations (Setting the Computation Channels).....	2-30
2.6 Displaying the Monitor and Setting the Display Procedure.....	2-43
2.7 Starting and Stopping the Recording of Measured/Computed Data.....	2-50
2.8 Pausing the Updating of the Monitor Display and Reading Measured/Computed Values Using Cursors	2-52
2.9 Setting Alarms and Alarm Indications.....	2-54
2.10 Digital Output Settings	2-57
2.11 Analog/PWM Output Settings	2-60
2.12 Saving/Loading and Printing Setup Data (Project).....	2-64
2.13 Other Displays and Settings.....	2-67
Chapter 3 Viewer	
3.1 Loading Data Files	3-1
3.2 Display Settings	3-6
3.3 Reading Values Using Cursors	3-18
3.4 Statistical Computation over an Area of Measured/Computed Data.....	3-20
3.5 Saving the Display Settings	3-22
3.6 Saving the Display Template.....	3-23
3.7 Converting Data Formats.....	3-24
3.8 Printing the Data	3-26
Chapter 4 Calibrator	
4.1 Connecting the MX100.....	4-1
4.2 Calibration Procedure	4-4
Chapter 5 Troubleshooting	
5.1 Troubleshooting	5-1
5.2 Error Messages and Their Corrective Actions.....	5-5
Appendix	
Appendix 1 Configuring/Removing the Firewall	App-1

Index

1.1 Functional Explanation of the MX100 Standard Software

Functional Overview

The software can be used when the PC and the MX100 are connected in a one-to-one configuration. To connect multiple MX100s to a PC, you need to use MXLOGGER, a software program sold separately.

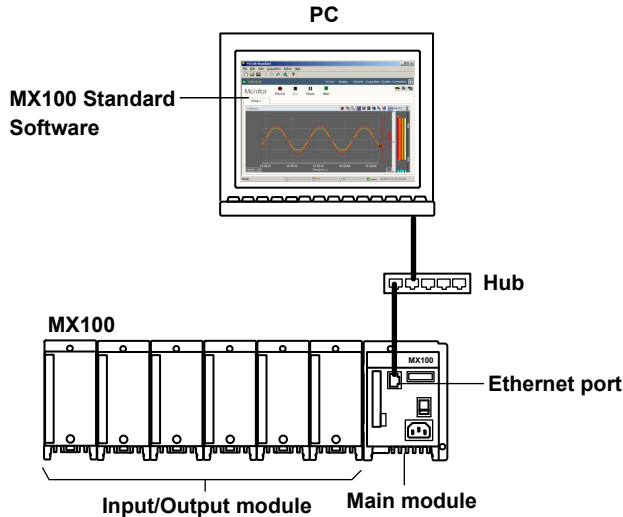

The MX100 Standard Software consists of the three software programs described below.

- **Integration Monitor**

Enables you to connect or disconnect the MX100, configure acquisition conditions and display conditions of the measured data, set up computations, monitor measured and computed data, save measured and computed data, and carry out other operations.

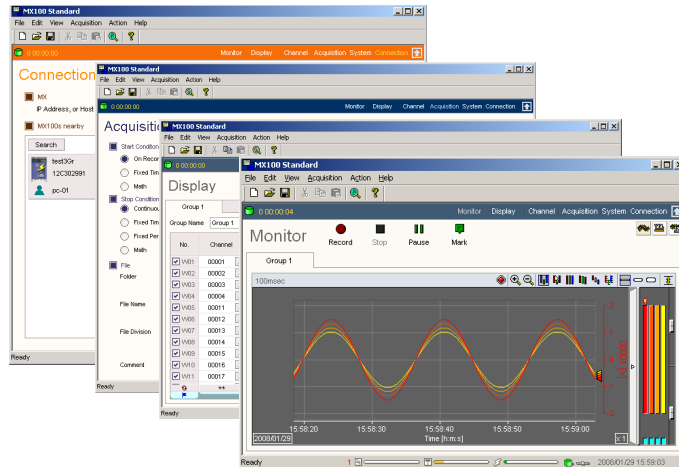

1.1 Functional Explanation of the MX100 Standard Software

- **Viewer**

Enables you to display measured and computed data that has been saved, read values and perform statistical computation over an area using cursors, and convert the measured and computed data into various file formats such as Excel.

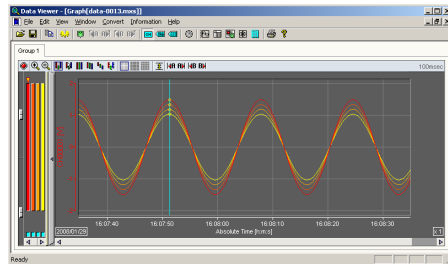

- **Calibrator**

Enables you to calibrate the MX100 input/output modules.

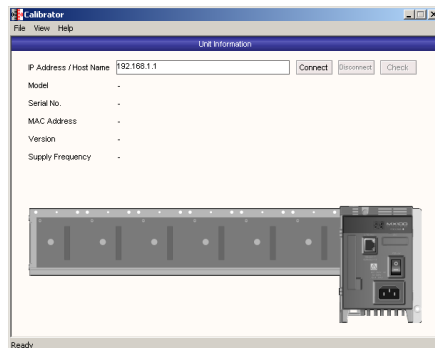

Integration Monitor

The main operations are carried out using the six windows shown below. If the MX100 is not connected, the windows other than the Connection window cannot be displayed.

- **Connection screen**

You can search for MX100s in the same segment, and connect to the target MX100. You can also assign a machine name, IP address, subnet mask, and default gateway to the detected MX100. Once a connection is established, the connection is made automatically to the same MX100 the next time the Integration Monitor is started.

- **System setup screen**

You can change the A/D integration time and check the main module information. When the attached input/output module is changed, you can update the module configuration information.

You can check the network setup information of the connected MX100.

You can format the CF card or check the free space on the CF card of the connected MX100.

- **Acquisition setup screen**

You can set the monitor interval of the measured data and the record start/stop conditions. You can also set the save destination, file name, file division, and comment of the recorded data.

- **Channel setup screen**

For each measurement channel you can set: the input type, measurement range, measurement span, and other measurement conditions; whether or not to assign the channel for measurement/recording; the alarm output conditions, and the initial balancing of the strain input modules. You can also set computations such as the four arithmetical operations using the measured data (computation channel setting), set the signal to be output from the digital output module (DO channel setting), set the signal to be output from the analog output module (AO channel settings), and set the signal to be output from the PWM output module (PWM channel settings).

- **Display setup screen**

For each display group, you can set the channel to be displayed, display scale, display zone, trip point (the value of interest in the waveform display), display color, and other parameters.

- **Monitor screen**

You can display the waveforms and numeric values of the measured/computed data, change the display method, start/stop the recording of the measured/computed data, pause the monitor, manually control the digital output, analog output, and PWM output, and perform other operations. When the monitor is paused, you can display the past data and read computed/measured values using cursors.

In addition to the operations described above, you can also save the setup data (project), print a list of settings, and perform other operations from the menu.

Viewer

You can load the measured/computed data that was saved in the past and carry out the following operations.

- Synchronization
When the data file is opened, the measurement time is corrected based on the time information of the PC.
- Waveform display/numeric display
- Alarm/mark list display
- Change the display conditions (group assignments, scale, trip point, display color and other parameters)
- Read values using cursors
- Perform statistical computation over an area
- Display and add marks
- Print the waveform display and numeric value display
- Save or load display conditions
- Display the file information
- Convert data formats (ASCII, Excel, and Lotus)
- Printing data (waveforms, numeric values, alarm/mark list, cursor values, statistics over an area, and computed values)
- Use and save templates

Calibrator

You can connect to the MX100, display the modules that can be calibrated, and carry out calibration of each measurement range and output range.

1.2 System Requirements

OS (Operating System)

Run the software under any of the following operating systems.

- Windows 2000 Professional SP4
- Windows XP Home Edition SP3
- Windows XP Professional SP3 (excluding Windows XP Professional x64 Edition)
- Windows Vista Home Premium SP1, SP2 (excluding the 64-bit edition)
- Windows Vista Business SP1, SP2 (excluding the 64-bit edition)
- Windows 7 Home Premium (32-bit and 64-bit editions)
- Windows 7 Professional (32-bit and 64-bit editions)

The language displayed by the software under different language versions of the OS are as follows.

OS Language	Software Display Language
English or other	English
Japanese	Japanese or English

PC

A PC that runs one of the OS above, and that meets the following CPU and memory requirements.

- **When Using Windows 2000 or Windows XP**
Pentium 4, 1.6 GHz or faster Intel x64 or x86 processor; 512 MB or more of memory
- **When Using Windows Vista**
Pentium 4, 3 GHz or faster Intel x64 or x86 processor; 2 GB or more of memory
- **When Using Windows 7**
32-bit edition: Intel Pentium 4, 3 GHz or faster x64 or x86 processor; 2 GB or more of memory
64-bit edition: Intel x64 processor that is equivalent to Intel Pentium 4, 3 GHz or faster; 2 GB or more of memory

Free Hard Disk Space and RPM

Free space: 50 MB or more (1 GB or more recommended)

RPM: 7200 rpm or faster recommended

Input Devices (Mouse, Keyboard, Etc.)

Input devices supported by the OS.

Display

A video card that is recommended for the OS and a display that is supported by the OS, has a resolution of 1024×768 or higher, and that can show 65,536 colors (16-bit, high color) or more.

Ethernet Port

An Ethernet port compatible with the OS (10BASE-T or 100BASE-TX) required.

1.3 Setup Procedures of the MX100 Standard Software

The following procedures are for installing the software on Windows XP.

1. Start Windows.

Log onto Windows as an administrator (Otherwise, you will not be able to install the software). This is the same when using an OS other than Windows XP.

When Auto Run Is Enabled

2. Insert the CD-ROM in the CD-ROM drive.

The setup program automatically starts. Proceed to step 4.

When Auto Run Is Disabled

2. Double-click the CD-ROM icon from **My Computer to open the CD-ROM drive window.**

3. Double-click the **SETUP.EXE file.**

The setup program starts.

4. Select the languages and click **Next.**

5. Click **Next.** Read the Software License Agreement that appears. If you agree to the terms, select the **I accept terms of the license agreement** check box. Click **Next**.

6. In the next dialog box, enter the user name, company name, and license number, and click **Next.**

The license number is written on the label that is attached to the front of the case for the MX100 Standard Software Setup CD-ROM.

MX100 Standard Software - InstallShield Wizard

Customer Information
Please enter your information.

Please enter your name, the name of the company for which you work, and the product license number.

User Name:
MX100

Company Name:
Yokogawa Electric Corporation

License Number:

InstallShield < Back Next > Cancel

1.3 Setup Procedures of the MX100 Standard Software

7. Select the setup type to install, and click **Next**.
The default destination to install is [C:\MX100 Standard]. If you click **Custom** check box, you can select the installation location and installed functions. Note that if you select **MX100 Standard** in the installation function, **MX100 Viewer** will also be installed. Follow the on-screen instructions.

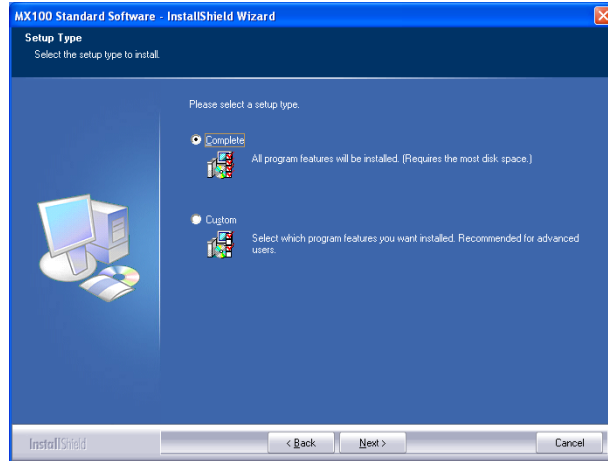

8. Click **Install** to start the installation.
9. Click **Finish** to finish the installation.

Explanation**Installation Result**

When the software program is installed properly, the folder MX100 Standard Software is created in the specified directory (C:\ by default). MX100 Standard is registered in the program list and MX100 Standard (referred to as the Integration Monitor in this operation guide), MX100 Viewer, and MX100 Calibrator are registered under it.

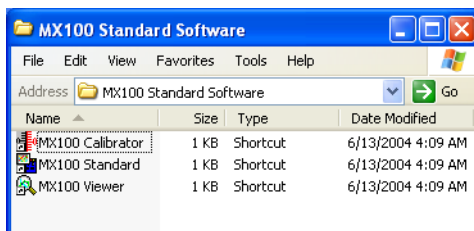
**Note**

- The Data, Work, and Conv folders are created within the MX100 Standard folder. Recording files are saved in the Data folder. The Work folder is used as a temporary folder for saving files created by the MX100 Standard Software, and must not be deleted.
- The Conv folder is created by the Historical Viewer. It is used as a temporary folder for storing files used for file conversion, and must not be deleted.

1.4 Starting and Exiting Software Programs

Procedure

Starting the Software Programs

As shown in the figure below, click the **Start** button, point to **Programs**, point to **MX100 Standard**, and choose **MX100 Standard** (referred to as the Integration Monitor in this manual), **MX100 Viewer**, or **MX100 Calibration**.

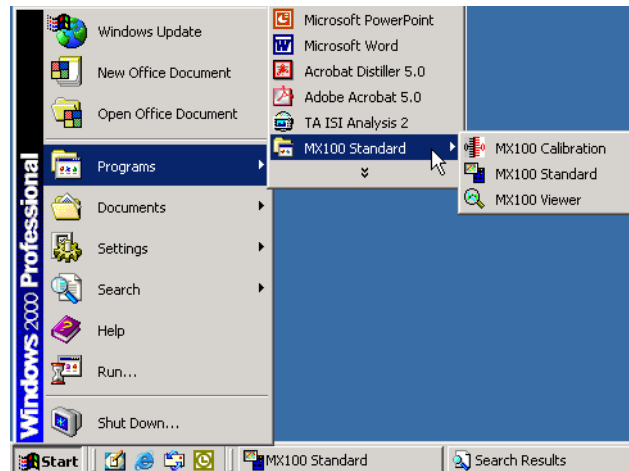

Exiting the Software

From the **File** menu, choose **Exit**.

The following figure shows an example of the Integration Monitor (MX100 Standard)

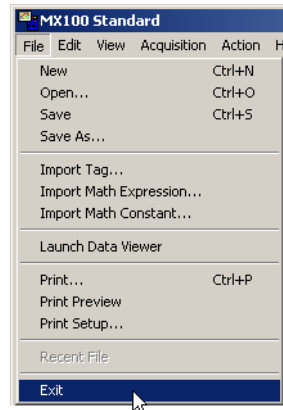

Note

When exiting the MX100 Viewer, a dialog box confirming whether to save the display settings opens if the display settings have been changed.

2.1 Connecting and Disconnecting the MX100

Procedure

Before carrying out the procedure below, turn ON the power to the relevant MX100 and connect the MX100. When connecting the MX100 for the first time, the MX100 and the PC must be connected locally in a one-to-one configuration.

Note

Connecting the MX100 and the PC to a mission-critical network before an appropriate IP address is assigned to the MX100 may adversely affect other connected devices on the network.

Connecting to an MX100 That Has Not Been Configured for the Network

1. Start the Integration Monitor according to the procedure given in section 1.4. The Connection screen opens.

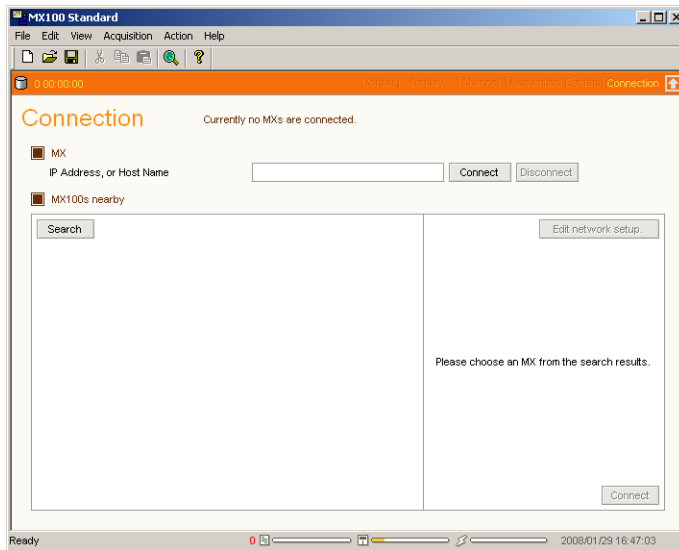

2. Click the Search button. If an MX100 is found, icons appear in the frame containing the Search button for MX100s in the same network segment.

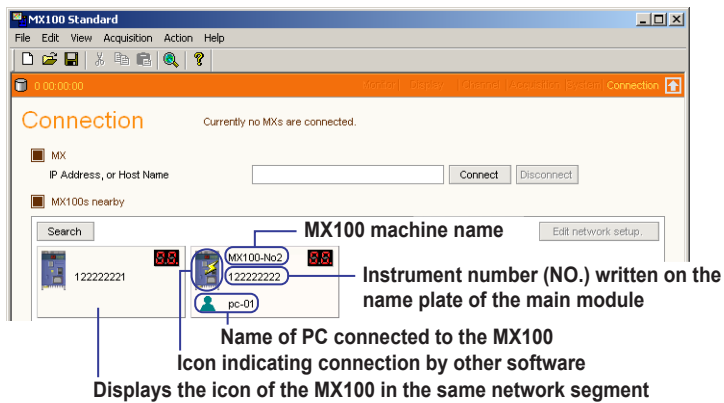

Note

- If multiple MX100s are connected in the same network segment, multiple icons appear together with the corresponding instrument numbers (NO.).
- When using Windows XP, Windows Vista, or Windows 7 with the firewall enabled, recognition is sometimes not successful even when clicking the Search button. To solve the problem, see appendix 1. (The same problem may also occur if your anti-virus software is using a firewall.)

2.1 Connecting and Disconnecting the MX100

- Click the MX100 icon that appeared.
In the box containing the Edit Network setup button, the icon and the initial network information of the selected MX100 appear.
Even if you click the Connect button in this condition (with the initial IP address), connection cannot be made.

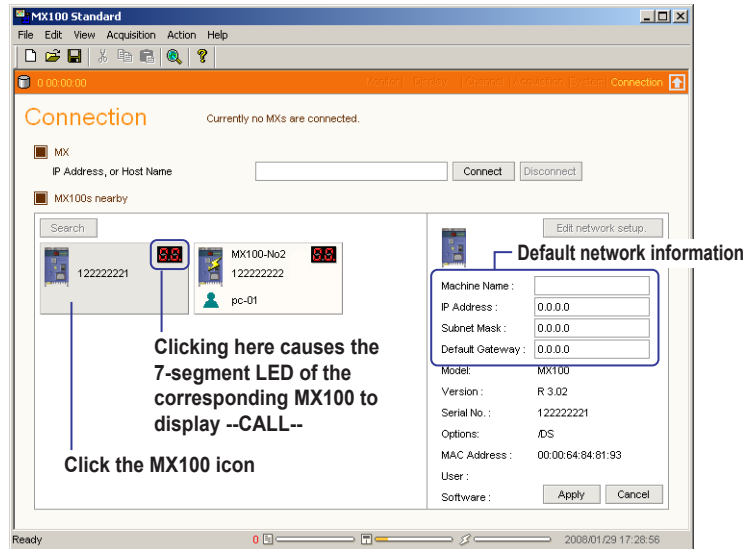

- Click the Edit Network setup button.
The Machine Name, IP address, Subnet Mask, and Default Gateway items turn into text boxes.
- Refer to the explanations in this section and enter the required information in the boxes.
The Apply and Cancel buttons appear.
- Click Apply.
In the box containing the Edit Network setup button, the icon and the network information of the MX100 disappear. At this moment, the 7-segment LED that has been configured turns off for an instant.

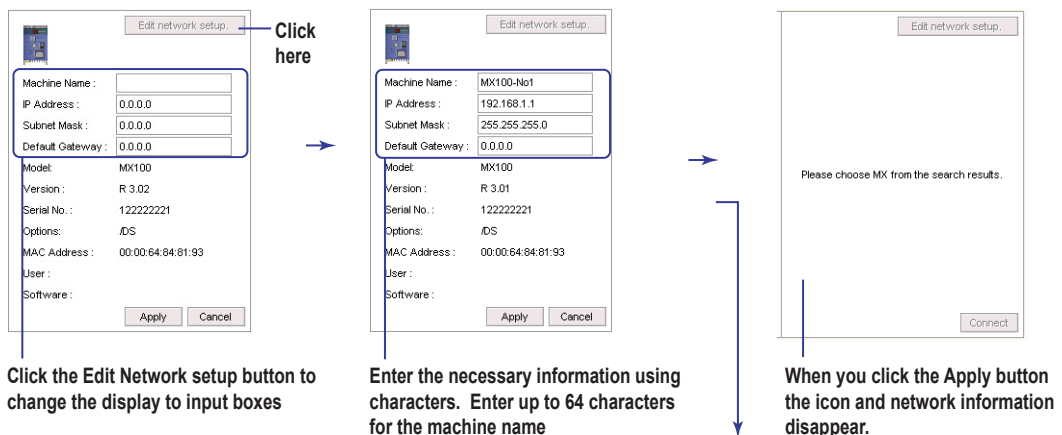

If the network setup does not work, the following screen appears.

• Invalid IP address setting



Check whether the IP address setting is appropriate and whether the combination of the IP address and subnet mask is appropriate.

• Invalid Subnet mask setting



Check whether the subnet mask setting is appropriate.

• Invalid default gateway setting

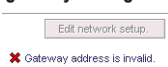

Check whether the default gateway setting is appropriate.

• Failed to change settings



Check if the MX100 is connected by another program or if the power to the MX100 is OFF.

• Failed to change settings



Repeat steps 2 through 6

- Click the MX100 icon in the box containing the Search button. In the box containing the Edit Network setup button, the icon and the network information of the configured MX100 appear.

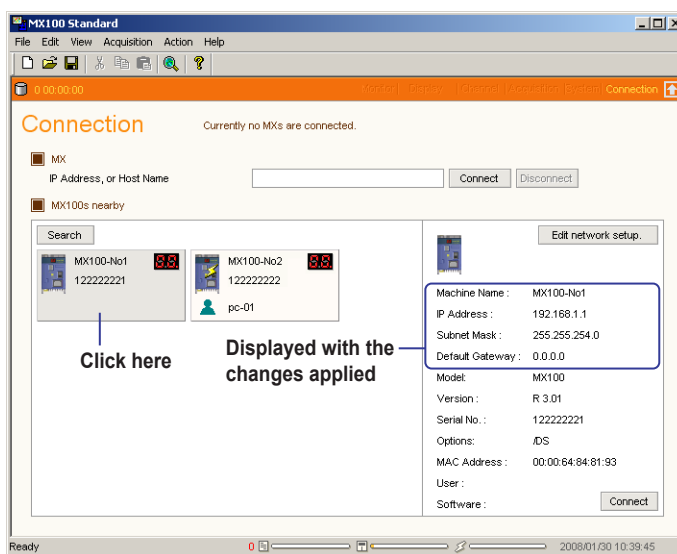

- Click the Connect button in the box containing the Edit Network setup button. If the MX100 is connected, the Monitor screen appears and measurement begins.

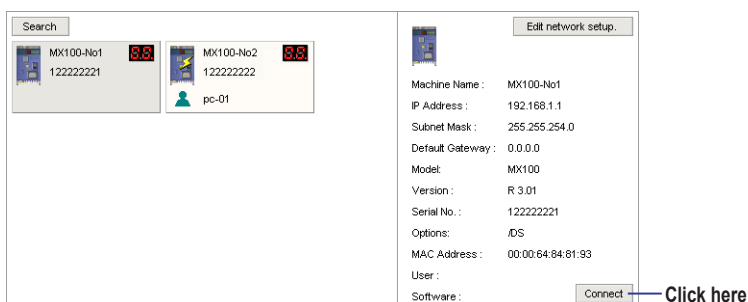

Monitor screen

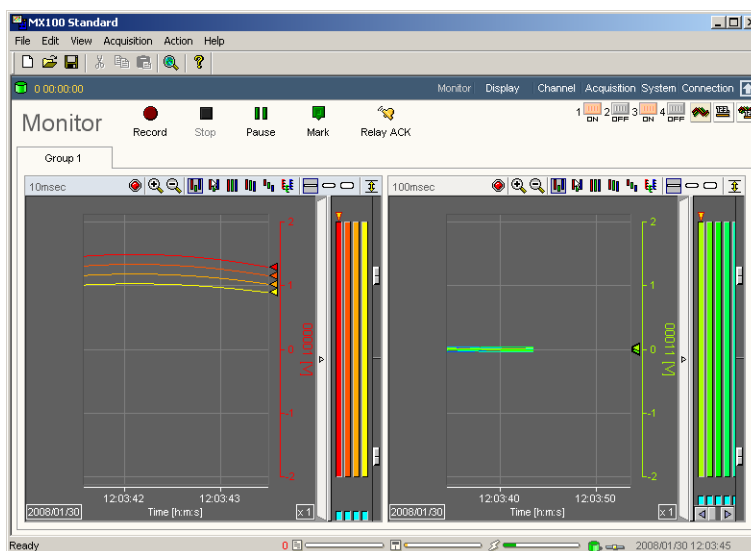

Connecting to an MX100 That Has Been Configured for the Network

1. Start the Integration Monitor.
If the MX100 that was connected when the program was started the previous time is still connected, a connection is automatically established with that MX100, the Monitor screen opens, and measurement starts. To connect to another MX100, click Connection located at the top section of the Monitor screen to show the Connection screen and click Disconnect.
2. In the IP Address or Host Name box on the Connection screen, enter the IP address of the MX100 to which you wish to connect.
To connect using a host name, the host name must be registered in a DNS server (see the explanation in this section) and the DNS server must be connected to the network.
3. Click the Connect button to the right of the IP Address or Host Name text box.
The Monitor screen opens.

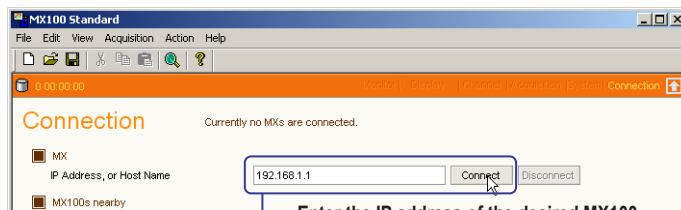

Note

- If the connection cannot be made for some reason such as when the MX100 is already connected by another software program, the dialog box indicating that it is connecting remains on the screen. If the MX100 that you are trying to connect to is in the same segment, click Abort in the dialog box and then click Search to see if the MX100 is actually connected to the network or if it is connected by another software program.

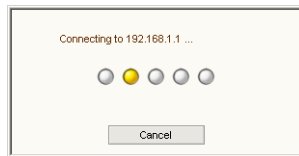

- If you changed the module configurations on the MX100 that you had connected before, a dialog box with the message "Some detected modules do not match the current software configuration. Rebuild based on the current MX hardware setup?" appears. If this happens, carry out the procedure in the next section, 2.2, "Configuring the System, Setting the Write Mode of the CF Card, and Formatting the CF Card."

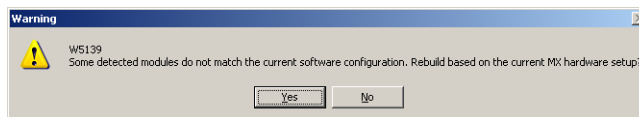

- If there is a record file that has not been finalized (data writing has not been completed) in the previous connection, the finalization of the record file is carried out immediately after startup. If this occurs, the progress of the finalization is displayed on the status bar (see "Setting the Status Bar Display on the View Menu" in section 2.6).

Changing the Network Configuration

1. With the MX100 icon and network information displayed in the box containing the Edit Network setup button on the Connection screen, click the Edit Network setup button.
The Machine Name, IP address, Subnet Mask, and Default Gateway items turn into text boxes.
2. Refer to the explanations in this section and enter the required information in the boxes.
The Apply and Cancel buttons appear.
3. Click Apply.
Click Cancel to return to the original settings.

Click here

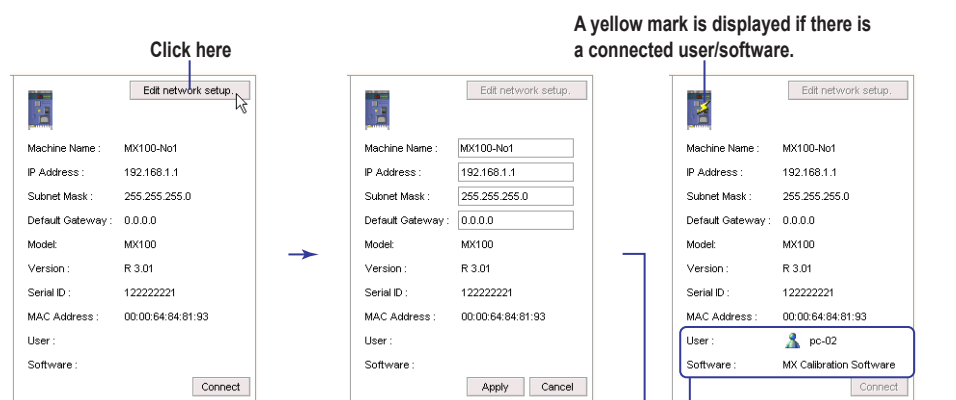

A yellow mark is displayed if there is a connected user/software.

Network setup cannot be changed when there is another connected software program

When network setup does not work, the following screen appears.

- When the MX100 you wish to configure is connected by another software program
- When you attempt to change the IP address while the connection is established
- When the message "Search MX100s nearby again" appears.

- Invalid IP address setting
- Invalid Subnet mask setting
- Invalid default gateway setting

Check whether the IP address setting is appropriate and whether the combination of the IP address and subnet mask is appropriate.

Check whether the subnet mask setting is appropriate.

Check whether the default gateway setting is appropriate.

Note

Enter network settings to avoid conflicts with other PCs. If network settings or searches are performed on multiple PCs simultaneously, the operation may fail.

Disconnecting the MX100

1. Click Connection to show the Connection screen.
2. Click the Disconnect button to the right of the IP Address or Host Name text box.

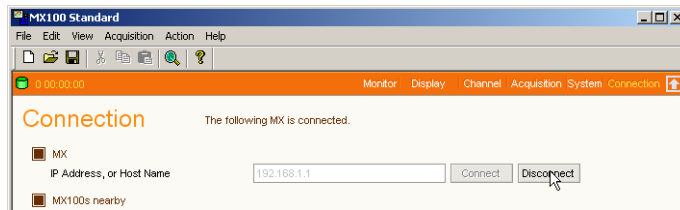

When the connection is dropped, a message “Currently no MXs are connected” appears at the top section of the screen. To reconnect, click Connect.

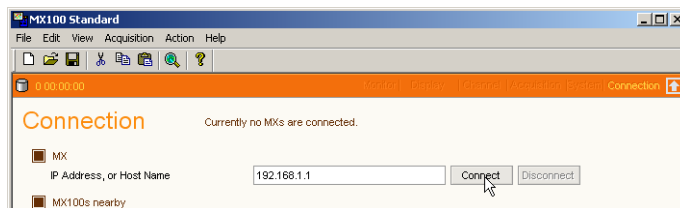

Creating a New Project and Connecting

Creating a New Project

Carry out the procedure below to discard current settings and create new setup data (project).

1. From the File menu, click New.
A dialog box with the message “Cancel the current settings and create a new project?” appears. To save the current setup data before creating a new project, click No and save the setup data (project) (see “Saving Setup Data (Project)” in section 2.12).
2. Click Yes.
The Connection screen opens. If you click New while the MX100 is connected, communication with the connected MX100 is disconnected.

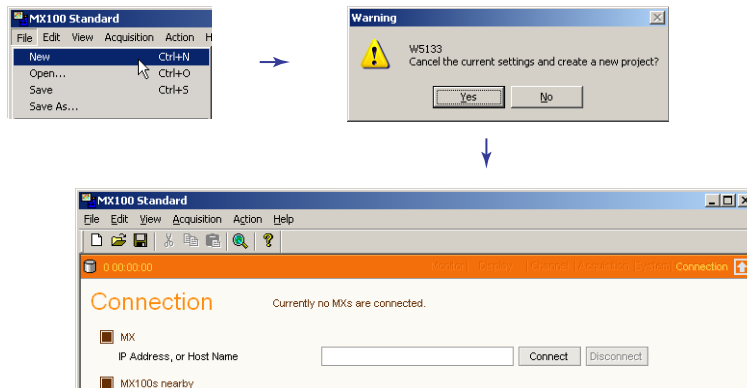

Connecting after Creating a New Project

3. On the Connection screen, connect to the MX100.
(See “Connecting to an MX100 That Has Not Been Configured for the Network,” or “Connecting to an MX100 That Has Been Configured for the Network,” in this section.)

Explanation**Machine Name**

To distinguish individual MX100s, you can enter a name that is easy to identify using up to sixty-four characters (not required).

IP Address

Enter a new IP address to assign to the MX100. The default address is 127.1.1.XX (where XX is a unique number for the device). This address cannot be used even when the PC and the MX100 are connected in a one-to-one configuration. You must change to a different address such as 192.168.1.XX (where XX is a value between 1 and 254). When connecting the PC locally, do not set the PC to obtain the IP address automatically. Enter the IP address manually to an address other than the one that is to be assigned to the MX100 (192.168.1.100 if 192.168.1.1 was assigned to the MX100, for example).

Note

- To connect to the MX100 by entering a host name in the IP Address or Host Name box, the host name (name used on the TCP/IP network) must be registered in a DNS server and the DNS server must be connected to the network. However, the MX100 Standard Software does not have a function for registering host names on the DNS server. For the procedure of registering host names, consult your network administrator.
- To initialize all settings including the IP address to their factory default values, see "Initializing the Settings" in section 2.6 of the *MX100 Data Acquisition Unit User's Manual* (IM MX100-01E).

Subnet Mask

Enter the mask value used when determining the subnet network address from the IP address. The default value is 255.255.255.0. When connecting to the PC locally in a one-to-one configuration, this value does not need to be changed. In this case, set the subnet mask on the PC to 255.255.255.0 as well.

Note

Huge TCP/IP networks such as the Internet are often divided up into smaller networks called sub networks. The subnet mask is a 32 bit value that specifies the number of bits of the IP address used to identify the network address. The portion other than the network address is the host address that identifies individual computers on the network. Consult your network administrator for the subnet mask value. You may not need to set the value.

Default Gateway

Set the IP address of the gateway (default gateway) used to communicate with other networks. The default value is 0.0.0.0. When connecting to the PC locally in a one-to-one configuration, this value does not need to be changed. In this case, you do not have to set the default gateway on the PC.

Note

The default gateway is a router or computer that is used when accessing a computer outside its own network. Consult your network administrator for the IP address of the default gateway.

2.1 Connecting and Disconnecting the MX100

Model

Displays MX100.

Option

Displays /DS or None.

Version

Firmware version number of the main module.

The version number shows the style number (before the decimal point) and revision number (after the decimal point).

Serial ID

The instrument number (NO.) marked on the name plate of the main module.

MAC Address

Displays the MAC address that is assigned when the MX100 is shipped from the factory (unique ID number for identifying the Ethernet card). The MAC address is marked on the name plate on the main module.

Connected Users

Displays the computer name of the PC that is connected to the MX100. This item is blank if there is no PC connected to it.

Software

Displays the name of the software program that is connected to the MX100. This item is blank if there is no software program connected to it.

- MX100 Standard: Integration Monitor of the MX100 Standard Software
- MX100 Calibrator: Calibrator of the MX100 Standard Software or
MXLOGGER (sold separately)
- MXLOGGER: MXLOGGER (sold separately)
- API: Software applications can be created using the MX100/
DARWIN API (sold separately)

2.2 Configuring the System, Setting the Write Mode of the CF Card, and Formatting the CF Card

Procedure

Reconfiguring the System

If you change the attachment positions or type of the input/output modules you must carry out the procedure below.

Note

- If you change the MX100 input/output modules, a message, “Some detected modules do not match the current software configuration. Rebuild based on the current MX hardware setup?” appears when you start the Integration Monitor. Current configuration refers to the module configuration (attachment positions and types of modules) that is detected by the software. To match the current configuration with the actual module configuration (referred to as reconfiguring the system), click Yes. If you reconfigure, the settings (measurement conditions, etc.) of the modified modules are initialized. The reconfigured module configuration can be confirmed on the System screen that appears by clicking System. If you Click No, the connection is made without reconfiguration, and the module settings are left unchanged.
- Turn OFF the power to the MX100 when attaching or detaching input/output modules.

1. Click System to show the System setup screen.

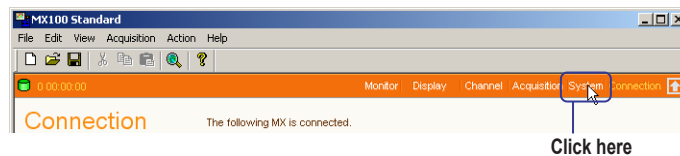

2. Click the Actual Configuration tab followed by the Retrieve current configuration button.

An X mark is displayed on the changed modules.

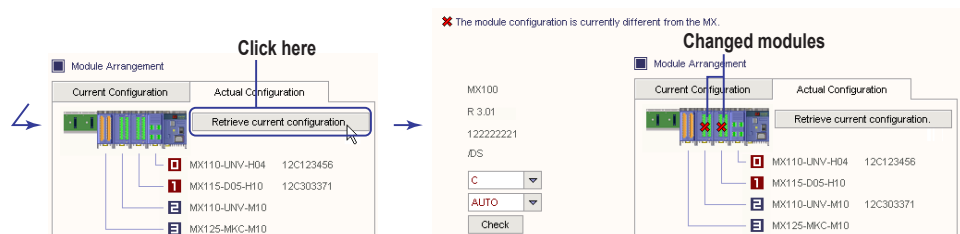
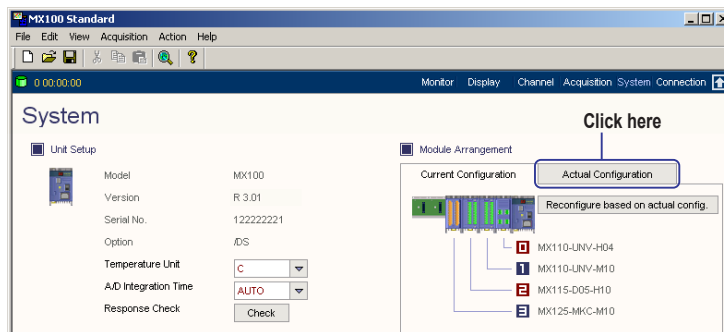

Note

- The × mark appears at slots where the module has been changed, and which are not operating correctly.
- The serial number is not displayed to the right of the module type (MX115-D05-H10, MX125-MKC-M10, MX114-PLS-M10, etc.) for the DO, DI, and PWM modules.

2.2 Configuring the System, Setting the Write Mode of the CF Card, and Formatting the CF Card

3. Click the Current Configuration tab followed by the Reconfigure based on actual config. button.

A dialog box with the message “Module settings which do not match the current software configuration will be initialized.” appears.

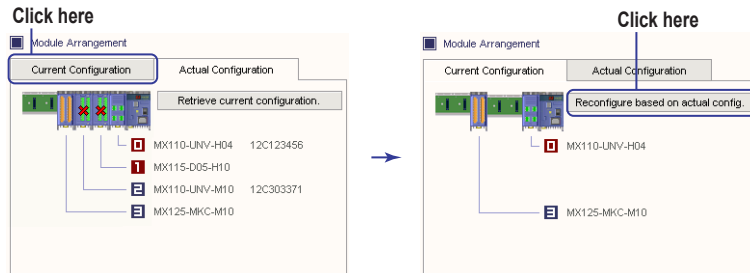

Note

If the × mark remains even after reconfiguring the system numerous times, see the corrective action described for “The connected input/output module is not detected” in section 5.1.

4. Click the OK button.

The current module configuration is matched to the actual configuration.

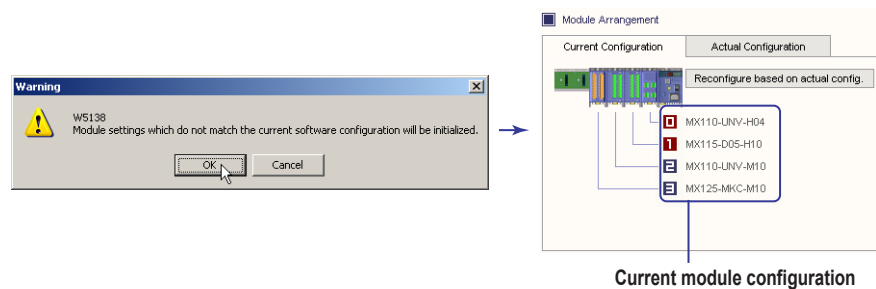

Setting the A/D Integration Time

1. Click System to show the System setup screen.
2. From the A/D Integration Time list box, select AUTO, 50 Hz, or 60 Hz.

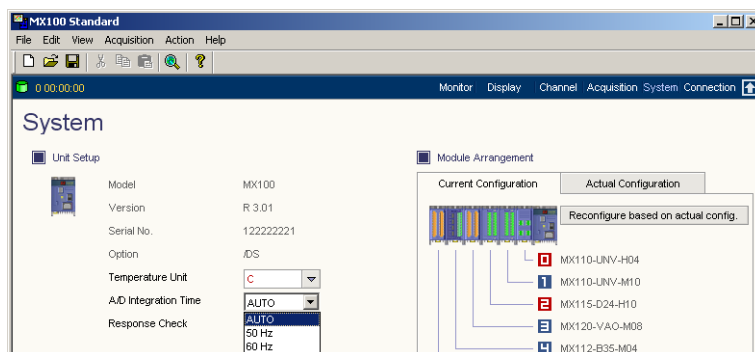

MX100 Response Check

1. Click System to show the System setup screen.
2. Click the Execute button to the right of Response Check.
The 7-segment LED on the main module of the connected MX100 displays "--CALL--"

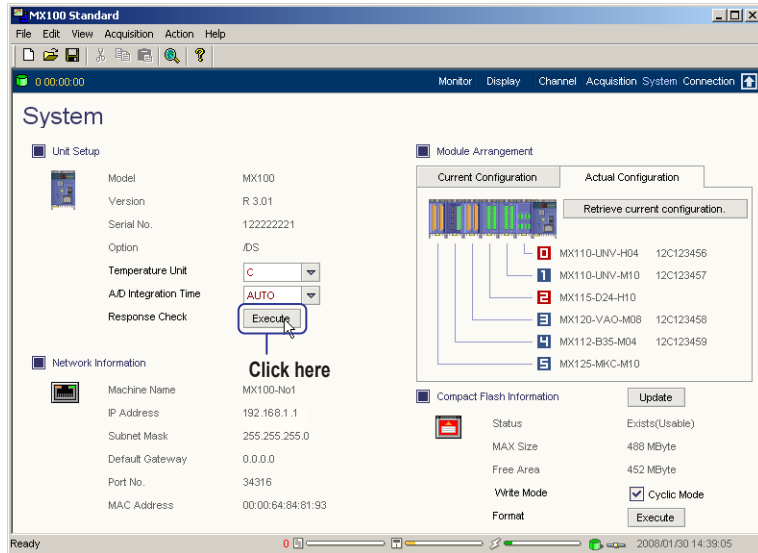

Setting the Write Mode and Formatting the CF Card

1. Click System to show the System setup screen.
2. Click the Update button to the right of Compact Flash Information.
The most recent status of the CF card that is inserted in the card slot is displayed.

Setting the Write Mode

3. To save the file repeatedly by deleting the old file when there is no more free space on the CF card, select the Cyclic Mode check box under Compact Flash Information > Write mode.
To stop the save operation when there is no more free space, clear the check box.

Format

3. Click the Execute button to the right of Format under Compact Flash Information.
A confirmation message "Format Compact Flash?" appears.

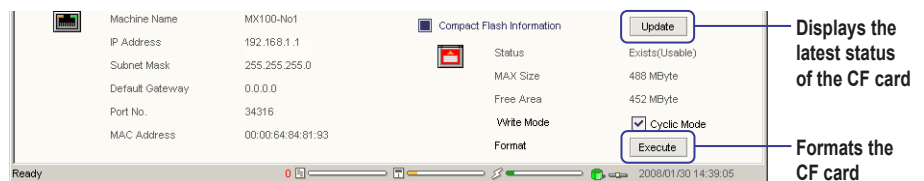

4. Click the OK button.
The message "Format was successful." appears.

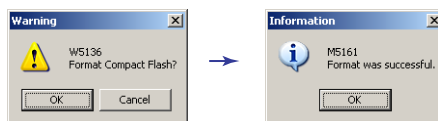

2.2 Configuring the System, Setting the Write Mode of the CF Card, and Formatting the CF Card

While the CF card is being formatted, the 7-segment LED of the main module displays the following.

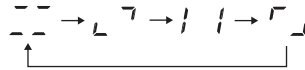

Explanation

Items That Can Be Confirmed on the System Screen

- **Unit Setup**

You can check the model, version, serial ID, option, temperature unit, and the A/D integration time.

- **Module Arrangement**

If you click the Current Configuration tab, the attachment conditions (attachment positions and types) of the input/modules identified by the software are displayed.

If you click the Actual Configuration tab, the attachment conditions of the actual input/output modules are displayed.

- **Network Information**

You can check the machine name, IP address, subnet mask, default gateway, port number, and MAC address.

- **Compact Flash Information**

You can check the status, maximum size, and free area of the CF card inserted in the card slot.

The CF card status indicates the following:

None: The CF card is not inserted in the slot.

Exists (Usable): The CF card is inserted in the slot and usable.

Exists (Unusable): The card is inserted in the slot but unusable due to reasons such as an unformatted card, unsupported file system, or broken card.

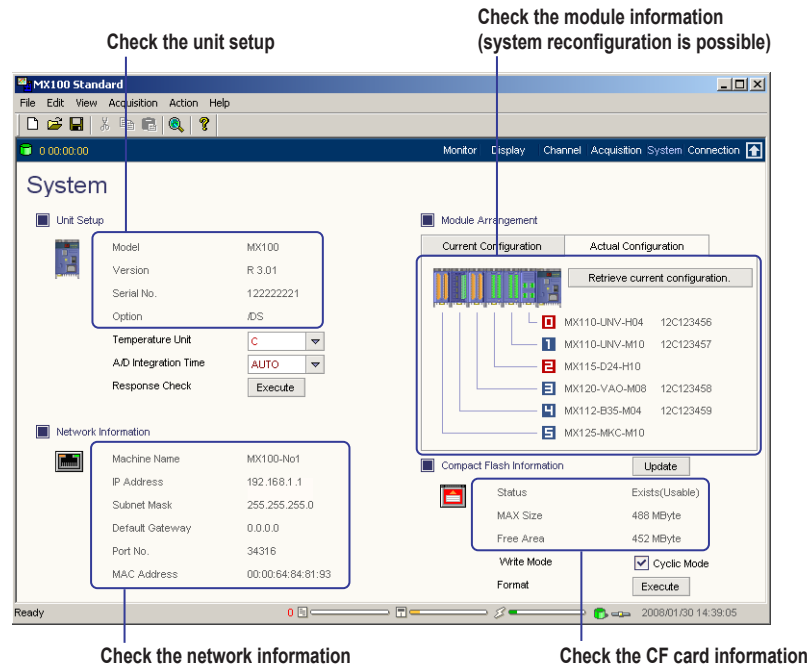

2.2 Configuring the System, Setting the Write Mode of the CF Card, and Formatting the CF Card

Setting the A/D Integral Time

When the measurement interval is one of the setting values in the table below, the A/D integral time setting of the input module becomes active. The default setting is AUTO.

- **AUTO**
Automatically sets the A/D integral time to 50 Hz or 60 Hz according to the frequency of the power supplied to the main module.
- **50 Hz**
Sets the integral time to 20 ms.
- **60 Hz**
Sets the integral time to 16.67 ms.

Input Module Type	Measurement Interval Setting
4-CH, High-Speed Universal Input Module (MX110-UNV-H04)	50 ms
10-CH, Medium-Speed Universal Input Module (MX110-UNV-M10)	500 ms
30-CH, Medium-Speed DCV/TC/DI Input Module (MX110-VTD-L30)	1 s
6-CH, Medium-Speed Four-Wire RTD Resistance Input Module (MX110-V4R-M06)	500 ms
4-CH, Medium-Speed Strain Input Module (MX112-B12-M04, MX112-B35-M04, and MX112-NDI-M04)	200 ms

* For the A/D integral times when setting other measurement intervals, see chapter 4, "Specification" in the *MX100 Data Acquisition Unit User's Manual* (IM MX100-01E).

Setting the Write Mode of the CF Card

If the connection between the software and the MX100 is dropped while the measured/computed data is being recorded (see section 2.7), the measured data is saved (backed up) to the CF card on the main module. If the Cyclic Mode check box is selected and measured data is saved in backup mode, the data continues to be saved by deleting the oldest data file when there is no more free space on the CF card. If the check box is cleared, data saving stops when there is no more free space on the CF card.

2.3 Setting the Acquisition Conditions of the Measured/Computed Data

Procedure

Setting the Monitor Interval and Record Interval of Measured Data

1. Click Acquisition to show the Acquisition setup screen.

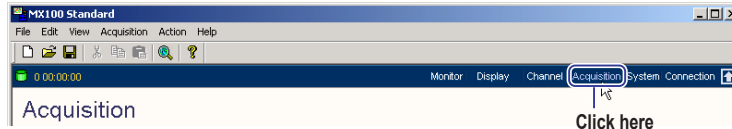

2. Drag and drop the input module icon within the Measurement Group 1, Measurement Group 2, or Measurement Group 3 frame. Drag the input module with the same monitor interval to the same measurement group. Drag the input modules that are not to make measurements to the Unused Modules frame. Only the Monitor interval list boxes and the Rec. interval boxes of the measurement groups that contain input modules are activated.

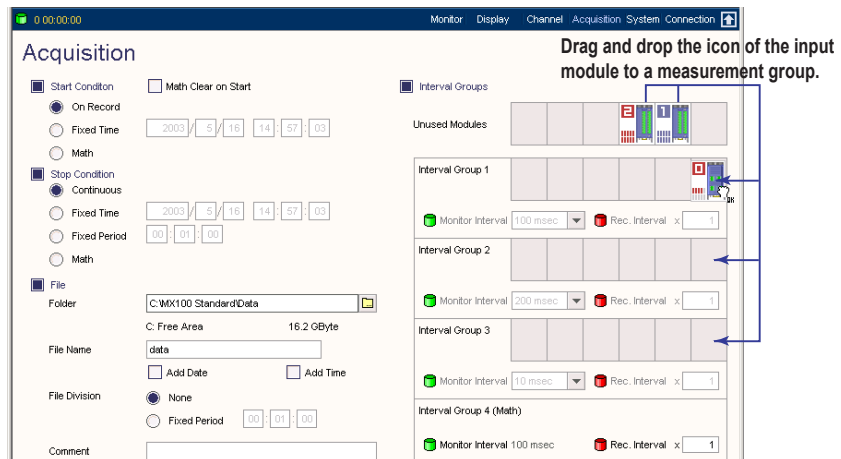

3. Select the monitor interval (measurement interval) from the Monitor Interval list box.
4. Enter the record interval (integer multiplication factor) in the Rec. Interval text box.

Select the monitor interval of each interval group
The selectable monitor interval varies depending on the types of modules assigned to the same group and the measurement range.

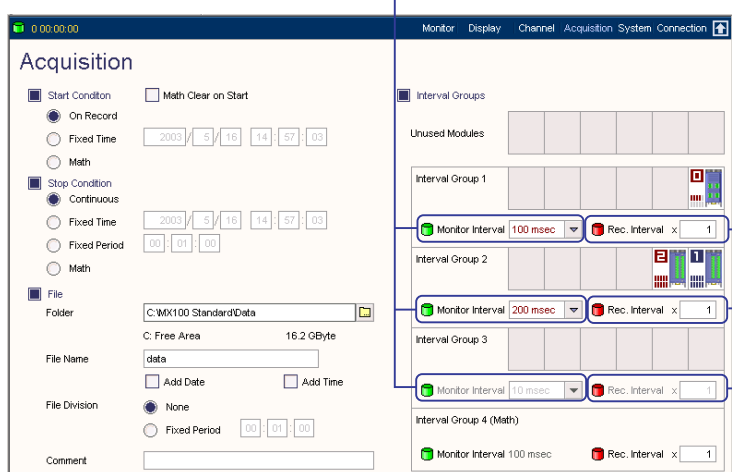

Set using an integer multiple of the monitor interval for each interval group (up to 128).
The recording to the data file is carried out at (monitor interval × multiplication factor).

Setting the Record Interval of Computed Data

1. Click Acquisition to show the Acquisition setup screen.
2. Enter the record interval (integer multiplication factor) in the Rec. Interval text box.

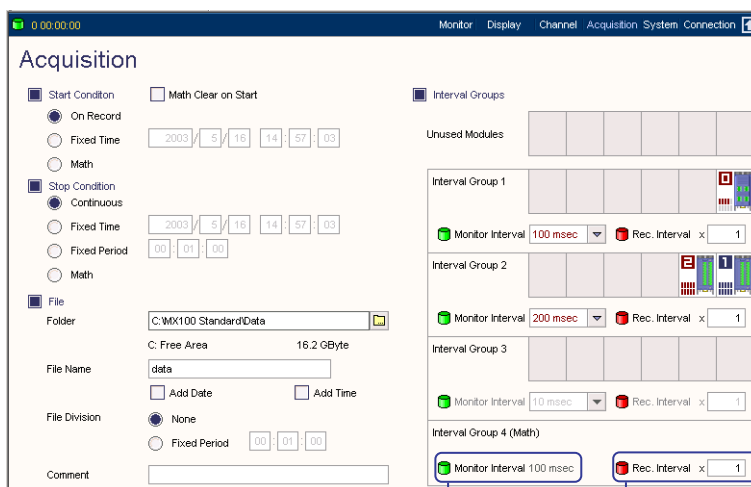

Set using an integer multiple of the monitor interval for each computation group (up to 128)
The recording to the data file is carried out at (monitor interval × multiplication factor).

Automatically set to the minimum monitor interval of the interval group with modules assigned or 100 ms, whichever is less (cannot be changed).

Setting the Record Start and Stop Conditions and Resetting Computation

1. Click Acquisition to show the Acquisition setup screen.
2. Select On Record, Fixed Time, or Math under Start Condition.
If you select Fixed time, enter the start date/time.
3. Select Manual, Fixed Time, Fixed Period or Math under Stop Condition.
If you select Fixed time, enter the stop date/time.
If you select Fixed period, enter the record time.

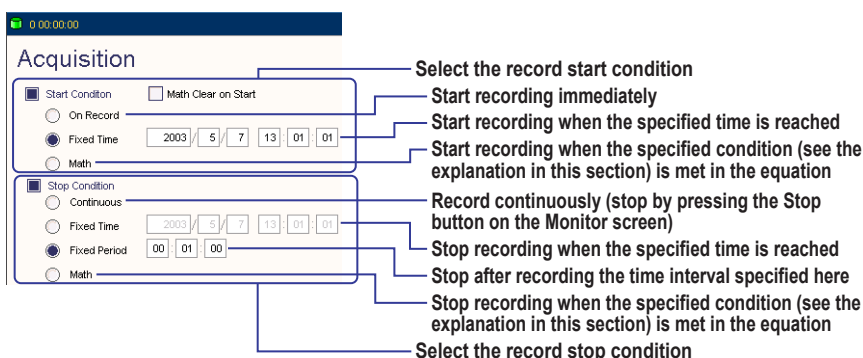

4. To reset the computed results at the same time recording is started, select the Math Clear on Start check box.

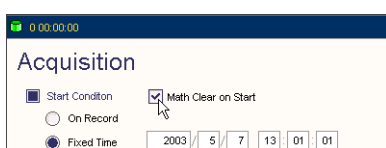

Setting the Record File

1. Click Acquisition to show the Acquisition setup screen.
2. Enter the save destination of the file in the Folder box.
If you click the folder icon, the Browse for Folder dialog box opens, and you can select the save destination folder. To do so, click the New Folder button, enter the folder name to create a new folder within the save destination folder, and then set it as the save destination.
3. Enter the name of the record file in the File Name box.
To add the record date information to the specified file name, select the Add Date check box. To add the record time information to the specified file name, select the Add Time check box. If both check boxes are selected, both the record date and record time information are added to the specified file name.
If a file with the same name already exists, a hyphen and a four-digit sequence number starting with 0000 is added to the end of the file name.
4. To record the data by changing the file every specified time interval, choose Fixed Period under File Division and enter the time.
5. To attach a comment to the file, enter the comment string in the Comment box.

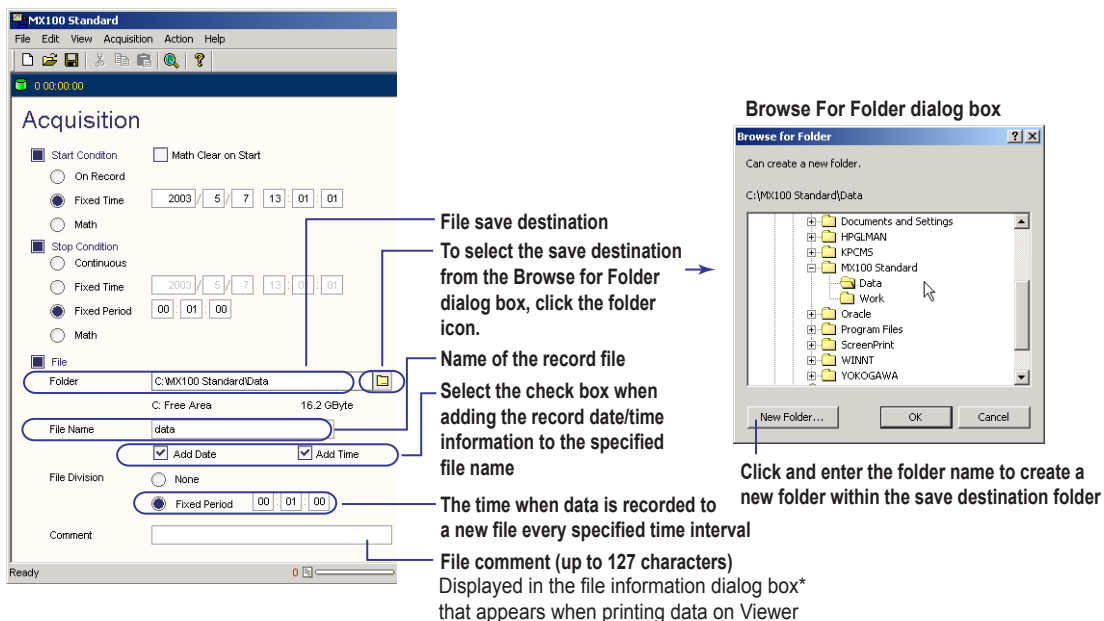

* Displayed by choosing Information > File Information in Viewer.

Explanation**Monitor Interval**

Sets the measurement interval, monitor update interval, and alarm detection interval. However, if the specified monitor interval is short, the data monitor update interval may be slower depending on the PC environment.

If the monitor interval is set greater than or equal to two minutes, the Integration Monitor acquires data from the MX100 at the specified interval, but the measurement interval and alarm detection interval on the MX100 are one minute.

The input modules can be divided into three interval groups, and different monitor intervals can be specified for each interval group.

Note

The shortest interval that you can specify for the monitor interval is the longest of the shortest measurement intervals of all the input modules assigned to the same measurement group.

For example, if an input module with the shortest measurement interval of 10 ms and an input module with 100 ms are assigned, 100 ms is the shortest interval that can be specified for the group.

When saving backup data to the CF card, for monitor intervals of up to one minute, the data is saved at the monitor interval, and for monitor intervals of two minutes or more, the data is saved at one-minute intervals.

Record Interval of Measurement Channels

The record interval is the interval at which the data of measurement channels is saved to a PC hard disk. It is set as an integer multiple of the monitor interval (up to $\times 128$).

Monitor Interval and Record Interval of Computation Channels

The monitor interval of computation channels is the minimum monitor interval of the interval group or 100 ms, whichever is greater. The record interval is set as an integer multiple of the monitor interval (up to $\times 128$).

Note

Computation channels are not saved to the CF card.

Record Start Condition

Select the start condition for saving the data of measurement/computation channels from the following.

- **On Record**
Immediately starts recording when the Record button on the Monitor screen is clicked or Record is chosen from the Acquisition menu.
- **Fixed Time**
Starts recording at the specified date/time. Set the date/time as “year/month/day/hours:minutes:seconds” If the specified time has already been passed, the operation is the same as On Record.
- **Math**
Starts recording when the StartRec() event function (see “Event Function” under “Explanation” in section 2.5) is executed on a computation channel. This is valid when you click the Record button on the Monitor screen (see section 2.7) and the word “Waiting” is displayed.

2.3 Setting the Acquisition Conditions of the Measured/Computed Data

Record Stop Condition

Select the condition for stopping the recording from the following:

- **Continuous**
Immediately stops recording when the Stop button on the Monitor screen is clicked or Stop is chosen from the Acquisition menu.
- **Fixed Time**
Stops recording at the specified date/time. Set the date/time as “year/month/day/hours:minutes:seconds” If the specified time has already been passed, the operation is the same as Manual.
- **Fixed Period**
Stops recording after the specified time elapses after the recording is started. Set the time as “hours:minutes:seconds”
- **Math**
Stops recording when the StopRec() event function (see “Event Function” under “Explanation” in section 2.5) is executed on the computation channel.

Save Destination and Name of the Record File

Select the hard disk drive of your PC for the save destination. By default, the save destination is the Data folder in the MX100 Standard folder where the MX100 Standard Software is installed.

Note

Do not set the save destination to a storage medium other than the hard disk or to a network drive. Doing so may cause problems in terms of performance.

The default file name is “data” If multiple files are created, the name is “data-XXXX”(where XXXX is a four-digit sequence number starting with 0000). The extension is .mxd. You can also add the file creation date and time to the file name as follows.

- When adding both the date and time: data-0224-1316 (recording started at 13 hours and 16 minutes on February 24)
- When only the date is added: data-20080224 (recording started on February 24, 2008)
- When only the time is added: data-1319 (started recording at 13 hours 16 minutes)

If a file with the same name already exists, a hyphen and a four-digit sequence number starting with 0000 is added to the end of the file name.

File Division of Record Files

The file can be divided every specified time interval. Set the time as “hours:minutes:seconds”

Even if file division is not specified, the file is automatically divided when the size of a single file exceeds approximately 1 GB or when the number of data points of any of the channels in the file exceeds 2 million.

Number of Characters That Can Be Entered for the Comment of the Record File

The maximum number of characters that can be entered is 127.

Selecting the Channel to Be Recorded

You can specify recording/no recording on individual channels. The settings are as follows.

- Measurement channels: 2.4, “Setting the Measurement Conditions (Setting the Measurement Channels)”
- Computation channels: 2.5, “Setting Computations (Setting the Computation Channels)”

2.4 Setting the Measurement Conditions (Setting the Measurement Channels)

Procedure

Measurement channel tab

Click here

Icon of the attached modules
Point to the icon to display information about the module
Click the icon to select the channels of the module (gray background and red characters)

Record check box

Monitor check box

Select the input mode
If changed, the Range setting and others to its right are initialized^{*1}

Select the measurement range
If changed, the Span setting and others to its right are initialized^{*1}

Minimum/Maximum value of span

The Use check box for Scale^{*2}

Decimal point position of the scale^{*2}

Maximum/Minimum values of the scale^{*2}

When making the settings the same as the first item^{*3}

Reset to default^{*3}

To copy^{*3}

Turn ON/OFF collectively^{*3}

***1 Excluding Tag No. and Tag comment**
***2 Cannot be used when Mode is set to RRJC**
***3 Applied to the selected range by dragging the cursor. Applied to all lines if a range is not selected.**

Record	Monitor	Mode	Range	Min	Max	Use	Dec. Point	Min	Max
[00001]	<input checked="" type="checkbox"/>	TC	Type-R	0.0	1760.0	<input type="checkbox"/>	0	-30000	30000
[00002]	<input checked="" type="checkbox"/>	RTD1	Type-R	0.0	1760.0	<input type="checkbox"/>	0	-30000	30000
[00003]	<input checked="" type="checkbox"/>	RRJC(TC)	Type-R	0.0	1760.0	<input type="checkbox"/>	0	-30000	30000
[00004]	<input checked="" type="checkbox"/>	VOLT	2V	-2.0000	2.0000	<input type="checkbox"/>	0	-3.0000	3.0000
[00011]	<input checked="" type="checkbox"/>	VOLT	2V	-2.0000	2.0000	<input type="checkbox"/>	0	-3.0000	3.0000
[00012]	<input checked="" type="checkbox"/>	VOLT	2V	-2.0000	2.0000	<input type="checkbox"/>	0	-3.0000	3.0000
[00013]	<input checked="" type="checkbox"/>	VOLT	2V	-2.0000	2.0000	<input type="checkbox"/>	0	-3.0000	3.0000
[00014]	<input checked="" type="checkbox"/>	VOLT	2V	-2.0000	2.0000	<input type="checkbox"/>	0	-3.0000	3.0000
[00015]	<input checked="" type="checkbox"/>	VOLT	2V	-2.0000	2.0000	<input type="checkbox"/>	0	-3.0000	3.0000
[00016]	<input checked="" type="checkbox"/>	VOLT	2V	-2.0000	2.0000	<input type="checkbox"/>	0	-3.0000	3.0000
[00017]	<input checked="" type="checkbox"/>	VOLT	2V	-2.0000	2.0000	<input type="checkbox"/>	0	-3.0000	3.0000
[00018]	<input checked="" type="checkbox"/>	VOLT	2V	-2.0000	2.0000	<input type="checkbox"/>	0	-3.0000	3.0000
[00019]	<input checked="" type="checkbox"/>	VOLT	2V	-2.0000	2.0000	<input type="checkbox"/>	0	-3.0000	3.0000
[00020]	<input checked="" type="checkbox"/>	VOLT	2V	-2.0000	2.0000	<input type="checkbox"/>	0	-3.0000	3.0000

1. Click Channel to show the Channel setup screen.
2. Click Meas. Channel tab.

Setting the Measurement Channels for Recording and Monitoring

3. Select Record check boxes of the channels to record.
4. Select the Monitor check boxes of the channels to monitor.

Setting the Input Mode

5. Select the input mode from the Mode list box.

Setting the Measurement Range

6. Select the measurement range from the Range list box.

Setting the Measurement Span

7. Click the Min box or Max box under Span and enter the minimum or the maximum value of the span.

Setting the Scale (Only When Scaling)

8. Select the Use check boxes under Scale to enable changing of the scale.
9. Select the decimal point position from the Point list box for Scale.
10. Click the Min box or Max box under Scale and enter the minimum or the maximum value of the scale.
11. Click the Unit box and enter the unit of the scaled value.

Setting the Reference Channel for Difference Input (Valid Only When Measuring the Difference with Respect to the Measured Value of the Reference Channel)

12. Select the Use check box under Difference Input.
13. Select the reference channel for the difference input from the Ref. Ch. list box under Delta.

Setting the Remote RJC Reference Channel (Valid Only When the Input Mode Is Set to RRJC (TC))

14. Select the reference channel for the remote RJC from the Ref. Ch. list box under RRJC.

Note

If moving from the Channel screen to the Display Setup or Monitor screen, if the differential input reference channel or remote RJC reference channel setting is inappropriate the following message appears.

Yes: Disable measurement channels with inappropriate settings (clear the Monitor check box in the Channel screen) and move to the Display Setup or Monitor screen

No: Change the settings of the measurement channels with inappropriate settings without moving to the next screen

Message

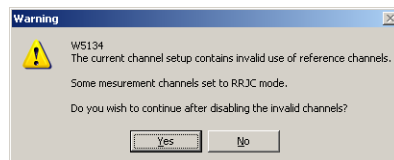

Setting the Time Constant of the First-Order Lag Filter (Valid Only When the Input Mode Is Set to Something Other than DI)

15. Select the time constant from the Filter list box.

Setting the Burnout (Valid Only When the Input Mode Is Set to TC)

16. Select the direction in which the measured value is set off the range (+OVER or -OVER) when a burnout occurs from the Burnout list box.

Setting the RJC (When the Input Mode Is Set to TC)

17. Click the Type box under RJC and select Internal or External.
18. If you select External, click the Volt box under RJC and enter the compensation voltage.

2.4 Setting the Measurement Conditions (Setting the Measurement Channels)

Check here to measure the difference input (difference with respect to the measured value of the reference channel)*

Select the reference channel for difference input*

* Cannot be used when Mode is set to RRJC

Select the remote RJC reference channel (only when the input mode is set to RRJC (TC))

Unit (up to six characters, only when the Use check box of Scale is selected)

Enter the tag number (up to 15 characters)

Enter the tag comment (up to 30 characters)

Set the time constant of the first-order lag filter (when the input mode is set to something other than DI)

Set the burnout (only when the input mode is set to something other than DI)

Set the RJC (only when the input mode is set to something other than DI)

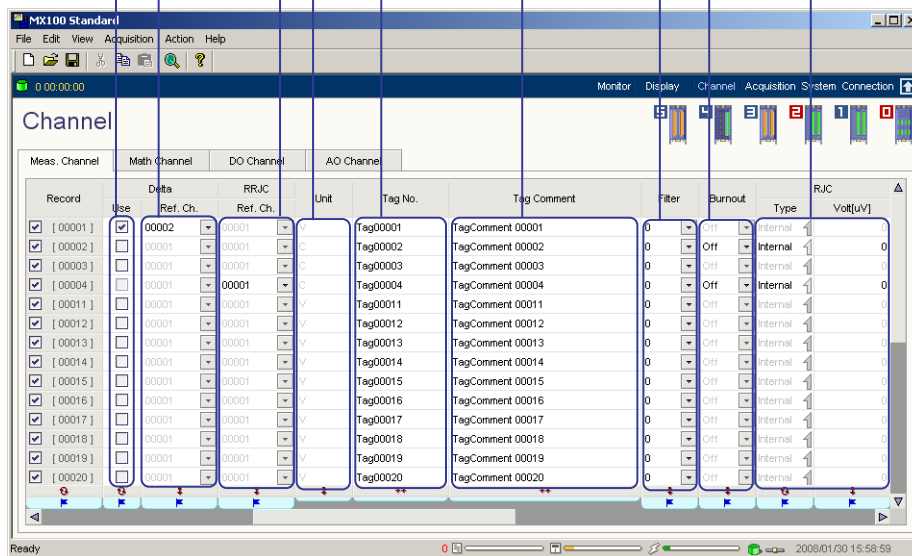

Importing Tag Numbers and Tag Comments

You can import just the tag numbers and tag comments from the saved setup data and replace the current tag numbers and tag comments with the imported information. From the File menu, choose Import Tag. Then, select an MX100 project file (a file with the .mxd extension) in the Open dialog box to import the tag numbers and tag comments.

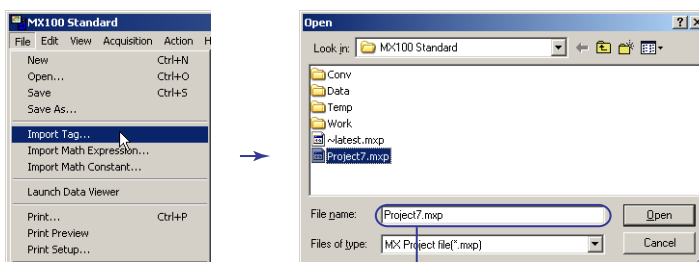

Select the MX100 project file (file with .mxd extension) you wish to import

Note

When you carry out the procedure above, the tag numbers and tag comments of computation channels are also imported.

2.4 Setting the Measurement Conditions (Setting the Measurement Channels)

Set the type for alarms 1 to 4, the setting value, and the hysteresis (see section 2.9)

Set the initial balance for strain input channels (only when the input mode is set to STR)

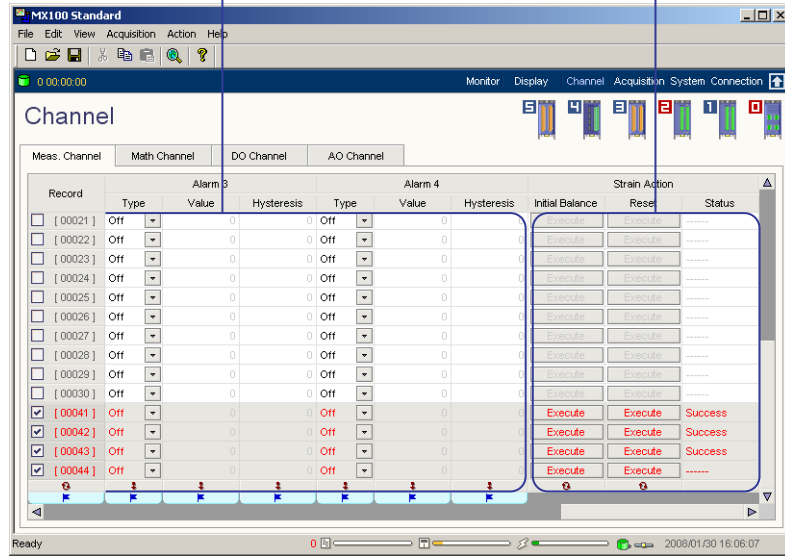

Set the Initial Balance for Strain Input Channels (Only When the Input Mode Is Set to STR)

- Under Strain function, click the Execute button under Initial balance or Reset. The Executing Initial balancing dialog box appears, and Executing is displayed in the Status box. When execution is complete, the result is displayed in the Status box.



2.4 Setting the Measurement Conditions (Setting the Measurement Channels)

Note

- You can execute initial balancing and reset the initial balance value on multiple recording channels at once by selecting the channels and clicking the collective execution button.

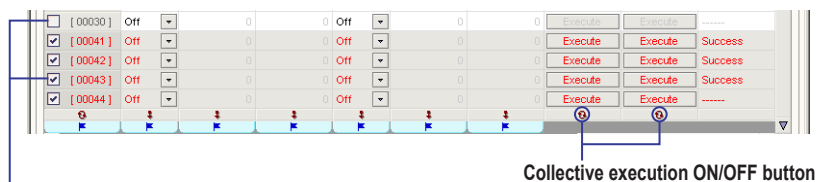

Drag and drop channels on which to perform initial balancing to select them
Selected channels are displayed with red characters against a gray background

- To execute initial balancing on a strain input module, you must finalize MX100 channel settings and send them. If invalid channel settings are entered, a dialog box will appear prompting you to correct the settings.

Message

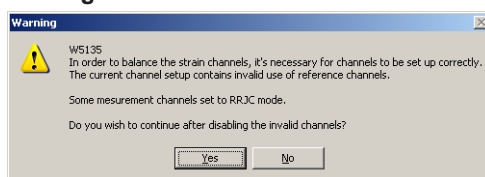

Initializing, Copying, and Pasting of Settings on the Display Setup Screen

The procedures are the same as those for Initializing, Copying, and Pasting of Settings on the Display Setup Screen described in section 2.6.

Explanation

Input Mode and Measurement Range

Measurement channel settings differ depending on the hardware style number of the MX100. See the table below.

Connectable module types or setting items	MX100 Hardware Style Number*			Notes
	S3	S2	S1	
30ch module MX110-VTD-L30	Yes	No	No	—
GOST range	Yes	No	No	Can be set only for MX110-UNV-M10, MX110-UNV-H04, MX110-V4R-M06, and MX110-VTD-L30

Yes: Setting and operation allowed, No: Setting and operation not allowed

* The style number is printed on the MX100 main module name plate.

2.4 Setting the Measurement Conditions (Setting the Measurement Channels)

On the channels of the input module, select from the modes below according to the input signal. For details of the measurable range, measurement accuracy, and resolution, see chapter 4, "Specification" in the *MX100 Data Acquisition Unit User's Manual* (IM MX100-01E).

- **VOLT (DC voltage)**

Select the measurement range from 20 mV, 60 mV, 200 mV, 2 V (default), 6 V, 20 V, or 100 V.

Note

Current input is possible by attaching a shunt resistor to the input terminal and converting to voltage input. The shunt resistors in the table below are available for purchase separately. For example, a 250 Ω shunt resistor is used to convert the signal in the range of 1 to 5 V for 4 to 20 mA input.

Part Name	Model	Resistance
Shunt resistor (for clamp terminal)	415920	250 $\Omega \pm 0.1\%$
	415921	100 $\Omega \pm 0.1\%$
	415922	10 $\Omega \pm 0.1\%$
Shunt resistor (for screw terminal)	438920	250 $\Omega \pm 0.1\%$
	438921	100 $\Omega \pm 0.1\%$
	438922	10 $\Omega \pm 0.1\%$

- **TC (thermocouple), on the Universal Input Module and 30-CH, Medium-Speed DCV/TC/DI Input Module**

Select the thermocouple type (referred to as Range in the setup) from Type-R (default), Type-S, Type-B, Type-K, Type-E, Type-J, Type-T, Type-N, Type-W, Type-L, Type-U, or KpvsAu7Fe.

- **RTD1 (resistance temperature detector, measured current: 1 mA), on the 4-CH, High-Speed Universal Input Module**

Select the RTD type (referred to as Range in the setup) from Pt100 (default), JPt100, HQ Pt100 (high resolution Pt100), HQ JPt100 (high-resolution JPt100), Ni100:SAMA, Ni100:DIN, or Ni120.

- **RTD1 (resistance temperature detector, measured current of 1 mA), on the 10-CH, Medium-Speed Universal Input Module/6-CH, Medium-Speed Four-Wire RTD Resistance Input Module**

Select the RTD type (referred to as Range in the setup) from Pt100 (default), JPt100, HQ Pt100 (high-resolution Pt100), HQ JPt100 (high-resolution JPt100), Ni100:SAMA, Ni100:DIN, Ni120, Pt50, Cu10:GE, Cu10:L&N, Cu10:WEED, Cu10:BAILEY, or J263B.

- **RTD2 (resistance temperature detector, measured current: 2 mA), on the 4-CH, High-Speed Universal Input Module**

Select the RTD type (referred to as Range in the setup) from Pt100 (default), JPt100, HQ Pt100 (high-resolution Pt100), HQ JPt100 (high-resolution JPt100), Pt50, Cu10:GE, Cu10:L&N, Cu10:WEED, Cu10:BAILEY, or J263B.

The RTD2 selection is not available on the 10-CH, Medium-Speed Universal Input Module and the 6-CH, Medium-Speed Four-Wire RTD Resistance Input Module.

- **RTDEX (resistance temperature detector, measured current: 0.25 mA), on the 6-CH, Medium-Speed Four-Wire RTD Resistance Input Module**

Select the RTD type (referred to as Range in the setup) from Pt500 (default setting) or Pt1000.

- **OHM (resistance), on the 6-CH, Medium-Speed Four-Wire RTD Resistance Input Module**

Select a measurement range of 20 ohm (measured current: 1 mA), 200 ohm (measured current: 1 mA), or 2 kohm (measured current: 0.25 mA).

2.4 Setting the Measurement Conditions (Setting the Measurement Channels)

- DI (digital input), on the 10-CH, Medium-Speed Digital Input Module**
 Only the DI (digital input) setting is available for the input type. Select LEVEL (D10) (voltage input) for -D05, or CONTACT (D10) (non-voltage contact input) for the measurement range to match the input. For -D24, only LEVEL (24 V) is available.
- DI (digital input), on the 4-CH, Medium-Speed Universal Input Module**
 Select LEVEL (voltage input) or CONTACT (HS) (non-voltage contact input) to match the input.
- DI (digital input), on the 10-CH, Medium-Speed Universal Input Module, 30-CH, Medium-Speed DCV/TC/DI Input Module, 6-CH, Medium-Speed Four-Wire RTD Resistance Input Module**
 Select LEVEL (voltage input) or CONTACT (SC) (non-voltage contact input) to match the input.
- STR (strain), on the 4-CH, Medium-Speed Strain Input Module**
 Select a measurement range of 2000 μ STR, 20000 μ STR (default), or 200000 μ STR.
- RRJC (TC)**
 RRJC (TC) refers to temperature measurement using a thermocouple. Select a channel when referring to the temperature of a relay terminal (the temperature input of the relay terminal is specified at RRJC Ref. Ch.). When the item to be measured is located at a great distance, you can setup relay terminals near the item to be measured to make temperature measurements without having to use large quantities of high-cost thermocouples. Connect the item to be measured and the relay terminal using a copper wire. By connecting one terminal of the MX100 and the relay terminal using a thermocouple and measuring the temperature of the relay terminal, reference junction compensation is carried out on the temperature measurement and the temperature measurement on the item is made.

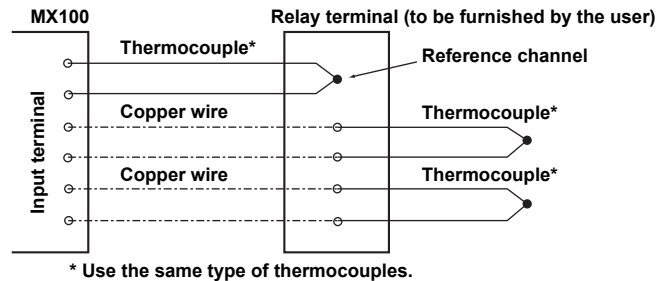

Setting the Measurement Span

Set the minimum and maximum values of the range that is actually measured within the measurable range.

Setting the Scale

Set this item when linearly scaling the measured values. Set the scale by entering the maximum and minimum values corresponding to the maximum and minimum values of the measurement span and selecting the decimal point position of the scaled value (see the figure below). The selectable range of the scale is -30000 to 30000 . The decimal point position can be set to 4 (X.XXXX), 3 (XX.XXX), 2 (XXX.XX), 1 (XXXX.X), or 0 (XXXXX). In addition, a unit can be assigned to the scaled value.

You can set the unit using up to six characters.

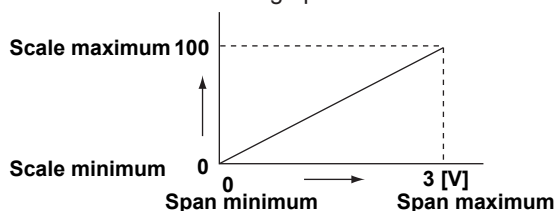

2.4 Setting the Measurement Conditions (Setting the Measurement Channels)

Setting the Reference Channel for Difference Input

Set this item when making the difference between the measured value of the channel and the measured value of the reference channel the measured value (referred to as difference computation). The reference channel can be set to a channel that is scaled. Difference computation can be executed even if the measurement range of its own channel and that of the reference channel are not the same.

If the decimal point position setting is different between its own channel and the reference channel, the decimal point position of the measured value of the reference channel is matched to that of its own channel, and the difference is computed.

Example: When the measured value of the channel set to difference input is 10.00 and the measured value of the reference channel is 100.0

The computed result is $10.00 - 100.0 = -90.00$.

Set the reference channel for difference input to a measurement channel that has the Monitor check box selected.

Setting the Remote RJC Reference Channel (Valid Only When the Input Mode Is Set to RRJC (TC))

This item sets the reference channel when the input mode is set to RRJC (TC).

Set the reference channel for remote RJC to a channel that meets the two conditions below.

- The reference channel is a measurement channel (channel existing on the measurement channel tab) with the Monitor check box selected.
- The range of the reference channel and that of the corresponding measurement channel are the same.

Setting the Time Constant of the First-Order Lag Filter (Valid Only When the Input Mode Is Set to Something Other than DI)

A first-order lag filter is available. Select a time constant N (time until 63.2% of the output value is reached) from the Filter list box for the case when the measurement interval (Monitor interval in the settings) is set to 1 s. Time constants when the measurement interval is set to a value other than 1 s follow the equation below.

Time constant = measurement interval \times N (where N = 5, 10, 20, 25, 40, 50, or 100)

The table below lists the relationship.

Measurement Interval (s)	Selectable Time Constants (s)						
0.01	0.05	0.1	0.2	0.25	0.4	0.5	1
0.05	0.25	0.5	1	1.25	2	2.5	5
0.1	0.5	1	2	2.5	4	5	10
0.2	1	2	4	5	8	10	20
0.5	2.5	5	10	12.5	20	25	50
1	5	10	20	25	40	50	100
2	10	20	40	50	80	100	200
5	25	50	100	125	200	250	500
10	50	100	200	250	400	500	1000
20	100	200	400	500	800	1000	2000
30	150	300	600	750	1200	1500	3000
60	300	600	1200	1500	2400	3000	6000

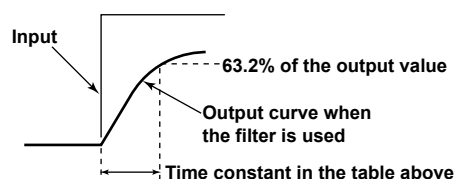

Setting the Burnout

When the input mode is set to TC, you can set the burnout detection behavior. If set to Up, the measured value is fixed to +OVER when a burnout is detected (condition in which the input signal level exceeds the upper limit of the measurement range). If set to Down, the measured value is fixed to +OVER (condition in which the input signal level exceeds the lower limit of the measurement range). To not detect burnouts, select Off (default).

Setting the RJC

When the input mode is TC, select whether to use the internal reference junction compensation function of the input module or an external reference junction compensation function. (This setting is possible when the input mode is set to a mode other than DI, but the setting takes effect only when the mode is TC.) When using the external reference junction compensation function, set an appropriate reference junction compensation voltage (Volt in the setup) in the range of $-20000 \mu\text{V}$ to $20000 \mu\text{V}$. For example, if the reference junction temperature of the external reference compensation is $T_0^\circ\text{C}$, set the reference compensation junction voltage to the thermoelectromotive force of the 0°C reference of $T_0^\circ\text{C}$.

Initial Balancing of Strain Input Channels (Initial Unbalance Value Adjustment)

When configuring a bridge circuit with a strain gauge, the bridge circuit will not necessarily be balanced even if the strain of the circuit under test is zero due to the slight deviation in resistance of the strain gauge, and the measured value may not be zero (the value in such cases is called the initial unbalanced value).

Therefore, when taking measurements you must first balance the bridge and, if the strain is zero, obtain a measured value of zero. This is called initial balancing. (setting the initial unbalanced value to zero).

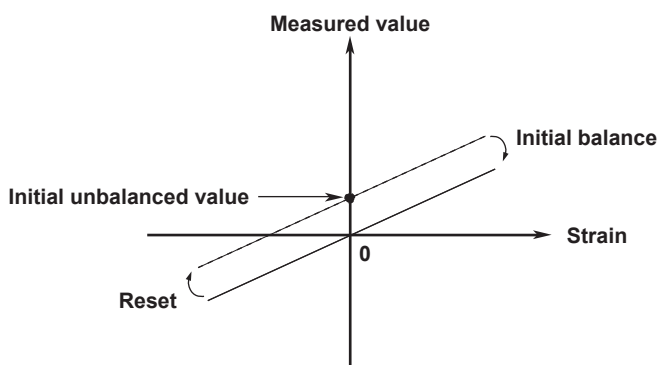

With the MX100, initial balancing is performed in the $\pm 10000\mu$ strain range.

Initial balance: The value when the command is executed is set as the initial unbalanced value, and the measured value is set to zero.

Reset: The value set during initial balancing is reset to zero. The initial unbalanced value is used as-is for the measured value.

Note

If the measuring range is changed, the initial balancing is reset.
After a range change, you must redo initial balancing.

2.4 Setting the Measurement Conditions (Setting the Measurement Channels)

The results of initial balancing are as follows.

Status box display	Status
----	Not executed
Successful	Initial balancing was executed successfully.
Failed	Initial balancing failed.
OVER	Initial balancing succeeded, but the output value exceeded the upper limit or fell below the lower limit, and the value was rounded to the upper limit value or the lower limit value.
Executing	Executing initial balancing

Note

If initial balancing fails, “ $E5$ ” is displayed in the 7-segment LED on the main module. Check the installation status of the strain input module and perform the initial balancing again. If the error occurs even after rebalancing, servicing is required. Please contact your nearest Yokogawa representative.

Scaling Settings When Using a Strain Gauge Type Sensor

The following is an explanation of scaling settings used when measuring physical quantities such as load and length with a strain gauge type sensor.

The basic relational expression is as follows.

$$1 \text{ mV/V} = 2000 \text{ } \mu\text{strain (Equation 1)}$$

Two examples are given below: 1) when rated input and output are listed in the user's manual of the strain gauge type sensor, and 2) when listed with the calibration coefficient. (hereinafter, “ μ strain” will be expressed as “ μ Str.”)

When Rated Input and Rated Output Are Given

A specific example is given below.

- Rated input 200 N (set to Y)
- Rated output 0.985 mV/V (set to K)

In this case, these figures indicate that if a 200 N load is applied, 0.985 mV/V is output.

From the relationship in equation 1, if 200 N is applied, an output of $0.985 \text{ mV/V} \times 2000 = 1970 \text{ } \mu\text{STR}$ is attained.

In other words, for each 1 N, $1970 \text{ } \mu\text{STR} / 200 \text{ N} = 9.85 \text{ } \mu\text{STR/N}$ is output. Therefore, the scaling settings are entered as follows.

When Measuring at 50-150 N

- Scale minimum: 50 (units: N) (set to Smin)
- Scale maximum: 150 (units: N) (set to Smax)

therefore,

- Span minimum: $50 \times 9.85 \text{ } \mu\text{STR/N} = 492.5 \text{ } \mu\text{STR}$
- Span maximum: $150 \times 9.85 = 1477.5 \text{ } \mu\text{STR}$

...can be set.

Thus, the measuring range is 2000 μ STR.

2.4 Setting the Measurement Conditions (Setting the Measurement Channels)

Generally, the range is as follows.

Using the symbols that have appeared in the explanation thus far, after setting the scale maximum and minimum, the values are as follows.

$$\text{Span minimum} = [(K(\text{mV/V}) \times 2000) / Y(\text{unit})] \times S_{\text{min}} (\mu\text{STR})$$

$$\text{Span maximum} = [(K(\text{mV/V}) \times 2000) / Y(\text{unit})] \times S_{\text{max}} (\mu\text{STR})$$

When Listed at the Calibration Coefficient

An example is given with a displacement gauge.

- Rated input 20 mm
- Calibration coefficient 0.003998 mm / (1 $\mu\text{V/V}$)

Basically, if you can convert the calibration coefficient to the rated output mentioned in "When Rated Input and Rated Output Are Listed," the following is a calculation following the explanation in "When Rated Input and Rated Output Are Given."

Using equation 1,

$$1\text{mV/V} = 0.001\text{mV/V} = 0.001 \times 2000 \mu\text{STR} = 2 \mu\text{STR}$$

therefore the rated output with this sensor when 20 mm is input would be

$$20 \text{ mm} \div 0.003998 \text{ mm} / 2 \mu\text{STR}] = 10005 \mu\text{STR}$$

In other words, for each 1 mm, an output of

$$10005 \mu\text{STR} / 20\text{mm} = 500.25 \mu\text{STR/mm}$$

can be obtained.

Thereafter in the same manner, if you wish to measure with a scale of 2 mm to 15 mm, the settings are:

Scale minimum: 2

Scale maximum: 15 (units: mm)

therefore,

Span minimum: $2 \times 500.25 \mu\text{STR/mm} = 1000.5 \mu\text{STR}$

Span maximum: $15 \times 500.25 \mu\text{STR/mm} = 7503.75 \mu\text{STR}$

...would be appropriate settings.

The measuring range becomes 20000 μSTR , making the resolution on the MX100 1 μSTR , therefore we can round as follows.

Span minimum: 1001 μSTR

Span maximum: 7504 μSTR

2.5 Setting Computations (Setting the Computation Channels)

Procedure

Math Channel tab

Click here

Minimize button

Record check box

Monitor check box

Enter the equation (up to 127 characters, not case sensitive)

Specifies the decimal places for the minimum/maximum value of span

Used for output channel scaling and the initial value of the span for the General Display screen.

1. Click Channel to show the Channel setup screen.
2. Click the Math Channel tab.

Setting the Computation Channels for Recording and Monitoring

3. Select Record check boxes of the channels to record.
4. Select the Monitor check box of the channels to monitor.

Setting the Equation

5. Click the Expression box, and enter the expression.

Setting the Computation Span

6. Specify a number of digits in the Decimal Places list box for Span that is less than or equal to that of the maximum and minimum values.
7. Click the Min box or Max box next to Span and enter the minimum or the maximum value of the span.

2.5 Setting Computations (Setting the Computation Channels)

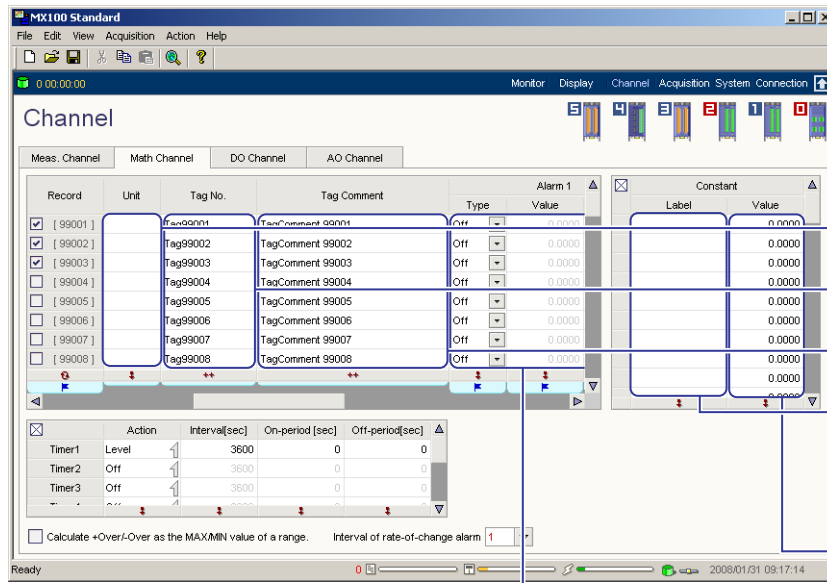

- Enter the unit of the computed value (up to 6 characters)
- Enter the tag number (up to 15 characters)
- Enter the tag comment (up to 30 characters)
- Enter the label for identifying the constant
- Appropriate labels are displayed in black Inappropriate labels are displayed in peach
- Enter the constant value
- Alarm settings (see section 2.9)

Note

Sixty computation channels are always shown.

Setting the Unit, Tag Number, and Tag Comment

8. Click the Unit, Tag No., and Tag Comment text box and enter the unit, tag number, and tag comment, respectively.

Setting the User-Defined Constant

9. Click the Label box under Constant and enter a label for identifying the constant.
10. Click the Value box under Constant and enter the value of the constant.

Importing Equations

You can import saved expressions from a file. From the File menu, choose Import Math Expression. Then, select an MX100 project file (a file with the .mxd extension) in the Open dialog box. Only saved expressions can be imported.

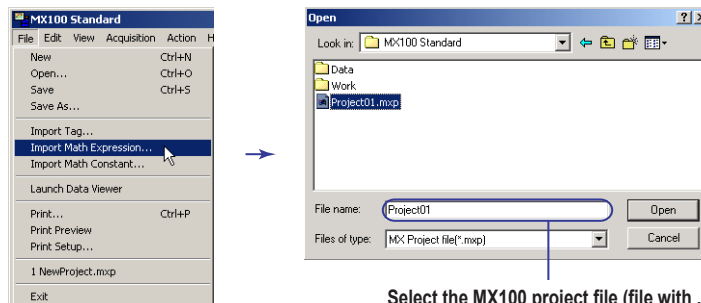

Select the MX100 project file (file with .mxd extension) you wish to import

2.5 Setting Computations (Setting the Computation Channels)

Importing Tag Numbers and Tag Comments

You can import just the tag numbers and tag comments from the saved setup data and replace the current tag numbers and tag comments with the imported information. From the File menu, choose Import Tag. Then, select an MX100 project file (a file with the .mxp extension) in the Open dialog box to import the tag numbers and tag comments.

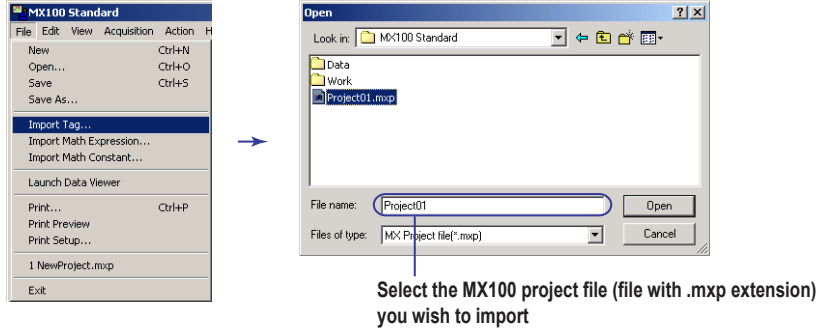

Note

When you carry out the procedure above, the tag numbers and tag comments of measurement channels are also imported.

Importing User-Defined Constants

On the File menu click Import Tag, then select an MX100 project file (a file with an .mxp extension) in the Open dialog box to import just the saved tag numbers and tag comments.

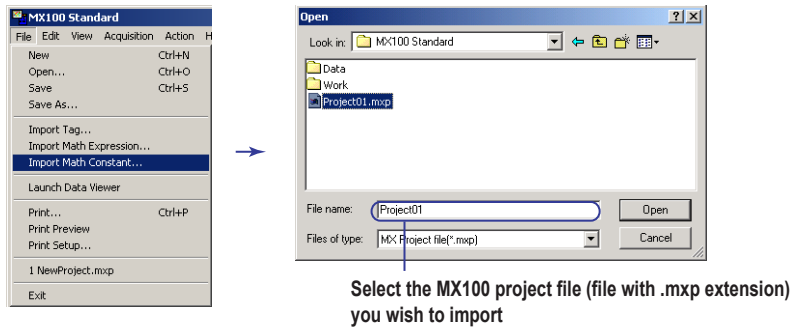

Setting Timers (Only When Using Timers in the Computations)

11. Click Action for a timer and select Edge or Level.
When not using the timer, select Off (default).
12. Click the Interval box, and enter the interval.
13. If Action was set to Edge, click the On-period box and enter the time interval over which the timer is to be turned ON. If Action was set to Level, click the On-period or Off-period box and enter the time over which the timer is turned ON or OFF.

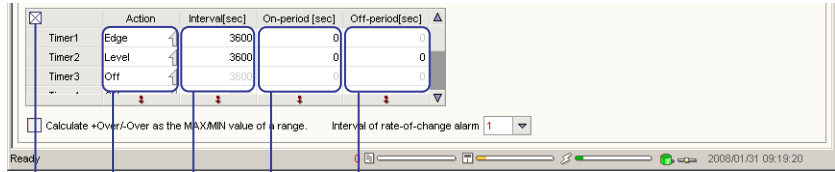

Minimize button

If Action is set to Level, enter the time interval over which the timer is OFF.

If Action is set to Edge or Level, enter the time interval over which the timer is ON.

Set the timer interval

To use a timer in the computation, select Edge or Level
When not using the timer, select Off (default).

When Calculating ±Overrange Values of Measurement Channels as the Maximum and Minimum Values of the Measurement Range

14. Select the Calculate +Over/-Over as the MAX/MIN value of the measurement range check box.

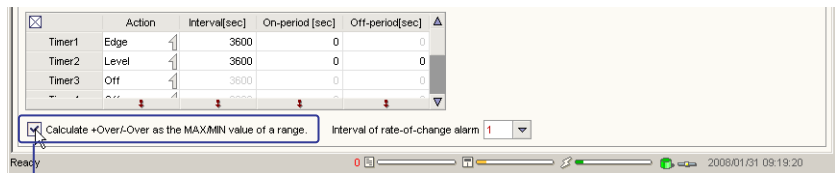

Check here to calculate +Over and -Over as maximum and minimum values of the measurement range

Resetting the Computations

From the Action menu, choose Math Clear.

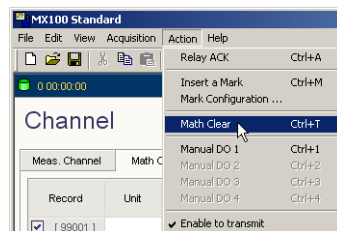

Explanation

Computation Overview

You can enter computation equations using the constants, operators, and functions described below. The computed results can be displayed and recorded (saved) as computed data. Computation allows you to determine the average/maximum/minimum of a specified channel on a specified date/time, or output events (start/stop record, reset time, etc.) under specified conditions. The number of available computation channels is 60 (channel numbers 99001 to 99060), and the number of characters that can be used in the equation is 127.

Constants

The following three types of constants can be used.

- **User-defined constants**

A constant can be assigned to an arbitrary string (name). You can set up to sixty user-defined constants. Set the Name of the constant using a string (up to ten characters) that is not used by predefined constants or functions. They are not case-sensitive. The precision and range of the constant values are the same as the single-precision floating point format (32 bits, negative values: $-3.4028235E+38$ to $-1.401298E-45$, and positive values: $1.401298E-45$ to $3.4028235E+38$).

- **Predefined constants**

The five strings below are used for predefined constants. They are not case-sensitive.

- **NaN:** Represents an invalid value or error value. For a description of the computed result when NaN is used in the computation, see “Notes on Computation” in this section.
- **POver:** Represents +Over (positive overrange). The expression $POver > x$ is satisfied for any arbitrary value x .
- **MOver:** Represents –Over (negative overrange). The expression $MOver < x$ is satisfied for any arbitrary value x .
- **Pi:** Represents the ratio of the circumference (3.14...).
- **e:** Represents the base of the natural logarithm (2.718...).

- **Numeric constants**

Numeric values that are written directly in the equation. They are expressed in the following form.

[digits].[digits][{d|D|e|E}[digits]]

Example: 1.0d+1 represents 10.0.

Channel Numbers

Channel numbers can be used to specify the <channel> (measurement or computation channels). The channel number is specified using five digits, the unit number in the highest two digits and the channel number within the unit in the lowest three digits. On the MX100 Standard Software, measurement channels are specified using 00001 to 00060 (1 to 60 are also allowed). Measurement channels are specified using 990001 to 99060.

Tag Numbers

Tag numbers can be used to specify the <channel> (measurement or computation channels). The tag numbers are enclosed in double quotation marks as in “TagNo.00001” They are case-sensitive.

Note

If the same tag number is specified on multiple channels, proper operation is not guaranteed.

Manual Output, and User Output (DO Channels, AO Channels, and PWM Channels)

Specify an integer starting with 1. The arguments for the ManualDO() and ManualAO() functions are as follows.

<ManualDOno.> 1-4
<ManualAOno.> 1

Operators

The operators listed below can be used.

Operator	Description	Example
+	Unary plus operator	+ch(00010)
-	Unary minus operator	-ch(00010)
!	Logical negation operator, 1 when 0 and 0 when non-zero	!ch(00010)
+	Addition	ch(00010)+ch(00011)
-	Subtraction	ch(00010)-ch(00011)
*	Multiplication	ch(00010)*ch(00011)
/	Division	ch(00010)/ch(00011)
%	Remainder	ch(1)%ch(2)<=1 ? AlarmAck() : 0
<	Less than, 1 when the condition is met and 0 when it is not	ch(1) > ch(2) ? AlarmAck() : 0
>	Greater than, 1 when the condition is met and 0 when it is not	ch(1) < ch(2) ? AlarmAck() : 0
<=	Less than or equal to, 1 when the condition is met and 0 when it is not	ch(00010)<=1.0 ? StartRec() : 0
>=	Greater than or equal to, 1 when the condition is met and 0 when it is not	ch(00010)>=1.0 ? StartRec() : 0
==	Equal to, 1 when the condition is met and 0 when it is not	ch(00010)==1.0 ? StartRec() : 0
!=	Not equal to, 1 when the condition is met and 0 when it is not	ch(00010)!=0 ? StartRec() : 0
&&	Logical product	ch(1) && ch(2)==1 ? AlarmAck() : 0
	Logical sum	ch(1) ch(2)==1 ? AlarmAck() : 0
^^	Exclusive OR	ch(1) ^^ ch(2)==1 ? AlarmAck() : 0
? :	Conditional operator (Write a ? b : c to mean b if a is met and c if not met)	ch(00010)>=1.0 ? StartRec() : 0
,	Order operator	Condition?(ResetTimer(), StartRec()) : 0

The order of precedence of the operators is as follows.

+ - ! (unary operators) ← + - * / % (arithmetic operators) ← < > <= >= == != (relational operators) ← && || ^^ (logical operators) ← ? (conditional operator) ← ,(order operator)

2.5 Setting Computations (Setting the Computation Channels)

Reference Functions and TLOG Functions

The function below are used to retrieve measured values and alarm values. The functions are not case sensitive. For the format used to specify the <channel>, <alarm level>, and <manual>, see "Procedure" in this section.

Function	Description	Example
ch(<channel>)	Returns the current value of the specified channel (see "Channel Number" under "Explanation" in this section)	ch(00001)/ch("Tag")
prech(<channel>)	Returns the previous value of the specified channel (see "Channel Number" under "Explanation" in this section)	prech(00001)/prech("Tag")
alarm(<channel>, <alarm level>)	Returns the alarm value of the specified channel and specified alarm level, ON=1, OFF=0	alarm(00001,2)/alarm("Tag",2)
alarm(<channel>)	Returns the alarm value of the specified channel, ON=1, OFF=0	alarm(00001)/alarm("Tag")
alarm()	Returns the alarm value of any channel, ON=1, OFF=0	alarm()==1 ? StartRec() : 0
tlogmax(<channel>)	Returns the maximum value of the TLOG computation of the specified channel	tlogmax(00001)/tlogmax("Tag")
tlogmin(<channel>)	Returns the minimum value of the TLOG computation of the specified channel	tlogmin(00001)/tlogmin("Tag")
tlogpp(<channel>)	Returns the (maximum value – minimum value) of the TLOG computation of the specified channel	tlogpp(00001)/tlogpp("Tag")
tlogsum(<channel>)	Returns the sum of the TLOG computation of the specified channel	tlogsum(00001)/tlogsum("Tag")
tlogave(<channel>)	Returns the average value of the TLOG computation of the specified channel	tlogave(00001)/tlogave("Tag")
ManualDO (<manual>)	Returns the values being output on the specified ManualDO.	ManualDO(1)
ManualAO (<manual>)	Returns the values being output on an user output channel.	ManualAO(1)

*1 The TLOG computation computes the maximum, minimum, maximum–minimum, sum, and average values of the specified channel. If the TLOG function is present in the equation, the computation is executed

*2 The reference function or TLOG function returns NaN in the following cases.

- When the data to be referenced by the CH function or PRECH function does not exist (when disconnected or immediately after starting the monitor operation)
- When the specified channel does not exist or when the specified alarm level is not 1, 2, 3, or 4.
- If the MX100 returns an INVALID value

*3 Select the behavior taken when the value of the measurement channel is \pm Over from the following:

- Continue the calculation as \pm Over (behavior when the check box is not selected)
- Continue the calculation by setting \pm Over to the maximum or minimum value of the measurement range of the specified channel.

The selection is made using the Calculate +Over/–Over as the MAX/MIN value of a range check box.

Arithmetic Functions

Below are the arithmetic functions that are available. They are not case-sensitive.

Function	Description	Example
sin(<value>)	Returns the sine of the <value>	sin(ch("TagNo.00001"))
cos(<value>)	Returns the cosine of the <value>	cos(ch("TagNo.00001"))
tan(<value>)	Returns the tangent of the <value>	tan(ch("TagNo.00001"))
asin(<value>)	Inverse sine	asin(ch("TagNo.00001"))
acos(<value>)	Inverse cosine	acos(ch("TagNo.00001"))
sinh(<value>)	Hyperbolic sine	sinh(ch("TagNo.00001"))
cosh(<value>)	Hyperbolic cosine	cosh(ch("TagNo.00001"))
tanh(<value>)	Hyperbolic tangent	tanh(ch("TagNo.00001"))
pow(<value 1>, <value 2>)	<value 1> to the power of <value 2>	pow(ch(1),ch(2))
sqrt(<value>)	Square root	sqrt(ch(1))
logE(<value>)	Natural logarithm	logE(ch(1))
log10(<value>)	Common logarithm	log10(ch(1))
expE(<value>)	e to the power of <value>	expE(ch(1))
exp10(<value>)	10 to the power of <value>	exp10(ch(1))
abs(<value>)	Absolute value	abs(ch(1))
max(<value>,.....,<value>)	Maximum value among multiple specified values	max(ch(1),ch(2),ch(3))
min(<value>,....,<value>)	Minimum value among multiple specified values	min(ch(1),ch(2),ch(3))
pp(<value>,....,<value>)	(Maximum – minimum) among multiple specified values	pp(ch(1),ch(2),ch(3))
sum(<value>,....,<value>)	Sum of multiple specified values	sum(ch(1),ch(2),ch(3))
ave(<value>,....,<value>)	Average of multiple specified values	ave(ch(1),ch(2),ch(3))
poly(<x>,<a0>,<a1>,....,<an>)	Polynomial with variable parameters Calculates $a_0x^n+a_1x^{n-1}+...+a_nx^0$	poly(ch(1),ch(2),ch(3))
ceil(<value>)	Returns the minimum integer greater than <value>	ceil(ch(1))
floor(<value>)	Returns the maximum integer less than <value>	floor(ch(1))
limit(<x>,<a>,)	If x is outside the range defined by a and b, round the value to a or b.	limit(ch(1),10,20)
rnd()	Returns a random number between 0 and 1	ch(1)*rnd()
isNaN(<value>)	Returns 1 if \value is NaN or 0 if it is not.	isNaN(ch(1))

2.5 Setting Computations (Setting the Computation Channels)

Time Functions

The table below shows the functions related to time. The functions are not case sensitive. Only integer numeric constants can be written in the function parameters <year>, <month>, <day>, <hours>, and <minutes> in the table below. The terminology used in the description in the table are defined below.

Edge: Returns 1.0 for computation immediately after the specified absolute or relative time.

Previous edge: Returns 1.0 for computation immediately before the specified absolute or relative time.

Level: Returns 1.0 during the specified absolute time or relative time.

- **Selectable range of parameters**

<years>: 1970 to 2036

<month>: 1 to 12 (1: January, 2: February, ..., 12: December)

<day>: 1 to 31

<week day>: 0 to 6 (0: Sunday, 1: Monday, ..., 6: Saturday)

<hours>: 0 to 23

<minutes>: 0 to 59

Function	Description	Example
time(<year>,<month>,<day> <hours>,<minutes>)	Edge operation on the date/time	time(2003,6,3,9,53) ? StartRec() : 0
bfTime(<year>,<month>,<day>,<hours>,<minutes>)	Previous edge operation on the date/time	bfTime(2003,6,3,9,3) ? StartRec() : 0
time(<year A>,<month A>,<day A>,<hours A>,<minutes A>,<year B>,<month B>,<day B>,<hours B>,<minutes B>)	Level operation between date/time A and B	time(2003,6,3,8,53,2003,6,3,9,13) ? sum(ch(1),ch(2),ch(3)) : 0
monthly(<day>,<hours>,<minutes>)	Edge operation every month on the specified day, hour, and minute.	monthly(3,9,53) ? StartRec() : 0
bfMonthly(<day>,<hours>,<minutes>)	Previous edge operation every month on the specified day, hour, and minute.	bfMonthly(3,9,53) ? StartRec() : 0
monthly(<day A>,<hours A>,<minutes A>,<day B>,<hours B>,<minutes B>)	Level operation between the specified day, hour, and minute of A to the specified day, hour, and minute of B every month	monthly(3,9,3,4,9,3) ? StartRec() : 0
weekly(<week day>,<hours>,<minutes>)	Edge operation every week on the specified week day, hour, and minute.	weekly(3,9,53) ? StartRec() : 0
bfweekly(<week day>,<hours>,<minutes>)	Previous edge operation every week on the specified week day, hour, and minute.	bfWeekly(3,9,53) ? StartRec() : 0
weekly(<week day A>,<hours A>,<minutes A>,<week day B>,<hours B>,<minutes B>)	Level operation between the specified week day, hour, and minute of A to the specified week day, hour, and minute of B every week.	weekly(10,00,11,05) ? sum(ch(1),ch(2),ch(3)) : 0
daily(<hours>,<minutes>)	Edge operation at the specified hour and minute every day	daily(10,00) ? StartRec() : 0
bfdaily(<hours>,<minutes>)	Previous edge operation at the specified hour and minute every day	dfDaily(10,00) ? StartRec() : 0
daily(<hours A>,<minutes A>,<hours B>,<minutes B>)	Level operation between time A and B	daily(10,00,11,05) ? sum(ch(1),ch(2),ch(3)) : 0
hourly(<minutes>)	Edge operation at the specified minute every hour	hourly(30) ? StartRec() : 0
bfhourly(<minutes>)	Previous edge operation at the specified minute every hour	bfHourly(30) ? StartRec() : 0
hourly(<minutes A>,<minutes B>)	Level operation between minute A and B every hour	hourly(10,20) ? sum(ch(1),ch(2),ch(3)) : 0
timer(<timerNo>)	Returns the status of the specified timer	timer(1)==1.0 ? StartRec() : 0

• **Timer (<timerNo>)**

Up to eight timers can be specified. The timer is specified using a number between 1 and 8.

Select the timer operation from the choices below. Select Off to disable the timer.

Edge: Returns 1.0 when performing computation after the ON time elapses after the beginning of each interval. Specify the interval for detecting the condition and the ON time in ms.

Level: Returns 1.0 from the time after the ON time elapses until after the OFF time elapses. Specify the interval for detecting the condition, ON time, and OFF time.

The selectable range of the interval for detecting the condition is 1 s to 86400000 s = 1000 days. The ON/OFF time is specified using the elapsed time from the beginning of the interval.

Timer Level Operation

• **When ON < OFF**

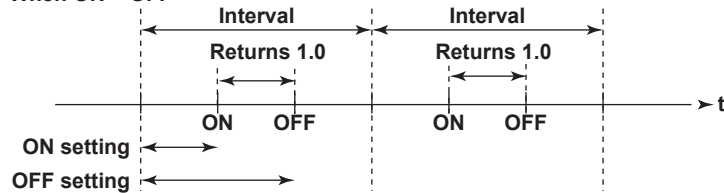

• **When ON > OFF**

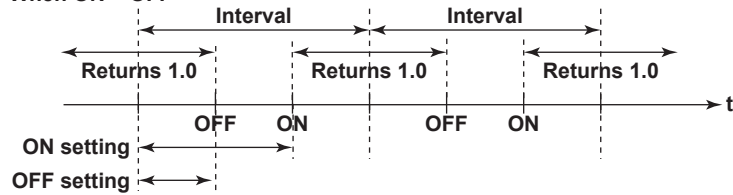

2.5 Setting Computations (Setting the Computation Channels)

Event Functions

A function used to carry out a given operation (event). They are not case-sensitive. They are mainly used in conjunction with the conditional operator (?). The return values are indicated below. The event is actually executed after the computation is complete.

- Execution successful: 1.0
- Execution failure: 0.0
- Invalid parameter: NaN

Function	Description	Example
AlarmAck()	Issue an alarm acknowledge	ch(1)>ch(2) ? AlarmAck() : 0
ResetMath()	Reset the computation	ch(00010)>=1.0 ? ResetMath() : 0
ResetTimer()	Reset the values of all timers	ch(00010)>=1.0 ? ResetTimer() : 0
ResetTimer(<timerNo>)	Reset the specified timer	ch(00010)>=1.0 ? ResetTimer(1) : 0
ResetTLog()	Reset the TLOG computation	ch(00010)>=1.0 ? ResetTLog() : 0
StartRec()	Start recording Valid after carrying out the record start procedure. Discarded if the recording is already stopped (returns 1.0).	ch(00010)>=1.0 ? StartRec() : 0
SplitRec()	Move to the next record file Valid after carrying out the record start procedure.	ch(00010)>=1.0 ? SplitRec() : 0
StopRec()	Stop recording Valid after carrying out the record start procedure. Discarded if the recording is already started (returns 1.0).	ch (00010) >=0 ? StopRec() : 0
Mark("mark")	Create a mark. The text inside the double quotation marks is arbitrary.	ch (00010) >=0 ? Mark("mark") : 0

- If the spacing between the execution of StopRec() and StartRec() is short, StartRec() may not be executed. When repeating start/stop frequently, consider using the Split function.
- The computed result at the time record start is executed is not necessary recorded to the file.

Notes on Computation

- The equation is not case sensitive. The exception is tag numbers specified on the Channel setup screen.
- The precision and range of computed values are the same as data in single-precision floating point format.
- The sampling interval of the computed channel is 100 ms to 10 min.
- Measured value used in computations

The measured value with the closest time is used among the measured values existing at the time of computation. Resampling of the measured value or interpolation are not performed while computation is being executed.

Example 1:

If the measured values indicated by ○ and ● exist and computation indicated by ■ is performed, the measured value indicated by ● on each channel is used. If the measured value does not exist such as in Ch 5, NaN is used as the measured value.

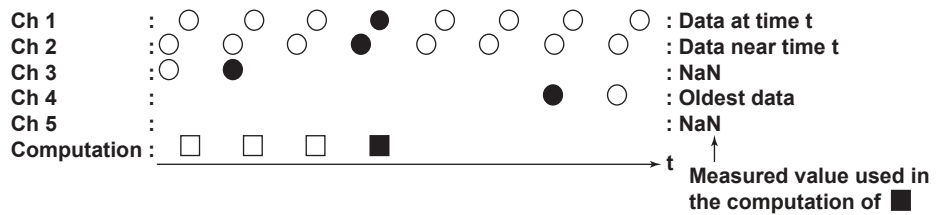

Example 2:

If the disconnection (disconnected after ×) is detected, NaN is used as the measured value of Ch 3.

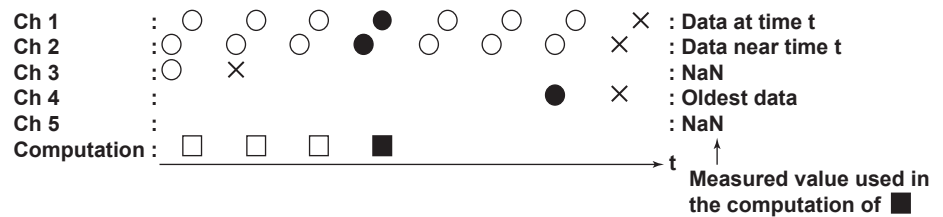

- Alarm values used in computations

Basically handled the same as measured values except the behavior differs in the following two cases.

 - When the alarm value does not exist (Ch 5 in example 1 above)

Always returns 0 (no alarm).
 - When the communication is cut off (Ch 3 in example 2 above)

Always returns the most-recent value.
- Syntax error and execution error
 - Syntax error

Equations containing items that are inappropriate are indicated in peach when the equation is being entered. If monitoring is started without correcting the equation, they are ignored.
 - Execution error

Execution errors are detected after starting the execution. Below are the two cases. NaN is returned as the result in either case.

 - When the reference destination does not exist when monitoring is started
 - When the computed result is undefined.
- Handling of NaN values
 - In the case of a TLOG function (tlogmax, tlogmin, tlogpp, tlogsum, and tlogave)

If NaN exists in the channel values, it is handled as though the value did not exist.
 - In the case of the IsNaN() function

This function can determine whether the value is NaN.
 - NaN is ignored for the functions min, max, sum, ave, and pp.

2.5 Setting Computations (Setting the Computation Channels)

- The value of NaN is considered true for the &&, ||, ^, and ! operators.
 - For all other computations
Computation is performed taking NaN as a value. Thus, NaN is returned as the computed result.
 - The numeric value display on the Monitor screen displays INVALID.
 - Handling when the value of a measurement channel is \pm Over (exceeding the upper and lower limits of the measurement range)
If the measured value used in the reference function or TLOG function is \pm Over, computation continues in one of two ways. Select the handling method using the Calculate +Over/–Over as the MAX/MIN value of a range check box.
 - Continue the computation as \pm Over.
 - Continue the calculation by setting \pm Over to the maximum or minimum value of the measurement range of the specified channel.
Use the following values as the maximum and minimum value of the measurement range.
 - DC voltage: $\pm 10\%$ of the range
Example: 6 V range
+OVER: +6.6 V
–OVER: –6.6 V
 - Temperature: $\pm 10^\circ\text{C}$ of the rated measurement range
However, 0 K and 10 K for KpVsAu7Fe and J263B.
 - Linear scaling: Maximum and minimum values of the scale corresponding to $\pm 10\%$ of the measurement span
However, ± 32000 when the scale value exceeds ± 32000 .
Example 1: When the measurement span is set to ± 1 V and the scale is set to ± 10000 at 2 V range
+OVER: +22000
–OVER: –22000
Example 2: When the measurement span is set to ± 2 V and the scale is set to ± 30000 at 2 V range
+OVER: +32000
–OVER: –32000
- To suppress \pm Over from occurring in an arbitrary computation, use the limit function (see “Arithmetic Functions” under “Explanation” in this section).
- Alarms for computation using the Alarm() function
The alarm corresponding to the current value is used for the alarm of a measurement channel.
The alarm corresponding to the current value is used for the alarm of a computation channel. However, for computation channels that have not yet computed the current value, the alarm corresponding to the previous value is used.

Setting the Computation Span

This section provides an explanation of the span of transmission output for the analog output and PWM output modules.

- MATH channel range over
The upper and lower limits for the display of the monitor screen and other items. The MATH span setting range is as shown below depending on the decimal place. If the computed results fall outside of the MATH span setting range, they are displayed on screen as plus over or minus over data.

Decimal Place	MATH span setting range	Decimal Place	MATH span setting range
0	–9999999 to 99999999	3	–9999.999 to 99999.999
1	–999999.9 to 9999999.9	4	–999.9999 to 9999.9999
2	–99999.99 to 999999.99		

2.6 Displaying the Monitor and Setting the Display Procedure

Procedure

Changing the Display Settings on the Display Setup Screen

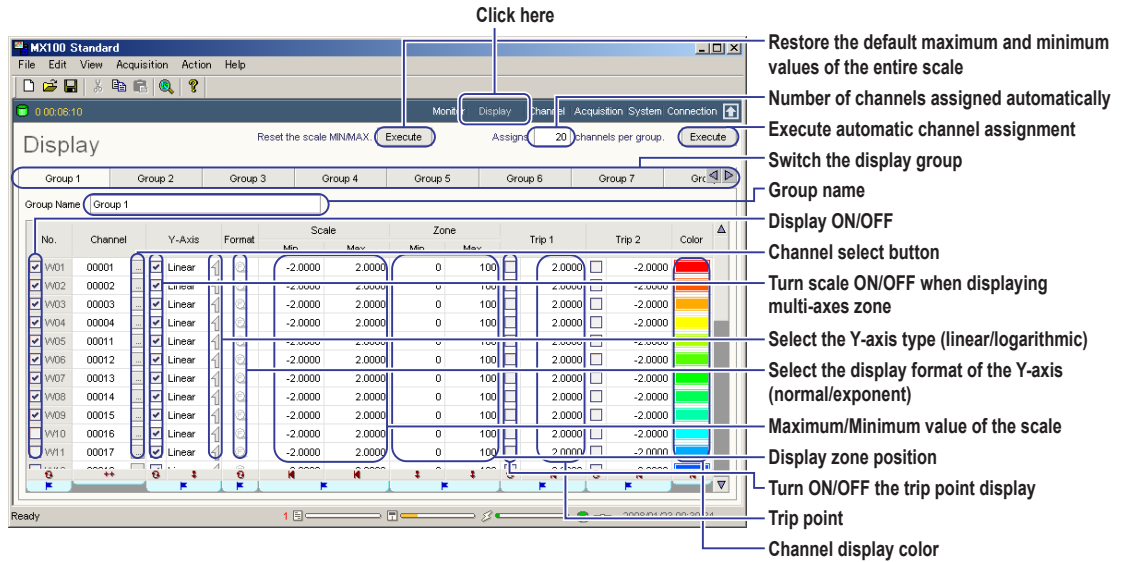

1. Click Display to show the Display setup screen.
2. Change the display settings according to the explanation in the figure below. Set the display for each display group. You can set up to ten display groups.

Initializing, Copying, and Pasting of Settings on the Display Setup Screen

On the Display Setup Screen, you can reset the settings to default or copy and paste the settings of one or multiple waveforms to the settings of other waveforms. You can copy and paste according to the procedure below.

Click the copy source waveform number (No. column), choose Copy from the Edit menu, click the copy destination waveform number, and choose Paste from the Edit menu.

Drag to select the range

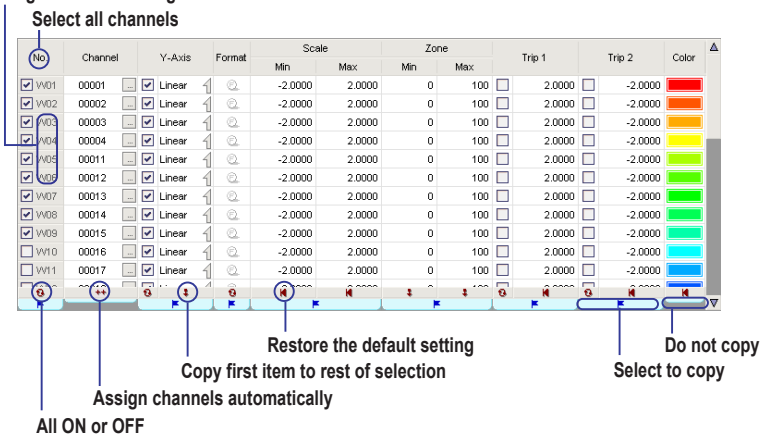

2.6 Displaying the Monitor and Setting the Display Procedure

Displaying the Monitor Screen and Settings on the Monitor Screen

1. Click Monitor to show the Monitor screen.
2. Change the display settings according to the explanation in the figure below. If the channels of different interval groups or channels of computation groups are assigned to the same display group, a monitor is displayed for each interval group or computation group (see the figure below).

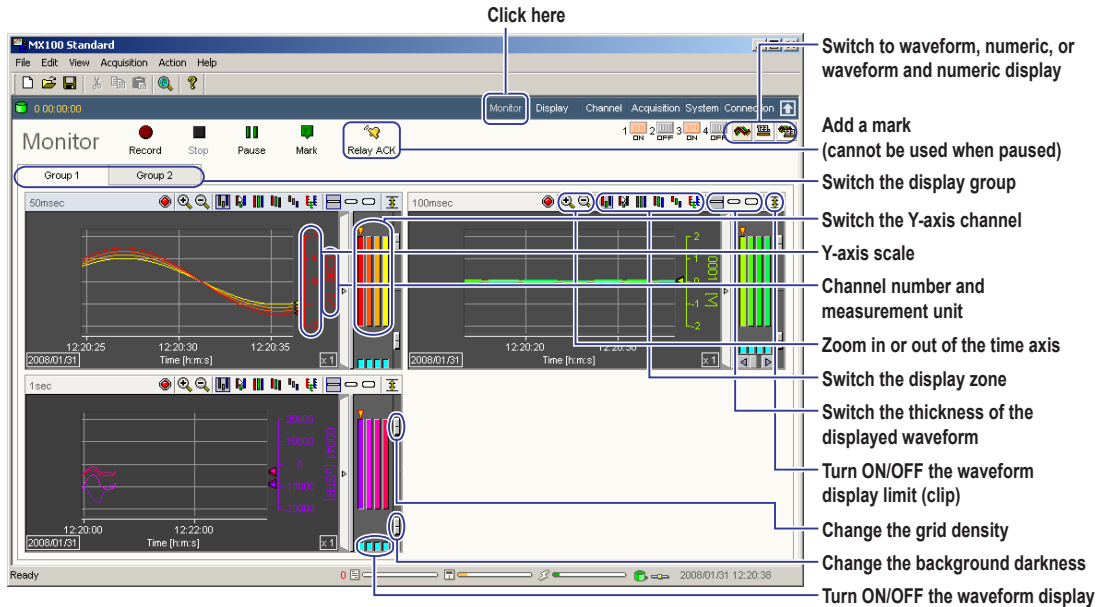

Note

You can switch the screen to waveform display, numerical display, or waveform and numerical display.

Setting the Status Bar Display on the View Menu

1. Click View to open the View menu.
2. Select the item to be shown or hidden. Items that have check marks are shown.

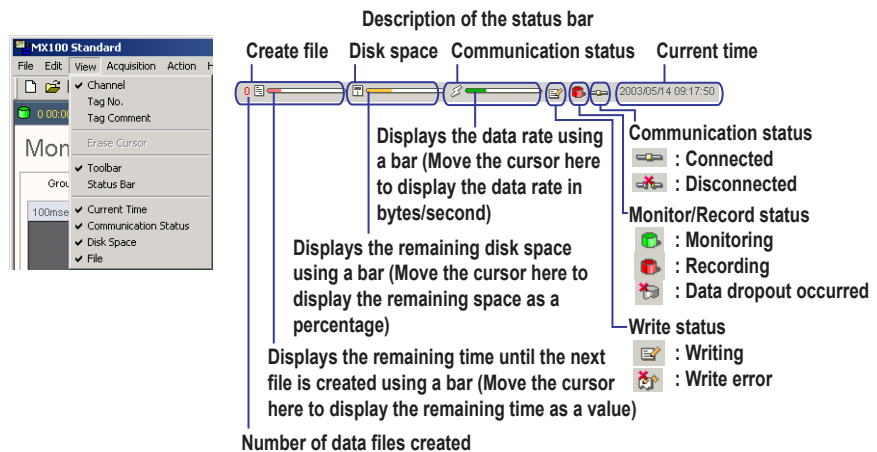

Note

If there is a record file that has not been finalized (data writing has not been completed) in the previous connection, the finalization of the record file is carried out immediately upon establishing the connection. If this occurs, the progress of the finalization is displayed on the status bar. The number of remaining data files is indicated between the Communication performance and Write status. If there are none, the bar is not displayed.

Explanation**Display Groups and Group Names**

On the Monitor screen, the channels are divided into groups and displayed using waveforms or numerical values. The measured/computed values can be divided into up to ten groups. Up to thirty-two channels can be registered to a single group. The channels that can be registered are those where the Monitor check boxes are selected in the Channel setup screen. When you click a channel selection button on the Display setup screen, the channel numbers of the channels that can be registered are displayed (see the figure below).

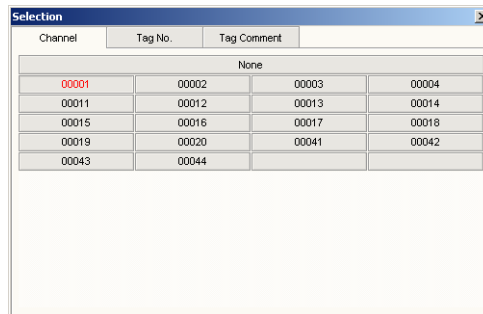

Channel	Tag No.	Tag Comment	
None			
00001	00002	00003	00004
00011	00012	00013	00014
00015	00016	00017	00018
00019	00020	00041	00042
00043	00044		

To turn ON/OFF the waveform display on the Monitor screen, click the light-blue button below the scale bar as shown in the figure below.

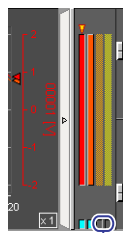

Hide the waveform

You can enter a group name using up to thirty characters. By default, group names Group 01 to Group 10 are assigned. The names of the display groups that have channels registered are displayed on the Monitor screen.

**Y-Axis Type**

You can select linear or logarithmic scale for the Y-axis when displaying the waveforms.

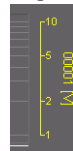
Linear scale**Logarithmic scale**

2.6 Displaying the Monitor and Setting the Display Procedure

Maximum and Minimum Values of the Y-Axis and the Display Format of the Scale Values

Specify the maximum and minimum values of the Y-axis scale. The scale values can also be displayed using logarithmic format as shown below.

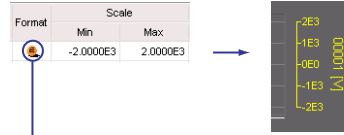

Select the exponential format

Selecting the Display Zone of the Waveform

You can select from the following. In the Zone setting on the Display setup screen, assume the bottom and top edges of the waveform display area to be 0% and 100%, respectively, and set the waveform display position by specifying the minimum value (0 to 99%) and the maximum value (1 to 100%).

- **User zone**

Displays each waveform at the position specified by Zone on the Display setup screen. A single Y-axis scale of the active waveform can be displayed.

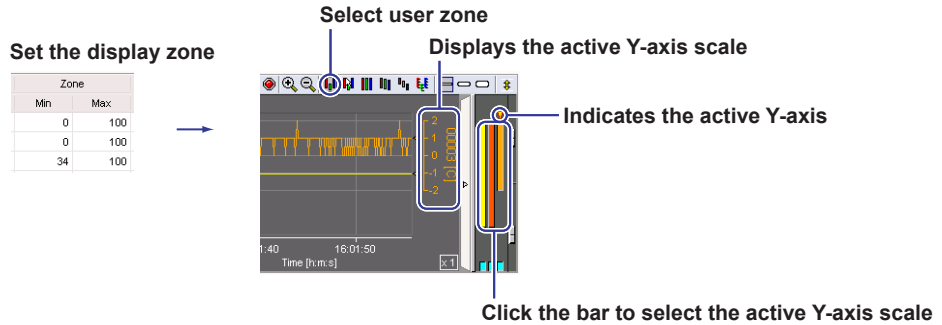

- **Edit zone**

Like the user zone, each waveform is displayed at the position specified by Zone on the Display setup screen. However, you can change the zone on the Monitor screen. A single Y-axis scale of the active waveform can be displayed.

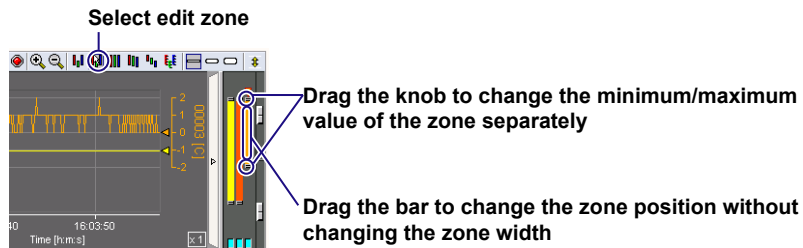

- **Full zone**

Displays all the waveforms over the full zone of the waveform display area regardless of the Zone settings on the Display setup screen. A single Y-axis scale of the active waveform can be displayed.

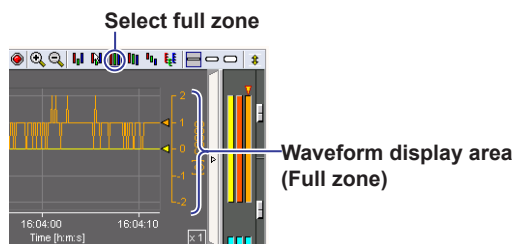

• **Slide zone**

Displays the waveforms by slightly offsetting the display position of each waveform vertically regardless of the Zone settings on the Display setup screen. A single Y-axis scale of the active waveform can be displayed.

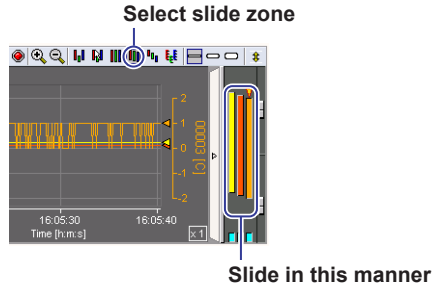

• **Auto zone**

Displays the waveforms by dividing the waveform display area evenly according to the number of displayed waveforms regardless of the Zone settings on the Display setup screen.

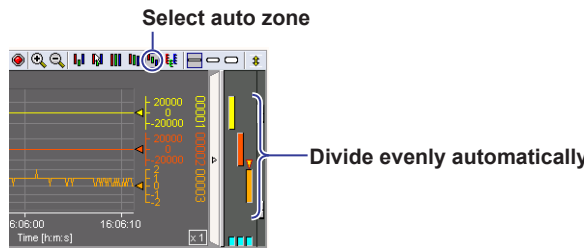

• **Multi-axis zone**

All the Y-axes of the displayed waveforms are aligned horizontally. To hide a Y-axis scale, clear the Y-Axis check box on the Display setup screen. The display zone is set to the position specified by Zone on the Display setup screen.

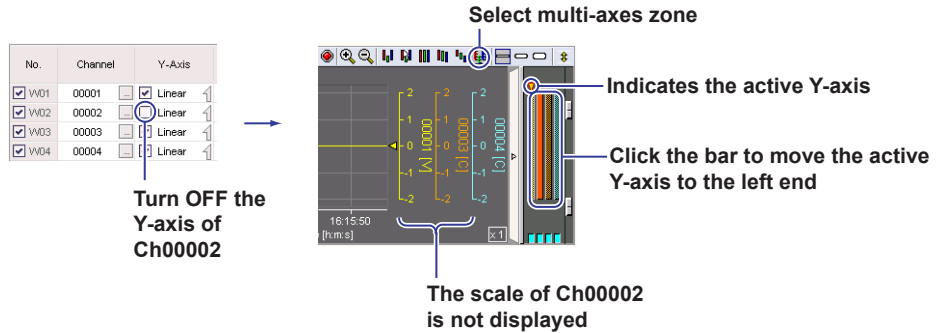

2.6 Displaying the Monitor and Setting the Display Procedure

Trip Point

You can display a trip line to indicate a particular value of interest (trip point) in the waveform display area. Two trip points (trip 1 is red, trip 2 is blue) can be set on each waveform. The trip line of the waveform corresponding to the left-most Y-axis is shown in the waveform display area.

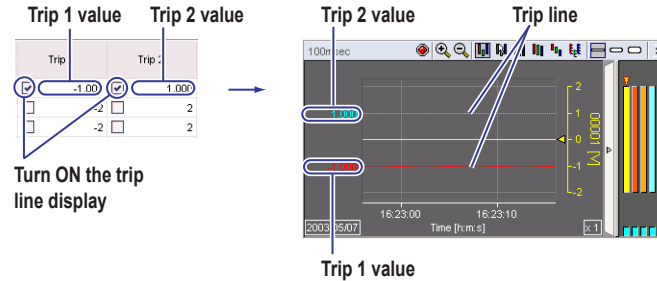

Channel Color

Clicking the channel color displayed in the Color column on the Display setup screen opens the Color dialog box. You can select the color of each channel using the Color dialog box. To create custom colors, click the Define Custom Colors button in the Color dialog box.

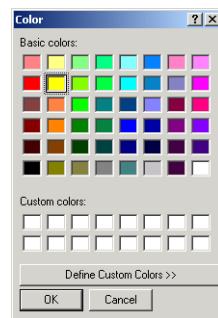

Clipping of Waveforms

By default (clip OFF), the waveform is not displayed when the measured/computed value exceeds the minimum/maximum value of the scale (see the lower left figure). When clip is turned ON, values that are smaller than the minimum value of the scale are displayed as the minimum value and the values that are larger than the maximum value of the scale are displayed as the maximum value.

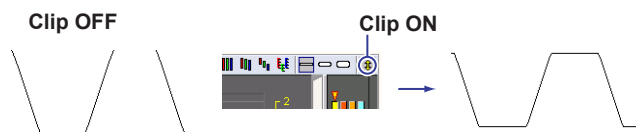

Expanding or Reducing the Time Axis on the Waveform Display

On the waveform display, you can click the expand/reduce icon to expand or reduce the time axis for each waveform display area. The maximum magnification is x20. The minimum magnification varies depending on the size of the waveform display area.

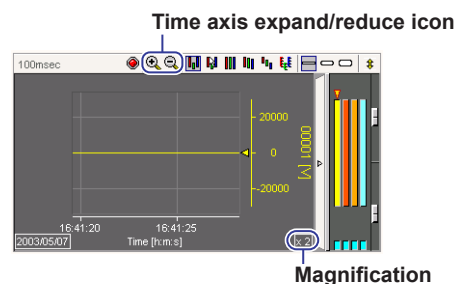

Adding Marks

You can display marks in the waveform display area (see the figure below). You can enter a text to be attached to the mark ("Mark" by default) using up to fifteen characters. Click the Mark button or choose Mark Configuration from the Action menu. You can enter the text in the dialog box that opens.

Up to 200 marks can be displayed. When 200 is exceeded, the marks are erased from the oldest ones. However, if the data is being recorded, the marks are saved to the record file.

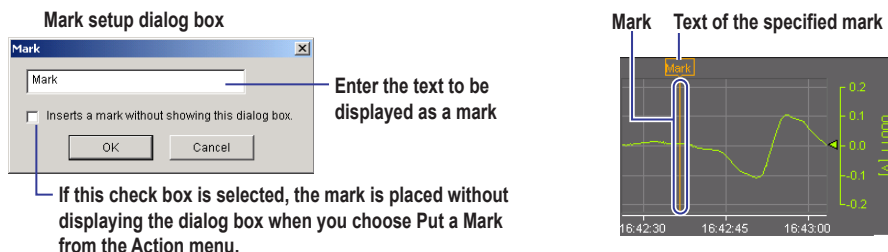

Note

Marks cannot be placed when the monitor update is paused.

Numeric Display

You can switch from the waveform display to numeric display as shown below.

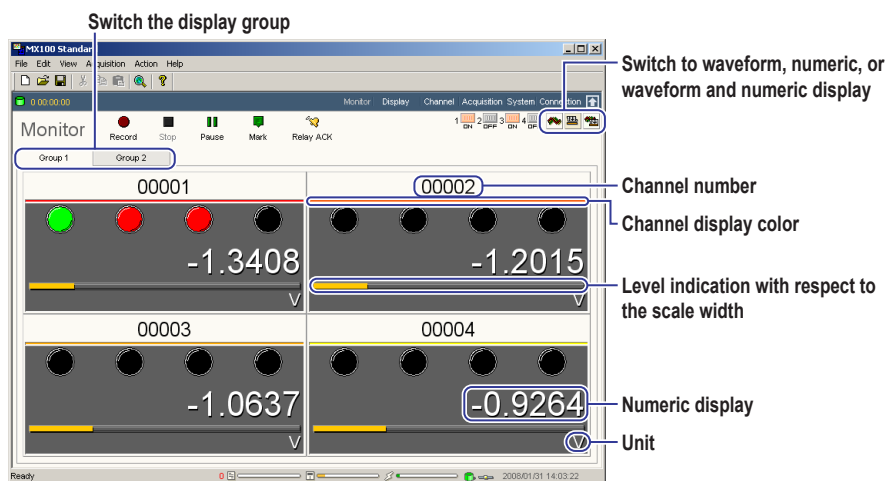

Waveform and Numeric Display

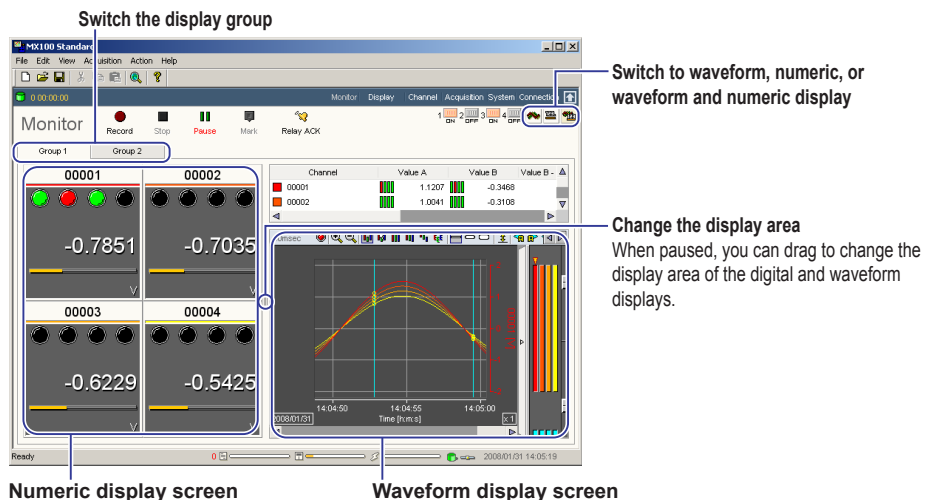

2.7 Starting and Stopping the Recording of Measured/Computed Data

Procedure

Record Start Operation

Click the Record button on the Monitor screen, or choose Record from the Acquisition menu.

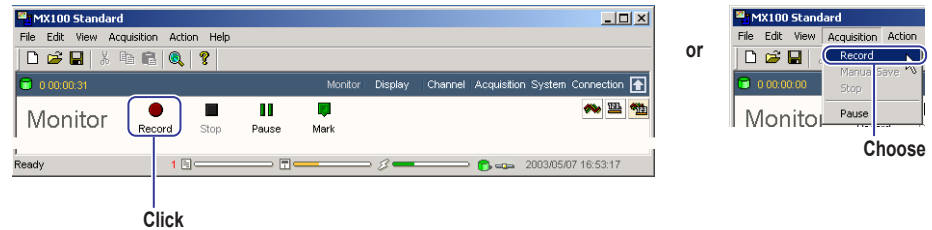

When recording starts, the display changes as shown in the figure below. To divide the file during recording, click the Manual Save button or choose Manual Save from the Acquisition menu.

Changes to red when recording starts

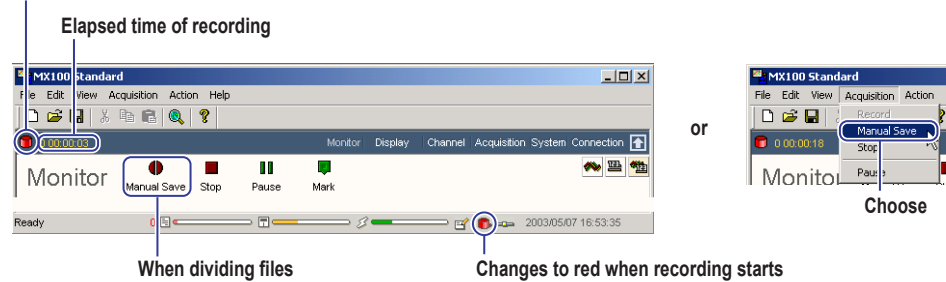

While the Start Condition specified on the Acquisition setup screen is not met, the word "Waiting" appears under the Record button (see figure below).

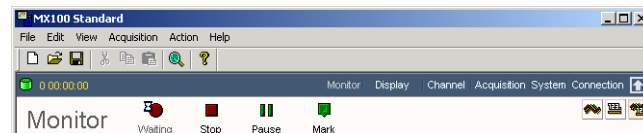

Note

Clicking the Record or Stop buttons repetitively at short intervals or clicking the Manual Save button many times may hinder the measurement operation and file division process.

Record Stop Operation

To stop recording when Stop Condition specified on the Acquisition screen is set to Manual or before the stop condition is met, click the Stop button on the Monitor screen or choose Stop from the Acquisition menu.

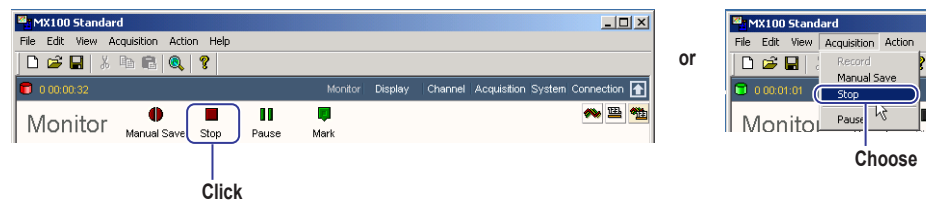

2.7 Starting and Stopping the Recording of Measured/Computed Data

When you click the Stop button on the Monitor screen or choose Stop from the Acquisition menu, a dialog box shown below opens.



Click OK. When you click OK, the word “Saving” appears below the Stop button until the recording stops.

Explanation

Start/Stop Recording

Data is recorded according to the Start condition and Stop condition specified on the Acquisition setup screen. Recording starts immediately when you click the Record button only when Start condition is set to On Record. For all other settings, the detection of whether the start condition is met is started when you click the Record button.

Note

- The creation of the data file starts after the recording is stopped. Therefore, it may take time for the data save operation to complete.
- You cannot exit the software if the saving of the data is not complete. If you attempt to do so, a dialog box with the message “Writing data files Currently” opens. At the same time, the number of remaining record files to be finalized is indicated on the status bar (see section 2.6, “Setting the Status Bar Display on the View Menu.”). The software closes when this indication clears.
- If the record file cannot be created at the specified destination, the file is created in the Data folder in the directory where the MX100 Standard Software is installed.
- You can click the arrow button shown in the figure below to reduce the size of the display of the Record button and other items and widen the waveform display area. To set the size back to the original condition, click the arrow button again.

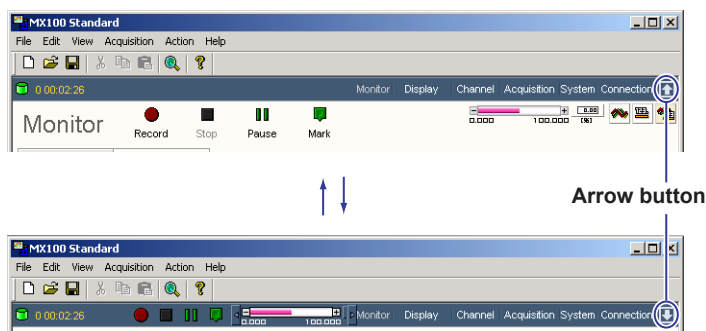

2.8 Pausing the Updating of the Monitor Display and Reading Measured/Computed Values Using Cursors

Procedure

Pausing and Resuming the Updating of the Monitor Display

To pause the monitor display, click the Pause button on the Monitor screen or choose Pause from the Acquisition menu. When paused, the word "Pause" under the button toggles between red and black.

To resume the monitor display, click the Pause button on the Monitor screen or choose Pause release from the Acquisition menu.

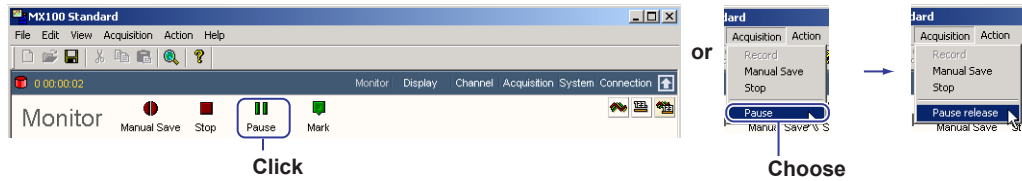

Note

Recording continues even when the updating of the monitor display is stopped.

Reading Measured/Computed Values Using Cursors

When updating of the monitor display is paused, you can read measured (computed) values with the cursor. Click the position in the waveform display area where you wish to read the value. If you wish to read another point simultaneously, drag the mouse. Cursor A appears at the position where you first clicked; cursor B appears at the position where you released the mouse button. The measured point is the yellow circle displayed where the waveform and the cursor cross.

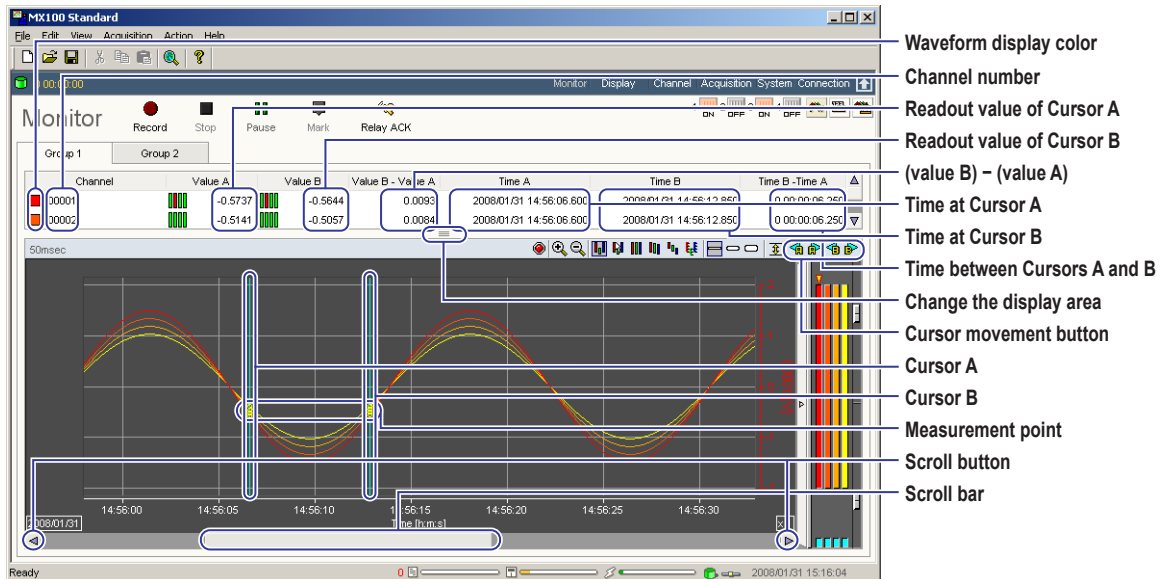

2.8 Pausing the Updating of the Monitor Display and Reading Measured/Computed Values Using Cursors

To clear the cursors, choose Hide Cursor from the View menu.

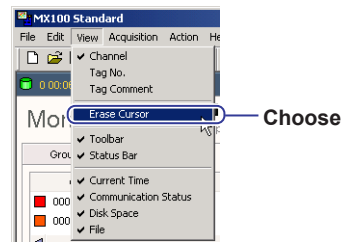

Explanation

Pausing the Updating of the Waveform Display

While monitoring the waveform, you can pause the updating of the waveform display and check the past waveforms (up to 1800 points).

Pausing the display on the numeric display holds the current values immediately before the pause operation on display.

Reading Measured/Computed Values Using Cursors

When the updating of the waveform display is paused, you can read values using cursors. Two cursors can be displayed. Below are the values that can be read using cursors.

- Values at the cursors.
- Difference in the value between the cursors.
- The time at the cursor position.
- The time between the cursors.

2.9 Setting Alarms and Alarm Indications

Procedure

Setting the Alarm

For computation channels

Click here

Alarm 1 type

Alarm value of alarm 1

Hysteresis of alarm 1

Alarm 2 type

Alarm value of alarm 2

Hysteresis of alarm 2

Scroll to the right to display alarms 1 to 4

Rate-of-change interval when the Type is set to rHigh and rLow

Record	Type	Alarm 1 Value	Alarm 1 Hysteresis	Alarm 2 Type	Alarm 2 Value	Alarm 2 Hysteresis	Constant Label	Constant Value
[99001]	High	1.5000	0.3000	rHigh	1.0000	0.5000		0.0000
[99002]	High	0.0000	0.2000	rLow	0.5000	0.1000		0.0000
[99003]	Off	0.0000	0.0000	Off	0.0000	0.0000		0.0000
[99004]	Off	0.0000	0.0000	Off	0.0000	0.0000		0.0000
[99005]	Off	0.0000	0.0000	Off	0.0000	0.0000		0.0000
[99006]	Off	0.0000	0.0000	Off	0.0000	0.0000		0.0000
[99007]	Off	0.0000	0.0000	Off	0.0000	0.0000		0.0000
[99008]	Off	0.0000	0.0000	Off	0.0000	0.0000		0.0000

1. Click Channel to show the Channel setup screen.
2. Click the Meas. Channel tab or the Math Channel tab.
3. In the Type list, select the alarm type for Alarm 1, Alarm 2, Alarm 3, or Alarm 4. When not using difference input on measurement channels, select OFF, High, or Low. When using difference input, select OFF, dHigh, or dLow. On computation channels, select OFF, High, Low, rHigh, or rLow.
4. Click the value box, and enter the alarm value.
5. Click the Hysteresis box, and enter the alarm hysteresis value.
6. If you selected a rate-of-change alarm rHigh or rLow for the alarm type, select the interval used to detect the rate-of-change from the Interval of rate-of-change alarm list box.

Showing/Hiding Alarms

1. Click Monitor to show the Monitor screen.
2. Click the Alarm ON/OFF button.

Show/Hide alarm

Switch the active channel

Alarm display area

Explanation

Alarm Types

Alarm level settings and operation differ depending on the hardware style number of the MX100. See the table below.

Connectable module types or setting items	MX100 Hardware Style Number*		
	S3	S2	S1
Alarm level setting (alarm 3 to alarm 4)	Yes	No	No

Yes: Setting and operation allowed, No: Setting and operation not allowed

* The style number is printed on the MX100 main module name plate.

There are six types of alarms.

When not using difference input on measurement channels, select OFF, High, or Low.

When using difference input, select OFF, dHigh, or dLow.

On computation channels, select OFF, High, Low, rHigh, or rLow.

- **Upper limit alarm (High)**

An alarm occurs when the measured/computed value exceeds the alarm value.

- **Lower limit alarm (Low)**

An alarm occurs when the measured/computed value falls below the alarm value.

- **Difference upper limit alarm (dHigh)**

An alarm occurs when the difference input (difference between the measured value of its own channel and that of the reference channel) exceeds the alarm value.

- **Difference lower limit alarm (dLow)**

An alarm occurs when the difference input (difference between the measured value of its own channel and that of the reference channel) falls below the alarm value.

Upper-limit alarm
Difference upper limit alarm

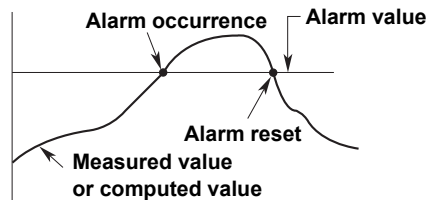

Lower-limit alarm
Difference lower limit alarm

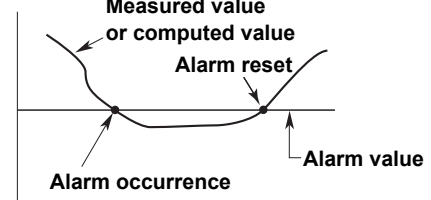

- **Upper limit on rate-of-change alarm (rHigh)**

An alarm occurs if the amount of change in the computed value in the rising direction exceeds the alarm setting value within the rate-of-change detection interval.

- **Lower limit on rate-of-change alarm (rLow)**

An alarm occurs if the amount of change in the computed value in the falling direction exceeds the alarm setting value within the rate-of-change detection interval.

Upper limit on rate-of-change alarm

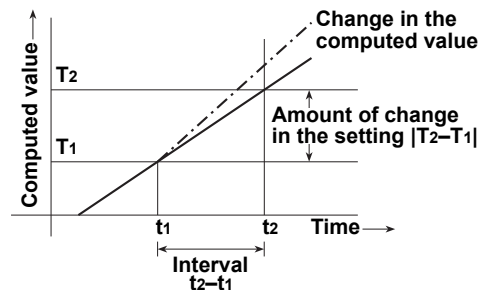

Lower limit on rate-of-change alarm

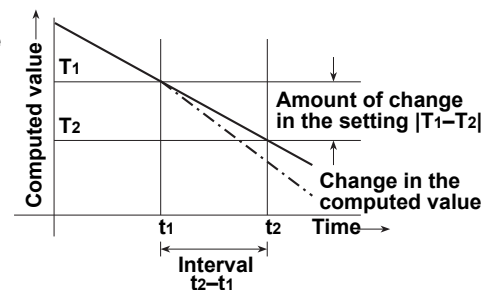

The rate-of-change detection interval is equal to measurement interval × measurement count. Select the measurement count (1 to 15) using the Interval of rate-of-change alarm box.

2.9 Setting Alarms and Alarm Indications

Alarm Hysteresis

You can set a width (hysteresis) to the values used to activate and release alarms. Alarm hysteresis prevents frequent activation and release of alarms when the measured/computed value is unstable around the alarm value.

Upper limit alarm

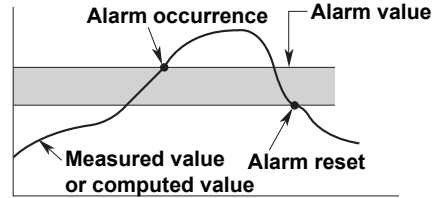

Lower limit alarm

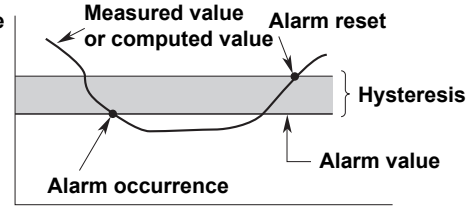

Alarm Indication on the Numerical Display

Four alarm signals are displayed above the value (see the figure below). The changes in the color of these alarm signals indicate the alarm status.

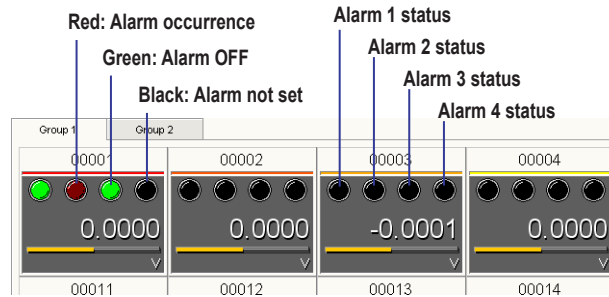

Note

When using computation channel alarms, do not disconnect the MX100 and the PC software. Computation channel alarms will not occur because the computation function does not work when using only the MX100.

2.10 Digital Output Settings

Procedure

Setting the Digital Output of Alarms

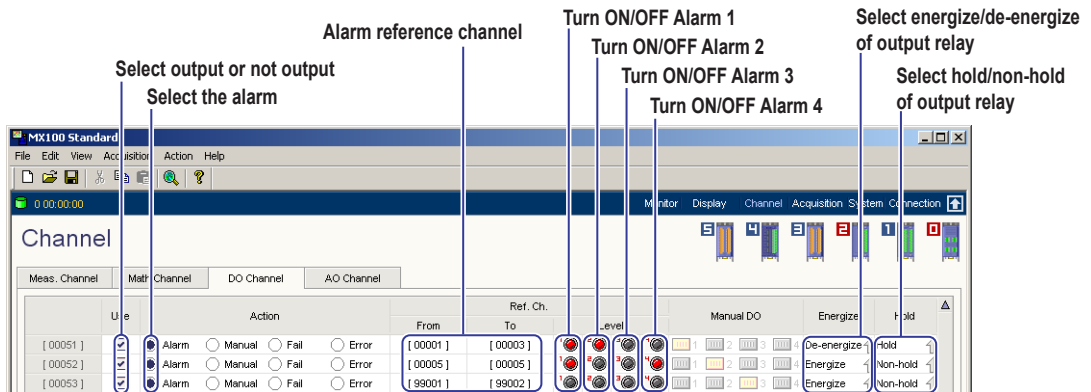

1. Click Channel to show the Channel setup screen.
2. Click the DO Channel tab.
3. Select the Use check boxes for the DO channels you wish to output.
4. Click the Alarm button under Action.
5. Click the First or Last alarm reference channel box under Ref. Ch. and enter the measurement or computation channel numbers to reference for the alarm output.
6. Click the Level 1, Level 2, Level 3, or Level 4 button under Ref. Ch.
7. Click the Energize box to select an output relay action of Energize or De-energize.
8. Click the Hold box to select an output relay behavior of Hold or Non-hold.

Setting the Digital Output Other Than Alarms

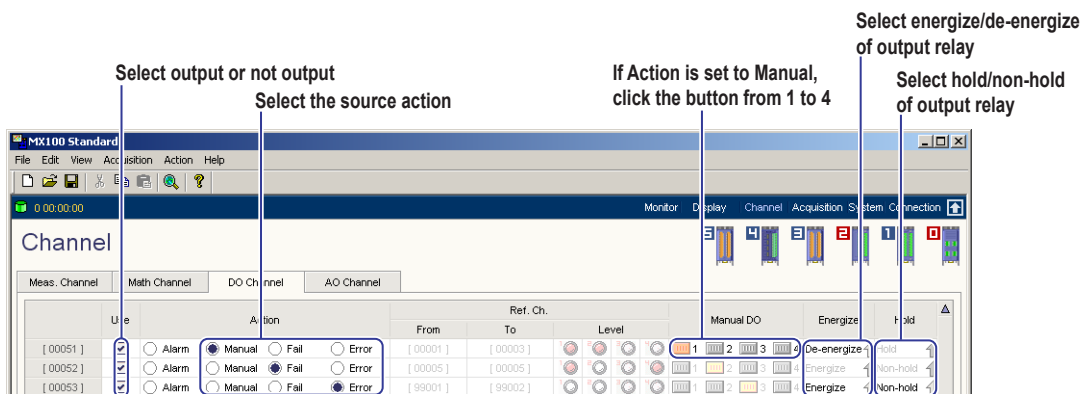

4. Click the option button under Action to select the action used as the digital output source.
5. If you set Action to Manual, click any of the Manual DO buttons 1 to 4.
6. Click the Energize box to select an output relay action of Energize or De-energize.
7. Click the Hold box to select an output relay behavior of Hold or Non-hold.

Explanation

Alarm Reference Channel Range

The alarm detection of multiple measurement channels or computation channels can be assigned to a single DO channel. If an alarm is detected on any one of the assigned channels, an alarm is output. A range of individual or consecutive channel numbers can be assigned.

Note

If connection with the PC is dropped, the state at the point at which the DO output was dropped is retained. However, DO output to which measurement channel alarm detection is assigned functions normally even if the connection with the PC is dropped.

Digital Output Operation Other Than Alarm Output

The digital output can be enabled for the following causes.

- **Manual DO**

DO channels assigned to the button number output relay contact signals collectively when the manual DO button on the Monitor screen is clicked.

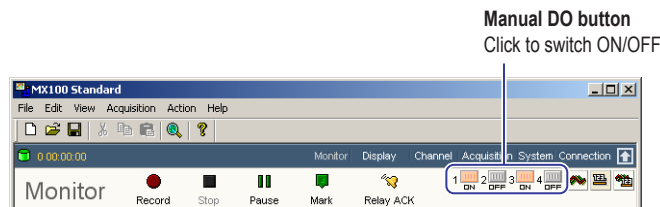

- **FAIL output**

Outputs a relay contact signal when an error occurs in the main module CPU. Relay output is turned ON (the relay is energized) when the CPU is operating normally. It is turned OFF when there is an error in the CPU and during power failures.

- **Error output**

Outputs a relay contact signal when any of the following events occur.

- A data output request timeout (60 s) occurs while recording data. (except when the /DS option functions are enabled)
- A module error occurs.
 - An input module detected at power-on that is able to make measurements is removed.
 - A module breaks down.
 - An unidentifiable module is attached.

When using the energize setting for contact output, the circuit switches from open to short when the output is enabled. When using the de-energize setting, the circuit switches from short to open.

Energized/De-energized Operation of Output Relays

You can select whether the output relay is energized or de-energized when an output event (such as an alarm) occurs. If De-energized is selected, the output relay behaves in the same fashion as when an output event occurs if the power is cut off. The default setting is Energized.

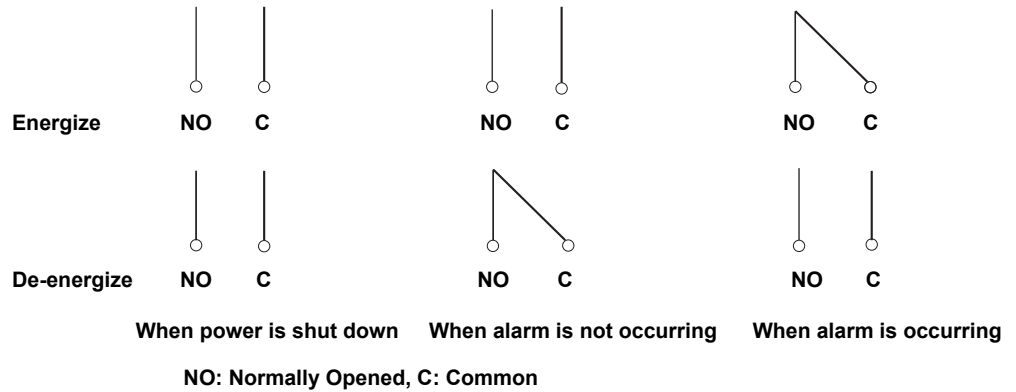

Hold/Non-Hold of Output Relays

Select the behavior of the output relay when an output event is released (recovers to a normal condition). The default setting is Non-hold.

- Turn OFF the output relay with the release of the output event (non-hold).
- Hold the output relay at ON until the Relay ACK button (see below) is clicked.

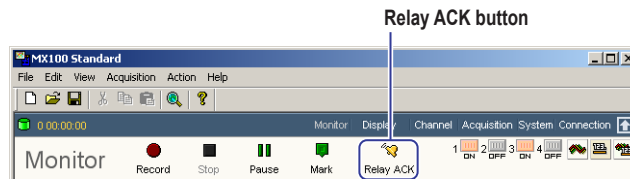

• When set to non-hold

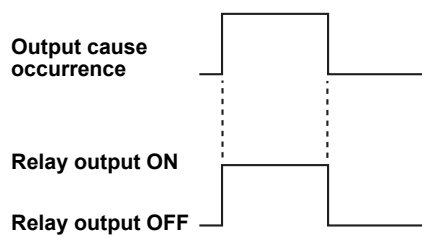

• When set to hold

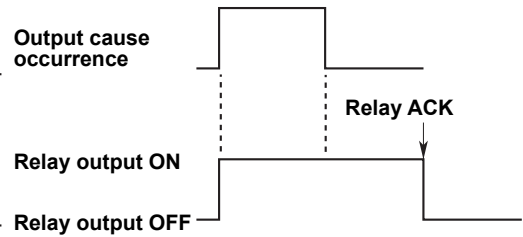

2.11 Analog/PWM Output Settings

Procedure

Analog Output Settings

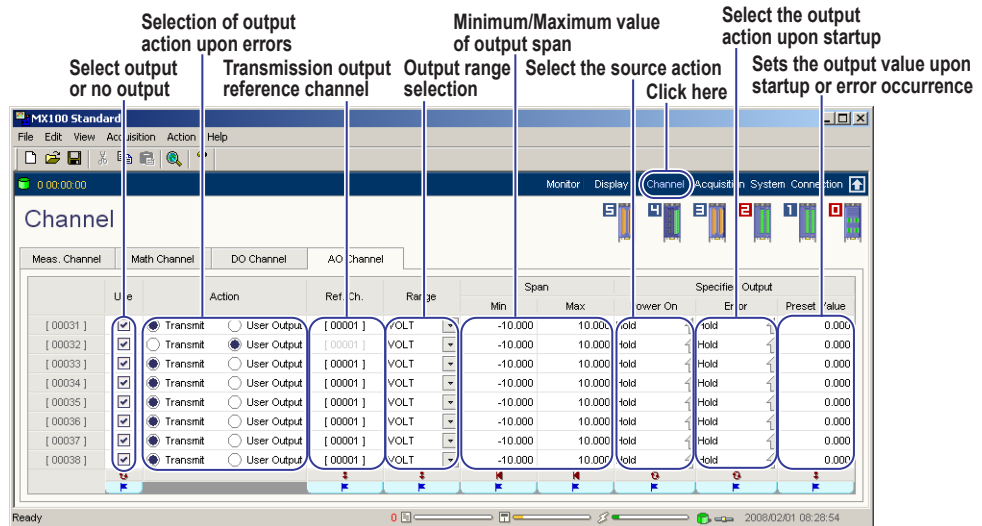

1. Click Channel to show the Channel setup screen.
2. Click the AO Channel tab.
3. Select the Use check boxes for the AO channels you wish to output.
4. Specify a channel operation of Transmission output or User output. If user output is specified, you can enter settings in the monitor screen.
Only one of all the AO and PWM channels can be selected for user output.
5. When transmission output is specified, enter the Reference channel.
The reference channel cannot be entered if the channel operation is user output.
6. Select a range from the Range list box.
7. Click the Min box or Max box under Span and enter the minimum or the maximum value of the span.
8. Click the Power ON box under Output Action and select Hold previous value or Preset value.
9. Click the Error box under Output Action and select Hold previous value or Preset value.
10. If you select Preset value under Output Action, click Preset value, and enter the voltage or current.

PWM Output Settings

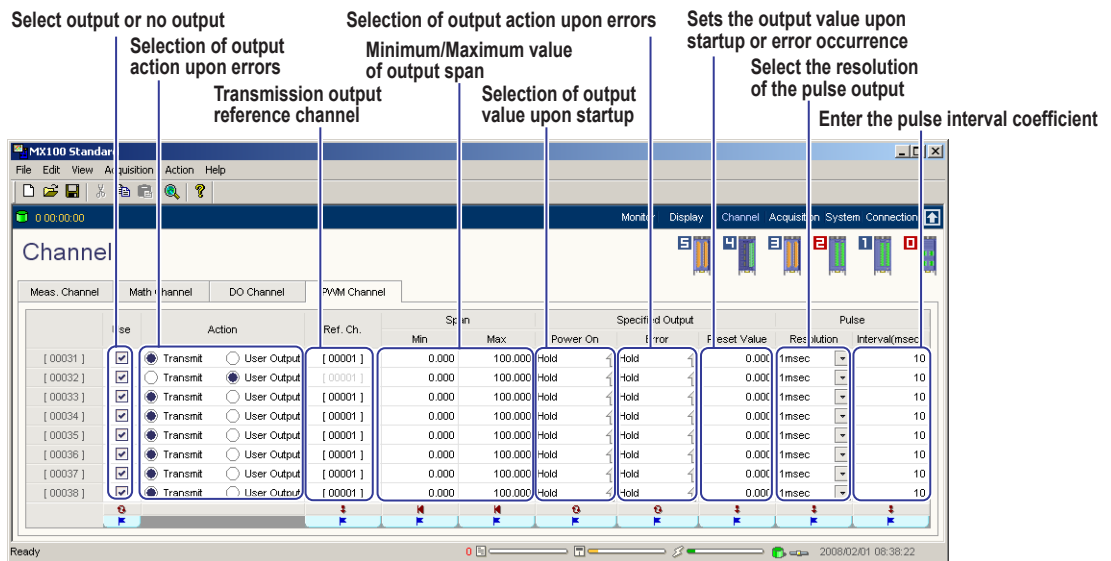

1. Click Channel to show the Channel setup screen.
2. Click the PWM Channel tab.
3. Select the Use check boxes for the PWM channels you wish to output.
4. Specify a channel action of Transmission output or User output. If user output is specified, you can enter settings in the monitor screen.
Only one of all the AO and PWM channels can be selected for user output.
5. When transmission output is specified, enter the Reference channel.
The reference channel cannot be entered if the channel operation is user output.
6. Click the Min box or Max box under Span and enter the minimum or the maximum value of the span.
7. Click the Power ON box under Output Action and select Hold previous value or Preset value.
8. Click the Error box under Output Action and select Hold previous value or Preset value.
9. If you select Preset value under Output Action, click Preset value, and enter the duty.
10. Select 1 msec or 10 msec in the Resolution list box under Pulse.
Click the Interval (msec) box under Pulse, and enter the pulse interval coefficient.

Turning Transmission Output ON and OFF Collectively for Analog Output/PWM Output

1. From the Action menu, choose Transmission output.
Transmission output on all active channels on the AO and PWM channel tabs is started (All ON).
2. From the Action menu, choose Transmission output again.
Transmission output on all active channels on the AO and PWM channel tabs is held at the values that were in use immediately before this operation was carried out.

Explanation

Setting up Output for AO Channels

Transmission Output: Values measured on the MX100, or computed values corresponding to computed results set on computation channels are converted to analog voltages (−10.000 V to 10.000 V) or analog current (0.000 mA to 22.000 mA) and output.

Note

The output range is −11.000 to 11.000 V or 0.000 to 22.000 mA, but the span setting range is −10.000 to 10.000 V or 0.000 to 20.000 mA.

User Output: You can set the analog voltage or analog current to an arbitrary value in the monitor screen. The setting ranges are −10.000 to 10.000 V (voltage), or 0.000 to 20.000 mA (current).

Setting the User Output of the Voltage Value

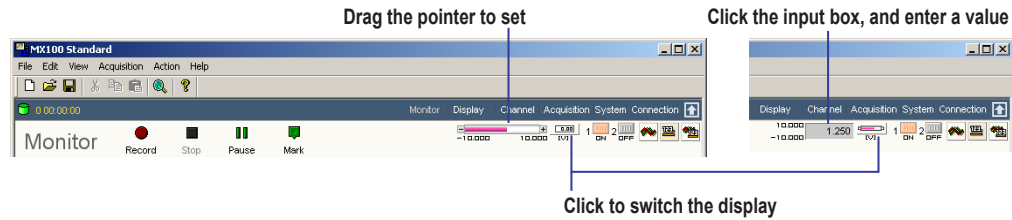

Setting the User Output of the Current Value

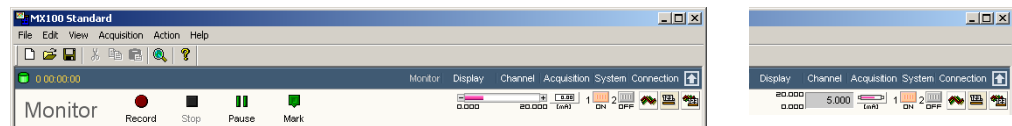

Setting up Output for PWM Channels

Transmission Output: Outputs a duty pulse waveform corresponding to values measured on the MX100, or the computed results set on the computation channels.

User Output: You can set the pulse duty ratio (0.000 to 100.000%) to an arbitrary value in the monitor screen.

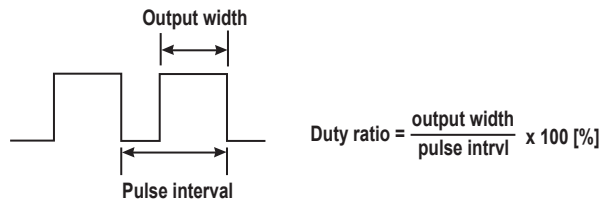

Setting the User Output of the Pulse (PWM Channel)

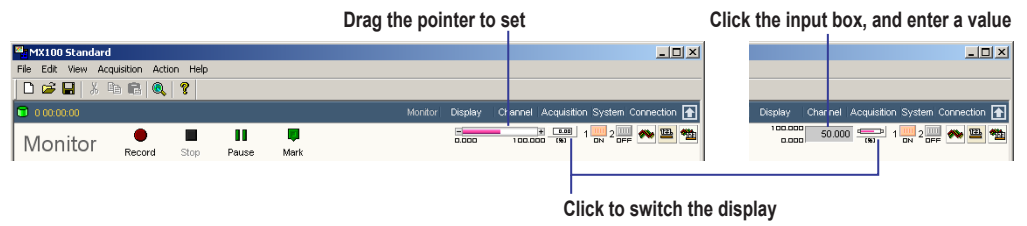

Overview of Output Action When Setting Holding of Previous Value of User Output

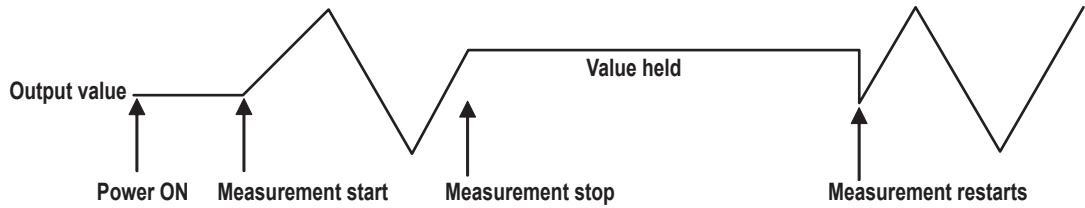

Note

If connection with the PC is dropped, the state at the point at which the AO or PWM output was dropped is retained. However, AO or PWM output to which measurement channel transmission output is assigned functions normally even if the connection with the PC is dropped.

2.12 Saving/Loading and Printing Setup Data (Project)

Procedure

Saving Setup Data (Project)

1. From the File menu, choose Save or Save As.
2. If you select Save As, enter the file name in the Save As dialog box and then click the Save button.

If you attempt to save the file using an existing file name, a dialog box appears for you to confirm whether the file is to be overwritten.

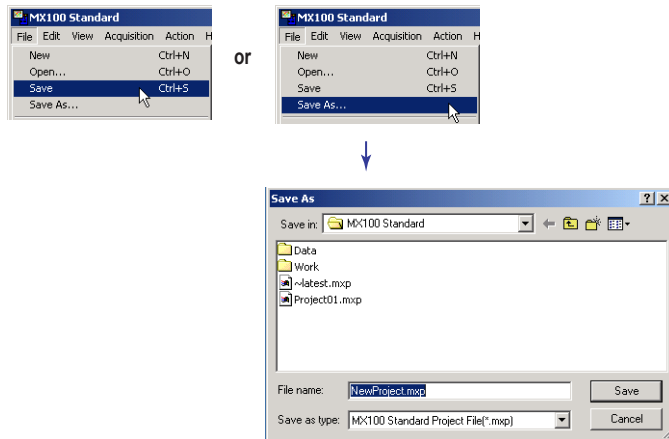

Loading Setup Data (Project)

1. From the File menu, choose Open.
2. In the Open dialog box, select a project file and click the Open button.

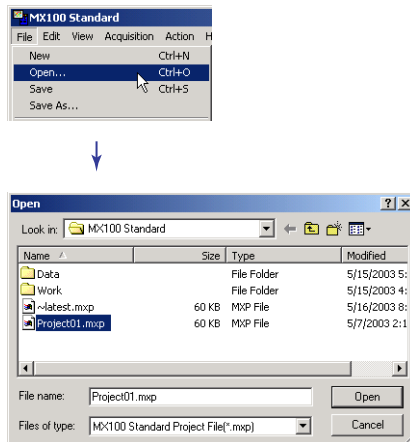

Note

- When you carry out the procedure above, the current setup data is discarded and changed to the setup data of the project that is loaded. If you need the current settings, save the project before loading the setup data.
- If there is a strain module, you can also save or load the initial balance value. Using the project file, you can save or load multiple initial balance values.

Printing Setup Data

1. From the File menu, choose Print.
The Print dialog box opens.
2. In the Print dialog box, select the printer, print range, and the number of copies, and then click OK.

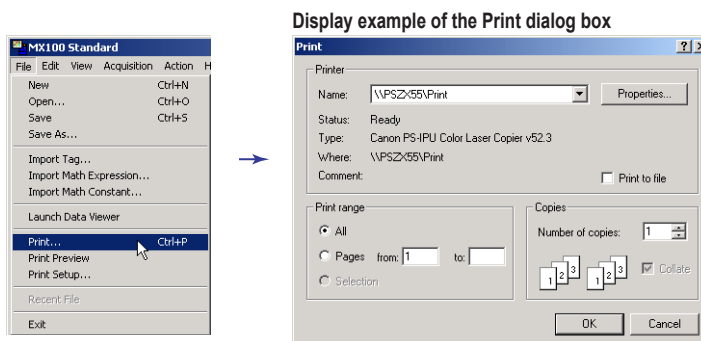

Print Preview

- From the File menu, choose Print Preview.
The print image is displayed.

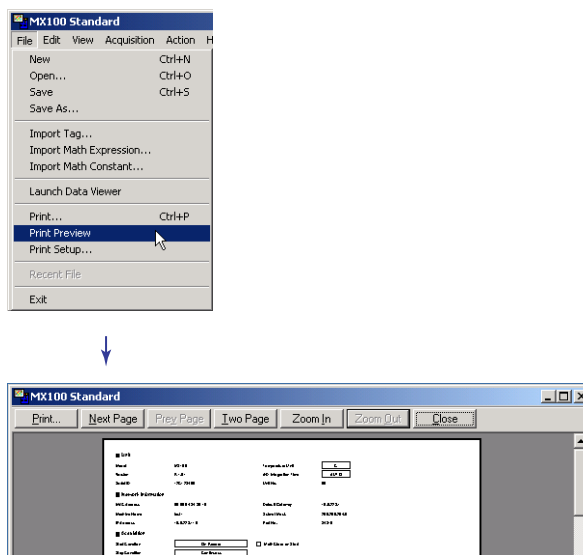

Setting Up the Printer

1. From the File menu, choose Print Setup.
The Print Setup dialog box opens.
2. Set the paper size, orientation, and other settings. Then, click OK.

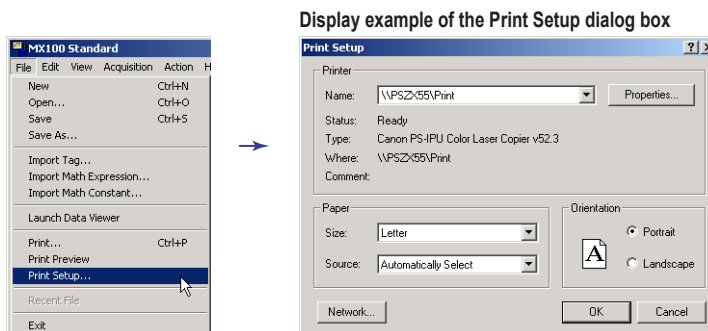

2.12 Saving/Loading and Printing Setup Data (Project)

Explanation

Save Destination

The default save destination varies depending on the system that is running.

File Name

The extension is .mxp. The default file name is NewProject.mxp.

Creating a New Project

Create a new project when you wish to monitor the measured/computed data using new settings.

Printed Contents of the Setup Data

The following figure show how the setup data is printed.

■ **Unit**

Model: MX100 Temperature Unit:
 Version: R.3.01 A/D Integration Time:
 Serial No.: 10C222221 Unit No.: 00
 Write Mode: Cyclic Mode

■ **Network Information**

MAC Address: 00:0054:94:51:93 Default Gateway: 0.0.0.0
 Machine Name: MX100-No1 Subnet Mask: 255.255.255.0
 IP Address: 192.168.1.1 Port No.: 34316

■ **Acquisition**

Start Condition: Man. Clear on Start
 Stop Condition:

■ **File**

Folder:
 File Name: Add Date Add Time
 File Disk:
 Comment:

■ **Module Arrangement**

No.	Type	Group	Monitor Interval	Record Interval
0	MX110-UNI-H10	Meas. 1	50 msec	50 msec
1	MX110-UNI-M10	Meas. 2	100 msec	100 msec
2	MX115-02-F110	Meas. 3	1 sec	1 sec
3	MX120-F110-M10			
4	MX110-S35-M10	Meas. 3	1 sec	1 sec
5	MX125-M1C-M10			

Math Interval: 100 msec Math Rec. Interval: 100 msec

■ **Channel**

Rec. Ch. No.	Module	Mode	Range	Span		Use	Disc. Pol.	Scale		Data	
				Min	Max			Min	Max	Use	Ref. C.
<input type="checkbox"/> [0000]	<input checked="" type="checkbox"/>	VOLT	2V	-2.0000	2.0000	<input type="checkbox"/>					<input type="checkbox"/>
<input type="checkbox"/> [0000]	<input checked="" type="checkbox"/>	VOLT	2V	-2.0000	2.0000	<input type="checkbox"/>					<input type="checkbox"/>
<input type="checkbox"/> [0000]	<input checked="" type="checkbox"/>	VOLT	2V	-2.0000	2.0000	<input type="checkbox"/>					<input type="checkbox"/>
<input type="checkbox"/> [0000]	<input checked="" type="checkbox"/>	VOLT	2V	-2.0000	2.0000	<input type="checkbox"/>					<input type="checkbox"/>

2.13 Other Displays and Settings

Procedure

Displaying the Version Information

1. From the Help menu, choose About.
A dialog box containing version information opens.

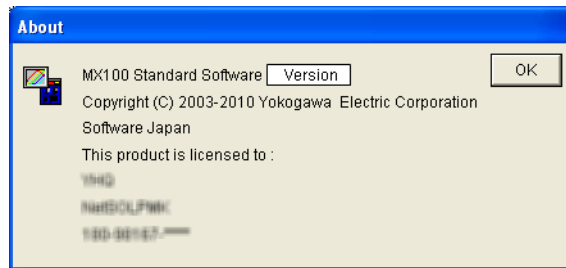

3.1 Loading Data Files

Procedure

1. Start the Viewer.
2. From the **File** menu, choose **Open**.

You can also click the  button on the toolbar. The Open dialog box opens.

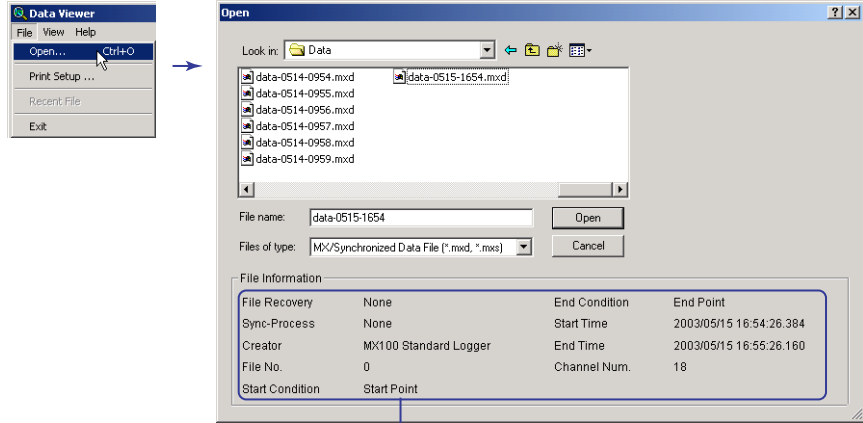

File information

This information is also printed when the display data is printed

3. Select the file you wish to load and click **Open**. The waveform display window opens.

When loading data files recorded using the MX100 Standard Software's Integration Monitor

Before the waveform display screen appears, the message, "This file is not synchronized. OK to synchronize?" is displayed to confirm whether or not to perform the synchronization. To synchronize the data file, click **Yes**, otherwise, click **No**.

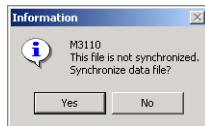

Displays the waveform display window

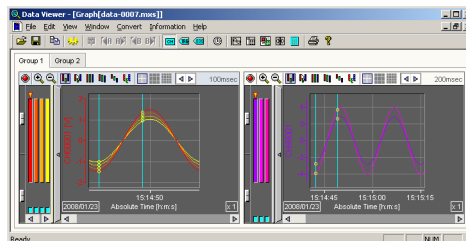

The graphs for each monitor interval specified in the Acquisition Conditions of the Integration Monitor and the graph of computation channels are display separately even within the same group.

Note

If you open a file (file created by recording the data of multiple units (MX100s)) created using MXLOGGER (software sold separately), a confirmation dialog box opens with a message "This file is not synchronized. Synchronize data file?" If you click No, a Select Unit No. dialog box opens. Click the desired unit number button to display the measured data of the corresponding unit and the computed data of MXLOGGER.

When Loading Data Files Divided on the MX100

If there are any files that can be joined a dialog box opens with the message, "Combining with related files?" before the waveform display window appears. Click the Yes button to join the files or the No button to display only the specified file.

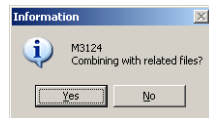

Displays the waveform display window

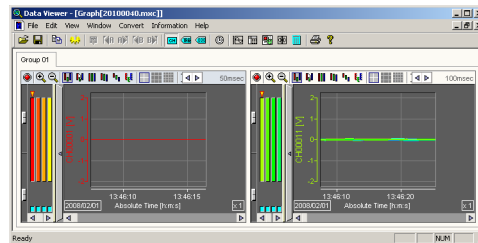

The graphs for each monitor interval specified in the Acquisition Conditions screen of the Integration Monitor are displayed separately even within the same group.

Explanation

Loadable Files

- Data files recorded using the Integration Monitor of the MX100 Standard Software or MXLOGGER (sold separately) (.mxd extension).
- Data files saved after performing synchronization using the Viewer (.mxs extension).
- Data backup files saved to the CF card using the MX100 (.MXD extension).

Display Range, File Size, and Number of Data Points of the Loadable Data

- 50 groups
- Maximum channels per group: 32
- File size: 2 GB
- Data points: 5 million

Note

- When loading files with approximately 5 million data points, the error message "Insufficient memory. Please exit immediately." may appear. If this happens, set the paging file size of the system virtual memory to 2 GB or more. To change the paging file size of the system virtual memory in Windows XP: In the control panel, double-click the System icon, click the Advanced tab, then click the Settings button under Performance. In the performance options dialog box, click the Advanced tab, then click the Change button under Virtual memory and make the desired changes.
- Whenever possible, avoid loading more than one file containing approximately 5 million data points because doing so can dramatically reduce the PC's performance.

Synchronization

The Integration Monitor of the MX100 Standard Software sends PC's time information to the MX100 at measurement intervals. The PC's time information is received along with the measured data when the data is received from the MX100. When measured data is recorded, the PC time information is also recorded.

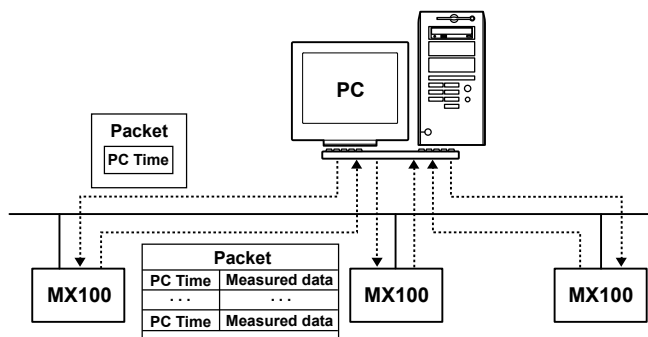

On the other hand, each MX100 makes measurements based on the main module clock. Therefore, the PC's time that is recorded with the measured data and the PC's time when measurements were made may be offset. When loading the data, the Viewer can process the time information to match the PC's time that was present at time of measurement. This process is called synchronization (for details, see Note on the next page).

The measured data and computed data recorded using the Integration Monitor have time stamps attached by the MX100 main module (see section 1.2, "Main Module Functions" in the *MX100 Data Acquisition Unit User's Manual* (IM MX100-01E)). When synchronization is performed, the time stamps are changed using those of the PC as a reference. The file created by synchronization takes on the same file name with the .mxs extension.

When synchronizing, if the backup file is placed in the same folder, data dropout from the recording file is embedded from the backup file (data saved to the CF card), and synchronization of channel data is performed. Also, the between-channel delay in the medium speed modules is compensated during synchronization.

Synchronized files created by the synchronization process are created in the same directory as the data file normally displayed. The file name is "the name of the file being displayed (excluding the .mxd extension)" + "mxs extension". However, if the destination storage medium is write-protected, the file is created in the temporary file directory. The temporary file directory is displayed in an error message dialog box.

When divided files are loaded, they are joined by the synchronization process. If a file that can be joined to the displayed data exists and you synchronize the data, the existing synchronized file is overwritten. If the existing synchronized file cannot be overwritten (set to read-only attribute, for example), a new synchronized file is created. A sequence number is added to the name of the new synchronized file ("the name of the file being displayed" + "sequence number" + "mxs extension"). For example, if the existing synchronized file name is "data-0000-1.mxs" the new file name is "data-0000-2.mxs".

3.1 Loading Data Files

The following limitations exist in the joining of files through synchronization.

- If any of the divided files are missing, the files after (or before) the missing file are not joined.
- If the total number of measured data points in the divided files exceeds 5 million, only files that would not cause the total number of displayed data points to exceed 5 million are joined.

When synchronizing files that exceed the 5 million point range, a specified file is used as the start file and succeeding files are joined. If 5 million points is not exceeded when the last file is joined, files before the start file are searched for in order, and files that would not cause 5 million points to be exceeded are also joined. In this case, because the files before the start file are also joined to the previous synchronized file, two synchronized files for this file would exist. If you open a file before the start file and perform synchronization, the viewer displays the first file the OS finds (either of the two existing synchronized files). In such cases, it is recommended that the files you wish to join are selected so that the limit is not exceeded, copied to the user's working folder, and synchronized there.

- Divided files can be joined up to the point in which the size of the joined file reaches 2 GB.

Note

- Details of Synchronization

Given M recorded data points of a given channel of a data file that has not been synchronized, synchronization (linear interpolation) is carried out as follows:

1. From the record start/stop time and record interval, determine N, the number of data points that will result after synchronization of the relevant channel.
2. From the record start time and record interval, determine St_n ($n=0, \dots, N-1$), the PC time after synchronization of each data point.
3. From the record start/stop time and the PC millisecond clock counter values at record start/stop, determine PCcntPerms, the clock counter value per millisecond.
4. From the PC millisecond clock counter values recorded with the data before synchronization and PCcntPerms, determine Rtm ($m=0, \dots, M-1$), the PC time of the data before synchronization.
5. Determine m such that the expression $Rtm-1 \leq St_n < Rtm$ is satisfied and retrieve the data values before synchronization $VRtm-1$ and $VRtm$ at the PC time of $Rtm-1$ and Rtm .
6. Determine the data values after synchronization from the expression $VSt_n = (St_n - Rtm-1) \times (VRtm - VRtm-1) / (Rtm - Rtm-1) + VRtm-1$ where ($n=0, \dots, N-1$ and $m=0, \dots, M-1$).
7. Determine the data values after synchronization for N data points, and then write them to the synchronized file.

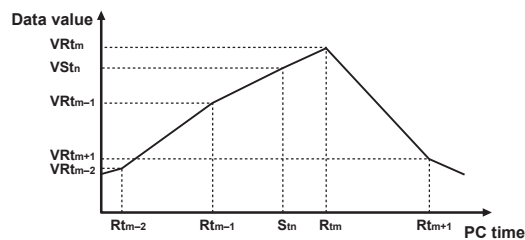

- When loading a data file saved by the MX100 to the CF card, synchronization is not possible because the PC time information needed in the data synchronization is not present.
- With the /DS option, when loading a data file saved by the MX100 to the CF card, synchronization is not possible because the PC time information needed in the data synchronization is not present.
- Synchronization may take time depending on the number of data points in the divided files.
- It is recommended that synchronization be performed on a hard disk with adequate free space.

- Even when synchronization is performed, the files before synchronization (.mxd extension) are not deleted.
- If you change the PC's time while data is being monitored on the Integration Monitor of the MX100 Standard Software, the error in the clock counter value per millisecond of the PC used in the synchronization process will become large. If the error in this value is greater than or equal to 2% when synchronizing the data file created at the time PC's time was changed, the clock counter value of 1 millisecond is considered to be 1 for the purpose of synchronization.
- If communication is disrupted temporarily due to power failure or network failure during the recording operation, the PC time of the data measured by the MX100 while communication is disrupted (see "Details of Synchronization" above) is recorded as the old PC time before communication was disrupted in the file created immediately after communication recovers. If you attempt to synchronize this file, a dialog box with the message "Some channels do not have enough information to synchronize." appears. In this case, synchronization is performed with the premise that the MX100 measured the data using the logical (estimated) record interval.

Joining

You can join data saved in the MX100's CF card.

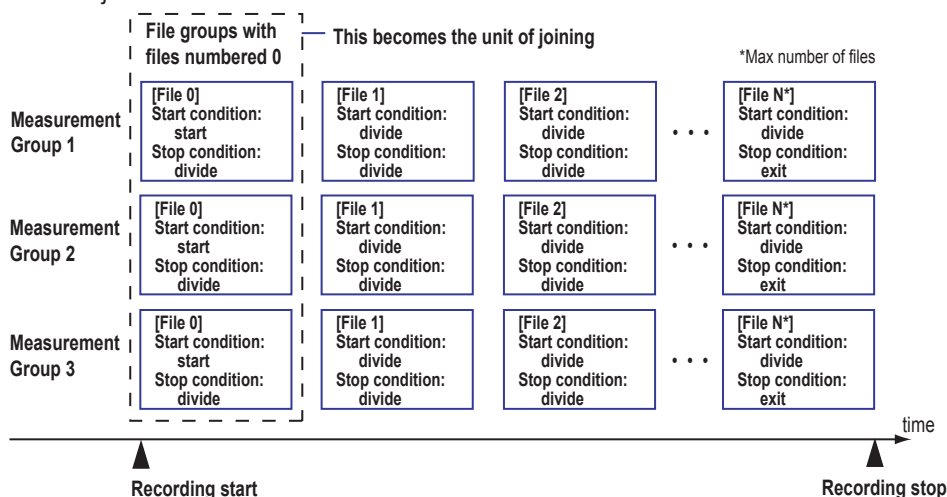

- Files from multiple measurement groups having the same file number are joined into file groups.
- The number of files contained in a file group must equal the number of measurement groups specified (for example, if 3 measurement groups are set, each file group contains 3 files). If one or more files are missing, file grouping stops.
- The resulting files that are created are limited to five million points or 2 GB. If the limit is not exceeded from the file group of the specified file number to the file group of the record stop file number, the software searches for file groups of file numbers preceding the file group of the specified file number and joins as many of them as possible without exceeding the limit.
- The extension for joined files is .mxc.

Note

- Copy CF card data to the PC hard disk before processing it.
- Joining may take time depending on the number of data points in the divided files.
- Even when joining is performed, files prior to the joining (with extension .MXD) are not deleted.

3.2 Display Settings

Procedure

Changing the Display on the Waveform Display Window

Change the display settings according to the explanation in the figure below.

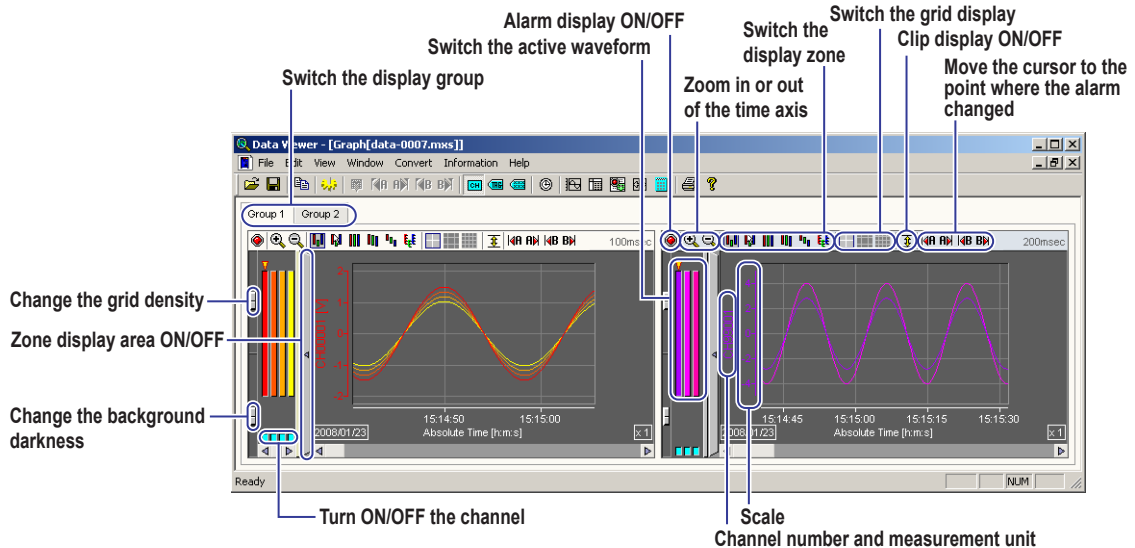

Changing the Display Using the Toolbar

Change the display settings according to the explanation in the figure below.

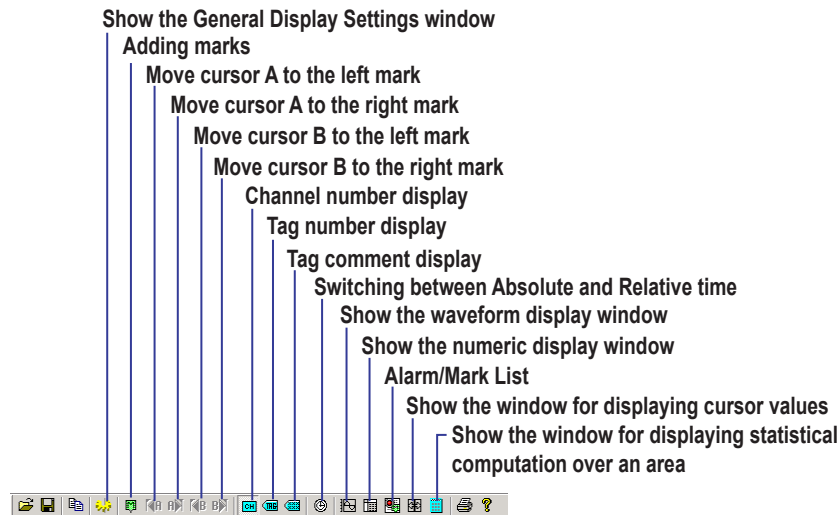

Changing the Display Using the Menu

Choose appropriate commands from the Edit, View, and Window menus to change the display.

Edit Menu:

- Copy (Ctrl+C)
- Select All (Ctrl+A)
- Erase Cursor
- Search Mark
- Append Mark ... (Ctrl+M)
- Delete Mark
- Reset Mark

Annotations for Edit Menu:

- Clear the Cursor
- Add/delete a mark

View Menu:

- General Display Settings...
- Apply Display Settings in Data File
- Channel No.
- Tag No.
- Tag Comment
- Absolute Time
- Relative Time
- Tool Bar
- Status Bar

Annotations for View Menu:

- Show the computation result display window
- Change the data file display
- Switch between channel number, tag number, and tag comment
- Switch between absolute and relative time*
- Turn ON/OFF the toolbar
- Turn ON/OFF the status bar

Window Menu:

- Cascade
- Tile
- Arrange Icons
- Graph
- Sheet
- Graph/Sheet Layout
- Alarm/Mark
- Control
- Statistics
- 1 Graph[data-0006.mxs]
- 2 Graph[data-0007.mxs]

Annotations for Window Menu:

- Arrange the display window (select cascade or tile)
- Arrange window icons
- Show the waveform display window
- Show the numeric display window
- Select how to arrange the display area from auto, horizontal, and vertical
- Alarm/Mark detailed list display
- Show the window for displaying cursor values
- Show the computation result display window
- Switch the display window

* Displays also the Format item during numeric display

Changing the Display Using the Display Setup Window

See the explanation in the figure below. Change the display settings and click OK. Set the display for each display group.

General Display Settings

Group Name: Group 1

No.	Channel No.	Y Axis	Form	Scale	Zone	Trip1	Trip2	Color
				Min. Max.	Min. Max.			
W01	CH00001	Linear		-2.0 2.0	0 100	-1.0	1.0	1.0
W02	CH00002	Linear		-30000.0 30000.0	0 100	-2.0	2.0	2.0
W03	CH00003	Linear		-30000.0 30000.0	0 100	-2.0	2.0	2.0
W04	CH00004	Linear		-30000.0 30000.0	0 100	-3.0	3.0	3.0
W05	CH00011	Linear		-0.2000 0.2000	0 100	-0.2000	0.2000	0.2000
W06	CH00012	Linear		-30000.0 30000.0	0 100	-30000.0	30000.0	30000.0
W07	CH00013	Linear		-30000.0 30000.0	0 100	-30000.0	30000.0	30000.0
W08	CH00014	Linear		-30000.0 30000.0	0 100	-30000.0	30000.0	30000.0
W09	CH00015	Linear		-3.0 3.0	0 100	-2.0	2.0	2.0
W10	CH00016	Linear		-3 3	0 100	-2	2	2
W11	CH00017	Linear		-3.0000 3.0000	0 100	-2.0000	2.0000	2.0000
W12	CH00018	Linear		-3.0000 3.0000	0 100	-2.0000	2.0000	2.0000
W13	CH00019	Linear		-3.0000 3.0000	0 100	-2.0000	2.0000	2.0000
W14	CH00020	Linear		-3.0000 3.0000	0 100	-2.0000	2.0000	2.0000
W15	stamps	Linear		-30000.0 30000.0	0 100	0.00	1.00	1.00

Annotations:

- Display ON/OFF (checkboxes)
- Group name (text field)
- Switch to another display group (dropdown)
- Turn ON/OFF the trip point display (checkboxes)
- Channel display color (color palette)
- Select the Y-axis display format (dropdown)
- Select the Y-axis type (linear/logarithmic) (dropdown)
- Turn Y-axis ON/OFF when displaying multi-axes zone (checkbox)
- Select channels (displays the channel selection dialog box) (checkboxes)
- Maximum and minimum values of the scale (input fields)
- Display zone position (input fields)
- Trip point value (input fields)

Explanation

Display Groups and Group Names

The values of each channel that are loaded are divided into groups that were used during recording and displayed using waveforms or numeric values. The measured/computed values can be divided into up to fifty groups. Up to thirty-two channels can be registered to a single group. If you click the channel selection button on the General Display Settings window, the Channel No. dialog box opens (see the figure below). The labels used to identify the waveforms can be set to tag numbers or tag comments in addition to channel number on the View menu. The selected label type (channel number, tag number, or tag comment) is used in the Channel No. dialog box. Select <None>, if you are not assigning a channel.

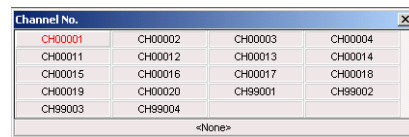

To turn ON/OFF the waveform display on the waveform display window, click the button below the scale bar as shown in the figure below.

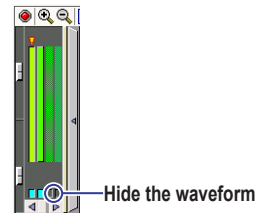

The name assigned to each group can be changed using up to thirty characters. The names of the display groups that have channels registered are displayed on the waveform display window or numeric display window.

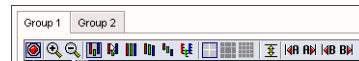

Y-Axis Type

You can select linear or logarithmic Y-axis for displaying the waveforms.

Linear scale



Logarithmic scale

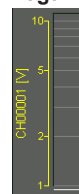

Maximum and Minimum Values of the Y-Axis and the Display Format of the Y-Axis Values

The maximum and minimum values of the scale on the waveform display can be changed. If you click the Scale Calc. button on the General Display Settings window, the maximum and minimum values of the Y-axes on the selected channels are calculated automatically according to the maximum and minimum values of the data. The scale values can also be displayed using logarithmic format as shown below.

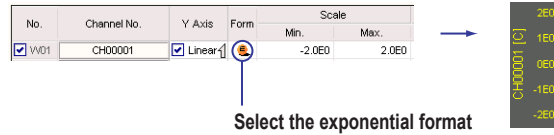

Selecting the Display Zone of the Waveform

You can select from the following. In the Zone setting on the General Display Settings window, assume the bottom and top edges of the waveform display area to be 0% and 100%, respectively, and set the waveform display position by specifying the minimum value (0 to 99%) and the maximum value (1 to 100%).

- **User zone**

Displays each waveform at the position specified by Zone on the General Display Settings window. A single Y-axis active channel waveform can be displayed.

Set the display zone

Zone	
Min.	Max.
10	70
30	100
0	100
0	100

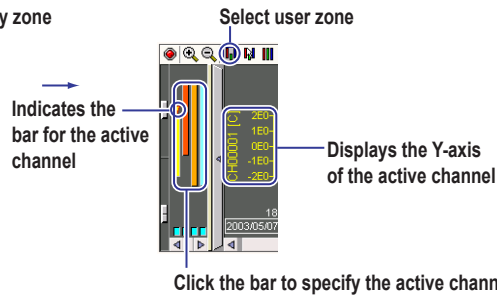

- **Edit zone**

Like the user zone, each waveform is displayed at the position specified by Zone on the General Display Settings window. However, you can change the zone on the waveform display window. A single Y-axis scale of the active channel can be displayed.

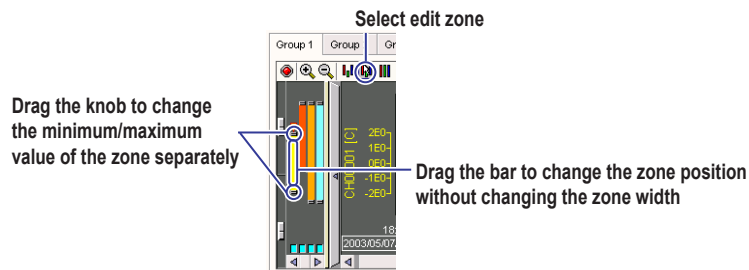

3.2 Display Settings

- **Full zone**

Displays all the waveforms over the full zone of the waveform display area regardless of the Zone settings on the General Display Settings window. A single Y-axis scale of the active channel can be displayed.

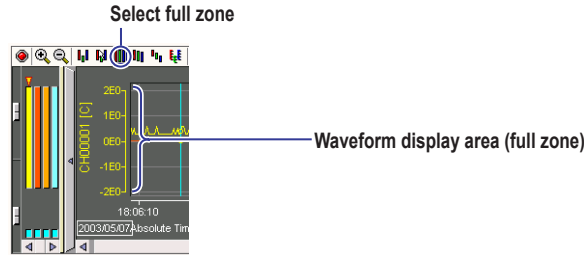

- **Slide zone**

Displays the waveforms by slightly offsetting the display position of each waveform vertically regardless of the Zone settings on the General Display Settings window. A single Y-axis scale of the active channel can be displayed.

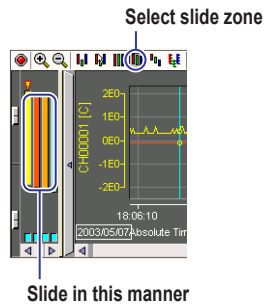

- **Auto zone**

Displays the waveforms by dividing the waveform display area evenly according to the number of displayed waveforms regardless of the Zone settings on the General Display Settings window.

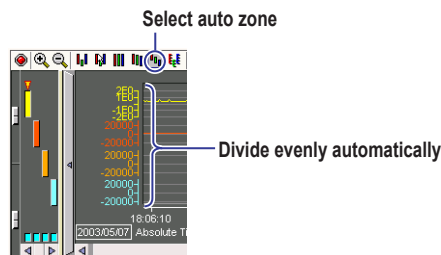

• **Multi-axes zone**

All the specified Y-axis of the displayed waveforms are aligned horizontally. To hide a Y-axis, clear the Y-axes check box on the General Display Settings window. The display position is set using Zone on the General Display Settings window. Dragging the channel bar to the waveform display area shows the Y-axis of the corresponding channel. Dragging the Y-axis to the zone display area hides the Y-axis of the corresponding channel.

No.	Channel No.	Y Axis
<input checked="" type="checkbox"/>	CH00001	<input checked="" type="checkbox"/> Linear
<input checked="" type="checkbox"/>	CH00002	<input type="checkbox"/> Linear
<input checked="" type="checkbox"/>	CH00003	<input checked="" type="checkbox"/> Linear

Turn OFF the Y-axis display of Ch00002

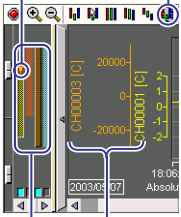

Indicates the specified Y-axis Select multi-axes zone

The Y-axis of Ch00002 is not displayed.

Click the bar to move the specified Y-axis to the right end

Grid Display

Select the grid type.

When this is selected

When this is selected

When this is selected

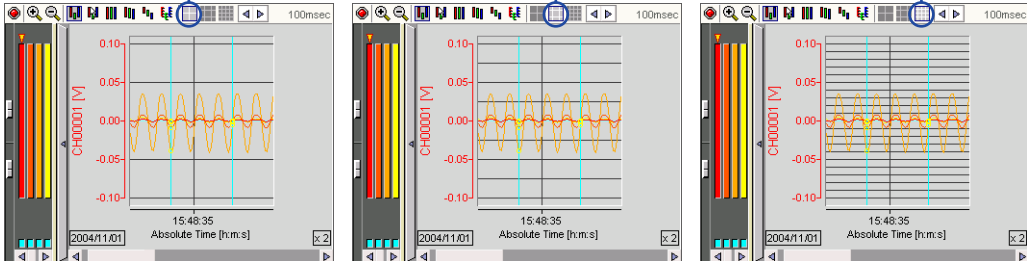

Trip Point

You can display a trip line to indicate a particular value of interest (trip point) in the waveform display area. Two trip points (trip 1 is red, trip 2 is blue) can be set on each waveform using the Trip 1 and Trip 2 settings on the General Display Settings window. The trip line of the waveform corresponding to the right-most Y-axis bar is shown in the waveform display area.

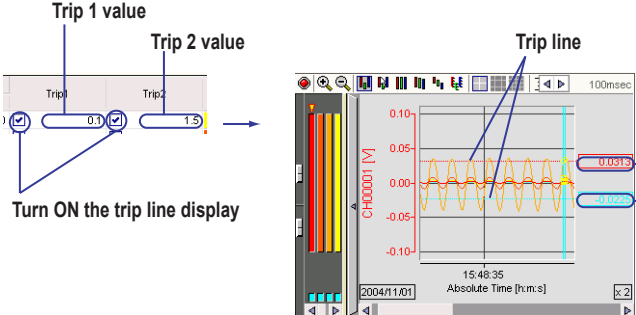

Trip 1 value

Trip 2 value

Turn ON the trip line display

Trip line

Trip 1 value*

Trip 2 value*

* Can be moved by dragging

Channel Color

Clicking the channel color displayed in the Color column on the Display setup screen opens the Color dialog box. You can select the color of each channel using the Color dialog box. To create custom colors, click the Define Custom Colors button in the Color dialog box.

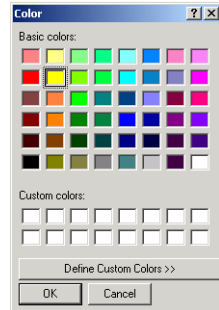

Clipping of Waveforms

By default (clip OFF), the waveform is not displayed when the measured/computed value exceeds the minimum/maximum value of the scale (see the lower left figure). When clip is turned ON, values that are smaller than the minimum value of the scale are displayed as the minimum value and the values that are larger than the maximum value of the scale are displayed as the maximum value.

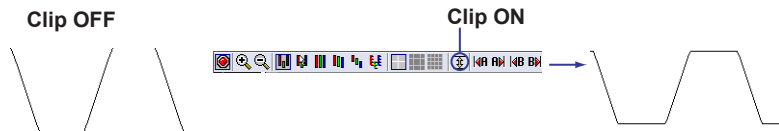

Expanding or Reducing the Time Axis on the Waveform Display

On the waveform display window, you can click the zoom in/out icons to zoom in or out on the time axis in the range of 20 to 1/1000 times for each waveform display area.

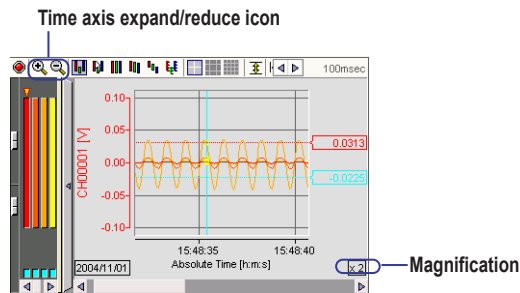

Adding Marks

In addition to the marks placed using other programs such as the Integration Monitor, you can add marks at the positions where you click (displays a cursor) on the waveform display area. You can enter a text to be attached to the mark ("Mark" by default) using up to fifteen characters. You can also select Left, Center (default), Right, or Flag (small mark without text) for the Type. For types other than Flag, the specified string and the relative or absolute time at the mark position are displayed.

You can set the string and type in the Mark dialog box that opens when you click the Append Mark icon (or choose Append Mark from the Edit menu). In the Mark dialog box, you can select whether to add the mark to the waveforms of all groups (default) or only the waveforms of the displayed group.

To delete specific displayed marks, select the range using cursors, and then choose Delete Mark from the Edit menu. To delete all the marks added using the Viewer, choose Reset Mark from the Edit menu.

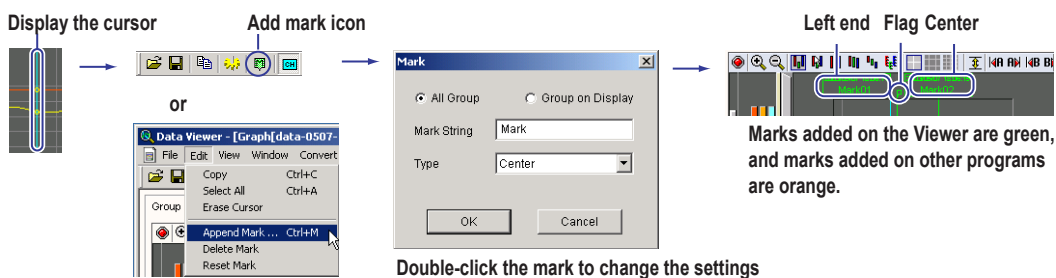

Switching between Absolute and Relative Time

By default, the time axis is displayed using absolute time. The time axis can also be displayed using time relative to the first data position.

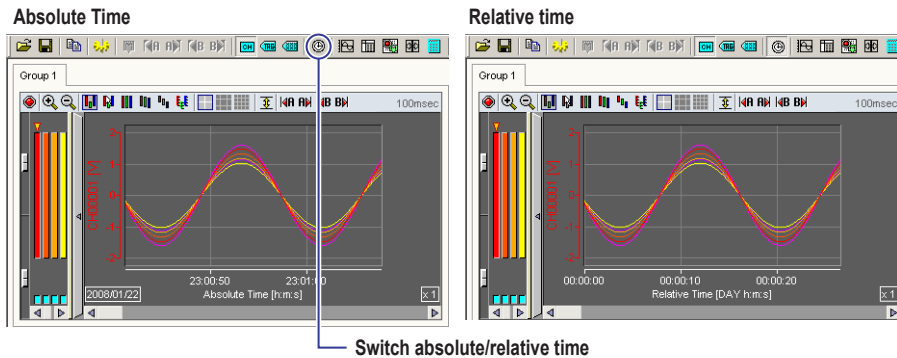

On the numeric display, you can select the display format of the absolute or relative time and turn ON/OFF the data numbers using Format on the View menu.

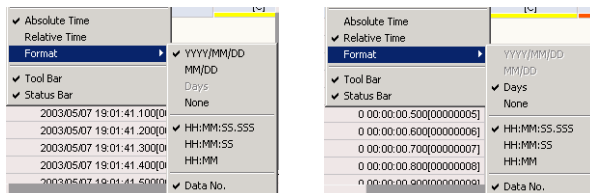

In the alarm/mark list, the time is always displayed using absolute time.

Showing/Hiding Alarms

You can hide the alarm display area that indicates the status of alarm occurrence. The alarms are displayed in the same fashion as the alarms displayed in the waveform display area of the Integration Monitor.

Show/Hide the alarms

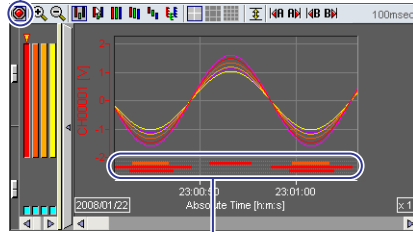

No alarm display

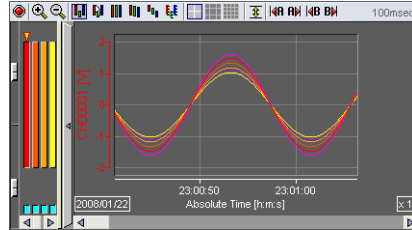

Alarm display area

Alarm/Mark List Display

Displays a detailed list of alarms and marks.

From the Window menu, choose Alarm/Mark List.

You can also click the  button on the toolbar.

- Alarm List

Sorted according to the clicked item

Currently sorted to the item indicated by this mark

Channel	Level	Type	Alarm ON	Alarm OFF
CH99001	1	Low	2004/1/01 15:48:31.200	2004/1/01 15:48:31.200
CH99001	2	High	2004/1/01 15:48:31.400	2004/1/01 15:48:31.800
CH99001	1	Low	2004/1/01 15:48:32.100	2004/1/01 15:48:32.100
CH99001	2	High	2004/1/01 15:48:32.400	2004/1/01 15:48:32.800
CH99001	1	Low	2004/1/01 15:48:33.000	2004/1/01 15:48:33.000
CH99001	2	High	2004/1/01 15:48:33.300	2004/1/01 15:48:33.800
CH99001	1	Low	2004/1/01 15:48:34.000	2004/1/01 15:48:34.000
CH99001	2	High	2004/1/01 15:48:34.300	2004/1/01 15:48:34.700
CH99001	1	Low	2004/1/01 15:48:34.900	2004/1/01 15:48:34.900
CH99001	2	High	2004/1/01 15:48:35.200	2004/1/01 15:48:35.200
CH99001	1	Low	2004/1/01 15:48:35.400	2004/1/01 15:48:35.800
CH99001	2	High	2004/1/01 15:48:36.100	2004/1/01 15:48:36.100
CH99001	1	Low	2004/1/01 15:48:36.300	2004/1/01 15:48:36.800
CH99001	2	High	2004/1/01 15:48:37.100	2004/1/01 15:48:37.100

- Mark List

Sorted according to the clicked item

Currently sorted to the item indicated by this mark

Absolute Time	Mark	Group	Kind
2004/1/01 16:31:07.020	mark		
2004/1/01 16:31:07.120	mark		
2004/1/01 16:31:07.220	mark		
2004/1/01 16:31:07.300	Mark		
2004/1/01 16:31:07.320	mark		
2004/1/01 16:31:07.420	mark		
2004/1/01 16:31:07.520	mark		
2004/1/01 16:31:07.800	Mark		
2004/1/01 16:31:07.770	Mark		
2004/1/01 16:31:07.900	Mark		
2004/1/01 16:31:07.920	mark		
2004/1/01 16:31:08.020	mark		
2004/1/01 16:31:08.120	mark		

Mark added in computation channels of the Integration software's channel screen

Mark added by Viewer software

Mark added in the Integration software's Monitor screen

Names of groups with marks
If the groups have no names, all groups are marked

The alarm/mark list display's cursors are linked with those of the waveform display and numeric display layout screens. Alarms or marks selected with the cursor in the alarm/mark list display can be copied to the clipboard using the Edit > Copy command. The alarm/mark list can be converted to ASCII, Excel, or Lotus format (see section 3.7).

Alarm display limitation: One file can display a maximum of 10000 alarms.

Left-to-Right Alarm Search (Waveform Display Screen Only)

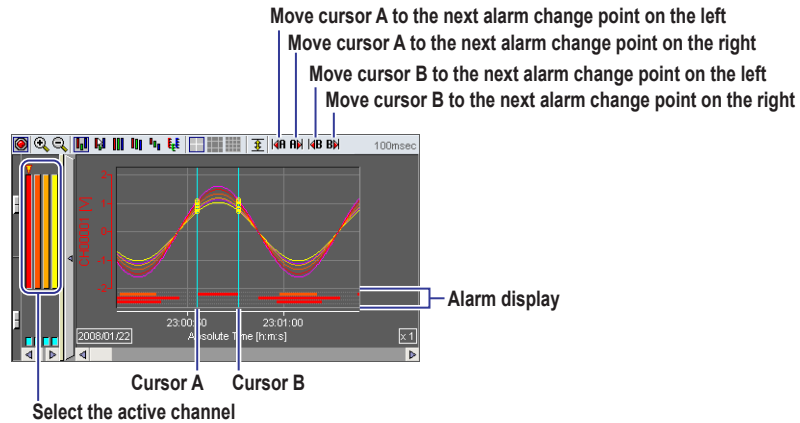

Left-to-Right Mark Search (Waveform Display Screen Only)

In the waveform display screen, move cursor A and B to the right or left side of the mark. From the Edit menu, choose Mark Search. Or click the corresponding toolbar button.

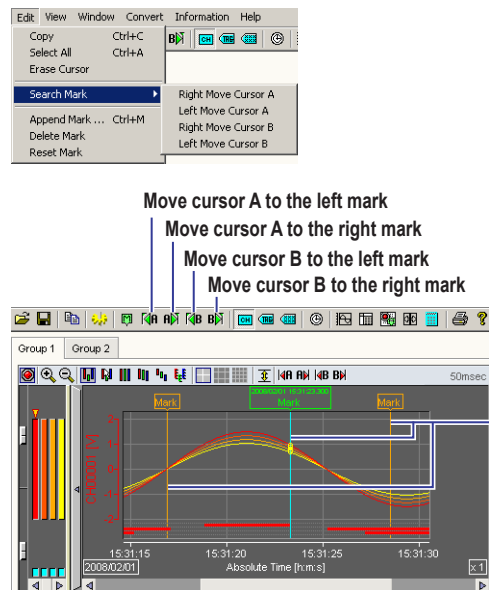

3.2 Display Settings

Numeric Display

Numeric display can be shown along with the waveform display window. When a group contain channels with different measurement intervals, the screen is divided accordingly. The display group, active channel, and mark display are synchronized to the waveform display.

If cursors are displayed on the waveform display window, the data values between the cursors are displayed in red. Also, the data column corresponding to the cursor position is displayed in gray.

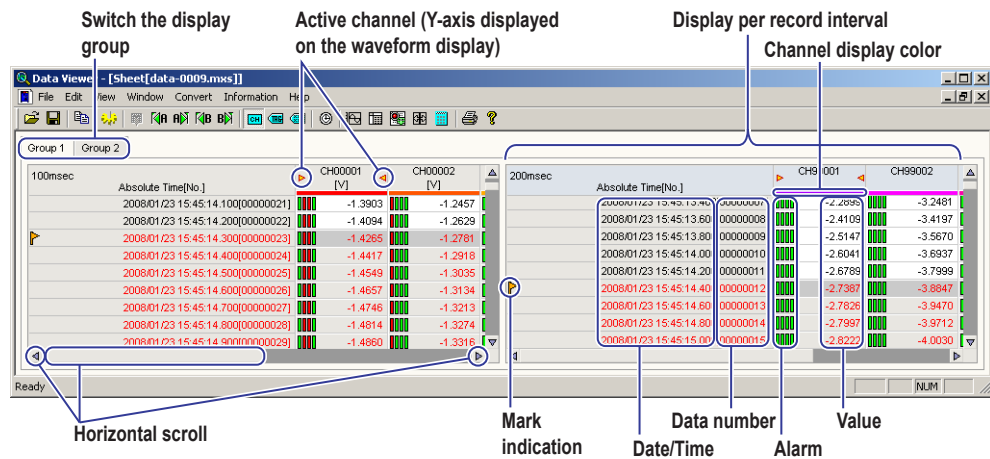

Note

- If you open the numeric display window when two cursors are shown on the waveform display window, the data in the interval between the cursors is displayed in red. If you choose Copy from the Edit menu (press the Ctrl + C key) in this condition, the data in the interval is copied to the clipboard as text data.
- Up to 1000 lines can be copied. (Copy on the Edit menu is not available if the number of lines specified by the cursors is above 1000.)
- If data of multiple measurement intervals is displayed, the data in the interval between the cursors on the data sheet with the active measurement interval is copied. (The newest line is displayed in light blue on the data sheet with the active measurement interval. The newest line and the newest column are displayed using the same color on non-active sheets. You can activate a sheet by clicking the sheet.)

Initializing, Copying, and Pasting of Settings on the General Display Settings Window

On the General Display Settings window, you can reset the settings to default or copy and paste the settings of one or multiple waveforms to the settings of other waveforms. You can copy and paste according to the procedure below.

Drag the copy source waveform numbers (No. column), click the Copy button, drag the copy destination waveform numbers, and click the Paste button.

Drag to select a range

Click to select all the channels

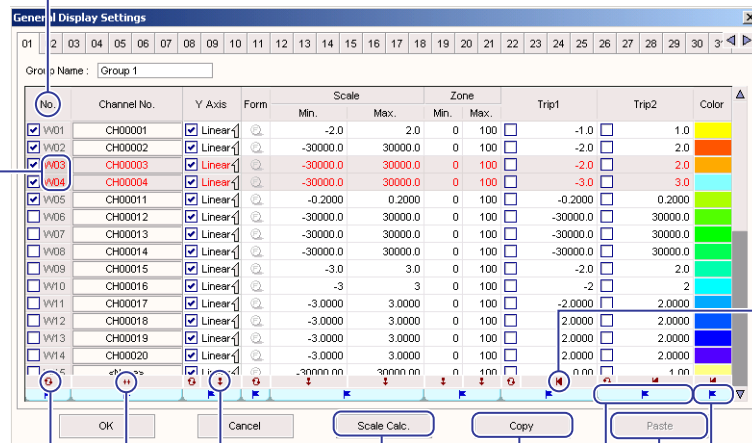

Click this button to reset to default settings

To set the scale to match the maximum and minimum values of the data

To copy the settings

To not copy/paste the item, click to hide the flag

To paste the copied settings

Click this button to enter the same settings as the first channel in the selected range

Click this button to automatically assign the channels in order

To copy/paste the item, click to show the flag.

Click this button to turn ON/OFF the channels collectively

Applying Data File Display Conditions

Group display conditions set using Viewer (including group data display conditions reflecting the use of templates or the display conditions setting file) are cleared, and the channel display returns to the data file display settings.

The settings configured using the tool buttons in the upper part of the waveform display screen for each group (alarm display ON/OFF, time axis zoom in/out, display zone switching, grid display switching, and grid display ON/OFF), and the grid color and waveform background color settings are restored to their default settings.

Alarm display ON/OFF

Zoom in or out of the time axis

Switch the display zone

Switch the grid display

Clip display ON/OFF

Move the cursor to the point where the alarm changed



3.3 Reading Values Using Cursors

Procedure

1. On the waveform display window, click the tag of the group from which you wish to read the value using cursors.
2. Click the position of the desired data in the waveform display area of the waveform display window.
 If you wish to read another point simultaneously, drag the cursor. Cursor A appears at the position where you first clicked; Cursor B appears at the position where you released the mouse button. A yellow circle is displayed where the waveform and the cursor cross. You can move the waveform that is displayed in the waveform display area using the scroll buttons or scroll bar.

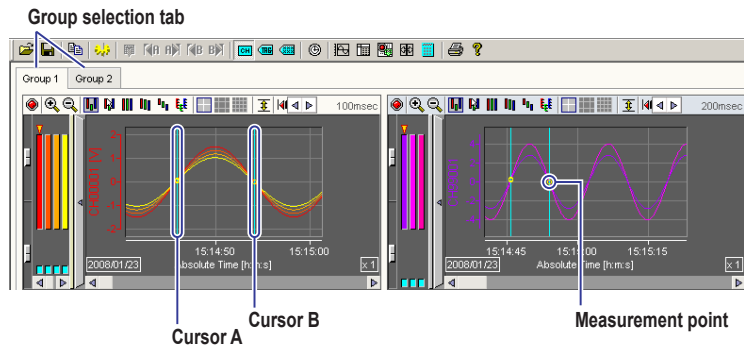

3. From the Window menu, choose Control.

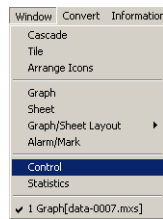

The Cursor Value window opens.

Time at Cursor A
 Data number at Cursor A
 Time at Cursor B
 Data number at Cursor B
 Time between Cursors A and B
 Difference in the data number between Cursors A and B

Data No.	Cursor A	Cursor B	Difference
	13	43	30
Absolute Time	2008/01/23 15:14:43.100	2008/01/23 15:14:49.100	00:00:06.000

Channel	Value A	Value B	Value B - Value A
CH00001[V]	-1.2543	1.4200	2.6743
CH00002[V]	-1.1238	1.2724	2.3963
CH00003[V]	-0.9951	1.1266	2.1217
CH00004[V]	-0.8665	0.9811	1.8476

Channel	Value A	Value B	Value B - Value A
CH99 [02]	-2.3659	2.6937	5.0596
CH99 [02]	-3.3559	3.8209	7.1768
CH99 [03]	-103.4458	117.7918	221.2375

Alarm indication
 Channel number and measurement unit
 Readout value of Cursor A
 Readout value of Cursor B
 Readout value of Cursor B – Readout value of Cursor A
 Channel display color

Clearing the Cursor

From the Edit menu, choose Erase Cursor.

The cursors are cleared as well as the cursor values displayed in the Cursor Value dialog box.

Explanation

Reading Measured/Computed Values Using Cursors

Two cursors can be displayed. The following values can be read on the Cursor Value window.

- Values at the cursors.
- Difference in the value between the cursors.
- Absolute time and data number at the cursor position.
- Time between the cursors and the difference between the data numbers.
- Alarm status of the value at the cursor.

Note

- The cursors used to display cursor values and those used to specify the interval for statistical computation over an area are the same.
- The Cursor Value window and the Statistics window can be displayed simultaneously.
- If you click the tab of another group on the waveform display window while the Cursor Value window is open, the cursor values of the selected group are displayed on the Cursor Value window.
- You can change the cursor positions on the waveform display window while the Cursor Value window is open.
- If you choose Select All from the Edit menu, Cursor A is displayed at the first data position and Cursor B is displayed at the last data position.

3.4 Statistical Computation over an Area of Measured/Computed Data

Procedure

1. On the waveform display window, click the tab of the group on which you wish to perform statistical computation over an area.
2. Click the start position of the computation area in the waveform display area. A light-blue cursor appears in the waveform display area. If multiple waveform display areas are displayed, the cursor is displayed at the time position each waveform display area.
3. Drag the cursor to the end position of the computation area. Another light-blue cursor appears at the position where the cursor was dragged.

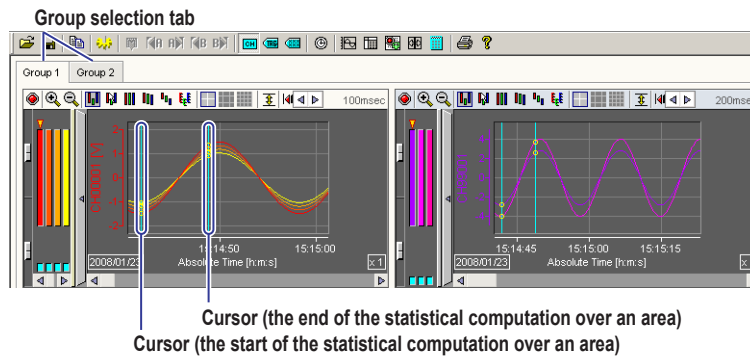

4. From the Window menu, choose Statistics.

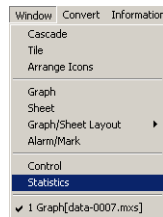

The Statistics window opens.

Channel	Start Data No.	End Data No.	Min.	Max.	P-P	Mean	RMS
CH00001[V]	13	83	-1.4857	1.3597	2.8454	-0.1843	0.9671
CH00002[V]	13	83	-1.3313	1.2184	2.5497	-0.1652	0.8666
CH00003[V]	13	83	-1.1787	1.0788	2.2575	-0.1462	0.7673
CH00004[V]	13	83	-1.0264	0.9394	1.9658	-0.1274	0.6682
CH99001[I]	7	42	-2.8030	2.6270	5.4300	-0.2561	1.8455
CH99002[I]	7	42	-3.9759	3.7262	7.7021	-0.3633	2.6177
CH99003[I]	7	42	-122.5718	114.8725	237.4444	-11.2005	80.6958

Explanation

Statistical Computation over an Area

Specify using two cursors the interval over which computation is to be performed. If the cursors are not displayed, all the data are used in the statistical computation. The statistical parameters are the minimum value, the maximum value, the P-P value (maximum – minimum), the average value, and the rms value.

Copying Data to the Clipboard

If you click the Copy button, the results of statistical computation over an area are copied to the clipboard as text data. You can press Ctrl + C when the statistical computation over and area window is active to copy the displayed results as text data to the clipboard.

Note

-
- To redo the computation after changing the computation area, you must select the “statistics calculated over an area display window” button (see “Procedure” in section 3.2) or the menu command again.
 - The cursors used to specify the interval for statistical computation over an area and those used to read values are the same.
 - The Statistics window and the Cursor Value window can be displayed simultaneously.
-

3.5 Saving the Display Settings

Procedure

1. From the File menu, choose Save Display Setting File.

You can also click the  button on the toolbar.

The display setting file is created in the same folder as the data files.

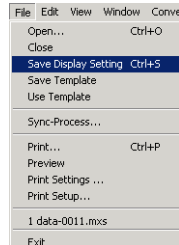

When Closing the Viewer

If you open a file and change the display settings, the dialog box below opens when you attempt to close the Viewer. To save the changed display settings, click Yes.

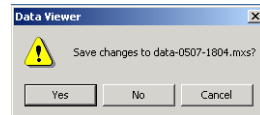

Explanation

Display Settings That Are Saved

- Information about the group whose waveform or numeric display is open.
- Settings entered using the tool buttons at the top section of the waveform display area of each group.
 - Alarm display ON/OFF, magnification, scale, clip ON/OFF of the waveform display.
- Cursor position (absolute time).
- General Display Settings on the View menu.
- Channel No., Tag ID, and Tag comment settings on the View menu.
- Absolute Time or Relative Time setting on the View menu.
- Graph/Sheet Layout setting on the Window menu.
- Check box items in the File Information dialog box on the Information menu.
 - The items are used as headers when the data is printed.
- Print setting on the File menu.
 - Range, Color, Print Groups, and Comment.
- Marks created on the Viewer.
- Position of the display screen.

Display Setting File

The display setting file (with the .mxv extension) is created in the folder containing the data files. If the data file name is data.mxs, the display setting file name is data.mxs.mxv. The next time the data file is opened, the display opens according to the information in the display setting file.

If the display setting file is deleted or moved to another folder, the display opens according to the display settings used when the data file was created.

Note

You cannot open a file containing the data you wish to view by selecting a file with .mxv extension.

3.6 Saving the Display Template

Procedure

Saving Templates

1. From the File menu, choose Save Template.
The currently displayed settings are saved as a template file to the same folder as the displayed data.

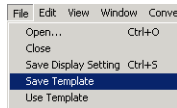

Using Templates

1. From the File menu, choose Use Template.
If the currently displayed data is not in the display conditions file, it is displayed according to the setting information of the template file residing in the same folder.
If the currently displayed data is in the display conditions file, it is displayed according to the setting information of the display conditions file.

Explanation

The template file is saved with the name default.mxt in the folder of the currently displayed data.

When using a template file, the template file residing in the same folder as the displayed data is used.

The setting information saved to the template file is as follows.

- Information about the group whose waveform or numeric display is open.
- Settings entered using the tool buttons at the top section of the waveform display area of each group.
Alarm display ON/OFF, magnification, scale, clip ON/OFF of the waveform display.
- General Display Settings on the View menu.
- Channel No., Tag ID, and Tag comment settings on the View menu.
- Absolute Time or Relative Time setting on the View menu.
- Graph/Sheet Layout setting on the Window menu.
- Check box items in the File Information dialog box on the Information menu.
The items are used as headers when the data is printed.
- Print setting on the File menu.
Range, Color, Print Groups, and Comment.
- Position of the display screen.

3.7 Converting Data Formats

Procedure

1. From the Convert menu, choose To ASCII, To Excel, or To Lotus.

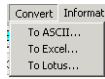

2. After entering various settings in the dialog box that opens, click OK. The file is created at the specified destination.

Waveform, Numeric, or Waveform/Numeric Display

Enter the range of group numbers to be converted

Select whether to set the range to be converted using groups or channels

Select the record interval
Only the channels with the selected record interval are converted.

Enter the data range to be converted
Can be specified using cursors before opening this dialog box.

Select the range of channels to be converted
Click to open the selection dialog box.

Displays the time of the specified data

Step when saving data at certain intervals

Displays the save destination and file name

When changing the save destination or file name
Click to open the save destination and file name setup dialog box.

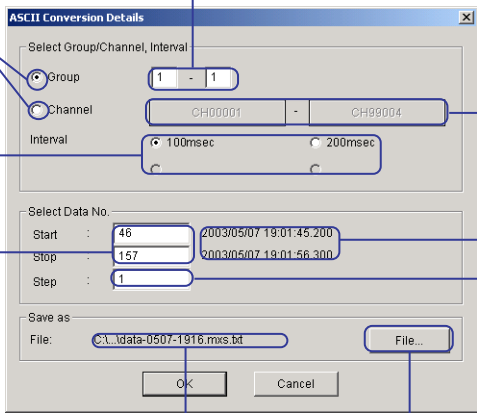

Alarm/Mark List Display

Displays the save destination and file name

When changing the save destination or file name
Click to open the save destination and file name setup dialog box.

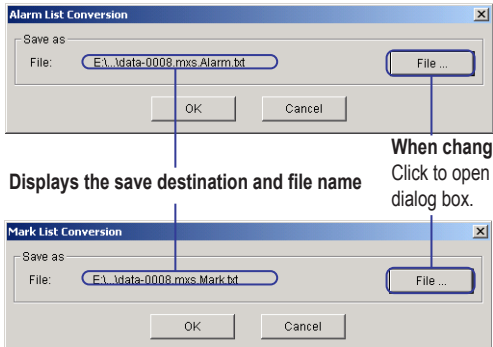

Explanation

Data Formats for Conversion

- ASCII
Text data with each data point separated by a comma. The extension is .txt.
- Excel
Data that can be opened using Microsoft's spreadsheet application Excel version 8.0 (Excel 97) or later. The extension is .xls.
- Lotus
Data that can be read using IBM's Lotus 1-2-3 spreadsheet program version 2.0 or later. The extension is .wj2.

Converted Data

Specify the range using group numbers or channel numbers. You can select the channel number by clicking in the dialog box as shown below.

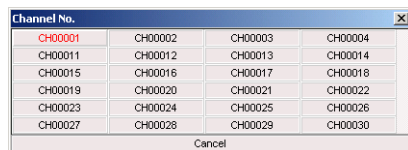

If multiple record intervals exist in the data to be converted, select the recording interval. Only the data of the channels having the selected recording interval is converted.

Conversion Range and Step

You can specify the range using data numbers or by using cursors. For information on specifying the range by using cursors, see "Procedure" in section 3.4. By specifying the step, you can save data sampled at certain intervals rather than converting all the data in the range (when step is set to 1).

Display Example of the Converted Data

	A	B	C	D	E	F	G	H	I	J	K	L
1	MX100 Standard	R3.01										
2	Data Viewer	R3.01										
3												
4												
5	File Name		data-0007.mxs									
6	File Recovery		None									
7	Creator		Data Viewer									
8	Sync-Process		Done									
9	Start Condition		Start Point									
10	End Condition		End Point									
11	Start Time		2008/01/21 15:14:40		0.500							
12	End Time		2008/01/21 15:21:15		0.600							
13	File Message											
14	File No.		0									
15	Num. of Ch.		17									
16	Num. of Ref. File		1									
17	Ref. File No.		0		0							
18	Record Interval		01:00 Second									
19	Converted Step		1									
20	Num. of Converted Ch.		15									
21	Num. of Converted De		83									
22	Converted Group		1		2							
23			Ch.	CH00001	CH00002	CH00003	CH00004	CH00011	CH00012	CH00013	CH00014	
24			Tag No.	Tag00001	Tag00002	Tag00003	Tag00004	Tag00011	Tag00012	Tag00013	Tag00014	
25			Tag Comm	TagComme	TagComme	TagComme	TagComme	TagComme	TagComme	TagComme	TagComme	
26	Mark	Date	Time	Second	V	V	V	V	V	V	V	V
27		2008/01/21 15:14:40		0.600	-1.3864	-1.2441	-1.1015	-0.9592	-0.0011	-0.0079	0.0507	-0.047
28		2008/01/21 15:14:40		0.700	-1.4079	-1.2615	-1.1170	-0.9726	-0.0032	-0.0075	0.0524	-0.047
29		2008/01/21 15:14:40		0.800	-1.4253	-1.2771	-1.1307	-0.9846	-0.0035	-0.0076	0.0539	-0.048
30		2008/01/21 15:14:40		0.900	-1.4406	-1.2908	-1.1429	-0.9953	-0.0037	-0.0076	0.0552	-0.049
31		2008/01/21 15:14:41		0.000	-1.4542	-1.3030	-1.1538	-1.0047	-0.0055	-0.0073	0.0569	-0.049
32		2008/01/21 15:14:41		0.100	-1.4655	-1.3132	-1.1627	-1.0125	-0.0058	-0.0071	0.0580	-0.050

Notes When Converting Data

- There is a limit in the number of data points that Excel and Lotus 1-2-3 can handle. Before conversion, set the data to be converted, the conversion range, and steps such that the number of data points is appropriate. In addition, if there is little free memory in the PC, Excel or Lotus 1-2-3 may not be able to load the data.
- If conversion conditions are specified that exceed the limitations of Excel or Lotus 1-2-3, the data is automatically divided before conversion. Therefore, multiple files are created. The file names are assigned automatically with sequential numbering. (For example, when converting the file "data.mxs" to Excel format, if the data is divided into n number of files, they are named data.mxs.0000.xls, data.mxs.0001.xls, ..., data.mxs.000n.xls).
- Up to 65510 data and 252 channels are saved to a single conversion file (when columns are channels and rows are data).
- If you set the save destination to a storage medium that has slow access such as a floppy disk, the saving of the data may take an extended time. It is recommended that such storage medium not be selected for the save destination.
- Select a save destination with adequate free space.
- The measured data during a burnout or measured data that exceeds the upper/lower limit of the measurement range are indicated as "OVER" or "OVER"
- If invalid data exists in the converted data (measured value of a channel without input or computed value when the data used in the equation does not exist), the data is indicated as "INVALID"

3.8 Printing the Data

Procedure

Setting the Contents to Be Printed

1. From the File menu, choose Print Settings.

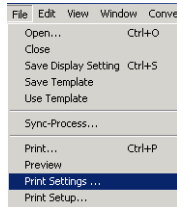

2. In the Print Setting dialog box, set Range, Color, and Print Group, and then click OK.

Enter a comment in the Comment box as necessary.
When printing numeric values, only a print range need be selected.

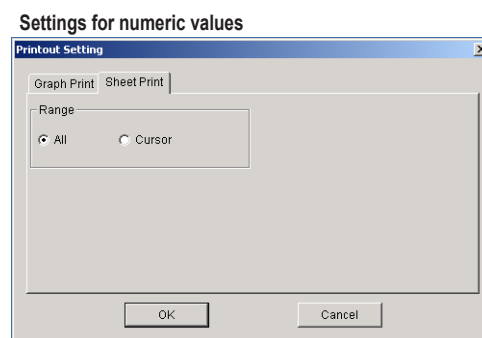
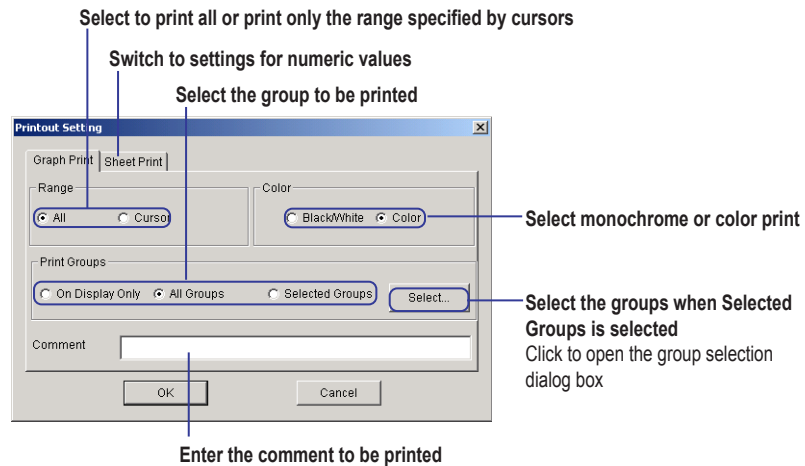

Executing the Print Operation

1. From the File menu, choose Print.
The Print dialog box opens.
2. In the Print dialog box, select the printer, print range, and the number of copies, and then click OK.
When printing waveforms, you cannot set the print range.

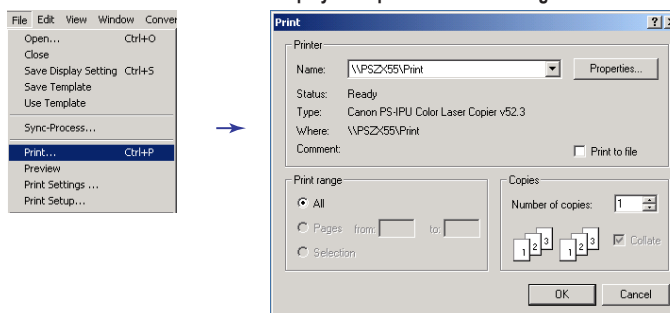

Print Preview

1. From the File menu, choose Print Preview.
The print image is displayed.

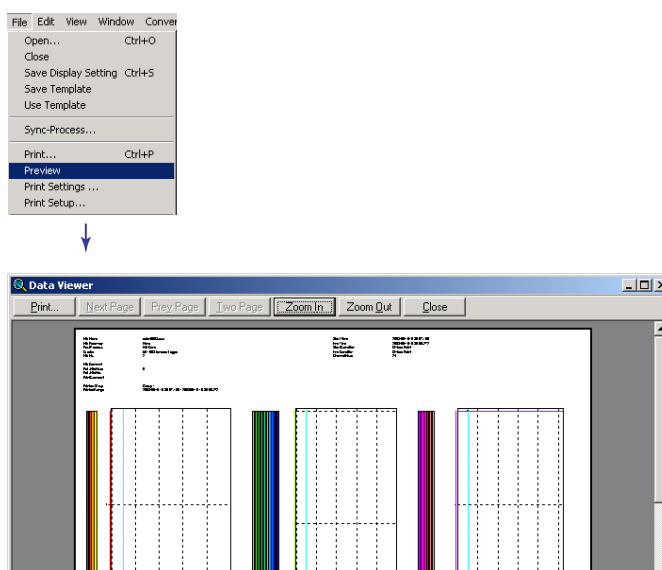

Setting Up the Printer

1. From the File menu, choose Print Setup.
The Print Setup dialog box opens.
2. Set the paper size, orientation, and other settings. Then, click OK.

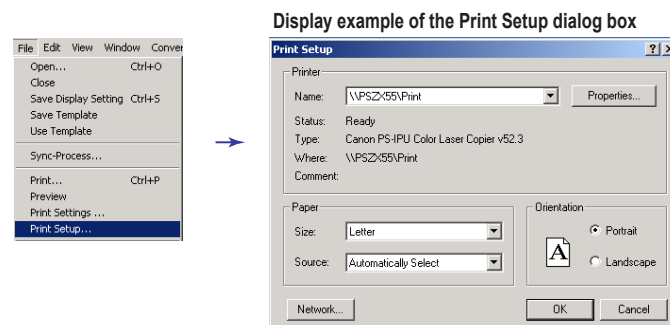

Explanation

Printed Items

To print waveforms, open the waveform display window; to print numeric values, open the numeric display window; to print alarm or mark lists, open the alarm/mark list display window. If multiple waveform display windows or numeric display windows are open, click the window you wish to print.

Also, to print alarm/mark lists, cursor values, or statistics calculated over and area along with waveforms, display those windows as well.

Print Range

If you wish to print only a specified range of the waveform, specify the range using cursors. For information on specifying the range by using cursors, see "Procedure" in section 3.4.

Printed Colors of Waveforms

You can select to print in black and white or in color.

Print Groups

- On Display Only
Only the groups whose waveforms are displayed are printed.
- All Groups
All groups that can be displayed on the waveform display window are printed.
- Selected Groups
Groups selected in the dialog box that opens (see the figure below) when the Select button is clicked are printed.

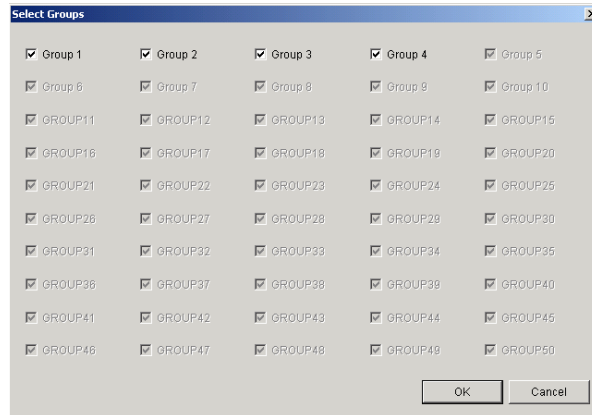

Printing a Comment

You can enter a comment using up to 127 characters. The comment is printed in the Print Comment column.

Printing File Information

When you print data, the file information is also printed. You can check the file information in the dialog box that appears when choosing File Information from the Information menu. You can also select the items to be printed using the check boxes.

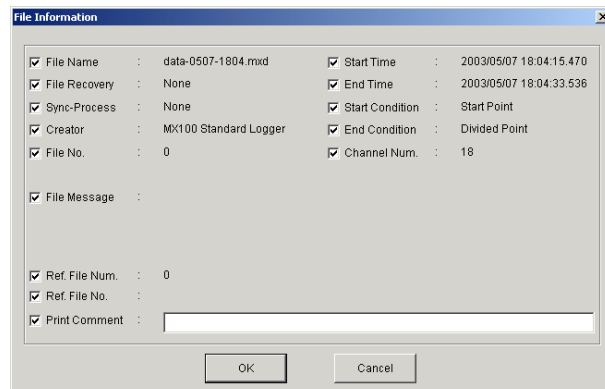

3.8 Printing the Data

- When printing an alarm list

Alarm List [test_take-0831-1511.mxs] 1/7

Channel	Level	Type	Alarm ON	Alarm OFF
CH0001	L1	L	2004/08/31 15:11:48.000	2004/08/31 15:11:48.400
CH0001	L1	L	2004/08/31 15:11:49.000	2004/08/31 15:11:49.400
CH0001	L1	L	2004/08/31 15:11:50.000	2004/08/31 15:11:50.400
CH0001	L1	L	2004/08/31 15:11:51.000	2004/08/31 15:11:51.400
CH0001	L1	L	2004/08/31 15:11:52.000	2004/08/31 15:11:52.400
CH0001	L1	L	2004/08/31 15:11:53.000	2004/08/31 15:11:53.300
CH0001	L1	L	2004/08/31 15:11:54.000	2004/08/31 15:11:54.300
CH0001	L1	L	2004/08/31 15:11:55.000	2004/08/31 15:11:55.300
CH0001	L1	L	2004/08/31 15:11:56.000	2004/08/31 15:11:56.300
CH0001	L1	L	2004/08/31 15:11:57.000	2004/08/31 15:11:57.300
CH0001	L1	L	2004/08/31 15:11:58.000	2004/08/31 15:11:58.300
CH0001	L1	L	2004/08/31 15:11:59.000	2004/08/31 15:11:59.300
CH0001	L1	L	2004/08/31 15:11:59.900	2004/08/31 15:12:00.300
CH0001	L1	L	2004/08/31 15:12:00.900	2004/08/31 15:12:01.300
CH0001	L1	L	2004/08/31 15:12:01.900	2004/08/31 15:12:02.300

- When printing a mark list

Mark List [test_take-0831-1511.mxs] 1/1

Absolute Time	Mark	Group	Kind
2004/08/31 15:11:48.400	Mark0		Viewer
2004/08/31 15:11:49.600	Mark		Monitor
2004/08/31 15:11:52.470	Mark		Monitor
2004/08/31 15:11:55.900	Mark1	1:Group 01	Viewer
2004/08/31 15:11:59.420	Mark		Monitor
2004/08/31 15:12:04.320	Mark		Monitor
2004/08/31 15:12:06.780	Mark		Monitor
2004/08/31 15:12:10.600	Mark2	1:Group 01	Viewer
2004/08/31 15:12:14.350	Mark		Monitor
2004/08/31 15:12:17.800	Mark3	1:Group 01	Viewer
2004/08/31 15:12:19.170	Mark		Monitor
2004/08/31 15:12:26.330	Mark		Monitor
2004/08/31 15:12:28.600	Mark		Viewer
2004/08/31 15:12:31.440	Mark		Monitor
2004/08/31 15:12:36.550	Mark		Monitor

- When printing a list of numeric values

Data List [data-0007.mxs] 1/80

Time (sec)	Absolute Time (sec)	CH0001	CH0002	CH0003	CH0004
2008/01/23 15:14:40.600p000000q	15:14:40.600p000000q	-1.369	-1.224	-1.0615	-0.944
2008/01/23 15:14:40.600p000000q	15:14:40.600p000000q	-1.384	-1.244	-1.1015	-0.952
2008/01/23 15:14:40.700p000000q	15:14:40.700p000000q	-1.409	-1.2615	-1.1170	-0.9726
2008/01/23 15:14:40.800p000000q	15:14:40.800p000000q	-1.4253	-1.271	-1.1307	-0.9846
2008/01/23 15:14:40.900p000000q	15:14:40.900p000000q	-1.4406	-1.2908	-1.1429	-0.9953
2008/01/23 15:14:41.000p000000q	15:14:41.000p000000q	-1.4562	-1.3030	-1.1538	-1.0047
2008/01/23 15:14:41.100p000000q	15:14:41.100p000000q	-1.4687	-1.3132	-1.1627	-1.0128
2008/01/23 15:14:41.200p000000q	15:14:41.200p000000q	-1.4747	-1.3214	-1.1700	-1.0188
2008/01/23 15:14:41.300p000000q	15:14:41.300p000000q	-1.4818	-1.3278	-1.1767	-1.0236
2008/01/23 15:14:41.400p000000q	15:14:41.400p000000q	-1.4888	-1.3323	-1.1796	-1.0272
2008/01/23 15:14:41.500p000000q	15:14:41.500p000000q	-1.4897	-1.3348	-1.1819	-1.0293
2008/01/23 15:14:41.600p000000q	15:14:41.600p000000q	-1.4903	-1.3353	-1.1823	-1.0296
2008/01/23 15:14:41.700p000000q	15:14:41.700p000000q	-1.4892	-1.3344	-1.1815	-1.0289
2008/01/23 15:14:41.800p000000q	15:14:41.800p000000q	-1.4887	-1.3313	-1.1787	-1.0284
2008/01/23 15:14:41.900p000000q	15:14:41.900p000000q	-1.4892	-1.3293	-1.1743	-1.0227
2008/01/23 15:14:42.000p000000q	15:14:42.000p000000q	-1.4724	-1.3194	-1.1682	-1.0173
2008/01/23 15:14:42.100p000000q	15:14:42.100p000000q	-1.4627	-1.3107	-1.1605	-1.0106
2008/01/23 15:14:42.200p000000q	15:14:42.200p000000q	-1.4609	-1.3000	-1.1511	-1.0023
2008/01/23 15:14:42.300p000000q	15:14:42.300p000000q	-1.4388	-1.2814	-1.1399	-0.9926
2008/01/23 15:14:42.400p000000q	15:14:42.400p000000q	-1.4208	-1.2731	-1.1272	-0.9816
2008/01/23 15:14:42.500p000000q	15:14:42.500p000000q	-1.4028	-1.2570	-1.1130	-0.9692
2008/01/23 15:14:42.600p000000q	15:14:42.600p000000q	-1.3828	-1.2391	-1.0971	-0.9554
2008/01/23 15:14:42.700p000000q	15:14:42.700p000000q	-1.3610	-1.2195	-1.0798	-0.9402
2008/01/23 15:14:42.800p000000q	15:14:42.800p000000q	-1.3372	-1.1961	-1.0609	-0.9236
2008/01/23 15:14:42.900p000000q	15:14:42.900p000000q	-1.3114	-1.1750	-1.0404	-0.9061
2008/01/23 15:14:43.000p000000q	15:14:43.000p000000q	-1.2839	-1.1504	-1.0185	-0.8870
2008/01/23 15:14:43.100p000000q	15:14:43.100p000000q	-1.2543	-1.1239	-0.9951	-0.8665
2008/01/23 15:14:43.200p000000q	15:14:43.200p000000q	-1.2290	-1.0959	-0.9703	-0.8440
2008/01/23 15:14:43.300p000000q	15:14:43.300p000000q	-1.1987	-1.0663	-0.9441	-0.8222
2008/01/23 15:14:43.400p000000q	15:14:43.400p000000q	-1.1657	-1.0355	-0.9169	-0.7994
2008/01/23 15:14:43.500p000000q	15:14:43.500p000000q	-1.1192	-1.0029	-0.8879	-0.7733
2008/01/23 15:14:43.600p000000q	15:14:43.600p000000q	-1.0814	-0.9669	-0.8680	-0.7471
2008/01/23 15:14:43.700p000000q	15:14:43.700p000000q	-1.0419	-0.9335	-0.8265	-0.7196
2008/01/23 15:14:43.800p000000q	15:14:43.800p000000q	-1.0009	-0.8965	-0.7941	-0.6915
2008/01/23 15:14:43.900p000000q	15:14:43.900p000000q	-0.9586	-0.8589	-0.7606	-0.6623
2008/01/23 15:14:44.000p000000q	15:14:44.000p000000q	-0.9160	-0.8199	-0.7259	-0.6322
2008/01/23 15:14:44.100p000000q	15:14:44.100p000000q	-0.8699	-0.7794	-0.6901	-0.6009
2008/01/23 15:14:44.200p000000q	15:14:44.200p000000q	-0.8296	-0.7360	-0.6534	-0.5690
2008/01/23 15:14:44.300p000000q	15:14:44.300p000000q	-0.7764	-0.6966	-0.6159	-0.5364
2008/01/23 15:14:44.400p000000q	15:14:44.400p000000q	-0.7229	-0.6622	-0.5775	-0.5029
2008/01/23 15:14:44.500p000000q	15:14:44.500p000000q	-0.6782	-0.6207	-0.5381	-0.4686
2008/01/23 15:14:44.600p000000q	15:14:44.600p000000q	-0.6271	-0.5824	-0.4980	-0.4337
2008/01/23 15:14:44.700p000000q	15:14:44.700p000000q	-0.5764	-0.5465	-0.4573	-0.3982
2008/01/23 15:14:44.800p000000q	15:14:44.800p000000q	-0.5233	-0.4668	-0.4169	-0.3622
2008/01/23 15:14:44.900p000000q	15:14:44.900p000000q	-0.4712	-0.4222	-0.3738	-0.3255
2008/01/23 15:14:45.000p000000q	15:14:45.000p000000q	-0.4176	-0.3742	-0.3313	-0.2886
2008/01/23 15:14:45.100p000000q	15:14:45.100p000000q	-0.3636	-0.3258	-0.2884	-0.2512
2008/01/23 15:14:45.200p000000q	15:14:45.200p000000q	-0.3087	-0.2766	-0.2449	-0.2133
2008/01/23 15:14:45.300p000000q	15:14:45.300p000000q	-0.2535	-0.2271	-0.2011	-0.1761
2008/01/23 15:14:45.400p000000q	15:14:45.400p000000q	-0.1981	-0.1775	-0.1571	-0.1398
2008/01/23 15:14:45.500p000000q	15:14:45.500p000000q	-0.1424	-0.1275	-0.1129	-0.0994
2008/01/23 15:14:45.600p000000q	15:14:45.600p000000q	-0.0963	-0.0773	-0.0684	-0.0596
2008/01/23 15:14:45.700p000000q	15:14:45.700p000000q	-0.0301	-0.0270	-0.0239	-0.0208
2008/01/23 15:14:45.800p000000q	15:14:45.800p000000q	0.0229	0.0232	0.0206	0.0179
2008/01/23 15:14:45.900p000000q	15:14:45.900p000000q	0.0823	0.0737	0.0662	0.0669

4.1 Connecting the MX100

Notes before Using the Calibrator

- If the MX100 is connected using the Integration Monitor, drop the connection before connecting the MX100 using the Calibrator.
- If you change the module configuration before connecting with the Calibrator, use the Integration Monitor to reconfigure the system (see section 2.2).

Procedure

1. Start the Calibrator.
The Unit Information window opens.
2. In the IP Address/Host Name box, enter the IP address or host name of the MX100 to be calibrated.
3. Click Connect.

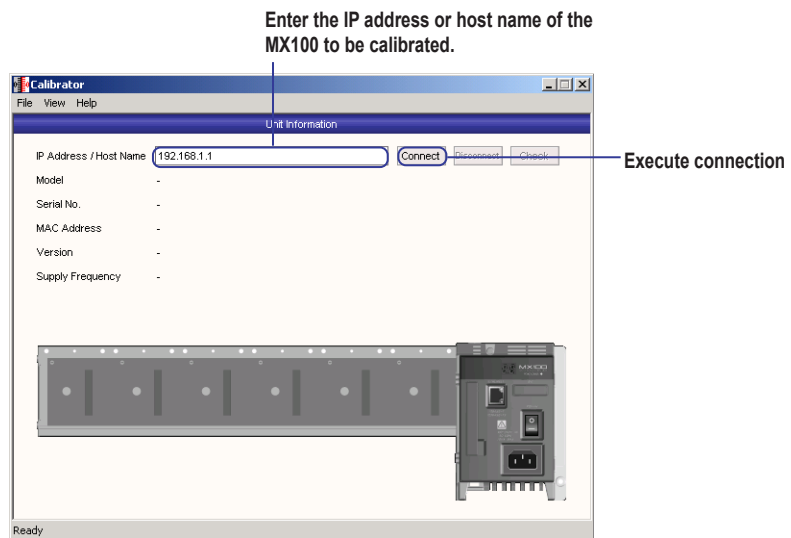

4.1 Connecting the MX100

When the connection is established, information about the unit's module configuration is displayed.

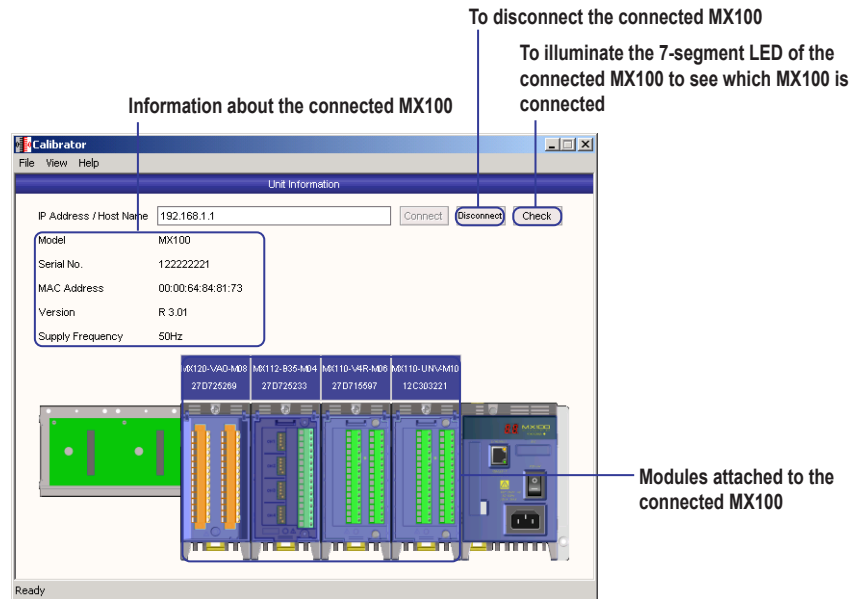

If the specified IP address or host name is not correct, or the MX100 is connected by another software program, the following dialog box opens.

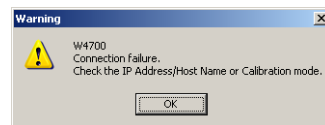

Note

- You cannot change the MX100 network settings using the Calibrator. Use the Integration Monitor (MX100 Standard Software) to change the IP address and other settings.
- If you change the module configuration before connecting with the Calibrator or if modules that are not operating properly exist, X marks are displayed on the modules as shown below. If you change the module configuration, use the Integration Monitor to reconfigure the system.

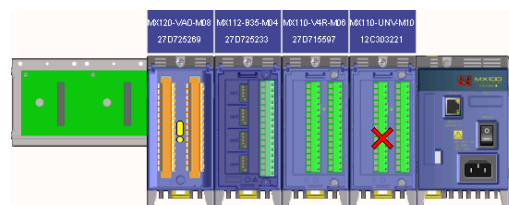

- When using Windows XP, Windows Vista, or Windows 7 with the firewall enabled, recognition is sometimes not successful even when clicking the Search button. To solve the problem, see appendix 1. (The same problem may also occur if your anti-virus software is using a firewall.)

Setting a Password for Startup

You can use the following procedure to set up the Calibrator so that it prompts the user to enter a password upon startup.

1. From the File menu, click Set Password.
The password setting dialog box opens.



2. Click the New Password box, and enter a password.
There are no restrictions on the characters that can be used in the password. However, the number of characters used must be no more than thirty.
3. Enter the same password in the Confirm New Password box, then click OK.
When the Calibrator is restarted, the password confirmation dialog box below appears. If an incorrect password is entered and the OK button is clicked, the message, "Incorrect Password" is displayed in a dialog box. Click OK to exit the Calibrator.

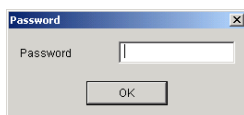

Note

To set up the Calibrator so that no password dialog box is displayed, open the password setting dialog box, make sure the entry boxes are blank, and click OK. There is no other way to cancel the password, so make sure you do not forget the password once it is set.

Explanation

Checking the Connected MX100

When the connection is established, the Unit Information window shows the serial number, MAC address, and input/output modules of the connected MX100. If you click the Check button, the 7-segment LED on the main module of the connected MX100 shows the text "--CALL--" flowing from right to left.

4.2 Calibration Procedure

Notes on Calibration

- Do not perform other operations during calibration. Take extra care because if you perform another operation while calibration is in progress, the module may suffer a break down.
- When connecting the plate with screw terminals (model 772080) to the 10-CH, Medium-Speed Universal Input module, note that the terminal arrangement is different than when connecting clamped terminals.

With the calibration software, modules to which plates with screw terminals are connected are recognized as clamp terminals, meaning that the wiring diagrams show the wiring for the clamp terminals.

Therefore when wiring and calibrating, refer to the text describing the terminal function and terminal symbols that show the type of signals input to each terminal that are printed on the back of the terminal cover of the 10-CH, plate with screw terminals.

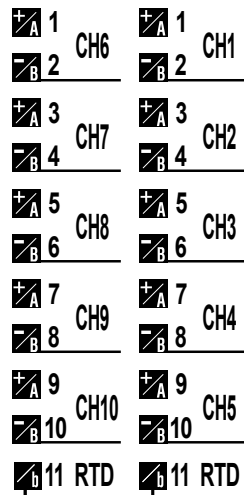

Note: The b terminals are common to all channels. They are connected internally.

Procedure

1. Click the illustration of the input/output module that you wish to calibrate.

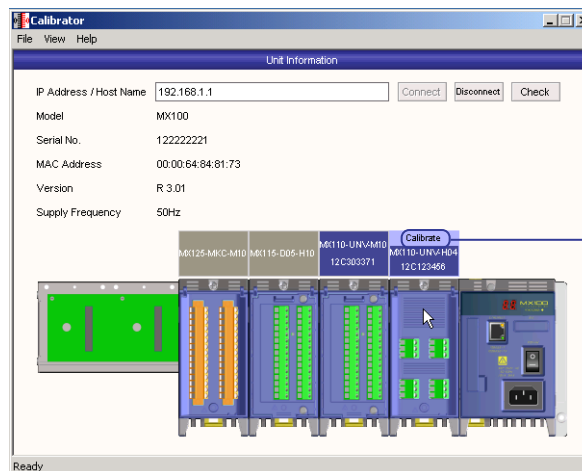

Moving the pointer over an module that can be calibrated shows the word "Calibrate"

- On the calibration detail setup screen that appears, select the channel and range to be calibrated and click the >> button.

The figure below is an example of the 4-CH, High-Speed Universal Input Module.

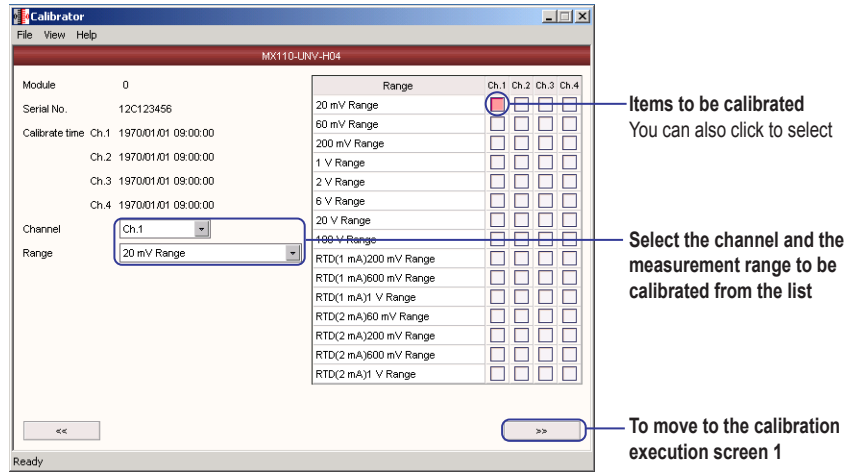

The figure below is an example of the 10-CH, Medium-Speed Universal Input Module. Channels are not selected.

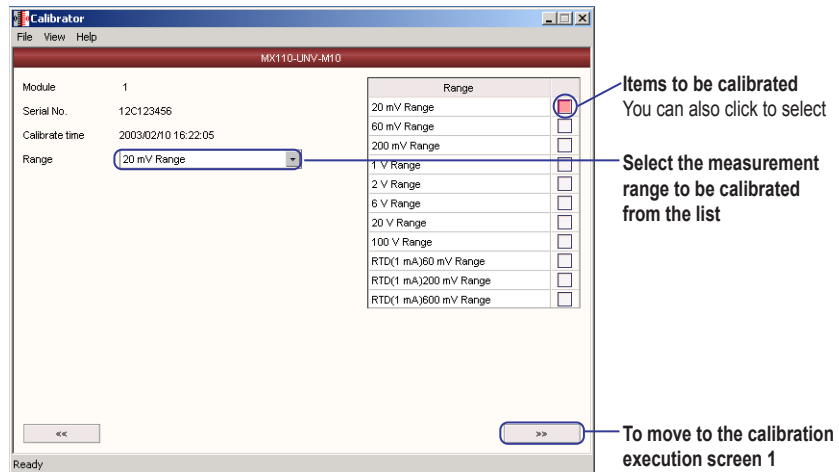

The figure below is an example of the 30-CH, Medium-Speed DCV/TC/DI Input Module. Channels are not selected.

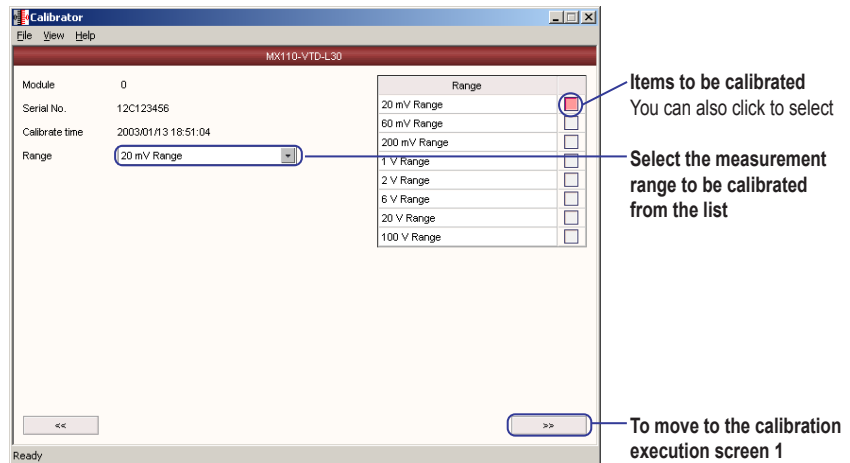

4.2 Calibration Procedure

The figure below is an example of the 6-CH, Medium-Speed, Four-Wire RTD Resistance Input Module. Channels are not selected.

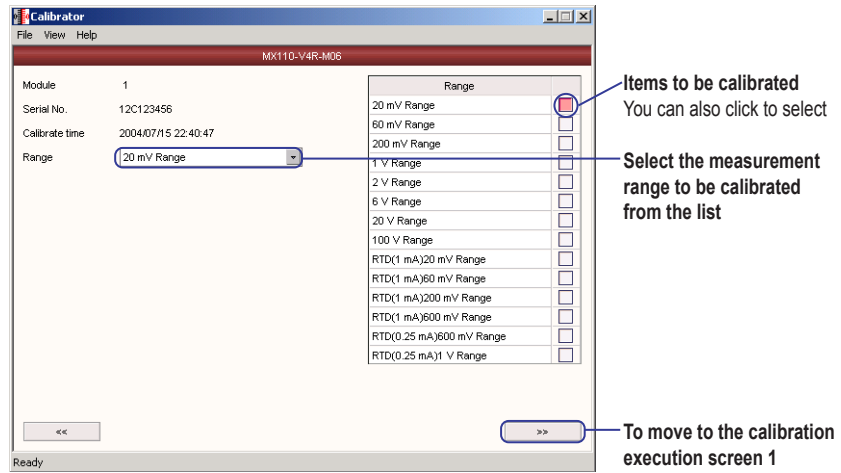

The figure below is an example of the 4-CH, Medium-Speed Strain Input Module. Channels are not selected.

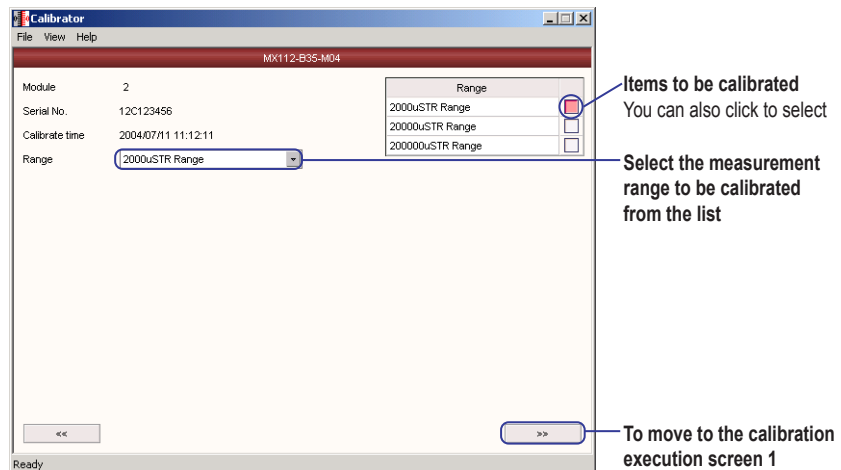

The figure below is an example of the 8-CH, Medium-Speed Analog Output Module. A range is not selected.

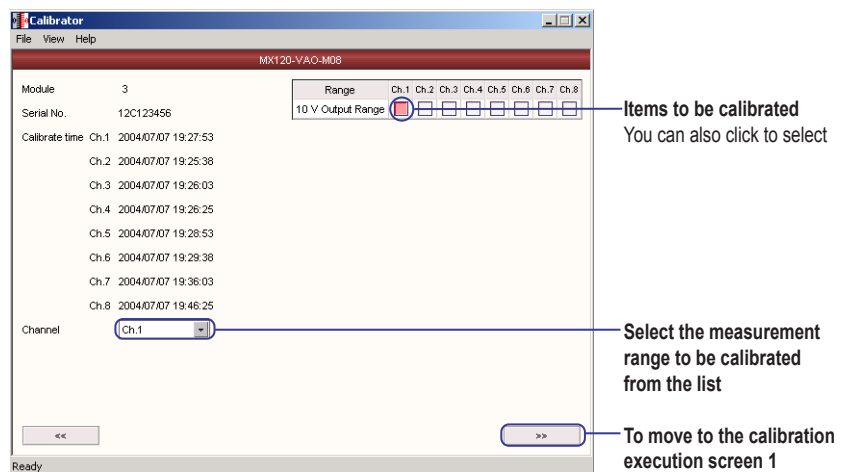

- After making the connections according to the explanation given on the calibration execution screen 1, click the Calibrate button.

For the 8-CH Medium Speed Analog Output module, after entering settings according to the explanation given on the calibration execution screen 1, click the Calibrate button.

The figure below is an example of the 4-CH, High-Speed Universal Input Module.

Exp. Calibration execution screen 1

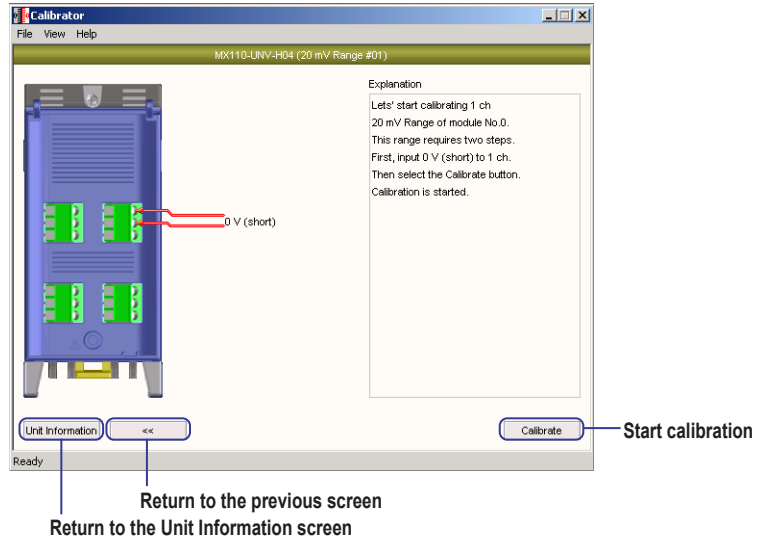

The figure below is an example of the 8-CH, Medium-Speed Analog Output Module.

Exp. Calibration execution screen 1

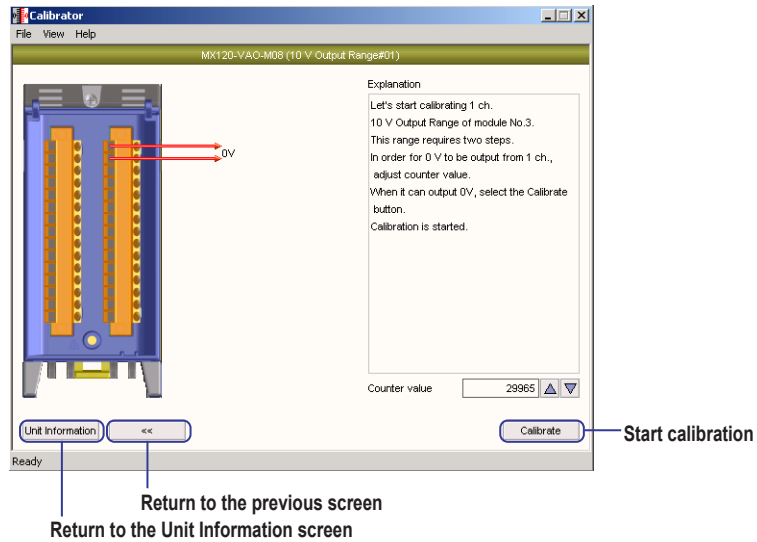

Click the Calibrate button.

The message, "Calibrating. Please wait and do not perform any other operation." appears.

When the calibration completes successfully, the calibration execution screen 2 appears.

4.2 Calibration Procedure

If the calibration fails, a message "Failed to calibrate." appears.



Note

For a description of the accuracy of the connected input module, the calibration accuracy, and the environmental conditions for calibration, see the *MX100 Data Acquisition Unit User's Manual* (IM MX100-01E).

4. After making the connections according to the explanation given on the calibration execution screen 2, click the Calibrate button.

The figure below is an example of the 4-CH, High-Speed Universal Input Module.

Exp. Calibration execution screen 2

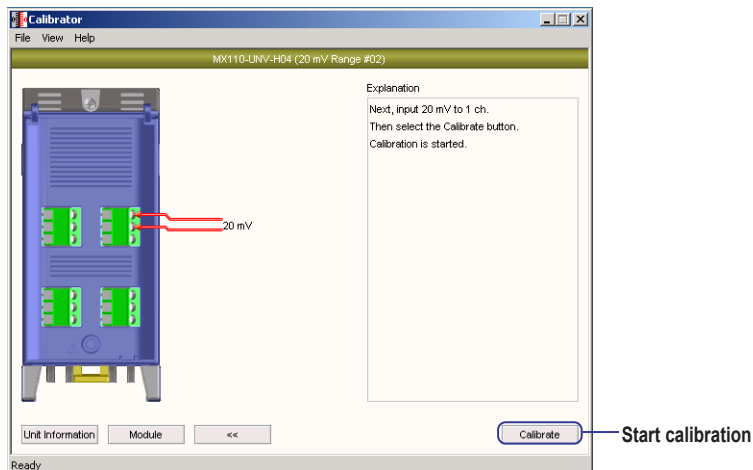

The figure below is an example of the 8-CH, Medium-Speed Analog Output Module.

Exp. Calibration execution screen 2

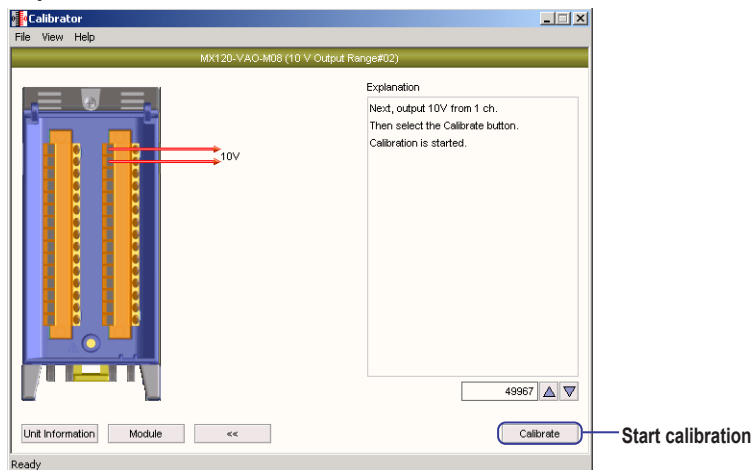

Click the Calibrate button.

The message, "Calibrating. Please wait and do not perform any other operation." appears.

5. Repeat steps 1 to 4 until all calibrations are completed.
6. From the File menu, choose Write.
The calibration values are written to the input module.

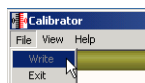

Note

During calibration, do not perform any other operations (especially turning the MX100 OFF or dropping communications). Doing so may cause the MX100 main unit to stop working.

Explanation

Calibrated Parameters

- 4-CH, High-Speed Universal Input Module (MX110-UNV-H04)

Calibration is carried out on a channel-by-channel basis.

Measurement Range to Be Calibrated	Input Value 1	Input Value 2
20 mV	0 mV	20 mV
60 mV	0 mV	60 mV
200 mV	0 mV	200 mV
1 V	0 V	1 V
2 V	0 V	2 V
6 V	0 V	6 V
20 V	0 V	20 V
100 V	0 V	100 V
RTD(1 mA)200 mV	0 Ω	200 Ω
RTD(1 mA)600 mV	0 Ω	300 Ω
RTD(1 mA)1 V	0 Ω	500 Ω
RTD(2 mA)60 mV	0 Ω	30 Ω
RTD(2 mA)200 mV	0 Ω	100 Ω
RTD(2 mA)600 mV	0 Ω	300 Ω
RTD(2 mA)1 V	0 Ω	250 Ω

- 10-CH, Medium-Speed Universal Input Module (MX110-UNV-M10)

Measurement Range to Be Calibrated	Input Value 1	Input Value 2
20 mV	0 mV on CH1	20 mV on CH2
60 mV	0 mV on CH1	60 mV on CH2
200 mV	0 mV on CH1	200 mV on CH2
1 V	0 V on CH1	1 V on CH2
2 V	0 V on CH1	2 V on CH2
6 V	0 V on CH1	6 V on CH2
20 V	0 V on CH1	20 V on CH2
100 V	0 V on CH1	100 V on CH2
RTD(1 mA)60 mV	0 Ω on CH3	60 Ω on CH6
RTD(1 mA)200 mV	0 Ω on CH3	200 Ω on CH4
RTD(1 mA)600 mV	0 Ω on CH3	300 Ω on CH5

- 30-CH, Medium-Speed DCV/TC/DI Input Module (MX110-VTD-L30)

Measurement Range to Be Calibrated	Input Value 1	Input Value 2
20 mV	0 mV on CH1	20 mV on CH2
60 mV	0 mV on CH1	60 mV on CH2
200 mV	0 mV on CH1	200 mV on CH2
1 V	0 V on CH1	1 V on CH2
2 V	0 V on CH1	2 V on CH2
6 V	0 V on CH1	6 V on CH2
20 V	0 V on CH1	20 V on CH2
100 V	0 V on CH1	100 V on CH2

- 6-CH, Medium-Speed Four-Wire RTD Resistance Input Module (MX110-V4R-M06)

Measurement Range to Be Calibrated	Input Value 1	Input Value 2
20 mV	0 mV on CH1	20 mV on CH2
60 mV	0 mV on CH1	60 mV on CH2
200 mV	0 mV on CH1	200 mV on CH2
1 V	0 V on CH1	1 V on CH2
2 V	0 V on CH1	2 V on CH2
6 V	0 V on CH1	6 V on CH2
20 V	0 V on CH1	20 V on CH2
100 V	0 V on CH1	100 V on CH2
RTD(1 mA)20 mV	0 Ω on CH3	20 Ω on CH4
RTD(1 mA)60 mV	0 Ω on CH3	60 Ω on CH5
RTD(1 mA)200 mV	0 Ω on CH3	200 Ω on CH6
RTD(1 mA)600 mV	0 Ω on CH3	300 Ω on CH4
RTD(0.25 mA)600 mV	0 Ω on CH3	2400 Ω on CH5
RTD(0.25 mA)1 V	0 Ω on CH3	3000 Ω on CH6

- 4-CH, Medium-Speed Strain Input Module (MX112-B12-M04, MX112-B35-M04, MX112-NDI-M04)

Measurement Range to Be Calibrated	Connection 1 (Zero Calibration)	Connection 2 (Full Calibration)
2000 μ STR (strain)	120.000 Ω on R1 to R4 of CH2	120.000 Ω on R1 to R3 of CH2 and 117.154 Ω on R4
20000 μ STR (strain)	120.000 Ω on R1 to R4 of CH2	120.000 Ω on R1 to R3 of CH2 and 113.010 Ω on R4
200000 μ STR (strain)	120.000 Ω on R1 to R4 of CH2	120.000 Ω on R1 to R3 of CH2 and 80,000 Ω on R4

Use a 4-gauge method connection when performing calibration. For information on this connection, see section 2.4 of the *MX100 Data Acquisition Unit User's Manual* (IM MX100-01E).

- 8-CH, Medium-Speed Analog Output Module (MX120-VAO-M08)

Adjust so that all channels output 0 V and 10 V. This differs from other input modules.

Range to Be Calibrated	Output Value 1	Output Value 2
10 V	0 V	10 V

Note

- For a description of the measurement range and accuracy of each input module, see chapter 4 in the *MX100 Data Acquisition Unit User's Manual* (IM MX100-01E).
- For a description of the calibration procedure and wiring, see section 3.3 of the *MX100 Data Acquisition Unit User's Manual* (IM MX100-01E).

5.1 Troubleshooting

If servicing is necessary, or if the instrument is not operating correctly after performing the corrective actions below, contact your nearest YOKOGAWA dealer for repairs.

The 7-segment LED does not illuminate.

Message	Corrective Action	Reference Page
The power switch is not ON.	Turn ON the power switch.	*
The supply voltage is too low.	Check whether the voltage is within the supply voltage rating range.	*
The fuse is blown.	Servicing required.	-
The power supply is broken.	Servicing required.	-

* See the *MX100 Data Acquisition Unit User's Manual* (IM MX100-01E).

The 7-segment LED blinks repeatedly.

Probable Cause	Corrective Action	Reference Page
The power supply is shorted inside the input/output module.	Remove the module one by one and determine which module is broken. (Servicing required.)	-
The power supply is shorted inside the main module.	Replace the main module. (Servicing required.)	*

* See the *MX100 Data Acquisition Unit User's Manual* (IM MX100-01E).

After power up, the 7-segment LED displays something other than (when the unit number is 00).

Probable Cause	Corrective Action	Reference Page
The display is b* (* is any character other than F). The dipswitch settings are not correct.	Turn OFF the power, remove the CF card, turn ON all dip switches, and power up again. If the situation does not change, servicing is required.	*
The display is bF. The dipswitch settings are not correct.	Powering up in setup reset mode. Turn OFF the power, turn ON all dip switches, and power up again. Since all settings such as the IP address are initialized, reconfiguration is necessary.	2-7, *
The display is F* (where * is any character). Hardware error on the main module.	Servicing required.	-
The display is E* (where * is any character). Hardware error on the input/output module.	The slot number is indicated by * in the n* display following the E* display. Remove the relevant module and power up again. The relevant module must be serviced.	*
The display is P0. CF card operation error.	Do not manipulate the CF card while it is being accessed.	*
The display is P1. CF card error.	Reformat the CF card or replace the CF card.	2-11, *
The display is P2. CF card format error.	Check whether the CF card is inserted correctly. Then, reformat the CF card or replace the card.	2-11, *
The display is P3. CF card insufficient free space	Delete the files on the CF card to free up some space.	-
The display is P4. CF card number of files over the limit.	The number of created files exceeded the allowed amount. Stop the recording, replace the CF card or delete files and restart.	*
The display is P5. Overwrite error in the data storage buffer.	The time needed to store the file must be reduced. Delete unneeded data to increase the free space, or format the CF card.	*
The display is C1. Multiple TCP connections.	Turn OFF the power and reconnect.	*

* See the *MX100 Data Acquisition Unit User's Manual* (IM MX100-01E).

5.1 Troubleshooting

The MX100 cannot be detected from the PC or cannot be detected with the Search button.

Message	Corrective Action	Reference Page
The LINK LED does not turn ON. The cable is broken.	Replace the Ethernet cable.	*
The LINK LED does not turn ON. There is a problem with the hub.	Check the hub's power supply. If it still does not work, replace the hub and check the hub's operation. Also, try to connect the MX100 using the 10-Mbps fixed mode.	*
The LINK LED does not turn ON. There is a problem with the PC.	Check whether the PC can connect to the network. Replace the PC's NIC.	*
The ACT LED does not turn ON. There is a problem in the connection between the hub and the MX100.	Check the hub's power supply. If it still does not work, replace the hub and check the hub's operation. Also, try to connect the MX100 using the 10-Mbps fixed mode.	*
The ACT LED does not turn ON. There is a problem with the PC.	Check whether the PC can connect to the network. Replace the PC's NIC.	*
There is a problem in the network configuration. The settings are not correct.	Check that the IP address, subnet mask, and default gateway settings of the PC correspond to the MX100 settings.	2-7
There is a problem in the network configuration. The setting changes have not taken effect.	Turn OFF the power to the PC and the MX100, and carry out reconnection.	2-5, *
PC and the MX100 are not in the same segment.	Connect the PC and the MX100 in the same network segment. If the PC and the MX100 are connected as shown in the following figure, the Search button cannot be used to detect the MX100. However, you can make a connection manually by specifying the IP address.	2-7

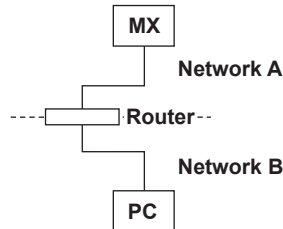

When using Windows XP, Windows Vista, or Windows 7, check the firewall function.

* See the *MX100 Data Acquisition Unit User's Manual* (IM MX100-01E).

The MX100 is detected by clicking the Search button, but connection cannot be made.

Message	Corrective Action	Reference Page
The IP address is set to the default value. The default value cannot be used to make the connection.	Enter the correct IP address.	2-7
There is a problem in the network configuration.	Check that the IP address, subnet mask, and default gateway settings of the PC and the MX100 settings are correct.	2-7
The PC software, main module style number, and release number do not conform to the rule.	Check the release number of the PC software and the main module style number, then upgrade the style. [PC software release no.] ≥ [main module style no.]	**

** See the *MX100 Data Acquisition Unit Operation Guide* (IM MX100-02E).

MX100 cannot be connected using the Calibrator

Message	Corrective Action	Reference Page
Attempting to make multiple connections. Another software program is already connected.	Exit all other software programs.	-
The main module and input/output module style numbers do not conform to the rule.	Check the release number of the PC software and the main module style number, then upgrade the style. [PC software release no.] ≥ [main module style no.] ≥ [input/output module style no.]	**

** See the *MX100 Data Acquisition Unit Operation Guide* (IM MX100-02E).

The connected input/output module is not detected.

Message	Corrective Action	Reference Page
Module connection or module startup error. Attached the module while the power was ON.	Turn OFF the power. Detach the input/output module once and attach it again.	*
The PC software, main module, and input/output module style and release numbers do not conform to the rule.	Check the release number of the PC software and the main module style number, then upgrade the style. [PC software release no.] ≥ [main module style no.] ≥ [input/output module style no.]	**
Carried out an incorrect calibration.	Recalibrate.	4-4
Connecting the 10-CH, Pulse Input Module (MX114-PLS-M10).	The 10-CH Pulse Input Module cannot be used with the MX100. Use this module with the MW100.	*

* See the *MX100 Data Acquisition Unit User's Manual* (IM MX100-01E).

** See the *MX100 Data Acquisition Unit Operation Guide* (IM MX100-02E).

Alarms are not output.

Message	Corrective Action	Reference Page
There is a problem in the alarm setting.	Make the alarm and numerical output (relay) settings appropriate. Both the alarm and numerical output (relay) must be set.	2-54 to 2-59

Current is not output from the analog output module, and no output comes from the PWM output module.

Message	Corrective Action	Reference Page
External power supply required.	Connect an external power supply.	*

* See the *MX100 Data Acquisition Unit User's Manual* (IM MX100-01E).

Transmission output is not output from the analog output module, nor from the PWM output module.

Message	Corrective Action	Reference Page
"Transmission output execution" not enabled.	Enable it.	2-62

No output from the PWM output module

Message	Corrective Action	Reference Page
The output current limit (1 A) has been exceeded. Once the limit is exceeded the protection circuit activates and will not recover until you turn OFF the external power.	Turn OFF the power. Check the load, then turn ON the power again.	-
The fuse is blown. (4 A/module limit has been exceeded)	Servicing required.	-

The CF card is not detected.

Message	Corrective Action	Reference Page
There is a problem with the CF card.	Replace the CF card. Eject and format the CF card, then insert it again.	*

* See the *MX100 Data Acquisition Unit User's Manual* (IM MX100-01E).

5.1 Troubleshooting

The measured value is not correct.

Message	Corrective Action/Description	Reference Page
The input wiring is not correct.	Check the input wiring.	*
The measured value indicates +Over or –Over. The measurement range setting and input range do not match.	Change to an appropriate setting.	*
The temperature error is large or is unstable. The TC type setting and the type actually connected are different.	Change to the correct setting.	*
The temperature error is large or is unstable. The RJC setting is not correct.	Change to the correct setting.	*
The temperature error is large or is unstable. The wind is hitting the terminals.	Block the wind from hitting the terminals.	-
The temperature error is large or is unstable. The ambient temperature change is drastic.	Suppress changes in the ambient temperature such as by placing the MX100 in a box.	-
The temperature error is large or is unstable. There is an error in the wiring resistance (in the case of an RTD).	Match the thickness and length of the three input wires.	*
The measurement error is large or is unstable. Noise effects.	Take measures against noise.	*
The measurement error is large or is unstable. Effects from the signal source resistance.	Reduce the signal source resistance such as by inserting a converter.	-
The temperature error is large or is unstable. Effects from parallel connections.	Stop parallel connections. Do not use the burnout setting.	-
Measured value from strain gauge type sensor not correct.	When using a sensor without a remote sensing wire, use the DV450-001 (conversion cable).	*
On the strain module (-B12, -B35), the gauge method dipswitch settings are not correct.	Enter the correct settings.	*
On the strain module (-B12, -B35), the gauge resistance and internal bridge resistance values are different.	Use a module that supports the resistance value of the strain gauge (for 120 Ω, -B12, and for 350 Ω, -B35.)	*
On the strain module, scaling corresponding to the gauge method is not set (for 2 gauge, 4 gauge methods, the amount of strain is doubled or quadrupled).	Displayed with 1 gauge method conversion. Set scaling appropriately depending on the gauge method.	*
On the strain module (-NDI), a strain gauge type sensor without a remote sensing wire is being used.	When using a sensor without a remote sensing wire, use the DV450-001 (conversion cable).	*

* See the *MX100 Data Acquisition Unit User's Manual* (IM MX100-01E).

5.2 Error Messages and Their Corrective Actions

Error Messages on the Integration Monitor

Error Code	Message	Corrective Action/Description	Reference Page
	IP address is invalid.	Enter the correct IP address.	2-7
	Subnet mask is invalid.	Enter the correct subnet mask.	2-7
	Default gateway is invalid.	Enter the correct gateway address.	2-7
	Failed to update.	Attempted to change the IP address while the connection is established, or the MX100 you wish to configure is connected by another software program. Disconnect the MX100.	-
	Search MX100s nearby again.	Click the Search button again on the Connection screen, and change the settings.	2-1, 2-5
	Broken modules exist.	Remove the input/output modules one by one and determine the broken module, then replace it.	*
	Some modules are not calibrated correctly.	Recalibrate.	4-4
	Undetermined directory.	The save destination of the record file cannot be found. Check whether the save destination exists.	2-16
	Write error	The record file cannot be created. Check whether free space on the destination drive exists, whether write permissions have been granted, whether the disk is damaged, and whether the file system is corrupt.	-
E5102	Failed to format CompactFlash.	Check whether communication with the MX100 is being performed. Insert a CF card correctly.	2-7 *
E5103	Invalid serial number. Please reinstall the software.	Enter the correct serial number.	1-5
E5104	Failed to create folder.	The directory of the folder to create is not correct. Check the file save destination.	2-16
E5105	Invalid folder name. Please enter a new name.	Entered folder name is incorrect. Enter a correct folder name.	-
E5106	Cannot contain any of the following characters: \\ / : ; * ? " < > CON PRN AUX CLOCK\$ NUL COM1-9 LPT1-9	Entered folder name includes illegal characters. Enter a correct folder name.	-
E5107	Compact Flash slot is empty.	Insert a CF card correctly.	*
W5131	Update the display settings.	The display setup is initialized according to the measurement and computation channel settings.	2-43
W5132	Writing data files Currently.	During finalization, do not close MX100 Standard.	2-51
W5133	Cancel the current settings and create a new project?	Settings are discarded and the MX100 Standard is restored to its default state.	2-6
W5134	The current channel setup contains invalid use of reference channels.	Click No and change the settings of the improper channels. To disable the channels with improper settings, click Yes.	2-25 to 2-27
W5135	In order to balance the strain channels, it's necessary for channels to be set up correctly. The current channel setup contains invalid use of reference channels.	Click No and change the settings of improper channels. To disable the channels with improper settings, click Yes.	2-25 to 2-27
W5136	Format Compact Flash?	The CF card is formatted.	2-11
W5137	Stop Record?	Data saving stops.	2-51
W5138	Module settings which do not match the current software configuration will be initialized.	If you click Yes, settings of modules that differ between the MX100 module configuration and the configuration recognized by MX100 Standard will be initialized. To not reconfigure, click No.	2-10
W5139	Some detected modules do not match the current software configuration. Rebuild based on the current MX hardware setup?	Click Yes reconfigure. To not reconfigure, click No.	2-9

* See the *MX100 Data Acquisition Unit User's Manual* (IM MX100-01E).

5.2 Error Messages and Their Corrective Actions

Error Messages on the Viewer

Error Code	Message	Corrective Action/Description	Reference Page
E0004	File write error.	The file cannot be created for some reason.	-
E0212	Can't read file.	Target files cannot be loaded, or are deleted.	3-2
E3111	Channels of the specified recording interval do not exist.	Channels with the specified measurement interval do not exist in the conversion of the data format. Change to the correct setting.	3-24
E3114	Sampling data number is over the Viewer display limit of 5 M.	Attempting to load a file containing 5 million or more data points.	3-2
E3120	Not a data file.	Target files cannot be loaded, or are damaged.	3-2
E3153	File open error.	File not created because allowable number of files in the CF card will be exceeded. Delete files to reduce the total number.	3-5
W3115	Exceeded the range of the Excel sheet. Convert to Excel?	Change the range to be converted so that it is within the allowed range of Excel.	3-25
W3116	Exceeded the range of the Lotus 1-2-3 sheet. Convert to Lotus?	Change the range to be converted so that it is within the allowed range of Lotus 1-2-3	3-25

Error Messages on the Calibrator

Error Code	Message	Corrective Action/Description	Reference Page
W4700	Connection failure. Check the IP Address/Host Name or Calibration mode.	To change the network settings such as the IP address, start the Integration Monitor. The MX100 has no Calibration mode.	2-5
W4701	Failed to write the calibrated value.	Recalibrate. If the message is still displayed, service required.	4-4 to 4-9
W4702	Failed to calibrate.	Recalibrate. If the message is still displayed, service required.	4-4 to 4-9

Appendix 1 Configuring/Removing the Firewall

Check the following before attempting to configure or remove a firewall.

- Check the internet connection status using the ping command. If the ping fails, check the cables, hub, IP address settings, and other factors to determine the cause.
- Check that procedures performed on the software are correct.

If the problem cannot be solved after taking the above measures, it is likely that there will be problems with the firewall settings. Configure or remove the firewall according to the following procedure.

Note that the following procedure describes the MX100 Standard, but it applies to the MX100 Calibration Software as well.

Windows XP SP3

1. From the Start menu, click **Control Panel**.
The **Control Panel** opens.

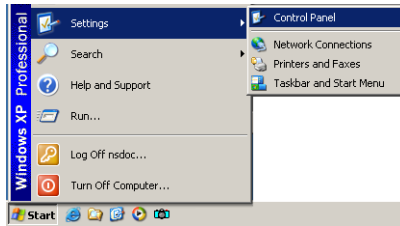

2. Double-click **Windows firewall**.
The **Windows Firewall** dialog box appears.

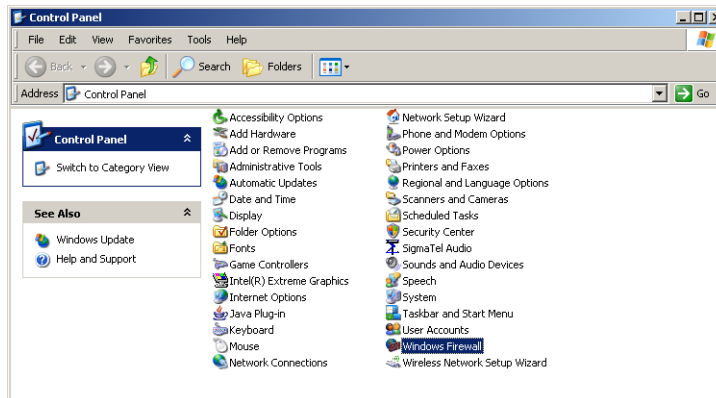

3. If **Off** is selected, click **Cancel** to exit.
If **On** is selected, clear the **Don't allow exceptions** check box.

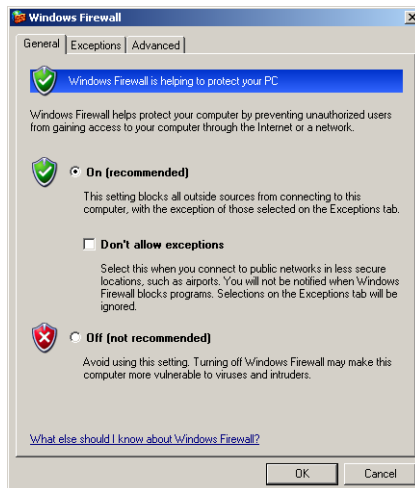

- Click the **Exceptions** tab, then click the **Add Program** button. The **Add program** dialog box is displayed.

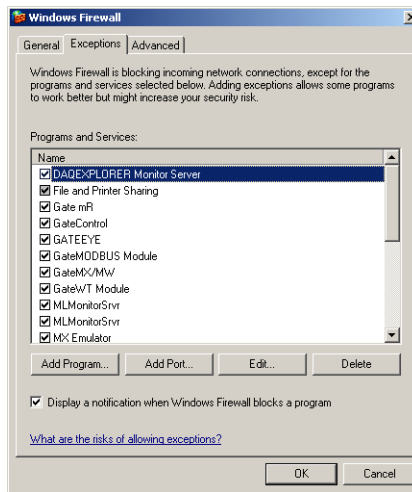

- Select **MX100 Standard**, then click the **OK** button.

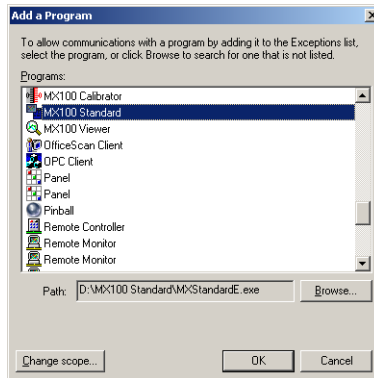

- Click the **Exceptions** tab. Confirm that the **MX100 Standard** item was added, then select the **MX100 Standard** check box and click the **OK** button.

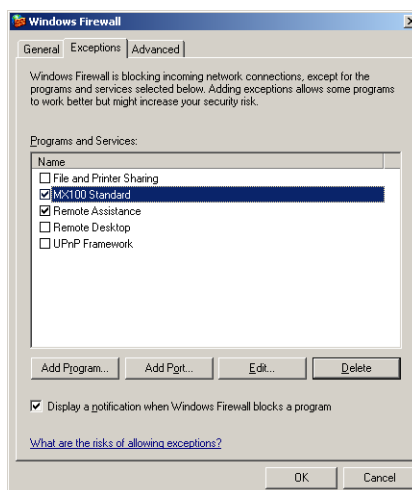

Windows Vista

1. From the **Start** menu, choose **Control Panel**.
The control panel opens.

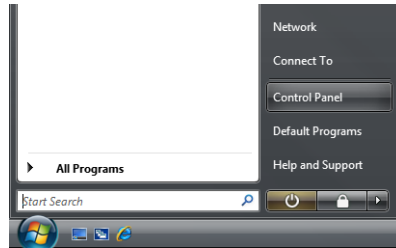

2. Click **Allow a program through Windows Firewall**.
The **User Account Control** dialog box appears.

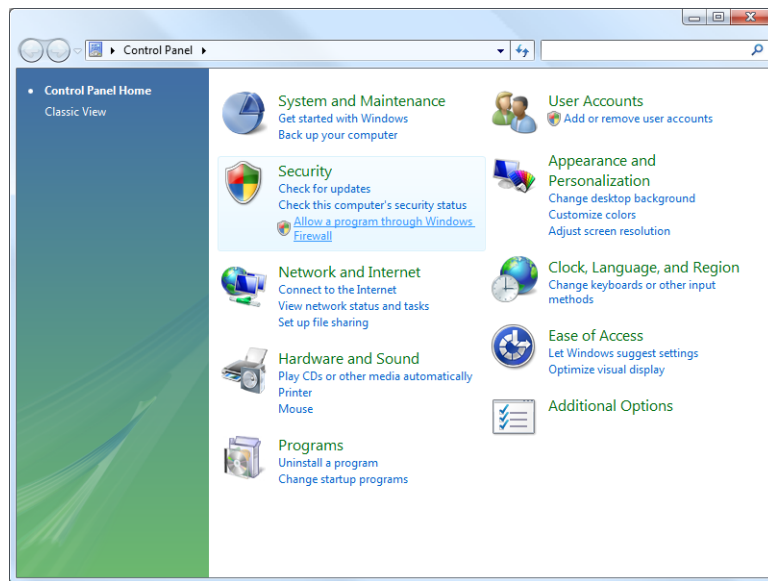

3. Click **Continue**.
The **Windows Firewall Settings** dialog box is displayed.

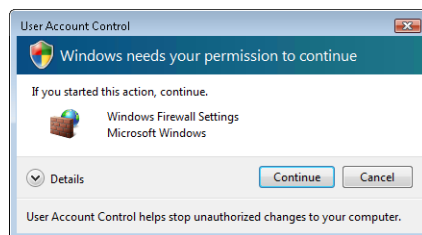

- Click the **General** tab.
If **Off** is selected, click **Cancel** to exit.
If **On** is selected, clear the **Block all incoming connections** check box.

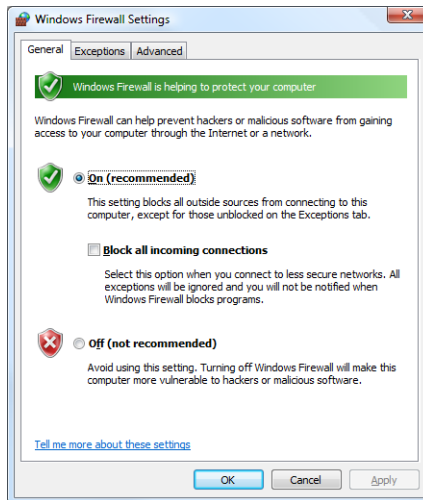

- Click the **Exceptions** tab, then click the **Add Program** button.
The **Add a Program** dialog box is displayed.

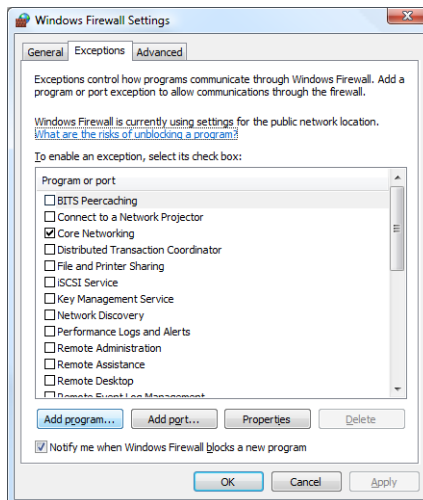

- Select **MX100 Standard**, then click the **OK** button.

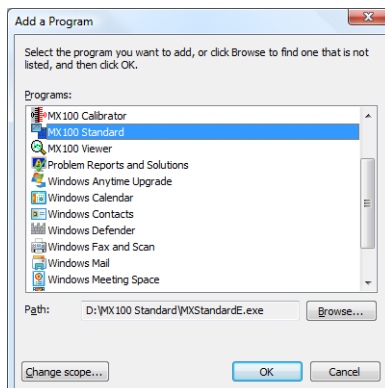

Appendix 1 Configuring/Removing the Firewall

7. Click the **Exceptions** tab. Confirm that the **MX100 Standard** item was added, then select the **MX100 Standard** check box and click the **OK** button.

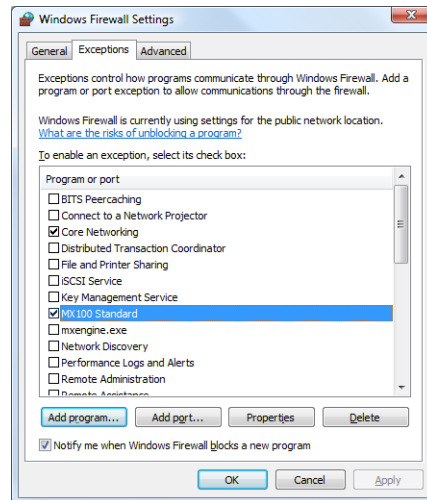

On Windows 7

1. Click the control panel on the Windows Start menu.
The **Control Panel** appears.

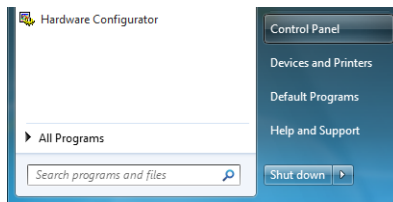

2. Click **System and Security**.

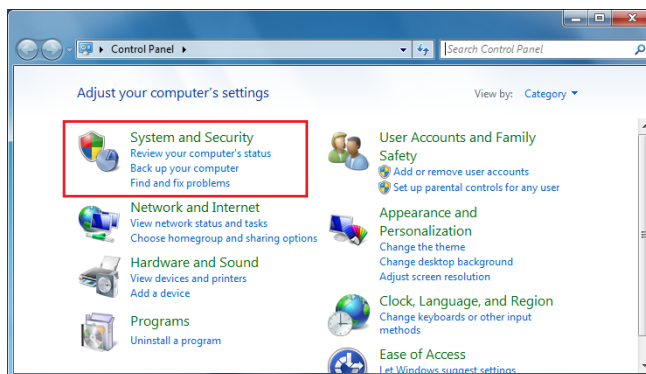

3. Click **Windows Firewall**.
The **Windows Firewall Settings** dialog box is displayed.

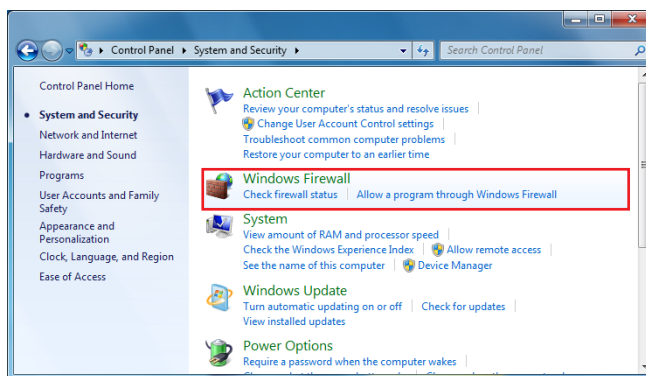

4. Click **Advanced settings**.

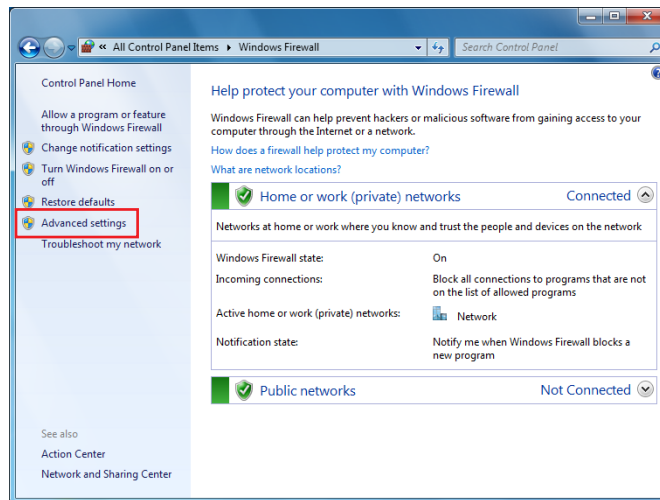

5. Click **Windows Firewall Properties**.

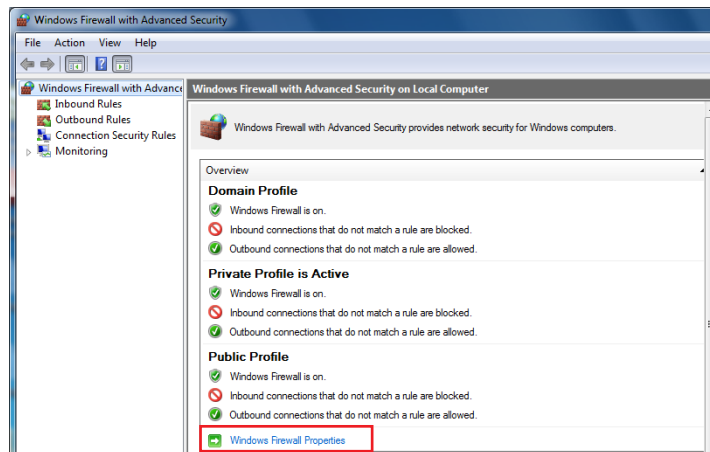

6. Click the tab of the profile appropriate for your operating environment. When the **Firewall state** is **Off**, click **Cancel** to exit. When the **Firewall state** is **On**, and **Inbound connections** or **Outbound connections** is **Block**, proceed to next step.

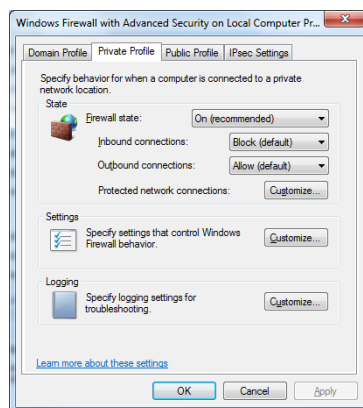

7. Click Inbound Rules.

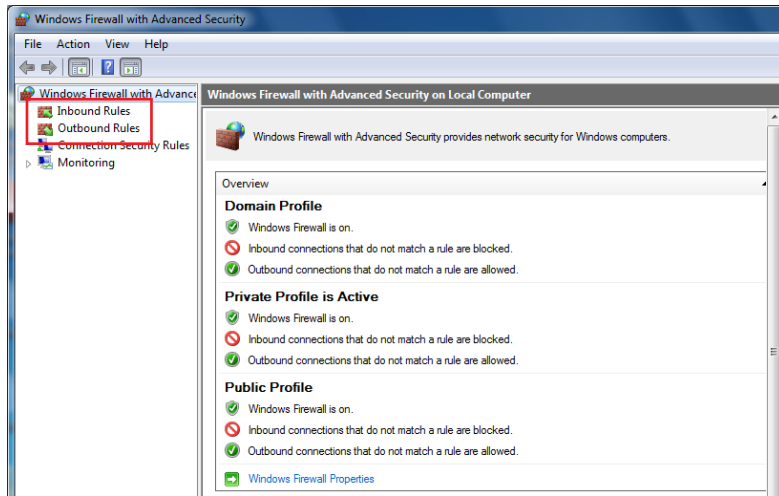

8. Select the Program check box. Click Next.

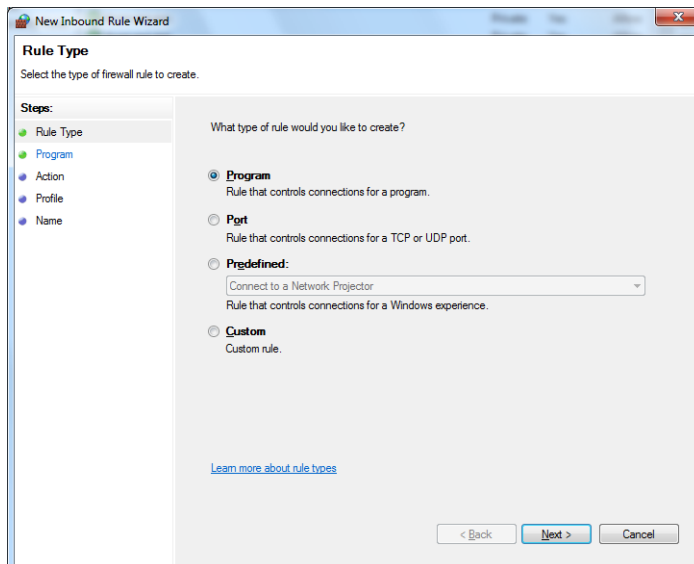

- 9. Select the **This program path** check box. Select **MXStandardE.exe** from the software's installation folder and click **Next**.

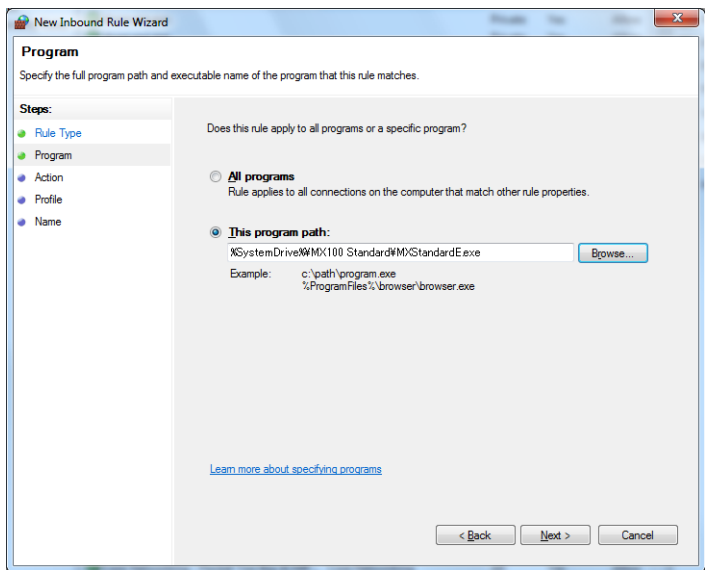

- 10. Select the **Allow the connection** check box. Click **Next**.

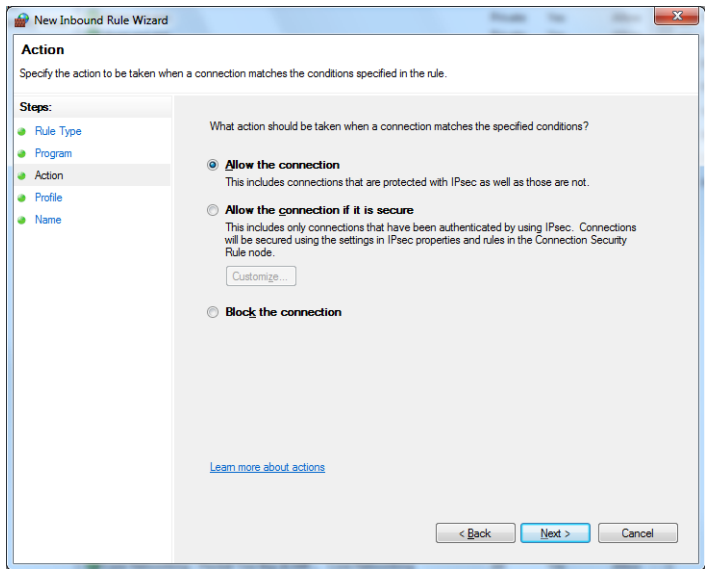

11. Specify the profiles for which this rule applies. Click **Next**.

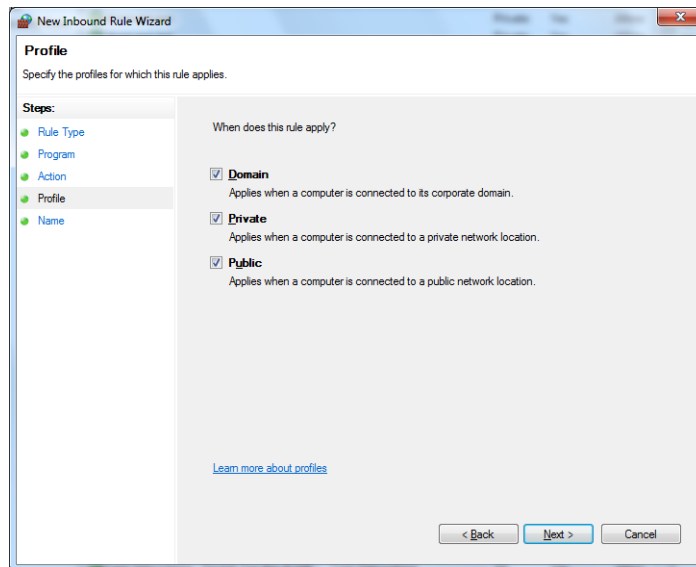

12. Specify the name of this rule, and click **Finish**.

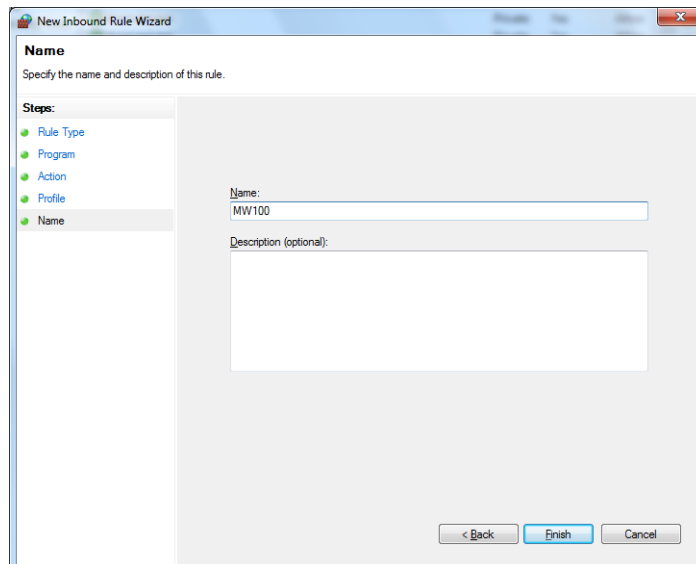

13. Follow the same procedure as the one in step 7 and select **MXCalibE.exe** and **MxEngine.exe**.

14. For **Outbound Rules** as well, follow the same procedure as the one in step 7 and select **MXStandardE.exe**, **MXCalibE.exe** and **MxEngine.exe**.

Index

Symbols

±Overrange..... 2-33

A

A/D integration time..... 2-10
 acquisition..... 2-14
 alarm..... 2-54
 alarm/mark list display..... 3-14
 alarm hysteresis..... 2-56
 alarm list..... 3-14
 analog output..... 2-60
 applying data file display conditions..... 3-17
 arithmetic functions..... 2-37
 arrow button..... 2-51
 auto zone..... 2-47, 3-10

B

burnout..... 2-20

C

calibration..... 4-4
 Calibrator..... 1-2, 1-3, 4-1
 CF card..... 2-11
 changing the display settings..... 2-43
 changing the network configuration..... 2-5
 channel color..... 2-48, 3-12
 channel numbers..... 2-34
 clearing the cursor..... 3-19
 clipping..... 2-48, 3-12
 compact flash information..... 2-12
 computation channels..... 2-30
 configured for the network..... 2-4
 connected users..... 2-8
 connecting to an MX100..... 2-1
 constants..... 2-34
 cursors..... 2-52, 3-18

D

data formats..... 3-24
 data formats for conversion..... 3-24
 de-energize..... 2-59
 default gateway..... 2-7
 dHigh..... 2-55
 difference input..... 2-20
 difference lower limit alarm..... 2-55
 difference upper limit alarm..... 2-55
 digital output..... 2-57
 disconnecting the MX100..... 2-1
 display groups..... 2-45, 3-8
 displaying the monitor screen..... 2-44
 displaying the settings..... 2-44
 display setting file..... 3-22
 display setup window..... 3-7
 display zone..... 2-46, 3-9
 dLow..... 2-55

E

edit zone..... 2-46, 3-9
 energize..... 2-59
 equation..... 2-30, 2-31
 error messages..... 5-5
 error messages on the Calibrator..... 5-6
 error messages on the Integration Monitor..... 5-5
 error messages on the Viewer..... 5-6
 error output..... 2-58
 event functions..... 2-40
 execution error..... 2-41
 exiting the software..... 1-8

F

FAIL output..... 2-58
 file information..... 3-28
 firewall..... App-1
 first-order lag filter..... 2-20
 format..... 2-11
 full zone..... 2-46, 3-10

G

grid display..... 3-11
 group names..... 2-45

H

High..... 2-55
 hold..... 2-59
 hysteresis..... 2-56

I

initial network information..... 2-2
 input mode..... 2-19
 installation..... 1-5
 Integration Monitor..... 1-1, 1-2
 IP address..... 2-7

J

joining..... 3-5

L

left-to-right mark search..... 3-15
 loading data files..... 3-1
 loading setup data..... 2-64
 Low..... 2-55
 lower limit alarm..... 2-55
 lower limit on rate-of-change alarm..... 2-55

Index

M

MAC address.....	2-8
machine name.....	2-7
manual DO.....	2-58
mark list.....	3-14
marks.....	2-49, 3-13
measurement channels.....	2-19
measurement conditions.....	2-19
measurement range.....	2-19
measurement span.....	2-19
menu.....	3-7
model.....	2-8
module arrangement.....	2-12
monitor.....	2-43
monitor interval.....	2-14
multi-axes zone.....	3-11
multi-axis zone.....	2-47

N

network information.....	2-12
new project.....	2-6
non-hold.....	2-59
numeric constants.....	2-34
numeric display.....	2-49, 3-16

O

operators.....	2-35
output relays.....	2-59

P

parameters.....	2-38
password.....	4-3
pause.....	2-52
predefined constants.....	2-34
print.....	2-65
printing setup data.....	2-65
printing the data.....	3-26
print operation.....	3-27
project.....	2-6, 2-64
PWM output.....	2-61

R

reading measured/computed values.....	2-52
reconfiguring the system.....	2-9
record file.....	2-16
record interval.....	2-14, 2-15
record start operation.....	2-50
record stop operation.....	2-50
reference channel.....	2-20
reference functions.....	2-36
relay ACK.....	2-59
release number.....	i
reset.....	2-15, 2-33
response check.....	2-11
revision number.....	2-8
rHigh.....	2-55
RJC.....	2-20
rLow.....	2-55
RRJC.....	2-20

S

save.....	2-64, 3-22
saving templates.....	3-23
scaling.....	2-20
scaling settings.....	2-28
selecting the display zone of the waveform.....	3-9
serial ID.....	2-8
set the initial balance.....	2-22
setting the A/D integral time.....	2-13
setting the computation span.....	2-30
setting the write mode of the CF card.....	2-13
setup.....	1-5
setup data.....	2-64
showing/hiding alarms.....	2-54
slide zone.....	2-47, 3-10
software.....	2-8
software license.....	iii
starting the recording.....	2-50
starting the software.....	1-8
statistical computation.....	3-20
stopping the recording.....	2-50
strain gauge type sensor.....	2-28
style number.....	2-8
subnet mask.....	2-7
switching between absolute and relative time.....	3-13
synchronization.....	3-3
syntax error.....	2-41
system requirements.....	1-4

T

tag numbers.....	2-21, 2-32, 2-34
time constant.....	2-20
time functions.....	2-38
timer.....	2-33
timer level operation.....	2-39
timers.....	2-39
TLOG function.....	2-36
transmission output.....	2-62
trip point.....	2-48, 3-11
troubleshooting.....	5-1
turning transmission output ON and OFF.....	2-62

U

unit setup.....	2-12
updating.....	2-52
upper limit alarm.....	2-55
upper limit on rate-of-change alarm.....	2-55
user-defined constant.....	2-31
user-defined constants.....	2-32, 2-34
user output.....	2-62
user zone.....	2-46, 3-9
using templates.....	3-23

V

version.....	2-8
version information.....	2-67
Viewer.....	1-2, 1-3, 3-1

W

waveform display.....	3-6
write mode.....	2-11

Y

Y-axis.....	2-45, 2-46, 3-8, 3-11
-------------	-----------------------