

User's manual MicroFlex e100 servo drive



Contents

1	General Information	
2	Introduction	
2.1	MicroFlex e100 features	2-1
2.2	Receiving and inspection	2-2
2.2.1	Identifying the catalog number	2-2
2.3	Units and abbreviations	2-3
3	Basic Installation	
3.1	Introduction	3-1
3.1.1	Power sources	3-1
3.1.2	Hardware requirements	3-1
3.1.3	Tools and miscellaneous hardware	3-2
3.1.4	Other information needed for installation	3-2
3.2	Mechanical installation and cooling requirements	3-3
3.2.1	Dimensions	3-4
3.2.2	Mounting and cooling the MicroFlex e100	3-5
3.2.3	Derating characteristic - 3 A model	3-6
3.2.4	Derating characteristic - 6 A model	3-7
3.2.5	Derating characteristic - 9 A model	3-8
3.2.6	Overtemperature trips	3-8
3.2.7	Heat dissipation	3-9
3.3	Connector locations	3-10
3.3.1	Front panel connectors	3-10
3.3.2	Top panel connectors	3-11
3.4	Power connections	3-12
3.4.1	Earthing / grounding	3-12
3.4.2	Earth leakage	3-13
3.4.3	Single-phase or three-phase power connections	3-14
3.4.4	Input power conditioning	3-15
3.4.5	Power disconnect and protection devices	3-16
3.4.6	Recommended fuses, circuit breakers and wire sizes	3-17
3.4.7	Drive overload protection	3-17
3.4.8	Power supply filters	3-18
3.4.9	24 V control circuit supply	3-19
3.5	Motor connections	3-20
3.5.1	Motor circuit contactors	3-21
3.5.2	Sinusoidal filter	3-21
3.5.3	Thermal switch connection	3-22
3.5.4	Motor brake connection	3-23

3.6	Brake (regeneration) resistor	3-24
3.6.1	Braking capacity	3-24
3.7	Brake resistor selection	3-25
3.7.1	Required information	3-25
3.7.2	Braking energy	3-26
3.7.3	Braking power and average power	3-26
3.7.4	Resistor choice	3-27
3.7.5	Resistor derating	3-28
3.7.6	Resistor pulse load rating	3-29
3.7.7	Duty cycle	3-30
4	Feedback	
4.1	Introduction	4-1
4.1.1	Incremental encoder feedback	4-2
4.1.2	BiSS interface	4-6
4.1.3	SSI feedback	4-7
4.1.4	EnDat (absolute encoder) feedback	4-8
4.1.5	Smart Abs interface	4-9
4.1.6	SinCos feedback	4-10
5	Input / Output	
5.1	Introduction	5-1
5.2	Digital I/O	5-2
5.2.1	Drive enable input	5-3
5.2.2	General purpose digital input DIN0	5-5
5.2.3	General purpose digital inputs DIN1 & DIN2	5-7
5.2.4	Special functions on inputs DIN1 & DIN2	5-8
5.2.5	General purpose / status output DOUT0	5-11
5.2.6	General purpose output DOUT1	5-13
5.3	USB communication	5-15
5.3.1	USB port	5-15
5.4	RS485 communication	5-15
5.4.1	RS485 port (2-wire)	5-15
5.5	Ethernet interface	5-17
5.5.1	TCP/IP	5-17
5.5.2	Ethernet POWERLINK	5-19
5.5.3	Ethernet connectors	5-20
5.6	CAN interface	5-21
5.6.1	CAN connector	5-21
5.6.2	CAN wiring	5-21
5.6.3	CANopen	5-23
5.7	Other I/O	5-25
5.7.1	Node ID selector switches	5-25
5.8	Connection summary - recommended system wiring	5-28

6	Configuration	
6.1	Introduction	6-1
6.1.1	Connecting the MicroFlex e100 to the PC	6-1
6.1.2	Installing Mint WorkBench	6-1
6.2	Starting the MicroFlex e100	6-2
6.2.1	Preliminary checks	6-2
6.2.2	Power on checks	6-2
6.2.3	Installing the USB driver	6-3
6.2.4	Configuring the TCP/IP connection (optional)	6-4
6.3	Mint Machine Center	6-5
6.3.1	Starting MMC	6-7
6.4	Mint WorkBench	6-8
6.4.1	Help file	6-9
6.4.2	Starting Mint WorkBench	6-10
6.4.3	Commissioning Wizard	6-12
6.4.4	Further tuning - no load attached	6-15
6.4.5	Further tuning - with load attached	6-17
6.4.6	Optimizing the velocity response	6-18
6.4.7	Performing test moves - continuous jog	6-21
6.4.8	Performing test moves - relative positional move	6-22
6.5	Further configuration	6-23
6.5.1	Fine-tuning tool	6-23
6.5.2	Parameters tool	6-25
6.5.3	Spy window	6-26
6.5.4	Other tools and windows	6-27
7	Troubleshooting	
7.1	Introduction	7-1
7.1.1	Problem diagnosis	7-1
7.1.2	SupportMe feature	7-1
7.1.3	Power-cycling the MicroFlex e100	7-1
7.2	MicroFlex e100 indicators	7-2
7.2.1	STATUS LED	7-2
7.2.2	CAN LEDs	7-3
7.2.3	ETHERNET LEDs	7-4
7.2.4	Communication	7-5
7.2.5	Power on	7-5
7.2.6	Mint WorkBench	7-5
7.2.7	Tuning	7-6
7.2.8	Ethernet	7-6
7.2.9	CANopen	7-7
8	Specifications	
8.1	Introduction	8-1
8.1.1	AC input power and DC bus voltage (X1)	8-1

8.1.2	24 V control circuit supply input (X2)	8-3
8.1.3	Motor output power (X1)	8-3
8.1.4	Braking (X1)	8-4
8.1.5	Digital inputs - drive enable and DIN0 general purpose (X3)	8-4
8.1.6	Digital inputs DIN1, DIN2 - high speed general purpose (X3)	8-5
8.1.7	Digital outputs DOUT0, DOUT1 - status and general purpose (X3)	8-5
8.1.8	Incremental encoder feedback option (X8)	8-5
8.1.9	BiSS interface (X8)	8-6
8.1.10	SSI encoder feedback option (X8)	8-6
8.1.11	Smart Abs interface (X8)	8-6
8.1.12	SinCos / EnDat encoder feedback option (X8)	8-7
8.1.13	Ethernet interface (E1 / E2)	8-7
8.1.14	CAN interface (OPT 1)	8-7
8.1.15	RS485 interface	8-7
8.1.16	Environmental	8-8
8.1.17	Weights and dimensions	8-8

Appendices

A Accessories

A.1	Introduction	A-1
A.1.1	Fan tray	A-2
A.1.2	Footprint filter (single-phase only)	A-3
A.1.3	24 V power supplies	A-3
A.1.4	EMC filters	A-4
A.1.5	Brake resistors	A-7
A.2	Cables	A-8
A.2.1	Motor power cables	A-8
A.2.2	Feedback cable part numbers	A-9
A.2.3	Ethernet cables	A-9

B Control System

B.1	Introduction	B-1
B.1.1	Servo configuration	B-2
B.1.2	Torque servo configuration	B-4

C Mint Keyword Summary

C.1	Introduction	C-1
C.1.1	Keyword listing	C-1

D CE, UL and environmental

D.1	Outline	D-1
D.1.1	CE marking	D-1

D.1.2	Compliance with the EMC Directive	D-1
D.1.3	Compliance with the Low Voltage Directive	D-2
D.1.4	Use of CE compliant components	D-2
D.1.5	EMC wiring technique	D-2
D.1.6	EMC installation suggestions	D-3
D.1.7	Wiring of shielded (screened) cables	D-4
D.2	C-tick marking	D-4
D.2.1	RCM marking	D-4
D.3	RoHS compliance	D-4
D.3.1	China RoHS compliance	D-5
D.3.2	WEEE notice	D-5
D.4	UL file numbers	D-6

LT0262A07EN Copyright ABB Oy (c) 2017. All rights reserved.

This manual is copyrighted and all rights are reserved. This document or attached software may not, in whole or in part, be copied or reproduced in any form without the prior written consent of ABB. ABB makes no representations or warranties with respect to the contents hereof and specifically disclaims any implied warranties of fitness for any particular purpose. The information in this document is subject to change without notice. ABB assumes no responsibility for any errors that may appear in this document.

Mint™ and MicroFlex™ are registered trademarks of Baldor, a member of the ABB group. Windows XP, Windows Vista and Windows 7 are registered trademarks of the Microsoft Corporation. UL and cUL are registered trademarks of Underwriters Laboratories.

MicroFlex e100 is UL listed; file NMMS.E470302.

ABB Motion Ltd
6 Hawkley Drive
Bristol, BS32 0BF
United Kingdom

Telephone: +44 (0) 1454 850000
Fax: +44 (0) 1454 859001
E-mail: motionsupport.uk@gb.abb.com
Web site: www.abbmotion.com

See rear cover for other international offices.

Product notice

Only qualified personnel should attempt the start-up procedure or troubleshoot this equipment. This equipment may be connected to other machines that have rotating parts or parts that are controlled by this equipment. Improper use can cause serious or fatal injury.

Safety Notice

Intended use: These drives are intended for use in stationary ground based applications in industrial power installations according to the standards EN60204 and VDE0160. They are designed for machine applications that require variable speed controlled three-phase brushless AC motors. These drives are not intended for use in applications such as:

- Home appliances
- Medical instrumentation
- Mobile vehicles
- Ships
- Airplanes.

Unless otherwise specified, this drive is intended for installation in a suitable enclosure. The enclosure must protect the drive from exposure to excessive or corrosive moisture, dust and dirt or abnormal ambient temperatures. The exact operating specifications are found in section 8 of this manual. The installation, connection and control of drives is a skilled operation, disassembly or repair must not be attempted. In the event that a drive fails to operate correctly, contact the place of purchase for return instructions.

Precautions



WARNING

Do not touch any circuit board, power device or electrical connection before you first ensure that no high voltage is present at this equipment or other equipment to which it is connected. Electrical shock can cause serious or fatal injury. Only qualified personnel should attempt to start-up, program or troubleshoot this equipment.



WARNING

The motor circuit might have high voltages present whenever AC power is applied, even when the motor is not moving. Electrical shock can cause serious or fatal injury.



WARNING

If a motor is driven mechanically, it might generate hazardous voltages that are conducted to its power terminals. The enclosure must be earthed/grounded to prevent possible shock hazard.



WARNING

Be sure the system is properly earthed/grounded before applying power. Do not apply AC power before you ensure that earths/grounds are connected. Electrical shock can cause serious or fatal injury.



WARNING

Be sure that you are completely familiar with the safe operation and programming of this equipment. This equipment may be connected to other machines that have rotating parts or parts that are controlled by this equipment. Improper use can cause serious or fatal injury.



WARNING

MEDICAL DEVICE / PACEMAKER DANGER: Magnetic and electromagnetic fields in the vicinity of current carrying conductors and industrial motors can result in a serious health hazard to persons with cardiac pacemakers, internal cardiac defibrillators, neurostimulators, metal implants, cochlear implants, hearing aids, and other medical devices. To avoid risk, stay away from the area surrounding a motor and its current carrying conductors.



Be sure all wiring complies with the National Electrical Code and all regional and local codes. Improper wiring may result in unsafe conditions.



The stop input to this equipment should not be used as the single means of achieving a safety critical stop. Drive disable, motor disconnect, motor brake and other means should be used as appropriate.



Improper operation or programming of the drive may cause violent motion of the motor and driven equipment. Be certain that unexpected motor movement will not cause injury to personnel or damage to equipment. Peak torque of several times the rated motor torque can occur during control failure.



If the drive enable signal is already present when power is applied to the MicroFlex e100, the motor could begin to move immediately.



The metal heatsink on the left side of the MicroFlex e100 can become very hot during normal operation.



When operating a rotary motor with no load coupled to its shaft, remove the shaft key to prevent it flying out when the shaft rotates.



A brake resistor may generate enough heat to ignite combustible materials. To avoid fire hazard, keep all combustible materials and flammable vapors away from the brake resistors. Some brake resistors are neither internally fused nor thermally protected and under extreme conditions, can cause a fire hazard if not suitably protected or rated for the application.



To prevent equipment damage, be certain that the input power has correctly sized protective devices installed.



To ensure reliable performance of this equipment be certain that all signals to/from the drive are shielded correctly.



Suitable for use on a circuit capable of delivering not more than the RMS symmetrical short circuit amperes listed here, at the rated maximum voltage:

<u>Horsepower</u>	<u>RMS Symmetrical Amperes</u>
1-50	5,000



Avoid locating the drive immediately above or beside heat generating equipment, or directly below water or steam pipes.



Avoid locating the drive in the vicinity of corrosive substances or vapors, metal particles and dust.



Do not connect AC power to the drive terminals U, V and W. Connecting AC power to these terminals may result in damage to the drive.



ABB does not recommend using “Grounded Leg Delta” transformer power leads that may create earth/ground loops and degrade system performance. Instead, we recommend using a four wire Wye.



Drives are intended to be connected to a permanent main power source, not a portable power source. Suitable fusing and circuit protection devices are required.



The safe integration of the drive into a machine system is the responsibility of the machine designer. Be sure to comply with the local safety requirements at the place where the machine is to be used. In Europe these are the Machinery Directive, the ElectroMagnetic Compatibility Directive and the Low Voltage Directive. In the United States this is the National Electrical code and local codes.



Drives must be installed inside an electrical cabinet that provides environmental control and protection. Installation information for the drive is provided in this manual. Motors and controlling devices that connect to the drive should have specifications compatible to the drive.



Failure to meet cooling air flow requirements will result in reduced product lifetime and/or drive overtemperature trips.



Violent jamming (stopping) of the motor during operation may damage the motor and drive.



Operating the MicroFlex e100 in Torque mode with no load attached to the motor can cause the motor to accelerate rapidly to excessive speed.



Do not tin (solder) exposed wires. Solder contracts over time and may cause loose connections. Use crimp connections where possible.



Electrical components can be damaged by static electricity. Use ESD (electrostatic discharge) procedures when handling this drive.



If the drive is subjected to high potential ('hipot') testing, only DC voltages may be applied. AC voltage hipot tests could damage the drive. For further information please contact your local ABB representative.



Ensure that encoder wires are properly connected. Incorrect installation may result in improper movement.



The threaded holes in the top and bottom of the case are for cable clamps. The holes are 11.5 mm deep and accept M4 screws, which must be screwed in to a depth of at least 8 mm.



Removing the cover will invalidate UL certification.



Motor overtemperature sensing is required to satisfy UL 508C. The drive has no provisions for motor overtemperature protection, so external provisions are required.

2.1 MicroFlex e100 features

The MicroFlex e100 is a versatile brushless servo drive, providing a flexible and powerful motion control solution for rotary and linear motors. Standard features include:



- Single axis AC brushless drive.
- Range of models with continuous current ratings of 3 A, 6 A or 9 A.
- Direct connection to 115 V AC or 230 V AC single-phase or 230 V AC three-phase supplies.
- Universal feedback interface supporting incremental encoder, BiSS, SSI, EnDat, Smart Abs or SinCos feedback.
- Position, velocity and current control.
- Auto-tuning wizard (including position loop) and software oscilloscope facilities provided by Mint WorkBench configuration software.
- 3 optically isolated general purpose digital inputs. Two inputs have 'fast input' capability, providing real-time position capture.
- 1 optically isolated drive enable input.
- 1 optically isolated general purpose digital output.
- 1 optically isolated digital output to indicate error conditions.
- USB 1.1 serial port (compatible with USB 2.0 and USB 3.0).
- CANopen protocol for communication with Mint controllers and other third party CANopen devices.
- Ethernet POWERLINK & TCP/IP support: Twin Ethernet ports with integrated hub for communication with host PC or other Ethernet POWERLINK devices.
- Programmable in Mint.

MicroFlex e100 will operate with a large range of brushless rotary and linear servo motors. It can also operate induction motors using closed-loop vector control. For information on selecting Baldor servo motors, please see the sales brochure BR1202 available from your local ABB representative.

This manual is intended to guide you through the installation of MicroFlex e100. The sections should be read in sequence.

The *Basic Installation* section describes the mechanical installation of the MicroFlex e100, the power supply connections and motor connections. The other sections require knowledge of the low level input/output requirements of the installation and an understanding of computer software installation. If you are not qualified in these areas you should seek assistance before proceeding.

2.2 Receiving and inspection

When you receive your MicroFlex e100, there are several things you should do immediately:

1. Check the condition of the shipping container and report any damage immediately to the carrier that delivered your MicroFlex e100.
2. Remove the MicroFlex e100 from the shipping container and remove all packing material. The container and packing materials may be retained for future shipment.
3. Verify that the catalog number of the MicroFlex e100 you received is the same as the catalog number listed on your purchase order. The catalog number is described in the next section.
4. Inspect the MicroFlex e100 for external damage during shipment and report any damage to the carrier that delivered your MicroFlex e100.
5. If MicroFlex e100 is to be stored for several weeks before use, be sure that it is stored in a location that conforms to the storage humidity and temperature specifications shown in section 8.1.16.

2.2.1 Identifying the catalog number

The MicroFlex e100 is available with different current ratings. The catalog number is marked on the side of the unit. It is a good idea to look for the catalog number (sometimes shown as ID/No:) and write it in the space provided here:

Catalog number: **MFE**_____

Installed at: _____

Date: _____

A description of a catalog number is shown here, using the example **MFE230A003x**:

	Meaning	Alternatives
MFE	MicroFlex e100 family	-
230	Requires an AC supply voltage of 115-230 Volts, 1Φ or 3Φ	-
A003	Continuous current rating of 3 A	A006 =6 A; A009 =9 A
x	A letter indicating the hardware revision. This does not affect the capabilities of the MicroFlex e100 unless otherwise stated.	-

2.2.1.1 Serial number

The first digit of the serial number refers to the manufacturing plant. The next four digits refer to the unit's manufacturing year and week, respectively. The remaining digits complete the serial number so that there are no two units with the same number.

2.3 Units and abbreviations

The following units and abbreviations may appear in this manual:

V Volt (also V AC and V DC)

W Watt

A Ampere

Ω Ohm

μ F microfarad

pF picofarad

mH millihenry

Φ phase

ms millisecond

μ s microsecond

ns nanosecond

mm millimeter

m meter

in inch

ft feet

lbf-in pound force inch (torque)

N·m Newton meter (torque)

ADC Analog to Digital Converter

ASCII American Standard Code for Information Interchange

AWG American Wire Gauge

CAL CAN Application Layer

CAN Controller Area Network

CDROM Compact Disc Read Only Memory

CiA CAN in Automation International Users and Manufacturers Group e.V.

CTRL+E on the PC keyboard, press **Ctrl** then **E** at the same time.

DAC Digital to Analog Converter

DS301 CiA CANopen Application Layer and Communication Profile

DS401 CiA Device Profile for Generic I/O Devices

DS402 CiA Device Profile for Drives and Motion Control

DS403 CiA Device Profile for HMIs

EDS Electronic Data Sheet

EMC Electromagnetic Compatibility

EPL Ethernet POWERLINK

HMI Human Machine Interface

ISO International Standards Organization

Kbaud kilobaud (the same as Kbit/s in most applications)

LCD Liquid Crystal Display

Mbps megabits/s

MB megabytes

MMC Mint Machine Center

(NC) Not Connected

RF Radio Frequency

SSI Synchronous Serial Interface

TCP/IP Transmission Control Protocol / Internet Protocol

UDP User Datagram Protocol

3.1 Introduction

You should read all the sections in *Basic Installation* to ensure safe installation.

This section describes the mechanical and electrical installation of the MicroFlex e100 in the following stages:

- Location considerations
- Mounting the MicroFlex e100
- Connecting the AC power supply
- Connecting the 24 V DC control circuit supply
- Connecting the motor
- Installing a brake resistor
- Connecting the feedback device

These stages should be read and followed in sequence.

3.1.1 Power sources

A 115 - 230 V AC power source (IEC1010 over-voltage category III or less) in the installation area is required. This may be single-phase or three-phase. An AC power filter is required to comply with the CE directive for which the MicroFlex e100 was tested (see section 3.4.8).

The 24 V DC control circuit supply must be a regulated power supply with a continuous current supply capability of 1 A (4 A power on surge).

3.1.2 Hardware requirements

The components you will need to complete the basic installation are:

- 24 V DC power supply.
- AC power supply filter (for CE compliance).
- The motor that will be connected to the MicroFlex e100.
- A motor power cable.
- An incremental encoder feedback cable, SSI cable, or BiSS / EnDat / SinCos cable. A separate Hall cable might also be required for linear motors.
- A USB cable.
- (Optional) A brake resistor might be required, depending on the application. Without the brake resistor, the drive may produce an overvoltage fault. All MicroFlex e100 models have overvoltage sensing circuitry. Brake resistors may be purchased separately - see Appendix A.
- A cooling fan may be required to allow operation of the MicroFlex e100 at full rated current (see section 3.2.2).

- A PC that fulfills the following specification:

	Minimum specification
Processor	1 GHz
RAM	512 MB
Hard disk space	2 GB
CD-ROM	A CD-ROM drive
Serial port	USB port or Ethernet* port
Screen	1024 x 768, 16-bit color
Mouse	A mouse or similar pointing device
Operating system	Windows XP or newer, 32-bit or 64-bit

* The Ethernet configuration used by a normal office PC is not suitable for direct communication with the MicroFlex e100. It is recommended to install a separate dedicated Ethernet adapter in the PC, which can be configured for use with the MicroFlex e100. See section 6.2.4.

3.1.3 Tools and miscellaneous hardware

- Your PC operating system user manual might be useful if you are not familiar with Windows.
- Small screwdriver(s) with a blade width of 3 mm or less for connector X1, and 2.5 mm (1/10 in) or less for connector X3.
- M5 screws or bolts for mounting the MicroFlex e100.

3.1.4 Other information needed for installation

This information is useful (but not essential) to complete the installation:

- The data sheet or manual provided with your motor, describing the wiring information of the motor cables/connectors.
- Knowledge of whether the digital input signals will be 'Active Low' or 'Active High'.

3.2 Mechanical installation and cooling requirements

It is essential that you read and understand this section before beginning the installation.



NOTICE

To prevent equipment damage, be certain that the input power has correctly rated protective devices installed.



NOTICE

To prevent equipment damage, be certain that input and output signals are powered and referenced correctly.



NOTICE

To ensure reliable performance of this equipment be certain that all signals to/ from the MicroFlex e100 are shielded correctly.



NOTICE

Avoid locating the MicroFlex e100 immediately above or beside heat generating equipment, or directly below water steam pipes.



NOTICE

Avoid locating the MicroFlex e100 in the vicinity of corrosive substances or vapors, metal particles and dust.



NOTICE

Failure to meet cooling air flow requirements will result in reduced product lifetime and/or drive overtemperature trips.

The safe operation of this equipment depends upon its use in the appropriate environment. The following points must be considered:

- The MicroFlex e100 must be installed indoors, permanently fixed and located so that it can only be accessed by service personnel using tools.
- The maximum suggested operating altitude is 1000 m (3300 ft).
- The MicroFlex e100 must be installed where the pollution degree according to IEC 60664-1 shall not exceed 2.
- The 24 V DC control circuit supply must be installed so that the 24 V DC supplied to the unit is isolated from the AC supply using double or reinforced insulation.
- The input of the control circuit must be limited to Safety Extra Low Voltage circuits.
- Both the AC supply and the 24 V DC supply must be fused.
- The atmosphere must not contain flammable gases or vapors.
- There must not be abnormal levels of nuclear radiation or X-rays.
- To comply with CE directive 89/336/EEC an appropriate AC filter must be installed.
- The MicroFlex e100 must be secured by the slots in the flange. The protective earth/ground (the threaded hole on the top of the MicroFlex e100) must be bonded to a safety earth/ground using either a 25 A conductor or a conductor of three times the peak current rating - whichever is the greater.
- The threaded holes in the top and bottom of the case are for cable clamps. The holes are threaded for M4 bolts no longer than 11 mm (0.43 in) in length.
- The D-type connectors on the front panel of the MicroFlex e100 are secured using two hexagonal jack screws (sometimes known as "screwlocks"). If a jack screw is removed accidentally or lost it must be replaced with a #4-40 UNC jack screw with an external male threaded section no longer than 10 mm (0.4 in).

3.2.1 Dimensions

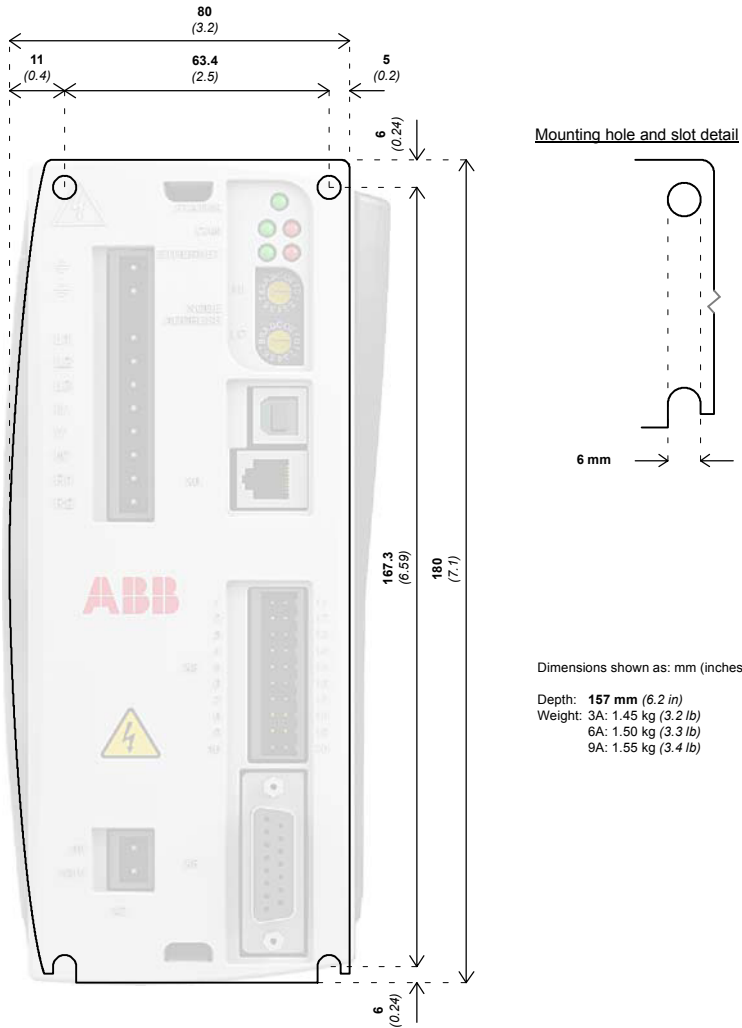

Figure 1: Mounting and overall dimensions

3.2.2 Mounting and cooling the MicroFlex e100

Ensure you have read and understood the *Mechanical installation and location requirements* in section 3.2. Mount the MicroFlex e100 vertically on its rear side, the side opposite the front panel. M5 bolts or screws should be used to mount the MicroFlex e100. Detailed dimensions are shown in section 3.2.1.

For effective cooling, the MicroFlex e100 must be mounted upright on a smooth vertical metal surface. The MicroFlex e100 is designed to operate in an ambient temperature of 0 °C to 45 °C (32 °F to 113 °F). Output current must be derated between 45 °C (113 °F) and the absolute maximum ambient temperature of 55 °C (131 °F). Within the ambient temperature range:

The 3 A model is designed to operate without any additional cooling methods.

The 6 A and 9 A models require a forced air flow, passing vertically from the bottom to the top of the MicroFlex e100 case, to allow full rated current at 45 °C (113 °F).

Temperature derating characteristics are shown in sections 3.2.3 to 3.2.5.

Note: Failure to meet cooling air flow requirements will result in reduced product lifetime and/or drive overtemperature trips. It is recommended to check periodically the operation of the cooling equipment. Optional fan tray FAN001-024, mounted exactly as shown in section A.1.1., ensures that correct cooling is provided and allows the MicroFlex e100 to be UL listed.

3.2.2.1 Effects of mounting surface and proximity

The proximity of the MicroFlex e100 to other components could affect cooling efficiency. If the MicroFlex e100 is mounted beside another MicroFlex e100 (or other obstruction), there should be a minimum space of 15 mm to maintain effective cooling.

If the MicroFlex e100 is mounted above or below another MicroFlex e100 (or other obstruction), there should be a minimum space of 90 mm to maintain effective cooling. Remember that when a MicroFlex e100 is mounted above another MicroFlex e100 or heat source, it will be receiving air that has been already heated by the device(s) below it. Multiple MicroFlex e100 units mounted above each other should be aligned, not offset, to promote air flow across the heatsinks.

The derating characteristics assume the MicroFlex e100 is mounted on 3 mm thick (or less) metal plate. If the MicroFlex e100 is mounted on 10 mm plate then the current characteristics shown in sections 3.2.3 to 3.2.5 may be increased by up to 7% if there is no forced air cooling, or 15% if forced air cooling is present.

It is recommended to allow approximately 60 mm at the front to accommodate wiring and connectors.

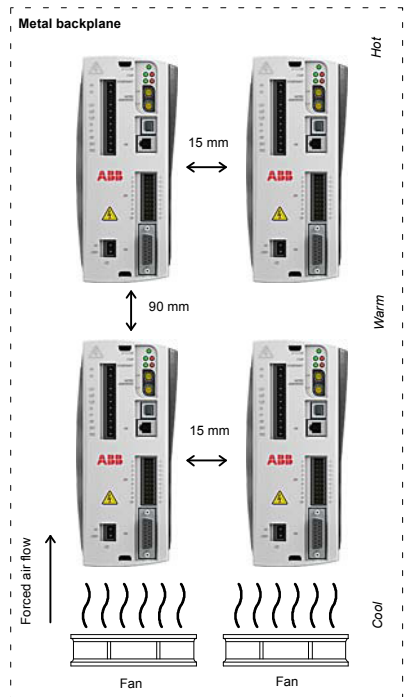
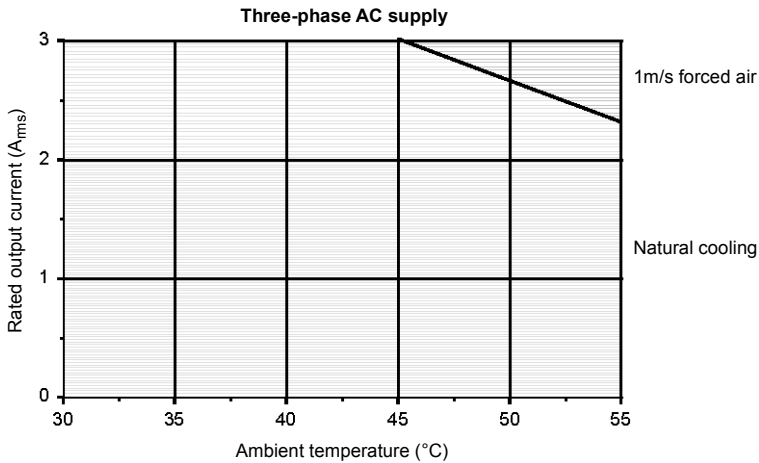
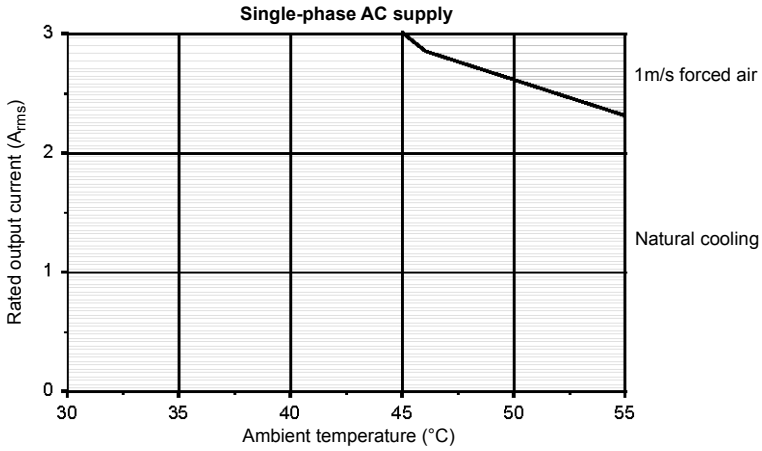

Figure 2: Cooling and proximity

3.2.3 Derating characteristic - 3 A model

The following derating characteristics are for model MFE230A003.



Notes:

Load power factor = 0.75

Overload limit for model MFE230A003 is 6 A

3.2.4 Derating characteristic - 6 A model

The following derating characteristics are for model MFE230A006.

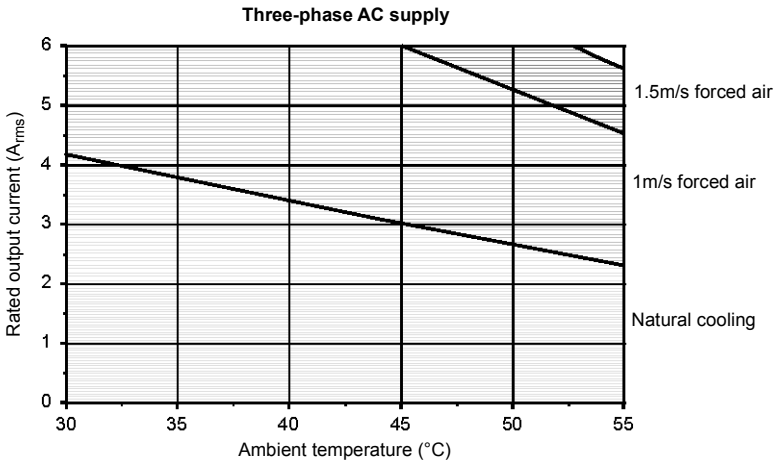
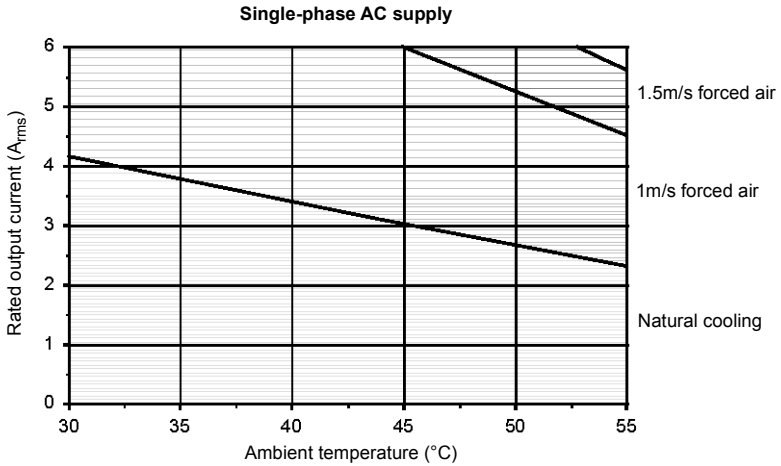

Notes:

Load power factor = 0.75

Overload limit for model MFE230A006 is 12 A

3.2.5 Derating characteristic - 9 A model

The following derating characteristics are for model MFE230A009.

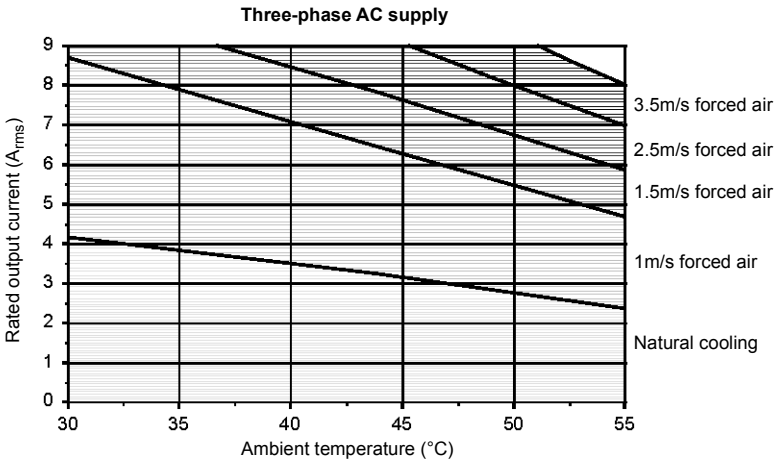
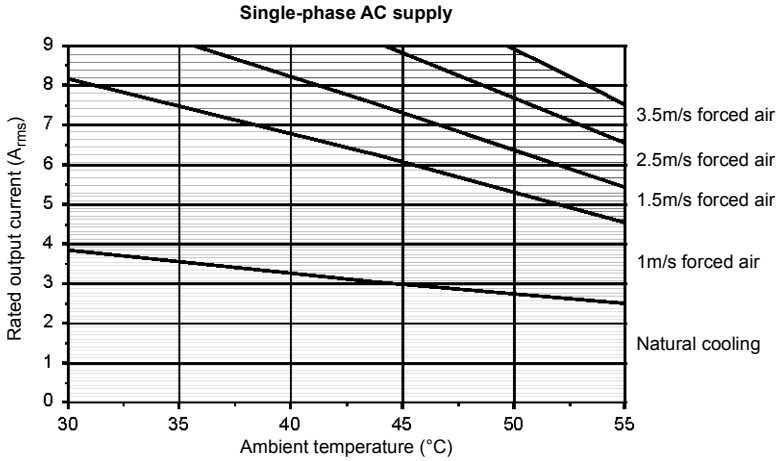

Notes:
 Load power factor = 0.78
 Overload limit for model MFE230A009 is 18 A

3.2.6 Overtemperature trips

The MicroFlex e100 contains internal temperature sensors that will cause it to trip and disable if the temperature exceeds 80 °C on the 3 A model, or 75 °C on the 6 A and 9 A models. This limit can be read using the `TEMPERATURELIMITFATAL` keyword - see the Mint help file for details.

3.2.7 Heat dissipation

The MicroFlex e100 emits heat during normal operation. The installation cabinet must provide sufficient ventilation to maintain the air temperature within the operating limits of all components in the cabinet. The power dissipation of the MicroFlex e100 can be calculated from the following formulae:

$$P_{out} = \sqrt{3} \times V_{out} \times I_{out} \times 0.85$$

where the DC bus voltage $V_{out} = 305$ V DC with a single phase AC supply or 321 V DC with a three phase AC supply. I_{out} is the nominal output phase current (see section 8.1.3) and 0.85 is a typical power factor.

$$P_{in} = P_{out} \times 0.95$$

where 0.95 is the typical drive efficiency.

$$P_{diss} = P_{in} - P_{out}$$

These formulae provide the figures shown in Table 1:

MicroFlex e100 catalog number	Heat dissipation (P_{diss})	
	AC input: 1 Φ	
	W	BTU / hr
MFE230A003	50	172
MFE230A006	101	343
MFE230A009	151	515

Table 1: Typical heat dissipation at rated output current

3.3 Connector locations

3.3.1 Front panel connectors

X1 Power

- Earth/Ground
- Earth/Ground (NC)
- L1 AC Phase 1 / L
- L2 AC Phase 2 / N
- L3 ACPhase 3
- U Motor U
- V Motor V
- W Motor W
- R1 Brake resistor
- R2 Brake resistor

LEDs



The STATUS, CAN and ETHERNET LEDs are described in section 7.2.1.

Node ID



These switches set the MicroFlex e100's node ID for Ethernet POWERLINK, and the final value of the IP address when using TCP/IP. See sections 5.7.1 and 6.2.4.

USB

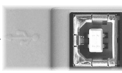

- 1 (NC)
- 2 Data-
- 3 Data+
- 4 GND

X6 RS485 port (2-wire)



- 1 TXA
- 2 TXB
- 3 GND
- 4 +7V out
- 5 (NC)
- 6 (NC)

X3 Input/Output



- | | |
|-----------------|------------------|
| 1 Status- | 11 Status+ |
| 2 DGND | 12 DGND |
| 3 DOUT1- | 13 DOUT1+ |
| 4 DIN2- | 14 DIN2+ |
| 5 DGND | 15 DGND |
| 6 DIN1- | 16 DIN1+ |
| 7 DIN0- | 17 DIN0+ |
| 8 DGND | 18 DGND |
| 9 Drive enable- | 19 Drive enable+ |
| 10 Shield | 20 Shield |

X8 Feedback In

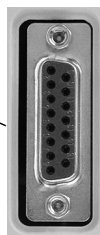

Pin	Incremental	SinCos	BiSS / SSI	EnDat
1	CHA+	(NC)	Data+	Data+
2	CHB+	(NC)	Clock+	Clock+
3	CHZ+	(NC)	(NC)	(NC)
4	Sense	Sense	Sense	Sense
5	Hall U-	Sin-	(NC)	Sin-
6	Hall U+	Sin+	(NC)	Sin+
7	Hall V-	Cos-	(NC)	Cos-
8	Hall V+	Cos+	(NC)	Cos+
9	CHA-	(NC)	Data-	Data-
10	CHB-	(NC)	Clock-	Clock-
11	CHZ-	(NC)	(NC)	(NC)
12	+5V out	+5V out	+5V out	+5V out
13	DGND	DGND	DGND	DGND
14	Hall W-	(NC)	(NC)	(NC)
15	Hall W+	(NC)	(NC)	(NC)
Shell	Shield	Shield	Shield	Shield

* EnDat v2.1 only. EnDat v2.2 does not use the Sin and Cos signals



X2 Control circuit power

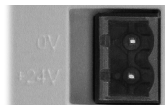

- 0 V
- +24 V

(NC) = Not Connected. Do not make a connection to this pin

Tightening torque for terminal block connections (X1 & X2) is 0.5-0.6 N·m (4.4-5.3 lb-in). Maximum wire sizes: X1: 2.5 mm²; X3: 0.5 mm². Connector X3 is designed to accept bare wires only; do not use bootlace ferrules.

3.3.2 Top panel connectors



OPT 1 CAN



- 1 (NC)
- 2 CAN-
- 3 CAN GND
- 4 (NC)
- 5 Shield
- 6 CAN GND
- 7 CAN+
- 8 (NC)
- 9 CAN V+



Ethernet

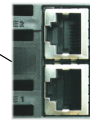

- 1 TX+
- 2 TX-
- 3 RX+
- 4 (NC)
- 5 (NC)
- 6 RX-
- 7 (NC)
- 8 (NC)

Both connectors have identical pinouts.

3.4 Power connections

This section provides instructions for connecting the AC power supply.

The installer of this equipment is responsible for complying with NEC (National Electric Code) guidelines or CE (Conformite Europeene) directives and application codes that govern wiring protection, earthing/grounding, disconnects and other current protection.



Electrical shock can cause serious or fatal injury. Do not touch any power device or electrical connection before you first ensure that power has been disconnected and there is no high voltage present from this equipment or other equipment to which it is connected.

MicroFlex e100 drives are designed to be powered from standard single and three-phase lines that are electrically symmetrical with respect to earth/ground. The power supply module within all MicroFlex e100 models provides rectification, smoothing and current surge protection. Fuses or circuit breakers are required in the input lines for cable protection.

Note: A Residual Current Device (RCD) must not be used for fusing the drive. An appropriate type of circuit breaker or fuse must be used.

All interconnection wires should be in metal conduits between the MicroFlex e100, AC power source, motor, host controller and any operator interface stations. Use UL listed closed loop connectors that are of appropriate size for the wire gauge being used. Connectors are to be installed using only the crimp tool specified by the manufacturer of the connector.

3.4.1 Earthing / grounding

A permanent earth/ground bonding point is provided on the heatsink, which must be used as the protective earth. It is labeled with the protective earth symbol in the casting and does not form any other mechanical function.

Connector X1 contains earth terminals, but these must not be used as protective earth since the connector does not guarantee earth connection first, disconnection last. Earthing methods are shown in section 3.4.3.

Note: When using unearthed/ungrounded distribution systems, an isolation transformer with an earthed/grounded secondary is recommended. This provides three-phase AC power that is symmetrical with respect to earth/ground and can prevent equipment damage.

3.4.2 Earth leakage

Maximum earth leakage from the MicroFlex e100 is 3.4 mA per phase (230 V, 50 Hz supply). This value does not include the earth leakage from the AC power filter, which could be much larger (see section A.1.4).

If the MicroFlex e100 and filter are mounted in a cabinet, the minimum size of the protective earthing conductor shall comply with the local safety regulations for high protective earthing conductor current equipment. The conductor must be 10 mm² (copper), 16 mm² (aluminium), or larger to satisfy EN61800-5-1.

3.4.2.1 Protection class

User protection has been achieved using Protective Class I (EN61800-5-1, 3.2.20), which requires an earth connection to the unit whenever hazardous voltages are applied. The equipment provides protection against electric shock by:

- Means of connection of protective earth to accessible live conductive parts.
- Basic insulation.

3.4.3 Single-phase or three-phase power connections

Location	Connector X1 (Mating connector: Phoenix COMBICON MSTB 2,5HC/11-ST-5,08)
Nominal input voltage	115 V AC or 230 V AC, 1 Φ or 3 Φ line to line
Minimum input voltage	105 V AC, 1 Φ or 3 Φ line to line (see Note*)
Maximum input voltage	250 V AC, 1 Φ or 3 Φ line to line

Note: * The MicroFlex e100 will operate at lower input voltages, although performance could be impaired. The drive will trip if the DC-bus voltage falls below 50 V or 60% of the no-load voltage, whichever occurs first.

For three phase supplies, connect supply to L1, L2 and L3 as shown in Figure 3. For single phase supplies, connect the supply and neutral to any two line inputs, for example L1 and L2.

For CE compliance, an AC filter must be connected between the AC power supply and the MicroFlex e100. If local codes do not specify different regulations, use at least the same gauge wire for earth/ground as is used for L1, L2 and L3.

Tightening torque for terminal block connections is 0.5-0.6 N·m (4.4-5.3 lb-in). The threaded hole in the top and bottom of the case may be used as an additional functional earth/ground connection for signals on connector X3. They may also be used to attach shield or strain relief clamps. The holes are threaded for M4 bolts no longer than 11 mm (0.43 in) in length.

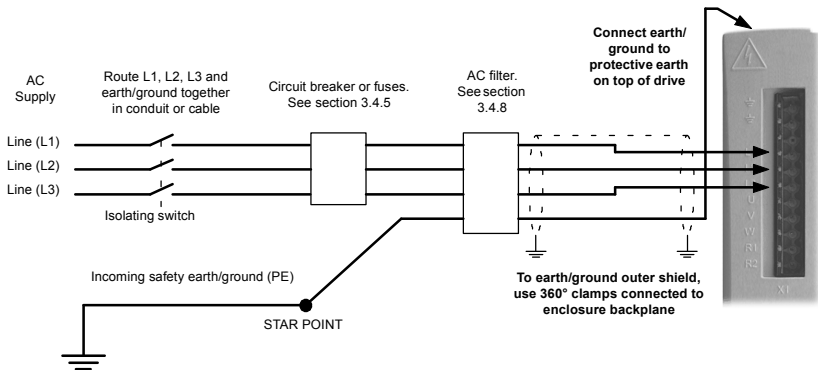

Figure 3: Single or three-phase power connections

3.4.4 Input power conditioning

Certain power line conditions must be avoided; an AC line reactor, an isolation transformer or a step up/step down transformer may be required for some power conditions:

- If the feeder or branch circuit that provides power to the MicroFlex e100 has permanently connected power factor correction capacitors, an input AC line reactor or an isolation transformer must be connected between the power factor correction capacitors and the MicroFlex e100 to limit the maximum symmetrical short circuit current to 5000 A.
- If the feeder or branch circuit that provides power to the MicroFlex e100 has power factor correction capacitors that are switched on line and off line, the capacitors must not be switched while the drive is connected to the AC power line. If the capacitors are switched on line while the drive is still connected to the AC power line, additional protection is required. A Transient Voltage Surge Suppressor (TVSS) of the proper rating must be installed between the AC line reactor (or isolation transformer) and the AC input to the MicroFlex e100.

3.4.4.1 Input power-cycling and inrush

If AC power has been removed from the MicroFlex e100, it should remain disconnected for the period specified in Table 2, before it is reapplied.

MicroFlex e100 current rating	Minimum power cycle delay period (seconds)
3 A	25
6 A	45
9 A	65

Table 2: Power cycle intervals

This delay allows the input surge protection circuit to perform correctly, ensuring that the inrush current (typically 1.7 A) is below the drive rated current. Power-cycling the drive more frequently could cause high inrush current and corresponding nuisance operation of circuit breakers or fuses. Repeated failure to observe the delay period could reduce the lifetime of the MicroFlex e100.

3.4.4.2 Discharge period



After AC power has been removed from the MicroFlex e100, high voltages (greater than 50 V DC) can remain on the brake resistor connections until the DC-bus circuitry has discharged. The high voltage can remain for the period specified in Table 3.

MicroFlex e100 current rating	Time for DC-bus to discharge to 50 V or less (maximum, seconds)
3 A	83
6 A	166
9 A	248

Table 3: DC-bus discharge periods

3.4.4.3 Supplying input power from a variac (variable transformer)

When AC power is supplied from a variac, the MicroFlex e100's pre-charge circuit may not operate correctly. To ensure that the pre-charge circuitry operates correctly, increase the variac voltage to the desired level and then power cycle the 24 V DC control circuit supply. This will restart the pre-charge circuit and allow it to operate correctly.

3.4.5 Power disconnect and protection devices

A power disconnect should be installed between the input power supply and the MicroFlex e100 for a fail-safe method to disconnect power. The MicroFlex e100 will remain in a powered condition until all input power is removed from the drive and the internal bus voltage has depleted.

The MicroFlex e100 must have a suitable input power protection device installed, preferably a fuse. Recommended circuit breakers are thermal magnetic devices (1 or 3 phase as required) with characteristics suitable for heavy inductive loads (C-type trip characteristic). Circuit breaker or fuses are not supplied - see section 3.4.6. For CE compliance, see Appendix D. UL compliance can only be achieved when using the recommended fuses. The use of circuit breakers does not guarantee UL compliance and provides protection for the wiring only, not the MicroFlex.

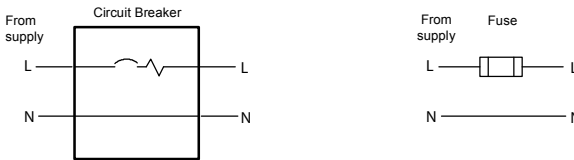

Figure 4: Circuit breaker and fuse, single-phase

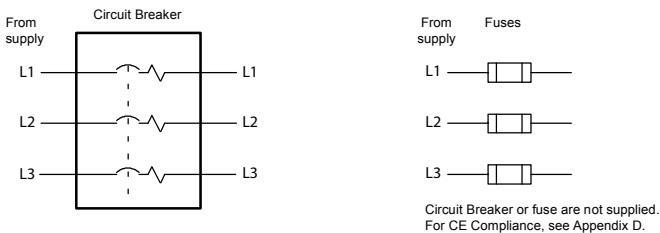

Figure 5: Circuit breaker and fuse, three-phase

Note: Metal conduit or shielded cable should be used. Connect conduits so the use of a line reactor or RC device does not interrupt EMI/RFI shielding.

3.4.5.1 Using 2 phases of a 3-phase supply

Power may be derived by connecting two phases of an appropriate three-phase supply (L1 and L2 for example). When supplying AC power in this way, the voltage between the two phases must not exceed the rated input voltage of the MicroFlex e100. A two pole breaker must be used to isolate both lines. Fuses must be fitted in both lines.

3.4.6 Recommended fuses, circuit breakers and wire sizes

Table 4 describes the recommended fuses, circuit breakers and suitable wires sizes to be used for power connections.

Catalog Number	Cont. Output Amps (RMS)	AC Supply Type	Input Fuse	Circuit breaker (C-type)	Minimum Wire Gauge	
					AWG	mm ²
MFE..A003	3 A	1Φ	Ferraz Shawmut: 6x32 FA series, 10 A (W084314P) or BS88 2.5 URGS 10 A (N076648)	10 A	14	2.0
		3Φ	Ferraz Shawmut: 6x32 FA series, 8 A (V084313P) or BS88 2.5 URGS, 7 A (M076647)	8 A	14	2.0
MFE..A006	6 A	1Φ	Ferraz Shawmut: 6x32 FA series, 20 A (A084318P) or BS88 2.5 URGS, 20 A (L097507)	20 A	14	2.0
		3Φ	Ferraz Shawmut: 6x32 FA series, 12.5 A (X084315P) or BS88 2.5 URGS, 12 A (P076649)	12.5 A	14	2.0
MFE..A009	9 A	1Φ	Ferraz Shawmut: BS88 2.5 URGS, 25 A (R076651)	25 A	14	2.5
		3Φ	Ferraz Shawmut: 6x32 FA series, 20 A (A084318P) or BS88 2.5 URGS, 20 A (L097507)	20 A	14	2.0

Table 4: Protection device and wire ratings

Note: All wire sizes are based on 75 °C (167 °F) copper wire. Higher temperature smaller gauge wire may be used per National Electric Code (NEC) and local codes. Recommended fuses are based on 25 °C (77 °F) ambient, maximum continuous control output current and no harmonic current. Earth/ground wires must be the same gauge, or larger, than the Line wires.

3.4.7 Drive overload protection

The MicroFlex e100 will immediately trip and disable if there is an overload condition. The parameters for managing drive overloads are configured automatically by the Commissioning Wizard (see section 6.4.3). If they need to be changed, use the Parameters tool in Mint WorkBench (see section 6.5.2).

3.4.8 Power supply filters

To comply with EEC directive 89/336/EEC, an AC power filter of the appropriate type must be connected. This can be supplied by ABB and will ensure that the MicroFlex e100 complies with the CE specifications for which it has been tested. Ideally, one filter should be provided for each MicroFlex e100; filters should not be shared between drives or other equipment. Table 5 lists the appropriate filters:

MicroFlex e100 current rating	Input voltages	
	230 V AC, 1Φ	230 V AC, 3Φ
3 A	FI0015A00 + line reactor (see sections 3.4.8.1 and 3.4.8.2) <i>or</i> FI0029A00 (see section A.1.2)	FI0018A00
6 A	FI0015A02 (see section 3.4.8.2) <i>or</i> FI0029A00 (see section A.1.2)	FI0018A00
9 A	FI0029A00 (see section A.1.2)	FI0018A03

Table 5: Filter part numbers

Maximum earth leakage from the MicroFlex e100 is 3.4 mA per phase (230 V, 50 Hz supply). This value does not include the earth leakage from the AC power filter, which could be much larger (see section A.1.4).

3.4.8.1 Harmonic suppression

When operating the 3 A MicroFlex e100 (part MFE230A003) on a single-phase AC supply, a 13 mH, 4 A_{rms} (10 A peak) line reactor is required to ensure compliance with EN61000-3-2:2000 class A limits, when the total equipment supply load is less than 1 kW.

3.4.8.2 Reversing the filter

When using filters FI0015A00 or FI0015A02 as specified in Table 5, they must be reversed to ensure that the MicroFlex e100 complies with the CE specifications for which it has been tested. The AC power supply should be connected to the filter terminals marked as the outputs, with the MicroFlex e100 connected to the filter terminals marked as the inputs.



This recommendation applies only to filters FI0015A00 and FI0015A02. Alternative filters or protection devices must be connected as specified by the manufacturer.

3.4.9 24 V control circuit supply

A 24 V DC supply must be provided to power the controlling electronics. This is useful for safety reasons where AC power needs to be removed from the power stage but the controlling electronics must remain powered to retain position and I/O information.

A separate fused 24 V supply should be provided for the MicroFlex e100. If other devices are likely to be powered from the same 24 V supply, a filter (part FI0014A00) should be installed to isolate the MicroFlex e100 from the rest of the system. Alternatively, a ferrite sleeve may be attached to the supply cable near connector X2.

Location	Connector X2
Nominal input voltage	24 V DC
Range	20-30 V DC
Input current	
Maximum	1 A continuous (4 A typical power on surge, limited by NTC)
Typical	0.5 A - 0.6 A (not powering feedback device) 0.6 A - 0.8 A (powering feedback device)

Tightening torque for terminal block connections is 0.5-0.6 N·m (4.4-5.3 lb-in).

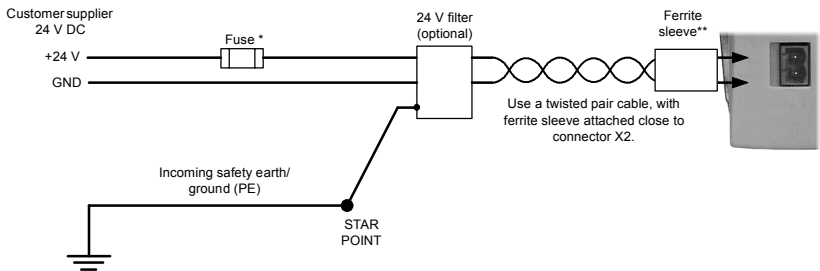

* Recommended fuse: Bussman S504 20 x 5 mm anti-surge 2 A

** Recommended ferrite sleeve: Fair-Rite part 0431164281 or similar

Figure 6: 24 V control circuit supply connections

3.5 Motor connections

MicroFlex e100 will operate with a large number of brushless servo motors. For information on selecting Baldor servo motors please see the sales brochure BR1202, available from your local ABB representative. The motor must be capable of being powered by an inverter PWM output - see section 8.1.3 for details. The motor can be connected directly to the MicroFlex e100 or through a motor contactor (M-Contactor). If the drive trips on a motor phase short circuit it will not restart unless AC power is removed. Remove all power from the drive, correct the short circuit and restart the drive. The motor outputs are conditionally short-circuit proof. Motors should ideally have a minimum inductance of 1 mH per winding; for motors with lower inductance an output reactor may be fitted in series with the motor. When using a Baldor motor, the parameters for managing motor overloads are configured automatically by the Commissioning Wizard (see section 6.4.3). If they need to be changed, or you are using an alternative motor, use the Parameters tool in Mint WorkBench (see section 6.5.2).

Location	Connector X1		
AC supply voltage	115 V AC, 1Φ	230 V AC, 1Φ	230 V AC, 3Φ
Output voltage range	0-115 V AC, 3Φ	0-230 V AC, 3Φ	0-230 V AC, 3Φ

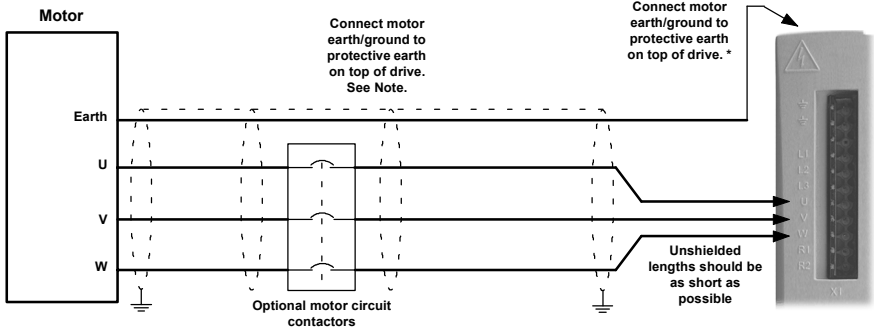

* The threaded holes in the top and bottom of the case are for M4 bolts no longer than 11 mm (0.43 in) in length.

Figure 7: Motor connections



Do not connect supply power to the MicroFlex e100 UVW outputs. The MicroFlex e100 might be damaged. The motor leads U, V and W must be connected to their corresponding U, V or W terminal on the motor. Misconnection will result in uncontrolled motor movement.

The motor power cable must be shielded for CE compliance. The connector or gland used at the motor must provide 360 degree shielding. The maximum recommended cable length is 30.5 m (100 ft).

Note: For CE compliance the motor earth/ground should be connected to the drive earth/ground.

3.5.1 Motor circuit contactors

If required by local codes or for safety reasons, an M-Contactor (motor circuit contactor) may be installed to provide a physical disconnection of the motor windings from the MicroFlex e100 (see section 3.5). Opening the M-Contactor ensures that the MicroFlex e100 cannot drive the motor, which may be necessary during equipment maintenance or similar operations. Under certain circumstances, it may also be necessary to fit a brake to a rotary motor. This is important with hanging loads where disconnecting the motor windings could result in the load falling. Contact your local supplier for details of appropriate brakes.



If an M-Contactor is installed, the MicroFlex e100 must be disabled at least 20 ms before the M-Contactor is opened. If the M-Contactor is opened while the MicroFlex e100 is supplying voltage and current to the motor, the MicroFlex e100 may be damaged. Incorrect installation or failure of the M-Contactor or its wiring may result in damage to the MicroFlex e100.

Ensure that shielding of the motor cable is continued on both sides of the contactor.

3.5.2 Sinusoidal filter

A sinusoidal filter is used to provide a better quality waveform to the motor, reducing motor noise, temperature and mechanical stress. It will reduce or eliminate harmful dV/dt values (voltage rise over time) and voltage doubling effects which can damage motor insulation. This effect occurs most noticeably when using very long motor cables, for example 30 m (100 ft) or more. Baldor motors intended to be used with drives are designed to withstand the effects of large dV/dt and overvoltage effects. However, if very long motor cables are unavoidable and are causing problems, then a sinusoidal filter may be beneficial.

3.5.3 Thermal switch connection

You might wish to wire the motor's thermal switch contacts (normally closed), using a relay, to a digital input on connector X3 (see section 3.3.1). Using the Mint WorkBench Digital I/O tool, the input can be configured to be the motor trip input. This allows the MicroFlex e100 to respond to motor over-temperature conditions. The Mint keyword `MOTORTEMPERATUREINPUT` can also be used to configure a digital input for this purpose. A typical circuit, using DIN1 as the input, is shown in Figure 8.

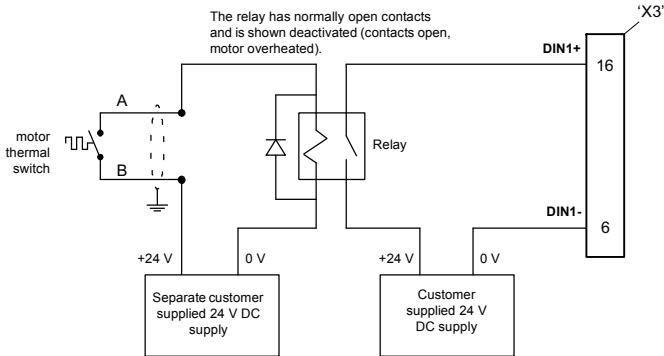

Figure 8: Motor thermal switch circuit



The 24 V DC power supply connected to the thermal switch must be a separate supply as shown in Figure 8. Do not use the 24 V DC supply used for the drive enable signal, or the internally generated supply (if present). The thermal switch wires often carry noise that could cause erratic drive operation or damage. The thermal switch contacts must never be wired directly to a digital input or any part of the logic supply for other components in the system.

The separate 24 V DC supply used for the thermal switch may also be used for the motor brake circuit (section 3.5.4).

3.5.4 Motor brake connection

You might wish to wire a motor's brake, via relays, to digital outputs on connector X3 (see section 3.3.1). This provides a way for the MicroFlex e100 to control the motor's brake. A typical circuit is shown in Figure 9.

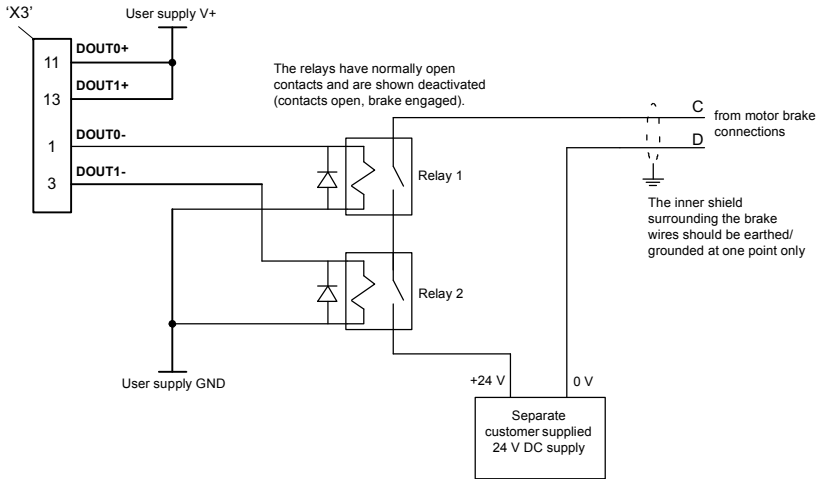

Figure 9: Motor brake control circuit

This circuit uses the drive enable signal (configured using `DRIVEENABLEOUTPUT` to appear on DOUT0) in conjunction with DOUT1 (configured as the `MOTORBRAKEOUTPUT`). See the Mint help file for details. With this configuration, the following sequences can be used to control the brake.

To engage the brake:

- The motor is brought to rest under normal control;
- Relay 2 is deactivated, causing the brake to engage;
- The drive is disabled. This removes power from the motor and causes Relay 1 to be deactivated.

To disengage the brake:

- The drive is enabled, activating Relay 1;
- Power is applied to the motor to hold position under normal control;
- Relay 2 is activated, causing the brake to be disengaged.

It may be necessary to include a small delay, after Relay 2 has been activated, before starting motion. This delay will allow time for the relay contacts to engage and the brake to release.



The 24 V DC power supply used to power the brake must be a separate supply as shown in Figure 9. Do not use the supply that is powering the MicroFlex e100 digital outputs. The brake wires often carry noise that could cause erratic drive operation or damage. The brake contacts must never be wired directly to the digital outputs. The relay(s) should be fitted with a protective flyback diode, as shown. The separate 24 V DC supply used for the motor brake may also be used to power the relay in the thermal switch circuit (section 3.5.3).

3.6 Brake (regeneration) resistor

An optional external brake resistor may be required to dissipate excess power from the internal DC bus during motor deceleration. The brake resistor must have a resistance of at least 39 Ω, an inductance of less than 100 μH, and a minimum power rating of 44 W. Care should be taken to select the correct resistor for the application - see section 3.7. Suitable brake resistors are listed in section A.1.5. The brake resistor output is conditionally short-circuit proof.



Electrical shock hazard. DC bus voltages may be present at these terminals. Use a suitable heatsink (with fan if necessary) to cool the brake resistor. The brake resistor and heatsink (if present) can reach temperatures in excess of 80 °C (176 °F).

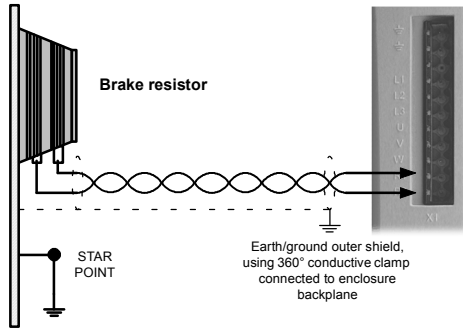

Figure 10: Brake resistor connections

3.6.1 Braking capacity

The braking capacity of the MicroFlex e100 can be calculated from the following formula:

$$E = 0.5 \times DC \text{ bus capacitance} \times \left((Brake \text{ switching threshold})^2 - (\sqrt{2} \times Supply \text{ voltage})^2 \right)$$

where the *Brake switching threshold* is 388 V. This gives the following typical values:

MicroFlex catalog number	DC bus capacitance (μF)	Braking capacity (J)	
		115 V AC supply	230 V AC supply
FMH2A01/3...	560	34.7	12.5
FMH2A06...	1120	69.4	25
FMH2A09...	1680	104.2	37.6

Table 6: Braking capacity

3.7 Brake resistor selection

The following calculations can be used to estimate the type of brake resistor that will be required for the application.

3.7.1 Required information

To complete the calculation, some basic information is required. Remember to use the worst-case scenario to ensure that the braking power is not underestimated. For example, use the maximum possible motor speed, maximum inertia, minimum deceleration time and minimum cycle time that the application might encounter.

Requirement	Enter value here
a) Initial motor speed, before deceleration begins, in radians per second. <i>Multiply RPM by 0.1047 to give radians per second.</i>	Initial motor speed, U = _____ rad/s
b) Final motor speed after deceleration is complete, in radians per second. <i>Multiply RPM by 0.1047 to get radians per second. This value will be zero if the load is going to be stopped.</i>	Final motor speed, V = _____ rad/s
c) The deceleration time from initial speed to final speed, in seconds.	Decel time, D = _____ s
d) The total cycle time (i.e. how frequently the process is repeated), in seconds.	Cycle time, C = _____ s
e) Total inertia. <i>This is the total inertia seen by the drive, accounting for motor inertia, load inertia and gearing. Use the Mint WorkBench Autotune tool to tune the motor, with the load attached, to determine the value. This will be displayed in kg·m² in the Autotune tool. If you already know the motor inertia (from the motor spec.) and the load inertia (by calculation) insert the total here.</i> <i>Multiply kg·cm² by 0.0001 to give kg·m².</i> <i>Multiply lb-ft² by 0.04214 to give kg·m².</i> <i>Multiply lb-in-s² by 0.113 to give kg·m².</i>	Total inertia, J = _____ kg·m²

3.7.2 Braking energy

The braking energy to be dissipated, E, is the difference between the initial energy in the system (before deceleration begins) and the final energy in the system (after deceleration has finished). If the system is brought to rest then the final energy is zero.

The energy of a rotating object is given by the formula:

$$E = \frac{1}{2} \times J \times \omega^2$$

where E is energy, J is the moment of inertia, and ω is the angular velocity.

The braking energy, which is the difference between the initial energy and the final energy, is therefore:

$$\begin{aligned} E &= \left(\frac{1}{2} \times J \times U^2 \right) - \left(\frac{1}{2} \times J \times V^2 \right) \\ &= \frac{1}{2} \times J \times (U^2 - V^2) \\ &= \text{_____ J (joules)} \end{aligned}$$

Calculate E using the values for J, U and V entered in section 3.7.1. If E is less than the drive's braking capacity, shown in Table 6 on page 3-24, a brake resistor will not be required. If E is greater than the drive's braking capacity, then continue to section 3.7.3 to calculate the braking and average power dissipation.

3.7.3 Braking power and average power

The braking power, P_r , is the *rate* at which the braking energy is dissipated. This rate is defined by the deceleration period, D. The shorter the deceleration period, the greater the braking power.

$$\begin{aligned} P_r &= \frac{E}{D} \\ &= \text{_____ W (watts)} \end{aligned}$$

Although the resistors shown in Table 7 can withstand brief overloads, the average power dissipation, P_{av} , must not exceed the stated power rating. The average power dissipation is determined by the proportion of the application cycle time spent braking. The greater the proportion of time spent braking, the greater the average power dissipation.

$$\begin{aligned} P_{av} &= P_r \times \frac{D}{C} \\ &= \text{_____ W (watts)} \end{aligned}$$

3.7.4 Resistor choice

P_{av} is the value to use when assessing which brake resistor to use. However, a safety margin of 1.25 times is recommended to ensure the resistor operates well within its limits, so:

$$\text{Required resistor power rating} = 1.25 \times P_{av}$$

$$= \text{_____ W (watts)}$$

The range of suitable brake resistors is shown in Table 7. Choose the resistor that has a power rating equal to or greater than the value calculated above.

Resistor part	Resistance	Power rating
RGJ139	39 Ω	100 W
RGJ160	60 Ω	100 W
RGJ260	60 Ω	200 W
RGJ360	60 Ω	300 W

Table 7: Brake resistors



The brake resistance must be 39 Ω or greater to ensure the drive's maximum regeneration switching current (10 A) is not exceeded. Failure to observe the minimum resistance could result in damage to the drive.

Dimensions are shown in section A.1.5.

* The brake resistors listed in Table 7 can withstand a brief overload of 10 times the rated power for 5 seconds. Please contact ABB if larger power ratings are required.

3.7.5 Resistor derating

The brake resistors shown in Table 7 can achieve their stated power rating only when mounted on a heatsink. In free air a derating must be applied. Furthermore, in ambient temperatures greater than 25 °C (77 °F), a temperature derating must be applied.

Resistor part	Nominal power rating (W)	In free air	On heatsink
RGJ139 RGJ160	100	Derate power linearly from: 80% @ 25 °C (77 °F) to 70% @ 55 °C (113 °F)	Derate power linearly from: 100% @ 25 °C (77 °F) to 88% @ 55 °C (113 °F) Typical heatsink: 200 mm x 200 mm x 3 mm
RGJ260	200	Derate power linearly from: 70% @ 25 °C (77 °F) to 62% @ 55 °C (113 °F)	Derate power linearly from: 100% @ 25 °C (77 °F) to 88% @ 55 °C (113 °F) Typical heatsink: 400 mm x 400 mm x 3 mm
RGJ360	300		

Table 8: Brake resistor derating

3.7.6 Resistor pulse load rating

The brake resistors shown in Table 7 can dissipate power levels greater than the stated continuous power rating, provided the duty cycle (see section 3.7.7) is reduced, as shown in Figure 11.

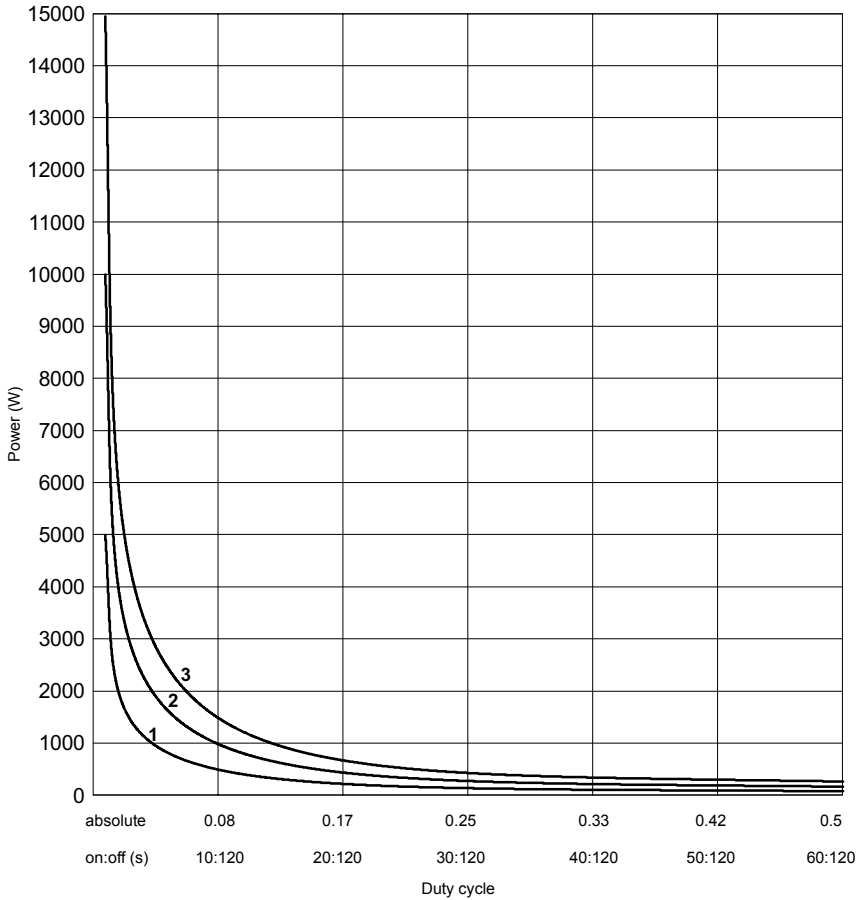

- 1 100 W models: Maximum pulse 5 kW for 1 s, 120 s off.
- 2 200 W models: Maximum pulse 10 kW for 1 s, 120 s off.
- 3 300 W models: Maximum pulse 5 kW for 1 s, 120 s off.

Figure 11: Brake resistor pulse load rating

3.7.7 Duty cycle

The braking duty cycle is the amount of time taken braking as a proportion of the overall application cycle time. For example, Figure 12 shows a system which performs a trapezoidal move profile, with braking during part of the deceleration phase.

The braking duty is 0.2 (0.5 second braking / 2.5 second cycle time):

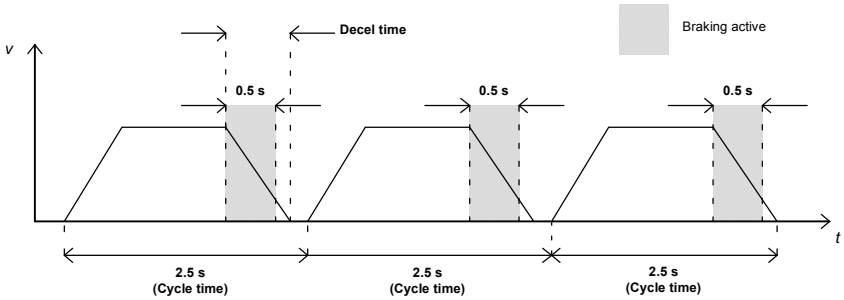

Figure 12: Duty cycle = 0.2

4.1 Introduction

MicroFlex e100 supports many feedback options for use with linear and rotary motors, including incremental encoder, encoder with BiSS (Bi-directional Synchronous Serial interface), encoder with SSI (Synchronous Serial Interface), EnDat or Smart Abs absolute encoder or SinCos encoder. All suitable types of feedback device can be connected to the universal feedback interface available on connector X8.

There are some important considerations when wiring the feedback device:

- The feedback device wiring must be separated from power wiring.
- Where feedback device wiring runs parallel to power cables, they must be separated by at least 76 mm (3 in)
- Feedback device wiring must cross power wires at right angles only.
- To prevent contact with other conductors or earths/grounds, unearthed/ungrounded ends of shields must often be insulated.
- Linear motors use two separate cables (encoder and Hall). The cores of these two cables will need to be wired to the appropriate pins of the 15-pin D-type mating connector.
- The inputs are not isolated.

4.1.1 Incremental encoder feedback

The incremental encoder connections (ABZ channels and Hall signals) are made using the 15-pin D-type female connector X8. The encoder inputs (CHA, CHB and CHZ) accept differential signals only. Twisted pairs must be used for each complementary signal pair e.g. CHA+ and CHA-. The Hall inputs may be used as differential inputs (recommended for improved noise immunity) or single ended inputs. When used as single ended inputs, leave the Hall U-, Hall V- and Hall W- pins unconnected. The overall cable shield (screen) must be connected to the metallic shell of the D-type connector. Connector X8 includes a 'Sense' pin, which is used to detect the voltage drop on long cable runs. This allows the MicroFlex e100 to increase the encoder supply voltage on pin 12 to maintain a 5 V supply at the encoder (200 mA max).

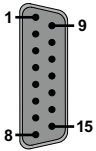
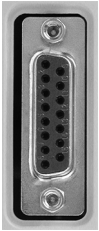

Pin	Incremental encoder function
1	CHA+
2	CHB+
3	CHZ+
4	Sense
5	Hall U-
6	Hall U+
7	Hall V-
8	Hall V+
9	CHA-
10	CHB-
11	CHZ-
12	+5 V out
13	DGND
14	Hall W-
15	Hall W+

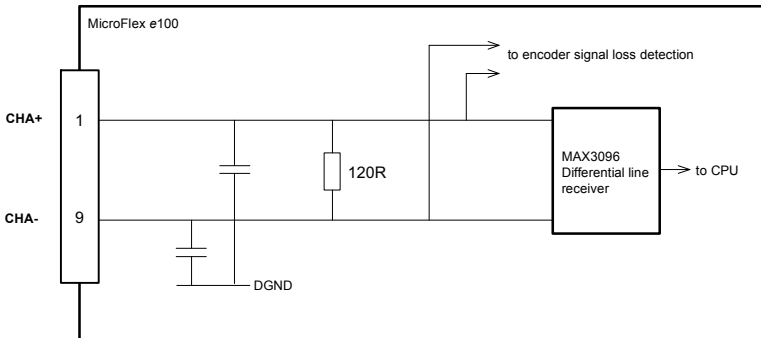

Figure 13: Encoder channel input circuit - Channel A shown

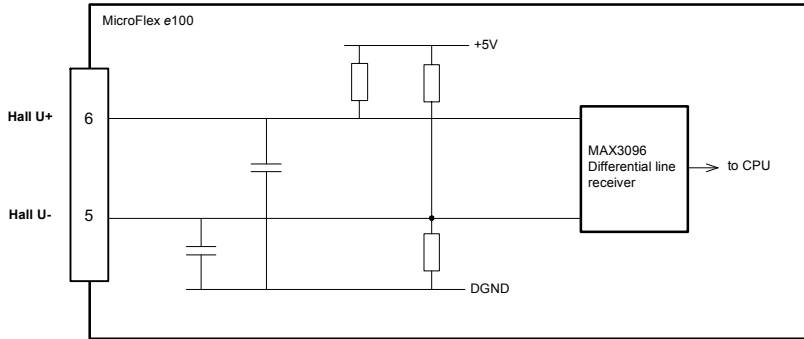

Figure 14: Hall channel input circuit - U phase shown

4.1.1.1 Encoder cable configuration - Baldor rotary motors

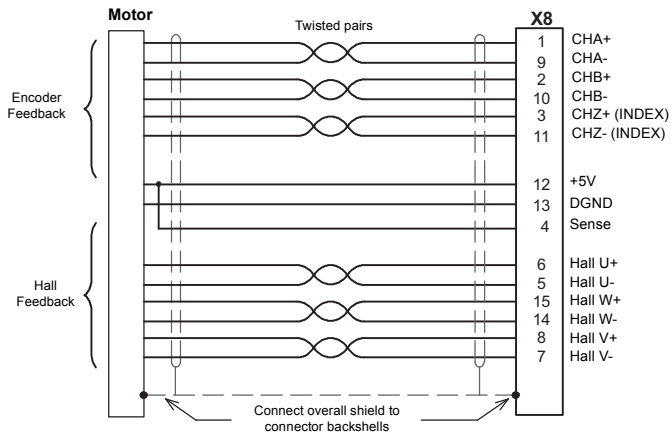

Figure 15: Encoder cable connections - rotary motors

Note: If the Hall inputs are used as single ended inputs, leave the Hall U-, Hall V- and Hall W- pins unconnected; do not connect them to ground.

The maximum recommended cable length is 30.5 m (100 ft).

4.1.1.2 Encoders without Halls

Incremental encoders without Hall feedback connections may be connected to the MicroFlex e100. However, if Hall connections are not present, it will be necessary for the MicroFlex e100 to perform an automatic phase search sequence each time it is powered. This will cause motor movement of up to 1 turn on rotary motors, or one pole-pitch on linear motors.

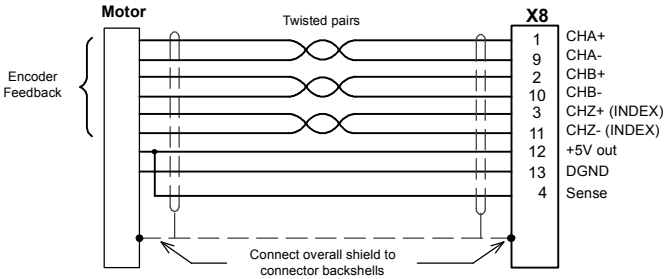

Figure 16: Encoder cable connections without halls - rotary motors

4.1.1.3 Halls-only feedback devices

Feedback devices using only Hall sensors may be connected to the MicroFlex e100. However, since there are no encoder connections, the MicroFlex e100 will not be able to perform speed control or positioning control.

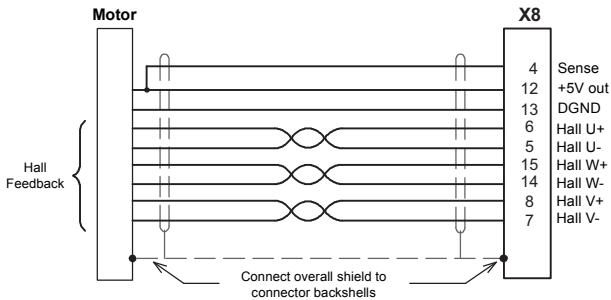

Figure 17: Halls-only feedback cable connections - rotary motors

Note: If the Hall inputs are used as single ended inputs, leave the Hall U-, Hall V- and Hall W- pins unconnected; do not connect them to ground.

4.1.1.4 Encoder cable pin configuration - Baldor linear motors

Baldor linear motors use two separate cables (encoder and Hall). The cores of these two cables must be wired to the appropriate pins of the 15-pin D-type mating connector:

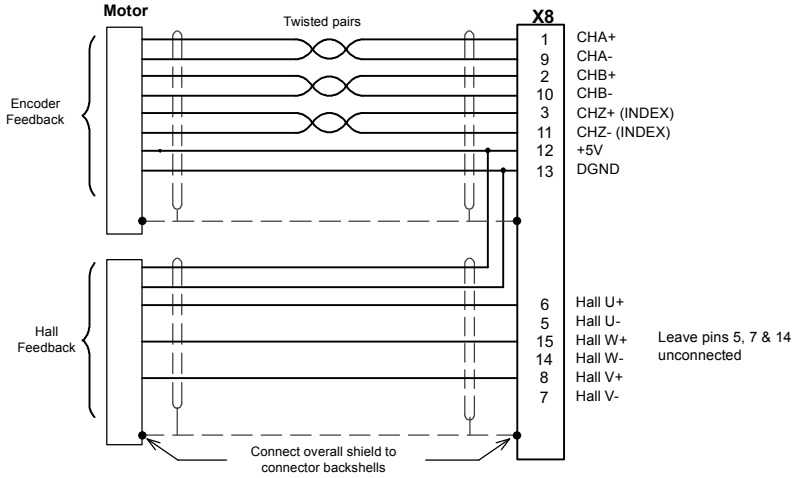
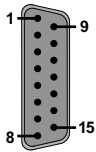
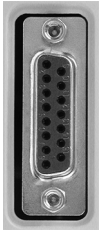

Figure 18: Encoder cable connections - linear motors

4.1.2 BiSS interface

The BiSS (Bi-directional Serial Synchronous interface) is an open-source interface that can be used with many types of absolute encoder. The BiSS interface connections are made using the 15-pin D-type female connector X8. Twisted pair cables must be used for the complementary signal pairs e.g. Data+ and Data-. The overall cable shield (screen) must be connected to the metallic shell of the D-type connector. Connector X8 includes a 'Sense' pin, which is used to detect the voltage drop on long cable runs. This allows the MicroFlex e100 to increase the supply voltage on pin 12 to maintain a 5 V DC supply at the encoder (200 mA max).



Pin	BiSS function	
1	Data+	
2	Clock+	
3	(NC)	
4	Sense	
5	<i>Sin-</i>	Note: If your cable has <i>Sin</i> and <i>Cos</i> pairs they may be connected here. However, these signals are not required or used by the MicroFlex e100 for BiSS operation.
6	<i>Sin+</i>	
7	<i>Cos-</i>	
8	<i>Cos+</i>	
9	Data-	
10	Clock-	
11	(NC)	
12	+5 V out	
13	DGND	
14	(NC)	
15	(NC)	

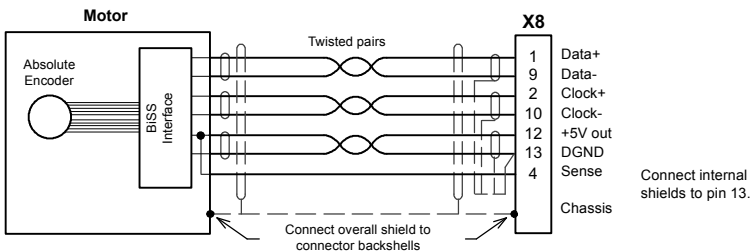
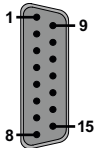
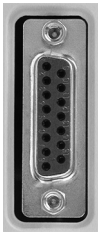

Figure 19: BiSS interface cable connections

The maximum recommended cable length is 30.5m (100ft).

4.1.3 SSI feedback

The SSI (Synchronous Serial Interface) encoder interface is specifically designed for use with Baldor SSI motors, which incorporate a custom Baumer SSI encoder. Correct operation with other SSI interfaces cannot be guaranteed. The SSI encoder connections are made using the 15-pin D-type female connector X8. Twisted pair cables must be used for the complementary signal pairs e.g. Data+ and Data-. The overall cable shield (screen) must be connected to the metallic shell of the D-type connector. Connector X8 includes a 'Sense' pin, which is used to detect the voltage drop on long cable runs. This allows the MicroFlex e100 to increase the encoder supply voltage on pin 12 to maintain a 5 V supply at the encoder (200 mA max).



Pin	SSI function
1	Data+
2	Clock+
3	(NC)
4	Sense
5	(NC)
6	(NC)
7	(NC)
8	(NC)
9	Data-
10	Clock-
11	(NC)
12	+5 V out
13	DGND
14	(NC)
15	(NC)

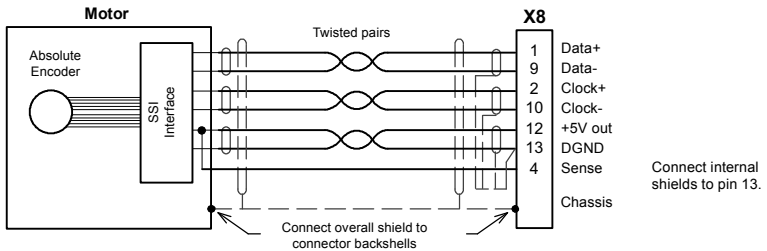
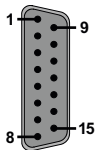
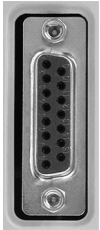

Figure 20: SSI encoder cable connections

The maximum recommended cable length is 30.5 m (100 ft).

4.1.4 EnDat (absolute encoder) feedback

The absolute encoder interface supports both incremental and absolute (multi and single turn) feedback using EnDat technology. It is possible to read and write information to the encoder. The absolute encoder connections are made using the 15-pin D-type female connector X8. Twisted pair cables must be used for the complementary signal pairs e.g. Sin+ and Sin-. The overall cable shield (screen) must be connected to the metallic shell of the D-type connector. Connector X8 includes a 'Sense' pin, which is used to detect the voltage drop on long cable runs. This allows the MicroFlex e100 to increase the encoder supply voltage on pin 12 to maintain a 5 V supply at the encoder (200 mA max). Version 2.2 EnDat encoders do not use the Sin and Cos channels.



Pin	Absolute encoder function
1	Data+
2	Clock+
3	(NC)
4	Sense
5	Sin-
6	Sin+
7	Cos-
8	Cos+
9	Data-
10	Clock-
11	(NC)
12	+5 V out
13	DGND
14	(NC)
15	(NC)

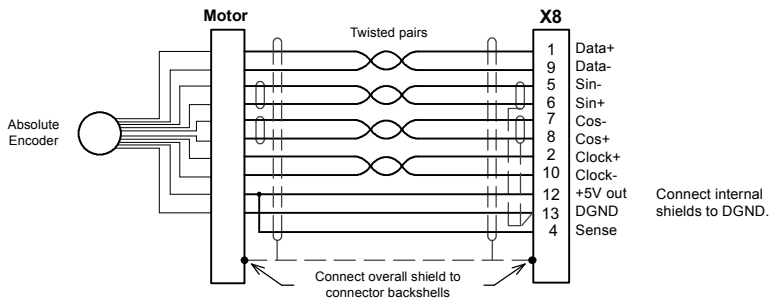
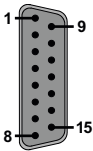
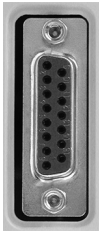

Figure 21: Absolute encoder cable connections

The maximum recommended cable length is 30.5 m (100 ft).

4.1.5 Smart Abs interface

The Smart Abs encoder connections are made using the 15-pin D-type female connector X8. Twisted pair cables must be used for the complementary signal pairs e.g. Data+ and Data-. The overall cable shield (screen) must be connected to the metallic shell of the D-type connector. Connector X8 includes a 'Sense' pin, which is used to detect the voltage drop on long cable runs. This allows the MicroFlex e100 to increase the supply voltage on pin 12 to maintain a 5 V DC supply at the encoder (200 mA max).



Pin	Smart Abs function	
1	Data+	
2	(NC)	
3	(NC)	
4	Sense	
5	(NC)	Note: If your cable has Sin and Cos pairs they may be connected here. However, these signals are not required or used by the MicroFlex e100 for Smart Abs.
6	(NC)	
7	(NC)	
8	(NC)	
9	Data-	
10	(NC)	
11	(NC)	
12	+5 V out	
13	DGND	
14	(NC)	
15	(NC)	

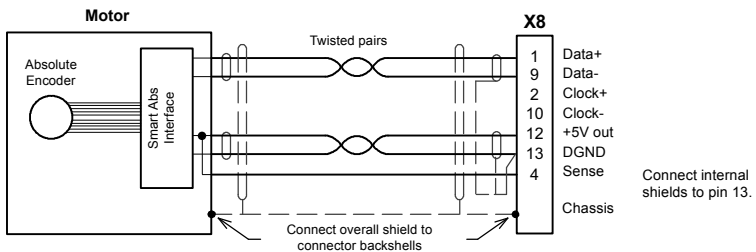
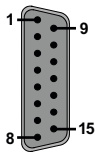
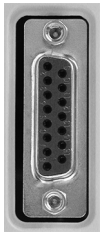

Figure 22: Smart Abs interface cable connections

The maximum recommended cable length is 30.5 m (100 ft).

4.1.6 SinCos feedback

The SinCos connections (Sin and Cos incremental channels only) are made using the 15-pin D-type female connector X8. Twisted pair cables must be used for the complementary signal pairs e.g. Sin+ and Sin-. The overall cable shield (screen) must be connected to the metallic shell of the D-type connector. Connector X8 includes a 'Sense' pin, which is used to detect the voltage drop on long cable runs. This allows the MicroFlex e100 to increase the encoder supply voltage on pin 12 to maintain a 5 V supply at the encoder (200 mA max). The Sin and Cos channel input circuits accept a nominal 1 V pk-pk sine wave centered on a 2.5 V reference.



Pin	SinCos function
1	(NC)
2	(NC)
3	(NC)
4	Sense
5	Sin-
6	Sin+
7	Cos-
8	Cos+
9	(NC)
10	(NC)
11	(NC)
12	+5 V out
13	DGND
14	(NC)
15	(NC)

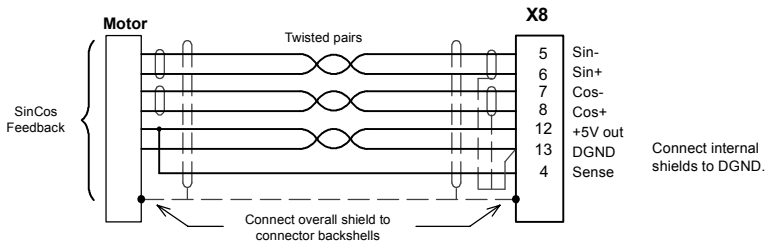

Figure 23: SinCos cable connections

The maximum recommended cable length is 30.5 m (100 ft).

5.1 Introduction

This section describes the various digital and analog input and output capabilities of the MicroFlex e100, with descriptions of each of the connectors on the front panel.

The following conventions are used to refer to the inputs and outputs:

I/O Input / Output
DIN Digital Input
DOUT Digital Output
AIN Analog Input

5.2 Digital I/O

The MicroFlex e100 provides as standard:

- 3 general purpose digital inputs.
- 1 dedicated drive enable input.
- 1 general purpose digital output.
- 1 general purpose / drive status output.

The general purpose digital inputs can be configured for typical input functions:

- Error input
- Reset input
- Stop input
- Forward / reverse limit input - see important details in section 5.2.2.1 or 5.2.3.1.
- Home input.

5.2.1 Drive enable input

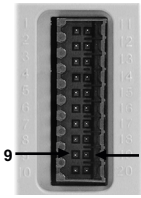

Location	Connector X3, pins 9 & 19 (Mating connector: Weidmüller Minimate B2L 3.5/20)
Name	Drive enable
Description	Dedicated drive enable input. Nominal input voltage: +24 V DC (input current not to exceed 50 mA) Sampling interval: 1 ms

The drive enable input is buffered by a TLP280 opto-isolator, allowing the input signal to be connected with either polarity.

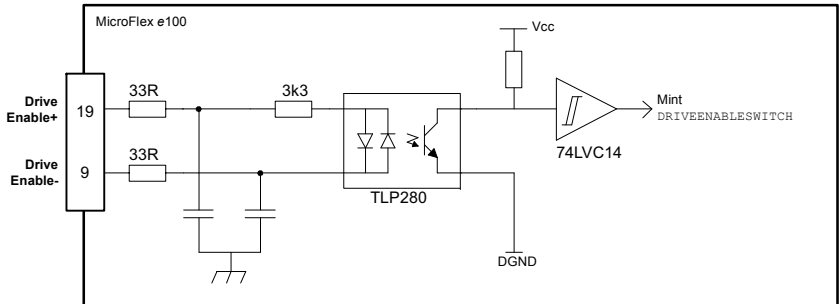



Figure 24: Drive enable input circuit

In normal use, the drive enable input controls the enabled status of the drive. However, when the MicroFlex e100 is connected to Mint WorkBench, additional methods are available for controlling the drive enable status. In all cases, the drive enable input must be active and there must be no errors present before the MicroFlex e100 can be enabled. It is recommended that an emergency stop switch or emergency stop control system is incorporated in the drive enable circuit.

- The drive enable button  on the motion toolbar toggles the enable/disable status. Alternatively, the Mint command `DRIVEENABLE(0)=1` can be used in the command window to enable the MicroFlex e100. `DRIVEENABLE(0)=0` will disable the MicroFlex e100.
- The Tools, Reset Controller menu item will clear errors and enable the MicroFlex e100. Alternatively, the Mint command `RESET(0)` can be used in the command window to perform the same action.

The state of the drive enable input is displayed in the Mint WorkBench Spy window. Alternatively, the state of the drive enable input can be read (but not set) using the Mint command `Print DRIVEENABLESWITCH` in the command window. See the Mint help file for details.

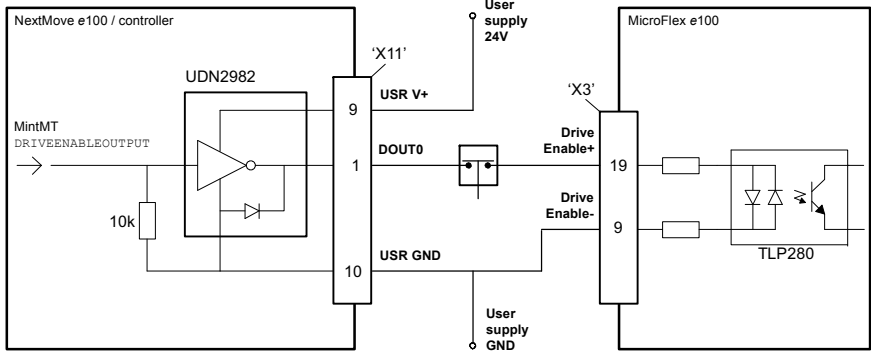
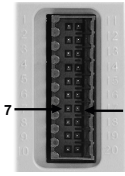

Figure 25: Drive enable input - typical connection from an ABB NextMove e100

5.2.2 General purpose digital input DIN0



Location	Connector X3, pins 7 & 17 (Mating connector: Weidmüller Minimate B2L 3.5/20)
Name	DIN0
Description	General purpose opto-isolated digital input. Nominal input voltage: +24 V DC (input current not to exceed 50 mA) Sampling interval: 1 ms

This general purpose digital input is buffered by a TLP280 opto-isolator, allowing the input signal to be connected with either polarity. The state of the digital input is displayed in the Mint WorkBench Spy window. The input can be configured for different user definable functions.

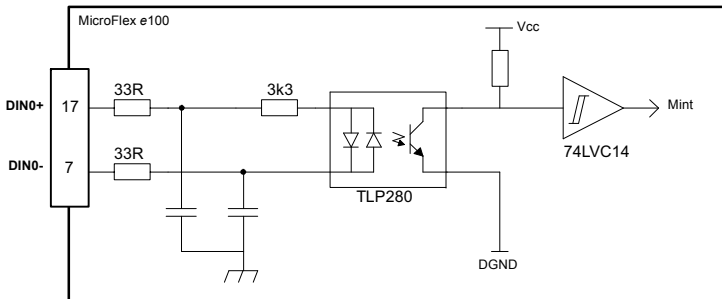

Figure 26: General purpose digital input circuit

When the MicroFlex e100 is connected to Mint WorkBench, the digital input can be configured using the Digital I/O tool. Alternatively, Mint keywords including `RESETINPUT`, `ERRORINPUT`, `STOPINPUT`, `FORWARDLIMITINPUT`, `REVERSELIMITINPUT`, `POWERREADYINPUT` and `HOMEINPUT` can be used in the command window. The state of the digital input can be viewed using the Mint WorkBench Spy window's Axis tab. See the Mint help file for details.

5.2.2.1 Using a digital input as a home switch input

When the MicroFlex e100 is being controlled over EPL by a manager node (e.g. NextMove e100), the home switch input must be wired to the MicroFlex e100, not the manager node. This is because the manager node only *triggers* the homing sequence, which is then performed entirely by the MicroFlex e100. It is therefore the MicroFlex e100 which must receive the home switch input signal, otherwise it will not be able to complete its homing routine. Similarly, it is the MicroFlex e100's own `HOME...` keyword parameters that define the homing sequence.

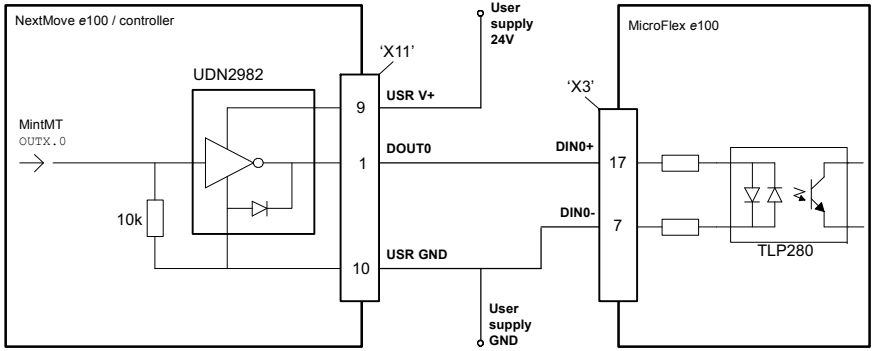
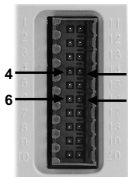

Figure 27: Digital input - typical connection from an ABB NextMove e100

5.2.3 General purpose digital inputs DIN1 & DIN2



Location	Connector X3, pins 6 & 16 (DIN1), 4 & 14 (DIN2) (Mating connector: Weidmüller Minimate B2L 3.5/20)
Name	DIN1, DIN2
Description	General purpose fast opto-isolated digital inputs. Nominal input voltage: +24 V DC (input current not to exceed 20 mA) Maximum input frequency: 1 MHz maximum

These general purpose fast digital inputs are buffered by a TLP115 opto-isolator, allowing the input signal to be connected with either polarity. The state of the digital input is displayed in the Mint WorkBench Spy window. The inputs can be configured for different user definable functions.

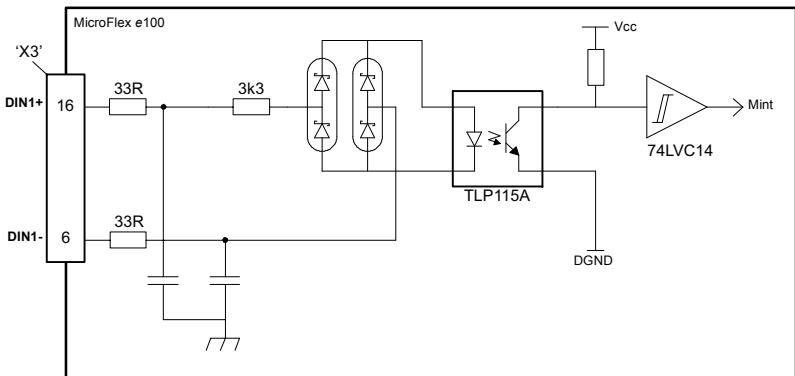

Figure 28: General purpose fast digital input circuit

When the MicroFlex e100 is connected to Mint WorkBench, the digital input can be configured using the Digital I/O tool. Alternatively, Mint keywords including `RESETINPUT`, `ERRORINPUT`, `STOPINPUT`, `FORWARDLIMITINPUT`, `REVERSELIMITINPUT`, `POWERREADYINPUT` and `HOMEINPUT` can be used in the command window. The state of the digital input can be viewed using the Spy window's Axis tab. See the Mint help file for details.

5.2.3.1 Using a digital input as a home switch input

When the MicroFlex e100 is being controlled over EPL by a manager node (e.g. NextMove e100), the home switch input must be wired to the MicroFlex e100, not the manager node. This is because the manager node only *triggers* the homing sequence, which is then performed entirely by the MicroFlex e100. It is therefore the MicroFlex e100 which must receive the home switch input signal, otherwise it will not be able to complete its homing routine. Similarly, it is the MicroFlex e100's own `HOME...` keyword parameters that define the homing sequence.

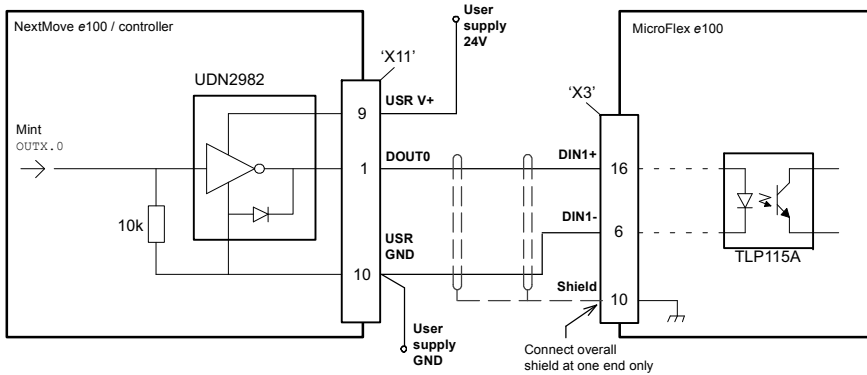

Figure 29: Digital input - typical connection from an ABB NextMove e100

5.2.4 Special functions on inputs DIN1 & DIN2

DIN1 and DIN2 can be configured to perform special functions.

5.2.4.1 Step (pulse) and direction inputs

DIN1 and DIN2 can be configured using the statement `ENCODERMODE (1) = 4` to become step and direction inputs:

- DIN1 is used as the step input. The step frequency controls the speed of the motor.
- DIN2 is used as the direction input. The state of the direction input controls the direction of motion. An active input will result in forward motion. An inactive input will result in motion in the opposite direction.

To operate at high frequencies, a pull up resistor R_p might be required to ensure that the input operates correctly. The pull-up resistor depends on the user supply voltage and the maximum input frequency required, as shown in the following table:

Resistor value, R_p	User supply voltage		
	24 V	12 V	5 V
(None)	Low	15 kHz	100 kHz
470R	90 kHz	160 kHz	700 kHz
110R	250 kHz	500 kHz	2000 kHz

The pull up resistor R_p must have the correct minimum power rating, as shown in the following table:

Resistor value, R_p	User supply voltage		
	24 V	12 V	5 V
470R	1.5 W	0.5 W	0.1 W
110R	6 W	1.5 W	0.3 W

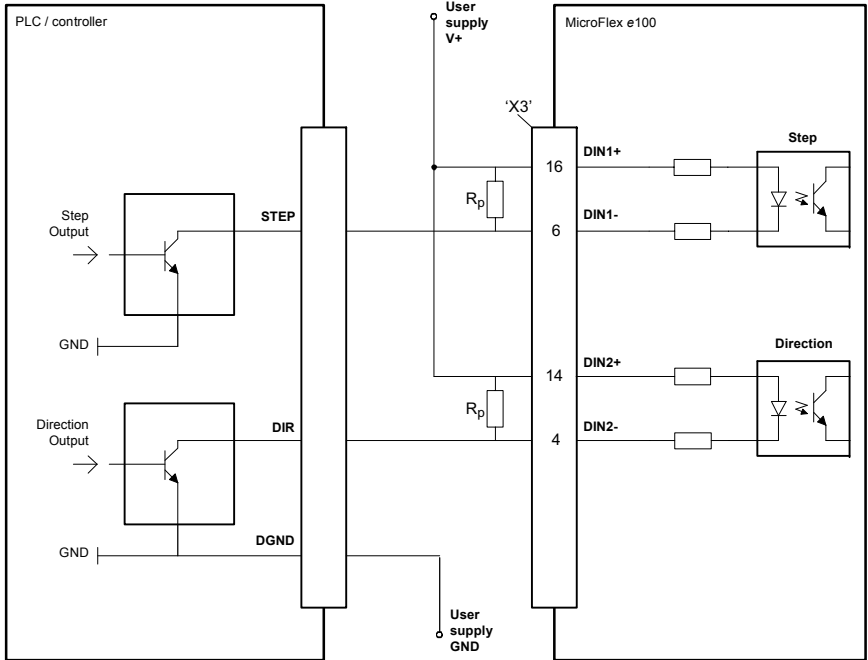

Figure 30: Step and direction inputs - typical connections from an external controller

5.2.4.2 Encoder input

DIN1 and DIN2 can be configured using the statement `ENCODERMODE(1)=0` to form an additional encoder input. The two channels are read as a quadrature (CHA, CHB) encoder input. In Mint, the encoder input formed by digital inputs DIN1 and DIN2 is encoder 1.

When using an incremental encoder source, do not connect the A- or B- outputs; leave them unconnected as shown in Figure 31.

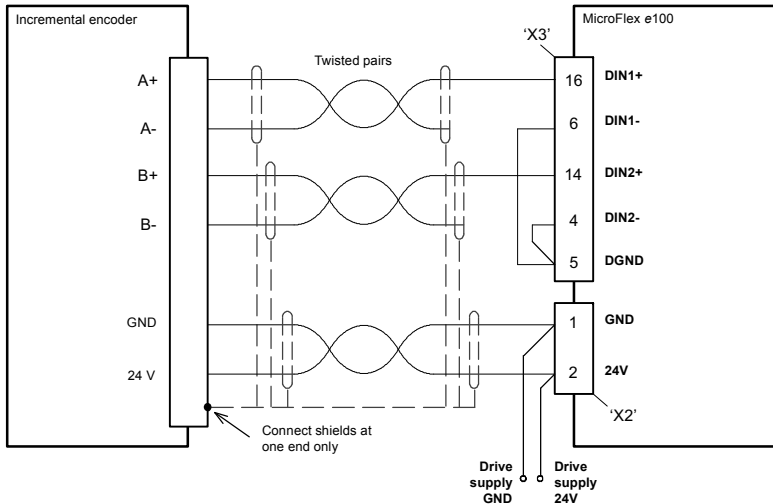

Figure 31: Encoder inputs - typical connection from an incremental encoder

5.2.4.3 Fast position capture

DIN1 or DIN2 can be configured using the `LATCHTRIGGERCHANNEL` keyword to become a fast latch input. This allows the position of the axis to be captured in real-time and read using the Mint keyword `LATCHVALUE`. The input can be configured using the `LATCHTRIGGEREDGE` keyword to be triggered either on a rising or falling edge. Further control of position capture is provided by various other keywords beginning with `LATCH...`. See the Mint Help file for details.

The maximum latency to read the fast position depends on the feedback device. For an incremental encoder, the latency is approximately 150 - 300 ns. For other feedback devices latency may be up to 62.5 μ s, resulting from the 16 kHz sampling frequency used for these types of feedback device. The fast interrupt will be latched on a pulse width of about 30 μ s, although a width of 100 μ s is recommended to ensure capture. To prevent subsequent inputs causing the captured value to be overwritten, the interrupt is latched in software.

Note: The fast inputs are particularly sensitive to noise, so inputs must use shielded twisted pair cable. Do not connect mechanical switches, relay contacts or other sources liable to signal 'bounce' directly to the fast inputs. This could cause unwanted multiple triggering.

5.2.5 General purpose / status output DOUT0

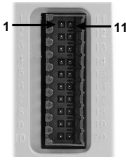

Location	Connector X3, pins 1 & 11 (Mating connector: Weidmüller Minimate B2L 3.5/20)
Name	Status / DOUT0
Description	General purpose opto-isolated digital output Output current: 100 mA maximum User supply: +28 V DC maximum Update interval: 1 ms

The optically isolated general purpose / status output is designed to source current from the user supply as shown in Figure 32. The TLP127 has a maximum power dissipation of 150 mW at 25 °C.

The output includes a self-resetting fuse that operates at approximately 200 mA. The fuse may take up to 20 seconds to reset after the load has been removed. If the output is used to directly drive a relay, a suitably rated diode must be fitted across the relay coil, observing the correct polarity. This is to protect the output from the back-EMF generated by the relay coil when it is de-energized. The sense of the output can be configured in Mint WorkBench, and its state is displayed in the Spy window.

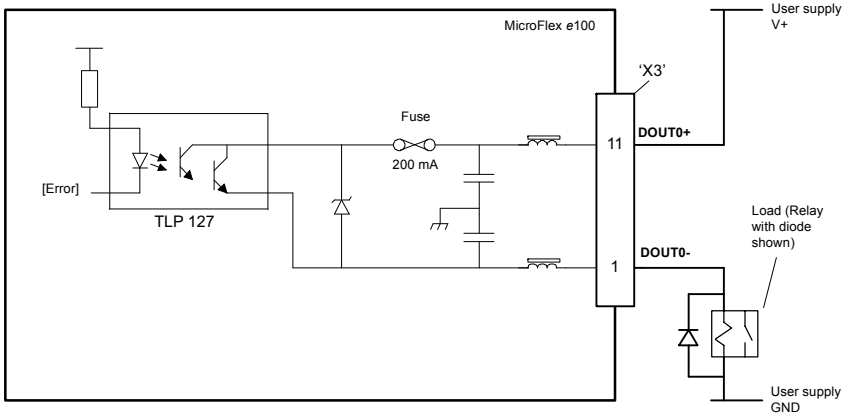

Figure 32: DOUT0 output circuit

By default, DOUT0 is configured as an error status output, which becomes inactive in the event of an error. When the MicroFlex e100 is connected to Mint WorkBench, the active level of the output can be configured using the Digital I/O tool. Alternatively, the Mint keyword `OUTPUTACTIVELEVEL` can be used in the command window. See the Mint help file for details.

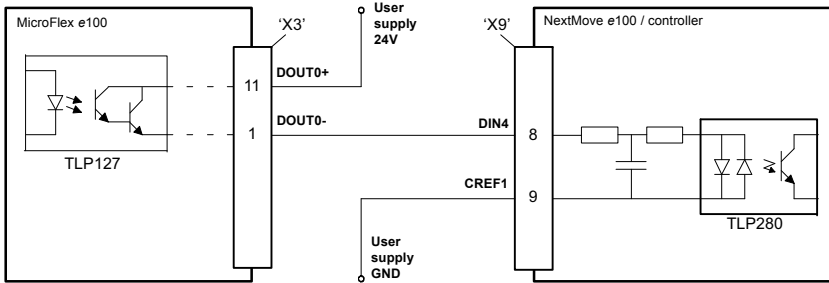
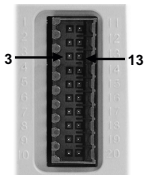

Figure 33: DOUT0 - typical connections to an ABB NextMove e100

5.2.6 General purpose output DOUT1



Location	Connector X3, pins 3 & 13 (Mating connector: Weidmüller Minimate B2L 3.5/20)
Name	DOUT1
Description	General purpose opto-isolated digital output Output current: 100 mA maximum User supply: +28 V DC maximum Update interval: 1 ms

The optically isolated general purpose output is designed to source current from the user supply as shown in Figure 34. The TLP127 has a maximum power dissipation of 150 mW at 25 °C.

The output includes a self-resetting fuse that operates at approximately 200 mA. The fuse may take up to 20 seconds to reset after the load has been removed. If the output is used to directly drive a relay, a suitably rated diode must be fitted across the relay coil, observing the correct polarity. This is to protect the output from the back-EMF generated by the relay coil when it is de-energized. The sense of the output can be configured in Mint WorkBench, and its state is displayed in the Spy window.

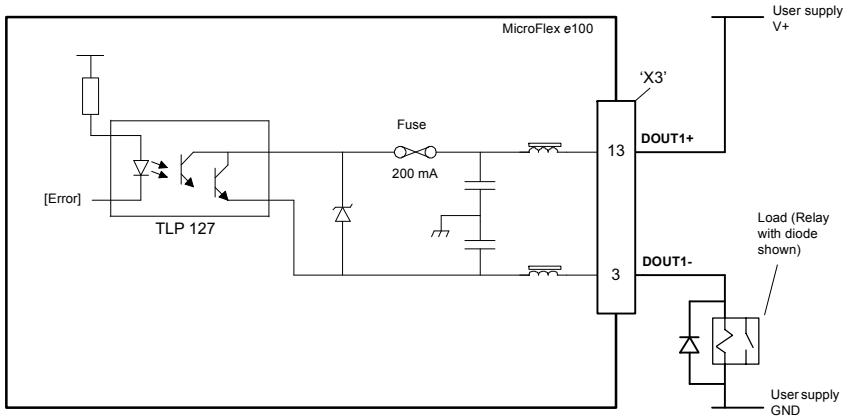

Figure 34: DOUT1 output circuit

When the MicroFlex e100 is connected to Mint WorkBench, the active level of the output can be configured using the Digital I/O tool. Alternatively, the Mint keyword `OUTPUTACTIVELEVEL` can be used in the command window. See the Mint help file for details.

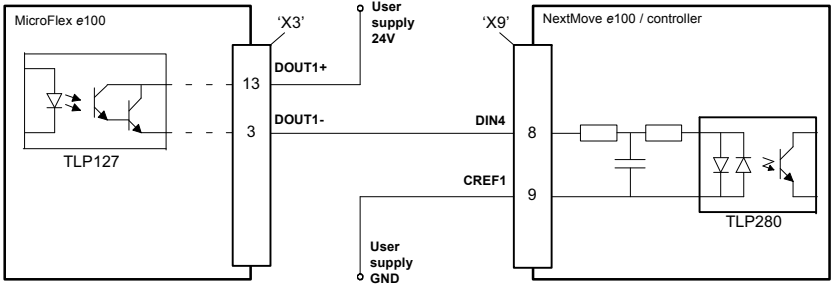
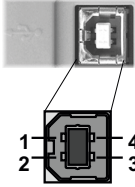

Figure 35: DOUT1 - typical connections to an ABB NextMove e100

5.3 USB communication

5.3.1 USB port



Location	USB Mating connector: USB Type B (downstream) plug	
Pin	Name	Description
1	VBUS	USB +5 V
2	D-	Data-
3	D+	Data+
4	GND	Ground

The USB connector is used to connect the MicroFlex e100 to a PC running Mint WorkBench. The MicroFlex e100 is a self-powered, USB 1.1 (12 Mbps) compatible device. If it is connected to a slower USB 1.0 host PC or hub, communication speed will be limited to the USB 1.0 specification (1.5 Mbps). If it is connected to a faster USB 2.0 (480 Mbps) or USB 3.0 (5 Gbps) host PC or hub, communication speed will remain at the USB 1.1 specification of the MicroFlex e100.

Ideally, the MicroFlex e100 should be connected directly to a USB port on the host PC. If it is connected to a hub shared by other USB devices, communication could be affected by the activity of the other devices. The maximum recommended cable length is 5 m (16.4 ft).

5.4 RS485 communication

5.4.1 RS485 port (2-wire)

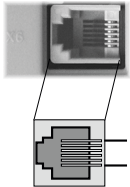

Location	X6 Mating connector: RJ11 plug	
Pin	Name	Description
1	TXA	Transmit / receive +
2	TXB	Transmit / receive -
3	GND	Ground
4	+7 V out	7 V supply for ABB accessories
5	(NC)	-
6	(NC)	-

The RS485 2-wire port is used to connect third-party serial devices such as operator panels. The Baldor Keypad and Baldor HMI panel range cannot be connected to this port. The 7 V supply on pin 4 is provided for future ABB accessories, so care should be taken to ensure this supply will not damage connected devices. The RS485 port could be damaged if a USB plug is accidentally inserted while the drive is powered.

The Mint keyword `Print` can be used to send characters to the attached device. The Mint keyword `InKey` can be used to receive characters. MicroFlex e100 supports various protocols over the RS485 interface, such as Modbus RTU and HCP (Host Comms Protocol), as well as simple ASCII character handling. See the Mint WorkBench help file for details.

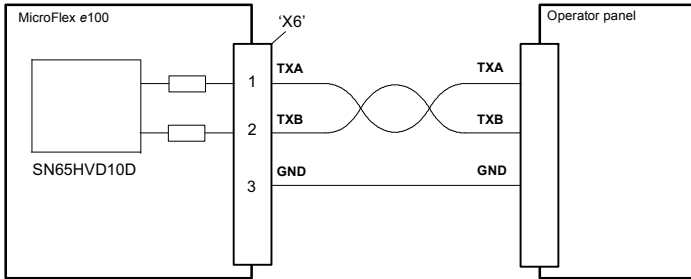

Figure 36: RS485 port - typical connections to an RS485 2-wire operator panel

Note: The MicroFlex e100 and other ABB equipment use 'big endian' word order and byte order for Modbus protocols. If this is incompatible with other Modbus equipment, the word and byte order for the MicroFlex e100 can be changed in Mint WorkBench. See the Mint WorkBench help file for details.

5.5 Ethernet interface

The Ethernet interface provides TCP/IP, Modbus TCP and Ethernet POWERLINK (EPL) networking capabilities.

5.5.1 TCP/IP

Transmission Control Protocol / Internet Protocol (TCP/IP) is a common set of protocols used to transfer information between devices over a network, including the internet. TCP enables two devices to establish a connection, and guarantees the delivery of packets (datagrams) of information in the correct order. IP specifies the format of the individual packets (which includes the destination address of the receiving device) but has no influence on whether the packet is delivered correctly.

TCP/IP allows the MicroFlex e100 to support standard Ethernet communication with a host PC running Mint WorkBench. The connection uses a high level ICM (Immediate Command Mode) protocol to allow Mint commands, Mint programs and even firmware to be sent to the controller over the Ethernet network.

When operating in standard Ethernet mode, TCP/IP cannot be used to communicate with a controller on a daisy-chained network. This is due to cumulative timing errors caused by each controller's internal hub. It is necessary to connect the host PC to the controller either directly or via a switch or hub, as shown in Figure 37. A switch is preferable to a hub as it will provide faster performance when there is a large amount of data being transmitted.

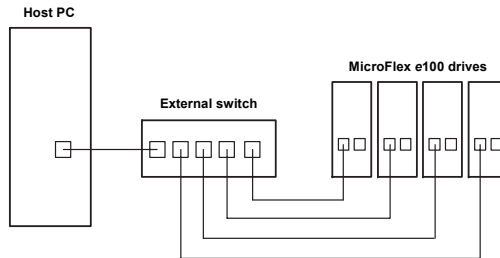

Figure 37: Connecting to drives using TCP/IP in standard Ethernet mode

Note: The MicroFlex e100 and other ABB equipment use 'big endian' word order and byte order for Modbus protocols. If this is incompatible with other Modbus equipment, the word and byte order for the MicroFlex e100 can be changed in Mint WorkBench. See the Mint WorkBench help file for details.

When operating in EPL mode, in conjunction with an EPL compatible router, the host PC *can* use TCP/IP to communicate with controllers on a daisy-chained network. In this situation, the router will use TCP/IP only within EPL's asynchronous time slots. See the Mint help file for further details.

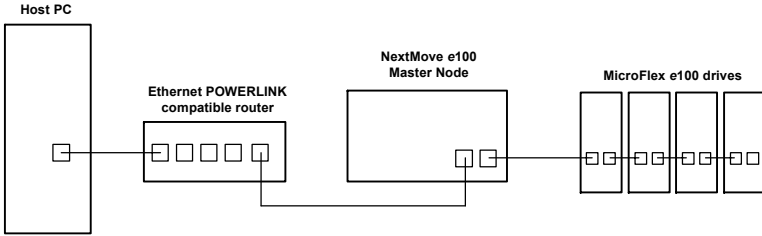

Figure 38: Connecting to daisy-chained drives using TCP/IP and EPL mode

5.5.2 Ethernet POWERLINK

MicroFlex e100 supports the deterministic Ethernet POWERLINK (EPL) protocol. This protocol provides very precise and predictable 'real-time' communication over a 100 Mbit/s (100Base-T) Fast Ethernet (IEEE 802.3u) connection. This makes it suitable for the transmission of control and feedback signals between the MicroFlex e100 and other EPL enabled controllers such as NextMove e100. The EPL protocol implemented in Mint is based on the CANopen DS402 Device Profile for Drives and Motion Control. The structure of the physical network is informal so does not need to reflect the logical relationship between nodes.

MicroFlex e100 incorporates a built-in repeating hub, providing two ports for connection to other equipment. This allows nodes to be connected as a 'daisy-chain' network. Each node introduces a delay of approximately 500 ns, so in time-critical applications this could limit the number of nodes in a chain. Propagation delays due to cabling should also be considered. Hubs may be used if necessary, but Ethernet switches must not be used in EPL networks as their timing cannot be guaranteed.

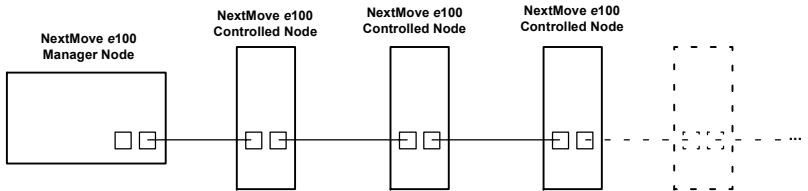

Figure 39: Simple daisy-chained EPL network

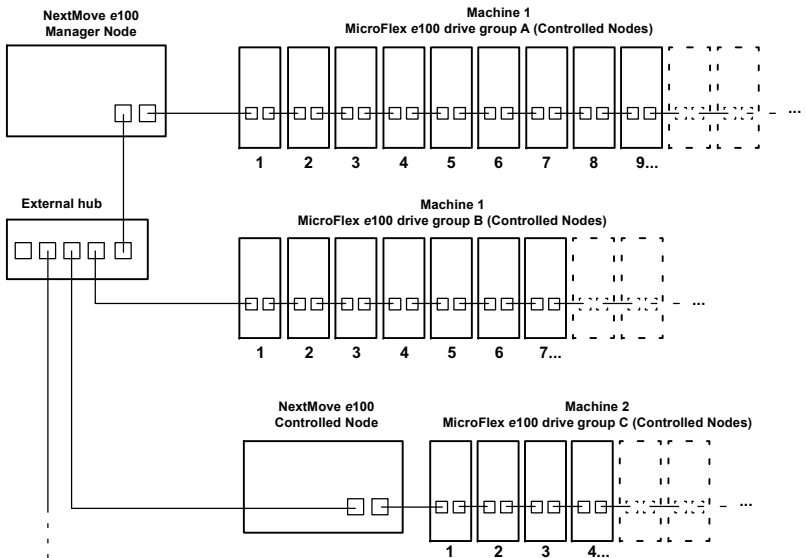
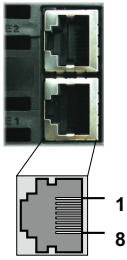

Figure 40: Example multi-branch EPL network

5.5.3 Ethernet connectors

Ethernet connections are made using the identical RJ45 Ethernet receptacles.



Location		E1 & E2	
Pin	Name	Description	
1	TX+	Transmit+	
2	TX-	Transmit-	
3	RX+	Receive+	
4	-	(NC)	
5	-	(NC)	
6	RX-	Receive-	
7	-	(NC)	
8	-	(NC)	

To connect the MicroFlex e100 to other EPL devices use CAT5e Ethernet cables - either S/UTP (screened unshielded twisted pairs) or preferably S/FTP (screened fully shielded twisted pairs).

The MicroFlex e100 Ethernet interface is galvanically isolated from the rest of the MicroFlex e100 circuitry by magnetic isolation modules incorporated in each of the Ethernet connectors. This provides protection up to 1.5 kV. The connector/cable screen is connected directly to the chassis earth of the MicroFlex e100. Termination components are incorporated in each of the Ethernet connectors, so no further termination is required. To ensure CE compliance, especially where Ethernet cables are frequently unplugged, all Ethernet cables should be bonded to the metal backplane using conductive clamps at one point at least (see section D.1.7). Cables longer than 3 m should be S/FTP cables bonded to the metal backplane at both ends. Do not run Ethernet cables close to AC supply cables, motor power cables, or other sources of noise as this can sometimes cause spurious errors to be reported.

Cables may be up to 100 m (328 ft) long. Two varieties of CAT5e cable are available; 'straight' or 'crossed'. Straight cables have the TX pins of the connector at one end of the cable wired to the TX pins of the RJ45 connector at the other end of the cable. Crossover cables have the TX pins of the connector at one end of the cable wired to the RX pins of the RJ45 connector at the other end of the cable. Provided the network consists of only ABB EPL controllers and drives (and any hub), straight or crossed cables may be used. This is because many Ethernet devices, including hubs and all ABB EPL products, incorporate Auto-MDIX switching technology which automatically compensates for the wiring of the straight cable. However, if other manufacturer's EPL nodes are included in the network, crossover cables should be used as recommended by the Ethernet POWERLINK Standardization Group (EPSPG). Similarly, if a host PC does not provide Auto-MDIX on its Ethernet port, then a crossed cable will be essential for the connection between the PC and an EPL router, e.g. OPT036-501.

The EPL network supports the 100Base-TX (100 Mbit/s) system only, so attempting to connect slower 10Base-T (10 Mbit/s) nodes will cause a network error.

5.6 CAN interface

The CAN bus is a serial based network originally developed for automotive applications, but now used for a wide range of industrial applications. It offers low-cost serial communications with very high reliability in an industrial environment; the probability of an undetected error is 4.7×10^{-11} . It is optimized for the transmission of small data packets and therefore offers fast update of I/O devices (peripheral devices) connected to the bus.

The CAN protocol only defines the physical attributes of the network, i.e. the electrical, mechanical, functional and procedural parameters of the physical connection between devices. The higher level network functionality on MicroFlex e100 is defined by the CANopen protocol, one of the most used standards for machine control.

5.6.1 CAN connector



Location	OPT 1 Mating connector: 9-pin female D-type	
Pin	Name	Description
1	-	(NC)
2	CAN-	CAN channel negative
3	CAN GND	Ground/earth reference for CAN signals
4	-	(NC)
5	Shield	Shield connection
6	CAN GND	Ground/earth reference for CAN signals
7	CAN+	CAN channel positive
8	-	(NC)
9	CAN V+	CAN power V+ (12-24 V)

5.6.2 CAN wiring

A very low error bit rate over CAN can only be achieved with a suitable wiring scheme, so the following points should be observed:

- The two-wire data bus line may be routed parallel, twisted and/or shielded, depending on EMC requirements. ABB recommends a twisted pair cable with the shield/screen connected to the connector backshell, in order to reduce RF emissions and provide immunity to conducted interference.
- The bus must be terminated at both ends only (not at intermediate points) with resistors of a nominal value of 120 Ω. This is to reduce reflections of the electrical signals on the bus, which helps a node to interpret the bus voltage levels correctly. If the MicroFlex e100 is at the end of the network then ensure that a 120 Ω resistor is fitted (normally inside the D-type connector).
- All cables and connectors should have a nominal impedance of 120 Ω. Cables should have a length related resistance of 70 mΩ/m and a nominal line delay of 5 ns/m.

- The maximum bus length depends on the bit-timing configuration (baud rate). The table opposite shows the approximate maximum bus length (worst-case), assuming 5 ns/m propagation delay and a total effective device internal in-out delay of 210 ns at 1 Mbit/s, 300 ns at 500 - 250 Kbit/s, 450 ns at 125 Kbit/s and 1.5 ms at 50 - 10 Kbit/s.

CAN Baud Rate	Maximum Bus Length
1 Mbit/s	25 m
500 Kbit/s	100 m
250 Kbit/s	250 m
125 Kbit/s	500 m
100 Kbit/s	600 m
50 Kbit/s	1000 m
20 Kbit/s	2500 m ⁽¹⁾
10 Kbit/s	5000 m ⁽¹⁾

(1) For bus lengths greater than about 1000 m, bridge or repeater devices may be needed.

- The compromise between bus length and CAN baud rate must be determined for each application. The CAN baud rate can be set using the `BUSBAUD` keyword. It is essential that all nodes on the network are configured to run at the same baud rate.
- The wiring topology of a CAN network should be as close as possible to a single line/bus structure. However, stub lines are allowed provided they are kept to a minimum (<0.3 m at 1 Mbit/s).
- The 0 V connection of all of the nodes on the network must be tied together through the CAN cabling. This ensures that the CAN signal levels transmitted by MicroFlex e100 or CAN peripheral devices are within the common mode range of the receiver circuitry of other nodes on the network.

5.6.2.1 Opto-isolation

On the MicroFlex e100, the CAN channel is opto-isolated. A voltage in the range 12-24 V DC must be applied between pin 9 (+24 V) and pin 3 or 6 (0 V) of the CAN connector. From this supply, an internal voltage regulator provides the 5 V at 100 mA required for the isolated CAN circuit. To allow easy connection of the 12-24 V DC supply, adaptor part OPT-CNV002 can be used, allowing connection by ordinary CAT 5e Ethernet cables. The adaptor also provides flying lead connections for the application of the CAN power supply.

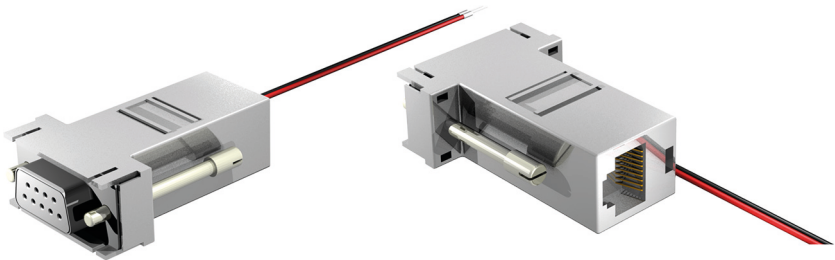

Figure 41: OPT-CNV002

Alternatively, a connector such as the Phoenix Contact SUBCON-PLUS F3 (part 2761871) provides a 9-pin D-type female connector with easily accessible terminal block connections (see Figure 42). CAN cables supplied by ABB are 'category 5' and have a maximum current rating of 1 A, so the maximum number of MicroFlex e100 units that may be used on one network is limited to 10.

5.6.3 CANopen

ABB has implemented a CANopen protocol in Mint (based on the 'Communication Profile' CiA DS-301) which supports both direct access to device parameters and time-critical process data communication. The MicroFlex e100 can use CANopen to extend its Mint capabilities by becoming a CANopen master to a variety of devices including:

- Digital and analog I/O devices that are compliant with the 'CANopen device profile for generic I/O modules' (CiA DS-401).
- Baldor HMI (Human Machine Interface) operator panels, which are based on the old 'CANopen device profile for Human Machine Interfaces' (DS403 – no longer supported by the CiA).
- Third party encoder devices that are compliant with the 'CANopen device profile for encoders' (CiA-DS406).
- Other ABB controllers with CANopen support for peer-to-peer access using extensions to the CiA specifications (DS301 and DS302).

Any other CANopen devices that are also based on the 'Communication Profile' CiA DS-301 should be able to communicate with MicroFlex e100, but with limited capabilities, e.g. no PDO communications possible, only SDO.

The functionality and characteristics of all ABB CANopen devices are defined in individual standardized (ASCII format) Electronic Data Sheets (EDS) which can be found on the Mint Motion Toolkit CD (OPT-SW-001), or downloaded from www.abbmotion.com. Figure 42 shows a typical CANopen network with a NextMove e100 manager node, one MicroFlex e100 slave node and a Baldor HMI operator panel:

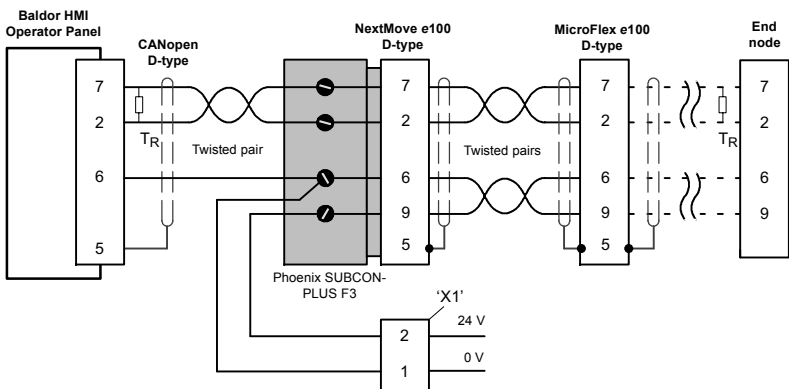

Figure 42: Typical CANopen network connections

Note: The MicroFlex e100 CAN channel is opto-isolated, so a voltage in the range 12-24 V must be applied between pin 9 and pin 6 of the OPT 1 connector.

The configuration and management of a CANopen network must be carried out by a single node acting as the network manager (for example NextMove e100), or by a third party CANopen manager device. Up to 126 CANopen nodes (node IDs 2 to 127) can be added to the network by the manager node using the Mint `NODESCAN` keyword. If successful, the

nodes can then be connected to using the Mint `CONNECT` keyword. Any network and node related events can then be monitored using the Mint `BUS1` event.

Note: All CAN related Mint keywords are referenced to CANOpen using the 'bus' dot parameter. For CANOpen the 'bus' dot parameter must be set to 1. Please refer to the Mint help file for further details on CANOpen, Mint keywords and dot parameters.

5.7 Other I/O

5.7.1 Node ID selector switches



The MicroFlex e100 has two selector switches which determine the unit's node ID on EPL networks. Each switch has 16 positions, allowing selection of the hexadecimal values 0 - F. In combination, the two switches allow node IDs of 0 - 255 (hexadecimal FF) to be selected. The switch labelled 'HI' sets the high nibble (half byte), and the switch labelled 'LO' sets the low nibble. The following table lists all node IDs from 0 to 255 with the equivalent HI and LO switch settings:

Node ID	HI	LO	Node ID	HI	LO	Node ID	HI	LO	Node ID	HI	LO
0	0	0	64	4	0	128	8	0	192	C	0
1	0	1	65	4	1	129	8	1	193	C	1
2	0	2	66	4	2	130	8	2	194	C	2
3	0	3	67	4	3	131	8	3	195	C	3
4	0	4	68	4	4	132	8	4	196	C	4
5	0	5	69	4	5	133	8	5	197	C	5
6	0	6	70	4	6	134	8	6	198	C	6
7	0	7	71	4	7	135	8	7	199	C	7
8	0	8	72	4	8	136	8	8	200	C	8
9	0	9	73	4	9	137	8	9	201	C	9
10	0	A	74	4	A	138	8	A	202	C	A
11	0	B	75	4	B	139	8	B	203	C	B
12	0	C	76	4	C	140	8	C	204	C	C
13	0	D	77	4	D	141	8	D	205	C	D
14	0	E	78	4	E	142	8	E	206	C	E
15	0	F	79	4	F	143	8	F	207	C	F
16	1	0	80	5	0	144	9	0	208	D	0
17	1	1	81	5	1	145	9	1	209	D	1
18	1	2	82	5	2	146	9	2	210	D	2
19	1	3	83	5	3	147	9	3	211	D	3
20	1	4	84	5	4	148	9	4	212	D	4
21	1	5	85	5	5	149	9	5	213	D	5
22	1	6	86	5	6	150	9	6	214	D	6
23	1	7	87	5	7	151	9	7	215	D	7
24	1	8	88	5	8	152	9	8	216	D	8
25	1	9	89	5	9	153	9	9	217	D	9
26	1	A	90	5	A	154	9	A	218	D	A
27	1	B	91	5	B	155	9	B	219	D	B
28	1	C	92	5	C	156	9	C	220	D	C
29	1	D	93	5	D	157	9	D	221	D	D

Node ID	HI	LO	Node ID	HI	LO	Node ID	HI	LO	Node ID	HI	LO
30	1	E	94	5	E	158	9	E	222	D	E
31	1	F	95	5	F	159	9	F	223	D	F
32	2	0	96	6	0	160	A	0	224	E	0
33	2	1	97	6	1	161	A	1	225	E	1
34	2	2	98	6	2	162	A	2	226	E	2
35	2	3	99	6	3	163	A	3	227	E	3
36	2	4	100	6	4	164	A	4	228	E	4
37	2	5	101	6	5	165	A	5	229	E	5
38	2	6	102	6	6	166	A	6	230	E	6
39	2	7	103	6	7	167	A	7	231	E	7
40	2	8	104	6	8	168	A	8	232	E	8
41	2	9	105	6	9	169	A	9	233	E	9
42	2	A	106	6	A	170	A	A	234	E	A
43	2	B	107	6	B	171	A	B	235	E	B
44	2	C	108	6	C	172	A	C	236	E	C
45	2	D	109	6	D	173	A	D	237	E	D
46	2	E	110	6	E	174	A	E	238	E	E
47	2	F	111	6	F	175	A	F	239	E	F
48	3	0	112	7	0	176	B	0	240	F	0
49	3	1	113	7	1	177	B	1	241	F	1
50	3	2	114	7	2	178	B	2	242	F	2
51	3	3	115	7	3	179	B	3	243	F	3
52	3	4	116	7	4	180	B	4	244	F	4
53	3	5	117	7	5	181	B	5	245	F	5
54	3	6	118	7	6	182	B	6	246	F	6
55	3	7	119	7	7	183	B	7	247	F	7
56	3	8	120	7	8	184	B	8	248	F	8
57	3	9	121	7	9	185	B	9	249	F	9
58	3	A	122	7	A	186	B	A	250	F	A
59	3	B	123	7	B	187	B	B	251	F	B
60	3	C	124	7	C	188	B	C	252	F	C
61	3	D	125	7	D	189	B	D	253	F	D
62	3	E	126	7	E	190	B	E	254	F	E
63	3	F	127	7	F	191	B	F	255	F	F

Figure 43: Decimal node IDs and equivalent HI / LO hexadecimal switch settings

Note: If the node ID selector switches are set to FF, the node's firmware will not run on power up. However, Mint WorkBench will still be able to detect the MicroFlex e100 and download new firmware.

In many networking environments, the node ID may also be referred to as the *address*. On EPL networks, limitations apply to the node IDs that may be selected:

- Node ID 0 (00) is reserved for special purposes and cannot be used.
- Node IDs 1 - 239 (01 - EF) cause the node to become a 'controlled node', a node that will accept commands from the manager node.
- Node ID 240 (F0) is reserved for the EPL manager node (for example NextMove e100) so cannot be used by MicroFlex e100.
- Node IDs 241 - 255 (F1 - FF) are reserved for special purposes and cannot be used.

For all other communication channels such as CANopen and USB, the node ID is set in software. Each channel can have a different node ID, selected using the Mint WorkBench Connectivity Wizard or the Mint `BUSNODE` keyword. See the Mint help file for details.

5.8 Connection summary - recommended system wiring

As an example, Figure 44 shows the recommended wiring necessary for the MicroFlex e100 to control a motor, while conforming to the EMC requirements for 'industrial' environments.

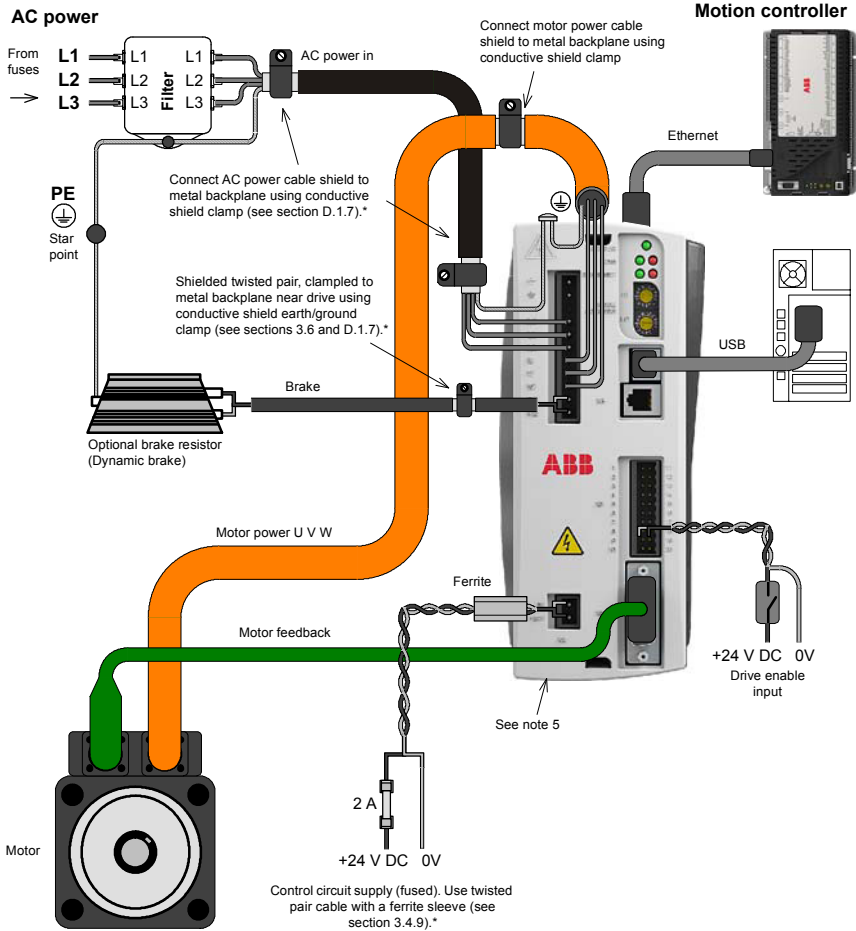

Notes:

1. The MicroFlex e100 should be mounted on an earthed metal backplane.
2. Ensure cables do not obstruct airflow to the heatsink.
3. Motor represents a typical Baldor BSM motor. Linear motors may also be controlled by MicroFlex e100
4. Conductive shield earth/ground clamps are not supplied.
5. The threaded holes in the top and bottom of the case are for M4 bolts no longer than 11 mm (0.43 in) in length.
6. When using single phase supplies it may be necessary to reverse the AC power filter - see section 3.4.8.2.

Figure 44: Recommended system wiring

6.1 Introduction

Before powering the MicroFlex e100 you will need to connect it to the PC using a USB or Ethernet cable and install the Mint WorkBench software. This includes a number of applications and utilities to allow you to configure, tune and program the MicroFlex e100. Mint WorkBench and other utilities can be found on the Mint Motion Toolkit CD (OPT-SW-001), or downloaded from www.abbmotion.com.

6.1.1 Connecting the MicroFlex e100 to the PC

The MicroFlex e100 can be connected to the PC using either USB (recommended) or TCP/IP.

To use USB, connect a USB cable between a PC USB port and the MicroFlex e100 USB port. Your PC must be using Windows XP, Windows Vista or Windows 7.

To use TCP/IP, connect a CAT5e Ethernet cable between the PC and one of the MicroFlex e100 Ethernet ports.



You cannot connect an ordinary office PC to the MicroFlex e100 without first altering the PC's Ethernet adapter configuration. However, if you have installed a second Ethernet adapter dedicated for use with the MicroFlex e100, then this adapter's configuration can be altered without affecting the PC's office Ethernet connection. If you are unsure about making changes to your PC's Ethernet adapter configuration, or are prevented by user permission levels, ask your I.T. administrator to assist you.



If there is a EPL manager node (node ID 240) on the Ethernet network, then the network will be operating in EPL mode. This means any TCP/IP connection from the PC must pass through an EPL compatible router.

6.1.2 Installing Mint WorkBench

The Windows user account requires administrative user rights to install Mint WorkBench.

6.1.2.1 To install Mint WorkBench from the CD (OPT-SW-001)

1. Insert the CD into the drive.
2. After a few seconds the setup wizard should start automatically. If the setup wizard does not appear, select Run... from the Windows Start menu and type

```
d:\start
```

where **d** represents the drive letter of the CD device.

Follow the on-screen instructions to install Mint WorkBench.

6.1.2.2 To install Mint WorkBench from the website

To install Mint WorkBench from www.abbmotion.com, download the application and run it.

6.2 Starting the MicroFlex e100

If you have followed the instructions in the previous sections, you should now have connected all the power sources, inputs and outputs, and the Ethernet cable or USB cable linking the PC to the MicroFlex e100.

6.2.1 Preliminary checks

Before you apply power for the first time, it is very important to verify the following:

- Disconnect the load from the motor until instructed to apply a load. If this cannot be done, disconnect the motor wires at connector X1.
- Verify that the AC line voltage matches the specification of the MicroFlex e100.
- Inspect all power connections for accuracy, workmanship and tightness.
- Verify that all wiring conforms to applicable codes.
- Verify that the MicroFlex e100 and motor are properly earthed/grounded.
- Check all signal wiring for accuracy.

6.2.2 Power on checks

If at any time the Status LED flashes red, the drive has detected a fault - see section 7.

1. Turn on the 24 V DC supply.
2. Turn on the AC supply.
3. Within approximately 20-30 seconds, the test sequence should complete and the Status LED should illuminate red. If the Status LED is not lit then re-check the power supply connections. If the Status LED flashes red, this indicates that the MicroFlex e100 has detected a fault - see section 7. Note that after downloading firmware, startup may take more than 1 minute.
4. If the motor wires were disconnected in section 6.2.1, turn off the AC supply and reconnect the motor wires. Turn on the AC supply.
5. To allow the Commissioning Wizard to function, the drive enable signal will need to be present on connector X3 to allow the MicroFlex e100 to be enabled (see section 5.2.1). If you do not wish to enable the MicroFlex e100 yet, the Commissioning Wizard will inform you when this step is necessary.

6.2.3 Installing the USB driver

When the MicroFlex e100 is powered, Windows will automatically detect the controller and request the driver.

1. Windows will prompt for the driver. On Windows XP, click Next on the following dialogs and Windows will locate and install the driver. For Windows Vista and newer, no interaction should be necessary.
2. When installation is complete, a new Motion Control category will be listed in Windows Device Manager.



The MicroFlex e100 is now ready to be configured using Mint WorkBench.

Note: If the MicroFlex e100 is later connected to a different USB port on the host computer, Windows may report that it has found new hardware. Either install the driver files again for the new USB port, or connect the MicroFlex e100 to the original USB port where it will be recognized in the usual way.

6.2.4 Configuring the TCP/IP connection (optional)

If you have connected the MicroFlex e100 to the PC using the Ethernet connection, it will be necessary to alter the PC's Ethernet adapter configuration to operate correctly with the MicroFlex e100.



You cannot connect an ordinary office PC to the MicroFlex e100 without first altering the PC's Ethernet adapter configuration. However, if you have installed a second Ethernet adapter dedicated for use with the MicroFlex e100, then this adapter's configuration can be altered without affecting the PC's office Ethernet connection. If you are unsure about making changes to your PC's Ethernet adapter configuration, or are prevented by user permission levels, ask your I.T. administrator to assist you.

The following explanation assumes the PC is connected directly to the MicroFlex e100, and not across an intermediate Ethernet network. If you wish to attempt the connection through an intermediate Ethernet network, then the network administrator must be consulted to ensure that the necessary IP addresses will be allowed and are not already allocated on the network. The MicroFlex e100 has a fixed IP address of the format 192.168.100.xxx. The last number, xxx, is the decimal value defined by the MicroFlex e100's node ID selector switches (see section 5.7.1).

1. On the Windows Start menu, select Settings, Network Connections.
2. In the Network Connections Window, right-click the 'Local Area Connection' entry for the required Ethernet adapter and choose Properties.
3. In the Local Area Connection Properties dialog, in the 'This connection uses the following items' list, select the 'Internet Protocol (TCP/IP)' entry and click **Properties**.
4. In the Internet Protocol (TCP/IP) Properties dialog, on the General tab, make a note of the existing settings. Click **Advanced...** and make a note of any existing settings. Click the Alternate Configuration tab and make a note of any existing settings.
5. On the General tab, choose the 'Use the following IP address' option.
6. In the IP address box, enter the IP address 192.168.100.241. This is the IP address that will be assigned to the Ethernet adapter. The value 241 is deliberately chosen as it is outside the range that can be used by MicroFlex e100, so avoiding possible conflicts.
7. In the Subnet mask box, enter 255.255.255.0 and click **OK**.
Click **OK** to close the Local Area Connection Properties dialog.
8. On the Windows Start menu, select Command Prompt (often found under Accessories).
9. In the Command Prompt window, type PING 192.168.100.16, where the final value (16 in this example) is the value selected by the MicroFlex e100's node ID selector switches. In this example, the MicroFlex e100's switches would be set to HI=1 LO=0, which represents hexadecimal 10, equivalent to decimal 16 (see section 5.7.1 for a list of hexadecimal / decimal equivalents). A reply message should be returned.
10. It should now be possible to run Mint WorkBench and connect to the MicroFlex e100 using the Ethernet / TCP/IP connection.

6.3 Mint Machine Center

The Mint Machine Center (MMC) is installed as part of the Mint WorkBench software. It is used to view the network of connected controllers in a system. Individual controllers and drives are configured using Mint WorkBench.

Note: If you have only a single MicroFlex e100 connected to your PC, then MMC is probably not required. Use Mint WorkBench (see section 6.4) to configure the MicroFlex e100.

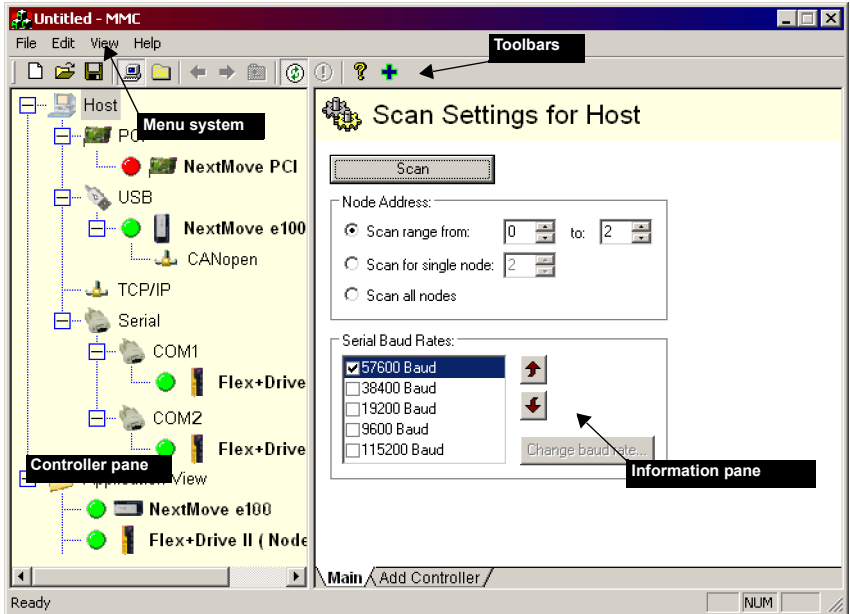

Figure 45: The Mint Machine Center software

The Mint Machine Center (MMC) provides an overview of the controller network currently accessible by the PC. The MMC contains a controller pane on the left, and an information pane on the right. In the controller pane select the Host item, then in the information pane click **Scan**. This causes MMC to scan for all connected controllers. Clicking once on a controller's name causes various options to be displayed in the information pane. Double-clicking on a controller's name launches an instance of Mint WorkBench that is automatically connected to the controller.

Application View allows the layout and organization of controllers in your machine to be modelled and described on screen. Controllers can be dragged onto the Application View icon, and renamed to give a more meaningful description, for example "Conveyor 1, Packaging Controller". Drives that are controlled by another product, such as a NextMove e100, can be dragged onto the NextMove e100 icon itself, creating a visible representation of the machine. A text description for the system and associated files can be added, and the resulting layout saved as an "MMC Workspace". When you next need to administer the system, simply loading the workspace automatically connects to all the required controllers. See the Mint help file for full details of MMC.

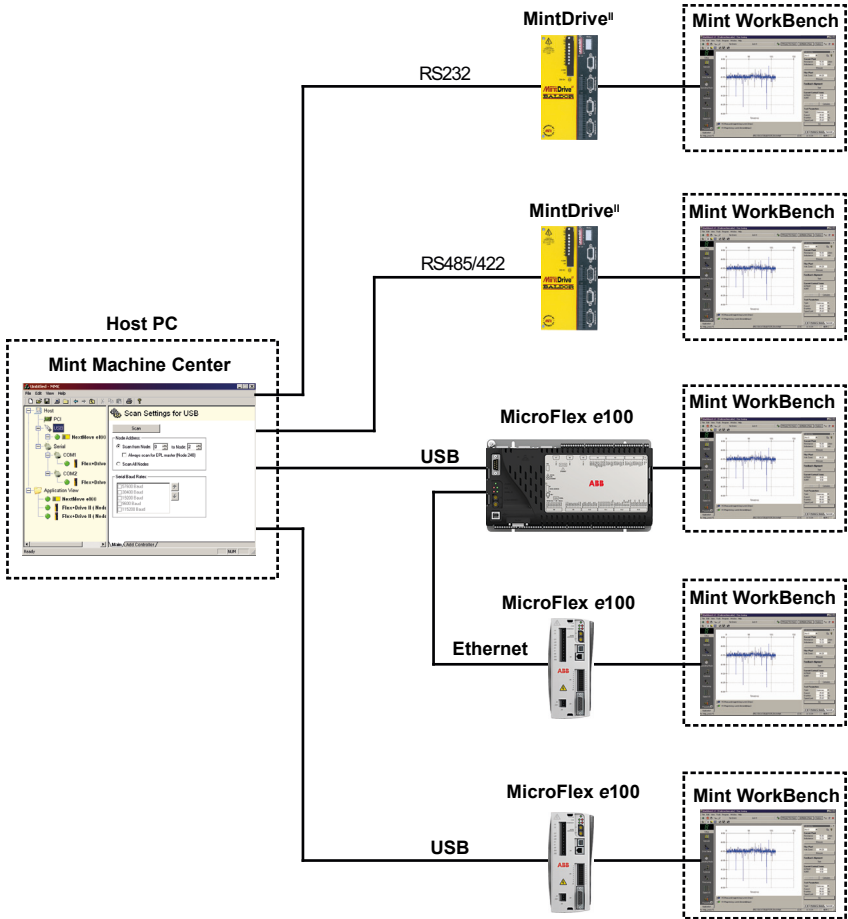
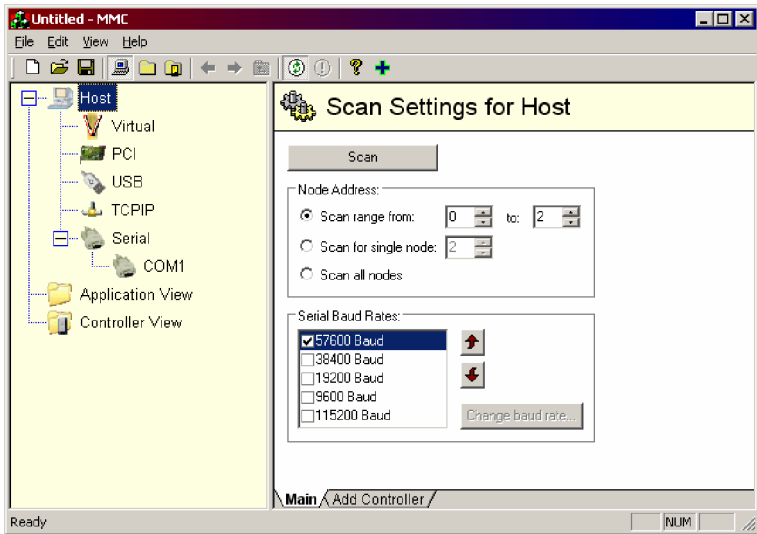

Figure 46: Typical network visibility provided by Mint Machine Center

6.3.1 Starting MMC

1. On the Windows Start menu, select Programs, Mint WorkBench, Mint Machine Center.



2. In the controller pane, ensure that Host is selected. In the information pane, click **Scan**.

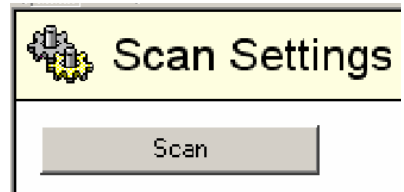

3. When the search is complete, click once on 'MicroFlex e100' in the controller pane to select it, then double click to open an instance of Mint WorkBench. The MicroFlex e100 will be already connected to the instance of Mint WorkBench, ready to configure.

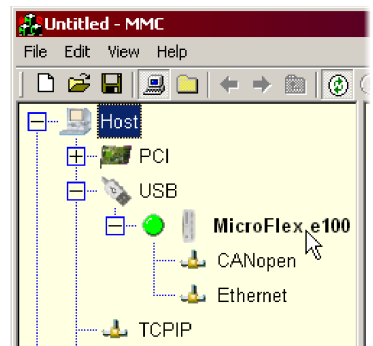

6.4 Mint WorkBench

Mint WorkBench is a fully featured application for commissioning the MicroFlex e100. The main Mint WorkBench window contains a menu system, the Toolbox and other toolbars. Many functions can be accessed from the menu or by clicking a button - use whichever you prefer. Most buttons include a 'tool-tip'; hold the mouse pointer over the button (don't click) and its description will appear.

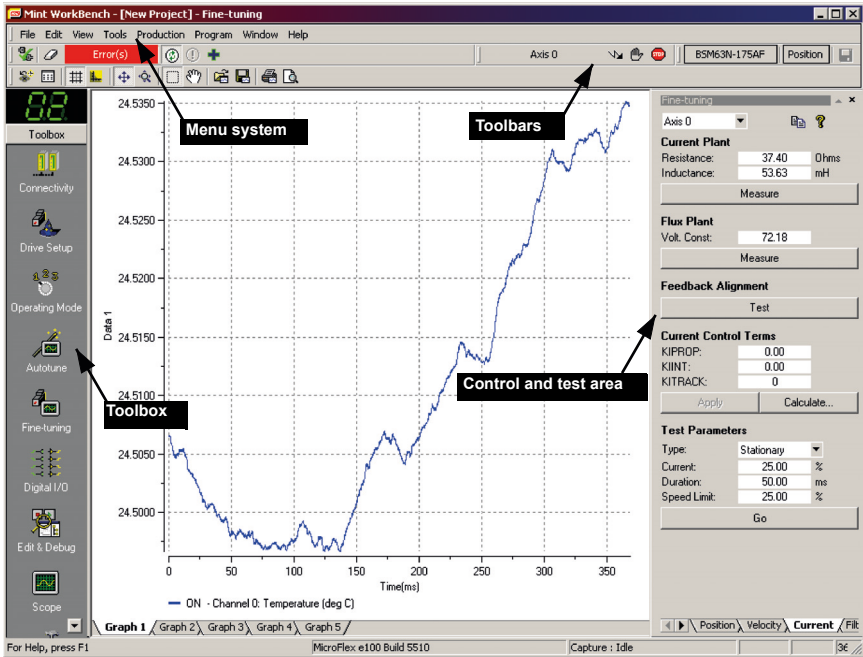

Figure 47: The Mint WorkBench software

6.4.1 Help file

Mint WorkBench includes a comprehensive help file that contains information about every Mint keyword, how to use Mint WorkBench and background information on motion control topics. The help file can be displayed at any time by pressing F1. On the left of the help window, the Contents tab shows the tree structure of the help file. Each book icon contains a number of topics. The Index tab provides an alphabetic list of all topics in the file, and allows you to search for them by name. The Search tab allows you to search for words or phrases appearing anywhere in the help file. Many words and phrases are underlined and highlighted with a color (normally blue) to show that they are links. Just click on the link to go to an associated keyword. Most keyword topics begin with a list of relevant *See Also* links.

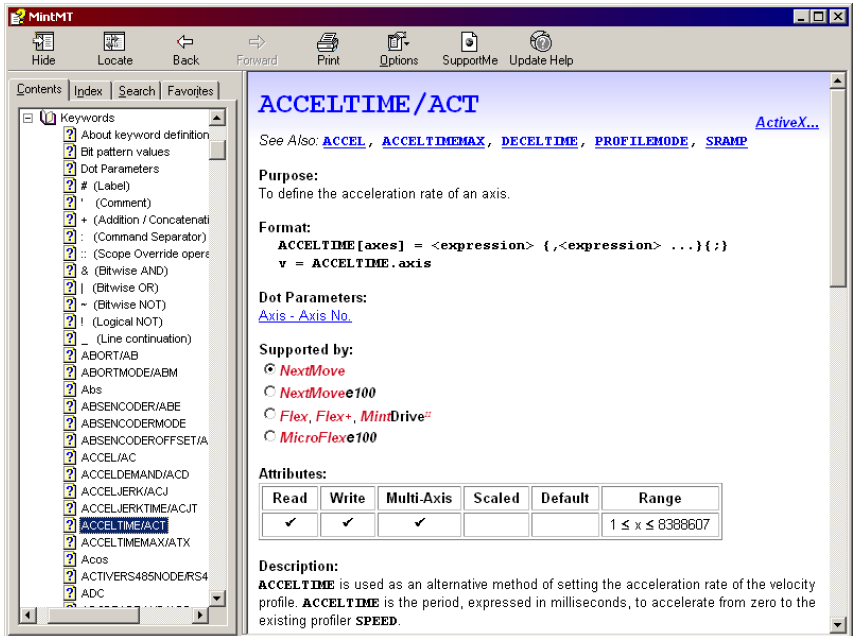



Figure 48: The Mint WorkBench help file

For help on using Mint WorkBench, click the **Contents** tab, then click the small plus sign  beside the **Mint WorkBench & Mint Machine Center** book icon. Double click a  topic name to display it.

6.4.2 Starting Mint WorkBench

Note: If you have already used MMC to start an instance of Mint WorkBench then the following steps are unnecessary. Go to section 6.4.3 to continue configuration.

1. On the Windows Start menu, select Programs, Mint WorkBench, Mint WorkBench.

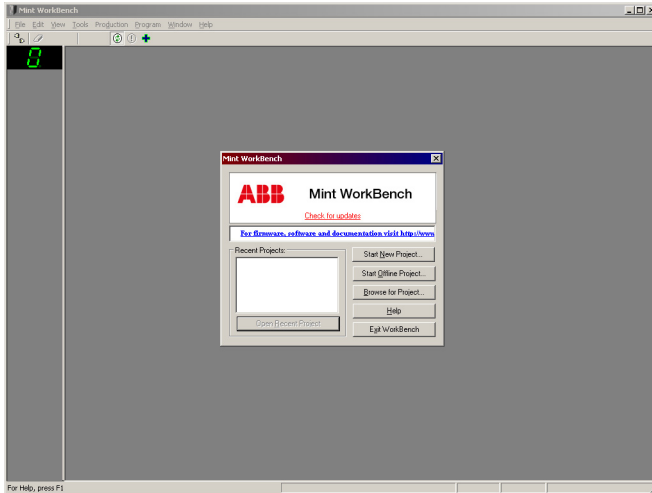

2. In the opening dialog box, click **Start New Project...**

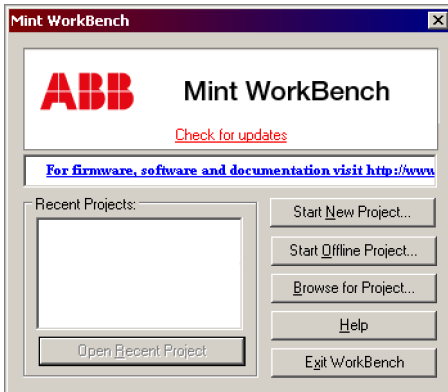

3. In the Select Controller dialog, click **Scan** to search for the MicroFlex e100. Mint WorkBench will scan the PC's ports for the MicroFlex e100.

When the search is complete, click 'MicroFlex e100' in the list to select it, then click **Select**.

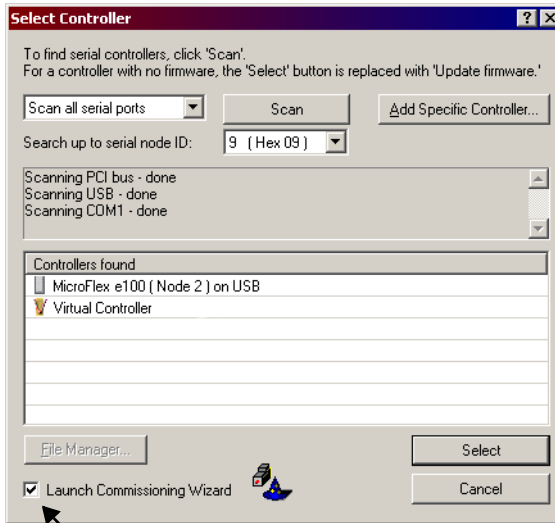

This check box is already selected for you. When you click **Select**, it means that the Commissioning Wizard will start automatically.

Note: If the MicroFlex e100 is not listed, check the USB or Ethernet cable between the MicroFlex e100 and the PC. Check that the MicroFlex e100 is powered correctly. Click **Scan** to re-scan the ports.

6.4.3 Commissioning Wizard

Each type of motor and drive combination has different performance characteristics. Before the MicroFlex e100 can be used to control the motor accurately, the MicroFlex e100 must be 'tuned'. This is the process where the MicroFlex e100 powers the motor in a series of tests. By monitoring the drive's output and the feedback from the motor's encoder, the MicroFlex e100 can make small adjustments to the way it controls the motor. This information is stored in the MicroFlex e100 and can be uploaded to a file if necessary.

The Commissioning Wizard provides a simple way to tune the MicroFlex e100 and create the necessary configuration information for your drive/motor combination, so this is the first tool that should be used. If necessary, any of the parameters set by the Commissioning Wizard can be adjusted manually after commissioning is complete.

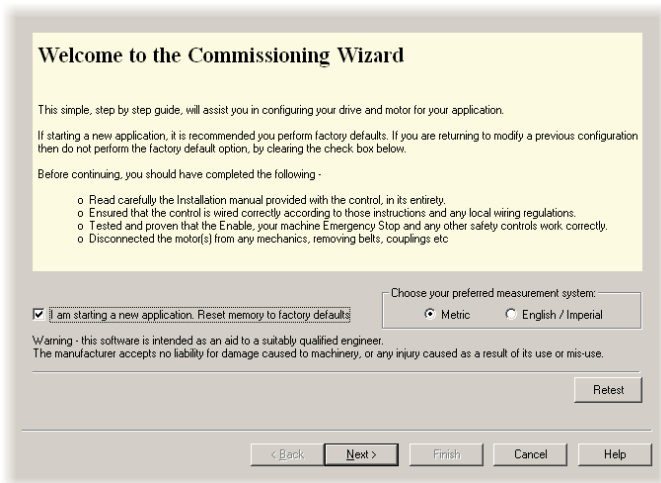

6.4.3.1 Using the Commissioning Wizard

Each screen of the Commissioning Wizard requires you to enter information about the motor, drive or application. Read each screen carefully and enter the required information. When you have completed a screen, click **Next >** to display the next screen. If you need to change something on a previous screen, click the **< Back** button. The Commissioning Wizard remembers information that you have entered so you will not need to re-enter everything if you go back to previous screens. If you need extra help, click **Help** or press F1.

Connectivity:

If you wish to change a node ID or baud rate then click in the appropriate cell and select an alternative value. When multiple controllers are to be connected on the same bus they must each have a unique node ID. For example, if two MicroFlex e100s and a NextMove e100 are connected to the PC using individual USB connections, they must each be assigned a unique USB nodeID.

Select your Motor Type:

Select the type of motor that you are using (rotary or linear).

Select your Motor:

Carefully enter the details of your motor. If you are using a Baldor Motor, the catalog number or spec. number can be found stamped on the motor's nameplate. If you are using a motor with EnDat feedback, are not using a Baldor motor, or need to enter the specification manually, select the *I would like to define a custom motor option*.

Confirm Motor and Drive information:

If you entered the catalog or spec. number on the previous page, it is not necessary to change anything on this screen; all the required data will be entered already. However, if you selected the *I would like to define a custom motor option*, it will be necessary to enter the required information before continuing.

Motor Feedback:

If you entered the catalog or spec. number on the previous page, it is not necessary to change anything on this screen; the feedback resolution will be entered already. However, if you selected the *I would like to define a custom motor option*, it will be necessary to enter the feedback resolution before continuing.

Drive Setup complete:

This screen confirms that drive setup is complete.

Select Operating Mode and Source:

In the Operating Mode section, choose the required operating mode. In the Reference Source section, it is important to select 'Host/Mint' as the Control Ref. Source. This will allow the Autotune Wizard to operate correctly, and allow further initial testing to be performed using Mint WorkBench. Although the MicroFlex e100 may eventually be controlled over Ethernet POWERLINK (EPL), the 'EPL' reference source should only be selected *after* the MicroFlex e100 has been commissioned and is ready to add to the EPL network. This can be selected by choosing the Operating Mode tool in the Toolbox.

Application Limits:

It is not necessary to change anything on this screen. However, if you wish to adjust the application peak current (*App. Peak Current*) and/or application maximum speed (*App. Max. Speed*), then click in the appropriate box and enter a value.

Scale Factor:

It is not necessary to change anything on this screen. However, it is recommended to select a user unit for position, velocity and acceleration. This allows Mint WorkBench to display distances, speeds and accelerations using meaningful units, instead of encoder counts. For example, selecting a *Position User Unit* of Revs (r) will mean that all position values entered or displayed in Mint WorkBench will represent revolutions. The *Position Scale Factor* value will change automatically to represent the required scale factor (the number of quadrature counts per revolution). If you need to use an alternative unit, for example degrees, type "Degrees" in the *Position User Unit* box and enter a suitable value in the *Position Scale Factor* box. Separate velocity and acceleration units can also be defined. See the Mint help file for more information about scale factors.

Profile Parameters:

It is not necessary to change anything on this screen. However, if you wish to adjust the parameters for any control method, click in the appropriate box and enter a value.

Operation setup complete:

This screen confirms that operation setup is complete.

During commissioning, changed parameters are stored in the MicroFlex e100's temporary (volatile) memory. For this reason, the Commissioning Wizard will occasionally prompt you to save the parameters. Selecting **Yes** will cause the parameters to be saved in the MicroFlex e100's non-volatile flash memory, to be retained when power is removed. If you select **No**, you must remember to use the *Save Drive Parameters* function before removing power from the MicroFlex e100; this function is available on the Tools menu, or by clicking the  button on the Mode toolbar. Saving parameters into flash memory will cause the MicroFlex e100 to be reset.

6.4.3.2 Autotune Wizard

The Autotune Wizard tunes the MicroFlex e100 for optimal performance with the attached motor. This removes the need for manual fine-tuning of the system, although in some critical applications this still may be required.

Click **Options...** to configure optional autotuning parameters. These include Triggered Autotune which allows the autotuning process to be delayed until the drive is enabled.



The motor will move during autotuning. For safety it is advisable to disconnect any load from the motor during initial autotuning. The motor can be tuned with the load connected after the Commissioning Wizard has finished.

Autotune

Click **START** to begin the auto-tuning process. Mint WorkBench will take measurements from the motor and then perform small test moves.

For further information about tuning with the load attached, see section 6.4.5.

6.4.4 Further tuning - no load attached

The Autotune Wizard calculates many parameters that allow the MicroFlex e100 to provide good control of the motor. In some applications, these parameters may need to be fine-tuned to provide the exact response that you require.

1. Click the Fine-tuning icon in the Toolbox on the left of the screen.

The Fine-tuning window is displayed at the right of the screen. This already shows some of the parameters that have been calculated by the Commissioning Wizard.



The main area of the Mint WorkBench window displays the capture window. When further tuning tests are performed, this will display a graph representing the response.

2. The Fine-tuning window has a number of tabs the bottom.



Click on the Velocity tab.

Note: Some tabs may not be available depending on the configuration mode you selected in the Commissioning Wizard.

3. In the Test Parameters area at the bottom of the tab, click in the Move Type drop down box and select Forward.

In the Velocity and Distance boxes, enter values to create a short move. The values you enter depend on the velocity scaling factor that was selected in the Commissioning Wizard. This example assumes the velocity scaling factor was selected as Revs Per Minute (rpm), so entering a value of 1000 here will create a move with a velocity of 1000 rpm. Similarly, assuming the position scaling factor had been set to Revolutions (r), the value 10 will create a move lasting for 10 revolutions of the motor.

Test Parameters

Move Type:	Forward	▼
Velocity:	1000	uu/utu
Distance:	10	uu

4. Click **Go** to start the test move. Mint WorkBench will perform the test move and display a graph of the result.

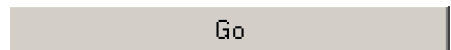

5. Click on the graph labels to turn off unwanted traces. Leave just Demand Velocity and Measured Velocity turned on.

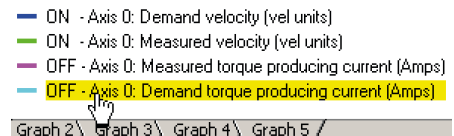

Note: The graph that you see will not look exactly the same as the following graph! Remember that each motor has a different response.

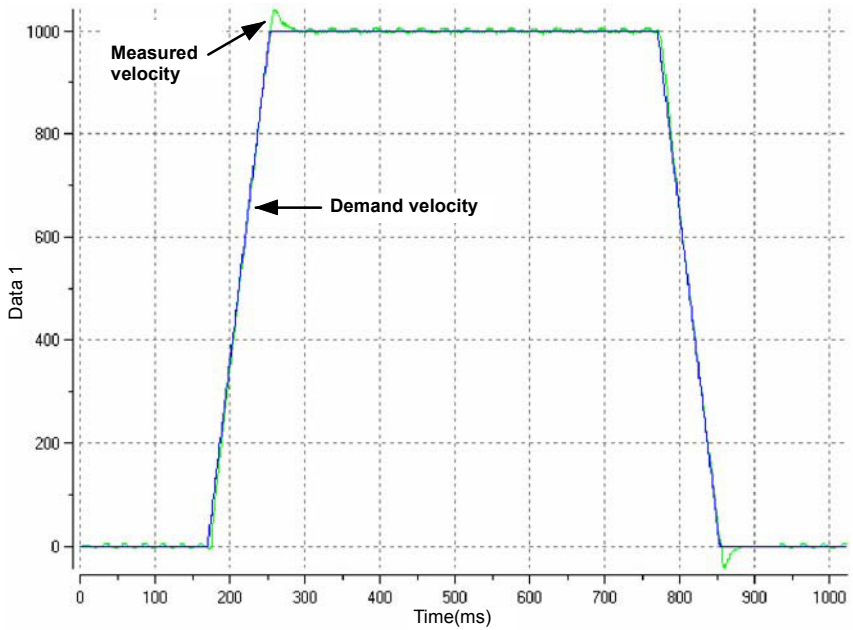

Figure 49: Typical autotuned response (no load)

Figure 49 shows that the response reaches the demand quickly and only overshoots the demand by a small amount. This can be considered an ideal response for most systems.

For further information about tuning with the load attached, see section 6.4.5.

6.4.5 Further tuning - with load attached

To allow Mint WorkBench to adjust the basic tuning to compensate for the intended load, it is necessary to attach the load to the motor and then perform the autotune procedure again.

1. Attach the load to the motor.
2. Click the Autotune icon in the Toolbox on the left of the screen.



3. Click the Autotune on load check box.



4. Click **START** to begin the auto-tuning process. Mint WorkBench will take measurements from the motor and then perform small test moves.



5. Click the Fine-tuning icon in the Toolbox on the left of the screen.



6. In the Velocity tab's Test Parameters area, ensure the same move parameters are entered and then click **Go** to start the test move.

Mint WorkBench will perform the test move and display a graph of the result.

Test Parameters

Move Type:	Forward	▼
Velocity:	1000	uu/utu
Distance:	10	uu

6.4.6 Optimizing the velocity response

It may be desirable to optimize the default autotuned response to better suit your application. The following sections describe the two main tuning issues and how to correct them.

6.4.6.1 Correcting overshoot

Figure 50 shows a response where the measured velocity overshoots the demand by a significant amount.

1. Go to the Fine-tuning window's Velocity tab.

To reduce the amount of overshoot, click **Calculate...** and increase the bandwidth using the slider control. Alternatively, type a larger value in the Bandwidth box.

Click **OK** to close the Bandwidth dialog.

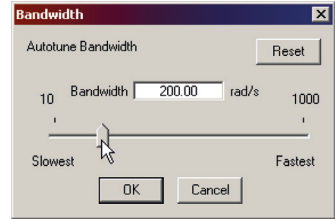

2. Click **Go** to start the test move. Mint WorkBench will perform the test move and display a graph of the result.

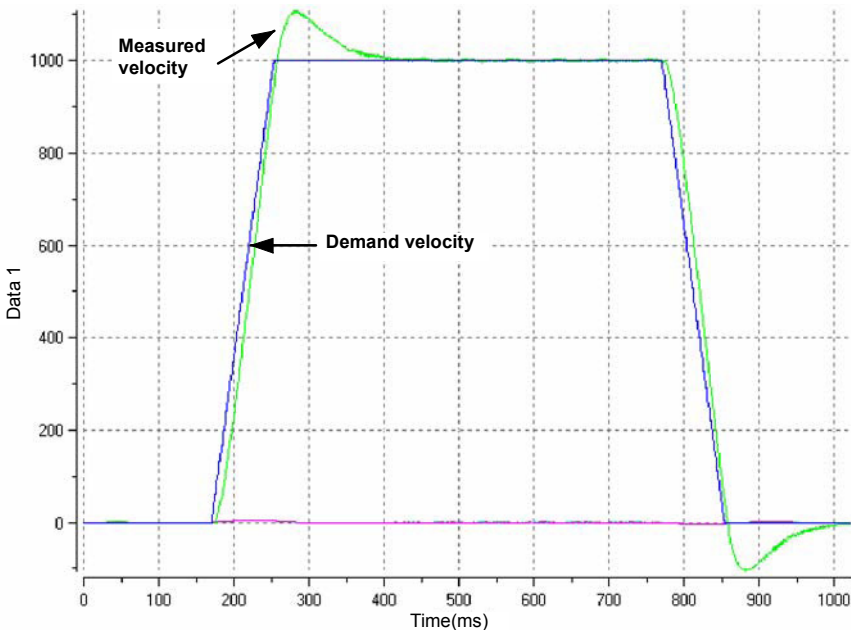
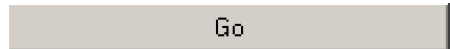

Figure 50: Velocity overshoots demand

6.4.6.2 Correcting zero-speed noise in the velocity response

Figure 51 shows a response where there is very little overshoot but a significant amount of zero-speed noise. This can cause undesirable humming or ringing in the motor.

1. Go to the Fine-tuning window's Velocity tab.

To reduce the amount of noise, click **Calculate...** and decrease the bandwidth using the slider control. Alternatively, type a smaller value in the Bandwidth box.

Click **OK** to close the Bandwidth dialog.

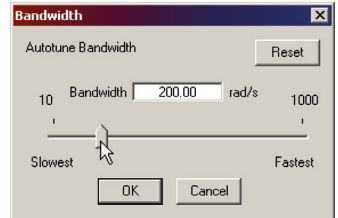

2. Click **Go** to start the test move. Mint WorkBench will perform the test move and display a graph of the result.

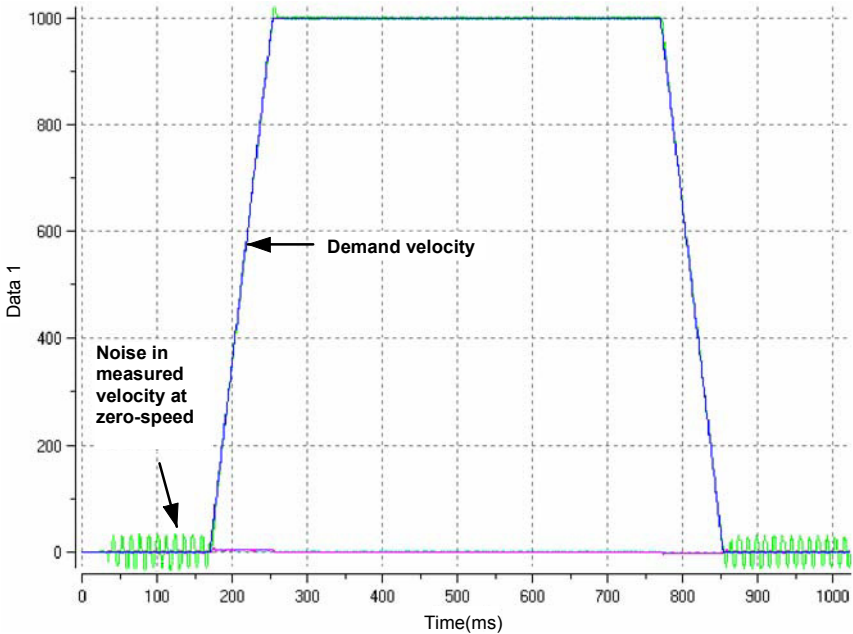
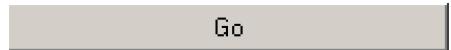

Figure 51: Zero-speed noise

6.4.6.3 Ideal velocity response

Repeat the tests described in sections 6.4.6.1 and 6.4.6.2 until the optimal response is achieved. Figure 52 shows an ideal velocity response. There is only a small amount of overshoot and very little zero-speed noise.

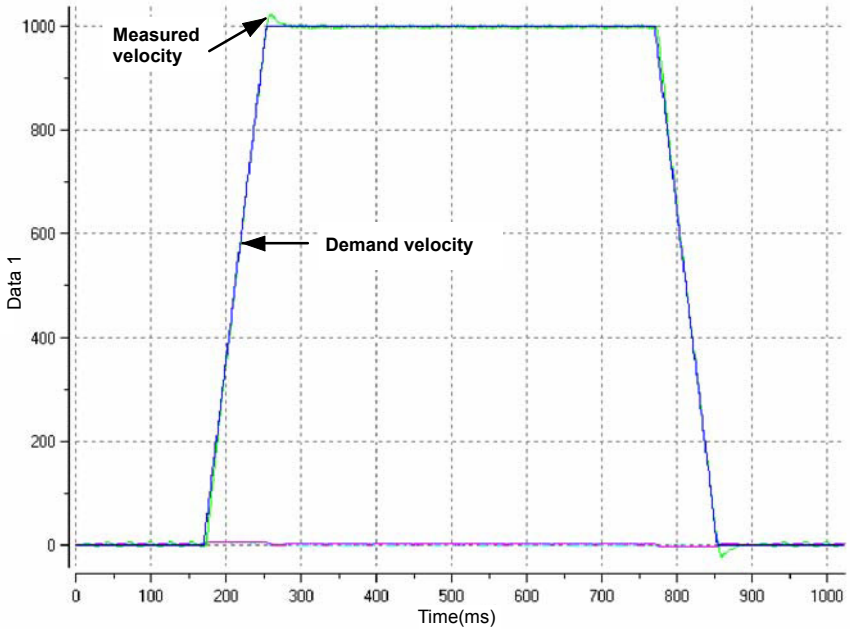

Figure 52: Ideal velocity response

6.4.7 Performing test moves - continuous jog

This section tests the basic operation of the drive and motor by performing a continuous jog.

Note: To stop a move in progress, click the red stop button or the drive enable button on the toolbar. Alternatively, use the Mint WorkBench 'Red Stop Button' feature.

1. Check that the Drive enable button is pressed (down).



2. In the Toolbox, click the Edit & Debug icon.



3. Click in the Command window.

4. Type:
`JOG (0) =10`

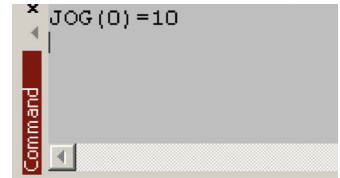

This will cause the motor to move continuously at 10 units per second. In Mint WorkBench, look at the Spy window located on the right of the screen. Check that the axis tab is selected. The Spy window's Velocity display should show 10 (approximately). If there seems to be very little motor movement, it is probably due to the scale factor. In the Commissioning Wizard, on the Select Scale Factor page, if you did *not* adjust the scale factor then the current unit of movement is feedback counts per second. Depending on the motor's feedback device, 10 feedback counts per second could equate to a very small velocity. Issue another JOG command using a larger value, or use the Operating Mode Wizard to select a suitable scale factor (e.g. 4000 if the motor has a 1000 line encoder, or 10,000 for a 2500 line encoder).

5. To stop the test, type:
`STOP (0)`

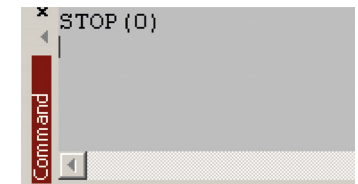

6. If you have finished testing click the Drive Enable button to disable the drive.



6.4.8 Performing test moves - relative positional move

This section tests the basic operation of the drive and motor by performing a positional move.

Note: To stop a move in progress, click the red stop button or the drive enable button on the toolbar. Alternatively, use the Mint WorkBench 'Red Stop Button' feature.

1. Check that the Drive enable button is pressed (down).



2. In the Toolbox, click the Edit & Debug icon.



3. Click in the Command window.

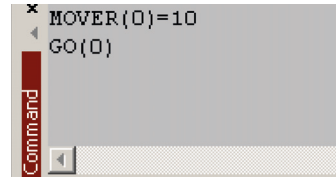

4. Type:
MOVER(0)=10
GO(0)

This will cause the motor to move to a position 10 units from its current position.

The move will stop when completed.

5. If you have finished testing click the Drive Enable button to disable the drive.



6.5 Further configuration

Mint WorkBench provides a number of other tools for testing and configuring the MicroFlex e100. Every tool is explained fully in the help file. Press F1 to display the help file, then navigate to the Mint WorkBench book. Inside this is the Toolbox book.

6.5.1 Fine-tuning tool

The Commissioning Wizard calculates many parameters that allow the MicroFlex e100 to provide basic control of the motor. These parameters may need to be fine-tuned to provide the exact response that you require. The Fine-tuning screen allows you to do this.

1. Click the Fine-tuning icon in the Toolbox on the left of the screen.

The Fine-tuning window is displayed at the right of the screen. This already shows some of the parameters that have been calculated by the Commissioning Wizard.



The main area of the Mint WorkBench window displays the capture window. When further tuning tests are performed, this will display a graph representing the response.

2. The Fine-tuning window has several tabs at the bottom - Position, Velocity, Current, SRamp etc. Click on a tab to select it.

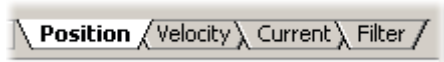

Click the tab for the type of tests you wish to perform.

Note: Some tabs may not be available depending on the configuration mode you selected in the Commissioning Wizard.

6.5.1.1 Fine-tuning - Position tab

The Position tab allows you to adjust position loop settings and perform test moves. The Commissioning Wizard may have already set some of these values, depending on the type of system selected on the mode screen.

Enter new values in the required boxes and then click **Apply** to download the values to the MicroFlex e100. To perform tests, go to the Test Parameters area at the bottom of the tab. Enter test values and then click **Go** to perform the test move. If you need help, just press F1 to display the help file.

6.5.1.2 Fine-tuning - Velocity tab

The Velocity tab allows you to set velocity loop gains and perform test moves. The Commissioning Wizard may have already set some of these values, depending on the type of system selected on the mode screen.

Enter new values in the required boxes and then click **Apply** to download the values to the MicroFlex e100. To perform tests, go to the Test Parameters area at the bottom of the tab. Enter test values and then click **Go** to perform the test move. If you need help, just press F1 to display the help file.

6.5.1.3 Fine-tuning - Current tab

The Current tab allows you to set current loop gains and perform test moves. The Commissioning Wizard may have already set some of these values, depending on the type of system selected on the mode screen. Normally, it should not be necessary to alter these values.

Enter new values in the required boxes and then click **Apply** to download the values to the MicroFlex e100. To perform tests, go to the Test Parameters area at the bottom of the tab. Enter test values and then click **Go** to perform the test move. If you need help, just press F1 to display the help file.

The additional **Measure** and **Feedback alignment** buttons can be used to repeat the same measurement and alignment tests that are used by the Commissioning Wizard.

6.5.1.4 Fine-tuning - SRamp / Simple SRamp tabs

The SRamp and Simple SRamp tabs allow you to set parameters and perform test moves using S-ramped profiles. These profiles cause the normal trapezoidal move profile to be modified to create smoother acceleration and deceleration.

Enter new values in the required boxes and then click **Preview** to see an example of the intended move profile. Click **Go** to perform the test move. If you need help, just press F1 to display the help file.

6.5.1.5 Fine-tuning - Filter tab

The Filter tab allows you to set the properties of the MicroFlex e100's two torque filters. It should only be necessary to use the torque filters if there is a particular problem with resonant frequencies in the load.

Enter new values in the required boxes and then click **Apply** to download the values to the MicroFlex e100. To perform tests, go to the Frequency Response Params area at the bottom of the tab. Enter test values and then click **Go** to perform the test move. If you need help, just press F1 to display the help file.

6.5.1.6 Fine-tuning - Flux tab

The Flux tab allows you to set gains and perform test moves when using induction motors.

Enter new values in the required boxes and then click **Apply** to download the values to the MicroFlex e100. Click **Go** to perform the test move. If you need help, just press F1 to display the help file.

6.5.2 Parameters tool

The Parameters tool can be used to view or change most of the drive's parameters.

1. Click the Parameters icon in the Toolbox on the left of the screen.

The main area of the Mint WorkBench window displays the Parameters editor screen.



Items listed with a grey **RO** icon are Read Only so cannot be changed.

Items listed with a green **FD** icon are currently set to their Factory Default value.

Items listed with a yellow **C** icon have been altered from their factory default value, either during the commissioning process or by the user.

2. In the parameters tree, scroll to the required item. Click on the small + sign beside the item's name.

The list will expand to show all items in the category.

Click on the item you wish to edit.

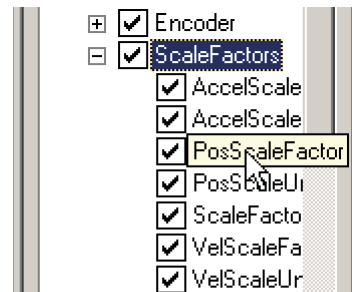

3. The adjacent table will list the chosen item. Click in the Active Table cell and enter a value. This immediately sets the parameter, which will remain in the MicroFlex e100 until another value is defined. The icon to the left of the item will become yellow to indicate that the value has been changed.

Parameter	Active Table
PosScaleFactor ...	C 10000.00 Counts

Many of the MicroFlex e100's parameters are set automatically by the Commissioning Wizard, or when tests are performed in the fine-tuning window.

6.5.3 Spy window

The Spy window can be used to monitor and capture parameters in real-time. If you tried the test moves in section 6.4.7 or 6.4.8 then you have already seen the Spy window, as it is displayed in conjunction with Edit & Debug mode. See the Mint help file for full details of each tab.

1. Click the Edit & Debug icon in the Toolbox on the left of the screen.



The Spy Window is displayed on the right of the screen. Click on the tabs at the bottom of the window to select the required function.

2. The Axis tab displays the five most commonly monitored parameters, together with the state of special purpose inputs and outputs.

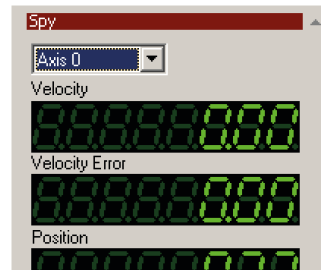

3. The I/O tab displays the state of all the digital inputs and outputs.

Clicking on an output LED will toggle the output on/off.

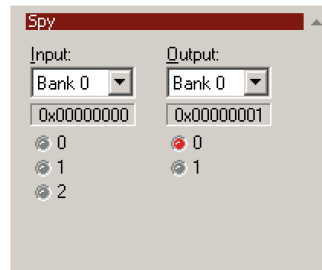

4. The Monitor tab allows up to six parameters to be selected for monitoring.

Click in a drop down box to select a parameter.

At the bottom of the Monitor tab, real-time data capture can be configured.

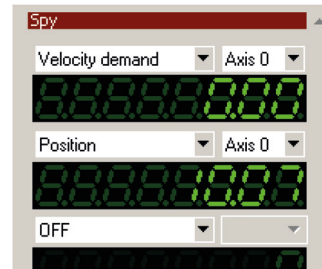

6.5.4 Other tools and windows

Remember, for help on each tool just press F1 to display the help file, then navigate to the Mint WorkBench book. Inside this is the Toolbox book.

- **Edit & Debug Tool**

This tool provides a work area including the Command window and Output window. The Command window can be used to send immediate Mint commands to the MicroFlex e100. If you tried the test moves in section 6.4.7 or 6.4.8, then you have already used Edit & Debug mode. Press Ctrl+N to open a new Mint program editing window.

```

x print temperature(0)
  24.000000
torqueref(0) = 50
  
```

- **Scope Tool**

Displays the capture screen. This screen is also shown when the Fine-tuning tool is selected.

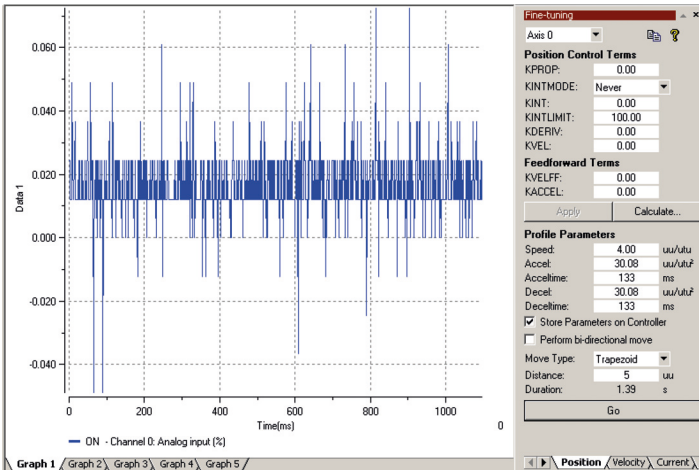

- **Digital I/O**

Allows you to configure the active states and special assignments for all the digital inputs and outputs.

See section 5.2.2.1 or 5.2.3.1 for important details about using a digital input as a home input.

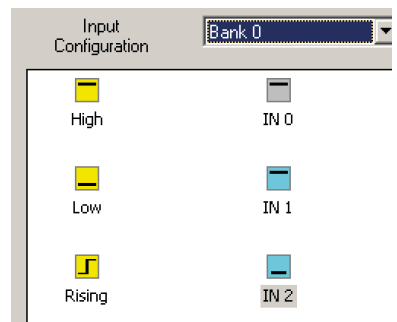

7.1 Introduction

This section explains common problems that may be encountered, together with possible solutions. If you want to know the meaning of the LED indicators, see section 7.2.

7.1.1 Problem diagnosis

If you have followed all the instructions in this manual in sequence, you should have few problems installing the MicroFlex e100. If you do have a problem, read this section first. In Mint WorkBench, use the Error Log tool to view recent errors and then check the help file. If you cannot solve the problem or the problem persists, the SupportMe feature can be used.

7.1.2 SupportMe feature

The SupportMe feature is available from the Help menu or by clicking the  button on the motion toolbar. SupportMe can be used to gather information which can then be e-mailed, saved as a text file, or copied to another application. The PC must have e-mail facilities to use the e-mail feature. If you prefer to contact technical support by telephone or fax, contact details are provided at the front of this manual. Please have the following information ready:

- The serial number of your MicroFlex e100 (if known).
- Use the Help, SupportMe menu item in Mint WorkBench to view details about your system.
- The catalog and specification numbers of the motor that you are using.
- A clear description of what you are trying to do, for example trying to establish communications with Mint WorkBench or trying to perform fine-tuning.
- A clear description of the symptoms that you can observe, for example the Status LED, error messages displayed in Mint WorkBench, or errors reported by the Mint error keywords `ERRORREADCODE` or `ERRORREADNEXT`.
- The type of motion generated in the motor shaft.
- Give a list of any parameters that you have setup, for example the motor data you entered/selected in the Commissioning Wizard, the gain settings generated during the tuning process and any gain settings you have entered yourself.

7.1.3 Power-cycling the MicroFlex e100





The term “Power-cycle the MicroFlex e100” is used in the Troubleshooting sections. Remove the 24 V supply, wait for the MicroFlex e100 to power down completely (the Status LED will turn off), then re-apply the 24 V supply.

7.2 MicroFlex e100 indicators



7.2.1 STATUS LED



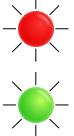



The Status LED indicates general MicroFlex e100 status information.

	<p>Solid green: Drive enabled (normal operation).</p>																										
	<p>Flickering / blinking green: Firmware download / update in progress.</p>																										
	<p>Solid red: Drive disabled, but no errors are latched.</p>																										
	<p>Flashing red: Powerbase fault or error(s) present. The number of flashes indicates which error has occurred. For example, to display error 3 (overcurrent trip), the LED flashes 3 times at 0.1 second intervals, followed by a 0.5 second pause. The sequence is repeated continuously.</p> <table border="0" data-bbox="257 598 1008 1013"> <thead> <tr> <th style="text-align: left;"><u>Error code</u> (no. of flashes)</th> <th style="text-align: left;"><u>Meaning</u></th> </tr> </thead> <tbody> <tr><td>1</td><td>DC bus overvoltage trip.</td></tr> <tr><td>2</td><td>IPM (integrated power module) trip.</td></tr> <tr><td>3</td><td>Overcurrent trip.</td></tr> <tr><td>4</td><td>Overspeed trip.</td></tr> <tr><td>5</td><td>Feedback trip.</td></tr> <tr><td>6</td><td>Motor overload (I^2t) trip.</td></tr> <tr><td>7</td><td>Overtemperature trip.</td></tr> <tr><td>8</td><td>Drive overload (I_t) trip.</td></tr> <tr><td>9</td><td>Following error trip.</td></tr> <tr><td>10</td><td>Error input triggered.</td></tr> <tr><td>11</td><td>Phase search error.</td></tr> <tr><td>12</td><td>All other errors, including: Internal supply error, encoder supply error, parameter restore failure, power base not recognized.</td></tr> </tbody> </table> <p>If multiple errors occur at the same time, the lowest numbered error code will be flashed. For example, a MicroFlex e100 which has tripped on both feedback error (code 5) and over-current error (code 3) will flash error code 3. If the drive is already displaying an error code when a new error with a lower code occurs, the drive will start flashing the new code. Note that undervoltage trip does not appear in the table because it is already indicated by the green/red flashing state. If an undervoltage trip occurs in conjunction with another error, the drive will flash the code of the additional error. Further details about error codes can be found in the Mint WorkBench help file. Press F1 and locate the <i>Error Handling</i> book.</p>	<u>Error code</u> (no. of flashes)	<u>Meaning</u>	1	DC bus overvoltage trip.	2	IPM (integrated power module) trip.	3	Overcurrent trip.	4	Overspeed trip.	5	Feedback trip.	6	Motor overload (I^2t) trip.	7	Overtemperature trip.	8	Drive overload (I_t) trip.	9	Following error trip.	10	Error input triggered.	11	Phase search error.	12	All other errors, including: Internal supply error, encoder supply error, parameter restore failure, power base not recognized.
<u>Error code</u> (no. of flashes)	<u>Meaning</u>																										
1	DC bus overvoltage trip.																										
2	IPM (integrated power module) trip.																										
3	Overcurrent trip.																										
4	Overspeed trip.																										
5	Feedback trip.																										
6	Motor overload (I^2t) trip.																										
7	Overtemperature trip.																										
8	Drive overload (I_t) trip.																										
9	Following error trip.																										
10	Error input triggered.																										
11	Phase search error.																										
12	All other errors, including: Internal supply error, encoder supply error, parameter restore failure, power base not recognized.																										
	<p>Alternate red/green flashing: Undervoltage warning (no AC power), but no errors are latched.</p> <p>The DC-bus voltage has dropped below the powerbase undervoltage level (see <code>DRIVEBUSUNDERVOLTS</code>). This error will only be generated if the drive is in the enabled state. Check the AC power is connected.</p>																										

7.2.2 CAN LEDs

The CAN LEDs display the overall condition of the CANopen interface, once the startup sequence has completed. The LED codes conform to the CAN in Automation (CiA) DR303_3 indicator standard. The green LED indicates the state of the node's internal CANopen 'state machine'. The red LED indicates the state of the physical CANopen bus.







Green (run)	
	Off: Node initializing or not powered.
	1 flash: Node in STOPPED state. 3 flashes: Software is being downloaded to the node. Continuous flashing: Node in PRE-OPERATIONAL state. Flickering (very fast flashing): Auto-baudrate detection or LSS services in progress; flickers alternately with red LED.
	Continuously illuminated, not flashing: Node in OPERATIONAL state.
Red (error)	
	Off: No errors or not powered.
	1 flash: Warning - too many error frames. 2 flashes: Guard event or heartbeat event has occurred. 3 flashes: The SYNC message has not been received within the timeout period. Flickering (very fast flashing): Auto-baudrate detection or LSS services in progress; flickers alternately with green LED.
	Continuously illuminated, not flashing: The node's CAN controller is in the BUS OFF state, preventing it from taking part in any CANopen communication.

7.2.3 ETHERNET LEDs

The ETHERNET LEDs display the overall condition of the Ethernet interface once the startup sequence has completed. The LED codes conform to the Ethernet POWERLINK Standardization Group (EPSG) standard at the time of production.



Green (status)	
	Off: Node in NOT ACTIVE state. The controlled node is waiting to be triggered by the manager node.
	<p>1 flash: Node in PRE-OPERATIONAL1 state. EPL mode is starting.</p> <p>2 flashes: Node in PRE-OPERATIONAL2 state. EPL mode is starting.</p> <p>3 flashes: Node in READY TO OPERATE state. The node is signalling its readiness to operate.</p> <p>Blinking (continuous flashing): Node in STOPPED state. The controlled node has been deactivated.</p> <p>Flickering (very fast flashing): Node in BASIC ETHERNET state (EPL is not operating, but other Ethernet protocols may be used).</p>
	Continuously illuminated, not flashing: Node in OPERATIONAL state. EPL is operating normally.
Red (error)	
	Off: EPL is working correctly.
	Continuously illuminated: An error has occurred.

7.2.4 Communication

Status LED is off:

- Check that the 24 V DC control circuit supply is connected correctly to connector X2 and is switched on.

ETHERNET LEDs blinking green and red simultaneously:

- Does the MicroFlex e100 have firmware in it? If you tried to download new firmware and the download failed, the controller may not have firmware. Download new firmware.

Mint WorkBench fails to detect the MicroFlex e100:

- Ensure that the MicroFlex e100 is powered and the Status LED is illuminated (see section 7.2.1).
- Check that the Ethernet or USB cable is connected between the PC and MicroFlex e100.
- Try an alternative cable or different port on the PC.
- In the “Search up to Nodexx” option in Mint WorkBench’s Select Controller dialog, check that the MicroFlex e100’s node ID is not higher than the selected value, or search up to a greater node ID.
- For USB connections, check that the cable is properly connected. Check the USB connector socket pins for damage or sticking. Check that the USB device driver has been installed; a ‘USB Motion Controller’ device should be listed in Windows Device Manager.
- Check that the PC’s Ethernet port has been correctly configured for TCP/IP operation (see section 6.2.4).

7.2.5 Power on

Drive does not start when applying AC power:

- Check that the motor output phases are not short circuited. If the drive trips on a motor phase short circuit it will not restart unless AC power is removed. Remove all power from the drive, correct the short circuit and restart the drive.

The Status LED is flashing red:

- The MicroFlex e100 has detected a motion error. Click the Error button on the motion toolbar to view a description of the error. Alternatively, select the Error Log tool to view a list of errors. Click the **Clear Errors** button on the motion toolbar.

7.2.6 Mint WorkBench

The Spy window does not update:

- The system refresh has been disabled. Go to the Tools, Options menu item, select the System tab and then choose a System Refresh Rate (500 ms is recommended).

Cannot communicate with the controller after downloading firmware:

- After firmware download, always power cycle the MicroFlex e100 (remove 24 V power and then reconnect).

Mint WorkBench loses contact with MicroFlex e100 while connected using USB:

- Check that the MicroFlex e100 is powered.
- Check that a ‘USB Motion Controller’ device is listed in Windows Device Manager. If not, there could be a problem with the PC’s USB interface.

7.2.7 Tuning

Cannot enable the MicroFlex e100 because there is an error 10010:

- Check the drive enable input on connector X3 pins 9 and 19 is connected and powered correctly.

When the MicroFlex is enabled the motor is unstable:

- Check that the load is firmly coupled to the motor.
- Use the Mint WorkBench Drive Setup Wizard to confirm that the correct motor data has been entered.
- Use the Mint WorkBench Autotune Wizard to retune the motor.
- If the motor is still unstable, select the Mint WorkBench Autotune Wizard once more. Click **Options...** On the Bandwidth tab, move the Current and/or Position and Speed Control sliders to a slower position to select to a lower bandwidth. Click **OK** to exit and then start the Autotune Wizard again.

7.2.8 Ethernet

Cannot connect to the drive over TCP/IP:

- Check that there is not an EPL manager node (for example NextMove e100 with node ID 240) on the network. If there is a manager node on the network, then an EPL compatible router must be used to allow TCP/IP communication on the EPL network.
- Check that the PC's Ethernet adapter has been correctly configured, as described in section 6.2.4.

There is a slow response when issuing a command from a host application:

- The drive automatically closes the TCP/IP socket after 30 seconds of inactivity. If the socket has closed, there is a delay before the drive responds to the next command. To keep the socket open, include in your application a timed procedure, with a period of less than 30 seconds, that issues a command (e.g. reading `AAABuild`).

The Ethernet POWERLINK network does not seem to be operating correctly:

- Confirm that only one device on the network is set to be the Ethernet POWERLINK manager node (node ID 240, selector switches LO = F, HI = 0).
- Confirm that the reference source on all controlled nodes has been set to EPL in the Mint WorkBench Operating Mode Wizard, and that the manager node has been configured correctly. For a NextMove e100 manager node, this requires the System Config Wizard to be used in Mint WorkBench.
- Confirm that each device on the network has a different node ID.
- Confirm that there are no more than 10 'daisy-chained' devices on each branch of the network.

7.2.9 CANopen

The CANopen bus is 'passive':

This means that the internal CAN controller in the MicroFlex e100 is experiencing a number of Tx and/or Rx errors, greater than the passive threshold of 127. Check:

- 12-24 V is being applied between pin 9 (+24 V) and pin 6 or 3 (0 V) of the OPT 1 connector, to power the opto-isolators.
- There is at least one other CANopen node in the network.
- The network is terminated *only* at the ends, not at intermediate nodes.
- All nodes on the network are running at the same baud rate.
- All nodes have been assigned a unique node ID.
- The integrity of the CAN cables.

The MicroFlex e100 should recover from the 'passive' state once the problem has been rectified (this may take several seconds).

The CANopen bus is 'off':

This means that the internal CAN controller in the MicroFlex e100 has experienced a fatal number of Tx and/or Rx errors, greater than the off threshold of 255. At this point the node will have switched itself to a state whereby it cannot influence the bus. Check:

- 12-24 V is being applied between pin 9 (+24 V) and pin 6 or 3 (0 V) of the OPT 1 connector, to power the opto-isolators.
- There is at least one other CANopen node in the network.
- The network is terminated *only* at the ends, not at intermediate nodes.
- All nodes on the network are running at the same baud rate.
- All nodes have been assigned a unique node ID.
- The integrity of the CAN cables.

To recover from the 'off' state, the source of the errors must be removed and bus then reset. This can be done using the Mint `BUSRESET` keyword, or by resetting the MicroFlex e100.

The Manager node cannot scan/recognize a node on the network using the Mint `NODESCAN` keyword:

Assuming that the network is working correctly (see previous symptoms) and the bus is in an 'Operational' state, check:

- Only nodes that conform to DS401, DS403 and other ABB CANopen nodes are recognized by the Mint `NODESCAN` keyword. Other types of node will be identified with a type "unknown" (255) when using the Mint `NODETYPE` keyword.
- Check that the node in question has been assigned a unique node ID.
- The node must support the node guarding process. MicroFlex e100 does not support the Heartbeat process.
- Try power-cycling the node in question.

If the node in question does not conform to DS401 or DS403 and is not an ABB CANopen node, communication is still possible using a set of general purpose Mint keywords. See the Mint help file for further details.

The node has been successfully scanned / recognized by the Manager node, but communication is still not possible:

For communication to be allowed, a connection must be made to a node after it has been scanned:

- Controller nodes are automatically connected to after being scanned.
- Nodes that conform to DS401, DS403 must have the connections made manually using the Mint `CONNECT` keyword.

If a connection attempt using `CONNECT` fails then it may be because the node being connected to does not support an object which needs to be accessed in order to setup the connection.

8.1 Introduction

This section provides technical specifications for the MicroFlex e100.

8.1.1 AC input power and DC bus voltage (X1)

All models	Unit	AC input					
		1 Φ			3 Φ		
Nominal input voltage	V AC	115 or 230					
Minimum input voltage		105*					
Maximum input voltage		250					
Nominal DC-bus voltage @230 V AC input	V DC	305			321		
Nominal input current @ maximum rated output current	A	3 A	6 A	9 A	3 A	6 A	9 A
		7.5	15	22	4	8	12

* The MicroFlex e100 will operate at lower input voltages, although the drive will trip if the DC-bus voltage falls below 50 V or 60% of the no-load voltage, whichever occurs first.

8.1.1.1 Effect of AC power supply voltage on DC-bus voltage

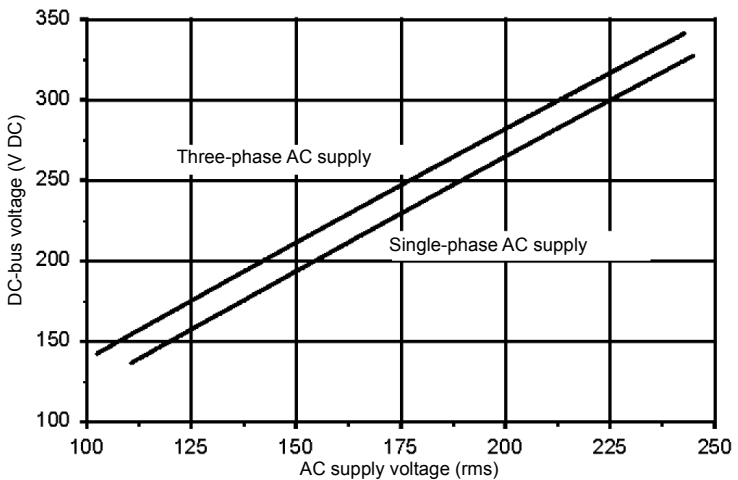

8.1.1.2 Effect of AC power supply voltage on DC-bus ripple

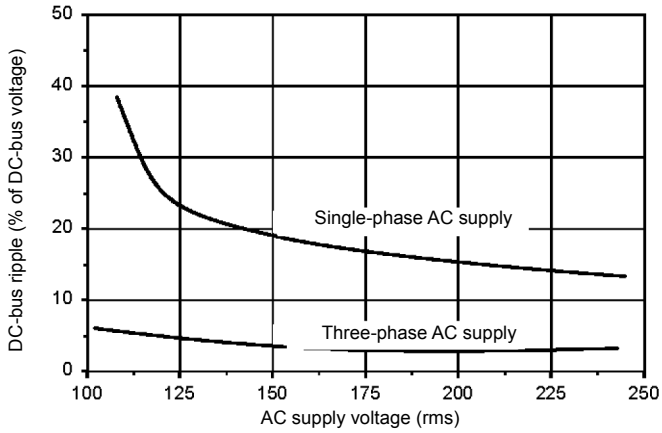

8.1.1.3 Effect of output current on DC-bus ripple voltage

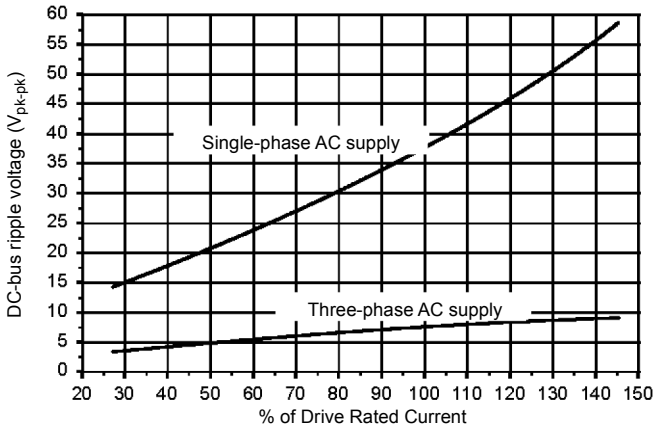

8.1.2 24 V control circuit supply input (X2)

	Unit	3 A	6 A	9 A
Nominal input voltage	V DC	24		
Minimum input voltage		20		
Maximum input voltage		30		
Maximum ripple	%	±10		
Maximum continuous current @24 V DC	A	0.6		
Power on surge current (typical) @24 V DC, 100 ms	A	4		

8.1.3 Motor output power (X1)

	Unit	3 A	6 A	9 A
Nominal phase current	A _{RMS}	3	6	9
Peak phase current for 3 s	A _{RMS}	6	12	18
Nominal output @ 230 V, 3Φ	VA	1195	2390	3585
Output voltage range (line-line) @VDC-bus=320 V	V _{RMS}	0 - 230		
Output frequency	Hz	0 - 550		
Output dv/dt at drive, phase-phase at drive, phase-ground at motor (using 20 m cable), phase-phase at motor (using 20 m cable), phase-ground	kV/μs	2 1.1 1.9 1.8		
Nominal switching frequency	kHz	8.0		
Minimum motor inductance (per winding)	mH	1		
Efficiency	%	>95		

8.1.3.1 Motor output rating adjustment

3 A		6 A		9 A	
200%, 3 s overload	300%, 3 s overload	200%, 3 s overload	300%, 3 s overload	200%, 3 s overload	300%, 3 s overload
3 A	2.5 A	6 A	5.25 A	9 A	7.5 A

Table 9: Continuous current ratings

8.1.4 Braking (X1)

	Unit	3 A	6 A	9 A
Nominal switching threshold (typical)	V DC	on: 388, off: 376		
Nominal power (10% power cycle, R=57Ω)	kW	0.25		
Peak power (10% power cycle, R=57Ω)	kW	2.7		
Maximum switching current	A _{PK}	10		
Minimum load resistance	Ω	39		
Maximum load inductance	μH	100		

8.1.5 Digital inputs - drive enable and DIN0 general purpose (X3)

	Unit	All models
Type		Opto-isolated inputs
Input voltage		
Nominal	V DC	24
Minimum		12
Maximum		30
Active		> 12
Inactive		< 2
Input current (maximum, per input)	mA	50
Sampling interval	ms	1
Minimum pulse width	μs	5

8.1.6 Digital inputs DIN1, DIN2 - high speed general purpose (X3)

	Unit	All models
Type		Opto-isolated inputs
Input voltage		
Nominal	V DC	24
Minimum		12
Maximum		30
Active		> 12
Inactive		< 2
Input current (maximum, per input)	mA	20
Maximum input frequency	MHz	1
Minimum pulse width	ns	250
Minimum step time	ns	250
Minimum space time	ns	250
Direction input setup time	ns	100
Direction input hold time	ns	100

8.1.7 Digital outputs DOUT0, DOUT1 - status and general purpose (X3)

	Unit	All models
User supply (maximum)	V	28
Output current (max. continuous)	mA	100
Fuse		
Approximate trip current	mA	200
Reset time	s	<20
Update interval	ms	1

8.1.8 Incremental encoder feedback option (X8)

	Unit	All models
Encoder input		RS422 A/B Differential, Z index
Maximum input frequency (quadrature)	MHz	8
Hall inputs		RS422 A/B Differential
Output power supply to encoder		5 V ($\pm 7\%$), 200 mA max.
Maximum recommended cable length		30.5 m (100 ft)

8.1.9 BiSS interface (X8)

	Unit	All models
BiSS encoder interface		Differential Data and Clock
Operating mode		Single or multi-turn. A wide range of devices can be supported. Contact ABB technical support before selecting a device.
Output power supply to encoder		5 V ($\pm 7\%$), 200 mA max.
Maximum recommended cable length		30.5 m (100 ft)

8.1.10 SSI encoder feedback option (X8)

	Unit	All models
SSI encoder inputs		Differential Data and Clock
Operating mode (Baldor motors)		Single turn. Positioning resolution up to 262144 counts/rev (18-bit)
Output power supply to encoder		5 V ($\pm 7\%$), 200 mA max.
Maximum recommended cable length		30.5 m (100 ft)

8.1.11 Smart Abs interface (X8)

	Unit	All models
Smart Abs encoder interface		Differential Data
Operating mode		Single or multi-turn. A wide range of devices can be supported. Contact technical support before selecting a device.
Output power supply to encoder		5 V DC ($\pm 7\%$), 200 mA max.
Maximum recommended cable length		30.5 m (100 ft)

8.1.12 SinCos / EnDat encoder feedback option (X8)

	Unit	All models
Absolute encoder input		EnDat / SinCos differential inputs and data input
Operating mode (Baldor motors)		Single or multi-turn. 512 or 2048 Sin/Cos cycles per turn, with absolute positioning resolution of up to 65536 steps. (Many other encoder specifications are supported - contact ABB.)
Output power supply to encoder		5 V ($\pm 7\%$), 200 mA max.
Maximum recommended cable length		30.5 m (100 ft)

8.1.13 Ethernet interface (E1 / E2)

<i>Description</i>	Unit	Value
Signal		2 twisted pairs, magnetically isolated
Protocols		Ethernet POWERLINK & TCP/IP
Bit rates	Mbit/s	100

8.1.14 CAN interface (OPT 1)

<i>Description</i>	Unit	Value
Signal		2-wire, isolated
Channels		1
Protocol		CANopen
Bit rates	Kbit/s	10, 20, 50, 100, 125, 250, 500, 1000

8.1.15 RS485 interface

<i>Description</i>	Unit	Value
Signal		RS485, 2-wire, non-isolated
Bit rates	Baud	9600, 19200, 38400, 57600 (default), 115200

8.1.16 Environmental

<i>All models</i>	Unit	All models		
Operating temperature range*		°C		°F
	Minimum Maximum Derate	+0 +45 See sections 3.2.2 to 3.2.6	+32 +113 See sections 3.2.2 to 3.2.6	
Storage temperature range*		-40 to +85	-40 to +185	
Humidity (maximum)*	%	93		
Forced air cooling flow (vertical, from bottom to top)		3 A	6 A	9 A
	m/s	None required	1	2.5
Maximum installation altitude (above m.s.l.)	m	1000 Derate 1.1% / 100 m over 1000 m		
	ft	3300 Derate 1.1% / 330 ft over 3300 ft		
Shock*		10 G		
Vibration*		1 G, 10-150 Hz		
IP rating		IP20**		

* MicroFlex e100 complies with the following environmental test standards:

BS EN60068-2-1:1993 low temperature operational 0°C.

BS EN60068-2-2:1993 high temperature operational 45°C.

BS EN60068-2-1:1993 low temperature storage/transportation -40°C.

BS EN60068-2-2:1993 high temperature storage/transportation +85°C.

BS 2011:part2.1 Cb: 1990: 45°C 93%RH humidity/high temperature operational.

DIN IEC 68-2-6/29

** MicroFlex e100 complies with EN61800-5-1:2003 part 5.2.2.5.3 (Impact test), provided all front panel connectors are inserted.

8.1.17 Weights and dimensions

Description	3 A	6 A	9 A
Weight	1.45 kg (3.2 lb)	1.5 kg (3.3 lb)	1.55 kg (3.4 lb)
Nominal overall dimensions	180 mm x 80 mm x 157 mm (7.1 in x 3.2 in x 6.2 in)		

A.1 Introduction

This section describes accessories and options that you may need to use with your MicroFlex e100. Shielded (screened) cables provide EMI / RFI shielding and are required for compliance with CE regulations. All connectors and other components must be compatible with the shielded cable.

A.1.1 Fan tray

The fan tray (part FAN001-024) provides sufficient cooling for the 3 A, 6 A or 9 A MicroFlex e100. It requires 23 - 27.5 V DC at 325 mA, which may be sourced from the same filtered control circuit supply used for the MicroFlex e100. The MicroFlex e100 is UL listed (file NMMS.E470302) when used in conjunction with the fan tray, mounted exactly as shown in Figure 53.

Fan tray
FAN001-024

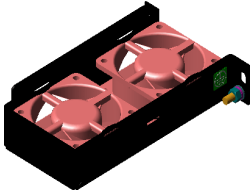

Fan tray dimensions

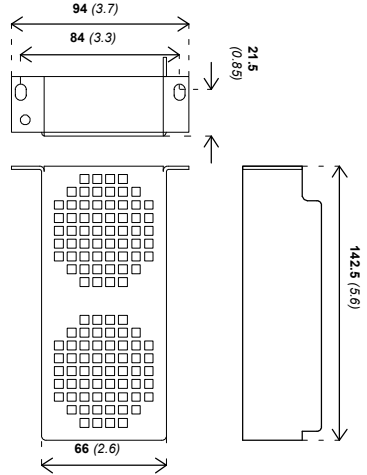

Assembled MicroFlex e100 and fan tray



Position of fan tray mounting holes relative to MicroFlex e100

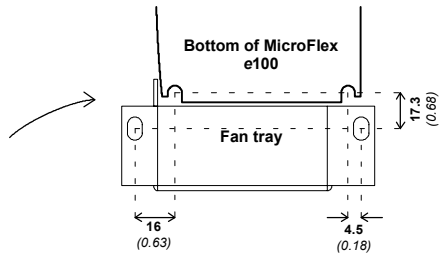

It is important that the fan tray is mounted in close proximity to the MicroFlex e100 as shown above. Failure to do so will result in decreased cooling efficiency.

Figure 53: Fan tray

A.1.2 Footprint filter (single-phase only)

The single-phase footprint AC power filter (part FI0029A00) provides mounting holes for the MicroFlex e100 and fan tray. This allows the filter, fan tray and MicroFlex e100 to use minimal panel mounting space. See section A.1.4 for details of filter FI0029A00.

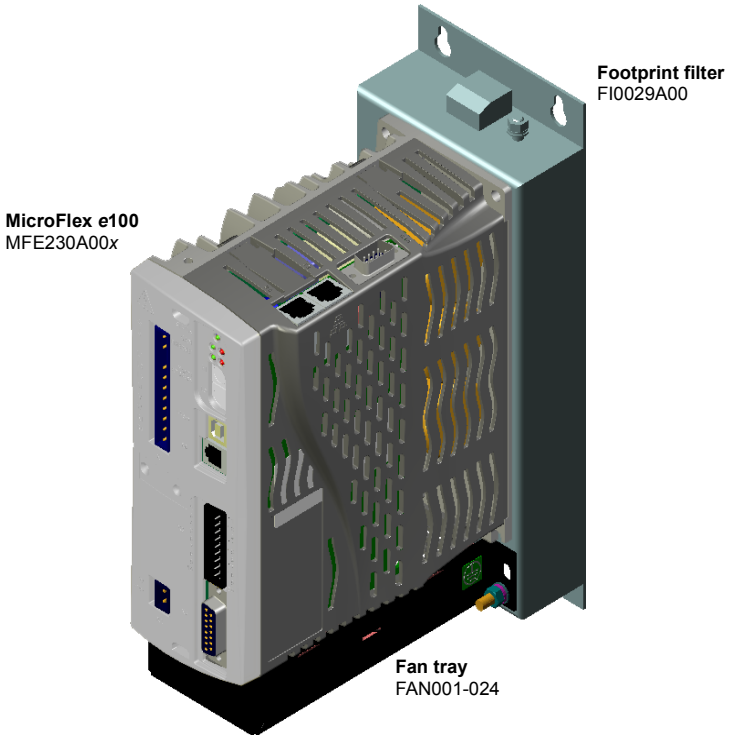

Figure 54: Assembled footprint filter, fan tray and MicroFlex e100

A.1.3 24 V power supplies

A range of compact 24 V DIN rail mounting power supplies are available. The supplies include short circuit, overload, over-voltage and thermal protection.

Part	Input voltage	Output voltage	Output rating
DR-75-24	110-230 V AC	24 V DC	75 W (3.2 A)
DR-120-24			120 W (5 A)
DRP-240-24			240 W (10 A)

Table 10: 24 V power supplies

A.1.4 EMC filters

AC filters remove high frequency noise from the AC power supply, protecting the MicroFlex e100. These filters also prevent high frequency signals from being transmitted back onto the power lines and help meet EMC requirements. To select the correct filter, see sections 3.4.8 and 3.4.9.

A.1.4.1 Part numbers

Part	Manufacturer	Rated volts	Rated amps @ 40°C	Leakage current (mA)	Weight kg (lbs)
FI0014A00	Schaffner FN9675-3/06	250	3	0.4	0.27 (0.6)
FI0015A00	Schaffner FN2070-6/06	250	6	0.4	0.45 (0.99)
FI0015A02	Schaffner FN2070-12/06	250	12	0.4	0.73 (1.61)
FI0018A00	Schaffner FN3258-7/45	480	7	33	0.5 (1.1)
FI0018A03	Schaffner FN3258-16-44	480	16	33	0.8 (1.76)
FI0029A00	Epcos B84142A22R215	250	22	33	3.0 (6.6)

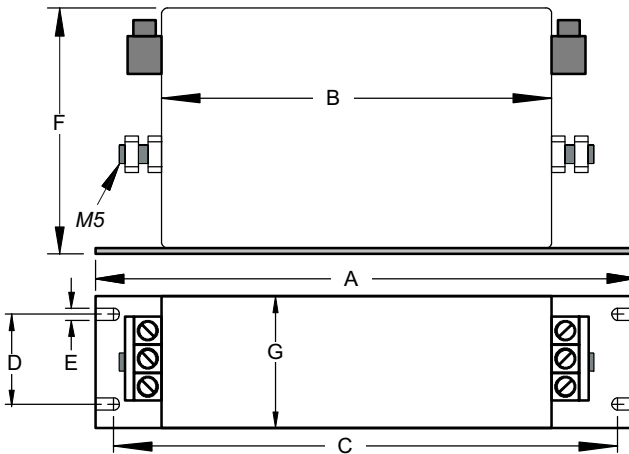

Dimension	Dimensions mm (inches)	
	FI0018A00	FI0018A03
A	190 (7.48)	250 (9.84)
B	160 (6.30)	220 (8.66)
C	180 (7.09)	235 (9.25)
D	20 (0.79)	25 (0.98)
E	4.5 (0.18)	5.4 (0.21)
F	71 (2.80)	70 (2.76)
G	40 (1.57)	45 (1.77)

Figure 55: Filter dimensions, types FI0018A00 and FI0018A03

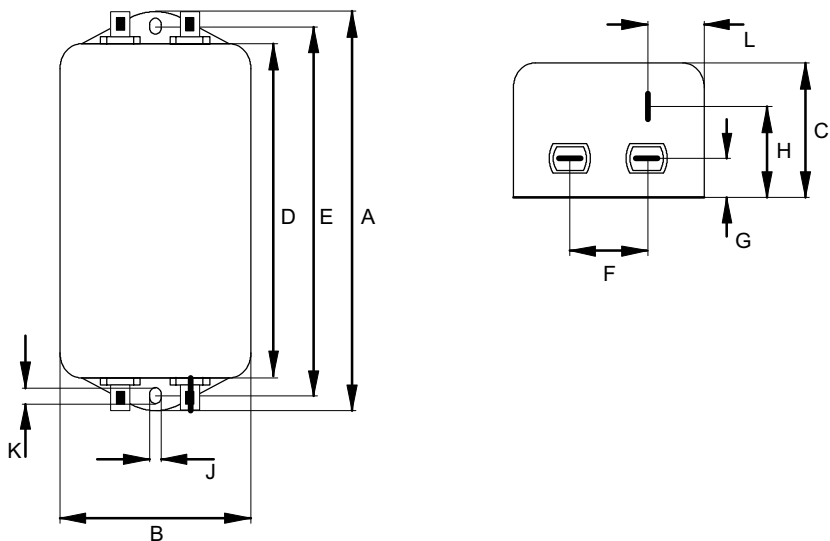

	Dimensions mm (inches)		
Dimension	F10014A00	F10015A00	F10015A02
A	85 (3.35)	113.5 (4.47)	156 (6.14)
B	54 (2.13)	57.5 (2.26)	
C	40 (1.57)	46.6 (1.83)	
D	65 (2.56)	94 (3.70)	130.5 (5.14)
E	75 (2.95)	103 (4.06)	143 (5.63)
F	27 (1.06)	25 (0.98)	
G	12 (0.47)	12.4 (0.49)	
H	29.5 (1.16)	32.4 (1.28)	
J	5.3 (0.21)	4.4 (0.17)	5.3 (0.21)
K	6.3 (0.25)	6 (0.24)	
L	13.5 (0.53)	15.5 (0.61)	

Figure 56: Filter dimensions, types F10014A00, F10015A00, F10015A02

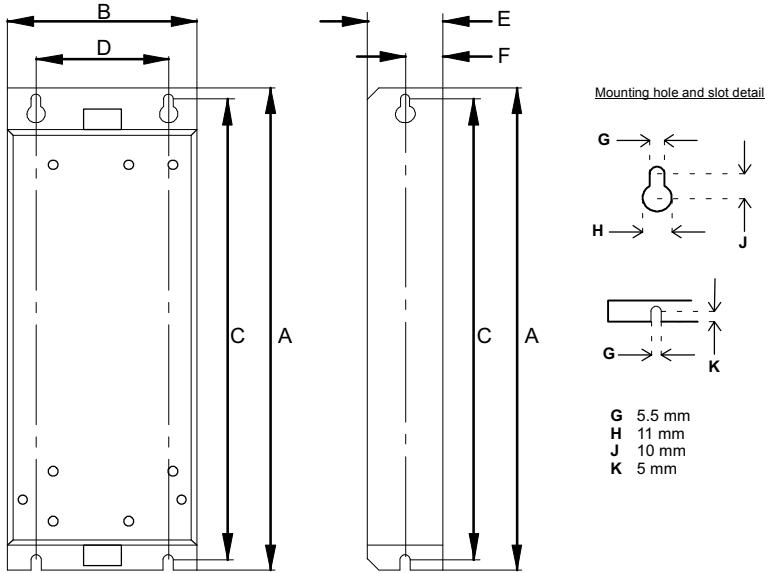

Dimensions shown as: mm (inches).

	Dimensions mm (inches)	
Dimension	F10029A00	
A	255 (10.04)	
B	100 (3.94)	
C	244.5 (9.63)	
D	70 (2.76)	
E	40 (1.57)	
F	20 (0.79)	

Figure 57: Filter dimensions, type F10029A00

A.1.5 Brake resistors

Depending on the application, MicroFlex e100 might require an external brake resistor to be connected to pins R1 and R2 of connector X1. The brake resistor dissipates energy during braking to prevent an over-voltage error occurring. See sections 3.6 and 3.7 for details about choosing the correct resistor.



Electrical shock hazard. DC bus voltages may be present at these terminals. Use a suitable heatsink (with fan if necessary) to cool the brake resistor. The brake resistor and heatsink (if present) can reach temperatures in excess of 80 °C (176 °F).

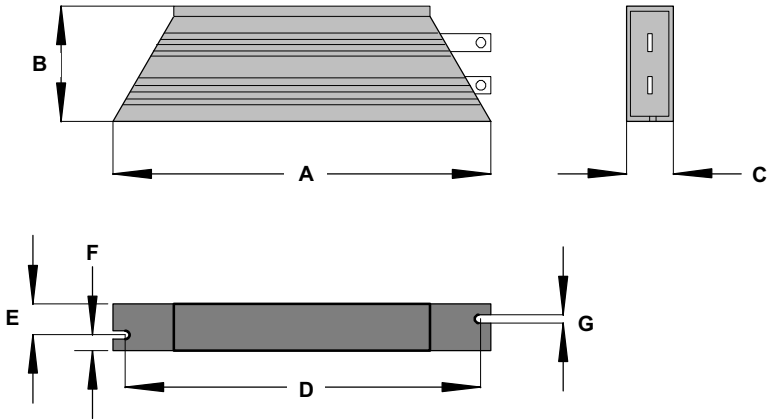

Resistor	Power W	Res. Ω	Dimensions <i>mm (inches)</i>						
			A	B	C	D	E	F	G
RGJ139	100	39	165 (6.49)	41 (1.61)	22 (0.87)	152 (5.98)	12 (0.47)	10 (0.39)	4.3 (0.17)
RGJ160	100	60	165 (6.49)	41 (1.61)	22 (0.87)	152 (5.98)	12 (0.47)	10 (0.39)	4.3 (0.17)
RGJ260	200	60	165 (6.49)	60 (2.36)	30 (1.18)	146 (5.75)	17 (0.67)	13 (0.51)	5.3 (0.21)
RGJ360	300	60	215 (8.46)	60 (2.36)	30 (1.18)	196 (7.72)	17 (0.67)	13 (0.51)	5.3 (0.21)

Figure 58: Brake resistor dimensions

A.2 Cables

A wide range of motor and feedback cables are available from ABB.

A.2.1 Motor power cables

For easier installation, it is recommended that a color-coded motor power cable is used. The part number for a BSM rotary motor power cable is derived as follows:

CBL	025	SP	-12	S			
	m	ft	SP	BSM style threaded motor connector (motor end only)	Current (Amps)	-	Standard connector
	1.5	5*			6	S	Stainless steel
	2.5	8.2			12		
	3.0	10*			20		
	5.0	16.4	WP	SDM style threaded motor connector (motor end only)	35		
	6.1	20*			50		
	7.5	24.6			90		
	9.1	30*					
	10	32.8					
	15	49.2	RP	Raw cable (no connector)			
	15.2	50*					
	20	65.6					
	22.9	75*					
	30.5	100*					

* North America only

Larger motors requiring 35 A cable or greater normally use terminal box connections, so a motor power connector is not required. For this reason connectors are not available on 35 A - 90 A cable.

Examples:

A 6.1 m cable, with a CE threaded standard connector, rated for 12 A has part number **CBL061SP-12**.

A 30.5 m cable, with a CE threaded stainless steel connector, rated for 20 A has part number **CBL305SP-20S**.

A 50 ft cable, with no connector, rated for 50 A has part number **CBL152RP-50**.

A.2.2 Feedback cable part numbers

The part number for a feedback cable is derived as follows:

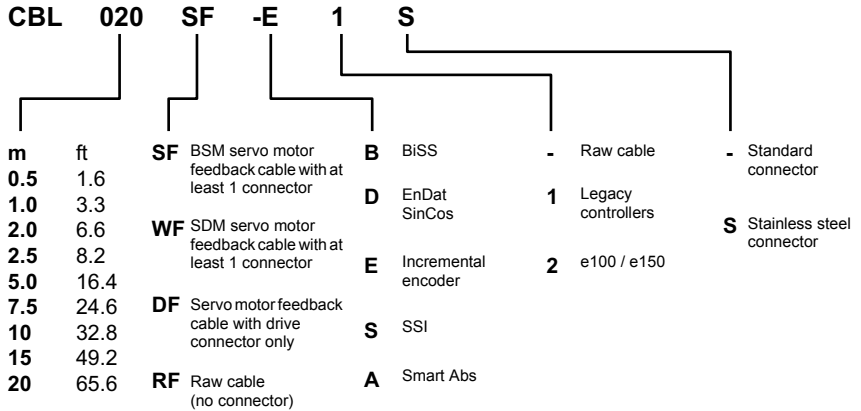

Other lengths available on request

Example:

A 2 m encoder feedback cable for a MicroFlex e100 drive, with required connectors at both ends, has part number **CBL020SF-E2**.

ABB feedback cables have the outer shield tied to the connector housing(s). If you are not using an ABB cable with your chosen feedback device, be sure to obtain a cable that is a shielded twisted pair 0.34 mm² (22 AWG) wire minimum, with an overall shield. Ideally, the cable should not exceed 30.5 m (100 ft) in length. Maximum wire-to-wire or wire-to-shield capacitance is 50 pF per 300 mm (1 ft) length, to a maximum of 5000 pF for 30.5 m (100 ft).

A.2.3 Ethernet cables

The cables listed in this table connect MicroFlex e100 to other EPL nodes such as NextMove e100, additional MicroFlex e100s, or other EPL compatible hardware. The cables are standard CAT5e shielded twisted pair (S/UTP) 'crossover' Ethernet cables:

Cable assembly description	Part	Length	
		m	ft
CAT5e Ethernet cable	CBL002CM-EXS	0.2	0.65
	CBL005CM-EXS	0.5	1.6
	CBL010CM-EXS	1.0	3.3
	CBL020CM-EXS	2.0	6.6
	CBL050CM-EXS	5.0	16.4
	CBL100CM-EXS	10.0	32.8
	CBL200CM-EXS	20.0	65.6

B.1 Introduction

The MicroFlex e100 can use two main control configurations:

- Servo (Position).
- Torque Servo (Current).

Each configuration supports different control modes, selected by using the Tools, Control Mode menu item or by using the `CONTROLMODE` keyword in the Command window (see the Mint help file). The control configurations are described in the following sections.

B.1.1 Servo configuration

The servo configuration is the default configuration for the drive, allowing the motor control system to operate as a torque controller, a velocity controller or a position controller. This configuration comprises 3 nested control loops; a current control loop, a velocity control loop and a position control loop, as shown in Figure 59.

The universal encoder interface reads rotor position from the encoder and estimates velocity. The commutation block uses the position to calculate the electrical angle of the rotor. The current sensor system measures U and V phase currents. These are fed into a current conversion block that converts them into quantities representing torque producing and magnetizing currents (the 'vector' currents which are locked to the rotor).

In the current control loop, a current demand and the final measured current values form the inputs to a PI (Proportional, Integral) control system. This control system generates a set of voltage demands that are fed into a PWM (pulse-width modulation) block. The PWM block uses the space-vector modulation method to convert these voltage demands into a sequence of U, V and W phase switching signals, which are applied to the output bridge of the drive. The PWM block uses the measured DC bus voltage to compensate for variations in supply voltage.

The torque controller converts a torque demand into a current demand and compensates for various load non-linearities. A 2-stage notch or low-pass filter allows the effects of load compliance to be reduced. To avoid motor damage, a user-defined application current limit is also applied, as well as individual positive and negative torque limits.

In the velocity control loop, a velocity demand and measured velocity form the inputs to a PI control system. The output of the control system is a torque demand which, when the drive is operating as a velocity controller, forms the input to the current control loop.

Finally, in the position control loop, a position demand and measured position form the inputs to a PID (Proportional, Integral, Differential) control system incorporating velocity feedback, velocity feed-forward and acceleration feed-forward. The output of the position control system is a velocity demand which, when the drive is operating as a position controller, forms the input to the velocity control loop.

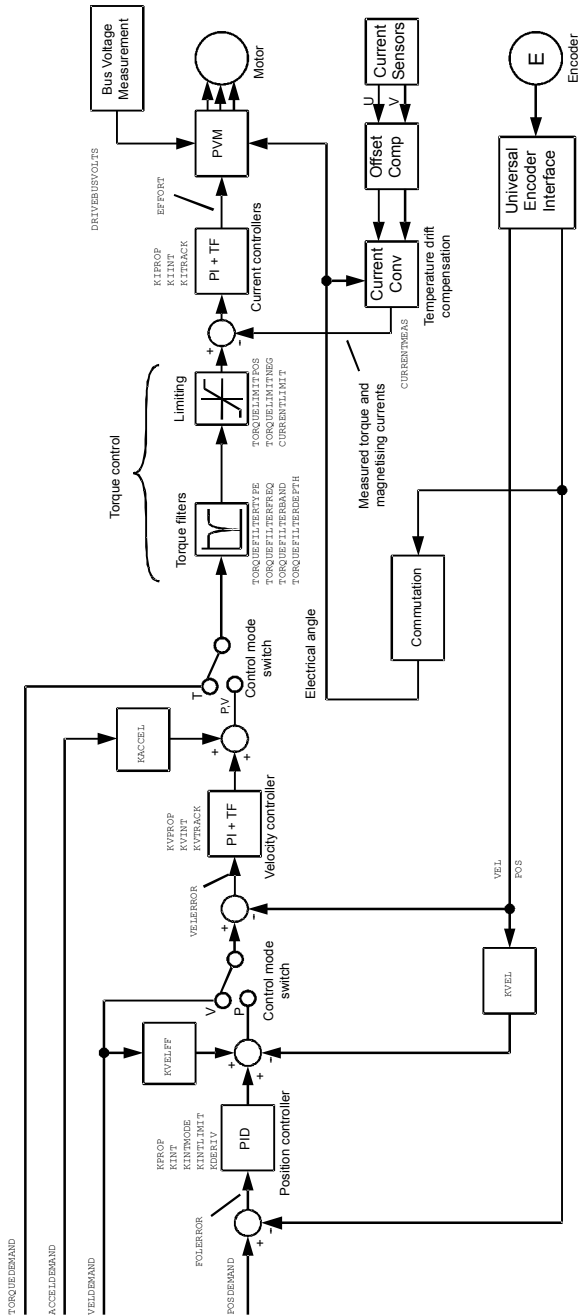

Figure 59: Servo configuration control structure

B.1.2 Torque servo configuration

Figure 60 shows the torque-servo control configuration. Here, the velocity loop has been removed and the output of the position controller is fed into the current loop via the torque filters.

The torque servo configuration is useful when the drive is operating as a closed-loop position controller and settling time must be minimized. Although the servo configuration tends to give better velocity tracking when operating in position mode, settling times can be longer.

The control mode switch allows the drive to operate in either torque or position modes, but not velocity mode.

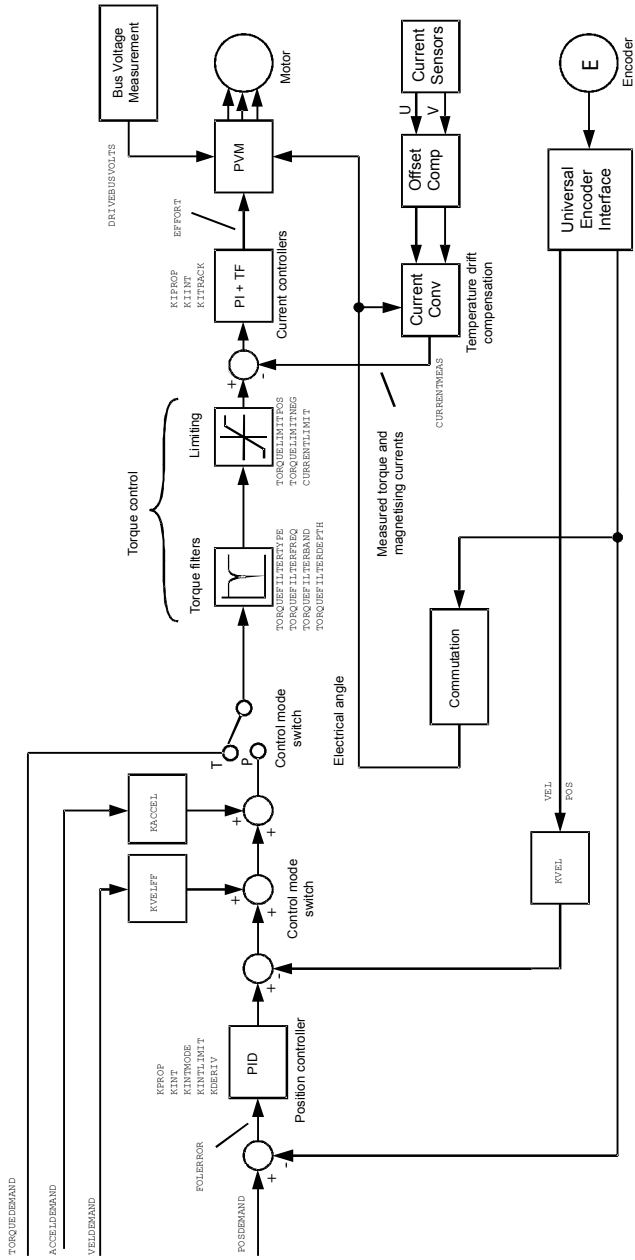

Figure 60: Torque Servo configuration control structure

C.1 Introduction

The following table summarizes the Mint keywords supported by the MicroFlex e100. Note that due to continuous developments of the MicroFlex e100 and the Mint language, this list is subject to change. Check the latest Mint help file for full details of new or changed keywords.

C.1.1 Keyword listing

Keyword	Description
ABORT	To abort motion on all axes.
ABORTMODE	To control the default action taken in the event of an abort.
ABSENCODER	To read the current EnDat encoder position.
ABSENCODERTURNS	To set or read the number of turns of unique information available on an absolute encoder.
ACCEL	To define the acceleration rate of an axis.
ACCELDEMAND	To read the instantaneous demand acceleration.
ACCELJERK	To define the jerk rate to be used during periods of acceleration.
ACCELJERKTIME	To define the jerk rate to be used during periods of acceleration.
ACCELSCALEFACTOR	To scale axis encoder counts, or steps, into user defined acceleration units.
ACCELSCALEUNITS	To define a text description for the acceleration scale factor.
ACCELTIME	To define the acceleration rate of an axis.
ACCELTIMEMAX	To define the acceleration rate of an axis.
AXISMODE	To return the current mode of motion.
AXISPOSENCODER	To select the source of the position signal used in dual encoder feedback systems.
AXISVELENCODER	To select the source of the velocity signal used in dual encoder feedback systems.
BUSBAUD	To specify the bus baud rate.
BUSENABLE	To enable or disable the operation of a fieldbus.

Keyword	Description
BUSEVENT	Returns the next event in the bus event queue of a specific bus.
BUSEVENTINFO	Returns the additional information associated with a bus event.
BUSNODE	To set or read the node ID used by this node for the specified bus.
BUSPROTOCOL	To read the protocol currently supported on a particular fieldbus.
BUSRESET	Resets the bus controller.
BUSSTATE	Returns the status of the bus controller.
CANCEL	To stop motion and clear errors on an axis.
CANCELALL	To stop motion and clear errors on all axes.
CAPTUREBUFFERSIZE	To read the total size of the capture buffer.
CAPTURECOMMAND	Controls the operation of capture.
CAPTUREDURATION	To define the total duration of the data capture.
CAPTUREMODE	To set or read the mode on a capture channel.
CAPTUREMODEPARAMETER	To specify a parameter associated with CAPTUREMODE.
CAPTURENUMPOINTS	To read the number of captured points per channel.
CAPTUREPERIOD	To define the interval between data captures.
CAPTUREPRETRIGGER-DURATION	To set the duration of the pre-trigger phase.
CAPTUREPROGRESS	To return the progress of the pre-trigger or post-trigger capture phase.
CAPTURESTATUS	To return the progress of the capture.
CAPTURETRIGGER	To generate a capture trigger.
CAPTURETRIGGERABSOLUTE	To ignore the sign of the trigger value when triggering from a capture channel source.
CAPTURETRIGGERCHANNEL	To set the channel to be used as the reference source for triggering.
CAPTURETRIGGERMODE	To set the method used to evaluate the trigger source.
CAPTURETRIGGERSOURCE	To set the reference source to be used for triggering.
CAPTURETRIGGERVALUE	To set the trigger value when triggering from a capture channel source.
COMMS	Accesses the reserved comms array.

Keyword	Description
COMMSINTEGER	Accesses the reserved comms array, storing values as integers.
COMPAREENABLE	To enable/disable the position compare control of a specific digital output.
COMPAREOUTPUT	To specify the digital output used for position compare.
COMPAREPOS	To write to the position compare registers.
CONFIG	To set the configuration of an axis for different control types.
CONNECT	To enable a connection between two remote nodes to be made or broken.
CONNECTSTATUS	Returns the status of the connection between this node and another node.
CONTROLMODE	To set or read the control mode.
CONTROLMODESTARTUP	To set or read the control mode used when the drive is turned on.
CONTROLRATE	To set the control loop and profiler sampling rates.
CONTROLREFCHANNEL	To specify a channel for the source of the control reference command.
CONTROLREFSOURCE	To specify the source of the control reference command.
CONTROLREFSOURCESTARTUP	To set or read the source of the control reference command used when the drive is turned on.
CONTROLTYPE	To set or read the motor control type.
CURRENTDEMAND	To read the demands to the current controllers.
CURRENTLIMIT	To restrict the current output to a defined range.
CURRENTMEAS	Reads the measured current.
CURRENTSENSORMODE	To enable a current sensor temperature drift compensation scheme.
DECEL	To set the deceleration rate on the axis.
DECELJERK	To define the jerk rate to be used during periods of deceleration.
DECELJERKTIME	To define the jerk rate to be used during periods of deceleration.
DECELTIME	To set the deceleration rate on the axis.
DECELTIMEMAX	To define the deceleration rate of an axis.

Keyword	Description
DRIVEBUSNOMINALVOLTS	To return the nominal value of the DC bus voltage for the drive.
DRIVEBUSOVERVOLTS	To set or return the overvoltage trip level for the drive.
DRIVEBUSUNDERVOLTS	To set or return the undervoltage trip level for the drive.
DRIVEBUSVOLTS	To return the current level of the DC bus.
DRIVEENABLE	To enable or disable the drive for the specified axis.
DRIVEENABLEINPUTMODE	To control the action taken in the event of the drive being disabled from the drive enable input.
DRIVEENABLEOUTPUT	To specify an output as a drive enable.
DRIVEENABLEREADY	To read if the drive is ready to be enabled.
DRIVEENABLESWITCH	To read the state of the drive enable input.
DRIVEID	To define a text description for the drive.
DRIVEOVERLOADAREA	Reads the extent of a drive overload condition.
DRIVEOVERLOADMODE	Sets or reads the action taken in the event of a drive overload condition.
DRIVEPEAKCURRENT	Reads the peak current rating of the drive.
DRIVEPEAKDURATION	Reads the duration for which peak drive current can be sustained.
DRIVERATEDCURRENT	Reads the continuous current rating for the drive.
DRIVESPEEDFATAL	To define the overspeed trip level.
DRIVESPEEDMAX	To set or read the maximum motor speed to be used.
EFFORT	To read the instantaneous effort applied by the current controllers.
ENCODER	To set or read the axis encoder value.
ENCODERCYCLESIZE	To set or read the size of a sin/cos cycle on an encoder.
ENCODERMODE	To make miscellaneous changes to the encoders.
ENCODEROFFSET	To set or read the offset used to calculate encoder position for absolute encoders.
ENCODERPRESCALE	To scale down the encoder input.
ENCODERRESOLUTION	To set or read the number of encoder lines (pre-quadrature) for the motor.
ENCODERSCALE	To set or read the scale factor for the encoder channel.
ENCODERTYPE	To set or read the feedback type of the motor.

Keyword	Description
ENCODERVEL	To read the velocity from an encoder channel.
ENCODERWRAP	To set or read the encoder wrap range for the encoder channel.
ENCODERZLATCH	To get and reset the state of an axis' encoder Z latch.
ERRCODE	To return the last error code read from the error list.
ERRDATA	To return data associated with the last error read from the error list.
ERRLINE	To return the line number of the last error read from the error list.
ERRORCLEAR	To clear all errors in the specified group.
ERRORDECEL	To set the deceleration rate on the axis for powered stops, in the event of an error or stop input.
ERRORINPUT	To set or return the digital input to be used as the error input for the specified axis.
ERRORINPUTMODE	To control the default action taken in the event of an external error input.
ERRORPRESENT	To determine if errors in a particular group are present in the error list.
ERRORREADCODE	To determine if a particular error is present in the error list.
ERRORREADNEXT	Returns the next entry in the specified group from the error list.
ERRORSWITCH	To return the state of the error input.
ERRSTRING	To return the error string for the last error code read from the error list.
ERRTIME	To return the time stamp for the last error code read from the error list.
EVENTACTIVE	To indicate whether an event is currently active.
EVENTDISABLE	To selectively enable and disable Mint events.
EVENTPEND	To manually cause an event to occur.
EVENTPENDING	To indicate whether an event is currently pending.
FACTORYDEFAULTS	To reset parameter table entries to their default values.
FIRMWARERELEASE	To read the release number of the firmware.
FOLERROR	To return the instantaneous following error value.

Keyword	Description
FOLErrorFatal	To set the maximum permissible following error before an error is generated.
FOLErrorMode	To determine the action taken on the axis in the event of a following error.
FOLLOW	To enable encoder following with a specified gear ratio.
FOLLOWMODE	To define the mode of operation of the FOLLOW keyword.
FOLLOWNUMERATOR	To set or read the follow ratio's numerator.
GLOBALERROROUTPUT	Allows the user to specify a global error output which will be deactivated in the event of an error.
GO	To begin synchronized motion.
HALL	To read the current Hall state on feedback devices which use Hall sensors.
HALLFORWARDANGLE	To define the electrical angles at which Hall states change, when the motor is running in the forward direction, for feedback devices which use Hall sensors.
HALLREVERSEANGLE	To define the electrical angles at which Hall states change, when the motor is running in the reverse direction, for feedback devices which use Hall sensors.
HALLTABLE	To define the Hall table for an encoder motor.
HOME	To find the home position on an axis.
HOMEACCEL	To set the acceleration rate for the homing profile.
HOMEBACKOFF	To set the home back-off speed factor.
HOMECREEPSPEED	To set the creep speed for homing moves.
HOMEDECEL	To set the deceleration rate for the homing profile.
HOMEINPUT	To set a digital input to be the home switch input for the specified axis.
HOMEPHASE	To find the phase of the homing sequence currently in progress.
HOMEPOS	To read the axis position at the completion of the homing sequence.
HOMEREFPOS	To define a reference position for homing moves.
HOMESPEED	To set the speed for the initial seek phase of the homing sequence.
HOMESTATUS	To set or read the status of a homing sequence.
HOMESWITCH	To return the state of the home input.

Keyword	Description
HOMETYPE	To set the homing mode to be performed at start-up.
IDLE	Indicates if a move has finished executing and the axis has finished moving.
IDLEMODE	To control the checks performed when determining if an axis idle.
IDLEPOS	Reads or sets the idle following error limit.
IDLESETTLINGTIME	To read the time taken for an axis to become idle.
IDLETIME	To specify the period for which the axis must meet its idle conditions before becoming idle.
IDLEVEL	Reads or sets the idle velocity limit.
IN	To read the state of all the inputs on an input bank.
INCA	To set up an incremental move to an absolute position.
INCR	To set up an incremental move to a relative position.
INPUTACTIVELEVEL	To set the active level on the digital inputs.
INPUTDEBOUNCE	To set or return the number of samples used to 'debounce' a digital input bank.
INPUTMODE	To set or return the sum of a bit pattern describing which of the user digital inputs should be edge or level triggered.
INPUTNEGTRIGGER	To set or return the user inputs that become active on negative edges.
INPUTPOSTRIGGER	To set or return the user inputs that become active on positive edges.
INSTATE	To read the state of all digital inputs.
INSTATEX	To read the state of an individual digital input.
INX	To read the state of an individual digital input.
JOG	To set an axis for speed control.
KACCEL	To set the servo loop acceleration feed forward gain.
KASINT	
KASPROP	
KDERIV	To set the servo loop derivative gain on the servo axes.
KFINT	To set or read the integral gain of the flux controller for induction motor control.
KFPROP	To set or read the proportional gain of the flux controller for induction motor control.

Keyword	Description
KIINT	To set the integral gain used by the current controller.
KINT	To set the servo loop integral gain.
KINTLIMIT	To restrict the overall effect of the integral gain KINT.
KINTMODE	To control when integral action will be applied in the servo loop.
KIPROP	To set the proportional gain used by the current controller.
KITRACK	To set the tracking factor used by the current controller.
KPROP	To set the proportional gain for the position controller.
KVEL	To set the servo loop velocity feedback gain term.
KVELFF	To set the velocity feedforward term for the position controller.
KVINT	To set the integral gain used by the speed controller.
KVPROP	To set the proportional gain used by the speed controller.
KVTIME	To set the time constant of a low pass filter, applied to measured speed.
KVTRACK	To set the tracking factor used by the speed controller.
LATCH	To read the state of a fast latch channel.
LATCHENABLE	Manually re-enables a fast latch channel.
LATCHINHIBITTIME	To specify a period during which further fast triggers will be ignored.
LATCHINHIBITVALUE	To specify a range of values within which further fast triggers will be ignored.
LATCHMODE	To set the default action to be taken to clear a fast latch.
LATCHSOURCE	To define the source of data to be latched by a fast latch channel.
LATCHSOURCECHANNEL	To define the channel of the source of data to be latched by a fast latch channel.
LATCHTRIGGERCHANNEL	To select which of the fast latch inputs (or outputs) will trigger a fast latch channel.
LATCHTRIGGEREDGE	To define which edge polarity should cause the fast latch to be triggered.
LATCHTRIGGERMODE	To select whether a fast latch is triggered by a digital input or a digital output.

Keyword	Description
LATCHVALUE	To return the instantaneous latch value that was recorded by a fast latch.
LIFETIME	Returns a lifetime counter for the drive.
LIMIT	To return the state of the forward and reverse limit switch inputs for the given axis.
LIMITFORWARD	To return the state of the forward limit switch input for the given axis.
LIMITFORWARDINPUT	To set the user digital input configured to be the forward end of travel limit switch input for the specified axis.
LIMITMODE	To control the default action taken in the event of a forward or reverse hardware limit switch input becoming active.
LIMITREVERSE	To return the state of the reverse limit switch input for the given axis.
LIMITREVERSEINPUT	To set the user digital input configured to be the reverse end of travel limit switch input for the specified axis.
LOADDAMPING	To define the equivalent viscous damping coefficient for the motor and load.
LOADINERTIA	To define the combined inertia of the motor and load.
MASTERCHANNEL	To set or read the channel of the input device used for gearing.
MASTERSOURCE	To set or read the source of the input device used for gearing.
MOTORBRAKEDELAY	To specify engage/disengage delays associated with motor brake control.
MOTORBRAKEMODE	To activate or deactivate motor brake control.
MOTORBRAKEOUTPUT	To specify an output to be used as a control signal for a braked motor.
MOTORBRAKESTATUS	To determine the state of the motor brake control.
MOTORCATALOGNUMBER	To return the catalog number of the motor.
MOTORDIRECTION	To set or read the electrical direction of the motor.
MOTORFEEDBACKANGLE	Reads the instantaneous value of commutation angle for the motor.
MOTORFEEDBACKOFFSET	To set or read the electrical angle at which the absolute position read from an EnDat, BiSS or SSI encoder is zero.

Keyword	Description
MOTORFLUX	To set the motor's magnetic flux level, to allow the drive to accurately calculate motor torque and compensate for back-EMF.
MOTORLINEARPOLEPITCH	To set or read the distance between north poles on a linear motor.
MOTORLS	To set or read the motor leakage inductance.
MOTORMAGCURRENT	To set or read the magnetizing current (I_m) of an induction motor.
MOTORMAGIND	To set or read the magnetizing inductance (L_m) of an induction motor.
MOTOROVERLOADAREA	Reads the extent of an overload condition.
MOTOROVERLOADMODE	To set or read the action taken in the event of a motor overload condition.
MOTORPEAKCURRENT	To set or read the peak current rating of the motor.
MOTORPEAKDURATION	To set or read the duration for which peak motor current can be sustained.
MOTORPOLES	To set or read the number of motor poles.
MOTORRATEDCURRENT	To set or read the rated current of the motor.
MOTORRATEDFREQ	To set or read the rated frequency of an induction motor.
MOTORRATEDSPEEDMPS	To set or read the rated speed of a linear induction motor in millimeters per second.
MOTORRATEDSPEEDRPM	To set or read the rated speed of an induction motor.
MOTORRATEDVOLTS	To set or read the rated voltage of an induction motor.
MOTORROTORLEAKAGEIND	To set or read the rotor leakage inductance of an induction motor.
MOTORROTORRES	To set or read the rotor resistance of an induction motor.
MOTORRS	To set the motor stator resistance.
MOTORSLIP	To read the slip of an induction motor.
MOTORSPECNUMBER	To return the spec number of the motor.
MOTORSTATORLEAKAGEIND	To set or read the stator leakage inductance of an induction motor.
MOTORSTATORRES	To set or read the stator resistance of an induction motor.
MOTORTEMPERATUREMODE	To set or read the action taken in the event of the motor overtemperature trip input becoming active

Keyword	Description
MOTORTEMPERATURESWITCH	To read the state of the motor overtemperature trip input.
MOTORTYPE	To read or set the type of motor.
MOVEA	To set up a positional move to an absolute position.
MOVEBUFFERFREE	To return the number of free spaces in the move buffer for the specified axis.
MOVEBUFFERLOW	To set or return the number of free spaces in the move buffer before a move buffer low event is generated.
MOVEBUFFERSIZE	To set or return the size of the move buffer allocated on the specified axis.
MOVER	To set up a positional move to a relative position.
NETFLOAT	To access a controller's network data array, storing values in floating-point format.
NETINTEGER	To access a controller's network data array, storing values as integers.
NODELIVE	To determine if a CAN node on the bus is currently live or dead.
NODESCAN	To scan a specific CAN bus for the presence of a specific node.
NODETYPE	To add or remove a CAN node to/from the CAN network. Can also be read to determine the node type.
NUMBEROF	To return information about the abilities of the controller.
NVFLOAT	To read or write a floating-point value in non-volatile memory.
NVLONG	To read or write a long integer value in non-volatile memory.
NVRAMDEFAULT	To clear the contents of non-volatile RAM (NVRAM).
OUT	To set or read the state of all the outputs on an output bank.
OUTPUTACTIVELEVEL	To set the active level on the digital outputs.
OUTX	To set or read an individual digital output.
PHASESEARCHBACKOFF	To select the back-off distance used to clear an end stop during the phase search sequence.
PHASESEARCHBANDWIDTH	To define the bandwidth used to design the 'debounce' controller used during the initial alignment stage of the phase search sequence.

Keyword	Description
PHASESEARCHCURRENT	To select amount of current applied to the motor during the phase search sequence.
PHASESEARCHINPUT	To set or read the digital input to be used as the phase search trigger input.
PHASESEARCHMODE	To turn on the 'debounce' controller used during the initial alignment stage of the phase search sequence.
PHASESEARCHOUTPUT	To assign a digital output as the phase search output.
PHASESEARCHSPEED	To select the speed of travel during the search sections of a phase search sequence.
PHASESEARCHSTATUS	To determine whether commutation is aligned on an axis.
PHASESEARCHSWITCH	To return the current state of the phase search input for the axis.
PHASESEARCHTRAVEL	To select the amount of travel during the search sections of a phase search sequence.
PLATFORM	To return the platform type.
POS	To set or read the current axis position.
POSDEMAND	To set or read the instantaneous position demand.
POSOFFSET	To set or read the offset used to calculate axis position for absolute encoders.
POSREMAINING	To indicate the remaining move distance.
POSSCALEFACTOR	To scale axis encoder counts, or steps, into user defined position units.
POSSCALEUNITS	To define a text description for the position scale factor.
POSTARGET	Reads the target position of the current positional move.
POSTARGETLAST	Reads the target position of the last move in the move buffer.
PROFILEMODE	To select the type of velocity profiler to use.
REMOTEOADC	To read the value of a remote analog input (ADC).
REMOTEOADCDELTA	To control the rate of change on a remote analog input before a REMOTEOADC message is sent.
REMOTECOMMS	Accesses the reserved comms array on another controller.
REMOTECOMMSINTEGER	Accesses the reserved comms array on another controller, storing values as integers.

Keyword	Description
REMOTEDAC	To control the value of a remote analog output channel (DAC). The value is a percentage (positive and negative) of the full-scale output value.
REMOTEEEMERGENCYMESSAGE	Returns the error code from the last emergency message received from a particular CANopen node.
REMOTEEENCODER	To read the value of a remote encoder channel.
REMOTEEERROR	Reads the CANopen error register information reported within the last emergency message received from a specific node.
REMOTEEIN	To read the state of all the digital inputs on a remote CAN node.
REMOTEEINBANK	To read the state of a bank of digital inputs on a remote CAN node.
REMOTEEINX	To read the state of individual digital inputs from a remote CAN node.
REMOTEEMODE	To control the update mode for a remote node.
REMOTEEOBJECT	To access the Object Dictionary of any CANopen node present on the network.
REMOTEEOBJECTFLOAT	To access 'floating-point' entries in the Object Dictionary of a remote node present on the network.
REMOTEEOBJECTSTRING	To access 'Vis-String' entries in the Object Dictionary of any CANopen node present on the network.
REMOTEEOUT	To control the state of digital outputs on a remote CAN node.
REMOTEEOUTBANK	To read the state of a bank of digital outputs on a remote CAN node.
REMOTEEOUTX	To control the state of individual digital outputs on a remote CAN node.
REMOTEEPDOIN	To request data from a node in the form of a PDO message.
REMOTEEPDOOUT	To force a controller node to transmit a variable length PDO message with a specific COB-ID. The PDO will contain up to 64 bits of data that can be passed in the form of two 32-bit values.
REMOTEESTATUS	To set or read the status register on a remote CAN node.
RESETEINPUT	To define the reset input for an axis.

Keyword	Description
SCALEFACTOR	To scale axis encoder counts, or steps, into user defined units.
SENTINELACTION	To control the action of a sentinel channel.
SENTINELACTIONMODE	To control how the action of a sentinel channel is performed.
SENTINELACTIONPARAMETER	To specify a parameter to fully define the sentinel action.
SENTINELSOURCE	To set or read the primary source used by a sentinel channel.
SENTINELSOURCE2	To set or read the secondary source used by a sentinel channel.
SENTINELSOURCEPARAMETER	To set or read the parameter used to qualify the primary sentinel source.
SENTINELSOURCE2-PARAMETER	To set or read the parameter used to qualify the secondary sentinel source.
SENTINELSTATE	To read the current state of a sentinel channel.
SENTINELTRIGGERABSOLUTE	To set or read the 'absolute' parameter used by a sentinel channel.
SENTINELTRIGGERMODE	To set or read the mode used by a sentinel channel.
SENTINELTRIGGERVALUE-FLOAT	To specify the 'lowVal' or 'highVal' parameter, as a floating-point number, to be used in a sentinel channel's trigger criteria.
SENTINELTRIGGERVALUE-INTEGERS	To specify the 'lowVal' or 'highVal' parameter, as an integer number, to be used in a sentinel channel's trigger criteria.
SEXTANT	To read the current sextant value for a motor using Hall sensors.
SOFTLIMITFORWARD	To set the forward software limit position on a specified axis.
SOFTLIMITMODE	To set or read the default action taken if a forward or reverse software limit position is exceeded.
SOFTLIMITREVERSE	To set or read the reverse software limit position on a specified axis.
SPEED	To set or read the slew speed of positional moves loaded in the move buffer.
STOP	To perform a controlled stop during motion.
STOPINPUT	To set or read the digital input to be used as the stop switch input for the specified axis.

Keyword	Description
STOPMODE	To set or read the action taken when an axis is stopped.
STOPSWITCH	To read the current state of the stop input for the axis.
SUSPEND	To pause the current move.
SUSPENDINPUT	To set or read the digital input to be used as the suspend switch input for the specified axis.
SUSPENDSWITCH	To return the current state of the suspend input for the axis.
SYSTEMSECONDS	To set or read a programmable system lifetime counter for the drive.
TEMPERATURE	To read the internal drive temperature.
TEMPERATURELIMITFATAL	To set or read the temperature fatal limit.
TERMINALADDRESS	To set or read the node ID for a CAN node associated with a terminal.
TERMINALDEVICE	To set or read the device type associated with a given terminal id.
TERMINALMODE	To set or read handshaking modes for a terminal.
TERMINALPORT	To set or read the communication port associated with a given terminal.
TORQUEDEMAND	To read the instantaneous torque demand.
TORQUEFILTERBAND	Defines the band of operation for a torque filter stage.
TORQUEFILTERDEPTH	Defines the reduction in gain for a notch torque filter stage.
TORQUEFILTERFREQ	Defines a characteristic frequency for a torque filter stage.
TORQUEFILTERTYPE	Defines the type of characteristic used for the given torque filter stage.
TORQUELIMITNEG	To set or read the maximum negative torque limit.
TORQUELIMITPOS	To set or read the maximum positive torque limit.
TORQUEREF	To set or read a torque reference for torque (constant current) mode on a servo axis.
TORQUEREFERRORFALLTIME	To set or read the 'deceleration ramp' for a torque profile in the event of an error.
TORQUEREFFALLTIME	To set or read the 'deceleration ramp' for a torque profile.
TORQUEREFRISETIME	To set or read the 'acceleration ramp' for a torque profile.
VEL	To return the instantaneous axis velocity.

Keyword	Description
VELDEMAND	To read the current instantaneous demand velocity.
VELERROR	To report the velocity following error.
VELFATAL	To set or read the threshold for the maximum difference between demand and actual velocity.
VELFATALMODE	To control the default action taken in the event of the velocity threshold being exceeded.
VELREF	To set or read a fixed point speed reference.
VELSCALEFACTOR	To scale axis encoder counts, or steps, into user defined velocity units.
VELSCALEUNITS	To define a text description for the velocity scale factor.
VFTHREEPOINTFREQ	To read and write the V/F three point intersection frequency.
VFTHREEPOINTMODE	To read and write the V/F three point mode.
VFTHREEPOINTVOLTS	To read and write the V/F three point intersection voltage.
VOLTAGEBOOST	To read and write the extra voltage added to the voltage demand at zero frequency.
VOLTAGEDEMAND	To read the voltage demand outputs from the current controllers.

D.1 Outline

This section provides general information regarding recommended methods of installation for CE compliance. It is not intended as an exhaustive guide to good practice and wiring techniques. It is assumed that the installer of the MicroFlex e100 is sufficiently qualified to perform the task, and is aware of local regulations and requirements. A CE mark is attached to the drive to verify that the unit follows the provisions of the European, EMC, and machinery directives. A duly signed CE declaration of conformity is available from ABB.



D.1.1 CE marking

The CE marking indicates a product's compliance with EU legislation and so enables the free movement of products within the European market. By affixing the CE marking to a product, a manufacturer declares, on his sole responsibility, that the product meets all the legal requirements for the CE marking, which means that the product can be sold throughout the European Economic Area.

However, not all products must bear the CE marking, only product categories mentioned in specific EU directives on the CE marking. The purpose of the directives is to state a minimum technical requirement common to all the member states within the European Union. In turn, these minimum technical requirements are intended to enhance the levels of safety both directly and indirectly.

D.1.2 Compliance with the EMC Directive

EU directive 2004/108/EC relating to Electro Magnetic Compliance (EMC) indicates that it is the responsibility of the system integrator to ensure that the entire system complies with all protection requirements at the time of installing into service.

Motors and controls are used as components of a system, per the EMC directive. Hence all components, installation of the components, interconnection between components, and shielding and grounding of the system as a whole determines EMC compliance.

Compliance with the EN 61800-3

The drive meets the requirements of the EMC Directive with the following provisions:

- The drive is equipped with optional mains filter.
- The motor and control cables are selected as specified in chapter 3.
- The drive is installed according to the instructions given in this manual.
- Motor cable length does not exceed 30 metres (98 ft).

D.1.3 Compliance with the Low Voltage Directive

The drive has been designed, constructed and equipped in such a way that when installed as instructed in this manual, all hazards of an electrical nature are, or can be, prevented. The drive complies with EN 61800-5-1 which specifies safety requirements in terms of electrical, thermal and energy.

Note: The final assembler of the machinery must take the necessary precautions to prevent all hazards of an electrical nature when integrating this equipment. General specifications for design of electrical equipment of machinery is given in EN 60204-1 and EN 60204-11. Specifications for electrical equipment are also given in many standards for specific categories of machinery.

D.1.4 Use of CE compliant components

The following points should be considered:

- **Using CE approved components will not guarantee a CE compliant system!**
- The components used in the drive, installation methods used, materials selected for interconnection of components are important.
- The installation methods, interconnection materials, shielding, filtering and earthing / grounding of the system as a whole will determine CE compliance.
- The responsibility of CE mark compliance rests entirely with the party who offers the end system for sale (such as an OEM or system integrator).

D.1.5 EMC wiring technique

Cabinet

Using a typical electroplated zinc coated enclosure, connected to earth/ground, means that all parts mounted on the back plane are connected to earth/ground and all outer shield (screen) connections can be connected to earth/ground. Within the cabinet there should be a spatial separation between power wiring (motor and AC power cables) and control wiring.

Shield (screen) connections

All connections between components must use shielded cables. The cable shields must be connected to the enclosure. Use conductive clamps to ensure good earth/ground connection. With this technique, a good earth/ground shield can be achieved.

EMC filters

The filter should be mounted next to the MicroFlex e100. The connections between the MicroFlex e100 and the filter should use shielded (screened) cables. The cable shields should be connected to shield clamps at both ends.

Earthing/grounding

For safety reasons (VDE0160), all components must be connected to earth/ground with a separate wire. Earth/ground connections must be made from the central earth/ground (star point) to the brake resistor enclosure and from the central earth/ground (star point) to the power supply.

D.1.6 EMC installation suggestions

To ensure electromagnetic compatibility (EMC), the following installation points should be considered to help reduce interference:

- Earthing/grounding of all system elements to a central earth/ground point (star point)
- Shielding of all cables and signal wires
- Filtering of power lines.

A proper enclosure should have the following characteristics:

- All metal conducting parts of the enclosure must be electrically connected to the back plane. These connections should be made with an earthing/grounding strap from each element to a central earthing/grounding point (star point). *
 - Keep the power wiring (motor and power cable) and control wiring separated. If these wires must cross, be sure they cross at 90 degrees to minimize noise due to induction.
 - The shield connections of the signal and power cables should be connected to the shield rails or clamps. The shield rails or clamps should be conductive clamps fastened to the cabinet. **
 - The cable to the brake resistor must be shielded. The shield must be connected to earth/ground at both ends.
 - The location of the AC filter has to be situated close to the drive so the AC power wires are as short as possible.
 - Wires inside the enclosure should be placed as close as possible to conducting metal, cabinet walls and plates. It is advised to terminate unused wires to chassis ground.*
 - To reduce earth/ground current, use the largest suitable wire available for earth/ground connections.
- * Earthing/grounding in general describes all metal parts which can be connected to a protective conductor, e.g. housing of cabinet, motor housing, etc. to a central earth/ground point (star point). This central earth/ground point (star point) is then connected to the main plant (or building) earth/ground.
- ** Or run as twisted pair at minimum.

D.1.7 Wiring of shielded (screened) cables

Remove the outer insulation to expose the overall shield. Clamp should provide 360° contact with the cable.

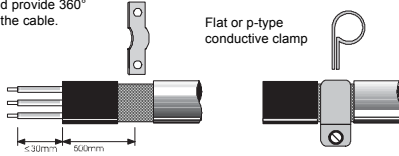

Flat or p-type conductive clamp

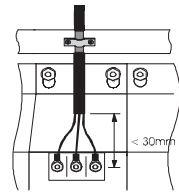

Figure 61: Earthing/grounding cable shields

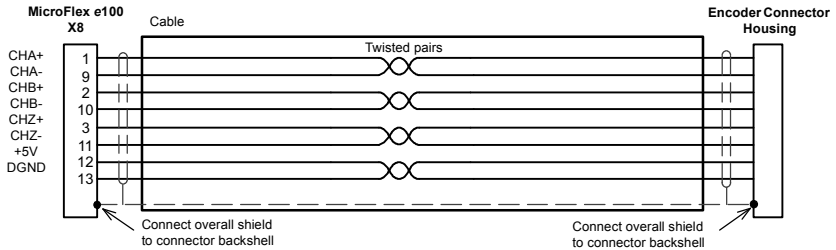

Figure 62: Encoder signal cable grounding

D.2 C-tick marking



"C-tick" marking is required in Australia and New Zealand. A "C-tick" mark is attached to each drive in order to verify compliance with the relevant standard (IEC 61800-3, *Adjustable speed electrical power drive systems - Part 3: EMC product standard including specific test methods*), mandated by the Trans-Tasman Mutual Recognition Arrangement (TTMRA).

D.2.1 RCM marking



RCM marking is pending for the drive.

D.3 RoHS compliance

MicroFlex e100 is in conformity with Directive 2011/65/EU of the European parliament and of the council of 8th June 2011 on the restriction of the use of certain hazardous substances in electrical and electronic equipment. The RoHS declaration 3AXD10000429153 is available on www.abb.com/drives.

D.3.1 China RoHS compliance



The People's Republic of China Electronic Industry Standard SJ/T 11364-2014 specifies the marking requirements for hazardous substances in electronic and electrical products. The '20' logo indicates the period, in years, during which the hazardous substances contained in the product will not leak or cause environmental pollution, bodily injury, or damage to other assets during normal use of the product.

Part	Hazardous substances					
	Lead (Pb)	Mercury (Hg)	Cadmium (Cd)	Hexavalent chromium (Cr(VI))	Polybrominated biphenyls (PBB)	Polybrominated diphenyl ethers (PBDE)
PCB	O	O	O	O	O	O
Heat sink	X	O	O	O	O	O
Metal parts	O	O	O	O	O	O
Plastic parts	O	O	O	O	O	O
Other non-metal parts	O	O	O	O	O	O
Fans	O	O	O	O	O	O
Cables/wires	O	O	O	O	O	O

The table is prepared in accordance with the provision of SJ/T 11364.
O: Indicates that said hazardous substance contained in all of the homogeneous materials for this part is below the limit requirement of GB/T 26572.
X: Indicates that said hazardous substance contained in at least one of the homogeneous materials used for this part is above the limit requirement of GB/T 26572. The limits are:

Pb: 1000 ppm (0.1%) Hg: 1000 ppm (0.1%) Cd: 100 ppm (0.01%)
Cr6+: 1000 ppm (0.1%) PBB: 1000 ppm (0.1%) PBDE: 1000 ppm (0.1%)

PCBA: Includes Printed Circuit Board and the components.
Depending on the model/type of the product, it may not contain all of the above parts. It is subject to the actual model/type purchased.
The environmental protection period applies only when the product is used according to the conditions required by the user manual. To protect the environment and human health:

- 1.The scrapped product should be separated from domestic waste and sent to a qualified place of disposal.
- 2.Recycling center should use appropriate methods to recycle/deal with the materials.

For more information about recycling this product, please contact local government, recycling center or your local dealer.

D.3.2 WEEE notice



According to the requirements of the Waste Electrical and Electronic Equipment Directive (WEEE) the following information is provided.

This symbol indicates that the product must not be disposed of with other general waste. It is your responsibility to dispose of your waste electrical equipment by handing it over to a designated collection point for the recycling of waste electrical and electronic equipment. The separate collection and recycling of your

waste equipment at the time of disposal will help conserve natural resources and ensure that it is recycled in a manner that protects human health and the environment. For more information about where you can recycle your waste, please contact your local authority.

D.4 UL file numbers

The following table lists UL file numbers for ABB products (formerly Baldor) and other accessories. Note that UL file numbers for accessories that not manufactured by ABB are beyond ABB's control and therefore subject to change without notice.

UL file number	Company	Description
E470302	ABB Motion Ltd.	Drives
E46145	Baldor Electric Co.	Motors
E132956	Cabloswiss s.p.a.	Power cables (6A, 12A, 20A, 25A, 50A, 90A) Encoder cables Resolver/SSI cables EnDat cables
E192076	Unika Special Cables s.p.a	Power cables (6A, 12A, 20A, 25A, 50A, 90A) Encoder cables Resolver/SSI cables EnDat cables
E153698	Coninvers GmbH	Connectors
E64388	Schaffner EMV AG	AC filters
E70122	Epcos AG	AC filters
E212934	Frizlen GmbH & Co. KG	Brake resistors
E227820	RARA Electronics Corp.	Brake resistors

A

Abbreviations *See* Units and Abbreviations

Accessories, A-1

24 V power supplies, A-3

brake resistors, A-7

EMC filters, A-4

fan tray, A-2

footprint filter, A-3

motor power cables, A-8

B

Basic Installation, 3-1

BiSS

interface, 4-6, 4-9

specification, 8-6

Brake

capacity, 3-24

duty cycle, 3-30

energy, 3-26

power, 3-26

resistor, 3-24

resistor, duty cycle derating, 3-29

resistor, selection, 3-25

specification, 8-4

C

CAN interface

CANopen, 5-23

connector, 5-21

introduction, 5-21

LEDs, 7-3

opto-isolation, 5-22

specifications, 8-7

termination, 5-21

wiring, 5-21

Catalog number

identifying, 2-2

CE Guidelines, C-1, D-1

Circuit breakers, 3-17

Command window, 6-27

Commissioning Wizard, 6-12

using, 6-12

Configuration, 6-23

Connections

See also Input / Output

feedback, 4-1

motor, 3-20

power, 3-12, 3-14

Connectors

CAN, 5-21

Ethernet, 5-17, 5-20

I/O, 5-3

locations, 3-10, 3-11

RS485, 5-15

USB, 5-15

Control system, B-1

servo configuration, B-2

torque servo configuration, B-4

Cooling, 3-5, 3-6, 3-7, 3-8, A-2, A-9

heat dissipation, 3-9

overtemperature trips, 3-8

D

Demand outputs, 6-21, 6-22

Derating, 3-6, 3-7, 3-8

Digital I/O, 5-2

digital input DIN0, 5-5, 8-4

digital inputs DIN1 & DIN2, 5-7, 8-5

digital output DOUT0, 5-11, 8-5

digital output DOUT1, 5-13, 8-5

drive enable input, 5-3, 8-4

fast position capture, 5-9

special functions on DIN1 & DIN2, 5-8

step & direction, 5-8

Dimensions, 3-4

E

Earthing (grounding)

- leakage, 3-13
- protection class, 3-13
- protective earth (PE), 3-12

Encoder, incremental

- cable, 4-3
- feedback, 4-2
- specification, 8-5
- without Halls, 4-4

EnDat (absolute) encoder

- feedback, 4-8
- specification, 8-7

Environmental

- cooling, 3-3
- location, 3-3
- specification, 8-8

Ethernet connector, 5-20

Ethernet interface

- cables, A-9
- connector, 5-20
- Ethernet POWERLINK, 5-19
- introduction, 5-17
- LEDs, 7-4
- specifications, 8-7
- TCP/IP, 5-17

F

Fast position capture, 5-10

Features, 2-1

Feedback

- BiSS, 4-6, 4-9
- connections, 4-1
- encoder without Halls, 4-4
- EnDat (absolute), 4-8
- Halls-only feedback, 4-4
- incremental encoder, 4-2
- SinCos, 4-10
- SSI, 4-7

Filters

- 24 V control circuit supply, 3-19
- AC power (EMC), 3-18, A-4
- part numbers, A-4

Footprint filter, A-3

Fuses, 3-17

G

General Information, 1-1

Grounding See Earthing (grounding)

H

Hardware requirements, 3-1

Heat dissipation, 3-9

Help file, 6-9

I

Incremental encoder

- cable, 4-3
- feedback, 4-2
- specification, 8-5
- without Halls, 4-4

Indicators

- CAN LEDs, 7-3
- ETHERNET LEDs, 7-4
- STATUS LED, 7-2

Input / Output, 4-1, 5-1

CAN interface, 5-21

connection summary, 5-28

digital input DIN0, 5-5, 8-4

digital inputs DIN1 & DIN2, 5-7, 8-5

digital output DOUT0, 5-11, 8-5

digital output DOUT1, 5-13, 8-5

drive enable input, 5-3, 8-4

encoder interface, 4-1

Ethernet interface, 5-17

node ID selector switches, 5-25

RS485 port, 5-15

serial port, 5-15

USB port, 5-15

Installation

See also Basic Installation

- cooling, 3-5
- dimensions, 3-4
- mechanical, 3-3
- Mint WorkBench, 6-1
- mounting, 3-5
- TCP/IP configuration, 6-4
- USB driver, 6-3

K

Keyword summary, C-1

L

LED indicators

CAN LEDs, 7-3

ETHERNET LEDs, 7-4

STATUS LED, 7-2

LED status indicator, 7-2

Linear motor

cable configuration, 4-5

M

Mint keyword summary, C-1

Mint Machine Center (MMC), 6-5
starting, 6-7

Mint WorkBench, 6-8

Commissioning Wizard, 6-12

fine-tuning tool, 6-23

help file, 6-9

other tools and windows, 6-27

parameters tool, 6-25, 6-26

starting, 6-10

Motor

brake connection, 3-23

circuit contactors, 3-21

connections, 3-20

power cable, A-8

sinusoidal filter, 3-21

thermal switch, 3-22

Mounting, 3-5

N

Node ID selector switches, 5-25

O

Operation, 6-1

configuring the TCP/IP connection, 6-4

connecting to the PC, 6-1

installing Mint WorkBench, 6-1

installing the USB driver, 6-3

power on checks, 6-2

preliminary checks, 6-2

starting, 6-2

Overloads

drive, 3-17

motor, 3-20

overtemperature trips, 3-8

P

Parameters tool, 6-25, 6-26

Power

24 V control circuit supply, 3-19

24 V power supplies, A-3

connections, 3-12

discharge period, 3-15

disconnect and protection devices, 3-16

input conditioning, 3-15

input cycling, 3-15, 7-1

inrush, 3-15

sources, 3-1

supply filters, 3-18, A-4

using a variac, 3-16

Precautions, 1-2

Product Notice, 1-2

R

Receiving and Inspection, 2-2

Regeneration See Brake

RS485

port, 5-15

RS485 interface

specifications, 8-7

S

Safety Notice, 1-2

Servo axis

testing the demand output, 6-21, 6-22

SinCos

feedback, 4-10

specification, 8-6, 8-7

Specifications, 8-1

24 V control supply, 8-3

AC input power and bus voltage, 8-1

BiSS interface, 8-6

braking, 8-4

CAN interface, 8-7

digital input DIN0, 8-4

- digital input DIN1, 8-5
- digital input DIN2, 8-5
- digital output DOUT0, 8-5
- digital output DOUT1, 8-5
- drive enable input, 8-4
- EnDat feedback, 8-7
- environmental, 8-8
- Ethernet interface, 8-7
- incremental encoder feedback, 8-5
- motor output, 8-3
- RS485 interface, 8-7
- SinCos feedback, 8-7
- SinCos interface, 8-6
- SSI encoder feedback, 8-6
- weights and dimensions, 8-8

T

- feedback, 4-7
- specification, 8-6

Status LED, 7-2

Step & Direction

- DIN1/2, 5-8
- specification, 8-5

T

TCP/IP

- configuring, 6-4

Testing

- demand output, 6-21, 6-22

Thermal switch connection, 3-22

Tools, 3-2

Troubleshooting, 6-1, 7-1

- CAN LEDs, 7-3
- CANopen, 7-7
- communication, 7-5
- Ethernet, 7-6
- ETHERNET LEDs, 7-4
- Mint WorkBench, 7-5
- power cycling, 7-1
- power on, 7-5
- problem diagnosis, 7-1
- STATUS LED, 7-2
- SupportMe, 7-1
- tuning, 7-6

U

UL file numbers, D-6

Units and abbreviations, 2-3

USB

- installing the driver, 6-3
- port, 5-15

W

Weights and dimensions, 8-8

Wires sizes, 3-17

WorkBench *See* Mint WorkBench

If you have any suggestions for improvements to this manual, please let us know. Write your comments in the space provided below, remove this page from the manual and mail it to:

Manuals
ABB Motion Ltd
6 Hawkley Drive
Bristol
BS32 0BF
United Kingdom.

Alternatively, you can e-mail your comments to:

manuals.uk@gb.abb.com

Comment:

continued...



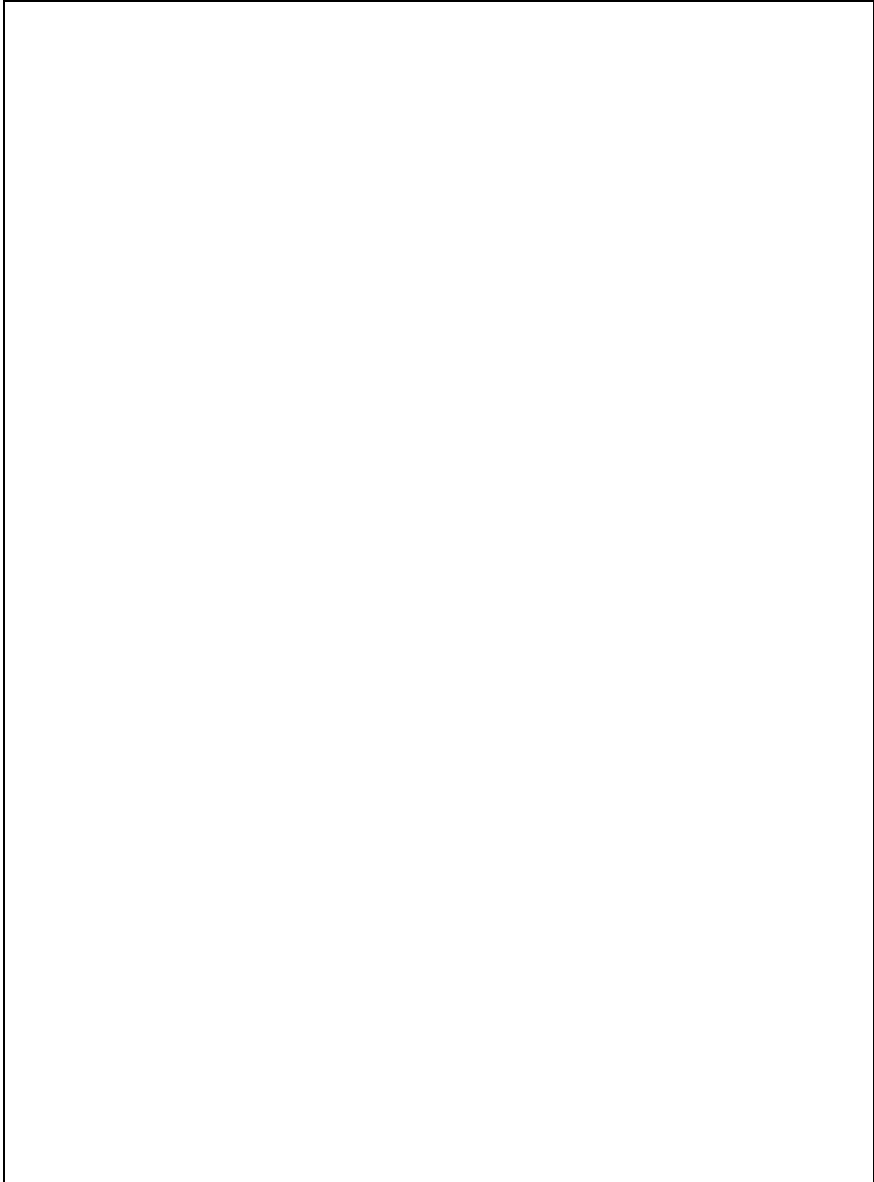

Thank you for taking the time to help us.

Contact us

ABB Oy
Drives
P.O. Box 184
FI-00381 HELSINKI
FINLAND
Telephone +358 10 22 11
Fax +358 10 22 22681
www.abb.com/drives

ABB Motion Ltd
6 Hawley Drive
Bristol, BS32 0BF
United Kingdom
Telephone +44 (0) 1454 850000
Fax +44 (0) 1454 859001
www.abb.com/drives

ABB Inc.
Automation Technologies
Drives & Motors
16250 West Glendale Drive
New Berlin, WI 53151
USA
Telephone 262 785-3200
1-800-HELP-365
Fax 262 780-5135
www.abb.com/drives

ABB Beijing Drive Systems Co. Ltd.
No. 1, Block D, A-10 Jiuxianqiao Beilu
Chaoyang District
Beijing, P.R. China, 100015
Telephone +86 10 5821 7788
Fax +86 10 5821 7618
www.abb.com/drives

LT0262A07EN EFFECTIVE: 2017-01-01



LT0262A07EN

Power and productivity
for a better world™

