

brookfield industries, inc.

Commercial / Industrial Door Operator Manual

SWINGING AND SLIDING DOOR OPERATORS FOR LEAD
SHIELDED DOORS

CE



Intertek

*For All Door Operator Model Numbers
for Swinging and Sliding Doors*

99 W. Hillside Ave.
Thomaston, CT 06786

P : 860-283-6211

F : 860-283-6123

www.bfimfg.com

info@bfimfg.com

brookfield industries, inc.

**NB-4100-PLC*
COMMERCIAL/INDUSTRIAL
SLIDING
DOOR OPERATOR
MANUAL**

6th edition (6/26/17)



Conforms to UL STD 325
Control No. 3011624



US Patent No. 6,177,771 B1

***PLC upgrade for momentary contact and safety sensor activation.
Includes Rotary Position Transducer/(A-D) converter (eliminates limit
switches); the addition of the Automatic Close feature with adjustable hold
open delay.**

Table of Contents

- **Important Instructions for Installation**
- **Important Safety Instructions**
- **Overview**
- **Installation Instructions**
- **Parameters for NB-4100 Sliding Door Operator**
- **Drawings: DO2003R1 and DO2003R2 for Single Slide Doors
DO28303R1 and DO28303R2 for Bi-Parting Doors
DO30903R1 and DO30903R2 for Multiple (stacked) Doors**
- **Terminal Strip Hookup Legend (Power Supply and Class 2 Voltages)**
- **Wiring Diagrams**
- **Maintenance Interval**
- **Safety System Test Interval**
- **Limited Warranty**
- **Sliding Door Operator Troubleshooting**

WARNING!

IMPORTANT INSTALLATION INSTRUCTIONS IMPROPER INSTALLATION CAN LEAD TO SEVERE INJURY OR DEATH READ AND FOLLOW ALL INSTRUCTIONS

- **Commercial/Industrial Sliding Door Operator** shall be installed more than 8' above the floor
- Install only on a properly operating and balanced door
- Do not connect door operator to source of power until instructed to do so
- This door operator shall be installed and serviced by a qualified technician, electrician or electrical maintenance person familiar with its operation and the potential hazards involved.
- Any person performing installation or service on this product shall read this manual first. Proper installation includes following all steps outlined in the **Installation Instructions** and the settings specified under the **Parameters** section.
- Assure all electrical wiring and grounding is installed as specified in this manual and as required by any local codes. Proper installation can also reduce the risk of electrical shock, fire or explosion.
- Locate activation switches or push button stations: (a) within sight of the door, (b) at a minimum height of 5' so small children cannot reach and (c) away from moving parts of the door.
- Install the Entrapment Warning Placard next to the activation switches in a prominent location
- As described in this manual, the Stop command controlled by the motor drive is not intended to be a fail safe or Emergency Stop (E-Stop) since it does not prevent the motor drive from malfunctioning. This can only be accomplished by disconnecting the AC power to the operator (terminals L1 and N).
- This door operator is to be a permanent or "hard" wired connection to the supply voltage. The electrical contractor shall install a dedicated breaker or line switch to disconnect each ungrounded pole of the door operator from the supply voltage. Each ungrounded pole shall have a minimum of 3mm contact separation.
- If this model is equipped with a manual release, disengage pin(s) between door and door operator before manually moving the door.

WARNING!

IMPORTANT SAFETY INSTRUCTIONS IMPROPER USAGE CAN LEAD TO SEVERE INJURY OR DEATH READ AND FOLLOW ALL INSTRUCTIONS

- **Commercial/Industrial Sliding Door Operator** for trained traffic* use only. The manufacturer of this product does not include external safety devices as a standard feature.
- **External safety devices** are required on this door operator. Refer to the Terminal Strip Hookup in this manual for proper wiring and to the owner's manual of the external safety device manufacturer for proper installation and use.
- No person shall perform any service or activate this door operator unless they have been properly trained in its safe usage and have read the owner's manual.
- Never let children operate or play with door controls.
- Before activating this door operator, check the following:
 1. Assure that all personnel are clear of the path of this operator and the door that it is attached to.
 2. Assure that all fingers, hands, feet, limbs and articles of clothing are clear of all moving parts and pinch points.
- Personnel should keep away from a door in motion and keep the moving door in sight until it is completely closed or open. **NO ONE SHOULD CROSS THE PATH OF A MOVING DOOR.**
- Test the door's safety features at least once a month. After adjusting either the force, speed or the limit of travel, retest the door operator's safety features. Failure to do so may cause severe injury or death.
- **KEEP DOORS PROPERLY OPERATING AND BALANCED.** Refer to door manufacturer's manual. Have repairs done by trained technicians.
- Prior to performing any service on this product (including the replacement of any fuses or circuit breakers), disconnect the operator from the supply voltage.
- For continued protection against fire, replacement fuses or circuit breakers shall be of the same type and ratings as those being replaced.

*Defined in ANSI 156.10 as a controlled group of people trained in the safe use and operation of a particular door installation.

SAVE THESE INSTRUCTIONS

Overview

The **NB-4100-PLC Commercial/Industrial Sliding Door Operator** has been designed, tested (over 500,000 cycles) and is manufactured by **brookfield industries, inc.** in accordance with UL 325. The NB-4100-PLC will operate any industrial sliding door system that requires horizontal operating forces up to 300 lbs, variable speeds up to 13 inches/sec and move doors across practically any opening specified.

The NB-4100-PLC mounts at the header of the door and disconnects for manual operation with a spring-loaded pull down pin. The operator features lightweight aluminum construction, which makes for easier installation and greater corrosion resistance. The steel reinforced, polyurethane timing belt and the *linear guide tracking system* are maintenance free and need no lubrication. The NB-4100-PLC can also be modified to operate a bi-parting door.

This power open/power close electro-mechanical operator with its state of the art components, make it the strongest, most reliable and easiest to install in the industry today. Refer to the **Terminal Strip Hookup** for all open, partial open, close, stop and **External Safety Device** inputs, which are all Class (2) 24VDC normally open momentary contact. Power supply hookups for both Class (2) 24VDC, 110VAC and 230VAC(European installations) are also indicated. The PLC then processes all this information for proper control of these heavy lead doors. This door operator is patented under **US Patent No. 6,177,771 B1**.

The NB-4100-PLC **Commercial/Industrial Sliding Door** is compliant with **UL 325 Section 30.2**

External Entrapment Protection (Fail Safe/Self-Monitoring) providing all External Safety Devices are wired and installed per this manual.

We are Authorized to Mark the NB-4100-PLC with the **ETL, CE** and **CSA** markings from Intertek Testing Services to assure compliance with UL 325, FCC Part 15 (Emissions) and the following International Standards: EN 60335-1 and - 2 (Safety), EN 61000-6-2 (Immunity) and EN 61000-6-4 (Emissions). The "listing" reports specifically refer to the heavy commercial/industrial doors associated with linear accelerator rooms.

Logic Control:

This Operator offers the latest technology in PLC (Programmable Logic Control). The following (2) modules snap to a DIN rail base:

CPU (Central Processing Unit) - processes and stores data in its internal register such as inputs from pushbutton stations and outputs to motor controls. This extremely compact unit houses (8) LED 24 VDC inputs and (6) LED outputs with (3) isolated commons.

Analog/Digital Converter- converts the analog signal of the Rotary Position Transducer to a digital value.

Class (2) 24 VDC Power Supply- converts 110 supply voltage to Class (2) 24VDC power to operate the CPU, A/D converter, Rotary Position Transducer and presence sensors.

These plug-in modules with LED make diagnostics and replacement of parts easy and quick to perform.

Interface with the PLC is necessary to adjust **Door Position Presets** in the field. This is accomplished by plugging in the **Programmable HMI (GT01)**, a hand held, touch screen device that is purchased separately.

The CPU has been programmed to adjust on the fly, such door position presets as **Back Check, Full Open, Latch Check** and **Full Closed**. In addition, we've included a **Partial Open** preset as required on most Linac Doors in the marketplace today.

Input commands to be processed by the PLC, are done so by making the appropriate connections on the **Terminal Strip Hookup**. By connecting separate normally open (SPST) switches between terminals 1 and 14 to open, terminals 1 and 13 to partially open, terminals 1 and 12 to close and a normally closed (SPDT) switch to terminals 1 and 10 to stop the door, provides the customer discrete control of each input from a **momentary contact push button station** (not included). Reversing the direction of the door while it's moving (dynamic) can be accomplished by simply pressing the appropriate switch to change direction.

The NB-4100-PLC features momentary contact **Input** commands for **External Safety Devices** that comply with **Entrapment Protection of UL 325 Section 30.2 (Fail Safe/Self-Monitoring)**. These devices are door mounted **4-wire reversing edge contact type sensors** that reverse the door while closing. **Note: The door will not be allowed to close unless these sensors are correctly wired per this manual.** When installing contact type sensors, assure that they are properly secured to the leading edge of the door and that a sufficient quantity of sensors are properly spaced and are of adequate length to assure safe operation. Momentary contact **Input** commands and a **low voltage Class (2) power supply** are also provided for **additional (redundant) sensors**, such as **non-contact type presence sensors** that are frame mounted. brookfield industries does not manufacture nor do we include **External Safety Devices** with any of our door operators. In order to assure that external safety devices are properly installed and adjusted correctly, refer to the owner's manual for that particular device. For proper wiring, refer to **Terminal Strip Hookup** and the **Wiring Diagram** included in this manual.

The **Stop** command (normally open terminal #10) will stop the door in any position when activated but it will not prevent a motor drive from malfunctioning nor is it a true emergency stop. **Emergency Stop (E-Stop) can only be accomplished by disconnecting AC power to the operator (Terminal L1 and Terminal N).**

The NB-4100-PLC features the same **Absolute Position Feedback Control** system and software as other **brookfield industries, inc.** door operators. There

are no limit or proximity switches to adjust or install for any of the door positions under normal operation. Simply adjust the door's positioning presets as required by interfacing with the PLC via a hand held Data Access Unit (purchased separately).

A **Rotary Position Transducer** attached to the worm gear output shaft provides the position of the door. As the door changes position, the output signal from the transducer varies in value. This signal, once converted to a digital value, is stored in the CPU for further processing. This device does not need to be "homed" or reset if there's a power loss, nor does it need to go through "learn speed" after power up or after any adjustments have been made.

Motor Control:

The NB-4100-PLC uses a state of the art **Regenerative (4-Quadrant) 90 VDC Motor Control**. This provides the best assurance that the door's high inertia characteristics will not "overhaul" (or "freewheel") the motor; thus, resulting in controlled door motion. The **NB-4100-PLC** features a **multi-speed board** that attaches to the top of the **motor control** that features control of up to (4) independent speeds. The **NB-4100-PLC** has the flexibility of controlling separate latch check speeds (**Preset 1**) and back check speeds (**Preset 2**) as well as close speeds (**Preset 3**) and open speeds (**Preset 4**). The motor control also features additional trimpots, which greatly improve the performance of the drive and motion profile of such heavy doors. The **DB** (Dead Band) trimpot controls the amount of delay before regeneration starts (if set too low oscillation may occur). The **RESP** (Response) trimpot adjusts the dynamic response of the system; therefore, increasing this setting will increase response time (if set too high, unstable operation may result). The **IR Comp** trimpot determines the amount in which the motor speed is held constant as the motor load changes. For example, if set too low, the motor may not obtain the desired speed fast enough or not at all. If set too high, the motor may oscillate. The **RCL** (Reverse Current Limit) trimpot and **FCL** (Forward Current Limit) trimpot adjusts the armature current limit or motor torque in their respective directions. When properly set, the operator will have sufficient torque to operate in both directions, while at the same time limiting the current to the motor. This will prevent damage to any of the mechanical components of the door operator (*also eliminates the need for unreliable and hard to adjust manual slip or electromagnetic clutches*). The **MAX** (maximum speed) trimpot adjusts the voltage or speed of the motor in the forward and reverse directions. The **FACC** (Forward Acceleration) trimpot adjusts the acceleration time in the forward direction as a function of the maximum rated motor speed. It also controls the Reverse Deceleration time. The **RACC** (Reverse Acceleration) trimpot adjusts the acceleration time in the reverse direction as a function of the maximum rated motor speed. It also controls the Forward Deceleration time.

Overload Protection for the DC motor is provided by using the appropriate line fuse to the 110VAC power supply of the motor control (see wiring diagram) and by the proper setting of the **Reverse Torque (RCL)** and **Forward Torque (FCL)** trimpots, which controls the amount of DC current to the motor in both directions.

Drive Train:

Power is supplied from a $\frac{3}{4}$ hp DC 1750 RPM 90 VDC motor coupled to a high torque 20:1 (1.75" center distance) cast aluminum wormgear. Rotary motion is transferred to linear motion through a steel reinforced, 1" wide x $\frac{1}{2}$ " pitch, polyurethane timing belt. The timing belt is supported by a *linear guide tracking system* and (2) 18 tooth-timing pulleys. One is attached to the wormgear output shaft, while the other is attached to the take-up end. The *linear guide tracking system* keeps the belt aligned and assures it is properly meshed into the pulleys at all times. The tracking system also allows the door operator to be disconnected from the door for manual operation. Once the adjustable take-up end of the belt is set with the proper pretension, the **NB-4100-PLC** becomes a reliable, maintenance free door operator that needs no lubrication and can operate at forces up to 300 lbs.

The *linear guide tracking system* consists of (4) self-aligning (open) linear plain bearings mounted to the same plate that the timing belt and the quick disconnect pin is attached to. The mounting plate assembly slides on (2) adjustable 5/8" diameter guides that are continuously supported along the length of the support channel.

Supply Voltage:

115 VAC, (+/- 10%), (230 VAC for European installations) 50/60 Hertz, single phase. In-line circuit breakers are supplied with Motor Control and Power Supply. Surge protection and line Filters are featured to protect door operator components and to assure their reliable performance (immunity) as well as minimizing RF noise (emissions).

For European installations we offer a 230 VAC single phase to 115 VAC step down, 1.5 KVA transformer. The transformer and surge protection are housed in a NEMA 1 enclosure ready to be field wired from the supply voltage to the door operator.

Manual Operation:

A spring loaded disconnect pin that when pulled down, disengages the door operator from the door, so it can be pushed manually.

Battery Backup (optional):

When power is interrupted, and if the door is in any position other than fully open, the battery backup will be activated and provide low voltage DC power directly to the motor. The system is designed to open the door once for each power interruption at a constant speed. This system is not designed to open and close the door repeatedly. A float charger is included to provide a constant charge on the battery. These components are installed in a NEMA 1 enclosure with a test switch that will interrupt power and allow for testing the system. Also included is an end of travel limit switch, which must be installed so that it disconnects power to the motor when the door is fully open. (this limit switch is only for use in battery backup mode and not for normal operation).

This is a redundant system and does not replace or substitute any requirements of UL 325 section 29.3 Interruption of Power for manual operation.

**Assure used batteries are disposed of at the appropriate drop off center
brookfield NB-4100-PLC Door Operator Installation Instructions.**

brookfield NB-4100-PLC Door Operator Installation Instructions

Although each NB-4100-PLC has been fully inspected and tested prior to shipment, assure that no physical damage has occurred during shipping and handling. *Premature failure of the timing belt assembly may occur if it's not installed properly.*

Caution! *When performing welding operations, assure ground leads are in direct contact with work piece. Do not ground through the operator, since this will damage components.*

Refer to drawings DO2003R1 and DO2003R2 for Single Slide Doors. Refer to drawings DO28303R1 and DO28303R2 and Bi-Parting Doors:

1. For wall mounted units, position the (3) leg mounting brackets above the hanger track. Assure each bracket is the same vertical dimension from the track within (+/-) 1/8". Locate each bracket in the correct horizontal location from the door per DO20032. Mounting holes for the brackets are pre-drilled in the 8" aluminum channel.
2. After leveling the brackets on the wall, use the bracket as a template to mark the location on the wall of the (3) mounting holes. Repeat for both brackets.
3. Drill and install (3) expansion anchors at each bracket location.
4. Mount the brackets with the expansion anchors properly secured.
5. Mount the 8" aluminum channel and the fully assembled operator to the slotted mounting holes of the wall brackets with the hardware provided.
6. If the operator has a splice in the 8" channel, assemble as follows. If not go to step 7.:
 - Before lifting the operator into place, slide the (2) 8" channel sections together while assuring the (2) dowel pins (protruding from the 5/8" diameter guide bars of the 8" channel with the motor) are aligned into the holes of the 5/8" diameter guide bars of the 8" channel with the take-up frame.
 - Mount the 8" channels sections together with the (2) flange splice plates and the web splice plate with the hardware included. Tighten all hardware.
 - Slide guide plate over transition point to assure smooth operation. *Guide bars are adjusted at the factory with the Bellville washers installed at the mounting bolts, but may require final adjustment after shipping.*
 - Place the timing belt over both 18-tooth pulleys and pre-tension the belt to the marking on the take-up end frame made at the factory.

7. Mount the disconnect pin and angle bracket to the door by welding (3/8" fillet weld) or mount with (2) 3/8" grade 5 bolts (not included) making sure bracket is straight and pin has adequate engagement into receptacle on door operator mounting plate.
8. Measure the horizontal distance from the door track to the 5/8" diameter guide bars on the door operator at (3) locations (at each end and the in middle) adjusting the operator in the slotted holes to get the desired measurement within (+/- 1/16").
9. Properly tighten all mounting hardware.
10. Check disconnect pin to assure it operates and disconnects freely.

Refer to drawings DO30903R1 and DO3093R2 for multiple (stacked) doors:

1. For units with the (4) slotted 12" long mounting plates, clamp the plates in a nominal position that allows for both (+/-) adjustments. Before welding the plates in place (3/8 fillet welds), run a string line across the top of each plate along the length of the operator. Shim (shim pack included) the plates as required to get each plate height within (+/- 1/16").
2. Mount the disconnect pin and angle bracket to the door by welding (3/8" fillet weld) or mount with (2) 3/8" grade 5 bolts (not included) making sure bracket is straight and pin has adequate engagement into receptacle on door operator mounting plate.
3. Measure the horizontal distance from the door track to the 5/8" diameter guide bars on the door operator at (3) locations (at each end and the in middle) adjusting the operator in the slotted holes to get the desired measurement within (+/- 1/16").
4. Properly tighten all mounting hardware.
5. Check disconnect pin to assure it operates and disconnects freely

External Safety Devices:

1. When installing contact type sensors, assure that they are properly secured to the leading edge of the door and that a sufficient quantity of sensors are properly spaced and are of adequate length to assure safe operation.
2. In order to assure that external safety devices including contact and non-contact type (presence sensors) are properly installed and adjusted correctly, refer to the owner's manual for that particular device. For proper wiring, refer to **Terminal Strip Hookup** and the **Wiring Diagram** included in this manual.

Electrical hookup (Caution!):

1. To prevent risk of serious injury, assure source voltage has been disconnected and all “Lock-Out” Safety Procedures have been strictly adhered to.
2. Hookup 115 VAC supply voltage (230VAC supply voltage for European installations) and grounding per **Terminal Strip Hookup** the applicable **Wiring Diagram** and/or local codes.

Connect all Class (2) (24) VDC inputs per the **Terminal Strip Hookup** and the **Wiring diagram** including required **External Safety Devices** (not included with operator) that comply with the **Entrapment Protection of UL 325 Section 30.2 (Fail Safe/Self-Monitoring)**. These devices are door mounted **4-wire reversing edge contact type sensors** that reverse the door while closing. **Note: The door will not be allowed to close unless these sensors are correctly wired per this manual.**

3. Connect the **90 VDC motor** with the wires provided and as indicated on the labels and per the wiring diagram

Final setup:

1. All **motor control** settings have been preset by brookfield industries, inc.; however, we recommend these values be double-checked with the **Parameter for NB-4100-PLC** sheet supplied.
2. Assure all **Safety Instructions** and **Installation Instructions** have been followed.
3. Activate Open, Partial Open and Close Commands.
4. Adjust **Open, Partial Open and Close** speed “Pots” clockwise to the recommended setting.
5. Adjust **Latch Check** and **Back Check** speed “Pots” until a smooth transition to stopping the door has been obtained.
6. Adjust **PLC** door position factory presets as required. Refer to the **Door Position Setup** and **DAU Instructions** and the **NB-4100-PLC Parameters** sheet if necessary.
7. Be prepared to hit stop button in case any obstacles are encountered.
8. The NB-4100-PLC should be operated at slower speeds at first and should only be increased in small increments at a time. Each time the speed (**Preset 3-close** and **Preset 4-open**) is increased, end of travel clearances should be checked. Fine tuning of the soft start and stop or **FACC** (Forward Acceleration) and **RACC** (Reverse Acceleration) may be necessary each time the speeds are changed.
Caution! Setting FACC ,RACC, Preset 3 and/or Preset 4 to high can damage or crash the operator

9. Operate the door several times to assure repeatability with the end of travel limits and to assure overall smooth operation. Fine tune the **FCL** and **RCL** trimpots to assure adequate motor torque exists to move the doors at the desired speed, while not being set too high, which could potentially damage components or injure personnel. *The net operating force can be checked with a force gage and is recommended not to exceed 30 lbs in either direction. Since this is an Industrial operator, this setting it is not mandatory.*

Door Position Setup and HMI Instructions

GT-01/02 Touch Screen

1. Plug the eight prong Phoenix Connector into GT-01/02. For operator series before 'G,' use the black cable, plug the opposite ROUND end into the PLC unit on the operator. For 'G' series and above, use the gray cable and plug the opposite ROUND end into the receptacle on the end cover of the operator (right side).
2. A "Please Wait" logo message will flash for a few seconds and then a selection screen will show.

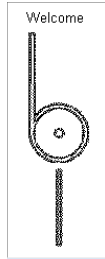

Fig. 2

3. For GT-01/02 software prior to Ver. 3, the screen in Fig. 3 will display. Choose either 'Standard' or 'Main/Sub' operator. For Ver. 3.7 of the GT-01/02 software, the screen in

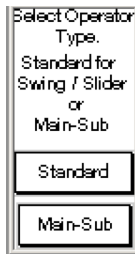

Fig. 3



Fig. 4

Fig. 4 will display. For Main/Sub, select 'Lead Door' or 'Follow Door' on the next screen (Fig. 5), then skip to step 5. NOTE: Check PLC model number for appropriate 'Main-Sub' selection.

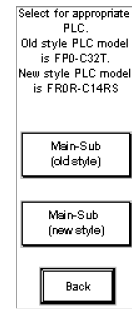
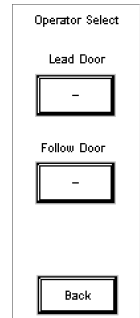

Fig. 5



4. Selecting Standard will give you the screen shown in Fig. 6. Choose the appropriate serial number series of the operator, to get to the first preset screen (Fig. 7)

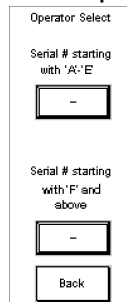

Fig. 6

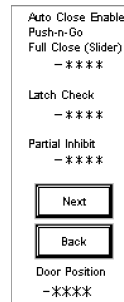

Fig. 7

- You'll be given a display of the first three user presets (Fig. 7). To edit a preset, simply touch the preset number.
- A keypad will then display for entering the new preset (Fig. 8). Enter the desired value and touch the ENTER (bent arrow) key to set the value. Press ESC to cancel and go back to the preset list.

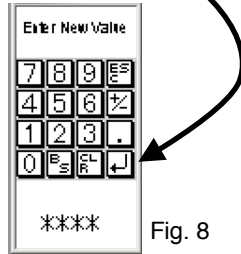

Fig. 8

- Press 'Next' (Fig. 7) to display the remaining user presets or 'Back' to return to the previous screen.

Note: Real Time Door Position (RTDP) is always displayed on both preset screens

I/O Diagnostics for Series 'i' Operators and Above only

Selecting the 'I/O Diag' button from main screen (Fig. 4), will bring you to the screen in Fig. 9. 'Outputs' will display the screen in Fig. 11.

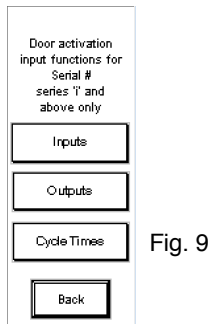

Fig. 9

Select 'Inputs' to display the Input Diagnostic Screen (Fig. 10).

The buttons down the left side, represent an actual input to the PLC. All standard Operator functions can be tested using these buttons.

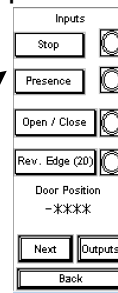
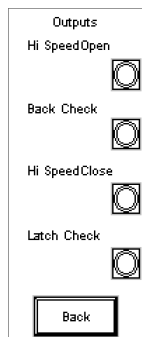

Fig. 10

The lamps down the right side of the screen indicate when an actual 'hard' input is being read by the PLC. E.g., if a Wall Switch or other device is sending an input, the applicable lamp will be lit.



The lamps down the right side of the screen indicate when the PLC is sending the corresponding Output to the motor control.

The serial number series referred to in these instructions is the starting letter of the Operators Serial Number.

NOTE: When using the newer GT-01/02 Software with an older PLC, or vice-versa, the initial startup of the GT-01/02 may be longer than usual and/or may display an error on the screen, it will then clear and go to the initial screen shown in either Fig. 3 or Fig. 4

HMI Instructions - For Sliding Doors

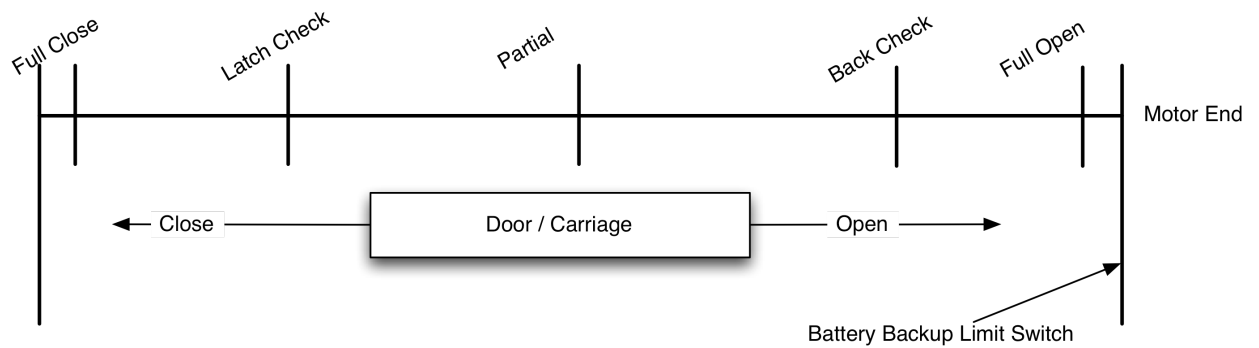

Door Position Setup Instructions

1. The factory settings represented in above diagram are a **starting point** and may need to be adjusted for each application depending on installation and environment variables.
2. Initiate a signal to have the operator close the door (Close button). Insure that the Creep speed pot is set so that the door doesn't "slam" into the frame. Operator will move closed at high speed then go into Creep and stop. Adjust the *Full Close* value lower or higher so that the door stops in the desired position.
3. Check position of door when fully open. Adjust *Back Check* and *Full Open* if necessary.
4. Adjust the *Partial Inhibit* value to the desired position to allow required access through doorway.

Tolerances	Decimal 1/8	Fractional +/- .003	Angular +/- .03
------------	-------------	---------------------	-----------------

Rev.	Revision note	Date	Sign	Check
2	REVISED NOTES	2/19/16		

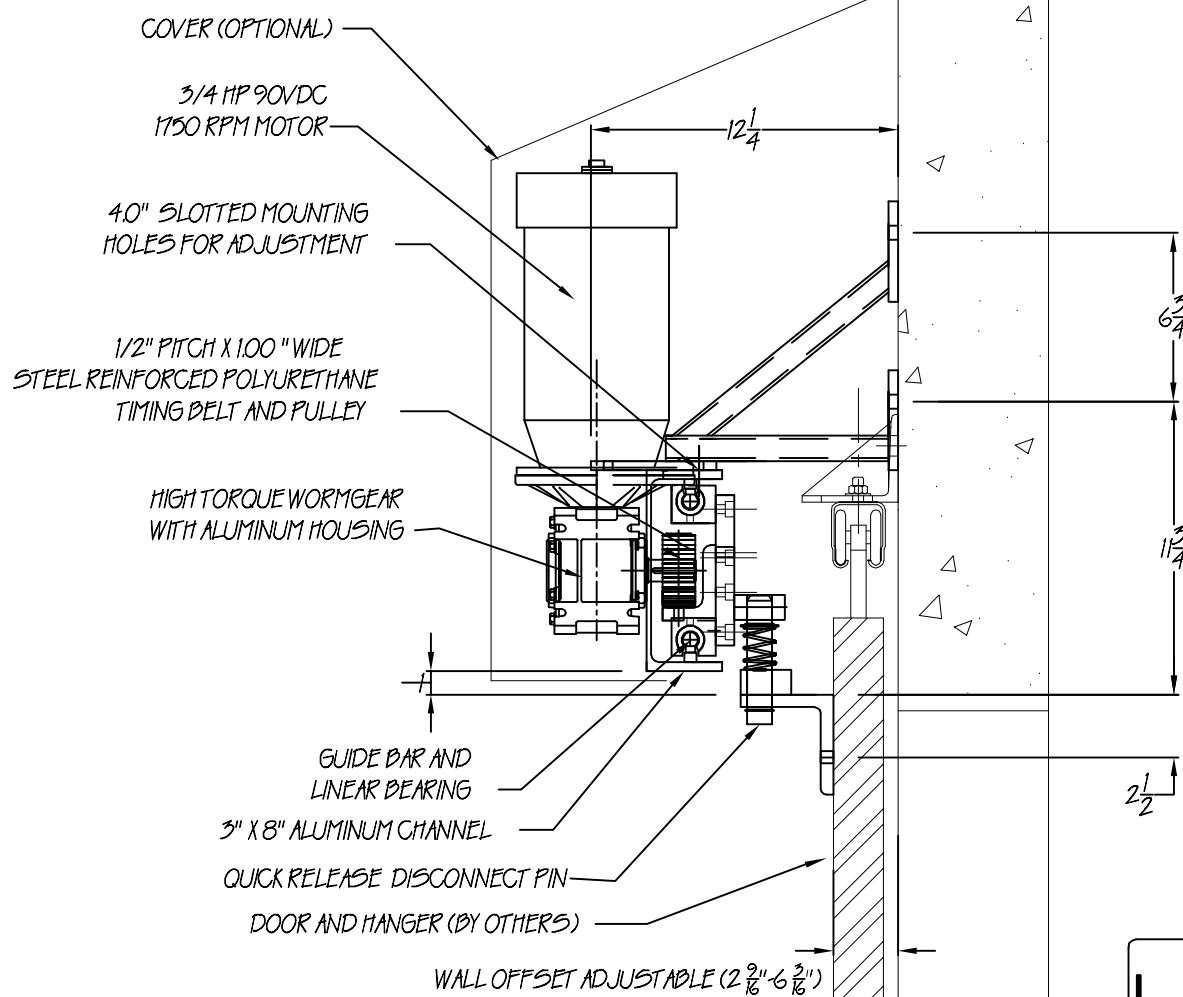

	NB-4100-1 SLIDING DOOR OPERATOR		Drawn by KPK
			Checked by XXX
	Material	Date 1/20/03	Scale 1:1
	SIDE ELEVATION / INSTALLATION DWG		
brookfield industries inc. 99 West Hillside Ave. : Thomaston, CT P: (860) 283-6211 F: (860) 283-6123 info@brookfieldindustries.com		www.brookfieldindustries.com Drawing No/File Name DO2003R1	

Tolerances	Decimal +/- .0005	Fractional +/- .001	Angular +/- .01
------------	-------------------	---------------------	-----------------

Rev.	Revision note	Date	Sign	Check
4	REVISE NOTES	5/19/16		

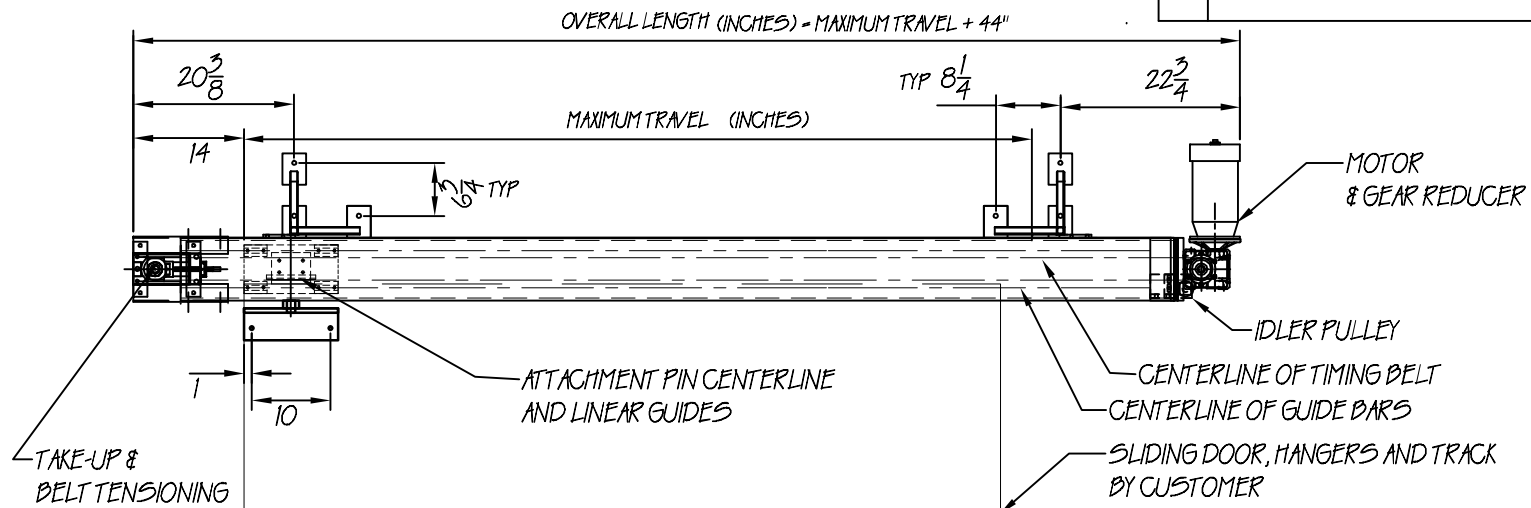

INDICATE WHICH
TRAVEL DIRECTION:

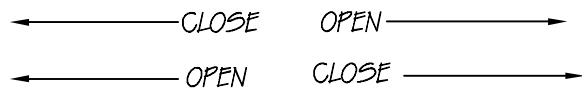

MOTOR /TAKE-UP ORIENTATION:
MOTOR RIGHT /TAKE-UP LEFT (AS SHOWN)
MOTOR LEFT /TAKE-UP RIGHT (OPPOSITE)

16 X 20 NEMA I BOX HOUSES
MOTOR CONTROL LOGIC AND POWER SUPPLY
HOOKUP

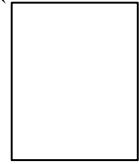

	NB-4100-1 SLIDING DOOR OPERATOR		Drawn by KPK
			Checked by XXX
	Material	Date 10-2-03	Scale 1:1
	ELEVATION/INSTALLATION DWG		
brookfield industries inc. 99 West Hillside Ave.: Thomaston, CT P: (860) 283-6211 F: (860) 283-6123 info@brookfieldindustries.com		www.brookfieldindustries.com Drawing No/File Name DO2003R2	

Tolerances	Decimal 1/8	Fractional +/- mm	Angular +/- mm
------------	-------------	-------------------	----------------

Rev.	Revision note	Date	Sign	Check
2	REVISE NOTES	5/16		

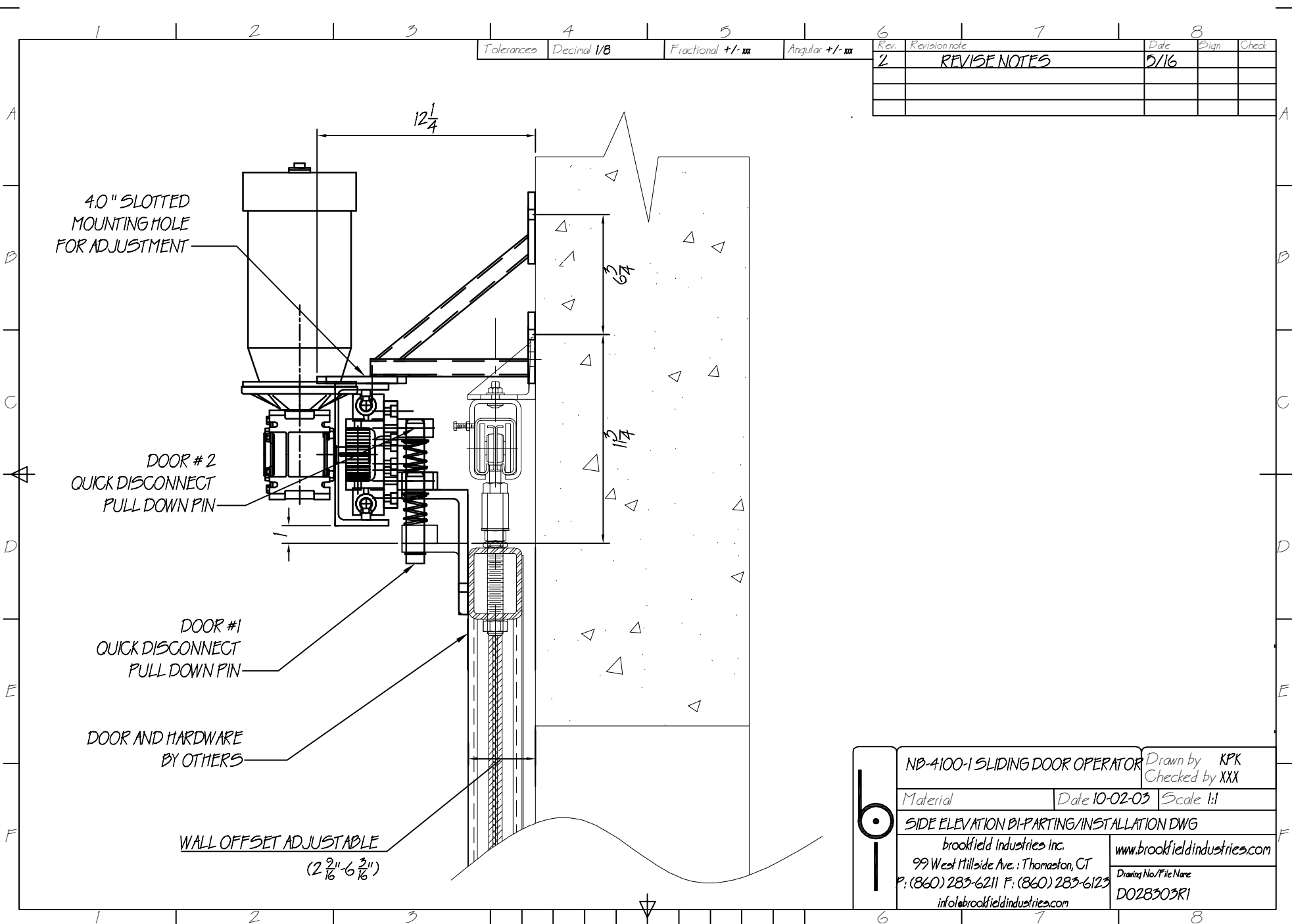

NB-4100-1 SLIDING DOOR OPERATOR		Drawn by KPK
		Checked by XXX
Material	Date 10-02-03	Scale 1:1
SIDE ELEVATION BI-PARTING/INSTALLATION DWG		
brookfield industries inc.		www.brookfieldindustries.com
99 West Hillside Ave.: Thomaston, CT		
P: (860) 283-6211 F: (860) 283-6123		Drawing No/File Name
info@brookfieldindustries.com		DO28303R1

Tolerances	Decimal +/-0.0005	Fractional +/- .0001	Angular +/- .001
------------	-------------------	----------------------	------------------

Rev.	Revision note	Date	Sign	Check
2	REVISE NOTES	5/2011		

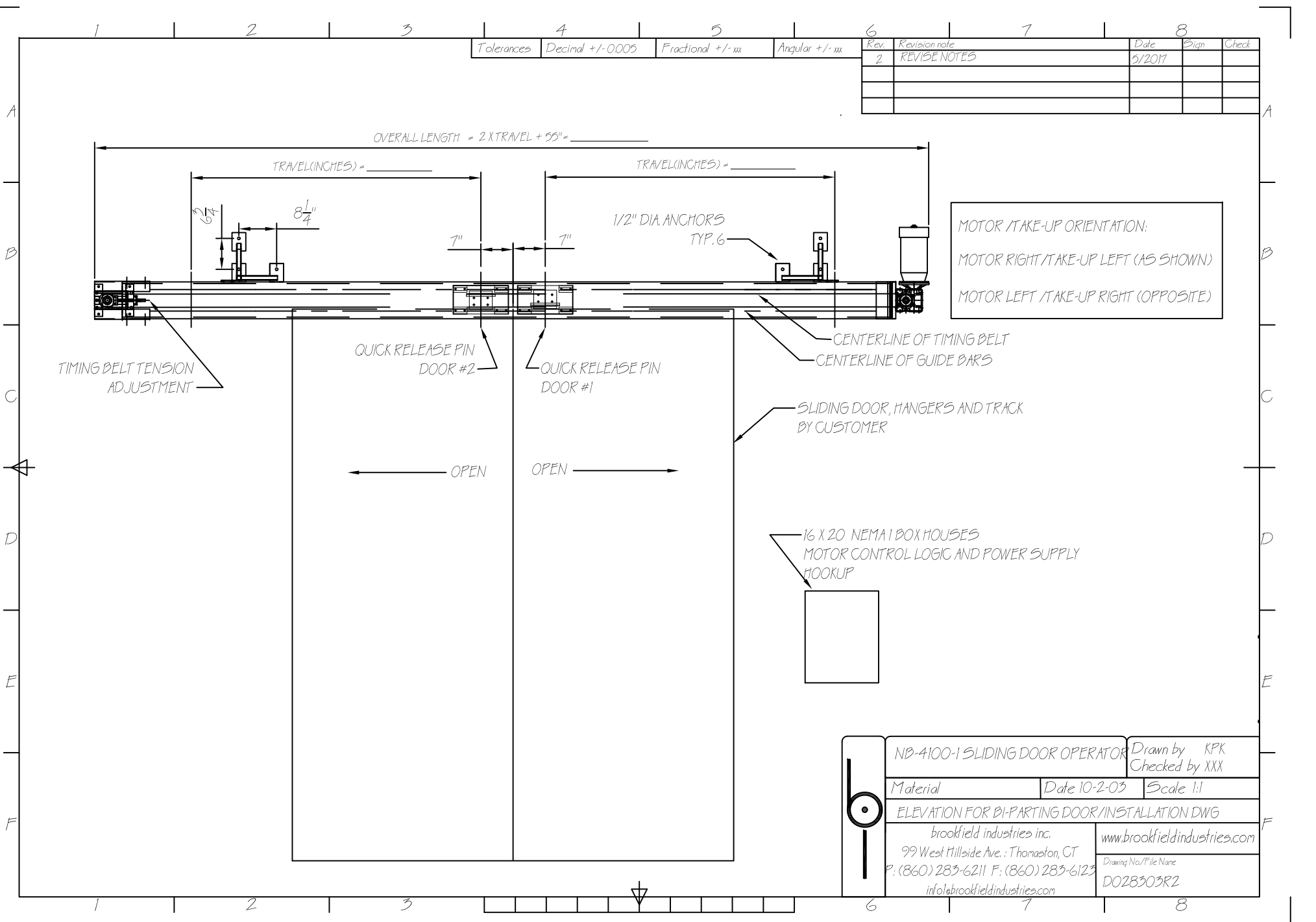

	NB-4100-1 SLIDING DOOR OPERATOR		Drawn by KPK
			Checked by XXX
	Material	Date 10-2-03	Scale 1:1
	ELEVATION FOR BI-PARTING DOOR/INSTALLATION DWG		
brookfield industries inc.		www.brookfieldindustries.com	
99 West Hillside Ave. : Thomaston, CT		Drawing No./File Name	
P: (860) 283-6211 F: (860) 283-6123		DO28303R2	
info@brookfieldindustries.com			

Tolerances	Decimal	Fractional/- xxx	Angular- xxx

Rev.	Revision note	Date	Sign	Check

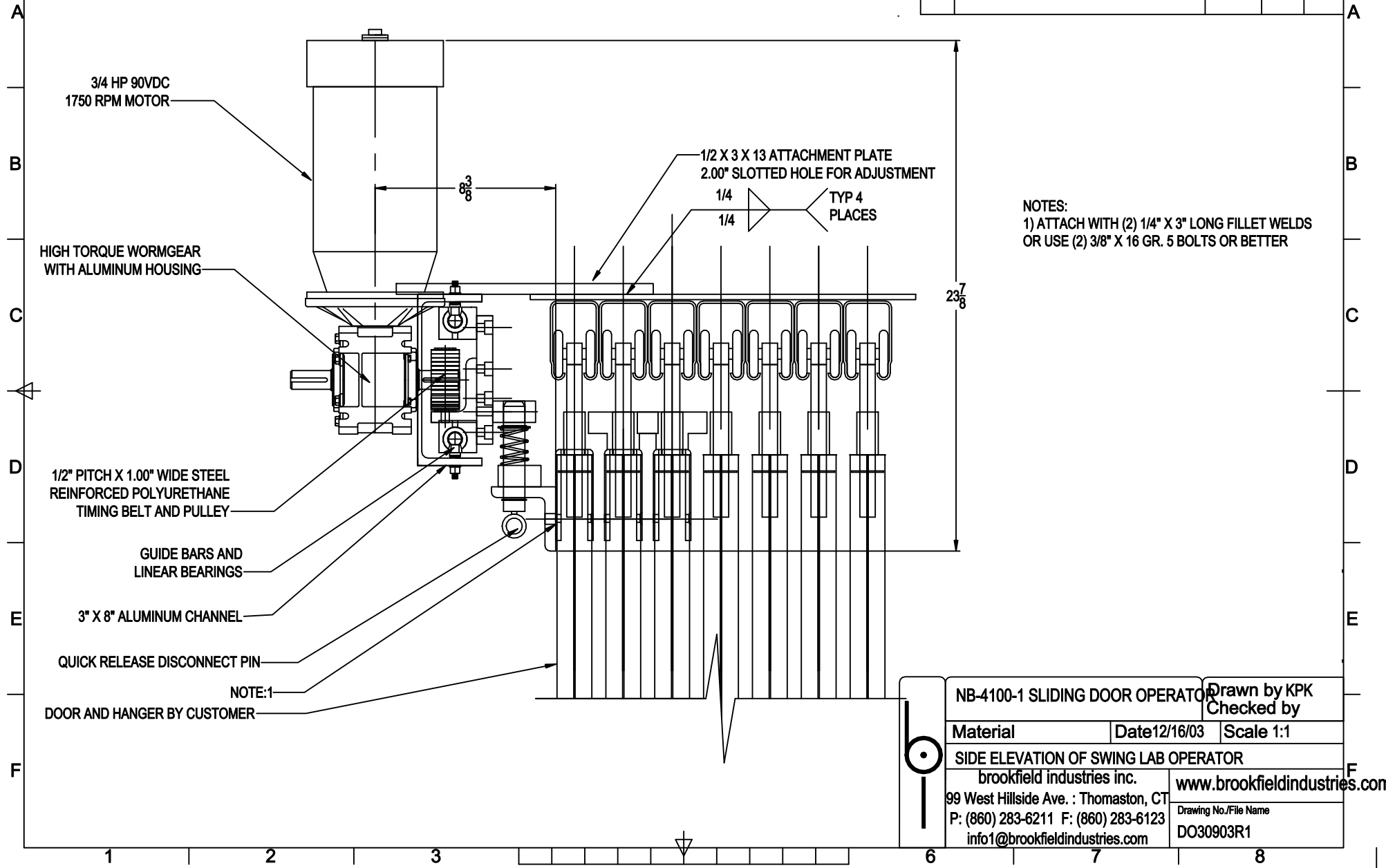

NOTES:
 1) ATTACH WITH (2) 1/4\" X 3\" LONG FILLET WELDS
 OR USE (2) 3/8\" X 16 GR. 5 BOLTS OR BETTER

	NB-4100-1 SLIDING DOOR OPERATOR		Drawn by KPK	
	Material		Checked by	
	Date 12/16/03	Scale 1:1		
	SIDE ELEVATION OF SWING LAB OPERATOR			www.brookfieldindustries.com
	brookfield industries inc. 99 West Hillside Ave. : Thomaston, CT P: (860) 283-6211 F: (860) 283-6123 info1@brookfieldindustries.com			
Drawing No./File Name		DO30903R1		

Tolerances	Decimal	Fractional/- xxx	Angular- xxx
------------	---------	------------------	--------------

Rev.	Revision note	Date	Sign	Check
1	ADD FORMULAS	3/05	KPK	
2	REVISE FORMULA	5/06	KPK	

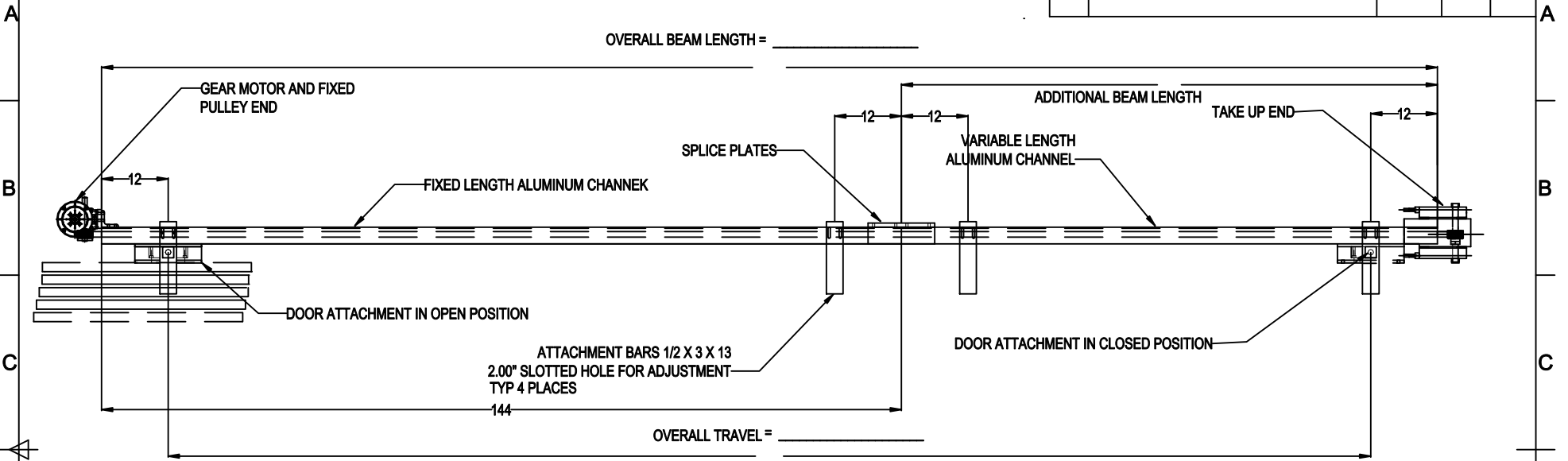

14 X 12 NEMA 1 ENCLOSURE
HOUSES MOTOR CONTROL, LOGIC AND
POWER SUPPLY HOOKUP

NOMINAL DOOR WEIGHT = 3500 LBS*
* DOOR WEIGHT MAY EXCEED THIS VALUE
PROVIDING THE MAX. HORIZONTAL OPERATING
FORCE IS LESS THAN THE RATED VALUES.
MAXIMUM HORIZONTAL FORCE:
PEAK = 300 LBS
CONTINUOUS = 250 LBS
MINIMUM LINEAR SPEED = 13 IN/SEC
REFER TO DRAWING D030903R1

OVERALL BEAM LENGTH = TRAVEL + 30 = _____
(AL 226, ST84)

ADDITIONAL BEAM LENGTH = OVERALL BEAM LENGTH - 144 = _____

OVERALL OPERATOR LENGTH = OVERALL BEAM LENGTH + 14 = _____

	NB-4100-1 SLIDING DOOR OPERATOR		Drawn by KPK
			Checked by
	Material	Date 12/16/03	Scale 1:1
	PLAN VIEW OF SWING LAB OPERATOR WITH SPLICE		
brookfield industries inc.			www.brookfieldindustries.com
99 West Hillside Ave. : Thomaston, CT			
P: (860) 283-6211 F: (860) 283-6123			
info1@brookfieldindustries.com			Drawing No./File Name D030903R2

TERMINAL STRIP EXTERNAL WIRING HOOKUP*
 NB-4000, NB-4000-XXX, NB-4120-2-DC, NB-4100-PLC

110VAC POWER SUPPLY

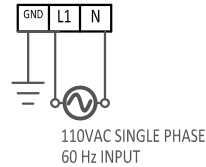

CLASS 2 POWER SUPPLY 24VDC

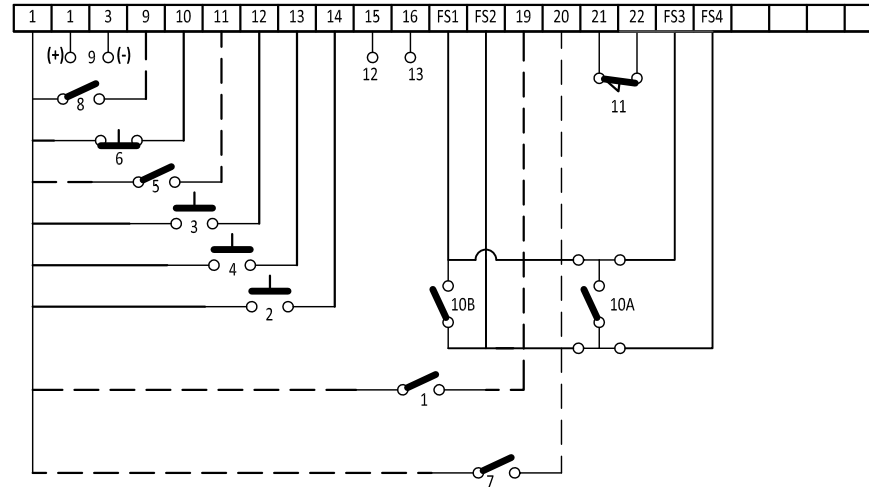

**INPUTS (CLASS 2 POWER SUPPLY 24VDC)
 NORMALLY OPEN MOMENTARY DRY CONTACT ACTIVATION (UNLESS NOTED OTHERWISE):**

1. RESERVED
2. PUSH TO OPEN (TYPE: PUSH BUTTON STATION)
3. PUSH TO CLOSE (TYPE: PUSH BUTTON STATION)
 OPTIONAL: MAINTAINED CONTACT TO CLOSE
4. PUSH FOR PARTIAL OPEN (TYPE: PUSH BUTTON OR PRESS WALL SWITCH)
5. RESERVED
6. PUSH ONCE TO STOP (TYPE: PUSH BUTTON STATION, **NORMALLY CLOSED**)
7. RESERVED
8. OPTIONAL: FIRE ALARM INPUT (MAINTAINED CONTACT)
- 10A. **REVERSES A CLOSING DOOR:** 4-WIRE (FAIL SAFE) TAPE SWITCH (UL325 SECT. 30.2) OR FAIL SAFE PRESENCE SENSOR**
- 10B. **REVERSES A CLOSING DOOR:** REDUNDANT NON-CONTACT PRESENCE SENSOR
11. BATTERY BACKUP: N.C. LIMIT SWITCH

OUTPUTS (CLASS 2 POWER SUPPLY 24VDC):

9. CONTINUOUS POWER FOR EXTERNAL SAFETY SENSORS OR ANY DEVICE WITH LOW CURRENT CONSUMPTION (mA Range).

OPTIONAL OUTPUTS:

(CLASS 2 POWER SUPPLY 24VDC, 2 AMP RATED):

12. DOOR CLOSED SIGNAL, OTHER (ADD + 15, -15 TERMINAL)
13. DOOR OPEN SIGNAL, OTHER (ADD +16, -16 TERMINALS)

**USE COPPER CONDUCTORS ONLY (MAXIMUM CROSS-SECTION OF TERMINALS (4mm²)
 USE ONLY TYPE CL2, CL2P, CL2R, CL2X OR OTHER CABLES WITH EQUIVALENT OR BETTER
 ELECTRICAL, MECHANICAL AND FLAMMABILITY RATINGS.*

****DOOR WILL NOT CLOSE UNLESS FAIL SAFE SENSOR IS PROPERLY INSTALLED**

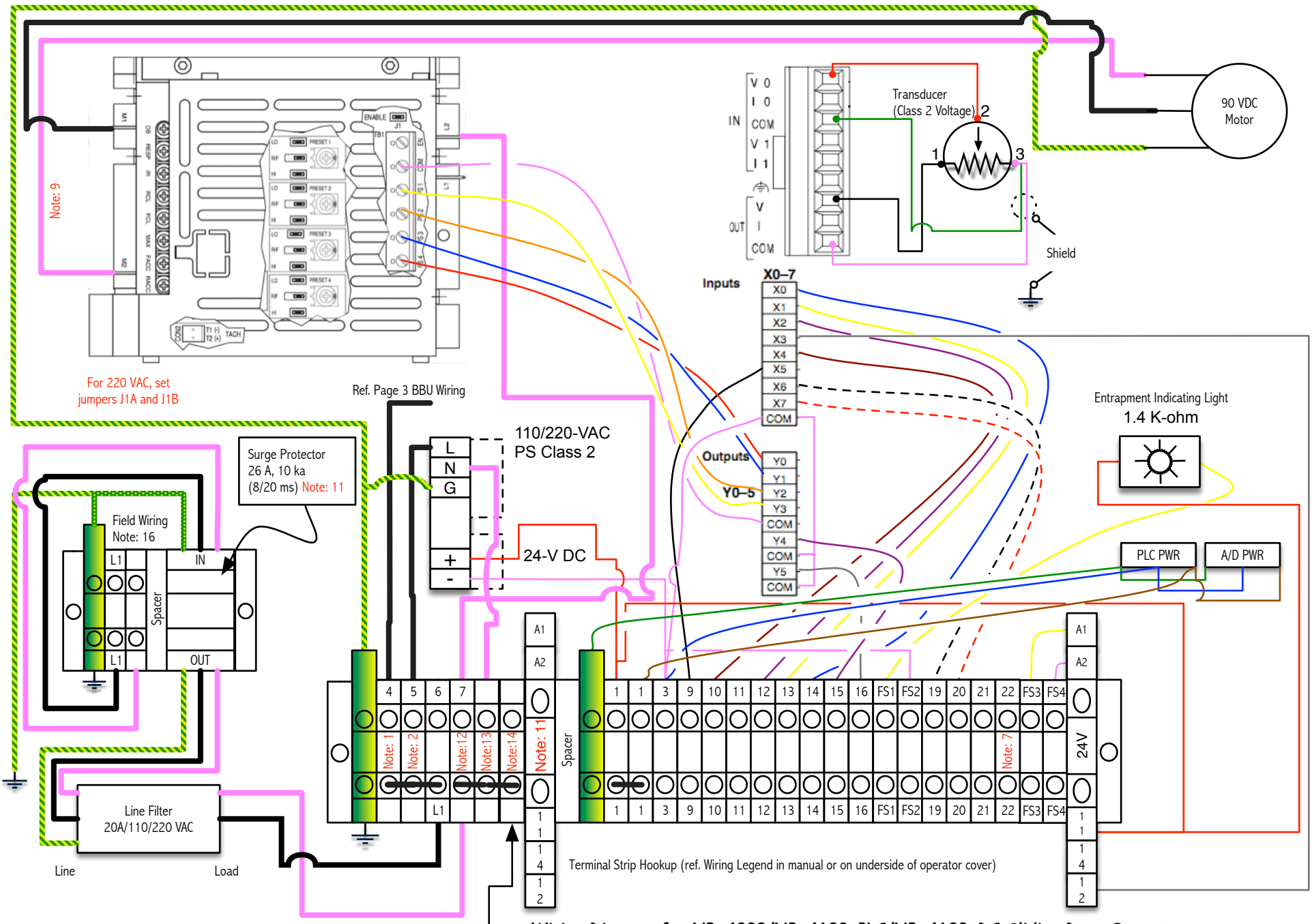

Review Page 2 for notes and External Entrapment Wiring.
Review Page 3 for Battery backup wiring detail.

110 VAC Input (L1&N)/220 VAC Input (L1&L2)

Wiring Diagram for NB-4000/NB-4100-PLC/NB-4120-DC Sliding Door Operator

Information contained herein is exclusive property of brookfield industries, inc. and may not be duplicated in part or in whole without written consent

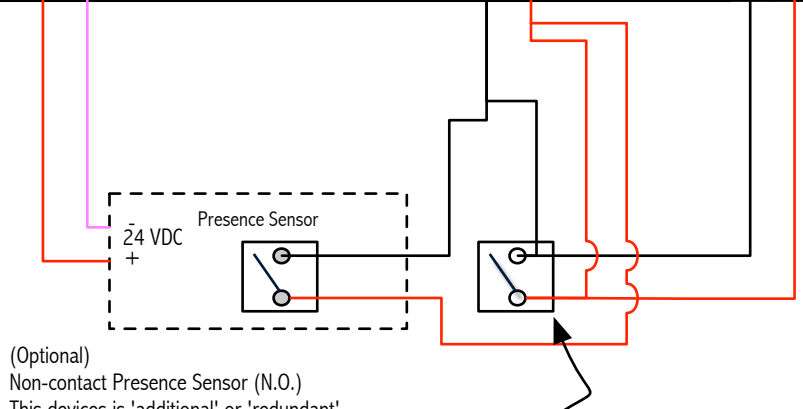
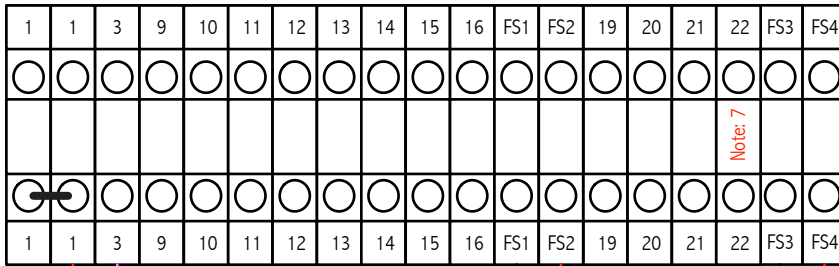

(Optional)
Non-contact Presence Sensor (N.O.)
This device is 'additional' or 'redundant'

(Required Device)
(N.O.) Reversing Edge Switch (contact type)
Fail Safe External Entrapment Device
Meeting requirements of UL 325 30.2 in order to Close Door this Device MUST be Wired as Shown

Daisy Chain Connection of 4-Wire Tape Switches

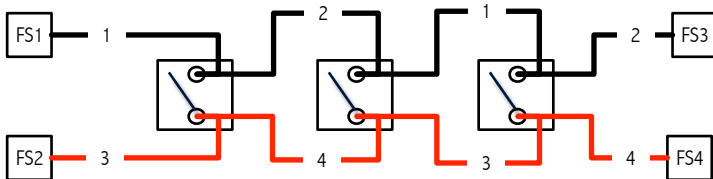

(Fail Safe)

Notes:

1. Use 15 Amp/110/220 VAC; Circuit Breaker
2. Use 1 Amp/110/220 VAC slow-blow; Circuit Breaker
3. Class (2) 24 VDC Terminals: Power Supply: (Com & 3)
Inputs: 9-14 & 17-22
4. All 110/220 AC wires shall be minimum 14 AWG & (105° C, 300 V)
5. All 12-24 VDC (non-motor) wires shall be minimum 20 AWG & (105° C, 300 V)
6. All motor wires shall be minimum 12 AWG & (105° C, 300 V) and 25' max. length
7. Use 8 Amp/110/220 VAC slow-blow; Circuit Breaker
8. Wire as shown for normal direction, reverse 1&3 for opposite direction and reset transducer to 320 at new home position
9. For normal direction wire M1 & M2 as shown. To reverse direction, switch black wire to M2 & white wire to M1.
DO NOT ALTER BATTERY BACKUP WIRING
10. Install Ferrite Core Red Lion FCOR (2 turns=440 ohm @ 25 MHz) on all incoming AC and DC voltage lines
11. Part must be changed to utilize 220 VAC power
12. For 220 VAC Power see Note: 1
13. For 220 VAC Power see Note: 2
14. Additional 'N' terminal block for battery backup only. For 220 VAC Power, See Note 2

Transducer Wiring:

Wire as shown for : RH Operator (pull open), LH Operator (push open), LH Door Mounted
Reverse 1 & 3 for : RH Operator (push open), LH Operator (pull open), RH Door Mounted

Legend:

Pink solid line designates a WHITE wire.

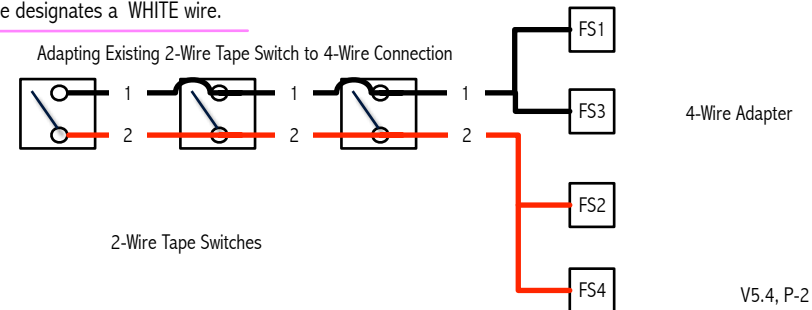

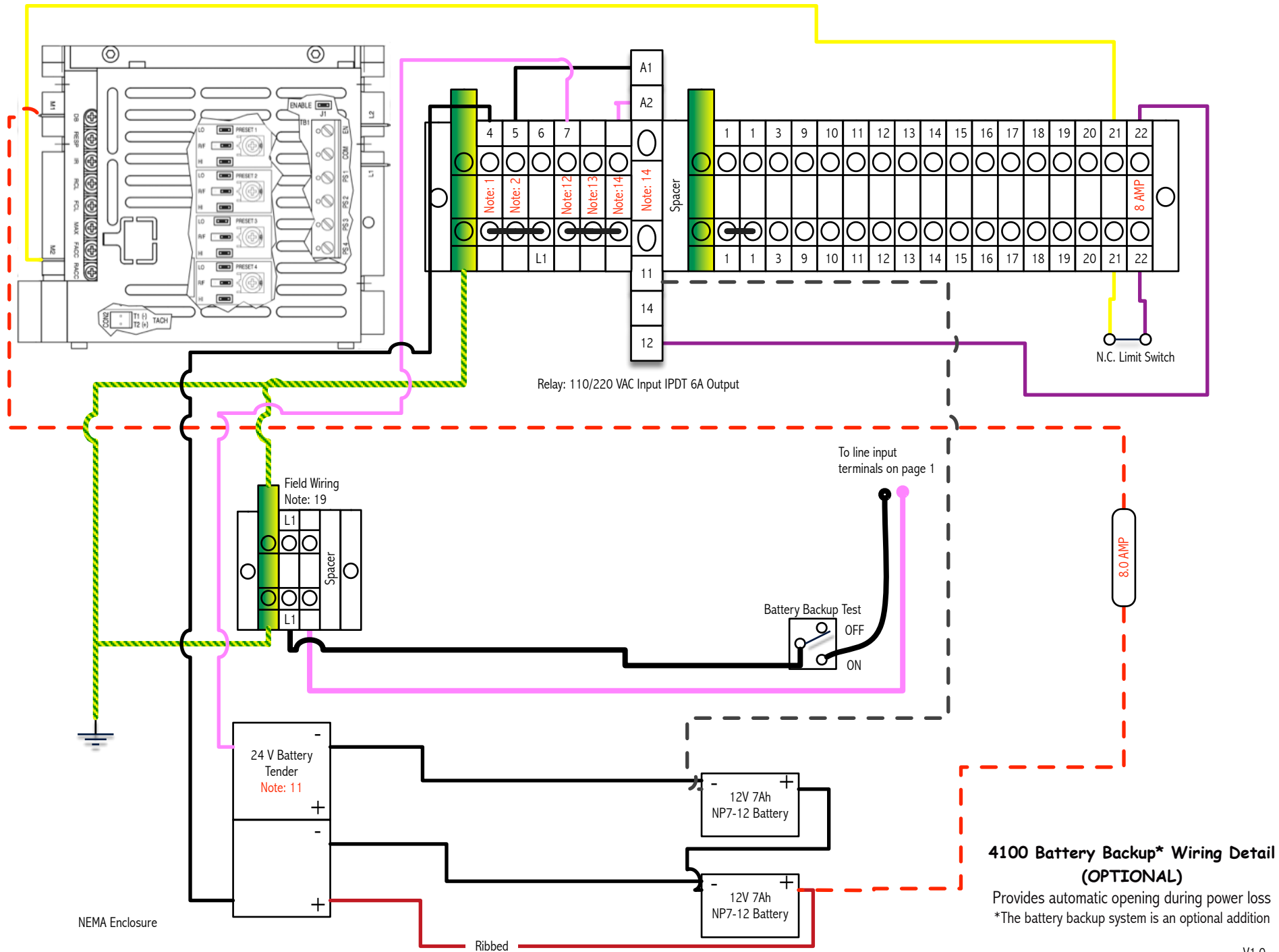

Parameters for NB-4100-PLC Door Operator

PLC Settings of Door Position in Digital Value (DV):

Full Close	=	320
Full Open	=	(Travel (in) x A+320)
Partial Open	=	(Desired Opening* (in) x A) + 320
Back Check	=	Full Open – (A x 6)
Latch Check	=	320 + (A x 6)
Resolution:		
DV/in	=	A= 18.2(≤ 192" Travel)** = 9.1 (> 192" ≤ 396" Travel)***

*For Bi-Parting divide by 2

**Shop Note: use NB 4120 PLC program

***Shop Note: use NB 4000 PLC program

Motor Control Jumper Setting:

Upper Board (Multi-Speed)

J1 Enable

PRESET 1 (Latch Check Speed): Lo
R / F
Hi

PRESET 2 (Back Check Speed): Lo
R / F
Hi

PRESET 3 (Close Speed): Lo
R / F
Hi

PRESET 4 (Open Speed): Lo
R / F
Hi

Lower Board

J1A- Line Voltage 115V / 230V

J1B- Line Voltage 115V / 230V

J2-Armature Current 1.7A / 2.5A / 5.0 / 7.5A / 10A

J3-Armature Voltage A90 / A180 / T7 / T50

J4-Potentiometer Operation 15V / 10V

J5-Speed Control SPD / TRQ

J6-Regenerate to Stop RTS / CTS

Motor Control Trimpot Settings (Approximate):

Upper Board (Multi Speed)

PRESET 1: Latch Check (REV) Speed POT 30%-35%

PRESET 2: Back Check (FWD) Speed POT 30%-35%

PRESET 3: Close (REV) Speed POT 50%-60%*

PRESET 4: Open (FWD) Speed POT 50%-60%*

*Approximate linear travel speed of 5.0-7.5 inches/second

Lower Board

DB 50%

RESP 50%

IR 50%

RCL 35-40%

FCL 35-40%

MAX 100%

FACC 10-20%

RACC 10-20%

Timing belt pre-tension:

This value is calculated and preset at the factory for every belt length. The take-up end is marked with the pre-tension setting. This is necessary for replacement belts and for the assembly of any spliced units.

$$F = 360 / (c - c)$$

Where:

c-c = the center to center distance of the pulleys

F = the vertical force to deflect the belt 1" at midpoint position (c-c/2) in order to obtain the required belt pre-tension.

Idler Pulley pre-tension:

The idler pulley assures the belt does not slip off the drive pulley on the slack side. After properly adjusting the belt tension, bring the idler pulley into contact with the timing belt. Raise the idler 0.375"; secure mounting hardware.

Maintenance Intervals

1. Lubricate the (2) bearings supporting the take-up end shaft every 250,000 cycles.
2. Check all nuts, bolts and screws for tightness every 250,000 cycles.
3. Inspect and replace the (4) linear bearings on the *Linear Guide Tracking System* every 250,000 cycles if required.
4. Inspect and replace the motor brushes every 300,000- 400,000 cycles if required.

Also, inspect the operator for wear or damage to any of its components, especially the timing belt and pulleys. Do not lubricate the timing pulley. The frequency of these inspections will vary upon installations and will be directly proportional to the usage of the operator. **Do not use the operator if any component is worn or damaged**

Safety Systems Test Intervals

External safety devices that are not normally supplied by the manufacturer of the door operator but added during installation, must be properly tested on a frequent enough basis so as not to compromise the safety and reliability of the complete door operating system on a continuing basis. These tests should be performed at least once a month

brookfield industries, inc.

Limited Warranty

brookfield industries, inc. warrants that door operator models NB-500, NB-1000, NB-2000 and **NB-4100-1** are free from defects in material and workmanship according to the following terms and conditions:

- 1) The limited warranty for all aforementioned products extends for (1) year beginning on the date of shipment from our facility.
- 2) During the limited warranty period, *brookfield industries, inc.* will repair or replace any defective component or any part that does not operate as originally specified or intended with a new or rebuilt part. No charge will be made to the consumer for any such parts. Credits or reimbursements, as well as associated shipping costs, will be issued only after any replacement parts have been returned by the consumer.
- 3) *brookfield industries, inc.* will also reimburse or credit the consumer for any reasonable labor charges associated with the repair or replacement of a particular part. *brookfield industries, inc.* and the consumer must agree upon the dollar amount as well as the scope of work, before any amount is allocated. This amount may vary depending on the geographical location of the labor market. Travel expenses are not applicable.
- 4) *brookfield industries, inc.* shall not cover, nor will the consumer have any benefits under this limited warranty if any of the following conditions apply to any returned parts as determined through an evaluation by *brookfield industries, inc.* or any of its vendors:
 - a) The product has been subjected to: improper installation, installation practices or any settings not in accordance with the operator manual, abnormal use, abnormal conditions, exposure to moisture, dampness or any other severe environmental conditions, unauthorized modifications, unauthorized connections, unauthorized repair, misuse, neglect, abuse, accident, altercation, door weights and/or door speeds and/or operating forces that exceed the rated values, or other acts which are out of the control of *brookfield industries, inc.*, such as damage caused by shipping.
 - b) Removing or altering of the serial number or any other action that prohibits *brookfield industries, inc.* from determining the original purchase date.

Troubleshooting Guide

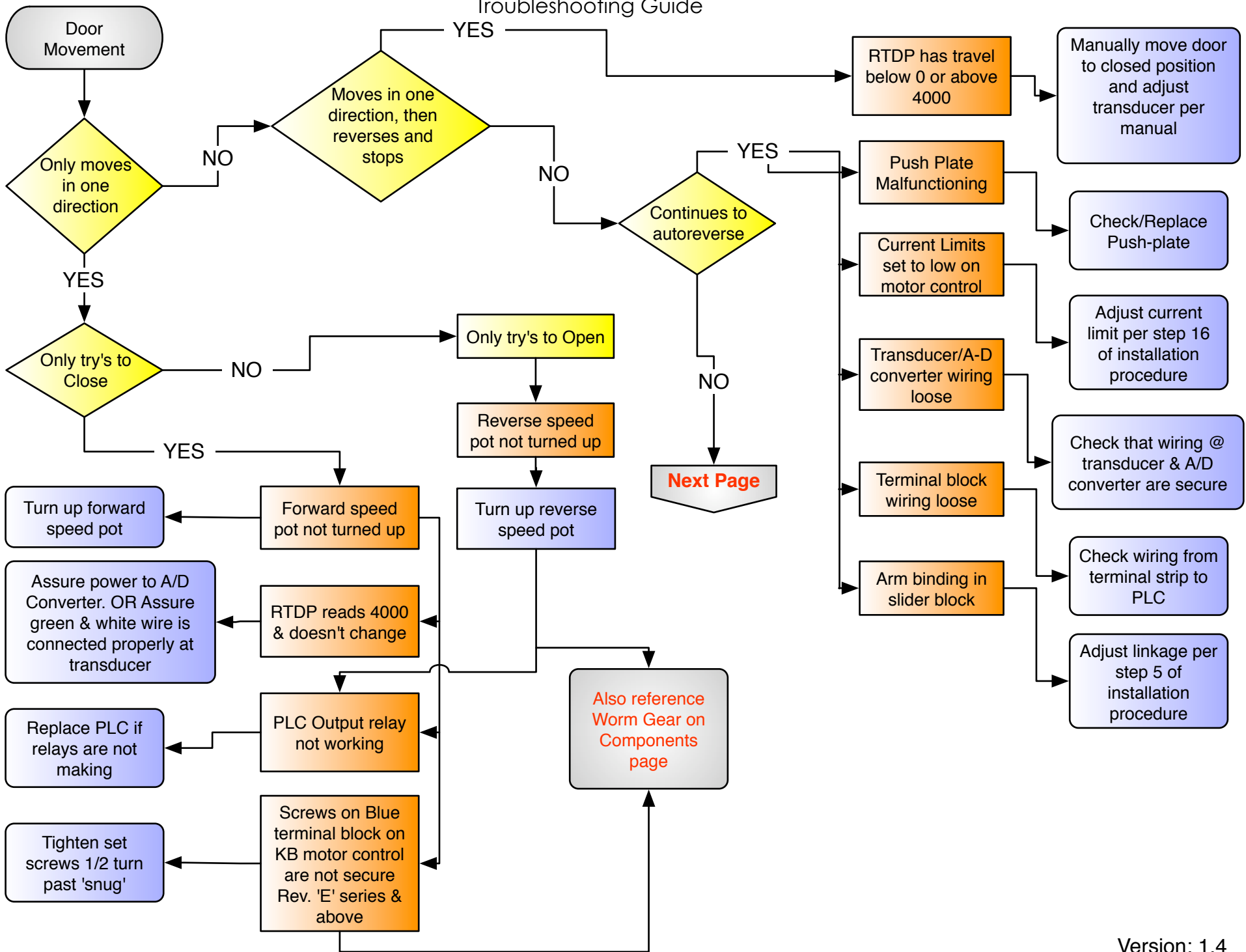

Troubleshooting Guide

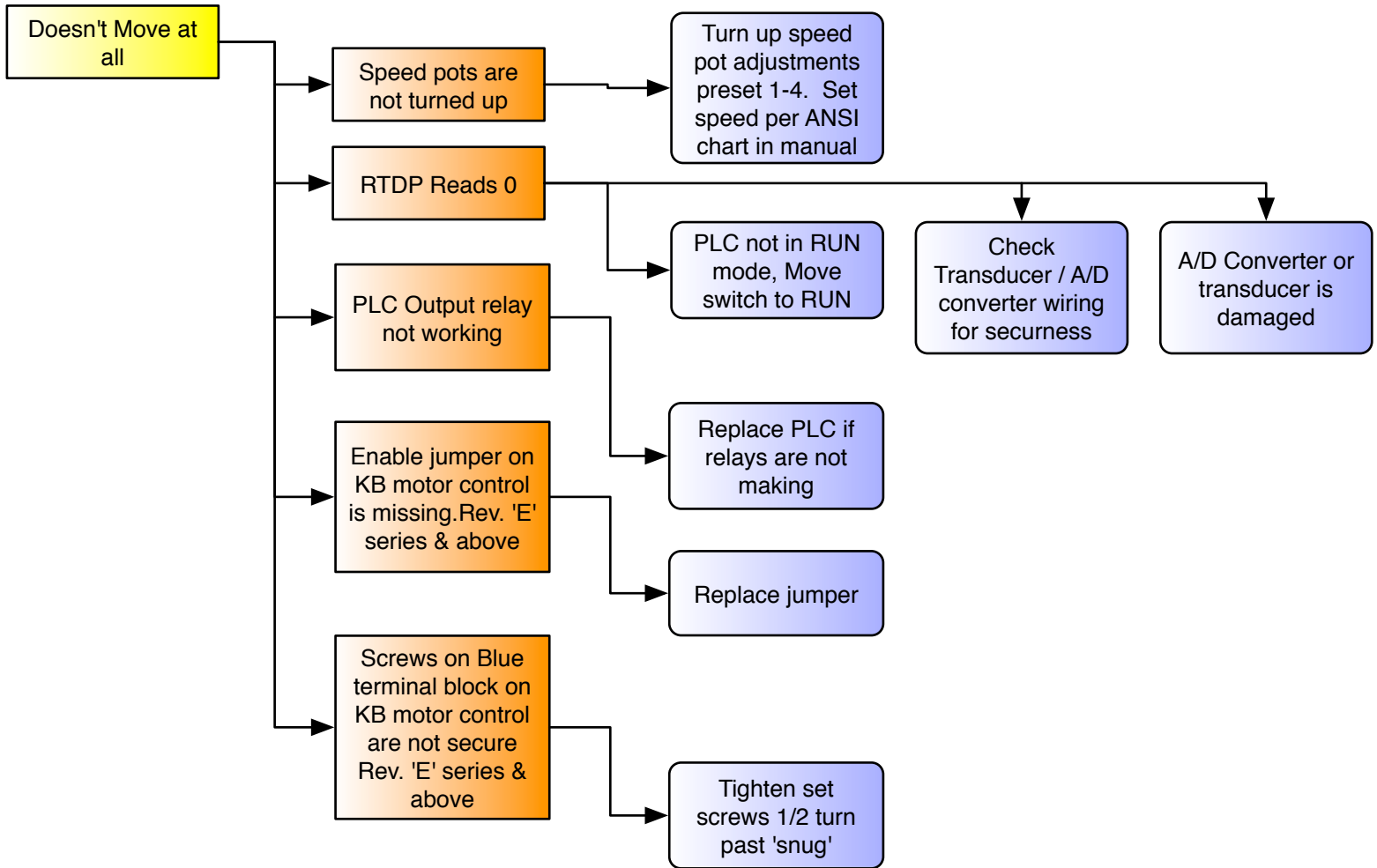

Component Specific Problems

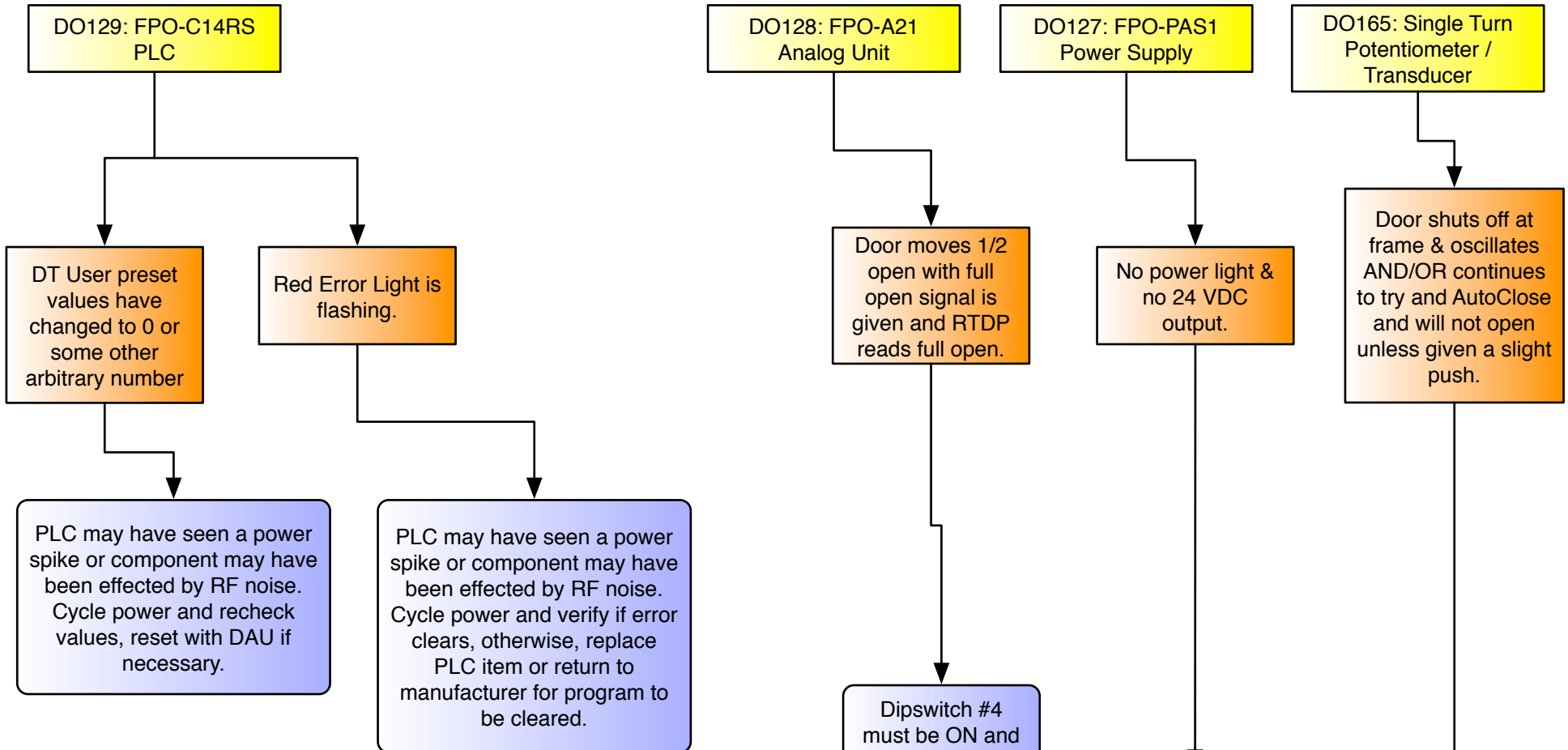

General I/O Information for PLC:

Input Lights:	Output Lights:
X0 - Open	Y0 - Hi Speed Fwd/Open
X1 - Partial	Y1 - Hi Speed Rev/Close
X2 - Close	Y2 - Low Speed Fwd/Open
X3 - Knife Edge	Y3 - Low Speed Rev/Close
X4 - Stop	
X5 - Presence Sensor	
X6 - Push Open/Push Close	

Component Specific Problems

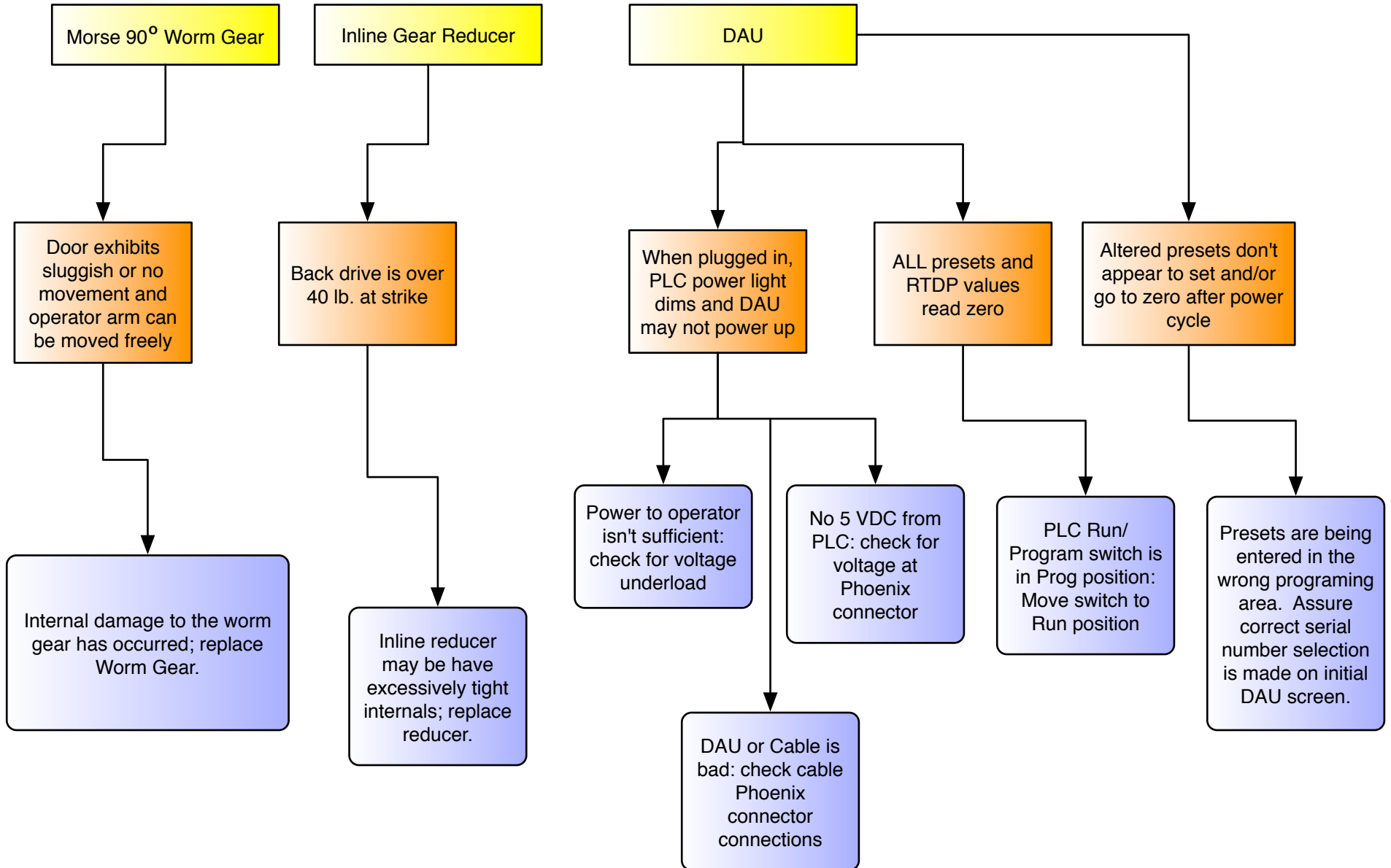

Component Specific Problems

