

NV5128 Multi-Format Router

User's Guide



Miranda Technologies Inc.
3499 Douglas B. Floreani
Montreal, Quebec
Canada H4S 2C6

NV5128 Multi-Format Router — User's Guide

- **Revision:** 2.5
- **Software Version:** N/A
- **Part Number:** UG5128-05
- Copyright: © 2009 Miranda Technologies, Inc. All rights reserved.
- No part of this manual may be reproduced in any form by photocopy, microfilm, xerography or any other means, or incorporated into any information retrieval system, electronic or mechanical, without the written permission of Miranda Technologies, Inc.
- The information contained in this manual is subject to change without notice or obligation.
- All title and copyrights as well as trade secret, patent and other proprietary rights in and to the Software Product (including but not limited to any images, photographs, animations, video, audio, music, test, and “applets” incorporated into the Software Product), the accompanying printed materials, and any copies of the Software Product, are owned by Miranda Technologies, Inc. The Software Product is protected by copyright laws and international treaty provisions. Customer shall not copy the printed materials accompanying the software product.

Notice

The software contains proprietary information of Miranda Technologies, Inc. It is provided under a license agreement containing restrictions on use and disclosure and is also protected by copyright law. Reverse engineering of the software is prohibited.

Due to continued product development, the accuracy of the information in this document may change without notice. The information and intellectual property contained herein is confidential between Miranda and the client and remains the exclusive property of Miranda. If you find any problems in the documentation, please report them to us in writing. Miranda does not warrant that this document is error-free.

FCC Statement

This equipment has been tested and found to comply with the limits for a Class A digital device, pursuant to part 15 of the FCC Rules. These limits are designed to provide reasonable protection against harmful interference when the equipment is operated in a commercial environment. This equipment generates, uses, and can radiate radio frequency energy and, if not installed and used in accordance with the instruction manual, may cause harmful interference to radio communications. Operation of this equipment in a residential area is likely to cause harmful interference in which case the user will be required to correct the interference at his own expense.

Declaration of Conformance (CE)

All of the equipment described in this manual has been designed to conform with the required safety and emissions standards of the European Community. Products tested and verified to meet these standards are marked as required by law with the CE mark. (See [Symbols and Their Meanings](#) on page v.)

When shipped into member countries of the European Community, this equipment is accompanied by authentic copies of original Declarations of Conformance on file in Miranda USA offices in Grass Valley, California USA.

Trademarks

Miranda is a registered trademark of Miranda Technologies, Inc.

Brand and product names mentioned in this manual may be trademarks, registered trademarks or copyrights of their respective holders. All brand and product names mentioned in this manual serve as comments or examples and are not to be understood as advertising for the products or their manufactures.

Software License Agreement and Warranty Information

Contact Miranda for details on the software license agreement and product warranty.

Technical Support Contact Information

Miranda has made every effort to ensure that the equipment you receive is in perfect working order and that the equipment fits your needs. In the event that problems arise that you cannot resolve, or if there are any questions regarding this equipment or information about other products manufactured by Miranda, please contact your local representative or contact Miranda directly through one of the appropriate means listed here.

- Main telephone: 530-265-1000 (9 am to 9 pm PST)
Fax: 530-265-1021
In the Americas, call toll-free: +1-800-224-7882 (9 am to 9 pm EST)
In Europe, the Middle East, African or the UK, call +44 (0) 1491 820222 (9 am to 6 pm, GMT)
In France, call +33 1 55 86 87 88 (9 am to 5 pm, GMT + 1)
In Asia, call +852-2539-6987 (9 am to 5 pm, GMT + 8)
In China, call +86-10-5873-1814
- Emergency after hours: toll-free: +1-800-224-7882
Tel: +1-514-333-1772
- E-Mail:
In the Americas, support@miranda.com
In Europe, the Middle East, African or the UK, eurotech@miranda.com
In France, eurotech@miranda.com
In Asia, asiatech@miranda.com
In China, asiatech@miranda.com
- Website: <http://www.miranda.com>
- Mail Shipping
Miranda USA Miranda USA
P.O. Box 1658 125 Crown Point Court
Nevada City, CA 95959, USA Grass Valley, CA 95945, USA

Note

Return Material Authorization (RMA) required for all returns.

Change History

The table below lists the changes to the Multi-Format Router User's Guide.

- User's Guide Part # UG5128-05
- Software version: N/A

Rev #	Date	ECO #	Description	Approved By
1.0	01 Feb 03	—	Initial Release.	—
2.0	—	—	—	—
2.1	24 Sep 07	13619	Document corrected and brought up to date. Many modifications.	DEM
2.2	22 Jan 08	14014	AES 3-pin reference pinout added (p. 59). Jumpers and switches for analog audio cards now described and depicted correctly (pp. 72, 73).	D. Cox
2.3	22 Oct 08	14426	BP-PORT-64's DE9 connectors are female. Updated formats.	DEM/D. Cox
2.4	31 Mar 09	15703	Format change.	DEM/D. Cox
2.5	10 Oct 09	16114	Corrected contact information	DEM

Restriction on Hazardous Substances (RoHS)

Miranda is in compliance with EU Directive RoHS 2002/95/EC governing the restricted use of certain hazardous substances and materials in products and in our manufacturing processes.

Miranda has a substantial program in place for RoHS compliance that includes significant investment in our manufacturing process, and a migration of Miranda product electronic components and structural materials to RoHS compliance.

It is our objective at NV to maintain compliance with all relevant environmental and product regulatory requirements. Detailed information on specific products or on the RoHS program at Miranda is available from Miranda Customer Support at

1-800-719-1900 (toll-free) or
1-530-265-1000 (outside the U.S.).

Important Safeguards and Notices

This section provides important safety guidelines for operators and service personnel. Specific warnings and cautions appear throughout the manual where they apply. Please read and follow this important information, especially those instructions related to the risk of electric shock or injury to persons.

Warning

Any instructions in this manual that require opening the equipment cover or enclosure are for use by qualified service personnel only. To reduce the risk of electric shock, do not perform any service other than that contained in the operating instructions unless you are qualified to do so.

Symbols and Their Meanings



The lightning flash with arrowhead symbol within an equilateral triangle alerts the user to the presence of dangerous voltages within the product's enclosure that may be of sufficient magnitude to constitute a risk of electric shock to persons.



The exclamation point within an equilateral triangle alerts the user to the presence of important operating and maintenance/service instructions.



The Ground symbol represents a protective grounding terminal. Such a terminal must be connected to earth ground prior to making any other connections to the equipment.



The fuse symbol indicates that the fuse referenced in the text must be replaced with one having the ratings indicated.



The presence of this symbol in or on Miranda equipment means that it has been designed, tested and certified as complying with applicable Underwriter's Laboratory (USA) regulations and recommendations.



The presence of this symbol in or on Miranda equipment means that it has been designed, tested and certified as essentially complying with all applicable European Union (CE) regulations and recommendations.

General Warnings

A warning indicates a possible hazard to personnel which may cause injury or death. Observe the following general warnings when using or working on this equipment:

- Heed all warnings on the unit and in the operating instructions.
- Do not use this equipment in or near water.
- This equipment is grounded through the grounding conductor of the power cord. To avoid electrical shock, plug the power cord into a properly wired receptacle before connecting the equipment inputs or outputs.
- Route power cords and other cables so they are not likely to be damaged.
- Disconnect power before cleaning the equipment. Do not use liquid or aerosol cleaners; use only a damp cloth.
- Dangerous voltages may exist at several points in this equipment. To avoid injury, do not touch exposed connections and components while power is on.
- Do not wear rings or wristwatches when troubleshooting high current circuits such as the power supplies.
- To avoid fire hazard, use only the specified fuse(s) with the correct type number, voltage and current ratings as referenced in the appropriate locations in the service instructions or on the equipment. Always refer fuse replacements to qualified service personnel.
- To avoid explosion, do not operate this equipment in an explosive atmosphere.
- Have qualified service personnel perform safety checks after any service.

General Cautions

A caution indicates a possible hazard to equipment that could result in equipment damage. Observe the following cautions when operating or working on this equipment:

- When installing this equipment, do not attach the power cord to building surfaces.
- To prevent damage to equipment when replacing fuses, locate and correct the problem that caused the fuse to blow before re-applying power.
- Use only the specified replacement parts.
- Follow static precautions at all times when handling this equipment.
- This product should only be powered as described in the manual. To prevent equipment damage, select the proper line voltage on the power supply(ies) as described in the installation documentation.
- To prevent damage to the equipment, read the instructions in the equipment manual for proper input voltage range selection.
- Some products include a backup battery. There is a risk of explosion if the battery is replaced by a battery of an incorrect type. Dispose of batteries according to instructions.
- Products that have (1) no on/off switch and (2) use an external power supply must be installed in proximity to a main power output that is easily accessible.



Table of Contents

Chapter 1	Preface	1
	Chapter Structure	1
	The PDF Document	1
	Terms, Conventions and Abbreviations	2
Chapter 2	Introduction.....	3
	Product Summary.....	3
	Mounting	3
	Fuses.....	4
	Cooling.....	4
	Filters	4
	Power Supply	4
	Fuses.....	5
	Cooling	5
	Signals Types and Rates	5
	Signal Rates	5
	Using Video and Audio References.....	6
	Mixing Analog and Digital	7
	Mono Channels	7
	Switching Configurations	8
	Classic SWB Switching Configurations	9
	Standard SWB Switching Configurations	9
	Module Slots and Rear Connectors	9
	Front Slots	10
	Rear Connections	11
	Backplanes	13
	Video Backplanes	13
	Machine Control Breakout Panel	14
	Backplane Types and Signals	14
	System Connections.....	16
	Router Control System Connections	16
	Diagnostic Connections	18
	AES Reference Connections	18
	Video Reference Connections	19
	Alarm Connections	20
	Time Code Reference Connections	20
	Active Cards	21
	Control Cards	21
	Systems Clock Generator Card	21
	Audio I/O Cards	22
	Card Power and Fuses	22
	Status Reporting	23
	AES Synchronous	23
	AES Asynchronous	24
	AES Sample Rate Converter (Input Only).....	24
	Analog Audio	25

Table of Contents

Video I/O Cards	26
Status Reporting	27
Standard Definition	27
Classic SWB	28
Standard SWB	28
Analog Video	29
Analog Video Converter	30
Machine Control Signals	31
Time Code Signals	32
Input Card	32
Output Card (EM0409)	33

Chapter 3

Installation	35
Summary	35
Package Contents	36
Preparing for Installation	36
Rack Mount	37
Connecting the Router to Power	38
Power Supply Monitor and Alarms Connections	38
Power Cords and Branch Circuits	38
Making Power Connections	38
Installing Backplanes	40
Installing Classic SWB Backplanes	41
Installing Machine Control Backplanes	42
Machine Control Breakout Panel	43
Installing Other Video, Audio and Time-Code Backplanes	43
Installing Active Cards	44
Systems Clock Generator Card	44
Cards Already Installed	44
Card Installation Rules	45
Rules for Partitions and Card Installation	45
Rules for Standard SWB Cards	45
Rules for Classic SWB Card Sets	46
Rules for Machine Control Card Sets	46
Limitations on Combining Classic SWB and Machine Control Card Sets	47
Configuration Tasks to Perform Before Installing Cards	47
Typical Card Combinations	48
Installing Cards	49
Making Signal Connections	50
AES Synchronous Signals	51
About Phoenix Connectors	51
Analog Signals	52
Mono Signals	53
Gain, Mute Detection and Operating Levels	53
Video Signals	54
Time Code Signals	55
Machine Control Signals	55
RJ-45 Connectors	56
DE9 Connectors	56
Making Reference Connections	57
AES Reference	57
Video Reference	58
Time Code Reference Signal	59

	Making Router Control System Connections	59
	Serial Router Control Connections	59
	Ethernet Router Control Connections	61
	GSC Node Bus Router Control Connections	61
	Making Diagnostic Connections	62
	Temporarily Connecting to UniConfig	62
	Permanently Connecting to UniConfig	63
	Making Alarm Connections	64
	Alarm Indicator Equipment	65
	Verification	65
Chapter 4	Configuration	67
	Introduction	67
	Setting Jumpers and Switches on Cards and Card Sets	67
	Control Card Jumper Settings	68
	Classic SWB Card Set Jumpers	68
	Standard SWB Jumpers	68
	Machine Control Card Set Jumpers	69
	Analog Audio Switches	69
	Individual Channel Gain	69
	Mute Detection	70
	Operating Levels	70
	Analog Video Conversion (AVC) Card Switches	71
Chapter 5	Operation	73
	Overview	73
	NV9000 Router Control System	73
	Third-Party Router Control Systems	74
Chapter 6	Maintenance	75
	Routine Maintenance	75
	Periodic Inspection	75
	Fuse Replacement	76
	Indicator LEDs	76
	Indicator LEDs on Power Supplies	77
	Indicator LEDs on Control Cards	77
	Indicator LEDs on Input and Output Cards	77
	Test Points	77
	Air Flow	78
	Fan Cleaning and Replacement	78
	Intake Filter Screen Cleaning	78
	Battery Replacement	78
	Replacing Modules	79
	Active Cards and Power Supply Modules	79
	Backplanes	79
	SWB Input/Output and SD Input Backplanes	79
	Troubleshooting	79
	Obtaining Service	80

Table of Contents

Chapter 7	Technical Details	83
	Power Specifications (Internal, PS6000)	83
	Physical Specifications	84
	Environmental Specifications	84
	Audio Specifications	85
	Video Specifications	85
	Time Code Specifications	87
	Machine Control Specifications	87
Chapter 8	Glossary	89
	Glossary	89
Appendix A	Part Numbers	93
	Cards, Card Sets, and Backplanes	93
	Analog and Digital Audio	93
	Analog Video and Standard Definition (SD)	94
	SWB (High Definition and Standard Definition Combined)	94
	Machine Control and Time Code	95
	Control Cards	95
	Power Supplies	95
Index	97

1. Preface

Chapter 1 provides an introduction to the NV5128 Multi-Format Router User's Guide. The following topics are discussed:

- [Chapter Structure](#)
- [The PDF Document](#)
- [Terms, Conventions and Abbreviations](#)

Chapter Structure

The following chapters provide detailed instructions for all aspects of Multi-Format Router:

- Chapter 1, [Preface](#), (this chapter) outlines easy ways to use this guide, provides a list of terms and conventions.
- Chapter 2, [Introduction](#), provides a functional description of the product.
- Chapter 3, [Installation](#), provides installation and connection instructions.
- Chapter 4, [Configuration](#), provides configuration instructions.
- Chapter 5, [Operation](#), provides operating instructions.
- Chapter 6, [Maintenance](#), provides maintenance and trouble-shooting instructions.
- Chapter 7, [Technical Details](#), provides electrical, video, audio, mechanical, and environmental specifications.
- Chapter 8, [Glossary](#), presents a glossary.
- Appendix A, [Part Numbers](#), presents a list of Miranda part numbers related to this router.
- An [Index](#) is also provided for your reference.

The PDF Document

This guide is provided in PDF format, allowing you to use Acrobat's "bookmarks" to navigate to any desired location. You can also easily print a hardcopy. Please note:

- Use the Table of Contents or the bookmarks page to jump to any desired section.
- Many hyperlinks are provided within the chapters.
- Use the Index to jump to specific topics within a chapter. Each page number in the index is a hyperlink.
- Use Acrobat's 'Go to Previous View' and 'Go to Next View' buttons to retrace your complete navigational path.

1. Preface

Terms, Conventions and Abbreviations

- Use the ‘First Page’, ‘Previous Page’, and ‘Next Page’, and ‘Last Page’ buttons to go to the first, previous, next, or last page within a PDF file.

Note

To display the navigation buttons, right-click the Tool Bar area, and check ‘Navigation’.

- Use Acrobat’s extensive search capabilities, such as the ‘Find’ tool and ‘Search’ tool to perform comprehensive searches as required.

Terms, Conventions and Abbreviations

The following conventions are used throughout this guide:

- The symbol ▲ denotes either an example or a special message.
- Notes, Cautions and Important messages are presented in note boxes.
- Entries written in bold-face or capital letters denote physical control panel buttons or GUI buttons.
 - Click **Apply** to ...
 - Press the **SRC 12** button.
- Entries in single quotes denote a field name, tab name, or label.
 - The AES reference connection is labeled ‘AES REF 1’.



2. Introduction

Chapter 2 provides a functional description of the product. It presents these topics:

- [Product Summary](#)
- [Power Supply](#)
- [Signals Types and Rates](#)
- [Switching Configurations](#)
- [Module Slots and Rear Connectors](#)
- [Active Cards](#)

Product Summary

The NV5128 Multi-Format Router is a highly flexible router supporting audio and video signals, both analog and digital, in a variety of combinations. (See [Signals Types and Rates](#) on page 5.) The router can support up to 128 inputs and 128 outputs (256 inputs and 256 outputs mono), typically organized in a block of 16 inputs and 16 outputs, expandable in increments of 16. A fully non-blocking matrix architecture, allows for one-to-one and one-to-many routing.

For audio signals, the NV5128 routes stereo signals internally as mono channels, enabling the recombination of channels to create new stereo signals. Analog audio signals are routed internally as digital signals. Converters housed on I/O cards convert incoming analog signals to digital and outgoing digital signals to analog as needed.

For video signals, the router can manage Standard Definition (SD) separately, or SD and High Definition (HD) signals combined, referred to as Super Wide Band (SWB). Analog video signals are routed internally without being converted to digital. However, an Analog Video Converter (AVC) card is available for the conversion of analog to digital and digital to analog.

Additionally, longitudinal time code signals and machine control signals can also be routed within the same frame enabling you to meet unique switching needs.

Active input cards, output cards, and control cards are “hot swappable” and installed through the front of the frame for easy access. The rear of the router features a back plate into which backplanes housing different types of connectors for receiving and distributing signals are installed. Each backplane receives or distributes signals for a single active card allowing for maximum switching configuration flexibility: backplanes are not pre-installed in pre-selected router slots. The back plate also contains connections to system functions, such as a router control system, alarms or reference signals.

Mounting

The NV5128 is designed to mount in a standard EIA rack with minimum dimensions of 8RUs (13.97 inches, 354.8 mm) high, 19 inches (482.6 mm) wide, and approximately 18 inches (457 mm)

2. Introduction

Power Supply

deep. Because of the router's compact size, multiple routers can be mounted in a single rack, saving facility space. For installation instructions, see [Rack Mount](#) on page 37.

Fuses

Active cards feature a “fast blow” or resettable fuse. If the card requires a large amount of power, the fuse is “fast blow” and must be replaced if blown. If the fuses are resettable, the fuses either reset automatically or can be reset manually by removing the card from the frame. For more information on fuses, see [Fuse Replacement](#) on page 76.

Cooling

The NV5128 frame has a single fan tray containing three fans with variable fan speed control. The fans draw cooling air from the front of the router, through the door, and exhaust it through the rear of the frame. The router must have the door installed and closed for proper airflow through the chassis.

Caution

If airflow is impeded, overheating can occur.

Each fan features speed control which spins the fan at the optimal rate required to ensure that a constant temperature is maintained within the router. Temperature sensors on the fans sense the exiting temperature and speed up or slow down the spinning of the fan as required. By spinning only as needed to meet cooling needs, fan noise is significantly reduced in partially loaded frames or in environments with lower ambient temperatures. In addition, by maintaining a constant temperature, circuitry life span is increased.

Each fan features two LEDs that indicate if the fan is receiving power and if there is a failure. For more information, see [Indicator LEDs](#) on page 76.

Filters

There is a removable air filter located on the inside of the door assembly. It is recommended that maintenance of the fan tray and filters be performed on a regular basis. For more information, see [Air Flow](#) on page 78.

Power Supply

The NV5128 uses the PS6000 power supply module, housing one primary module and one optional module (for redundancy). The PS6000 power supply module accepts a wide range of AC input voltages and produces five +48 VDC outputs. The power supply automatically senses the AC input voltage (90–130 and 180–250 VAC) and adjusts to maintain a relatively constant DC output; no voltage selection is required.

The five regulated outputs are directed to modules in the router where on-board regulators produce the DC voltages required by the local circuits. Each +48 VDC output powers one of the five green LEDs and output test points located on the front of each PS6000 power supply module. Under normal operation, all five LEDs are lit. For more information, see [Indicator LEDs](#) on page 76.

Figure 2-1 shows the power supply architecture.

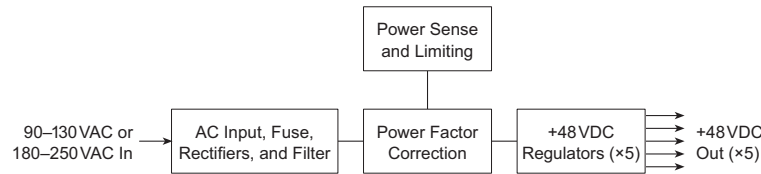

Figure 2-1. PS6000 Power Supply Module Diagram

Fuses

A fuse for the AC power inputs is located on the PS6000 power supply modules. When a NV5128 is ordered, fuses appropriate for the line voltage in use at the country of destination are installed on the PS6000 power supply modules. Be sure to check the fuse ratings for compliance with specific requirements in your area. An 8A fuse (part number HB0145-00) is required for 90–130 VAC applications. For 180–250 VAC operation, a 6.3A fuse (part number HB0031-00) is required.

The fuses are “slow blow” and designed to blow if there is an ongoing power issue, but not if there is a single, minor spike in the power flow. For information on replacing fuses, see [Fuse Replacement](#) on page 76.

Cooling

There are four low-speed fans located along the front edge of each PS6000 power supply module. Each fan pulls a small quantity of air across internal heat sinks.

Signals Types and Rates

The NV5128 supports several signals within a single router. Supported audio signals are analog, AES synchronous and AES asynchronous. Supported video signals are analog, SD, and SWB (SD and HD combined). Also supported are SMPTE longitudinal time code and machine control signals.

Incoming audio analog signals are converted to digital with a sample rate of 48kHz for internal routing and can be distributed externally as digital audio outputs. Conversely, incoming digital audio signals can be converted and distributed externally as analog audio outputs. In addition, all stereo signals are separated into left and right channels for switching as mono signals. Mono channels can be recombined to create new stereo signals. This unique architecture allows for cross-conversion between analog and synchronous AES signals within the same frame.

Analog and digital video signals can be intermixed with any other supported video format (analog, SD or SWB) while maintaining a high level of analog video performance, effectively replacing many single format routers already in use.

Signal Rates

The following table lists the sample rates and how many signals at each rate an input card or output card can support. Each signal type requires a specific input card or output card. For a description of each card and corresponding card part numbers, see [Active Cards](#) on page 21.

2. Introduction

Signals Types and Rates

The router can manage several types of signals in virtually any combination. Supported signals include:

Signal Type	Rates Supported	One Input Card Supports	One Output Card Supports
Audio AES synchronous (balanced or unbalanced)	Sample rate 48kHz	16 stereo inputs or 32 mono inputs	16 stereo outputs or 32 mono outputs
Audio AES asynchronous (balanced or unbalanced)	Sample rates 32 to 96kHz (passed through)	16 stereo inputs	16 stereo outputs
Audio Analog	Sample rate 48kHz; 24 bits	16 stereo inputs or 32 mono inputs. Converts analog to internal digital format.	16 stereo outputs or 32 mono outputs. Converts internal digital format to analog.
Video Standard Definition (SD)	SMPTE 259M. Reclock to 143, 177, and 270 Mb/s. Auto bypass at 10 Mb/s to 270 Mb/s	16 inputs	16 outputs
Video High Definition (SWB)	SMPTE 292M. Reclock to 143, 177, 360, 540 Mb/s, 1.483 and 1.485 Gb/s. Auto bypass at 10 Mb/s to 1.5 Gb/s	16 inputs	16 outputs
Video Analog	PAL 625/50: or NTSC 525/59.94: analog composite	16 inputs	16 outputs
Video Analog/Digital and Video Digital/Analog Conversion	PAL or NTSC analog composite decoded and encoded to SMPTE 259M-C, (4:2:2), 270 Mb/s	16 analog composite video inputs converted to SMPTE 259M-C	16 SMPTE 259M-C outputs converted to analog composite video
Time Code	1/30th to 100 times normal	16 inputs	16 outputs
Machine Control	up to 115.2 kb/s	16 inputs/outputs. Cards are bidirectional (both inputs and outputs)	

Using Video and Audio References

References are required for proper switching. The following lists input signal formats and if a video or AES reference is required.

Input Signal Format	Video Ref.	AES Ref.
Analog Audio (Stereo)	**	*
Analog Audio (Mono)	**	*
Synchronous AES Digital Audio (Stereo)	**	Yes
Synchronous AES Digital Audio (Mono)	**	Yes
Mixed Analog and Synchronous AES Digital Audio	**	Yes
Asynchronous AES Digital Audio (Stereo)	**	No
Analog Video (PAL or NTSC)	Yes	No
SD Video	Yes	No
SWB Video	Yes	No
Time Code (Linear)	Yes	No

Input Signal Format	Video Ref.	AES Ref.
Machine Control (RS-422)**	Yes	No

* If possible, connect an external AES 48 kHz reference signal.

** Video reference is not required for operation, but ensures proper video switching.

Mixing Analog and Digital

The NV5128 frame can mix analog and digital signals within a single routing system. For example, a digital audio input can be routed to an analog audio output. To perform this action the router uses analog-to-digital (A/D) converters and digital-to-analog (D/A) converters.

There are two types of A/D and D/A converter cards: one set for audio and one set for video. Analog audio converter cards cannot be mixed with analog video converter cards. The input signals type—audio or video—must match the output signal type. For more information on converter cards, see [Active Cards](#) on page 21.

The following is a list of audio and video inter-mix options and related delay times.

Input and Output Options	Delay
Analog audio input and analog audio output	< 1.2 mS
Analog audio input and AES synchronous output	~ 658 μ S
AES synchronous input and analog audio output	~ 539 μ S
AES synchronous input and AES synchronous output	83.2 μ s (4 samples)
AES asynchronous input and AES asynchronous output	< 1 μ S
Analog video input and analog video output	< 20 ns
Analog video input and SD output	1 video line
SD input and Analog video output	3 μ S
SD input and SD output	< 20 ns

Mono Channels

AES signals are composed of several parts, including a preamble, left channel, right channel, user bits, and channel status bits. When received as an AES signal, the signal is retained as an AES signal for internal routing to the output card. The crosspoint array on the output card breaks apart the signal, separating out the left and right channels to create two mono channels. The mono channels are then switched as separate signals, recombining left and right channels into new stereo signals. The channel status bit and user bits are passed through. When the signal is distributed as an AES output, the preamble, channel status bit and user bits are added back to the left and right channels to create a stereo signal.

Individual left or right channels can be combined with other individual channels and distributed as a new channel-pair combination (stereo signal). For example, a live news report may capture the news reporter's voice on the left channel and the background noises on the right channel. By splitting the AES signal into its left channel and right channel, the news reporter's voice (left channel) can be paired with a different background noise (right channel). If only one channel is present, the other channel is silent.

To perform mono switching, an external AES reference signal must be connected to maintain synchronization (see [Making Reference Connections](#) on page 57). How mono signals are recombined

and routed to outputs is determined by the router control system. For more information on mono signal switching, see [Setting Jumpers and Switches on Cards and Card Sets](#) on page 67.

Switching Configurations

Switching is performed by the output card. Each output card receives signals from the input card via the motherboard and routing commands from the control card. The inputs are then sent to a crosspoint array on the output card that performs the switching.

Figure 2-2 shows the basic architecture of the NV5128 switching configuration and the relationship between the backplanes and the input cards and output cards. Backplanes house connections that receive and distribute signals to and from the router. For more information, see [Backplanes](#) on page 13.

Each “X” (crosspoint symbol) represents a 16 input x 16 output crosspoint array. Taken together, eight crosspoints create a 128 input x 16 output crosspoint array. This unique architecture creates a fully non-blocking matrix such that an input can be switched to any output, and one input to one output, or one input to many outputs.

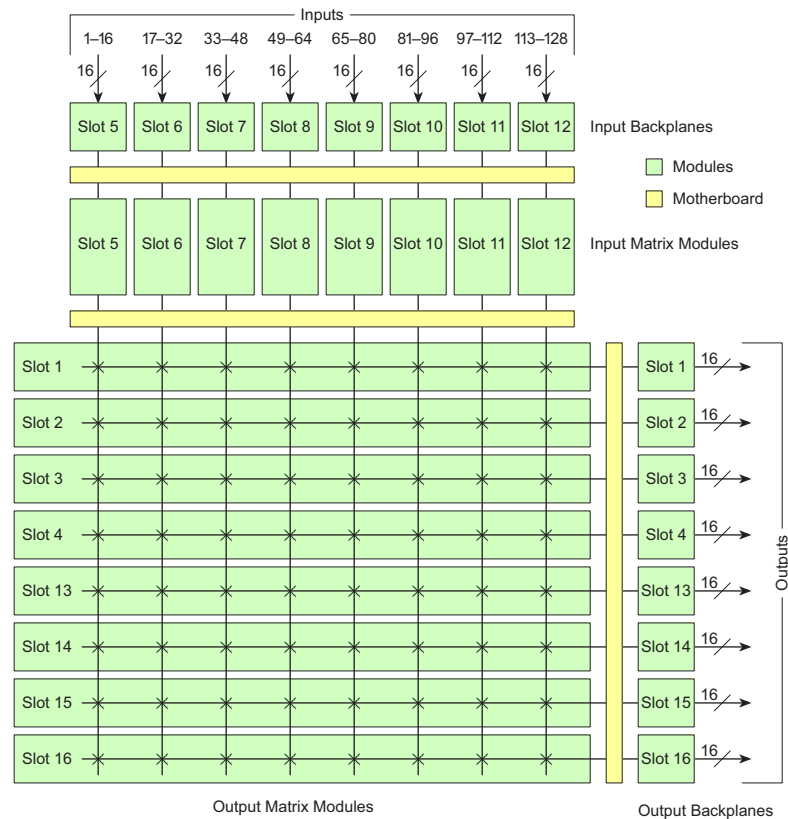

Figure 2-2. NV5128 Crosspoint Architecture

In general, input cards and output cards follow the 16 inputs x 16 outputs architecture, with one router card slot per card. There are three exceptions: Classic SWB card sets, Standard SWB cards and machine control card sets. Each card set switching configuration is discussed in the preceding sections.

Classic SWB Switching Configurations

The Classic SWB card set is composed of two cards connected together that occupy two card slots. The card set has a 16 input x 16 output crosspoint array. A single Classic SWB card set can be used to create a 16 input x 16 output switching matrix, or a pair of card sets can be coupled together to create a 32 input x 32 output matrix. The 32 input x 32 output configuration feeds the 16 inputs from one Classic SWB card set to the second Classic SWB card set and vice versa.

When creating a 32 input x 32 output matrix, the Classic SWB cards must be installed in specific router slots. For installation instructions, see [Installing Classic SWB Backplanes](#) on page 41. For more information about the card architecture, see [Classic SWB](#) on page 28.

Standard SWB Switching Configurations

There are two types of Standard SWB output cards: a main card with a “wing” and optional expansion cards that mate with the wing on the main card. The output cards occupy four contiguous slots. By installing the main card and up to three expansion cards, different crosspoint matrices can be created. Because the main output card receives all 128 SWB inputs, switching configurations can start at 16 inputs x 16 outputs, increasing in increments of 16 up to 128 inputs by 64 outputs. A second set of Standard SWB main output cards and expansion output cards can be installed, increasing the switching configuration to 128 inputs x 128 outputs.

The Standard SWB cards must be installed in specific router slots. For installation instructions, see [Installing Other Video, Audio and Time-Code Backplanes](#) on page 43. For more information about card architecture, see [Standard SWB](#) on page 28.

Machine Control Switching Configurations

The machine control card set is composed of two cards connected together that occupy two card slots. The machine control card set is bidirectional; it carries signals in both directions (input and output).

A single machine control card set can support 32 ports. If a second machine control card set is installed and combined with the first card set, the configuration can be doubled to 64 ports.

The Machine Control cards must be installed in specific router slots. For installation instructions, see [Installing Machine Control Backplanes](#) on page 42. For more information about the card architecture, see [Machine Control Signals](#) on page 31.

Module Slots and Rear Connectors

The NV5128 has slots for input cards, output cards, and control cards. Cards are installed through the front of the frame for easy access and are “hot swappable”. The rear of the router is a back plate into which backplanes housing connectors for receiving and distributing signals are installed. The back plate also contains connections to system functions, such as a router control system, alarms or reference signals.

Active circuitry is contained mainly on the input cards, output cards, control cards, power supply modules, and fan tray installed through the router’s front. However, some active circuitry for SD and HD signals are located on the associated backplanes, which are installed through the router’s rear. All cards and backplanes are “hot-swappable.”

2. Introduction

Module Slots and Rear Connectors

An internal motherboard spans the frame and interconnects front and rear modules, and distributes control signals, timing information, and power. Cards, power supply modules, and the fan tray plug into the motherboard from the front of the router and backplanes plug into the same motherboard from the rear. Each input card and output card has a corresponding backplane. For more information on each type of card, see [Active Cards](#) on page 21. For more information on backplanes, see [Backplanes](#) on page 13.

Front Slots

Figure 2-3, next page, shows the front of the NV5128 with the door removed. In the center of the router are eight slots designated for input cards. To the right and left of the input slots are four slots designated for output cards. On the far right, two slots house the primary and secondary control cards. A fan tray is located at the top of the router chassis.

Viewing the frame from the front, slots are numbered 1 through 16, from left to right. (See Figure 2-3.)

Each slot supports 16 channels, as follows:

- Slots 1 through 4 (for outputs): Slot 1 switches output channels 1 to 16, slot 2 switches output channels 17-32, and so on.
- Slots 5 through 12 (for inputs) receives and process inputs 1 to 128 respectively, in groups of 16 channels per slot, in ascending order, left to right, viewed from the front of the frame.
- Slots 13 through 16 (for outputs) are similar in function to slots 1 to 4, except that the output channels are in reverse order. That is, slot 13 switches output channels 113 to 128, slot 14 switches 97 to 112, slot 15 switches 81 to 96 and slot 16 switches 65 to 80. The reverse order of the output channels in the right-hand side of the frame is intentional; it makes it easier to obtain equal path lengths on the frame's motherboard, facilitates analog video timing, and facilitates the use of Classic SWB card sets and machine control card sets installed in slots 11 to 14 (see [Installing Active Cards](#) on page 44).

Figure 2-3 shows the location of the input card, output cards, and control card slots, as viewed from the front.

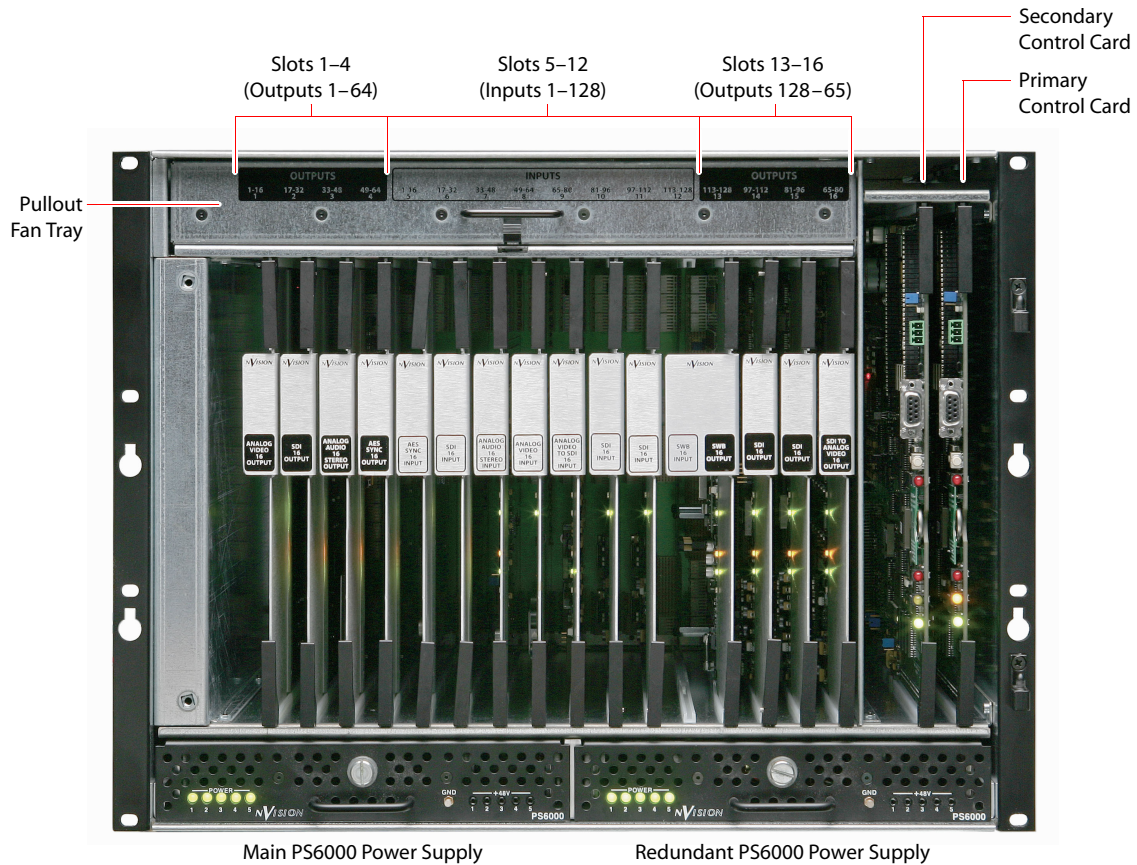

Figure 2-3. NV5128 Frame with Modules (Front View)

Rear Connections

The rear of the NV5128 (Figure 2-4) features a back plate containing backplanes for receiving and distributing signals. Backplanes plug into connectors located on the motherboard, which runs the width of the frame. In the left-hand region are connections for system functions, as shown in Figure 2-7 on page 16. Two AC power connections are located in the right-hand region.

2. Introduction

Module Slots and Rear Connectors

Figure 2-4 shows the router with backplanes installed on the rear of the NV5128 frame.

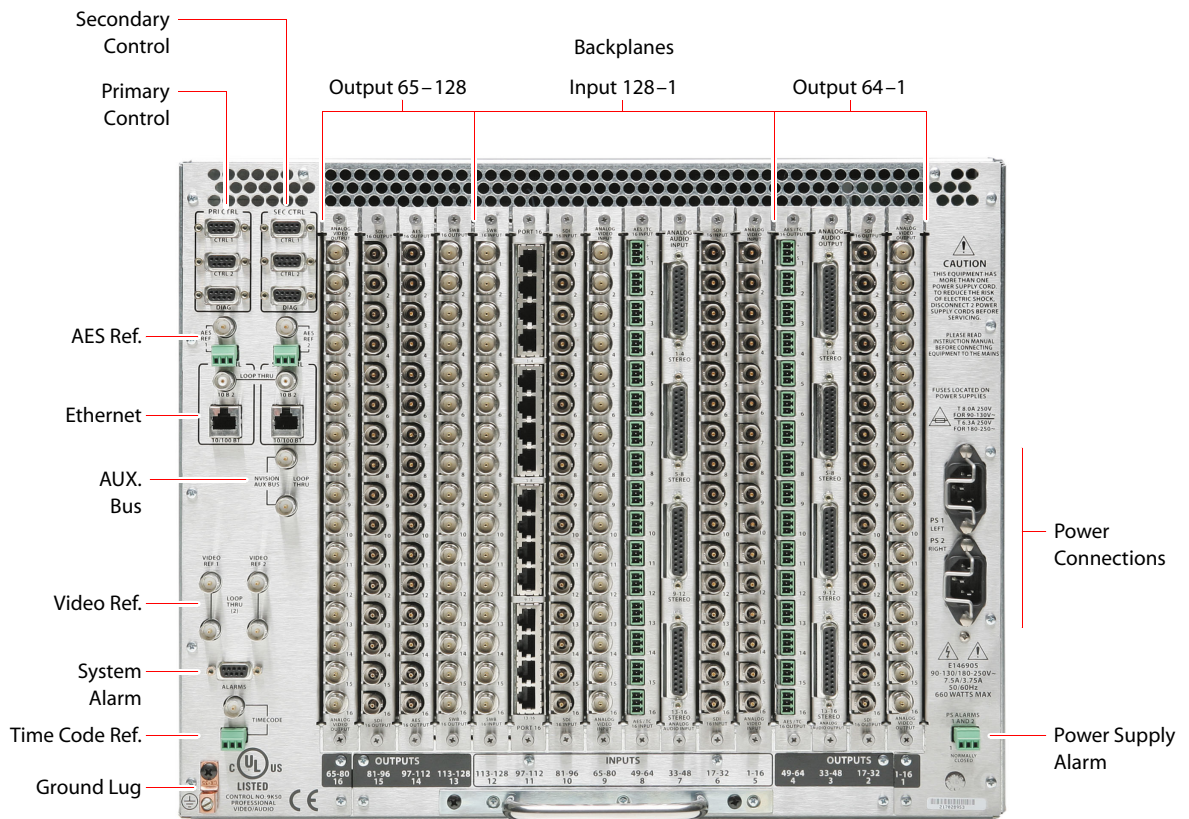

Figure 2-4. NV5128 Frame with Backplanes (Rear View)

Backplanes

The NV5128 features rear backplanes that can be inter-mixed in a single router frame, as shown in Figure 2-4 on page 12.

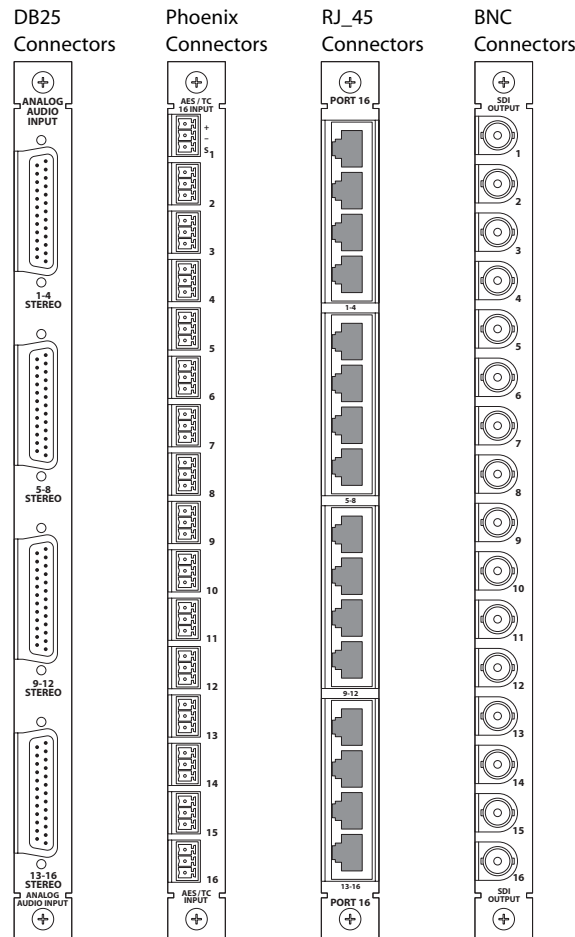

Figure 2-5. Backplanes

Each backplane contains connectors for receiving or distributing signals. The number of connectors on a backplane and the type of connector is determined by the type of signal. Figure 2-5 shows the four types of connectors available on backplanes.

There are five types of backplanes. All backplanes are passive unless otherwise noted:

- DB25 connectors—Used for analog audio signals.
- Phoenix connectors—Used for AES balanced signals and SMPTE longitudinal time code signals.
- RJ45 connectors—Used for machine control signals.
- BNC connectors—Used for analog video and AES unbalanced audio signals.
- BNC connectors (active)—Used for incoming and outgoing SWB signals and for incoming SD signals.

Important

The two backplanes containing BNC connectors are not interchangeable. The BNC backplane for SD and SWB signals are active and can *not* be used for analog video or AES audio signals.

The type of signal being received or distributed determines the backplane used (see [Backplane Types and Signals](#) on page 14). For each backplane installed a corresponding input card or output card must also be installed. For example, if a backplane is installed to receive AES unbalanced signals, then the input card capable of routing AES unbalanced signals must be installed in the corresponding card slot (see [Active Cards](#) on page 21).

Video Backplanes

Unlike other backplanes, the backplanes for incoming and outgoing SWB signals and incoming SD signals have active components. These backplanes cannot be used with analog video cards.

2. Introduction

Module Slots and Rear Connectors

Machine Control Breakout Panel

The backplane module for machine control signals has 16 RJ-45 connectors. Miranda offers an optional machine control breakout panel (BP2-PORT-64) that can be used with up four machine control backplane modules. The panel has 64 RJ-45 connectors on one side and 64 DE9 (female) connectors on the other, as shown in Figure 2-6. The DE9 connector wiring follows SMPTE-defined pin assignment standards. For installation instructions, see [Installing Machine Control Backplanes](#) on page 42.

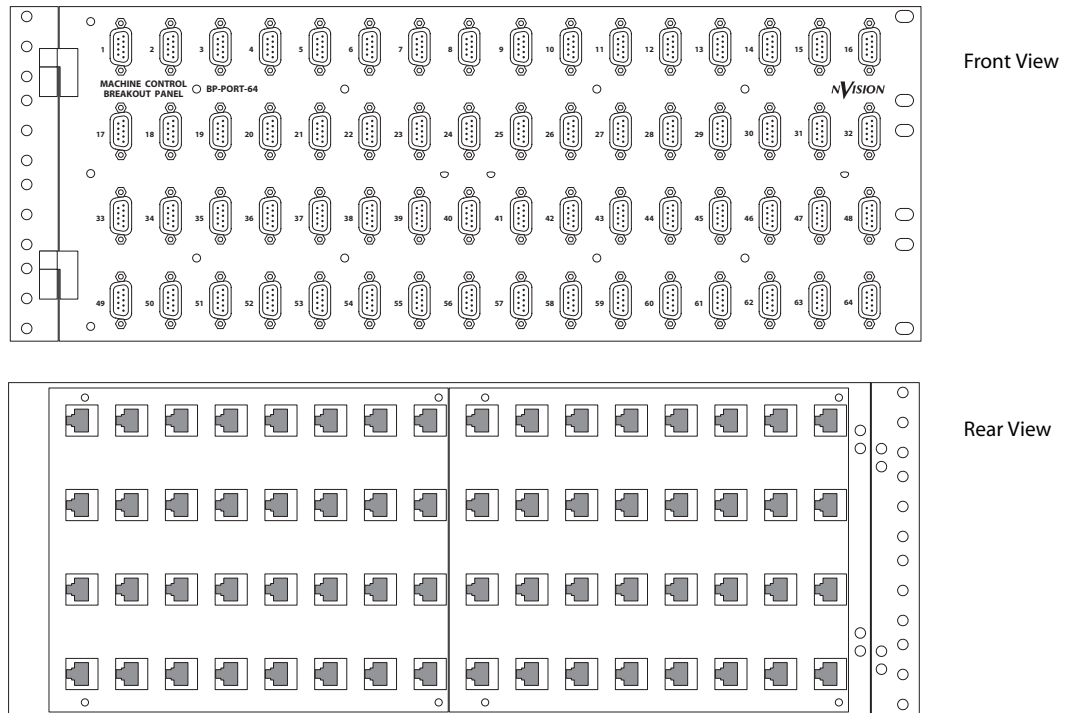

Figure 2-6. Optional Machine Control Breakout Panel

Backplane Types and Signals

The following is a list of each backplane type, associated connectors, signal types managed, and the number of signals each backplane can receive or distribute. For the part number for each backplane list, see [Cards, Card Sets, and Backplanes](#) on page 93.

Signal Types	Backplane Name	Connector Type	Connectors per Backplane	Signals Managed
AES unbalanced, synchronous	AES	BNC	16	16 stereo or 32 mono
AES balanced, synchronous	AES/TC	Phoenix	16	16 stereo or 32 mono
AES unbalanced, asynchronous	AES	BNC	16	16 stereo
AES balanced, asynchronous	AES/TC	Phoenix	16	16 stereo
Analog audio	Analog audio	DB25	4	16 stereo or 32 mono
Digital Video, SD	SDI	BNC	16	16
Digital Video, SWB	SWB	BNC	16	16

2. Introduction

Module Slots and Rear Connectors

Signal Types	Backplane Name	Connector Type	Connectors per Backplane	Signals Managed
Analog Video	Analog video	BNC	16	16
Time Code	AES/TC	Phoenix	16	16
Machine Control	PORT 16	RJ-45	16	16

The BP2-Port-64 panel has 64 RJ-45 connectors on one side and DE9 (female) connectors on the other side. It allows you to use DE9 cables to connect machine control ports to devices.

2. Introduction

Module Slots and Rear Connectors

System Connections

The NV5128 features connections for managing system functions. System connections are located on the left side of the frame when facing the rear of the router.

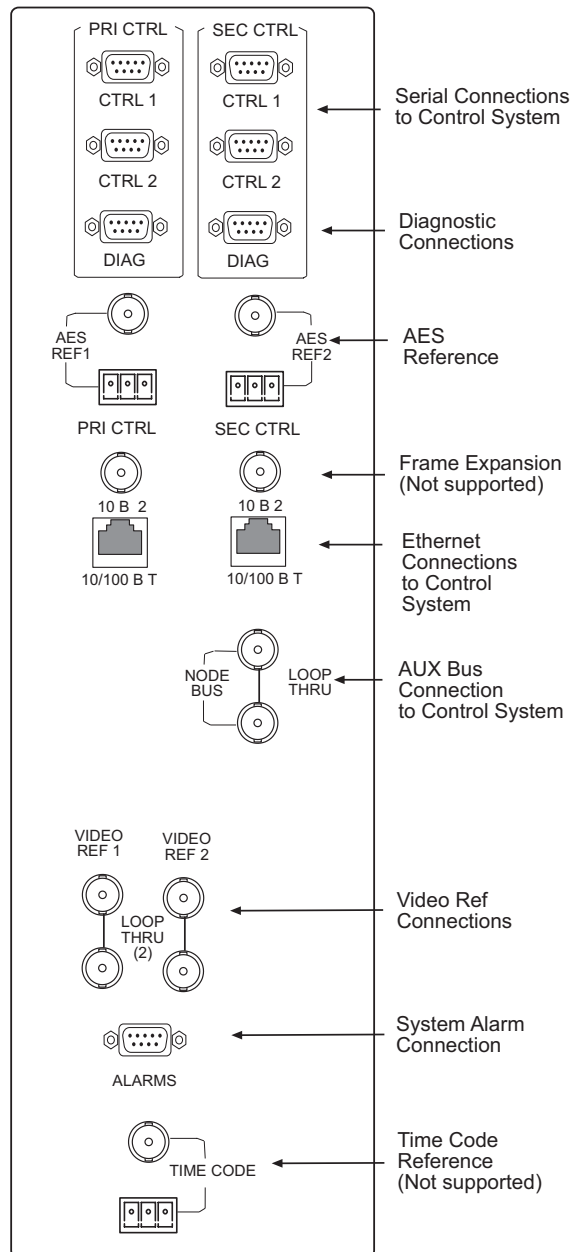

Figure 2-7. System Connections (Rear View)

These connections are used to connect to:

- A router control system using either serial, Ethernet or GSC Node Bus connectors.
- A stable source of audio and/or video signal for reference purposes.
- The UniConfig application, installed on a configuration PC.
- A system alarm that sends notification of a system failure, such as a fan malfunction.
- A power supply alarm that sends notification of a power supply failure.

Figure 2-7 shows the system connections located on the rear of the router. Each system connection and function is described in the preceding sections.

Router Control System Connections

A router control system is used to manage routing configurations in the router. The router control system sends instructions to the control card, which in turn sends commands directing signal switching within the router. (See [Control Cards](#) on page 21.) A router control system is a separate external unit, which is connected to the router. The NV5128 provides three types of a router

control system connections: serial, Ethernet or GSC Node Bus. The router control system determines which connection is used. For example, to connect to the NV9000 router control system an Ethernet connection is preferred.

Serial Connections

The NV5128 has four serial router control system connections, as shown in Figure 2-8. The connections are divided into two sets, one primary ('PRI CTRL') and one secondary ('SEC CTRL'). Primary control connects to the primary control card. Secondary control connects to the secondary (optional for redundancy) control card (see [Control Cards](#) on page 21). Each set is further divided into connections that correspond to router control systems: 'CTRL 1' corresponds to the primary control system and 'CTRL 2' corresponds to a redundant router control system. Using 'CTRL 2' connections, you can connect to an alternate control system (i.e., backup system) or set up dual control, if desired. For installation instructions, see [Serial Router Control Connections](#) on page 59.

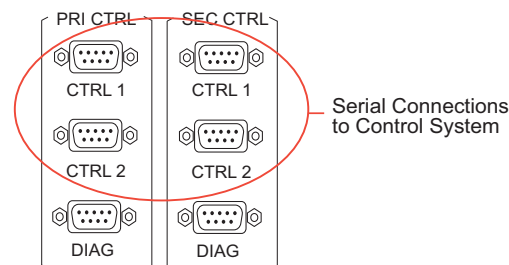

Figure 2-8. Serial Connections to Router Control System (Rear View)

Ethernet Connections

The NV5128 has two Ethernet router control system connections, labeled '10/100 BASE T', as shown in Figure 2-9. Both connections are shared by both the primary control card and the secondary control card. (See [Control Cards](#) on page 21.) Because Ethernet network connections can be used to connect to alternate control systems, there are no separate connections provided. For installation instructions, see [Ethernet Router Control Connections](#) on page 61.

In order for the router to communicate with the router control system through an Ethernet connection, an IP address for the router needs to be set in the control card. The IP address is set using UniConfig. For more information, see the UniConfig User's Guide.

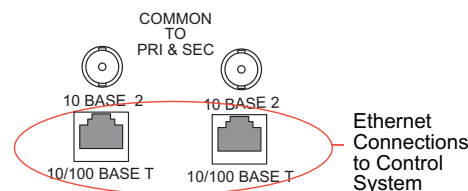

Figure 2-9. Ethernet Connections to Router Control System (Rear View)

GSC Node Bus Connections

Some third-party router control systems require a GSC Node Bus connection. The NV5128 has one GSC Node Bus connection, labeled 'NODE BUS', as shown in Figure 2-10, next page. The connection is shared by both the primary control card and the secondary control card. (See [Control Cards](#) on page 21.) To use the GSC Node Bus connection, an optional module must be installed on each control card being used. For details, contact Miranda. For installation instructions, see [GSC Node Bus Router Control Connections](#) on page 61.

2. Introduction

Module Slots and Rear Connectors



Figure 2-10. GSC Node Bus Connections to Router Control System (Rear View)

Control System Expansion Connections

The NV5128 has two connections for the router control system when connecting multiple router frames together, labeled '10 B 2', as shown in Figure 2-11. However, frame expansion is not supported in the NV5128 and these connections are inactive.

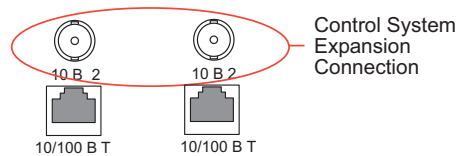

Figure 2-11. Control System Expansion Connection (Rear View)

Diagnostic Connections

The diagnostic connections enable the NV5128 to communicate with the UniConfig application. UniConfig runs on external hardware (e.g., PC) separate from the router and is used to perform system setup tasks, and configure and monitor the router. (See [Configuration](#) on page 67.) For more information on UniConfig, see the UniConfig User's Guide.

There are two types of diagnostic connections: temporary and permanent. A temporary diagnostic serial connection is located on the front of each control card. (See [Control Cards](#) on page 21.) Permanent diagnostic connections are located on the rear of the router, labeled 'DIAG', as shown in Figure 2-12 on page 18. Miranda recommends using the temporary diagnostic connection when reconfiguring the router because the port has fixed communications parameters. The permanent diagnostic connections are used for upgrading firmware or control card protocols when there is no Ethernet connection to the router. For instructions on making temporary or permanent diagnostic connections, see [Permanently Connecting to UniConfig](#) on page 63.

There are two permanent 'DIAG' ports, one primary ('PRI CTRL') and one secondary ('SEC CTRL'). The primary control connects to the primary control card. The secondary control connects to the secondary (optional for redundancy) control card.

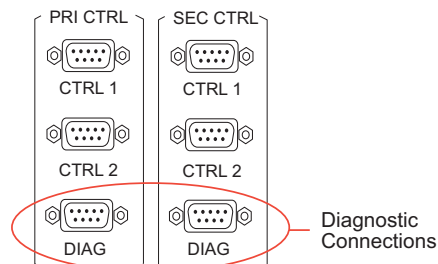

Figure 2-12. Permanent Diagnostic Connections (Rear View)

AES Reference Connections

The AES reference is used for clock generation, which provides a timing reference for AES synchronous signals and for timing circuits on the control card. Certain signals require an AES refer-

ence. (See [Using Video and Audio References](#) on page 6.) For optimum audio output, signals must be clock-locked to the same reference. Input impedance is selected by setting jumpers on the control card. (See [Control Card Jumper Settings](#) on page 68.)

The NV5128 has two AES reference connections labeled ‘AES REF1’ and ‘AES REF2’, as shown in Figure 2-13. Both connections are shared by the primary control card and the secondary control card. (See [Control Cards](#) on page 21.) The AES reference connections are “redundant” and use the same reference type. When both reference connections are connected, if one reference fails, the control card automatically fails-over to the redundant reference.

Synchronous AES input cards can work with inputs that are not locked to a common AES reference. These inputs are treated as non-synchronous AES signals. Although possible, this is not recommended for high-quality program audio feeds because the audible effects may be unpredictable, depending on the program content and the degree of offset in the incoming data rate.

An AES reference is required when using synchronous AES output cards. (See [AES Synchronous](#) on page 23.) While it is possible to let the clock generator on the control card free-run, the synchronous AES outputs may contain ticks and pops, the severity of which depends on the difference in clock rate.

The AES reference connection requires a stable signal source of AES with a sample rate of 48 kHz. For instructions on making AES reference connections, see [AES Reference](#) on page 57.

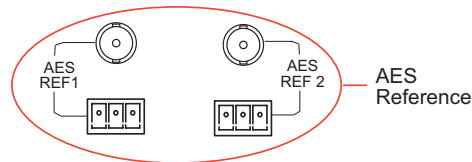

Figure 2-13. Connections to AES References (Rear View)

Video Reference Connections

The NV5128 provides timing reference connections for video signals, labeled ‘VIDEO REF 1’ and ‘VIDEO REF 2’, as shown in Figure 2-14 on page 20. These connections provide a reference input for determining the router’s video frame switch point and are required for certain signals. (See [Using Video and Audio References](#) on page 6.) The same reference can be used for both connections or a different reference used for each connection. For more information, see [Redundant and Dual References](#) on page 19.

If a video reference is present, signals switch at the defined frame and line switch points. If a video reference is not present, the router still switches the signal, but to an internal reference. When the video reference is not connected the control card red LEDs remain lit. (See [Indicator LEDs](#) on page 76.)

The video reference connections require a stable source of PAL, NTSC or Tri-level sync. For instructions on making video reference connections, see [Video Reference](#) on page 58.

Redundant and Dual References

There are two video reference connections. The same reference can be used for both connections or a different reference for each connection. When using the same, or “redundant,” references for both connections, if one reference fails, the control card automatically fails-over to the redundant reference. When using different references, or “dual” references, routing switch takes can be configured

2. Introduction

Module Slots and Rear Connectors

to occur based on one or the other reference. For example, ‘VIDEO REF 1’ uses NTSC as a reference and ‘VIDEO REF 2’ uses PAL as a reference.

“Redundant” or “dual” mode is selected using UniConfig. If “dual” is selected, each output can be configured individually to use ‘VIDEO REF 1’ or ‘VIDEO REF 2’ as the reference. For more information, see the UniConfig User’s Guide.

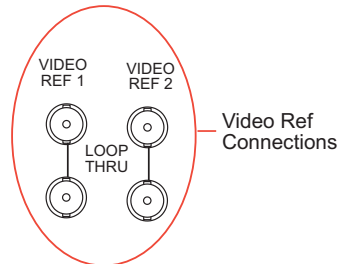

Figure 2-14. Connections to Video References (Rear View)

Alarm Connections

The NV5128 provides a system alarm that notifies you of a malfunction, such as when a fan or power supply is not functioning properly. The alarm connection can be connected to external equipment that display visual signals when an alarm is activated. Creation of external monitoring equipment is outside the scope of this manual. However, basic instructions on wiring the alarm connections for external monitoring is provided. See [Making Alarm Connections](#) on page 64.

In addition to an alarm connection, the router control system receives status information from the router’s control card(s). The control cards read the status of the router’s power supply and fans through the ‘Power Supply Alarm’ connection. The information is then communicated to the router control system and is viewable using UniConfig. For more information, see the UniConfig User’s Guide.

A SNMP agent can be installed on the router control system (i.e., NV9000) to communicate power supply information to a SNMP manager. Installation of SNMP agents and use of SNMP managers is outside the scope of this User’s Guide.

The router alarm connection is labeled ‘ALARM’, as shown in [Figure 2-15](#). For instructions on making alarm connections, see [Making Alarm Connections](#) on page 64.



Figure 2-15. Alarms Connection (Rear View)

Time Code Reference Connections

The NV5128 has connections for a reference source for Time Code signals labeled ‘TIME CODE’, as shown in Figure 2-16. However, time code references are not support at this time.

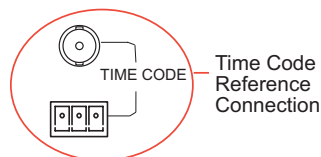

Figure 2-16. Time Code Reference Connection (Rear View)

Active Cards

The NV5128 features several active cards that manage incoming signals, forward commands from the router control system, perform signal switching, and distribute outgoing signals. Each card slides into a card guide and has two levers that aid card insertion and ejection.

There are:

- Two control cards (one primary, one secondary; optional for redundancy).
- Up to 8 input cards.
- Up to 8 output cards.

Each input card and output card supports a specific signal type and has a corresponding backplane. (See [Signals Types and Rates](#) on page 5 and [Backplanes](#) on page 13.)

Card functions are described in the proceeding sections. For information on installing cards, see [Installing Active Cards](#) on page 44.

Control Cards

The router has two control cards (EM0374), one primary and one secondary (optional for redundancy). A control card receives commands from the router control system, and in turn, controls the input and output cards. In addition, the control card manages reference signals, supplies appropriate timing and control signals to the input cards and output cards, and sends alarm signals to the router control system.

Both the primary control card and the secondary control card receive router control system commands, but only the primary control card actively sends commands to the output cards. Because both cards receive router control system commands, if the active (primary) control card fails, the back-up (secondary) control card automatically takes over processing without interruption. In addition, the primary control card and secondary control card communicate with each other. Should either control card fail, the now active control card communicates the failure to the router control system.

There are several jumpers on the control card which must be configured before putting the router into service. For more information, see [Control Card Jumper Settings](#) on page 68.

The control card receives power from the motherboard and includes a status reporting circuit. Four LEDs on the front of the control card indicate the card's status: low battery (Red), alarm (Red), active (Amber), and operating normally (Green). For more information, see [Indicator LEDs](#) on page 76.

Systems Clock Generator Card

The systems clock is located on the control card. (See [Control Cards](#) on page 21.) This clock is critical and used by all input cards and output cards; if the clock fails, the router cannot route audio signals. As a preventive measure, a secondary control card (optional for redundancy) can be installed to act as a backup should the primary control card fail. If you do not want to install two control cards, an optional Systems Clock Generator card (EM0414) can be installed in place of the secondary control card. The Systems Clock Generator card ensures that in the event of a primary control card failure the system continues to receive clock information. However, the Systems Clock Generator card only provides clock information and cannot take over control card tasks.

2. Introduction

Active Cards

Audio I/O Cards

Audio input cards and output cards support AES synchronous, AES asynchronous, and analog audio signals. Each type of signal requires a unique type of card. For example, to support AES synchronous signals, cards that specifically manage AES synchronous signals must be installed. Different types of audio input cards and output cards can be inter-mixed in a single frame to meet specific switching configuration needs.

For each input card and output card installed, an associated backplane must also be installed. For more information, see [Backplanes](#) on page 13.

Analog and AES synchronous signals may be converted between analog and digital within the NV5128 router frame. (See [Mixing Analog and Digital](#) on page 7.) In addition, analog or AES synchronous signals may be routed as stereo or mono signals, but not as AES asynchronous signals. AES asynchronous signals can only be routed as stereo signals. However, using the SRC input card, asynchronous AES signals can be converted to synchronous signals and then routed as stereo or mono signals. (See [AES Sample Rate Converter \(Input Only\)](#) on page 24.)

The following is a list of the different audio input cards and output cards available. Each card is listed by the type of signal it manages. For your convenience, the part number for each card has been included.

Input Card/Output Card	Inputs and Outputs	Incoming Signals per Sample Rate	Input Card Part Number	Output Card Part Number
AES synchronous balanced and unbalanced	16 stereo or 32 mono	16 stereo (32 mono) at 48kHz	EM0389	EM0390
AES asynchronous balanced and unbalanced	16 stereo	16 stereo at 32 kHz to 96 kHz (passed through)	EM0387	EM0388
AES Sample Rate Converter	16 stereo	16 stereo (32 mono) at 22 kHz to 108 kHz asynchronous, converted to synchronous AES locked to 48 kHz	EM0500 (input only)	N/A
Analog	16 stereo or 32 mono	16 stereo (rate N/A) or 32 mono (rate N/A). Converts analog input to internal digital format locked to 48 kHz	EM0585	EM0586

For a list of all audio input cards and output cards and their associated backplanes, see [Cards, Card Sets, and Backplanes](#) on page 93.

Card Power and Fuses

Analog audio and AES input cards and output cards receive power from the motherboard. Each card uses direct current converters (DC/DC) to convert the corresponding backplane's +48 VDC into the appropriate regulated supply voltage(s). The combination of pre-regulators and DC/DC converters and supply voltages varies from card type to card type, depending on the requirements of the associated circuitry. There is a non-serviceable, self-resetting 1A fuse located on each card. For more information, see [Fuse Replacement](#) on page 76.

Status Reporting

All audio input cards and output cards feature a circuit that performs status reporting and drives the card's functions. Two LEDs on the front of the card indicate the card's status: alarm (Red), power good (Green). Unique to the analog input card, three additional LEDs situated further back on the card indicate if software is loaded (Amber), and if there is good communication with the control card (Green) or bad communication with the control card (Red). For more information, see [Indicator LEDs](#) on page 76.

The functions of each type of card are described in the proceeding sections. Cards are listed by the signal type supported.

AES Synchronous

Incoming and outgoing AES synchronous signals, balanced or unbalanced, are received or distributed through passive connectors housed on backplanes: 16 BNC connectors for unbalanced signals or 16 Phoenix connectors for balanced signals. (See [Backplanes](#) on page 13.)

Input Card

The AES synchronous input (EM0389) receives up to 16 stereo signals through passive backplane I/O connectors. Each signal is routed as an AES signal and is transformer coupled and forwarded to a receiver. At that time, the signal is synchronized to the system clock; adding and dropping samples as needed until the signal is synchronized.

The receiver forwards the signal to a buffer, which in turns sends the signal to the motherboard and onward to output cards for switching.

Note

Near-synchronous operation may cause minor disturbances in the audio signal. These effects are usually masked by the program audio, depending on the sample rate offset or magnitude and timing of the disturbance.

Output Card

The AES synchronous output card (EM0390) receives up to 128 stereo inputs from the motherboard. The signals are sent to receivers and then to a crosspoint array (128 inputs x 16 outputs stereo; 256 inputs x 32 outputs mono) for switching. The crosspoint splits the AES signal into a right channel, a left channel, and channel status bits for switching as mono signals. Each mono channel is then recombined with another mono channel to create a new AES signal. The outgoing AES signals are switched synchronously and sent to drivers and backplane I/O connectors for distribution.

Figure 2-17 shows the synchronous AES signal path.

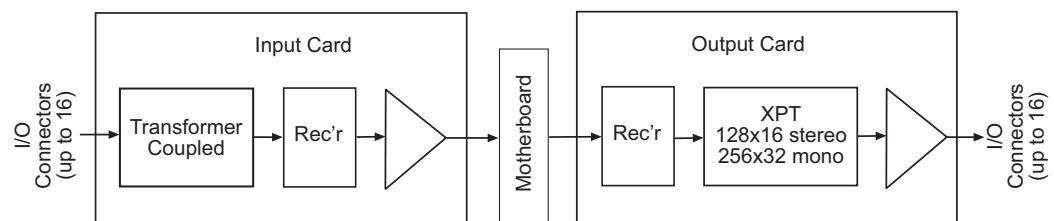

Figure 2-17. Synchronous AES Signal Flow (Balanced or Unbalanced)

2. Introduction

Active Cards

AES Asynchronous

Incoming and outgoing AES asynchronous signals are received or distributed through passive connectors housed on backplanes: 16 BNC connectors for unbalanced signals or 16 Phoenix connectors for balanced signals. (See [Backplanes](#) on page 13.) Asynchronous AES input signals can be routed only to asynchronous AES output cards; they cannot be routed to analog or AES synchronous output cards, nor can they be routed as mono channels.

Asynchronous AES operation is not intended for use with “live” or program audio feeds where glitches at switch boundaries are unacceptable. Instead, asynchronous input cards and output cards provide an economical way to select AES signal sources, even ones that are synchronous, for ongoing operations such as editing, monitoring or dubbing.

Input Card

The AES asynchronous input card (EM0387) receives up to 16 stereo signals through backplane I/O connectors. The architecture of the input card is identical to that of the AES synchronous input card, except that signals are not synchronized to the systems clock on the control card. (See [AES Synchronous](#) on page 23.)

Output Card

The AES asynchronous output card (EM0388) receives up to 128 stereo inputs from the motherboard. The signals are then sent to a crosspoint array (128 inputs x 16 outputs) for switching. The outgoing AES signals are switched asynchronously (i.e., not synchronous with a system clock) and then sent to balanced output drivers and backplane I/O connectors for distribution. Be aware that this may cause possible problems in the output signal stream.

Figure 2-18 shows the asynchronous AES signal path.

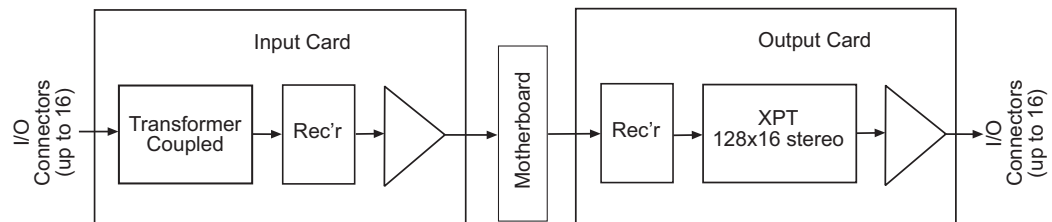

Figure 2-18. Asynchronous AES Signal Flow (Balanced or Unbalanced)

AES Sample Rate Converter (Input Only)

The AES Sample Rate Converter (SRC) input card (EM0500) provides additional routing flexibility. The card accepts up to 16 asynchronous AES inputs with a wide range of sample rates. The signals are converted into synchronous AES signals locked to the 48 kHz AES reference (page 18) before being forwarded to the motherboard. This means that a wide variety of AES-compatible digital audio inputs with sample rates from 22 kHz to 108 kHz can be integrated into a synchronous AES environment or converted to analog audio outputs as desired.

The receivers buffer the input, extracting audio data, sample clock, and applicable channel status information. The clock and data signals are then processed by an asynchronous SRC and the rate-converted data reformatted and combined with the appropriate channel status information and user bits. Reference clock signals from the control card are used to synchronize the data to create an AES format signal. The signal is then forwarded to the motherboard for distribution to output cards.

Figure 2-19 shows the signal path through the SRC.

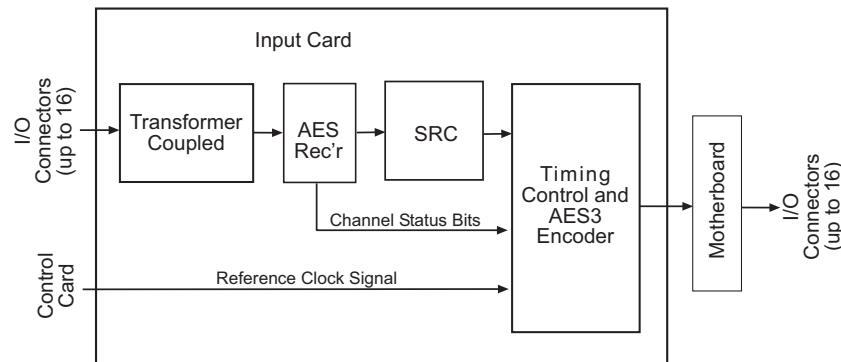

Figure 2-19. Signal Flow through SRC Card

Analog Audio

Incoming and outgoing analog audio signals are received or distributed through four DB25 connectors, housed on a backplane. (See [Backplanes](#) on page 13.)

The analog audio input card and output card feature DIP switches and a jumper that allow gain and mute detection to be set. (See [Analog Audio Switches](#) on page 69.) In addition, using a separate DIP switch set, the operating level of the card can be set to match the operating level of the facility. By matching the incoming signal level, there is less degradation of the signal when it is converted to digital for internal routing in the router. For information on setting analog input card levels, see [Analog Audio Switches](#) on page 69.

Input Card

The analog audio input card (EM0585) receives up to 16 stereo signals (32 mono channels) through passive backplane I/O connectors. Inputs are forwarded to an analog-to-digital (A/D) converter. The A/D converter accepts two analog signals, either left and right channels of a stereo pair or two mono channels. The A/D converter is rate locked to the systems clock on the control card, converting the signals to a sample rate of 48 kHz and into AES compatible bit streams containing the sampled data. The audio data is set to a common sample point, which is important for proper phase alignment of audio signals. The resulting synchronous AES signals are sent to the motherboard.

Output

The analog audio output card (EM0586) receives 128 stereo inputs from the motherboard. The signals are then sent to a crosspoint array of 128 inputs x 16 outputs (256 inputs x 32 outputs mono) for switching and then on to a digital-to-analog (D/A) converter which converts the signal from digital format to analog. From the D/A converters, the analog signals have low-pass filtering and gain correction applied and then forwarded to output cable drivers and backplane I/O connectors for distribution.

Note

The analog audio output card is designed to function in a voltage-matched system driving high impedance loads. The output drivers are not designed to drive 600 Ω loads continuously and may overheat if used in a 600 Ω environment.

2. Introduction

Active Cards

Figure 2-20 shows the signal path for an analog signal.

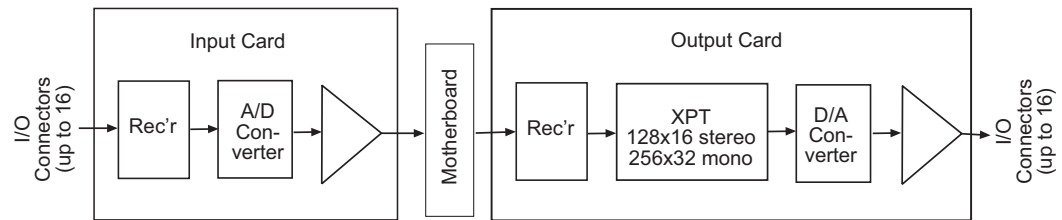

Figure 2-20. Simplified Analog Audio Signal Flow

Video I/O Cards

Video input cards and output cards support the routing of SD, SWB, and analog video signals. Each type of signal requires a unique type of card. For example, to support SWB signals, SWB input cards and SWB output cards must be installed. Different types of input cards and output cards can be inter-mixed in a single frame to meet specific switching configuration needs.

The output card does not need to match the signal type of the input card, but must be able to route compatible signals. For example, if an analog video input card is installed it can be paired with an analog video output card.

For each input card and output card installed, an associated backplane must also be installed. For more information, see [Backplanes](#) on page 13.

There are two unique sets of input cards and output cards that support SWB signals: Classic SWB card sets and Standard SWB cards. Both types of cards receive, switch and distribute SWB signals. The two sets of cards differ in the switching configuration each supports. The Classic SWB card set can be used individually for a 16 inputs x 16 outputs switching configuration, or coupled with another Classic SWB card set to create a 32 inputs x 32 outputs switching matrix. For details, see [Switching Configurations](#) on page 8.

The following is a list of the different video input cards and output cards available:

Input Card/Output Card	Inputs and Outputs	SMPTE Standard	Rates	Input Card Part Number	Output Card Part Number
SD	16	259M, 344M	< 270 Mb/s	EM0383	EM0384
Classic SWB	16	259M, 344M, 292M	≤ 1.5 Gb/s	EM0395 (I/O card set)	
Standard SWB	16	259M, 344M, 292M	≤ 1.5 Gb/s	EM0466	Standard: EM0463 Expansion: EM0465
Analog Video	16	PAL or NTSC analog composite video		EM0375	EM0376
Analog Video to SD Converter (AVC)	16	Input: PAL or NTSC analog composite video Converted to: SMPTE 259M-C, (4:2:2), 270 Mb/s		EM0432	N/A
SD to Analog Video Converter (AVC)	16	Input: SMPTE 259M-C, 270 Mb/s Converted to: PAL or NTSC analog composite video		N/A	EM0433

Each card is listed by the type of signal it manages. For your convenience, the part number for each card has been included. For a list of all video input cards and output cards and their associated backplanes, see [Cards, Card Sets, and Backplanes](#) on page 93.

Card Power and Fuses

Each input card and output card uses direct current converters (DC/DC) to convert the corresponding backplane's +48 VDC into the appropriate regulated supply voltage(s). The combination of pre-regulators and DC/DC converters and supply voltages varies from module type to module type, depending on the requirements of the associated circuitry. There is a non-serviceable, self-resetting 1A fuse located on each module.

Status Reporting

All video input cards and output cards feature a circuit that performs status reporting and drives the card's functions. Two LEDs on the front of the card indicate the card's status: alarm (Red), power good (Green). Three additional LEDs on the output cards, situated further back on the card, indicate the card is "healthy" (Amber) and that good communication (Green) or bad communication (Red) exists. For more information, see [Indicator LEDs](#) on page 76.

The functions of each type of card are described in the proceeding sections. Cards are listed by the signal type supported.

Standard Definition

Incoming and outgoing SD signals are received and distributed through 16 BNC connectors, housed on a backplane. The backplane for SD incoming signals is active and unique to SD signals. (See [Backplanes](#) on page 13.) The backplane for SD outgoing signals is passive.

SD input cards and output cards can be inter-mixed with Analog Video Converter (AVC) input cards and AVC output cards to achieve seamless conversion between digital and analog video formats. (See [Analog Video Converter](#) on page 30.) Inputs can be routed to both digital and analog destinations without the need for external conversion devices.

Input Card

The SD input card (EM0383) receives up to 16 incoming SD signals through BNC connectors on the active backplane. (See [Backplanes](#) on page 13.) Equalizers on the backplane automatically compensate for 300 m of cable (Belden 1694A or equivalent). The equalized signal is forwarded to cable drivers that feed the signal to the input card. On the input card, the SD signal is buffered to compensate for any loss accumulated as the signal is forwarded to the motherboard and the output card.

Output Card

The SD output card (EM0384) receives up to 16 SD signals from the motherboard. A bus receiver feeds the signals to a crosspoint array (128 inputs x 16 outputs) for switching. From the crosspoint, the SD signal is forwarded to a re-clocker, which automatically switches between 143, 177, and 270 Mb/s sample rates. If the sample rate is non-standard, the re-clockers pass the signal to the cable driver, which forwards the signal to passive backplane I/O connectors for distribution.

Note

If desired, each re-clocker can be selectively disabled or re-enabled using UniConfig. See the UniConfig User's Guide.

2. Introduction

Active Cards

Figure 2-21 shows the SD signal path.

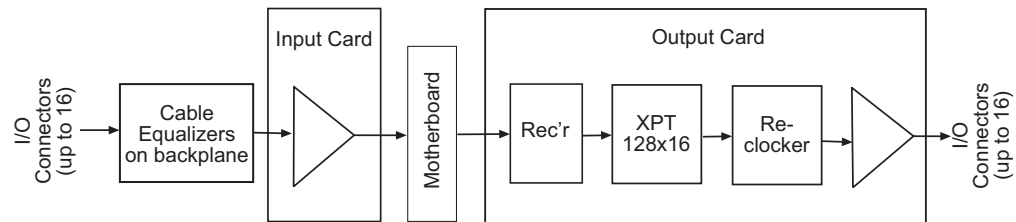

Figure 2-21. SD Digital Video Signal Flow

Classic SWB

The Classic SWB input card set (EM0395) is composed of two cards and occupies two slots in the router. The backplanes housing I/O connectors for receiving and distributing SWB signals are active and unique to video signals. (See [Backplanes](#) on page 13.) There are two types of backplanes: one for inputs (EM0396) and one for outputs (EM0424).

There is a jumper that configures the Classic SWB card set for DVB/ASI operation. For more information, see [Configuration](#) on page 67.

A single Classic SWB card set can switch 16 inputs x 16 outputs. Two card sets can be linked together such that the inputs from each card set is sent to the other card set, to create a switching configuration of 32 inputs x 32 outputs. For more information, see [Switching Configurations](#) on page 8.

Up to 16 incoming signals are received through connectors on an associated I/O backplane. Equalizers on the backplane automatically compensate for length of cable. (See [Technical Details](#) on page 83.) The equalized signal is forwarded to the card set and a crosspoint array (32 inputs x 16 outputs) for switching. From the crosspoint, the SWB signal is forwarded to a re-clocker, which automatically switches between 143, 177, 270, 360, and 540 Mb/s, and 1.483 and 1.485 Gb/s sample rates. If the sample rate is non-standard, the re-clockers pass the signal to the backplane for distribution without attempting to re-clock it. The signal is then sent to a cable driver on the backplane, which forwards the signal to backplane I/O connectors for distribution.

Figure 2-22 shows the Classic SWB signal path for a single card set:

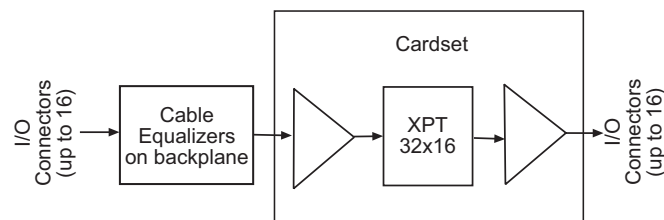

Figure 2-22. Classic SWB Video Signal Flow

Standard SWB

Similar to the Classic SWB card set, the Standard SWB card receives and distributes SWB signals through 16 BNC connectors, housed on a backplane. The backplanes for SWB incoming signals and outgoing signals are active and unique to video signals. (See [Backplanes](#) on page 13.)

There are three types of Standard SWB cards: an input card, a main output card and expansion output cards. Depending on how the cards are combined, different switching configurations can be created. A single set of Standard SWB output cards can switch 128 inputs x 64 outputs. By install-

ing a second set of Standard SWB output cards, the configuration can be doubled 128 inputs x 128 outputs. For more information, see [Switching Configurations](#) on page 8.

Input Cards

The Standard SWB input card (EM0466) receives 16 SWB signals through the active backplane connectors. Equalizers on the backplane automatically compensate for length of cable. (See [Technical Details](#) on page 83.) The equalized signal is forwarded to the input card. The input card buffers the equalized incoming signals from the backplane and forwards the signal to the motherboard.

Output Cards

There are two Standard SWB output cards: a main output card (EM0463) and an expansion output card (EM0465). The main output card has a “wing” that extends into the three slots to the right of the slot occupied by the main part of the card, using all four output slots on the side of the frame in which it is installed. (See Figure 2-23 on page 29.) Connectors on the wing mate with up to three optional expansion output cards, installed to the right of the main Standard SWB card.

The Standard SWB main output card receives all 128 available SWB sources from the motherboard. Two 64 inputs x 64 outputs crosspoint arrays on the main output card can switch up to 128 inputs x 64 outputs. From the crosspoint, 16 outputs are re-clocked and sent to the main card’s corresponding active backplane through connections to the motherboard. The crosspoint forwards the remaining 48 outputs to the wing connector, which feeds the signals to any installed expansion output cards. When installed, the expansion output cards are connected to the wing connector, the motherboard and associated backplanes.

Figure 2-23 shows the EM0463 module and wing connector:

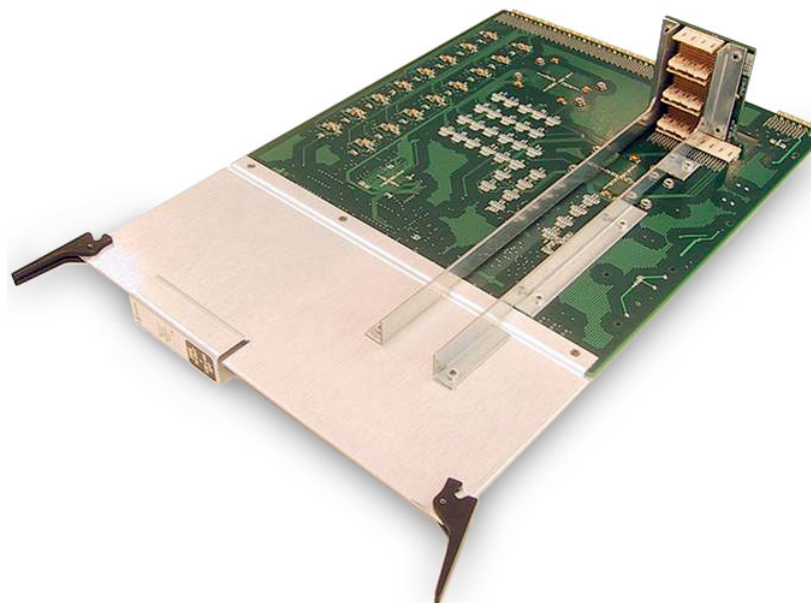

Figure 2-23. Standard SWB Main Output Card with Wing

Analog Video

Incoming and outgoing analog video signals are received or distributed through 16 BNC connectors housed on a backplane. (See [Backplanes](#) on page 13.) The analog video input card and output card manage NTSC and PAL signals transparently; no adjustment of jumper settings is required.

2. Introduction

Active Cards

Input Card

The analog video input card (EM0375) receives up to 16 analog video signals through backplane I/O connectors. Incoming signals are directly coupled to a differential Op-amp, which act as input buffers. The buffered outputs are applied to balanced bus drivers that forward the signal to the motherboard.

Output Card

The analog video output card (EM0376) receives up to 16 signals from the motherboard. Incoming analog video signals are buffered and converted to unbalanced video signals. The signals are then forwarded to four crosspoint arrays (32 inputs x 16 outputs) for switching creating a 128 inputs x 16 outputs switching matrix. From the crosspoints, the signals are sent to a 4 x 1 Mux, which forwards the signals to a buffer before sending the signals to backplane I/O connectors for distribution.

Figure 2-24 shows the signal path for analog video signals:

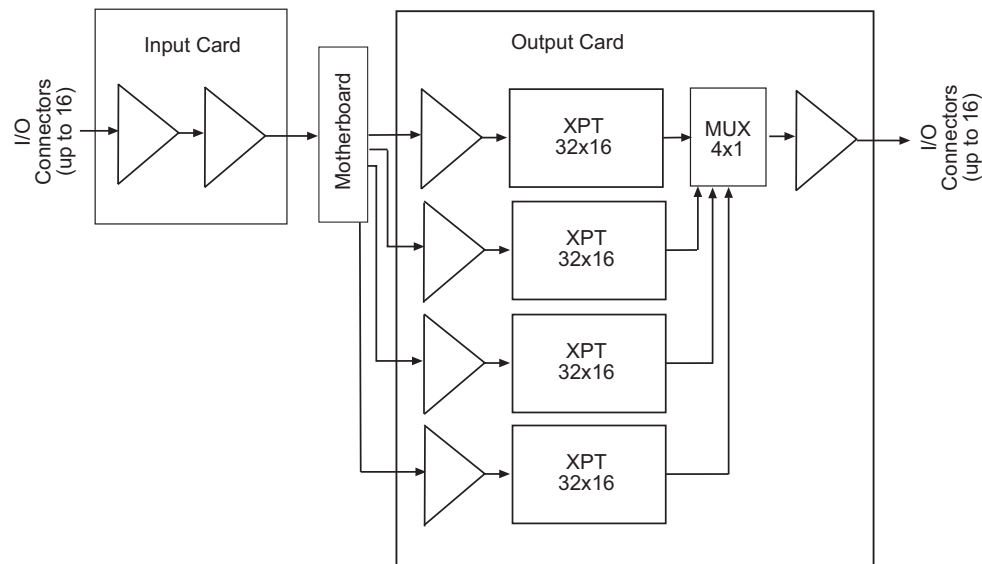

Figure 2-24. Analog Video Signal Flow

Analog Video Converter

The Analog Video Converter (AVC) input card and output card add versatility to the NV5128 Multi-Format Router by converting signals, as follows:

- The AVC input card converts incoming composite analog video signals (NTSC or PAL) to SD, serially-interfaced signals.
- The AVC output card accepts SD inputs from the motherboard and outputs them as analog composite signals in NTSC or PAL format.

An AVC input card can be paired with an AVC output card, SD output card or SWB output card. An AVC output card can be paired with an AVC input card, SD input card or SWB input card. Any video I/O card paired with an AVC input card or AVC output card must be able to manage a signal rate of 270 Mb/s.

Converting a signal from analog to SD delays the signal by approximately 1-1/4 lines; frame synchronization and sub-carrier phase alignment are not maintained with respect to reference. AVC input cards and output cards provide an economical way to convert NTSC/PAL inputs where signal

timing is not critical; there is a processing delay of approximately 4 pixels when using an AVC output card. With AVC output cards, frame synchronization and sub-carrier phase alignment are not maintained with respect to reference. This timing is not adjustable.

Incoming and outgoing analog video signals are received or distributed through 16 BNC connectors housed on a backplane. (See [Backplanes](#) on page 13.)

AVC Input Card

The AVC input card (EM0432) receives up to 16 composite analog video signals through backplane I/O connectors. Each incoming signal is received by a differential input amplifier. The amplifiers create single-ended outputs. The outputs are forwarded to anti-aliasing filters and then onward for processing by an NTSC decoder (AVC) synchronized to 27 MHz. The converter feeds the signal to a SMPTE 259M formatter and bus driver. A 27 MHz phase-locked loop (PLL), locked to the video converter, reduces jitter during the data formatting process. The SD output is line-locked to the incoming composite signal. The signals is then forwarded to the motherboard for distribution to a SD output card (EM0384) or to an AVC output card (EM0433).

AVC Output Card

The AVC output card (EM0433) receives up to 16 SD signals from the motherboard. Differential inputs from the motherboard are buffered by receivers on the output card. The signals are fed to a 128 inputs x 16 outputs crosspoint array for switching. Each of the 16 outputs is re-clocked and deserialized. The signals are then encoded as baseband video signals, buffered by an output line driver and sent to the backplane as composite analog.

Figure 2-25 shows the signal path through the two AVC I/O cards:

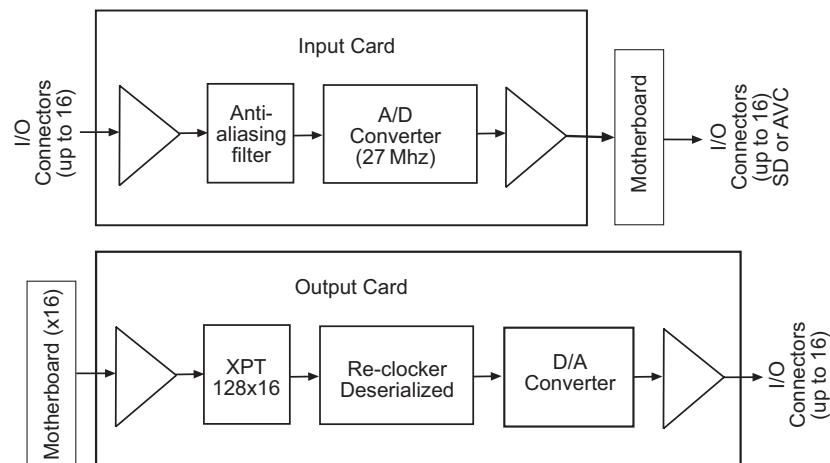

Figure 2-25. Analog Video Conversion Signal Flow

Machine Control Signals

The NV5128 supports machine control signals, either EIA-232 or EIA-422. Machine control signals are used to communicate between two machines, such as editing equipment and a tape machines. This enables control of two machines through a single interface.

The Machine Control card set (EM0482) is composed of two cards and occupies two slots in the router. The Machine Control card set receives 32 signals through two passive backplanes, each containing 16 RJ-45 connectors. (See [Backplanes](#) on page 13.)

2. Introduction

Active Cards

The Machine Control card set differs from other modules in that it is bi-directional. A Machine Control card set is neither an “input” nor an “output” card; it carries signals in both directions. The architecture of the Machine Control card set is similar to the Classic SWB card set: the port card set occupies two slots and uses two backplanes supporting up to 32 signals. (See [Classic SWB](#) on page 28.) Two card sets can be linked together, cross-coupling the inputs from each card set to the other card set, creating 64 ports. For more information, see [Switching Configurations](#) on page 8.

The port card set has one jumper used to configure the card set to function as a standalone 32-port card set regardless of where it is installed in the frame. This means that two 32 inputs x 32 inputs matrices can be installed instead of one 64 inputs x 64 inputs matrix. For more information, see [Configuration](#) on page 67.

Incoming and outgoing signals are buffered by differential transmitters and receivers on the card set. When two Machine Control card sets are connected, signals are sent directly to the 64 inputs x 32 outputs crosspoint array on each card set for switching (creating a 64 inputs x 64 outputs switching matrix) without going through the motherboard.

Figure 2-26 shows the signal flow path through a pair of Machine Control card sets.

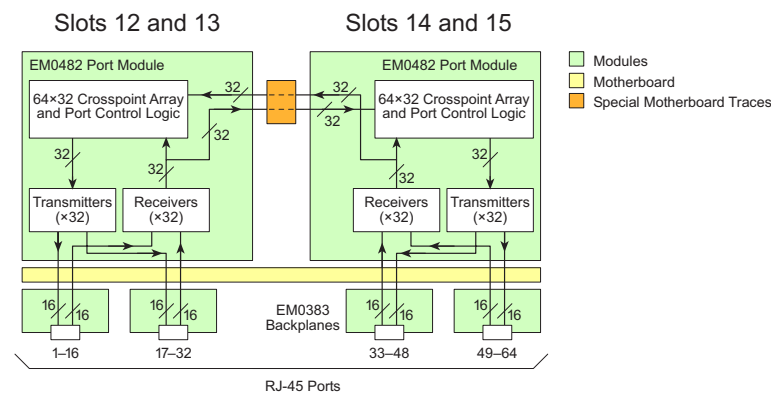

Figure 2-26. Machine Control Signal Flow (64-Port Configuration)

Time Code Signals

The NV5128 supports SMPTE time code signals. A time code is a sequence of numeric codes generated at regular intervals by a timing system. Time codes are usually used to synchronize a variety of signals to a specific start and end time, without regard to any other timing device. For example, a production plant may use a time code signal to which all signals distributed within the plant are synchronized. This ensures synchronization of signals to a single “master” clock instead of individual equipment clocks.

Input Card

The time code input card (EM0408) receives 16 time code signals through 16 Phoenix connectors housed on a backplane. (See [Backplanes](#) on page 13.) 16 differential input receivers accept time code input signals from the input backplane. The receivers send the single-ended outputs to Low Voltage Differential Signal (LVDS) buffers and then to the motherboard. The signal format on the motherboard is differential.

Output Card (EM0409)

The time code output card (EM0409) receives up to 16 inputs from the motherboard. Differential receivers buffer the inputs and forward them to a 128 inputs x 16 outputs crosspoint array for switching. The time code outputs are reformatted to comply with SMPTE standards and then sent to the output backplane through time code signal differential line drivers.

Figure 2-27 shows the time code signal path:

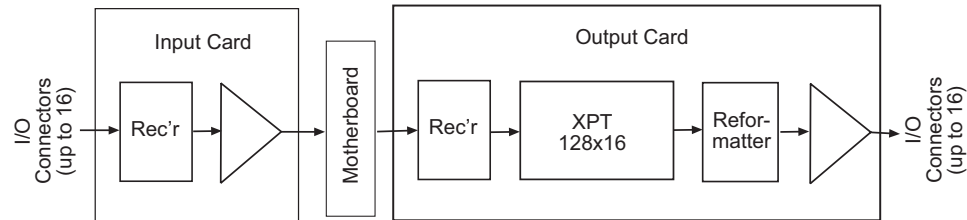

Figure 2-27. SMPTE Time Code Signal Flow

2. Introduction

Active Cards

3. Installation

Chapter 3 provides installation and connection instructions. It presents the following topics:

- [Summary](#)
- [Package Contents](#)
- [Preparing for Installation](#)
- [Rack Mount](#)
- [Connecting the Router to Power](#)
- [Installing Backplanes](#)
- [Installing Active Cards](#)
- [Making Signal Connections](#)
- [Making Reference Connections](#)
- [Making Router Control System Connections](#)
- [Making Diagnostic Connections](#)
- [Making Alarm Connections](#)
- [Verification](#)

Summary

When setting up the NV5128 for the first time or reconfiguring a NV5128, there are certain steps that must be performed. It is recommended that initial installation and later reconfiguration tasks be performed in a specific order to avoid possible complications.

Perform installation and reconfiguration tasks in the following order:

- 1 Mount the router in a rack. If reconfiguring, skip this step if the router is already rack mounted and not being remounted. See [Rack Mount](#) on page 37.
- 2 Connect power, being sure to install PS6000 modules after power is connected. See [Connecting the Router to Power](#) on page 38.
- 3 Install backplanes in the appropriate rear backplane slots. If reconfiguring, removed backplanes and reinstall in the newly desired slots. See [Installing Backplanes](#) on page 40.
- 4 Install active cards in the appropriate front card slots. If reconfiguring, removed cards and reinstall in the newly desired slots. Make sure that the appropriate backplane is installed for each active card. See [Installing Active Cards](#) on page 44.
- 5 Make connections between the source of incoming signals and the destination of outgoing signals, and the router. If reconfiguring, change signal connections to match new backplane and active card configuration. See [Making Signal Connections](#) on page 50.
- 6 Make connections to signals acting as references for audio and video signals. If reconfiguring, verify that all necessary reference connections are made for the signals being routed. See [Making Reference Connections](#) on page 57.

3. Installation

Package Contents

- 7 Make connections between the router and the router control system. If reconfiguring, skip this step if all necessary router control system connections are still adequate. See [Making Router Control System Connections](#) on page 59.
- 8 Make permanent or temporary diagnostic connections. Diagnostic connections enable the router and UniConfig to communicate. This is important when initially configuring the router and any time the router is reconfigured. See [Making Diagnostic Connections](#) on page 62.
- 9 Connect the alarm connection on the router to an external indicator. If reconfiguring, skip this step if alarm connections are still adequate. See [Making Alarm Connections](#) on page 64.
- 10 Install UniConfig. If reconfiguring, UniConfig does not need to be reinstalled. See the UniConfig User's Guide.

Package Contents

When your NV5128 products from Miranda arrive, immediately inspect the shipping container for any obvious damage. If the container is damaged, unpack and inspect the contents. If the contents are damaged, notify the carrier immediately.

When unpacking the shipping container, look for the packing slip and compare it against the contents to verify that everything ordered was received. If anything is missing (or if equipment is damaged unrelated to shipping), please contact Miranda. For contact information, see [Technical Support Contact Information](#) on page iii.

The package does not contain mounting rack, network cables, video cables, mounting screws, or grounding wire.

This document does not address the shipment or installation of any other equipment or software that can be used in conjunction with the routers, including router control systems or configuration software.

Preparing for Installation

You will need the following items before getting started:

- A PC running Windows® 2000 or higher, or Windows XP Professional.® This PC is required only for system configuration.
PC hardware requirements:
 - CD drive
 - EIA-232 serial COM port (DE9) capable of operating at 38.4 kb/s.
 - 10BaseT or 10/100BaseT (preferred) Ethernet port.
 - 100 Mb/s Ethernet switch with at least 4 ports.
 - RJ-45 connectors and Ethernet cables (category 5).
 - DE9 connectors EIA-232 serial cable.
- 75 Ω BNC connectors and coaxial cables.
- 50 Ω BNC connectors and coaxial cables.

- Reference audio and video source at the line rate appropriate for your system.
- Frame rack suitable for mounting the router and NV6257 power supply.

Depending on the nature of your usage, you will also need an assortment of video and audio cables, video and audio sources, video monitors, audio monitors, audio meters, small hardware (screws, nuts, washers), and tools.

Rack Mount

The NV5128 is designed to mount in a standard EIA 19" (483 mm) rack.

How to rack mount the router

- 1 Determine the placement of the router frame in the rack, and the rack in the facility. When placing the frame and rack, keep in mind the following requirements:
 - The router requires 8RUs (14 inches, 355.6 mm) of vertical space.
 - Be sure to locate the rack near an accessible AC source power outlet.
 - To ensure proper cooling, leave space for unrestricted air flow through the front of the router, and a minimum of six inches clearance at the rear where the cooling fans are located.
- 2 If the router was shipped with the PS6000 power supply modules in the frame, remove them to make the frame lighter for installation.

Important

Do not reinstall the PS6000 power supply modules. The modules are installed after power is connected.

- 3 If the router was shipped with the active cards (e.g., circuit boards) and fan tray in the frame, consider removing them to make the frame lighter for installation. If removing active cards, be sure to note which card was installed in which slot for later reinstallation.

Caution

Handle all circuit boards with care. Be sure to use ESD protection and place the circuit boards in ESD bags or on an ESD surface.

- 4 Lift the router frame into position and attach the router frame to the front of the rack with the appropriate screws. Have helpers assist in the installation, or use a jack, to keep the frame aligned in the rack. Do not use modules or other internal components as hand holds. Place screws in all frame mounting screw holes.
- 5 If not already installed, install the fan tray by inserting tray in the fan tray slot, located at the *top* when facing the front of the router frame, as shown in Figure 2-3 on page 11. The fan tray is installed right-side up.
- 6 Reinstall any previously removed active cards (circuit boards). Be sure to install them in the correct location. For installation instructions, see [Installing Backplanes](#) on page 40.
- 7 Close the front door.

3. Installation

Connecting the Router to Power

Connecting the Router to Power

The NV5128 uses the PS6000 power supply module. The NV5128 requires a minimum of one PS6000 power supply module (plus one optional modules for redundancy). The router requires two AC power cords.

The NV5128 has a ground lug on the back of the router. Whether to ground or not is optional and failure to connect the ground does not affect normal operation. However, grounding helps protect you and your equipment in case of a power anomaly such as a lightning strike.

Power Supply Monitor and Alarms Connections

The NV5128 has a 'Power Supply Alarm' connection, located on the rear of the frame. The connection carries alarm and temperature signals to the router. This connection is connected at the same time the power connections are made.

Power Cords and Branch Circuits

For added protection in the event of a mains power failure, it is recommended that each power cord connected to the router frame be connected to a separate branch circuit. A wire bail can be used to hold the power cable in place to reduce the possibility of an accidental disconnect.

The power cords are the only means of disconnecting AC power. Clearly mark the line side power connection with its function so that in the event of an emergency, power can be disconnected quickly.

Making Power Connections

Important! Be sure to connect to AC power before installing PS6000 power supply modules. Connecting to AC power *after* PS6000 modules are installed may result in an electric shock.

How to connect the router to a power source

- 1 Locate the power cords and PS6000 power supply modules.
- 2 If not already removed, facing the front of the router, remove all PS6000 power supply modules, as shown in Figure 3-1.

3. Installation

Connecting the Router to Power

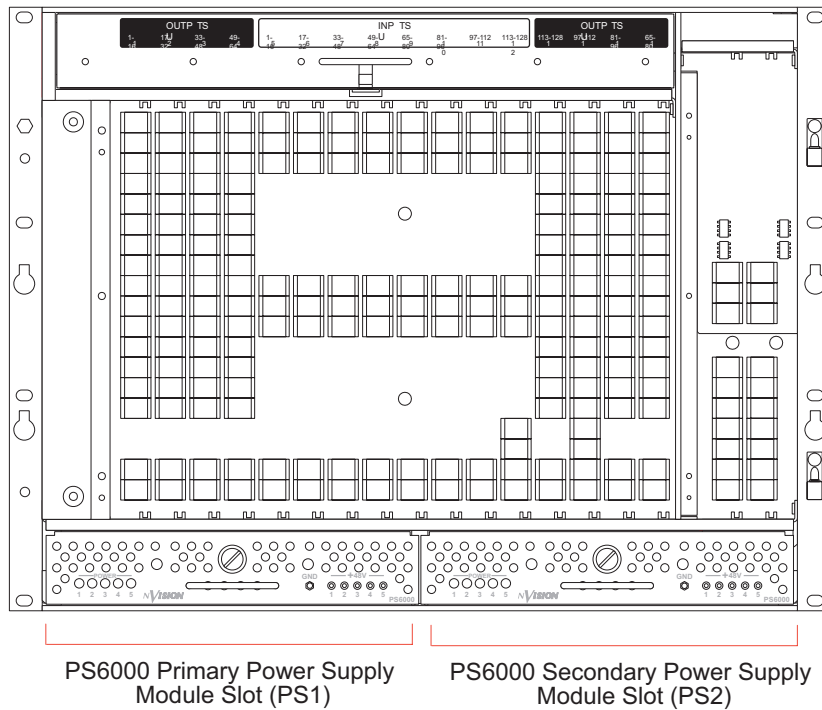

Figure 3-1. PS6000 Power Supply Module Slot - No Cards Installed (Front View)

3 Facing the rear of the NV5128, connect one of the two power cords to 'PS1':

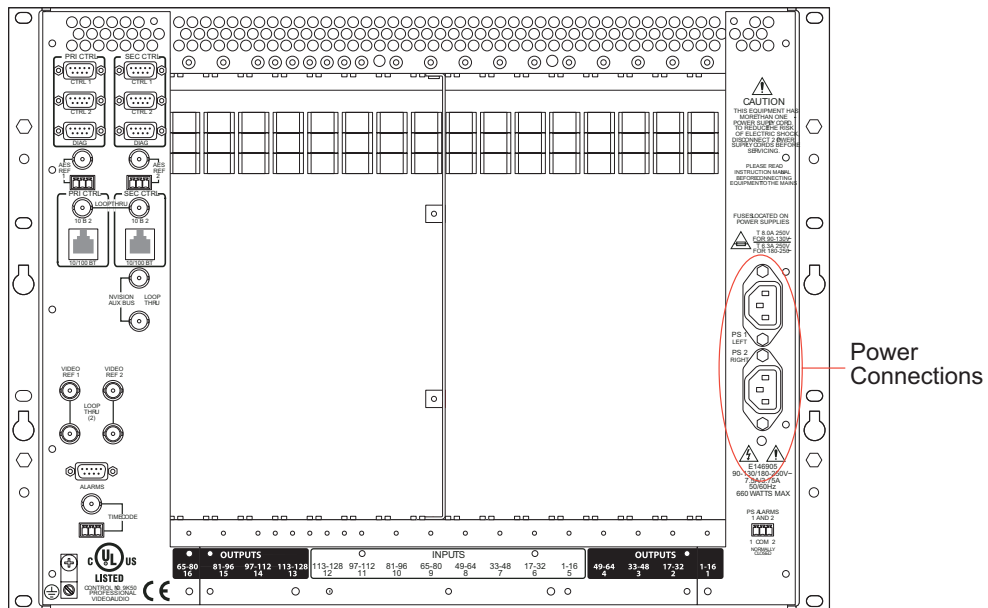

Figure 3-2. Power Connections - No Backplanes Installed (Rear View)

4 Connect the other end of the power supply cable to a source of AC power source (90-130/180-250 VAC, 50/60 Hz).

5 Facing the rear of the NV5128, connect the remaining power cord to 'PS2', as shown in Figure 3-2 on page 39.

3. Installation

Installing Backplanes

- 6 Connect the other end of the power supply cable to a source of AC power source (90-130/180-230 VAC, 50/60 Hz).
- 7 Install the PS6000 power supply modules as follows:
 - a Facing the front of the NV5128, install the primary PS6000 power supply module in the *primary* power supply slot, as shown in Figure 3-1 on page 39.
 - b (Optional) Facing the front of the NV5128, install the redundant PS6000 power supply module in the secondary power supply slot, as shown in Figure 3-1 on page 39.
- 8 Facing the rear of the NV5128, connect the ground lug to ground using a copper wire from 14 to 6 AWG. The ground lug is located in the lower, left-hand corner.

Installing Backplanes

The NV5128 features backplanes that correspond to different signal types. A backplane is a separate metal plate that contains connectors for receiving or distributing signals for an associated input card or output card. Backplanes are inserted into empty slots in the back plate on the rear of the router. Be careful to install backplanes in the correct slot. With the exception of the SWB input backplane, the SWB output backplane and the SD input backplane, backplanes are passive and contain no active circuitry. Backplanes containing active components receive power from the corresponding input card or output card installed in the slot the backplane serves.

Figure 3-3 shows the backplanes installed on the rear of the router. For more information about backplanes, and the type of signal supported, see [Backplanes](#) on page 13.

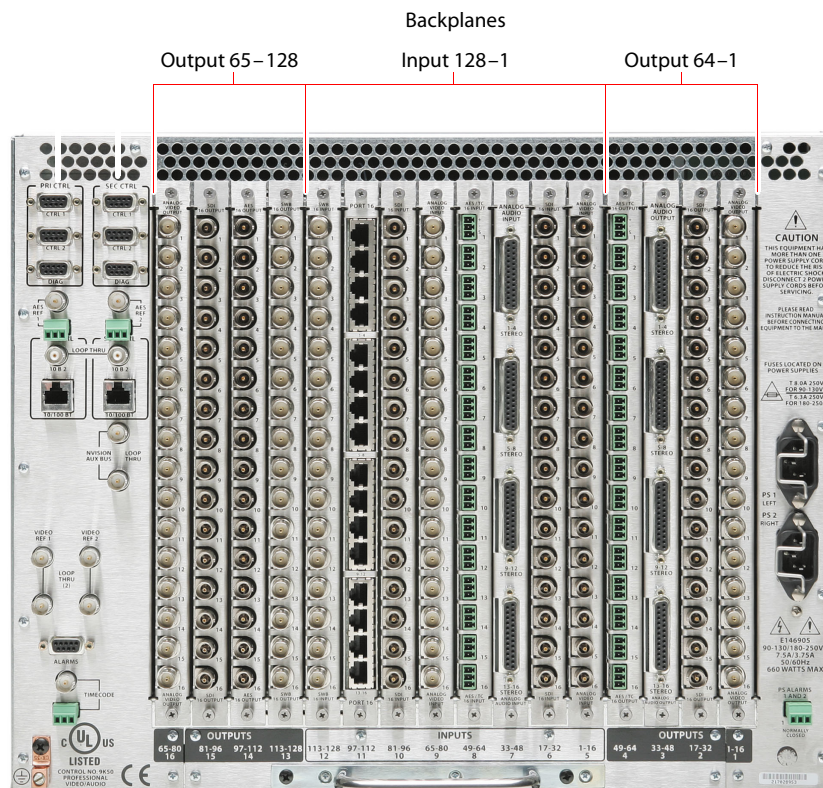

Figure 3-3. NV5128 Frame with Backplanes (Rear View)

Each backplane must have a corresponding input card or output card installed in the associated slot. For example, if a backplane for receiving SD signals is installed, a corresponding SD input card must be installed in the associated card slot. Typically, for each backplane installed to receive a specific type of signal, a corresponding backplane is installed that distributes the same type of signal. For more information, see [Installing Active Cards](#) on page 44.

Caution Although different backplanes may appear to be identical (e.g., contain the same type of connectors), some have active components while others do not. Always verify that the correct backplane is being for the associated front-loaded active input card or output card.

Installing Classic SWB Backplanes

Classic SWB backplanes contain 16 BNC connectors and must be installed in specific slots. Install these backplanes first. Before installing Classic SWB backplanes, review [Rules for Classic SWB Card Sets](#) on page 46.

When installing Classic SWB backplanes in the frame, the silk-screened slot designations on the rear of the frame are incorrect. To remedy this, a thin plate with the correct I/O designations is included with the Classic SWB backplanes. This plate should be installed on top of the existing legends.

Each Classic SWB card set requires two backplanes: One is a 16-input active backplane; it includes automatic cable equalization circuits for the 16 inputs. The other is an output backplane with active line drivers for the 16 outputs. One Classic SWB card set supports 16 inputs x 16 outputs.

How to install a Classic SWB backplane

- 1 Facing the rear of the router, locate the legend plate, as shown in Figure 3-4.
- 2 Remove the two screws, as shown Figure 3-4.

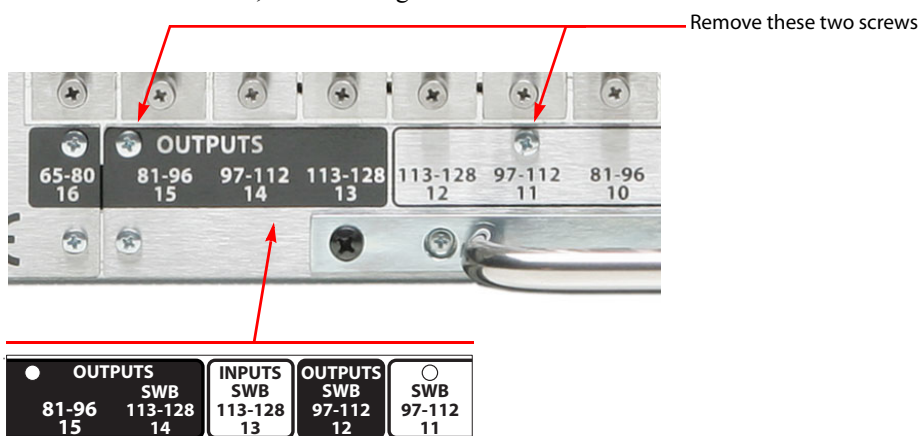

Figure 3-4. Classic SWB Legend Plate (Rear View)

- 3 Place the new Classic SWB legend plate over the existing plate, aligning the two screw holes.
- 4 Reinstall the screws removed in Step 2.
- 5 Locate the Classic SWB backplanes for inputs (EM0396) and outputs (EM0424).
- 6 **Important:** If any Classic SWB card sets are currently installed, unseat the card set before installing the associated backplanes.

3. Installation

Installing Backplanes

- 7 Remove any blank plate covering the desired slot by loosening the spring-loaded retention screws using a #1 Phillips screwdriver. Gripping the screws, gently pull the blank plate free from the frame, using a slight rocking motion if needed. Use caution to avoid damaging connector pins.

Or

If reconfiguring the router, relocate backplanes as needed.

- 8 Insert the new backplane into the frame being sure to align the printed circuit board with the stamped guides in the frame. Use gentle pressure at the top of the backplane to ensure the backplane connector is fully mated with the motherboard.

Classic SWB backplanes must be installed in specific slots, as follows:

Number of Classic SWB Card Sets installed	Slot Number	Slot Number
Part Number:	EM0396	EM0424
One (16 x 16)	Install in slot 12	Install in slot 13
Two (32 x 32)	Install in slots 11 and 13	Install in slots 12 and 14

See Figure 2-4 on page 12.

- 9 Use a #1 Phillips screwdriver to tighten the two spring-loaded backplane retention screws.
- 10 To maintain proper airflow for cooling, cover any unused backplane slots with a blank plate.

Installing Machine Control Backplanes

The Machine Control card set requires two backplanes. If you are installing a single Machine Control card set, the two backplanes may be located in any two adjacent slots associated with the Machine Control card set. If you are installing two Machine Control card sets (64-port configuration), the two backplanes must be installed in specific slots.

Miranda offers an optional connector breakout panel that can be used to convert up to 64 RJ-45 connectors on the router backplane to 9-pin subminiature D connectors (DE9). This breakout panel occupies 4RUs and hinges open for easy access and to facilitate cable routing. The DE9 connector wiring follows SMPTE-defined pin assignment standards. For more information, see [Machine Control Breakout Panel](#) on page 43.

How to install a Machine Control backplane

- 1 Facing the rear of the router, remove any blank plate covering the desired slot by loosening the spring-loaded module retention screws using a #1 Phillips screwdriver. Gripping the screws, gently pull the blank plate free from the frame, using a slight rocking motion if needed. Use caution to avoid damaging connector pins.
- Or
- If reconfiguring the router, relocate backplanes as needed.
- 2 Insert the new backplane into the frame being sure to align the printed circuit board with the stamped guides in the frame. Use gentle pressure at the top of the backplane to ensure the backplane connector is fully mated with the motherboard.

Machine Control backplanes must be installed in specific slots, as follows:

Configuration	Card Set 1	Card Set 2	Backplane Modules
32-port (1–32)	Install this card set in any two adjacent slots. Slots 11 and 12 are the preferred locations. Note: you cannot install this card slot in slots 13 and 14 unless a jumper is moved out of its “normal” position. See Machine Control Card Set Jumpers on page 69.	—	Install two machine control backplanes (EM0483) in rear slots corresponding to the front-loaded machine control card set
64-port (1–32, 33–64)	Install in slots 11 and 12	Install in slots 13 and 14	Install four machine control backplanes (EM0483) in rear slots 11, 12, 13 and 14

See Figure 2-4 on page 12.

- 3 Use a #1 Phillips screwdriver to tighten the two spring-loaded backplane retention screws.
- 4 To maintain proper airflow for cooling, cover any unused backplane slots with a blank plate.

Machine Control Breakout Panel

Miranda offers an optional breakout panel (BP2-PORT-64) that can be used with up to 4 machine control backplanes. This 4RU breakout panel connects internally 64 RJ-45 connectors to 64 DE9 connectors. For more information, see [Machine Control Breakout Panel](#) on page 14.

The breakout panel allows you to use DE9 cables to your machine control devices.

How to install a Breakout Panel

- 1 Rack-mount the (4RU) breakout panel in a convenient location.
- 2 Cable one or more of its RJ-45 connectors to machine control ports of the NV5128.
- 3 Cable the matching DE9 connector(s) to the machine control devices (VTRs, etc.) that correspond to the ports.

You can use any of the RJ-45/DE9 connector pairs on the breakout panel that you wish.

Installing Other Video, Audio and Time-Code Backplanes

After installing any Classic SWB or Machine Control backplanes, you can install any other needed video, audio or time code backplanes. Install input and output backplanes in their respective locations as defined by your plan for populating the frame. Be careful not to confuse input backplanes with output backplanes, and make certain that each backplane is installed in the correct slot.

Caution

Be sure to cover any unused slots with blank plates. (See [Installing Backplanes](#) on page 40.) Leaving openings in the rear may cause the frame to run warmer than desired, possibly resulting in reduced reliability.

How to install a backplane

- 1 Unseat any SD input cards and SD output cards before removing or installing SD backplanes. All other backplanes may be “hot swapped”.
- 2 Facing the rear of the router, remove any blank plate covering the desired slot by loosening the spring-loaded module retention screws using a #1 Phillips screwdriver. Gripping the screws,

3. Installation

Installing Active Cards

gently pull the blank plate free from the frame, using a slight rocking motion if needed. Use caution to avoid damaging connector pins.

Or

If reconfiguring the router, relocate backplanes as needed.

- 3 Insert the new backplane into the frame being sure to align the printed circuit board with the stamped guides in the frame. Use gentle pressure at the top of the backplane to ensure the backplane connector is fully mated with the motherboard.

Note

Before placing the router into service, be sure to verify the quantity and location of each backplane. Each backplane must have a corresponding input card and output card.

- 4 Use a #1 Phillips screwdriver to tighten the two spring-loaded backplane retention screws.
- 5 To maintain proper airflow for cooling, cover any unused backplane slots with a blank plate.

Installing Active Cards

The NV5128 router features several active cards that manage incoming signals, forward control system commands, perform signal switching and distribute outgoing signals. Cards slide into a card guide such that the connectors on the rear of the card interface with the motherboard. Each card has two levers—one at the top and one at the bottom—that help eject the card for easy removal. For a description of each card, see [Active Cards](#) on page 21. Cards are held in place by pressure from the closed router door against the metal plate on the front of each card. All cards can be inserted and removed with the power on.

There are many possible ways to populate the NV5128 frame with active cards. Before installing any cards, make sure that for each input card and output card being installed in a slot, a corresponding backplane has been installed on the rear for that slot (see [Installing Backplanes](#) on page 40).

Unlike other active cards, the Classic SWB card set and the Machine Control card set take up two card slots. Each card set requires two associated backplanes, either for SWB or Machine Control signals. For a description of each card, see [Active Cards](#) on page 21. For a description of associated backplanes, see [Backplanes](#) on page 13.

Legend strips attached to the frame identify card locations. Output cards occupy the outer four slots on either side of the frame, while input cards are located in the center eight slots. (See Figure 2-3 on page 11.)

Systems Clock Generator Card

If only one control card is being installed, an optional Systems Clock Generator card may be installed to ensure system clock backup. See [Systems Clock Generator Card](#) on page 21.

Cards Already Installed

The NV5128 is usually shipped with the active cards already installed in a specific order. Starting at the lowest numbered input and output position (input 1 or output 1) and ending with the highest input and output positions (input 128 or output 128), the boards are normally positioned as follows:

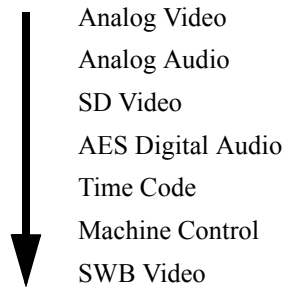

Card Installation Rules

The NV5128 was designed to make installation and expansion easy to perform. Some cards, such as the control card and analog input card or analog output card, have jumpers or switches for options. It is recommended that all jumpers and switches be set before placing the router into service. (See [Configuration Tasks to Perform Before Installing Cards](#) on page 47.)

There are some restrictions as to which slots cards can be installed in the NV5128 frame. Slots 11, 12, 13 and 14 are unique. (See Figure 2-3 on page 11.) These slots have inter-slot connectors that allow signals to be passed between cards installed in these slots. This communication is necessary for proper functioning of the Classic SWB card set and the Machine Control card set. The proceeding sections outline card and card set installation rules.

Rules for Partitions and Card Installation

When installing or reconfiguring input cards and output cards in the router frame, it is important to keep in mind how partitions for the router control system are created. Some third-party control systems require contiguous partitions, that is, that signal types are grouped together and placed in specific sequence in the router frame.

If using an NV9000 router control system partitions do not need to be contiguous. Using the “virtual level” feature in the NV9000, signal types can be organized into different levels, no matter where the active cards are installed in the frame. For more information, see the NV9000 User’s Guide.

If using a third-party router control system, active cards should be installed such that physical partitions are contiguous. This helps ensure maximum compatibility. If you are unsure about future router control system applications, configuring the frame with contiguous physical partitions is the best choice.

Rules for Standard SWB Cards

Standard SWB input cards (EM0466) may be installed in any input slot in the frame. There are two types of Standard SWB output cards: main (EM0463) and expansion (EM0465). The main output card occupies four slots in the router frame: one for the main output card with a “wing” and three slots for optional expansion cards that mate with the wing on the main card. For more information on card functions, see [Standard SWB](#) on page 28.

When installing four or fewer standard SWB input cards, it is recommended that the cards be installed in the right-hand input slots in the frame, beginning with slot 12 and working backwards. This leaves room for installation of the standard SWB output cards. If your switching configuration requires 64 SWB outputs or fewer, install the standard SWB main output card (EM0463) in slot 13. Use slots 14, 15, and 16 for additional standard SWB expansion output cards (EM0465). If more

3. Installation

Installing Active Cards

than 64 outputs are desired, begin by installing input cards and output cards on the left side of the router frame, when facing the front of the router, beginning with the first slots. (See Figure 2-3 on page 11.) For more information on switching configurations, see [Switching Configurations](#) on page 8.

The following lists examples of different configurations using standard SWB cards:

Configuration	Slots for Standard SWB Input Card (EM0466)	Main Slots for Standard SWB Output Card (EM0463)	Expansion Slots for Standard SWB Output Card (EM0465)
32 × 48	11, 12	13	14, 15
64 × 64	9, 10, 11, 12	13	14, 15, 16
96 × 96	4, 5, 6, 7, 8, 9	1, 13	2, 3, 4, 14

Rules for Classic SWB Card Sets

Classic SWB card sets (EM0395) occupy two slots each. One card set serves as a SWB video 16×16 output crosspoint array. Two classic SWB card sets can be combined to create a 32×32 output crosspoint array. For more information on card functions, see [Classic SWB](#) on page 28. For more information on switching configurations, see [Switching Configurations](#) on page 8.

Each Classic SWB card set requires two backplanes: One is a 16-input active backplane; it includes automatic cable equalization circuits for the 16 inputs. The other is an output backplane with active line drivers for the 16 outputs. For more information, see [Backplanes](#) on page 13.

Classic SWB card set must be installed in specific slots, as follows:

Configuration	Slots for Classic SWB Card Set 1 (EM0395)	Slots for Classic SWB Card Set 2 (EM0395)	Slots for Input Backplane Slot Number (EM0396)	Slots for Output Backplane Slot Number (EM0424)
16 × 16	Slots 12 and 13	Not used	Slot 12	Slot 13
32 × 32	Slots 11 and 12	Slots 13 and 14	Slots 11 and 13	Slots 12 and 14

See Figure 2-3 on page 11.

Rules for Machine Control Card Sets

A single machine control card set (EM0482) can be installed in any two adjacent slots to create a 32-port array. However, Miranda recommends that the first 32-port card set and backplane set be installed in slot 11 and slot 12. If two Machine Control card sets are being combined, to create a 64-port configuration, the card sets must be installed in slots 11 and 12 and in slots 13 and 14, respectively. (See Figure 2-3 on page 11.) It is not possible to install two independent 32-port module sets in separate 32-port partitions. For more information on card functions, see [Machine Control Signals](#) on page 31. For more information on switching configurations, see [Switching Configurations](#) on page 8.

The following lists examples of different configurations using machine control card sets:

Configuration	Slots for Card Set 1 (EM0482)	Slots for Card Set 2 (EM0482)	Slots for Backplane (EM0483)
32-port (1–32)	Install in any two adjacent slots. Slots 11 and 12 are preferred locations.	None	Install two machine control backplanes in rear slots corresponding to the machine control card sets
64-port (1–32, 33–64)	Install in slots 11 and 12	Install in slots 13 and 14	Install four machine control backplanes in rear slots 11, 12, 13 and 14

Limitations on Combining Classic SWB and Machine Control Card Sets

There are limitations if both the Classic SWB card set and the machine control card set are installed in a single frame. It is not possible to install two machine control card sets in a 64-port configuration while a classic SWB card set is installed because both use the same slots.

The following lists possible combinations of classic SWB card sets and machine control card sets:

Combination	Machine Control Card Sets (EM0482)	Classic SWB Card Sets (EM0395)
Mixed machine control and classic SWB	32-port* (Install in any pair of adjacent unused slots)	32 × 32 (Install in slots 11, 12, 13 and 14)
Machine control only	64-port (Slots 11, 12, 13 and 14)	None

*Several independent 32-port machine control card sets may co-exist in the same frame.

Configuration Tasks to Perform Before Installing Cards

Before installing active cards, make sure all jumpers and switches are set to meet your configuration needs. For configuration instructions, see [Setting Jumpers and Switches on Cards and Card Sets](#) on page 67.

- Control cards—configure rear connections for Ethernet or to connect to third-party router control systems and for AES reference impedance. All jumpers should be set before the card or card set is installed.
- Analog audio cards—set gain, mute detection and operating levels.
- Sample rate converter—enables up to 16 asynchronous AES inputs with a wide range of sample rates to be supported and converts the signals to synchronous AES signals locked to a sample rate of 48 kHz.
- Classic SWB card sets—can configure the output cards for DVB/ASI operation.
- Standard SWB cards—enable automatic re-clocking of the output signal and configure re-clockers for operation with DVB/ASI signals.
- Machine control card sets—can configure the card set to function as a 32-port standalone Machine Control card set even if another Machine Control card set is installed, allowing for two 32 inputs x 32 outputs matrices instead of one 64 inputs x 64 outputs matrix.
- Analog video conversion module—converts incoming composite analog video (NTSC or PAL) to SD format or converts SD formatted signals to composite analog video outputs in NTSC or PAL formats.

3. Installation

Installing Active Cards

Typical Card Combinations

The following are two examples of typical input card and output card combinations. Figure 3-5 shows a 64 inputs x 64 outputs analog video and 64 inputs x 64 outputs audio installation:

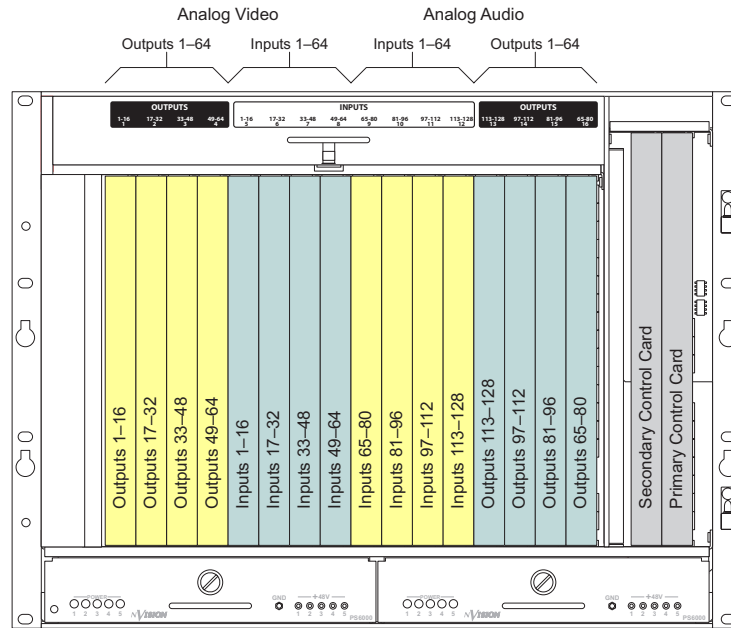

Figure 3-5. Simple Layout

Figure 3-6 shows 48 SD inputs with 32 SD and 32 analog video outputs, 48 AES synchronous inputs with 48 AES synch and 16 analog audio outputs, and a 32-port machine control card set:

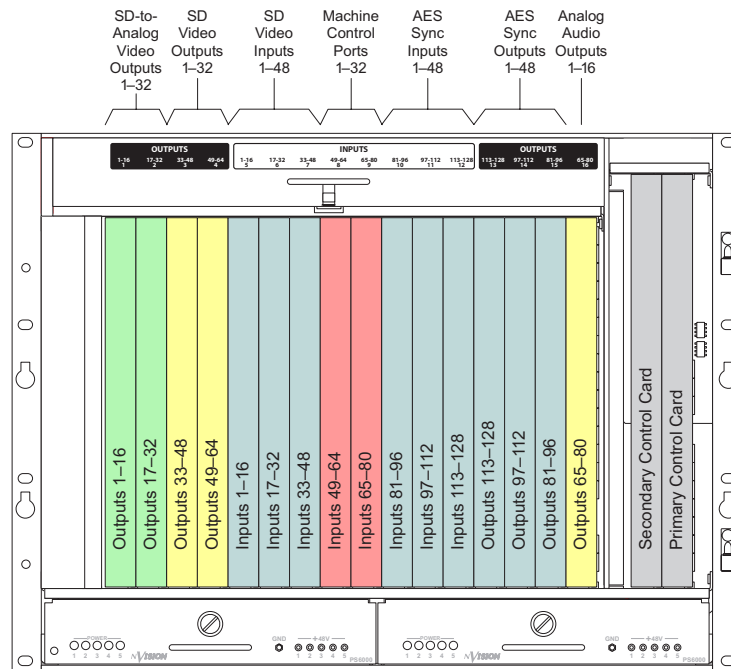

Figure 3-6. Complex Layout

Installing Cards

All cards can be inserted and removed with the power on.

How to install active cards

Caution

Do not drop, roughly handle, or stack active cards. If a card does not remove or insert easily, stop installation activities and contact Miranda Technical Support. (See [Technical Support Contact Information](#) on page iii.)

- 1 Set jumpers and/or switches on each card as needed. See [Configuration Tasks to Perform Before Installing Cards](#) on page 47.
- 2 Facing the front of the router (door open), locate the control, input and output card slots.
- 3 Insert each card into the router frame by sliding it into a card guide in the slot. On all cards, the metal plate on the front of the card should be facing outward and levers located at the top and bottom of each card.

Insert the card in designated slots only, as follows (see Figure 3-7 on page 50):

- Insert a control card in each of the two *control card* slots for primary and secondary control cards.

Or

Insert one primary control card in the primary control card slot and a clock generator in the secondary control card slot. See [Systems Clock Generator Card](#) on page 44.

- Insert input cards for AES, analog video, analog audio or time code signals in the eight *center* slots 5–12, based on your configuration.
- Insert classic SWB card sets in slots 11 and 12 *or* 12 and 13. Specific slots used are based on your configuration. See [Rules for Classic SWB Card Sets](#) on page 46.
- Insert standard SWB cards in slots 1–16. Specific slots used are based on your configuration. See [Rules for Standard SWB Cards](#) on page 45.
- Insert machine control card sets in slot 11–14. Specific slots used are based on your configuration. See [Rules for Machine Control Card Sets](#) on page 46.
- Insert output cards for AES, analog video, analog audio or time code signals in the four *left* slots 1–4 and the four *right* slots 13–16, based on your configuration.

3. Installation

Making Signal Connections

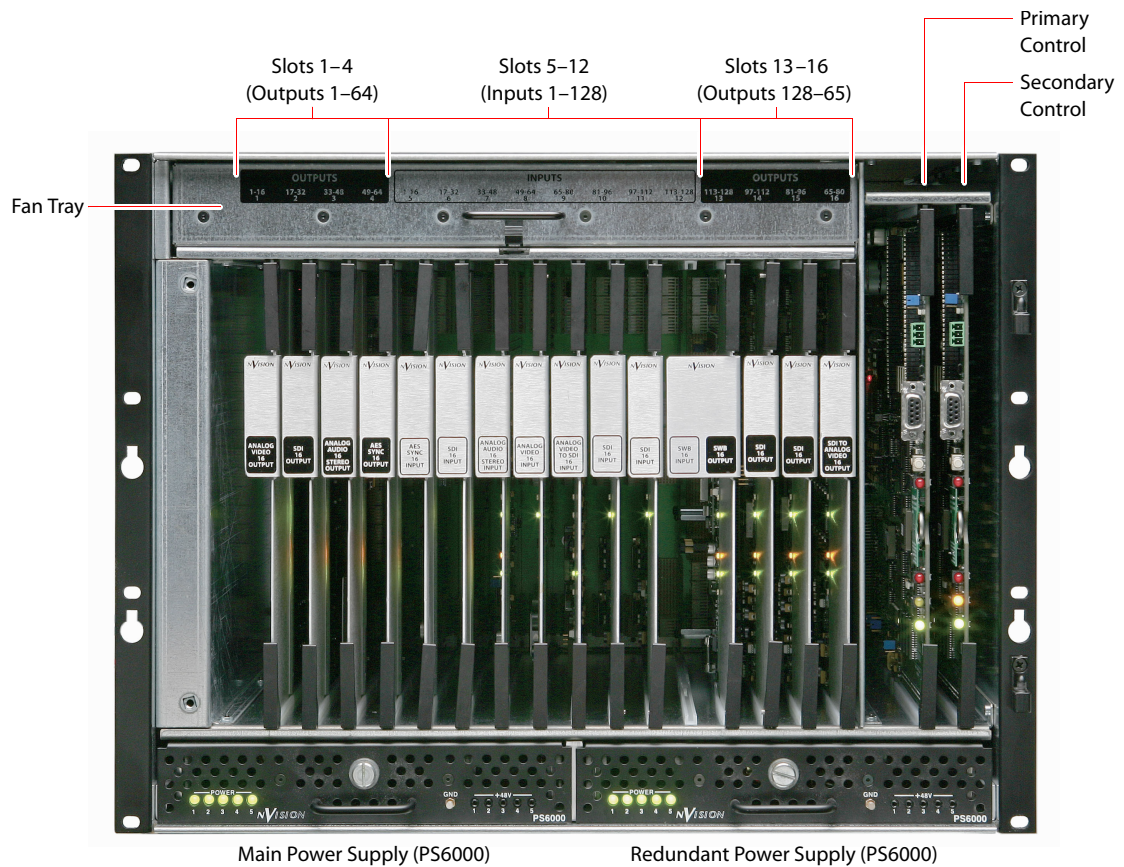

Figure 3-7. Card Locations (Front View)

- 4 Press each lever downward so that the lever is tucked into the channel at the edge of the shelf on the top and bottom. When the door is closed, pressure from the door ensures that the card is fully seated with the motherboard.
- 5 Reinstall and close the frame front door after all cards have been installed. The door must be closed for the router cooling system to work properly.

Making Signal Connections

For the NV5128 to route incoming and outgoing signals properly, the I/O connections housed on backplanes on the rear of the router must be connected to cables that receive and distribute the signals. (See [Backplanes](#) on page 13.) The NV5128 contains a maximum of 128 input connections and a maximum of 128 output connections. The total number of connections depends on the type of signals being routed and the corresponding backplane installed.

Figure 3-8 shows the rear of the router with backplanes containing connectors for receiving and distributing signals and the location of inputs and outputs for signal connections.

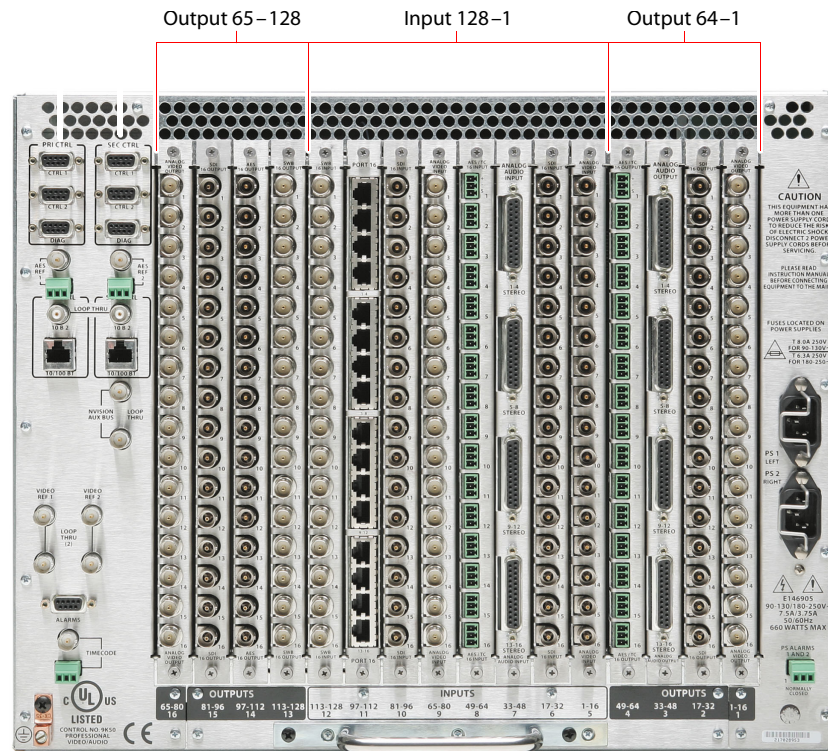

Figure 3-8. NV5128 Frame with Backplanes (Rear View)

Instructions for making signal connections are listed by signal type in the preceding sections.

AES Synchronous Signals

The NV5128 can route both balanced and unbalanced AES synchronous signals. Unbalanced signals are received and distributed through BNC connectors. Balanced signals are received and distributed through Phoenix connectors. Both types of connectors are housed on backplanes located on the rear of the router. Each backplane contains 16 connections labeled '1', '2' and so on up to '16'. The labels correspond to the signal numbers assigned to the signal passing through that connector. For more information on backplanes, see [Backplanes](#) on page 13.

About Phoenix Connectors

Phoenix terminal blocks accept a stripped (bare) wire 18 AWG or smaller. The connectors plug into the mating receptacle on the backplane, using friction to hold them in place.

When using Phoenix connectors, be sure that only the bare wire end is captive under the clamp screw and that there are no stray strands that can cause short circuits or accidental ground connections. Also make sure that the weight of the cable or cable bundle does not cause the connector(s) to disengage over time. Provide adequate support for the cables 12 to 18 inches from the rear of the frame.

3. Installation

Making Signal Connections

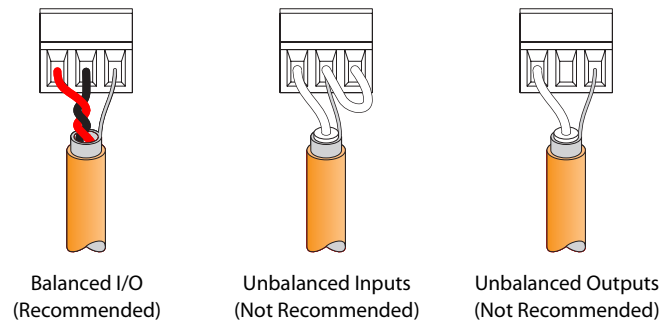

Figure 3-9. Phoenix Connectors and Connection Methods

How to make connections for AES signals

- 1 Locate the AES *input* connections at the rear of the router, as shown in Figure 3-8 on page 51. There are 16 BNC connectors on each backplane for AES unbalanced signals and 16 Phoenix connectors on each backplane for AES balanced signals.
- 2 For each input connection, connect using the connector and cable appropriate for the type of incoming signal:
 - For **AES unbalanced** signals, use a BNC connector and 75 Ω cable.
 - For **AES balanced** signals, use a Phoenix connector and twisted-pair 110 Ω cable. See [About Phoenix Connectors](#) on page 51.
- 3 Connect the other end of the cable to the source of the signal.
- 4 Locate the AES *output* connections on the rear of the router, as shown in Figure 3-8 on page 51.
- 5 For each output connection, connect using the connector and cable appropriate for the type of outgoing signal as described in Step 2.
- 6 Connect the other end of the cable to the signal destination.
- 7 Make other signal connections, as needed.

Analog Signals

The NV5128 can manage analog signals. Signals are received and distributed through DB25 connections, housed on backplanes. (See [Backplanes](#) on page 13.)

Each backplane contains four DB25 connectors. Each connector supports either stereo or mono signals:

- Stereo—4 channel pairs, for a total of 16 stereo signals per backplane.
- Mono—8 channels, for a total of 32 mono signals per backplane.

The DB25 connectors are labeled ‘1–4 Stereo’, ‘5–8 Stereo’, ‘9–12 Stereo’ and ‘13–16 Stereo’. The labels correspond to the signal number assigned to the signals passing through that connector.

Analog signals are converted to digital (sample rate of 48kHz) for internal routing. (See [Analog Audio](#) on page 25.) For proper conversion to occur, the system AES reference connection must be connected. For instructions on connecting the AES reference, see [AES Reference](#) on page 57.

3. Installation

Making Signal Connections

The analog audio output card is designed to function in a voltage-matched system driving high-impedance loads. The output drivers are not designed to drive 600 Ω loads continuously and may overheat if used in a 600 Ω environment.

Mono Signals

How the NV5128 switches mono signals is dependent upon the router control system. Before setting up analog signals, make sure that the router control system can manage mono signals. All signal number labeling on the router frame refers to stereo signals, not mono signals. In order to successfully install and implement the receiving and distributing of mono signals, great care should be taken to avoid confusion. For more information on mono signals and signal number labeling, see [Mono Channels](#) on page 7.

Gain, Mute Detection and Operating Levels

When receiving and distributing unbalanced analog signals, a drop in level of 6dB occurs. This is due to one-half of the input signal being lost when the ‘-’ input is grounded and is normal. Using a switch located on the analog audio input card, an additional 6dB of gain can be added to compensate for the drop. In addition, mute detection and operating levels can be set, ensuring a clearer audio signal. For instructions on setting gain, mute detection and operating levels, see [Analog Audio Switches](#) on page 69.

How to make connections for analog signals

- 1 Locate the analog *input* connections on the rear of the router, as shown in Figure 3-8 on page 51. There are four DB25 connectors on each analog backplane.
- 2 For each **analog** input, connect using a DB25 connector and cable, wiring the connectors as follows:

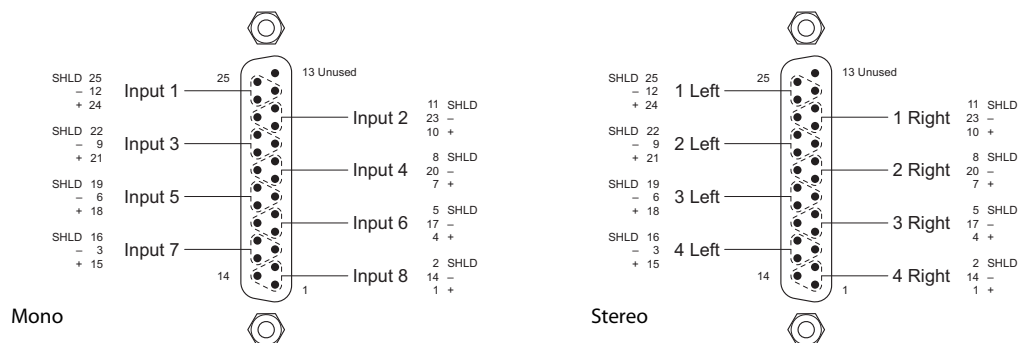

Figure 3-10. Mono Pin Assignments

An optional pre-made DB25 male to pigtail breakout cable is available from Miranda (NV5000-Cable1). The wiring details for this cable are as follows:

Channel	Pair	Jacket Color	DB25 Connector Pin Number		
			Red (+)	Black (-)	GND
1 - Left	1	BROWN	24	12	25
1 - Right	2	RED	10	23	11
2 - Left	3	ORANGE	21	9	22
2 - Right	4	YELLOW	7	20	8
3 - Left	5	GREEN	18	6	19

3. Installation

Making Signal Connections

Channel	Pair	Jacket Color	DB25 Connector Pin Number		
			Red (+)	Black (-)	GND
3 - Right	6	BLUE	4	17	5
4 - Left	7	VIOLET	15	3	16
4 - Right	8	GRAY	1	14	2

*Note: Pin 13 is not used.

Connect the signal or “hot” wire from the single ended source to the balanced input “+” connection. Connect the common or “shield” wire from the single ended source to the balanced input “-” connection. Bridge the balanced input ground pin to the “-” pin, or single ended shield.

The following lists the signal managed by each pin:

Channel	DB25 Connector Pin Number	
	Signal	Common
1 - Left	24	12 & 25
1 - Right	10	11 & 23
2 - Left	21	9 & 22
2 - Right	7	8 & 20
3 - Left	18	6 & 19
3 - Right	4	5 & 17
4 - Left	15	3 & 16
4 - Right	1	2 & 14

*Note: Pin 13 is not used.

- 3 Connect the other end of the cable for each input to the source of the signal.
- 4 Locate the analog *output* connections on the rear of the router, as shown in Figure 3-8 on page 51.
- 5 For each output, connect using a DB25 connector and cable, wiring the connectors as described in Step 2.
- 6 Connect the other end of the cable to the signal destination.
- 7 Make other signal connections, as needed.

Video Signals

The NV5128 can support SD, SWB and analog video signals. Each requires a unique backplane and signal connections. SD, SWB and analog video signals are received and distributed through 16 BNC connectors labeled ‘1’, ‘2’ and so on up to ‘16’. Connections are housed on a backplane installed in the back plate. The labels correspond to the signal number assigned to the signal passing through that connector. (See [Backplanes](#) on page 13.) However, the backplanes for incoming SD signals and for incoming and outgoing SWB signals contain active connections; the backplane for analog video signals contains passive connections. Do not intermix backplanes! SD and SWB backplanes cannot be used for analog video signals, SD backplanes for SWB signals, and so on.

How to make video signal connections

- 1 Locate the *input* connections at the rear of the router, as shown in Figure 3-8 on page 51. There are 16 BNC connectors on each SD, SWB or analog video backplane.
- 2 For each input, connect using a BNC connector and 75 Ω cable.
- 3 Connect the other end of the cable to the source of the incoming signal.
- 4 Locate the *output* connections on the rear of the router, as shown in Figure 3-8 on page 51.
- 5 For each output, connect using a BNC connector and 75 Ω cable.
- 6 Connect the other end of the cable to the distribution destination for the outgoing signal.
- 7 Make other signal connections, as needed.

Time Code Signals

Time code signals are received and distributed through Phoenix connectors. Connectors are housed on backplanes installed in the router's rear back plate. The backplane contains 16 connections labeled '1', '2' and so on up to '16'. The labels correspond to the signal number assigned to the signal passing through that connector. (See [Backplanes](#) on page 13.)

Before making connections, review Phoenix wiring information. See [About Phoenix Connectors](#) on page 51.

How to make connections for time code signals

- 1 Locate the time code *input* connections on the rear of the router, as shown in Figure 3-8 on page 51. There are 16 Phoenix connectors on each time code backplane.
- 2 For each input, connect using a Phoenix connector and 110 Ω twisted pair cable or coaxial cable, whichever you prefer. (See [About Phoenix Connectors](#) on page 51.)
- 3 Connect the other end of the cable to the source of the time code signals.
- 4 Locate the time code *output* connections on the rear of the router, as shown in Figure 3-8 on page 51.
- 5 For each output, connect using a Phoenix connector (1 positive, 1 negative and 1 ground) and 110 Ω twisted pair cable or coaxial cable, whichever you prefer. (See [About Phoenix Connectors](#) on page 51.)
- 6 Connect the other end of the cable to the signal destination.
- 7 Make other signal connections, as needed.

Machine Control Signals

Machine control signals are received and distributed through 16 RJ-45 connectors labeled '1-4', '5-8', '9-12' and '13-16'. Connectors are housed on a backplane installed in the back plate. The labels correspond to the signal numbers assigned to signals passing through that connector. (See [Backplanes](#) on page 13.)

Machine control signal connections can be 16 RJ-45 connectors on a backplane or 64 DE9 connectors on a Machine Control converter backplane. For more information, see [Machine Control Break-out Panel](#) on page 14.

3. Installation

Making Signal Connections

Follow the instructions provided in the preceding sections for the type of connector being used: [RJ-45 Connectors on this page](#) or [DE9 Connectors](#) on page 56.

RJ-45 Connectors

The RJ-45 connectors are wired according to industry standard SMPTE 207M. For best performance, use category 5 Ethernet cable and the proper tooling to ensure a secure and reliable connection when installing RJ-45 connectors. This is the connector pinout:

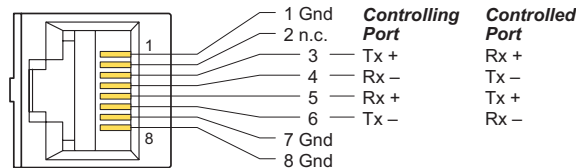

These are the functions of the pins:

Pin	RS-422		RS-232	
	Controlling	Controlled	DTE	DCE
3	Tx+	Rx+	Tx	Rx
4	Rx-	Tx-	Gnd	Gnd
5	Rx+	Tx+	Rx	Tx
6	Tx-	Rx-	Gnd	Gnd

(The other pins are grounded except for pin 2 which is not connected.)

DE9 Connectors

The machine control breakout panel (BP-PORT-64) has 64 RJ-45 connectors and 64 matching DE9 connectors. It lets you use DE9 cables to connect your machine control devices. The DE9 wiring follows SMPTE-defined pin assignment standards. For more information on the converter backplane, see [Machine Control Breakout Panel](#) on page 14.

If you are using the breakout panel, you might need to know the mapping of the signals from the RJ-45 side to the 9-pin (female) side. The breakout panel is RS-422/485 only.

This is the RJ-45 to DE9 mapping for RS-422:

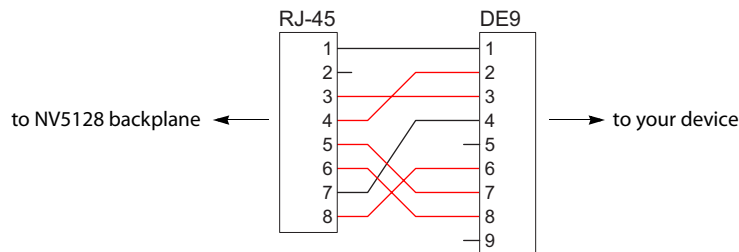

This cable wiring is applicable whether the port is a controlling port or controlled port.

- ▲ Older breakout panels might have incorrect wiring. Contact Miranda if your breakout panel does not function correctly.

If you make your own RS-232 cables, follow this pattern:

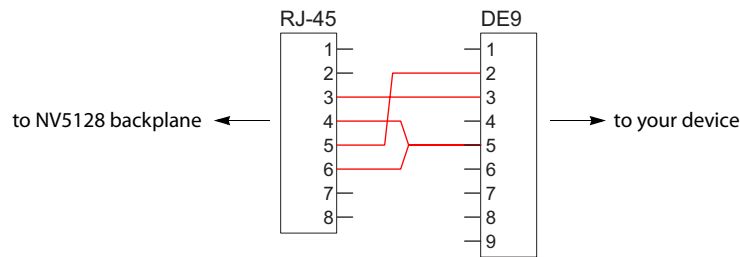

This cable wiring is applicable whether the port is DTE or DCE.

How to Make Machine Control Signal Connections

- 1 Locate the machine control connections at the rear of the router. There are 16 RJ-45 connectors on each machine control backplane.
- 2 If your machine control devices have RJ-45 connectors, use category 5 Ethernet cable to connect the port to the devices.
- 3 If your machine control devices have DE9 connectors, either use the breakout panel to make the connections or construct RJ-45 to DE9 cables to make the connections.

Making Reference Connections

The NV5128 uses reference signals to properly time the switching of signals and to avoid picture disturbances and undesirable discontinuities in audio and time code signals. The reference signal inputs are located on the left rear of the frame, as shown in Figure 2-4 on page 12.

AES Reference

The AES reference is used for clock generation and provides a timing reference for AES synchronous signals and for the control card's timing circuits. For optimum audio output, signals must be clock-locked to the same reference. Input impedance is selected by setting jumper located on the control card. (See [Control Card Jumper Settings](#) on page 68.)

The NV5128 has two AES reference connections labeled 'AES REF 1' and 'AES REF 2'. Both connections are used by the primary and the secondary (optional for redundancy) control card. This provides a backup reference source should one of the sources fail. The AES reference connection requires a stable signal source set at 48 kHz. For a detailed description of the AES reference connections, see [AES Reference Connections](#) on page 18.

An AES reference must be connected when using AES synchronous I/O cards. (See [Audio I/O Cards](#) on page 22.) When mixing analog audio and AES signals, an AES reference is not required because the clock generator on the control card provides all necessary clock signals. However, the AES reference makes it easier to inter-mix analog and AES audio formats.

The AES reference signals have two self-terminating inputs: one BNC and one Phoenix. Each input supports either balanced or unbalanced formats, but only one connector can be used at a time for any given input. The unused connection may not be used as a looping output.

3. Installation

Making Reference Connections

How to make connections to the AES reference

- 1 Locate the AES reference connections on the rear of the router, as shown in Figure 3-11. AES reference connections are labeled 'AES REF 1' and 'AES REF 2'.

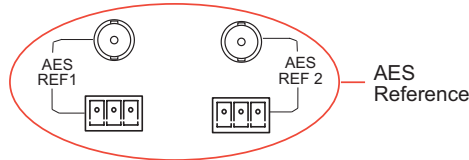

Figure 3-11. AES Reference Connection (Rear View)

- 2 Connect to the 'AES REF1' connection using the connector and cable appropriate for the reference signal type:

For **AES unbalanced** signals, use a BNC connector and 75 Ω cable.

For **AES balanced** signals, use an Phoenix connector and 110 Ω twisted pair cable.

- 3 Connect the other end of the cable to a stable source of 48kHz AES audio signals.
- 4 For redundancy, connect to the 'AES REF 2' connection as described in Step 2.
- 5 Connect the other end of the cable to a stable source of 48 kHz AES audio signals.

Video Reference

The NV5128 provides timing reference connections for analog video signals. The video reference requires a stable source of PAL, NTSC or Tri-level sync. The video reference connections are labeled 'VIDEO REF 1' and 'VIDEO REF 2'. For more information on signal switching when a reference is or is not present and a detailed description of the video reference connections, see [Video Reference Connections](#) on page 19.

Each 'VIDEO REF' connection can use the same reference source (redundant for backup should one source fail) or two unique reference sources (dual). For more information, see [Redundant and Dual References](#) on page 19.

Video reference connections can use a loop-through to connect to other routers. Terminate any unused 'VIDEO REF' connections using a 75 Ω BNC terminator.

How to make connections to the video reference

- 1 Locate the video reference connections on the rear of the router, as shown in Figure 3-12. Video reference connections are labeled 'VIDEO REF 1' and 'VIDEO REF 2'.

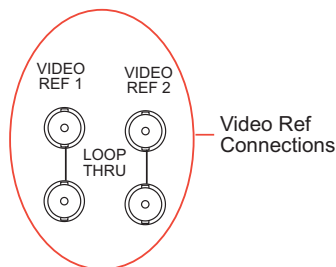

Figure 3-12. Video Reference Connections (Rear View)

- 2 Connect to the 'VIDEO REF 1' connection using a BNC connector and 75 Ω cable.

3 Connect the other end of the cable to a video reference signal. Be sure the incoming signal is from a stable source. The signals can be:

PAL

NTSC

Tri-Level Sync (1080i 50/59.94/60 and 720p 50/59.94/60)

4 Connect to the 'VIDEO REF 2' input connection, as described in Steps 2 and 3. The reference can use redundant or dual sources. For more information, see [Redundant and Dual References](#) on page 19.

5 **Important:** Install a 75 Ω BNC terminator on any unused video reference loop-through connection.

Time Code Reference Signal

The NV5128 does not support a time code reference at this time.

Making Router Control System Connections

To manage signal switching in the NV5128, connections need to be created between the router control system, UniConfig and the router. UniConfig is an application installed on external hardware that manages router configuration and set up tasks. For more information, see the UniConfig User's Guide.

Connections are as follows:

- Serial control. Use to connect to third-party router control systems requiring a serial control connection. (See [Serial Router Control Connections](#) on page 59.)
- Ethernet. Use to connect to the NV9000 router control system and to create network connections. (See [Ethernet Router Control Connections](#) on page 61.)
- GSC Node Bus. Use to connect to third-party router control systems requiring a GSC Node Bus connection. (See [GSC Node Bus Router Control Connections](#) on page 61.)

The router and the router control system cannot communicate with each other until the port through which the control system connection is made is initialized. For more information, see the UniConfig User's Guide.

Serial Router Control Connections

Serial router control connections are used to connect a router to the router control system and are often used for third-party control systems. Although serial connections can be used for the NV9000 control system, it is recommended that an Ethernet connection is used instead. (See [Ethernet Router Control Connections](#) on page 61.)

Serial control connections use SMPTE 207M DE9 connectors and serial (RS-422/489) cable. For a detailed description of the serial control connections, see [Serial Connections](#) on page 17.

3. Installation

Making Router Control System Connections

How to make a serial connection to the router control system

- 1 Locate the serial control connections on the rear of the router, as shown in Figure 3-13. Serial control connections are labeled 'PRI CTRL' for the primary control card and 'SEC CTRL' for the secondary control card.

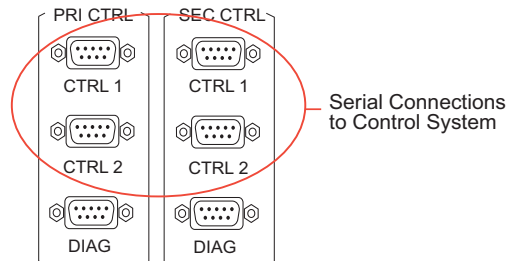

Figure 3-13. Serial Connections to Router Control System (Rear View)

- 2 Connect to the 'CTRL 1' connection in the 'PRI CTRL' section using a DE9 connector and serial cable.
- 3 Connect the other end of the serial cable to the (primary) router control system using a DE9 connector.

The following lists the pin wiring for the DE9 connector:

Router Control System	Pins	Router
Ground	1 -----1	Ground
Rx-	2 -----2	Tx-
Tx+	3 -----3	Rx+
Tx Common	4 -----4	Rx Common
N/C	5 -----5	N/C
Rx Common	6 -----6	Tx Common
Rx+	7 -----7	Tx+
Tx-	8 -----8	Rx-
Ground	9 -----9	Ground

- 4 If a secondary control card (optional for redundancy) is installed, connect to the 'CTRL 1' connection in the 'SEC CTRL' section as described in Step 2 and Step 3.
- 5 If an alternate router control system (e.g., for redundancy or dual control) is being used, make connections as follows:
 - a Connect to the 'CTRL 2' connection in the 'PRI CTRL' section using a DE9 connector and serial cable.
 - b Connect the other end of the serial cable to the *secondary* router control system using a DE9 connector, wiring the connector as described in Step 3.
 - c Connect to the 'CTRL 2' connection in the 'SEC CTRL' section using a DE9 connector and serial cable.
 - d Connect the other end of the serial cable to the *secondary* router control system using a DE9 connector, wiring the connector as described in Step 3.

Ethernet Router Control Connections

Ethernet router control connections connect the router to the router control system using Ethernet connectors. Ethernet connections are helpful if the PC running the router control system is going to be part of a network. An Ethernet connection is recommended for the NV9000 router control system. The Ethernet ports are shared by the primary and secondary control cards. For a detailed description of the Ethernet connections, see [Ethernet Connections](#) on page 17.

In order for the router to communicate with the router control system through an Ethernet connection, an IP address for the router needs to be set in the control card. For more information, see the UniConfig User's Guide.

The Ethernet connections use RJ45 connectors and Category 5 Ethernet cable, or better. The Ethernet port is 10/100 BT.

How to make an Ethernet connection to the router control system

- 1 Locate the Ethernet connections on the rear of the router, as shown in Figure 3-14. Ethernet control connections are labeled '10/100 BASE T'.

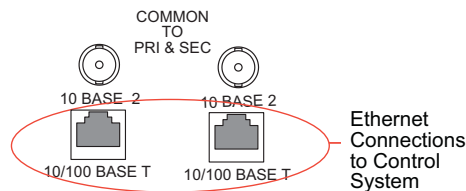

Figure 3-14. Ethernet Connections to Router Control System (Rear View)

- 2 Connect to either '10/100 BASE T' connection using a RJ45 connector and Category 5 Ethernet cable, or better.
- 3 Connect the other end of the Ethernet cable to the primary router control system PC.
- 4 If a secondary (optional for redundancy) control card is installed, connect to the remaining '10/100 BASE T' connection using a RJ45 connector and Category 5 Ethernet cable, or better.
- 5 Connect the other end of the second Ethernet cable to the redundant router control system PC.

GSC Node Bus Router Control Connections

Some third-party router control systems require a GSC Node Bus connection to connect the router to the router control system. The NV5128 has one GSC Node Bus connection, labeled 'NODE BUS', which is shared by both the primary and secondary control cards. For a detailed description of the GSC Node Bus connection, see [GSC Node Bus Connections](#) on page 17.

To use the GSC Node Bus connection, an optional module must be installed on each control card. For details, contact Miranda.

The GSC Node Bus connection can use a loop-through to connect to other routers. Terminate any unused GSC Node Bus connections using a 75 Ω BNC connectors.

3. Installation

Making Diagnostic Connections

How to make GSC Node Bus connection to the router control system

- 1 Locate the GSC Node Bus connection on the rear of the router, as shown in Figure 3-15. The GSC Node Bus connection is labeled 'NODE BUS'.



Figure 3-15. GSC Node Bus Connection to Control System (Rear View)

- 2 Connect to the 'NODE BUS' connection using a 75 ohm BNC connector and coaxial cable.
- 3 Connect the other end of the coaxial cable to the router control system.
- 4 **Important:** Install a 75 Ω BNC terminator on any unused GSC Node Bus loop-through connections.

Making Diagnostic Connections

The diagnostic connections enable the NV5128 to communicate with the UniConfig application. UniConfig is installed on hardware (e.g., a PC), separate from the router, and is used to perform system setup tasks, and configure and monitor the router. (See Chapter 4, [Configuration](#), on page 67.) For information about using UniConfig, see the *UniConfig User's Guide*.

There are two types of diagnostic connections: temporary and permanent. A temporary diagnostic serial connection is located on the front of each control card. Permanent diagnostic serial connections are located on the rear of the router, labeled 'DIAG'. For a detailed description of the permanent diagnostic connections, see [Diagnostic Connections](#) on page 18.

Temporarily Connecting to UniConfig

A temporary connection is created through the DE9 port located on the front of the primary control card. (See [Control Cards](#) on page 21.) This connection is set to RS-232, DTE, 9600 baud, 8 data bits, no parity.

How to make a temporary diagnostic connection

- 1 Locate the primary control card slot, as shown in Figure 3-8 on page 51. When facing the front of the router, the control cards are located in the upper, right-hand section.
- 2 On the front of the control card, connect to the DE9 connection using a DE9 connector and a serial cable set for EIA-232.

The following lists the wiring for the DE9 pin connectors for RS-232:

Hardware	Pins	Router
DCD	1 -----1	Ground
RXD	2 -----2	TXD
TXD	3 -----3	RXD
DTR	4 -----4	DSR

Hardware	Pins	Router
Signal Ground	5 -----5	Signal Ground
DSR	6 -----6	DTR
RTS	7 -----7	CTS
CTS	8 -----8	RTS
Ground	9 -----9	Ground

- 3 Connect the other end of the cable to the hardware running the UniConfig application using a DE9 connector (see the UniConfig User’s Guide).
- 4 Using UniConfig, initialize the router control system connection. For more information, see the UniConfig User’s Guide.
- 5 When done configuring, remove the temporary connection.

Permanently Connecting to UniConfig

There are two diagnostic ports located on the rear of the router, labeled ‘DIAG’. The diagnostic ports default to 38400 baud, RS-232, but can be set to RS-422 using UniConfig. For more information, see the UniConfig User’s Guide.

How to make a permanent diagnostic connection

- 1 Locate the diagnostic connections on the rear of the router, as shown in Figure 3-16. The diagnostic connections are labeled ‘DIAG’.

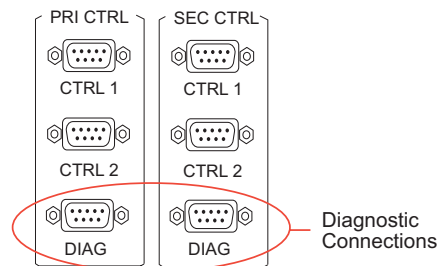

Figure 3-16. Diagnostic Connections (Rear View)

- 2 Connect to the ‘DIAG’ connection in the ‘PRI CTRL’ section using a DE9 connector and a serial cable. The ports are set for RS-232:

The following lists the wiring for the DE9 pin connectors for RS-232:

Hardware	Pins	Router
DCD	1 -----1	Ground
RXD	2 -----2	TXD
TXD	3 -----3	RXD
DTR	4 -----4	DSR
Signal Ground	5 -----5	Signal Ground
DSR	6 -----6	DTR
RTS	7 -----7	CTS

3. Installation

Making Alarm Connections

Hardware	Pins	Router
CTS	8 -----8	RTS
Ground	9 -----9	Ground

The DE9 connector can be set for RS-422, but adjustments will need to be made in UniConfig. For more information, see the UniConfig User's Guide. The following lists the wiring for the DE9 pin connectors for RS-422:

Hardware	Pins	Router
Ground	1 -----1	Ground
Rx-	2 -----2	Tx-
Tx+	3 -----3	Rx+
Transmit Common	4 -----4	Receive Common
N/C	5 -----5	N/C
Receive Common	6 -----6	Transmit Common
Rx+	7 -----7	Tx+
Tx-	8 -----8	Rx-
Ground	9 -----9	Ground

- 3 Connect the other end of the cable to the hardware running the UniConfig application.
- 4 If a secondary control card is installed (optional for redundancy), connect to the 'DIAG' connection in the 'SEC CTRL' section using a DE9 connector and a serial cable as described in Step 2 and Step 3.

Making Alarm Connections

The NV5128 provides alarms that send notification when a system malfunction occurs, such as when a fan or power supply is not functioning properly. Alarms can be connected to an external alarm indicator that displays visual cues when an alarm is activated. Miranda does not provide external indicator equipment, but does provide instructions on wiring the alarm connections. See [Alarm Indicator Equipment](#) on page 65. The router also sends status information to the router control system. For a detailed description of the router alarm connection, see [Making Alarm Connections](#) on page 64.

How to make alarm connections

- 1 On the rear of the router, locate the 'ALARMS' connection, as shown in Figure 3-17.



Figure 3-17. Alarms Connection (Rear View)

- 2 Connect to the 'ALARMS' connection using a DE9 connector and serial cable.
- 3 Connect the other end of the cable to an external alarm indicator. See [Alarm Indicator Equipment](#), following, for information on wiring the DE9 connector.

Alarm Indicator Equipment

An external alarm indicator can be created to display visual cues when a failure has occurred on the router frame. The ‘ALARM’ connection on the rear of the NV5128 uses a DE9 connector. LEDs can be wired to specific pins on a DE9 connector. Each LED indicates what specific router module has failed. An “alarm” or ON condition occurs when the connection between an alarm pin and Alarm_COM (common) opens. The alarm turns OFF when the connection between Alarm_COM and the alarm pin closes again.

To create an indicator box, connect to the ‘ALARM’ connection using a DE9 female connector, wiring as shown in Figure 3-18. Each pin monitors a specific function and activates a specific alarm.

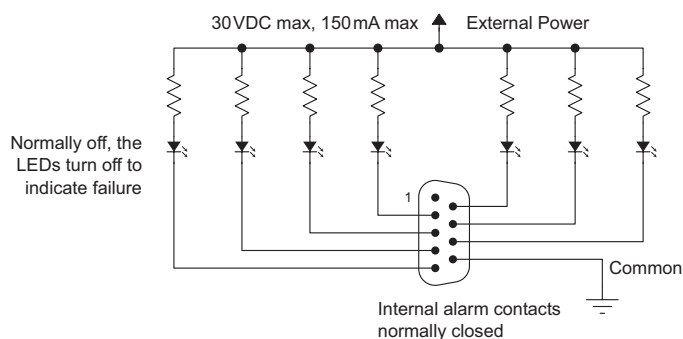

Figure 3-18. Alarm Connections and On/Off Switches

The following lists each DE9 pin and the associated alarm. The pin number listed corresponds to the pin numbers in Figure 3-18 on page 65:

Pin	Signal	Description	Possible Conditions Causing the Alarm
1, 9	Alarm_COM	Common	Common connection for all alarm pins.
2	Alarm_1	Major alarm	Indicates missing reference inputs, or missing power supplies.
3	Alarm_2	Minor alarm	Alarm_3, or Alarm_4, or Alarm_5, or Alarm_6
4	Alarm_3	Power supply	Missing power supply module.
5	Alarm_4	Video ref	Missing Video Ref 1 or Video Ref 2.
6	Alarm_5	AES ref	Missing AES Ref 1 or AES Ref 2
7	Alarm_6	Fans or temperature	Indicates a fan failure or module over temperature.
8	Alarm_7	Control module health	Any control module not “healthy.”

Verification

When installation is complete, perform the following checks to make sure the router is operating properly:

- On each PS6000 power supply module, check that all 5 green power LEDs on the front of each module are lit. If any or all LEDs are off:
 - Check that the power supply module is fully seated in its slot.
 - Check the AC fuse on the power supply.

3. Installation

Verification

- Check for +48 volts at each of the 5 front test points.
- On the NV5128, check that the LEDs on the input cards, control cards and output cards are lit and indicating a “healthy” system. See [Indicator LEDs](#) on page 76 for a list of normal and alert LED states.
- Make sure that the flow of air through the front of the router is unimpeded and the door is properly installed and closed. For more information, see [Air Flow](#) on page 78.

4. Configuration

Chapter 4 provides configuration instructions for the NV5128. It presents the following topics:

- [Introduction](#)
- [Setting Jumpers and Switches on Cards and Card Sets](#)

Introduction

Before being placed into service, the NV5128 router needs to be configured for your particular routing needs, router control system, and settings. Configuration includes initializing ports so that the router and UniConfig can communicate, setting up partitions, switch point settings, and testing switching configurations. Configuration tasks are performed using the UniConfig application, which resides on a unit (e.g., PC) separate from the router. For detailed information on using UniConfig, see the UniConfig User's Guide.

Setting Jumpers and Switches on Cards and Card Sets

Several cards in the NV5128 have jumpers and switches that control optional functions or settings. Jumpers and switches should be set before putting the cards and router into service.

How to set jumpers

- 1 Facing the front of the router, locate the card or card set. For a detailed description of each card and its jumpers, refer to the appropriate topic:
 - [Control Card Jumper Settings](#) on page 68.
 - [Classic SWB Card Set Jumpers](#) on page 68.
 - [Standard SWB Jumpers](#) on page 68.
 - [Machine Control Card Set Jumpers](#) on page 69.
 - [Analog Audio Switches](#) on page 69.
 - [Analog Video Conversion \(AVC\) Card Switches](#) on page 71.
- 2 Gently remove the card or card set for which jumpers are being set.
- 3 On the card, if appropriate, locate each jumper by its label number, placing jumper sleeves as needed. Descriptions of jumper functions are provided in the preceding sections, listed by card name. Jumpers are colored blue.
- 4 On the card, if appropriate, locate each switch being changed. Using a small, pointed object, such as a ball point pen, slide the beige switch piece to 'ON' or 'OFF' as desired.
- 5 When all jumpers and switches are set, gently slide the card or card set back into place in the router frame.

4. Configuration

Setting Jumpers and Switches on Cards and Card Sets

6 Close the router door.

Control Card Jumper Settings

The control card(s) (EM0374) contains several jumpers. Each jumper connection is labeled with a jumper identification number. By default, jumpers are placed in the position most commonly used. These jumpers must be set before the control card is placed into service.

The following lists each jumper label number, function, and correct setting. Any jumpers not listed are unused and should be left in the factory position:

Jumper Label	Settings
J1 SBUS/10B2	Sets rear connectors labeled 10Base2 to be used for Ethernet. Default set to lower 10Base2 position.
J2 SBUS/10B2	Sets rear connectors labeled 10Base2 to be used for Ethernet. Default set to lower 10Base2 position.
J4 SMS7/SBUS	Sets rear Node Bus connectors to be used for third-party router control systems. Default set to upper position.
J6 SMS7/SBUS	Sets rear Node Bus connectors to be used third-party router control systems. Default set to upper position.
J13 AES REF2	Sets the rear AES REF 2 input impedance to 110 Ω , 75 Ω , or Hi-Z (high impedance). Upper position selects 110 Ω for use with Phoenix rear connectors, the middle position selects 75 Ω for use with BNC rear connectors, or the lower position selects Hi-Z if this input is the last connection in an equipment chain.
J16 AES REF1	Sets the rear AES REF 1 input impedance to 110 Ω , 7 Ω , or Hi-Z (high impedance). Upper position selects 110 Ω for use with Phoenix rear connectors, the middle position selects 75 Ω for use with BNC rear connectors, or the lower position selects Hi-Z if this input is the last connection in an equipment chain.

Classic SWB Card Set Jumpers

Classic SWB card sets (EM0395) automatically re-clock signals at 177, 270, 360, 540 or 1485 Mb/s. If the data is at any other rate, the re-clocker automatically bypasses the signal, sending it to the output without re-clocking it.

Individual output re-clockers on the Classic SWB card set can be selectively disabled and the signal passed directly to the output. This can be done on an output-by-output basis using the UniConfig application. For more information, see the UniConfig User's Guide.

Jumper J21, located near the rear of the output module, under the mezzanine board, can be used to configure the Classic SWB card set for DVB/ASI operation. The jumper (J21) is labeled DVB/ASI. The default position is DISABLED, allowing normal SWB operation. When J21 is set to ENABLED, the re-clockers are configured for DVB/ASI operation. In this mode, the re-clockers ignore the 177 Mb/s sub-harmonic in the signal thereby re-clocking the signal correctly. When set to DVB/ASI mode, the output re-clockers work properly with all standard SWB signals except those at 177 Mb/s.

Standard SWB Jumpers

The SWB output cards (EM0463 and EM0465) each contain two jumpers. One jumper (J30) is located near the front top edge of the board and is labeled RECLOCKER MODE. When the jumper

is in the AUTO position, the output re-clocker automatically re-clocks signals at 177, 270, 360, 540 or 1485 Mb/s. If the data is at any other rate, the re-clocker ignores the jumper setting and automatically bypass the signal, sending it to the output without re-clocking it.

When in AUTO mode, individual output re-clockers on SWB output cards can be selectively disabled and the signal passed directly to the output, ignoring the jumper setting. This can be done on an output-by-output basis using the UniConfig application. For more information, see the UniConfig User's Guide.

When the jumper is in the OFF position, all output re-clockers are bypassed and the signal sent directly to the output. The primary use of this jumper is for factory testing; it is normally left in the default AUTO position.

A second jumper (J25) is located above J30 and can be used to allow operation with DVB/ASI signals. The default position is DISABLED, allowing normal SWB operation at all accepted data rates. When J25 is set to ENABLED, the re-clockers are configured for DVB/ASI operation and work properly with all standard SWB signals *except* those at 177 Mb/s.

Machine Control Card Set Jumpers

The Machine Control card set (EM0482) has one jumper (J51). In the *lower* (default) position, the card set functions as a 32-port standalone port card set (ports 1-32). If the port card set is plugged into slot 13, it functions as ports 33-64. A module is usually plugged into slot 13 when another port module is already plugged into slot 11. If the jumper is placed in the *upper* position, the port card set functions as a single standalone 32-port module regardless of where it is installed in the frame.

Analog Audio Switches

Depending on the analog audio source equipment you are using, you might want to change several setting on the analog audio input card (EM0585) and/or analog output card (EM0586). Options include:

- Setting the gain of individual channels.
If you are using single-ended inputs, you can double the input level by choosing a +6dB switch setting for those input channels.
- Activating mute detection.
- Setting operating levels to match facility production levels.

Individual Channel Gain

The analog audio input card (EM0585) has four 8-position DIP switch sets near the center of the board that allow the gain of each channel to be increased by 6 dB (doubled). These switches are labeled SW1, SW2, SW3, and SW5. (SW4 is elsewhere on the board.) Place the switch in the OFF position for normal gain (0 dB). Place the switch in the ON position for a gain of 6 dB. There are 32 switches, one for each channel, 1L, 1R, 2L, 2R, and so on up to 16L and 16R.

These switches affect *only* input gain. The router output continues to operate with an effective FSD of +24 dBu. With the additional gain, source inputs are limited to +18 dB.

4. Configuration

Setting Jumpers and Switches on Cards and Card Sets

Mute Detection

The analog audio input card (EM0585) also has a mute detect enable jumper (J21), labeled 'MUTE CONTROL'. When the analog audio input level drops to -78 dB or lower for more than 0.25 per second, the output sample values are replaced with digital silence. This jumper affects *all* inputs on the card globally. The 'ON' position activates mute control; the 'OFF' position deactivates mute control.

Figure 4-1 shows the location of the DIP switches for the analog audio input card (EM0585).

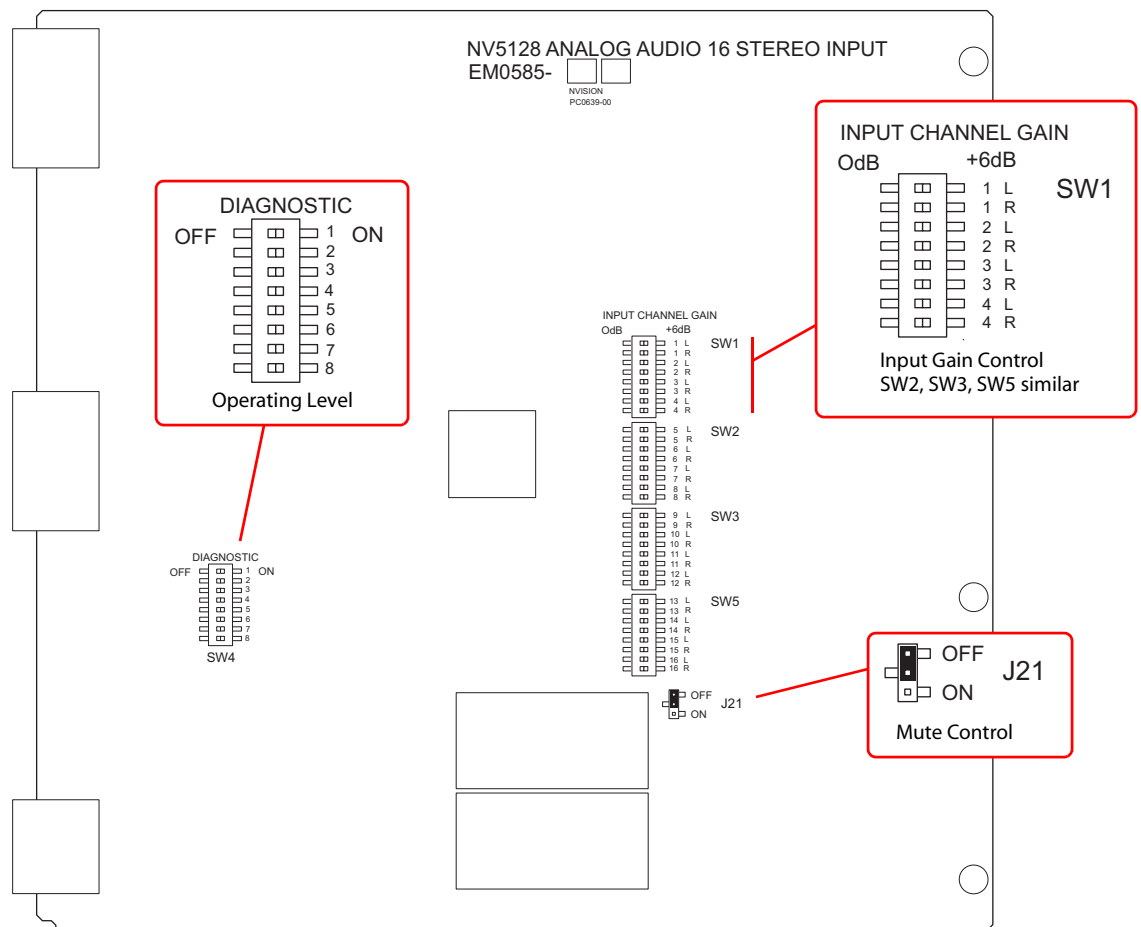

Figure 4-1. Analog Audio Input Card Switch and Jumper Locations

Operating Levels

Both the analog input card (EM0585) and the analog output card (EM0586) have an additional DIP switch set that can be used to match the operating level of the facility. For example, if the incoming signal operating level is $+24$ dBu, the card can be set to $+24$ dBu. By matching the incoming signal level, there is less degradation of the signal when it is converted to digital for internal routing in the router. Operating levels can be set for $+15$ dBu, $+18$ dBu or $+24$ dBu.

4. Configuration

Setting Jumpers and Switches on Cards and Card Sets

The DIP is SW4 on the input card and S1 on the output card. Only the first two switches on the DIP are used for the operating level. The following shows the switch positions for each operating level:

Switch 1	Switch 2	Operating Level (Max)
Off	—	+24 dBu
On	Off	+18 dBu
On	On	+15 dBu

By default, all switches are set to 'OFF' and the operating level set to +24 dBu.

Figure 4-2 shows the location of the DIP switches for analog audio output card (EM0586):

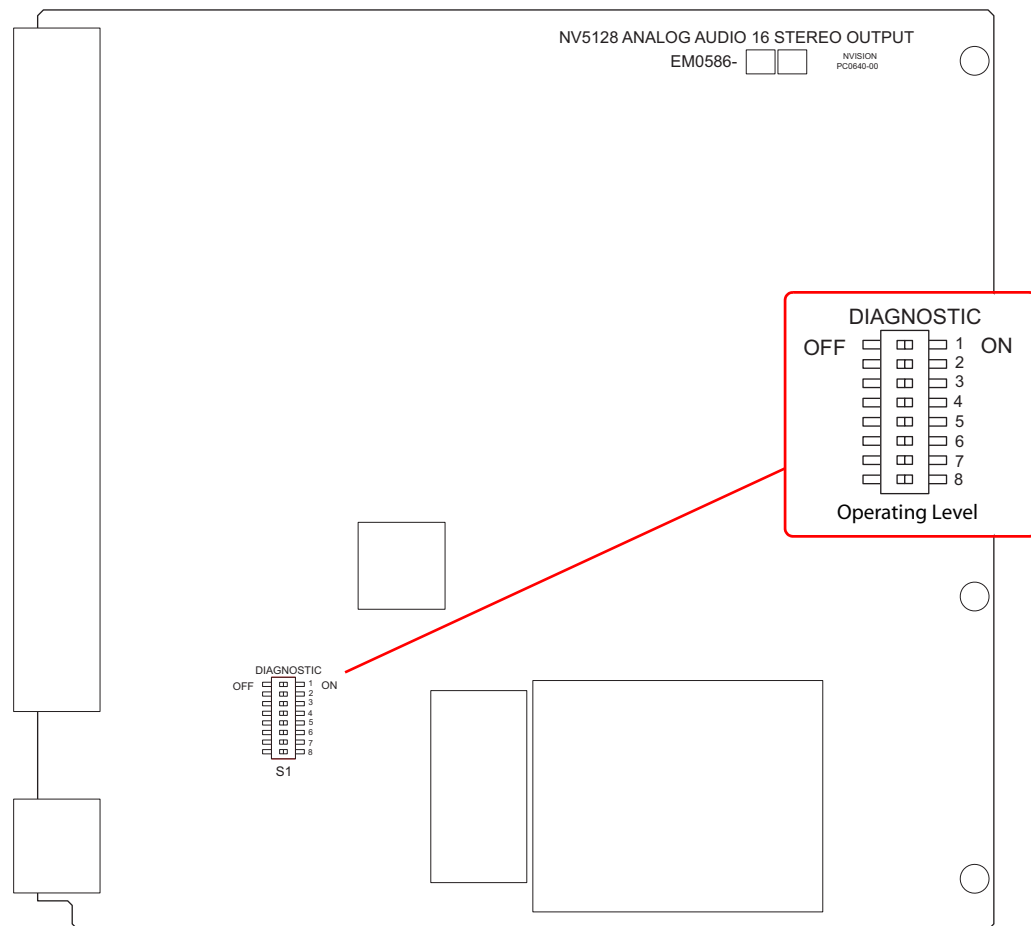

Figure 4-2. Analog Audio Output Card Switch Locations

Analog Video Conversion (AVC) Card Switches

The AVC input card (EM0432) receives incoming composite analog video (NTSC or PAL) and converts the signal to SD format for delivery to the motherboard. The AVC output card (EM0433), receives SD formatted signals from the motherboard and converts them to composite analog video outputs in NTSC or PAL formats. Because the color space for SD signals differs from that of composite signals, the absence or presence of pedestal in NTSC signals must be accommodated if color and luminance information is to be maintained. To accommodate these differences, DIP switches

4. Configuration

Setting Jumpers and Switches on Cards and Card Sets

are provided to preserve as best as possible the color and luminance integrity of signals processed using AVC cards.

While composite PAL and NTSC inputs can be applied to and simultaneously routed by the AVC input card (EM0432), all NTSC signals must be in the same format (NTSC-M or NTSC-J). The 8-position DIP switch (S1) on the AVC input card configures the card to process NTSC signals correctly. If the incoming signals are NTSC-M formatted signals, set DIP Switch S1-1 to ON. The ON position for S1-1 is determined by the markings on the body of the DIP switch. If the incoming format is NTSC-J (no pedestal), set S1-1 to OFF. The remaining seven switch positions (S1-2 through S1-8) are not used. Switch S1-1 settings have no effect on PAL signal processing.

There are three 8-position DIP switches on the AVC output card (EM0433), labeled S1, S2 and S3. Switch S2 is not used. The S1 and S3 switches (labeled 'USER SETTINGS') configure each output for the correct NTSC output format (pedestal or no pedestal).

The AVC input card feeds NTSC signals to the AVC output card. All 16 outputs on each output card must have pedestal settings that match the pedestal settings on the AVC input card. For example, if the input card's S1-1 is set to ON, then the output card's S1 and S2 must have all 16 switches set to ON. Refer to the silk screen markings on the AVC output card to identify and set switches to their proper positions. Do *not* use markings on the actual switch bodies.

Note

Attempting to convert NTSC-M signals to NTSC-J signals or *vice versa* results in large Chroma/Luma gain errors.

If signals fed to the AVC output card originate from SD input cards, then each output can be configured for pedestal or no pedestal (NTSC-M or NTSC-J) composite outputs. DIP switches S1 and S3 have no effect when handling PAL signals.

5. Operation

Chapter 5 provides operating instructions for the NV5128. It presents the following topics:

- [Overview](#)
- [NV9000 Router Control System](#)
- [Third-Party Router Control Systems](#)

Overview

To use the NV5128 router, you need a router control system. The router control system provides an interface for the operations and maintenance personnel. Through the router control system, signal switching can be actively configured, reference inputs selected, partitions for organizing signal switching created, and certain system functions monitored.

The NV5128 was designed to partner with the NV9000 or NV915 control system. However, the routers are designed with a certain degree of flexibility and can be used with certain third-party router control systems. For detailed information on using the NV9000 or NV915 control system, see the associated User's Guide. For information on using third-party router control systems, see the third-party vendor literature and User Guide. You can also contact Miranda for more information on compatible control systems. (See [Technical Support Contact Information](#) on page iii.)

NV9000 Router Control System

Most facilities require multi-level switching capability (audio follow video, for example) and intuitive device naming capabilities. The choice of control system dramatically affects how operators use the NV5128 and the ease with which devices are accessed.

Miranda's NV9000 and NV915 control systems provide a powerful and flexible approach to controlling Miranda equipment and third party equipment. The Miranda control systems are comprised of software and hardware. The control system application runs on a server and can be loaded on a primary server alone, or also on a secondary (redundant) server as a fail-over backup. Miranda control panels or third-party systems connected to the server can be used to manage the router and other network equipment.

Miranda's NV9000 control system offers the choice of several control surfaces, supports redundancy and facilitates easy expansion as routing needs change. The NV9000 control system is also capable of interfacing with third-party signal routing equipment. Because of the variety of features, capabilities and limitations of other manufacturers' equipment, users are urged to work closely with Miranda's technical staff and with the supplier of the third-party equipment when integrating it into an NV9000 control system.

5. Operation

Third-Party Router Control Systems

Third-Party Router Control Systems

NV5128 control cards use a default protocol. However, at the timing or ordering, a number of third-party control protocols can be installed upon request.

Miranda provides assistance to users wanting to configure Miranda products to function with third-party control systems. However, because Miranda does not manufacture or warrant control systems from other vendors, we cannot guarantee overall performance or answer all possible configuration-related questions. For assistance, contact the manufacturer of the control system in use.

In many cases, router features and functionality are limited when using a third-party control system. For example, the third-party system may not optimally manage mono routing, while the NV9000 control system easily manages this function.

Please consult with Miranda if you are considering using a third-party interface to control an NV5128 router. (See [Technical Support Contact Information](#) on page iii.)

6. Maintenance

Chapter 6 provides instructions regarding maintenance. It discusses the following topics:

- [Routine Maintenance](#)
- [Fuse Replacement](#)
- [Indicator LEDs](#)
- [Air Flow](#)
- [Intake Filter Screen Cleaning](#)
- [Battery Replacement](#)
- [Troubleshooting](#)
- [Obtaining Service](#)

Routine Maintenance

The NV5128 requires very little in the way of routine or preventative maintenance. Other than cleaning the fan air intake filter, all that is required is periodic inspection of the system to make sure no failures have occurred.

You might want to examine the system's [Indicator LEDs](#) occasionally to ensure that the system is operating normally and to make sure that air flow to the power supply fans is unobstructed.

Caution

Only qualified service personnel should perform procedures in this section.

Periodic Inspection

Periodically inspecting the NV5128 for signs of trouble is the best way to prevent unplanned outages. The following items will be helpful when performing this inspection.

Begin the inspection at the front of the frame. Open the door to the router and make these observations.

- 1 Check the +48VDC LEDs on the front of the PS6000 power supplies. An LED that is off or very dim in brightness indicates a failed or failing supply.
- 2 Place your hand lightly across the air intakes on the front of the power supplies. Slight air movement should be felt, indicating that the internal cooling fans are running. These fans run at very low speed, so only slight air movement will be noticed. A flashlight may be used to verify that the fan blades are rotating at the proper speed.
- 3 Look at each active card and verify that none of the red alarm LEDs are illuminated. Normally, the green and/or amber LED's should be illuminated. Refer to [Indicator LEDs](#) on page 76 to interpret the LED status indicators.

6. Maintenance

Fuse Replacement

- 4 Look at the control card(s) and verify that the green and amber LED's are illuminated on the active controller, and that the green LED is ON for the standby controller (if present). Verify that the low battery LED is off on one or both control cards. Refer to [Indicator LEDs](#) on page 76 for a description of the various LEDs and their meaning.
- 5 Inspect the air intake filter located inside the door. If the filter is dirty or clogged, refer to the next section for information on how to clean it.
- 6 Next, move around to the rear of the matrix frame. Ensure that there are no missing backplane cover plates. Replace any missing cover plates to ensure proper cooling in the frame.
- 7 Place a hand near the air exhausts. Strong air pressure should be felt evenly across the entire opening.
- 8 Check cable connectors for any sign of unseating.
- 9 Verify that one or both AC cords are firmly seated at both ends. Make sure that the spring bail power cord retainers on the rear of the frame are in place.

Fuse Replacement

If a problem occurs on a card, the first thing to do is check the fuses.

Fuses are located on each of the router's active cards. Each card features either a "fast blow" or a fuse that can be reset ("slow blow"). If the card requires a large amount of power, the fuse is "fast blow" and must be replaced if blown. If the fuse can be reset, reset the fuse by removing the card from the frame and letting the card temperature cool down. When the fuse temperature reduces to a safe operating temperature, the fuse automatically resets itself and the card can be reinstalled. The following table lists the fuses on each card:

Card or Module	Fuse Value
Power supply AC Line Fuse	8 amp, 5 × 20 mm, slow-blow
Control card	1 amp
Crosspoint card	1 amp
Input card	1 amp
Output card	1 amp
Monitor card	1 amp

Warning

Dangerous voltages are present at the rear AC power connector and on the power supply module. Take precautions to prevent electric shock: Do not touch exposed wires or connecting pins.

Indicator LEDs

Indicator LEDs indicate whether AC power is present and if a card is operating normally. LEDs are visible when the router front door is closed. In the following sections, LEDs are listed in the order they appear on the cards, from top to bottom.

Indicator LEDs on Power Supplies

The five green LEDs on the front of the power supply modules indicate presence of the five +48 VDC outputs of the five branch circuits. All five LEDs should be lit at all times when AC power is present. If any LED is off, either the power supply has failed or the branch circuit is shorted.

Indicator LEDs on Control Cards

The LEDs on the front of the control cards can be monitored to determine whether the card is operating normally. The meanings of the LED indicators are as follows:

LED Indicator	Indicator Function
Red (alarm)	Indicates a problem or fault. Check the external reference signals; if this does not resolve the problem, call Miranda Technical Support (see Technical Support Contact Information on page iii).
Red (low battery)	Indicates the battery needs replacing. See Battery Replacement on page 78.
Amber (active)	Indicates the card is the active control card. On the reserve control card, this LED should be OFF.
Green (health)	Normally ON. Indicates the card is operating normally.

Indicator LEDs on Input and Output Cards

The LEDs on the front of the input and output cards can be monitored to determine whether the cards are operating normally. The LEDs indicate the following:

LED Indicator	Indicator Function
Red (alarm)	Normally OFF. If it is lit, it indicates a problem; replace the card or call Miranda Technical Support.
GREEN (Power)	Normally ON. Indicates the card is operating normally and receiving power.

Three additional LEDs situated further back on the output card indicate the following:

LED Indicator	Indicator Function
Amber (health)	Normally ON. Indicates software has loaded and the card is operating normally.
Green (good communication)	Normally ON. Indicates good communication with the control card.
Red (bad communication)	Normally OFF. If lit, indicates that communication is not working properly with the control card; the communication is “bad.”

Test Points

All active cards, except the control cards, feature power supply test points located in the same pattern along the lower portion of the front edge. This simplifies verification of power supply status. Test points are provided only for voltages actually present on the module.

The matrix controller also provides front card edge mounted test points. These are in a slightly different pattern than the matrix modules, but are clearly labeled for function.

6. Maintenance

Air Flow

Air Flow

The NV5128 draws cooling air from the front of the router, through the door, and exhausts heated air through the rear of the frame. The router must have the door properly installed and closed for proper airflow through the chassis. For maximum air flow, regularly inspect router fans and filters.

Caution

If airflow is impeded overheating may occur.

Fan Cleaning and Replacement

One plug-in fan tray containing cooling fans is located at the top of the router frame (when viewing from the front). The tray can be removed for inspection or cleaning by opening the frame front door, sliding the latches that hold the fan module in place, and pulling the module out of the frame. If the fans become dusty or clogged with lint, use a vacuum or compressed air to clean the dust off. Also check the openings at the back of the frame where air enters and exits to be sure dust and lint have not accumulated.

The fan tray is easily replaced simply by sliding the tray out of the front of the frame and inserting a new tray. The fans on the tray are held in place by four screws and a pluggable connector. To replace the fans, remove the screws and unplug the connector.

Intake Filter Screen Cleaning

The intake filter is located on the front door assembly of the NV5128 Multi-Format Router. To access the filter open the router door by releasing the two thumbscrew locks. Remove the upper module brace by loosening the two ¼ turn screws, then slide the filter up and to the right to remove it. This process may be easier if the entire door is removed by lifting it straight up while open.

The system can be operated safely with the door removed for short periods of time. If the filter is only lightly contaminated with debris, a vacuum cleaner or compressed air may be used for cleaning purposes. Clean the filter by vacuuming up loose debris or by blowing air from the clean side to the dirty side. For filters badly loaded with debris, rinse with cold water or wash with warm water and mild detergent. Be sure the filter is completely dry before re-installing it.

Battery Replacement

If the red Low Battery indicator on the control card turns on, the battery located on the front edge of the card needs replacing. Grasp the exposed edge of the battery with your fingers and pull it towards you to remove it.

Call Miranda for replacement battery information. For contact information, see [Technical Support Contact Information](#) on page iii.

When you insert the new battery, be careful to observe the correct polarity.

Caution

To prevent explosion of the battery and possible equipment damage or harm to personnel, be sure the battery is oriented with the correct polarity. Polarity markings are visible on the card's battery housing.

Replacing Modules

Active cards, power supply modules and backplanes can be replaced or reconfigured in the router frame. Whenever reconfiguring, be sure each active card has the correct corresponding backplane.

Active Cards and Power Supply Modules

All front-loaded active cards and the power supply modules (PS6000) may be removed or installed with the power on ("hot swapped"). Prior to installing a replacement card, verify that user settings are configured correctly. Cards that receive and process serial data from the control card will automatically configure themselves at power up. If a card appears to be defective, first try re-seating it in the frame.

Caution

When removing SWB output cards, be sure to remove the expansion output cards (EM0465) before attempting to remove the main output card (EM0463). Otherwise, damage to the connector "wing" assembly on the main output card may occur.

Backplanes

All but the SWB input and output backplane and the SD input backplane are passive and may be removed at any time. Use the same cautions as exercised with front-loaded modules. Be sure to match backplanes to the corresponding front active cards. The backplanes housing BNC connectors are especially easy to install in the wrong location because they look very similar. However, no damage will normally occur from an unintentional mismatch.

SWB Input/Output and SD Input Backplanes

Unlike other backplanes, SWB input and output and SD input backplanes contain active circuitry. Power to these modules is supplied by the associated active card installed in the front. To remove one of these backplanes, first remove the front associated card containing the power supply circuitry.

Troubleshooting

Many system troubles are caused by easily-corrected errors, such as poor quality or missing input or reference signals, incorrect configuration, and so on. This section lists common problems and their solutions in the most likely order of occurrence. Refer also to the [Introduction](#) on page 3 for an

6. Maintenance

Obtaining Service

overview of the system and its major components. Try troubleshooting the system yourself, and if you are not successful, call Miranda Technical Support as explained near the front of this manual.

In the event that a problem is caused by a bad circuit board, swapping the bad board with a replacement circuit board is the quickest solution. If you need to order replacement boards or other components, see [Technical Support Contact Information](#) on page iii.

Symptom	Possible Causes and Solutions
System not powering up.	Verify that the power cord(s) are plugged into the frame and the AC power source. Use a voltmeter to verify the presence of power. Check the AC line fuse on the power supply module. See Fuse Replacement on page 76.
One or a few PS6000 power supply modules not powering up or not operating properly.	Check that the PS6000 is fully seated in the frame. Reset the PS6000 by reseating it in the frame. Check that all five green LEDs on the front of the power supply modules are lit. If an LED is not lit, it indicates a branch circuit may be faulty, which could affect only certain modules in the frame. Replace the power supply. Check PS6000 fuses. See Fuse Replacement on page 76.
Intermittent signal on one or two outputs.	Check input and output cable continuity. Check AES Reference. Check Video Reference. Check cable terminations. Possible bad card. Swap each card in the signal path with another card to see if the problem moves with the card. If so, replace the card. If all cables, terminations, and cards check out OK, call Technical Support. (See Technical Support Contact Information on page iii.)
Intermittent or missing signals on all outputs.	Problems with the AES reference inputs could cause all inputs to operate intermittently or not at all. Check the quality of the reference signals and their cable connections. Check the control card, which processes the references to produce sync. A synchronous system requires an operational control card in order to pass signals. An asynchronous system will operate in its last state even if the control card is removed. Change over to the reserve control card to see if the problem goes away. Possible low voltage on power supply module. Check power test points on power supply. Voltages at power supply test points may be slightly high in lightly loaded systems. Replace the power supply if any test points indicate low voltage.

Obtaining Service

For service advice, warranty exchange, warranty repair, or out-of-warranty repair:

- 1 Call Miranda Customer Support at the telephone number in the front of this manual under the heading [Technical Support Contact Information](#) on page iii. Our Customer Service Personnel will help you resolve any service issues.
- 2 If you need an exchange or repair, Miranda will assign you a Return Material Authorization (RMA) number. **Do not return equipment without first receiving an RMA number.** Miranda uses the RMA to track receipt of the equipment and to record repair or replacement information.

For out-of-warranty equipment, the Miranda Technical Support Engineer estimates the cost of repair when you call and requests a purchase order payable to Miranda.

6. Maintenance

Obtaining Service

If repair or exchange is required, package the assembly in an antistatic bag and place it in a shipping box with plenty of padding to prevent damage.

- 3 Address the package using the Shipping Address listed in the front of this manual under the heading [Technical Support Contact Information](#) on page iii, and ship the equipment to Miranda at your company's expense.
- 4 When repair or replacement of in-warranty equipment is complete, Miranda return ships the items at our expense. For out-of-warranty equipment Miranda charges a shipping and handling fee. The standard shipping method is Second Day.

For out-of-warranty service, Miranda will send your company an invoice following the repair or replacement.

6. Maintenance

Obtaining Service

7. Technical Details

Chapter 7 provides electrical, video, audio, and mechanical specifications for the NV5128. It discusses these topics:

- [Power Specifications \(Internal, PS6000\)](#)
- [Physical Specifications](#)
- [Environmental Specifications](#)
- [Audio Specifications](#)
- [Video Specifications](#)
- [Time Code Specifications](#)
- [Machine Control Specifications](#)

Power Specifications (Internal, PS6000)

The following table provides power specifications for the NV5128 Multi-Format Router's internal power supplies (PS6000):

Specification	Details
AC input	90–130 or 180–250 VAC, 50/60 Hz, Auto-ranging
AC fuses	Power Supplies: 8A (part number HB0145-00), slow-blow; 90–130 V 6.3A (part number HB0031-00), slow-blow, 180–250 V
AC connectors	2, IEC 320
AC power	PS6000, 660 Watts, one IEC 320
AC power usage	Note: Power is based on PS6000 modules and power consumption dependent on number of cards installed. 425 Watts nominal (128×128 SD), power factor corrected. 550 Watts nominal (128×128 SWB), power factor corrected. 260 Watts nominal (128×128 Analog Video), power factor corrected. 500 Watts nominal (128×128 AVC), power factor corrected. 225 Watts nominal (128×128 Sync AES), power factor corrected 625 Watts nominal (128×128 Analog Audio), power factor corrected.
Regulatory	UL listed and CE compliant

7. Technical Details

Physical Specifications

Physical Specifications

The following table provides physical specifications for the NV5128 Multi-Format Router:

Specification	Details
Dimensions	8RU (13.97 inches, 354.8 mm) high 19.0 inches (482.6 mm) wide 18.0 inches (457.2 mm) deep
Weight	56 lbs (25.5 kg); 182 lbs (82.7 kg) fully loaded.
Mounting	EIA 310-C, 19.0 inches (482.6 mm)
Grounding terminal	Copper, accepts 14–6 AWG
Modules and slots	8 input cards, 16 signals each, 8 output cards, 16 signals each, 2 control cards (1 primary, 1 optional secondary), 1 fan module, 2 PS6000 power modules (1 required, 1 optional redundant).
Diagnostic	Standard: SMPTE 207M, RS-422/RS-232, configurable. Connectors: 2, DE9
Serial control	Standard: SMPTE 207M, RS-422 Connectors: 4, DE9 (2 per control card)
Ethernet	10/100baseT, IEEE 802.3 Protocol: Miranda Ethernet protocol Connectors: 2, RJ-45
GSC “Node Bus”	Standard: proprietary, serial Connectors: 2, BNC, loop-through, non-terminating pair. Impedance: 75 Ω
Power supply alarm	Connector: Phoenix, 3-pin

Environmental Specifications

The following table provides environmental specifications for the NV5128 Multi-Format Router.

Specification	Detail
Operating temperature	0 to 40°C.
Relative humidity	0 to 90%, non-condensing.

Audio Specifications

The following table provides audio specifications for the NV5128 Multi-Format Router.

Specification	Detail
Audio reference input	Standard: AES3 or AES3-id (serial digital audio). Sample rate: 48 kHz. Connectors: 2, BNC or Phoenix. Impedance: 75 Ω or 110 Ω . Input level: 0.5 Vpp to 2.0 Vpp.
AES3 inputs and outputs	Standard: AES3 (balanced digital audio). Sample rate: synchronous 48 kHz; asynchronous 32–96 kHz. Connectors: Phoenix. Impedance: 110 Ω Input level: 200 mV to 10 Vpp. Output level: 2 Vpp.
AES3-id inputs and outputs	Standard: AES3-id (unbalanced digital audio). Sample rate: synchronous 48 kHz; asynchronous 32–96 kHz. Connector: BNC. Impedance: 75 Ω Input Level: 100 mV to 1.2 Vpp.
Analog audio inputs and outputs	Standard: 24-bit at 48 kHz (analog audio). Sample rate: 48 kHz. Connector: DB25 Impedance: input > 20 k Ω , output 50 Ω . Input level: FSD, +15, +18 and +24 dBu. Output level: FSD, +15, +18 and +24 dBu, selectable +6 dB gain via switch. Frequency response: 20 Hz to 20 kHz \pm 0.2 dB THD: < 0.02% at +4 dBu at 1 kHz IMD: < 0.5% (per SMPTE method using a 60 Hz +12 dBu wave and a 7 kHz, 0 dBu, sine wave. Noise: 95 dB below +24 dBu. Inter-route delay: < 1 μ S. Input-to-output delay: < 1.2 mS Crosstalk: –80 dB, worst case. Insertion gain: \pm 0.1 dB. CMRR: > 75 dB from 60 Hz to 20 kHz.

Video Specifications

The following table provides video specifications for the NV5128 Multi-Format Router:

Specification	Detail
Video reference input	Type: analog video reference. Standard: PAL, NTSC, or tri-level sync. Connector: loop-through, BNC. Impedance: 75 Ω or Hi-Z (greater than 20 k Ω), not selectable. Input Level: 0.5 Vpp to 2.0 Vpp. Input Return Loss: \geq 30 dB to 5 MHz.

7. Technical Details

Video Specifications

Specification	Detail
SD inputs and outputs	<p>Type: standard definition, serial digital video. Standard: SMPTE 259M and 344M. Data rates: Automatic reclocking at 143, 177, or 270 Mb/s or automatic bypass. Data rates: Pass-through at 10 Mb/s to 270 Mb/s. Connector: BNC. Impedance: 75 Ω. Cable equalization: 300 m Belden 1694A, or equivalent cable, at 270 Mb/s. Router path: non-inverting. Input and output return loss: > 15 dB, 5 to 270 MHz. Output level: 800 mVpp \pm 10%. Output rise/fall time: 600 ps \pm 10%. Output overshoot: \leq 10% of max amplitude. Output alignment jitter: \leq 0.2 UIpp from 1.0 kHz to 27 MHz Output timing jitter: \leq 0.2 UIpp from 10 Hz to 1.0 kHz</p>
SWB (SD and HD) inputs and outputs	<p>Type: high definition, serial digital video. Standard: SMPTE 259M, 344M and 292M. Data rate: Auto re-clocking at 143, 177, 270, 360, 540 Mb/s and 1.483 and 1.485 Gb/s or auto bypass. Data rate: pass-through at 10 Mb/s to 1.5 Gb/s. Connector: BNC. Impedance: 75 Ω. Cable equalization: 150 m Belden 1694A, 85 m Belden 1855A, or equivalent cable, at 1.5 Gb/s. Router path: non-inverting. Output level: 800 mVpp \pm 10%. Input and output return loss: > 15 dB, 5 MHz to 1.5 GHz. Output rise/fall time: \leq 270 ps. Output overshoot: \leq 10% of max amplitude. Output alignment jitter: \leq 0.2 UIpp from 100 kHz to 150 MHz. Output timing jitter: \leq 1.0 UIpp from 10 Hz to 100 kHz.</p>
Analog video inputs and outputs	<p>Type: Analog video./ Standard: NTSC, PAL. Connector: BNC, impedance: 75 Ω Input return loss: > 45 dB to 6 MHz. Output return loss: > 45 dB to 6 MHz. Input level: 1 Vpp. Output level: 1 Vpp, nominal. Output DC offset: \pm3 mV, relative to backporch. Input range: \pm2 V. Insertion loss: 0 dB \pm0.1 dB, all inputs to any one output. Frequency response: \pm0.1 dB to 8 MHz. Differential gain: < 0.1 dB. Differential phase: < 0.1 degrees. Tilt: < 0.2%. Delay scatter: \pm1.75 degrees any input to any output, \pm1.5 degrees any input to any output slot (16 outputs), \pm1.0 degrees any input to any single output. Noise spectrum: > 80 dB with pedestal unweighted to 7 MHz. CMRR: > 60 dB to 10 kHz. Crosstalk: 57 dBrms, worst case (100% PAL color bars), 72 dBrms, worst case (single to adjacent crosstalk). Output-to-output isolation: >40 dB.</p>

7. Technical Details

Time Code Specifications

Specification	Detail
Analog/digital video conversion	Type: analog digital video. Standard: NTSC, PAL analog composite video. Connector: BNC, Impedance: 75 Ω Level: 1 Vpp, nominal. Common mode range: ± 2 Vpp. Frequency response (input): ± 0.5 dB to 5.5 MHz (luminance). Frequency response (output): ± 0.2 dB to 5.5 MHz (luminance). Luma/chroma delay: < 12 ns. Luma/chroma gain inequality: < 0.5 dB. Differential gain: < 0.3%. Differential phase: < 0.3 degrees. Pedestal (input): > 75 dB, unweighted. Pedestal (output): > 75 dB, unweighted. Ramp (input): > 50 dB, unweighted. Ramp (output): > 62.5 dB, unweighted.

Time Code Specifications

The following table provides time code specifications for the NV5128 Multi-Format Router:

Specification	Detail
Time code reference input	Type: 1 BNC, 1 Phoenix. Standard: SMPTE 12M. Connector: BNC terminating, Phoenix. Data Rates: 1/30th to 80 times normal. Impedance: 75 Ω or 110 Ω .
Time code inputs and outputs	Type: longitudinal time code. Standard: SMPTE 12M. Connector: Phoenix. Data Rates: 1/30th to 100 times normal. Impedance: 600 Ω or Hi-Z (> 20 k Ω), not selectable. Input Level: 100 mV to 10 Vpp. Output Level: 2.0 Vpp.

Machine Control Specifications

The following table provides port machine specifications for the NV5128 Multi-Format Router:

Specification	Detail
Machine control inputs and outputs	Type: bidirectional, dynamically configured. Standard: RS-422 (Optional RS-232), ANSI/SMPTE 207M. Connector: RJ-45. Data rates: up to 115.2 kb/s.

7. Technical Details

Machine Control Specifications

8. Glossary

Chapter 8 is a glossary.

Glossary

Active Cards	See Modules.
AES	Audio Engineering Society, Inc., New York, www.aes.org .
AES/EBU	(Audio Engineering Society/European Broadcasting Union) a professional serial interface for transferring digital audio from CD and DVD players to amplifiers and TVs. AES/EBU is typically used to transmit PCM and Dolby Digital 5.1, but is not tied to any sampling rate or audio standard.
AES3, AES3-id	The AES routers support AES3-id and provide 75Ω BNC connectors. AES3-id uses 75Ω coaxial cable up to 1000 meters. (AES3 uses 110Ω shielded twisted pair (STP) cable with XLR connectors up to a distance of 100 meters.)
Analog Audio	A signal where the instantaneous voltage is proportional to the diaphragm velocity at the microphone.
Async AES, Sync AES	The term “Async AES” refers to an asynchronous AES-compliant audio signal, whereas “Sync AES” refers to a synchronous AES signal with a data rate of 48 kHz. A system where various signals are unlocked (not synchronized). Switching between signals leads to unpredictable results.
AVC	“Analog Video Conversion.” Miranda uses this abbreviation to describe a simple conversion technique used to create an SD digital output signal from a composite analog video input, or to describe the means by which SD signal is coded into an analog composite video output signal. Path delay and subcarrier phase may not be precisely maintained in an AVC conversion path within an NV5128 frame. AVC coding provides a cost-effective method to provide feeds to picture monitors without requiring an external conversion device. AVC modules are not a substitute for professional-grade format converters.”
Backplane	Modular, rear-mounted assemblies containing the NV5128’s input and output connectors.
D/A	Digital to analog
DC	Direct Current
dBu	Unit of audio level where 0dBu is 0.775 Vrms.
DB25	A DB25 connector is the common 25-pin subminiature D connector. Most modern PCs use a female DB25 connector for the printer parallel port connector.
DE9	Sometimes mistakenly referred to as a DB9 connector, a DE9 connector is the common 9-pin sub-miniature D connector. The serial port of modern PCs employ a male DE9 connector.
Device	As the term is used in a NV9000 system, a device is a grouping of input and output ports that define a logical entity. (The logical entity does not have to be a real entity.) For example, a system might have 3 levels: video, AES, and time code. A hypothetical device in this system is Camera 1, which

8. Glossary

Glossary

consists of video on input port 1 of the video router, AES on input port 5 of the AES router, and time code on input port 8 of the time code router. (The NV5128 does presently include time-code routers.)

EIA	Electronic Industries Alliance. The EIA (until 1997 Electronic Industries Association) is a trade organization for electronics manufacturers in the United States. EIA is accredited by the American National Standards Institute (ANSI) to help develop standards on electronic components, consumer electronics, electronic information, telecommunications, and Internet security.
ESD	Electrostatic discharge
HD	HD and HD-SDI are equivalent in Miranda terminology. An HD signal is a high definition, serial digital interface video format that conforms to the SMPTE 292M standard.
Hot-Swappable	A module that is “hot-swappable” can be safely removed and/or installed while power is applied to the system.
I/O	Inputs and outputs are the physical connections (e.g., BNCs) on the back of the routing switcher. The term “input port” is used interchangeably with “input” and the term “output port” is used interchangeably with “output.”
Jumpers	Jumpers are small, plastic sleeves that fit over a set of pins. The placement of the jumper either turns a function on or off, or reconfigure a function.
LED	Light Emitting Diode
Matrix	<ol style="list-style-type: none">1. The rack-mounted NV5128 chassis or frame which contains the subassemblies (modules, backplanes, power supplies, etc.) which comprise the NV5128.2. An X-Y array of crosspoint switches, a <i>crosspoint matrix</i>.
Module	<ol style="list-style-type: none">1. In the NV5128, modules are electronic assemblies that plug into the matrix. Modules include but are not limited to input, output and controller printed circuit boards also called active cards.2. Any removable subassembly may be referred to as a module. NV5128 backplanes may occasionally be referred to as modules.
Operator	The term operator usually refers to users other than the system administrator. An operator is responsible for making most of the routes.
Physical Level	In a Multi-Format Router system, a physical level is the same thing as a router. The idea is that multiple routers provide different “levels” on which to switch the signals of devices. Any particular device might send or receive HD, SD, AES, time-code, or machine-code signals. A Multi-Format Router switches one type, or level, of a device’s signal set.
Physically Contiguous	Matrix modules are said to be in physically contiguous slots in an NV5128 frame when both the inputs and outputs associated with those slots are in numerical sequence. For example, input slots 5 and 6 are physically contiguous because inputs 1-16 and 17-32 are in numerical sequence. In the same way, output slots 4 and 16 are contiguous because outputs 49-64 (slot 4) and 65-80 (slot 16) are in numerical sequence.
Port	A port is the physical connection on a router. In a Multi-Format Router system, a port can only be an input port or an output port.
Reference Signal	A timing signal used to synchronize events such as the switching of video signals during a specific portion of the vertical interval. Reference signals are externally applied. In their absence, internally generated signals are used to sustain operation.

RAM	Random Access Memory
RJ45, RJ-45	Registered Jack, type 45 as defined in the United States Code of Federal Regulations. A common 8-pin modular plug and/or jack used in the telecommunications and broadcast industry to transport Ethernet or machine control signals.
RS-422	Sometimes referred to as RS-422 or TIA/RS-422-B and other similar variations. A bidirectional communications standard. The use of this term implies that Miranda refers to the latest standard in effect at the time the product was developed.
RU	Rack Units. A standard measure or size for frames (1.75 inches).
SD	SD and SDI are equivalent terms in Miranda documents. An SD signal is a standard definition, serial digital interface video format that conforms to the SMPTE 259M standard.
Source/Destination	<p>The term “source device” is used interchangeably with “source” and the term “destination device” is used interchangeably with “destination.” A source is a device that is connected to one or more input ports. A destination is a device that is connected to one or more output ports. An example of such a device would be a monitor.</p> <p>A device can be both a source and destination. An example of such a device is a VTR.</p>
SWB	<p>(Super Wide Band). A term originated by Miranda that refers to the ability of a router to pass a wide range of digital bit rates and formats. Miranda’s SWB supports data rates from about 15Mb/s to 1.5GB/s.</p> <p>Input signals must be nominally 800mV p-p and bi-level or tri-level in nature. The NV5128 video routers bypasses re-clocking for non-video rates. Rates that <i>are</i> re-clocked include common SD data rates of 143 and 270 Mb/s (SMPTE 259M-A and -C, but not B or D) and HD data rates at nominally 1.485Gb/s. SWB accepts SD at 177 Mb/s, but does not reclock it.</p>
Sync AES, Async AES	The term “Async AES” refers to an asynchronous AES-compliant audio signal, whereas “Sync AES” refers to a synchronous AES signal with a data rate of 48 samples per second.
System administrator	The system administrator is the person responsible for installing, configuring, and maintaining a router control system.
Time Code	A linear time code signal complying with SMPTE 12M or the corresponding EBU standard.
UniConfig	A Windows-based application (Universal Configuration) used to configure Miranda products using a serial or Ethernet connection. UniConfig uses an easy-to-learn GUI (Graphical User Interface) to simplify the configuration process.

8. Glossary

Glossary

A. Part Numbers

Appendix A provides part numbers for cards, card sets and backplanes used for the NV5128. It discusses the following topics:

- [Cards, Card Sets, and Backplanes](#)
- [Power Supplies](#)

Cards, Card Sets, and Backplanes

Analog and Digital Audio

This table lists all the audio I/O cards and associated backplanes:

Part	Name or Function	Backplane(s)	Slots	Compatible with...
EM0389	AES synchronous input module	EM0393 (BNC) EM0391 (TP)	1	EM0586 (analog audio out) EM0390 (sync AES out)
EM0390	AES synchronous output module	EM0394 (BNC) EM0392 (TP)	1	EM0585 (analog audio in) EM0389 (sync AES in)
EM0387	AES asynchronous input module	EM0393 (BNC) EM0391 (TP)	1	EM0388 (async AES out)
EM0388	AES asynchronous output module	EM0394 (BNC) EM0392 (TP)	1	EM0387 (async AES in)
EM0500	AES sample rate converter (SRC) input module	EM0393 (BNC) EM0391 (TP)	1	EM0586 (analog audio out) EM0390 (sync AES out)
EM0585	Analog Audio input module	EM0381 (DB25)	1	EM0586 (analog out) EM0388 (sync AES out)
EM0586	Analog Audio output module	EM0382 (DB25)	1	EM0585 (analog in) EM0389 (sync AES in)

Note

The abbreviation “TP” in the above table denotes Phoenix-type connectors used for shielded twisted-pair cables.

A. Part Numbers

Cards, Card Sets, and Backplanes

Analog Video and Standard Definition (SD)

The table lists the analog and SD I/O cards and associated backplanes:

Part	Name or Function	Backplane(s)	Slots	Compatible with...
EM0375	Analog video input module	EM0377 (BNC)	1	EM0376 (analog video out)
EM0376	Analog video output module	EM0378 (BNC)	1	EM0375 (analog video in)
EM0383	SD digital video input module	EM0385 (BNC)	1	EM0384 (SD video out) EM0433 (AVC video out)
EM0384	SD digital video output module	EM0386 (BNC)	1	EM0383 (SD video in) EM0432 (AVC video in)
EM0432	Analog-to-SD video input module (AVC Video In)	EM0377 (BNC)	1	EM0384 (SD video out) EM0433 (AVC video out)
EM0433	SD-to-analog video output module (AVC video out)	EM0378 (BNC)	1	EM0383 (SD video in) EM0432 (AVC video in)

SWB (High Definition and Standard Definition Combined)

This table lists all of the SWB I/O cards and associated backplanes:

Part	Name or Function	Backplane(s)	Slots	Compatible with...
EM0395	Classic SWB 16×16 digital video I/O module (Slots 12 & 13)	EM0396 (1 ea.) EM0424 (1 ea.)	2	See Classic SWB on page 28.
EM0395 (2 each)	Classic SWB 32×32 digital Video I/O module (Slots 11 & 12 and 13 & 14)	EM0396 (2 ea.) EM0424 (2 ea.)	4	See Classic SWB on page 28.
EM0466	Standard SWB 16 input digital video Input module (Input)	EM0396 (1 ea.)	1	EM0463 (SWB, 128×64 Out)
EM0463	Standard SWB digital video output module, 16 outputs, with support for an additional 48 outputs. See Classic SWB on page 28 and description below for EM0465.	EM0424 (1 ea.)	4	EM0465 (16 SWB outputs. A maximum of three EM0465 modules may be used per EM0463 host.)
EM0465	Standard SWB digital video output module (16 outputs, mates with required EM0463 host module. (Required)	EM0424 (1 for each installed module.**)	*	EM0463 (128×64 SWB output. A maximum of three EM0465 modules may be used per EM0463 host.)

*EM0465 16-output SWB modules plug into slots already occupied by the 4-slot-wide EM0463 host module.

** Use blank plates to cover the rear of unused slots. This is required to maintain proper air flow through the frame.

Machine Control and Time Code

This table lists the port cards and associated backplanes for machine control (port) routing and for switching linear time code signals:

Part	Name or Function	Backplane(s)	Slots	Compatible with...
EM0482	32-port machine control I/O module, standalone (any two slots)	EM0483 (RJ-45) 2 each.	2	N/A
EM0482 (2 each)	64-port machine control I/O module, 2 each (Slots 11 and 12 and 13 and 14)	EM0483 (RJ-45) 4 each.	4	N/A
EM0408	Time code input module (any Input Slot)	EM0415 (TP)	1	EM0409 (time code output module)
EM0409	Time code output module (any output slot)	EM0416 (TP)	1	EM0408 (time code output module)

Control Cards

This table lists the control card. One card is required, but two may be installed for redundancy:

Part	Name or Function	Backplane(s)	Slots
EM0374	Router control card (control card slots 1, 2, or both)**	N/A	1

**Single controllers should be inserted in slot 1. Redundant (backup) modules should be inserted in slot 2.

Power Supplies

This table lists the power supplies used in the NV5128 frame. One module is required, but two may be installed for redundancy:

Part	Name or Function	Backplane(s)	Slots
PS6000	NV5128 power supply	N/A	2 power supply bays, either or both bays

**Single controllers should be inserted in slot 1. Redundant (backup) modules should be inserted in slot 2.

A. Part Numbers

Power Supplies

Index

A

About the product	3
AC power	38
Acrobat usage	
bookmarks	1
hyperlinks	1
navigating and searching	1
Active cards	
About	21
Defined	89
Installation	44
Address	
mailing	iii
AES asynchronous modules, part numbers	93
AES backplane	13
AES Reference connection	18, 57
AES reference connection	57
AES synchronous	
Connections	51
AES synchronous modules, part numbers	93
AES, defined	89
AES/EBU, defined	89
AES3-id (defined)	89
Air flow	4, 78
Alarm connection	20, 64
Alarm connection, diagram	65
Analog	
Connections	52
Gain	53
Mute detection	53
Operation levels	53
Analog and digital, mixing	7
Analog audio modules, part numbers	93
Analog audio, defined	89
Analog backplane	13
Analog signals, about	5
Analog Video Conversion	30
Analog video modules, part numbers	94
Analog/Digital Video Conversion modules, part numbers	94

Analog-to-digital video conversion (AVC), defined	89
Analog-to-digital, audio	25
Analog-to-digital, video	30
Appendix A, part numbers	93
Asynchronous AES modules, part numbers	93
Asynchronous AES, defined	89
Audio	
digital	89
Audio backplanes	43
Audio cards	
AES asynchronous	24
AES SRC (input only)	24
Audio Engineering Society	89
Audio I/O cards	
About	22
AES synchronous	23
Analog audio	25
Power, fuses	22
Status reporting	23
Audio references, about	6
Audio references, mono	7
Audio signals, about	5

B

Backplane, defined	89
Backplanes	
about	13
machine control signals	14
Replacing modules	79
Types and Signals	14
Video signals	13
Backplanes, installing	
About	40
Audio	43
Classic SWB	41
Machine control	42
machine control breakout panel	43
Time code	43
Video	43

Index

Battery replacement	78
BNC connections	13
BNC connector	37
BNC connectors	89
Bold-face or capital letters	2
Bookmarks, Acrobat	1
BP-PORT-64	56
Branch circuits	38
Breakout panel	56

C

Cable

Ethernet	36
RS-232	36

Capital or bold-face letters	2
------------------------------	---

Card slots	9–10
------------	------

Cards

AES asynchronous	24
AES SRC	24
AES synchronous	23
Analog	25
Analog video	29
Audio I/O	22
AVC	30
Classic SWB	28
Control	21
Machine control	31
Replacing modules	79
SD	27
Standard SWB	28
Time code	32
Video	26

Cards, installing

About	44
Already installed	44
Classic SWB	46
Classic SWB, limitations	47
Configuration tasks	47
How to	49
Machine control	46
Machine control, limitations	47
Partitions and installation	45
Rules	45
Standard SWB	45
system clock generator	44
Typical combinations	48

Cards, types of	21
-----------------	----

CE declaration	ii
----------------	----

Channels, mono signals	7
------------------------	---

Chapter structure	1
-------------------	---

Chapters

1, Preface	1
2, Introduction	3
3, Installation	35
4, Configuration	67
5, Operation	73
6, Maintenance	75
7, Technical details	83
8, Glossary	89

Circuit boards, about	21
-----------------------	----

Classic SWB

Installing card	46
Installing card, limitations	47
Switching	9

Classic SWB backplanes	41
------------------------	----

Classic SWB modules, part numbers	94
-----------------------------------	----

Cleaning fans	78
---------------	----

Cleaning intake filter	78
------------------------	----

Clock generator module	21
------------------------	----

Clock, systems	21
----------------	----

Combinations, typical	48
-----------------------	----

Configuration	67
---------------	----

Configuration tasks, installing cards	47
---------------------------------------	----

Configuration, introduction	67
-----------------------------	----

Configuration, required PC	36
----------------------------	----

Connecting power	38
------------------	----

Connection

AES reference	57
Alarm	64
Video reference	58

Connector

BNC	37
DE9	36
RJ-45	36

Connectors	16
------------	----

AES reference	18
Alarms	20
BNC	89
Control system expansion	18
DB25	53, 89
DE9	89
Diagnostic	16, 18
Ethernet Control system	17
GSC Node Bus control system	17
I/O	14
References	16
RJ45, RJ-45	56, 91
Router control system	16
Serial control system	17
System	16
Time Code	20
UniConfig	16, 18

Video reference 19
 XLR 89
 Connectors, signals 9, 11
 Connectors, system 9, 11
 Contact information
 technical support iii
 Contiguous, defined 90
 Control card, diagnostic connection 62
 Control cards, about 21
 Control cards, part numbers 95
 Control system connections 59
 About 16
 Ethernet 17, 61
 GSC Node Bus 61
 Serial 17, 59
 Control system expansion connections 18
 Control systems, third-party 74
 Conversion
 A/D, audio 25
 A/D, video 30
 D/A audio 25
 D/A video 30
 Cooling, power supply 5
 Cooling, router 4
 Copyright notice ii
 Customer support 80

D

D/A, defined 89
 DB25 connections 13
 DB25 connectors 53
 dBu, defined 89
 DC, defined 89
 DCE 57
 DE9 56
 DE9 connector 36
 Declaration of conformance (CE) ii
 Destination, defined 91
 Device, defined 89
 Diagnostic connections 18, 62
 Digital and analog, mixing 7
 Digital audio 89
 Digital signals, about 5
 Digital-to-analog, audio 25
 Digital-to-analog, video 30
 Document
 part number ii
 revision ii
 Dolby Digital 5.1 89

DTE 57
 Dual references 19

E

EIA, defined 90
 EM0585 69–70
 EM0586 69, 71
 Email address
 tech support iii
 ESD, defined 90
 Ethernet
 Hub 36
 Ethernet control connections 61
 Ethernet control system connections 17
 European Broadcasting Union 89
 Examples, symbol for 2

F

Fans 78
 Fans, power supply 5
 Fault location 79
 FCC statement ii
 Filter, intake 78
 Filters 4
 Find, Acrobat 2
 First Page, Acrobat 2
 Formats, inter-mixing 7
 Frame
 Front view 11, 50
 Rear View 40
 Rear view 12, 51
 Front slots 9–10
 Fuse Replacement 76
 Fuses, power supply 5
 Fuses, router 4

G

Gain, analog 53
 Glossary 89
 Go to Next View, Acrobat 1
 Go to Previous View, Acrobat 1
 Grounding terminal 40
 GSC Node Bus control connections 61
 GSC Node Bus control system connections 17
 GSC Node Bus router control system connections 17

Index

H

HD modules, part numbers	94
HD, defined	90
Hot-Swappable	9
Hot-Swappable, defined	90
Hub, Ethernet	36
Hyperlinks, Acrobat	1

I

I/O connections	50
Indicator LEDs	76
Control card	77
I/O cards	77
Power supplies	77
Initial router configuration	67
Input signal connections	50
Inspection of router	75
Installation	35
AES reference	57
AES reference connections	57
Alarm connection	64
Audio backplanes	43
Backplanes	40
Classic SWB backplanes	41
Diagnostic connections	62
Ethernet control connections	61
GSC Node Bus control connections	61
Machine Control backplanes	42
machine control breakout panel	43
package contents	36
Router control system connections	59
Rules for	45
Serial control connections	59
Signal I/O connections	50
System clock generator	21
Time code backplanes	43
Time code reference connections	59
Video backplanes	43
Video reference connections	58
Video reference input	58
Installation, cards	
About	44
Cards already installed	44
Classic SWB	46
Configuration tasks	47
How to	49
Limitations	47
Machine control	46
Partitions	45

Standard SWB	45
system clock generator	44
Typical combinations	48
Installation, signals	
About	50
AES synchronous	51
Analog	52
Machine control	55
Phoenix connectors	51
Time code	55
Video	54
Intake filter	78
Inter-mixing signal formats	7
Introduction	3

L

Last Page, Acrobat	2
LED, defined	90
LEDs	76
Control card	77
I/O cards	77
Power supplies	77
Level, physical	90
Location of	
AES reference connection	58
Diagnostic connections	63
Ethernet connections	61
GSC Node Bus connections	62
Serial control connections	60
Video reference connection	58

M

Machine control	
Installing card	46
Installing card, limitations	47
Switching	9
Machine Control backplanes	42
Machine control backplanes	13
Machine control breakout panel	14, 43
Machine control modules, part numbers	95
Machine control signals	
About	5
backplanes	14
Mailing address	iii
Maintenance	75
Maintenance, routine	75
Matrix	
Crosspoint Architecture	8

- Matrix, defined 90
- MCPM, RS-232 port 36
- Miranda
- email, tech support iii
 - mailing address iii
 - main number iii
 - sales number iii
 - technical support iii
 - website address iii
- Mixing analog and digital 7
- Module slots 9–10
- Module, defined 90
- Mono channels 7
- Mono signals
- Connection 53
- Mounting the router 3
- Mounting, router 37
- Mute detection, analog 53
- N**
- Next Page, Acrobat 2
- NV9000 router control system 73
- O**
- Obtaining service 80
- Operating levels, analog 53
- Operating temperature 84
- Operation 73
- Operation, overview 73
- Operator, defined 90
- Output signal connections 50
- Overview of configuration 67
- Overview of operation 73
- Overview of product 3
- P**
- Package contents 36
- Part number, document ii
- Part numbers 93
- Partitions and card installation 45
- PC
- configuration 36
- PC requirements 36
- PCM 89
- PDF documents 1
- navigating and searching 1
- Permanent diagnostic connection 63
- Phoenix connections 13
- Phoenix connectors 51
- Physical level 90
- Placing router into service 67
- Port
- RS-232, MCPM 36
- Port, defined 90
- Power
- Audio cards 22
 - Video cards 27
- Power connection 38
- Power cords 38
- Power supply 4, 38
- Indicators 76
 - Replacing modules 79
- Power supply alarm connections 38
- Power supply connections 38
- Power supply fuses 76
- Power supply modules, part numbers 95
- Power supply, about 4
- Power supply, cooling 5
- Power supply, fuses 5
- Preface 1
- about PDF documents 1
 - chapter structure 1
 - terms, conventions and abbreviations 2
- Previous Page, Acrobat 2
- Problem correction 79
- Product summary 3
- PS6000 power supply module 4
- Installing 38
- R**
- Rack 3
- Rack mount 37
- RAM, defined 91
- Rates, signals 5
- Rear connectors 9, 11
- Redundant references 19
- Reference
- Video, dual 19
 - Video, redundant 19
- Reference connection
- AES 57
 - Video 58
- Reference Signals
- Time Code *Not supported*
- Reference video source 37

Index

References

Audio, about	.6
audio, installation	.57
Defined	.90
Mono	.7
Time code, installation	.59
Video, about	.6
Video, installation	.58
Replacing battery	.78
Replacing fans	.78
Replacing modules	.79
Requirements, PC	.36
Return Material Authorization (RMA)	.iii
Revision	
document	.ii
RJ-45	.56
RJ45 connections	.13
RJ-45 connector	.36
RMA	.iii
Router control system	.73
Router control system connections	.16, 59
Router control system, NV9000	.89
Router, cooling	.4
Router, fuses	.4
Routine maintenance	.75
RS-232	.57
RS-232 port	.36
RS-422	.56
RU, defined	.91
RU, rack size	.3
Rules for installing cards	.45

S

Sales number	.iii
Sample Rate Converter, AES	.24
SD modules, part numbers	.94
Search, Acrobat	.2
Serial control connections	.59
Serial control system connections	.17
Service	.80
Signal rates	.5
Signal types	.5
Signals	
AES synchronous	.51
Analog	.52
Machine control, connections	.55
Making I/O connections	.50
Mono	.53
Time code, connections	.55
Video, connections	.54

Signals and related backplanes	.14
Signals, backplanes	.14
Software version	.ii
Source, defined	.91
Special messages, symbol for	.2
Standard SWB	
Installing card	.45
Switching	.9
Standard SWB modules, part numbers	.94
Standards Organizations, SMPTE	.5
Status reporting	
Audio cards	.23
Control card	.21
Video cards	.27
SWB backplane	.13
SWB, defined	.91
Switching	
Classic SWB	.9
Machine control	.9
Standard SWB	.9
Symbols	
for examples	.2
for special messages	.2
Synchronous AES modules, part numbers	.93
Synchronous AES, defined	.89
System administrator, defined	.91
System alarm connections	.65
System clock generator, installing	.44
System connections	.59
System connections, location of	.16
Systems clock generator	.21

T

Technical details	.83
Technical support	.iii
Telephone number	
main	.iii
sales	.iii
technical support	.iii
Temperature, operating	.84
Temporary diagnostic connection	.62
Terms, conventions and abbreviations	.2
Third-party control systems	.74
Time code backplanes	.43
Time Code connections	.20
Time code reference connections	.59
Time code signals	
About	.5
Time code, defined	.91
Trademarks	.iii

Troubleshooting	79
Types of backplanes	14
Types of signals	5
Typical combinations of cards	48

U

UniConfig, connecting to	62
Uniconfig, connections to	18
UniConfig, defined	91
User's guide, chapter structure	1

V

Verification, installation	65
Version, software	ii
Video backplanes	43
Video I/O cards	
About	26
Analog video	29

AVC	30
Machine control	31
Power, fuses	27
SD	27
Standard SWB	28
Status reporting	27
Time code	32
Video reference connection	58
Video reference connections	19, 58
Video references, about	6
Video signals, backplanes	13

W

Website, Miranda	iii
------------------------	-----

X

XLR connectors	89
----------------------	----

Index