



naturebytes

Wildlife cam kit guide
Version 2

Ages 8 +





About this guide and your kit

The guide

This guide will take you through the assembly process and give you all the information you need to know to get started with your naturebytes wildlife cam Kit.

Use the images and read the description carefully to help you through each step.



Attention! When you see these symbols pay particular attention to make sure everything is assembled correctly.

What is the naturebytes wildlife cam kit ?

The naturebytes wildlife cam kit is a wildlife camera that anyone can build to take stealthy high definition images of wildlife. Beginner, expert, wildlife enthusiast or hacker, the Raspberry Pi powered kit is a fun way to develop your digital making skills and gain a new insight into the natural world around you



This kit contains small parts. DO NOT allow children under 5 years old to play with or near this product.





- 1. Check List**
- 2. The PIR Sensor**
- 3. The LiPo Rider**
- 4. The Camera**
- 5. The Raspberry Pi and Real Time Clock**
- 6. The Battery**
- 7. The Case**
- 8. Testing Your Kit**
- 9. Tip and Tricks**
- 10. Additional Features**





Check list

Open your kit and check you have all of the components displayed :

- Case
- Raspberry pi Camera V2
- Strap
- Raspberry Pi A+
- SD Card
- USB
- RTC (Real time clock)
- PIR Sensor
- Main Insert
- USB Wire
- Rechargeable Battery
- Battery holder
- Lipo rider
- Lipo rider holder
- 3 x Wires - Black, Yellow, Red
- Velcro dots
- 3 x Wire ties
- 6 x Large Screws 6 mm
- 7 x 25 mm Screws
- 2 x 12 mm Screws
- 9 x Brass nuts
- 2 x Spacer 18 mm
- 5 x Spacer 15 mm
- 2 x Spacer 3 mm





The PIR Sensor

What is a PIR sensor ?

The PIR (Passive InfraRed) sensor is a clever part of your kit. The sensor can detect invisible radiation from warm blooded animals (birds, foxes, dogs and even you). When a warm blooded animal walks past the kit, the PIR sensor will detect it and trigger the camera to take a photo!





The PIR Sensor

Task 1 - Connecting the PIR sensor wires

Attach the three colour wires to the sensor pins. The three PINs are labelled (from left-right in image) VCC, OUT and GND. Make sure the correct colour cable is connected to the correct pin as follows:

- Red Wire - VCC
- Yellow Wire - OUT
- Black Wire - GND

Note: your PIR sensors may vary from that in the image.

What you will need :

PIR



Wires



Red
Yellow
Black

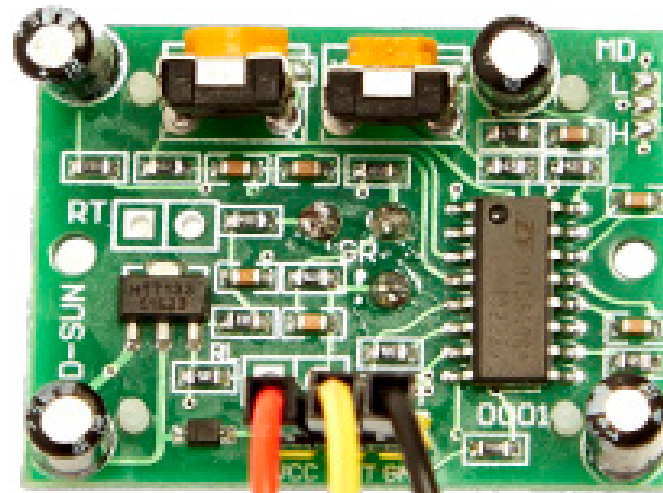

VCC - Red wire

GND - Black wire

OUT - Yellow wire





The PIR Sensor

Task 2 - Feeding the wire through the insert

Feed the wire through the insert. Pass the jumper wires through the lower-middle hole as highlighted in the image below. Make sure that the wires are fed through the correct side of the insert.

What you will need :

Main Insert

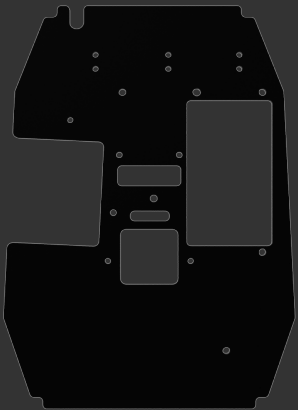

PIR Assembly



Front of Insert to hold the PIR and Camera

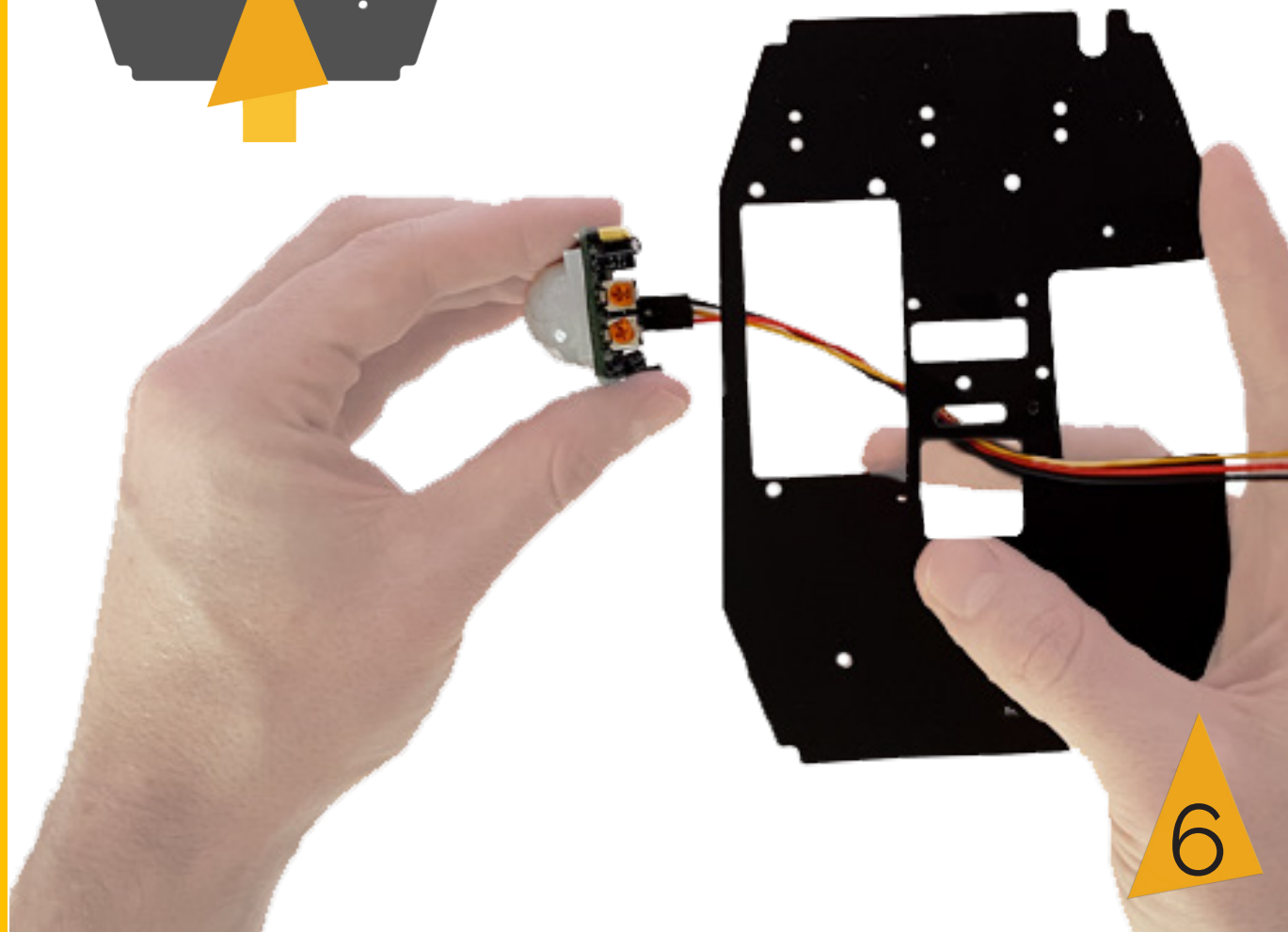



The PIR Sensor

Task 3 - Secure the PIR sensor

Screw the PIR onto the insert making sure the spacers go between the two. See the diagram for how the setup works.

What you will need :

2 x 25 mm Screws

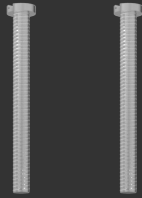

2 x 15 mm Spacers



2 x Brass nuts



Insert from Task 2

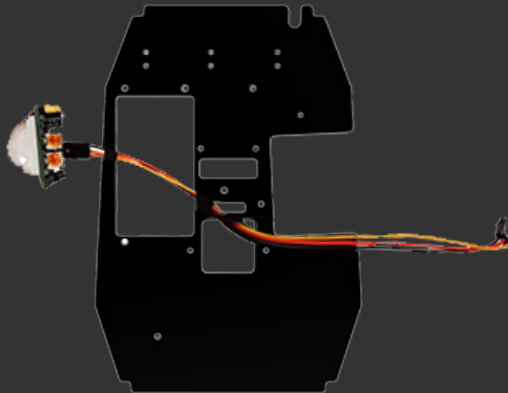

Make sure you are using the correct size spacers and screws. Use a ruler to double check them.

15 mm Spacer 25 mm Screw

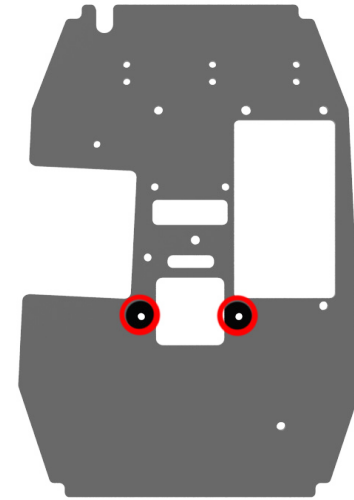
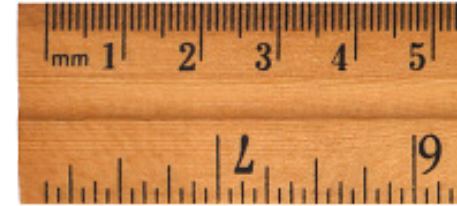

PIR Hole location

i)

ii)

25 mm Screw



15 mm Spacer

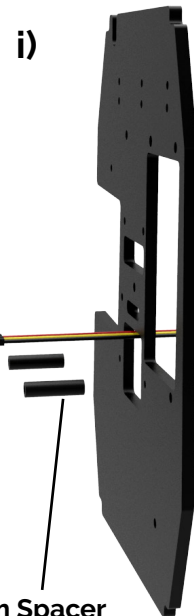

Brass Nuts

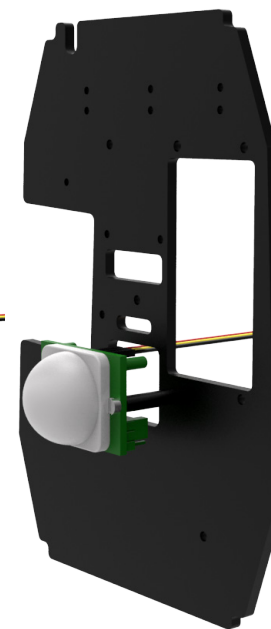



The PIR Sensor

Task 4 - Feeding the wires back through the insert

Feed the wires through the insert from the back to the front, as shown in the diagram

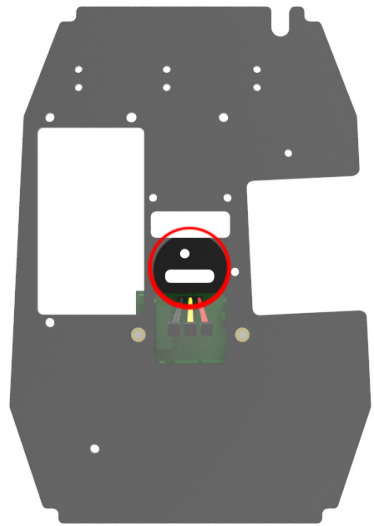

2nd hole location for PIR wires

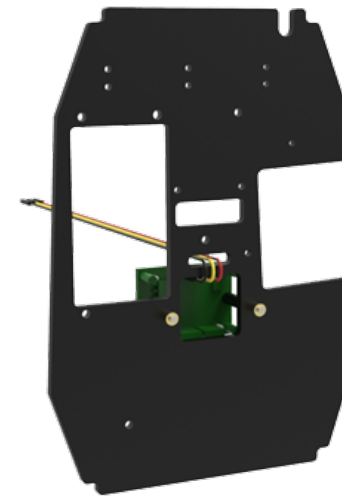
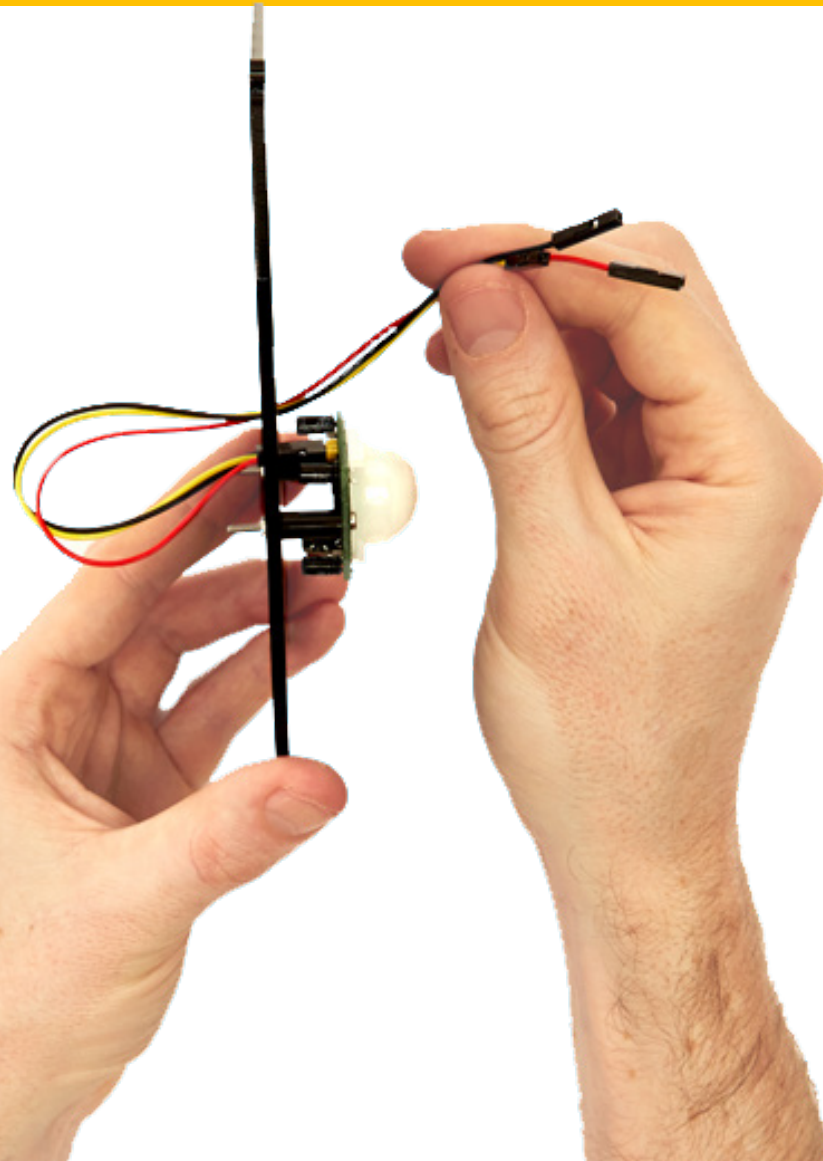

Back of insert

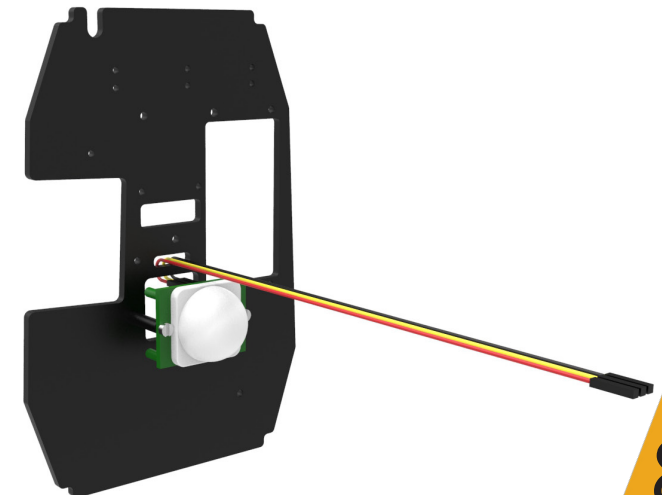

Front of insert



Controlling the power

The LiPo Rider

The LiPo Rider board allows you to connect power to your wildlife cam kit. It boosts and regulates the power from the rechargeable battery to the Raspberry Pi and allows for the battery to be charged using a micro USB charger. It even enables the kit to be powered by solar power.

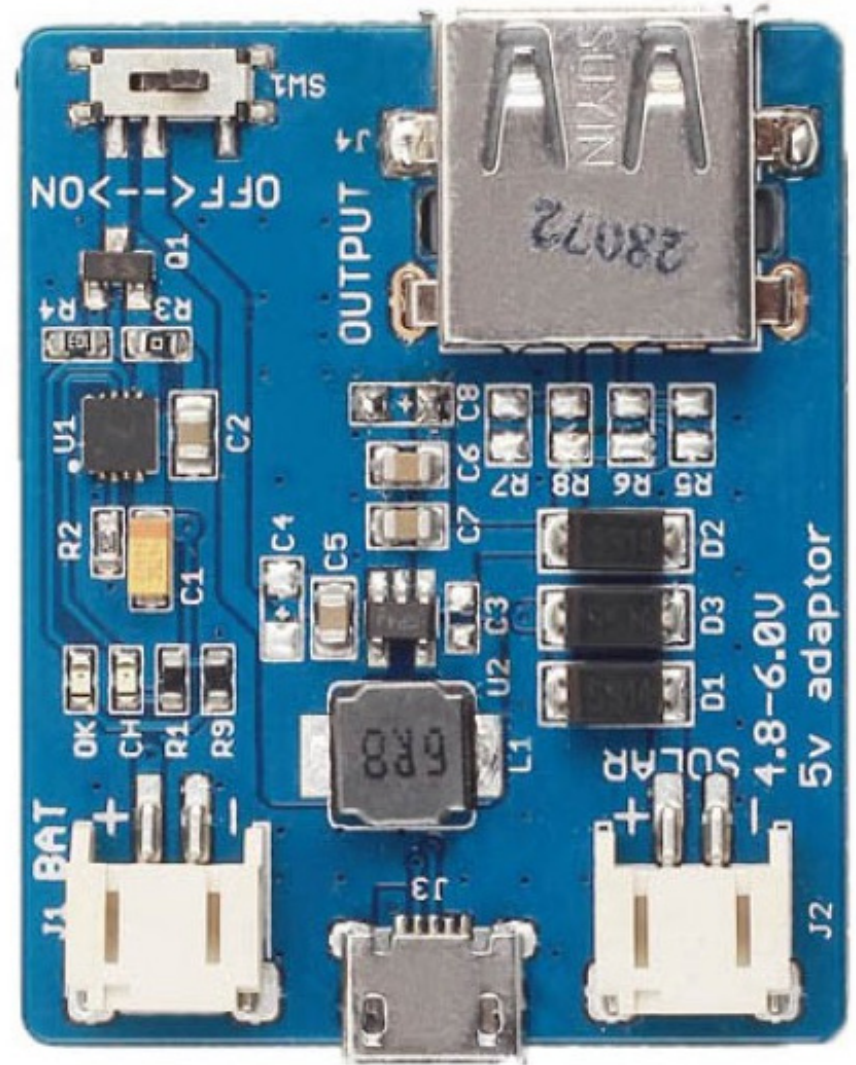



The LiPo Rid-

Task 5 - Secure the LiPo Rider

Attach the LiPo Rider to the insert using the LiPo holder. Make sure the spacers are placed between the insert and the LiPo holder. See the diagram for how the setup works.

What you will need :

2 x 12 mm Screws

2 x 3 mm Spacers

2 x Brass nuts

LiPo Rider

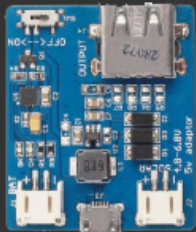

Insert from Task 4

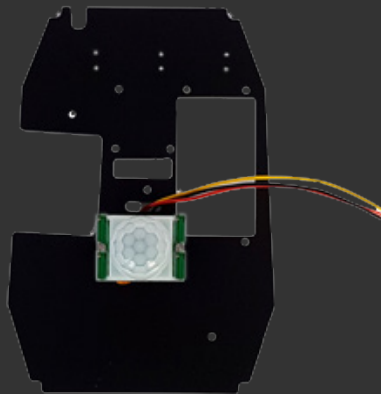

LiPo holder

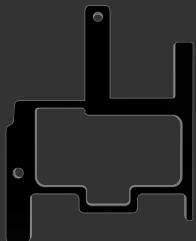

Make sure you are using the correct size spacers and screws. Use a ruler to double check them.

3 mm Spacer 12 mm Screw

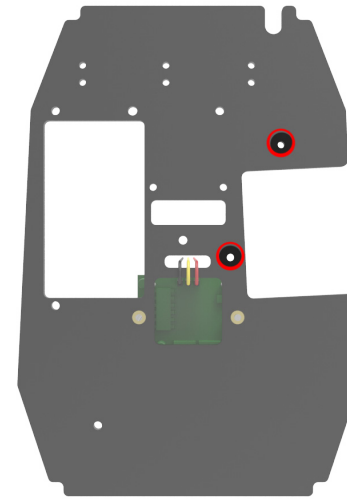

LiPo Rider hole location

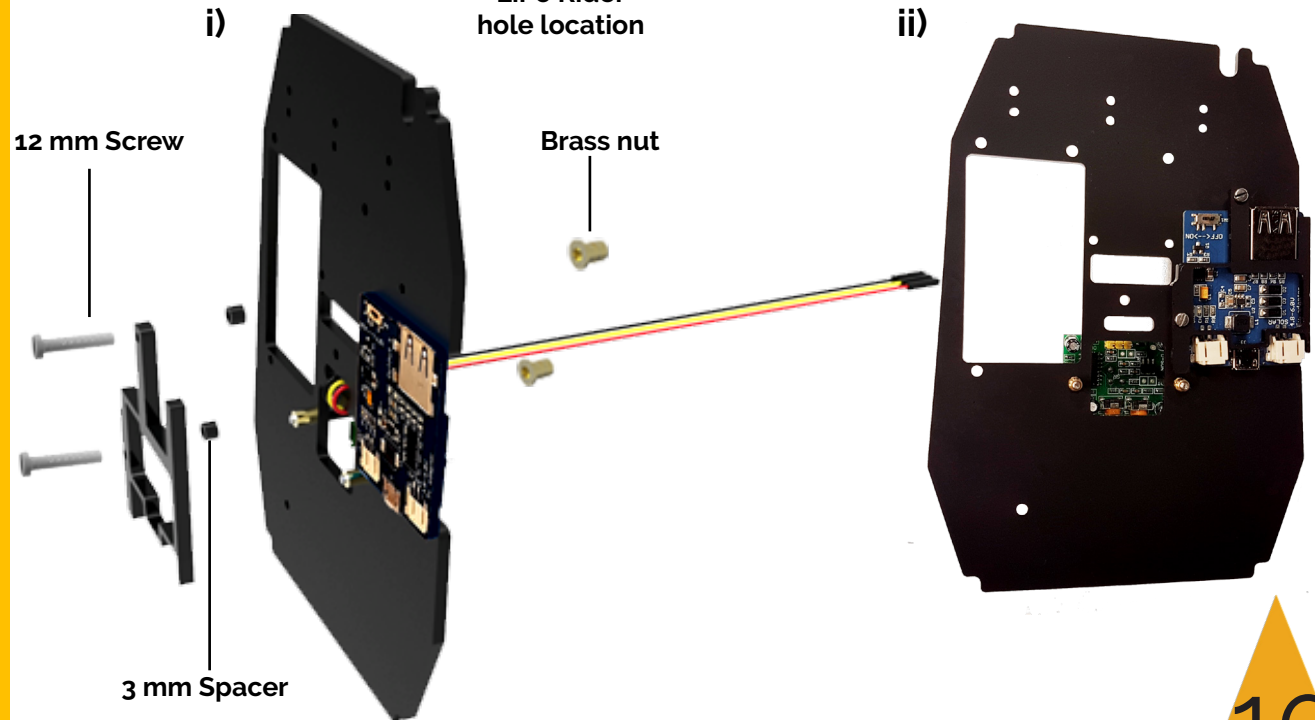



The Camera

About the Camera

The Raspberry Pi v2 camera module can be used to take high-definition video and stills photographs.

It is a 8-megapixel camera with a fixed focus that connects to the Raspberry pi through the ribbon.

Product Description:

Size: 25 mm x 23 mm x 9 mm

Resolution: 8-megapixels

Static images: up to 3280 x 2464 pixels

Video Mode: up to 1080p

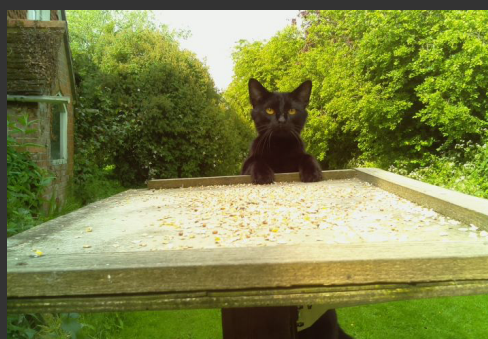



The Camera

Task 6 - Feed the camera ribbon through the insert

Next feed the ribbon through the insert from the front (same side as the PIR), to the rear side with the LiPo rider.

What you will need :

Camera

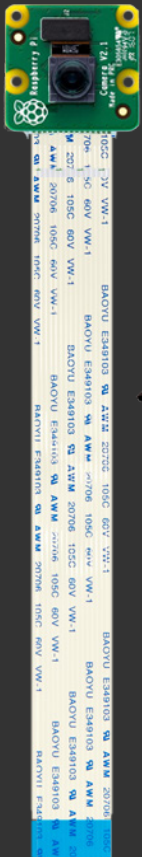

Insert assembly from Task 5

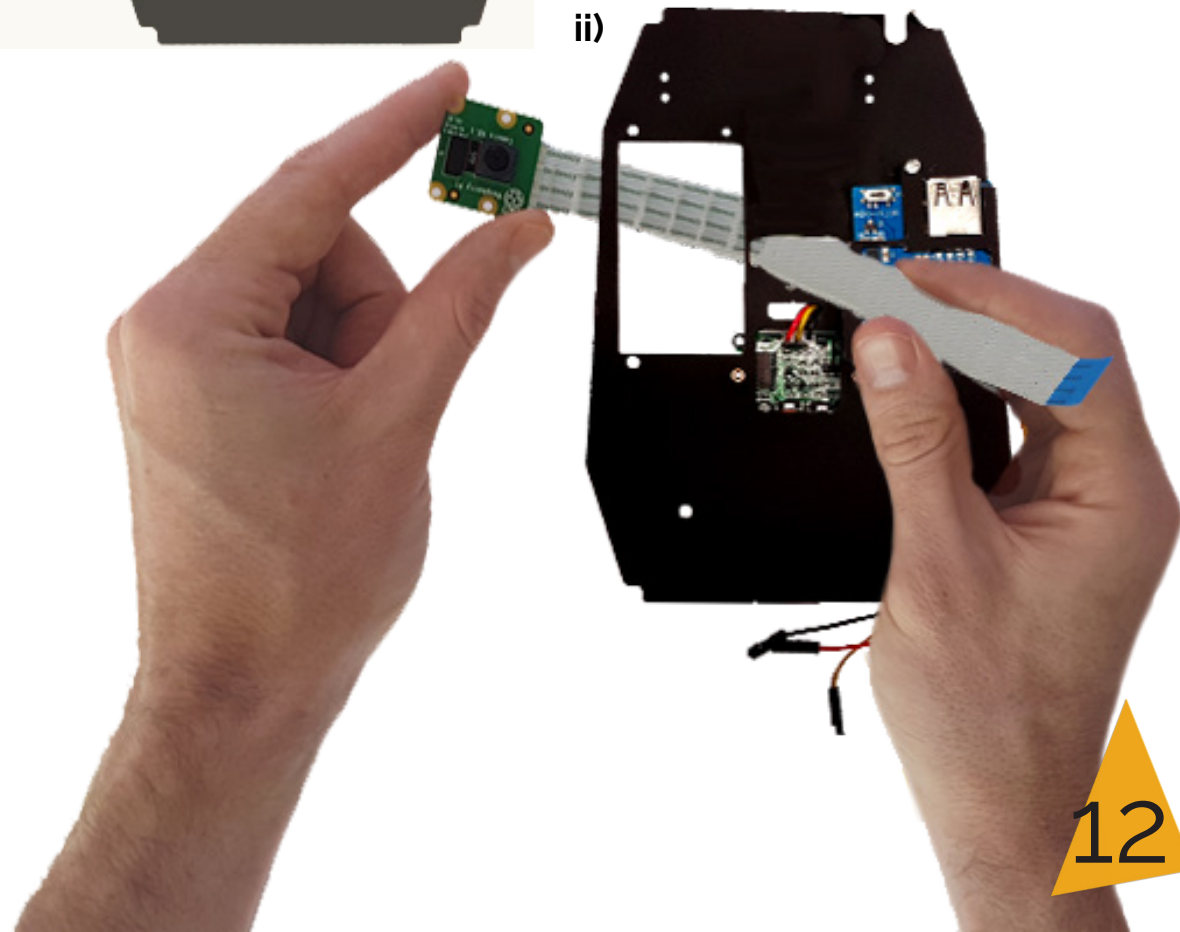
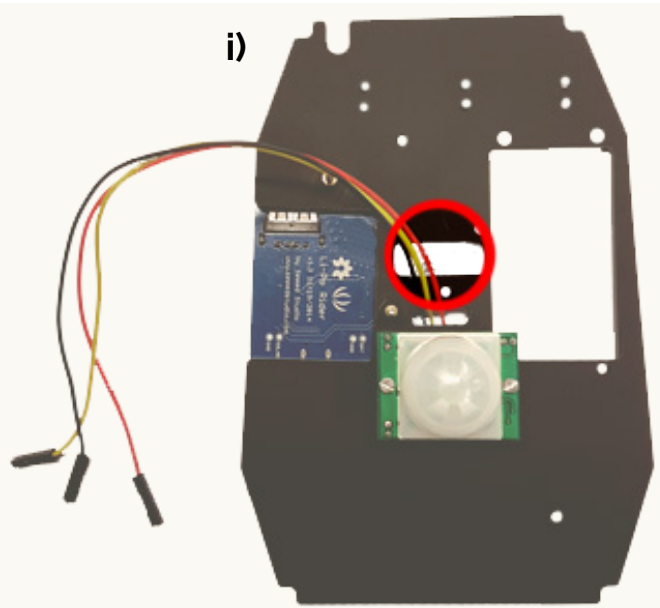
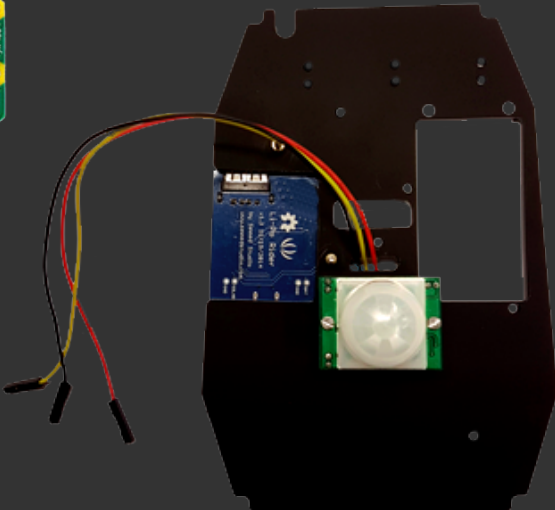



The Camera

Task 7 - Secure the Camera

Now attach the camera to the insert assembly using the screws, spacers and brass nuts.

What you will need :

2 x 25 mm Screws

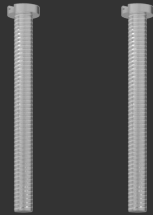

2 x 18 mm Spacers



2 x Brass nuts



Insert from Task 6



Make sure you are using the correct size spacers and screws. Use a ruler to double check them.

18 mm Spacer

25 mm Screw

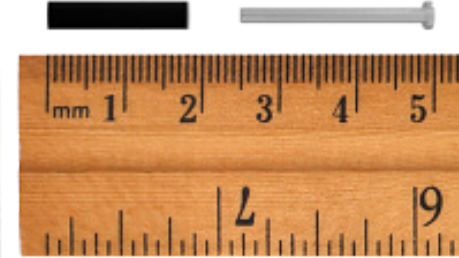

i)

Brass nut

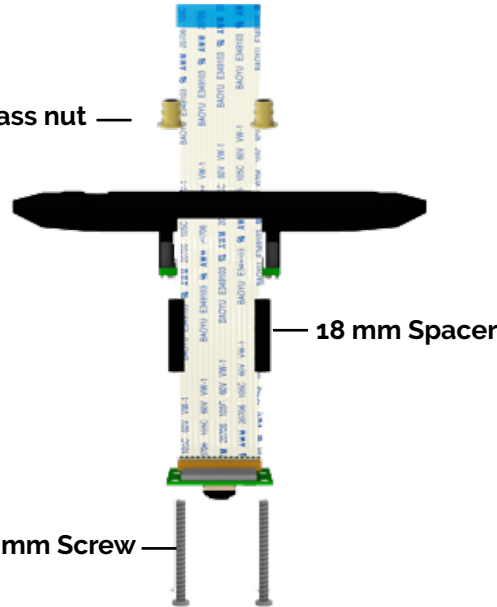

18 mm Spacer

25 mm Screw

ii)

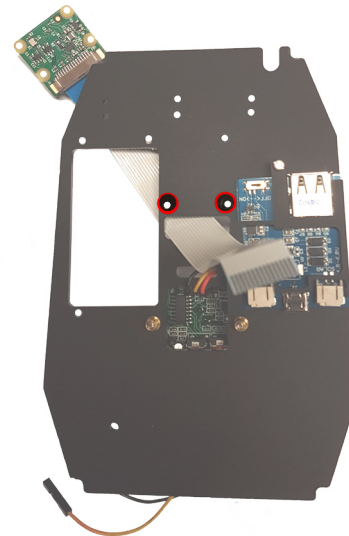
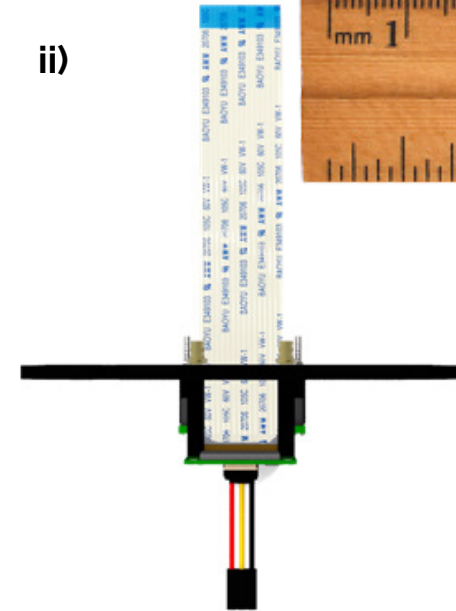

Camera hole location

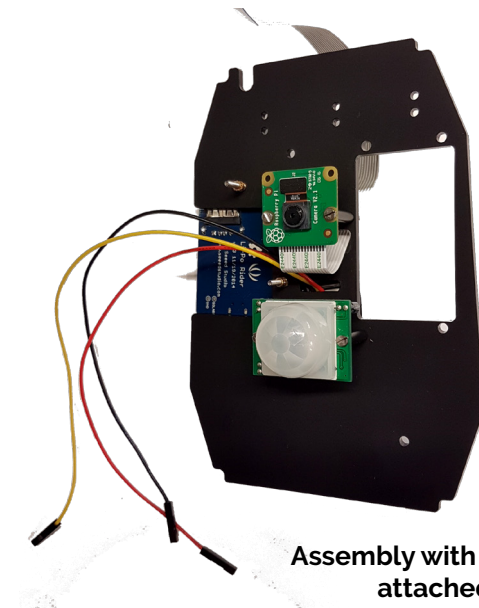

Assembly with camera attached



Your assembly should look like this

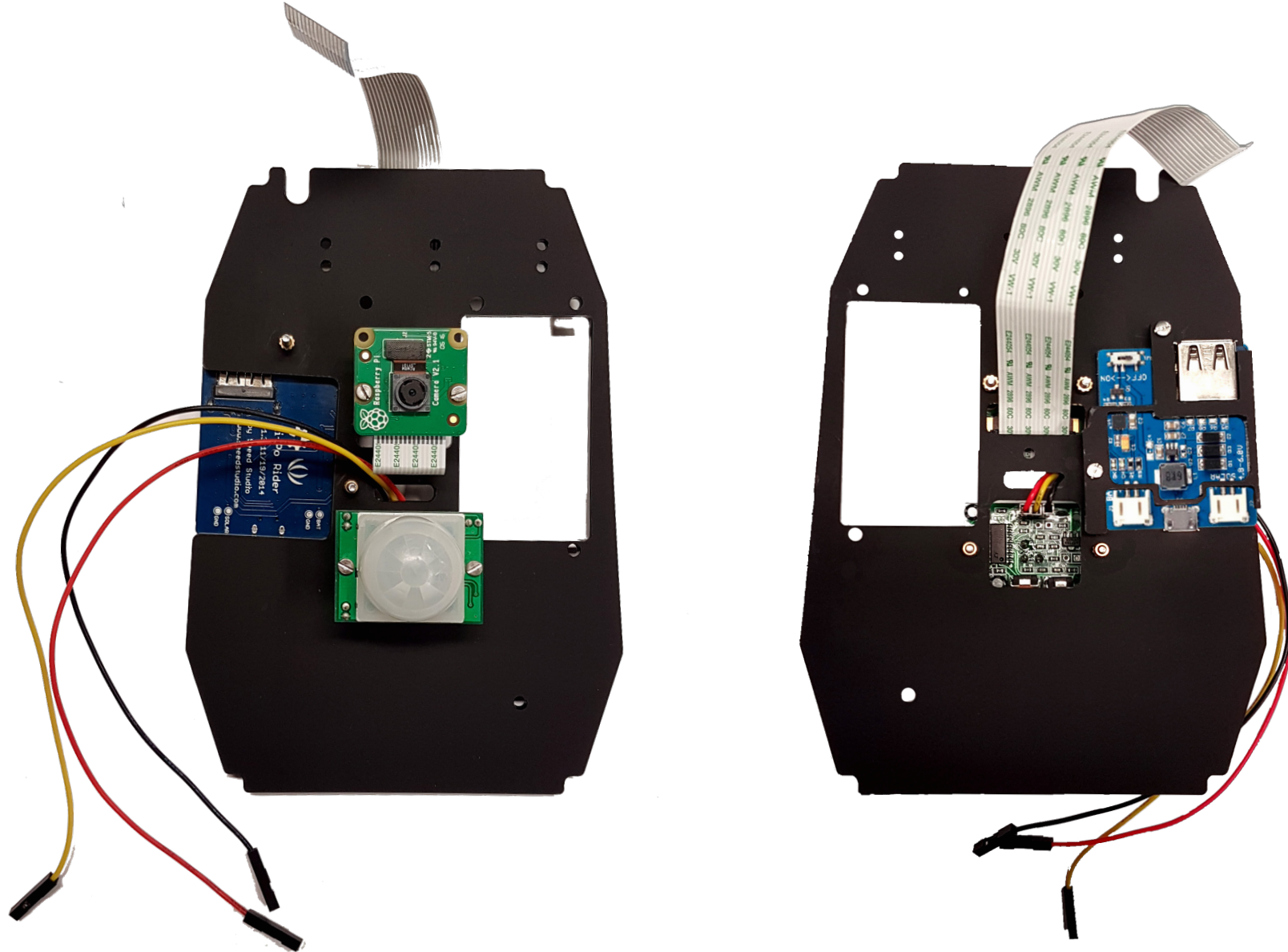



The Raspberry Pi and RTC

The Raspberry Pi A+

The Raspberry Pi inside your cam kit is a small yet powerful computer. It is the brains of the kit, connecting and controlling all the other electronic parts. You can use any Raspberry Pi model with the wildlife cam kit.

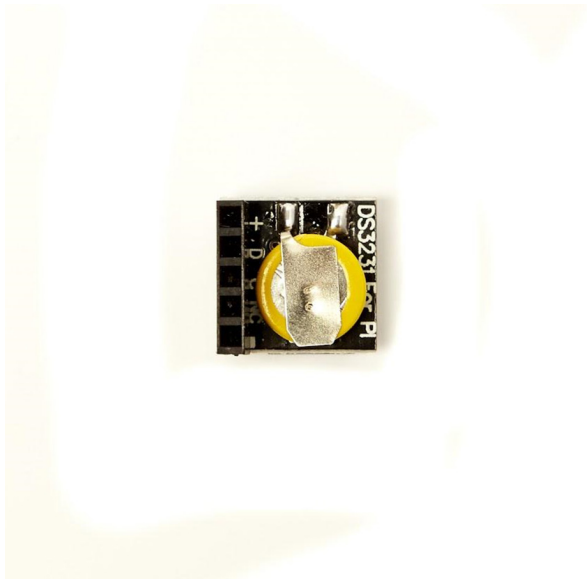
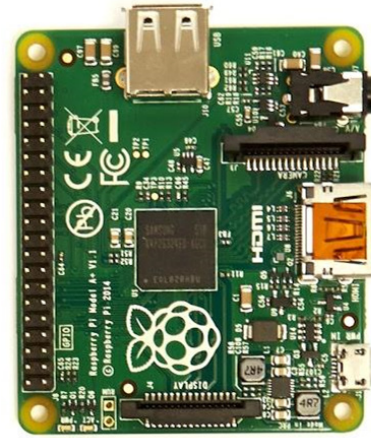

The Real Time Clock

The Real Time Clock (RTC) is the time-keeper of your kit. It provides useful information on when each of the photos or videos are taken. You can even code your kit to timestamp each image.



Attaching the Real Time Clock to the Raspberry Pi

Task 8 - Attach the RTC

Attach the RTC to the Raspberry Pi, positioning it on the pins shown to the right.

What you will need :

Real Time Clock



Raspberry Pi A +



Make sure the real time clock is positioned the right way round. Compare your Raspberry Pi with the image on the right to check its correct

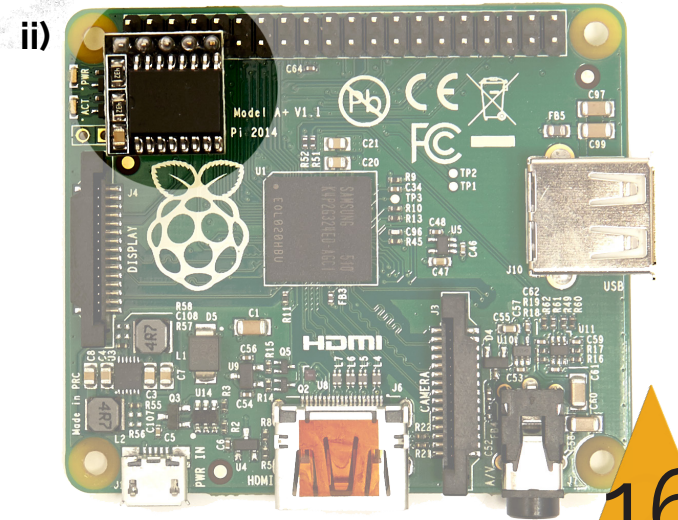
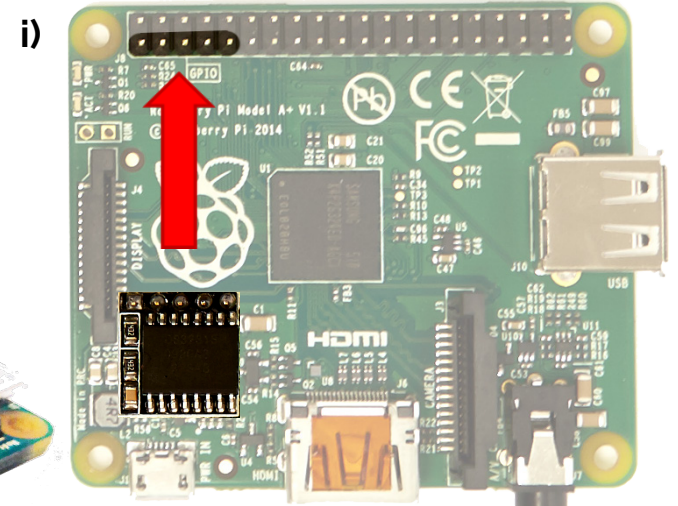
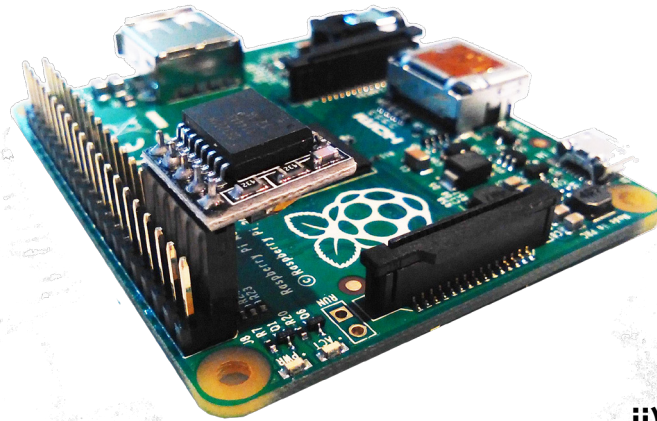



Attaching the Raspberry Pi

Task 9 - Connect the Camera to the Raspberry Pi

The camera ribbon locates into the port highlighted in the image (right).

Follow these steps below with the help of the images on the following page.

I) Gently lift the clasp on the camera port, highlighted in image i) on the following page.

II) Insert the camera ribbon into the port ensuring the blue tab on the ribbon is facing away from the HDMI port (labelled on the Pi) as seen in image ii) on the following page.

III) Secure the ribbon by holding it in the port and gently pushing down on the clasp. Make sure the ribbon is pushed down evenly and not at an angle.

What you will need :

Task 7 Insert Assembly

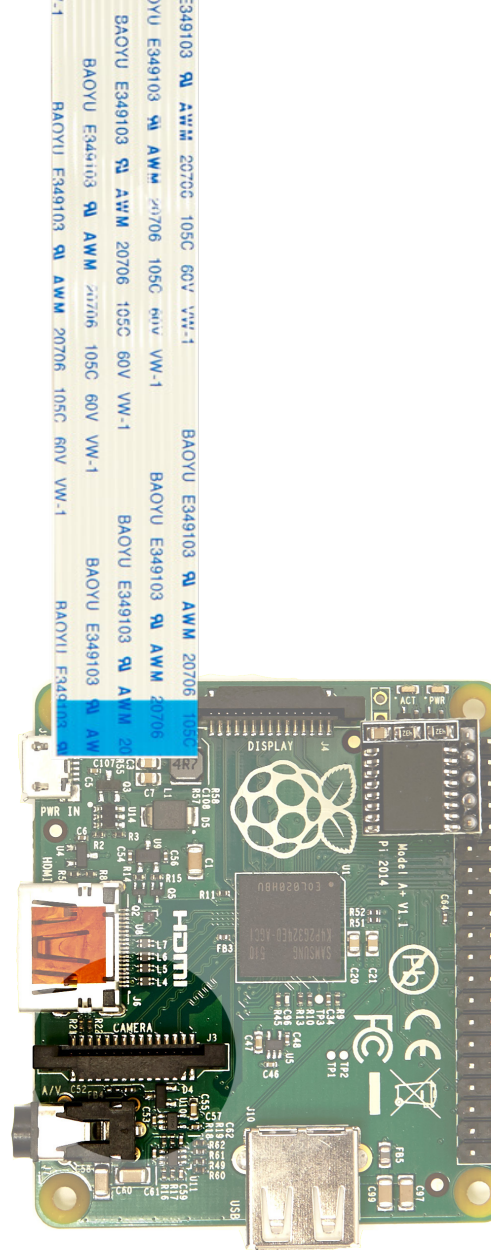



Locating the Camera Ribbon

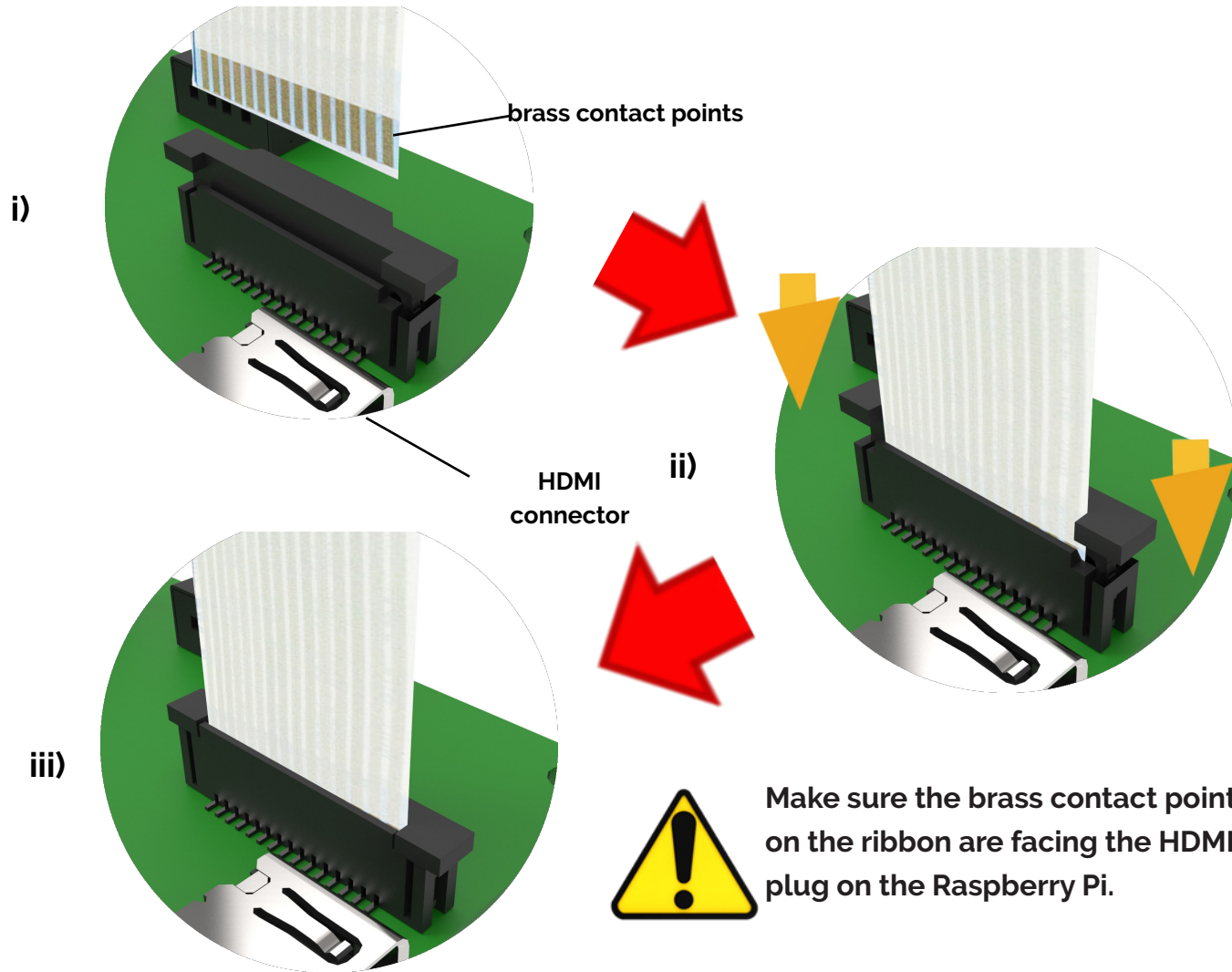

Finished Assembly



Attaching the Raspberry Pi

Task 10 - Connect the Raspberry Pi to the insert assembly

Attach the A+ Raspberry Pi to the insert using the screws, nuts and bolts provided.

What you will need :

3 x 25 mm Screws

3 x 15 mm Spacers

3 x Brass nuts

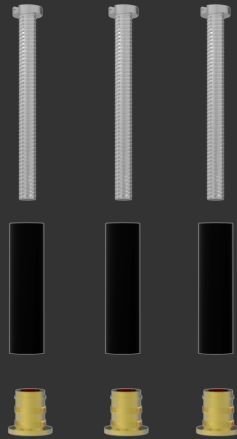

Task 9 Insert Assembly



i)

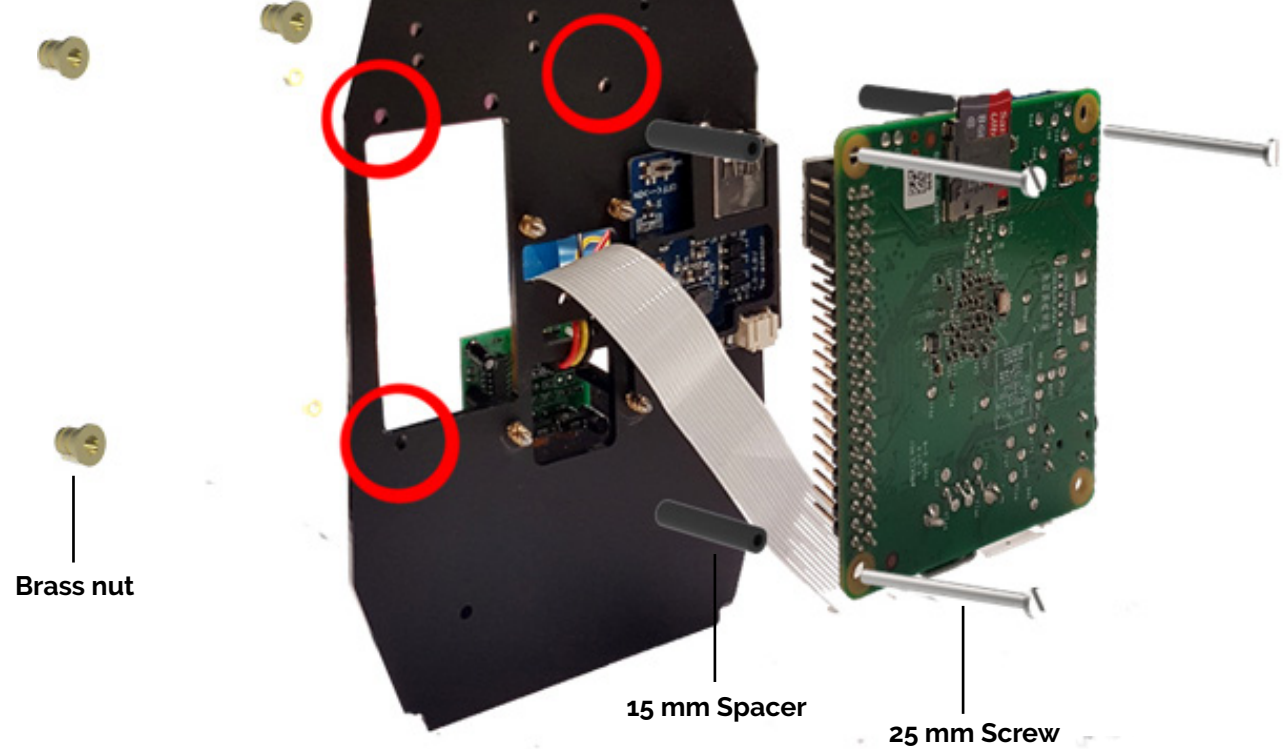

ii)

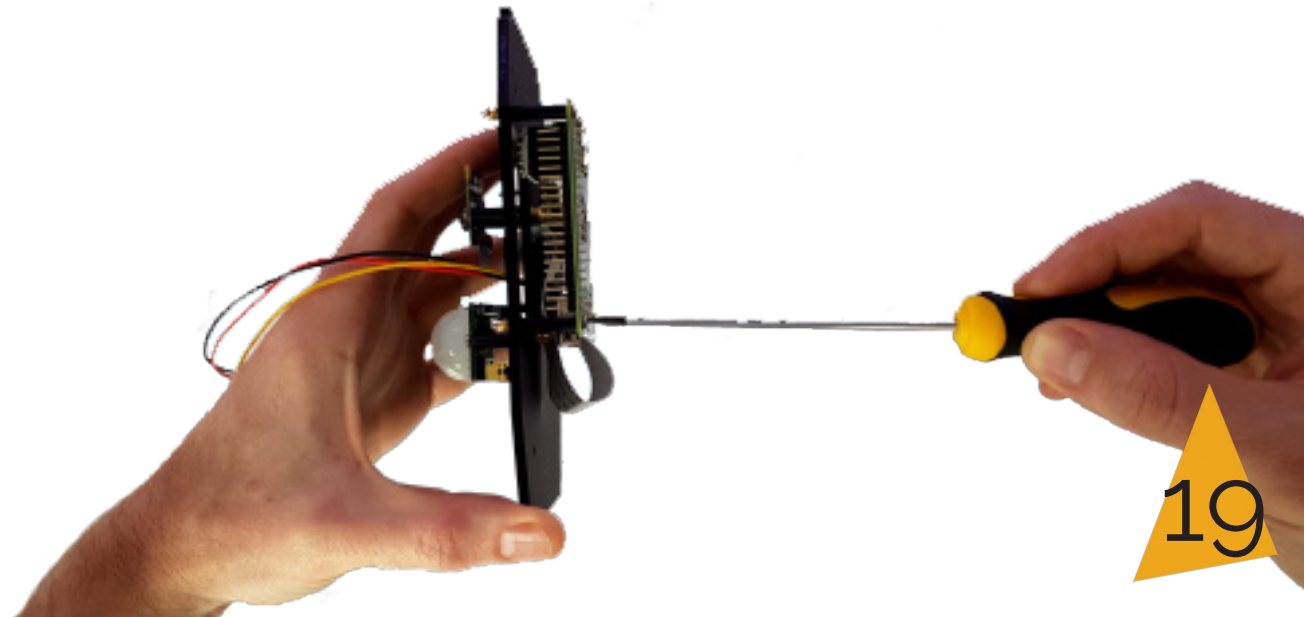



Connecting the Raspberry Pi

Task 11 - Connect the PIR wires to the Raspberry Pi

Attach the three wires from the PIR to the correct pins on the Raspberry Pi as shown in the diagram. Ensure the wires go around the camera and onto the correct pins.

What you will need :

Task 9 Insert Assembly



Red wire goes to pin 2

Black wire goes to pin 14

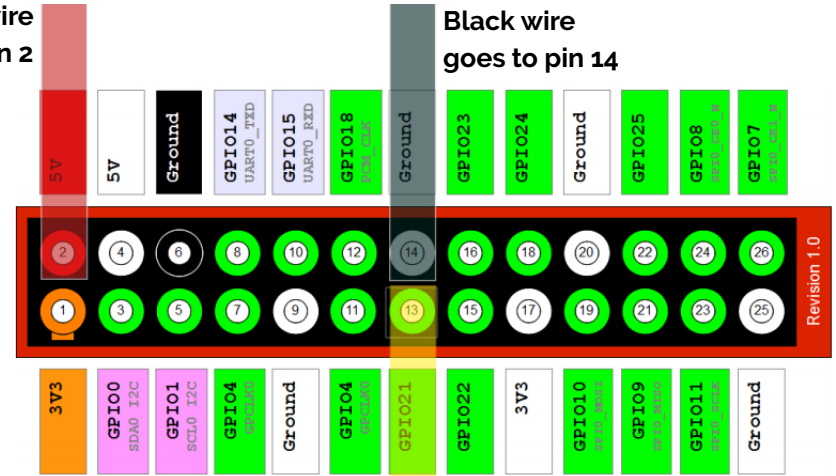

Yellow wire goes to pin 13

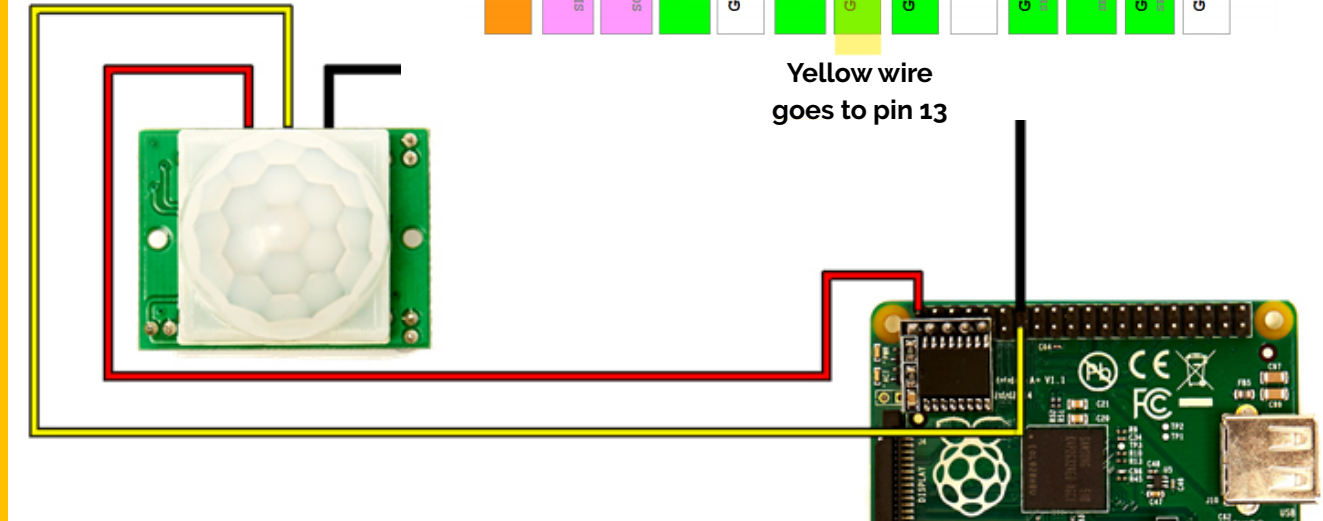



Securing the wires

Task 12 - Secure the wires onto the insert

Feed the 3 black cable-ties through the holes and twist them to secure the wires to the insert.

What you will need :

3 x Black cable ties



Task 11 Insert Assembly



i)

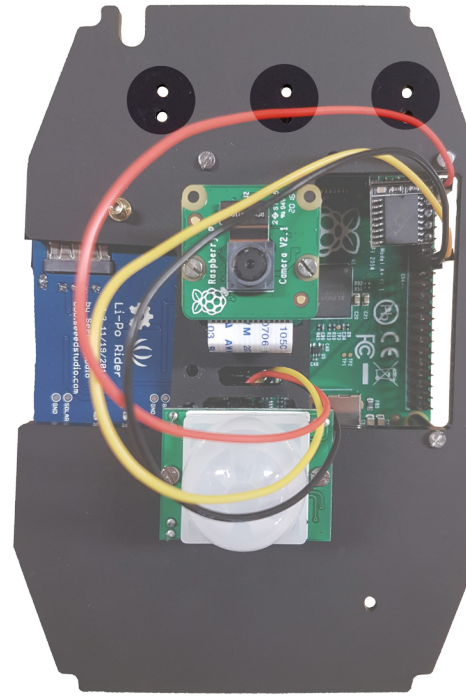



Final Insert Assembly

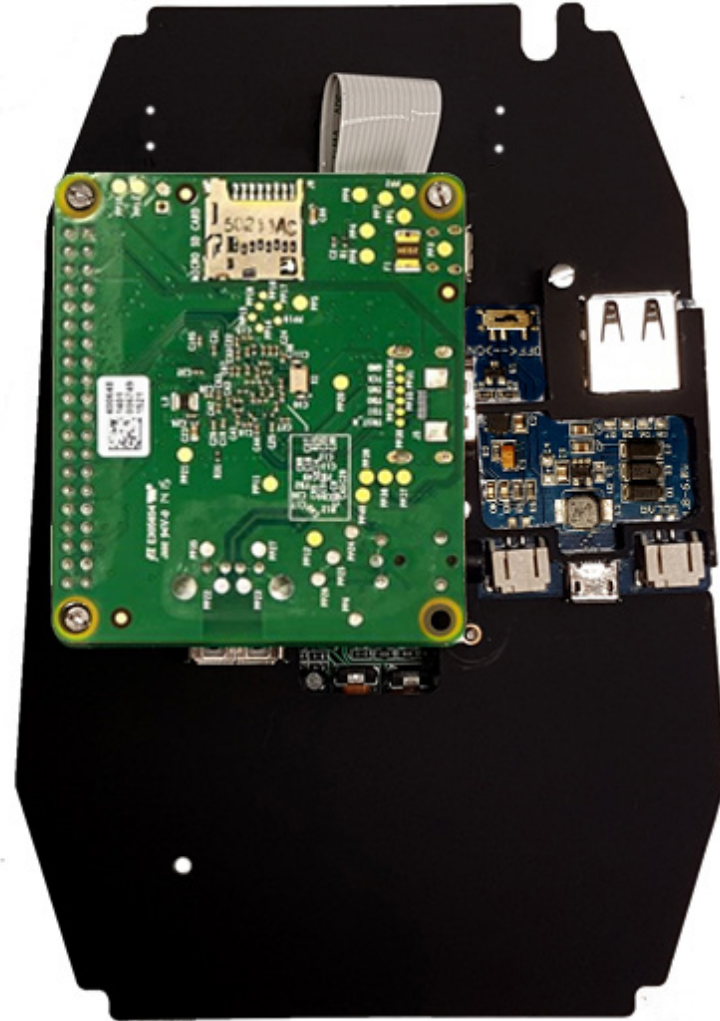



The Case

About the Wildlife Cam Kit Case

It looks snappy but the best thing about the case is that it's weather-proof, protecting all the parts inside from the elements.

The weatherproof case has passed ingress testing to gain a certified IP rating of 55. The case has been designed so that it is hackable and will fit all the Raspberry Pi's and additional add-on modules and power units.





Controlling the power

Task 12 - Assemble the Case

I) Place the insert assembly into the front of the case with camera facing down, and secure with the large screws at the four corners.

II)) Connect the LiPo Rider to the Raspberry Pi using the USB cable.

What you will need :

Task 12 Insert
Assembly

USB cable

4 x Large Screws
6 mm

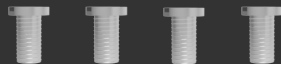

Case

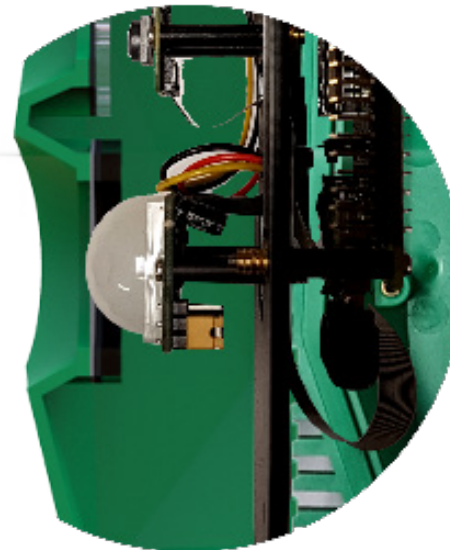
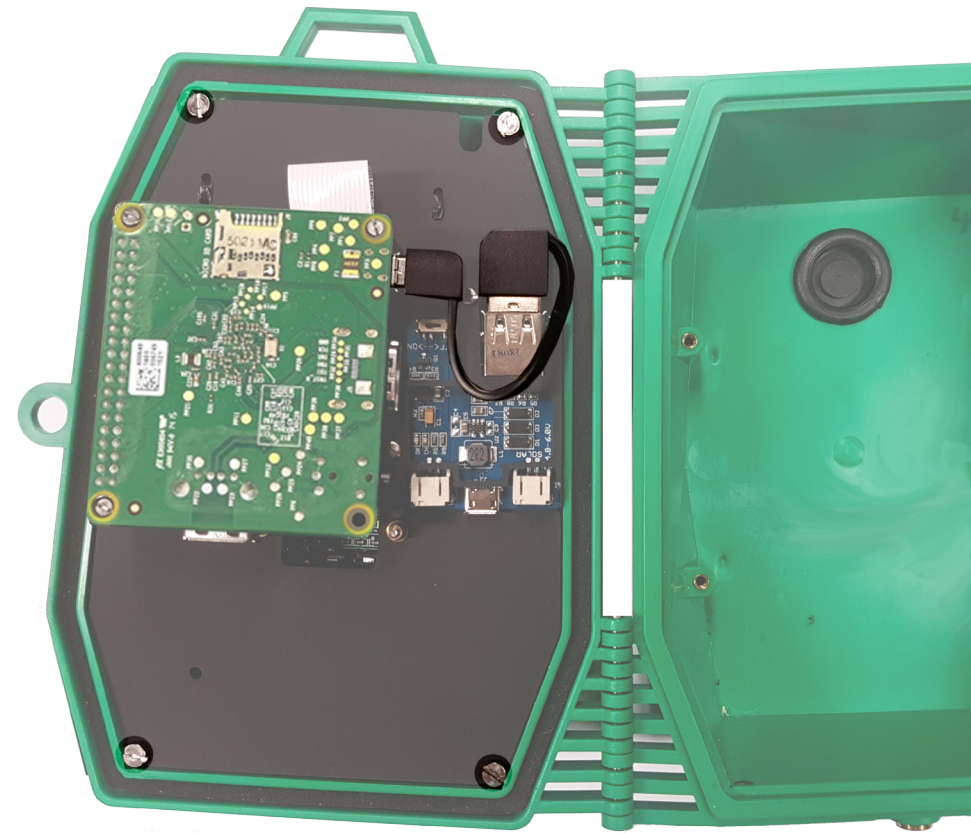

There will be resistance when placing and securing the insert assembly but don't worry. - the kit is designed so the PIR sensor dome presses against the flexible Fresnel PIR window. This optimises animal detection and triggering of the camera.



Secure the Battery

Task 13 - Attach velcro pads to Battery

Attach the velcro pads to the battery following the steps in the diagram.

What you will need:

Battery



Velcro Straps

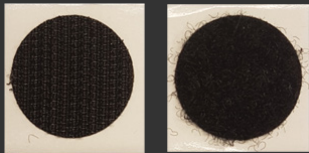

Task 12 Insert Assembly

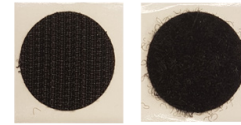

1) Get the two velcro discs



2) Join the disc together leaving the backing on

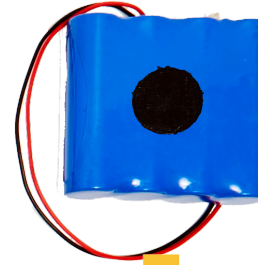

3) remove the backing paper off of both sides and stick the pads onto the back of the battery.

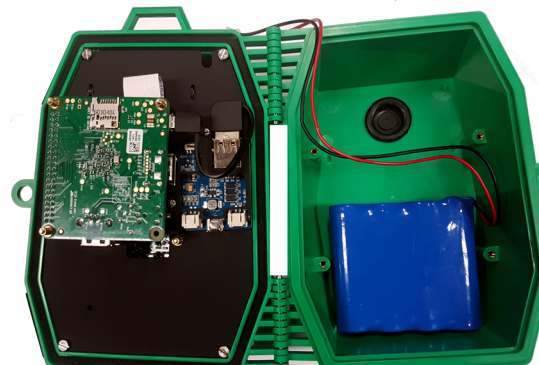

4) then place into the bottom of the back of the case



Connecting the battery

Task 14 - Attach and connect the battery pack

The battery pack sits in the back of the case and is connected to the LiPo Rider. Use the screws to secure the battery holder. Now plug the battery into the LiPo Rider socket labelled "BAT".

Caution - ensure the LiPo Rider is switched to off before connecting.

What you will need :

Task 12 Insert
Assembly

2 x Large Screws
6 mm

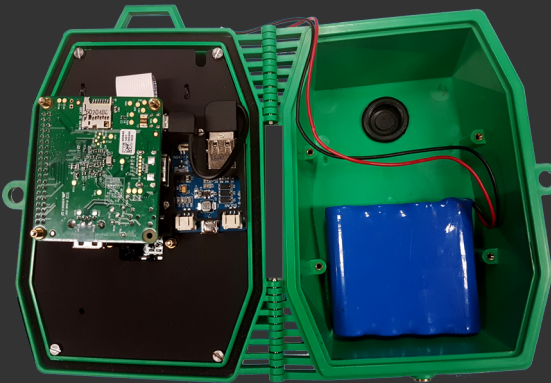

Battery Holder

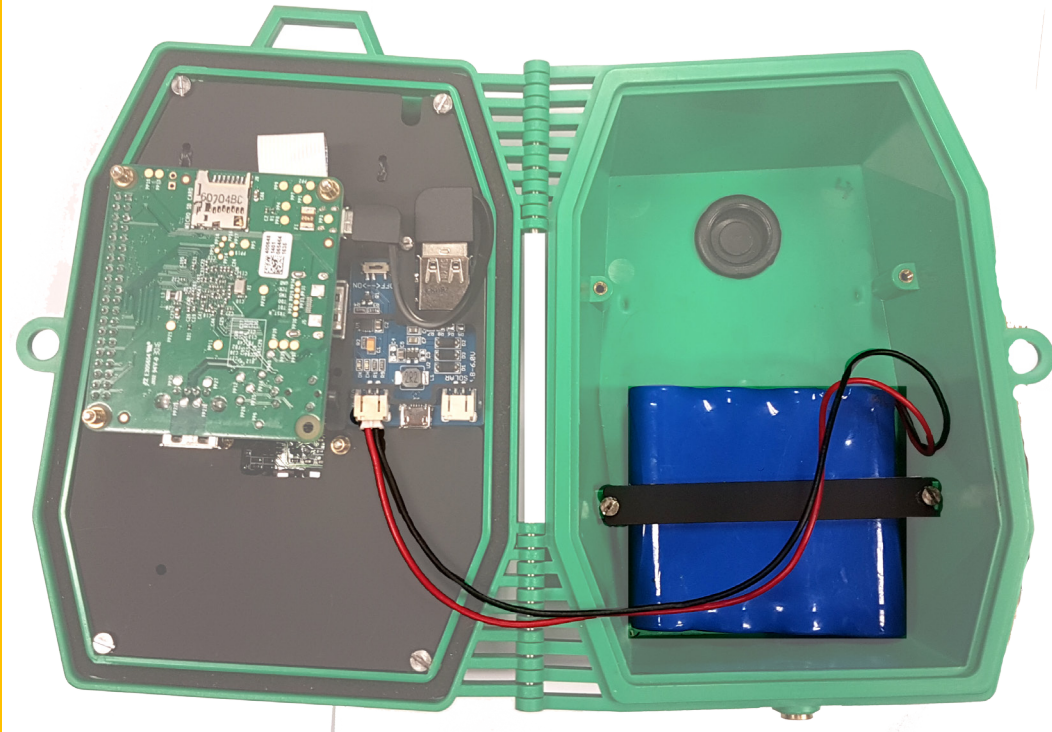



SD card and USB Flashdrive

Task 15 - Insert the SD and USB Flashdrive

Insert the USB Flashdrive into the lower USB slot on the Raspberry PI and to finish, insert the SD card into the top slot.

What you will need :

USB



SD CardR

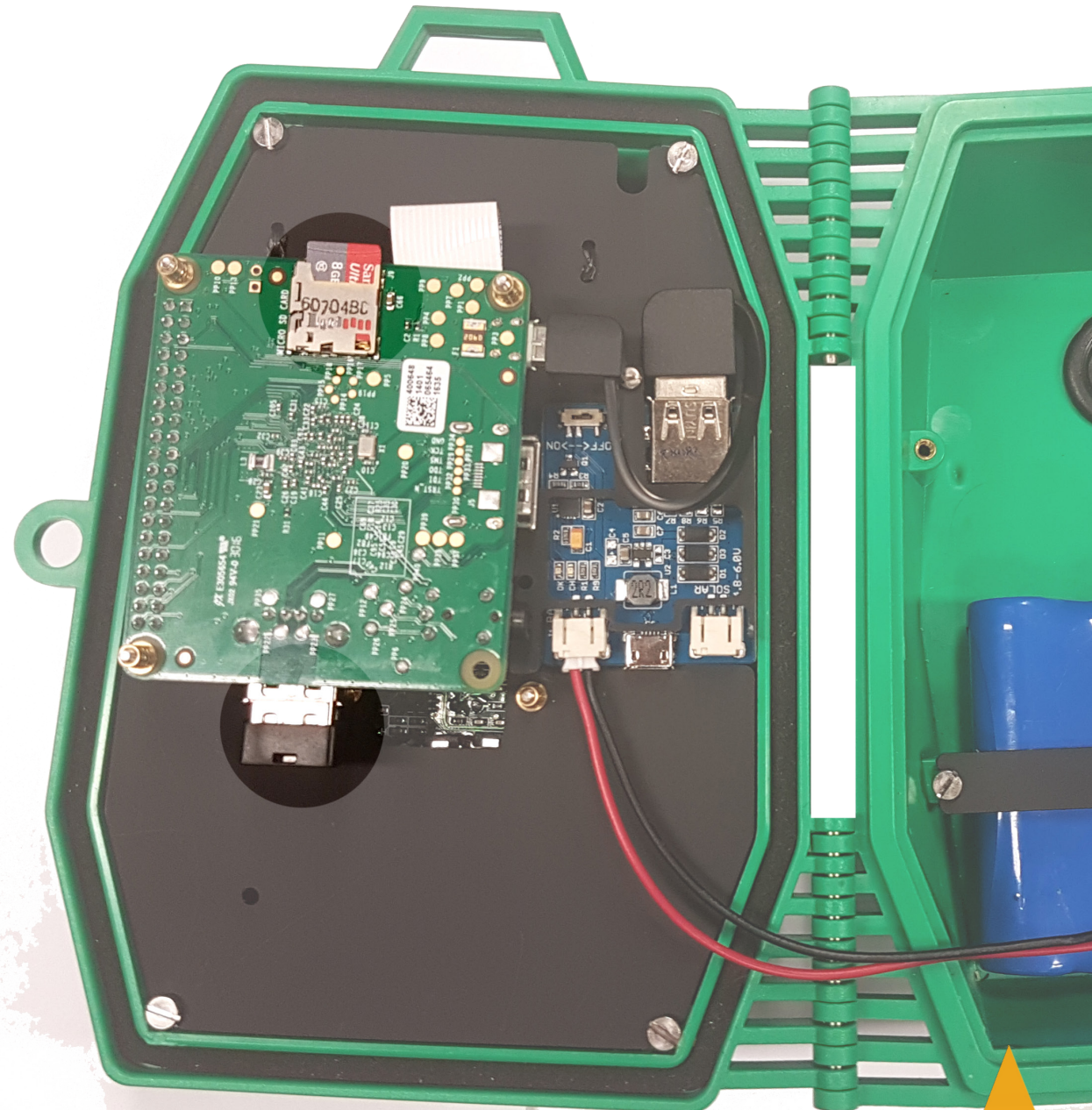



The Complete Wildlife cam kit

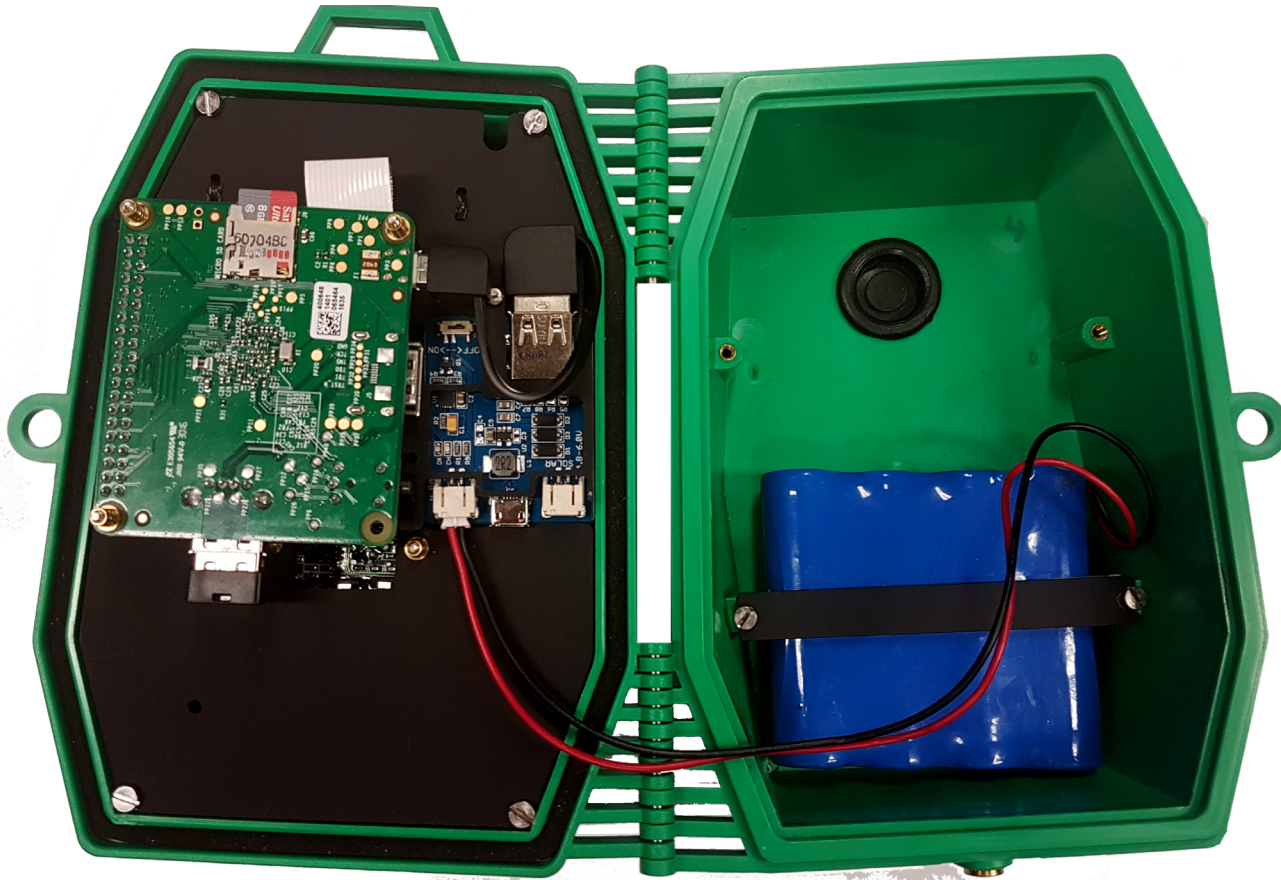



Charge your kit

You must charge your kit before putting it outside. This will ensure you get the best performance out of your kit and the most out of your battery life. To charge the battery:



i) You must first disconnect the micro usb wire connecting the LiPo Rider to the Raspberry Pi.

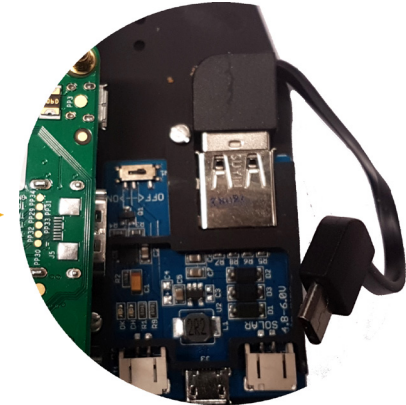

ii) Plug a micro USB cable into the LiPo rider as illustrated in the image below

iii) Connect the micro USB charging device. A plug adapter or computer will do.

iv) When charging, the Orange LED will light up

v) When fully charged, the Green LED will light up. The initial full charge will take approximately 8 hours.

vi) When fully charged disconnect the LiPo Rider from the charging device and reconnect the LiPo Rider and Raspberry Pi.

Charging - orange light

Charged - green light

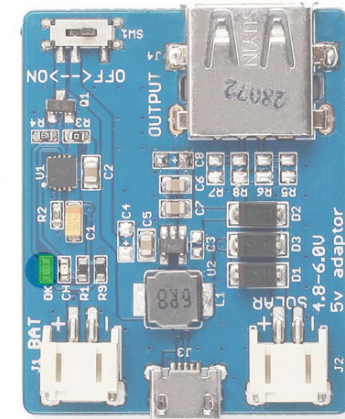
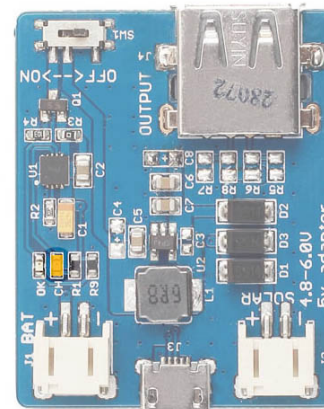
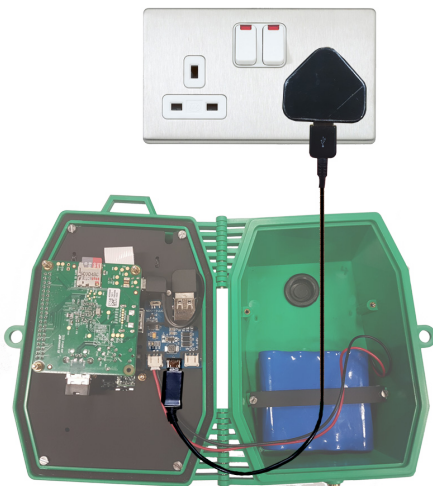



Switching on your kit

Now you are ready to test your kit.

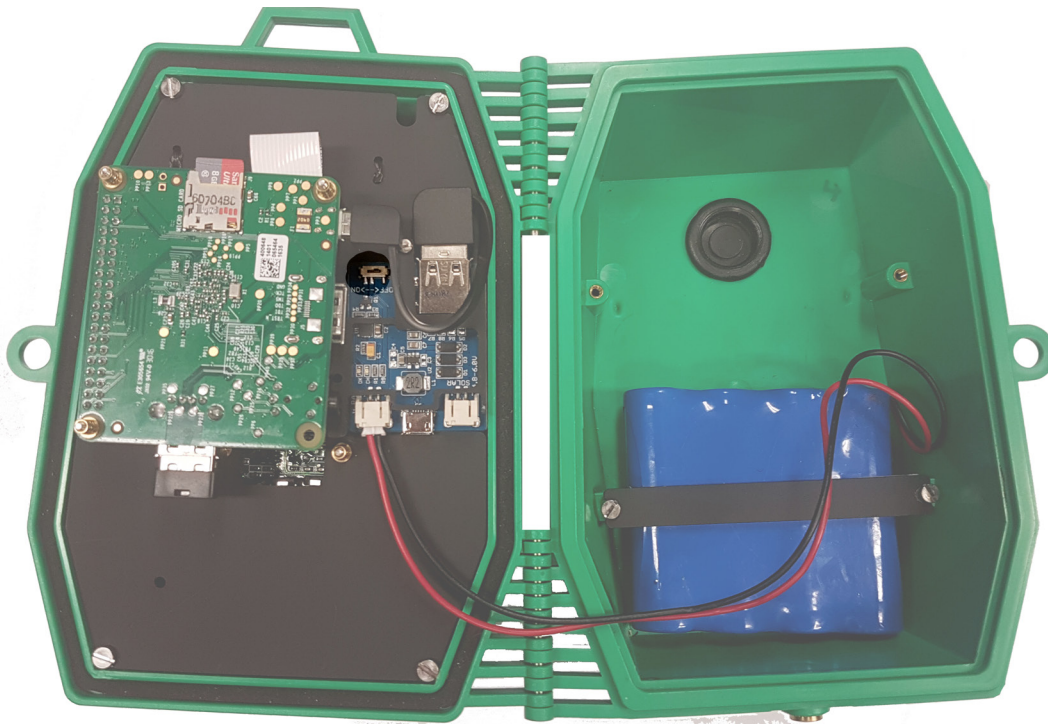

i) Turn the power on, flip the switch on the LiPo Rider highlighted in the image.

ii) Leave the camera face down as the Raspberry Pi boots - you will see the LEDs flashing indicating it is loading. This should take approximately 1 minute.

iii) Now take a selfie, Close the case and turn the camera to face you. You should trigger the camera.

iv) Grab your images, after a few selfies and giving enough time for the images to save (approx. 1 min),

Go to the next steps to see how to view your test images.





Getting your Images

To view your test images:

i) Remove the USB Flashdrive from the camera and plug it into another laptop or computer.

ii) If you are able to view your images, your camera is working correctly. Your Cam Kit is ready to go out into the wild.

If you do not see any images check back through the manual steps paying special attention to the PIR wire arrangement and Camera ribbon connection, then repeat the test.

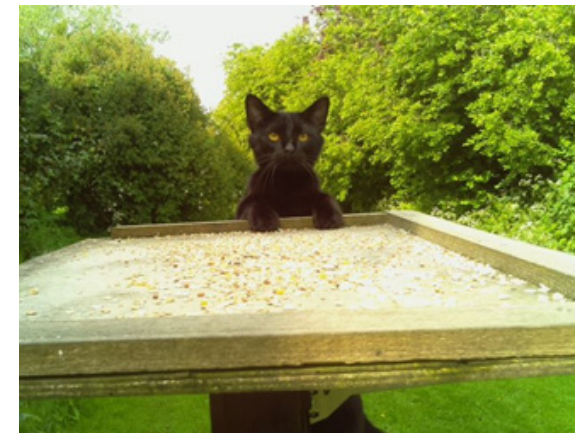
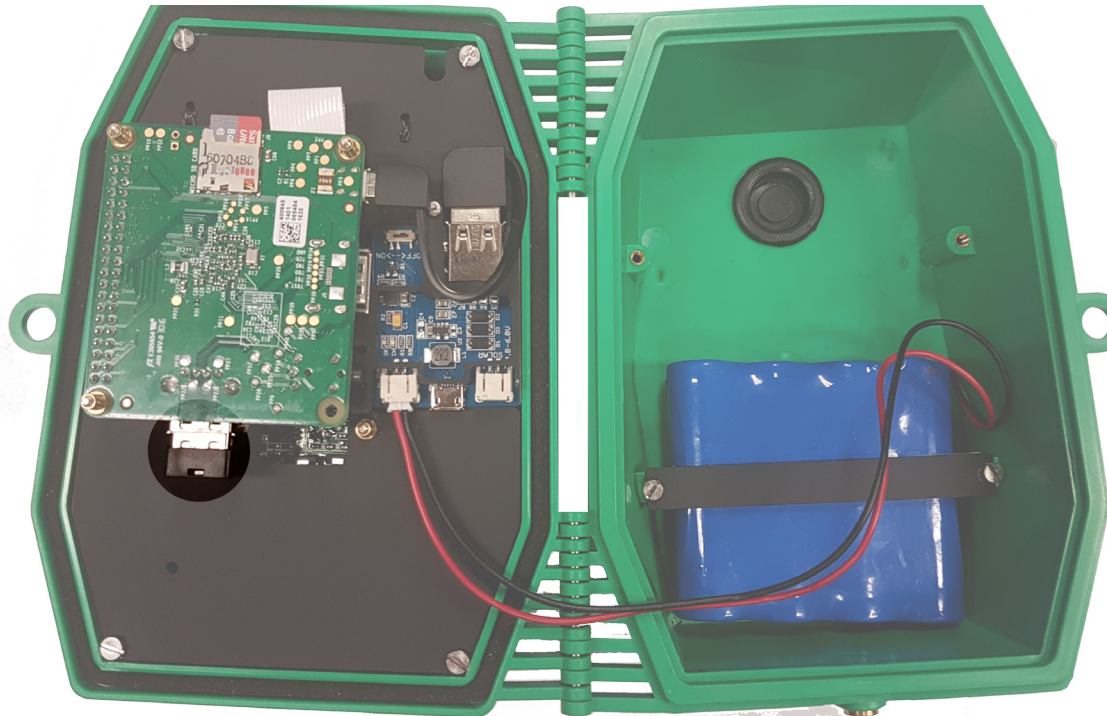



Think about a suitable location



There are many different ways to place your camera. Where, when and how you place it will determine which animals you are likely to photograph. Make sure you get off to a good start following these tips:

- 1) Look for wildlife corridors and signs of activity such as paths, fences and where you've seen animals before.
- 2) Height and direction - would you prefer a wider view looking down at a bird table to capture multiple birds, or are you focusing on individuals close up?



Locating your Kit - Tips

Place your camera where it is protected from direct sunlight. Changes in heat will trigger your camera, so avoid false triggers by placing the kit away from the glare of morning and afternoon sun. You can adjust the sensitivity of your PIR sensor (see online for details) if you find that the camera is taking too few or too many photos, regardless of placement.

Make sure the kit is positioned in a convenient and accessible location. You'll want to open the case and removed the USB drive to check how your camera is doing, so leave enough space to



Locating your Kit - Tips

Place your camera at least 500 mm away from the point where you expect to capture your subject.

Set up at dawn and retrieve the kit at dusk. This will allow for you to review the images you've captured and charge your cam kit overnight.

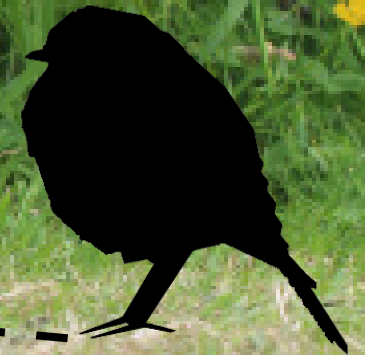

500 mm



Additional Features



Using my kit as a computer

To benefit from the additional features on your wildlife cam kit you simply can access the code that powers your kit by using it as a computer.

You can plug your kit into a screen with a HDMI cable. You can use any TV for this as long as it has a HDMI input.

You will then need a mouse in order to navigate the interface and a keyboard to write the code.

We suggest using a wireless keyboard and mouse for this as the dongle will plug straight into the single USB socket on the Raspberry Pi A+.

If you don't have a wireless keyboard and mouse then we suggest using a usb splitter to connect multiple devices.

The image (right) illustrates how to set up the kit. Instead of using the battery, you can also power your kit by plugging it into a standard home mains supply using a micro USB, similar to charging a mobile phone.

What you will need :-

- HDMI Wire
- 3 Port USB Hub
- Mouse & Keyboard
- Wireless WIFI dongle
- Micro USB charger

- USB Hub to connect
- Mouse
- Keyboard
- Wifi Adapter
- USB



Keyboard and Mouse



Setting the time module

When first starting your cam kit it wont know what time it is so it will stamp the images with the wrong time and date. You may want to change this so follow these steps to change it.

Connect the cam kit to a screen , keyboard and mouse and turn on your kit and let the Naturebytes screen load up. Once loaded click on the Terminal x function and type the following code >

```
sudo date -s "04 MAR 2015 13:24:00"
```

PRESS ENTER

```
sudo hwclock -w
```

PRESS ENTER

```
sudo hwclock -r
```

PRESS ENTER

This will then change the time for you and stamp your images with the correct time and date.

```
63     if(!isBuilding)
64     {
65         if(GUI.Button(new Rect(Screen.width - btnWidth, Screen.height - btnHeight, btnWidth, btnHeight), "Tower One"))
66         {
67             buildGrid.transform.position = buildGridOriPos;
68
69             for(int i = 0; i < availableTowersList.Count; i++)
70             {
71                 if(availableTowersList[i])
72                 {
73                     curTowerBeingBuilt = 1;
74
75                     //The code below causes an error in x-code
76                     towersList[i].transform.position = AvailablePlate();
77                     availableTowersList[i] = false;
78
79                     curTowerIndex = i;
80                     curTowerToBeBuild = towersList[i];
81
82                     PlaceRangeIndicator();
83
84                     isBuilding = true;
85                     //ableToBuild = false;
86
87                     break;
88                 }
89             }
90         }
91     }
```



Warning Lithium-ion Batteries!

This kit contains small parts. DO NOT allow children under 5 years old to play with or near this product.

Li-ion battery packs may leak, overheat or explode if abused or incorrectly used. Ensure you read and adhere to the following safety warnings. Lithium Ion batteries are a great power source for naturebytes kits but they require care during use and charging. The batteries as part of your kit have passed testing and certification but you must be careful and follow the warnings and cautions listed below:

WARNING!

Do not short-circuit the battery by directly connecting the positive (+) and negative (-) terminal with metal objects such as wire. Do not reverse the position (+) and negative (-) terminals.

Do not expose the battery in water, seawater or allow the battery to get wet. Keep the battery in a cool dry environment during stand-by period.

Do not carry or store the battery together with necklaces, hairpins or other metal objects.

Do not pierce the battery with nails, strike the battery with a hammer or other object, step on the battery or otherwise subject it to strong impacts or shocks.

If you are unable or unwilling to follow these instructions, please do not use the battery and return it immediately to naturebytes. Email info@naturebytes.org

The battery is not for use by small children. Please ensure proper supervision of children by an adult at all times.

Switch of the cam kit and battery when not in use.

Do not use or leave the battery in a high temperature location or near a heat source such as fire or heater.

Do not use or leave the battery in direct sunlight, or in a vehicle in hot weather. Doing so may cause the battery to overheat, ignite or explode. Treating the battery in this manner may also result in a loss of performance and shortened life expectancy.

Do not disassemble or modify the battery or plastic casing. The battery contains safety and protection devices, which, if damaged, may cause the battery to overheat, explode or ignite.

When recharging, use a specified battery charger. Do not connect the battery to an electrical outlet.

Do not charge unattended.

CAUTIONS

In the event the battery leaks and fluid get into one's eye, do not rub the eyes! Rinse the eyes with clean running water, and seek medical attention immediately. If left untreated, the battery fluid could cause damage to the eye.

Do not use it in a location with high static electricity or magnetic fields as the safety devices may be damaged, without the damage being visible.

If the battery gives off an odor, generates heat, becomes discolored or deformed, or in any way appear abnormal during use, recharging or storage, immediately discontinue use of the battery, remove it from the device or battery charger and place it in a sealed container or box. Contact Naturebytes if this occurs.

If the battery terminals are contaminated, clean the terminals with a dry cloth before use. Poor connection between the battery and the electronic circuitry of the instrument may cause power failure or charge failure.

Be aware discarded batteries may cause fire, tape the battery terminals to insulate them before disposal.

Do not dispose the battery in fire or heat.

Disposal of batteries and Electronic Equipment

If you live in the UK, you can find your local recycling facility at www.recyclenow.co.uk.

Most supermarkets and shops that sell batteries will have collection bins for used batteries, and some town halls, libraries or schools may also set up collection points. Customers may find stores in their local area more accessible.

Electronic Equipment Disposal Information

In common with all Electrical and Electronics Equipment (WEEE) regulations, The Naturebytes Wildlife Cam Kit should be disposed of separately from household waste and recycled where possible.

Many electrical items can be repaired or recycled, saving natural resources and the environment. If you do not recycle electrical equipment will end up in landfill where hazardous substances will leak out and cause soil and water contamination – harming wildlife and also human health.

