

# ***Nikon***

DIGITAL CAMERA

# 1 J5

## Reference Manual

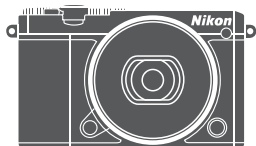

Nikon Manual Viewer 2

Install the Nikon Manual Viewer 2 app on your smartphone or tablet to view Nikon digital camera manuals, anytime, anywhere.

Nikon Manual Viewer 2 can be downloaded free of charge from the App Store and Google Play.

**En**

1 J5

## Model Name: N1407

To get the most from your camera, please be sure to read all instructions thoroughly and keep them where they will be read by all who use the product.

### Camera Settings

The explanations in this manual assume that default settings are used.

### Symbols and Conventions

To make it easier to find the information you need, the following symbols and conventions are used:







This icon marks cautions; information that should be read before use to prevent damage to the camera.



This icon marks notes; information that should be read before using the camera.





This icon marks references to other pages in this manual.

The , , , and  symbols represent up, down, left, and right on the multi selector.

### For Your Safety

Before using the camera for the first time, read the safety instructions in “For Your Safety” (□ ix–xi).

# 1 J5

<b>Touch Controls</b>	 ii
<b>Table of Contents</b>	 iii
 <b>Introduction</b>	 1
 <b>Taking and Viewing Photographs</b>	 33
 <b>Recording and Viewing Movies</b>	 42
 <b>Other Shooting Modes</b>	 58
 <b>More on Photography</b>	 94
 <b>Wi-Fi</b>	 114
 <b>More on Playback</b>	 125
 <b>Connections</b>	 140
 <b>The Playback Menu</b>	 149
 <b>The Shooting Menu</b>	 158
 <b>The Setup Menu</b>	 193
 <b>Technical Notes</b>	 202

## Touch Controls

Touch controls can be used for photography and a variety of other operations (☞ 16).

### Photographs

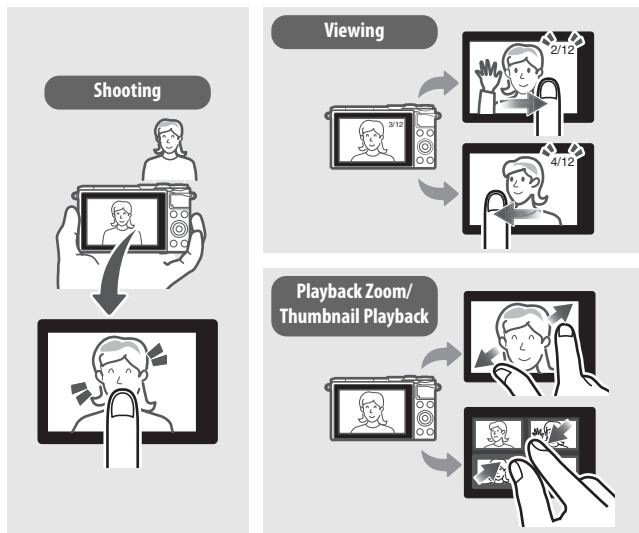

### Movies

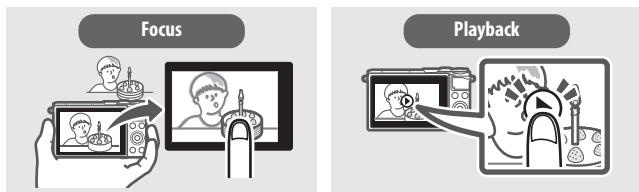

In addition to the functions listed above, touch controls can be used to adjust settings and navigate the menus.

## Table of Contents

Touch Controls .....	ii
For Your Safety .....	ix
Notices.....	xii
Wireless .....	xviii
<b>Introduction</b> .....	<b>1</b>
Before You Begin.....	1
Parts of the Camera .....	2
Using the Touch Screen .....	16
First Steps .....	21
<b>Taking and Viewing Photographs</b> .....	<b>33</b>
Point-and-Shoot Photography (Auto Mode) .....	33
Viewing Photographs .....	37
Deleting Pictures.....	38
<b>Recording and Viewing Movies</b> .....	<b>42</b>
Recording Movies .....	42
Taking Photographs During Movie Recording .....	45
Viewing Movies .....	46
Deleting Movies .....	47
📹+ Advanced Movie Options .....	49
Filming Time-Lapse Movies .....	52
Filming Slow-Motion Movies.....	55
<b>Other Shooting Modes</b> .....	<b>58</b>
📷 Choosing a Creative Mode .....	58
Choosing a Mode That Matches the Subject or Situation ....	59
HDR.....	62
Easy Panorama.....	63
Selective Color .....	66

<b>Taking Photos in P, S, A, and M Modes</b> .....	<b>67</b>
<b>P</b> Programmed Auto.....	67
<b>S</b> Shutter-Priority Auto.....	68
<b>A</b> Aperture-Priority Auto .....	69
<b>M</b> Manual .....	70
Long Time-Exposures ( <b>M</b> Mode Only) .....	72
🏆 <b>Photographing Subjects in Motion (Sports Mode)</b> .....	<b>74</b>
📷 <b>Choosing the Moment (Best Moment Capture)</b> .....	<b>76</b>
Choosing a Shot Manually (Active Selection) .....	76
Choosing Your Moment (Slow View) .....	81
Letting the Camera Choose the Moment (Smart Photo Selector) .....	83
📷 <b>Combining Photos with Brief Movie Vignettes         (Motion Snapshot Mode)</b> .....	<b>88</b>
Viewing Motion Snapshots.....	93
Deleting Motion Snapshots.....	93
<b>More on Photography</b> .....	<b>94</b>
<b>Live Image Control</b> .....	<b>94</b>
<b>Continuous Mode</b> .....	<b>97</b>
<b>Self-Timer Modes</b> .....	<b>99</b>
<b>Exposure Compensation</b> .....	<b>101</b>
<b>The Built-in Flash</b> .....	<b>102</b>
Auto Pop-up Modes .....	102
Manual Pop-up Modes.....	104
<b>Self-Portraits</b> .....	<b>108</b>
<b>Tap Shooting Options</b> .....	<b>111</b>
📷 Auto, 📷 Creative, and Self-Portrait Modes .....	111
🏆 Sports Mode .....	111
<b>P, S, A, and M Modes</b> .....	112
🎬+ Advanced Movie Mode.....	113

<b>Wi-Fi</b>	<b>114</b>
What Wi-Fi Can Do for You .....	114
Wireless Security .....	115
Connecting via Wi-Fi.....	118
Android and iOS: Connecting via SSID .....	118
Android: Connecting via NFC.....	119
Uploading Photos to a Smart Device .....	121
Uploading Photos One at a Time .....	121
Uploading Multiple Selected Photos.....	122
Uploading Photos via NFC .....	123
Downloading Selected Pictures to the Smart Device .....	124
<b>More on Playback</b>	<b>125</b>
Photo Information .....	125
Thumbnail Playback.....	129
Calendar Playback .....	130
Playback Zoom .....	131
Viewing Bursts .....	132
Deleting Pictures .....	134
Deleting the Current Picture .....	134
The Playback Menu.....	134
Glamour Retouch .....	135
Slide Shows .....	137
<b>Connections</b>	<b>140</b>
Copying Pictures to a Computer .....	140
Installing ViewNX-i .....	140
Copying Pictures to the Computer .....	141
Viewing Pictures on TV .....	144
High-Definition Devices .....	144
Printing Photographs.....	146
Connecting the Printer .....	146
Printing Pictures One at a Time .....	147
Printing Multiple Pictures .....	148

**The Playback Menu** **149**

Selecting Multiple Images.....	151
Rotate Tall .....	152
Sequence Display Options.....	152
Protect .....	152
D-Lighting .....	153
Resize .....	154
Crop.....	155
Edit Movie .....	156

**The Shooting Menu** **158**

Reset Shooting Options .....	161
Exposure Mode .....	161
Image Quality .....	162
Image Size .....	162
Frame Size/Frame Rate.....	165
Metering.....	166
White Balance.....	167
Fine-Tuning White Balance .....	168
Preset Manual.....	169
ISO Sensitivity .....	172
Picture Control .....	173
Modifying Picture Controls.....	173
Auto Distortion Control.....	177
Color Space .....	177
Active D-Lighting.....	178
Long Exposure NR .....	179
High ISO Noise Reduction .....	179
Movie Sound Options .....	180
Auto Image Capture.....	180



Interval Timer Shooting .....	181
Optical VR .....	183
Electronic VR (Movies) .....	183
Focus Mode .....	184
Manual Focus .....	186
AF-Area Mode .....	188
Focus Lock .....	189
Face-Priority .....	191
Built-in AF Assist .....	191
Flash Control .....	192
Flash Compensation .....	192
<b>The Setup Menu</b> .....	<b>193</b>
Format Memory Card .....	195
Slot Empty Release Lock .....	195
Image Review .....	195
Display .....	196
Display Brightness .....	196
Grid Display .....	196
Shooting .....	196
Playback .....	196
Sound Settings .....	197
Auto Power Off .....	197
Self-Portrait Mode .....	197
Flicker Reduction .....	198
Reset File Numbering .....	198
Time Zone and Date .....	199
Auto Image Rotation .....	200
Pixel Mapping .....	201

<b>Optional Accessories .....</b>	<b>202</b>
Approved Memory Cards .....	203
Attaching a Power Connector and AC Adapter .....	204
<b>Storage and Cleaning .....</b>	<b>206</b>
Storage.....	206
Cleaning.....	206
<b>Caring for the Camera and Battery: Cautions .....</b>	<b>207</b>
<b>Defaults .....</b>	<b>211</b>
<b>Memory Card Capacity .....</b>	<b>213</b>
<b>Troubleshooting .....</b>	<b>214</b>
Battery/Display.....	214
Shooting (All Modes) .....	215
Shooting (P, S, A, and M Modes) .....	216
Movies .....	217
Tap Shooting Options .....	217
Playback.....	217
Wi-Fi (Wireless Networks).....	218
Miscellaneous.....	218
<b>Error Messages.....</b>	<b>219</b>
<b>Specifications .....</b>	<b>222</b>
Nikon 1 J5 Digital Camera .....	222
Battery Life.....	241
<b>Index .....</b>	<b>242</b>

## For Your Safety

To prevent damage to your Nikon product or injury to yourself or to others, read the following safety precautions in their entirety before using this equipment. Keep these safety instructions where all those who use the product will read them.

The consequences that could result from failure to observe the precautions listed in this section are indicated by the following symbol:



This icon marks warnings. To prevent possible injury, read all warnings before using this Nikon product.

### ■ WARNINGS

- ⚠ **Keep the sun out of the frame.** Keep the sun well out of the frame when shooting backlit subjects. Sunlight focused into the camera when the sun is in or close to the frame could cause a fire.
- ⚠ **Turn off immediately in the event of malfunction.** Should you notice smoke or an unusual smell coming from the equipment or AC adapter (available separately), unplug the AC adapter and remove the battery immediately, taking care to avoid burns. Continued operation could result in injury. After removing the battery, take the equipment to a Nikon-authorized service center for inspection.
- ⚠ **Do not use in the presence of flammable gas.** Do not use electronic equipment in the presence of flammable gas, as this could result in explosion or fire.
- ⚠ **Keep dry.** Do not immerse in or expose to water or handle with wet hands. Failure to keep the product dry could result in damage to the product, fire, or electric shock, while handling the product with wet hands could result in electric shock.
- ⚠ **Do not disassemble.** Touching the product's internal parts could result in injury. In the event of malfunction, the product should be repaired only by a qualified technician. Should the product break open as the result of a fall or other accident, remove the battery and/or AC adapter and then take the product to a Nikon-authorized service center for inspection.
- ⚠ **Keep out of reach of children.** Failure to observe this precaution could result in injury. In addition, note that small parts constitute a choking hazard. Should a child swallow any part of this equipment, consult a physician immediately.
- ⚠ **Do not place the strap around the neck of an infant or child.** Placing the camera strap around the neck of an infant or child could result in strangulation.
- ⚠ **Follow the instructions of airline and hospital personnel.**

- ⚠ Do not remain in contact with the camera, battery, or charger for extended periods while the devices are on or in use.** Parts of the device become hot. Leaving the device in direct contact with the skin for extended periods may result in low-temperature burns.
- ⚠ Do not leave the product where it will be exposed to extremely high temperatures, such as in an enclosed automobile or in direct sunlight.** Failure to observe this precaution could cause damage or fire.
- ⚠ Do not aim the flash at the operator of a motor vehicle.** Failure to observe this precaution could result in accidents.
- ⚠ Observe caution when using a flash.**
- Using the camera with the flash in close contact with the skin or other objects could cause burns.
  - Using a flash close to the subject's eyes could cause temporary visual impairment. The flash should be no less than one meter (3 ft 4 in.) from the subject. Particular care should be observed when photographing infants.
- ⚠ Avoid contact with liquid crystal.** Should the display break, care should be taken to avoid injury due to broken glass and to prevent the liquid crystal from the display touching the skin or entering the eyes or mouth.
- ⚠ Do not carry tripods with a lens or camera attached.** You could trip or accidentally strike others, resulting in injury.
- ⚠ Do not touch the moving parts of the lens.** Failure to observe this precaution could result in injury.
- ⚠ Observe proper precautions when handling batteries.** Batteries may leak, overheat, rupture, or catch fire if improperly handled. Observe the following precautions when handling batteries for use in this product:
- Use only batteries approved for use in this equipment.
  - Do not short or disassemble the battery.
  - Do not expose the battery or the camera in which it is inserted to powerful physical shocks.
  - Be sure the product is off before replacing the battery. If you are using an AC adapter, be sure it is unplugged.
  - Do not attempt to insert the battery upside down or backwards.
  - Do not expose the battery to flame or to excessive heat.
  - Do not immerse in or expose to water.
  - Replace the terminal cover when transporting the battery. Do not transport or store the battery with metal objects such as necklaces or hairpins.
  - Batteries are prone to leakage when fully discharged. To avoid damage to the product, be sure to remove the battery when no charge remains.
  - When the battery is not in use, attach the terminal cover and store in a cool, dry place.

- The battery may be hot immediately after use or when the product has been used on battery power for an extended period. Before removing the battery turn the camera off and allow the battery to cool.
- Discontinue use immediately should you notice any changes in the battery, such as discoloration or deformation.

**⚠ Observe proper precautions when handling the charger:**

- Keep dry. Failure to observe this precaution could result in injury or product malfunction due to fire or electric shock.
- Do not short the charger terminals. Failure to observe this precaution could result in overheating and damage to the charger.
- Dust on or near the metal parts of the plug should be removed with a dry cloth. Continued use could result in fire.
- Do not go near the charger during thunderstorms. Failure to observe this precaution could result in electric shock.
- Do not handle the plug or charger with wet hands. Failure to observe this precaution could result in injury or product malfunction due to fire or electric shock.
- Do not use with travel converters or adapters designed to convert from one voltage to another or with DC-to-AC inverters. Failure to observe this precaution could damage the product or cause overheating or fire.

**⚠ Use appropriate cables.** When connecting cables to the input and output jacks, use only the cables provided or sold by Nikon for the purpose to maintain compliance with product regulations.

## Notices

- No part of the manuals included with this product may be reproduced, transmitted, transcribed, stored in a retrieval system, or translated into any language in any form, by any means, without Nikon's prior written permission.
- Nikon reserves the right to change the specifications of the hardware and software described in these manuals at any time and without prior notice.
- Nikon will not be held liable for any damages resulting from the use of this product.
- While every effort has been made to ensure that the information in these manuals is accurate and complete, we would appreciate it were you to bring any errors or omissions to the attention of the Nikon representative in your area (address provided separately).

### **Notice for Customers in Canada**

CAN ICES-3 (B) / NMB-3 (B)

### **Notice for Customers in Europe**

**CAUTION: RISK OF EXPLOSION IF BATTERY IS REPLACED BY AN INCORRECT TYPE. DISPOSE OF USED BATTERIES ACCORDING TO THE INSTRUCTIONS.**

This symbol indicates that electrical and electronic equipment is to be collected separately.



The following apply only to users in European countries:

- This product is designated for separate collection at an appropriate collection point. Do not dispose of as household waste.
- Separate collection and recycling helps conserve natural resources and prevent negative consequences for human health and the environment that might result from incorrect disposal.
- For more information, contact the retailer or the local authorities in charge of waste management.

This symbol on the battery indicates that the battery is to be collected separately.



The following apply only to users in European countries:

- All batteries, whether marked with this symbol or not, are designated for separate collection at an appropriate collection point. Do not dispose of as household waste.
- For more information, contact the retailer or the local authorities in charge of waste management.

## Notice for Customers in the U.S.A.

The Battery Charger

# IMPORTANT SAFETY INSTRUCTIONS—SAVE THESE INSTRUCTIONS

## DANGER—TO REDUCE THE RISK OF FIRE OR ELECTRIC SHOCK, CAREFULLY FOLLOW THESE INSTRUCTIONS

For connection to a supply not in the U.S.A., use an attachment plug adapter of the proper configuration for the power outlet if needed. This power unit is intended to be correctly oriented in a vertical or floor mount position.

### Federal Communications Commission (FCC) Radio Frequency Interference Statement

This equipment has been tested and found to comply with the limits for a Class B digital device, pursuant to Part 15 of the FCC rules. These limits are designed to provide reasonable protection against harmful interference in a residential installation. This equipment generates, uses, and can radiate radio frequency energy and, if not installed and used in accordance with the instructions, may cause harmful interference to radio communications. However, there is no guarantee that interference will not occur in a particular installation. If this equipment does cause harmful interference to radio or television reception, which can be determined by turning the equipment off and on, the user is encouraged to try to correct the interference by one or more of the following measures:

- Reorient or relocate the receiving antenna.
- Increase the separation between the equipment and receiver.
- Connect the equipment into an outlet on a circuit different from that to which the receiver is connected.
- Consult the dealer or an experienced radio/television technician for help.



**Nikon**  
1 J5

#### CAUTIONS

##### *Modifications*

The FCC requires the user be notified that any changes or modifications made to this device that are not expressly approved by Nikon Corporation may void the user's authority to operate the equipment.

##### *Interface Cables*

Use the interface cables sold or provided by Nikon for your equipment. Using other interface cables may exceed the limits of Class B Part 15 of the FCC rules.

### Notice for Customers in the State of California

**WARNING:** Handling the cord on this product may expose you to lead, a chemical known to the State of California to cause birth defects or other reproductive harm. *Wash hands after handling.*

Nikon Inc., 1300 Walt Whitman Road, Melville, New York 11747-3064, U.S.A. Tel.: 631-547-4200

## **Notice Concerning Prohibition of Copying or Reproduction**

Note that simply being in possession of material that has been digitally copied or reproduced by means of a scanner, digital camera, or other device may be punishable by law.

### **• Items prohibited by law from being copied or reproduced**

Do not copy or reproduce paper money, coins, securities, government bonds, or local government bonds, even if such copies or reproductions are stamped "Sample."

The copying or reproduction of paper money, coins, or securities which are circulated in a foreign country is prohibited.

Unless the prior permission of the government has been obtained, the copying or reproduction of unused postage stamps or post cards issued by the government is prohibited.

The copying or reproduction of stamps issued by the government and of certified documents stipulated by law is prohibited.

### **• Cautions on certain copies and reproductions**

The government has issued cautions on copies or reproductions of securities issued by private companies (shares, bills, checks, gift certificates, etc.), commuter passes, or coupon tickets, except when a minimum of necessary copies are to be provided for business use by a company. Also, do not copy or reproduce passports issued by the government, licenses issued by public agencies and private groups, ID cards, and tickets, such as passes and meal coupons.

### **• Comply with copyright notices**

The copying or reproduction of copyrighted creative works such as books, music, paintings, woodcuts, prints, maps, drawings, movies, and photographs is governed by national and international copyright laws. Do not use this product for the purpose of making illegal copies or to infringe copyright laws.



### ***Disposing of Data Storage Devices***

Please note that deleting images or formatting memory cards or other data storage devices does not completely erase the original image data. Deleted files can sometimes be recovered from discarded storage devices using commercially available software, potentially resulting in the malicious use of personal image data. Ensuring the privacy of such data is the user's responsibility.

Before discarding a data storage device or transferring ownership to another person, erase all data using commercial deletion software, or format the device and then completely refill it with images containing no private information (for example, pictures of empty sky). Wi-Fi settings can be reset to default values by selecting **Reset Wi-Fi settings** for **Wi-Fi connection type** in the Wi-Fi menu (☐ 117). Care should be taken to avoid injury when physically destroying data storage devices.

### ***AVC Patent Portfolio License***

THIS PRODUCT IS LICENSED UNDER THE AVC PATENT PORTFOLIO LICENSE FOR THE PERSONAL AND NON-COMMERCIAL USE OF A CONSUMER TO (i) ENCODE VIDEO IN COMPLIANCE WITH THE AVC STANDARD ("AVC VIDEO") AND/OR (ii) DECODE AVC VIDEO THAT WAS ENCODED BY A CONSUMER ENGAGED IN A PERSONAL AND NON-COMMERCIAL ACTIVITY AND/OR WAS OBTAINED FROM A VIDEO PROVIDER LICENSED TO PROVIDE AVC VIDEO. NO LICENSE IS GRANTED OR SHALL BE IMPLIED FOR ANY OTHER USE. ADDITIONAL INFORMATION MAY BE OBTAINED FROM MPEG LA, L.L.C. SEE <http://www.mpegla.com>

### ***Temperature Warnings***

The camera may become warm to the touch during use; this is normal and does not indicate a malfunction. At high ambient temperatures, after extended periods of continuous use, or after several photographs have been taken in quick succession, a temperature warning may be displayed, following which the camera will turn off automatically to minimize damage to its internal circuits. Wait for the camera to cool before resuming use.

### **Use Only Nikon Brand Electronic Accessories**

Nikon cameras are designed to the highest standards and include complex electronic circuitry. Only Nikon brand electronic accessories (including chargers, batteries, AC adapters, and lens accessories) certified by Nikon specifically for use with this Nikon digital camera are engineered and proven to operate within the operational and safety requirements of this electronic circuitry.

The use of non-Nikon electronic accessories could damage the camera and may void your Nikon warranty. The use of third-party rechargeable Li-ion batteries not bearing the Nikon holographic seal shown at right could interfere with normal operation of the camera or result in the batteries overheating, igniting, rupturing, or leaking.



For more information about Nikon brand accessories, contact a local authorized Nikon dealer.

### ✔ Use Only Nikon Brand Accessories

Only Nikon brand accessories certified by Nikon specifically for use with your Nikon digital camera are engineered and proven to operate within its operational and safety requirements. THE USE OF NON-NIKON ACCESSORIES COULD DAMAGE YOUR CAMERA AND MAY VOID YOUR NIKON WARRANTY.

### ✔ Servicing the Camera and Accessories

The camera is a precision device and requires regular servicing. Nikon recommends that the camera be inspected by the original retailer or a Nikon-authorized service representative once every one to two years, and that it be serviced once every three to five years (note that fees apply to these services). Frequent inspection and servicing are particularly recommended if the camera is used professionally. Any accessories regularly used with the camera, such as lenses, should be included when the camera is inspected or serviced.

### ✍ Before Taking Important Pictures

Before taking pictures on important occasions (such as at weddings or before taking the camera on a trip), take a test shot to ensure that the camera is functioning normally. Nikon will not be held liable for damages or lost profits that may result from product malfunction.

### ✍ Life-Long Learning

As part of Nikon's "Life-Long Learning" commitment to ongoing product support and education, continually-updated information is available on-line at the following sites:

- **For users in the U.S.A.:** <http://www.nikonusa.com/>
- **For users in Europe and Africa:** <http://www.europe-nikon.com/support/>
- **For users in Asia, Oceania, and the Middle East:** <http://www.nikon-asia.com/>

Visit these sites to keep up-to-date with the latest product information, tips, answers to frequently-asked questions (FAQs), and general advice on digital imaging and photography. Additional information may be available from the Nikon representative in your area. For contact information, visit <http://imaging.nikon.com/>

## Wireless

This product, which contains encryption software developed in the United States, is controlled by the United States Export Administration Regulations and may not be exported or re-exported to any country to which the United States embargoes goods. The following countries are currently subject to embargo: Cuba, Iran, North Korea, Sudan, and Syria.

The use of wireless devices may be prohibited in some countries or regions. Contact a Nikon-authorized service representative before using the wireless features of this product outside the country of purchase.

### **Notices for Customers in the U. S. A.**

This device complies with Part 15 of FCC Rules and Industry Canada licence-exempt RSS standard(s). Operation is subject to the following two conditions: (1) this device may not cause interference, and (2) this device must accept any interference, including interference that may cause undesired operation of the device.

### **FCC WARNING**

The FCC requires the user to be notified that any changes or modifications made to this device that are not expressly approved by Nikon Corporation may void the user's authority to operate the equipment.

### **FCC Radio Frequency Interference Statement**

Note: This equipment has been tested and found to comply with the limits for a Class B digital device, pursuant to part 15 of the FCC Rules. These limits are designed to provide reasonable protection against harmful interference in a residential installation. This equipment generates, uses and can radiate radio frequency energy and, if not installed and used in accordance with the instructions, may cause harmful interference to radio communications. However, there is no guarantee that interference will not occur in a particular installation. If this equipment does cause harmful interference to radio or television reception, which can be determined by turning the equipment off and on, the user is encouraged to try to correct the interference by one or more of the following measures:

- Reorient or relocate the receiving antenna.
- Increase the separation between the equipment and receiver.
- Connect the equipment into an outlet on a circuit different from that to which the receiver is connected.
- Consult the dealer or an experienced radio/TV technician for help.

### **Co-location**

This transmitter must not be co-located or operated in conjunction with any other antenna or transmitter.

Nikon Inc., 1300 Walt Whitman Road, Melville, New York 11747-3064, U.S.A.

Tel.: 631-547-4200

### **Notices for Customers in Canada**

This device complies with Part 15 of FCC Rules and Industry Canada licence-exempt RSS standard(s). Operation is subject to the following two conditions: (1) this device may not cause interference, and (2) this device must accept any interference, including interference that may cause undesired operation of the device.

### **FCC/IC RF Exposure Statement**

The available scientific evidence does not show that any health problems are associated with using low power wireless devices. There is no proof, however, that these low power wireless devices are absolutely safe. Low power Wireless devices emit low levels of radio frequency energy (RF) in the microwave range while being used. Whereas high levels of RF can produce health effects (by heating tissue), exposure of low-level RF that does not produce heating effects causes no known adverse health effects. Many studies of low-level RF exposures have not found any biological effects. Some studies have suggested that some biological effects might occur, but such findings have not been confirmed by additional research. The 1 J5, which is equipped with a DW092 (FCC ID:EW4DW092 / IC ID:4634A-3149EC) wireless LAN module, has been tested and found to comply with FCC/IC radiation exposure limits set forth for an uncontrolled environment and meets the FCC radio frequency (RF) Exposure Guidelines in Supplement C to OET65 and RSS-102 of the IC radio frequency (RF) Exposure rules. Please refer to the SAR test report that was uploaded to FCC website.

### **Notices for Customers in Europe**

Hereby, Nikon Corporation, declares that the 1 J5 is in compliance with the essential requirements and other relevant provisions of Directive 1999/5/EC. The declaration of conformity may be consulted at [http://imaging.nikon.com/support/pdf/DoC\\_1J5.pdf](http://imaging.nikon.com/support/pdf/DoC_1J5.pdf)



### **Notice for Customers in Singapore**

Trade Name: <b>Nikon</b> Model: 1 J5
---

This device complies with radio-frequency regulations. The content of certification labels not affixed to the device is given below.

Complies with IDA Standards DA103423
--

### **Notice for Customers in Algeria**

This device complies with Part 15 of FCC Rules and Industry Canada licence-exempt RSS standard(s). Operation is subject to the following two conditions: (1) this device may not cause interference, and (2) this device must accept any interference, including interference that may cause undesired operation of the device.

### **Co-location**

This transmitter must not be co-located or operated in conjunction with any other antenna or transmitter.

### **FCC/IC RF Exposure Statement**

The available scientific evidence does not show that any health problems are associated with using low power wireless devices. There is no proof, however, that these low power wireless devices are absolutely safe. Low power Wireless devices emit low levels of radio frequency energy (RF) in the microwave range while being used. Whereas high levels of RF can produce health effects (by heating tissue), exposure of low-level RF that does not produce heating effects causes no known adverse health effects. Many studies of low-level RF exposures have not found any biological effects. Some studies have suggested that some biological effects might occur, but such findings have not been confirmed by additional research. The 1 J5, which is equipped with a DW092 (FCC ID:EW4DW092 / IC ID:4634A-3149EC) wireless LAN module, has been tested and found to comply with FCC/IC radiation exposure limits set forth for an uncontrolled environment and meets the FCC radio frequency (RF) Exposure Guidelines in Supplement C to OET65 and RSS-102 of the IC radio frequency (RF) Exposure rules. Please refer to the SAR test report that was uploaded to FCC website.

### **Security**

Although one of the benefits of this product is that it allows others to freely connect for the wireless exchange of data anywhere within its range, the following may occur if security is not enabled:

- Data theft: Malicious third-parties may intercept wireless transmissions to steal user IDs, passwords, and other personal information.
- Unauthorized access: Unauthorized users may gain access to the network and alter data or perform other malicious actions. Note that due the design of wireless networks, specialized attacks may allow unauthorized access even when security is enabled.

# Introduction

## Before You Begin

Before using your camera for the first time, confirm that the package contains the items listed in the *User's Manual*.

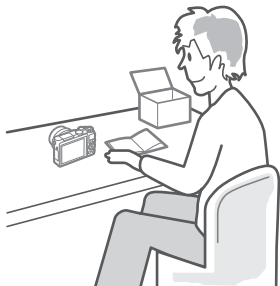

## Parts of the Camera

Take a few moments to familiarize yourself with camera controls and displays. You may find it helpful to bookmark this section and refer to it as you read through the rest of the manual.

### The Camera Body

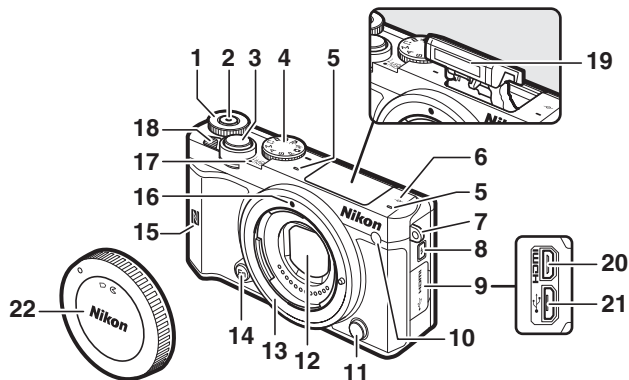

<b>1</b> Command dial ..... 37, 67, 68, 70, 186, 236	<b>11</b> Lens release button..... 27
<b>2</b> Movie-record button ..... 43, 53, 56	<b>12</b> Dust shield..... 206, 207
<b>3</b> Shutter-release button ..... 39, 45, 77, 82, 84, 89	<b>13</b> Lens mount ..... 26, 187
<b>4</b> Mode dial ..... 6	<b>14</b> Fn button ..... 13
<b>5</b> Microphone ..... 180	<b>15</b> N-Mark (NFC antenna)..... 119
<b>6</b> Focal plane mark (∞) ..... 187	<b>16</b> Mounting mark ..... 26
<b>7</b> Eyelet for camera strap..... 21	<b>17</b> Power lamp ..... 28
<b>8</b> Flash pop-up button ..... 104	<b>18</b> Power switch..... 28
<b>9</b> Connector cover	<b>19</b> Built-in flash..... 102
<b>10</b> AF-assist illuminator ..... 191 Self-timer lamp..... 100 Red-eye reduction lamp ..... 103, 105	<b>20</b> HDMI connector ..... 144
	<b>21</b> USB connector ..... 141, 146
	<b>22</b> Body cap ..... 202



## The Camera Body (Continued)

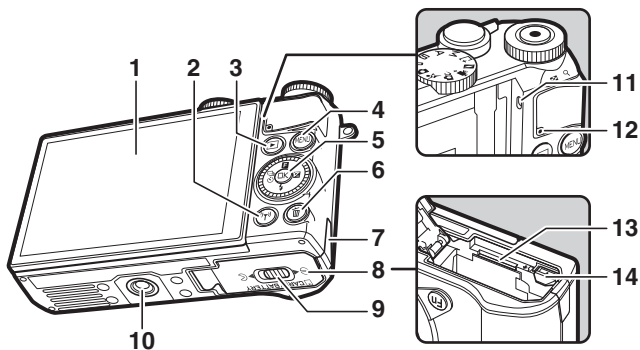

<b>1</b> Tilting monitor ..... 4, 125, 196	<b>7</b> Power connector cover for optional power connector.....204
<b>2</b> (Wi-Fi) button ..... 118, 121	<b>8</b> Battery-chamber/ memory card slot cover ... 23, 25, 204
<b>3</b> (playback) button .....37, 86, 93	<b>9</b> Battery-chamber/memory card slot cover latch..... 23, 25, 204
<b>4</b> MENU (menu) button ..... 9	<b>10</b> Tripod socket *
<b>5</b> Multi selector..... 8	<b>11</b> Speaker
(OK) button..... 8	<b>12</b> Memory card access lamp ..... 25, 35
(feature) ..... 11	<b>13</b> Memory card slot.....23
(exposure compensation)..... 101	<b>14</b> Battery latch..... 23, 25, 204
(flash mode)..... 102	
(continuous shooting/ self-timer)..... 74, 97, 99	
<b>6</b> (delete) button.....38, 134	

\* Camera does not support TA-N100 tripod mounting spacer.

### Holding the Camera

When framing photographs, hold the camera as shown below.

Hold the camera in  
your right hand.

Keep your elbows  
propped lightly  
against your torso.

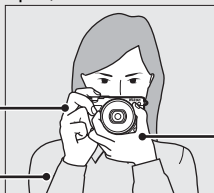

Cradle the lens with  
your left hand.

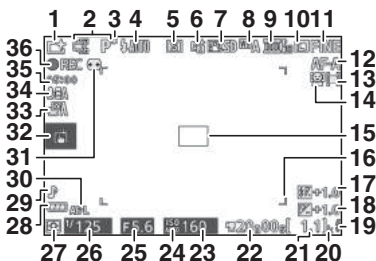

<b>1</b> Shooting mode .....	6	<b>20</b> "k" (appears when memory remains	for over 1000 exposures) .....	32
<b>2</b> Live image control .....	94	<b>21</b> Number of exposures remaining .....	32	
Creative mode .....	58	Number of shots remaining	before memory buffer fills .....	75, 98
Best moment capture		White balance		
selection .....	76, 81, 83	recording indicator .....	170	
Advanced movie selection .....	49	Card warning indicator.....	195, 219	
Exposure mode .....	161	<b>22</b> Time available.....	43	
<b>3</b> Flexible program indicator .....	67	<b>23</b> ISO sensitivity .....	172	
<b>4</b> Flash mode .....	103, 105	<b>24</b> ISO sensitivity indicator.....	172	
<b>5</b> Self-timer .....	99	Auto ISO sensitivity indicator .....	172	
Continuous mode * .....	74, 97	<b>25</b> Aperture.....	69, 70	
<b>6</b> Active D-Lighting * .....	178	<b>26</b> Shutter speed .....	68, 70	
<b>7</b> Picture Control * .....	173	<b>27</b> Metering .....	166	
<b>8</b> White balance * .....	167	<b>28</b> Battery indicator * .....	32	
<b>9</b> Frame size/frame rate * .....	165	<b>29</b> Sound settings * .....	197	
<b>10</b> Image size * .....	162	<b>30</b> Autoexposure (AE) lock		
<b>11</b> Image quality * .....	162	indicator .....	194	
<b>12</b> Focus mode * .....	184	<b>31</b> Auto distortion control.....	177	
<b>13</b> AF-area mode * .....	188	<b>32</b> Tap shooting options.....	111	
<b>14</b> Face-priority * .....	40, 191	<b>33</b> Auto image capture .....	180	
<b>15</b> Focus area .....	34, 188	<b>34</b> Microphone sensitivity * .....	180	
<b>16</b> AF-area brackets * .....	184	<b>35</b> Time elapsed.....	43	
<b>17</b> Flash compensation .....	192	<b>36</b> Recording indicator.....	43	
<b>18</b> Exposure compensation .....	101			
<b>19</b> Flash-ready indicator .....	106			

\* Available only when **Detailed** is selected for **Display > Shooting** in the setup menu (□ 196).

**Note:** Display shown with all indicators lit for illustrative purposes.

### Recording Area

The area recorded when electronic vibration reduction (📖 183) is in effect during movie recording is shown by a frame in the shooting display.

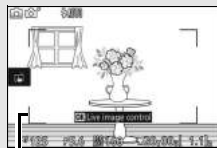

*Area recorded*



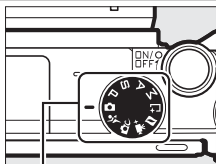

## The Mode Dial

The camera offers a choice of the following shooting modes:



Mode dial

 **Auto mode** (📖 33): Let the camera pick the settings for photographs and movies.

 **Sports mode** (📖 74): The camera takes pictures continuously while the shutter-release button is pressed. Choose for sporting events and other scenes with fast-moving subjects.

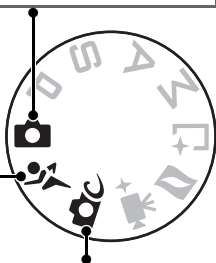

 **Creative mode** (📖 58): Use special effects or match settings to the scene.

 **POP Pop**

 **RETRO Retro**

 **High-contrast monochrome**

 **SEPIA Nostalgic sepia**

 **HDR HDR**

 **Soft**

 **Easy panorama**

 **Miniature effect**

 **Selective color**

 **Cross process**

 **Toy camera effect**

 **Cross screen**

 **Fisheye**

 **Skin softening**

 **Night landscape**

 **Night portrait**

 **Landscape**

 **Close-up**

 **Portrait**

**P, S, A, and M modes** (☞ 67): Control shutter speed and aperture for advanced photographic effects.

- **P:** Programmed auto (☞ 67)
- **S:** Shutter-priority auto (☞ 68)
- **A:** Aperture-priority auto (☞ 69)
- **M:** Manual (☞ 70)

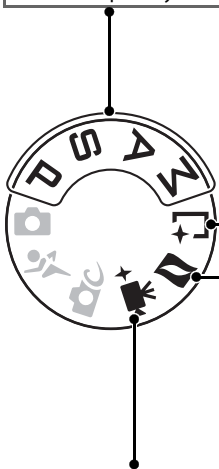

**☞ Best moment capture mode** (☞ 76): Choose **Active Selection** to select the best picture from 20 shots in temporary storage, **Slow view** to choose the best timing for the shot while the scene plays back in slow motion, or **Smart Photo Selector** to let the camera pick the best shot based on composition and movement.

**☞ Motion Snapshot mode** (☞ 88): Each time the shutter is released, the camera records a still image and about 1.6 s of movie footage. When the resulting “Motion Snapshot” is viewed on the camera, the movie will play back in slow motion over approximately 4 s, followed by the still image.

**☞+ Advanced movie mode** (☞ 49): Choose an exposure mode and adjust shutter-speed or aperture or record movies in slow or fast motion or with other special effects.



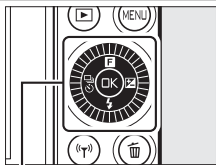

## The Multi Selector

The multi selector and  button are used to adjust settings and navigate the camera menus.



Multi selector

### Settings:

Access the  (feature) menu, a context-sensitive menu listing options for shooting or playback ( 11).

### Menu navigation:

Move cursor up.

### Settings:

View continuous shooting/self-timer menu ( 74, 97, 99).

### Menu navigation:

Return to previous menu.

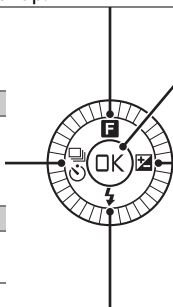

Select highlighted item.

### Settings:

View exposure compensation menu ( 101).

### Menu navigation:

Select highlighted item or display sub-menu.

### Settings:

View flash mode menu ( 102, 104).

### Menu navigation:

Move cursor down.

### The Multi Selector

Items can be highlighted by rotating the multi selector as shown at right.



## The MENU Button

Most shooting, playback, setup, and Wi-Fi options can be accessed from the camera menu. To view the menus, press the MENU button.

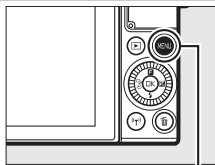

MENU button



### Tabs

Choose from the following menus:

▶ Playback menu (📖 149)

📷 P S A M ⚙️ + 📷 Shooting menu (📖 158)

🔧 Setup menu (📖 193)

📶 Wi-Fi menu (📖 114)

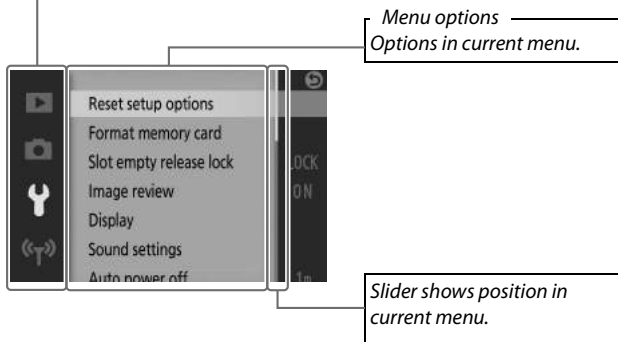

### ✎ Using the Menus

The items listed may vary with camera settings. Items displayed in gray are not currently available. To exit the menus and return to shooting mode, press the shutter-release button halfway (📖 39).

## ■ Using the Menus

Use the multi selector (📖 8) to navigate the playback, shooting, setup, and Wi-Fi menus.

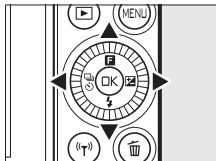

Multi selector

### 1 Select a menu.

Press ⬆️ or ⬆️ to highlight tabs and press ▶️ to position the cursor in the highlighted menu.

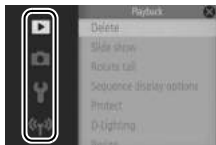

### 2 Select an item.

Press ⬆️ or ⬆️ to highlight menu items and press ▶️ to view options for the highlighted item.



### 3 Select an option.

Press ⬆️ or ⬆️ to highlight the desired option and press OK to select.

## ✍ Touch Controls

Slide up or down to scroll and tap menu items or icons to select options or adjust settings (📖 19).

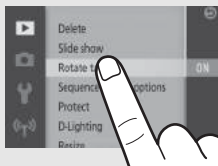



## The **F** (Feature) Menu

To display the feature menu and adjust camera settings or access playback options, press **F** (feature) on the multi selector.



**F** menu (shooting mode)

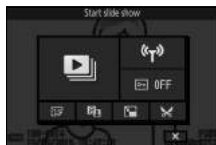

**F** menu (playback)

### 1 Select an item.

Use the multi selector to highlight an item and press **OK** to display options (to exit the **F** menu, press the shutter-release button halfway as described on page 39 or highlight **X** and press **OK**).



### 2 Select an option.

Highlight the desired option or value and press **OK** to select.

## The **F** Menu

The **F** menu is context-sensitive: its contents vary with camera settings or the type of image displayed; options that are currently unavailable are shown in gray. The **F** menu is not available in auto or sports mode.

## **F** Menu Touch Controls

Items in the **F** menu can also be selected by tapping the monitor.

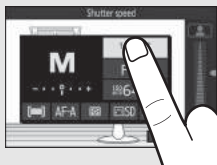

## The Function (Fn) Button

The **Fn** button can be used for quick recall of frequently-used settings during shooting. To choose the role played by the **Fn** button, select **Assign Fn button** in the setup menu (📖 193) and choose from the following options:

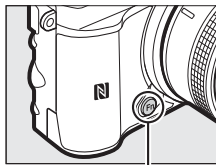

Fn button



- Exposure compensation (📖 101)
- Metering (📖 166)
- White balance (📖 167)
- ISO sensitivity (📖 172)
- Picture Control (📖 173)
- AF-area mode (📖 188)
- Focus mode (📖 184)

## Tilting the Monitor

The monitor can be angled and rotated as shown below.

**Normal use:** The monitor is normally used in storage position.

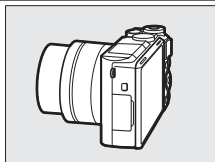

**Low-angle shots:** Tilt the monitor up to frame shots with the camera close to the ground. Once in the low-angle position, the monitor can be further lowered.

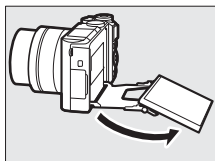
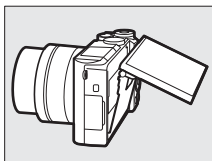
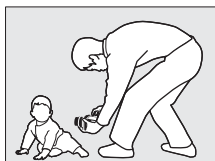
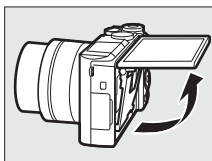

**High-angle shots:** Tilt the monitor down to frame shots while holding the camera over your head.

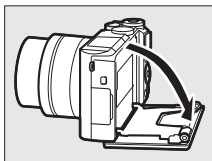

**Self-portraits** (📖 108): Reverse the monitor to select self-portrait mode.

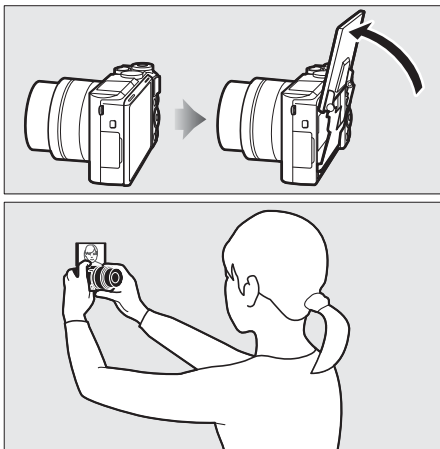

#### ✔ Using the Monitor

Rotate the monitor gently within the limits of the hinges. *Do not use force.* Failure to observe these precautions could damage the camera or monitor. If the camera is mounted on a tripod, care should be taken to ensure that the monitor does not contact the tripod.

Do not touch the area to the rear of the monitor. Failure to observe this precaution could cause product malfunction.

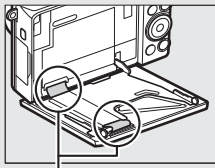

*Be particularly careful not to touch these areas.*

## Using the Touch Screen

The touch-sensitive monitor supports the following operations:

---

### Tap

Tap the monitor.



---

### Flick

Flick a finger a short distance across the monitor.

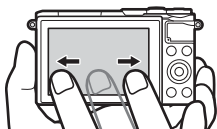

---

### Slide

Slide a finger over the monitor.

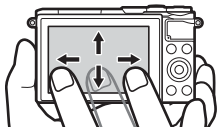

---

### Stretch/Pinch

Place two fingers on the monitor and move them apart or pinch them together.

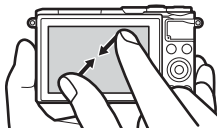
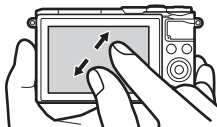

### ✓ The Touch Screen

The touch screen responds to static electricity and may not respond when covered with third-party protective films or when touched with fingernails or gloved hands. Do not use excessive force or touch the screen with sharp objects.

### ✓ Using the Touch Screen

The touch screen may not respond as expected if you attempt to operate it while leaving your palm or another finger resting on it in second location. It may not recognize other gestures if your touch is too soft, your fingers are moved too quickly or too short a distance or do not remain in contact with the screen, or if the movement of the two fingers in a pinch or stretch is not correctly coordinated.

### ✍ Enabling or Disabling Touch-screen Controls

Touch controls can be enabled or disabled using the **Touch-screen controls** option in the setup menu (📖 194).



## ■ Taking Pictures

The touch screen can be used for the following shooting operations.

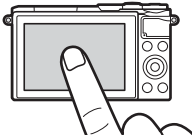
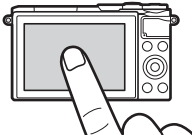
<b>Take a picture (tap shooting)</b>	 <p>In auto, creative, <b>P</b>, <b>S</b>, <b>A</b>, <b>M</b>, and self-portrait modes, you can focus and take a picture by tapping your subject in the display.</p>
<b>Focus (tap shooting)</b>	 <p>In advanced movie mode, you can focus by tapping your subject in the display.</p>

## Adjust settings

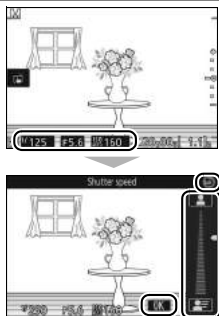

Tap highlighted icons to view settings and tap icons or sliders to change (the items available vary with camera settings). Tap **OK** to save changes and exit, or tap **↶** to exit to the previous display without saving changes.

## Tap Shooting Options

Tap shooting options can be adjusted by tapping the icon shown at right (111).

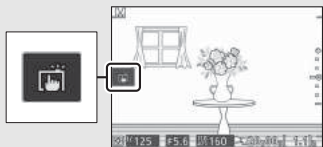

## Viewing Pictures

The touch screen can be used for the following playback operations.

### View other images

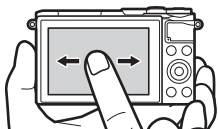

Flick left or right to view other images.



### View movies or panoramas



Tap the on-screen guide to start movie or panorama playback (movies are indicated by a  icon). Tap the display to pause or resume.

Guide

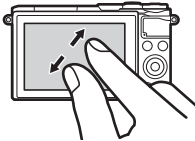
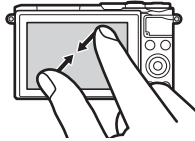
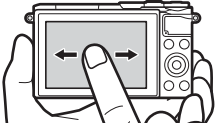

Zoom in		<p>Use stretch and pinch gestures to zoom in and out and slide to scroll. You can also double-tap a picture in full-frame playback to zoom in and double-tap again to exit zoom (☞ 131).</p>
View thumbnails		<p>To “zoom out” to a thumbnail view (☞ 129), use a pinch gesture in full-frame playback. Use pinch and stretch to choose the number of images displayed from 4, 9, or 16 frames.</p>
View other months		<p>Flick left or right to view other months in the calendar display (☞ 130).</p>
Use on-screen guides		<p>Various operations can be performed by tapping on-screen guides.</p>



## ■ Using the Menus

The touch screen can be used for the following menu operations.

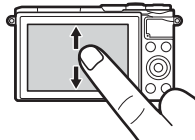
Scroll		<p>Slide up or down to scroll.</p>
--------	---	------------------------------------

**Choose a menu**



Tap a menu icon to choose a menu.

**Select items/  
adjust settings**





Tap menu items to display options and tap icons or sliders to change. Tap  to exit to the previous display without changing settings.

## ■ The **F** Menu

The touch screen can be used to adjust settings in the **F** menu.

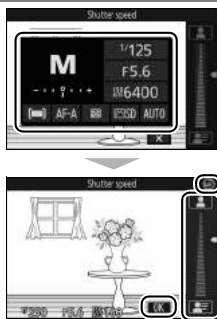
**Select items/  
adjust settings**



Tap menu items to display options and tap icons or sliders to change. Tap  to save changes and exit, or tap  to exit to the previous display without changing settings.

## First Steps

### 1 Attach the camera strap.

Attach the strap securely to the two camera eyelets.

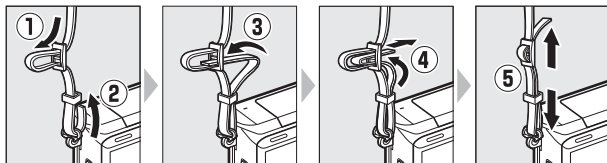

### 2 Charge the battery.

Insert the battery into the charger ① and plug the charger in ②. An exhausted battery fully charges in about two hours and 30 minutes. Unplug the charger and remove the battery when charging is complete.

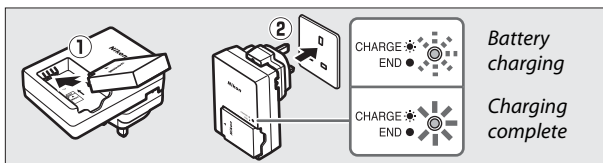

#### The Plug Adapter

Depending on the country or region of purchase, a plug adapter may be supplied with the charger. The shape of the adapter varies with the country or region of purchase. If a plug adapter is supplied, raise the wall plug and connect the plug adapter as shown at right, making sure the plug is fully inserted. Attempting to forcibly remove the plug adapter could damage the product.

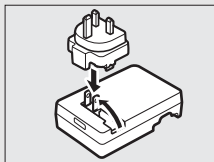

### **The Battery and Charger**

*Read and follow the warnings and cautions on pages ix–xi and 207–210 of this manual.* Do not use the battery at ambient temperatures below 0°C (32°F) or above 40°C (104°F); failure to observe this precaution could damage the battery or impair its performance. Capacity may be reduced and charging times may increase at battery temperatures from 0°C (32°F) to 10°C (50°F) and from 45°C (113°F) to 60°C (140°F); the battery will not charge if its temperature is below 0°C (32°F) or above 60°C (140°F).

Charge the battery at ambient temperatures between 5°C (41°F) and 35°C (95°F). If the **CHARGE** lamp flashes quickly during charging, cease use immediately and take battery and charger to your retailer or a Nikon-authorized service representative.

Do not move the charger or touch the battery during charging. Failure to observe this precaution could in very rare instances result in the charger showing that charging is complete when the battery is only partially charged. Remove and reinsert the battery to begin charging again.

Use the charger with compatible batteries only. Unplug when not in use.



### 3 Insert the battery and a memory card.

The camera stores pictures on microSD, microSDHC, and microSDXC memory cards (available separately;  203). Before inserting the battery or memory cards, check that they are in the correct orientation. Using the orange battery latch, slide the battery in until it latches, and then slide in the memory card until it clicks into place. Do not attempt to insert the card at an angle; failure to observe this precaution could damage the product.

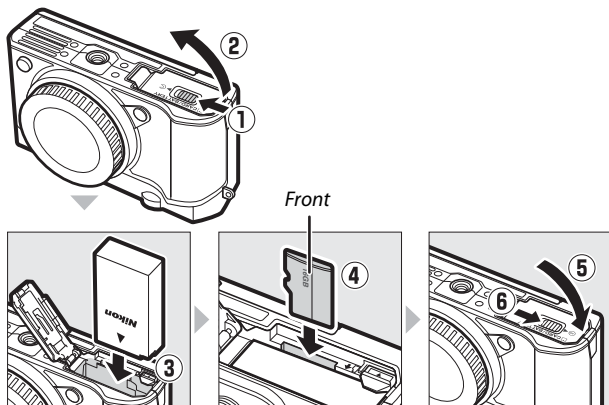

## ✔ Inserting and Removing Batteries and Memory Cards

Always turn the camera off before inserting or removing batteries or memory cards. Note that the battery and memory cards may be hot after use; observe due caution when removing the battery and memory cards.

### ✎ Formatting Memory Cards

If this is the first time the memory card will be used in the camera or if the card has been formatted in another device, select **Format memory card** in the setup menu and follow the on-screen instructions to format the card (☞ 195). *Note that this permanently deletes any data the card may contain.* Be sure to copy any photographs and other data you wish to keep to a computer before proceeding (☞ 140).

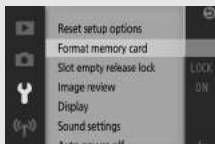

### Removing Batteries and Memory Cards

After turning the camera off, confirm that the memory card access lamp (📖 3) is off and open the battery-chamber/memory card slot cover. To remove the battery, first release it by pressing the orange battery latch in the direction shown by the arrow and then remove the battery by hand.

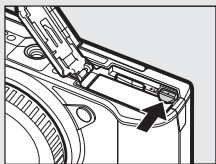

To remove a memory card, first press the card in to eject it (1); the card can then be removed by hand (2). Care should be taken to prevent the card popping from the camera when ejected.

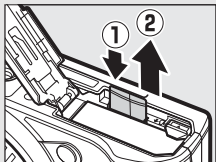

### Memory Cards

- Do not remove memory cards from the camera, turn the camera off, or remove or disconnect the power source during formatting or while data are being recorded, deleted, or copied to a computer. Failure to observe these precautions could result in loss of data or in damage to the camera or card.
- Do not touch the card terminals with your fingers or metal objects.
- Do not bend, drop, or subject to strong physical shocks.
- Do not apply force to the card casing. Failure to observe this precaution could damage the card.
- Do not expose to water, heat, high levels of humidity, or direct sunlight.
- Do not format memory cards in a computer.



## 4 Attach a lens.

Be careful to prevent dust from entering the camera when the lens or body cap is removed. The lens generally used in this manual for illustrative purposes is a 1 NIKKOR VR 10–30mm f/3.5–5.6 PD-ZOOM.

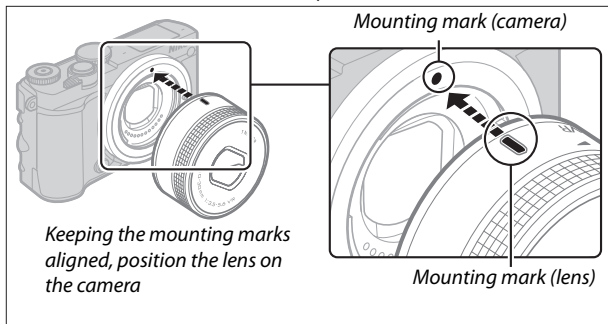
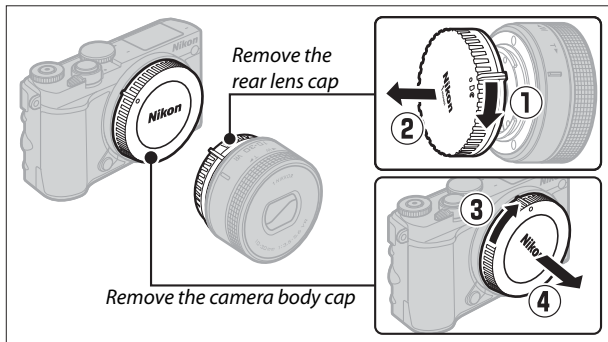



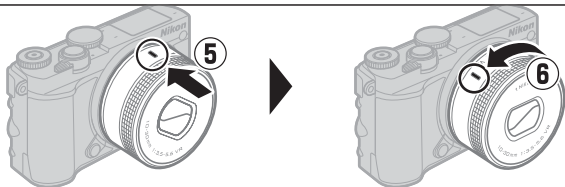

Rotate the lens as shown until it clicks into place.



If the lens supports vibration reduction (VR), vibration reduction can be controlled from the camera (183).

### Detaching the Lens

Be sure the lens is retracted before removal. To remove the lens, turn the camera off, then press and hold the lens release button (1) while turning the lens clockwise (2). After removing the lens, replace the camera body cap, the rear lens cap, and, if applicable, the front lens cap.

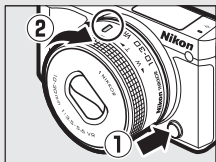

### Lenses with Retractable Lens Barrel Buttons

Lenses with retractable lens barrel buttons can not be used when retracted. To unlock and extend the lens, readying the camera for use, keep the retractable lens barrel button pressed (1) while rotating the zoom ring as shown (2). The lens can be retracted and the zoom ring locked by pressing the button and rotating the ring in the opposite direction. Be careful not to press the retractable lens barrel button while attaching or removing the lens.

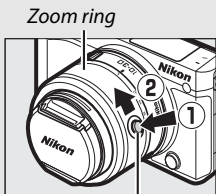

Retractable lens barrel button

## 5 Turn the camera on.

Rotate the power switch to turn the camera on. The power lamp will briefly light green and the monitor will turn on. If the lens is equipped with a front lens cap, remove the cap before shooting. If a 1 NIKKOR VR 10–30mm f/3.5–5.6 PD-ZOOM lens is attached, the lens will automatically extend when the camera is turned on and retract when the camera is turned off.

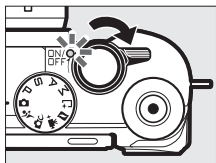

### Turning the Camera Off

To turn the camera off, rotate the power switch again. The monitor will turn off.

### Auto Power Off

If no operations are performed for about a minute, the display will turn off and the power lamp will start to flash (if desired, the delay before the display turns off automatically can be changed using the **Auto power off** option in the setup menu; □ 197). The camera can be reactivated by operating the shutter-release button. If no operations are performed for about three minutes after the display has turned off, the camera will turn off automatically.

### Attaching and Removing Lenses

Turn the camera off before attaching or removing lenses. Note that when the camera is turned off, the sensor protection barrier in the lens will close, protecting the camera image sensor.

### Lenses with Retractable Lens Barrel Buttons

The camera will turn on automatically when the retractable lens barrel lock is released; in addition, if the view through the lens is displayed or the monitor is off, the camera will turn off when the lens barrel is locked (in the case of 1 NIKKOR VR 10–30mm f/3.5–5.6 and 1 NIKKOR VR 30–110mm f/3.8–5.6 lenses, firmware version 1.10 or later is required if locking the lens barrel is to turn the camera off when the monitor is off; for information on updating lens firmware, visit the Nikon website for your area).





## 6 Choose a language.

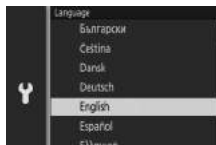

A language-selection dialog will be displayed the first time the camera is turned on. Use the multi selector and  button (8) to choose a language.







## 7 Set the clock.

Use the multi selector and  button ( 8) to set the time and date. *Note that the camera uses a 24-hour clock.*

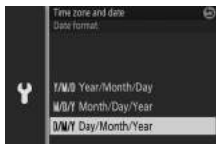



Press  or  to highlight time zone and press .



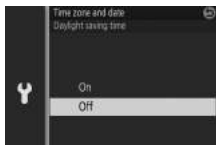



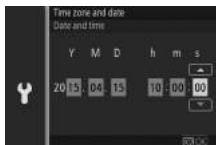

Press  or  to highlight date format and press .



Press  or  to highlight daylight saving time option and press .



Press  or  to highlight items and press  or  to change. Press  to exit to shooting display when setup is complete.

**Note:** Language and clock can be changed at any time using **Language** ( 194) and **Time zone and date** ( 199) options in setup menu.

### **The Camera Clock**

The camera clock is less accurate than most watches and household clocks. Check the clock regularly against more accurate time pieces and reset as necessary.

The camera clock is powered by an independent, rechargeable power source, which is charged as necessary when the main battery is installed or the camera is powered by an optional power connector and AC adapter (📖 204). Three days of charging will power the clock for about a month. If a message warning that the clock is not set is displayed when the camera is turned on, the clock battery is exhausted and the clock has been reset. Set the clock to the correct time and date.



## 8 Check the battery level and memory card capacity.

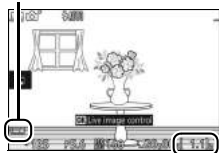

Check the battery level and number of exposures remaining in the monitor.

### Battery level



Exposures remaining

### ■ ■ Battery Level

Display	Description
NO ICON	Battery fully charged or partially discharged; level shown by  or  icon in detailed display ( <a href="#">□ 196</a> ).
	Low battery. Ready fully-charged battery or prepare to charge battery.
Cannot take pictures. Insert fully-charged battery.	Battery exhausted; shutter-release disabled. Insert charged battery.

### ■ ■ Number of Exposures Remaining

The monitor shows the number of pictures that can be stored on the memory card at current settings (values over 1000 are rounded down to the nearest hundred; e.g., values between 1200 and 1299 are shown as 1.2 k). If a warning is displayed stating that there is not enough memory for additional images, insert another memory card ([□ 23](#)) or delete some photos ([□ 134](#)).

# Taking and Viewing Photographs

This chapter describes how to take, view, and delete photographs in auto and creative mode.

## Point-and-Shoot Photography (Auto Mode)

Follow the steps below to take photographs in auto mode, a “point-and-shoot” mode in which the camera automatically detects the subject type and adjusts settings according to the subject and situation.

### 1 Turn the camera on.

Rotate the power switch to turn the camera on.

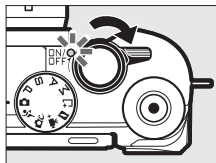

### 2 Select mode.

Rotate the mode dial to  (auto).

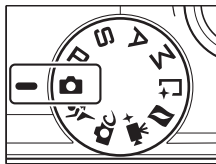

### 3 Ready the camera.

Hold the camera securely with both hands, being careful not to obstruct the lens, AF-assist illuminator, or microphone. Rotate the camera as shown at lower right when taking pictures in “tall” (portrait) orientation.

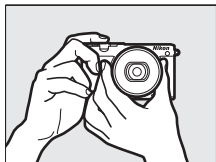

Shutter speeds slow when lighting is poor; use of the built-in flash ( 102) or a tripod is recommended.

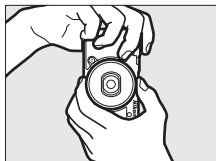

### 4 Frame the photograph.

Position your subject in the center of the frame. At default settings, the camera will automatically detect portrait subjects and position the focus point accordingly ( 40).

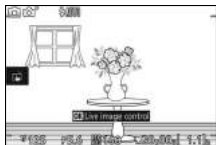

### 5 Focus.

Press the shutter-release button halfway to focus. If the subject is poorly lit, the flash may pop up ( 102) and the AF-assist illuminator ( 191) may light to assist the focus operation.

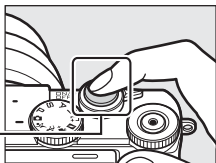

**If the camera is able to focus**, the selected focus area will be highlighted in green and a beep will sound (a beep may not sound if the subject is moving).

**If the camera is unable to focus**, the focus area will be displayed in red.

*Focus area*

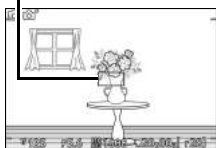



## 6 Shoot.

Smoothly press the shutter-release button the rest of the way down to release the shutter and record the photograph.

Pictures can also be taken using touch controls. Tap a subject anywhere in the frame to focus and release the shutter.

After the shutter is released, the memory card access lamp will light and the photograph will be displayed in the monitor for a few seconds (the photo will automatically clear from the display when the shutter-release button is pressed halfway). *Do not eject the memory card or remove the battery until the lamp has gone out and recording is complete.*

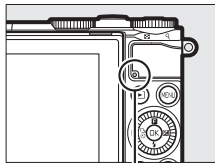
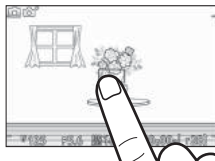
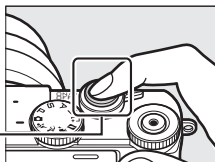

Memory card access lamp

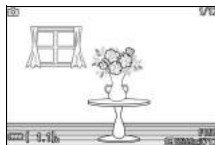

### **The Framing Grid**

A framing grid can be displayed by selecting **On** for **Display > Grid display** in the setup menu (📖 196).

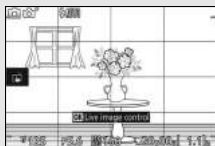

### **See Also**

See page 197 for information on silencing the beep that sounds when the camera focuses or the shutter is released.





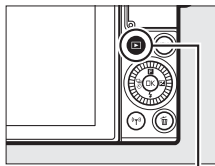

## Viewing Photographs

Press  to display your most recent photograph full frame in the monitor (full-frame playback).

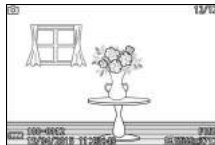



 button

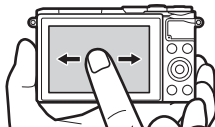

Press  or  or rotate the multi selector to view additional pictures. You can also scroll through pictures by flicking left or right ( 18).



To zoom in on the center of the current image, rotate the command dial to the right ( 131). Rotate left to zoom out (you can also zoom in or out using touch controls: place two fingers on the monitor and spread them apart to zoom in or pinch them together to zoom out). To view multiple images, rotate the dial left when the picture is displayed full frame ( 129).

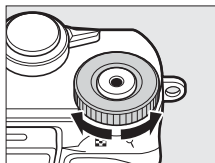

Command dial

To end playback and return to shooting mode, press the shutter-release button halfway.

## Deleting Pictures

To delete the current picture, press . *Note that once deleted, pictures can not be recovered.*

### 1 Display the photograph.

Display the photograph you wish to delete as described on the preceding page.

### 2 Press .

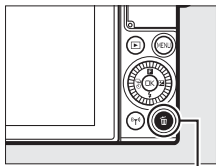

A confirmation dialog will be displayed.



 button



### 3 Delete the photograph.

Press  again to delete the picture and return to playback, or press  to exit without deleting the picture.

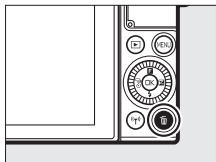

### **The Shutter-Release Button**

The camera has a two-stage shutter-release button. The camera focuses when the shutter-release button is pressed halfway. To take the photograph, press the shutter-release button the rest of the way down.



**Focus:** Press halfway



**Shoot:** Press the rest of the way down

### **Taking Several Photographs in Succession**







You can take additional photographs without refocusing by keeping the shutter-release button pressed halfway between shots.

### **Automatic Scene Selection**

In auto mode, the camera automatically analyzes the subject and selects the appropriate scene. The selected scene is shown in the monitor.

Scene icon



	<b>Portrait:</b> Human portrait subjects.
	<b>Landscape:</b> Landscapes and cityscapes.
	<b>Night portrait:</b> Portrait subjects framed against dark backgrounds.
	<b>Close-up:</b> Subjects close to the camera.
	<b>Night landscape:</b> Poorly-lit landscapes and cityscapes.
	<b>Auto:</b> Subjects that do not fall into the categories listed above.



## Using a Zoom Lens

Use the zoom ring to zoom in on the subject so that it fills a larger area of the frame, or zoom out to increase the area visible in the final photograph. During movie recording with the 1 NIKKOR VR 10–30mm f/3.5–5.6 PD-ZOOM, the zoom rate is unaffected by the speed with which the ring is rotated.

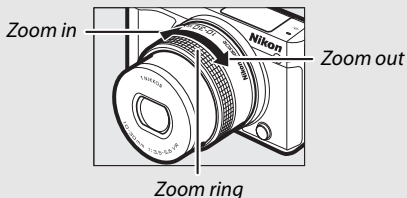

If you are using a 1 NIKKOR VR 10–100mm f/4.5–5.6 PD-ZOOM lens (available separately), slide the power drive zoom switch to **T** to zoom in and to **W** to zoom out. The speed with which the camera zooms in and out varies with how far you slide the switch. The zoom position is shown by the zoom guide in the display.

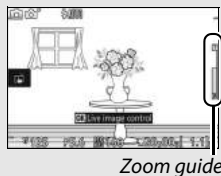

*Zoom guide*

## Face Priority

The camera detects and focuses on portrait subjects (face priority). A double yellow border will be displayed if a portrait subject is detected facing the camera (if multiple faces, up to a maximum of five, are detected, the camera will select the closest subject). Press the shutter-release button halfway to focus on the subject in the double yellow border. The border will clear from the display if the camera can no longer detect the subject (because, for example, the subject has looked away).



### **Deleting Multiple Pictures**

The **Delete** option in the playback menu (📖 134) can be used to delete all or selected pictures.

### **See Also**

For information on toggling photo info on or off, see page 196.



# Recording and Viewing Movies

## Recording Movies

### 1 Turn the camera on.

Rotate the power switch to turn the camera on.

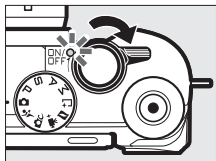

### 2 Choose a shooting mode.

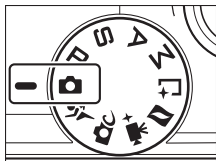

Rotate the mode dial to any of the positions shown at right.



### 3 Frame the opening shot.

Frame the opening shot with your subject in the center of the display.

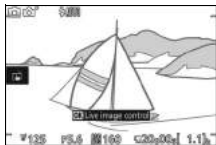

#### The Icon

A  icon indicates that movies can not be recorded.



## 4 Start recording.

Press the movie-record button to begin recording. A recording indicator, the time elapsed, and the time available are displayed while recording is in progress.

### **Audio Recording**

Be careful not to cover the microphone and note that the built-in microphone may record sounds made by the camera or lens. Except when recording time-lapse or slow-motion movies in advanced movie mode, the camera focuses continuously; to avoid recording focus noise, select **Single AF** for **Focus mode** in the movie menu (☞ 184).

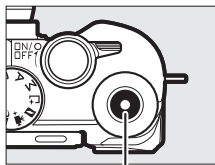

*Movie-record button*

*Recording indicator/  
Time elapsed*



*Time available*

## 5 End recording.

Press the movie-record button again to end recording. Recording will end automatically when the maximum length is reached (☞ 165), the memory card is full, another mode is selected, the lens is removed, or the camera becomes hot (☞ xv).

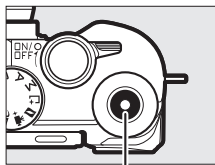

*Movie-record button*











### **Maximum Length**

The camera can record movies up to 4 GB in size (for more information, see page 165); note that depending on memory card write speed, shooting may end before this length is reached (☞ 203).



## ■ Choosing a Shooting Mode

The features available in each mode are listed below.

 <b>Auto mode</b> (☞ 33)	Choose this mode to record HD movies while leaving the camera in charge of choosing settings. The camera automatically adjusts settings according to the subject and situation.
 <b>Creative mode</b> (☞ 58)	Record HD movies with the selected effect. Note, however, that the selected effect is not applied in the cases of  <b>HDR</b> ,  <b>Soft</b> ,  <b>Easy panorama</b> ,  <b>Miniature effect</b> ,  <b>Toy camera effect</b> ,  <b>Cross screen</b> , and  <b>Skin softening</b> .
 <b>Sports mode</b> (☞ 74)	
<b>P S</b> <b>P, S, A, and M modes</b> <b>A M</b> (☞ 67)	Record HD movies in exposure mode <b>P</b> .
 <b>Advanced movie mode</b> (☞ 49)	Choose an exposure mode (☞ 161) and record HD movies at a selected shutter speed or aperture, or record movies in slow or fast motion or with other special effects.

### **Movie Sound**

The **Movie sound options** item in the movie menu offers microphone sensitivity and wind noise options (☞ 180).

## Taking Photographs During Movie Recording

Press the shutter-release button all the way down to take a photograph without interrupting movie recording. Photographs taken during movie recording have an aspect ratio of 3 : 2.

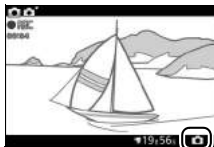

### 🔍 Taking Photographs During Movie Recording

Up to 20 photographs can be taken with each movie shot. Please note that photographs can not be taken with slow-motion, 4K, or time-lapse movies in advanced movie mode.

### 🔍 Focus Lock



If **Single AF** is selected for **Focus mode** in the shooting menu for advanced movie mode (📖 184), focus will lock while the shutter-release button is pressed halfway (📖 189). Note that focus lock is not available when **Scene auto selector** is selected for **Exposure mode** in the shooting menu (📖 161).

### 🔍 See Also

See page 180 for information on configuring the camera to take photographs automatically during movie recording.



## Viewing Movies

Movies are indicated by a  icon in full-frame playback ( 37). Press the  button or tap the  icon to start playback.



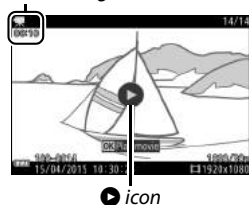



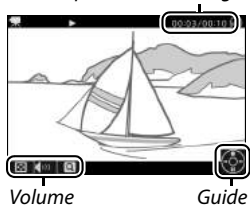



 icon/Length



Current position/total length



The following operations can be performed:

To	Use	Description
Pause		Pause playback; the current position is shown at the top of the display. Playback can also be paused by tapping the monitor. 
Play		Resume playback when the movie is paused or during rewind/advance.
Advance/ rewind		Press  to rewind,  to advance. Speed increases with each press, from 2x to 4x to 8x to 16x. If playback is paused, the movie rewinds or advances one frame at a time; keep the button pressed for continuous rewind or advance.
Adjust volume		Rotate the command dial to adjust volume.
Return to full-frame playback	 	Press  or  to exit to full-frame playback.



### See Also

See page 156 for information on trimming unwanted footage from movies. For information on the frame size and frame rate options available for HD movies, see page 165.

### Recording Movies



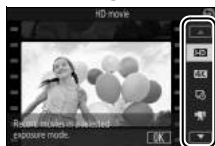
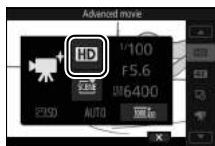

 Flicker, banding, or distortion may be visible in the display and in the final movie under fluorescent, mercury vapor, or sodium lamps or with subjects that are in motion, particularly if the camera is panned horizontally or an objects moves horizontally at high speed through frame (flicker and banding can be reduced by choosing a **Flicker reduction** option that matches the frequency of the local AC power supply as described on page 198, but note that the slowest shutter speed available is  $\frac{1}{100}$  s at **50 Hz**,  $\frac{1}{60}$  s at **60 Hz**; flicker reduction is not available with slow-motion movies). Bright light sources may leave after-images when the camera is panned. Jagged edges, color fringing, moiré, and bright spots may also appear. When recording movies, avoid pointing the camera at the sun or other strong light sources. Failure to observe this precaution could result in damage to the camera's internal circuitry.

## 📹+ Advanced Movie Options

Advanced movie mode can be used not only to shoot HD movies, but also to record movies with a variety of effects. The following options can be accessed by pressing **F** and selecting **Advanced movie** in the **F** (feature) menu.

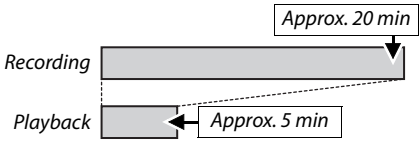

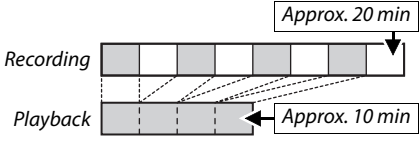
<b>HD</b> HD movie	Record HD movies in the exposure mode of your choice (📖 161).
<b>4K</b> 4K movie	Record movies at a frame size of 3840 × 2160 pixels and a frame rate of 15 fps.
<b>📺</b> Time-lapse movie	<p>The camera automatically takes photographs at selected intervals and joins them together in a silent time-lapse movie.</p>
<b>📺</b> Slow motion	<p>Record up to about three seconds of silent slow-motion footage. Slow-motion movies are recorded at 400 fps and play back at about 30 fps.</p>

 <b>Fast motion</b>	<p>Record silent fast-motion footage that plays back at about four times normal speed. Playback time is one quarter the recording time.</p> 
 <b>Jump cut</b>	<p>Record silent jump-cut movies. Recording pauses every other second for a drop-frame effect.</p> 
 <b>4-second movie</b>	<p>Record a 4-second movie clip.</p>

### Adjusting Focus During Recording

To change focus during recording, tap the desired subject in the display. The camera will display the new focus area and adjust focus.

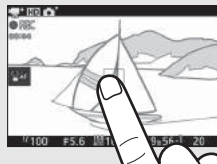

### 4K Movies

4K movies can be viewed on a computer and edited using ViewNX-i, the latest version of which is available for download from the website listed below. Note that a high-performance system is required; for information, see the website below.

<http://downloadcenter.nikonimglib.com/>

When the camera is connected to a 4K-movie compatible television using an HDMI cable, 4K movies will play back in Full HD (1920 × 1080 pixels, 30p). Even if the television is 4K-movie compatible, 4K movies can not be viewed by inserting the camera memory card in a television microSD card slot.



## The **F** (Feature) Menu (☐ 11)

Pressing **F** in advanced movie mode displays the items listed below. The items available vary with the type of movie selected (☐ 49).

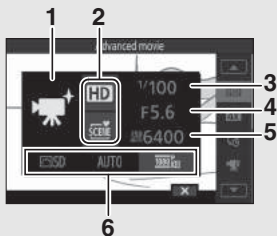

1	Shooting mode .....	6
2	Advanced movie .....	49
	Exposure mode .....	161
3	Shutter speed .....	68, 70
4	Aperture.....	69, 70
5	ISO sensitivity .....	172
6	Picture Control .....	173
	White balance.....	167
	Frame size/frame rate.....	165
	Slow motion.....	57
	Interval .....	52
	AE lock.....	53

## Recording Time

The following table lists the approximate maximum recording times for individual movies shot at the default frame rate in each shooting mode.

<b>Auto, creative, P, S, A, M, sports modes</b>	17 minutes
<b>Advanced movie mode</b>	
<b>HD movie</b>	17 minutes
<b>4K movie</b>	10 minutes
<b>Time-lapse movie</b>	25 minutes
<b>Slow motion</b>	3 seconds
<b>Fast motion</b>	20 minutes (☐ 50)
<b>Jump cut</b>	20 minutes (☐ 50)
<b>4-second movie</b>	4 seconds



## Filming Time-Lapse Movies

When **Time-lapse movie** is selected in  (advanced movie) mode, the camera automatically takes photos at selected intervals to create a silent time-lapse movie.

### 1 Select advanced movie mode.

Rotate the mode dial to .

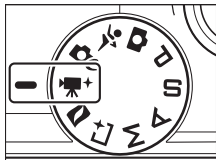

### 2 Select Time-lapse movie.

Press **F** (feature) on the multi selector to display the **F** menu. Highlight **Advanced movie** and press **OK** to display advanced movie options, then highlight **Time-lapse movie** and press **OK**.

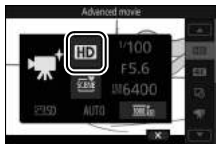

### 3 Choose the interval between shots.

Highlight **Interval** in the **F** menu and press **OK**, then highlight the desired interval and press **OK**.

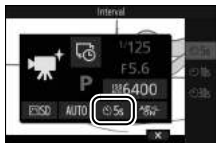



### Time-Lapse Movies

Use of a tripod is recommended. To ensure that shooting is not interrupted, use an optional AC adapter and power connector or charge the battery before recording. The camera will not turn off automatically during recording (☐ 28), but if the interval between shots is 30 s when the camera is operating on battery power, the monitor will turn off and the power lamp will flash green.

For consistent coloration, choose a white balance setting other than AUTO (auto, ☐ 167).

Time-lapse movies are recorded at a frame size of 1920 × 1080 pixels and play back at 30 fps. If recording ends before 30 frames have been recorded, the final frame will be copied as necessary to create a movie 1 second long.



## Filming Slow-Motion Movies

Silent slow-motion movies with an aspect ratio of 8 : 3 can be recorded by selecting **Slow motion** in **📹+** (advanced movie) mode. Slow-motion movies are recorded at 400 fps and play back at about 30 fps.

### 1 Select advanced movie mode.

Rotate the mode dial to **📹+**.

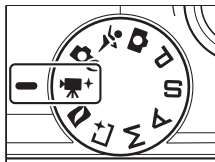

### 2 Select Slow motion.

Press **F** (feature) on the multi selector to display the **F** menu. Highlight **Advanced movie** and press **OK** to display advanced movie options, then highlight **Slow motion** and press **OK**.

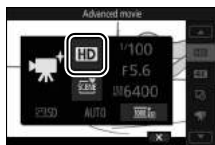

### 3 Frame the opening shot.

Frame the opening shot with your subject in the center of the display.

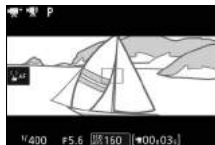

#### 4 Focus.

Press the shutter-release button half-way to focus.

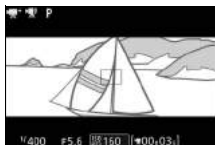

#### 5 Start filming.

Press the movie-record button to begin filming. A recording indicator, the time elapsed, and the time available are displayed while recording is in progress. The camera focuses on the subject at the center of the display; face detection (40) is not available and focus and exposure can not be adjusted.

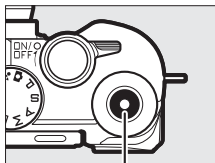

*Movie-record button*

*Recording indicator/  
time elapsed*

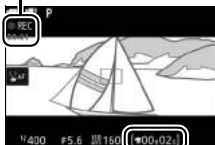

*Time available*

#### 6 End filming.

Press the movie-record button again to end filming. Filming will end automatically after 3 seconds or when the memory card is full.

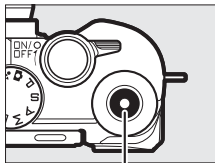

*Movie-record button*

### **Frame Rate and Playback Length**

The frame rate for slow-motion movies can be selected using the **Slow motion** option in the **F** menu; the faster the frame rate, the smaller the frame size.

Option	Frame size (pixels)	Bit rate <sup>1</sup>	Maximum length (shooting) <sup>1</sup>	Maximum length (playback) <sup>1,2</sup>
<b>120 fps</b>	1280 × 720	12 Mbps	3 seconds	12 seconds
<b>400 fps</b>	800 × 296	3 Mbps		40 seconds
<b>1200 fps</b>	400 × 144	1 Mbps		120 seconds

**1** All figures are approximate.

**2** Slow-motion movies will play back over a period of about 4 (120 fps), 13 (400 fps), or 40 (1200 fps) times the recording time.



# Other Shooting Modes

The camera offers a choice of modes that can be used to match settings to the subject or situation, take photos using special effects, control shutter speed and aperture, help with hard-to-time shots, or combine photos with brief movie vignettes.

## Choosing a Creative Mode



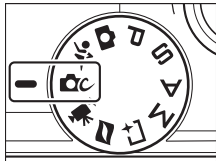

Choose creative mode to match settings to the subject or situation or take photos using special effects.

### 1 Select mode.

Rotate the mode dial to  (creative).



### 2 Choose an option.

Press  (feature) on the multi selector to display the  menu, then highlight **Creative** and press . Highlight an option suited to your subject and creative intent ( 59) and press .





## Choosing a Mode That Matches the Subject or Situation

Choose a creative mode according to the subject or situation:

Option	Description
<b>Pop (POP)</b>	Shoot bright, vivid pictures.
<b>Retro (RETRO)</b>	Choose for a faded, retro effect. Use the <b>F</b> (feature) menu (☐ 61) to choose a hue from red and yellow.
<b>High-contrast monochrome (☐)</b>	Shoot in high-contrast black-and-white.
<b>Nostalgic sepia (SEPIA)</b>	Shoot in sepia for an antique look.
<b>HDR (HDR)</b>	Photograph high-contrast scenes (☐ 62).
<b>Soft (O)</b>	<p>Shoot photographs with a soft filter effect. Use the <b>F</b> menu to select the amount of softening and to choose how softening applies when a portrait subject is detected:</p> <ul style="list-style-type: none"><li>• <b>Filter strength:</b> Choose from <b>O H</b> (high), <b>O N</b> (normal), and <b>O L</b> (low).</li><li>• <b>Portrait:</b> If <b>☒ ON</b> is selected and the camera detects portrait subjects (up to three), softening will be adjusted to make them stand out. If <b>☒ OFF</b> is selected, softening will be applied equally to the portrait subject and the background.</li></ul>
<b>Easy panorama (☐)</b>	Shoot panoramas for later viewing on the camera (☐ 63).
<b>Miniature effect (☐)</b>	The top and bottom of each photo is blurred so that the subject appears to have been a diorama photographed at short range. Works best when shooting from a high vantage point.
<b>Selective color (☐)</b>	Take photos in which only a selected hue appears in color (☐ 66).
<b>Cross process (☐)</b>	Choose a base color to create photographs with different hues. Use the <b>F</b> menu to choose a base color from red, green, blue, and yellow.



Option	Description
<b>Toy camera effect</b> (📷)	<p>Alter color saturation and reduce peripheral illumination for a toy camera effect. The following options are available in the <b>F</b> menu (📄 61):</p> <ul style="list-style-type: none"> <li>• <b>Saturation:</b> Choose from 📊 H (high), 📊 N (normal), and 📊 L (low).</li> <li>• <b>Vignetting:</b> Choose the amount of vignetting from 📊 H (high), 📊 N (normal), and 📊 L (low).</li> </ul>
<b>Cross screen</b> (✳️)	<p>Add starburst effects to light sources.</p>
<b>Fisheye</b> (📷)	<p>Create the effect of a fisheye lens. The following option is available in the <b>F</b> menu:</p> <ul style="list-style-type: none"> <li>• <b>Filter strength:</b> The level of the fisheye effect. Choose from 📊 H (high), 📊 N (normal), and 📊 L (low).</li> </ul>
<b>Skin softening</b> (📷)	<p>Soften the look of skin for up to three portrait subjects at a time. The amount of softening can be selected using the <b>Filter strength</b> option in the <b>F</b> menu; choose from 📊 H (high), 📊 N (normal), and 📊 L (low).</p>
<b>Night landscape</b> (📷)	<p>Capture poorly-lit landscapes and cityscapes.</p>
<b>Night portrait</b> (📷)	<p>Choose for portraits taken against a poorly-lit backdrop.</p>
<b>Landscape</b> (📷)	<p>Choose for vibrant landscapes and cityscapes.</p>
<b>Close-up</b> (📷)	<p>Use for close-up shots of flowers, insects, and other small objects.</p>
<b>Portrait</b> (📷)	<p>Use for portraits with soft, natural-looking skin tones.</p>

## The **F** (Feature) Menu (📖 11)

Pressing **F** in creative mode displays the items listed below. The items available vary with the option selected for creative mode (📖 59).

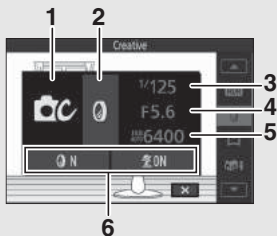

<b>1</b>	Shooting mode .....	6
<b>2</b>	Creative .....	58
<b>3</b>	Shutter speed .....	68, 70
<b>4</b>	Aperture.....	69, 70
<b>5</b>	ISO sensitivity .....	172
<b>6</b>	AF-area mode .....	188
	Focus mode.....	184
	Metering .....	166
	Picture Control .....	173
	White balance.....	167
	Image size.....	162
	Select color.....	66
	Filter strength .....	59, 60
	Portrait .....	59
	Hue.....	59
	Saturation.....	60
	Vignetting.....	60



## HDR

Details in highlights and shadows are preserved using HDR (high dynamic range). Each time the shutter-release button is fully pressed, the camera takes two shots in quick succession and combines them to preserve details in highlights and shadows in high-contrast scenes; the built-in flash does not fire. Some time may be required to process the pictures; the final photograph will be displayed when processing is complete.



### Framing HDR Photographs

The edges of the image will be cropped out. The desired results may not be achieved if the camera or subject moves during shooting. Depending on the scene, shading may be uneven and shadows may appear around bright objects or halos around dark objects.

## Easy Panorama

Follow the steps below to shoot panoramas. During shooting, the camera focuses using auto-area AF (📖 188); face detection (📖 40) is not available. Exposure compensation (📖 101) can be used, but the built-in flash will not fire.

### 1 Set focus and exposure.

Frame the start of the panorama and press the shutter-release button halfway. Guides will appear in the display.

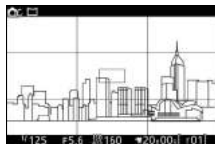

### 2 Start shooting.

Press the shutter-release button the rest of the way down and then lift your finger from the button. ⤴, ⤵, ⤶, and ⤷ icons will appear in the display to indicate the possible pan directions.

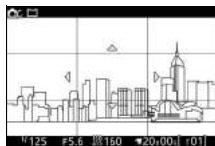

### 3 Pan the camera.

Slowly pan the camera up, down, left, or right as shown below. Shooting will start when the camera detects the pan direction and a progress indicator will appear in the display. Shooting ends automatically when the end of the panorama is reached.

*Progress indicator*

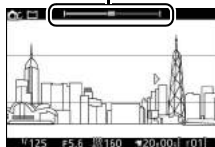

An example of how to pan the camera is shown below. Without changing your position, pan the camera in a steady curve either horizontally or vertically. Time the pan according to the option selected for **Image size** in the shooting menu: about 15 seconds are needed to complete the pan when **STANDARD Normal panorama** is selected, about 30 seconds when **WIDE Wide panorama** is selected.

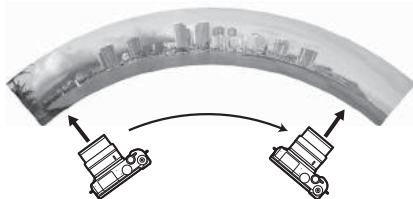



### Panoramas

High-distortion wide-angle lenses may fail to produce the desired results. An error message will be displayed if the camera is panned too quickly or unsteadily. Note that because panoramas are composed of multiple images, the joins between images may be visible and the desired results may not be achieved with moving subjects or with neon lights or other subjects that exhibit rapid changes in color or brightness, subjects that are too close to the camera, poorly-lit subjects, and subjects such as the sky or sea that are a solid color or contain simple repeating patterns.







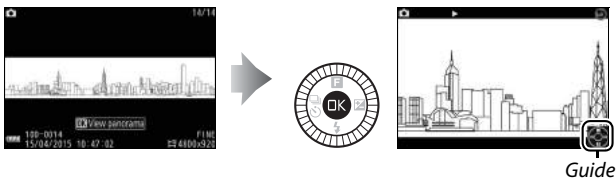

The completed panorama will be slightly smaller than the area visible in the display during shooting. No panorama will be recorded if shooting ends before the halfway point; if shooting ends after the halfway point but before the panorama is complete, the unrecorded portion will be shown in gray.

## ■ Viewing Panoramas

Panoramas can be viewed by pressing  when a panorama is displayed full frame ( 37). The start of the panorama will be displayed with the smallest dimension filling the display and the camera will then scroll through the picture in the original pan direction.



The following operations can be performed:

To	Use	Description
Pause		Pause playback. A navigation window will appear at the bottom of the display. 
Play		Resume playback when the panorama is paused or during rewind/advance.
Advance/ rewind		Press  to rewind,  to advance. If playback is paused, the panorama rewinds or advances a segment at a time; keep the button pressed for continuous rewind or advance.
Return to full-frame playback		Press  or  to exit to full-frame playback.



## Selective Color

Take black-and-white pictures in which one hue appears in a color.

### 1 Choose Select color.

Press **F** to display the **F** (feature) menu, then highlight **Select color** and press **OK**.



### 2 Choose a color.

Use the multi selector to choose a color and press **OK**.

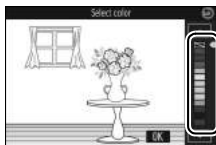

### 3 Take pictures.

Press the shutter-release button all the way down to take pictures. Only the selected hue will appear in color; all other hues will be recorded in shades of gray.



## Taking Photos in P, S, A, and M Modes

**P, S, A,** and **M** modes offer varying degrees of control over shutter speed and aperture. Choose a mode and adjust settings according to your creative intent.



### **P Programmed Auto**

In this mode, the camera automatically adjusts shutter speed and aperture for optimal exposure in most situations. This mode is recommended for snapshots and other situations in which you want to leave the camera in charge of shutter speed and aperture.

#### **Choosing a Combination of Shutter Speed and Aperture**

Although the shutter speed and aperture chosen by the camera will produce optimal results, you can also choose from other combinations that will produce the same exposure ("flexible program"). Rotate the command dial to the right for large apertures (low f-numbers) that blur background details or fast shutter speeds that "freeze" motion. Rotate the dial to the left for small apertures (high f-numbers) that increase depth of field or slow shutter speeds that blur motion. \* is displayed while flexible program is in effect.

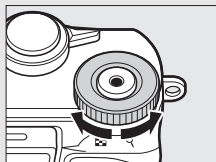

*Command dial*

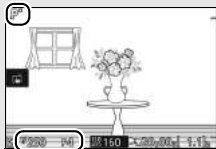

#### **Restoring Default Shutter Speed and Aperture Settings**

To restore default shutter speed and aperture settings, rotate the command dial until \* is no longer displayed or turn the camera off. The default shutter speed and aperture is automatically restored when the camera enters standby mode.



## S Shutter-Priority Auto

In shutter-priority auto, you choose the shutter speed while the camera automatically selects the aperture that will produce the optimal exposure. Use slow shutter speeds to suggest motion by blurring moving subjects, fast shutter speeds to “freeze” motion.



Fast shutter speed ( $1/1600$  s)



Slow shutter speed (1 s)

### ■ Choosing a Shutter Speed

Rotate the command dial to choose from shutter speeds between 30 s and  $1/16,000$  s. Rotate the dial to the right for faster shutter speeds, to the left for slower shutter speeds.

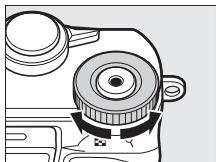

Command dial

### ✎ Continuous Shooting

The selected shutter speed may change when a frame rate of 10 fps or faster is selected in continuous shooting mode (□ 97).

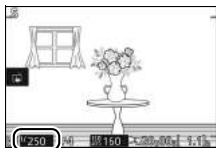

## A Aperture-Priority Auto

In aperture-priority auto, you choose the aperture while the camera automatically selects the shutter speed that will produce the optimal exposure. Large apertures (low f-numbers) reduce depth of field, blurring objects behind and in front of the main subject. Small apertures (high f-numbers) increase depth of field, bringing out details in the background and foreground. Short field depths are generally used in portraits to blur background details, long field depths in landscape photographs to bring the foreground and background into focus.



*Large aperture (f/5.6)*



*Small aperture (f/16)*



### ■ ■ Choosing an Aperture

Rotate the multi selector counterclockwise for larger apertures (lower f-numbers), clockwise for smaller apertures (higher f-numbers). The minimum and maximum values depend on the lens currently in use.

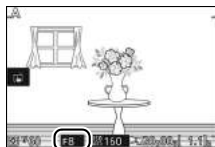

## M Manual

In manual mode, you control both shutter speed and aperture.

### ■ Choosing Shutter Speed and Aperture

Adjust shutter speed and aperture with reference to the exposure indicator (☞ 71). Rotate the command dial to adjust shutter speed and the multi selector to adjust aperture: rotate the control to the right for faster shutter speeds or smaller apertures (higher f-numbers), to the left for slower shutter speeds and larger apertures (lower f-numbers). Shutter speeds can be set to values as fast as  $\frac{1}{16,000}$  s or as slow as 30 s, or to “Bulb” to hold the shutter open indefinitely for a long time-exposure (☞ 72). Aperture can be set to values between the minimum and maximum for the lens.

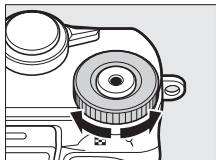

Command dial



### ✎ Continuous Shooting

The selected shutter speed may change when a frame rate of 10 fps or faster is selected in continuous shooting mode (☞ 97).

## The Exposure Indicator

When shutter speeds other than “Bulb” are selected, the exposure indicator shows whether the photograph would be under- or over-exposed at current settings.

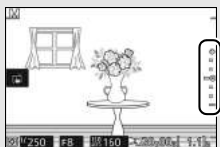

Optimal exposure	Underexposed by $\frac{1}{3}$ EV	Overexposed by over 2 EV
+	+	+
.	.	.
.	.	.
-0	=0	0
.	.	.
.	.	.
-	-	-

## ISO Sensitivity (P, S, A, and M Modes)

When an “auto” option is selected for **ISO sensitivity** (☐ 172), the camera will automatically adjust sensitivity within the selected range if optimal exposure can not be achieved at the selected shutter speed or aperture.

## The F (Feature) Menu (☐ 11)

Pressing **F** in mode P, S, A, or M displays the items listed below.

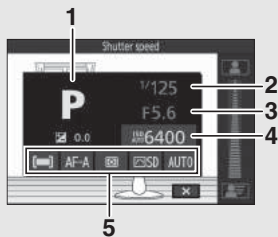

<b>1</b> Shooting mode .....	6
<b>2</b> Shutter speed .....	68, 70
<b>3</b> Aperture.....	69, 70
<b>4</b> ISO sensitivity .....	172
<b>5</b> AF-area mode .....	188
Focus mode.....	184
Metering .....	166
Picture Control .....	173
White balance.....	167



## Long Time-Exposures (M Mode Only)

Select a shutter speed of “Bulb” for long time-exposures of moving lights, the stars, night scenery, or fireworks. The shutter remains open while the shutter-release button is held down. To prevent blur, use a tripod.



### 1 Ready the camera.

Mount the camera on a tripod or place it on a stable, level surface. To prevent loss of power before the exposure is complete, use a fully charged battery or an optional AC adapter and power connector. Note that noise (bright spots, randomly-spaced bright pixels, or fog) may be present in long exposures. Bright spots and fog can be reduced by choosing **On** for **Long exposure NR** in the shooting menu (📖 179).

### 2 Choose a shutter speed of “Bulb”.

Rotate the command dial to the left to select “Bulb”.

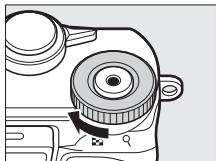

Command dial

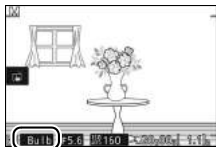

---

### **3 Open the shutter.**

After focusing, press the shutter-release button all the way down. Keep the shutter-release button pressed until the exposure is complete.

---

### **4 Close the shutter.**

Take your finger off the shutter-release button.

Shooting ends automatically after about two minutes. Note that some time may be required to record long exposures.



## 🏃 Photographing Subjects in Motion (Sports Mode)

Choose 🏃 (sports) mode for sporting events and other scenes with fast-moving subjects. The camera takes pictures continuously while the shutter-release button is pressed (📖 97).

### 1 Select sports mode.

Rotate the mode dial to 🏃.

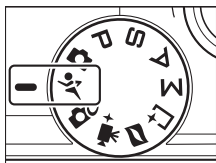

### 2 Display release mode options.

Press 🏃 (📖) to display release mode options.



### 3 Select a frame rate.

Highlight the desired frame rate and press **OK**. Frame rate is expressed in terms of the number of frames recorded per second (fps); choose from frame rates of approximately 5, 10, 20, 30, and 60 fps (📖, 📖10, 📖20, 📖30, and 📖60, respectively). Except when 📖 is selected, the maximum number of shots that can be recorded in a single burst is 20.

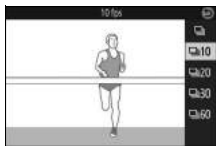

### 4 Compose the shot and start shooting.

The camera takes pictures while the shutter-release button is held all the way down.





### The **F** (Feature) Menu

The **F** menu is not available.

### Sports Mode

The camera uses single-point (□ 188), continuous-servo autofocus (□ 184). The flash, AF-assist illuminator, face priority (□ 191), and image review (□ 195) turn off automatically.

### Burst Photography

While photographs are being recorded to the memory card, the memory card access lamp will light (□ 35). Depending on shooting conditions and memory card write speed, recording may continue for some time after shooting ends. If the battery is exhausted before all photographs are recorded, the shutter-release will be disabled and the remaining images transferred to the memory card.

### Viewing Photographs

Each burst plays back as a group. This can be changed using the **Sequence display options** item in the playback menu (□ 152).

### Buffer Size

The camera is equipped with a memory buffer for temporary storage, allowing shooting to continue while photographs are being saved to the memory card. The approximate number of images that can be stored in the memory buffer at current settings is displayed while the shutter-release button is pressed halfway (this number is an approximation only and varies with shooting conditions). The illustration shows the display when space remains in the buffer for about 20 pictures.

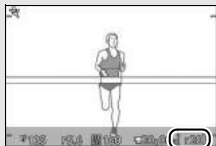

## **Choosing the Moment (Best Moment Capture)**

Choose a shot from 20 frames recorded to temporary storage shortly before or after the shutter is released (Active Selection), choose the moment to release the shutter as the scene plays back in slow motion (slow view), or let the camera choose the best shot based on composition and movement (Smart Photo Selector).

### ***Choosing a Shot Manually (Active Selection)***

Choose up to 20 shots from 20 frames recorded shortly before or after the shutter-release button is pressed all the way down.

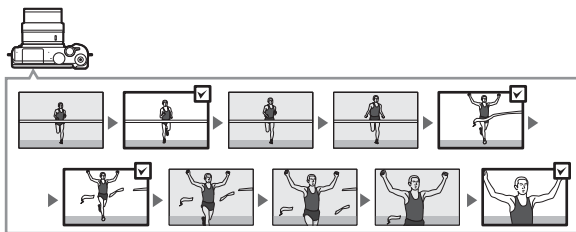

#### **1** Select mode.

Rotate the mode dial to  (best moment capture).

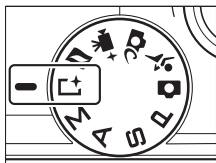

## 2 Choose Active Selection.

Press **F** (feature) to display the **F** menu. Highlight **Best moment capture** and press **OK**, then highlight **Active Selection** and press **OK**.



## 3 Frame the photograph.

Compose the photograph with your subject in the center of the frame.



## 4 Begin buffering photographs.

Press the shutter-release button half-way to focus (34). A  icon will be displayed as the camera begins recording images to the memory buffer.

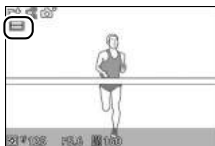

## 5 Shoot.

Smoothly press the shutter-release button the rest of the way down. The 20 frames recorded to the buffer in the moments before and after the shutter-release button was pressed all the way down will be copied to temporary storage, and an indicator will appear at the top of the display.

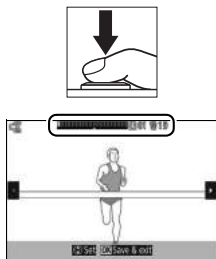

## 6 Select up to 20 frames.

Press or to scroll through the frames and press or to select or deselect (the number of frames selected by default varies with the option selected for **Frames saved (default)** in the **F** (feature) menu). Selected images are shown by dots in the indicator.

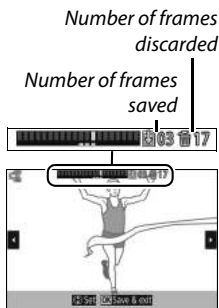

## 7 Save the selected frames.

Press to save the selected frames to the memory card. The memory card access lamp will light while recording is in progress; note that depending on shooting conditions and memory card write speed, some time may be required to save the selected frames. Once recorded, the frames will be treated as a single group during playback.

### On Release, Record

The **On release, record** option in the **F** (feature) menu is used to choose the frames copied from the buffer to temporary storage when the shutter-release button is pressed all the way down.

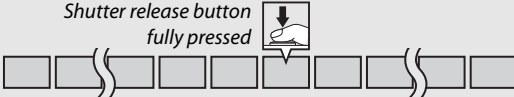
<b>Preceding frames</b>	The camera captures the 20 preceding frames. <i>Shutter release button fully pressed</i> 
<b>Preceding and following</b>	The camera captures the 10 preceding frames and 10 following frames. <i>Shutter release button fully pressed</i> 

### Capture 20 Frames Over

The **Capture 20 frames over** option in the **F** menu is used to choose whether the frames are captured over  $\frac{1}{3}$ s (a frame rate of 60 fps) or 1 s (20 fps).

### Active Selection

At default settings, the frame recorded at the moment the shutter-release button was pressed all the way down is automatically marked with a  icon in Step 6.



## The **F** (feature) Menu (📖 11)

Pressing **F** in best moment capture mode displays the items listed below. The items available vary with the mode selected (📖 76, 81, 83).

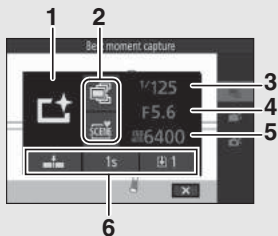

<b>1</b>	Shooting mode .....	6
<b>2</b>	Best moment capture.....	76
	Exposure mode .....	161
<b>3</b>	Shutter speed .....	68, 70
<b>4</b>	Aperture.....	69, 70
<b>5</b>	ISO sensitivity .....	172
<b>6</b>	On release, record.....	79
	Capture 20 frames over.....	79
	Frames saved (default).....	78
	Number of shots saved .....	84

## Best Moment Capture Mode

Movies can not be recorded, and pressing the movie-record button has no effect. The flash can not be used.

## Choosing Your Moment (Slow View)

When slow view is selected in  (best moment capture) mode, the camera captures a short sequence of still images and plays them back in slow motion so that you can choose the precise moment for a photograph.

### 1 Select mode.

Rotate the mode dial to  (best moment capture).

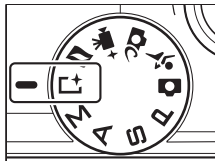

### 2 Select **Slow view**.

Press **F** (feature) to display the **F** menu. Highlight **Best moment capture** and press **OK**, then highlight **Slow view** and press **OK**.

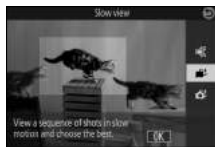

### 3 Frame the photograph.

Compose the photograph with your subject in the center of the frame.

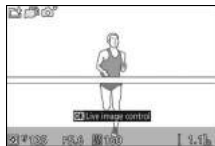

#### 4 Press the shutter-release button halfway.

After focusing, the camera will record 20 frames to a temporary memory buffer. It will then slowly play them back in a continuous loop while the shutter-release button is kept pressed halfway. A  icon is displayed in the monitor.



*Progress indicator*



When the desired frame is displayed, press the shutter-release button the rest of the way down to record the current frame and discard the remaining images. The selected frame will be displayed for a few seconds when recording is complete. To delete the buffer contents and exit without recording a photograph, release the button without pressing it the rest of the way down.





## Letting the Camera Choose the Moment (Smart Photo Selector)

The Smart Photo Selector helps you capture a fleeting expression on the face of a portrait subject or other hard-to-time shots such as group photos in party scenes. Each time the shutter is released, the camera automatically selects the best shot and four best shot candidates based on composition and motion.

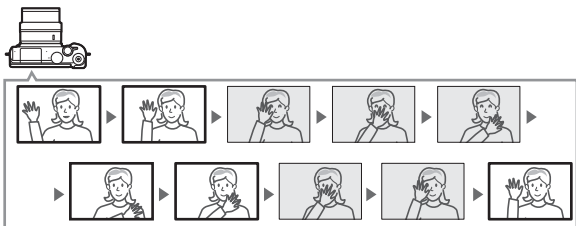

### 1 Select mode.

Rotate the mode dial to  (best moment capture).

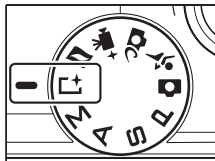

### 2 Choose Smart Photo Selector.

Press **F** (feature) to display the **F** menu. Highlight **Best moment capture** and press **OK**, then highlight **Smart Photo Selector** and press **OK**.



---

### 3 Frame the photograph.

Compose the photograph with your subject in the center of the frame.



---

### 4 Begin buffering photographs.

Press the shutter-release button half-way to focus ( 34). A  icon will be displayed as the camera begins recording images to the memory buffer. The camera continuously adjusts focus to account for changes in the distance to the subject while the shutter-release button is pressed halfway.



---

### 5 Shoot.

Smoothly press the shutter-release button the rest of the way down. The camera will compare shots recorded to the buffer both before and after the shutter-release button was pressed all the way down, and select the best shot and four best shot candidates to the memory card; during playback, these frames will be treated as a single group. If  1 is selected for **Number of**

**shots saved** in the  (feature) menu, the camera will instead save only the best shot. The best shot is displayed in the monitor when recording is complete; note that some time may be required.



### **Smart Photo Selector**

The camera automatically chooses a scene mode appropriate to the subject.

### **Buffering**

Buffering begins when the shutter-release button is pressed halfway and ends after about 90 seconds or when the shutter-release button is pressed all the way down.

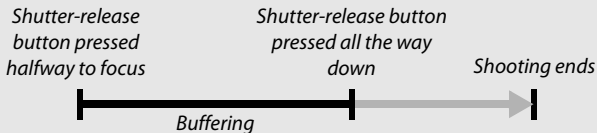



### **Smart Photo Selector Files**

Do not delete the "NCSPSLST.LST" file from the "NCFL" folder on the memory card or change the file names of images taken with the Smart Photo Selector. The camera will no longer recognize the affected files as Smart Photo Selector images and will instead handle them as independent photographs.



## ■ Viewing Photos Taken with the Smart Photo Selector



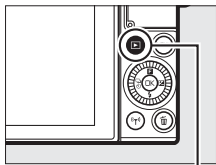

Press  and use the multi selector to display photographs taken with the Smart Photo Selector (book 37; pictures taken with the Smart Photo Selector are indicated by a  icon). Of the photographs recorded by the Smart Photo Selector, only the best shot will be displayed (when you press  to view the next picture, the camera will skip over the best shot candidates, with the result that the next picture displayed will not have a file number that immediately follows that of the current picture). To end playback and return to shooting mode, press the shutter-release button halfway.



 button





### Choosing the Best Shot

When a photograph taken with the Smart Photo Selector is displayed, you can choose the best shot by pressing . Press  or  to view the other pictures in the sequence and press  to select the current picture as the best shot. To return to normal playback, press .

Note that best shot selection is available only if  5 was selected for **Number of shots saved** in the **F** (feature) menu when the picture was taken.



## ■ Deleting Pictures

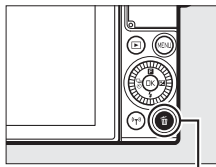

Pressing  when a picture taken with the Smart Photo Selector is selected displays a confirmation dialog; press  again to delete the best shot and the best shot candidates, or press  to exit without deleting the pictures. *Note that once deleted, pictures can not be recovered.*

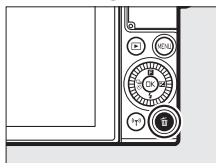

 button



## Deleting Individual Photographs

Pressing the  button in the best shot selection dialog displays the following options; highlight an option using the multi selector and press  to select.

- **This image:** Delete the current photo (note that the picture currently selected as the best shot can not be deleted).
- **All except best shot:** Delete the best shot candidates, but not picture currently selected as the best shot.

A confirmation dialog will be displayed; to delete the selected image or images, highlight **Yes** and press .



## ☑ Combining Photos with Brief Movie Vignettes (Motion Snapshot Mode)

Record brief movie vignettes with your photographs. Each time the shutter is released, the camera records a still image and about 1.6 s of movie footage. When the resulting “Motion Snapshot” is viewed on the camera, the movie will play back in slow motion over approximately 4 s, followed by the still image.

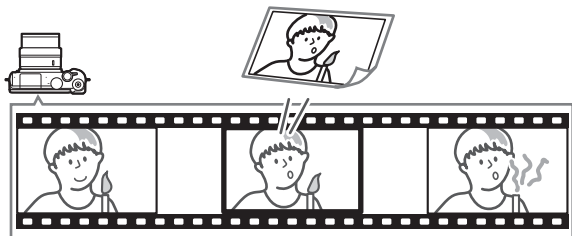

### 1 Select ☑ mode.

Rotate the mode dial to ☑ (Motion Snapshot).

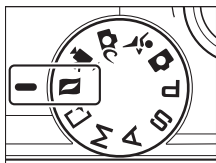

### 2 Frame the picture.

Compose the photograph with your subject in the center of the frame.



### 3 Begin buffering.

Press the shutter-release button half-way to focus (□ 34). A □ icon will be displayed as the camera begins recording footage to the memory buffer.



### 4 Shoot.

Smoothly press the shutter-release button the rest of the way down. The camera will record a photograph, together with about 1.6 s of movie footage beginning before and ending after the time the shutter-release button was pressed all the way down. Note that some time may be required. When recording is complete, the photograph will be displayed for a few seconds.



#### Buffering

Buffering begins when the shutter-release button is pressed halfway and ends after about 90 seconds or when the shutter-release button is pressed all the way down.

*Shutter-release  
button pressed  
halfway to focus*

*Shutter-release button  
pressed all the way  
down*

*Shooting ends*



## Motion Snapshot Mode

Movies can not be recorded using the movie-record button and the flash can not be used.

## The (Feature) Menu 11

Pressing  in Motion Snapshot mode displays the following items:

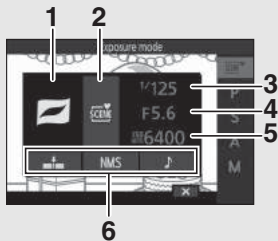

<b>1</b>	Shooting mode .....	6
<b>2</b>	Exposure mode .....	161
<b>3</b>	Shutter speed .....	68, 70
<b>4</b>	Aperture.....	69, 70
<b>5</b>	ISO sensitivity .....	172
<b>6</b>	Movie before/after .....	91
	File format .....	92
	Audio .....	92



## ■ Movie Before/After

Use the **Movie before/after** option in the **[F]** (feature) menu (📖 90) to choose whether the movie portions of Motion Snapshots end when the shutter-release button is pressed all the way down or about 0.6 s after (📖 88). If **1.6 s : 0 s** is selected, the photograph used for the Motion Snapshot will feature the last frame of the movie.

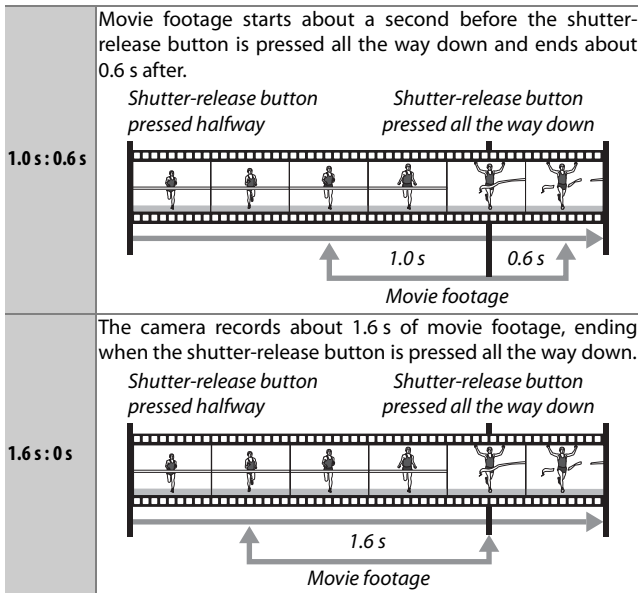

## ■ File Format

The **File format** option in the **F** menu can be used to choose the file format for Motion Snapshots.





<b>NMS files</b>	Motion Snapshots are recorded as a MOV file about 4 s long and a JPEG image. Motion Snapshots can only be viewed on the camera or using ViewNX-i (□ 140).
<b>MOV file</b>	Motion Snapshots are recorded as a MOV file about 10 s long that can be viewed in a variety of computer applications. The Motion Snapshot is not displayed automatically when shooting ends (□ 89); for information on viewing Motion Snapshot movies, see page 46.

## ■ Audio

To record about four seconds of sound with Motion Snapshots beginning at the start of movie recording, use the multi selector and **OK** button to select **Ambient** for **Audio** in the **F** (feature) menu. Motion Snapshots can also be recorded with background music (**Background music**) or no sound (**None**).



## Viewing Motion Snapshots

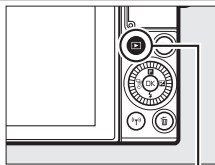

Press  and use the multi selector to display a Motion Snapshot (📖 37; Motion Snapshots are indicated by a  icon). Pressing the  button or tapping the  icon when a Motion Snapshot is displayed plays back the movie portion in slow motion over a period of about 4 s, followed by the photo; playback is accompanied by the audio track selected using the **Audio** option (📖 92). To end playback and return to shooting mode, press the shutter-release button halfway.



 button



## Deleting Motion Snapshots

To delete the current Motion Snapshot, press . A confirmation dialog will be displayed; press  again to delete the photo and movie and return to playback, or press  to exit without deleting the file. *Note that once deleted, Motion Snapshots can not be recovered.*

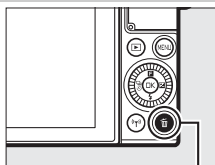

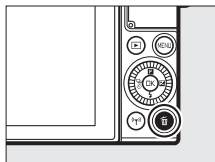

 button



# More on Photography



This section describes the other features you can use when taking pictures.

## Live Image Control

Live image control lets you preview how changes to each control will affect the final photography. Live image controls are available in the modes shown at right (in modes other than auto, live image controls are available only when  **Scene auto selector** is selected for exposure mode,  161). In advanced movie mode, live image controls apply to HD, fast-motion, jump-cut, and 4-second movies. In best moment capture mode, live image controls apply to Active Selection and slow view, but the  **Active D-Lighting** control is not available.



### 1 Choose a live image control.

Press  in the shooting display, then highlight an option and press  to view the selected control. For more information, see page 95.



### 2 Choose a setting.

Rotate the multi selector to adjust the control, using the preview in the monitor as your guide. Press  when the control is adjusted to your satisfaction. For information on using the creative palette, see page 96.



**Active D-Lighting:** Preserve details in highlights and shadows for natural contrast.



*Active D-Lighting: High*    *Active D-Lighting: Low*

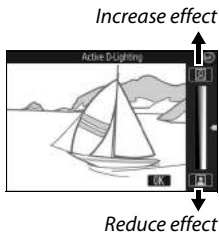

**Background softening:** Soften background details to make your subject stand out, or bring both background and foreground into focus.



*Background sharp*

*Background softened*

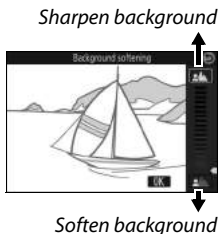

**Motion control (auto mode only):** Suggest motion by blurring moving objects, or "freeze" motion to capture moving objects clearly.



*Freeze motion*

*Blur motion*

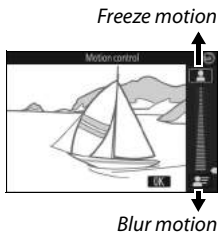

**Brightness control:** Make pictures brighter or darker.



Brighter



Darker

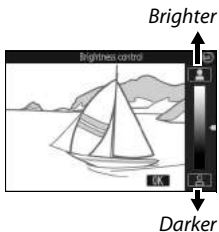

Darker

**Creative palette:** To choose a creative effect, rotate the multi selector or use a finger to rotate the creative palette in the monitor. The selected effect is visible in the monitor and changes gradually as the palette is rotated (to reset the palette, tap **Reset** while the creative palette cursor is displayed).

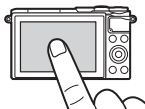

Photographs and movies will be recorded with the selected effect, but note that tap shooting options are not available when the creative palette is displayed (111).



**Live Image Control**

Continuous shooting is not available (97) and the built-in flash can not be used when live image control is in effect.

## Continuous Mode



Shoot a continuous series (burst) of photographs.

### 1 Display release mode options.

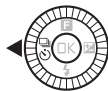
Press  () to display release mode options.







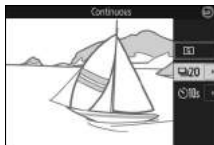



### 2 Select .

Highlight  (continuous) and press  to display frame rate options.



### 3 Select a frame rate.

Highlight the desired frame rate and press . Frame rate is expressed in terms of the number of frames recorded per second (fps); choose from frame rates of approximately 5, 10, 20, 30, and 60 fps (, , , , , and , respectively). Except when  is selected, the maximum number of shots that can be recorded in a single burst is 20.



### 4 Frame your subject and shoot.

Press the shutter-release button all the way down to shoot the burst.



### ✔ Continuous Mode

Only one picture will be taken if the flash fires when  is selected; at settings of 10, 20, 30, and 60 fps, the built-in flash will not fire.

While photographs are being recorded to the memory card, the memory card access lamp will light. Depending on shooting conditions and memory card write speed, recording may take some time. If the battery is exhausted before all photographs are recorded, the shutter release will be disabled and the remaining images transferred to the memory card.

Continuous shooting is not available with live image controls ( 94) or in self-portrait, creative, best moment capture, advanced movie, or Motion Snapshot mode.

### ✎ Viewing Pictures Taken in Continuous Mode

Each burst plays back as a group. This can be changed using the **Sequence display options** item in the playback menu ( 152).

### ✎ Buffer Size

The camera is equipped with a memory buffer for temporary storage, allowing shooting to continue while photographs are being saved to the memory card. The approximate number of images that can be stored in the memory buffer at current settings is displayed while the shutter-release button is pressed halfway (this number is an approximation only and varies with shooting conditions). The illustration shows the display when space remains in the buffer for about 20 pictures.

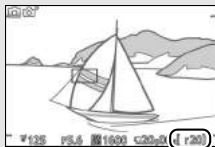

### ✎ Single Frame



To take only one picture each time the shutter-release button is pressed all the way down, select  (single frame) for release mode. Single frame is not available in sports mode.



## Self-Timer Modes



The self-timer is used to delay shutter release until 10 or 2 seconds after the shutter-release button is pressed all the way down.

### 1 Display release mode options.

Press  () to display release mode options.



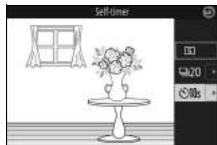

### 2 Select .

Highlight  (self-timer) and press  to display self-timer options.



### 3 Select the desired self-timer option.

Use the multi selector to highlight  or  and press .

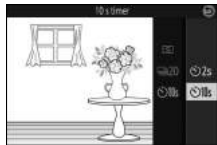

### 4 Mount the camera on a tripod.

Mount the camera on a tripod or place the camera on a stable, level surface.



## 5 Frame the photograph and shoot.

Press the shutter-release button half-way to focus, and then press the button the rest of the way down. The self-timer lamp will start to flash and a beep will begin to sound. Two seconds before the photo is taken, the lamp will stop flashing and the beeping will become more rapid.

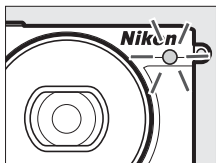

Note that the timer may not start or a photograph may not be taken if the camera is unable to focus or in other situations in which the shutter can not be released. Turning the camera off cancels the self-timer.



### **Movie Mode**

To record movies using the self-timer, select advanced movie mode and use the movie-record button to start the timer. Movie recording ends when the movie-record button is pressed a second time.

### **Raising the Flash**

In **P**, **S**, **A**, or **M** mode, press the flash pop-up button to raise the flash before shooting. Shooting will be interrupted if the flash is raised while the timer is counting down.

### **See Also**

For information on controlling the beeps that sound when the self-timer is used, see page 197.

## Exposure Compensation

Exposure compensation is used to alter exposure from the value suggested by the camera, making pictures brighter or darker.



-1 EV



No compensation



+1 EV

### 1 Display exposure compensation options.

Press ( ) to display exposure compensation options.



### 2 Choose a value.

Use the multi selector to choose from values between -3 EV (underexposure) and +3 EV (overexposure) in increments of  $\frac{1}{3}$ EV. In general, positive values make the image brighter while negative values make it darker.

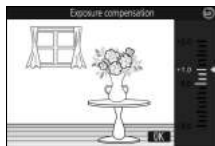

Normal exposure can be restored by setting exposure compensation to  $\pm 0$ . In modes **P**, **S**, and **A**, exposure compensation is not reset when the camera is turned off.

#### Exposure Compensation

Exposure compensation is most effective when used with center-weighted or spot metering ( 166).



#### The Built-in Flash

When used with the built-in flash, exposure compensation affects both background exposure and flash level.



## The Built-in Flash

Use the built-in flash for additional lighting when the subject is poorly lit or to “fill-in” (illuminate) back-lit subjects. The built-in flash is available in the following shooting modes, but note that some camera settings automatically disable the built-in flash:

### Auto Pop-up Modes

In  (auto) mode and when an option other than HDR (HDR), easy panorama (panorama icon), night landscape (night landscape icon), or landscape (landscape icon) is selected in  (creative) mode, the flash will pop-up automatically and fire when required.

#### 1 Choose a flash mode.

Press  () on the multi selector to display a list of flash modes, then use the multi selector to highlight the desired mode and press  to select.

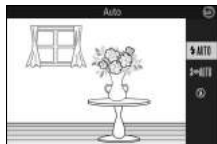

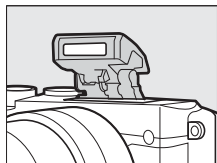

#### 2 Take pictures.

Press the shutter-release button half-way to focus and the rest of the way down to shoot. The flash will pop up and fire when required.



## ■ Flash Modes

The following flash modes are available:

-  AUTO (auto flash): When lighting is poor or the subject is backlit, the flash pops up automatically when the shutter-release button is pressed halfway and fires as required.
-  AUTO (auto with red-eye reduction): Use for portraits. The flash pops up and fires as required, but before it fires, the red-eye reduction lamp lights to help reduce “red-eye.”
-  (off): The flash does not fire.



## Manual Pop-up Modes

In **P**, **S**, **A**, **M**, and self-portrait modes, the flash must be raised manually. The flash will not fire if it is not raised.

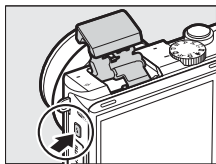

### 1 Raise the flash.

Press the flash pop-up button to raise the flash.



Flash pop-up button

### 2 Choose a flash mode.

Press  () on the multi selector to display a list of flash modes, then use the multi selector to highlight the desired mode and press  to select.

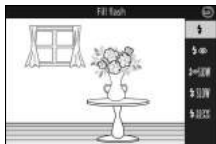





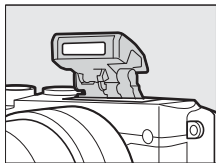

### 3 Take pictures.

The flash will fire with every shot. To disable the flash, press it gently downward until it latches.



## Flash Modes

The following flash modes are available:

-  (fill flash): The flash fires with every shot.
-  (red-eye reduction): Use for portraits. The flash fires with every shot, but before it fires, the red-eye reduction lamp lights to help reduce “red-eye.”
-  SLOW (red-eye reduction with slow sync): As for “red-eye reduction”, above, except that shutter speed slows automatically to capture background lighting at night or under low light. Use when you want to include background lighting in portraits. Available only in modes **P** and **A**.
-  SLOW (fill flash + slow sync): As for “fill flash”, above, except that shutter speed slows automatically to capture background lighting at night or under low light. Use when you want to capture both subject and background. Available only in modes **P** and **A**.
-  SLOW REAR (rear curtain + slow sync): As for “rear-curtain sync”, below, except that shutter speed slows automatically to capture background lighting at night or under low light. Use when you want to capture both subject and background. Available only in modes **P** and **A**.
-  REAR (rear-curtain sync): The flash fires just before the shutter closes, creating a stream of light behind moving light sources as shown below at right. Available only in modes **S** and **M**.



*Front-curtain sync*



*Rear-curtain sync*



### ✓ Raising the Flash

When using the flash, be sure it is fully raised as shown at right. Do not touch the flash during shooting.

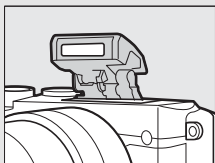

### ✎ Lowering the Built-in Flash

To save power when the flash is not in use, press it gently downward until the latch clicks into place. *Do not use force.* Failure to observe this precaution could result in product malfunction.

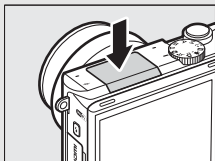

### ✎ The Flash-Ready Indicator

The flash-ready indicator (⚡) lights to show that the flash is fully charged when the shutter-release button is pressed halfway.





### **Using the Built-in Flash**

If the flash is fired multiple times in quick succession, the flash and shutter may be temporarily disabled to protect the flash. Shooting can be resumed after a brief pause.

Objects close to the camera may be overexposed in photographs taken with the flash at high ISO sensitivities.

To avoid vignetting, remove lens hoods and shoot at ranges of at least 0.6 m (2 ft). Some lenses may cause vignetting at greater distances or obstruct the red-eye reduction lamp, interfering with red-eye reduction. The following illustrations show the effect of vignetting caused by shadows cast by the lens when the built-in flash is used.

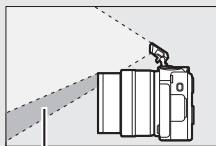

*Shadow*



*Vignetting*

### **See Also**

See page 192 for information on adjusting flash level.

### **Aperture, Sensitivity, and Flash Range**

Flash range varies with sensitivity (ISO equivalency) and aperture.



## Self-Portraits

To frame self-portraits in the monitor, reverse it as shown and follow the steps below.

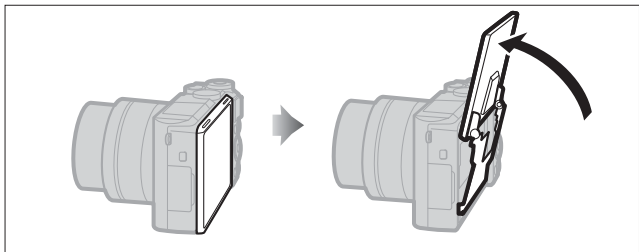

### 1 Reverse the monitor.

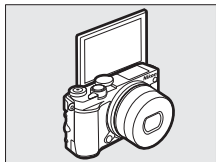

The camera will select self-portrait mode.



## 2 Adjust settings.

The following settings can be adjusted using touch controls:



 <b>Skin softening</b>	Tap to enable or disable skin softening. Enabling skin softening softens the look of skin for portrait subjects detected by the camera (up to a maximum of three), but note that the effect can not be previewed in the monitor.
 <b>Self-timer</b>	Tap to cycle through self-timer settings as follows: 2 s timer, 10 s timer, and self-timer off.
 <b>Exposure compensation</b>	Tap the exposure indicator to adjust exposure compensation (□ 101) and tap <b>OK</b> to exit when adjustments are complete.



## 3 Shoot.

Tap the monitor to focus on the selected subject and shoot, or press the shutter-release button halfway to focus and all the way down to take photographs. Use the movie-record button to shoot movies. Movies are recorded at 1080/30p.

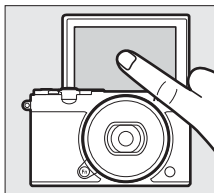

## 4 Exit self-portrait mode.

Moving the monitor out of the self-portrait position ends self-portrait mode.

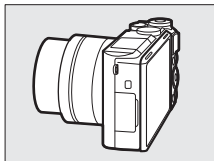

## Self-Portrait Mode

Touch-screen controls are always available in self-portrait mode regardless of the option selected for **Touch-screen controls** in the setup menu (☐ 194). All other controls except the power switch and the shutter-release, movie-record, and flash pop-up buttons are disabled; use the flash pop-up button to raise the flash as required. The flash fires in  **ALL** (auto + red-eye reduction) mode. Photographs taken in self-portrait mode with **NEF (RAW)** or **NEF (RAW) + JPEG fine** selected for image quality will be recorded as fine-quality JPEG images.

If **Off** is selected for **Self-portrait mode** in the setup menu (☐ 197), the camera will not enter self-portrait mode when the monitor is reversed, and pictures will instead be taken in the mode selected with the mode dial.



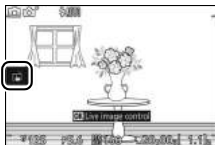

## Tap Shooting Options

Tap the icon shown at right to choose the operation performed by tapping the monitor in shooting mode. The options available vary with the shooting and focus mode.





### **Auto**, **Creative**, and **Self-Portrait Modes**

Choose from the following options.

	When you tap a subject in the display, the camera will focus and take a picture.
	Tap the monitor to position the focus area when <b>Night landscape</b> , <b>Landscape</b> , or <b>Close-up</b> is selected in creative mode. To focus, press the shutter-release button halfway.
	Tapping the display during shooting has no effect.

### **Sports Mode**

	Tap the monitor to position the focus area. To focus, press the shutter-release button halfway.
	Tapping the display during shooting has no effect.







## P, S, A, and M Modes

The operation performed by tapping the display depends on whether the camera is in autofocus or manual focus mode.



### ■ Autofocus Modes

The following options are available in autofocus modes (AF-A, AF-S, and AF-C).

	When you tap a subject in the display, the camera will focus and take a picture.
	Tap the display to position the focus area when single-point AF is selected for AF-area mode (📖 188). To focus, press the shutter-release button halfway.
	Tap a subject to start tracking when subject tracking is selected for AF-area mode (📖 188).
	Tapping the display during shooting has no effect.

### ■ Manual Focus Mode

The following options are available in manual focus mode.



	When you tap the display, the camera will take a picture without first adjusting focus.
	Tap a subject to display it at a higher magnification in the monitor (📖 186).
	Tapping the display during shooting has no effect.

## **Advanced Movie Mode**

The operation performed by tapping the display depends on whether the camera is in autofocus or manual focus mode.



### **Autofocus Modes**

The following options are available in autofocus modes (AF-F and AF-S).

	To focus when auto-area AF or single-point AF is selected for AF-area mode (□ 188), tap your subject in the display.
	Tap a subject to start tracking when subject tracking is selected for AF-area mode (□ 188).
	Tapping the display during shooting has no effect.

### **Manual Focus Mode**

The following options are available in manual focus mode.

	Tap a subject to display it at a higher magnification in the monitor (□ 186).
	Tapping the display during shooting has no effect.



#### **Unsupported Modes**

Tap shooting options are not available in best moment capture and Motion Snapshot modes or when **4K movie** is selected in advanced movie mode.

#### **Taking Pictures Using Tap Shooting Options**

Avoid tapping too hard. The camera may move when the shutter is released, blurring photographs.

The shutter-release button can be used to focus and take pictures even when the  icon is displayed to show that tap shooting options are active. Use the shutter-release button to take photographs in continuous shooting mode (□ 97) and during movie recording. Tap shooting options can be used only to take pictures one at a time in continuous shooting mode and can not be used to take photographs during movie recording. In self-timer mode (□ 99), tapping the monitor locks focus and starts the timer; the photograph will be taken after ten or two seconds.

## What Wi-Fi Can Do for You

The camera can connect via Wi-Fi wireless networks to a smart device (smartphone or tablet) running Nikon's dedicated Wireless Mobile Utility app (📖 118).

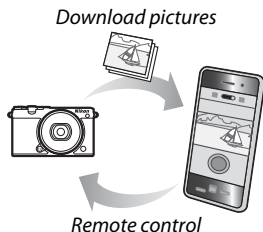

### 📝 Installing the Wireless Mobile Utility App

#### 1 Find the app.

On the smart device, connect to the Google Play service, the App Store, or another app marketplace and search for "Wireless Mobile Utility". For more information, see the instructions provided with the smart device.

#### 2 Install the app.

Read the app description and install the app. A pdf manual for the Wireless Mobile Utility is available for download at the following URLs:

- **Android:** <http://nikonimglib.com/ManDL/WMAU/>
- **iOS:** <http://nikonimglib.com/ManDL/WMAU-ios/>



Android



iOS



## Wireless Security

At default settings, wireless security is not enabled. Enable wireless security on the camera before connecting.

### ■ Enabling Wireless Security

Follow the steps below to enable wireless security.

#### 1 Select Wi-Fi connection type.

Select **Wi-Fi connection type** in the Wi-Fi menu.



#### 2 Enable encryption.

Select **Authentication/encryption** to display encryption options. Highlight **WPA2-PSK-AES** and press **OK** to enable wireless security. A password will now be required when connecting to the camera; the default password is "NIKON\_J5" (the current password can be viewed at any time by selecting **Current settings** in the Wi-Fi menu). To allow connection without a password, select **Open** for **Authentication/encryption**.

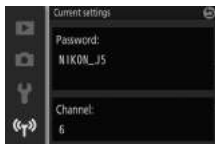
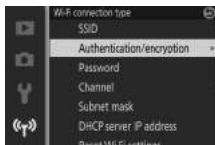

## ■ Changing the Password

The password can be changed as described below. The password can only be changed when **WPA2-PSK-AES** is selected for **Authentication/encryption** in the Wi-Fi menu.

### 1 Select Wi-Fi connection type > Password.

Select **Wi-Fi connection type** in the Wi-Fi menu, then highlight **Password** and press **OK**.



### 2 Enter a password.

The text-entry dialog shown at right will be displayed with the current password (by default, "NIKON\_J5") in the password area. Tap to highlight characters in the password area or rotate the command dial to move the cursor. To enter a new character at the current cursor position, tap the keys in the keyboard area or highlight characters using the multi selector and press **OK**. To switch between lower and upper case, numbers, and symbols, press the **Fn** button or tap the shift key.

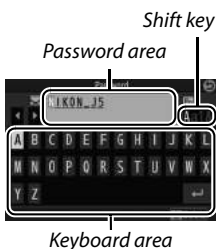

Passwords can be from 8 to 36 characters long. After entering the password, tap **OK**. The password can be viewed at any time by selecting **Current settings** in the Wi-Fi menu.





## ✔ Security

Although one of the benefits of a wireless-enabled device is that it allows others to freely connect for the wireless exchange of data anywhere within its range, the following may occur if security is not enabled:

- **Data theft:** Malicious third-parties may intercept wireless transmissions to steal user IDs, passwords, and other personal information.
- **Unauthorized access:** Unauthorized users may gain access to the network and alter data or perform other malicious actions. Note that due to the design of wireless networks, specialized attacks may allow unauthorized access even when security is enabled.

## ✍ Wi-Fi Connection Type

In addition to authentication/encryption and password options, the **Wi-Fi connection type** menu contains the following items:

- **SSID:** Choose the camera SSID (network name). The process for entering the SSID is the same as that for editing the password.
- **Channel:** The wireless channel used for wireless connections. Press  or  to choose from channels 1 through 11 and press  to select.
- **Subnet mask/DHCP server IP address:** We recommend that you use the default sub-net mask (255.255.255.0) and DHCP server IP address (192.168.0.1).
- **Reset Wi-Fi settings:** Select **Yes** to reset wireless settings to their default values.



## ✍ Current Settings

Select **Current settings** to view the current SSID, authentication/encryption settings, password, channel, subnet mask, and DHCP server IP address.



## Connecting via Wi-Fi

Before connecting via Wi-Fi (wireless LAN), install the Wireless Mobile Utility on your compatible Android or iOS smart device.

### Android and iOS: Connecting via SSID

Enable Wi-Fi on the smart device before connecting. For details, see the documentation provided with the smart device.

#### 1 Press the (Wi-Fi) button.

The camera SSID will be displayed (the camera SSID can also be displayed by highlighting **Connect to smart device** in the Wi-Fi menu and pressing .

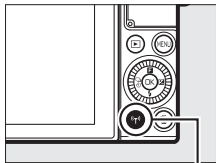

 (Wi-Fi) button



#### 2 Select the camera SSID.

On the smart device, select **Settings** > **Wi-Fi** and select the camera SSID to connect via Wi-Fi. If this is the first time you have connected since changing password settings (□ 116), enter the new password when prompted.

#### 3 Launch the Wireless Mobile Utility.

Launch the copy of Wireless Mobile Utility installed on the smart device. See Wireless Mobile Utility manual for details (□ 114).

## **Android: Connecting via NFC**

If the smart device supports NFC (Near Field Communication), a Wi-Fi connection can be established simply by touching the camera **N** (N-Mark) logo to the smart device NFC antenna. Before connecting, enable NFC and Wi-Fi on the smart device as described in the documentation provided with the smart device.

To connect via NFC, touch the camera **N** (N-Mark) logo to the smart device NFC antenna (for the location of the NFC antenna, see the documentation provided with the smart device). Maintain contact until the camera displays a message stating that an NFC device has been detected.

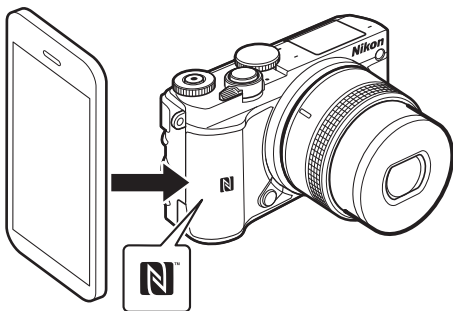

Once the smart device has been detected, a Wi-Fi connection will be established and the Wireless Mobile Utility will launch automatically. See the Wireless Mobile Utility manual for more information (📖 114).

### **NFC**

NFC (Near Field Communication) is an international standard for short-range wireless communications technology.

### **No Connection**

If you are unable to establish a connection using NFC as described above, connect by manually selecting the camera SSID (☐ 118).

### **Wi-Fi**

Before using the Wi-Fi function, read the warnings on pages xviii to xx; to prevent loss of power while connected, you should also charge the camera battery. Do not use Wi-Fi in settings in which its use is prohibited. Note that the camera Wi-Fi function can not be used when a USB cable is connected.

### **Terminating Wi-Fi Connections**

Wi-Fi will terminate automatically if the smart device does not initiate a connection within five minutes. To terminate Wi-Fi manually, press the MENU button to exit the Wi-Fi standby or connection display.



## Uploading Photos to a Smart Device

Follow the steps below to upload photos from the camera to a smart device. Movies can not be selected for upload.

### Uploading Photos One at a Time

Use the  (Wi-Fi) button to upload the photo currently displayed in full-frame playback.

#### 1 Display the photo on the camera.

Display the desired photo in full-frame playback.

#### 2 Press the (Wi-Fi) button.

Pressing the  (Wi-Fi) button initiates a Wi-Fi connection; the camera SSID will be displayed in the monitor.

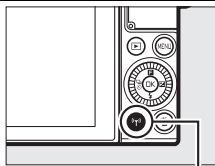

 (Wi-Fi) button



#### 3 Select the camera SSID.

On the smart device, select **Settings** > **Wi-Fi** and select the camera SSID to connect via Wi-Fi. If this is the first time you have connected since changing password settings (116), enter the new password when prompted.

#### 4 Download the photo to the smart device.

Launch the Wireless Mobile Utility on the smart device and follow the instructions on page 124 to download the photo.

#### The **F** (Feature) Menu

Photos can also be uploaded by pressing **F** in full-frame playback and then highlighting **Wi-Fi upload** and pressing .



## Uploading Multiple Selected Photos

To upload multiple selected photos, use the **Upload from camera** option in the Wi-Fi menu.

### 1 Choose Upload from camera.



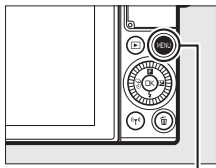

Press the MENU button to display the menus. Highlight **Upload from camera** in the Wi-Fi menu and press .

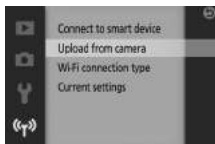

MENU button



### 2 Select photos.

Press  or  to scroll through pictures and press  to select or deselect. You can also tap the monitor to select or deselect photos. Selected photos are indicated by a  icon.



### 3 Press .

Press  to complete the operation. The camera SSID will be displayed in the monitor.



---

#### 4 Select the camera SSID.

On the smart device, select **Settings** > **Wi-Fi** and select the camera SSID to connect via Wi-Fi. If this is the first time you have connected since changing password settings (📖 116), enter the new password when prompted.

---

#### 5 Download the photos to the smart device.

Launch the Wireless Mobile Utility on the smart device and follow the instructions on page 124 to download the selected photos.

### ***Uploading Photos via NFC***

---

Photos displayed full frame or highlighted in the thumbnail list can be uploaded via NFC (📖 119).

---

#### 1 Display or highlight the desired photo.

Display the photo full frame or highlight it in the thumbnail list.



---

#### 2 Connect.

Touch the camera  (N-Mark) logo to the smart device NFC antenna until the camera displays a message stating that an NFC device has been detected.

---

#### 3 Download the photos to the smart device.

The Wireless Mobile Utility will launch automatically on the smart device; follow the instructions on page 124 to download the selected photos.

## Downloading Selected Pictures to the Smart Device

To download the selected pictures to the smart device, establish a Wi-Fi connection with the camera (📖 118, 119) and select **View photos** in the Wireless Mobile Utility. A confirmation dialog will be displayed; select **OK** to download the pictures selected with the camera.

### Android OS

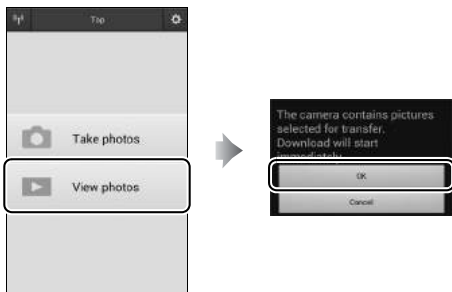

### iOS

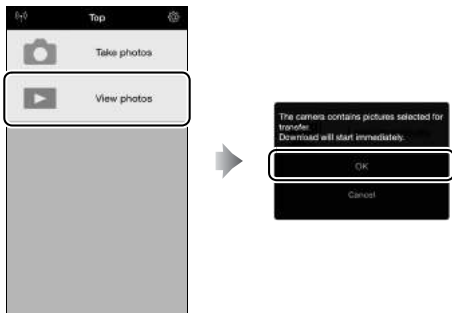

# More on Playback

## Photo Information

Photo information is superimposed on images displayed in full-frame playback (☞ 37). The information displayed can be selected using the **Display > Playback** option in the setup menu (☞ 196).

### Basic Info

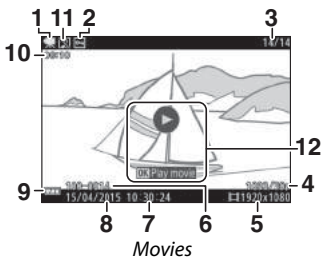
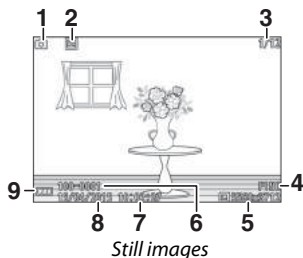

<b>1</b> Shooting mode		<b>6</b> Folder number-file number .....	127
<b>2</b> Protect status .....	152	<b>7</b> Time of recording .....	30, 199
<b>3</b> Frame number/total number of images		<b>8</b> Date of recording .....	30, 199
<b>4</b> Image quality .....	162	<b>9</b> Battery indicator .....	32
Frame rate .....	57, 165	<b>10</b> Movie length .....	46
<b>5</b> Image size .....	162	<b>11</b> Audio recording indicator .....	180
Frame size .....	57, 165	<b>12</b> On-screen guide (for movies) .....	46



## ■ Detailed info

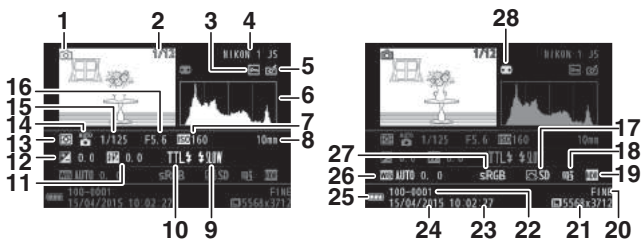

*Still images*

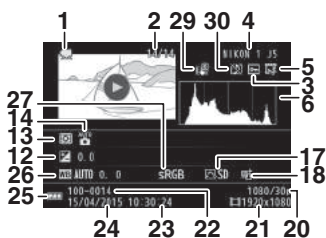

*Movies*

<b>1</b> Shooting mode	<b>13</b> Metering ..... 166
<b>2</b> Frame number/total number of images	<b>14</b> Creative mode ..... 58
<b>3</b> Protect status ..... 152	Exposure mode ..... 161
<b>4</b> Camera name	<b>15</b> Shutter speed ..... 68, 70
<b>5</b> Retouch indicator ..... 153, 154, 155	<b>16</b> Aperture ..... 69, 70
Movie edit indicator ..... 156	<b>17</b> Picture Control ..... 173
<b>6</b> Histogram showing distribution of tones in image ..... 127	<b>18</b> Active D-Lighting indicator ..... 178
<b>7</b> ISO sensitivity ..... 172	<b>19</b> HDR indicator ..... 62
<b>8</b> Focal length ..... 229	<b>20</b> Image quality ..... 162
<b>9</b> Flash mode ..... 103, 105	Frame rate ..... 57, 165
<b>10</b> Flash control ..... 192	<b>21</b> Image size ..... 162
<b>11</b> Flash compensation ..... 192	Frame size ..... 57, 165
<b>12</b> Exposure compensation ..... 101	

22	Folder number-file number	27	Color space.....	177	
23	Time of recording .....	30, 199	28	Auto distortion control .....	177
24	Date of recording .....	30, 199	29	Electronic VR (movies).....	183
25	Battery indicator .....	32	30	Audio recording indicator .....	180
26	White balance.....	167			
	White balance fine-tuning .....	168			

### Folder and File Numbers

Photographs are stored as files with names containing a four-digit number between 0001 and 9999 assigned automatically in ascending order by the camera. These in turn are stored in folders containing up to 999 images. A new folder is created automatically when file numbering reaches 9999 or the number of images in the current folder reaches 999.

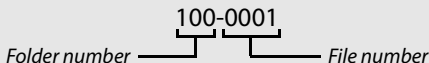

### Histograms (📖 126)

Camera histograms are intended only as a guide and may differ from those in imaging applications. Sample histograms are shown below:

- **If brightness varies evenly across the image**, the distribution of tones will be relatively even.



- **If the image is dark**, tone distribution will be shifted to the left.



- **If the image is bright**, tone distribution will be shifted to the right.



Exposure compensation shifts the distribution of tones to the right when raised, to the left when lowered. Histograms can give you a rough idea of overall exposure when bright ambient lighting makes it difficult to see the display in the monitor.



## The **F** (Feature) Menu 11

The following options can be accessed by pressing **F** during playback:

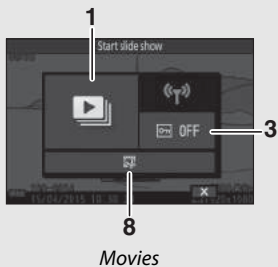
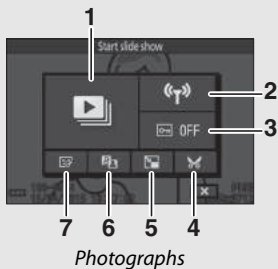







<b>1</b> Start slide show.....	137	<b>5</b> Resize .....	154
<b>2</b> Wi-Fi upload.....	114	<b>6</b> D-Lighting.....	153
<b>3</b> Protect.....	152	<b>7</b> Glamour retouch .....	135
<b>4</b> Crop .....	155	<b>8</b> Edit movie .....	156



## Thumbnail Playback

To view pictures in “contact sheets” of 4, 9, or 16 images, rotate the command dial left when a picture is displayed full frame.

The following operations can be performed:









To	Use	Description
Display more images		Rotate the command dial left to increase the number of images displayed. 
Display fewer images		Rotate the command dial right to decrease the number of images displayed. To view the highlighted image full frame, rotate the dial right when 4 images are displayed. 
Highlight images		Use the multi selector to highlight images. You can delete (□ 134) the highlighted image or zoom in for a closer look (□ 131).
View highlighted image		Press  to view the highlighted image full frame.
Delete highlighted image		See page 134.

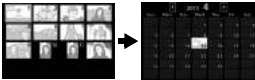

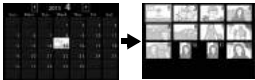
## Calendar Playback

To view pictures taken on a selected date, rotate the command dial left when 16 pictures are displayed (□ 129).

The following operations can be performed:









To	Use	Description
Display calendar		To view the calendar, rotate the command dial left when 16 images are displayed. 
Exit to thumbnail playback		To return to the 16-image display, rotate the command dial right when the calendar is displayed. 
Highlight date		Use multi selector to highlight date in calendar display.
View pictures taken on highlighted date		Press  to view the first picture taken on the highlighted date.
Delete pictures taken on highlighted date		Press  to delete all pictures taken on the highlighted date.



## Playback Zoom

To zoom in on a photograph, display it full frame and rotate the command dial right. Playback zoom is not available with movies or Motion Snapshots.

The following operations can be performed:

To	Use	Description	
Zoom in		Rotate the command dial right to zoom in, left to zoom out. Whenever you zoom in or out, a navigation window will briefly appear with the area currently visible in the display indicated by a yellow border. Press  ,  ,  , or  to scroll the image.	
Zoom out			
View other areas of image			
Exit zoom		Return to full-frame playback.	







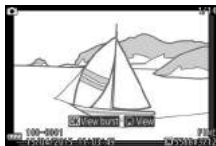





## Viewing Bursts

Each burst or series of pictures taken in sports (📖 74) or continuous (📖 97) mode or with **Active Selection** (📖 76) or **Smart Photo Selector** (📖 83) selected in best moment capture mode is represented by a key frame during playback. The key frame is either the first shot or, in the case of pictures taken in Smart Photo Selector mode, the best shot. Pressing  when the key frame is displayed full frame displays the remaining pictures in the series one after the other.



When a key frame is displayed in full-frame playback, the pictures in the series can be displayed by pressing . The following operations can be performed:

To	Use	Description
View other images	 	Press  or  or rotate the multi selector to view the other images in the series.
Zoom in		Rotate the command dial right to zoom in on the current picture.
Zoom out		Rotate the command dial left to zoom out from the current picture.
Scroll		While the picture is zoomed in, you can use the multi selector to view other areas of the image.
Select key frame/best shot		Press  to select the current picture as the key frame (or in the case of the Smart Photo Selector, the best shot).

To	Use	Description
Delete pictures		A menu will be displayed; choose <b>This image</b> to delete the current image or <b>All but selected frame</b> (or <b>All except best shot</b> in the case of images taken with the Smart Photo Selector) to delete all images except the key frame or best shot.

#### **Maintaining Burst Files**

Removing the “NCCONLST.LST” file from the “NCFL” folder on the memory card or renaming the individual files in a burst or series will break the link between the files and the key frame or best shot. The affected files will play back as individual images unassociated with a burst or series.

#### **See Also**



See page 152 for information on choosing how bursts are displayed.



## Deleting Pictures

Pictures can be deleted from the memory card as described below. *Note that once deleted, pictures can not be recovered; protected images, however, will not be deleted.*

### Deleting the Current Picture

To delete the picture currently displayed in full-frame playback or selected in the thumbnail list, press . A confirmation dialog will be displayed; press  again to delete the picture and return to playback, or press  to exit without deleting the picture.

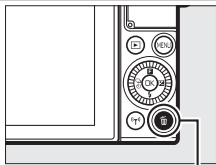



 button

### The Playback Menu









To delete multiple images, press the MENU button, select **Delete** in the playback menu, and choose from the options below. A confirmation dialog will be displayed; select **Yes** to delete the images (note that some time may be required if a large number of images is selected).



<b>Delete selected images</b>	Highlight images and press  to select or deselect (  151). Press  to exit when the selection is complete.
<b>Delete all images</b>	Delete all pictures on the memory card.

## Glamour Retouch

During playback, the **Glamour retouch** option in the **F** (feature) menu offers eight retouch options specifically tailored to portraits.

 <b>Skin softening</b>	Make skin look softer.
 <b>Small face</b>	Make faces smaller.
 <b>Big eyes</b>	Make eyes larger.
 <b>Brighten faces</b>	Make faces brighter.
 <b>Hide eye bags</b>	Conceal dark patches under the eyes.
 <b>Whiten eyes</b>	Make eyes brighter.
 <b>Whiten teeth</b>	Make teeth whiter.
 <b>Redden cheeks</b>	Mimic the effect of any of 12 colors of rouge.

### 1 Select Glamour retouch.

Display the desired picture and press **F** on the multi selector to display the playback **F** menu, then highlight **Glamour retouch** and press **OK**. Note that the **Glamour retouch** option will be unavailable if no portrait subject is detected or the picture is otherwise ineligible for glamour retouch effects.

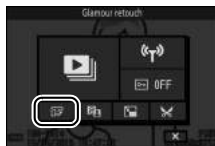

### 2 Select a subject.

Glamour effects can be applied to only one subject at a time. If the camera has detected multiple subjects, press **←** or **→** to highlight the desired subject and press **OK**. If only one subject was detected, the subject selection dialog will not be displayed; proceed to Step 3.

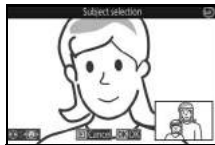

### 3 Choose a retouch option.

Press or to highlight the desired option (options that can not be used with the current picture are grayed out and unavailable).

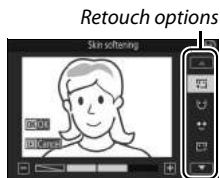

### 4 Choose an effect.

Press or to choose the effect. Repeat Steps 3 and 4 as desired to apply additional effects. Press to preview the result once effects have been adjusted to your satisfaction (to adjust settings after viewing the preview, press ).

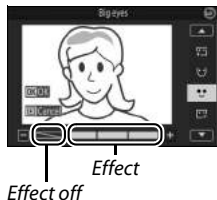

### 5 Save the retouched copy.

Press to save the retouched copy. Note that some time may be required, particularly if multiple effects are selected or if the shot contains a close-up of a portrait subject.

#### Image Quality

Copies created from JPEG photos are the same quality as the original (162). NEF (RAW) photos can not be retouched; when retouch options are used with pictures taken at an image quality of **NEF (RAW) + JPEG fine**, the JPEG image will be retouched and saved as a fine-quality JPEG copy.

## Slide Shows

To view a slide show of the pictures on the memory card, press the **MENU** button, select **Slide show** in the playback menu, and follow the steps below.

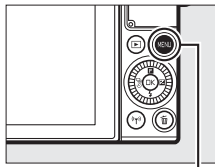

MENU button

### 1 Select the type of image used in the show.

Highlight the desired option and press **OK**.

<b>All images</b>	Display all the images on the memory card.
<b>Still images</b>	Display still images only. Images taken using <b>Easy panorama</b> will be displayed in panorama mode (□ 65).
<b>Movies</b>	Display movies and Motion Snapshots recorded with <b>MOV file</b> selected for <b>File format</b> (□ 92).
<b>Motion Snapshot</b>	Display Motion Snapshots recorded with <b>NMS files</b> selected for <b>File format</b> (□ 92). Only the movie portion will be played; the associated photographs are not displayed.
<b>Select images by date</b>	Display only images recorded on a selected date. A calendar will be displayed; use the multi-selector to highlight a date.



## 2 Adjust display times and audio settings.

Adjust the following options:

<b>Frame interval</b>	Choose how long each still image is displayed.
<b>Movie playback time</b>	Choose how much of each movie is played back before the next slide is displayed. Choose <b>Same as frame interval</b> to display the next slide after the time selected for <b>Frame interval</b> , <b>No limit</b> to play back the entire movie before displaying the next slide.
<b>Audio</b>	Mute audio playback, or select <b>Movie sound tracks</b> to play audio recorded with movies and with Motion Snapshots recorded with <b>Ambient</b> selected for <b>Audio</b> (□ 92). No sound is played for still images.

## 3 Select Start.

Highlight **Start** and press **OK** to start the slide show.

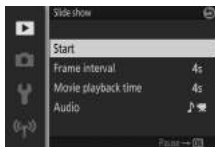







### Viewing Bursts

Bursts (□ 132) may be represented in slide shows by a key frame or each image in the burst can be played back individually. To view only the key frame, select **Key picture only** for **Sequence display options** in the playback menu (□ 152). To view each image individually, select **Individual pictures**.



The following operations can be performed while a slide show is in progress:

To	Use	Description
Skip back/skip ahead		Rotate the multi selector to skip back or ahead, or press  to return to the previous frame,  to skip to the next frame.
Pause/resume		Pause the show. Press again to resume.
Adjust volume		Rotate the command dial to adjust volume.
Exit to playback mode		End the show and return to playback mode.

The options shown at right are displayed when the show ends. Select **Resume** to restart or **Exit** to exit to the playback menu.

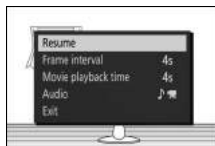

# Connections

## Copying Pictures to a Computer

Pictures can be copied to a computer using ViewNX-i.

### Installing ViewNX-i

To upload and view pictures, download the latest version of the ViewNX-i installer from the following website and follow the on-screen instructions to complete installation. An Internet connection is required. For system requirements and other information, see the Nikon website for your region (□ xvii).

<http://downloadcenter.nikonimglib.com/>

#### Capture NX-D

Use Nikon's Capture NX-D software to fine-tune photos or to change settings for NEF (RAW) pictures and save them in other formats.

Capture NX-D is available for download from:

<http://downloadcenter.nikonimglib.com/>

#### Motion Snapshots

ViewNX-i is required to view Motion Snapshots saved using the **File format > NMS files** option (□ 92).



## Copying Pictures to the Computer

Before proceeding, be sure you have installed ViewNX-i (📖 140).

### 1 Connect the USB cable.

After turning the camera off and ensuring that a memory card is inserted, connect the supplied USB cable as shown and then turn the camera on.

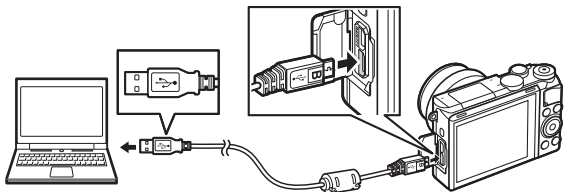

#### Use a Reliable Power Source

To ensure that data transfer is not interrupted, be sure the camera battery is fully charged.

#### Connecting Cables

Be sure the camera is off when connecting or disconnecting interface cables. Do not use force or attempt to insert the connectors at an angle.

#### During Transfer

Do not turn the camera off or disconnect the USB cable while transfer is in progress.

#### USB Hubs

Transfer may not proceed as expected if the camera is connected via a USB hub or keyboard.



## 2 Start Nikon Transfer 2 component of ViewNX-i.

If a message is displayed prompting you to choose a program, select Nikon Transfer 2.

### Windows 7

If the following dialog is displayed, select Nikon Transfer 2 as described below.

- 1 Under **Import pictures and videos**, click **Change program**. A program selection dialog will be displayed; select **Import File using Nikon Transfer 2** and click **OK**.



- 2 Double-click **Import File**.

### Windows 8.1

Windows 8.1 may display an AutoPlay prompt when the camera is connected. Tap or click the dialog and then tap or click **Import File/Nikon Transfer 2** to select Nikon Transfer 2.



---

### 3 Click **Start Transfer**.

At default settings, pictures on the memory card will be copied to the computer.



**Start Transfer**

---

### 4 Terminate the connection.

When transfer is complete, turn the camera off and disconnect the USB cable.

#### **For More Information**

Consult online help for more information on using ViewNX-i.



## Viewing Pictures on TV

Connect the camera to a television for playback.

### Connecting an HDMI Cable

Always turn the camera off before connecting or disconnecting HDMI cables. When connecting cables, do not use force or attempt to insert the connectors at an angle.

## High-Definition Devices

A type D High-Definition Multimedia Interface (HDMI) cable (available separately from third-party suppliers) can be used to connect the camera to high-definition video devices.

---

### 1 Connect the HDMI cable.

Turn the camera off and connect the HDMI cable.

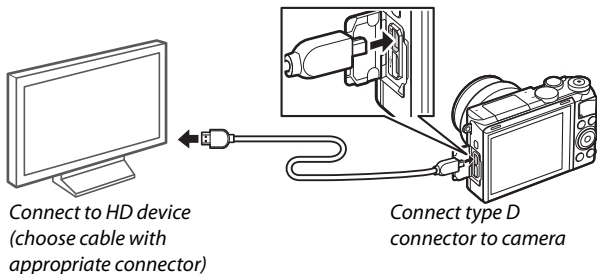

---

### 2 Tune the device to the HDMI channel.

---

### 3 Turn the camera on.

Turn the camera on; the camera monitor will remain off and the camera shooting mode display will appear on the HD device. Pictures can be played back using camera controls as described elsewhere in this manual; note that the edges of images may not be visible in the display.

**✔ Close the Connector Cover**

Close the connector cover when the connectors are not in use. Foreign matter in the connectors can interfere with data transfer.

**✍ Television Playback**

Volume can be adjusted using the controls on the television; adjusting volume on the camera has no effect. Use of an EH-5b AC adapter and EP-5F power connector (available separately) is recommended for extended playback.



## Printing Photographs

Selected JPEG images can be printed on a PictBridge printer connected directly to the camera.

### Connecting the Printer

Connect the camera using the supplied USB cable.

---

#### 1 Turn the camera off.

---

#### 2 Connect the USB cable.

Turn the printer on and connect the USB cable. Do not use force or attempt to insert the connectors at an angle.

---

#### 3 Turn the camera on.

A welcome screen will be displayed in the monitor, followed by a PictBridge playback display. To print pictures one at a time, proceed to page 147. To print multiple selected pictures or all pictures, proceed to page 148.

#### Selecting Photographs for Printing

Movies and NEF (RAW) photographs (📄 162) can not be selected for printing. If Motion Snapshots are selected, only the photographs will be printed; the movie portion will not be printed.

#### Panoramas

Some printers may not print panoramas, while at some settings others may not print entire panoramas. See the printer manual or consult the manufacturer for details.













## Printing Pictures One at a Time









---

### 1 Display the desired picture.

Press  or  to view additional pictures. Rotate the command dial right to zoom in on the current frame ( 131; rotate the dial left to exit zoom). To view nine pictures at a time, rotate the dial left when a picture is displayed full frame. Use the multi selector to highlight pictures, or rotate the command dial right to display the highlighted picture full frame.

### 2 Adjust printer settings.



Press  to display the following items, then press  or  to highlight an item and press  to view options (only options supported by the current printer are listed; to use the default option, select **Use printer settings**). After selecting an option, press  to return to the printer settings menu.

Option	Description
Page size	Choose a page size.
Number of copies	This option is listed only when pictures are printed one at a time. Press  or  to choose number of copies (maximum 99).
Print border	Choose whether to frame photos in white borders.
Print time stamp	Choose whether to print the times and dates of recordings on photos.
Crop	This option is listed only when pictures are printed one at a time. To exit without cropping, highlight <b>No</b> and press  . To crop the current picture, highlight <b>Yes</b> and press  . A crop selection dialog will be displayed; rotate the command dial right to increase the size of the crop, left to decrease. Press  ,  ,  , or  to position the crop. Note that print quality may drop if small crops are printed at large sizes.



---

### 3 Start printing.

Highlight **Start printing** and press  to start printing. To cancel before all copies have been printed, press .

## Printing Multiple Pictures





---

### 1 Display the PictBridge menu.

Press the MENU button in the PictBridge playback display ( 146).

### 2 Choose an option.

Highlight one of the following options and press .



- **Select images for printing:** Select pictures for printing. Press  or  to highlight pictures and press  or  to choose the number of prints (up to 99).
- **Index print:** To create an index print of all JPEG pictures on the memory card, proceed to Step 3. Note that if the memory card contains more than 256 pictures, a confirmation dialog will be displayed and only the first 256 images will be printed. A warning will be displayed if the page size selected in Step 3 is too small.

---

### 3 Adjust printer settings.

Adjust printer settings as described in Step 2 on page 147.

### 4 Start printing.

Highlight **Start printing** and press  to start printing. To cancel before all copies have been printed, press .

 **Errors**

See page 219 for information on what to do if an error occurs during printing.

# The Playback Menu

To display the playback menu, press **MENU** and select **Playback**.

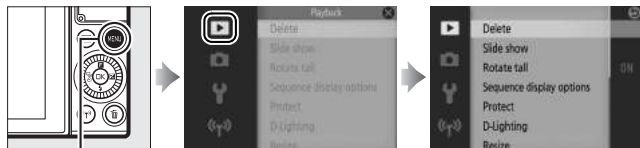

MENU button

The playback menu contains the following options:

Option	Description	Default	
<b>Delete</b>	Delete multiple images.	—	134
<b>Slide show</b>	View movies and photos in a slide show.	<b>Image type:</b> All images <b>Frame interval:</b> 4 s <b>Movie playback time:</b> Same as frame interval <b>Audio:</b> Movie sound tracks	137
<b>Rotate tall</b>	Rotate “tall” (portrait-orientation) pictures for display during playback.	On	152
<b>Sequence display options</b>	Choose how bursts are displayed.	Key picture only	152
<b>Protect</b>	Protect pictures from accidental deletion.	—	152
<b>D-Lighting</b>	Brighten shadows in dark or backlit photos, creating a retouched copy that is saved separately from the unmodified original.	—	153
<b>Resize</b>	Create small copies of selected pictures.	<b>Choose size:</b> 1280×856; 1.1 M	154

Option	Description	Default	
<b>Crop</b>	Create cropped copies of selected pictures.	—	155
<b>Edit movie</b>	Create copies of movies from which unwanted footage has been trimmed.	—	156

### Playback



The camera may be unable to display or retouch images that were created or have been edited with other devices.

### Image Quality

Copies created from JPEG photos are the same quality as the original ( 162). NEF (RAW) photos can not be retouched; when retouch options are used with pictures taken at an image quality of **NEF (RAW) + JPEG fine**, the JPEG image will be retouched and saved as a fine-quality JPEG copy.



## Selecting Multiple Images

Choosing the options listed below displays an image selection dialog. Press  or  to highlight pictures (only pictures to which the operation applies are available for selection).



- **Delete > Delete selected images** (📖 134)
- **Protect > Select/set** (📖 152)
- **D-Lighting** (📖 153)
- **Resize > Select images** (📖 154)
- **Crop** (📖 155)
- **Edit movie** (📖 156)



## Rotate Tall

Choose whether to rotate “tall” (portrait-orientation) pictures for display during playback. Note that because the camera itself is already in the appropriate orientation during shooting, images are not rotated automatically during image review.

<b>On</b>	“Tall” (portrait-orientation) pictures are automatically rotated for display in the camera monitor. Pictures taken with <b>Off</b> selected for <b>Auto image rotation</b> (📖 200) will be displayed in “wide” (landscape) orientation.
<b>Off</b>	“Tall” (portrait-orientation) pictures are displayed in “wide” (landscape) orientation.

## Sequence Display Options

Choose how the camera displays bursts or series of photographs taken in sports (📖 74) or continuous (📖 97) mode or with **Active Selection** (📖 76) or **Smart Photo Selector** (📖 83) selected in best moment capture mode.

<b>Key picture only</b>	Only the key frame is displayed. The other pictures in the series can be viewed as described on page 132.
<b>Individual pictures</b>	Each picture in the series is shown separately.



## Protect

Protect selected images from accidental deletion. Note that this option does NOT protect files from deletion when the memory card is formatted (📖 195).

<b>Select/set</b>	Press ⏪ or ⏩ to highlight pictures (📖 151) and press ⏴ to select or deselect. Press ⏹ to exit when the operation is complete.
<b>Reset</b>	Remove protection from all pictures.

## D-Lighting

Applied to selected images, D-Lighting creates copies that have been processed to brighten shadows.



*Before*



*After*

Press or to highlight an image ( 151) and press to display the options shown at right. Press or to choose the amount of correction performed (the effect can be previewed in the display) and press to create a retouched copy.



### D-Lighting





Noise (randomly-spaced bright pixels, fog, or lines) may appear in copies created with **D-Lighting**. Uneven shading may be visible with some subjects.

### Image Size

Copies are the same size as the original.



## Resize

Create small copies of selected photographs. Select **Choose size** and choose a size from **1280x856; 1.1 M** (1280 × 856 pixels), **960x640; 0.6 M** (960 × 640 pixels), and **640x424; 0.3 M** (640 × 424 pixels), and then choose **Select images**. Press  or  to highlight pictures (📖 151) and press  to select or deselect. When the selection is complete, press  to display a confirmation dialog and select **Yes** to save the resized copies.

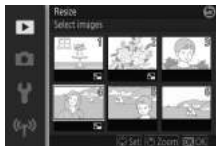



### Resized Copies

Playback zoom may not be available with resized copies.













## Crop

Create a cropped copy of selected photographs. Press  or  or rotate the multi selector to highlight a picture (151) and press  to display the image with the default crop shown in yellow. Use the controls below to choose a crop and save the copy.



To	Use	Description
Choose size		Rotate the command dial to choose the crop size.
Choose aspect ratio		Rotate the multi selector to choose between aspect ratios of 3 : 2, 4 : 3, 1 : 1, and 16 : 9.
Position crop		Press  ,  ,  , or  to position the crop.
Create copy		Save the current crop as a separate file.

### Cropped Copies

Playback zoom may not be available with cropped copies. The size of the copy varies with crop size and aspect ratio and appears at upper left in the crop display.

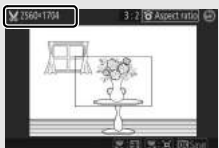

## Edit Movie

Trim footage from movies to create edited copies.

### 1 Choose an edit option.

Highlight one of the following options and press **OK**:

- **Choose start point:** Remove all frames before a chosen starting frame.



- **Choose end point:** Remove all frames after a chosen closing frame.

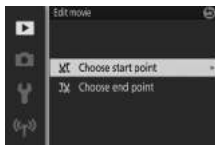
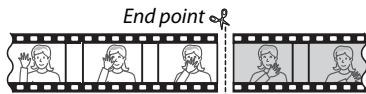

### 2 Select a movie.

Press **Left** or **Right** to highlight a movie (151) and press **OK** to select.

### 3 Pause the movie on opening or closing frame.

Play the movie back, pressing **OK** to begin and resume playback and **Stop** to pause (46; the first frame is indicated by a **Play** icon in the display, the last frame by **End**). While playback is paused, press **Left** or **Right** to rewind or advance one frame at a time. Pause playback when you reach the frame that will become the new opening or closing frame.



---

#### 4 Delete the unwanted frames.

Press  to delete all frames before **(Choose start point)** or after **(Choose end point)** the current frame.



---

#### 5 Save the copy.

Highlight **Yes** and press  to save the edited copy. If necessary, the copy can be trimmed as described above to remove additional footage.



#### **Trimming Movies**

Movies must be at least two seconds long (or, in the case of 4K and slow-motion movies, at least three seconds long). If a copy can not be created at the current playback position, the current position will be displayed in red in Step 4 and no copy will be created. The copy will not be saved if there is insufficient space available on the memory card.

To prevent the camera from turning off unexpectedly, use a fully-charged battery when editing movies.



# The Shooting Menu



To display the shooting menu, press **MENU** and select **Shooting**.



MENU button

The shooting menu contains the following options:

Option	Description	Default	
<b>Reset shooting options</b>	Reset shooting options to default values.	—	161
<b>Creative</b>	Choose a creative mode.	Pop	59
<b>Best moment capture</b>	Choose from <b>Active Selection</b> , <b>Slow view</b> , and <b>Smart Photo Selector</b> .	Active Selection	76
<b>Advanced movie</b>	Choose a movie type for advanced movie mode.	HD movie	49
<b>Exposure mode</b>	Choose how the camera sets shutter speed and aperture.	Scene auto selector	161
<b>Image quality</b>	Choose a file format and compression ratio.	JPEG fine	162
<b>Image size</b>	Choose a size for new photos.	5568 × 3712; 20.6 M (standard photos)/ Normal panorama (panoramas)	162

Option	Description	Default	
<b>Frame size/ frame rate</b>	Choose a frame size and rate for movies recorded in auto, <b>P</b> , <b>S</b> , <b>A</b> , <b>M</b> , and sports modes and when <b>HD movie</b> is selected in advanced movie mode (  49).	1080/30p	165
<b>Metering</b>	Choose how the camera meters exposure.	Matrix	166
<b>White balance</b>	Adjust settings for different types of lighting.	Auto	167
<b>ISO sensitivity</b>	Control the camera's sensitivity to light.	Auto (160–6400)	172
<b>Picture Control</b>	Choose how the camera processes pictures.	Standard	173
<b>Auto distortion control</b>	Choose whether the camera corrects barrel and pin-cushion distortion.	Off	177
<b>Color space</b>	Choose a color space for new pictures.	sRGB	177
<b>Active D-Lighting</b>	Avoid loss of detail in highlights and shadows.	On	178
<b>Long exposure NR</b>	Reduce noise in long time-exposures.	Off	179
<b>High ISO noise reduction</b>	Reduce noise at high ISO sensitivities.	On	179
<b>Movie sound options</b>	Choose sound recording options.	<b>Microphone:</b> Auto sensitivity (A) <b>Wind noise reduction:</b> On	180
<b>Auto image capture</b>	Choose whether the camera takes photos automatically during movie recording and select the number of pictures taken per minute.	<b>Auto photography:</b> Off <b>Max. shots per minute:</b> 4	180



Option	Description	Default	
<b>Interval timer shooting</b>	Take photos at a pre-selected interval.	<b>Interval:</b> 01' 00" <b>Number of shots:</b> 001	181
<b>Optical VR</b>	Choose whether to use optical vibration reduction with compatible 1 NIKKOR lenses.	On	183
<b>Electronic VR (movies)</b>	Choose whether to use electronic vibration reduction with Motion Snapshots or movies.	Off	183
<b>Focus mode</b>	Choose how the camera focuses.	—	184
<b>AF-area mode</b>	Choose how the focus area is selected.	Auto-area	188
<b>Face-priority</b>	Turn face priority on or off.	On	191
<b>Built-in AF assist</b>	Control the built-in AF-assist illuminator.	On	191
<b>Flash control</b>	Choose a flash mode for the built-in flash.	TTL ( <b>Manual:</b> Full)	192
<b>Flash compensation</b>	Control flash output.	0.0	192



## Reset Shooting Options

Select **Yes** to reset the options in the shooting menu and other shooting settings to default values (☞ 158, 211).

## Exposure Mode

The options in the exposure mode menu offer varying degrees of control over shutter speed and aperture in Motion Snapshot mode (☞ 88), when an option other than **Time-lapse movie** is selected in advanced movie mode (☞ 49), and when **Active Selection** or **Slow view** is chosen in best moment capture mode (☞ 76).

 <b>Scene auto selector</b>	An automatic, “point-and-shoot” mode in which the camera not only chooses shutter speed and aperture but adjusts other settings to suit the subject (automatic scene selection; ☞ 39).
<b>P Programmed auto</b>	The camera sets shutter speed and aperture for optimal exposure (☞ 67). Recommended for snapshots and in other situations in which there is little time to adjust camera settings.
<b>S Shutter-priority auto</b>	You choose the shutter speed; the camera selects an aperture for best results (☞ 68). Use to freeze or blur motion.
<b>A Aperture-priority auto</b>	You choose the aperture; the camera selects a shutter speed for best results (☞ 69). Use to blur the background or bring both foreground and background into focus.
<b>M Manual</b>	You control both shutter speed and aperture (☞ 70). Set shutter speed to “Bulb” for long time-exposures.



## Image Quality

Choose a file format and compression ratio for photographs.



Option	File type	Description
NEF (RAW)	NEF	Compressed 12-bit raw data from the image sensor are saved directly to the memory card. White balance, contrast, and other settings can be adjusted on a computer after shooting.
JPEG fine	JPEG	Record JPEG images at a compression ratio of roughly 1 : 4 (fine quality).
JPEG normal		Record JPEG images at a compression ratio of roughly 1 : 8 (normal quality).
NEF (RAW)+ JPEG fine	NEF/ JPEG	Two images are recorded: one NEF (RAW) image and one fine-quality JPEG image.

## Image Size

Choose the size of photographs.

### ■ Standard Photographs

The following options are available in still image and Smart Photo Selector modes and when an option other than **Easy panorama** is selected in creative mode.

Option	Size (pixels)	Approximate print size at 300 dpi (cm/in.)*
 <b>5568×3712; 20.6 M</b>	5568 × 3712	47.1 × 31.4/18.5 × 12.4
 <b>4176×2784; 11.6 M</b>	4176 × 2784	35.4 × 23.6/13.9 × 9.3
 <b>2784×1856; 5.1 M</b>	2784 × 1856	23.6 × 15.7/9.3 × 6.2



\* Print size in inches equals image size in pixels divided by printer resolution in dots per inch (dpi; 1 inch=approximately 2.54 cm).





## ■ Panoramas

The following options are available when **Easy panorama** is selected in creative mode.

Option	Size (pixels) <sup>1</sup>	Approximate print size at 300 dpi (cm/in.) <sup>2</sup>
 <b>Normal panorama</b>	Camera panned horizontally: 4800 × 920	40.6 × 7.8/16.0 × 3.1
	Camera panned vertically: 1536 × 4800	13.0 × 40.6/5.1 × 16.0
 <b>Wide panorama</b>	Camera panned horizontally: 9600 × 920	81.3 × 7.8/32.0 × 3.1
	Camera panned vertically: 1536 × 9600	13.0 × 81.3/5.1 × 32.0

**1** Figures for horizontal and vertical panorama are reversed if camera is rotated 90 degrees.

**2** Print size in inches equals image size in pixels divided by printer resolution in dots per inch (dpi; 1 inch=approximately 2.54 cm).



### NEF (RAW)/NEF (RAW) + JPEG

The option selected for image size does not affect the size of NEF (RAW) images. NEF (RAW) images can be viewed on the camera or using software such as Capture NX-D.

When photographs taken at NEF (RAW) + JPEG are viewed on the camera, only the JPEG image will be displayed. When photographs taken at these settings are deleted, both NEF and JPEG images will be deleted.

### File Names

Photos and movies are stored as image files with names of the form “xxx\_nnnn.yyy,” where:

- xxx is either NMS (Motion Snapshots recorded with **NMS files** selected for **File format**;  92) or DSC (photos, MOV-format Motion Snapshots, and movies),
- nnnn a four-digit number between 0001 and 9999 assigned automatically in ascending order by the camera, and
- yyy one of the following three-letter extensions: “NEF” for NEF (RAW) images, “JPG” for JPEG images, or “MOV” for movies.

The NEF and JPEG files recorded at settings of NEF (RAW)+JPEG have the same file names but different extensions. Copies created with the retouch options in the playback menu have file names beginning with “CSC” (e.g., “CSC\_0001.JPG”). Images recorded with **Adobe RGB** selected for **Color space** ( 177) have names that begin with an underscore (e.g., “\_DSC0001.JPG”).





### Image Quality and Size

Together, image quality and size determine how much space each photograph occupies on the memory card. Larger, higher quality images can be printed at larger sizes but also require more memory, meaning that fewer such images can be stored on the memory card ( 213).



## Frame Size/Frame Rate

Choose a frame size and frame rate for movies recorded in auto, P, S, A, M, and sports modes and when **HD movie** is selected in advanced movie mode (📖 49).

Option	Frame size (pixels)	Recording rate	Bit rate (approx.)	Maximum length
 <b>1080/60p</b>	1920 × 1080	59.94 fps	42 Mbps	10 minutes
 <b>1080/30p</b>		29.97 fps	24 Mbps	17 minutes
 <b>720/60p</b>	1280 × 720	59.94 fps	16 Mbps	20 minutes
 <b>720/30p</b>		29.97 fps	12 Mbps	29 minutes

### Photo Frame Size

Photographs recorded by pressing the shutter-release button all the way down during movie recording are 5568 × 3712 pixels in size (aspect ratio 3 : 2).





### See Also

For information on the total length of movies that can be stored on the memory card, see page 213.



## Metering







Choose how the camera sets exposure.

 <b>Matrix</b>	The camera meters a wide area of the frame and adjusts for contrast (tone distribution), color, composition, and subject distance, producing natural results in most situations.
 <b>Center-weighted</b>	The camera meters the entire frame but assigns the greatest weight to the center area. This is the classic meter for portraits and is recommended if you are using filters with an exposure factor (filter factor) over 1×.
 <b>Spot</b>	The camera meters the current focus area; use to meter off-center subjects (if <b>Auto-area</b> is selected for <b>AF-area mode</b> as described on page 188, the camera will meter the center focus area, while during face priority the camera will meter the focus area closest to the center of the selected face;  40). Spot metering ensures that the subject will be correctly exposed, even when framed against a background that is much brighter or darker.



## White Balance

White balance ensures that colors are unaffected by the color of the light source. Auto white balance is recommended for most light sources, but other values can be selected if necessary according to the type of source.

<b>AUTO Auto</b>	Automatic white balance adjustment. Recommended in most situations.
 <b>Incandescent</b>	Use under incandescent lighting.
 <b>Fluorescent</b>	Use with cool-white fluorescent lighting.
 <b>Direct sunlight</b>	Use with subjects lit by direct sunlight.
 <b>Flash</b>	Use with built-in flash.
 <b>Cloudy</b>	Use in daylight under overcast skies.
 <b>Shade</b>	Use in daylight with subjects in the shade.
<b>PRE Preset manual</b>	Measure white balance (☞ 169).



## Fine-Tuning White Balance

Options other than **Preset manual** can be fine-tuned as follows:

### 1 Display fine-tuning options.

Highlight an option other than **Preset manual** and press  to display the fine-tuning options shown at right.

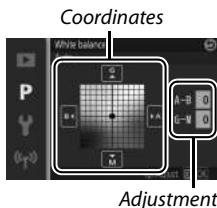

### 2 Fine-tune white balance.

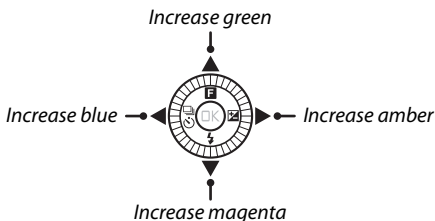

Use the multi selector to fine-tune white balance.



#### White Balance Fine Tuning

The colors on the fine-tuning axes are relative, not absolute. For example, moving the cursor to **B** (blue) when a “warm” setting such as  (incandescent) is selected will make photographs slightly “colder” but will not actually make them blue.

### 3 Save changes and exit.

Press . An asterisk will appear next to the white balance icon ( 4) in the detailed display ( 196) to show that white balance has been altered from default values.

## Preset Manual

---

Preset manual is used to record and recall custom white balance settings for shooting under mixed lighting or to compensate for light sources with a strong color cast.

---

### 1 Light a reference object.

Place a neutral gray or white object under the lighting that will be used in the final photograph. A standard gray panel can be used for increased precision.

---

### 2 Select Preset manual.

Highlight **Preset manual** in the white balance menu and press  $\odot$ . The dialog shown at right will be displayed; highlight **Yes** and press  $\odot$  to overwrite the existing value for preset manual white balance.

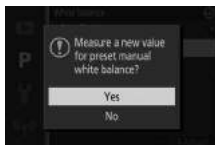

The message shown at right will be displayed.

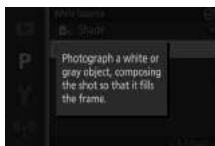

### 3 Measure white balance.

When the camera is ready to measure white balance, a flashing PRE will be displayed. Before the indicator stops flashing, frame the reference object so that it fills the display and press the shutter-release button all the way down. No photograph will be recorded; white balance can be measured accurately even when the camera is not in focus.

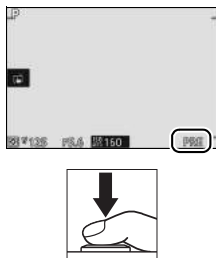

### 4 Check the results.

If the camera was able to measure a value for white balance, the message shown at right will be displayed. To return to shooting mode immediately, press the shutter-release button half-way.



If lighting is too dark or too bright, the camera may be unable to measure white balance. The message at right will be displayed. Return to Step 3 and measure white balance again.

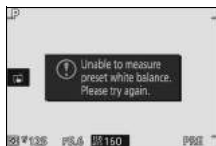



### ✔ Auto Power Off



White balance measurement will end without a new value being acquired if no operations are performed for the time selected for **Auto power off** in the setup menu (☞ 197; the default is 1 minute).

### ✔ Preset White Balance

The camera can store only one value for preset white balance at a time; the existing value will be replaced when a new value is measured. Note that exposure is automatically increased by 1 EV when measuring white balance; in mode **M**, adjust exposure so that the exposure indicator shows  $\pm 0$  (☞ 70).

### 🔍 Color Temperature

The perceived color of a light source varies with the viewer and other conditions. Color temperature is an objective measure of the color of a light source, defined with reference to the temperature to which an object would have to be heated to radiate light in the same wavelengths. While light sources with a color temperature in the neighborhood of 5000–5500 K appear white, light sources with a lower color temperature, such as incandescent light bulbs, appear slightly yellow or red. Light sources with a higher color temperature appear tinged with blue. The camera white balance options are adapted to the following color temperatures (all figures are approximate):

- Sodium-vapor lamps: **2700 K**
-  (incandescent)/  
Warm-white fluorescent: **3000 K**
- White fluorescent: **3700 K**
-  (cool-white fluorescent): **4200 K**
- Day white fluorescent: **5000 K**
-  (direct sunlight): **5200 K**
-  (flash): **5400 K**
-  (cloudy): **6000 K**
- Daylight fluorescent: **6500 K**
- Mercury-vapor lamps: **7200 K**
-  (shade): **8000 K**



## ISO Sensitivity

The camera's sensitivity to light can be adjusted according to the amount of light available. The higher the ISO sensitivity, the less light needed to make an exposure, allowing faster shutter speeds or smaller apertures.

<b>A6400 Auto (160–6400)</b> <b>A3200 Auto (160–3200)</b> <b>A800 Auto (160–800)</b>	The camera adjusts ISO sensitivity in response to lighting conditions. ISO sensitivity is adjusted in the range given in brackets; choose larger ranges for increased sensitivity when lighting is poor, smaller ranges to reduce noise (randomly-spaced bright pixels, fog, or lines).
<b>160, 200, 400, 800, 1600, 3200, 6400, 6400 (NR), 12800, 12800 (NR)</b>	ISO sensitivity is fixed at the selected value. If <b>6400 (NR)</b> or <b>12800 (NR)</b> is selected, the camera will take four shots each time the shutter-release button is pressed all the way down and combine them to create a single image processed to reduce the noise that occurs at high sensitivities.

### "Auto" ISO Sensitivity Options

When auto ISO sensitivity control is in effect, the display shows an **ISO AUTO** icon and the current ISO sensitivity.









### 6400 (NR)/12800 (NR)

The edges of the image will be cropped out and the built-in flash and Active D-Lighting can not be used. The desired results may not be achieved if the camera or subject moves during shooting. If **NEF (RAW)** or **NEF (RAW) + JPEG fine** is selected for image quality, the picture will be recorded as a fine-quality JPEG image. Only one shot will be taken if the shutter speed is slower than  $\frac{1}{30}$  s.

## Picture Control



Choose how the camera processes photographs.

 <b>SD Standard</b>	Standard processing for balanced results. Recommended in most situations.
 <b>NL Neutral</b>	Minimal processing for natural results. Choose for photographs that will later be extensively processed or retouched.
 <b>VI Vivid</b>	Pictures are enhanced for a vivid, photoprint effect. Choose for photographs that emphasize primary colors.
 <b>MC Monochrome</b>	Take monochrome photographs.
 <b>PT Portrait</b>	Process portraits for natural texture and a rounded feel.
 <b>LS Landscape</b>	Take vibrant photographs of landscapes and cityscapes.

### Modifying Picture Controls

Picture Controls can be modified to suit the scene or your creative intent.





#### 1 Display options.

Highlight an item in the Picture Control menu and press  to display Picture Control settings ( 175). To use an unmodified Picture Control, highlight it and press .



---

## 2 Adjust settings.

Press  or  to highlight the desired setting and press  or  to choose a value. Repeat this step until all settings have been adjusted, or select **Quick adjust** to choose a preset combination of settings. Default settings can be restored by pressing the  button.





---

## 3 Save changes and exit.

Press .

### Modified Picture Controls

Picture Controls that have been modified from default settings are indicated by an asterisk ("\*") in the Picture Control menu ( 173) and in the detailed display ( 196).

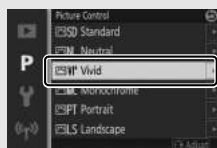

## Picture Control Settings



<b>Quick adjust</b>		Mute or exaggerate the effect of the selected Picture Control (note that this resets all manual adjustments). Not available with <b>Neutral</b> or <b>Monochrome</b> .
<b>Manual adjustments (all Picture Controls)</b>	<b>Sharpening</b>	Manually adjust the sharpness of outlines, or select <b>A</b> to adjust sharpness automatically.
	<b>Contrast</b>	Adjust contrast manually, or select <b>A</b> for automatic contrast adjustment.
	<b>Brightness</b>	Adjust brightness without affecting exposure.
<b>Manual adjustments (non-monochrome only)</b>	<b>Saturation</b>	Control the vividness of colors. Select <b>A</b> to adjust saturation automatically.
	<b>Hue</b>	Adjust hue.
<b>Manual adjustments (monochrome only)</b>	<b>Filter effects</b>	Simulate the effect of color filters on monochrome photographs.
	<b>Toning</b>	Choose the tint used in monochrome photographs.

### "A" (Auto)

Results for auto sharpening, contrast, and saturation vary with exposure and the size and position of the subject in the frame.



### Previous Settings

The line under the value displayed in the Picture Control setting menu indicates the previous value for the setting. Use this as a reference when adjusting settings.





### Filter Effects (Monochrome Only)

The options in this menu simulate the effect of color filters on monochrome photographs. The following filter effects are available:

<b>Y</b> (yellow)	Enhance contrast. Can be used to reduce the brightness of
<b>O</b> (orange)	the sky in landscape photographs. Orange produces more
<b>R</b> (red)	contrast than yellow, red more contrast than orange.
<b>G</b> (green)	Softens skin tones. Can be used for portraits.

Note that the effects achieved with **Filter effects** are more pronounced than those produced by physical glass filters.

### Toning (Monochrome Only)

Choose from **B&W** (black-and-white), **Sepia**, **Cyanotype** (blue-tinted monochrome), **Red**, **Yellow**, **Green**, **Blue Green**, **Blue**, **Purple**, **Blue**, **Red Purple**. Pressing  when **Toning** is highlighted displays saturation options. Press  or  to adjust saturation. Saturation control is not available when **B&W** (black-and-white) is selected.



## Auto Distortion Control

Enable or disable auto distortion control.

<b>On</b>	Reduce barrel distortion in pictures taken with wide-angle lenses and pin-cushion distortion in pictures taken with long lenses.
<b>Off</b>	Auto distortion control off.

Auto distortion control is available only with 1 NIKKOR lenses and not with NIKKOR lenses attached using the FT1 mount adapter (□ 202, 235). Results are not guaranteed with third-party lenses. Note that when auto distortion control is enabled, the edges of photographs may be cropped out and there may be an increase in the time needed to process images before they are saved.

## Color Space

The color space determines the gamut of colors available for color reproduction. Choose **sRGB** for general-purpose printing and display; **Adobe RGB**, with its broader gamut of colors, is more suited to shots destined for professional publication and commercial printing. Regardless of the option selected, movies are recorded in sRGB.

### Color Space

Capture NX-D automatically selects the correct color space when opening photographs created with this camera. Results can not be guaranteed with third-party software.

### Adobe RGB

For accurate color reproduction, Adobe RGB images require applications, displays, and printers that support color management.



## Active D-Lighting

Active D-Lighting preserves details in highlights and shadows for natural contrast. Use with high contrast scenes such as a brightly lit outdoor view framed in a door or window or a subjects in the shade on a sunny day. It is most effective when used with **Matrix** metering (☞ 166).



Active D-Lighting: **Off**



Active D-Lighting: **☑ On**

### ☑ Active D-Lighting

Noise (randomly-spaced bright pixels, fog, or lines) may appear in photographs taken with Active D-Lighting. Uneven shading may be visible with some subjects.

### ✎ “Active D-Lighting” Versus “D-Lighting”

The **Active D-Lighting** option in the shooting menu adjusts exposure before shooting to optimize the dynamic range, while the **D-Lighting** option in the playback menu (☞ 153) brightens shadows in images after shooting.





## Long Exposure NR

Select **On** to reduce “noise” (bright spots or fog) in photographs taken at shutter speeds slower than 1 s. The time required to record images increases by roughly 1.5 to 2 times. During processing, a warning will be displayed and pictures can not be taken (if the camera is turned off before processing is complete, the picture will be saved but noise reduction will not be performed). In continuous release mode, frame rates will slow and while photographs are being processed, the capacity of the memory buffer will drop. Long exposure noise reduction does not apply to movies.

## High ISO Noise Reduction

Select **On** to reduce “noise” (randomly-spaced bright pixels). If **Off** is selected, noise reduction will still be performed, but the amount is less than that performed when **On** is selected.



## Movie Sound Options

Adjust movie sound recording settings for the built-in microphone.

### ■ Microphone

Select **Microphone off** to disable sound recording. Selecting any other option enables recording and sets the microphone to the selected sensitivity.

#### The Icon

Movies recorded with the microphone off are indicated by a  icon in full-frame and movie playback.

### ■ Wind Noise Reduction

Select **On** to enable the low-cut filter, reducing noise produced by wind blowing over the microphone (note that other sounds may also be affected).

## Auto Image Capture

Choose whether the camera takes photos automatically while movies are being recorded in auto, creative, **P**, **S**, **A**, **M**, or sports mode or with **HD movie** selected in advanced movie mode. Photos will be taken when a suitably-framed portrait subject is in focus and the composition is stable. The maximum number of photos that can be taken during a single clip is 20, including photos taken manually ( 45).



<b>Auto photography</b>	The camera will take photos automatically during movie recording if <b>On</b> is selected.
<b>Max. shots per minute</b>	Choose the maximum number of shots per minute (one or four).

## Interval Timer Shooting







Take photographs automatically at preset intervals.

### ✓ Before Shooting

Before proceeding, check that the clock is set correctly (📖 30, 199) and then take a test shot at current settings and view the results in the monitor.



Use of a tripod is recommended. To ensure that shooting is not interrupted, be sure the battery is fully charged or use an optional AC adapter and power connector.

### 1 Choose the interval.

Highlight **Interval** and press  to view the interval. Press  or  to highlight minutes or seconds and press  or  to choose an interval longer than the slowest anticipated shutter speed. Press  to return to the interval timer shooting menu when settings are complete.



### 2 Choose the number of intervals.

Highlight **Number of shots** and press , then use the multi selector to choose the number of intervals. Press  to return to the interval timer shooting menu when settings are complete.



### 3 Start shooting.

Highlight **Start** and press  $\odot$ . Shooting will start after about 3 s, and continue at the selected interval until all the shots have been taken (one shot is taken at each interval). Note that the pause following the recording of each shot varies with shutter speed and the time needed to record the image, with the result that photographs may not be recorded at the selected interval.

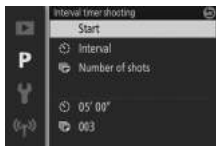

#### Interval Timer Photography

A warning will be displayed if the camera is unable to start interval timer photography at current settings (for example, when "Bulb" is selected for shutter speed). While interval timer photography is in progress, settings can not be adjusted and the camera will not turn off automatically (☐ 28).

#### Interrupting Interval Timer Photography

Interval timer shooting ends and interval timer settings are reset when the camera is turned off, the battery is exhausted, the memory card is full, the mode dial is rotated to a new setting or the MENU or  $\blacktriangleright$  button is pressed.



## Optical VR

Choose **On** to use optical vibration reduction with compatible 1 NIKKOR lenses.

### Vibration Reduction

When the camera is panned, vibration reduction applies only to motion that is not part of the pan (if the camera is panned horizontally, for example, vibration reduction will be applied only to vertical shake), making it much easier to pan the camera smoothly in a wide arc. The composition may appear to change after the shutter is released, but this does not indicate a malfunction.

### Optical VR

If the lens supports both normal and active vibration reduction, selecting **On** will enable active vibration reduction, reducing both the relatively mild camera shake that occurs when the photographer is stationary and the strong camera shake associated with shooting from a moving vehicle or while walking.

## Electronic VR (Movies)

Select **On** to enable electronic vibration reduction in Motion Snapshot mode (📖 88), when using the movie-record button, and when **HD movie** is selected in advanced movie mode (📖 49). This feature is available even if the attached 1 NIKKOR lens does not support vibration reduction. Note that there will be a slight delay before recording begins. The area recorded is shown by guides in the display; the appearance of the guides depends on the option selected for **Electronic VR (movies)**.

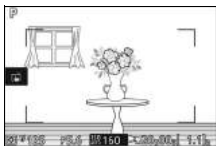

*Electronic vibration reduction on*

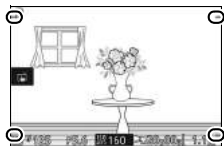

*Electronic vibration reduction off*



## Focus Mode

Choose how the camera focuses. The options available vary with the shooting mode.

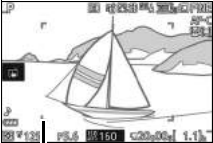
<b>AF-A</b>	<b>Auto-select AF:</b> The camera automatically selects AF-S if the subject is stationary, AF-C if it is moving.
<b>AF-S</b>	<b>Single AF:</b> For stationary subjects. Focus locks when the shutter-release button is pressed halfway.*
<b>AF-C</b>	<b>Continuous AF:</b> For subjects in motion. The camera focuses continuously on the subject in the AF-area brackets while the shutter-release button is pressed halfway (note that the AF-area brackets appear only in the detailed display; □ 196). Photos can be taken whether or not the camera is in focus. 
<b>AF-F</b>	<b>Full-time AF:</b> For subjects in motion. The camera focuses continuously; photos can be taken whether or not the camera is in focus.
<b>MF</b>	<b>Manual focus:</b> Focus manually (□ 186). Photos can be taken whether or not the camera is in focus.

\* Shutter can only be released if camera is able to focus.



## Getting Good Results with Autofocus

Autofocus does not perform well under the conditions listed below. The shutter release may be disabled if the camera is unable to focus under these conditions, or the focus area may be displayed in green and the camera may sound a beep, allowing the shutter to be released even when the subject is not in focus. In these cases, focus manually (📖 186) or use focus lock (📖 189) to focus on another subject at the same distance, and then recompose the photograph.

*There is little or no contrast between the subject and the background.*

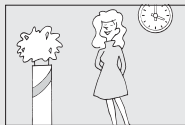

**Example:** The subject is the same color as the background.

*The subject contains areas of sharply contrasting brightness.*

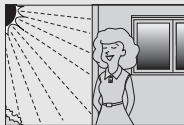

**Examples:** The subject is half in the shade; a night scene with point illumination.

*The subject contains objects at different distances from the camera.*



**Example:** The subject is inside a cage.

*Background objects appear larger than the subject.*

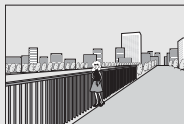

**Example:** A building is in the frame behind the subject.

*The subject is dominated by regular geometric patterns.*

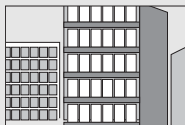

**Example:** Blinds or a row of windows in a skyscraper.

*The subject contains many fine details or is made up of objects that are small or lack variation in brightness.*

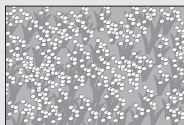

**Example:** A field of flowers.

## See Also

See page 197 for information on controlling the beep that sounds when the camera focuses.



## Manual Focus

Manual focus can be used when autofocus does not produce the desired results.

### 1 Select manual focus.

Highlight **Manual focus** in the focus mode menu (184) and press .

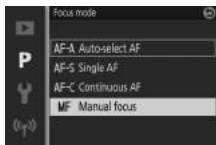

### 2 Display the manual focus guides.

In the shooting display, press  to display manual focus guides and magnify the view at the center of the frame. This feature is not available during movie recording or in 4K or slow-motion movie mode.



*Focus-distance indicator*

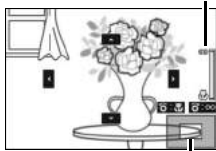

*Navigation window*

### 3 Choose a magnification.

Rotate the command dial to choose from magnifications of up to about 10 $\times$ .

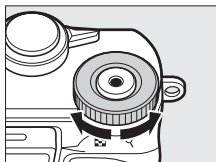

*Command dial*



## 4 Focus.

Rotate the multi selector until the subject is in focus. Rotate the multi selector clockwise to increase the focus distance, counterclockwise to decrease; the faster you rotate the multi selector, the quicker the focus distance changes. The focus indicator shows the approximate focus distance. Press  $\text{OK}$  when the subject is in focus.

Press  $\text{L}$ ,  $\text{R}$ ,  $\text{U}$ , or  $\text{D}$  to view areas of the frame not currently visible in the display; the visible portion is shown by the navigation window.



Focus indicator

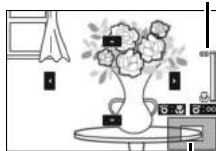

Navigation window

### Movies

The multi selector can also be used to choose the focus distance if manual focus is selected prior to movie recording. Rotate the multi selector clockwise to increase the focus distance, counterclockwise to decrease; the faster you rotate the multi selector, the quicker the focus distance changes.

### Focal Plane Position

To determine the distance between your subject and the camera, measure from the focal plane mark on the camera body. The distance between the lens mounting flange and the focal plane is approximately 17 mm (0.7 in.).

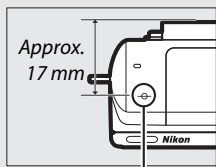









Focal plane mark

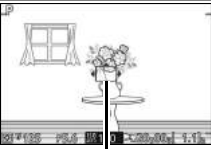

## AF-Area Mode

Choose how the focus area for autofocus is selected.

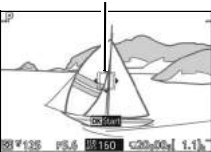
 <b>Auto-area</b>	The camera automatically detects the subject and selects the focus area.	
 <b>Single-point</b>	Press  to view the focus area selection display, then use the multi selector to position the focus area over your subject and press  ; the camera focuses on the subject in the selected focus area only. Use with stationary subjects.	 <p data-bbox="725 444 849 465"><i>Focus area</i></p>
 <b>Subject tracking</b>	Press  to view the focus area selection display, then use the multi selector to position the focus area over your subject and press  . The focus area will track the subject as it moves through the frame. The camera will focus on the selected subject when the shutter-release button is pressed halfway. To end focus tracking when shooting is complete, press  .	<p data-bbox="725 516 849 538"><i>Focus area</i></p> 



### Subject Tracking

The camera may be unable to track subjects if they move quickly, leave the frame or are obscured by other objects, change visibly in size, color, or brightness, or are too small, too large, too bright, too dark, or similar in color or brightness to the background.

## Focus Lock

When **Single AF** is selected for **Focus mode** (📖 184), focus lock can be used to change the composition after focusing on the subject in the center of the frame, allowing you to focus on a subject that will not be in the center of the final composition. If the camera is unable to focus using autofocus (📖 185), you can also focus on another subject at the same distance and then use focus lock to recompose the photograph. Focus lock is most effective when an option other than **Auto-area** is selected for **AF-area mode** (📖 188).

### 1 Lock focus.

Position the subject in the center of the frame and press the shutter-release button halfway to initiate focus. Check that the focus area is displayed in green. Focus will remain locked while the shutter-release button is pressed halfway.

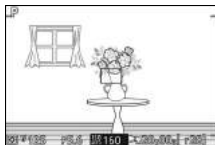

## 2 Recompose the photograph and shoot.

Focus will remain locked between shots.

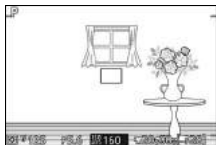

Do not change the distance between the camera and the subject while focus lock is in effect. If the subject moves, lift your finger from the shutter-release button to end focus lock and then focus again at the new distance.

### Auto Area AF

The camera selects from 41 focus areas. Except in manual focus mode, the selected focus area is displayed when the shutter-release button is pressed halfway.

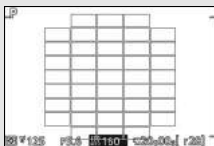

Large focus areas are used when:

- 4K movies are recorded with **AF-S** selected for focus mode
- Motion Snapshots are recorded with electronic vibration reduction enabled
- HD movies are recorded in advanced movie mode with electronic vibration reduction enabled and **AF-S** selected for focus mode

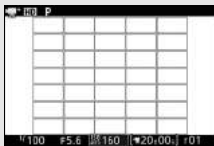

## Face-Priority

Choose **On** to enable face priority (📖 40).

## Built-in AF Assist

When **On** is selected, the built-in AF-assist illuminator will light to illuminate poorly-lit subjects if:

- **AF-S** is selected for focus mode (📖 184) or single AF is selected in **AF-A**, and
- **Auto-area** or **Single-point** is selected for **AF-area mode** (📖 188).

*AF-assist illuminator*



The AF-assist illuminator will not light to assist the focus operation in sports or advanced movie mode, during movie recording, or when **Off** is selected. If the AF-assist illuminator does not light, autofocus may not produce the desired results when lighting is poor.



### **The AF-Assist Illuminator**

Larger lenses may prevent the illuminator lighting all or part of the subject. Remove lens hoods when using the illuminator.



## Flash Control

Choose a flash control mode for the built-in flash.

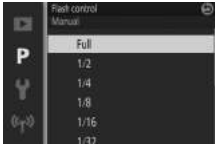
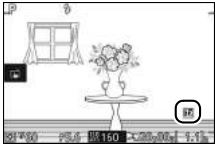
TTL  TTL	Flash output is adjusted automatically in response to shooting conditions (i-TTL flash control).
Manual  Manual	<p>Choose a flash level between <b>Full</b> and <b>1/32</b> (1/32 of full power). At full power, the built-in flash has a guide number of about 5/16 (m/ft, ISO 100, 20 °C/68 °F; at ISO 160, the guide number is about 6.3/20.7).</p> <p>A  icon flashes in the display during flash photography when this option is selected.</p>  

## Flash Compensation

Flash compensation alters flash output from the level suggested by the camera, changing the brightness of the main subject relative to the background. Choose from values between  $-3$  EV (darker) and  $+1$  EV (brighter) in increments of  $1/3$  EV; in general, positive values make the subject brighter while negative values make it darker.

A  icon is displayed when flash compensation is in effect. Normal flash output can be restored by setting flash compensation to  $\pm 0$ . Flash compensation is not reset when the camera is turned off.

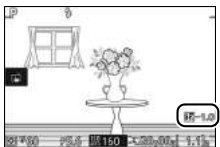
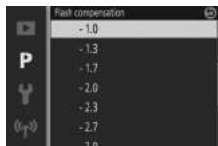



# The Setup Menu

To display the setup menu, press MENU and select **Setup**.



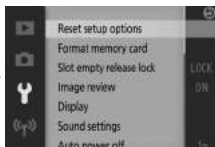
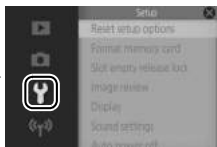

MENU button



The setup menu contains the following options:

Option	Description	Default	
<b>Reset setup options</b>	Reset setup menu options other than <b>Flicker reduction</b> , <b>Time zone and date</b> , and <b>Language</b> to default values.	—	—
<b>Format memory card</b>	Format the memory card.	—	195
<b>Slot empty release lock</b>	Allow the shutter to be released when no memory card is inserted in the camera.	Release locked	195
<b>Image review</b>	Choose whether pictures are displayed after shooting.	On	195
<b>Display</b>	Adjust display brightness, view or hide a framing grid, and choose the information displayed in the monitor.	<b>Display brightness:</b> 0 <b>Grid display:</b> Off <b>Shooting:</b> Simple <b>Playback:</b> Basic info	196



Option	Description	Default	
<b>Sound settings</b>	Choose the beeps made by the camera.	<b>AF:</b> On <b>Self-timer:</b> On <b>Shutter:</b> On <b>Touch-screen controls:</b> On	197
<b>Auto power off</b>	Choose the auto power off delay.	1 min	197
<b>Self-portrait mode</b>	Choose whether reversing the monitor causes the camera to enter self-portrait mode (  108).	On	197
<b>Touch-screen controls</b>	Enable or disable touch-screen controls.	Enable	—
<b>Assign Fn button</b>	Choose the role played by the <b>Fn</b> button.	ISO sensitivity	13
<b>Shutter button AE lock</b>	Choose whether exposure locks when the shutter-release button is pressed halfway.	Off	—
<b>Flicker reduction</b>	Reduce flicker or banding.	—	198
<b>Reset file numbering</b>	Reset file numbering.	—	198
<b>Time zone and date</b>	Set the camera clock.	<b>Daylight saving time:</b> Off	199
<b>Language</b>	Choose a language for the camera displays.	—	—
<b>Auto image rotation</b>	Record camera orientation with pictures.	On	200
<b>Pixel mapping</b>	Check and optimize the camera image sensor and image processors.	—	201
<b>Firmware version</b>	Display the current firmware version.	—	—





## Format Memory Card

Select **Yes** to format the memory card. *Note that this permanently deletes all data on the card, including protected images; before proceeding, be sure to copy important pictures and other data to a computer (📖 141).* To exit without formatting the memory card, highlight **No** and press **OK**.

The message shown at right is displayed while the card is formatted; *do not remove the memory card or remove or disconnect the power source until formatting is complete.*

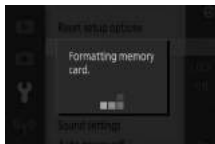

## Slot Empty Release Lock

If **Enable release** is selected, the shutter can be released when no memory card is inserted. No pictures will be recorded, although they will be displayed in demo mode. Select **Release locked** to enable the shutter only when a card is inserted.

## Image Review



If **On** is selected, pictures will be displayed immediately after shooting. To view pictures when **Off** is selected, press the **▶** button.



## Display

Adjust the following display options.

### Display Brightness

Press  or  to choose a value for monitor brightness. Choose higher values to brighten the display and lower values to make the display darker.



### Grid Display

Select **On** to display a framing grid (book 36).

### Shooting

Choose the information displayed during shooting (book 4).

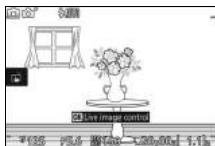

*Simple*

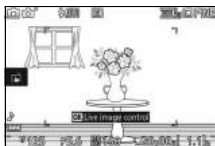

*Detailed*

### Playback

Choose the information displayed during playback (book 125).

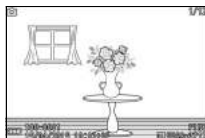

*Basic info*

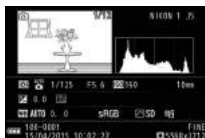

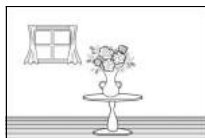

*Detailed info*



*Image only*

## Sound Settings

Highlight items and press  to select or deselect. Select **AF** to sound a beep when the camera focuses, **Self-timer** to sound a beep during self-timer photography, **Shutter** to sound a beep when the shutter is released, **Touch-screen controls** to sound a beep in response to use of the touch-screen controls, or remove the checks to mute these sounds. Press  to exit when settings are complete.

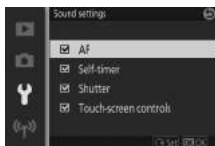

## Auto Power Off

Choose how long the display remains on when no operations are performed ( 28). Choose shorter delays to reduce the drain on the battery. Once the display has turned off, it can be reactivated by pressing the shutter-release button.

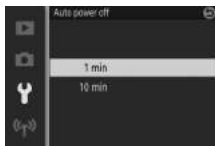

## Self-Portrait Mode

Choose whether reversing the monitor causes the camera to enter self-portrait mode ( 108). If **Off** is selected, the camera will not enter self-portrait mode when the monitor is reversed, and pictures will be taken in the mode selected with the mode dial. Regardless of the option selected, the display shows a mirror image of the view through the lens when the monitor is reversed.



## Flicker Reduction

Reduce flicker and banding in the display and in movies while shooting under fluorescent or mercury-vapor lighting. Choose a frequency which matches that of the local AC power supply.

### Flicker Reduction

If you are unsure as to the frequency of the local power supply, test both options and choose the one that produces the best results. Flicker reduction may not produce the desired results if the subject is very bright, in which case you should select mode **A** or **M** and choose a smaller aperture (higher f-number).

## Reset File Numbering

When a photograph is taken or a movie is recorded, the camera names the file by adding one to the number of the previous file (see 164). If the current folder is numbered 999 and contains either 999 photographs or a photograph numbered 9999, the shutter-release button will be disabled and no further photographs can be taken. To reset file numbering to 0001, select **Yes** for **Reset file numbering** and then either format the current memory card or insert a new memory card.



## Time Zone and Date

Change time zones, set the camera clock, choose the date display order, or turn daylight saving time on or off (📖 30).

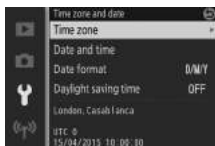

<b>Time zone</b>	Choose a time zone. The camera clock is automatically set to the time in the new time zone.
<b>Date and time</b>	Set the camera clock.
<b>Date format</b>	Choose the order in which the day, month, and year are displayed.
<b>Daylight saving time</b>	Turn daylight saving time on or off. The camera clock will automatically be advanced or set back one hour. The default setting is <b>Off</b> .



## Auto Image Rotation

Photographs taken while **On** is selected contain information on camera orientation, allowing them to be rotated automatically during playback or when displayed in ViewNX-i or Capture NX-D. The following orientations are recorded:

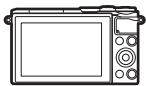

*Landscape (wide)  
orientation*

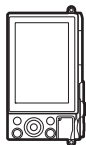

*Camera rotated 90°  
clockwise*

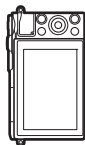

*Camera rotated 90°  
counterclockwise*

Camera orientation is not recorded when **Off** is selected. Choose this option when panning or taking photographs with the lens pointing up or down.

### Auto Image Rotation

Image orientation is not recorded for movies, Motion Snapshots, or panoramas.

### Rotate Tall

To automatically rotate “tall” (portrait-orientation) photographs for display during playback, select **On** for the **Rotate tall** option in the playback menu (📖 152).



## Pixel Mapping

Check and optimize the camera image sensor and image processors if you notice unexpected bright spots in your pictures (note that the camera comes with the sensor and processors already optimized). Before performing pixel mapping as described below, check that the battery is fully charged.

---

### 1 Attach a lens and lens cap.

Turn the camera off and attach a 1 NIKKOR lens. If the lens is equipped with a cap, do not remove it.

---

### 2 Select Pixel mapping.

Turn the camera on, press MENU, and select **Pixel mapping** in the setup menu.

---

### 3 Select Yes.

Pixel mapping begins immediately. Note that other operations can not be performed while pixel mapping is in progress. *Do not turn the camera off or remove or disconnect the power source until pixel mapping is complete.*

---

### 4 Turn the camera off.

Turn the camera off when pixel mapping is complete.



# Technical Notes

Read this chapter for information on compatible accessories, cleaning and storing the camera, and what to do if an error message is displayed or you encounter problems using the camera.

## Optional Accessories

At the time of writing, the following accessories were available for your camera.

<b>Lenses</b>	<b>1 mount lenses</b>
<b>Mount adapters</b>	<b>Mount Adapter FT1:</b> The FT1 allows NIKKOR F mount lenses to be used with Nikon 1 interchangeable lens format digital cameras. The angle of view of an F mount lens mounted on the FT1 is equivalent to that of a 35 mm format lens with a focal length about $2.7 \times$ longer. See page 235 for information on using the FT1; be sure to update to the latest version of the FT1 firmware before use. For information on attaching and removing the FT1 and on precautions for use, see the <i>FT1 Mount Adapter User's Manual</i> .
<b>Power sources</b>	<ul style="list-style-type: none"><li>• <b>Rechargeable Li-ion Battery EN-EL24</b> (□ 21–23): Additional EN-EL24 batteries are available from local retailers and Nikon-authorized service representatives.</li><li>• <b>Battery Charger MH-31</b> (□ 21): Recharge EN-EL24 batteries.</li><li>• <b>Power Connector EP-5F, AC Adapter EH-5b:</b> These accessories can be used to power the camera for extended periods (EH-5a and EH-5 AC adapters can also be used). An EP-5F power connector is required to connect the camera to the EH-5b, EH-5a, or EH-5; see page 204 for details.</li></ul>
<b>Body caps</b>	<b>Body Cap BF-N1000:</b> The body cap keeps the dust shield free of dust when a lens is not in place.





<b>Nikon software for digital cameras</b>	<ul style="list-style-type: none"> <li>• <b>Capture NX-D:</b> Fine-tune pictures taken with the camera and convert NEF (RAW) images to other formats.</li> <li>• <b>ViewNX-i:</b> Copy pictures to the computer for viewing.</li> </ul>
---	---

### **Optional Accessories**

Availability may vary with country or region. See our website or brochures for the latest information.

## **Approved Memory Cards**

The following cards have been tested and approved for use in the camera. Cards with class 6 or faster write speeds are recommended for movie recording. Recording may end unexpectedly when cards with slower write speeds are used.

	microSDHC cards <sup>1</sup>	microSDXC cards <sup>2</sup>
<b>SanDisk</b>	4 GB, 8 GB, 16 GB, 32 GB	64 GB, 128 GB
<b>Toshiba</b>		—
<b>Panasonic</b>		—
<b>Lexar Media</b>	8 GB, 16 GB, 32 GB	64 GB

**1** Check that any card readers or other devices with which the card will be used are SDHC-compliant. The camera supports UHS-I.

**2** Check that any card readers or other devices with which the card will be used are SDXC-compliant. The camera supports UHS-I.



Other cards have not been tested. For more details on the above cards, please contact the manufacturer.



## Attaching a Power Connector and AC Adapter

Turn the camera off before attaching an optional power connector and AC adapter.

### 1 Ready the camera.

Open the battery-chamber/memory card slot and power connector covers.

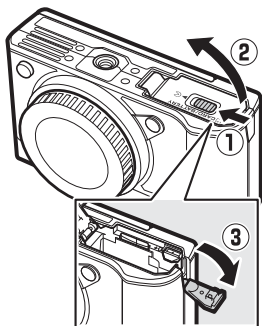

### 2 Insert the EP-5F power connector.

Be sure to insert the connector in the orientation shown, using the connector to keep the orange battery latch pressed to one side. The latch locks the connector in place when the connector is fully inserted.

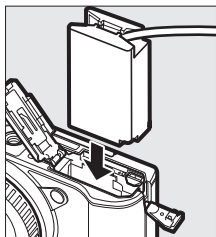

### 3 Close the battery-chamber/memory card slot cover.

Position the power connector cable so that it passes through the power connector slot and close the battery-chamber/memory card slot cover.

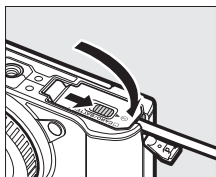

#### 4 Connect the AC adapter.

Connect the AC adapter power cable to the AC socket on AC adapter (①) and the EP-5F power cable to the DC socket (②). A  icon is displayed in the monitor when the camera is powered by the AC adapter and power connector.

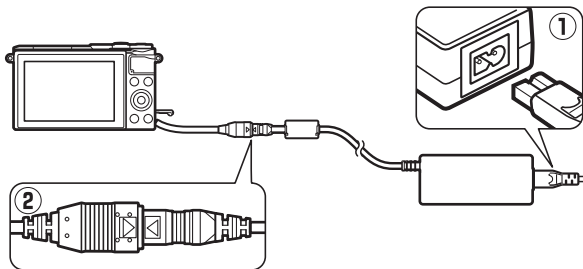

## Storage and Cleaning

### Storage

If the camera will not be used for an extended period, remove the battery and store it in a cool, dry area with the terminal cover in place. To prevent mold or mildew, store the camera in a dry, well-ventilated area. Do not store your camera with naphtha or camphor moth balls or in locations that:

- are poorly ventilated or subject to humidities of over 60%
- are next to equipment that produces strong electromagnetic fields, such as televisions or radios
- are exposed to temperatures above +50 °C (122 °F) or below -10 °C (14 °F)

### Cleaning

<b>Camera body</b>	Use a blower to remove dust and lint, then wipe gently with a soft, dry cloth. After using the camera at the beach or sea-side, wipe off sand or salt with a cloth lightly dampened in distilled water and dry thoroughly. <b>Important:</b> <i>Dust or other foreign matter inside the camera may cause damage not covered under warranty.</i>
<b>Lens</b>	Lenses are easily damaged. Remove dust and lint with a blower. If using an aerosol blower, keep the can vertical to prevent the discharge of liquid. To remove fingerprints and other stains, apply a small amount of lens cleaner to a soft cloth and clean with care.
<b>Monitor</b>	Remove dust and lint with a blower. When removing fingerprints and other stains, wipe the surface lightly with a soft cloth or chamois leather. Do not apply pressure, as this could result in damage or malfunction.
<b>Dust shield</b>	The dust shield is easily damaged. Remove dust and lint with a blower.

*Do not use alcohol, thinner, or other volatile chemicals.*



## Caring for the Camera and Battery: Cautions

**Do not drop:** The product may malfunction if subjected to strong shocks or vibration.

**Keep dry:** This product is not waterproof, and may malfunction if immersed in water or exposed to high levels of humidity. Rusting of the internal mechanism can cause irreparable damage.

**Avoid sudden changes in temperature:** Sudden changes in temperature, such as those that occur when entering or leaving a heated building on a cold day, can cause condensation inside the device. To prevent condensation, place the device in a carrying case or plastic bag before exposing it to sudden changes in temperature.

**Keep away from strong magnetic fields:** Do not use or store this device in the vicinity of equipment that generates strong electromagnetic radiation or magnetic fields. Strong static charges or the magnetic fields produced by equipment such as radio transmitters could interfere with the display, damage data stored on the memory card, or affect the product's internal circuitry.

**Keep the lens mount covered:** Be sure to attach the body cap if the camera is without a lens.

**Do not touch the dust shield:** The dust shield covering the image sensor is easily damaged. Under no circumstances should you exert pressure on the shield or poke it with cleaning tools. These actions could scratch or otherwise damage the shield.

**Turn the product off before removing or disconnecting the power source:** Do not unplug the product or remove the battery while the product is on or while images are being recorded or deleted. Forcibly cutting power in these circumstances could result in loss of data or in damage to product memory or internal circuitry. To prevent an accidental interruption of power, avoid carrying the product from one location to another while the AC adapter is connected.



**Cleaning:** When cleaning the camera body, use a blower to gently remove dust and lint, then wipe gently with a soft, dry cloth. After using the camera at the beach or seaside, wipe off any sand or salt using a cloth lightly dampened in pure water and then dry the camera thoroughly.

Lenses are easily damaged. Dust and lint should be gently removed with a blower. When using an aerosol blower, keep the can vertical to prevent discharge of liquid. To remove fingerprints and other stains from the lens, apply a small amount of lens cleaner to a clean, soft cloth and wipe the lens carefully.

**Storage:** To prevent mold or mildew, store the camera in a cool, dry, well-ventilated area. If you are using an AC adapter, unplug the adapter to prevent fire. If the product will not be used for an extended period, remove the battery to prevent leakage and store the camera in a plastic bag containing a desiccant. Do not, however, store the camera case in a plastic bag, as this may cause the material to deteriorate. Note that desiccant gradually loses its capacity to absorb moisture and should be replaced at regular intervals.

To prevent mold or mildew, take the camera out of storage at least once a month. Turn the camera on and release the shutter a few times before putting it away.

Store the battery in a cool, dry place. Replace the terminal cover before putting the battery away.

**Notes on the monitor:** The monitor is constructed with extremely high precision; at least 99.99% of pixels are effective, with no more than 0.01% being missing or defective. Hence while these displays may contain pixels that are always lit (white, red, blue, or green) or always off (black), this is not a malfunction and has no effect on images recorded with the device.



Images in the monitor may be difficult to see in a bright light.

Do not apply pressure to the display, as this could cause damage or malfunction. Dust or lint on the display can be removed with a blower. Stains can be removed by wiping lightly with a soft cloth or chamois leather. Should the monitor break, care should be taken to avoid injury from broken glass and to prevent liquid crystal from the display touching the skin or entering the eyes and mouth.

**Do not leave the lens pointed at the sun:** Do not leave the lens pointed at the sun or other strong light source for an extended period. Intense light may cause the image sensor to deteriorate or produce a white blur effect in photographs.

**Moiré:** Moiré is an interference pattern created by the interaction of an image containing a regular, repeating grid, such as the pattern of weave in cloth or windows in a building, with the camera image sensor grid. In some cases, it may appear in the form of lines. If you notice moiré in your photographs, try changing the distance to the subject, zooming in and out, or changing the angle between the subject and the camera.

**Lines:** Noise in the form of lines may in rare cases appear in pictures of extremely bright or backlit subjects.

**Batteries:** Batteries may leak or explode if improperly handled. Observe the following precautions when handling batteries:

- Use only batteries approved for use in this equipment.
- Do not expose the battery to flame or excessive heat.
- Keep the battery terminals clean.
- Turn the product off before replacing the battery.
- Remove the battery from the camera or charger when not in use and replace the terminal cover. These devices draw minute amounts of charge even when off and could draw the battery down to the point that it will no longer function. If the battery will not be used for some time, insert it in the camera and run it flat before removing it and storing it in a location with an ambient temperature of 15 °C to 25 °C (59 °F to 77 °F; avoid hot or extremely cold locations). Repeat this process at least once every six months.
- Turning the camera on and off repeatedly when the battery is fully discharged will shorten battery life. Batteries that have been fully discharged must be charged before use.
- The internal temperature of the battery may rise while the battery is in use. Attempting to charge the battery while the internal temperature is elevated will impair battery performance, and the battery may not charge or charge only partially. Wait for the battery to cool before charging.
- Continuing to charge the battery after it is fully charged can impair battery performance.



- A marked drop in the time a fully charged battery retains its charge when used at room temperature indicates that it requires replacement. Purchase a new EN-EL24 battery.
- Charge the battery before use. When taking photographs on important occasions, ready a spare EN-EL24 battery and keep it fully charged. Depending on your location, it may be difficult to purchase replacement batteries on short notice. Note that on cold days, the capacity of batteries tends to decrease. Be sure the battery is fully charged before taking photographs outside in cold weather. Keep a spare battery in a warm place and exchange the two as necessary. Once warmed, a cold battery may recover some of its charge.
- Used batteries are a valuable resource; recycle in accord with local regulations.

#### **Servicing the Camera and Accessories**

The camera is a precision device and requires regular servicing. Nikon recommends that the camera be inspected by the original retailer or Nikon-authorized service representative once every one to two years, and that it be serviced once every three to five years (note that fees apply to these services). Frequent inspection and servicing are particularly recommended if the camera is used professionally. Any accessories regularly used with the camera, such as lenses, should be included when the camera is inspected or serviced.





## Defaults

Defaults for the options in the playback, shooting and setup menus may be found on pages 149, 158, and 193, respectively. Defaults for the **F** (feature) menu are listed below.

Option	Default
Interval (☐ 52)	⌚ 5s
AE lock (☐ 53)	<b>AE-L (On)</b>
Slow motion (☐ 57)	400 fps
Hue (☐ 59)	<b>Retro: Yellow</b> <b>Cross process: Blue</b>
Filter strength (☐ 59, 60)	<b>Soft:</b> 0 N (normal) <b>Fisheye:</b> ☒ N (normal) <b>Skin softening:</b> +↑ (normal)
Portrait (☐ 59)	<b>ON</b>
Saturation (☐ 60)	⊕ N (normal)
Vignetting (☐ 60)	☐ N (normal)
Select color (☐ 66)	—
On release, record (☐ 79)	Preceding and following
Capture 20 frames over (☐ 79)	1 s
Frames saved (default) (☐ 78)	↓ 1
Number of shots saved (☐ 84)	↓ 5
Movie before/after (☐ 91)	1.0 s : 0.6 s
File format (☐ 92)	NMS files
Audio (☐ 92)	Background music



Defaults for other settings are as follows:

Option	Default
Focus area (☞ 188)	Center*
Flexible program (☞ 67)	Off
Focus lock (☞ 189)	Off
Continuous/self-timer (☞ 97, 99)	<b>Sports:</b> 10 fps <b>Other modes:</b> [S] (single frame)
Exposure compensation (☞ 101)	0.0
Flash mode (☞ 103, 105)	<b>Auto, Pop, Retro, High-contrast monochrome, Nostalgic sepia, Soft, Cross process, Toy camera effect, Fisheye, Close-up:</b> Auto <b>P, S, A, M:</b> Fill flash <b>Miniature effect, Selective color, Cross screen:</b> Flash off <b>Skin softening, Night portrait, Portrait, Self-portrait:</b> Auto + red-eye reduction
Picture Control settings (☞ 175)	Unmodified

\* Not displayed when **Auto-area** is selected for **AF-area mode**.



## Memory Card Capacity

The following table shows the number of pictures or amount of movie footage that can be stored on a 16 GB SanDisk SDSDQXP-016G-J35A UHS-I microSDHC card at different image quality, size, or movie settings. All figures are approximate; file size varies with the type of card and scene recorded.

### ■ ■ Photographs

Image quality (□ 162)	Image size (□ 162)	File size	No. of images
NEF (RAW) + JPEG fine*	5568 × 3712	41.3 MB	367
	4176 × 2784	35.7 MB	424
	2784 × 1856	31.7 MB	478
NEF (RAW)	—	27.9 MB	544
JPEG fine	5568 × 3712	13.4 MB	1100
	4176 × 2784	7.8 MB	1900
	2784 × 1856	3.8 MB	3900
JPEG normal	5568 × 3712	7.0 MB	2100
	4176 × 2784	4.2 MB	3500
	2784 × 1856	2.2 MB	6800

\* Image size applies to JPEG images only. Size of NEF (RAW) images can not be changed. File size is the total for NEF (RAW) and JPEG images.

### ■ ■ HD Movies

Frame size/frame rate (□ 165) <sup>1</sup>	Maximum total length <sup>2</sup>
1080/60p	35 minutes
1080/30p	1 hour
720/60p	1 hour 30 minutes
720/30p	2 hours

**1** Time-lapse, fast-motion, jump-cut, and 4-second movies are recorded at 1080/30p.

**2** For information on the maximum length that can be recorded in a single clip, see page 165.

### ■ ■ 4K Movies

Maximum total length
35 minutes



## Troubleshooting

If the camera fails to function as expected, check this list of common problems before consulting your retailer or Nikon representative.

### **Battery/Display**

---

**The camera is on but does not respond:** Wait for recording or any other processing to end. If the problem persists, turn the camera off. If the camera still does not respond, remove and replace the battery or disconnect and reconnect the AC adapter, but note that this will delete any data not yet saved. Data already saved to the memory card are unaffected.

---

**The display is off:**

- The camera is off (☐ 28) or the battery is exhausted (☐ 21, 32).
  - The display has turned off automatically to save power (☐ 197). The display can be reactivated by pressing the shutter-release button.
  - The camera is connected to a computer (☐ 141) or television (☐ 144).
- 

**The camera turns off without warning:**

- The battery is low (☐ 21, 32).
  - The display has turned off automatically to save power (☐ 197). The display can be reactivated by pressing the shutter-release button.
  - The camera's internal temperature is high (☐ xv, 221). Wait for the camera to cool before turning it on again.
- 

**Indicators are not displayed:** Use the **Display > Shooting** and **Display > Playback** options in the setup menu to choose the information displayed (☐ 196).



## Shooting (All Modes)

---

**The camera takes time to turn on:** Delete files or format the memory card.

---

**The shutter-release is disabled:**

- The battery is exhausted (☐ 21, 32).
  - The memory card is full (☐ 32).
  - The flash is charging (☐ 106).
  - The camera is not in focus (☐ 34).
  - You are currently filming a slow-motion, 4K, or time-lapse movie (☐ 45).
- 

**Only one picture is taken each time the shutter-release button is pressed in continuous release mode:**  is selected in continuous mode (☐ 97) and the built-in flash is raised.

---

**The camera does not focus automatically:**

- The subject is not suited to autofocus (☐ 185).
  - The camera is in manual focus mode (☐ 184, 186).
- 

**Focus does not lock when the shutter-release button is pressed halfway:** Set the focus mode to **AF-S** (☐ 184, 189).

---

**Focus area selection is unavailable:** Focus area selection is not available in auto-area AF (☐ 188) or face priority (☐ 40). In other AF-area modes, the focus area can be selected by pressing .

---

**AF-area mode selection is unavailable:** The camera is in auto, creative, sports, or best moment capture mode (☐ 33, 58, 74, 76), manual focus mode is selected (☐ 184), the  **Scene auto selector** is used (☐ 161), or electronic vibration reduction is enabled for movies (☐ 183).

---

**Image size selection is unavailable:** **NEF (RAW)** is selected for image quality (☐ 162).

---

**The camera is slow to record photos:** Turn long exposure noise reduction off (☐ 179) and choose an option for ISO sensitivity (☐ 172) other than **6400 (NR)** and **12800 (NR)**. In creative mode, additional time may be needed to record photos when **HDR** or **Easy panorama** is selected (☐ 62, 63).

---



---

**Noise (bright spots, randomly-spaced bright pixels, fog, or lines) appears in photos:**

- Bright spots, randomly-spaced bright pixels, fog, and lines can be reduced by lowering ISO sensitivity. Randomly-spaced bright pixels at high ISO sensitivities can be reduced by enabling high ISO noise reduction (□ 179).
- Use the **Long exposure NR** option in the shooting menu to limit the occurrence of bright spots or fog in photos taken at shutter speeds slower than 1 s (□ 179).
- Fog and bright spots may indicate that the camera's internal temperature has become elevated due to high ambient temperatures, long exposures, or similar causes: turn the camera off and wait for it to cool before resuming shooting.

---

**Smudges appear in photographs:** Clean the front and rear lens elements or the dust shield (□ 206).

---

**Flicker or banding appears in movies or in the display:** Choose a **Flicker reduction** setting that matches the local AC power supply (□ 198).

---

**No flash:** See page 107. The flash will not fire when off (□ 103); in **P, S, A, M**, and self-portrait modes, the flash will not fire when lowered.

---

**Menu items are grayed out and unavailable:** Some options are only available in particular shooting or exposure modes.

## ***Shooting (P, S, A, and M Modes)***

---

**The shutter release is disabled:** You selected mode **S** after choosing a shutter speed of "Bulb" in mode **M** (□ 70). Choose a different shutter speed.

---

**Some shutter speeds are not available:** You are using the flash.

---

**Colors are unnatural:**

- Adjust white balance to match the light source (□ 167).
- Adjust Picture Control settings (□ 173).

---

**Cannot measure white balance:** The subject is too dark or too bright (□ 170).

---

**Picture Controls produce varying results:** **A** (auto) is selected for sharpening, contrast, or saturation. For consistent results over a series of photos, choose another setting (□ 175).

---

**Noise (reddish areas and other artifacts) appears in long time-exposures:** Enable long exposure noise reduction (□ 179).



## Movies

---

**Cannot record movies:** The movie-record button can not be used to record movies in best moment capture or Motion Snapshot mode (☐ 80, 90).

**No sound is recorded for movies:**

- **Microphone off** is selected for **Movie sound options > Microphone** (☐ 180).
- Live audio is not recorded with time-lapse, slow-motion, fast-motion, or jump-cut movies (☐ 49) or with Motion Snapshots recorded with **None** selected for **Audio** (☐ 92).

**Large focus areas are used in auto-area AF AF-area mode:**

- 4K movies are recorded with **AF-S** selected for focus mode
- Motion Snapshots are recorded with electronic vibration reduction enabled
- HD movies are recorded in advanced movie mode with electronic vibration reduction enabled and **AF-S** selected for focus mode

## Tap Shooting Options

---

**The touch screen can not be used for shooting or focus:**

- Touch shooting options are not available in best moment capture or Motion Snapshot mode.
- The edges of the display can not be used for shooting or focus. Tap closer to the center of the display.

**Pictures are blurred:** The camera may move when the display is tapped, which may under some conditions result in blurred pictures. Use both hands to hold the camera steady.

## Playback

---

**NEF (RAW) images are not displayed:** The camera displays only the JPEG copies of NEF (RAW) + JPEG fine images (☐ 164).

**“Tall” (portrait) orientation photos are displayed in “wide” (landscape) orientation:**

- Select **On** for **Rotate tall** (☐ 152).
- The photos were taken with **Auto image rotation** off (☐ 200).
- Camera was pointed up or down when the photo was taken (☐ 200).
- Photo is displayed in image review (☐ 152).



---

**Cannot hear movie sound:**

- Rotate the command dial right to raise the volume (☐ 46). If the camera is connected to a television (☐ 144), use the controls for the TV to adjust the volume.
- Live audio is not recorded with time-lapse, slow-motion, fast-motion, or jump-cut movies (☐ 49) or with Motion Snapshots recorded with **None** selected for **Audio** (☐ 92).

---

**Cannot delete images:** Remove protection from the files before deletion (☐ 152).

---

**Cannot print NEF (RAW) photos:** Transfer the pictures to a computer and print them in Capture NX-D or ViewNX-i (☐ 140).

---

**Pictures are not displayed on TV:** The camera is not correctly connected (☐ 144).

---

**Pictures cannot be transferred to a computer:** If your system does not meet the requirements for Nikon software, you may still be able to transfer pictures to the computer using a card reader.

---

**Computer displays NEF (RAW) images differently from camera:** Third-party software does not display effects of Picture Controls or Active D-Lighting. Use Capture NX-D (☐ 140).

---

***Wi-Fi (Wireless Networks)***

---

**Smart devices do not display the camera SSID (network name):**

- Confirm that camera Wi-Fi is enabled (☐ 118).
- Try turning the smart device Wi-Fi off and then on again.

---

**Can not connect to smart devices using NFC (☐ 119):** Connect using the camera SSID (☐ 120).

---

***Miscellaneous***

---

**The date of recording is not correct:** Set the camera clock (☐ 30, 199).

---

**Menu items are grayed out and unavailable:** Some options are only available at particular settings or when a memory card is inserted (☐ 23).



## Error Messages

This section lists the error messages that appear in the display.

Message	Solution	
(Shutter-speed or aperture display flashes)	If the subject is too bright, lower ISO sensitivity or choose a faster shutter speed or smaller aperture (higher f-number).	68, 69, 70, 172
	If the subject is too dark, raise ISO sensitivity, use the flash, or choose a slower shutter speed or larger aperture (lower f-number).	68, 69, 70, 102, 172
Keeping the zoom ring button pressed, rotate the zoom ring to extend the lens.	A lens with a retractable lens barrel button is attached with the lens barrel retracted. Keeping the retractable lens barrel button pressed, rotate the zoom ring to extend the lens.	27, 231, 232
Check lens. Pictures can only be taken when a lens is attached.	Attach a lens.	26
Lens error. Try again after turning the camera off and on.	Turn the camera off and then on again. If the problem persists or reoccurs frequently, contact a Nikon-authorized service representative.	28
Cannot take pictures. Insert fully-charged battery.	Turn the camera off and recharge the battery or insert a fully charged spare battery.	21, 23
The clock has been reset.	Set the camera clock.	30, 199
No memory card.	Turn the camera off and confirm that the card is correctly inserted.	23



Message	Solution	
This memory card cannot be used. Card may be damaged; insert a different card.	<ul style="list-style-type: none"> <li>• Use an approved card.</li> <li>• Format the card. If the problem persists, the card may be damaged. Contact a Nikon-authorized service representative.</li> <li>• Insert a new memory card.</li> </ul>	203 195  23, 203
This memory card is not formatted. Format the memory card?	Select <b>Yes</b> to format the card, or turn the camera off and insert another memory card.	23, 195
Memory card is full.	<ul style="list-style-type: none"> <li>• You may be able to record additional images if you reduce image quality or size.</li> <li>• Delete unwanted images.</li> <li>• Insert another memory card.</li> </ul>	162  134 23, 203
Cannot create additional folders on memory card.	If the current folder is numbered 999 and contains either 999 photographs or a photograph numbered 9999, the shutter-release button will be disabled and no further photographs can be taken. Choose <b>Yes</b> for <b>Reset file numbering</b> and then either format the current memory card or insert a new memory card.	198
The movie-record button cannot be used in this mode.	The movie-record button can not be used in best moment capture or Motion Snapshot modes.	80, 90
Photographs cannot be recorded in this mode.	The shutter-release button can not be used to take photographs while a slow-motion, 4K, or time-lapse movie is being recorded.	45
Photographs cannot be taken in shutter-priority auto mode at a shutter speed of "Bulb".	Choose a different shutter speed, or select mode <b>M</b> .	68, 70



Message	Solution	
Cannot shoot panorama with lens of this focal length.	Use a lens with a focal length of 6 to 30 mm to shoot panoramas. If you are using a zoom lens, choose a focal length between 6 and 30 mm.	63
Failed to update lens firmware. Try again after turning the camera off and on.	Turn the camera off and then on again and reattempt the update. If the problem persists or reoccurs frequently, contact a Nikon-authorized service representative.	—
An error has occurred in the internal circuitry. Try again after turning the camera off and on.	Turn the camera off and then on again. If the problem persists or reoccurs frequently, contact a Nikon-authorized service representative.	—
The camera's internal temperature is high. The camera will now turn off.	Wait for the camera to cool.	xv
Memory card contains no images.	To view pictures, insert a memory card containing images.	23
Cannot display this file.	The file has been created or modified on a computer or different make of camera, or is corrupt.	—
Check printer.	Check the printer.	—*
Check paper.	Select <b>Resume</b> after loading paper of the correct size.	—*
Paper jam.	Clear the jam and select <b>Resume</b> .	—*
Out of paper.	Insert paper and select <b>Resume</b> .	—*
Check ink supply.	Select <b>Resume</b> after checking the ink.	—*
Out of ink.	Replace the ink and select <b>Resume</b> .	—*

\*See the printer manual for more information.



## Specifications

### Nikon 1 J5 Digital Camera

Type		
Type	Digital camera with support for interchangeable lenses	
Lens mount	Nikon 1 mount	
Effective angle of view	Approx. 2.7× lens focal length (35 mm format equivalent)	
Effective pixels	20.8 million	
Image sensor		
Image sensor	13.2 mm × 8.8 mm CMOS sensor (Nikon CX format)	
Total pixels	23.01 million	
Storage		
Image size (pixels)	<b>Still images taken in auto, P, S, A, M, sports, best moment capture, and all creative modes other than easy panorama (aspect ratio 3 : 2)</b>	
	• 5568 × 3712	• 4176 × 2784
	• 2784 × 1856	
	<b>Still images taken in normal panorama mode with camera panned horizontally (aspect ratio 120 : 23)</b>	
	4800 × 920	
	<b>Still images taken in normal panorama mode with camera panned vertically (aspect ratio 8 : 25)</b>	
	1536 × 4800	
	<b>Still images taken in wide panorama mode with camera panned horizontally (aspect ratio 240 : 23)</b>	
	9600 × 920	
	<b>Still images taken in wide panorama mode with camera panned vertically (aspect ratio 4 : 25)</b>	
1536 × 9600		
<b>Still images taken during movie recording (aspect ratio 3 : 2)</b>		
5568 × 3712		
<b>Motion Snapshots (photo portion, aspect ratio 16 : 9)</b>		
5568 × 3136		



Storage	
<b>File format</b>	<ul style="list-style-type: none"> <li>• <b>NEF (RAW)</b>: 12-bit, compressed</li> <li>• <b>JPEG</b>: JPEG-Baseline compliant with fine (approx. 1 : 4), normal (approx. 1 : 8) compression</li> <li>• <b>NEF (RAW) + JPEG</b>: Single photograph recorded in both NEF (RAW) and JPEG formats</li> </ul>
<b>Picture Control system</b>	Standard, Neutral, Vivid, Monochrome, Portrait, Landscape; selected Picture Control can be modified
<b>Media</b>	microSD (micro Secure Digital), microSDHC, and microSDXC memory cards
<b>File system</b>	DCF 2.0, Exif 2.3, PictBridge
Shooting modes	
	auto;  sports;  creative, with a choice of the following options: <b>POP</b> pop, <b>RETRO</b> retro,  high-contrast monochrome, <b>SEPIA</b> nostalgic sepia, <b>HDR</b> HDR,  easy panorama,  soft,  miniature effect,  selective color,  cross process,  toy camera effect,  cross screen,  fisheye,  skin softening,  night landscape,  night portrait,  landscape,  close-up, and  portrait; <b>P</b> programmed auto with flexible program, <b>S</b> shutter-priority auto, <b>A</b> aperture-priority auto, and <b>M</b> manual;  best moment capture ( Active Selection,  slow view and  Smart Photo Selector);  advanced movie ( <b>HD</b> HD movie, <b>4K</b> 4K movie,  time-lapse movie,  slow motion,  jump cut,  fast motion and  4-second movie);  Motion Snapshot;  self-portrait
Shutter	
<b>Type</b>	Electronic shutter
<b>Speed</b>	$\frac{1}{16,000}$ –30 s in steps of $\frac{1}{3}$ EV; Bulb <b>Note:</b> Bulb ends automatically after approximately 2 minutes
<b>Flash sync speed</b>	Synchronizes with shutter at $X=\frac{1}{60}$ s or slower



Release	
<b>Mode</b>	<ul style="list-style-type: none"> <li>• Single frame, continuous</li> <li>• Self-timer</li> <li>• Interval timer shooting</li> </ul>
<b>Frame advance rate</b>	Approx. 5, 10, 20, 30, or 60 fps
<b>Self-timer</b>	2 s, 10 s
Exposure	
<b>Metering</b>	TTL metering using image sensor
<b>Metering method</b>	<ul style="list-style-type: none"> <li>• <b>Matrix</b></li> <li>• <b>Center-weighted:</b> Meters 4.5 mm circle in center of frame</li> <li>• <b>Spot:</b> Meters 2 mm circle centered on selected focus area</li> </ul>
<b>Mode</b>	<b>P</b> programmed auto with flexible program; <b>S</b> shutter-priority auto; <b>A</b> aperture-priority auto; <b>M</b> manual;  scene auto selector
<b>Exposure compensation</b>	-3–+3 EV in increments of 1/3 EV
<b>Exposure lock</b>	Luminosity locked at metered value when shutter-release button is pressed halfway
<b>ISO sensitivity (Recommended Exposure Index)</b>	ISO 160; ISO 200–12800 in steps of 1 EV; 6400 (NR); 12800 (NR); auto ISO sensitivity control (ISO 160–6400, 160–3200, 160–800) available (user controlled in exposure modes <b>P</b> , <b>S</b> , <b>A</b> , and <b>M</b> )
<b>Active D-Lighting</b>	On, off



Focus	
<b>Autofocus</b>	Hybrid autofocus (phase-detection/contrast-detect AF); AF-assist illuminator
<b>Lens servo</b>	<ul style="list-style-type: none"> <li>• <b>Autofocus (AF):</b> Single AF (AF-S); continuous AF (AF-C); auto AF-S/AF-C selection (AF-A); full-time AF (AF-F)</li> <li>• <b>Manual focus (MF)</b></li> </ul>
<b>AF-area mode</b>	Single-point, auto-area, subject tracking
<b>Focus area</b>	<ul style="list-style-type: none"> <li>• <b>Single-point AF:</b> 171 focus areas; the center 105 areas support phase-detection AF</li> <li>• <b>Auto-area AF:</b> 41 focus areas</li> </ul>
<b>Focus lock</b>	Focus can be locked by pressing shutter-release button halfway (single AF)
<b>Face priority</b>	On, off
Flash	
<b>Built-in flash</b>	<ul style="list-style-type: none"> <li>• <b>Auto and all creative modes other than HDR, easy panorama, landscape, and night landscape:</b> Flash pops up automatically and fires as required</li> <li>• <b>P, S, A, M, and self-portrait:</b> Manual</li> </ul>
<b>Guide Number (GN)</b>	Approx. 5/16 (m/ft, ISO 100, 20 °C/68 °F; at ISO 160, Guide Number is approx. 6.3/20.7)
<b>Control</b>	i-TTL flash control using image sensor
<b>Mode</b>	Auto, auto + red-eye reduction, fill flash, fill flash + slow sync, red-eye reduction, red-eye reduction + slow sync, rear-curtain sync, rear curtain + slow sync, off
<b>Flash compensation</b>	-3 – +1 EV in increments of 1/3 EV
<b>Flash-ready indicator</b>	Lights when built-in flash unit is fully charged
<b>White balance</b>	Auto, incandescent, fluorescent, direct sunlight, flash, cloudy, shade, preset manual, all except preset manual with fine tuning



<b>Movie</b>	
<b>Metering</b>	TTL metering using image sensor
<b>Metering method</b>	<ul style="list-style-type: none"> <li>• <b>Matrix</b></li> <li>• <b>Center-weighted:</b> Meters 4.5 mm circle in center of frame</li> <li>• <b>Spot:</b> Meters 2 mm circle centered on selected focus area</li> </ul>
<b>Frame size (pixels)/ recording rate</b>	<b>HD movies (aspect ratio 16 : 9)</b>
	<ul style="list-style-type: none"> <li>• 1920 × 1080/60p (59.94 fps)</li> <li>• 1920 × 1080/30p (29.97 fps)</li> <li>• 1280 × 720/60p (59.94 fps)</li> <li>• 1280 × 720/30p (29.97 fps)</li> </ul>
	<b>4K movies (aspect ratio 16 : 9)</b>
	3840 × 2160/15p (14.99 fps)
	<b>Slow-motion movies</b>
	<ul style="list-style-type: none"> <li>• 1280 × 720/120 fps (aspect ratio 16 : 9; plays at 30p/29.97 fps)</li> <li>• 800 × 296/400 fps (aspect ratio 8 : 3; plays at 30p/29.97 fps)</li> <li>• 400 × 144/1200 fps (aspect ratio 8 : 3; plays at 30p/29.97 fps)</li> </ul>
	<b>Time-lapse, fast-motion, jump-cut, and 4-second movies (aspect ratio 16 : 9)</b>
1920 × 1080/30p (29.97 fps)	
<b>File format</b>	<b>Motion Snapshots (movie portion, aspect ratio 16 : 9)</b>
	1920 × 1080/60p (59.94 fps) (plays at 24p/ 23.976 fps)
<b>Video compression</b>	MOV
<b>Audio recording format</b>	H.264/MPEG-4 Advanced Video Coding
<b>Audio recording device</b>	PCM
<b>Monitor</b>	Built-in stereo microphone; sensitivity adjustable
	7.5 cm (3-in.), approx. 1037k-dot, tilting TFT LCD touch screen with brightness adjustment





<b>Playback</b>	Full-frame and thumbnail (4, 9, or 16 images or calendar) playback with playback zoom, bursts shown as key frames or as consecutive pictures, movie and panorama playback, slide show, histogram display, and auto image rotation
<b>Interface</b>	
<b>USB</b>	Hi-Speed USB
<b>HDMI output</b>	Type D HDMI connector
<b>Wireless</b>	
<b>Standards</b>	IEEE 802.11b, IEEE 802.11g
<b>Operating frequency</b>	2412–2462 MHz (channels 1–11)
<b>Range (line of sight)</b>	Approximately 10 m/33 ft (assumes no interference; range may vary with signal strength and presence or absence of obstacles)
<b>Data rate</b>	54 Mbps Maximum logical data rates according to IEEE standard. Actual rates may differ.
<b>Authentication</b>	Open system, WPA2-PSK
<b>Access protocols</b>	Infrastructure
<b>NFC</b>	
<b>Operation</b>	NFC Forum Type 3 Tag
<b>Supported languages</b>	Arabic, Bulgarian, Chinese (Simplified and Traditional), Czech, Danish, Dutch, English, Finnish, French, German, Greek, Hindi, Hungarian, Indonesian, Italian, Japanese, Korean, Norwegian, Persian, Polish, Portuguese (European and Brazilian), Romanian, Russian, Serbian, Spanish, Swedish, Thai, Turkish, Ukrainian, Vietnamese
<b>Power source</b>	
<b>Battery</b>	One rechargeable Li-ion EN-EL24 battery
<b>AC adapter</b>	EH-5b AC adapter; requires EP-5F power connector (available separately)
<b>Tripod socket</b>	1/4-in. (ISO 1222)



<b>Dimensions/weight</b>	
<b>Dimensions (W × H × D)</b>	Approx. 98.3 × 59.7 × 31.5 mm (3.9 × 2.4 × 1.3 in.), excluding projections
<b>Weight</b>	Approx. 265 g (9.4 oz) with battery and memory card but without body cap; approx. 231 g (8.2 oz), camera body only

<b>Operating environment</b>	
<b>Temperature</b>	0 °C–40 °C (+32 °F–104 °F)
<b>Humidity</b>	85% or less (no condensation)

- Unless otherwise stated, all measurements are performed in conformity with Camera and Imaging Products Association (CIPA) guidelines.
- All figures are for a camera with a fully-charged battery.
- Nikon reserves the right to change the specifications of the hardware and software described in this manual at any time and without prior notice. Nikon will not be held liable for damages that may result from any mistakes that this manual may contain.

<b>MH-31 battery charger</b>	
<b>Rated input</b>	AC 100–240 V, 50–60 Hz, 0.2 A
<b>Rated output</b>	DC 8.4 V/0.6 A
<b>Supported batteries</b>	Nikon EN-EL24 rechargeable Li-ion batteries
<b>Charging time</b>	Approx. 2 hours and 30 minutes at an ambient temperature of 25 °C (77 °F) when no charge remains
<b>Operating temperature</b>	0 °C–40 °C (+32 °F–104 °F)
<b>Dimensions (W × H × D)</b>	Approx. 67 × 28 × 94 mm (2.7 × 1.2 × 3.8 in.), excluding plug adapter
<b>Weight</b>	Approx. 83 g (3.0 oz), excluding plug adapter

<b>EN-EL24 rechargeable Li-ion battery</b>	
<b>Type</b>	Rechargeable lithium-ion battery
<b>Rated capacity</b>	7.2 V, 850 mAh
<b>Operating temperature</b>	0 °C–40 °C (+32 °F–104 °F)
<b>Dimensions (W × H × D)</b>	Approx. 29 × 47 × 13 mm (1.2 × 1.9 × 0.6 in.)
<b>Weight</b>	Approx. 34 g (1.2 oz), excluding terminal cover



**1 NIKKOR VR 10–30mm f/3.5–5.6 PD-ZOOM**

<b>Type</b>	1 mount lens
<b>Focal length</b>	10–30 mm
<b>Maximum aperture</b>	f/3.5–5.6
<b>Construction</b>	9 elements in 7 groups (including 4 aspherical lens elements, 1 ED lens element, and HRI lens elements)
<b>Angle of view</b>	77°–29° 40'
<b>Vibration reduction</b>	Lens shift using voice coil motors (VCMs)
<b>Minimum focus distance</b>	0.2 m (0.7 ft) from focal plane at all zoom positions
<b>Diaphragm blades</b>	7 (rounded diaphragm opening)
<b>Diaphragm</b>	Fully automatic
<b>Aperture range</b>	<ul style="list-style-type: none"><li>• <b>10 mm focal length:</b> f/3.5–16</li><li>• <b>30 mm focal length:</b> f/5.6–16</li></ul>
<b>Dimensions</b>	Approx. 58 mm diameter × 28 mm (distance from camera lens mount flange when lens is retracted)
<b>Weight</b>	Approx. 85 g (3.0 oz)

**1 NIKKOR VR 30–110mm f/3.8–5.6**

<b>Type</b>	1 mount lens
<b>Focal length</b>	30–110 mm
<b>Maximum aperture</b>	f/3.8–5.6
<b>Construction</b>	18 elements in 12 groups (including 2 ED lens elements)
<b>Angle of view</b>	29° 40'–8° 20'
<b>Vibration reduction</b>	Lens shift using voice coil motors (VCMs)
<b>Minimum focus distance</b>	1.0 m (3.3 ft) from focal plane at all zoom positions
<b>Diaphragm blades</b>	7 (rounded diaphragm opening)
<b>Diaphragm</b>	Fully automatic
<b>Aperture range</b>	<ul style="list-style-type: none"><li>• <b>30 mm focal length:</b> f/3.8–16</li><li>• <b>110 mm focal length:</b> f/5.6–16</li></ul>
<b>Filter-attachment size</b>	40.5 mm (P=0.5 mm)
<b>Dimensions</b>	Approx. 60 mm diameter × 61 mm (distance from camera lens mount flange when lens is retracted)
<b>Weight</b>	Approx. 180 g (6.3 oz)



<b>1 NIKKOR VR 10–100mm f/4–5.6</b>	
<b>Type</b>	1 mount lens
<b>Focal length</b>	10–100 mm
<b>Maximum aperture</b>	f/4–5.6
<b>Construction</b>	19 elements in 12 groups (including 3 aspherical lens elements, 2 ED lens elements, and HRI lens elements)
<b>Angle of view</b>	77°–9° 10'
<b>Vibration reduction</b>	Lens shift using voice coil motors (VCMs)
<b>Minimum focus distance</b>	<ul style="list-style-type: none"> <li>• <b>10 mm focal length:</b> 0.35 m (1.1 ft) from focal plane</li> <li>• <b>60 mm focal length:</b> 1.0 m (3.3 ft) from focal plane</li> <li>• <b>100 mm focal length:</b> 0.65 m (2.1 ft) from focal plane</li> </ul>
<b>Diaphragm blades</b>	7 (rounded diaphragm opening)
<b>Diaphragm</b>	Fully automatic
<b>Aperture range</b>	<ul style="list-style-type: none"> <li>• <b>10 mm focal length:</b> f/4–16</li> <li>• <b>100 mm focal length:</b> f/5.6–16</li> </ul>
<b>Filter-attachment size</b>	55 mm (P=0.75 mm)
<b>Dimensions</b>	Approx. 60.5 mm diameter × 70.5 mm (distance from camera lens mount flange when lens is retracted)
<b>Weight</b>	Approx. 298 g (10.5 oz)

Specifications subject to change without notice. Nikon will not be held liable for damages that may result from any mistakes that this manual may contain.



## ■ 1 NIKKOR Lenses

### 1 NIKKOR VR 10–30mm f/3.5–5.6 PD-ZOOM

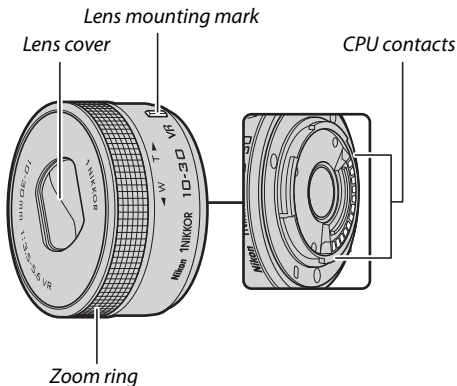

### 1 NIKKOR VR 30–110mm f/3.8–5.6

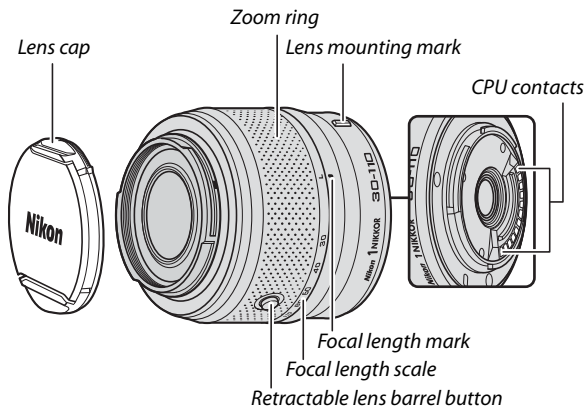

## 1 NIKKOR VR 10–100mm f/4–5.6

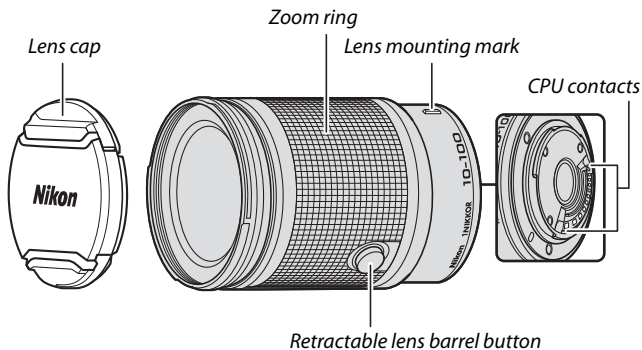

1 NIKKOR lenses are exclusively for Nikon 1 interchangeable lens format digital cameras. The angle of view is equivalent to a 35 mm format lens with a focal length about 2.7× longer. The lenses listed above support vibration reduction and can be used with **On** or **Off** selected for **Optical VR** in the camera menus (📖 183).

Zoom lenses can be zoomed in or out using the zoom ring (📖 40).



## Lens Care

- Keep the CPU contacts clean.
- Use a blower to remove dust and lint from the lens surfaces. To remove smudges and fingerprints, apply a small amount of ethanol or lens cleaner to a soft, clean cotton cloth or lens-cleaning tissue and clean from the center outwards using a circular motion, taking care not to leave smears or touch the glass with your fingers.
- Never use organic solvents such as paint thinner or benzene to clean the lens.
- A lens hood or NC filter can be used to protect the front lens element. When using an optional lens hood, do not pick up or hold the lens or camera using only the hood. Lens hoods and filters are not available for the 1 NIKKOR VR 10–30mm f/3.5–5.6 PD-ZOOM.
- When the lens is not in use, attach the rear cap and either ensure that the lens is retracted and the cover closed (1 NIKKOR VR 10–30mm f/3.5–5.6 PD-ZOOM) or attach the front cap (other lenses).
- If the lens will not be used for an extended period, store it in a cool, dry location to prevent mold and rust. Do not store in direct sunlight or with naphtha or camphor moth balls.
- Keep the lens dry. Rusting of the internal mechanism can cause irreparable damage.
- Leaving the lens in extremely hot locations could damage or warp parts made from reinforced plastic.
- When using the 1 NIKKOR VR 10–30mm f/3.5–5.6 PD-ZOOM, be sure not touch the lens cover. Failure to observe this precaution could result in product malfunction.



### Supplied Accessories

- 40.5 mm snap-on Front Lens Cap LC-N40.5 (for use with the 1 NIKKOR VR 30–110mm f/3.8–5.6 only)
- 55 mm snap-on Front Lens Cap LC-N55 (for use with the 1 NIKKOR VR 10–100mm f/4–5.6 only)
- Bayonet Hood HB-N103 (for use with the 1 NIKKOR VR 30–110mm f/3.8–5.6 only)
- Rear Lens Cap LF-N1000

### Attaching the HB-N103 Bayonet Hood

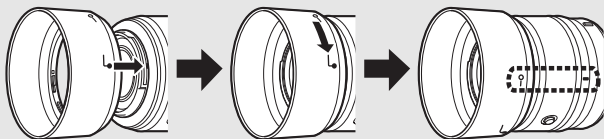

### Optional Accessories

- 40.5 mm screw-on filters (for use with the 1 NIKKOR VR 30–110mm f/3.8–5.6 only)
- 55 mm screw-on filters (for use with the 1 NIKKOR VR 10–100mm f/4–5.6 only)
- Bayonet Hood HB-N106 (for use with the 1 NIKKOR VR 10–100mm f/4–5.6 only)
- Semi-soft Case CL-N101 (for use with the 1 NIKKOR VR 10–100mm f/4–5.6 only)





## ■ The Optional FT1 Mount Adapter

Read this section for information on using the optional FT1 mount adapter. Before proceeding, be sure that you have read and understood this manual and the documentation for the FT1 and lenses.

### Autofocus

Autofocus is available only with AF-S lenses; other lenses support manual focus only. Set the camera focus mode to **AF-S** or **AF-C**. The only AF-area mode available is **Single-point** and the camera focuses on the subject in the center focus area only. Face priority is not supported. In some cases, a beep may sound, the in-focus indicator may be displayed, and pictures can be taken when the camera is not in focus; if this occurs, focus manually.

### Manual Focus

Follow the steps below to focus manually when using the FT1 with a NIKKOR F mount lens.

---

#### 1 Select manual focus mode.

Select **Manual focus** for **Focus mode** in the shooting menu (📖 186).

---

#### 2 Focus.

Rotate the lens focus ring until the subject is in focus.

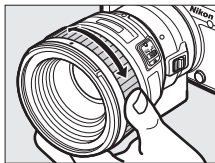

If **AF-S** or **AF-C** is selected for **Focus mode** and the lens supports autofocus with manual override, you can focus using autofocus and then keep the shutter-release button pressed halfway and rotate the lens focus ring to fine-tune focus manually. To refocus using autofocus, press the shutter-release button halfway again.

To zoom in on the display for more precise focus, press **OK** (note that this feature is not available in some modes). A navigation window will appear in a gray frame at the bottom right of the display.

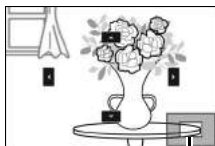

*Navigation window*

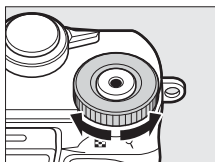

*Command dial*

Use the command dial to zoom in or out (to a maximum magnification of 10×) and the multi selector to scroll to areas of the frame not visible in the display. Press **OK** to exit zoom.



## The Electronic Rangefinder

If a CPU lens is attached in manual focus mode, the focus indicator can be used to check whether the camera is focused on the subject in the center focus area.

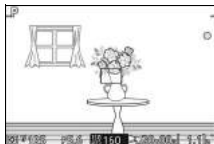

Focus indicator	Status
●	In focus.
▶	Camera focused in front of subject.
◀	Camera focused behind subject.
▶ ◀ (flashes)	Unable to determine focus.

Note that with some subjects, the in-focus indicator (●) may be displayed when the camera is not in focus. Check focus in the display before shooting.

## Error Messages and Displays

The following warnings appear in the camera aperture display.

Display	Problem	Solution
FEE	Lens aperture ring is not locked at minimum aperture.	When using CPU lenses, lock aperture ring at minimum aperture (highest f-number).
F---	Non-CPU lens is attached, or no lens is attached.	When using non-CPU lens, rotate lens aperture ring to adjust aperture.



## Restrictions

- Pictures can not be taken in some modes. Choose a different mode if necessary.
- Motion Snapshots can be recorded only when an AF-S lens is attached and the camera is in autofocus mode and then only when the subject is in focus. Do not attempt to adjust focus using the focus ring.
- The sound monitor switch and focus operation button (Focus Lock/MEMORY RECALL/AF Start) have no effect.

## Precautions for Use

- Lenses over 380 g (13.4 oz) should be supported at all times. Do not hold the camera or carry the camera by the strap without supporting the lens. Failure to observe this precaution could damage the camera lens mount.
- Lines may appear in photographs taken with non-CPU lenses stopped down to minimum aperture.
- In advanced movie mode, select exposure mode **A** or **M** to prevent sounds made by the lens being picked up by the microphone.
- Frame rates may slow when  is selected in continuous mode.
- Certain lenses will block the AF-assist illuminator and, at some distances, the flash.
- The tops and bottoms may be missing from circular *bokeh* shapes created at wide apertures using lenses with a maximum aperture of f/1.4.

### Incompatible Lenses

The following lenses can not be used with the FT1. For more information, see the latest catalog or visit the Nikon website for your area.

- AF-S NIKKOR 200–400mm f/4G ED VR II
- AF-S NIKKOR 200mm f/2.8G ED VR II
- AF-S NIKKOR 300mm f/2.8G ED VR II
- AF-S NIKKOR 400mm f/2.8E FL ED VR
- AF-S NIKKOR 400mm f/2.8G ED VR
- AF-S NIKKOR 500mm f/4G ED VR
- AF-S NIKKOR 600mm f/4G ED VR
- AF-S NIKKOR 800mm f/5.6E FL ED VR



## ■ Supported Standards

- **DCF Version 2.0:** The Design Rule for Camera File Systems (DCF) is a standard widely used in the digital camera industry to ensure compatibility among different makes of camera.
- **Exif version 2.3:** The camera supports Exif (Exchangeable Image File Format for Digital Still Cameras) version 2.3, a standard in which information stored with photographs is used for optimal color reproduction when the images are output on Exif-compliant printers.
- **PictBridge:** A standard developed through cooperation with the digital camera and printer industries, allowing photographs to be output directly to a printer without first transferring them to a computer.
- **HDMI:** High-Definition Multimedia Interface is a standard for multimedia interfaces used in consumer electronics and AV devices capable of transmitting audiovisual data and control signals to HDMI-compliant devices via a single cable connection.

### Trademark Information

IOS is a trademark or registered trademark of Cisco Systems, Inc., in the United States and/or other countries and is used under license. Windows is either a registered trademark or a trademark of Microsoft Corporation in the United States and/or other countries. PictBridge logo is a trademark. The microSD, microSDHC, and microSDXC logos are trademarks of the SD-3C, LLC. HDMI, the HDMI logo and High-Definition Multimedia Interface are trademarks or registered trademarks of HDMI Licensing, LLC.

## HDMI

Wi-Fi and the Wi-Fi logo are trademarks or registered trademarks of the Wi-Fi Alliance. N-Mark is a trademark or registered trademark of NFC Forum, Inc., in the United States and/or other countries. All other trade names mentioned in this manual or the other documentation provided with your Nikon product are trademarks or registered trademarks of their respective holders.



## Certificates

- México

COFETEL: RCPNIDW12-1580  
DW092

- Brasil



## FreeType License (FreeType2)

Portions of this software are copyright © 2012 The FreeType Project (<http://www.freetype.org>). All rights reserved.

## MIT License (HarfBuzz)

Portions of this software are copyright © 2015 The HarfBuzz Project (<http://www.freedesktop.org/wiki/Software/HarfBuzz>). All rights reserved.



## Battery Life

---

The number of shots or movie footage that can be recorded with fully-charged batteries varies with the condition of the battery, temperature, the interval between shots, and the length of time menus are displayed. Sample figures for EN-EL24 (850 mAh) batteries are given below.

- **Still images: Approximately 250 shots**
- **Movies: Approximately 60 minutes at 1080/30p**

Measured according to CIPA standards at  $23 \pm 2^\circ\text{C}$  ( $73.4 \pm 3.6^\circ\text{F}$ ) with the camera at default settings, a fully-charged battery, a 1 NIKKOR VR 10–30mm f/3.5–5.6 PD-ZOOM lens, and a 16 GB SanDisk SDSDQXP-016G-J35A UHS-I microSDHC card. Value for still images obtained under the following test conditions: photographs taken at intervals of 30 s with the built-in flash fired with every other shot and the camera turned off and then on after every ten shots. Value for movies obtained under the following test conditions: a series of 17 minute movies with a file size of up to 4 GB were recorded; recording was only interrupted when temperature warning was displayed.

The following can reduce battery life:

- Keeping the shutter-release button pressed halfway
- Repeated autofocus operations
- Taking NEF (RAW) photographs
- Slow shutter speeds
- Using Wi-Fi
- Using vibration reduction mode with VR lenses
- Using zoom with power zoom lenses





























To ensure that you get the most from rechargeable Nikon EN-EL24 batteries:





















- Keep the battery contacts clean. Soiled contacts can reduce battery performance.
- Use batteries immediately after charging. Batteries will lose their charge if left unused.



# Index

## Symbols

 (Auto mode) .....	6, 33
 + (Advanced movie mode) .....	7, 49
 C (Creative mode) .....	6, 58
<b>P</b> (Programmed auto) .....	67, 161
<b>S</b> (Shutter-priority auto) .....	68, 161
<b>A</b> (Aperture-priority auto) .....	69, 161
<b>M</b> (Manual) .....	70, 161
 (Sports mode) .....	6, 74
 (Best moment capture mode) .	7, 76
 (Motion Snapshot mode) .....	7, 88
<b>HD</b> (HD movie) .....	49
<b>4K</b> (4K movie) .....	49
 (Time-lapse movie) .....	49
 (Slow motion) .....	49
 (Fast motion) .....	50
 (Jump cut) .....	50
 (4-second movie) .....	50
<b>POP</b> (Pop) .....	59
<b>RETRO</b> (Retro) .....	59
 (High-contrast monochrome) .	59
<b>SEPIA</b> (Nostalgic sepia) .....	59
<b>HDR</b> (HDR) .....	59, 62
 (Soft) .....	59
 (Easy panorama) .....	59, 63
 (Miniature effect) .....	59
 (Selective color) .....	59, 66
 (Cross process) .....	59
 (Toy camera effect) .....	60
 (Cross screen) .....	60
 (Fisheye) .....	60
 (Skin softening) .....	60
 (Night landscape) .....	39, 60
 (Night portrait) .....	39, 60
 (Landscape) .....	39, 60
 (Close-up) .....	39, 60
 (Portrait) .....	39, 60
 (Auto) .....	39
 (Scene auto selector) .....	161

 (flexible program) .....	67
<b>MENU</b> (menu) button .....	9, 149, 158, 193
 (playback) button .....	37, 86, 93
 (delete) button .....	38, 47, 87, 93, 134
 (Wi-Fi) button .....	118, 121
 (OK) button .....	8
 (feature) .....	11, 51, 61, 71, 80, 90, 128
 (continuous shooting/self-timer) .	74, 97, 99
 (continuous) .....	97
 (self-timer) .....	99
 (exposure compensation) .....	101
 (flash mode) .....	103, 105
 (red-eye reduction) .....	103, 105
<b>SLOW</b> (slow sync) .....	105
<b>REAR</b> (rear-curtain sync) .....	105
 (flash-ready indicator) .....	106
 (matrix) .....	166
 (center-weighted) .....	166
 (spot) .....	166
 (auto-area) .....	188
 (single-point) .....	188
 (subject tracking) .....	188
 (Creative palette) .....	96
<b>PRE</b> (Preset manual) .....	169
 (Single frame) .....	98

## Numerics

4K movie .....	49
4-second movie .....	50

## A

AC adapter .....	202, 204
Accessories .....	202
Active D-Lighting .....	178
Active selection .....	76
Adobe RGB .....	177
Advanced movie mode .....	7, 49
AE lock .....	53
AF .....	184, 188



AF-A .....	184
AF-area mode .....	188
AF-assist illuminator .....	191
AF-C .....	184
AF-F .....	184
AF-S .....	184
Aperture .....	69, 70
Aperture-priority auto .....	69, 161
Assign Fn button .....	13
Attaching the lens .....	26
Audio .....	92
Auto distortion control .....	177
Auto image capture .....	180
Auto image rotation .....	200
Auto mode .....	33
Auto photography .....	180
Auto power off .....	28, 197
Auto-area (AF-area mode) .....	188
Autofocus .....	184, 188
Automatic scene selection .....	39
Auto-select AF .....	184

## B

Basic info .....	125, 196
Battery .....	21, 23, 32, 228
Beep .....	34, 100, 197
Best moment capture mode .....	76
Best shot .....	83, 86, 132
Body cap .....	2, 202
Border (PictBridge) .....	147
Brightness (Picture Control) .....	175
Buffering .....	77, 84, 89
Built-in AF assist .....	191
Built-in flash .....	102
Bulb .....	72

## C

Calendar .....	130, 137
Calendar playback .....	130
Capture 20 frames over .....	79
Capture NX-D .....	140, 164
Center-weighted (Metering) .....	166
Charging a battery .....	21

Clock .....	30, 31, 199
Clock battery .....	31
Close-up .....	39, 60
Color space .....	177
Color temperature .....	171
Command dial 2, 37, 67, 68, 70, 186, 236	
Connect to smart device .....	118
Continuous .....	74, 97
Continuous AF .....	184
Contrast .....	178
Contrast (Picture Control) .....	175
Creative mode .....	58
Creative palette .....	96
Crop .....	155
Crop (PictBridge) .....	147
Cross process .....	59
Cross screen .....	60
Current settings .....	117

## D

Date and time .....	30, 199
Date format .....	30, 199
Daylight saving time .....	30, 199
DCF version 2.0 .....	239
Defaults .....	211
Delete .....	38, 47, 87, 93, 134
Delete all images .....	134
Delete selected images .....	134
Detailed display .....	4, 196
Detailed photo information .....	126, 196
Display .....	196
Display brightness .....	196
D-Lighting .....	153
Dust shield .....	206, 207

## E

Easy panorama .....	59, 63
Edit movie .....	156
Electronic VR (movies) .....	183
Exif version 2.3 .....	239
Exposure .....	101, 161, 166



Exposure compensation .....	101
Exposure compensation (self-portraits) .....	109
Exposure indicator .....	71
Exposure mode .....	161

## F

Face priority .....	40, 191
Fast motion .....	50
File format .....	92
Fill flash .....	105
Filter effects (Picture Control) ....	175, 176
Filter strength (Fisheye) .....	60
Filter strength (Skin softening) ....	60
Filter strength (Soft) .....	59
Fine-tuning white balance .....	168
Firmware version .....	194
Fisheye .....	60
Flash .....	102, 192
Flash compensation .....	192
Flash control .....	192
Flash mode .....	103, 105
Flash range .....	107
Flash-ready indicator .....	106
Flexible program .....	67
Flicker reduction .....	198
<b>Fn</b> button .....	13
Focal length .....	126
Focal length scale .....	231
Focal plane mark .....	2, 187
Focus .....	184, 188
Focus area .....	34, 188
Focus lock .....	189
Focus mode .....	184
Format .....	24, 195
Format memory card .....	24, 195
Frame rate .....	57, 125, 165
Frame size/frame rate .....	165
FT1 .....	235
Full-frame playback .....	37, 125
Full-time AF .....	184

## G

Glamour retouch .....	135
Grid display .....	36

## H

H.264 .....	226
HD movies .....	49, 165
HDMI .....	144, 239
HDR .....	62
High definition .....	144, 239
High ISO noise reduction .....	179
High-contrast monochrome .....	59
Histogram .....	127
Hue (Cross process) .....	59
Hue (Picture Control) .....	175
Hue (Retro) .....	59

## I

Image quality .....	162
Image review .....	195
Image selection .....	151
Image size .....	162
Index print .....	148
Interval .....	52
Interval timer shooting .....	181
ISO sensitivity .....	172

## J

JPEG .....	162
Jump cut .....	50

## L

Landscape .....	39, 60, 173
Language .....	30
Lens .....	26, 40, 183, 202, 229, 230
Lens cap .....	27
Lens mount .....	187
Live image control .....	94
Long exposure NR .....	179

## M

Manual .....	70, 161
Manual focus .....	186



Matrix (Metering) .....	166
Max. shots per minute .....	180
Maximum aperture .....	229, 230
Memory card ...	23, 25, 195, 203, 213
Memory card access lamp .....	35
Memory card capacity .....	213
Metering .....	166
Microphone .....	43, 180
Miniature effect .....	59
Monitor .....	4, 14, 196
Monochrome .....	173
Motion Snapshot mode .....	88
Mount adapter .....	202, 235
MOV .....	92, 164
Movie before/after .....	91
Movie sound options .....	180
Movie-record button ...	2, 43, 53, 56
Movies .....	42, 49, 165
Multi selector .....	8

## N

NEF (RAW) .....	162, 164
Neutral .....	173
NFC .....	119, 123
Night landscape .....	60
Night portrait .....	60
Nikon Transfer 2 .....	142
N-Mark .....	2, 119
NMS .....	92, 164
Normal panorama .....	163
Nostalgic sepia .....	59
Number of copies .....	147
Number of shots saved .....	84

## O

On release, record .....	79
Optical VR .....	183

## P

Page size (PictBridge) .....	147
Photo information .....	125
PictBridge .....	146, 239
Picture Control .....	173

Pixel mapping .....	201
Playback .....	37, 125
Playback menu .....	149
Playback zoom .....	131
Pop .....	59
Portrait .....	39, 60, 173
Portrait (Soft) .....	59
Power connector .....	202, 204
Power drive zoom .....	40
Power switch .....	28
Preset manual .....	167, 169
Press the shutter-release button all the way down .....	35, 39
Press the shutter-release button halfway .....	34, 39
Print border .....	147
Print time stamp .....	147
Printing .....	146
Programmed auto .....	67, 161
Protect .....	152

## Q

Quick adjust .....	175
--------------------	-----

## R

Rear-curtain sync .....	105
Red-eye reduction .....	103, 105
Removing the lens from the camera 27	
Reset file numbering .....	198
Reset setup options .....	193
Reset shooting options .....	161
Resize .....	154
Retractable lens barrel button ....	27, 29, 231, 232
Retro .....	59
Rotate tall .....	152

## S

Saturation (Picture Control) .....	175
Saturation (Toy camera effect) ....	60
Scene auto selector .....	161
Scene selection .....	59



Select color .....	66
Select images for printing .....	148
Select to send to smart device ...	122
Selective color .....	59, 66
Self-portrait mode .....	15, 108
Self-portrait mode (setup menu) .....	197
Self-timer .....	99
Self-timer (self-portraits) .....	109
Sensitivity .....	172
Sequence display options .....	152
Setup menu .....	193
Sharpening (Picture Control) .....	175
Shooting menu .....	158
Shutter speed .....	68, 70
Shutter-priority auto .....	68, 161
Shutter-release button .....	34, 39, 77, 82, 84, 89
Single AF .....	184
Single frame .....	98
Single-point .....	188
Size .....	154, 162, 165, 222, 226
Skin softening .....	60
Skin softening (self-portraits) .....	109
Slide show .....	137
Slot empty release lock .....	195
Slow motion ( <b>F</b> menu) .....	57
Slow motion (advanced movie mode) .....	49, 55
Slow sync .....	105
Slow view .....	81
Smart device .....	114
Smart Photo Selector .....	83
Soft .....	59
Sound settings .....	197
Speaker .....	3
Sports mode .....	6, 74
Spot (Metering) .....	166
sRGB .....	177
SSID .....	118
Standard .....	173
Start printing (PictBridge) .....	148

Strap .....	21
Subject tracking .....	188

## T

Tap shooting options .....	111
Television .....	144
Temperature warnings .....	xv
Thumbnail playback .....	129
Tilting monitor .....	14, 108
Time .....	30, 199
Time stamp (PictBridge) .....	147
Time zone .....	199
Time zone and date .....	199
Time-lapse movie .....	49, 52
Timer .....	99, 181
Toning (Picture Control) .....	175, 176
Touch screen .....	16
Toy camera effect .....	60
Trimming movies .....	156

## U

Upload from camera .....	122
USB .....	141, 146
USB cable .....	141, 146

## V

ViewNX-i .....	140
Vignetting .....	60
Vivid .....	173
Volume .....	46, 139
VR .....	183

## W

White balance .....	167
Wide panorama .....	163
Wi-Fi .....	xviii, 114
Wi-Fi connection type .....	115, 117
Wi-Fi menu .....	115, 122
Wi-Fi upload .....	121
Wind noise reduction .....	180
Wireless .....	xviii, 114
Wireless Mobile Utility .....	114, 124
Wireless network .....	114



Wireless security ..... 115

## **Z**

---

Zoom guide ..... 40

Zoom ring ..... 27, 40, 231, 232



No reproduction in any form of this manual, in whole or in part (except for brief quotation in critical articles or reviews), may be made without written authorization from NIKON CORPORATION.

**NIKON CORPORATION**

---

© 2015 Nikon Corporation



SB5G02(11)  
6MVA9111-02