

Nikon

Nikon F2 (Body)

ニコン F2 (ボディ)

REPAIR MANUAL (Revised-1)

修理指針 (改訂-1)



NIPPON KOGAKU K.K.

Tokyo, Japan

CONTENTS

I. Repair manual

1. Marks in the parts list -----	1
2. Lubricant and binding agent list -----	3 - 4
3. Specifications -----	5
4. Illustrations of Each Parts (Fig. 1 - Fig. 10) -----	8 - 17
5. Electrical Wiring (Fig. 11) -----	18
6. Sectional views of Main part (Fig. 12 - Fig. 15) -----	19 - 22
7. Plane views of Main part (Fig. 16 - Fig. 18) -----	23 - 25
8. Relative Angles (Fig. 19) -----	26
9. Attaching the shutter curtains (Fig. 20) -----	27
10. Accuracy Adjustments -----	29, 31
11. Assembling points -----	33, 35

© This Repair Manual are applied to the products manufactured up to June 1th, 1975.

1. MARKS IN THE PARTS LIST

1. The name and shape column

- ⊕Cross recessed head screw
- ⊖Slotted head screw
- POval countersink head screw
- QFlat head screw
- RPan head screw, flat fillister head screw
- SRound head screw
- TTruss head screw
- USet screw
- U SSet screw (cone point)

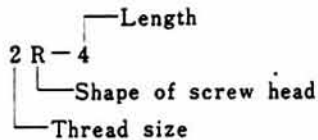

- (1),(3)1st class, 3rd class
- (S)Special screw
- dDiameter of the material
- TPTaper pin
- SPStraight pin

2. The term of sale column

-Can be supplied individually
- △Not supplied individually but only as subassembly
- △Supplied either as part or subassembly
- ×Not considered as repair part
- ※Should be sent to the factory if the repair is needed
- ☒Delivered as a product from the sales department
(i.e., not supplied as repair part)

3. The remarks column

- P-10001Part number used in common
- D-2222Part number in stock
- 49F1001Technical data sheet number
- 1×100/1000Starting order
- Rev.Revision
- Add.Addition
- Dis.Discontinuation
- #1-#3Relative parts number

記 号 説 明

1. 名 称 欄

⊕	十字穴付ねじ
⊖	スリワリ付ねじ
P	丸サラ頭ねじ
Q	サラ頭ねじ
R	ナベ頭ねじ, 平頭ねじ
S	丸頭ねじ
T	トラス頭ねじ
U	止めねじ
US	止めねじ (とがり先)

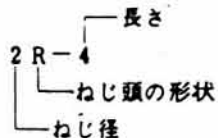

(1), (3)	1種, 3種
(S)	特殊ねじ
d	線 径
TP	テーパースクリュー
SP	ストレートピン

2. 販売区分欄

○	単独部品として販売するもの
△	部組品でなければ販売しないもの
○△	単独部品でも部組品でも販売するもの
×	修理部品とは考えないもの
*	単体では交換できないので, 組む場合に工場での加工が必要なもの
☒	商品として販売店で販売しているもの (修理部品扱いはしない)

3. 備 考 欄

P-10001	共通部品番号
D-2222	貯藏品番号
49F1001	製品技術資料番号
~1×101/1000	実施オーダー
Rev.	訂 正
Add.	追 加
Dis.	廃 止
#1-#3	関係部品番号

2. Lubricant and binding agent list 潤滑剤・接着剤一覧表

LUBRICANTS 潤滑剤							
Oil 油	Usage 用途	Items number 番号	Items 商品名				
			Japanese	日本	Remarks 備考		
Liquid oil 液体油	At a normal temperature 常温用	L 1212	日本石油	白スピンドル油 ㊦5			
		L 1233	シエル石油	トナオイル #33			
		L 1309	モービル石油	モービループ HD80-90			
		L 1314	モービル石油	モービループ HD140			
	At a low temperature 低温用	L 2010	ウイリアム・エフ・ナイ(木村産業)	アストロオイル			
		L 2113	三達化工	D. O. S			
		L 2215	エクリプス・バイオニア	エクリプス・バイオニア #10(ジャイロ油)			
		L 3016	理研製油	スクワレル LA-10			
		L 3025	理研製油	スクワレル M-1			
		L 3034	理研製油	スクワレル M-2			
		L 3044	理研製油	スクワレル M-5			
		L 3047	理研製油	スクワレル H-1			
		Grease oil グリース	At a normal temperature 常温用	G 5201	社内調合		
				G 5204	社内調合		
G 5214	社内調合						
G 6053	日本鉱油			パーマルブ H1003			
G 6252	出光興産			ダフニコロネックス 2			
G 6372	シエル石油			シエルアルバニア 2			
G 6414	杉浦研究所			光学用グリース Z-2			
G 6433	杉浦研究所			光学用グリース X-2			
G 7821	丸善石油			リマックス 2			
G 8681	ロックレー(大東商事)		リキモリオート LM-81				
At a low temperature 低温用	G 7100		理研製油	スクワグリース L-2			
	G 7811		日本鉱油	フォートルブ 024			
	G 7812		日本鉱油	フォートルブ 025			
	G 7813		社内調合				
	G 7814		協同油脂	マルテンブPS ㊦1			
	G 7815		協同油脂	マルテンブPS ㊦2			
	G 7833		東レシリコーン	シリコーンSH.33(F)グリース			
	G 7848		日本石油	ユニテンプグリース			
	G 7854	日本鉱油	パーマルブ C-1				
G 7855	日本鉱油	パーマルブ C-2					

LUBRICANTS 潤滑油

Oil 油	Usage 用途	Items number 番号	Items 商品名		Remarks 備考	
			Japanese	日本		
Grease oil グリース	At a low temperature 低温用	G 7856	日本鉱油	パーマラルプ C-3		
		G 7862	日本鉱油	パーマラルプ D-2		
		G 7866	日本鉱油	フォートルプ 023		
		G 7870	モービル石油	モービルグリース 27		
		G 8181	社内調合			
		G 8610	ロノフレール(大東商事) リキモリブペースター LM-83			
		G 8613	ロノフレール(大東商事) リキモリブペースター LM-13			

BINDING AGENTS 接着剤

Usage 用途	Items number 番号	Items 商品名		Remarks 備考
		Japanese	日本	
For leather or rubber goods. 皮類, ゴム類	# 330	スミボンド	VA-1000	
	# 501	プライオボンド	#30	
For make metal goods together with metal goods or glass with metal 一般金属相互 ガラスと金属	# 616	セメダインスーパー	(家庭用)	
	# 621	セメダイン	#1500 (工業用)	
	# 631	アララダイト	AT1	
	# 634	工用 アラルダイト	AY 101	
	# 645HB, #645HE	硬化剤	ハードナー HY 951	
For temporary adhesion in the process 工程上の仮止め	# 201	セラック	オレンジ色, レモン色可	
	# 350	ねじロック		
	# 410	ロックタイト	(B/M黄, ST/L赤, SC/L紫, N/L青, D橙)	
	# 921	アロンアルファ	# 201	
	# 922	アロンアルファ	# 202	
	# 503	ウェザーバンシーラー		
For replenishment 充填をいとする接着	# 506	スリーボンド	粘4	
	# 508	シラシール	3DW	
	# 512	シラシール	FSXS-1548	
	# 646HB, #646HE	DM	D6	
	# 647HB, #647HE	DM	K3	

3. Specifications

- . Type: 35mm single lens reflex camera
- . Viewing system: Interchangeable bright Photomic viewfinder with 100% frame accuracy, exposure data visible in the viewfinder, Type A focusing screen supplied as standard equipment.
- . Lens mount: Nikon F bayonet mount
- . Depth-of-field preview button: Coaxial with the mirror lock
- . Mirror: Automatic instant-return type with lock-up feature
- . Shutter: Titanium focal plane with speeds from 10 to 1/2000 sec. plus B, T and X synchro
- . Self-timer: Can be set for 2, 4, 6, 8, 10-second delay
- . Film-advance lever: Winds the film, cocks the shutter and operates the frame counter with a single stroke or a series of strokes. Also switches the meter on or off. Play angle of the lever is 20° and working angle 120°.
- . Frame counter: Automatic resetting.
- . Flash synchronization: At any speed except B, X and T with flashbulbs and speeds up to 1/80 sec. with electronic flash.
- . Camera back: Hinged, detachable type
- . Dimensions: 152.5mm long x 65mm wide x 102mm high
- . Weight: 840g without lens

3. 主要諸元

- 形式 ----- 35mm 一眼レフレックスカメラ
- 画面サイズ ----- 24mm × 36mm
- ファインダー視野 ----- 撮影画面の100%
- レンズマウント ----- ニコンFマウント
- レンズ絞り ----- 瞬時復元式 被写界深度観測用絞り込みボタンつき
- ミラー ----- 瞬時復元サスペンション式 ミラーアップ可能
- シャッター ----- チタン (軽金属) 製フォーカルプレ・シャッター
T.B.I. ~ 1/2000 秒
および2秒~10秒の超スローシャッター可能
1/80秒 (X接点) ~ 1/2000秒は白昼の中間スピード
可能
- セルフタイマー ----- 作動秒時可変式
- シャッターチャージ ----- レバー式フィルム巻上げ兼用 - 作動 (120°) 巻上げ
小刻み巻上げ可能
- フィルムカウンター ----- 自動復元順算式
- シンクロソケット ----- コードレス接点およびJIS-5型 (おじこの式) 接点
X接点は1/80秒
- 裏ぶた ----- 蝶番式 (取りはずし可能)
- サイズ ----- 152.5mm (横) × 102mm (高さ) × 65mm (幅)
(ボディおよびファインダー)
- 重量 ----- 840g (ボディおよびファインダー)

4. Illustrations of Each Parts 展開図

Nikon F2

ニコン F2

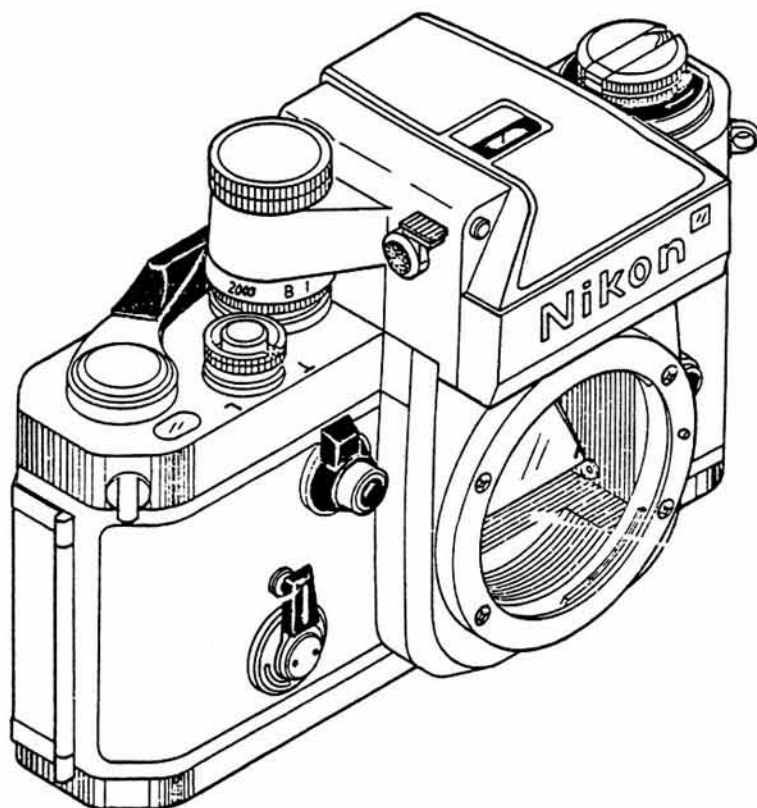

Front Plate, Mirror Box 前板・ミラーボックス

通常に分解しない
Do not disassemble
as a rule

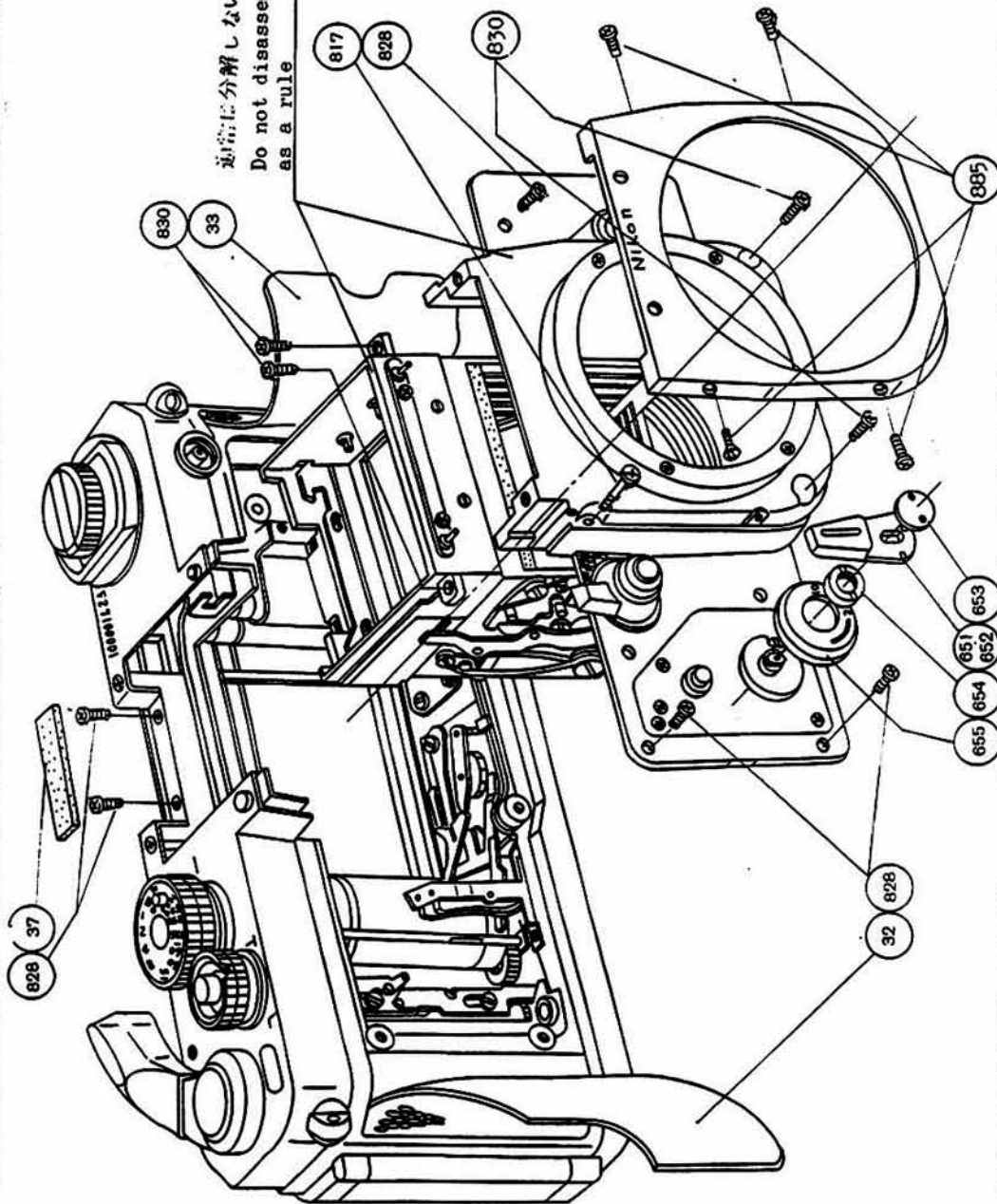

Fig. 1

Top Cover (right and left) 左右上フタ

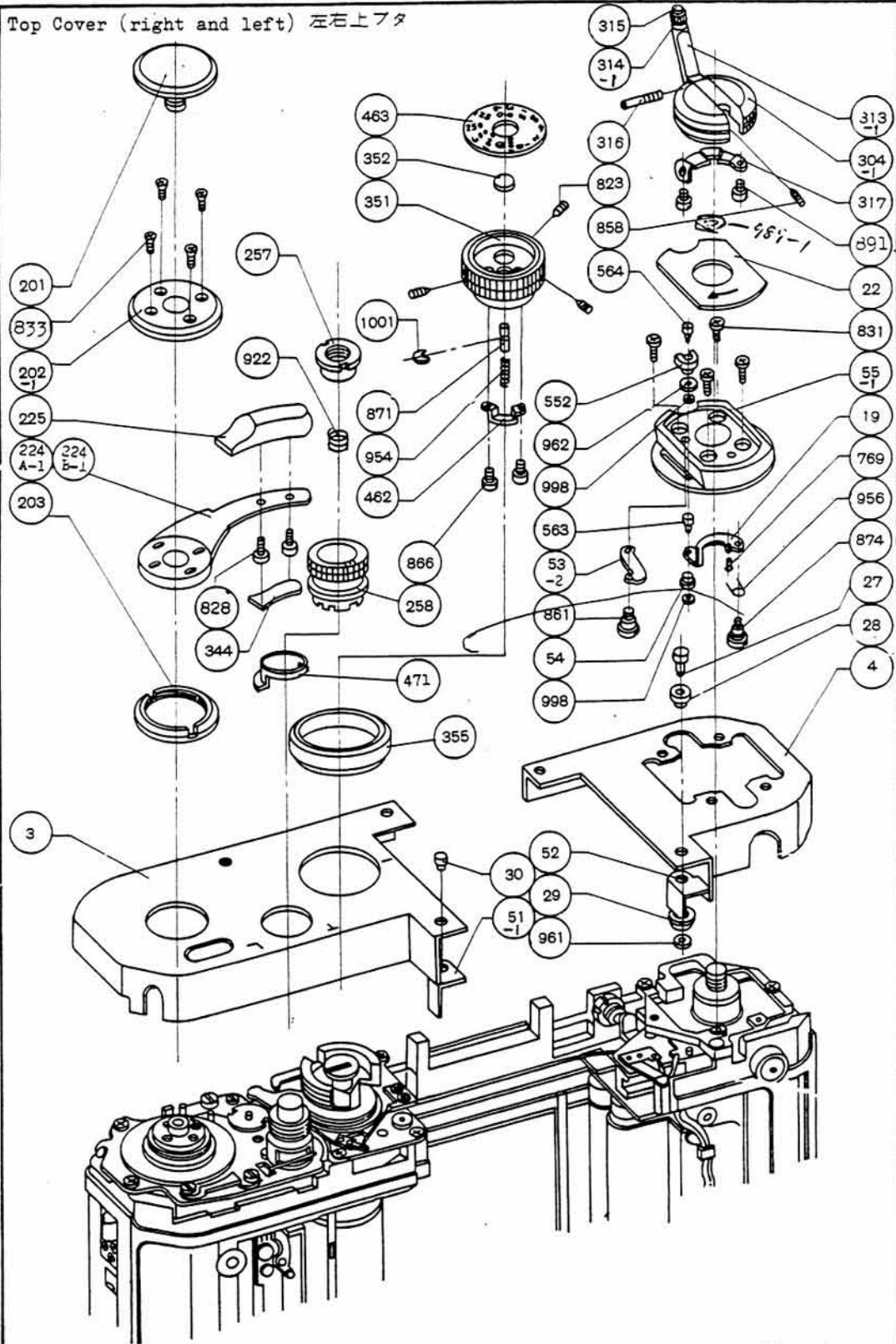

Fig. 2

Top of the Body ボディ上部

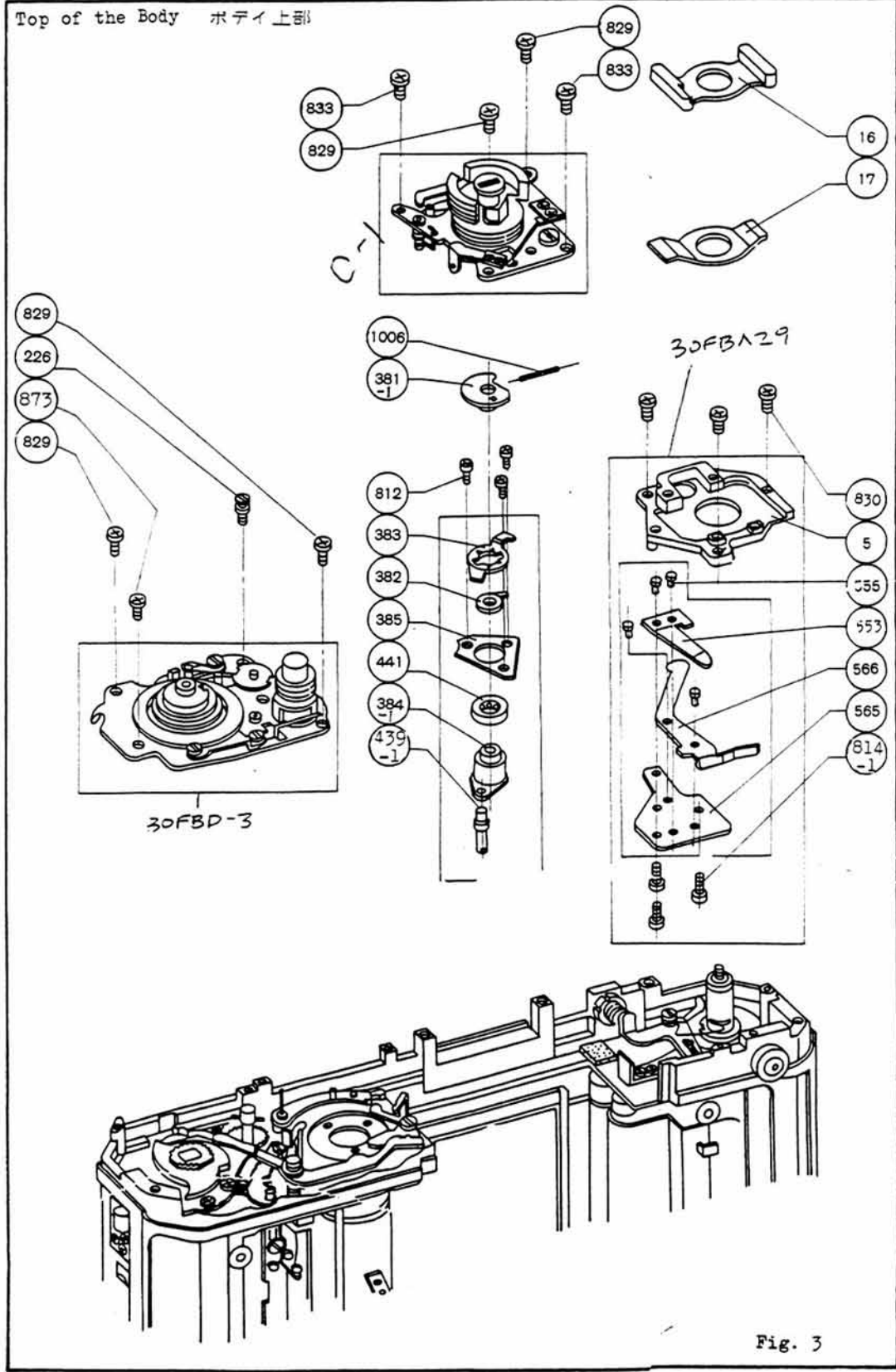

Fig. 3

12

Take-up Middle Plate 卷上中板

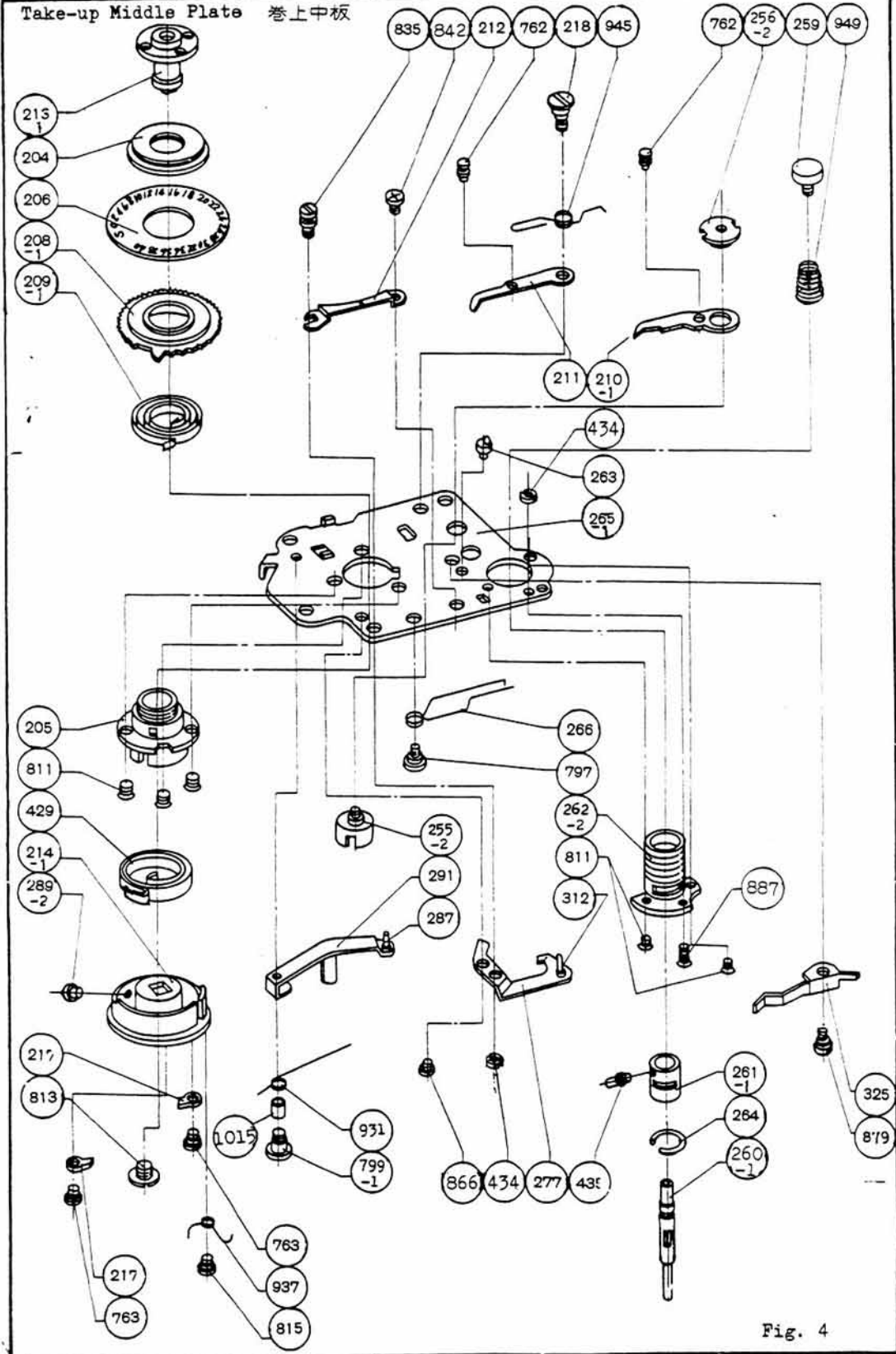

Fig. 4

Front of the Body ボディ前部

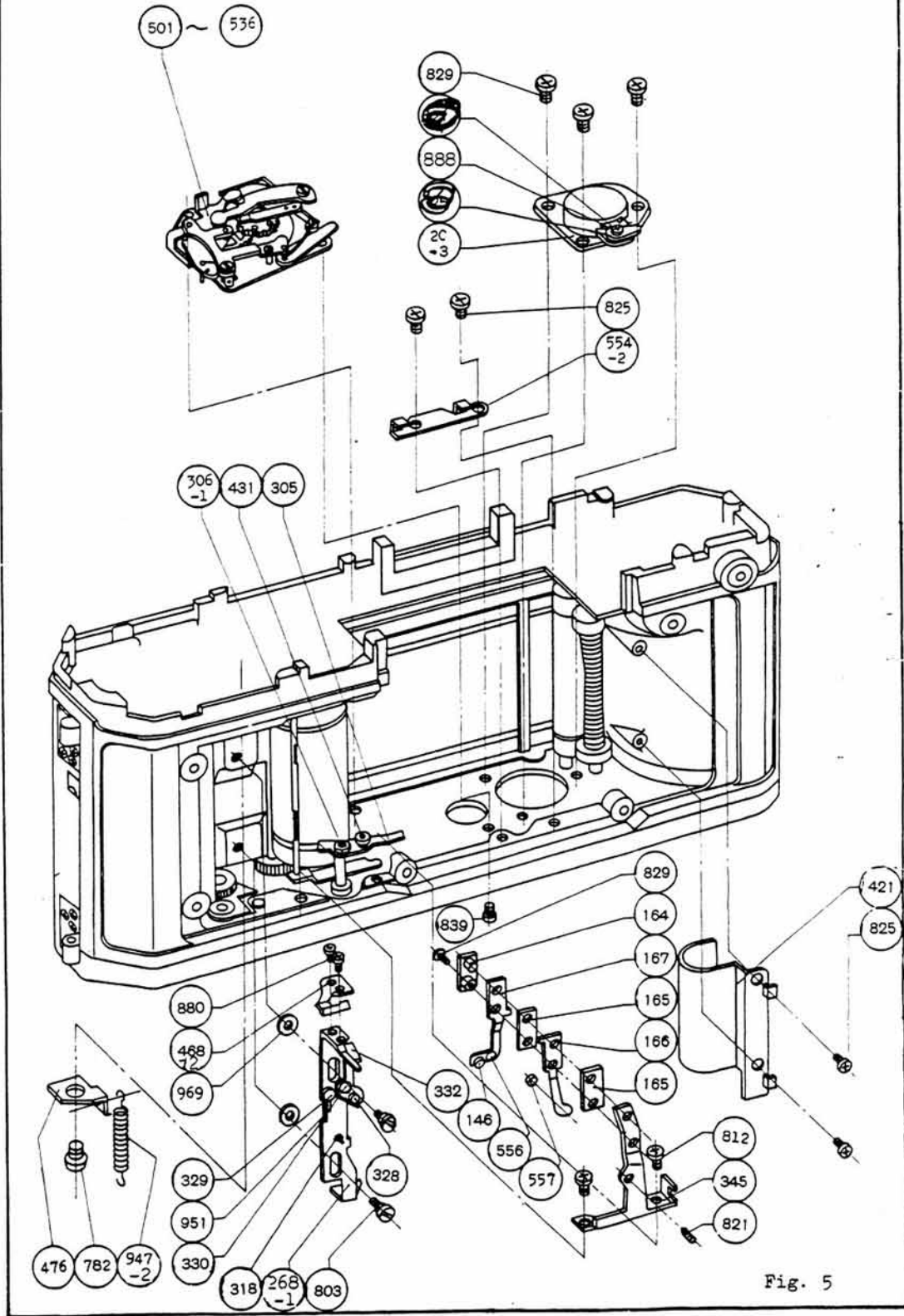

Fig. 5

14

Bottom Cover 底カバー

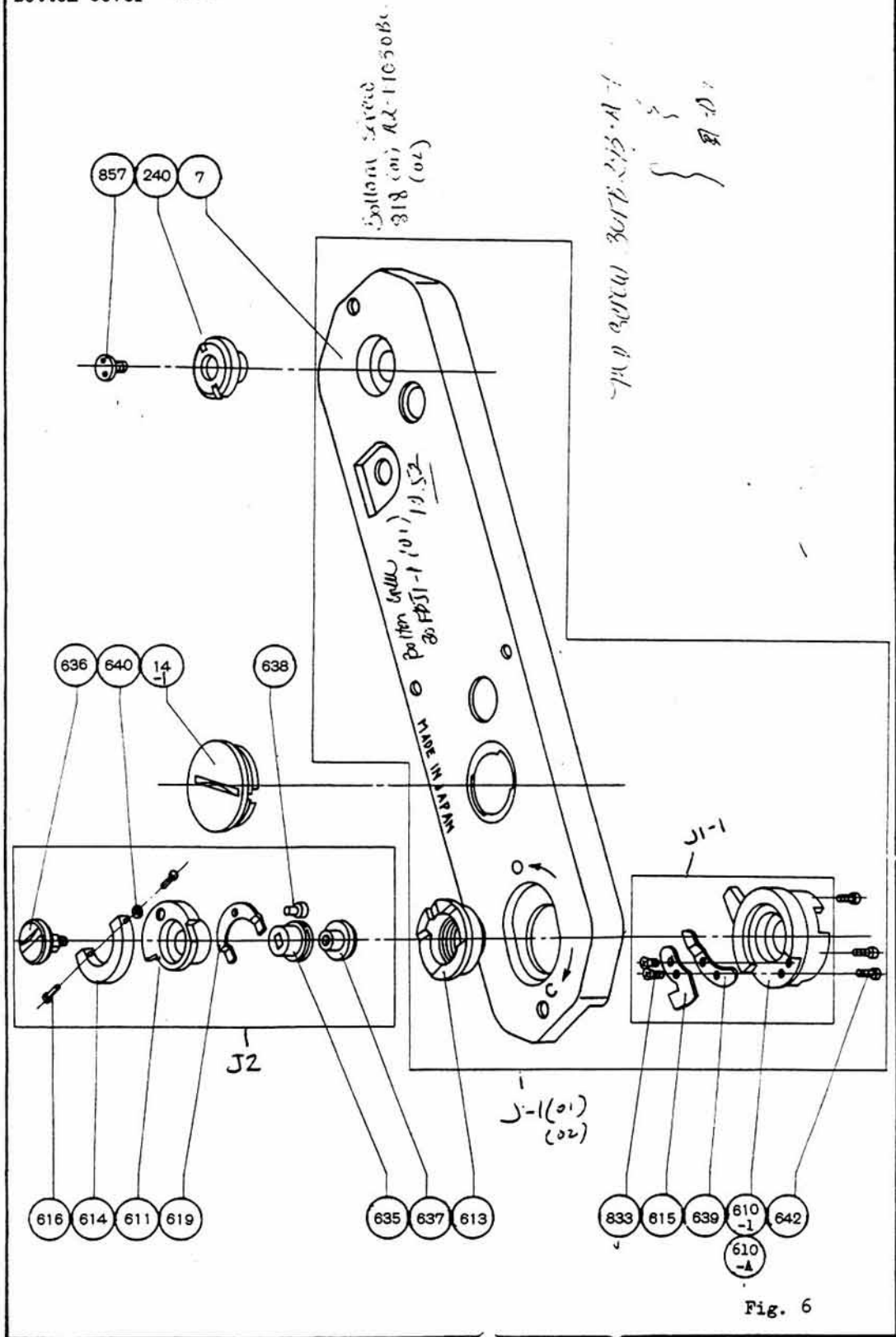

Fig. 6

Bottom of the Body ボディ底部

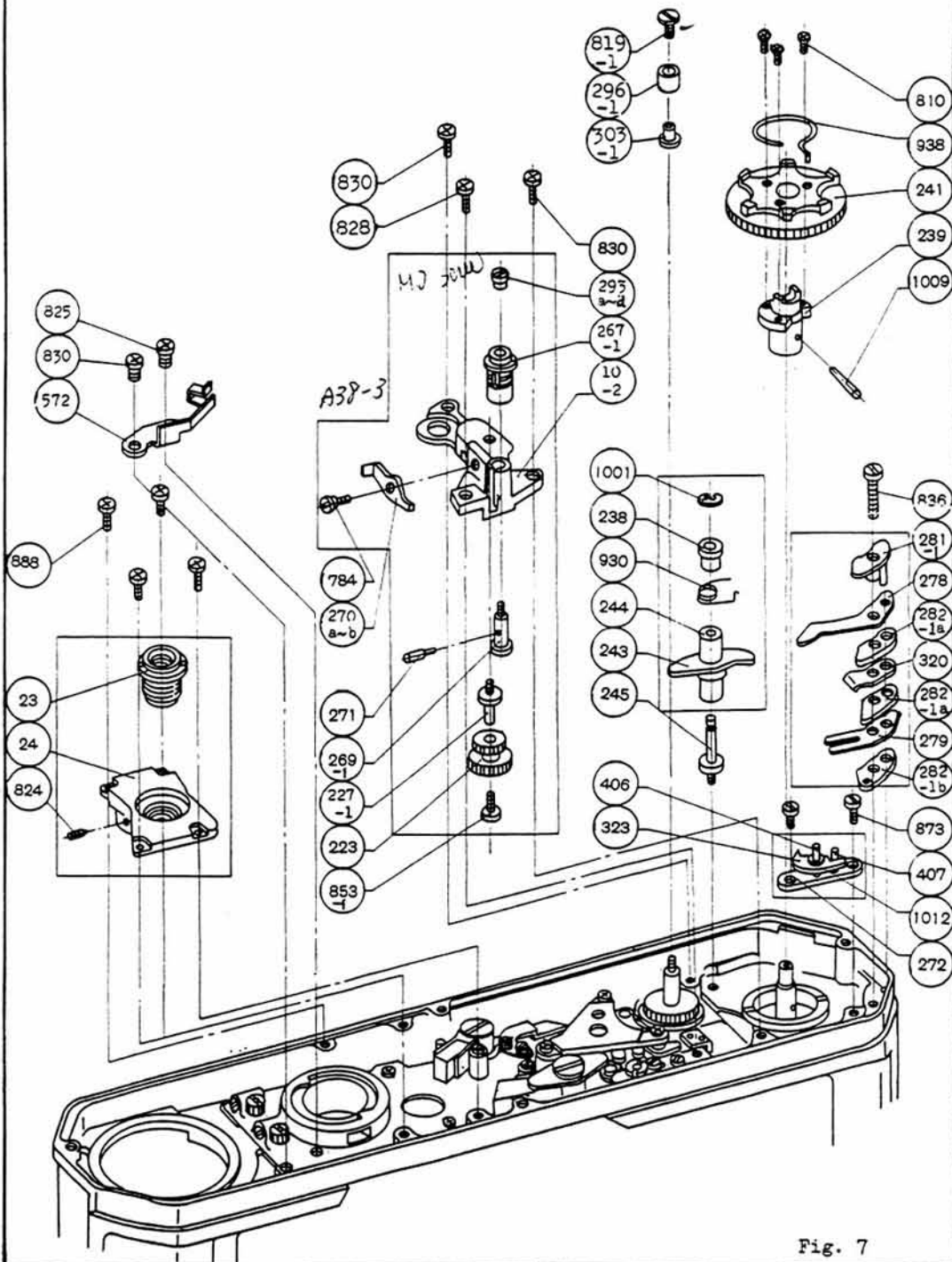

Fig. 7

Front Plate 前板

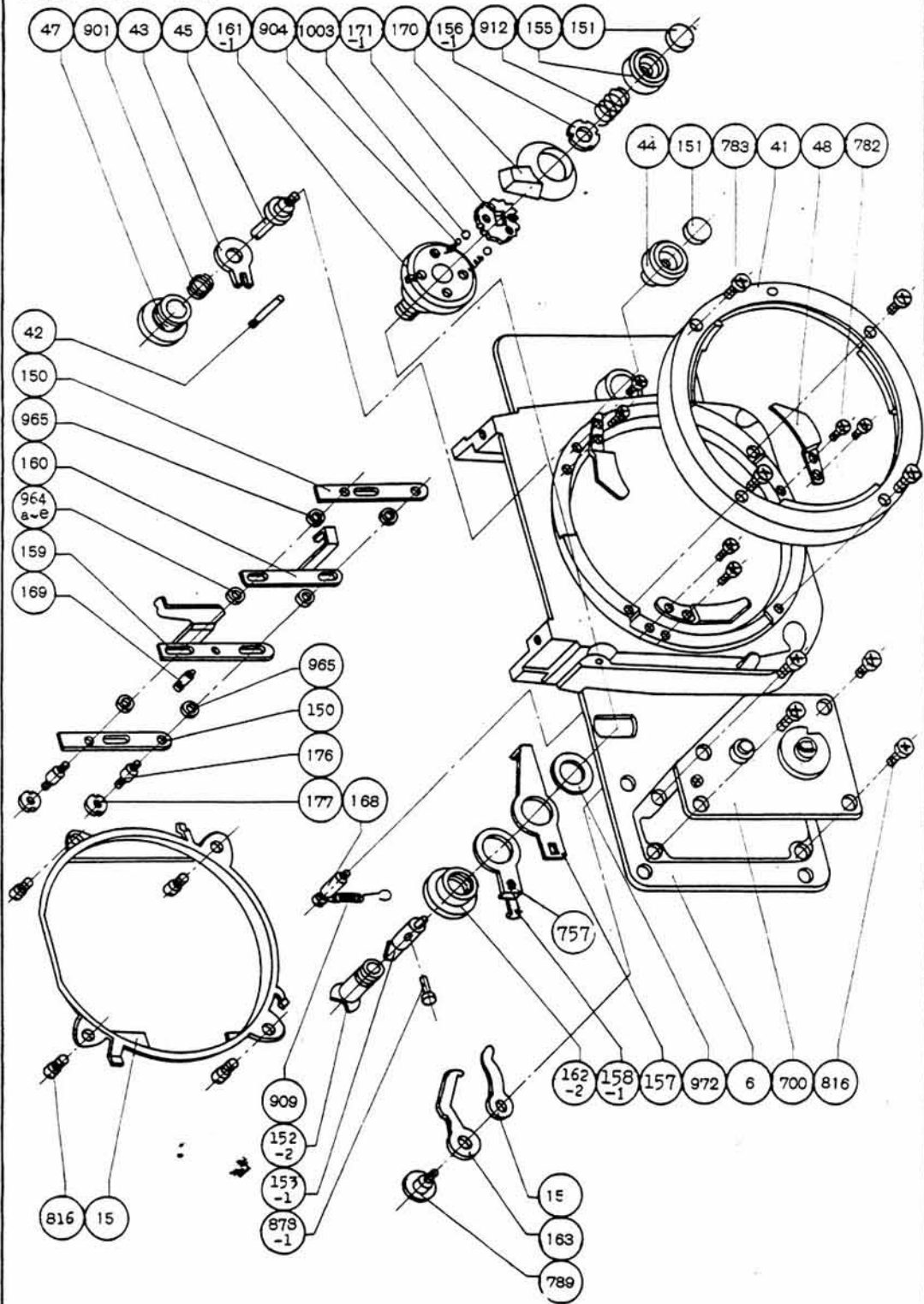

Fig. 8

17

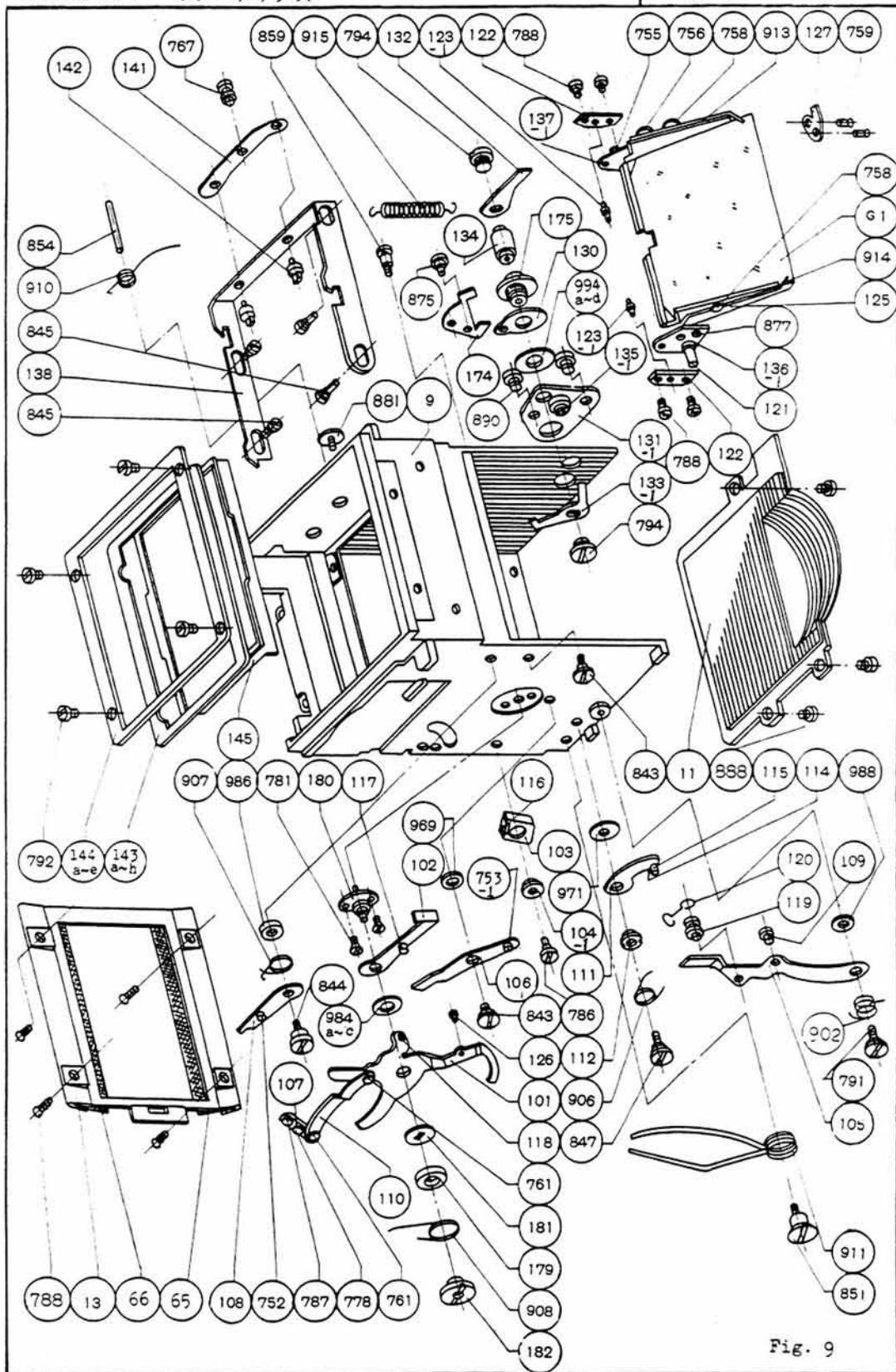

Fig. 9

Rear Cover 裏フタ

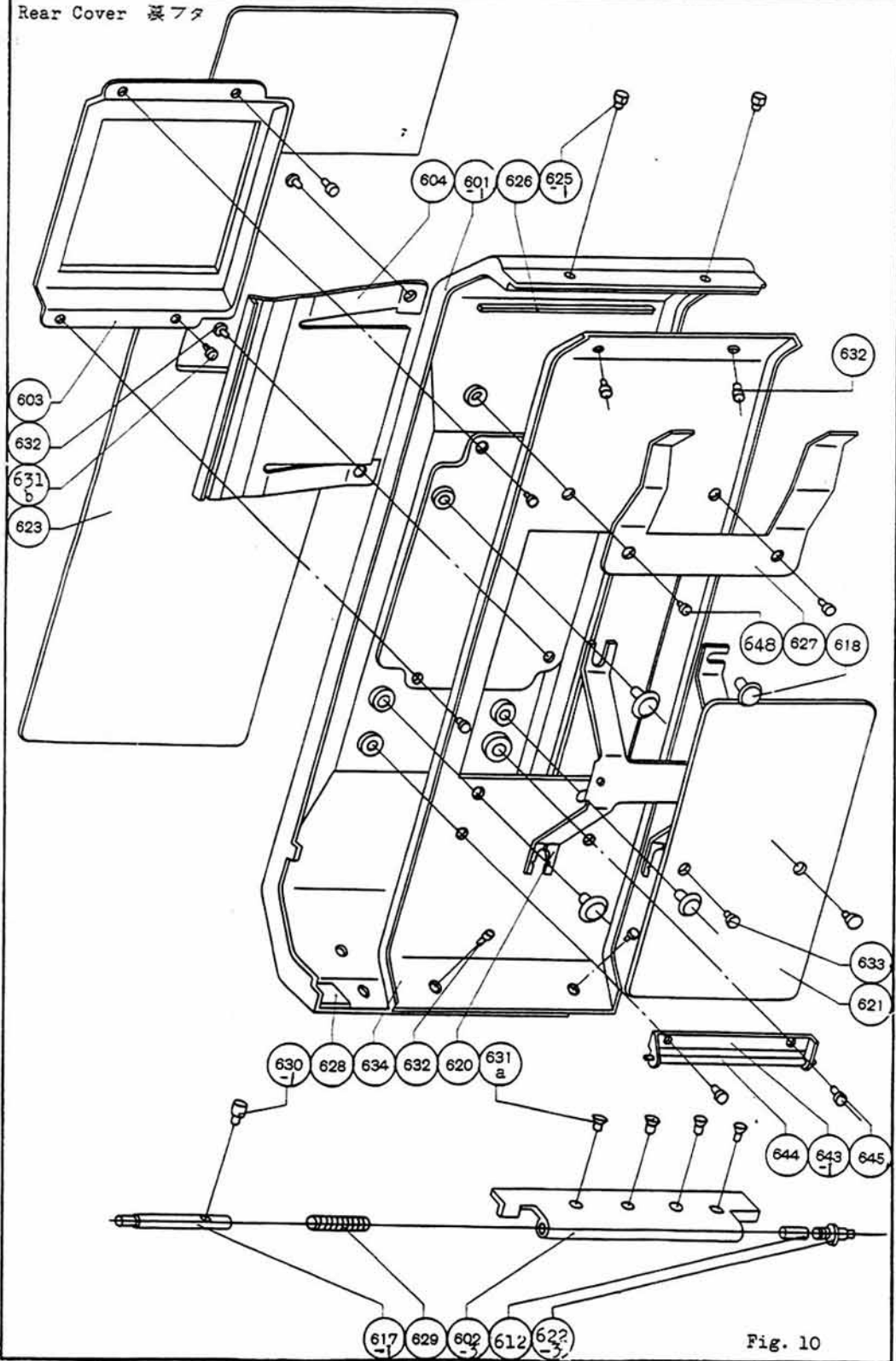

Fig. 10

5. Electrical Wiring 電気結線図

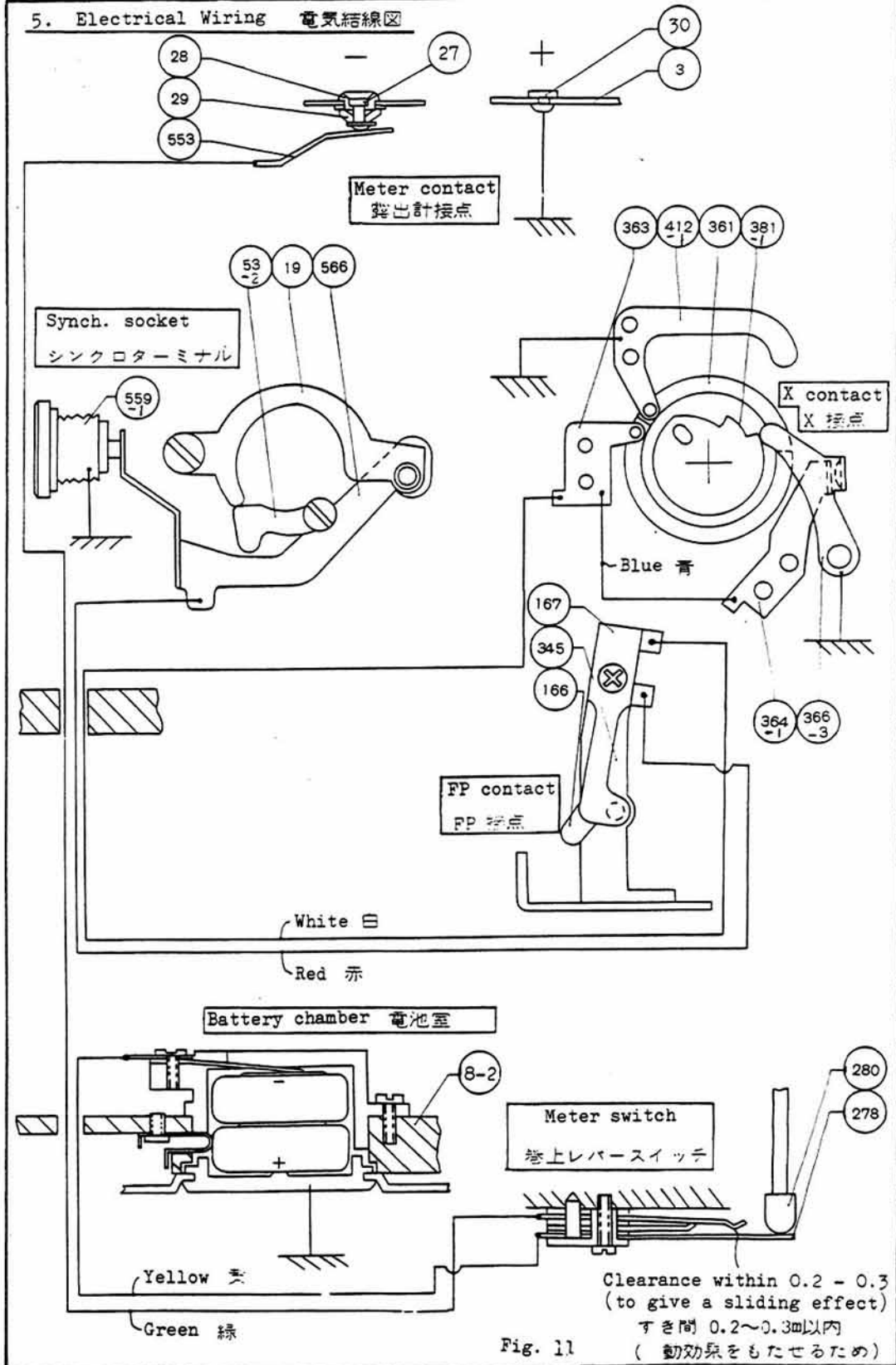

Fig. 11

6. Sectional views of Main part 主要部断面図

30FB - R.2012.B

Sectional View of the Spool and spocket スプール、スプロケット断面図

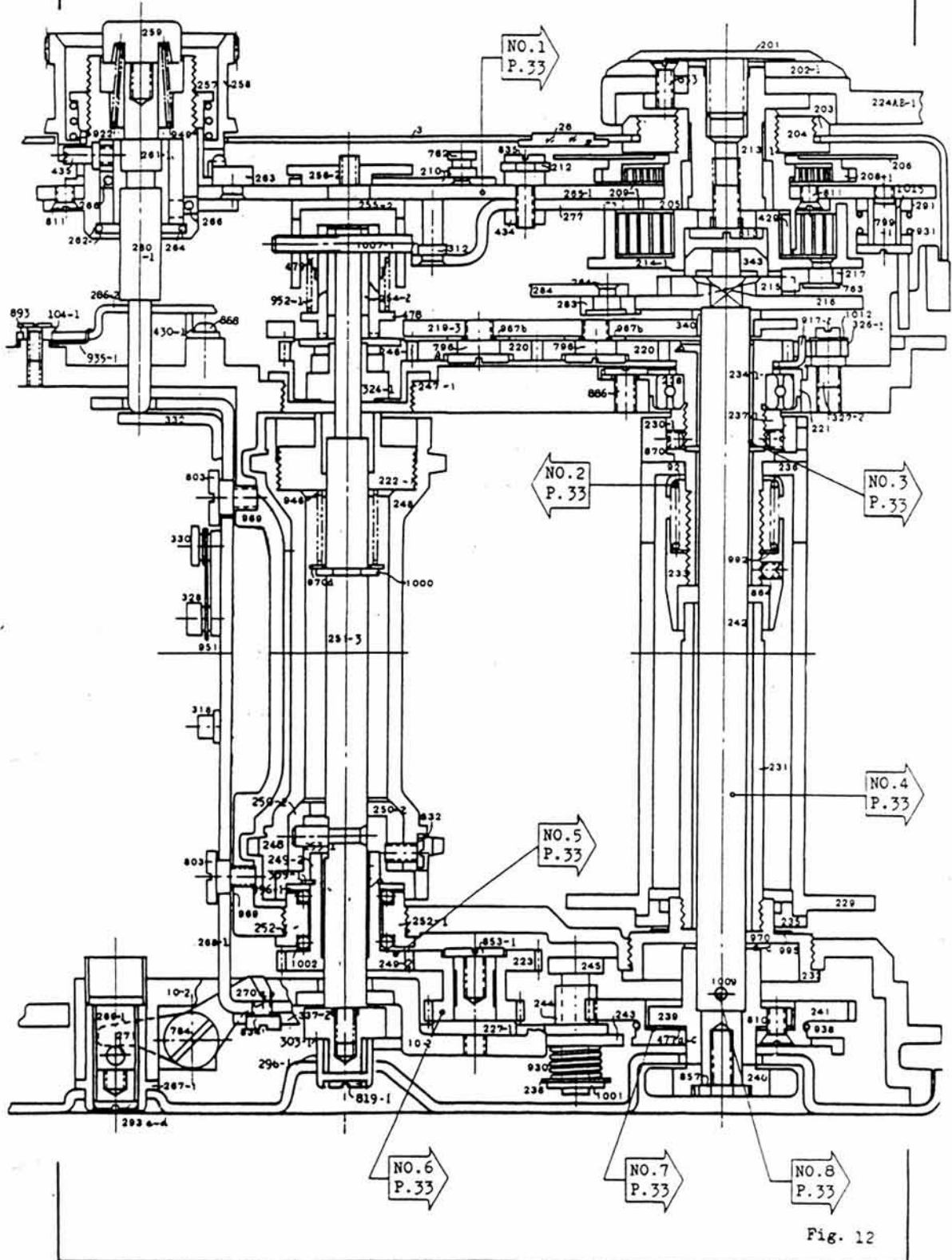

Fig. 12

2

Sectional View of the Shutter シャッター断面図

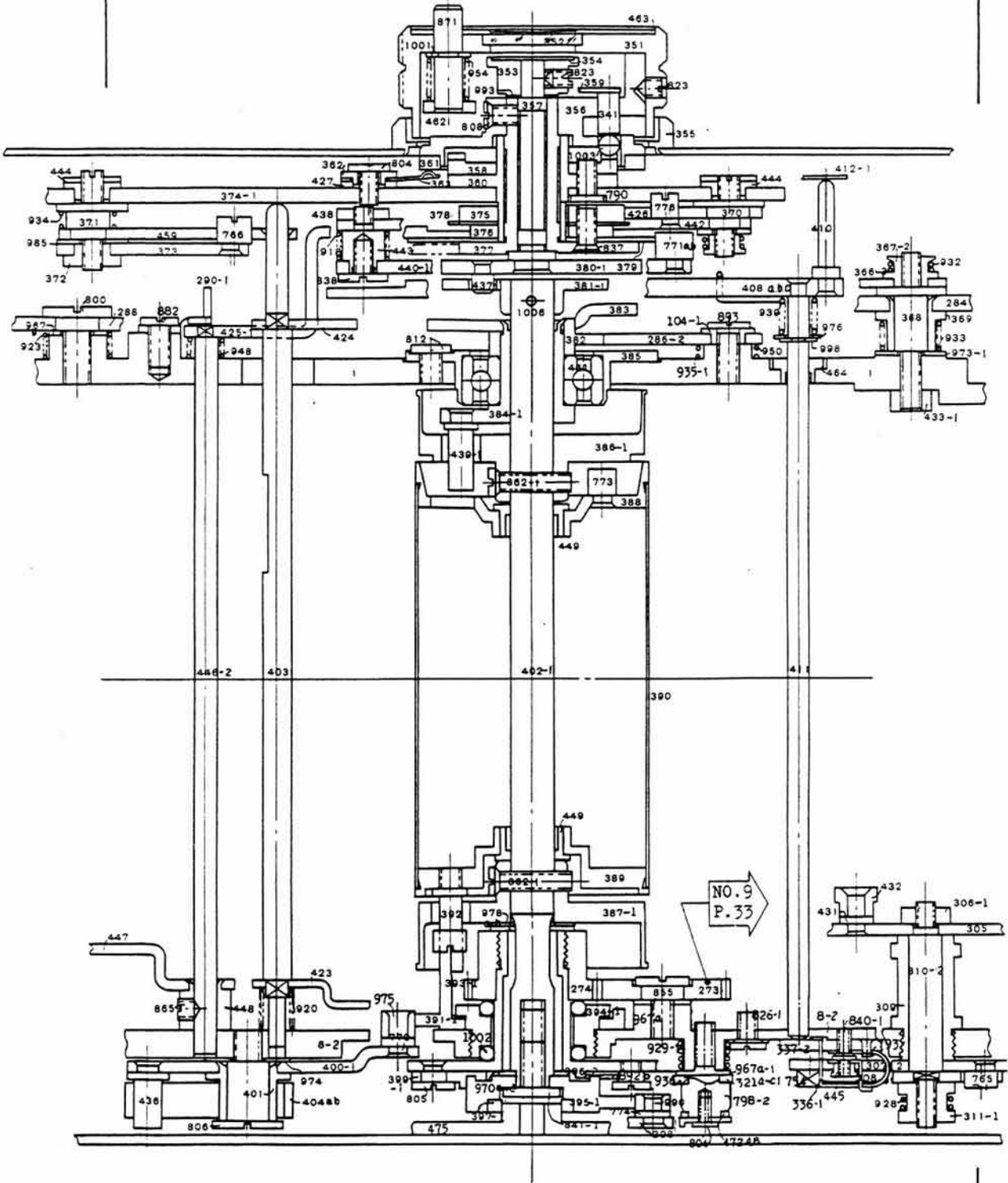

Fig. 13

22

Sectional View of the Shutter Curtain Tube 絞機部断面図

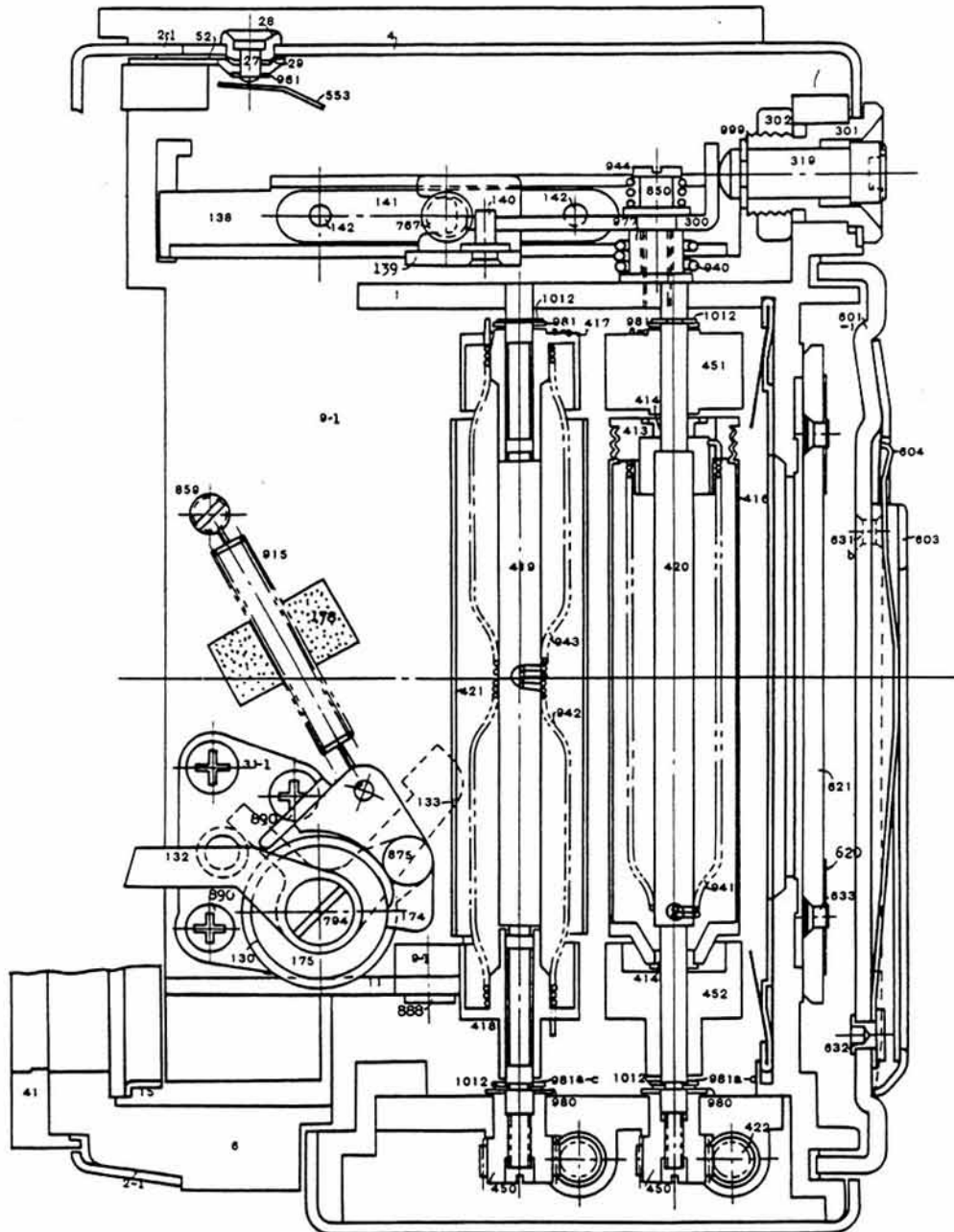

Fig. 14

Sectional View of the Rewind Shaft 巻戻し軸断面図

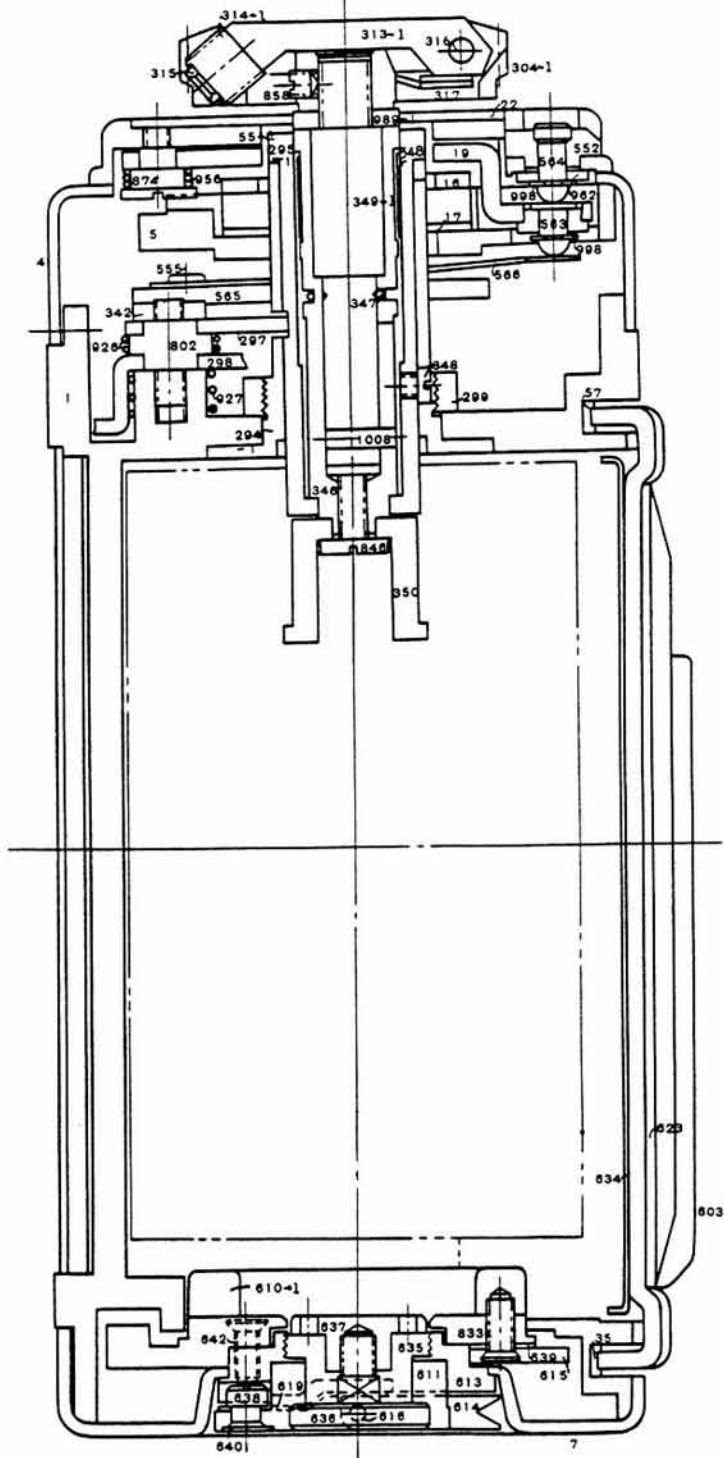

Fig. 15

24

Bottom View of the Body ボデー底部平面図

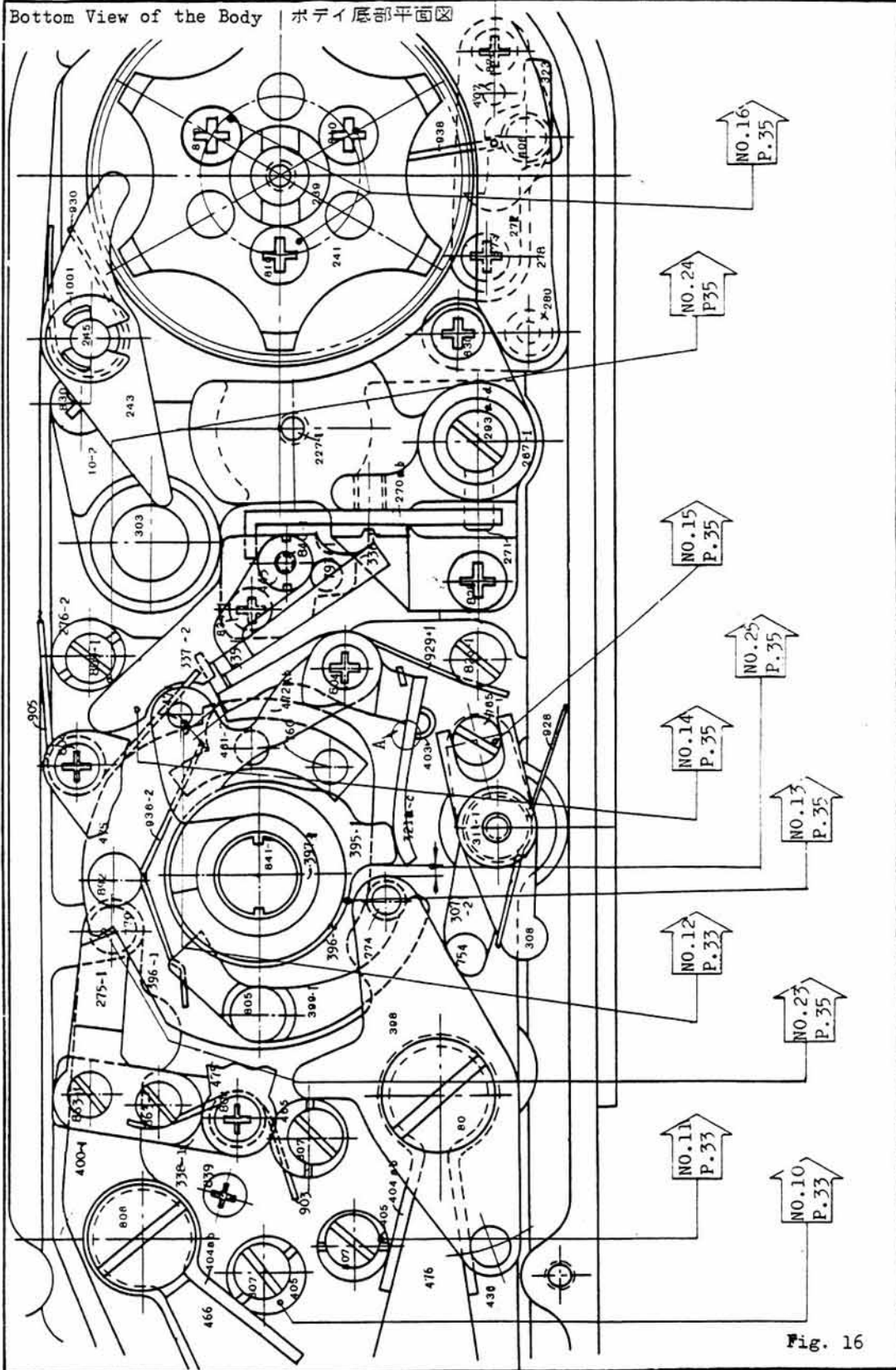

Fig. 16

Top View of the Body ボディ上部平面図

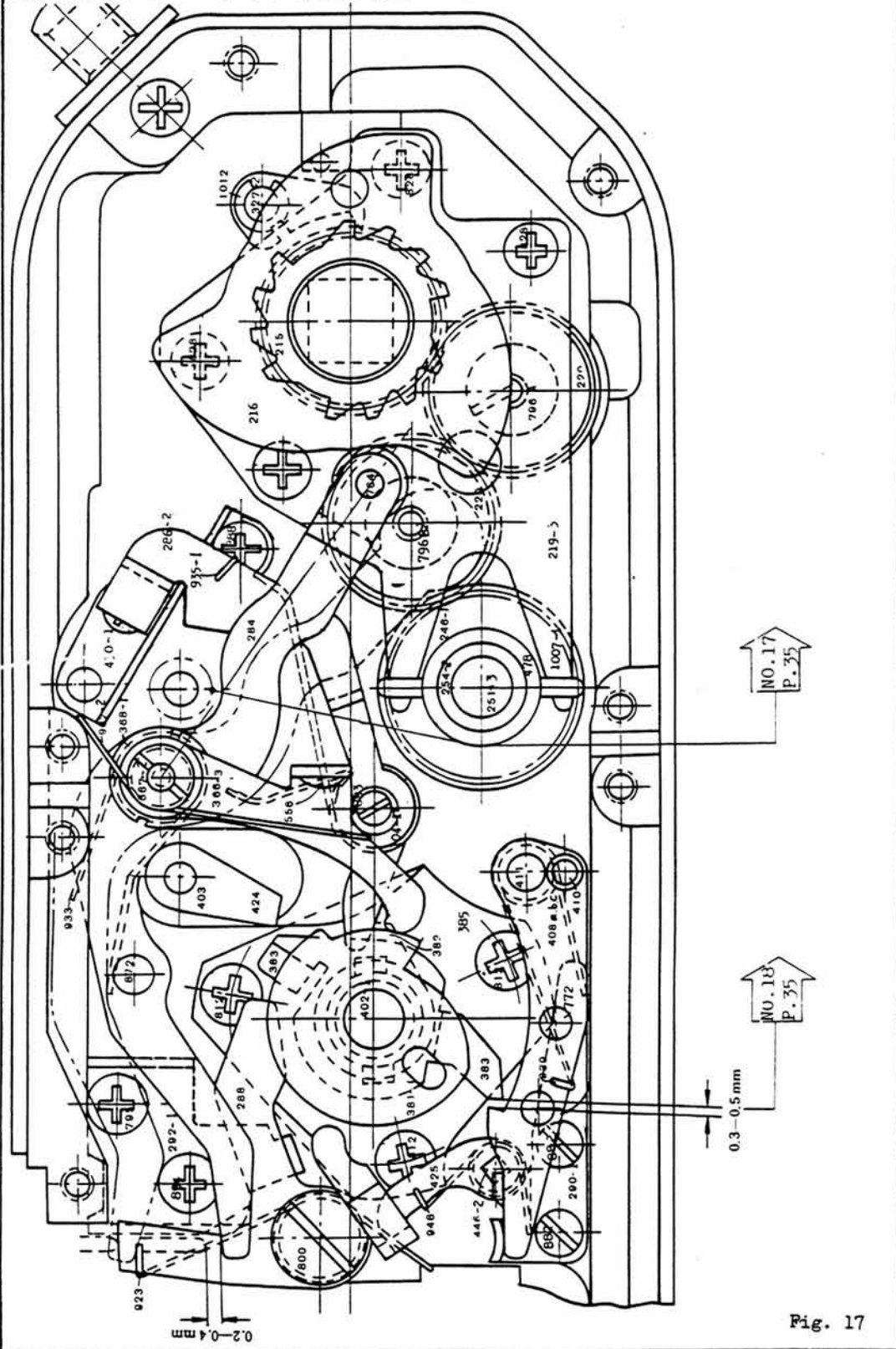

Fig. 17

Side View of the Mirror Box ミラーボックス平面図

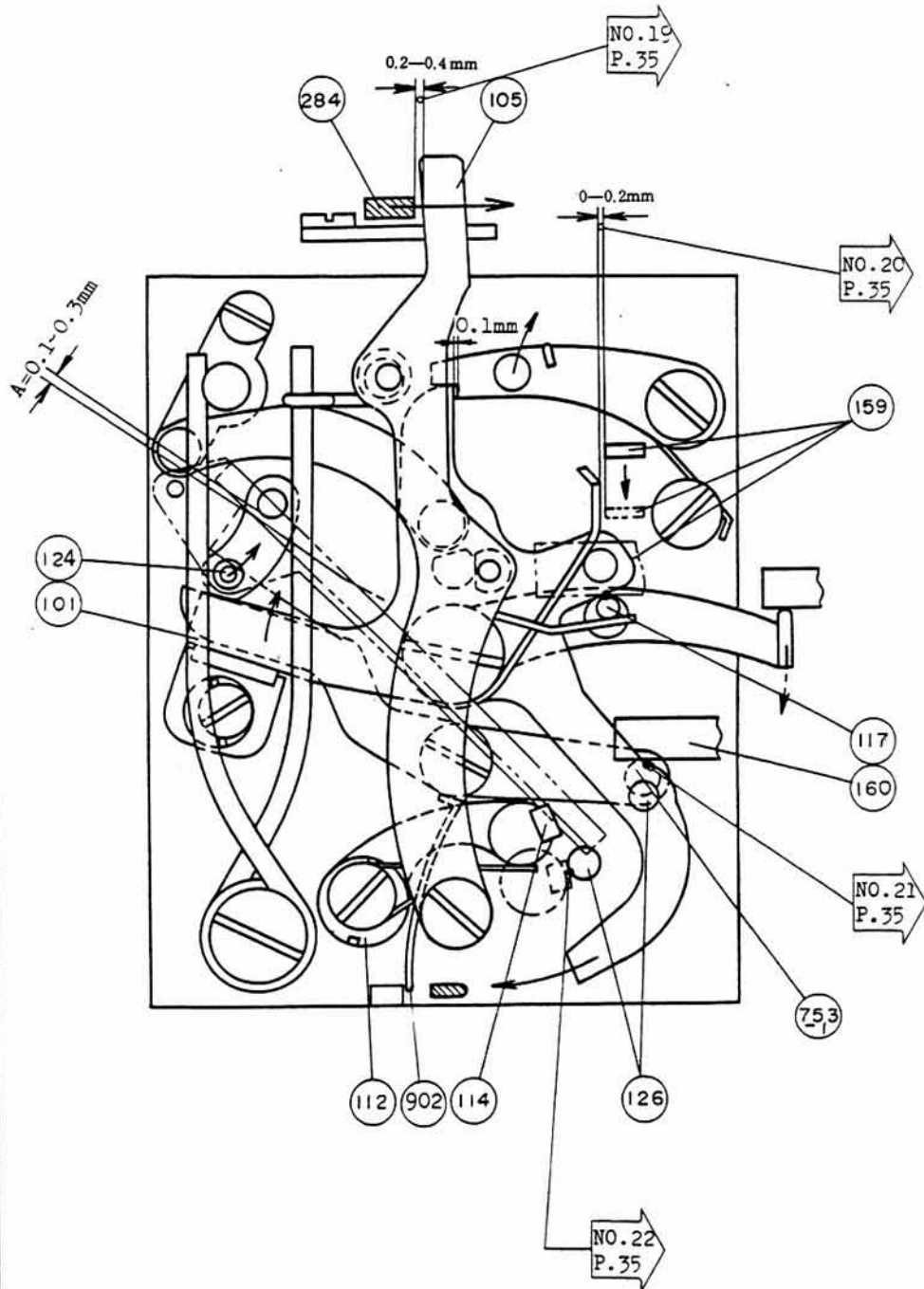

Fig. 18

27

8. Relative Angles 関係角度図

(Sectional Views from top of the Camera)
 カメラ上方より見た図

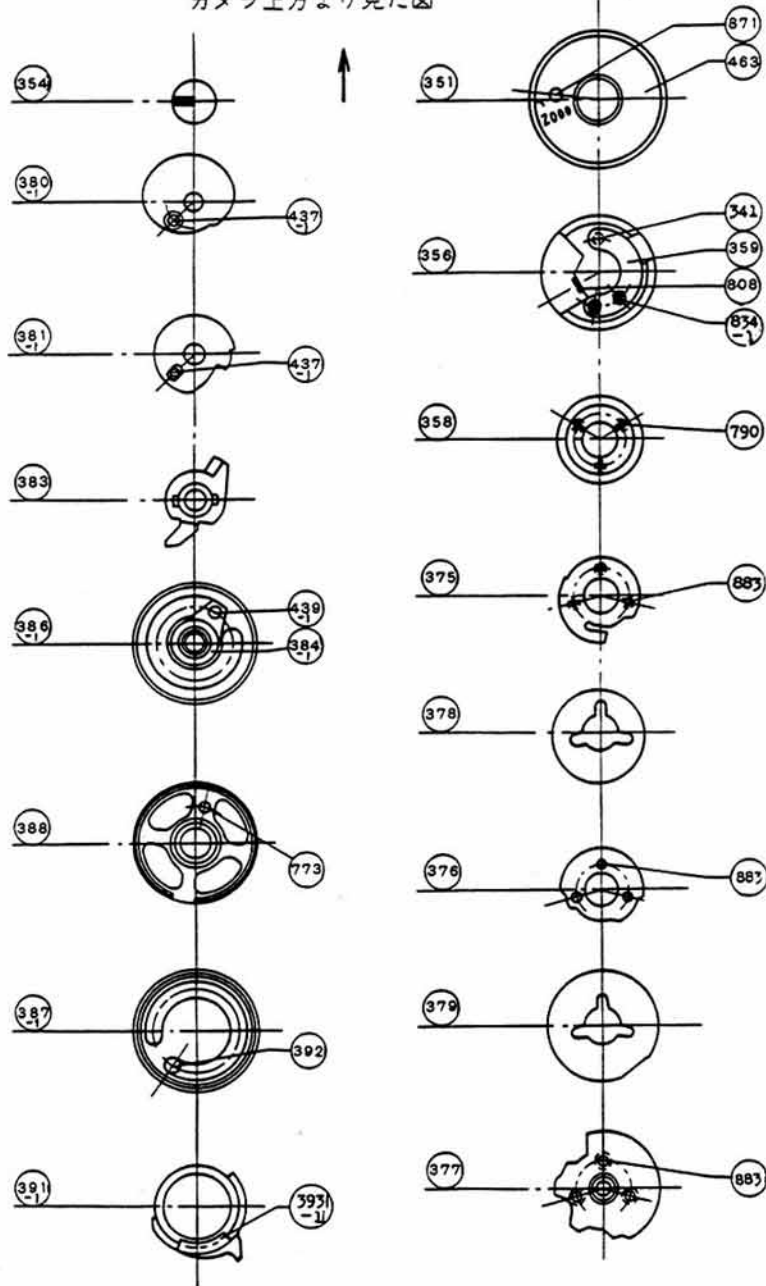

Fig. 19

82

9. Attaching the shutter curtains

(Unit : mm)

	Standard	Allowance
Overlap	3.4	2.8-3.2
Clearance of front curtain	3.2	3.0 <
Clearance of rear curtain	6.2	5.9-6.5

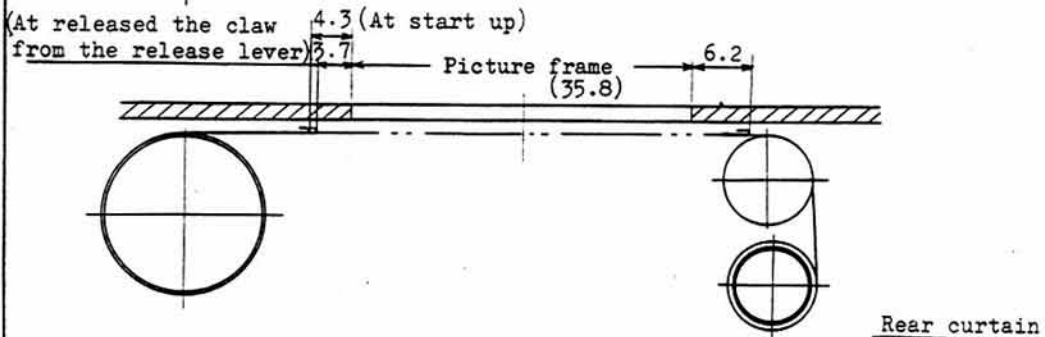
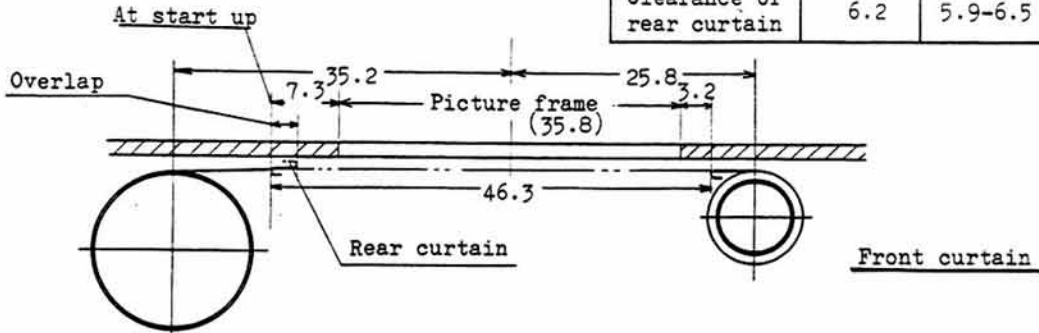

1. For correct positioning, make the clearances between the picture ends and the curtain end plates over 3mm at the time when the front curtain comes in contact with the stopper. Adhere the front curtain parallel to the picture ends. First, attach the ribbon to the pulley, and then the curtain to the front spring tube.
2. Correct the parallelism of the rear curtain principally in reference that of the front curtain. Make the overlap of the two curtains 2.8 - 3.2 mm.

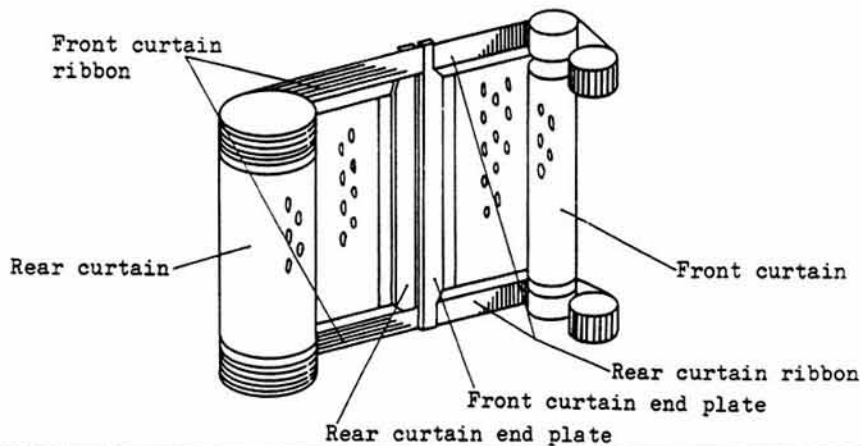
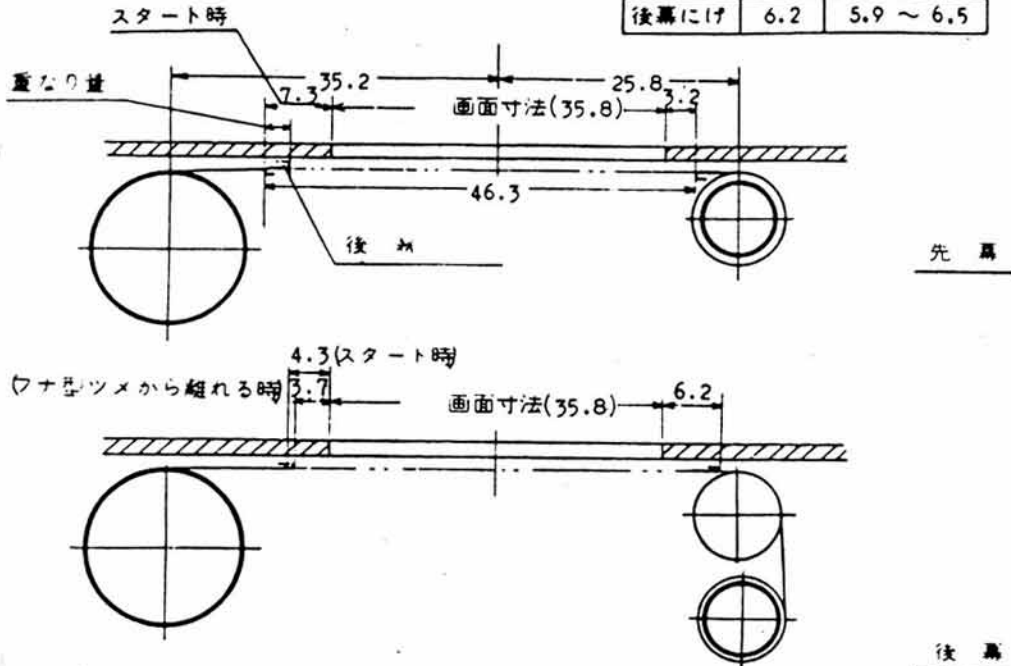

Fig. 20

9. 幕貼り要領図

	規 準	規 格
重なり	3	2.8 ~ 3.2
先幕にけ	3.2	3.0
後幕にけ	6.2	5.9 ~ 6.5



1. 先幕の位置決めはシャッター落ち（完全に制限に当たっていること）の位置で画面と幕枠との間隔を3mm以上にする。先幕は画面に平行に貼ること。貼付は紐を先にプーリーに付け次に先ばね筒に幕を付ける。
2. 後幕の修正は主として先幕に合わせる。先幕との平行を出し、先幕との重なり量を2.8~3.2に出す。

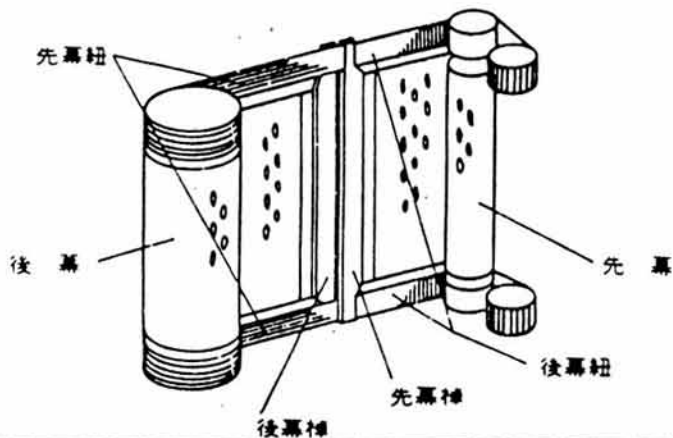

Fig. 21

10. Accuracy Adjustments

(1) Adjustment of shutter speeds

(i) High speeds

1. Setting the shutter speed to X-contact (1/80 sec.), adjust the running speed of the rear curtain to 10ms (the reading on the shutter tester will be 8.8 ± 0.2 ms).
2. See that parallelism between the front and rear curtains is maintained, setting the shutter speed to 1/80 sec and 1/1000 sec.
3. Using the large eccenter and small eccenter, adjust the shutter speed to 1/1000 sec.
4. Changing the width of the slit on the high speed cam (#375), adjust the shutter speed to 1/2000 sec.
Changing the tension of the front curtain, make the running speeds the start and at the end equal to each other. (Do not change the tension of the rear curtain, because this gives an influence to the slow speeds).
5. Check for the correct speed at each shutter speed indication on the shutter speed dial.

(ii) Low speeds

1. Setting the shutter speed to 1/30 sec, adjust the angle of the change-over axle relative to the governer.
2. Setting the shutter speed to 1/4 sec, attach the governer.
Check the relationship between the slow bottom lever (#423) and the second brake ring (#391-1).
3. Using the large eccenter and small eccenter, adjust the shutter speeds to 1 sec and 1/4 sec.
4. Adjust the shutter speed to 1/60 sec.
5. Check for the correct speed at each shutter speed indication on the shutter speed dial.

(iii) Extra-low shutter speeds

1. Adjust the eccenter pin (#318) so that the rear curtain starts running at the same time the self-timer stops operation.
2. Attach the self-timer dial (#655) in such a position that the index on the self-timer lever (#651) comes into coincidence with the top end of the red line.
3. Make sure that the shutter is released at T. (the shutter release button remains depressed).
4. Make sure that the shutter release button (#259) returns to the original position, when the wind-up lever (#224A,B-1) is wound up.

10. 精度出し

(1) シャッタースピードの精度出し

(1) 高 速

1. X接点 (1/80秒) にて後幕速 10ms を出す。
(シャッターテスターでの読みは、 8.8 ± 0.2 ms)
先幕、後幕の平行をみる。
2. 1/1000秒にて先幕、後幕の平行をみる。
3. 大偏心、小偏心を使って、1/1000秒の秒時を出す。
4. 巻カム (#375) のスリワリの隙を調節して、1/1000秒の秒時を出す。
先幕のテンションを覚えて、元と末の速度を等しくすること。
(後幕のテンションは低速に影響しますから覚えてない方がよい。)
5. シャッターダイヤル上の各秒時をチェックする。

(11) 中 速

1. 1/60秒にして、ガバナーに対する切換軸の側角角度をセッ
2. 1/4秒にして、ガバナーを取付ける。
スロー下レバー (#423)、後プレーキリング (#391-1) との関係をみる。
3. 大偏心、小偏心を使って、1/4秒、1/4秒を出す。
4. 1/60秒を出す。
5. シャッターダイヤル上の各秒時をチェックする。

(111) 超スローシャッター

1. セルフタイマーの停止直前に、後幕が解除されるようにする。
2. タイム自盛 (#655) の赤いの上端がセルフ作動レバー (#651) の
指標と合うように、位を決める。
3. T になることを確認する。(押しボタンは引っこんだままになる。)
4. 巻上げレバー (#224A, B-1) を巻き上げた時、押しボタン (#259)
復元するかどうかを確認する。

(iv) Adjustment of Time, Lock, Bulb.

1. Make sure of the correct operation for Time and Lock.
2. Make sure of the correct operation for Bulb. The incorrectness will be attributed to incorrect returning of the shutter vertical lever (#268-1), due to too weak tension of the spring (#947-2) or too strong tension of the release lever spring (#412-1).
Heaviness of the button is caused also by too strong tension of the spring (#268-1).

(2) Adjustment of the body-flange-back

Setting the shutter speed to T, remove the back cover.

Using the back-focus measuring tool and a dial indicator, measure the body-flange-back length. Adjust this to 46.5 ± 0.02 mm.

(3) Optical back focus

1. Using the autocollimeter, adjust the optical back focus to 46.5 ± 0.02 mm by means of the finder frame (#144a-e) and the adjusting liner (#143a-h).
2. Insert the finder screen (type A) and mount the finder.
Check the coincidence of the split images for an object at infinity. The coincidence accuracy should be kept within 30" on the collimeter scale.

(4) Height of the aperture coupling lever

See that the height is 3.1 ± 0.1 mm, using the measuring tool.

If not, bend the top of the aperture coupling lever (#102), using a plier.

(5) Interchangeability of Photomic Finder

If the mirror box be detached (do not detach it as a rule!),

determine the relative positions of the Photomic Finder locating pins (#751) to the lens mount, using the locating tool.

Thereafter, fix the locating plate in position.

(1V) T・L・B の精度出し

1. T・L の作動を確認する。
2. B の作動を確認する

-----シャッター縦レバー(#268-1)の戻り不良

スプリング(#947-2)のはねが弱い。}

舟型ばね(#412-1)が強すぎる。}

#947-2が強すぎても押ボタンが重くなる。

(2) バック出し

シャッターをTにし、裏フタを出し、バック外し工具とダイヤルインテ
グレーターにてバックを測定、調節する。(46.5 \pm 0.02に出す)

(3) オプティカルバック出し

1. オートコリメータを用い、視野枠(#144a-e)および調整座(#143a-h)に
て調整する。(46.5 \pm 0.02に出す)
2. A型ファインダースクリーンを入れ、ファインダーを装着し、 ∞ を覗き、
全致偏差が $\pm 30''$ 以内のこと。(スプリットの像のズレを見る)

(4) 絞りレバー高さ

(3.1 \pm 0.1に出す)

絞りレバー(#102)をヤットコにて先端を曲げて調整する。
工具にて調整する。

(5) フォトミックファインダー互換性



ミラーボックスを外した時は(通常は外さない)、フォトミック基準
ピン#751のレンズマウントに対する関係位置を、位置決め工具にて
出し固定する。

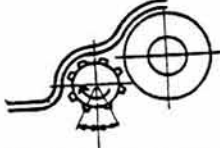

11. Assembling points

NO.	Point	
1	To attach the wind-up middle plate, release once the four attaching screws, and fasten them up in such a position that the winding up is not heavy and the wind-up lever correctly returns.	
2	For adjustment of the friction torque of the spool, hang a weight on the spool. Adjust the torque so that the spool does not slip by 220g and begins to slip by 260g.	
3	When correct positioning of the idle gear, the internal surface of the spool gear(#234-1) should not come in contact with the spool shaft (#242), because otherwise a heavy winding up.	
4	Here, make a small slack in the direction of thrust, because no slack will cause heavy winding up.	
5	Adjustment of the positions of the teeth of the sprocket: Every turn of the sprocket corresponding to eight teeth of this gear causes a rotation of 3° of the sprocket. When the sprocket is pushed in the direction of the arrow, two teeth of the sprocket should stay symmetrical.	
6	The slack on the direction of thrust is to be as small as possible (to avoid the difficulty of adjusting the R-button).	
7	Adjust the clearance between R lever and spool bottom gear by choosing the thickness of this washer, so that setting and releasing of R action correctly at any point the gear.	
8	This taper pin has been tempered for the specified hardness. Take caution not to mix the taper pin with other ordinary ones.	
9	For the correct positioning, move the bottom plate(#8-2).	
10	Adjustment of front brake spring.	• The too strong tension will cause too great a winding-up resistance.
11	Adjustment of rear brake spring.	• The too weak tension will cause too great a shock to the shutter. If the front curtain bounds, adjust the tension by #404a or #404b.
12	Bend A portion of the arm of the take-up stopper claw #321a-1 (or #321b-1, or #321c-1) using the tool, so that the catching depth of #461-1 against the arm becomes to 0.7±0.1mm.	

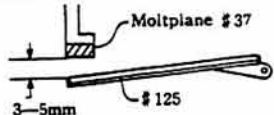
11. 組立要点

NO.	組立要点	
1	巻上げ中板の取り付けは、4本の取付けビスをゆるめておき、巻上げが軽く、かつ、巻上げレバーの戻りのよいところで締めつける。	
2	スプールフリクションの調整は、スプールにおもりを巻きつけ、220gのおもりでスリップせず、260gのおもりでスリップするように調節する。	
3	Eアイドルギアの位置出しを行なうとき、#234-1（スプールギア）の内径と#242（巻取軸）とが当たらないように注意のこと。当たると巻上げが重くなる。	
4	スラストガタは小さい方がよい。（Rボタンの調整がむつかしくなるため）	
5	<p>スプロケットの歯の位置出しの場合、このギアの歯を8枚ずらすとスプロケットの歯を3°修正することができる。</p> <p>（矢印の方向に寄せたときに振分けになるように調整）</p>	
6	スラストガタをつけること ガタがないと巻上げが重くなる。	
7	ARレバーとスプール下ギヤー間隔調整ワッシャーを選択使用して、Rのセットと解除がギヤーの全周にわたり、確実に行われるようにする。	
8	焼入れテーパピン（強度必要につき） 一般品と混入しないよう注意	
9	#8-2（底板）を動かして位置出しのこと	
10	後ブレーキばね調整用	強からず、弱からず
11	先ブレーキばね調整用	<ul style="list-style-type: none"> 強すぎると巻上げ抵抗が大きい 弱すぎるとシャッターのショック及び音が大きい 先幕のパウンド発生時は#404a, bにて選択調整すること
12	#461-1と#321a-1～#321c-1とのかかり量を、0.7 ^{±0.1} になるよう工具にて#321a-1～#321c-1の腕A部を曲げて調整する。	

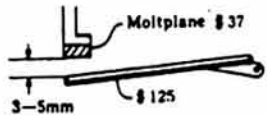
13	clearance is correctly 0.2mm between #395-1 and #990 (front brake collar). If not, select the proper one of #321a-1, #321b-1 and #321c-1.	
14	Adjust the clearance becomes to within 0.1mm by #336-1. After adjustment, check the operation of shutter vertical lever (#268-1).	
15	Adjustment of the releasing position of the shutter during rising of the mirror. Make this adjustment so that the shutter is released when the clearance becomes 3-5mm.	
16	Correct clearance between the ratchet and ratchet wheel keep a small clearance so that no insufficient winding up occurs.	
17	Safety device for the shutter releasing button is to be adjusted by eccentering the safety lever (#104-1)	
18	If no clearance between the release lever #408 and second curtain claw #383, the curtain will not be opened. In this case, replace #408. (Select the proper one of #408a, b or c.)	
19	If too large, an insufficient driving power will result.	
20	The too large clearance will cause shutter releasing only by depressing the release button (mirror does not operate).	
21	Make the clearance as small as possible, but no contact. If not, it caused a clearance is made at the time of the mirror lifted up.	
22	Change the eccentering of the stopper #112 for mirror drive lever #101 to make the clearance A becomes to 0.1 -- 0.3mm, to avoid causing sound or shock.	
23	Under the state where wind-up lever is loaded, release #863-1 and adjust #275-1 so that the clearance becomes to 0.05mm or less. After adjustment, check the correct catching of #275-1 against #396-2 at the end of wind-up stroke.	
24	Change the eccentering of the collar #276-2 to make the clearance becomes to within 0.1mm. After adjustment, check the operation of the shutter vertical lever (#268-1).	
25	See if the clearance is correctly 0.2 -- 0.6mm between #395-1 and #990 (front brake collar). If not, select the proper one of #321a-1, #321b-1 and #321c-1.	

13	#395-1と#990(先ブレーキカラー)とのすき間0.2mmを確保のこと (#321a-1~#321c-1を選択して調整)。	
14	すき間0~0.1に#336-1を調整する。調整後、レバー(#205-1)の動き 具合をチェックする。	
15	ミラー上昇中のシャッターの切れる位置は#37(ナ ルトブレン)と#125(ナリトリ)のすき間が3~5mm になるように調節する。	
16	ラチェットとラチェット歯の位置出しは2回巻き上げ になったらようすき間を小さくすること。ただし、 巻き上げレバー連り角は強要に調整すること。	
17	押ボタン安全装置 #104-1(安全レバー中心)にて調整する。	
18	船型(#408)と後おつめ(#383)のスキマが、なくなると、開かず。 代換しは、#408a, b, cの交換で可能。	
19	すき間が大きいとミラーの駆動力不足となる。	
20	すき間が大きいとミラー空転となる。	
21	できるだけすき間を小さくすること(接触してはいけません)大きいと、 ミラーアップ時#37(ナルトブレン)と#125(ナリトリ)のすきまが出る。	
22	ミラーアップ時、#101(レバー)のストッパーとなる#112(偏心)を回して、 すき間Aを0.1~0.3にする。(シャッター閉、ショック時)	
23	巻き上げレバーに力をかけた状態で、すき間が0.05以下になるように#863-1を ゆるめて、#275-1を調整すること。(調整後巻き上げ完了時に#275-1が #396-2に確実に落ち込むかどうか、チェックすること)。	
24	すき間0~0.1に偏心カラー#276-2を調整する。 調整後、板レバー(#268-1)の動き具合をチェックする。	
25	#395-1と#990(先ブレーキカラー)とのすき間0.2~0.6を確保のこと。 (#321a-1~321c-1を選択して調整する。)	

Nikon

Nikon F2 (Body)

ニコン F2 (ボディ)

PARTS LIST (Revised-1)

部 品 表 (改訂-1)



NIPPON KOGAKU K.K.

Tokyo, Japan

CONTENTS

	Page
Parts List	1 - 75
Subassembly List	76 - 83

This Parts List and Subassembly List are applied to the products manufactured up to June 22th 1976











目 次

部 品 表.....	1~75
部 組 品 表.....	76~83

•この部品表および部組品表は、1976年6月22日までの製品に適用します。

Parts List

30FB - R.2012.B





Part No. 部品番号	Name and Shape 名称および形状	Pcs. per Unit 1台分個数	Reference Subassembly No. 参照部組品番号	Reference Fig. No. 参照図番	Term of Use 販売区分	Remarks 備考
1	Body casting 本体 	1		13, 14 15	×	*50F1017 *Rev.
2-1 ⁽⁰¹⁾ (02)	Front cover エプロン 	1		14	○	-1
3	Top cover (right) ^{WIND} 右上蓋 	1	(01) A31-1 ⁽⁰²⁾	2, 11 12	△	
4	Top cover (left) 左上蓋 	1	A32 ⁽⁰¹⁾ (02)	2, 14 15	△	
5	Accessory shoe base plate シュー座 	1	*A29	3, 15	○△*	*Rev.
6	Front plate 前板 	1	E-2	8, 14	△	
7	Bottom cover 底蓋 	1	J-1	6, 14 15	△	
*8-2	Bottom plate 底板 	1	B-1	11, 13	△	*-16-25001 *Rev.
9-1	Mirror box casting ミラーボックス 	1	F-1	9, 14	△	-10-15001
10-2	Idle gear bottom plate アイドルギア用底板 	1	A38-2	7, 12 16	△	-13
11	Bottom light baffle 下透光板 	1	F-1	9, 14	△	













Revision (訂正)











— 1 —





















Date Jun. 22th 1976











4















Part No. 部品番号	Name and Shape 名称 および 形状	Pcs. per Unit 1百分個数	Reference Subassembly No. 参照部品番号	Reference Fig. No. 参照図番	Term of Sale 販売区分	Remarks 備考
Blank 欠						
13	Rear light baffle 後側遮光板 	1	F-1, F12-1	9	△	
14-1	Battery chamber cap 電池キャップ 	1		6	○	-13
15	Front light baffle 前側遮光板 	1	E-2	8, 14	○△	
16	Accessory shoe clip シュー足 	1		3, 15	○	
17	Shoe spring シューバネ 	1		3, 15	○	
18	Eyelet 耳 	2	A39		△	
19	Shoe contact safety lever ストロボ感電防止レバー 	1	H-1 H1	2, 11	△	
#20-3	Battery chamber 電池室  プラス #25 丸2-17025FR	1	B8-1	5 ¥60-	△ ○	no. 8815 -13 *Rev.
#21-1	Battery contact plate 電池室バネ 	1	B8-1	5 ¥10-	△ ○	no. 8815 -13
22	Shoe cover シュー飾板 	1		2, 15	○	
23	Tripod female screw 三脚ネジ 	1	A35	7	△	
24	Tripod screw mount 三脚座 	1	A35	7	△	
#25	Lug ラグ板 	1	B8-1	5 ¥20-	△ ○	no. 8815















Part No. 部品番号	Name and Shape 名称および形状	Pcs. per Unit 1台分個数	Reference Subassembly No. 参照部組品番号	Reference Fig. No. 参照図番	Term of Sale 販売区分	Remarks 備考
26	Frame counter window コマ数計窓 	1	A31-1	12	○△	
27	Meter contact(hot) 露出計絶縁側接点 	1	A32	2, 11 14	○△*	*Rev.
28	Contact insulating collar 露出計接点絶縁カラー 	1	A32	2, 11 14	○△*	*Rev.
29	Contact(hot) bush 絶縁側接点受 	1	A32	2, 11 14	○△*	*Rev.
30	Meter contact(ground) 露出計アース側接点 	1	A31-1	2	○△	
31	Leatherette 貼皮 	1			○	
32	Leatherette 貼皮 	1	¥120-	1	○	no. 58064
33	Leatherette 貼皮 	1		1	○	
35	Light-tight 裏蓋溝用モルトブレン 	1		15	○	
36A	Mirror cushion ミラ - 制限 	1	F-1		○△	-12
36B	" " 	1	F-1		○△	-12
#37	Finder cushion ファインダー受けモルトブレン 	1		1	○	*要求1袋 (100枚入)











Part No. 部品番号	Name and Shape 名称および形状	Pcs. per Unit 1台分個数	Reference Subassembly No. 参照部組品番号	Reference Fig. No. 参照図番	Term of Sale 販売区分	Remarks 備考
39	Light-tight 漏光防止モルトブレン 	1			○	
40	Light-tight 漏光防止モルトブレン 	1			○	
41	Bayonet バヨネット 	1	E-2	8, 14	○△	
42	Lens lock pin ロックピン 	1	E-2	8	○△	
43	Lock coupling ロック運動板 	1	E-2	8	○△	
44	Lens lock button 着脱釦 	1	E-2	8	○△	
45	Lens lock button shaft 着脱釦軸 	1	E-2	8	○△	
46	Finder locating plate ファインダー基準ピン座板 	1	A34	14	△	
47	Lens lock button sleeve 釦軸メタル 	1	E-2	8	○△	
#48	Bayonet spring バヨネットバネ 	3	E-2	8	○△	*-19 *Rev.
Blank 欠						
Blank 欠						
51-1	Top cover retainer 上蓋押え板 	1	A31-1	2	○△	







Part No. 部品番号	Name and Shape 名称および形状	Pcs. per Unit 1台分個数	Reference Subassembly No. 参照部組品番号	Reference Fig. No. 参照図番	Term of Sale 販売区分	Remarks 備考
52	Top cover retainer 上蓋押え板 	1	A32	2, 14		*Rev.
53-2	Shoe contact signal lever シュー接点シグナルレバー 	1	H-1	2, 11		-12
54	Shoe contact sleeve シュー接点棒受 	1	H-1 H1	2		
55-1	Accessory shoe シュー 	1	H-1	2, 15		-5-5001
57	Camera back light-tight 裏蓋溝用モルトブレン 	1		15		
58	Mirror light-tight, left ミラー左モルトブレン 	1	F-1 x 1			
(DEP) 59	Synchro light-tight 漏光防止モルトブレン 	1				USE 1K115-27/ CUTTED
60	Eyelet bush 耳ブッシュ 	2	A39			
63	Mirror light-tight, right ミラー右モルトブレン 	1	F-1			
64	Light baffle mount カーテン止め板 	1	A40			









Part No. 部品番号	Name and Shape 名称および形状	Pcs. per Unit 1台分個数	Reference Subassembly No. 参照部組品番号	Reference Fig. No. 参照図番	Term of Sale 販売区分	Remarks 備考
65	Light baffle, mirror box, top ミラーボックス側カーテン下 	1	F12-1		△	
66	Light baffle, mirror box, bottom ミラーボックス側カーテン上 	1	F12-1		△	
67	Light baffle, body, lower ボディ側カーテン(下方用) 	1	A40		△	
69	Light baffle, body, upper ボディ側カーテン(上方用) 	1	A40		△	
70	Light baffle blind 遮光板穴ふさぎ 	4			○	RP. 8535
*71	Shoe signal lever collar シューシグナルレバー カラー 	1	H-1		△	-11-10001 *Add.
73	Triangular grommet K100-035 三角環 	2			○	*50F1008 *Rev. -12-35001
74	Protection pad 当て革 	2			○	*50F1008 *Rev. -13-16001
75	Protection seat 保護シート 	2			○	*50F1008 *Rev. -12-35001
*76A	Dust-tight packing (White) 防ジンのパッキン (白) 	1			○	*Add. 50F1053 -15-15001
*76B	" (Black) 防ジンのパッキン (黒) 	1			○	*Add. -15-15001 50F1053











Part No. 部品番号	Name and Shape 名称 および 形状	Pcs. per Unit 1台分個数	Reference Subassembly No. 参照部組品番号	Reference Fig. No. 参照図番	Term of Sale 販売区分	Remarks 備考
101	Mirror drive lever 主レバー 	1	F-1 F2	9, 18	△	
102	Aperture coupling lever 絞りレバー 	1	F-1 F1	9	△	
103	Drive lever stopper 主レバーストッパー 	1	F-1 F10	9	△	
104-1	Stopper adjusting ring 主レバーストッパー調整リング 	2	F-1	9	○△	-3
105	Vertical lever 縦レバー 	1	F-1 F9	9, 18	△	
106	Mirror-up lever ミラーアップレバー 	1	F-1 F6	9	△	
107	T-shaped lever T型レバー 	1	F-1 F2	9	△	
108	Release hook リリースカギ 	1	F-1 F8	9	△	
109	Vertical lever pin 縦レバーピン 	2	F-1 F2×1, F9×1		△	
110	Connecting lever 連結レバー 	1	F-1 F2	9	△	
111	Mirror-up stopper ミラーアップストッパー 	1	F-1 F3	9	△	
112	Stopper adjusting ring ストッパー調整リング 	1	F-1	9, 18	○△	
113	Spring holder カギバネ掛けピン 	1				Dis. 廃止
114	Mirror-up stopper ミラーアップストッパーゴム 	1	F-1 F3	9, 18	○△	













Part No. 部品番号	Name and Shape 名称および形状	Pcs. per Unit 1台分個数	Reference Subassembly No. 参照部組品番号	Reference Fig. No. 参照図番	Term of Sale 販売区分	Remarks 備考
115	Mirror-up stopper pin ミラーアップストッパーピン 	1	F-1 F3	9	△	
116	Main lever rubber stopper 主レバーストッパーゴム 	1	F-1 F10	9	△	
117	Stopping down lever pin 絞りレバーピン 	1	F-1 F1	9, 18	△	
118	Stopping down spring holder 絞りバネ掛けピン 	1	F-1 F2	9	△	
119	S-shaped ring holder S型リング掛けピン 	1	F-1 F9	9	△	
120	S-shaped ring S型リング 	1	F-1	9	○△	
121	Mirror holder pin チリトリピン 	1	F-1 F4-1	9, 18	△	
122	Mirror holder mount チリトリ保持板 	2	F-1 F5-1	9	△	
123-1	Mirror axle ミラー軸 	2	F-1, F5-1	9	△	-2-5001
124	Mirror pin ミラーピン 	1	F-1 F4-1		△	
125	Mirror holder チリトリ 	1	F-1 F4-1	9	△	
126	Mirror-up stopper pin ミラーアップストッパーピン 	1	F-1 F2	9, 18	△	
127	Mirror stopper ミラーストッパー 	1	F-1 F4-1	9	△	
128	Sync-circuit board contact シグクロ配線板接点 	1				Dis.廃止







Part No. 部品番号	Name and Shape 名称および形状	Pcs. per Unit 1台分個数	Reference Subassembly No. 参照部組品番号	Reference Fig. No. 参照図番	Term of Sale 販売区分	Remarks 備考
129	Nut ナット 					Dis.廃止
130	Mirror brake ring ミラーブレーキ環 	1	F-1 F7-1	9, 14	△	
131-1	Baffle lever holder 緩衝レバー地板 	1	F-1, F7-1	9, 14	△	-10
132	45° adjusting lever 45° 調整レバー 	1	F-1	9, 14	○△	
133-1	45° stopper 45° ストッパー 	1	F-1	9, 14	○△	-10
134	Mirror brake axle ミラーブレーキ軸 	1	F-1	9	○△	
135-1	45° eccentric pin 45° 偏心ピン 	1	F-1, F7-1	9, 14	△	-10
136-1	Mirror holder bracket チリトリ保持板 	1	F-1, F4-1	9	△	-2-5001
137-1	Mirror holder bracket チリトリ保持板 	1	F-1, F4-1	9	△	-2-5001
138	Finder holder lever プリズム枠保持レバー 	1	F-1 F11	9, 14	△	











Part No. 部品番号	Name and Shape 名称および形状	Pcs. per Unit 1台分個数	Reference Subassembly No. 参照部組品番号	Reference Fig. No. 参照図番	Term of Sale 販売区分	Remarks 備考
139	Finder holder connector 引出し差し手 	1	A28		△	
140	Pin ピン 	1	A28		△	
141	Focusing screen spring ビントガラス押えバネ 	1	F-1 F11	9, 14	△	
142	Focusing screen stopper ビントガラス押え 	2	F-1 F11	9, 14	△	
#143a	Focus adjusting liner t = 0.05 調整座金 	1			○	
#143b	t = 0.06	1		9	○	-1
#143c	" " t = 0.07	1		9	○	-1
#143d	" " t = 0.08	1		9	○	-1
#143e	" " t = 0.09	1		9	○	-1
#143f	" " t = 0.10	1		9	○	-1
#143g	" " t = 0.11	1		9	○	-1
#143h	" " t = 0.12	1		9	○	-1
144a	Finder field frame 視野枠 t = 1.1 	1	F-1	9	○△	-1
144b	t = 1.2	1	F-1	9	○△	-1











Part No. 部品番号	Name and Shape 名称および形状	Pcs. per Unit 1台分個数	Reference Subassembly No. 参照部組品番号	Reference Fig. No. 参照図番	Term of Sale 販売区分	Remarks 備考
144c	Finder field frame 視野枠 $t = 1.3$ 	1	F-1	9	○△	-1
144d	" $t = 1.4$	1	F-1	9	○△	-1
144e	" $t = 1.5$	1	F-1	9	○△	-1
145	Light-tight frame 遮光枠 	1	F-1	9	○△	
146	FP contact insulating pin 高速接点絶縁ピン 	1	A26	5	△	
147	Main spring nut 主バネナット 	1	F-1		○△	
148	Neon tube ネオン管 					Dis.廃止
149	Neon tube retainer ネオン管押え 					Dis.廃止
150	Stopper plate 制限板 	2	E-2	8	○△	
151	Button top LENS RELEASE STEPPING DOWN BUTTON (ON TOP OF LENS RELEASE BUTTON) ボタン "BLACK" 	2	E-2	8	○△	
152-2	Mirror-up cam 	1	E-2	8	○△	-5













Part No. 部品番号	Name and Shape 名称 および 形状	Pcs. per Unit 1台分個数	Reference Subassembly No. 参照部組品番号	Reference Fig. No. 参照図番	Term of Sale 販売区分	Remarks 備考
153-1	Stopping down button axle 絞り込みボタン軸 	1	E-2	8	○△	-5
154	Mirror-up lever ミラーアップレバー 	1	E-2	8	○△	
155	Stopping down button 絞り込みボタン 	1	E-2	8	○△	
156-1	Mirror-up cam shaft nut ミラーアップカム軸ナット 	1	E-2	8	○△	-5
157	See-saw lever A シーソーレバー-A 	1	E-2	8	○△	
158-1	See-saw lever B シーソーレバー-B 	1	E-2, E2-1	8	△	-5-10001
159	Slide lever スライドレバー 	1	E-2, E3	8, 18	△	
160	Slide lever スライドレバー 	1	E-2	8, 18	○△	
161-1	Mirror-up lever bearing 受金 	1	E-2	8	○△	-4
162-2	Bearing nut 受金ナット 	1	E-2	8	○△	-5-10001















Part No. 部品番号	Name and Shape 名称および形状	Pcs. per Unit 1台分個数	Reference Subassembly No. 参照部組品番号	Reference Fig. No. 参照図番	Term of Sale 販売区分	Remarks 備考
163	Stopping down lever 絞り込みレバー 	1	E-1 E-2	8	○△	
164	Sync contact insulator シンクロ用ベーク 	1	A26	5	△	
165	Sync contact insulator シンクロ用ベーク 	2	A26	5	△	
166	Contact spring A 接点バネ A 	1	A26	5, 11	△	
167	Contact spring B 接点バネ B 	1	A26	5, 11	△	
168	Slide lever spring holder A スライドレバーバネかけA 	1	E-2	8	○△	
169	Slide lever spring holder B スライドレバーバネかけB 	1	E-2, E3	8	△	
170	Mirror-up knob ミラーアップノブ 	1	E-2 E1-1	8	△	
171-1	Mirror-up click ミラーアップクリック板 	1	E-2, E1-1		△	
Blank 欠						
Blank 欠						
174	Mirror brake lever ミラーブレーキレバー 	1	F-1 F7-1	9, 14	△	
175	Mirror brake bearing ミラーブレーキメタル 	1	F-1 F7-1	9, 14	△	
176	Slide lever axle スライドレバー軸 	2	E-2	8	○△	



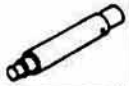







Part No. 部品番号	Name and Shape 名称 および 形状	Pcs. per Unit 1台分個数	Reference Subassembly No. 参照部組品番号	Reference Fig. No. 参照図番	Term of Sale 販売区分	Remarks 備考
177	Slide lever nut スライドレバーナット 	2	E-2	8	○△	
178	Mirror bound absorber ミラーバウンドバネモルト 	1	F-1		○△	
179	Main lever plastic collar 主レバーテフロンカラー 	1	F-1	9	○△	
180	Main lever shaft 主レバー軸 	1	F-1	9	○△	
181	Main lever washer 主レバー角ワッシャー 	1	F-1	9	○△	
182	Main lever nut 主レバーナット 	1	F-1	9	○△	











Part No. 部品番号	Name and Shape 名称および形状	Pcs. per Unit 1台分個数	Reference Subassembly No. 参照部組品番号	Reference Fig. No. 参照図番	Term of Sale 販売区分	Remarks 備考
(01) 201-1 (02)	Take-up lever cover screw 巻上げレバー飾ビス 	1			2, 12	○
202-1 (01)	Take-up lever mount 巻上げレバー取付け板 	1				○ -5
203	Top cover nut 上カバーナット 	1			2, 12	○
204	Frame counter nut コマ数計ナット 	1	D-3	4, 12		△
205	Frame counter bearing コマ数メタル 	1	D-3	4, 12		△
206	Frame counter dial コマ数目盛 	1	D-3	4, 12		○△
Blank 欠						
208-1	Frame counter ratchet コマ数ラチェット 	1	D-3	4, 12		△ -12-22001
209-1	Frame counter spring コマ数戻りゼンマイ 	1	D-3	4, 12		○△ -12-22001
210-1	Take-up claw 送り爪 	1	D-3, D2-1			△ *50F1032 *Rev. -11
211	Lock claw ロック爪 	1	D-3, D3	4		△
212	Frame index plate コマ数指標板 	1	D-3	4, 12		○△











Part No. 部品番号	Name and Shape 名称および形状	Pcs. per Unit 1台分個数	Reference Subassembly No. 参照部組品番号	Reference Fig. No. 参照図番	Term of Sale 販売区分	Remarks 備考
213-1	Take-up lever shaft 巻き上げレバー軸 	1	D-3	4, 12	△	-5
214-1	Take-up barrel drum 巻き上げ番函 	1	D-3, D4-2	4, 12	△	-6-15001
215	Take-up ratchet 巻き上げラチェット 	1	A9	12, 17	△	
216	Mirror charge cam ミラーチャージカム 	1	A9	12	△	
217	Ratchet claw ラチェット爪 	2	D-3, D4-2	4, 12	△	
218	Frame counter retainer コマ数計止め爪軸 	1	D-3	4	○△	
219- [*] 3	Top idle gear base 上アイドルギア座 	1	A7-2	12, 17	△	*-17-12001 *Rev.
220	Top idle gear 上アイドルギア 	2	A7-2	12, 17	△○ [*]	*Rev.
221	Spool top bearing スプール上メタル 	1	A3-1	12	△	
222-1	Sprocket top ring スプロケット上受け 	1	A41-1, A5- [*] 3	12	△	*Rev. -13-10001
223	Bottom idle gear 下アイドルギア 	1	A38-2	7, 12	△	









Part No. 部品番号	Name and Shape 名称 および 形状	Pcs. per Unit 1付分個数	Reference Subassembly No. 参照部品番号	Reference Fig. No. 参照図番	Term of Sale 販売区分	Remarks 備考
224A-1	Take-up lever 巻き上げレバー 	1	A33-1	2, 12	△	-3-10001
224B-1	" " 	1	A33-1	2, 12	△	-3-10001
225	Take-up lever knob 巻き上げレバー指当て 	1	A33-1	2, 4	△	
225-A	Take-up lever knob insert 指当てインサート金具 	1	A33-1	2, 4	△	-2-1001
226	Frame counter spring holder コマ数計バネカケビス 	1		3, 17	○	
227-1	Bottom idle gear shaft 下アイドルギア軸 	1	A38-2		△	*Rev. -4-5001
228	Ball bearing スプール上ボールベアリング 	1	A3-1	12	△	
229	Take-up spool スプール 	1		12	○	
230-1	Spool top roller スプール上コロ 	1		12	○	-6-20001
231	Spool inner tube スプール内筒 	1		12	○	
232	Spool bottom bearing スプール下軸 	1		12	○	
233	Spool friction nut スプールのリクシオンナット 	1		12	○	







Part No. 部品番号	Name and Shape 名称および形状	Pcs. per Unit 1内分個数	Reference Subassembly No. 参照部品番号	Reference Fig. No. 参照図番	Term of Sale 販売区分	Remarks 備考
234-1	Spool gear スプールギア 	1	A3-1	12	△	-5-10001
235	Spool bottom metal スプール下受 	1		12	○	
236	Spool top metal スプール上皿 	1		12	○	
237-1	Spool top bearing スプール上軸 	1	A3-	12	△	-5-20001
238	R lever spring collar ARバネカラー 	1	A13	7, 12	△	
239	Spool bottom gear boss スプール下ギア座 	1	A9	7, 12 16	△	
240	MD coupling ring MDカップリング 	1		6, 12	○	
241	Spool bottom gear スプール下ギア 	1		7, 12 16	○	
242	Take-up shaft 巻取り軸 	1	A9	12	△	
243	R lever ARレバー 	1	A13	7, 12 16	△	
244	R lever base ARレバー受 	1	A13	7, 12	△	
245	R lever shaft RIA戻しレバー軸 	1	A13	7, 12 16	○△	
246-1	Sprocket top gear スプロケット上ギア 	1	*A42	12, 17	△	*Rev. -13-10001
247-1	Sprocket top bearing スプロケット上メタル 	1	* 	12	○	*Rev. -13-10001













Part No. 部品番号	Name and Shape 名称および形状	Pcs. per Unit 1台分個数	Reference Subassembly No. 参照部組品番号	Reference Fig. No. 参照図番	Term of Sale 販売区分	Remarks 備考
248	Sprocket スプロケット 	1	*A41-1 *A5-3	12	△	*Rev.
249-2	Sprocket bottom gear スプロケット下ギア 	1	A6-2	12	△	*51F2012 *-20 *Rev.
250-2	Sprocket slot cap スプロケット溝環 	1	*A5-3	12	△	*51F2012 *-20 *Rev.
251-3	Sprocket shaft スプロケット軸 	1	A5-3	12, 17	△	*51F2012 *-20 *Rev.
252-1	Sprocket bottom bearing スプロケットメタル 	1	A6-2	12	△	*51F2012 *-20 *Rev.
253-1	Sprocket pin スプロケットピン 	1	A5-3	12	△	*-13-10001 *Rev.
254-2	Sprocket collar スプロケット軸制限カラー 	1	A5-3	12, 17	△	-13-10001 *Rev.
255-2	Frame counter coupling ring コマ数運動環 	1	D-3	12	○△	-13-10001
256-2	Frame counter eccenter コマ数偏心 	1	D-3	4, 12	○△	*50F1032 -11 *Rev.
257	T-L ring nut TLリングナット 	1		2, 12	○	









Part No. 部品番号	Name and Shape 名称および形状	Pcs. per Unit 1台分個数	Reference Subassembly No. 参照部組品番号	Reference Fig. No. 参照図番	Term of Sale 販売区分	Remarks 備考
(a) 258(02)	T-L ring T.L リング 	1		2, 12	○	
259	Shutter release button 押 鈕 	1	D-3, D6-2	4, 12	○△	
260-1	Shutter release shaft シャッター鉤軸 	1	D-3, D6-2		○△	-7
261-1	T-L coupling ring T.L 回 転 環 	1	D-3, D6-2	4, 12	△	*-14-10001 *Rev.
262-2	Release screw mount レ リ ー ス ネ ジ 	1	D-3, D6-2	4, 12	△	-15
263	T-L ring click pin T.L リング クリック ピン 	1	D-3	4, 12	△	
264	Snap ring 止 め 輪 	1	D-3, D6-2	4, 12	△	
265-1	Take-up middle plate 巻上げ中板 	1	D-3	4, 12	△	-6-15001
266	T-L spring T.L バ ネ 	1	D-3	4, 12	○△	
267-1	MD release button ring M D 押 鈕 環 	1	A38-2	12, 16	△	-13
268-1	Shutter vertical lever シャッター縦レバー 	1	A14-1		△	-5











Part No. 部品番号	Name and Shape 名称 および 形状	Pcs. per Unit 1台分個数	Reference Subassembly No. 参照部品番号	Reference Fig. No. 参照図番	Term of Sale 販売区分	Remarks 備考
269-1	MD release shaft M D 軸 	1	A38-2	7, 12	△	-13
270a	See-saw lever シーソーレバー 	1	A38-2		△	-4-10001
270b	"	1	A38-2	7, 12 16	△	*-4-10001 *Rev.
271	MD release shaft pin M D 軸 ピン 	1	A38-2	7, 12 16	△	
272	Reverse claw mount 逆転爪取付座 	1	A22-1	7, 16	△	
273	Shutter bottom idle gear シャッター下アイドルギア 	1	B-1	13	△	
274	Shutter gear シャッターギア 	1	B-1	13	△	
275-1*	Shutter setting lever シャッター位置決めレバー 	1	B-1	13, 16	○△	*-16-25001 *Rev.
276-1*	Shutter setting lever stopper 巻上げ位置決めレバー制限 	1	B-1	13, 16	○△	*-16-25001 *Rev.
277	Take-up lever stopper 巻上げレバー戻り制限バネ 	1	D-3, (D5)	4, 12	△	
278	Meter switch(top) 上メータースイッチ 	1	A24-1	7, 11	△	











Part No. 部品番号	Name and Shape 名称および形状	Pcs. per Unit 1台分個数	Reference Subassembly No. 参照部組品番号	Reference Fig. No. 参照図番	Term of Sale 販売区分	Remarks 備考
279	Meter switch(bottom) 下メータースイッチ 	1	A24-1	7	△	
280	Meter switch pin メータースイッチピン 	1	A25	11, 16	△	
281-1	Insulator mold A 絶縁板 A 	1	A24-1	7	△	-9
282-1a	Insulating plate B 絶縁板 B 	2	A24-1	7	△	-9
282-1b	Insulating plate C 絶縁板 C 	1	A24-1	7	△	-9
283	Rollar ロ - ラ - 	1	A20	12	△	
284	Mirror charge lever 大レバ - 	1	A20	12, 13 17, 18	△	
286-2	Release button safety lever 安全レバ - 	1	A20		OA	-9
287	Frame counter lever pin 0戻しレバ - ピン 	1	D-3,*D1	4	△	*Rev.













Part No. 部品番号	Name and Shape 名称 および 形状	Pcs. per Unit 1台分個数	Reference Subassembly No. 参照部品番号	Reference Fig. No. 参照図番	Term of Sale 販売区分	Remarks 備考
288a	Quick return lever 掛け外しレバー 	1		13, 17	○	-1
288b	"	1		13, 17	○	-1
289-2	T release pin T 解除ピン 	1	D-3, D4-2	4	△	-6-15001
290-1*	Release lever stopper 舟型制限 	1		13, 17	○	*-18 *51F1017 *Rev.
291	Counter reverse lever O 戻しレバー 	1	D-3, D1	4, 12	△	
292-1*	Quick return lever stopper 掛け外しレバー制限 	1		17	○	*-19 *Rev.
293a-1	MD release button モータードライブリリースボタン 	1	A38-2		○△	-1
293b-1	"	1	A38-2		○△	-1
293c-1	"	1	A38-2		○△	-1
293d-1	"	1	A38-2	7, 12 16	○△	-6
294-1	Rewind sleeve bearing 巻戻し軸メタル 	1	A27-1		△	-3-7501















Part No. 部品番号	Name and Shape 名称 および 形状	Pcs. per Unit 1台分個数	Reference Subassembly No. 参照部品番号	Reference Fig. No. 参照図番	Term of Sale 販売区分	Remarks 備考
295-1	Rewind shaft outer sleeve 巻戻し外軸 	1	A27-1		△	-3-7501
*296-1	Rewind button collar RIAボタンカラー 	1	A43		△	*Add. -17-20001 *51F2013
297	Rewind safety lever 巻戻し安全レバー 	1		15	○	
298	Rewind shaft release lever 巻戻し軸解除レバー 	1		15	○	*Rev.
299	Rewind shaft nut 巻戻し軸ナット 	1		15	○	
300	Finder lock button lever ファインダー着脱レバー 	1		14	○	
301	Finder lock button ring ファインダー着脱鉤環 	1	A1	14	△	
302	Nut ナット 	1		14	○	
303-1*	Rewind button RIA 釦 	1	*A43	7, 12 16	*△	*-17-20001 *51F2013 *Rev.
304-1	Rewind knob 巻戻しノブ 	1	A36-1	2, 15	△	-10
305	Mirror signal lever ミラー信号レバー 	1	B6-2	5, 13	△	
306-1	Nut ナット 	1	B6-2	5, 13	○△	-12









Part No. 部品番号	Name and Shape 名称および形状	Pcs. per Unit 1台分個数	Reference Subassembly No. 参照部品番号	Reference Fig. No. 参照図番	Term of Sale 販売区分	Remarks 備考
307-2*	Release lever リリースレバー 	1	B7-2	13, 16	△	-7 *Rev.
308	Release lower lever リリース下レバー 	1		13, 16	○	
309	Release bearing(lower) リリース下メタル 	1	B-1	13	△	
310-2	Release shaft リリース軸 	1	B6-2	13	○	-12
311-1	Nut ナット 	1		13	○	-12
312	Stopper pin 制限バネストッパーピン 	1	D-3, D5	4, 12	△	
313-1	Rewind crank 巻戻クラック 	1	A36-1	2, 15	△	-10
314-1	Rewind crank knob 巻戻レツマミ 	1	A36-1		△	-10













Part No. 部品番号	Name and Shape 名称および形状	Pcs. per Unit 1台分個数	Reference Subassembly No. 参照部組品番号	Reference Fig. No. 参照図番	Term of Sale 販売区分	Remarks 備考
315	Knob retainer 巻戻しツマミ押え 	1	A36-1	2, 15	△	*Rev. -10 *20FB1- #552B
316	Rewind crank shaft 巻戻しクランク軸 	1	A36-1	2, 15	△	*20FB1- #553 *Rev.
317	Rewind plate spring 巻戻し板バネ 	1	A36-1	2, 15	△	
318	Self-timer pin セルフピン 	1	A14-1	5, 12	△	
319	Finder lock button 保持レバー指外し釘 	1	A1	14	△	
320	Meter switch adjuster メータースイッチ調節板 	1	A24-1	7	△	
321a-1*	Take-up stopper claw 巻上げ制限爪 	1		7, 16	○	*-16-25001 *Rev.
321b-1*	"	1		7, 16	○	*-16-25001 *Rev.
321c-1*	"	1		7, 16	○	*-16-25001 *Rev.
*322	Take-up release lever collar 巻上げ制限解除レバーカラー 	1		7	○	*-16-25001 *Rev.
323	Take-up reverse stopper 巻上げ逆転爪 	1	A22-1	7, 16	○	
324-1	Sprocket top coupling ring スプロケット上カップリング 	1	A4-2	12	△	-13 *Rev.
325	Time release lever タイム解除レバー 	1	D-3	4	○△	









Part No. 部品番号	Name and Shape 名称 および 形状	Pcs. per Unit 1台分個数	Reference Subassembly No. 参照部組品番号	Reference Fig. No. 参照図番	Term of Sale 販売区分	Remarks 備考
326-1	Spool gear pawl スプール上ギア逆転爪 	1	A8-3	12, 17	△	-9
327-3	Pawl axle スプール上ギア逆転爪軸 	1	A8-3	12, 17	△	-14
328	Spring holder * 補助レバーバネ掛けピン 	1	A14-1	5, 12	△	*-13 *Rev.
329	Slow speed separator * * スローセパレーター 	1	A14-1	5	△	*Rev.
330	Shutter auxiliary lever axle シャッター補助レバー軸 	1	A14-1	5, 12	△	
332	Shutter auxiliary lever シャッター補助レバー 	1	A14-1	5, 12	△	
*335-1	Take-up stopper spring adjusting lever 巻上げ制限ばね 調整レバー 	1	A4-1	12	○	-16-25001 *Add.
336-1*	Bound preventing claw バウンドセリ防止爪 	1	A43 *312	13, 16	* ⊖△	*-16-25001 *Rev.
337-2*	Shutter lower lever シャッター下レバー 	1	A43 *312	12	*△	*-16-25001 *Rev.
*338-1	Reverse lever 逆転防止レバー 	1	B-1		△	-16-25001 *Add.









Part No. 部品番号	Name and Shape 名称および形状	Pcs. per Unit 1台分個数	Reference Subassembly No. 参照部組品番号	Reference Fig. No. 参照図番	Term of Sale 販売区分	Remarks 備考
339-1*	Sprocket bottom gear clip *CE-5 スプロケット下ギヤクリップ 	1	A6-2	12	△	*-20 *51F2012 *Rev.
340	Spool shaft bearing スプール軸メタル 	1		12	○	
341	Shutter dial click pin ダイヤルクリップピン 	1	C-1	13	○△	
342	Rewind safety lever nut 巻戻し安全レバーナット 	1		15	○	
343	Take-up lever collar 巻上げレバーカラー 	1		12	○	
344	Take-up lever cover plate * 巻上げレバー貼板 	1	A33-1	2	△	*Rev.
345	FP contact plate シンクロ受板 	1	A26	5, 11	△	
346	Rewind shaft sleeve 巻戻し中軸受 	1	A27-1	15	△	
347	Rewind shaft click spring 巻戻し軸クリックバネ 	1	A27-1	15	△	-10
348	Rewind friction spring 巻戻しフリクションバネ 	1	A27-1	15	○△	
349-1	Rewind shaft 巻戻し中軸 	1	A27-1	15	△	-10
350	Rewind fork 巻戻し股 	1	A27-1	15	○△	









Part No. 部品番号	Name and Shape 名称 および 形状	Pcs. per Unit 1台分個数	Reference Subassembly No. 参照部品番号	Reference Fig. No. 参照図番	Term of Sale 販売区分	Remarks 備考
351	Shutter dial シャッターダイヤル環 	1	C-1 C3-1	2, 13 19	△	
352	Shutter dial window plate アクリル窓 	1	C-1 C3-1	2, 13	○△	
353	Index ring 指標座 	1	C-1	13	△	
354	Shutter cocked index 指標 	1	C-1	13, 19	○△	
355	Shutter dial cover ring シャッターダイヤル飾環 	1	A31-1	2, 13	△	
356	Shutter dial base ring シンクロ切替え 	1	C-1	13, 19	△	
357	Shutter top shaft シャッター上軸 	1	C-1	13	△	
358	Click drum クリック盤 	1	C-1	13, 19	△	
359	Click spring クリックボール用バネ 	1	C-1	13, 19	△	
360	Shutter dial bearing シャッターダイヤルメタル 	1	C-1	13	△	
361	Sync change-over ring シンクロ切替え板 	1	C-1	11, 13	△	
362	Insulator 絶縁板 	2	C-1	13	○△	
363	Sync change-over contact シンクロ切替え接点 	1	C-1	11, 13	△	
364-1	Sync X contact シンクロX接点 	1	C-1 C4	11	△	*Rev. -14
365	Lead wire コード 	1	C-1		○△	







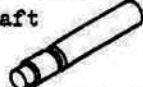





Part No. 部品番号	Name and Shape 名称および形状	Pcs. per Unit 1台分個数	Reference Subassembly No. 参照部品番号	Reference Fig. No. 参照図番	Term of Sale 販売区分	Remarks 備考
366-3	Sync actuate lever シンクロ走行レバー 	1	A19-3	11, 13 17	△	-11
367-2	Sync actuate lever axle シンクロ走行レバー軸 	1		13, 17	○	
368-1	Mirror charge lever* shaft 大レバー軸 	1		13, 17	*○	-3 *Rev.
369	Mirror charge lever bearing 大レバーホス 	1	A20	13	△	
370	High speed shutter lever axle 高速レバー軸 	1	C-1 C1-1	13	△	
371	Slow speed shutter lever axle スロレバー軸 	1	C-1 C2-1	13	△	
372	Slow lever nut スロレバーナット 	1	C-1 C2-1	13	△	
373	Slow cam lever スロカムレバー 	1	C-1 C2-1	13	△	



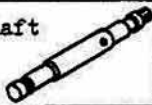









Part No. 部品番号	Name and Shape 名称および形状	Pcs. per Unit 1台分個数	Reference Subassembly No. 参照部組品番号	Reference Fig. No. 参照図番	Term of Sale 販売区分	Remarks 備考
374-1	Shutter middle plate シャッター中板 	1	C-1	13	△	-3-10001
375	High speed cam 高速カム 	1	C-1	13, 19	△	
376	Change-over cam 切替えカム 	1	C-1	13, 19	△	
377	Slow cam スロ-カム 	1	C-1	13, 19	△	
378	High speed separator 高速セパレーター 	1	C-1	13, 19	△	
379	Slow speed separator スロ-セパレーター 	1	C-1	13, 19	△	
380-1	Stroking cam ケトバシカム 	1	C-1	13, 19	△	-8-5001
381-1	Sync running cam シンクロ走行カム 	1	B-1, B3-1	3, 11 13, 17 19	△	-3-10001
382	Safety signal ring 安全シグナル 	1	A12-1	3, 13 17	△	
383	Second curtain claw 後幕爪 	1	A12-1	3, 13 17, 19	△	
384-1	Drum hook ドラム掛け 	1	A12-1	3, 13 19	△	-6
385	Drum top metal ドラム上メタル 	1	A12-1	3, 13	△	













Part No. 部品番号	Name and Shape 名称および形状	Pcs. per Unit 1台分個数	Reference Subassembly No. 参照部品番号	Reference Fig. No. 参照図番	Term of Sale 販売区分	Remarks 備考
386-1	Top pulley 上プーリー 	1	B-1, B3-1	13, 19	△	-10-20001
387-1	Bottom pulley 下プーリー 	1	B-1, B3-1	13, 19	*△	*Rev. -10-20001
388	Drum top bearing ドラム上受け 	1	B-1, B3-1	13, 19	△	
389	Drum bottom bearing ドラム下受け 	1	B-1, B3-1	13	△	
390	Drum ドラム 	1	B-1, B3-1	13	△	
391-1	Second brake ring 後ブレーキ環 	1	B-1, B9-1	13, 19	△	*-12 *Rev.
392	Brake pin ブレーキピン 	1	B-1, B3-1	13, 19	△	
393-1	Second brake shoe 後ブレーキ・ナイロン 	1	B-1, B9-1	13	△	-12
394-1	Shutter bottom metal ドラム下メタル 	1	B-1	13	△	-12













Part No. 部品番号	Name and Shape 名称および形状	Pcs. per Unit 1台分個数	Reference Subassembly No. 参照部組品番号	Reference Fig. No. 参照図番	Term of Sale 販売区分	Remarks 備考
395-1	Start cam スタートカム 	1	B-1, B3-1		△	*-18 *Rev.
396-2	Shutter charge disk 巻上げ盤 	1	B-1, B10-2	13	△	*-16-25001 *Rev.
397-1	Drum shaft bearing スタートカムブッシュ 	1	B-1, B3-1	13	△	-5
398	First brake lever 先ブレーキレバー 	1	B5 B-1	13, 16	△	*Rev.
399-1	Shutter cocking claw シャッター巻上げ爪 	1	B-1, B10-2	13, 16	△	-6 *Rev.
400-1	Second brake lever 後ブレーキレバー 	1	B4 B-1	13	△	*-16-25001 *Rev.
401	Brake bearing ブレーキメタル 	2	B4, B5 B-1	13	△	
402-1	Drum shaft ドラム軸 	1	B-1, B3-1	13, 17	△	-5
403	Slow shaft スロ - 軸 	1	A21	13, 16 17	△	*Rev.









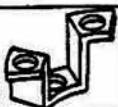





Part No. 部品番号	Name and Shape 名称および形状	Pcs. per Unit 1台分個数	Reference Subassembly No. 参照部品番号	Reference Fig. No. 参照図番	Term of Sale 販売区分	Remarks 備考
404a	Brake spring ($\alpha = 35^\circ$) ブレーキバネ 	2	B-1		○△	-10
404b	Brake spring ($\alpha = 40^\circ$) ブレーキバネ	2	B-1	13, 16	○△	-10
405	Brake adjusting collar ブレーキ調整偏心 	2	B-1	16	○△	
406	Reverse claw axle 逆転爪軸 	1	A22-1	7, 16	△	
407	Reverse claw stopper 逆転爪制限 	1	A22-1	7, 16	△	
408a	Release lever 舟型 *t=4.36 	1	All-1	13, 17	△	*-10 *Rev.
408b	*t=4.5	1	All-1	13, 17	△	-10 *Rev.
408c	" *t=4.25	1	All-1	13, 17	△	-10 *Rev.
409	Meter switch connecting rod 露出計 スイッチ用連結棒 	1	*A25		△	*Rev.
410	Release lever spring holder 舟型バネピン 	1	All-1	13, 17	△	
411	Release lever shaft 舟型軸 	1	All-1	13, 17	△	
412-1	Release lever spring 舟型バネ 	1	C-1	11, 13	○△	-3-10001
413	First curtain spindle end 口金 	1	B1 B-1	14	△	















Part No. 部品番号	Name and Shape 名称および形状	Pcs. per Unit 1台分個数	Reference Subassembly No. 参照部組品番号	Reference Fig. No. 参照図番	Term of Sale 販売区分	Remarks 備考
414	Bush フッシュ 	2	B1 B-1	14	△	
415a	Bearing metal washer ベアリングメタルワッシャ t = 0.1 * 	1			○	-1 *Rev.
415b	" * t = 0.2	1			○	-1 *Rev.
415c	" * t = 0.3	1			○	-1 *Rev.
416	First curtain spindle 先筒 	1	B1 B-1	14	△	
417	Second ribbon pulley 後紐プーリー 	1	B2 B-1	14	△	
418	Second ribbon pulley 後紐プーリー 	1	B2 B-1	14	△	
419	Second spring shaft 後バネ軸 	1	B2 B-1	14	△	
420	First spring shaft 先バネ軸 	1	B1	14	△	
421	Second spring cover 後バネカバー 	1		5, 14	○	
422	Tension worm テンションウォーム 	2	B-1	14	○△	
423	Slow bottom lever スロー下レバー 	1	A21	13	△	
424	Slow top lever スロー上レバー 	1	A21	13, 17	△	
425-1*	Change-over top lever 切替え上レバー 	1	A10-2*	13, 17	△	*-18 *51F1017 *Rev.















Part No. 部品番号	Name and Shape 名称および形状	Pcs. per Unit 1台分個数	Reference Subassembly No. 参照部組品番号	Reference Fig. No. 参照図番	Term of Sale 販売区分	Remarks 備考
426	High speed cam lever 高速カムレバー 	1	C-1 C1-1	13	△	
427	Sync insulating plate シンクロ絶縁板 	2	C-1	13	△	
428	Cassette retainer ビデオテープ押え板 	1				Dis.廃止
429	Take-up spring 巻上げレバーゼンマイ 	1	D-3	4, 12	○△	
430-1	Mirror safety bearing ミラー安全軸受板 	1			○	-7
431	Sync F contact pin シンクロ下接点ピン 	1	B6-2	5, 13	△	
432	Insulating collar 絶縁カラー 	1	B6-2	13	△	
433-1	Large lever nut 大レバー軸ナット 	1		13	○	-3
434	Nut 制限バネ取付ナット 	2	D-3	4, 12	△	
435	T-L connecting pin TL回転環運動ピン 	1	D-3	3, 4 12	△	
436	Brake pin ブレーキピン 	2	B4, B5 B-1	13, 16	△	
437-1	Stroking pin ケットバシピン 	1		13, 19	△	-8-5001







Part No. 部品番号	Name and Shape 名称 および 形状	Pcs. per Unit 1台分個数	Reference Subassembly No. 参照部組品番号	Reference Fig. No. 参照図番	Term of Sale 販売区分	Remarks 備考
438	Stroking shaft nut ケトバシレバー軸ナット 	1	C-1 C1-1	13	△	*20FB1- #271 *Rev.
439-1	Drum pin ドラム掛けピン 	1	A12-1	13, 19	△	-6 *Rev.
440-1	Stroking lever ケトバシレバー 	1	C-1, C1-1	13	△	-9
441	Ball bearing ボールベアリング 	1	A12-1	3, 13	△	
442	High speed lever 高速レバー 	1	C-1 C1-1	13	△	
443	Stroking lever axle ケトバシレバー軸 	1	C-1 C1-1	13	△	
444	Nut 高速レバーナット 	2	C-1	13	△	
445	Nut 高速レバーバネナット 	*2	C-1 C1-1	13	△	*-16-25001 *20FB1- *Rev.#287C
446-2	Change-over shaft 切替え軸 	1	A10-2	13	△	*-18 *51F1017 *Rev.
447	Change-over bottom lever 切替え下レバー 	1	A10-2	13	△	*Rev.
448	Bottom lever bearing 切替え下レバーボス 	1	A10-2	13	△	*20FB1- #322 *Rev.
449	Drum bush ドラムブッシュ 	2	B-1, B3-1	13	△	*20FB1- #337 *Rev.













Part No. 部品番号	Name and Shape 名称 および 形状	Pcs. per Unit 1台分個数	Reference Subassembly No. 参照部組品番号	Reference Fig. No. 参照図番	Term of Sale 販売区分	Remarks 備考
450	Tension nut テンションナット 	2	B-1	14	○△	*20FB1- #363 *Rev.
451	Ribbon roller ヒモコロ 	1	B1 B-1	14	△	*20FB1- #364 *Rev.
452	Ribbon roller ヒモコロ 	1	B1 B-1	14	△	*20FB1- #364A *Rev.
453-1	Shutter first curtain シャッター-先幕 	1	A16-1		△	-9
454	Shutter second curtain シャッター-後幕 	1	A17		△	
455	Second curtain ribbon 後幕紐 	2	A17		△	*20FB1- #2398 *Rev.
456-1	Curtain end plate 後幕紐 	1	A17		△	*-14-27001 *Rev.
457	Cotton yarn 綿糸 	4	A16-1 A17		△	*20FB1- #497 *Rev.
458	First curtain ribbon 先幕紐 	2	A16-1		△	*20FB1- #2397 *Rev.
459	Slow lever スローレバー 	1	C-1 C2-1	13	△	
460-1	First curtain end plate 先幕竿 	1	A16-1		△	*-14-27001 *Rev.
461-1	Bound preventing claw 巻上げ安全爪 	1	B-1, B10-1	16	△	-5
462	Meter coupling pin catch フォトミック運動 受板 	1	C-1 C3-1	2, 13	△	









Part No. 部品番号	Name and Shape 名称 および 形状	Pcs. per Unit 1台分個数	Reference Subassembly No. 参照部組品番号	Reference Fig. No. 参照図番	Term of Sale 販売区分	Remarks 備考
463	Shutter dial シャッターダイヤル文字盤 	1	C-1 C3-1	2, 13 19	△	
464	Release lever shaft bearing 舟型軸メタル 	1		13	○	
465	Brake eccenter collar ブレーキ偏心 	1	B-1	16	○△	
466	Second brake(rubber) 後ブレーキゴム 	1			○	
467	First brake(rubber) 後ブレーキゴム 	1			○	
468-2*	Mirror safety spring ミラー安全バネ 	1	A14-1	5	○△	*-18 *Rev.
469-2*	Mirror safety spring holder ミラー安全バネ軸 	1		16	○	*-18 *Rev.
*470	Nut ミラー安全バネナット 			16	○	*-18 *Dis.
471	T-L guide TLガイド 	1			○	
472A*	Bound preventing claw バウンド防止爪 	1	B-1, B11		△	*-16-20001 *Rev.
472B*	Bound preventing claw バウンド防止爪 	1	B-1, B11		△	*-16-20001 *Rev.
473	Stand 支柱 	1	B-1		○△	
474	Claw release pin 爪逃がしピン 	1	B-1, B11		△	
475	Base plate 基板 	1	B-1		○△	









Part No. 部品番号	Name and Shape 名称 および 形状	Pcs. per Unit 1台分個数	Reference Subassembly No. 参照部品番号	Reference Fig. No. 参照図番	Term of Sale 販売区分	Remarks 備考
501	Segment 扇形 	1	A23	5	△	
502	Segment pin 扇形のピン 	1	A23	5	△	
503	Segment axle 扇形の軸 	1	A23	5	△	
504	Large lever boss 大レバーボス 	1	A23	5	△	
505	Large lever axle 大レバー軸 	1	A23	5	△	
506	Large lever 大レバー 	1	A23	5	△	
507	Small lever axle 小レバー軸 	1	A23	5	△	
508	Small lever 小レバー 	1	A23	5	△	
509	Center wheel 2番車 	1	A23	5	△	
510	Center wheel shaft 2番軸 	1	A23	5	△	
511	Escapement shaft ガンギ軸 	1	A23	5	△	
512	Escapement ガンギ車歯形 	1	A23	5	△	
513	Ankle shaft アングル軸 	1	A23	5	△	
514	Ankle アングル 	1	A23	5	△	
515	L-shaped top lever ユの字上レバー 	1	A23	5	△	

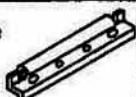



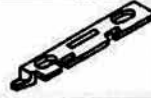







Part No. 部品番号	Name and Shape 名称および形状	Pcs. per Unit 1台分個数	Reference Subassembly No. 参照部組品番号	Reference Fig. No. 参照図番	Term of Sale 販売区分	Remarks 備考
516	Threaded rivet ⊙ 1.2R-1.4(S) カシメビス 	2	A23	5	△	
517	L-shaped lever ユの字 	1	A23	5	△	
518	F-shaped lever ヒノ字 	1	A23	5	△	
519	Support screw ⊙ 1.4R-1(S) 長支柱ビス 	1	A23	5	△	
520	Spring holder バネかけピン 	4	A23	5	△	
521-1	Spring 扇形用バネ 	1	A23	5	△	-11
522	Spring 小レバーバネ 	1	A23	5	△	
523	Floor plate 地板 	1	A23	5	△	
524	Long support 長支柱 	1	A23	5	△	
525	Support screw ⊙ 1.4R-1.3(S) 長支柱ビス上 	2	A23	5	△	
526	Stopper screw ⊙ 1.2R-4 制限ビス 	1	A23	5	△	
527	Spring holder ヒゲ止め 	1	A23	5	△	
528	Escapement spring ガンギ押えヒゲ 	1	A23	5	△	
529	L-shaped lever axle ユの字回転軸 	1	A23	5	△	



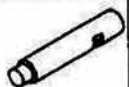









Part No. 部品番号	Name and Shape 名称 および 形状	Pcs. per Unit 1台分個数	Reference Subassembly No. 参照部品番号	Reference Fig. No. 参照図番	Term of Sale 販売区分	Remarks 備考
530	Short support 短支柱 	1	A23	5	△	
531	Spring ユの字バネ 	1	A23	5	△	
532	Spring 大レバーバネ 	1	A23	5	△	
533	Ankle washer アングル座金 	1	A23	5	△	
534	Rivet カシメ鉄 	1	A23		△	
535	Set screw (1.2U-1.1) 1ミリセット 	1	A23		△	
536	Large lever screw 1.4R-2(S) 大レバービス 	1	A23		△	













Part No. 部品番号	Name and Shape 名称および形状	Pcs. per Unit 1台分個数	Reference Subassembly No. 参照部品番号	Reference Fig. No. 参照図番	Term of Sale 販売区分	Remarks 備考
552	Flash contact holder シュー-接点座 	1	H-1	2, 15	△	
553	Contact spring 露出用接点バネ 	1	A29	3, 11 14	△	
554-2	Lead wire holder コード押え板 	1		5	○	-12-11001
555	Rivet カシメ鉄 	4	A29	3, 15	△	
556	Oval contact オーバル型接点 	2	A19-3, A26	5, 17	△	*20PB1- #706 *Rev.
557	Disk contact ディスク型接点 	2	C-1 C4, A26		△	*20PB1- #707 *Rev.
559-1	Sync-terminal socket ターミナル外環 	1	A2	5, 11	△	*50F1033 -14 *Rev.
560-1	Insulator モールド 	1	A2		△	*50F1033 -14 *Rev.
561-1	Inner collar プラグ内芯 	1	A2		△	*50F1033 -14 *Rev.
562-1	Outer collar プラグ外芯 	1	A2		△	*50F1033 -14 *Rev.
563	Flash contact (top) シュー-下接点 	1	H-1 H1	2, 15	△	
564	Flash contact (bottom) シュー-接点 	1	H-1	2, 15	△	
565	Insulating plate 巻戻し部ベーク板 	1	A29	2, 15	△	

Part No. 部品番号	Name and Shape 名称および形状	Pcs. per Unit 1台分個数	Reference Subassembly No. 参照部組品番号	Reference Fig. No. 参照図番	Term of Sale 販売区分	Remarks 備考
566	Contact spring シンクロ ターミナル接点バネ 	1	A29	3, 11 15	△	
567	Lead wire (White) コード (白) 	1	A26		○△	*Rev.
568	Lead wire (Red) コード (赤) 	1	A26		○△	*Rev.
569	Lead wire (Green) コード (緑) 	1	A24-1		○△	*Rev.
570	Lead wire (Yellow) コード (黄) 	1	A24-1		○△	*Rev.
571	Terminal cap ターミナル蓋 	1			○	
572	Battery grounding spring バッテリーアースバネ 	1	B-1		○△	
*573	Bakelite plate light baffle ベーク板ルミラー 	1	A29		○△	-16 *Add.



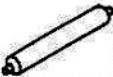



Part No. 部品番号	Name and Shape 名称および形状	Pcs. per Unit 1台分個数	Reference Subassembly No. 参照部品番号	Reference Fig. No. 参照図番	Term of Sale 販売区分	Remarks 備考
601-1	Camera back ウラ蓋本体 	1	K2-2	10, 14	△	-3
602-*	Camera back hinge 蝶番 	1	K2-2	10	△	*-17-19001 *Rev.
603	Memo holder カード差し込み函 	1	K2-2	10, 14 15	△	
604	Plate spring カード押えバネ 	1	K2-2	10, 14	△	
605	Key guide 鍵案内ビス 	2			○	
606	Key cover 鍵カバー 	1			○	
607-1	Key 鍵 	1			○	-2
608	Upper hinge 上蝶番軸受 	1			○	
609	Lower hinge 下蝶番軸受 	1			○	
610-1	Cassette bearing マガジン受 	1	J-1, J1-1	6, 15	△	*50F1006 -3 *Rev.
610A-1	Cassette bearing cover metal マガジン受上のセメタル 	1			○	















Part No. 部品番号	Name and Shape 名称および形状	Pcs. per Unit 1台分個数	Reference Subassembly No. 参照部品番号	Reference Fig. No. 参照図番	Term of Sale 販売区分	Remarks 備考
611	OC lever bearing OC 爪 受 	1	J2	6, 15	△	
*612	Pin テヨウ香軸 ばね圧縮ピン 	1	K2-2		△	-17-19001 *Add.
613	OC coupling OCカップリング 	1	J-1	6, 15	○△	
614	OC lever OC ハシドル 	1	J-1 J2	6, 15	△	
615	OC catch OC 外 し 爪 	1	J-1 J1-1	6, 15	△	
616	Index pin 底矢印止めピン 	2	J-1 J2	6, 15	△	
617-1	Hinge shaft 上 蝶 番 軸 	1	K2-2	10	○△	-4-15001
618	Rivet 圧 板 バ ネ 鉄 	4	K2-2	10	△	
619	OC spring O C バ ネ 	1	J-1 J2	6, 15	△	
620	Pressure plate spring 圧 板 バ ネ 	1	K1	10	△	
621	Pressure plate 圧 板 	1	K1	10, 14	△	
622-3	Hinge shaft 下 蝶 番 軸 	1	K2-2	10	○△	*-17-19001 *Rev.
623	Leatherette 裏 重 機 革 	1	K2-2	10, 15	○△	













Part No. 部品番号	Name and Shape 名称および形状	Pcs. per Unit 1台分個数	Reference Subassembly No. 参照部組品番号	Reference Fig. No. 参照図番	Term of Sale 販売区分	Remarks 備考
624	Leatherette 鍵カバー擬革 	1			○	
625-1	Key pin 鍵ピン 	2	K2-2	10	△	-2
626	Light-tight 鍵側モルトブレン 	1	K2-2	10	○△	
627	Cassette holder spring パトロ-ネ押えバネ 	1	K2-2	10	△	
628	Light-tight 裏蓋溝モルトブレン 	2	K2-2	10	○△	
629	Spring 裏蓋バネ 	1	K2-2	10	○△	
630-1	Pin 裏蓋外レピン 	1	K2-2	10	○△	-4-15001
631a	Rivet 裏蓋皿カシメピン 	4	K2-2x4	10, 14	△	-5
631b	" " 	4	K2-2x4	10, 14	△	-5
632	Rivet カード押えバネカシメピン 	6	K2-2x6	10, 14	△	
633	Rivet 圧板鉄 	2	K1	10, 14	△	
634	Inner cover 裏蓋透光カバー 	1	K2-2	10, 15	△	

Part No. 部品番号	Name and Shape 名称および形状	Pcs. per Unit 1台分個数	Reference Subassembly No. 参照部組品番号	Reference Fig. No. 参照図番	Term of Sale 販売区分	Remarks 備考
635	OC center screw OCレバー外しネジ 	1	J-1 J2	6, 15	△	
636	OC axle OCレバー外し輪 	1	J-1 J2	6, 15	△	
637	OC nut OCレバー外し輪ナット 	1	J-1 J2	6, 15	△	
638	OC coupling pin OCカップリングピン 	1	J-1 J2	6, 15	△	
639	OC friction spring OCフリクションバネ 	1	J-1 J1-1	6, 15	△	
640	OC index OC指標 	1	J-1 J2	6, 15	○△	
641	Spring *d=0.29 裏蓋カギバネ 	1			○	*Rev.
642	OC coupling screw 1.40-3 (3) OCカップリング止めネジ 	3	J-1	6, 15	○△	*Rev.
643-1	Roller holder ローラー支持板 	1	K2-2	10	△	-6-10001
644	Roller ローラー 	1	K2-2	10	○△	
645	Rivet ローラー支持板カシメピン 	2	K2-2	10	△	
646-1	Camera back guide plate 鏡当て板 	1			○	-2-9001
647	Cover disk 裏蓋穴かくし 	6	K2-2		○△	













Part No. 部品番号	Name and Shape 名称および形状	Pcs. per Unit 1ヶ分個数	Reference Subassembly No. 参照組品番号	Reference Fig. No. 参照図番	Term of Sale 販売区分	Remarks 備考
648	Inner cover rivet 透光カバーカシメピン 	2	K2-2X2		△	
649			J-1, J1-2		△	
650	SCREW 六角ボルト		J-1, J1-2		△	















Part No. 部品番号	Name and Shape 名称および形状	Pcs. per Unit 1台分個数	Reference Subassembly No. 参照部組品番号	Reference Fig. No. 参照図番	Term of Sale 販売区分	Remarks 備考
651	Self-timer lever セルフ作動レバー 	1	A37	1	△	
652	Lever knob 指当て 	1	A37	1	△	
653	Screw #653(01) #653(02) 止めネジ 	1		1	○	
654	Time dial retainer タイム目安押え環 	1		1	○	
655	Time dial タイム目安 	1		1	○	
700	Self-timer (subassembly) セルフタイマー部組品 	1	A30	8	△	















Part No. 部品番号	Name and Shape 名称および形状	Pcs. per Unit 1台分個数	Reference Subassembly No. 参照部品番号	Reference Fig. No. 参照図番	Term of Sale 販売区分	Remarks 備考
751	Photomic finder locating pin フォトミック基準ピン 	2	A34		△	
752	Mirror release pin ミラリリースピン 	1	F-1 F8	9	△	
753-1	Mirror-up pin ミラーアップピン 	1	F-1, F6	9, 10 13, 16	△	
754	First curtain release pin 先幕リリースピン 	1	B7-2		△	
755	Mirror shaft rivet ミラー軸受板カシメピン 	1	F-1 F4-1	9	△	
756	Mirror down pin ミラーダウンバネカケピン 	1	F-1 F4-1	9	△	
757	Release eccentric リリース偏心ピン 	1	E-2, E2-1		△	
758	Mirror holder pin ミラー押えバネカケピン 	2	F-1 F4-1	9	△	
759	45° stopper rivet 45° ストッパーカシメピン 	2	F-1 F4-1	9	△	
760	Rivet 巻上げ安全爪カシメピン 	2	B-1, B10-2		△	*Rev.
761	Coupling lever pin 連絡レバー軸ピン 	2	F-1 F2	9	△	
762	Spring holder バネカケ 	2	D-3 D2-1, D3	4, 12	△	
763	Ratchet axle ラチェット爪軸 	2	D-3 D4-2	4, 12	△	
764	Roller axle ローラ軸 	1	A20	12, 17	△	















Part No. 部品番号	Name and Shape 名称および形状	Pcs. per Unit 1台分個数	Reference Subassembly No. 参照部組品番号	Reference Fig. No. 参照図番	Term of Sale 販売区分	Remarks 備考
765-1	Eccenter pin 偏心ピン 	1	B7-2	13, 16	△	
766	Slow eccenter pin スロー偏心ピン 	1	C-1 C2-1	13	△	
767	Finder holder pin 引出しピン 	1	F-1 F11	9, 14	△	
769	Signal pin 接点シグナルバネピン 	1	H-1 H1	2	△	
770	Follow brake pin 後ブレーキピン 	1	B-1 B4	13, 16	△	
771a	Stroking stopper pin ケトバシ制限ピン 	1	C-1 C1-1	13	△	
771b						-5
772	Release lever pin 舟型ピン 	1	All-1	17	△	
773	Drum pin ドラムピン 	1	B3 B3-1	13, 19	△	
774	First brake pin 先ブレーキピン 	1	B5 B-1	13, 16	△	
*775	Brake rivet ブレーキカムス鉄 	2	B-1, B9	13, 19	△	*-12 *Dis.
776	High speed eccenter pin 高速偏心 	1	C-1 C1-1	13	△	
777	Stroking pin ケトバシバネピン 	1	C-1 C1-1		△	*20FB1- #291 *Rev.
778	T spring pin T型バネピン 	1	F-1 F2	9	△	











Part No. 部品番号	Name and Shape 名称および形状	Pcs. per Unit 1台分個数	Reference Subassembly No. 参照部組品番号	Reference Fig. No. 参照図番	Term of Sale 販売区分	Remarks 備考
Blank 欠						
781	Screw ⊕ 1.4Q-1.2*(S) 後側遮光板止めビス 	6	F-1	9	○△	*Rev.
782	Screw ⊕ 1.7R-1.8(1) バヨネットバネ取付ビス 	7	E-2×6	8	○△	
783	Screw ⊕ 2R-3.6*(S) バヨネット止めビス 	4	E-2	8	○△	*20FB1- #2064 *Rev.
784	See-saw lever axle シーソーレバー軸 	1	A38-2	7, 12	△	
785	Screw ⊕ 1.7R-2.5(S) フォトミック基板止めビス 	2			○	
786	Screw ⊖ 1.7R-3(S) ストッパー止めビス 	1	F-1	9	○△	
787	T lever axle T型レバー軸 	1	F-1	9	○△	
788	Screw ⊕ 1.4R-1.6(1) チリトリ保持ビス 	*8	F-1	9	○△	*-16 *Rev.
789	Mirror-up lever axle ミラーアップレバー軸 	1	E-2	8	○△	
790	Screw ⊕ 1.4R-2.5(1) 受金止めビス 	5	C-1×3 E-2×2		○△	
791	Mirror charge lever axle M縦レバー軸 	1	F-1	9, 13 17	○△	
792	Screw ⊖ 1.4R-2.1(S) 視野枠止めビス 	4	F-1	9	○△	
793-1*	*Plate screw rivet 板ばねかしのピン 	1	A43 B-12	16	△	*-16-25001 *Rev.
794	Screw ⊖ 1.4R-2(S) 緩衝レバー止めビス 	2	F-1	9, 14	○△	









Part No. 部品番号	Name and Shape 名称および形状	Pcs. per Unit 1台分個数	Reference Subassembly No. 参照部組品番号	Reference Fig. No. 参照図番	Term of Sale 販売区分	Remarks 備考
795	Screw ⊕ 1.7R-2.8*(S) 掛け外し制限ビスA 	1	F-1×2	9, 14 17	○△	*-12 *Rev.
796A*	Upper idle gear axle 	*1	A7-2	12, 17	* ○△	*-17-12001 *Rev.
796B*	上アイドルギア軸					
797	Shutter buton spring holder 押釦制限バネ軸 	1	D-3	4	○△	
798-2*	*Wind-up pawl shaft 巻上げ制限つめ軸 	1	B-1		○△	*-16-25001 *Rev.
799-1	Frame counter lever axle 0戻しレバー軸 	1	D-3	12	○△	-1
800	Mirror driving lever axle 掛け外しレバー軸 	1		13, 17	○	
801	Rewind shaft screw 巻戻し位置決めビス 	1			○	
802	Safety lever axle 巻戻し安全レバー軸 	1		15	○	
803	Shutter release slide lever axle シャッター繰レバー軸 	2		5, 12	○	
804	Screw ⊕ 1.4R-2.5(S) シンクロ板取付ビス 	7	C-1	13	○△	
805	Claw axle 爪軸 	1	B-1 B10-2*	13, 16	△	*Rev.
806	Brake axle ブレーキ軸 	2	B-1	13, 16	○△	
807	Brake screw ブレーキ偏心ビス 	3	B-1	16	○△	













Part No. 部品番号	Name and Shape 名称および形状	Pcs. per Unit 1台分個数	Reference Subassembly No. 参照部組品番号	Reference Fig. No. 参照図番	Term of Sale 販売区分	Remarks 備考
808	Screw ⊖ 1.4Q-2.5(S) シンクロ切替えビス 	2	C-1	13, 19	△	
*809-1	Screw ⊖ 1.7R-4(S) 小ねじ 	3	C-1		○	-16-25001 *Add.
810	Screw ⊕ 1.4Q-2.8(3) 巻取り第一ギア止めビス 	3		7, 12 16	○	
^{A2-140207} 811	Screw ⊕ 1.4Q-2(1) コマ数メタル止めビス 	5	D-3	4, 12	○△	
812	Screw ⊕ 1.7R-2.2(1) ドラム上メタルビス 	5	F	3, 9 12, 13 14, 17	○△	-12
813	Screw ⊖ 2R-3(S) 巻き上げ番函止めビス 	1	D-3	4, 12	○△	
*814-1	Screw ⊕ 1.7R-3.5(S) ねじ 	3	A-29	5, 7 13, 17	○△	-18 *Add.
815	Ratchet claw spring holder ラチェット爪バネビス 	1	D-3, D4-2	4	○△	
816	Screw ⊕ 1.7R-1.5(1) セルフ取付ビス 	8	E-2×4	8	○	
817	Front plate long screw 前板長ネジ 	1		1	○	
⁽¹⁰⁾ ₍₁₂₎ 818	Screw ⊕ 1.7Q-3(1) Bottom cover screw 底カバー取付ビス 	4	A2-17808C		○	
*819-1	Rewind button screw RIAボタンねじ 	1	A-43		△	*-17-20001 51F2013 *Add.
820	Screw ⊕ 2R-7(1) 耳止めビス 	2	A1-20070FA	17	○	
821	Set screw 1.4U-3.5 セットビス 	1	A26	5	○△	
822	Set screw 2US-2.5 " 	1			○	















Part No. 部品番号	Name and Shape 名称および形状	Pcs. per Unit 1台分個数	Reference Subassembly No. 参照部品番号	Reference Fig. No. 参照図番	Term of Sale 販売区分	Remarks 備考
823	Set screw 1.4US-2 → US K2-1402075 セットビス 	4	*C3-1	2, 13	○△	*Rev.
824	Set screw 1.7US-2.5 " 	1	A35	7, 14	○△	
825	Screw ⊕ 1.7R-2(3) アースバネ止めビス 	5		5	○	
826-1*	Screw ⊖ 1.7R-2.5(S) 底板止めビス 	1		8	○	*-16-25001 *Rev.
Blank 欠						
828	Screw ⊕ 1.7R-3(3) 止めビス 	*12	A33-1	1, 2 17	○△	*-18 *Rev.
829	Screw ⊕ 1.7R-3.5(3) 電池室止めビス 	8	A26	3, 4 5	○△	
830	Screw ⊕ 1.7R-4(3) 止めビス 	*12		3, 7 16	○	*-16-25001 *Rev.
831	Screw ⊕ 1.7R-6(3) アクセサリシュー 止めビス 	4		2, 3	○	
832	Screw ⊕ 1.4R-2.1(S) スプロケットビス 	2		12	○	
AZ-17030FA 833	Screw ⊕ 1.7Q-3(1) 中板止めビスQ 	8	J-1, J1-1×2	3, 6 15	○△	
834-1*	Screw ⊕ 1.4R-1.8*(3) たてレバービス 	*3	C-1 *D	4, 12 16	○△	*-16-25001 *Rev.
835	Stopper spring holder 制限バネ取付ビス 	1	D-3	4, 12	○△	
836	Screw ⊕ 1.4R-7(S) 露出針スイッチ止めビス 	1		7	○	
837	Screw ⊕ 1.4Q-2.5(1) カギカバー止めビス 	2		2, 13 19	○	











Part No. 部品番号	Name and Shape 名称 および 形状	Pcs. per Unit 1台分個数	Reference Subassembly No. 参照部組品番号	Reference Fig. No. 参照図番	Term of Sale 販売区分	Remarks 備考
838	Screw ⊖ 1.4R-2(S) ケトバシレバービス 	1	C-1 C1-1	13	△	*20FB1-#286 *Rev.
839	Screw ⊕ 1.4R-3(3) ガバナー止めビス 	2		5	○	*-9 *Rev.
*840-1	Screw 巻上げ制限 調整レバービス 	1			*	-10-25001 *Add.
841-1	Screw ⊖ 1.7R-6 (S) ドラム軸下ビス 	1	B-1, B3-1	13, 16	○△	*Rev.
842	Screw ⊖ 1.4R-1.4(S) 板バネビス 	3	A36-1×1 C-1×1* D-3×1	2	○△	*Rev.
843	Mirror-up lever axle ミラーアップレバー軸 	3	F-1×3	9	○△	
844	Mirror release holder axle レリーズカギ軸 	1	F-1	9	○△	
845	Finder holder screw 引出しリードビス 	4	F-1	9	○△	
846	Screw ⊖ 1.7R-3(S) 巻戻し股ビス 	1	A27-1	15	○△	
847	Mirror-up stopper ミラーアップストッパー軸 	1	F-1	9	○△	
848	Screw ⊖ 1.4R-1(S) 巻戻し軸ビス 	1	*A27-1	15	△	*Rev.
849	Screw ⊕ 1.7Q-2.5(S) 蝶番止めビス 	6			○	
850	Lens lock button lever axle 着脱扣レバー軸 	1		14	○	
851	Main spring holder 主バネ軸 	1	F-1	9	○△	











Part No. 部品番号	Name and Shape 名称および形状	Pcs. per Unit 1台分個数	Reference Subassembly No. 参照部組品番号	Reference Fig. No. 参照図番	Term of Sale 販売区分	Remarks 備考
853-1	Screw ⊕ 1.7R-2.6(S) 下アイドルギアビス 	1	A38-2	7, 12	△	
854	Mirror down spring holder ミラーダウンバネ軸 	1	F-1	9	○△	
855	Idle gear axle シャッター下アイドルギア軸 	1	B-1	13	△	
(01) 856 (02)	Screw ⊕ 1.7Q-2(1) TOP COVER SCREW 上カバービス 	2		1	○	
857	MD coupling screw MDカップリングビス 	1		6, 12	○	
858	Screw 1.7US-2 巻戻しノブセットビス 	1	52-17020 FA A36-1 K2-170207B	2, 15	○	
859	Mirror brake spring holder ミラーブレーキバネ仕掛け ビス 	1	F-1	9, 14	○△	
861	Shoe signal screw ⊖ 1.4R-1.7(S) シューシグナルビス 	1	H-1	2	○△	
862-1	Pulley screw ⊕ 1.4Q-5(1) プーリービス 	2	B-1, B3-1	13	△	
863-1*	*Reverse claw screw 逆転防止つめ止めビス 	2	*B-1	7, 16	* ○△	*-16-25001 *Rev.
864 → 02P	Set screw 1.4US-1.5 → 05E K2-14016 FA セットビス 	5	B-1	12, 13	○△	











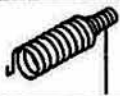

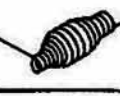
Part No. 部品番号	Name and Shape 名称 および 形状	Pcs. per Unit 1台分個数	Reference Subassembly No. 参照部組品番号	Reference Fig. No. 参照図番	Term of Sale 販売区分	Remarks 備考
865-1	Set screw 1.7US-1.5 セットビス 	1	A10-2*	13	○△	*Rev.
866	Screw *⊕1.4R-1.6(1) 運動ピン板止めビス 	*3	C-1 C3-1x2	2, 17	○	*-16-25001 *Rev.
868	Screw 引出しねじ手こめビス 	2			○	
870	Set screw 1.4U-1.2 スプールギアセットビス 	2	A3-1	12	○△	
871	Meter coupling pin フォトミック運動ピン 	1	C-1 C3-1	2, 13 19	△	
872	Large lever spring holder 大レバーバネ掛けピン 	1	A20	17	○△	
873	Screw ⊕ 1.7R-3(1) 逆転爪取付座ビス 	3		7, 16	○	
874	Flash contact lever screw シュ-接点レバービス 	1	H-1	2, 15	○△	
875	Rivet ミラ-プレ-キレバ-カシメピン 	1	F-1 F7-1	9, 14	△	







Part No. 部品番号	Name and Shape 名称および形状	Pcs. per Unit 1台分個数	Reference Subassembly No. 参照部組品番号	Reference Fig. No. 参照図番	Term of Sale 販売区分	Remarks 備考
876-2	Take-up stopper lever axle 巻き上げ制限レバー軸 	1	B-1	7, 16	○	
877	Rivet チリトリ保持板カシメピン 	2	F-1 F4-1	9	△	
878-1	Stop-down button pin 絞り込ボタン軸ピン 	1	E-1, E-2	8	○△	
					○△	
879	T release lever axle タイム解除レバー軸 	1	D-3		○△	
880	Screw ⊕ 1.4R-1.5(1) ミラー安全バネビス 	2	A14-1	5	○△	
881	Screw ⊖ 1.4R-1(S) ミラーダウンバネ軸押えビス 	1	F-1	9	○△	*20FB1- #2191 *Rev.
882	Screw ⊖ 1.7R-2.5(S) 舟型制限止めビス 	2			○	
883	Screw ⊕ 1.4R-3(1) フローカム止めビス新 	3	C-1		○△	
885 ⁽⁰¹⁾ 885 ⁽⁰²⁾	Screw ⊕ 1.7R-2(1) エプロンビス 	4			○	
886	Screw ⊕ 1.7R-2(1) スプール上メタル止めビス 	3			○	
887	Screw ⊕ 1.4Q-3(1) リリーススネジ止めビス長 	1			○	
888 A2-1702574	Screw ⊕ 1.7R-2.5(1) ミラー安全軸受板止めビス 	10	B-1, B8-1x1 F-1x3		○△	-12











Part No. 部品番号	Name and Shape 名称 および 形状	Pcs. per Unit 1台分個数	Reference Subassembly No. 参照部組品番号	Reference Fig. No. 参照図番	Term of Sale 販売区分	Remarks 備考
901	Lens lock spring *d=0.4 着脱ボタンバネ 	1	E-2	8	○△	*Rev.
902	Mirror auxiliary spring *d=0.7 ミラー戻り補助バネ 	1	F-1		○△	*Rev.
903-1	Take-up lever spring *d=0.23 巻上げレバーバネ 	1	*B-1	7, 16	○△ *	*-16-25001 *Rev.
904	Mirror-up lever spring *d=0.23 クリックバネ 	2	E-2	8	○△	*Rev.
905	Bound preventing claw spring *d=0.23 バウンド防止爪用バネ 	1	B-1		○△	*Rev.
906	Mirror-up stopper spring *d=0.29 ミラーアップストッパーバネ 	1	F-1	9	○△	*Rev.
907	Mirror hook spring *d=0.29 かぎバネ 	1	F-1	9	○△	*Rev.
908	Diaphragm actuator spring *d=0.55 絞りバネ 	1	F-1	9	○△	*Rev.
909	Front plate slider spring *d=0.18 スライドレバーバネ 	1	E-2	8	○△	*Rev.
910	Mirror down spring *d=0.35 ミラーダウンバネ 	1	F-1	9	○△	*Rev.
911	Mirror main spring *d=1.2 主バネ 	1	F-1	9	○△	*Rev.
912	Stop-down button spring *d=0.3 絞りボタンバネ 	1	E-2	8	○△	*Rev.
913	Mirror keep spring *d=0.45 ミラー押えバネ 	1	F-1 F4-1	9	○△	*Rev.
914	Mirror keep spring *d=0.45 ミラー押えバネ 	1	F-1 F4-1	9	○△	*Rev.
915	Mirror brake spring *d=0.35 ミラーブレーキバネ 	1	F-1	9, 14	○△	*Rev.













Part No. 部品番号	Name and Shape 名称および形状	Pcs. per Unit 1台分個数	Reference Subassembly No. 参照部組品番号	Reference Fig. No. 参照図番	Term of Sale 販売区分	Remarks 備考
Blank 欠						
917-2	Spool gear reverse spring スプールギア逆転バネ *d=0.3 	1	A3-1	12	○	*Rev. -14-30000
918	Kick lever spring *d=0.26  ケットバシレバーバネ	1	C-1 C1-1	13	△	*Rev.
919	High speed lever spring *d=0.45  高速レバーバネ	1	C-1 C1-1	13	△	*Rev.
920	Slow speed shaft spring *d=0.15  スロ-軸バネ	1		13	○	*Rev.
921	Spool spring *d=0.7  スプールバネ	1		12	○	*Rev.
922	T-L ring spring *d=0.6  T.Lリングバネ	1		2, 12	○	*Rev.
923	Mirror charge lever spring *d=0.23  掛け外しレバーバネ	1		13, 17	○	*Rev.
Blank 欠						
Blank 欠						
926	Rewind safety lever spring *d=0.26  巻戻し安全レバーバネ	1		15	○	*Rev.
927	Rewind release lever spring *d=0.45  巻戻し解除レバーバネ	1		15	○	*Rev.
928	Shutter release lever spring *d=0.26  レリーズレバーバネ	1		13, 16	○	*Rev.
X 929 X 929-1	Shutter locator spring *d=0.18  シャッター位置決めレバーバネ	1	*B-1	13, 16	○	*-16-25001 *Rev.













Part No. 部品番号	Name and Shape 名称 および 形状	Pcs. per Unit 1台分個数	Reference Subassembly No. 参照部品番号	Reference Fig. No. 参照図番	Term of Sale 販売区分	Remarks 備考
930	Rewind button lever spring *d=0.23 RIA戻しレバーバネ 	1	A13	7, 12 16	○△	*Rev.
931	Counter reverse lever spring *d=0.6 0戻しレバーバネ 	1	D-3	12	○△	*Rev.
932-2	Sync lever spring *d=0.4 シンクロ走行レバーバネ 	1		13, 17	○	-13 *Rev.
933	Large lever spring *d=0.29 大レバーバネ 	1		13, 17	○	*Rev.
934	Slow lever spring *d=0.45 スローレバーバネ 	1	C-1 C2-1	13	△	*Rev.
935-1	Fork lever spring *d=0.26 安全レバーバネ 	1		12, 17	○	-7 *Rev.
936-2	Take-up claw spring *d=0.26 シャッター巻上げ爪バネ 	1	B-1, B10-2*	13, 16	○△	-6 *Rev.
937	Ratchet claw spring *d=0.28 爪バネ 	1	D-3, D4-2	4	○△	*Rev.
938	Reverse lock spring *d=0.5 逆転防止バネ 	1		7, 12 16	○	*Rev. *-17
939-1*	Release lever spring *d=0.35 舟型回転バネ 	1	All-1	13, 17	○△	*Rev.
940	Finder lock button spring *d=0.6 ファインダー着脱鎖レバーバネ 	1		14	○	*Rev.











Part No. 部品番号	Name and Shape 名称および形状	Pcs. per Unit 1台分個数	Reference Subassembly No. 参照部品番号	Reference Fig. No. 参照図番	Term of Sale 販売区分	Remarks 備考
941	First curtain spring 先バネ *d=0.32 	1	B1 B-1	14	△	*Rev.
942	Second curtain spring 後バネ *d=0.29 	1	B2 B-1	14	△	*Rev.
943	Second curtain spring 後バネ *d=0.29 	1	B2 B-1	14	△	*Rev.
944	Rewind shaft click spring 巻戻し軸クリックバネ *d=0.6 	1		14	○	*Rev.
945	Frame counter spring *d=0.35 コマ数計バネ 	1	D-3	4	○△	*Rev.
946	Sprocket spring *d=0.4 スポロバネ 	1		12	○	*Rev.
947-2	Self-timer lever spring *d=0.32 縦レバーバネ 	1		5, 12	○	*-16-25001 *Rev.
948	Slow speed change spring 切替えレバーバネ *d=0.29 	1	A10-2	13, 17	○△	*Rev.
949	Shutter button spring *d=0.23 	1	D-3, D6-2	4, 12	○△	*Rev.
951	Shutter auxiliary lever spring シャッター補助レバーバネ *d=0.2 	1	A14-1	5, 12	○△	*Rev.
952-1	Speedlight clutch spring *d=0.29 スプロクラッチバネ 	1	*44	12	○	*-13-10001 *Rev.
Blank 欠						
954	Meter coupling pin spring *d=0.26 フォトミック運動ピンバネ 	1	C-1 C3-1	2, 13	○△	*Rev.













Part No. 部品番号	Name and Shape 名称および形状	Pcs. per Unit 1台分個数	Reference Subassembly No. 参照部組品番号	Reference Fig. No. 参照図番	Term of Sale 販売区分	Remarks 備考
Blank						
956	Shoe signal lever spring おじりバネ 線径0.45 左、巻数1½ 	1	H-1	2, 12 15	○△	
Blank						
Blank						
Blank						
Blank						
961	Washer (2.5×1×0.2) 露出計接点用ワッシャー 	1	A32	2, 14	△	
* 962*	Washer (4×1.5×0.6) ミラ-シグナルワッシャー 	1	H-1		○△	*Rev.
962b	" (4×1.5×0.7)	1	H-1	2, 15	○△	*Dis.
962c	Washer (4×1.5×0.8) " 	1	H-1	2, 15	○△	*Dis.
963	Washer (4×2.5×0.2) レバ-ワッシャー 	1	B-1 E-2	13	○△	
964a	Washer (3.6×2.6×0.1) レバ-下ワッシャー 	2	E-2	8	○△	-1
964b	" (3.6×2.6×0.12)	2	E-2	8	○△	-1
964c	Washer (3.6×2.6×0.15) " 	2	E-2	8	○△	-1











Part No. 部品番号	Name and Shape 名称および形状	Pcs. per Unit 1台分個数	Reference Subassembly No. 参照部品番号	Reference Fig. No. 参照図番	Term of Sale 販売区分	Remarks 備考
964d	Washer (3.6×2.6×0.2) レバー下ワッシャー 	2	E-2	8	○△	-1
964e	Washer (3.6×2.6×0.25) " 	2	E-2	8	○△	-6
964f	Washer (3.6×2.6×0.05) " 	*1	E-2	8	○△	-6 *Rev
965	Washer (3.5×1.8×0.05) レバー上ワッシャー 	4	E-2	8	○△	
966	Washer (3×2.1×0.1) ミラ-連絡レバー座金 	2	F-1 F2		△	
967a-1*	Washer (4.5×2.1×0.2) 上アイドルギア座金 	*5	A7-2, B-1		*	*-16-25001 *Rev.
967b	" (4.5×2.1×0.3)	*2	A7-2		△	*-16-25001 *Rev.
* 968a	Washer (6×3×0.3) スボロ下ギヤ座金 	1			○	*Dis. *51F2012 *-18
* 968b	" (6×3×0.4)	1		12	○	*Dis. *51F2012 *-18
* 968c	Washer (6×3×0.5) " 	1		12	○	*Dis. *51F2012 *-18
* 968d	Washer (6×3×0.6) " 	1		12	○	*Dis. *51F2012 *-18
969	Washer (4×1.9×0.2) シャッター縦レバー座金 	*5	B-1, E-1 F-1×3, B-1	9, 12 13	○△	*Rev.

Part No. 部品番号	Name and Shape 名称および形状	Pcs. per Unit 1台分個数	Reference Subassembly No. 参照部品番号	Reference Fig. No. 参照図番	Term of Sale 販売区分	Remarks 備考
970a	Washer (5.5×3.5×0.05) 巻上げ軸調整座金 	2 - 3	B-1	12	○△	-1
970b	Washer (5.5×3.5×0.1) " 	2 - 3	B-1	12	○△	-1
970c	Washer (5.5×3.5×0.2) " 	2 - 3	B-1	12	○△	-1
970d	Washer (5.5×3.5×0.3) " 	2 - 3	A5- [*] 3	12	○△	-1 *Rev.
971	Washer (5×1.8×0.2) Mアップストッパー座金 	1	F-1	5, 9	○△	
972	Washer (9.6×6.2×0.2) クリックバネ制限座金 	1	E-1 E-2	8	○△	
973-1	Washer (5× [*] 2×0.3) 大レバー軸座金 	1		13	○	*Rev.
974	Washer (6×2.2×0.2) フレキ座金 	2	B-1	13	○△	
975	Collar (2.5×1.2×1.5) 後フレキカラー 	1	B4 B-1		△	
976	Washer (3.5×1.7×0.2) 舟型軸座金 	1	All-1	13	○△	
977	Collar (3.2×1.8×2.6) フアインダー着脱レバーカラー 	1		14	○	
978a	Washer (6×3×0.1) 下ブリー座金 	1	B-1	13	△	-6
978b	" (6×3×0.2) 	1	B-1	13	△	-6

Part No. 部品番号	Name and Shape 名称および形状	Pcs. per Unit 1台分個数	Reference Subassembly No. 参照部組品番号	Reference Fig. No. 参照図番	Term of Sale 販売区分	Remarks 備考
979	Washer (3.8×1.5×0.4) 高速レバー軸座金 	1	C-1 C1-1	13	△	
980	Washer (4×1.6×0.3) バネ軸下座金 	2	B-1	14	△	*20FB1- #368 *Rev.
981a	Washer (3×1.6×0.1) バネ軸調整座金 	4	B-1 B1, B2	14	○△	-1
981b	" (3×1.6×0.2) 	4	B-1 B1, B2	14	○△	-1
981c	Washer (3×1.6×0.3*) " 	4	B-1 B1, B2	14	○△	-1 *Rev.
982a	Washer (3.8×2.1×0.05) バック調整用座金 	1		15	○	*Rev. -1
982b	" (3.8×2.1×0.06) 	1		15	○	-1
982c	Washer (3.8×2.1×0.07) " 	1		15	○	-1
982d	Washer (3.8×2.1×0.08) " 	1		15	○	-1
982e	Washer (3.8×2.1×0.09) " 	1		15	○	-1
982f	Washer (3.8×2.1×0.1) " <i>IK050.04</i> 	1		15	○	-1
982g	Washer (3.8×2.1×0.15) " 	1		15	○	-1

Part No. 部品番号	Name and Shape 名称および形状	Pcs. per Unit 1台分個数	Reference Subassembly No. 参照部組品番号	Reference Fig. No. 参照図番	Term of Sale 販売区分	Remarks 備考
983	Collar (3×1.7×0.5) T形レバーカラー 	1	F-1		○△	
984a	Washer (5×2.6×0.15) 主レバー座金 	1	F-1	9	○△	-1
984b	" (5×2.6×0.2) 	1	F-1	9	○△	-1
984c	Washer (5×2.6×0.25) " 	1	F-1	9	○△	-1
985	Washer (5×1.4×0.3) スローレバー軸座金 	1	C-1 C2-1	13	△	
986	Collar (3.8×1.9×1) Mレリーズカギカラー 	1	F-1	9	○△	
988	Washer (3.8×1.8×0.5) M縦レバー座金 	1	F-1	9, 12	○△	
989-1	Washer (5.5×3.2×0.8) 巻戻しノブ座金 	1		15	○	*Rev.
990	Collar (2.5×1.2×1.2) 先ブレーキカラー 	1	B5 B-1	13	△	
991	Washer (4.8×3.1×0.4) 裏蓋カギ軸座金 	2	*A		*○	*Rev.
992	Washer (7.7×5.8×0.1) スプールバネ座金 	1		12	○	

Part No. 部品番号	Name and Shape 名称 および 形状	Pcs. per Unit 1台分個数	Reference Subassembly No. 参照部組品番号	Reference Fig. No. 参照図番	Term of Sale 販売区分	Remarks 備考
993	Washer (3×1.5×0.05) 指標座金 	1	C-1	13	△	*20FB1-#260 *Rev.
994a	Washer (4.5×3.1×0.1) (4.5×3.1×0.2) (4.5×3.1×0.25) ドラム軸調整座金 	2	*H1, H-1	9, 13	○△	-1 *Rev
994b	Washer (4.5×3.1×0.15) " 	2	*H-1	9, 13	○△	-1 *Rev.
994c	Washer (4.5×3.1×0.2) " 	2	*H-1	9, 13	○△	-1 *Rev.
994d	Washer (4.5×3.1×0.25) " 	2	*H-1	9, 13	○△	-1 *Rev.
995	Washer (10.5×7.5×0.1) スプール下座金 	1		12	○	
996 -1	Washer (8×5.2×0.4) ミラープレーキ座金 	*2	*A6-2		△	*-20 *51F2012 *Rev.
Blank 欠						
998	Snap ring (E - 10) Eリング 	3	A11-1 H-1×1 H1×1	2, 13 15	○△	
999	Snap ring (E - 17) Eリング 	1	A1 B-1	14	○△	
1000	Snap ring (E - 20) Eリング 	1		12	○	
1001	Snap ring (E - 13) Eリング 	2	A13 C-1 C3-1	2, 7 12, 13 16, 19	○△	
1002	Steel ball, stainless (1/60") 鋼球 	76	* A6-2×36 B-1×40	12	△	-13 *Rev.
1003	Steel ball, stainless (1.0mm) 鋼球 	3	C-1×1 E-2×2	8, 13	○△	

Part No. 部品番号	Name and Shape 名称 および 形状	Pcs. per Unit 1台分個数	Reference Subassembly No. 参照部組品番号	Reference Fig. No. 参照図番	Term of Sale 販売区分	Remarks 備考
Blank 欠						
Blank 欠						
1006	Taper pin (TP ₁ [*] -8) テーパピン 	1	B-1, B3-1	3, 13	○△	*Rev.
1007-1	Spring pin スプリングピン 	1	A5- [*] 3	12	○△	*Rev. -13-10001
1008	Straight pin (SP1 [*] -3.6(S)) ストレートピン 	1	A27-1	15	○△	*Rev.
1009	Take-up shaft taper pin 巻き上げ軸テーパピン 	1	A9	7	○△	
Blank 欠						
Blank 欠						
1012	Snap ring ウォームCクリップ 	6	A8-3, A1 A22-1, B1 B2	7, 12 14, 17	○△	*20FB1-#285 *Rev.
1013a	Washer (4×1.9×0.05) ミラーアップレバー調整用座金 	1	E-2		○△	-1
1013b	Washer (4×1.9×0.1) 	1	E-2		○△	-1
1013c	Washer (4×1.9×0.15) " 	1	E-2		○△	-1
Blank 欠						
1014a	Washer (11×9×0.2) T.Lリング調整用座金 	1			○	
1014b	Washer (11×9×0.3) " 	1			○	

部組品一覽表

30FB - R.2012.B

No. of Subassembly 部組品番号	Name 名 称	Pcs. per Unit 1台分個数	No. of Constituent parts 構成部品番号	Reference Fig. No. 参照図番 号	Remarks
A1	Finder lock button ファインダー着脱ボタン部	1	309 319, 992 , 999, 301		*Rev.
#A2	Sync-terminal socket ターミナル部	1	*559-1, 550 , 560-I, 561-1 *562-1		*Rev.
#A3= 2	Spool gear bearing スプールギヤメタル部	1	221, 228, 234-1 , 237-1 870x2, 917-*2		*Rev.
#A4-2	Sprocket top bearing スプロケット上メタル部	1	247-1 , 246-1, 324-1, 252-1		*Rev.
A5-*3	Sprocket shaft スプロケット軸部	1	251-*3, 253-1, 254-2, 1007-1 970d, 222-1, 248, *250-2		*Rev.
A6-*2	Sprocket bottom bearing スプロケット下メタル部	1	249-*2, 252-*1, 339-*1, 996-*1, 1002x36		*Rev.
A7-2	Top idle gear 上アイドルギヤ部	1	219-*3, 220x2, *796A, *796B, *967bx2		*Rev.
A8-3	Spool gear pawl スプール逆転ツメ	1	326-1, 327-3, 1012, 1016		
A9	Take-up shaft 巻取り軸部	1	242, 215, 216, 239, 1009		
A10-*2	Change-over shaft 切替え軸部	1	446-*2, 425-*1, 447, 448, 865-1, 948		*Rev.
A11-1 1A 1B 1C	Release lever shaft 舟型軸部	1	411, 410, 772, 939-1 976, 998, 408a (or b - c)		*Rev.
A12-1	Drum top metal ドラム上メタル部	1	385, 382, 383, 384-1, 439-1 441		
A13	AR lever AR レバー部	1	243, 238, 244, 245, 930 1001		
A14-1	Shutter vertical lever シャッター縦レバー部	1	268-1, 318, 328, 329, 330 332, 468-*2 880x2, 951		*Rev.

Revision (訂正)

A14-2 NEW TYPE (MODIFY)

— 76 —

Date Jun. 22th 1976

Subassembly list

部組品一覧表

JOFB - R.2012.B

No. of Subassembly 部組品番号	Name 名 称	Pcs. per Unit 1台分個数	No. of Constituent parts 構成部品番号	Reference Fig. No. 参照図番	Remarks 備 考
Blank 欠					
A16-1	Shutter first curtain 先 幕 部	1	453-1, 457x2, 458x2, 460-1 *480x2		*Rev.
A17	Shutter second curtain 後 幕 部	1	454, 455x2, 456-*1, 457x2 *480x2		May be used 20FB-A9 20FB1 A9適用可
A18	Release button safety lever 安全レバー部	1	286, *460		*Rev.
A19-3	Sync actuating lever シンクロ走行レバー部	1	366-3, 556		
A20	Mirror change lever ミレバー部	1	284, 283, 369, 764, 872		
A21	Slow shaft スロー軸部	1	403, 423, 424		
A22-1	Reverse claw mount * 逆転つもの部	1	272, 323, 406, 407, 1012		*Rev.
A23	Governor ガバナー	1	501-536 Subassembly 式		
A24-1	Meter switch メータースイッチ部	1	281-1, 278, 279, 282-1ax2 282-1b, 320, 569, 570		*Rev.
A25	Meter switch, connecting rod メータースイッチ棒部	1	409, 280		
A26	FP contact plate シンクロ高速接点座部	1	345, 146, 164, 165x2, 166 167, 556, 557, 568, 821 829		
A27-1	Rewind shaft 巻戻し軸部	1	294-1, 295-1, 346, 347, 348 349-1, 350, 846, *848, *1008		*Rev.
A28	Finder holder connector 接 手 部	1	139, 140		

Revision (訂正)

— 77 —

Date Jun. 22th 1970

117

Subassembly list

部組品一覧表

30FB - R.2012.B

No. of Subassembly 部組品番号	Name 名 称	Pcs. per Unit 1台分個数	No. of Constituent parts 構成部品番号	Reference Fig. No. 参照図番 号	Remarks 備 考
A29	Rewind base plate contact 巻戻し座接点部	1	*5, *573, *814-1x3 565, 553, 555x4, 566		*Rev.
A30	Self-timer セルフタイマー	1	700x1 Subassembly 一式		
A31-1	Top cover, right 右上ふた部	1	3, 26, 30, 51-1, 355		
A32	Top cover, left 左上ふた部	1	4, 27, 28, 29, 52, 961		
A33-1	Take-up lever 巻き上げレバー部	1	224A-1 or 224B-1, 225, 225A 344, A28x2		
A34	Finder locating plate ファインダー基準板部	1	46, 751x2		
A35	Tripod screw mount 三脚座部	1	24, 23, 824		
A36-1	Rewind knob 巻戻しノブ部	1	304-1, 313-1, 314-1, 315 316, 317, 842x2, 658		
A37	Self-timer lever セルフタイマーレバー部	1	651, 652		
A38-2	Idle gear bottom plate フアイドルギヤ部	1	10-2, 223, 227-1, 267-1 269-1, 271, 270a or 270b 853-1, 784, 293a (or b - d)		
A39	Eyelet 耳環部	2	18, 60		
A40	Light baffle, body side ボディ側遮光板部	1	64, 67, 69		
A41-1	Sprocket スプロケット	1	248, 222-1		
A42	Sprocket top gear スプロ上ギア	1	246-1, 324-1		
*A435	Rewind button H Aボタン	1	296-1, 303-1, 819-1		*Add.

部品品一覽表

30FB - R.2012.B

No. of Subassembly 部品品番号	Name 名 称	Pcs. per Unit 1台分個数	No. of Constituent parts 構成部品番号	Reference Fig. No. 参照図番号	Remarks 備 考
B1	First spring shaft 先主バネ部	1	420, 413, 414x2, 416, 451 452, 941, 981x2, 1012x2		
B2	Second spring shaft 後主バネ部	1	419, 417, 418, 942, 943 981x2, 1012x2		
B3-1	Drum ド ラ ム 部	1	390, 381, 386-1, 387-1, 388 389, 392, 395-1, 397-1 402-1, 449x2, 773, 841-1 862-1x2, 1006		
B4	Second brake lever 後ブレーキレバー部	1	400-1, 401, 436, 770, *993 , 975		*Rev.
B5	First brake lever 先ブレーキレバー部	1	398, 401, 436, 774, 990		
B6-2	Mirror signal lever ミラー信号レバー部	1	305, 306-1, 310-2, 431, 432		
B7-2	Release lever リリースレバー部	1	307-2, 754, 765-1		
B8-1	Battery chamber 電池室部	1	20-3, 21-1, 25, *814 , *888		*Rev.
B9-1	Second brake ring 後ブレーキリング	1	391-1, 393-1		
B10-2	Shuttercharge disk 巻 上 げ 盤	1	396-2, 399-1, 461-1, 760x2 805* 10 , 936-2, *892		*Rev.
B11	Bound preventing claw バウンド防止ツメ	1	*472A, *472B, 474		*Rev.
B-1	Bottom plate 底 板 部	1	8-2, 273, 274, 275-1, 276-1, 309, 338-1, *336 , 394-1, 397-1, 404x2, 405x2, 422x2, 450x2, 465, 473, 798-2, 805, 806x2, 807x3 855, 864x4, *809-1, *863-1, 876-2, *903-1, 905, *929 , 963, *967 , 969, 970, 974x2, 978, 999 980x2, 1002x40, B1, B2, B3-1, B4, B5, B9, B10, B11,		*Rev.
*B1-3	Shutter under lever START CAM シャッター下レバー部	1	336-1, 337-2, 793-1		*Add.

Subassembly list

部組品一覧表

3QFB - R. 2012. B

No. of Subassembly 部組品番号	Name 名 称	Pcs. per Unit 1台分個数	No. of Constituent parts 構成部品番号	Reference Fig. No. 参照図番 号	Remarks 備 考
C1-1	High speed lever 高速レバー部	1	442, 370, 426, 438, 440-1 443, 445, 771, 776, 777, 838 918, 919, 979		
C2-1	Slow speed lever スローレバー部	1	459, 371, 372, 373, 766 934 985		
C3-1	Shutter dial シャッターダイヤル部	1	351, 352, 462, 463, 866x2 871, 954, 1001, *823x3		*Rev.
C4-1	Sync contact シンクロ接点部	1	364 -1, 557	*140- R-INTNO 883	*Rev.
C-1	Shutter middle plate シャッター中板部	1	374-1, 341, 353, 354, 356, 357 358, 359, 360, 361, 362x2 363, 365, 375, 376, 377, 378 379, 380-1, 412-1, 427x2 437-1, 444x2, 790x3, 804x4 808x2, 809-1x3, 834-1x2 842x2, 883x3, 919, 934, 993 1003, C1-1, C2-1, C3-1, C4 *364-1		*Rev.
D-3	TAKE-UP PLATE				
D1	Counter reverse lever 0戻しレバー部	1	291, 287		
D2-1	Advance claw 送りツメ部	1	210-1, 762		
D3	Lock claw ロックツメ部	1	211, 762		
D4-2	Take-up barrel drum 巻き上げ番筒部	1	214-1, 217x2, 289-*2, 763x2 815, 937		*Rev.
D5	Take-up lever stopper 巻き上げレバー戻り制限部	1	277, 312		
D6-2	Shutter release button シャッターボタン軸部	1	262-2, 259, 260-1, 261-1 264, 949		

部品一覧表

30FB - R.2012.B

No. of Subassembly 部品番号	Name 名称	Pcs. per Unit 1台分個数	No. of Constituent parts 構成部品番号	Reference Fig. No. 参照図番号	Remarks 備考
D-3	Take-up middle plate 巻上げ中板部	1	265-1, 204, 205, 206, 208-1 209-1, 212, 213-1, 218, 255-2 256-2, 263, 266, 325, 429 434, 435, 797, 799-1, 811x5, 813, 834, 835, 842, 879, 931 945, 1015, D1, D2-1, D3, D4-2, D5, D6-2		*Rev.
E1-1	Mirror-up knob ミラーアップノブ部	1	170, 171-1		
E2-1	See-saw lever B シーソーレバーB部	1	158-1, 757		
E3	Slide lever スライドレバー部	1	159, 169		
E-2	Front plate 前板部	1	6, 15, 41, 42, 43, 44, 45 47, 48x3, 150x2, 151, 152-2, 153-1, 154, 155, 156-1, 157 160, 161-1, 162-2, 163, 168 176x2, 177x2, 782x6, 783x4 789, 790x2, 816x4, 878-1 901, 912, 963, 964x2, 965x4 969, 972, 1003x2, 1013, E1-1, E2-1, E3		
F1	Aperture coupling lever 絞りレバー部	1	102, 117		
F2	Mirror drive lever 主レバー部	*1	101, 107, 109, 110, 118, 126 761x2, 778, 966x2		*Rev.
F3	Mirror-up stopper ミラーアップストッパー部	1	111, 114, 115		
F4-1	Mirror holder チリトリ部	*1	125, 121, 124, 127, 136-1 137-1, 755, 756, 758x2 759x2, 877x2, 913, 914, G1		*Rev.
F5-1	Mirror holder mount チリトリ保持板部	2	122, 123-1		
F6	Mirror-up lever ミラーアップレバー部	1	106, 753-1		*Rev.

Revision (訂正)

-- 81 --

Date Jun. 22th 1976

121

Subassembly list

部組品一覧表

30FB - R.2012.B

No. of Subassembly 部組品番号	Name 名 称	Pcs. per Unit 1台分個数	No. of Constituent parts 構成部品番号	Reference Fig. No. 参照図番 号	Remarks 備 考
F7-1	Mirror brake ミラーブレーキ部	1	131-1, 130, 135-1, 174, 175 875, 996 -1		*Rev.
F8	Release hook リリースカギ部	1	108, 752		
F9	Vertical lever 縦レバー部	1	105, 109, 119		
F10	Drive lever stopper 主レバーストッパー部	1	103, 116		
F11	Finder holder lever 引 出 し 部	1	138, 141, 142x2, 767		
F12-1	Rear light baffle 後側シャ光板部	1	13, 65, 66		
F-1	Mirror box ミラーボックス部		9-1, 11, 36, 58x1, 63x1 104-1, 112, 120, 132, 133-1 134, 144, 145, 147, 178 179, 180, 181, 182, 781x6 786, 787, 788*8, 791, 792x4 794x2, 795, 843x2, 844 845x4, 847, 851, 854, 859, 881, 888x3, 894, 902, 906 907, 908, 910, 911, 915, 969 971, 983, 984, 986, 988, F1 F2, F3, F4-1, F5-1, F6, F7-1 F8, F9, F10, F11, F12-1 36a or 36b, 144a (or 144b - e) *913, *914		*Rev.
H1	Shoe contact シュー接点シグナル部	1	19, 54, 563, 769, 998,		
H-1	Accessory shoe シュー部	1	55-1, 53-2 552, 564, 861 874, 956, 962, 998, H1 *71, *994a-d		*Rev.
J1-1	Cassette bearing マガジン受部	1	610-1, 615, 639, 833x2		
(01) J2 (DEP)	OC lever → USE J-1(01) OCレバー部	*1	611, 614, 616x2, 619, 635, 636, 637, 638, 640	NO. 9504	*Rev.
(01) J-1 (02)	Bottom plate 底 ぶ た 部	1	7, 613, 642x3, J1-1, J2		

Revision (訂正)

— 82 —

Date Jun. 22th 1976

122

