

**Nikon**

DIGITAL CAMERA

# COOLPIX S5100

User's Manual



En

### **Trademark Information**

- Microsoft, Windows and Windows Vista are either registered trademarks or trademarks of Microsoft Corporation in the United States and/or other countries.
- Macintosh, Mac OS, and QuickTime are trademarks of Apple Inc.
- Adobe and Acrobat are registered trademarks of Adobe Systems Inc.
- SD and SDHC Logos are trademarks of SD-3C, LLC.
- PictBridge is a trademark.
- All other trade names mentioned in this manual or the other documentation provided with your Nikon product are trademarks or registered trademarks of their respective holders.

**Introduction**

**First Steps**

**Basic Photography and Playback: 📷 (Auto) Mode**

**More on Shooting**

**More on Playback**

**Editing Images**

**Movie Recording and Playback**

**Connecting to Televisions, Computers, and Printers**

**Basic Camera Setup**

**Caring for the Camera**

**Technical Notes and Index**

## For Your Safety

To prevent damage to your Nikon product or injury to yourself or to others, read the following safety precautions in their entirety before using this equipment. Keep these safety instructions where all those who use the product will read them.



This icon marks warnings, information that should be read before using this Nikon product, to prevent possible injury.

### WARNINGS

#### **Turn off in the event of malfunction**

Should you notice smoke or an unusual smell coming from the camera or Charging AC Adapter, unplug the Charging AC Adapter and remove the battery immediately, taking care to avoid burns. Continued operation could result in injury. After removing or disconnecting the power source, take the equipment to a Nikon-authorized service representative for inspection.

#### **Do not disassemble**

Touching the internal parts of the camera or Charging AC Adapter could result in injury. Repairs should be performed only by qualified technicians. Should the camera or Charging AC Adapter break open as the result of a fall or other accident, take the product to a Nikon-authorized service representative for inspection, after unplugging the product and/or removing the battery.

#### **Do not use the camera or Charging AC Adapter in the presence of flammable gas**

Do not use electronic equipment in the presence of flammable gas, as this could result in explosion or fire.

#### **Handle the camera strap with care**

Never place the strap around the neck of an infant or child.

#### **Keep out of reach of children**

Particular care should be taken to prevent infants from putting the battery or other small parts into their mouths.

### **Observe caution when handling the battery**

The battery may leak, overheat, or explode if improperly handled. Observe the following precautions when handling the battery for use in this product:

- Before replacing the battery, turn the product off. If you are using the Charging AC Adapter/AC adapter, be sure it is unplugged.
- Use only a Rechargeable Li-ion Battery EN-EL10 (supplied). Charge the battery by using a camera that supports battery charging or by using a Battery Charger MH-63 (available separately). To charge the battery with the camera, use either Charging AC Adapter EH-68P/EH-68P (AR) (supplied) or the **Charge by computer** function.
- When inserting the battery, do not attempt to insert it upside down or backwards.
- Do not short or disassemble the battery or attempt to remove or break the battery insulation or casing.
- Do not expose the battery to flame or to excessive heat.
- Do not immerse in or expose to water.
- Put the battery in the battery case before transporting it. Do not transport or store with metal objects such as necklaces or hairpins.
- The battery is prone to leakage when fully discharged. To avoid damage to the product, be sure to remove the battery when no charge remains.
- Discontinue use immediately should you notice any change in the battery, such as discoloration or deformation.

### **Observe the following precautions when handling the Charging AC Adapter**

- If liquid from the damaged battery comes in contact with clothing or skin, rinse immediately with plenty of water.
- Keep dry. Failure to observe this precaution could result in fire or electric shock.
- Dust on or near the metal parts of the plug should be removed with a dry cloth. Continued use could result in fire.
- Do not handle the plug or go near the Charging AC Adapter during lightning storms. Failure to observe this precaution could result in electric shock.
- Do not damage, modify, forcibly tug or bend the USB cable, place it under heavy objects, or expose it to heat or flames. Should the insulation be damaged and the wires become exposed, take it to a Nikon-authorized service representative for inspection. Failure to observe these precautions could result in fire or electric shock.
- Do not handle the plug or Charging AC Adapter with wet hands. Failure to observe this precaution could result in electric shock.
- Do not use with travel converters or adapters designed to convert from one voltage to another or with DC-to-AC inverters. Failure to observe this precaution could damage the product or cause overheating or fire.

**⚠ Use appropriate cables**

When connecting cables to the input and output jacks, use only the cables provided or sold by Nikon for the purpose, to maintain compliance with product regulations.

**⚠ Handle moving parts with care**

Be careful that your fingers or other objects are not pinched by the lens cover or other moving parts.

**⚠ CD-ROMs**

The CD-ROMs supplied with this device should not be played back on audio CD equipment. Playing CD-ROMs on an audio CD player could cause hearing loss or damage the equipment.

**⚠ Observe caution when using the flash**

Using the flash close to your subject's eyes could cause temporary visual impairment. Particular care should be observed if photographing infants, when the flash should be no less than 1 m (3 ft. 4 in.) from the subject.

**⚠ Do not operate the flash with the flash window touching a person or object**

Failure to observe this precaution could result in burns or fire.

**⚠ Avoid contact with liquid crystal**

Should the monitor break, care should be taken to avoid injury caused by broken glass and to prevent liquid crystal from the monitor touching the skin or entering the eyes or mouth.

**⚠ Turn the power off when using inside an airplane or the hospital**

Turn the power off while inside the airplane during take off or landing. Follow the instructions of the hospital when using while in a hospital. The electromagnetic waves given out by this camera may disrupt the electronic systems of the airplane or the instruments of the hospital.

# Notices

## Notices for Customers in the U.S.A.

### **IMPORTANT SAFETY INSTRUCTIONS -**

#### **SAVE THESE INSTRUCTIONS.**

#### **DANGER - TO REDUCE THE RISK OF FIRE OR ELECTRIC SHOCK, CAREFULLY FOLLOW THESE INSTRUCTIONS**

For connection to a supply not in the U.S.A., use an attachment plug adapter of the proper configuration for the power outlet if needed.

The power supply unit is intended to be correctly orientated in a vertical or floor mount position.

#### **Federal Communications Commission (FCC) Radio Frequency Interference Statement**

This equipment has been tested and found to comply with the limits for a Class B digital device, pursuant to Part 15 of the FCC rules. These limits are designed to provide reasonable protection against harmful interference in a residential installation. This equipment generates, uses, and can radiate radio frequency energy and, if not installed and used in accordance with the instructions, may cause harmful interference to radio communications. However, there is no guarantee that interference will not occur in a particular installation. If this

equipment does cause harmful interference to radio or television reception, which can be determined by turning the equipment off and on, the user is encouraged to try to correct the interference by one or more of the following measures:

- Reorient or relocate the receiving antenna.
- Increase the separation between the equipment and receiver.
- Connect the equipment into an outlet on a circuit different from that to which the receiver is connected.
- Consult the dealer or an experienced radio/television technician for help.



**Nikon**

COOLPIX S5100

### **CAUTIONS**

#### **Modifications**

The FCC requires the user to be notified that any changes or modifications made to this device that are not expressly approved by Nikon Corporation may void the user's authority to operate the equipment.

#### **Interface Cables**

Use the interface cables sold or provided by Nikon for your equipment. Using other interface cables may exceed the limits of Class B Part 15 of the FCC rules.

## **Notice for customers in the State of California**

### **WARNING**

Handling the cord on this product will expose you to lead, a chemical known to the State of California to cause birth defects or other reproductive harm.

#### ***Wash hands after handling.***

Nikon Inc.,

1300 Walt Whitman Road

Melville, New York 11747-3064

USA

Tel: 631-547-4200

## **Notice for customers in Canada**

### **CAUTION**

This Class B digital apparatus complies with Canadian ICES-003.

### **ATTENTION**

Cet appareil numérique de la classe B est conforme à la norme NMB-003 du Canada.

## **Notices for customers in Europe**

### **CAUTIONS**

#### **RISK OF EXPLOSION IF BATTERY IS REPLACED BY AN INCORRECT TYPE.**

#### **DISPOSE OF USED BATTERIES ACCORDING TO THE INSTRUCTIONS.**

This symbol indicates that this product is to be collected separately.

The following apply only to users in European countries:

- This product is designated for separate collection at an appropriate collection point. Do not dispose of as household waste.
- For more information, contact the retailer or the local authorities in charge of waste management.

This symbol on the battery indicates that the battery is to be collected separately.



The following apply only to users in European countries:

- All batteries, whether marked with this symbol or not, are designated for separate collection at an appropriate collection point. Do not dispose of as household waste.
- For more information, contact the retailer or the local authorities in charge of waste management.





# Table of Contents

For Your Safety .....	ii
WARNINGS .....	ii
Notices .....	v
<hr/>	
Introduction .....	1
About This Manual .....	1
Information and Precautions .....	2
Parts of the Camera .....	4
The Camera Body .....	4
The Monitor .....	6
Main Features of the Operation Controls .....	8
Common Menu Operations .....	10
Switching Between Tabs .....	11
The Shutter-release Button .....	11
Attaching the Camera Strap .....	11
<hr/>	
First Steps .....	12
Inserting the Battery .....	12
Removing the Battery .....	13
Charging the Battery .....	14
Turning On and Off the Camera .....	17
Setting Display Language, Date, and Time .....	18
Inserting Memory Cards .....	20
Removing Memory Cards .....	20
<hr/>	
Basic Photography and Playback:  (Auto) Mode .....	22
Step 1 Turn the Camera On and Select  (Auto) Mode .....	22
Indicators Displayed in  (Auto) Mode .....	23
Step 2 Frame a Picture .....	24
Using the Zoom .....	25
Step 3 Focus and Shoot .....	26
Step 4 Playing Back and Deleting Images .....	28
Playing Back Images (Playback Mode) .....	28
Deleting Unwanted Images .....	29
Using the Flash .....	30
Setting the Flash Mode .....	30
Taking Pictures with the Self-timer .....	32
Macro Mode .....	33
Adjusting Brightness (Exposure Compensation) .....	34











## Table of Contents

---

<b>More on Shooting .....</b>	<b>35</b>
<b>Selecting a Shooting Mode .....</b>	<b>35</b>
<b>Changing  (Auto) Mode Settings (Shooting Menu) .....</b>	<b>36</b>
Image Mode (Image Quality/Image Size) .....	37
White Balance (Adjusting Hue) .....	39
Metering .....	41
Continuous .....	42
ISO Sensitivity .....	43
Color Options .....	44
AF Area Mode .....	45
Autofocus Mode .....	48
Camera Settings that Cannot Be Applied Simultaneously .....	49
<b>Shooting Suited to Scenes (Scene Mode) .....</b>	<b>51</b>
Selecting a Scene Mode .....	51
Shooting in the Scene Mode Selected by the Camera (Scene Auto Selector) .....	52
Selecting a Scene Mode to Take Pictures (Features) .....	54
Shooting for a Panorama .....	62
<b>Shooting Smiling Faces (Smart Portrait Mode) .....</b>	<b>64</b>
Changing Smart Portrait Mode Settings .....	66
<b>Focusing on a Moving Subject (Subject Tracking Mode) .....</b>	<b>67</b>
Changing Subject Tracking Mode Settings .....	69

---

<b>More on Playback .....</b>	<b>70</b>
<b>Operations in Full-frame Playback Mode .....</b>	<b>70</b>
Displaying the Histogram and Shooting Information .....	71
<b>Viewing Multiple Images: Thumbnail Playback .....</b>	<b>72</b>
Calendar Display .....	74
<b>Taking a Closer Look: Playback Zoom .....</b>	<b>75</b>
<b>Playing Back Images by Category .....</b>	<b>77</b>
<b>Finding Images in Auto Sort Mode .....</b>	<b>78</b>
Viewing Images in Auto Sort Mode .....	78
Operations in Auto Sort Mode .....	80
Auto Sort Menu .....	80
<b>Viewing Images by Date (List by Date) .....</b>	<b>81</b>
Viewing Images in List by Date Mode .....	81
Operations in List by Date Mode .....	82
List by Date Menu .....	82

<b>Playback Options: Playback Menu</b> .....	<b>83</b>
 Print Set (Creating a DPOF Print Order) .....	84
 Slide Show .....	87
 Protect .....	88
 Rotate Image .....	90
 Voice Memo .....	91
 Copy (Copy Between Internal Memory and Memory Card) .....	93
<hr/>	
<b>Editing Images</b> .....	<b>94</b>
<b>Editing Functions</b> .....	<b>94</b>
<b>Image Editing</b> .....	<b>96</b>
 Quick Retouch: Enhancing Contrast and Saturation .....	96
 D-Lighting: Enhancing Brightness and Contrast .....	97
 Skin Softening: Softening Skin Tones .....	98
 Small Picture: (Reducing Image Size) .....	99
 Crop: Creating a Cropped Copy .....	100
<hr/>	
<b>Movie Recording and Playback</b> .....	<b>101</b>
<b>Recording Movies</b> .....	<b>101</b>
Changing Movie Recording Settings .....	103
Movie Options .....	104
Autofocus Mode .....	105
<b>Movie Playback</b> .....	<b>106</b>
Deleting Movies .....	106
<hr/>	
<b>Connecting to Televisions, Computers, and Printers</b> .....	<b>107</b>
<b>Connecting to a TV</b> .....	<b>107</b>
<b>Connecting to a Computer</b> .....	<b>108</b>
Before Connecting the Camera .....	108
Transferring Images from a Camera to a Computer .....	109
Charging While Connecting to a Computer .....	113
<b>Connecting to a Printer</b> .....	<b>114</b>
Connecting the Camera to a Printer .....	115
Printing Images One at a Time .....	116
Printing Multiple Images .....	117

## Table of Contents

---

<b>Basic Camera Setup</b> .....	<b>120</b>
<b>Setup Menu</b> .....	<b>120</b>
Welcome Screen .....	122
Date .....	123
Monitor Settings .....	126
Date Imprint (Imprinting Date and Time) .....	128
Vibration Reduction .....	129
Motion Detection .....	130
AF Assist .....	131
Digital Zoom .....	131
Sound Settings .....	132
Auto Off .....	133
Format Memory/Format Card .....	134
Language .....	135
Video Mode .....	135
Charge by Computer .....	136
Blink Warning .....	137
Reset All .....	139
Firmware Version .....	141

---

<b>Caring for the Camera</b> .....	<b>142</b>
<b>Maximizing Camera Life and Performance</b> .....	<b>142</b>
Cleaning .....	144
Storage .....	144

---

<b>Technical Notes and Index</b> .....	<b>145</b>
<b>Optional Accessories</b> .....	<b>145</b>
Approved Memory Cards .....	145
<b>Image/Sound File and Folder Names</b> .....	<b>146</b>
<b>Error Messages</b> .....	<b>147</b>
<b>Troubleshooting</b> .....	<b>151</b>
<b>Specifications</b> .....	<b>158</b>
Supported Standards .....	161
<b>Index</b> .....	<b>162</b>

## About This Manual

Thank you for your purchase of a Nikon COOLPIX S5100 digital camera. This manual was written to help you enjoy taking pictures with your Nikon digital camera. Read this manual thoroughly before use, and keep it where all those who use the product will read it.

### Symbols and Conventions

To make it easier to find the information you need, the following symbols and conventions are used:



This icon marks cautions, information that should be read before use, to prevent damage to the camera.



This icon marks tips, additional information that may be helpful when using the camera.



This icon marks notes, information that should be read before using the camera.



This icon indicates that more information is available elsewhere in this manual.

### Notations

- Secure Digital (SD) memory card and SDHC memory card are referred to as “memory card.”
- The setting at the time of purchase is referred to as the “default setting.”
- The names of menu items displayed in the camera monitor, and the names of buttons or messages displayed on a computer monitor appear in bold.

### Screen Samples

In this manual, images are sometimes omitted from monitor display samples so that monitor indicators can be more clearly shown.

### Illustrations and Screen Display

Illustrations and text displays shown in this manual may differ from actual display.

### Internal Memory and Memory Cards

Pictures taken with this camera can be stored in the camera’s internal memory or on removable memory cards. If a memory card is inserted, all new pictures will be stored on the memory card and delete, playback, and format operations will apply only to the pictures on the memory card. The memory card must be removed before the internal memory can be formatted or accessed for picture storage, deletion, or viewing.

# Information and Precautions

## Life-Long Learning

As part of Nikon's "Life-Long Learning" commitment to ongoing product support and education, continually updated information is available online at the following sites:

- For users in the U.S.A.: <http://www.nikonusa.com/>
- For users in Europe and Africa: <http://www.europe-nikon.com/support/>
- For users in Asia, Oceania, and the Middle East: <http://www.nikon-asia.com/>

Visit these sites to keep up-to-date with the latest product information, tips, answers to frequently asked questions (FAQs), and general advice on digital imaging and photography. Additional information may be available from the Nikon representative in your area. Visit the site below for contact information:

<http://imaging.nikon.com/>

## Use Only Nikon Brand Electronic Accessories

Nikon COOLPIX cameras are designed to the highest standards and include complex electronic circuitry. Only Nikon brand electronic accessories (including battery charger, batteries, Charging AC Adapter, and AC adapters) certified by Nikon specifically for use with this Nikon digital camera are engineered and proven to operate within the operational and safety requirements of this electronic circuitry.

THE USE OF NON-NIKON ELECTRONIC ACCESSORIES COULD DAMAGE THE CAMERA AND MAY VOID YOUR NIKON WARRANTY.

The use of third-party rechargeable Li-ion batteries not bearing the Nikon holographic seal could interfere with normal operation of the camera or result in the batteries overheating, igniting, rupturing, or leaking.

For more information about Nikon brand accessories, contact a local authorized Nikon dealer.

**Holographic seal:** Identifies this device as an authentic Nikon product.



## Before Taking Important Pictures

Before taking pictures on important occasions (such as at weddings or before taking the camera on a trip), take a test shot to ensure that the camera is functioning normally. Nikon will not be held liable for damages or lost profits that may result from product malfunction.

## About the Manuals

- No part of the manuals included with this product may be reproduced, transmitted, transcribed, stored in a retrieval system, or translated into any language in any form, by any means, without Nikon's prior written permission.
- Nikon reserves the right to change the specifications of the hardware and software described in these manuals at any time and without prior notice.
- Nikon will not be held liable for any damages resulting from the use of this product.
- While every effort was made to ensure that the information in these manuals is accurate and complete, we would appreciate it were you to bring any errors or omissions to the attention of the Nikon representative in your area (address provided separately).

## Notice Concerning Prohibition of Copying or Reproduction

Note that simply being in possession of material that was digitally copied or reproduced by means of a scanner, digital camera or other device may be punishable by law.

### • Items prohibited by law from being copied or reproduced

Do not copy or reproduce paper money, coins, securities, government bonds or local government bonds, even if such copies or reproductions are stamped "Sample." The copying or reproduction of paper money, coins, or securities which are circulated in a foreign country is prohibited. Unless the prior permission of the government was obtained, the copying or reproduction of unused postage stamps or post cards issued by the government is prohibited.

The copying or reproduction of stamps issued by the government and of certified documents stipulated by law is prohibited.

### • Cautions on certain copies and reproductions

The government has issued cautions on copies or reproductions of securities issued by private companies (shares, bills, checks, gift certificates, etc.), commuter passes, or coupon tickets, except when a minimum of necessary copies are to be provided for business use by a company. Also, do not copy or reproduce passports issued by the government, licenses issued by public agencies and private groups, ID cards and tickets, such as passes and meal coupons.

### • Comply with copyright notices

The copying or reproduction of copyrighted creative works such as books, music, paintings, woodcut prints, maps, drawings, movies, and photographs is governed by national and international copyright laws. Do not use this product for the purpose of making illegal copies or to infringe copyright laws.

## Disposing of Data Storage Devices

Please note that deleting images or formatting data storage devices such as memory cards or built-in camera memory does not completely erase the original image data. Deleted files can sometimes be recovered from discarded storage devices using commercially available software, potentially resulting in the malicious use of personal image data. Ensuring the privacy of such data is the user's responsibility.

Before discarding a data storage device or transferring ownership to another person, erase all data using commercial deletion software, or format the device and then completely refill it with images containing no private information (for example, pictures of empty sky). Be sure to also replace any pictures selected for the **Select an image** option in the **Welcome screen** setting (📖 122). Care should be taken to avoid injury or damage to property when physically destroying data storage devices.

# Parts of the Camera

## The Camera Body

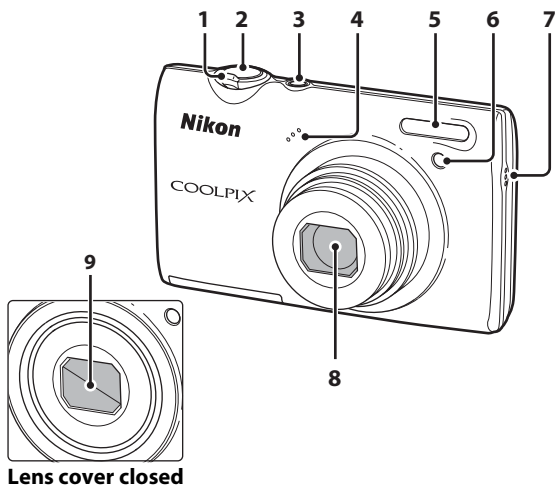

**Lens cover closed**

<b>1</b>	Zoom control.....25	<b>4</b> Microphone.....91, 101
	<b>W</b> : wide.....25	<b>5</b> Flash.....30
	<b>T</b> : tele.....25	<b>6</b> Self-timer lamp.....32
	: thumbnail playback..... 72, 74	AF-assist illuminator..... 131
	: playback zoom.....75	<b>7</b> Speaker.....92, 106
	: help.....51	<b>8</b> Lens.....144, 158
<b>2</b>	Shutter-release button..... 11, 26	<b>9</b> Lens cover
<b>3</b>	Power switch/power-on lamp ..... 17, 133	



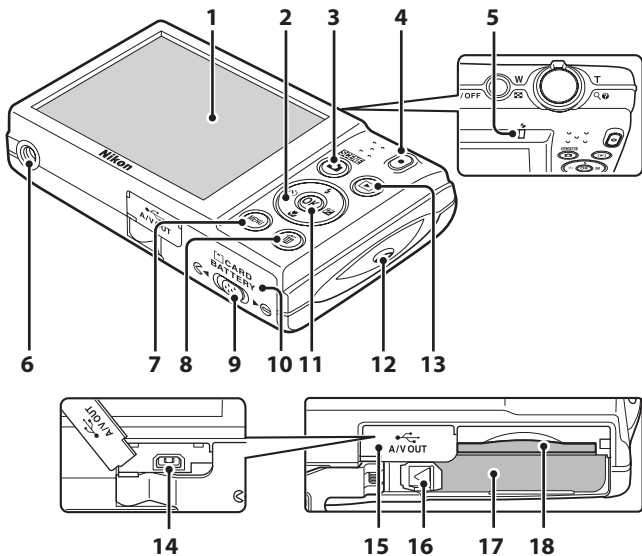

- |           |   |           |   |
|-----------|---|-----------|---|
| <b>1</b>  | Monitor .....6, 23                                    | <b>11</b> | <b>OK</b> (apply selection) button.....9                    |
| <b>2</b>  | Multi selector.....9                                  | <b>12</b> | Eyelet for camera strap..... 11                             |
| <b>3</b>  | <b>⏎</b> (shooting mode) button .....8, 35            | <b>13</b> | <b>▶</b> (playback) button ..... 8, 28, 77                  |
| <b>4</b>  | <b>●</b> (movie-record) button .....8, 101            | <b>14</b> | USB/audio/video output connector<br>..... 14, 107, 109, 115 |
| <b>5</b>  | Charge lamp .....15, 113<br>Flash lamp .....31        | <b>15</b> | Connector cover..... 14, 107, 109, 115                      |
| <b>6</b>  | Tripod socket .....159                                | <b>16</b> | Battery latch .....12, 13                                   |
| <b>7</b>  | <b>MENU</b> button .....10, 36, 83, 103, 121          | <b>17</b> | Battery chamber .....12                                     |
| <b>8</b>  | <b>🗑</b> (delete) button.....29, 92, 106              | <b>18</b> | Memory card slot .....20                                    |
| <b>9</b>  | Cover latch .....12, 20                               |           |   |
| <b>10</b> | Battery-chamber/<br>memory card slot cover.....12, 20 |           |   |

## The Monitor

The following indicators may appear in the monitor during shooting and playback (actual display varies with current camera settings).

The indicators that appear in the monitor during shooting and playback disappear after a few seconds (📖 126).

### Shooting

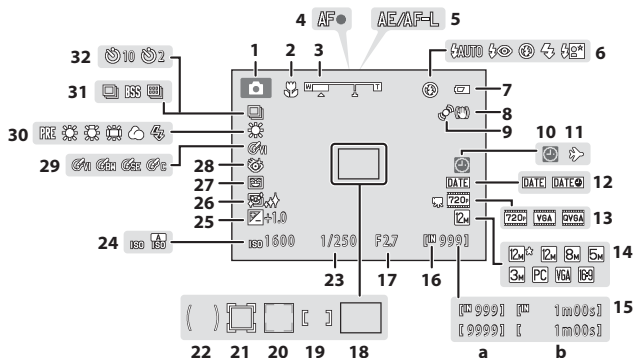

<b>1</b>	Shooting mode*	22, 51, 64, 67	<b>17</b>	Aperture.....	26
<b>2</b>	Macro mode .....	33	<b>18</b>	Focus area (auto).....	26, 45
<b>3</b>	Zoom indicator .....	25, 33	<b>19</b>	Focus area (for manual or center) ....	45
<b>4</b>	Focus indicator.....	26	<b>20</b>	Focus area (face detection) .....	45, 64
<b>5</b>	AE/AF-L indicator.....	63	<b>21</b>	Focus area (subject tracking mode).....	67
<b>6</b>	Flash mode .....	30	<b>22</b>	Center-weighted metering area .....	41
<b>7</b>	Battery level indicator .....	22	<b>23</b>	Shutter speed.....	26
<b>8</b>	Vibration reduction icon .....	23, 129	<b>24</b>	ISO sensitivity.....	31, 43
<b>9</b>	Motion detection icon.....	23, 130	<b>25</b>	Exposure compensation value.....	34
<b>10</b>	"Date not set" indicator.....	123, 147	<b>26</b>	Skin softening.....	66
<b>11</b>	Travel destination icon.....	123	<b>27</b>	Smile timer .....	66
<b>12</b>	Date imprint.....	128	<b>28</b>	Blink proof icon .....	66
<b>13</b>	Movie options.....	104	<b>29</b>	Color options .....	44
<b>14</b>	Image mode .....	37	<b>30</b>	White balance mode .....	39
<b>15</b>	(a) Number of exposures remaining (still images).....	22	<b>31</b>	Continuous shooting mode .....	42
	(b) Movie length.....	101	<b>32</b>	Self-timer indicator .....	32
<b>16</b>	Internal memory indicator .....	23			

\* The icon displayed varies with the shooting mode.

## Playback

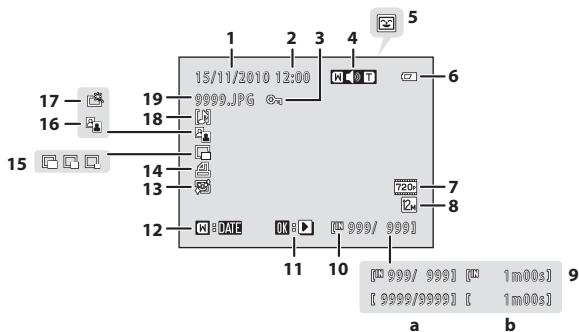





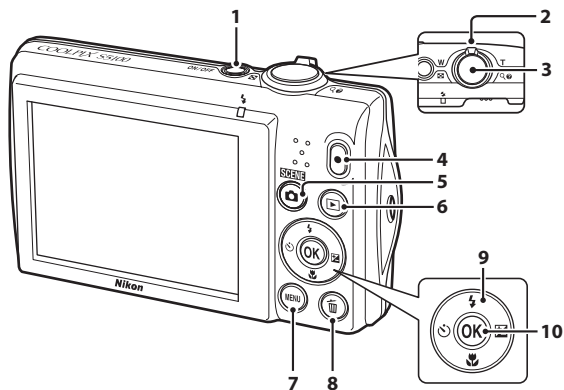

<b>1</b>	Date of recording .....	18	<b>10</b>	Internal memory indicator .....	28
<b>2</b>	Time of recording .....	18	<b>11</b>	Movie playback indicator .....	106
<b>3</b>	Protect icon .....	88	<b>12</b>	List by date guide .....	81
<b>4</b>	Volume indicator .....	92, 106	<b>13</b>	Skin softening icon .....	98
<b>5</b>	Category icon in auto sort mode <sup>1</sup> .....	78	<b>14</b>	Print set icon .....	84
<b>6</b>	Battery level indicator .....	22	<b>15</b>	Small picture icon .....	99
<b>7</b>	Movie options <sup>2</sup> .....	104	<b>16</b>	D-Lighting icon .....	97
<b>8</b>	Image mode <sup>2</sup> .....	37	<b>17</b>	Quick retouch icon .....	96
<b>9</b>	(a) Current frame number/ total number of frames .....	28	<b>18</b>	Voice memo indicator .....	92
	(b) Movie length .....	106	<b>19</b>	File number and type .....	146

<sup>1</sup> The icon for the selected category in auto sort mode in playback mode is displayed.

<sup>2</sup> The icon displayed varies with the setting that was set at the time of shooting.

# Main Features of the Operation Controls



	Control	Name	Function
1	 ON/OFF	Power switch	Turns the camera on and off ( 17)
2		Zoom control	Shooting mode: rotate to <b>T</b> (Q) to zoom in; rotate to <b>W</b> (R) to zoom out ( 25)
3		Shutter-release button	Shooting mode: releases the shutter ( 11, 26)
4		Movie-record button	Shooting mode: starts and stops movie recording ( 101)
5		Shooting mode button	Shooting mode: changes the shooting mode (displays the shooting-mode selection menu) ( 35)
6		Playback button	Playback mode: switches to the shooting screen
			Shooting mode: plays back images ( 28, 106)
			Playback mode: changes the playback mode (displays the playback-mode selection menu) ( 77)

	Control	Name	Function
7		<b>MENU</b> button	Turns the menu on and off (📖 10, 36, 83, 103, or 121)
8		Delete button	Shooting mode: deletes the last image captured (📖 29)
			Playback mode: deletes images or voice memo (📖 29, 92, or 106)
9		Multi selector (up)	Shooting mode: displays the  (flash mode) menu (📖 30) Playback mode: selects previous images During menu display: moves the highlight up
		Multi selector (left)	Shooting mode: displays the  (self-timer) menu (📖 32) Playback mode: selects previous images During menu display: moves the highlight left/ returns to the previous screen
		Multi selector (down)	Shooting mode: displays the  (macro mode) menu (📖 33) Playback mode: selects next images During menu display: moves the highlight down
		Multi selector (right)	Shooting mode: displays the  (exposure compensation) setting screen (📖 34) Playback mode: selects next images During menu display: moves the highlight right/ proceeds to next screen (applies selection)
10		Apply selection button	Playback mode (Full-frame playback): displays histogram and shooting information (except for movies)/returns to full-frame playback (📖 71) Playback mode (Zoom in/thumbnaill display): switches to full-frame playback (📖 72, 75) During menu display: applies selection (goes to next screen)

## Common Menu Operations

Press the **MENU** button (📖 9) to display the menu for the selected mode.

Use the multi selector (📖 9) to navigate the menus.

Tab for the menus available in the current shooting/playback mode

Tab for displaying the movie menu (during shooting mode)

Tab for displaying the setup menu

⏪ is displayed when previous menu items are available

📄 is displayed when the menu contains two or more pages

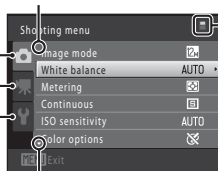

⏩ is displayed when there are one or more menu items to follow

**1** Press the **MENU** button.

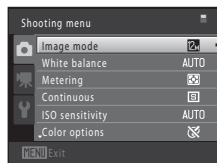
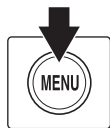

**2** Press the multi selector ▲ or ▼ to choose an item, and then press ► or the **OK** button.

To change tabs, press ◀ (📖 11).

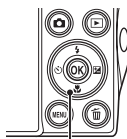

Multi selector

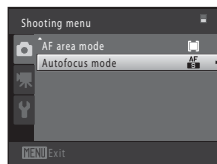

**3** Press ▲ or ▼ to choose an item and press the **OK** button.

The setting is applied.

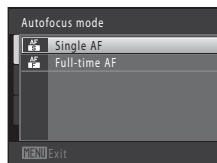

**4** When setting is finished, press the **MENU** button.

The camera exits the menu display.

## Switching Between Tabs

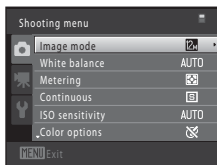

Press the multi selector ◀ to highlight the tab



Press the multi selector ▲ or ▼ to select a tab, and press either the OK button or ▶

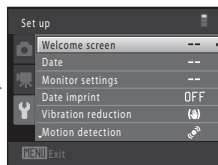

The selected menu is displayed

## The Shutter-release Button

The camera features a two-stage shutter-release button. To set focus and exposure, press the shutter-release button halfway, stopping when you feel resistance. When the shutter-release button is pressed halfway, focus and exposure (shutter speed and aperture value) are set. Focus and exposure remain locked while the shutter-release button is pressed halfway.

While the shutter-release button is held in this position, release the shutter and take a picture by pressing the shutter-release button the rest of the way down. Do not use force when pressing the shutter-release button, as this may result in camera shake and blurred images.



Press halfway to set focus and exposure



Press the rest of the way down to take a picture

## Attaching the Camera Strap

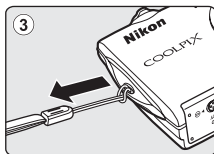
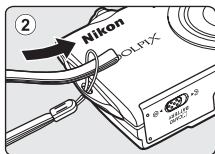
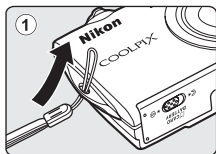

## Inserting the Battery

Insert a Rechargeable Li-ion Battery EN-EL10 (supplied) into the camera.

- Charge the battery before the first use or when the battery is running low (📖 14).

- 1 Open the battery-chamber/memory card slot cover.

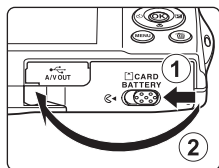

- 2 Insert the supplied battery.

Use the edge of the battery to push the orange battery latch in the direction indicated by the arrow (1) and fully insert the battery (2).

When the battery is fully inserted, the battery latch will lock it in place.

Battery chamber

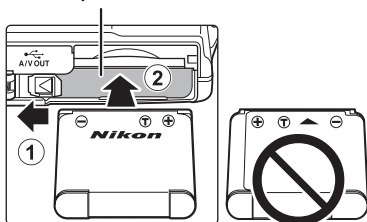

### ✓ Inserting the Battery

**Inserting the battery upside down or backwards could damage the camera.** Be sure to check that the battery is in the correct orientation.

- 3 Close the battery-chamber/memory card slot cover.

While the battery-chamber/memory card slot cover is open, the camera cannot be turned on. Additionally, the battery inserted in the camera cannot be charged.

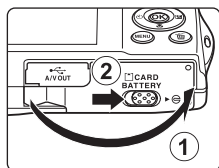



## Removing the Battery

Turn the camera off (📖 17) and be sure that the power-on lamp and the monitor have turned off before opening the battery-chamber/memory card slot cover.

To eject the battery, open the battery-chamber/memory card slot cover and slide the orange battery latch in the direction indicated by the arrow (①). The battery can then be removed by hand (②).

- Note that the battery and memory card may become hot during use; observe caution when removing the battery or memory card.

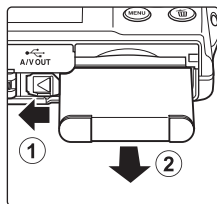

### ✓ Notes on the Battery

- Be sure to read and follow the warnings for the battery on page iii and the section, "The Battery" (📖 143), before use.
- If the battery will not be used for an extended period, recharge it at least once every six months and run it flat before returning it to storage.

# Charging the Battery

Charge the supplied Rechargeable Li-ion Battery EN-EL10 inserted into the camera, by connecting the supplied Charging AC Adapter EH-68P to the camera via the supplied USB Cable UC-E6, and then plugging the Charging AC Adapter into an electrical outlet.

## 1 Prepare the Charging AC Adapter EH-68P.

If a plug adapter\* is included, attach the plug adapter to the plug on the Charging AC Adapter. Push the plug adapter firmly until it is securely held in place. Once the two are connected, attempting to forcibly remove the plug adapter could damage the product.

\* The shape of the plug adapter varies according to the country or region in which the camera was purchased.

### For Customers in Argentina

If the camera was purchased in Argentina, the shape of the Charging AC Adapter EH-68P (AR) differs from that supplied in other countries, and a plug adapter is not included. Proceed to step 2.

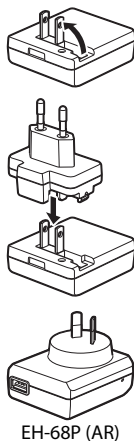

## 2 Insert the battery ( 12).

Do not turn the camera on.

## 3 Use the supplied USB cable to connect the Charging AC Adapter to the camera.

Be sure that connectors are properly oriented. Do not attempt to insert connectors at an angle, and do not use force when connecting or disconnecting the USB cable. Close the battery-chamber/memory card slot cover.

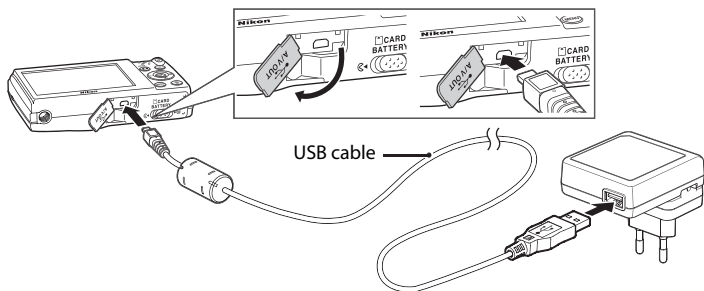

## 4 Plug the Charging AC Adapter into an electrical outlet.

The charge lamp slowly blinks green to indicate that the battery is charging.

About three hours are required to charge a fully exhausted battery.

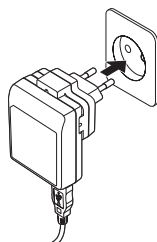

The following chart explains charge lamp status when the camera is plugged into the electrical outlet.

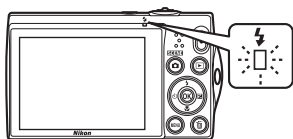

Charge lamp	Description
Blinks slowly (green)	Battery charging.
Off	Battery not charging. When charging is complete, the charge lamp stops blinking green and turns off.
Flickers (green)	<ul style="list-style-type: none"> <li>The ambient temperature is not suited to charging. Charge the battery indoors with an ambient temperature of 5 °C to 35 °C (41 °F to 95 °F).</li> <li>The USB cable or Charging AC Adapter is not properly connected, or there is a problem with the battery. Disconnect the USB cable or unplug the Charging AC Adapter and correctly connect it again, or change the battery.</li> </ul>

## 5 Disconnect the Charging AC Adapter from the electrical outlet and then disconnect the USB cable.

## Charging the Battery

### Notes on Charging AC Adapter

- The Charging AC Adapter EH-68P is for use only with compatible devices. Do not use with another make or model of device.
- Be sure to read and follow the warnings for the Charging AC Adapter on page iii and the section, “The Battery” (📖 143), before use.
- The EH-68P is compatible with AC 100-240 V, 50/60 Hz electrical outlets. When using in other countries, use a plug adapter (commercially available) as necessary. For more information about plug adapters, consult your travel agency.
- The Charging AC Adapter EH-68P is for charging the battery inserted into the camera. When the camera is connected to an electrical outlet with the Charging AC Adapter, the camera cannot be turned on.
- Do not, under any circumstances, use another make or model of AC adapter other than Charging AC Adapter EH-68P or USB-AC adapter. Failure to observe this precaution could result in overheating or in damage to the camera.

### AC Power Source

- If the AC Adapter EH-62D (available separately; 📖 145) is used, power is supplied to the camera from an electrical outlet and taking pictures and playing back images are available with this camera.
- Do not, under any circumstances, use another make or model of AC adapter other than EH-62D. Failure to observe this precaution could result in overheating or in damage to the camera.

### Charging Using Computer or Battery Charger

- Connecting the COOLPIX S5100 to a computer also charges the Rechargeable Li-ion Battery EN-EL10 (📖 108, 136).
- The EN-EL10 can be charged without using the camera by using the Battery Charger MH-63 (available separately; 📖 145).

## Turning On and Off the Camera

Press the power switch to turn on the camera. The power-on lamp (green) will light, and then the monitor will turn on (the power-on lamp turns off when the monitor turns on). To turn off the camera, press the power switch again. When the camera is turned off, the power-on lamp and the monitor will turn off.



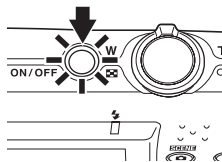

- If the camera is turned off, hold down the  button to turn the camera on in playback mode ( 28).



### Power Saving Function (Auto Off)

If no operations are performed for a while, the monitor will turn off, the camera will enter standby mode, and the power-on lamp will blink. If no operations are performed for another three minutes, the camera will turn off automatically.

When the power-on lamp is blinking, pressing any of the following buttons will turn the monitor back on.

- Power switch, shutter-release button,  button,  button, or  (movie-record) button
- In shooting or playback mode, the camera will enter standby mode in about one minute (default setting).
- The time allowed to elapse before the camera enters standby mode can be changed from the **Auto off** option ( 133) in the setup menu ( 120).

# Setting Display Language, Date, and Time

When the first time the camera is turned on, the language-selection screen and the date and time setting screen for the camera clock are displayed.

## 1 Press the power switch to turn on the camera.

The power-on lamp (green) will light, and then the monitor will turn on (the power-on lamp turns off when the monitor turns on).

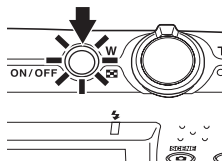

## 2 Press the multi selector ▲, ▼, ◀, or ▶ to choose the desired language and press the OK button.

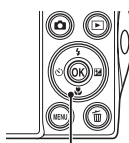

Multi selector



## 3 Press ▲ or ▼ to choose **Yes** and press the OK button.

To cancel setting the date and time, press ▲ or ▼ to select **No**.

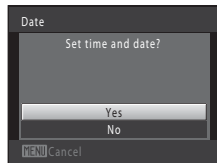

## 4 Press ◀ or ▶ to choose your home time zone (📖 125) and press the OK button.

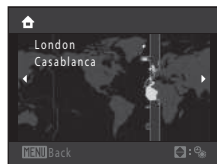

## Daylight Saving Time

If daylight saving time is in effect, press ▲ to enable the daylight saving time function while setting the region in step 4.

When the daylight saving time function is enabled,  is displayed at the top of the monitor. Press ▼ to disable the daylight saving time function.

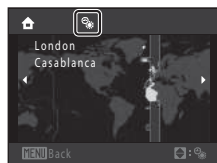

## 5 Edit the date and time.

Select an item: Press ► or ◀ (changes between **D**, **M**, **Y**, hour, minute, **DMY** (the order in which the day, month, and year are displayed)).

Edit the highlighted item: press ▲ or ▼.

Day, month, and year can be displayed in DMY, YMD, and MDY order.

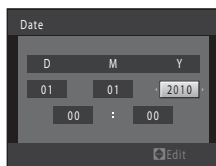

## 6 Finally, choose **DMY** (the order in which the day, month, and year are displayed) and press the **OK** button or press ►.

The clock starts. The lens extends and the screen used for taking pictures is displayed.

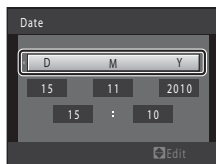

## Date Imprint and Changing the Date and Time

- To imprint the date on images while taking pictures, enable date imprint from the **Date imprint** option (📖 128) in the setup menu (📖 120) after the date and time have been set.
- To change the camera's internal time setting, select **Date** from the **Date** option (📖 123) in the setup menu (📖 120) and follow the procedure described from step 5.
- To change the time zone and daylight saving time settings, select **Time zone** from the **Date** option (📖 123) in the setup menu.

## Inserting Memory Cards

Image, sound, and movie files are saved in the camera's internal memory (approximately 32 MB) or on removable Secure Digital (SD) memory cards (commercially available;  145).

**If a memory card is inserted in the camera, data are automatically saved on the memory card and data saved to the memory card can be played back, deleted, or transferred. Remove the memory card to save data in the internal memory, or play back, delete, or transfer data from the internal memory.**

- 1 Be sure that the power-on lamp and the monitor are off and open the battery-chamber/memory card slot cover.

Be sure to turn off the camera before opening the cover.

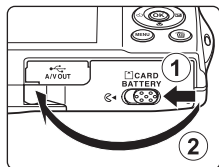

- 2 Insert the memory card.

Slide the memory card in until it clicks into place.

### Inserting Memory Cards

**Inserting the memory card upside down or backwards could damage the camera or the memory card.** Be sure to check that the memory card is in the correct orientation.

Memory card slot

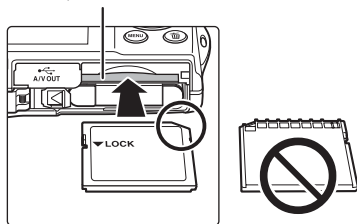

- 3 Close the battery-chamber/memory card slot cover.

## Removing Memory Cards

Turn the camera off and be sure that the power-on lamp and the monitor have turned off before opening the battery-chamber/memory card slot cover.

Press the card in (1) to partially eject the card, then remove the card by hand while being careful not to remove the card at an angle (2).

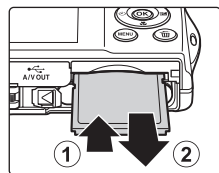

- Note that the battery and memory card may become hot during use; observe caution when removing the battery or memory card.



## ✓ Formatting Memory Cards

If the message on the right is displayed when the camera is turned on, the memory card must be formatted before use (📖 134). Note that **formatting permanently deletes all images and other data on the memory card**. Be sure to make copies of any images you wish to keep before formatting the memory card.

When formatting the memory card, use the multi selector to choose **Yes** and press the **OK** button. The confirmation dialog will be displayed. To start formatting, choose **Format** and press the **OK** button.

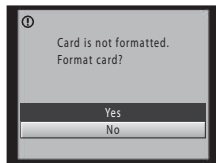

- Do not turn the camera off or open the battery-chamber/memory card slot cover until formatting is complete.
- Be sure to use this camera to format memory cards previously used in other devices the first time they are inserted into the COOLPIX S5100 (📖 134).

## ✓ The Write Protect Switch

When memory card switch is in the lock position, data cannot be written to, or deleted from, the memory card. If the switch is in the lock position, unlock it by sliding the switch to the write position to save or delete images, or to format the memory card.

Write protect switch

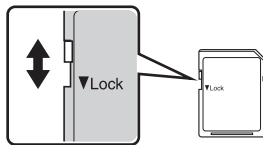

## ✓ Memory Cards

- Use only Secure Digital memory cards.
- Do not perform the following during formatting, while data is being written to or deleted from the memory card, or during data transfer to a computer. Failure to observe this precaution could result in the loss of data or in damage to the camera or memory card:
  - Remove the battery or memory card
  - Turn off the camera
  - Disconnect the AC adapter
- Do not format the memory card using a computer.
- Do not disassemble or modify.
- Do not drop, bend, or expose to water or strong physical shock.
- Do not touch the metal terminals with your fingers or metal objects.
- Do not affix labels or stickers to the memory card.
- Do not leave in direct sunlight, closed vehicles, or areas exposed to high temperatures.
- Do not expose to humidity, dust, or corrosive gases.

## Step 1 Turn the Camera On and Select (Auto) Mode

This section describes taking pictures in (auto) mode, an automatic, “point-and-shoot” mode recommended for first-time users of digital cameras.

### 1 Press the power switch to turn on the camera.

The lens extends and the monitor turns on.

Proceed to step 4 when is displayed.

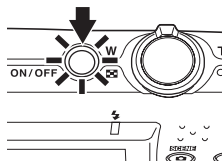

### 2 Press the button.

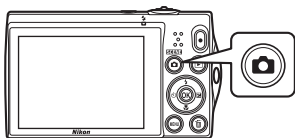

### 3 Press the multi selector or to choose **Auto mode** and press the button.

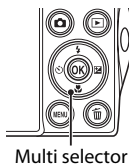

Multi selector

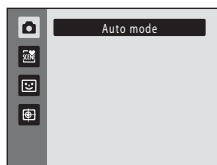

### 4 Check the battery level indicator and the number of exposures remaining.

Battery Level Indicator

Display	Description
(NO INDICATOR)	Battery fully charged.
	Battery low. Prepare to charge or replace the battery.
<b>Battery exhausted.</b>	Cannot take pictures. Recharge or replace with a fully charged battery.

Battery level indicator

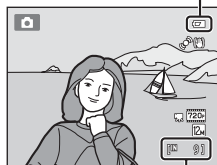



Number of exposures remaining

Number of Exposures Remaining

The number of pictures that can be taken is displayed.

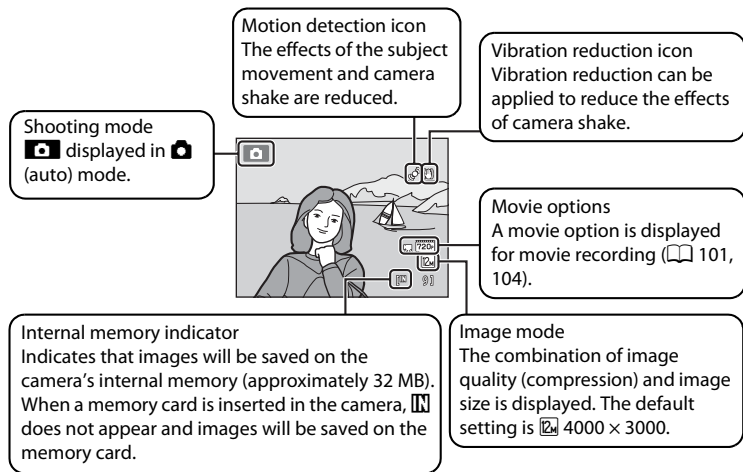
## Indicators Displayed in (Auto) Mode



- The indicators and photo info displayed during shooting and playback will turn off after a few seconds (see page 126).
- When the monitor has turned off in standby mode to save power (the power-on lamp is blinking) (see page 133), press the following buttons to turn it back on.  
→ Power switch, Shutter-release button,  button, or  (movie-record) button

## Functions Available in (Auto) Mode

- The flash mode (see page 30) can be adjusted, the self-timer (see page 32), macro mode (see page 33), and the exposure compensation (see page 34) can be applied.
- Press the **MENU** button to specify settings for all shooting menu items (see page 36) according to shooting conditions. The combination of image quality (compression) and image size can be set by using the **Image mode** option in the shooting menu.

## Vibration Reduction and Motion Detection

- See **Vibration reduction** (see page 129) or **Motion detection** (see page 130) in the setup menu (see page 120) for more information.
- Set **Vibration reduction** to **Off** when using a tripod to stabilize the camera during shooting.

## Step 2 Frame a Picture

### 1 Ready the camera.

Hold the camera steadily in both hands.

Keep fingers, hair and other objects away from the lens, flash, AF assist-illuminator and microphone.

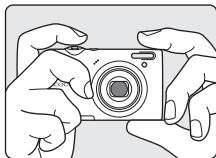

When taking pictures in portrait ("tall") orientation, turn the camera so that the flash is above the lens.

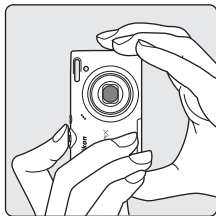

### 2 Frame the picture.

Frame the picture so that the intended subject is at or near the center of the frame.

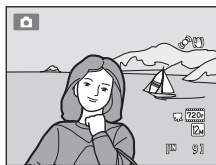

## Using the Zoom

Use the zoom control to activate optical zoom. Rotate the zoom control to **T** to zoom in so that the subject fills a larger area of the frame, or **W** to zoom out, thus increasing the area visible in the frame.

- When the camera is turned on, the zoom is at the widest position.
- A zoom indicator is displayed at the top of the monitor when the zoom control is rotated.

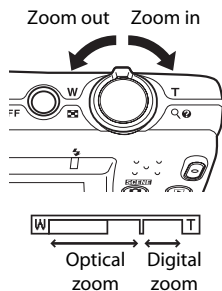

## Digital Zoom

When the camera is zoomed in to the maximum optical zoom position, rotating and holding the zoom control at **T** triggers digital zoom.

Digital zoom can magnify the subject up to about 2× beyond the maximum magnification of the optical zoom.

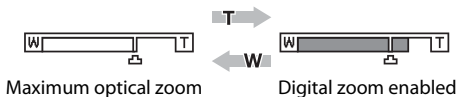



- The camera focuses at the center of the frame and the focus area is not displayed when digital zoom is in effect.

## Digital Zoom and Interpolation

Unlike optical zoom, digital zoom uses a digital imaging process known as interpolation to magnify images, resulting in slight deterioration of picture quality according to the image mode (📖 37) and digital zoom magnification.

Interpolation is applied at zoom positions beyond  when taking still images.

When zoom is increased beyond the  position, interpolation is initiated and the zoom indicator turns yellow to indicate that interpolation is being applied.

The position of  moves to the right as image size decreases, allowing for confirmation of the zoom positions at which shooting without interpolation is possible at the current image mode setting.

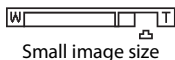

- Digital zoom can be disabled from the **Digital zoom** option (📖 131) in the setup menu (📖 120).

## Step 3 Focus and Shoot

### 1 Press the shutter-release button halfway.

When the shutter-release button is pressed halfway (📖 11), the camera sets focus and exposure (shutter speed and aperture value). Focus and exposure remain locked while the shutter-release button is pressed halfway.

The camera has nine focus areas, and automatically selects the focus areas containing the subject closest to the camera. When the subject is in focus, the focus areas that are in focus (up to nine areas) glow green.

The camera focuses at the center of the frame and the focus area is not displayed when digital zoom is in effect. Once focus has been acquired, the focus indicator (📖 6) glows green.

While the shutter-release button is pressed halfway, the focus area or focus indicator may blink red. This indicates that the camera is unable to focus. Modify the composition and press the shutter-release button halfway again.

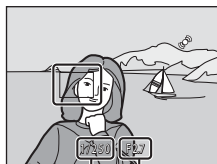
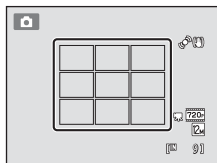
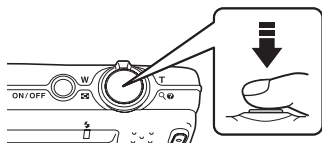

Shutter speed Aperture

### 2 Press the shutter-release button the rest of the way down.

The shutter is released and the image will be saved to the memory card or internal memory.



### ✓ During Saving

While images are being saved, the number of exposures remaining will blink. **Do not open the battery-chamber/memory card slot cover** while images are being saved. Cutting power or removing the memory card in these circumstances could result in loss of data or in damage to the camera or card.

### ✓ Autofocus

Autofocus may not perform as expected in the following situations. In some rare cases, the subject may not be in focus despite the fact that the focus area or the focus indicator glows green:

- Subject is very dark
- Objects of sharply differing brightness are included in the scene (e.g. the sun behind the subject makes that subject appear very dark)
- No contrast between the subject and surroundings (e.g. a portrait subject, wearing a white shirt, is standing in front of a white wall)
- Several objects are at different distances from the camera (e.g. the subject is inside a cage)
- Subjects with repeating patterns (window blinds, buildings with multiple rows of similarly shaped windows, etc.)
- Subject is moving rapidly

In the situations noted above, try pressing the shutter-release button halfway to refocus several times, or focus on another subject positioned at the same distance from the camera as the actual desired subject, and use focus lock (📖 46).

### ✓ When the Subject Is Close to the Camera

If the camera cannot focus, try shooting with macro mode (📖 33) or the **Close-up** scene mode (📖 58).

### ✍ AF-assist Illuminator and Flash





If the subject is dimly lit, the AF-assist illuminator (📖 131) may light when the shutter-release button is pressed halfway, or the flash (📖 30) may fire when the shutter-release button is pressed all the way down.



## Step 4 Playing Back and Deleting Images



### Playing Back Images (Playback Mode)

Press the  (playback) button.

The last image captured will be displayed in full-frame playback mode.

Press the multi selector  or  to view the previous image. Press  or  to view the next image.

To return to shooting mode, press the  button or the shutter-release button. Pressing the  (movie-record) button will also return the camera to shooting mode.

When playing back images saved in the camera's internal memory,  is displayed. When a memory card is inserted in the camera,  is not displayed and images saved on the memory card are played back.

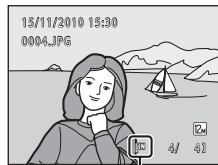
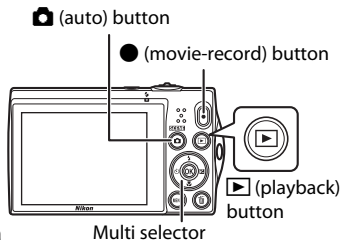

Internal memory indicator



#### When the Monitor Has Turned Off to Save Power

When the power-on lamp is blinking, press the  button to turn the monitor back on ( 133).

#### Operations Available in Playback Mode

See "More on Playback" ( 70) or "Editing Images" ( 94) for more information.

#### Displaying Shooting Information

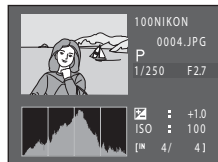

Press the  button in full-frame playback mode to display the histogram and shooting information ( 71). Press the  button again to return to full-frame playback mode.



#### Pressing the Button to Turn On the Camera

When the camera is off, holding down the  button will turn the camera on in playback mode. The lens will not extend.

#### Viewing Images

Images captured using face detection ( 47) will be rotated and displayed automatically according to the orientation of the faces detected, in full-frame playback mode (excluding images captured using **Continuous**, **BSS**, and **Multi-shot 16** ( 42)).





## Deleting Unwanted Images

- 1 Press the  button to delete the image currently displayed in the monitor.

To exit without deleting the image, press the **MENU** button.



- 2 Press the multi selector  or  to choose the desired deletion method and press the **OK** button.



**Current image:** Only the current image or voice memo ( 92) is deleted.

**Erase selected images:** Multiple images can be selected and deleted.

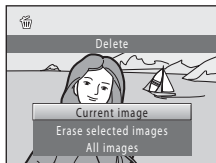

→ “Operating the Erase Selected Images Screen”

**All images:** All images are deleted.







- 3 Press  or  to choose **Yes** and press the **OK** button.

Deleted images cannot be recovered.

To cancel, press  or  to select **No** and press the **OK** button.



## Operating the Erase Selected Images Screen

- 1 Press the multi selector  or  to choose an image to be deleted, and then press  to display .

To undo the selection, press  to remove .

Rotate the zoom control ( 4) to **T** () to switch back to full-frame playback or **W** () to display thumbnails.



- 2 Add  to all desired images and then press the **OK** button to confirm the selection.

A confirmation dialog is displayed. Follow the instructions displayed in the monitor.

### Notes on Deletion

- Deleted images cannot be restored. Transfer important images to a computer before deleting them.
- Protected images cannot be deleted ( 88).

### Deleting the Last Image Captured While in Shooting Mode

In shooting mode, press the  button to delete the last image captured.

## Using the Flash

The flash mode can be set to match the shooting conditions.

- When **ISO sensitivity** is set to **Auto**, the flash has a range of 0.5-6.0 m (1 ft. 8 in.-19 ft.) at the maximum wide-angle zoom position and a range of 0.7-2.5 m (2 ft. 4 in.-8 ft.) at the maximum telephoto zoom position.

### **Auto**

Flash fires automatically when lighting is dim.

### **Auto with red-eye reduction**

Reduce “red-eye” in portraits (📖 31).

### **Off**

Flash will not fire even when lighting is dim.

### **Fill flash**

Flash fires whenever a picture is taken. Use to “fill-in” (illuminate) shadows and backlit subjects.

### **Slow sync**

 **Auto** (auto) is combined with slow shutter speed.



Suited to evening and night portraits that include background scenery. Flash illuminates main subject; slow shutter speeds are used to capture background at night or under dim lighting.

## Setting the Flash Mode

- 1 Press the multi selector  (flash mode).

The flash mode menu is displayed.



- 2 Press the multi selector  or  to choose the desired mode and press the  button.

The icon for the selected flash mode is displayed.

When  **Auto** (auto) is applied,  **Auto** is only displayed for a few seconds, regardless of **Photo info** settings (📖 126).

If a setting is not applied by pressing the  button within a few seconds, the selection will be canceled.

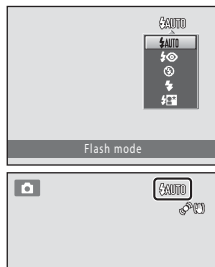

## ✓ Shooting When the Flash Is Disabled (🔇) or Lighting Is Dim

- Use of a tripod is recommended to stabilize the camera during shooting. Set **Vibration reduction** (📖 129) to **Off** in setup menu (📖 120) when using a tripod to stabilize the camera.
- **ISO** may be displayed in the shooting screen. When **ISO** is displayed, ISO sensitivity is automatically increased.
- The noise reduction function may be activated with some shooting conditions such as dim lighting. More time than usual is required to save images to which noise reduction is applied.

## ✓ Note on the Flash

When using the flash, reflections from dust particles in the air may appear as bright spots in images. To reduce these reflections, set the flash to 🔇 (off).

## 🔧 The Flash Lamp

The flash lamp indicates flash status when the shutter-release button is pressed halfway.

- On: Flash will fire when picture is taken.
- Blinks: Flash charging. Wait a few seconds and try again.
- Off: Flash will not fire when picture is taken.

If the battery is low, the monitor display will turn off, and remain off, until the flash is fully charged.

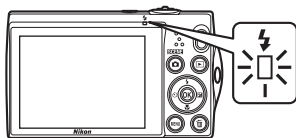

## 🔧 The Flash Mode Setting

The default flash mode setting varies with shooting mode (📖 35).

- 📷 (auto): ⚡AUTO (auto)
- Scene: varies with the selected scene mode (📖 54–61)
- 📸 (smart portrait): ⚡AUTO (auto) when **Off** is selected for **Blink proof**; fixed at 🔇 (off) when **On** is selected for **Blink proof** (📖 66)
- 📷 (subject tracking): 🔇 (off)

The flash cannot be used simultaneously with certain functions. See “Camera Settings that Cannot Be Applied Simultaneously” (📖 49) for more information.

The flash mode setting applied in 📷 (auto) mode is saved in the camera’s memory even after the camera is turned off, and reapplied the next time 📷 (auto) mode is selected.

## 🔧 Red-eye Reduction

This camera uses advanced red-eye reduction (In-Camera Red-Eye Fix). Pre-flashes are fired repeatedly at low intensity before the main flash, reducing the red-eye effect. Additionally, if the camera detects red eye while saving an image, the affected area will be processed to reduce red-eye before the image is saved.

Note the followings when shooting.

- Because pre-flashes are fired, there is a slight lag between when the shutter-release button is pressed and when the shutter is released.
- More time than usual is required to save images.
- Red-eye reduction may not produce the desired results in all situations.
- In extremely rare instances, areas not subject to red-eye may be affected by red-eye reduction processing; in these cases, choose another flash mode and try again.

## Taking Pictures with the Self-timer

The camera is equipped with a ten-second and two-second timer for self-portraits. This feature is useful for reducing the effects of camera shake that occurs when pressing the shutter-release button. When using the self-timer, use of a tripod is recommended. Set **Vibration reduction** (📖 129) to **Off** in the setup menu (📖 120) when using a tripod to stabilize the camera during shooting.

### 1 Press the multi selector (self-timer).

The self-timer menu is displayed.



### 2 Press the multi selector or to choose **10s** or **2s** and press the button.

**10s** (ten seconds): Use on important occasions, such as weddings.

**2s** (two seconds): Use to prevent camera shake.

The mode selected for self-timer is displayed.

If a setting is not applied by pressing the  button within a few seconds, the selection will be canceled.

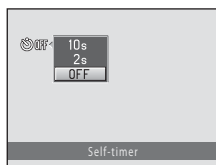

### 3 Frame the picture and press the shutter-release button halfway.

Focus and exposure will be set.

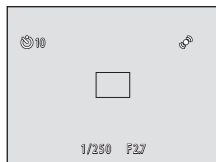

### 4 Press the shutter-release button the rest of the way down.

The self-timer starts, and the number of seconds remaining before the shutter is released is displayed in the monitor. The self-timer lamp blinks while the timer is counting down. About one second before the shutter is released, the lamp stops blinking and glows steadily.

When the shutter is released, the self-timer will be set to **OFF**.

To stop the timer before a picture is taken, press the shutter-release button again.

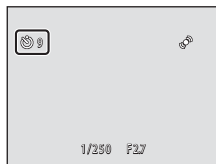

## Macro Mode

Macro mode is used for taking pictures of objects as close as 2 cm (0.8 in.). Note that the flash may be unable to light the entire subject at distances of less than 50 cm (1 ft. 8 in.).

### 1 Press the multi selector (macro mode).

The macro mode menu is displayed.



### 2 Press the multi selector or to choose **ON** and press the button.

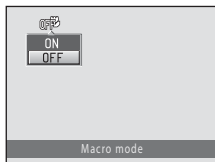

The macro mode icon () is displayed.

If a setting is not applied by pressing the  button within a few seconds, the selection will be canceled.





### 3 Rotate the zoom control to frame the picture.

The closest distance at which the camera can focus varies depending on the zoom position.

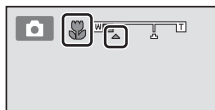
When the zoom is at a position where  and the zoom indicator glow green (to the left of ) , the camera can focus on subjects as close as 4 cm (1.6 in.) from the lens. When the zoom is fully zoomed out, the camera can focus on subjects as close as 2 cm (0.8 in.) from the lens.





### Autofocus

When using  (auto) mode, if **Autofocus mode** ( 48) is set to **Full-time AF**, the camera focuses continuously until the shutter-release button is pressed halfway to lock the focus. Therefore, the sound of lens drive movement can be heard.

When using other shooting modes, **Full-time AF** is turned on automatically when macro mode is turned on.

### The Macro Mode Setting

The macro mode setting applied in  (auto) mode is saved in the camera's memory even after the camera is turned off, and reapplied the next time  (auto) mode is selected.



# Adjusting Brightness (Exposure Compensation)

By adjusting exposure compensation when taking pictures, overall image brightness can be adjusted to make images brighter or darker.

- 1 Press the multi selector  (exposure compensation).

The exposure compensation guide and histogram are displayed.



- 2 Press the multi selector  or  to select a compensation value.

To make the image brighter, apply positive (+) exposure compensation.

To make the image darker, apply negative (-) exposure compensation.

Exposure compensation guide

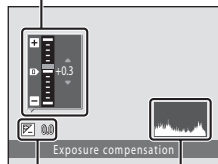

Exposure compensation value

- 3 Press the  button.

If a setting is not applied by pressing the  button within a few seconds, the selection will be canceled.

When an exposure compensation value other than **0.0** is applied, the value is displayed with the  indicator in the monitor.

- 4 Press the shutter-release button to take a picture.

To exit without altering exposure, return to step 1, change the value to **0.0** and press the  button.

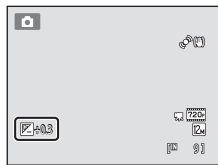

## Exposure Compensation Value

The exposure compensation value applied in  (auto) mode is saved in the camera's memory even after the camera is turned off, and reapplied the next time  (auto) mode is selected.









## Using the Histogram

A histogram is a graph showing the distribution of tones in the image. Use as a guide when using exposure compensation and shooting without the flash.

- The horizontal axis corresponds to pixel brightness, with dark tones to the left and bright tones to the right. The vertical axis shows the number of pixels.
- Increasing exposure compensation shifts tone distribution to the right, and decreasing it shifts tone distribution to the left.

## Selecting a Shooting Mode

The following shooting modes can be selected.



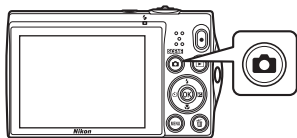

	<b>Auto mode</b>	 22
Pictures can be taken with an automatic, “point-and-shoot” mode recommended for first-time users of digital cameras. Shooting settings such as continuous shooting can be applied from the shooting menu (  36).		
	<b>Scene mode</b>	 51
Camera settings are automatically optimized for the selected scene. In scene auto selector mode, the camera automatically selects the optimum scene mode for simpler shooting.		
	<b>Smart portrait</b>	 64
The camera detects human faces and then automatically releases the shutter when a smile is detected. The skin softening option can be used to make skin tones of human faces displayed smoothly.		
	<b>Subject tracking</b>	 67
Suited to focus and take pictures of moving subjects.		

### 1 Press the button in shooting mode.

The shooting-mode selection menu is displayed.



### 2 Press the multi selector or to choose a shooting mode.

When scene mode is selected (select the second icon from the top and press ) , the type of scene can be chosen. Press , , , or  to choose a scene.

To return to the current shooting mode without switching shooting modes, press the  button or the shutter-release button.

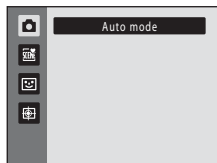

### 3 Press the button.

The camera enters the selected shooting mode.

# Changing (Auto) Mode Settings (Shooting Menu)

The following options can be set when shooting in  (auto) mode ([book 22](#)).

## Image mode

[book 37](#)

Choose the image mode (combination of image size and compression rate) at which images are saved. This setting can be changed when using shooting modes other than  (auto) mode.

## White balance

[book 39](#)

In order to make the colors in images appear as they do to the eye, set white balance to suit the light source.

## Metering

[book 41](#)

Choose how the camera meters exposure.

## Continuous

[book 42](#)

Change settings to Continuous or BSS (best shot selector).

## ISO sensitivity

[book 43](#)

Control the camera's sensitivity to light.

## Color options

[book 44](#)

Apply color effects to images as they are saved.

## AF area mode

[book 45](#)

Choose how the camera selects the focus area for autofocus.

## Autofocus mode

[book 48](#)

Choose how the camera focuses.

## Displaying the Shooting Menu

Enter  (auto) mode ([book 35](#)).

Press the **MENU** button to display the shooting menu.

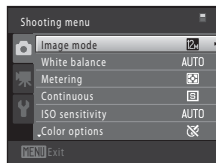
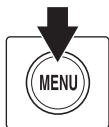

- Use the multi selector to choose and apply settings ([book 9](#)).
- To exit the shooting menu, press the **MENU** button.

## Camera Settings that Cannot Be Applied Simultaneously













Some functions cannot be enabled in conjunction with others ([book 49](#)).



## Image Mode (Image Quality/Image Size)



 (auto) → MENU (Shooting menu) → Image mode

Image mode refers to the combination of image size and image quality (compression) at which images are saved. Choose the image mode best suited to the manner in which images will be used and the capacity of the internal memory or memory card. The higher the image mode setting, the larger the size at which it can be printed or displayed without appearing noticeably “grainy,” but limiting the number of images that can be saved.

Image mode	Size (pixels)	Description
 4000 × 3000★	4000 × 3000	Images will be higher quality than  . The compression ratio is approximately 1:4.
 4000 × 3000 (default setting)	4000 × 3000	Best choice in most situations. The compression ratio is approximately 1:8.
 3264 × 2448	3264 × 2448	
 2592 × 1944	2592 × 1944	
 2048 × 1536	2048 × 1536	Smaller size than  ,  , or  allows more images to be saved. The compression ratio is approximately 1:8.
 1024 × 768	1024 × 768	Suited to display on a computer monitor. The compression ratio is approximately 1:8.
 640 × 480	640 × 480	Suited to full-screen display on a television with an aspect ratio of 4:3, or distribution by e-mail. The compression ratio is approximately 1:8.
 3968 × 2232	3968 × 2232	Images with an aspect ratio of 16:9 are saved. The compression ratio is approximately 1:8.









The icon for the current setting is displayed in the monitor in shooting and playback modes ( 6, 7).

### Image Mode

- When using shooting modes other than  (auto) mode, this setting can be changed by pressing the MENU button.
- The setting is also applied to other shooting modes.
- This function cannot be used simultaneously with certain functions. See “Camera Settings that Cannot Be Applied Simultaneously” ( 49) for more information.

 **Number of Exposures Remaining**

The following table lists the approximate number of images that can be saved in the internal memory and on a 4 GB memory card. Note that due to JPEG compression, the number of images that can be saved differs depending on the composition of the image. In addition, this number may vary depending on the make of memory card, even when the memory cards have the same specified capacity.

Image mode	Internal memory (approx. 32 MB)	Memory card <sup>1</sup> (4 GB)	Print size <sup>2</sup> (cm/in.)
 4000 × 3000★	5	600	34 × 25/13 × 10
 4000 × 3000	9	1100	34 × 25/13 × 10
 3264 × 2448	14	1600	28 × 21/11 × 8
 2592 × 1944	22	2600	22 × 16/8.5 × 6.5
 2048 × 1536	35	4100	17 × 13/7 × 5
 1024 × 768	113	13700	9 × 7/3.5 × 2.5
 640 × 480	227	29600	5 × 4/2 × 1.5
 3968 × 2232	12	1500	34 × 19/13 × 7.5

<sup>1</sup> If the number of exposures remaining is 10,000 or more, the number of exposures remaining display shows “9999.”

<sup>2</sup> Print size at an output resolution of 300 dpi. Print sizes are calculated by dividing the number of pixels by printer resolution (dpi) and multiplying by 2.54 cm (1 in.). However, at the same image size, images printed at higher resolutions will print smaller than the size indicated, and those printed at lower resolutions will print larger than the size indicated.

## White Balance (Adjusting Hue)

 (auto) → MENU (Shooting menu) → White balance

The color of light reflected from an object varies with the color of the light source. The human brain is able to adapt to changes in the color of the light source, with the result that white objects appear white whether seen in the shade, direct sunlight, or under incandescent lighting. Digital cameras can mimic this adjustment by processing images according to the color of the light source. This is known as “white balance.” For natural colors, choose a white balance setting that matches the light source before shooting. Although the default setting, **Auto**, can be used under most types of lighting, the white balance setting suited to a particular light source can be specified manually to achieve more accurate results.

### **AUTO** Auto (default setting)

White balance is automatically adjusted to suit lighting conditions. Best choice in most situations.

### **PRE** Preset manual

Useful when shooting under unusual lighting. See “Preset Manual” for more information ( 40).

### Daylight

White balance adjusted for direct sunlight.

### Incandescent

Use under incandescent lighting.

### Fluorescent

Use under fluorescent lighting.

### Cloudy



Use when taking pictures under overcast skies.

### Flash

Use with the flash.

The icon for the current setting is displayed in the monitor ( 6). However, when **Auto** is selected, no icon is displayed.

### Notes on White Balance

- There may be functions with which this setting cannot be enabled. See “Camera Settings that Cannot Be Applied Simultaneously” ( 49) for more information.
- At white-balance settings other than **Auto** or **Flash**, turn the flash off (  30).

## Preset Manual

Preset manual is used with mixed lighting or to compensate for light sources with a strong color cast when the desired effect has not been achieved with white balance settings like **Auto** and **Incandescent** (for example, to make images shot under a lamp with a red shade look as though they had been shot under white light).

Use the procedure below to measure the white balance value under the lighting used during shooting.

**1** Place a white or gray reference object under the lighting that will be used during shooting.

**2** Display the shooting menu (📖 36), use the multi selector to choose **PRE Preset manual** in the **White balance** menu, and press the **OK** button.

The camera zooms in to the position for measuring white balance.

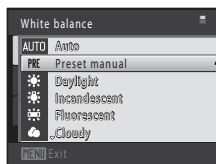

**3** Choose **Measure**.

To apply the most recently measured white balance value, choose **Cancel** and press the **OK** button. The white balance setting will not be measured again and the most recently measured value will be set.

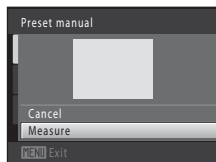

**4** Frame the reference object in the measuring window.

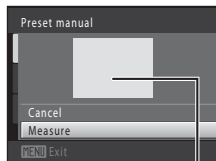

Measuring window

**5** Press the **OK** button to measure a value for preset manual.

The shutter is released and the new white-balance value is set. No image is saved.

### Note on Preset Manual

A value for flash lighting cannot be measured with **Preset manual**. When shooting using the flash, set **White balance** to **Auto** or **Flash**.

## Metering

 (auto) → MENU (Shooting menu) → Metering

The process of measuring the brightness of the subject to determine exposure is known as metering.

Choose how the camera meters exposure.

### Matrix (default setting)

The camera sets exposure for the entire frame. Recommended in most situations.

### Center-weighted

The camera meters the entire frame but assigns greatest weight to the subject in the center of the frame. Classic meter for portraits; preserves background details while letting lighting conditions at the center of the frame determine exposure. Can be used with focus lock ( 46) to meter off-center subjects.

### Note on Metering

When using digital zoom, **Metering** is set to **Center-weighted**, and the metered area is not displayed in the monitor.

### Metering Area

The active metering area is displayed in the monitor when **Center-weighted** is selected for **Metering**.

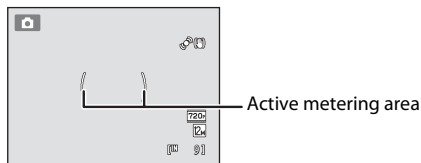

## Continuous

 (auto) → MENU (Shooting menu) → Continuous

Change settings to Continuous or BSS (best shot selector).

### Single (default setting)

One picture is taken each time the shutter-release button is pressed.

### Continuous

While the shutter-release button is held down, up to ten pictures are taken at a rate of about 0.7 frames per second (fps) (when **Image mode** is set to  **4000 × 3000**). Shooting ends when the shutter-release button is released, or ten pictures have been taken.

### **BSS** BSS (best shot selector)

The “best shot selector” is recommended when shooting with the flash off or the camera zoomed in, or in other situations in which inadvertent motion can result in blurred images. When BSS is on, camera takes up to ten pictures while the shutter-release button is held down. The sharpest image in the series is automatically selected and saved.

### Multi-shot 16

Each time the shutter-release button is pressed, camera takes 16 shots at a rate of about 30 fps and arranges them in a single image.

- **Image mode** is fixed at  (image size: 2560 × 1920 pixels).
- Digital zoom is not available.

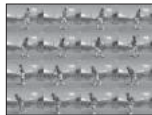

The icon for the current setting is displayed in the monitor ( 6). However, when **Single** is selected, no icon is displayed.

## Notes on Continuous Shooting

- When **Continuous**, **BSS**, or **Multi-shot 16** is selected, flash is disabled. Focus, exposure, and white balance are fixed at the values determined with the first image in each series.
- The frame rate with continuous shooting may vary depending upon the current image mode setting, the memory card used, or shooting condition.
- There may be functions with which this setting cannot be enabled. See “Camera Settings that Cannot Be Applied Simultaneously” ( 49) for more information.

## Note on BSS

**BSS** is best suited to shooting subjects that are not moving. When shooting moving subjects or when the composition of the picture changes while shooting, the desired results may not be achieved.

**✔ Note on Multi-shot 16**

Smear ( 144) visible in the monitor when shooting with **Multi-shot 16** enabled will be saved with images. Avoiding bright objects such as the sun, reflections of the sun, and electric lights when shooting with **Multi-shot 16** enabled is recommended.

**ISO Sensitivity**

 (auto) → MENU (Shooting menu) → ISO sensitivity

When ISO sensitivity is increased, less light is needed when taking pictures.

Higher ISO sensitivity allows darker subjects to be captured. Additionally, even with subjects of similar brightness, pictures can be taken at faster shutter speeds, and blurring caused by camera shake and subject movement can be reduced.

- Although higher ISO sensitivity is effective when shooting darker subjects, shooting without the flash, shooting while using the zoom, etc., images may contain noise.

**Auto (default setting)**

Sensitivity is ISO 100 when there is sufficient lighting; the camera compensates by raising sensitivity to a maximum of ISO 1600 when lighting is dim.



**Fixed range auto**

Choose the range in which the camera automatically adjusts ISO sensitivity, from **ISO 100-400** or **ISO 100-800**. The camera will not increase sensitivity beyond the maximum value in the selected range. Set the maximum value for ISO sensitivity for effective control over the amount of “grain” that appears in images.



100, 200, 400, 800, 1600, 3200

Sensitivity is locked at the specified value.

The icon for the ISO sensitivity setting is displayed in the monitor ( 6).

- When **Auto** is selected, the  icon is not displayed at ISO 100, but is displayed if the ISO sensitivity automatically increases to more than 100 ( 31).
- When **Fixed range auto** is selected,  and the maximum value for ISO sensitivity is displayed.

**✔ Notes on ISO Sensitivity**

- There may be functions with which this setting cannot be enabled. See “Camera Settings that Cannot Be Applied Simultaneously” ( 49) for more information.
- **Motion detection** ( 130) does not function when the ISO sensitivity is locked.

## Color Options

 (auto) → MENU (Shooting menu) → Color options

Make colors more vivid or save images in monochrome.

 **Standard color (default setting)**  
Use for images exhibiting natural color.

 **Vivid color**  
Use to achieve a vivid, “photoprint” effect.

 **Black-and-white**  
Save images in black-and-white.

 **Sepia**  
Save images in sepia tones.

 **Cyanotype**  
Save images in cyan-blue monochrome.

The icon for the current setting is displayed in the monitor ( 6). However, when **Standard color** is selected, no icon is displayed. Color tones shown in the monitor during shooting change according to the selected color option.

### **Note on Color Options**

There may be functions with which this setting cannot be enabled. See “Camera Settings that Cannot Be Applied Simultaneously” ( 49) for more information.



## AF Area Mode

 (auto) → MENU (Shooting menu) → AF area mode

Use this option to determine how the camera selects the focus area for autofocus.

### Face priority

When the camera detects a human face, it focuses on that face. See “Face Detection” ( 47) for more information. If more than one face is detected, the camera focuses on the face closest to the camera. When taking pictures of subjects other than people, or framing a subject with which no face is detected, the **AF area mode** setting switches to **Auto**, and the camera will automatically select the focus area (up to nine areas) containing the subject closest to the camera.

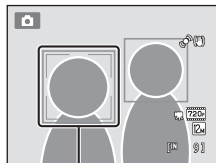





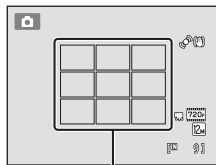

More on Shooting

### Auto (default setting)

The camera has nine focus areas, and automatically selects the focus areas containing the subject closest to the camera. Press the shutter-release button halfway to activate the focus area. When the shutter-release button is pressed halfway, the focus areas that are in focus (up to nine areas) selected by the camera will be displayed in the monitor.



### Manual

Select one of 99 focus areas in the monitor. This option is suited to situations in which the intended subject is relatively still and not positioned in the center of the frame. Press the multi selector , , , or  to move the focus area to where the subject is, and take a picture. To cancel focus area selection and adjust flash, macro mode, self-timer, and exposure compensation settings, press the  button. To return to the focus area selection screen, press the  button again.

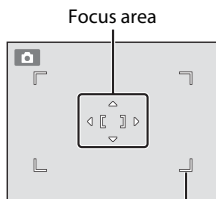

### Center

The camera focuses on the subject at the center of the frame.

The focus area is always displayed at the center of the screen.

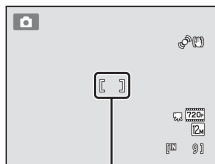

Focus area

### Notes on AF Area Mode

- When digital zoom is in effect, focus will be on the center of the screen regardless of the **AF area mode** setting.
- There may be functions with which this setting cannot be enabled. See “Camera Settings that Cannot Be Applied Simultaneously” (📖 49) for more information.
- Autofocus may not perform as expected (📖 27).

### Focus Lock







To focus on off-center subjects when **Center** is selected for **AF area mode**, use focus lock as described below.

- 1 Position the subject in the center of the frame.
- 2 Press the shutter-release button halfway.
  - Confirm that the focus area glows green.
  - Focus and exposure are locked.
- 3 Continue holding down the shutter-release button halfway and recompose the picture.
  - Be sure to maintain the same distance between the camera and the subject while the shutter-release button is pressed halfway.
- 4 Press the shutter-release button the rest of the way down to take the picture.



## Face Detection

When the camera is pointed at a human face, face detection, which the camera automatically detects that face and focus on it, starts. The face detection function is activated in the following situations.

- **AF area mode** ( 45) is set to **Face priority**
  - In **Scene auto selector** ( 52), **Portrait** ( 54), or **Night portrait** ( 55) scene mode
  - In smart portrait mode ( 64)
- \* For information about face detection when using subject tracking mode, see “Focusing on a Moving Subject (Subject Tracking Mode)” ( 67).

### 1 Frame a picture.

When the camera detects a face, that face is framed by a yellow double border.

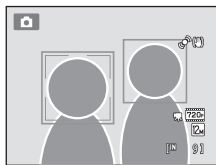

When the camera detects more than one face, operation varies as follows depending upon the shooting mode.

Shooting mode	Face framed by double border	Number of faces that can be detected
 (auto) mode <b>(Face priority)</b>	The face closest to the camera <ul style="list-style-type: none"> <li>• Other faces framed by single border.</li> </ul>	Up to 12
<b>Scene auto selector, Portrait, or Night portrait scene mode</b>		
Smart portrait mode	The face closest to the center of the frame <ul style="list-style-type: none"> <li>• Other faces framed by single border.</li> </ul>	Up to 3

### 2 Press the shutter-release button halfway.

The camera focuses on the face framed by the double border. The double border turns green and focus is locked. When the camera is unable to focus, the double border will blink. Press the shutter-release button halfway again to focus. Press the shutter-release button the rest of the way down to take a picture.



If the camera detects that the face framed by the double border is smiling in smart portrait mode, the **Smile timer** ( 66) is activated and the shutter is automatically released without the shutter-release button having been pressed.

### Notes on Face Detection

- If the camera is unable to detect any faces when the shutter-release button is pressed halfway with **AF area mode** set to **Face priority**, the AF area mode setting automatically switches to **Auto**.
- If no faces are detected when the shutter-release button is pressed halfway in **Portrait**, **Night portrait** scene mode, and smart portrait mode, the camera will focus on the subject at the center of the frame.
- The camera's ability to detect faces depends on a variety of factors, including whether or not the subject is facing the camera. The camera may be unable to detect faces in the following situations:
  - When faces are partially hidden by sunglasses or otherwise obstructed
  - When faces take up too much or too little of the frame
- When the frame includes more than one face, the faces detected by the camera and the face on which the camera focuses depend upon a variety of factors, including the direction in which the faces are looking.
- In some rare cases, the subject may not be in focus despite the fact that the double border turns green (📖 27). Should this occur, switch to  (auto) mode and set **AF area mode** to **Manual** or **Center**, refocus on another subject positioned at the same distance from the camera as the actual portrait subject, and use focus lock (📖 46).
- Images captured using face detection will be rotated and displayed automatically according to the orientation of the faces detected, in full-frame and thumbnail playback modes (excluding images captured using **Continuous**, **BSS**, and **Multi-shot 16** (📖 42)).

## Autofocus Mode

 (auto) → MENU (Shooting menu) → Autofocus mode

Choose how the camera focuses.

 **Single AF (default setting)**

The camera focuses when the shutter-release button is pressed halfway.

 **Full-time AF**

The camera focuses continuously until the shutter-release button is pressed down halfway. Use with moving subjects. The sound of lens drive movement will be heard while the camera focuses.

### Note on Autofocus Mode

There may be functions with which this setting cannot be enabled. See “Camera Settings that Cannot Be Applied Simultaneously” (📖 49) for more information.

### Note on the Autofocus Mode Setting for Subject Tracking Mode

**Autofocus mode** can be set for subject tracking mode. The default setting in subject tracking mode is **Full-time AF**. **Autofocus mode** can be set independently for both subject tracking mode and  (auto) mode.

### Autofocus Mode for Movie Recording



Autofocus mode for movie recording can be set with **Autofocus mode** (📖 105) in the movie menu (📖 103).

## Camera Settings that Cannot Be Applied Simultaneously

Some shooting settings cannot be used with other functions.

Restricted function	Setting	Descriptions
Flash mode	Continuous (📖 42)	When <b>Continuous</b> , <b>BSS</b> , or <b>Multi-shot 16</b> is selected, flash is disabled.
Image mode	Continuous (📖 42)	When <b>Multi-shot 16</b> is selected, the <b>Image mode</b> setting is fixed at <b>5</b> (image size: 2560×1920 pixels).
White balance	Color options (📖 44)	When using <b>Black-and-white</b> , <b>Sepia</b> , or <b>Cyanotype</b> , the <b>White balance</b> setting is fixed at <b>Auto</b> .
Metering	Digital zoom (📖 131)	When the digital zoom is in effect, <b>Metering</b> is fixed at <b>Center-weighted</b> .
Continuous	Self-timer (📖 32)	Fixed at <b>Single</b> when using self-timer.
ISO sensitivity	Continuous (📖 42)	When <b>Multi-shot 16</b> is selected, the <b>ISO sensitivity</b> setting is automatically specified according to the brightness.
AF area mode	Digital zoom (📖 131)	When the digital zoom is in effect, AF area mode is fixed at <b>Center</b> .
Autofocus mode	AF area mode (📖 45)	When using <b>Face priority</b> , <b>Autofocus mode</b> is fixed at <b>Single AF</b> .
Motion detection	Continuous (📖 42)	When <b>Multi-shot 16</b> is selected, <b>Motion detection</b> is disabled.
	ISO sensitivity (📖 43)	When the ISO sensitivity is locked, <b>Motion detection</b> is disabled.

## Changing (Auto) Mode Settings (Shooting Menu)

Restricted function	Setting	Descriptions
Blink warning	Continuous (  42)	When <b>Continuous</b> , <b>BSS</b> , or <b>Multi-shot 16</b> is selected, <b>Blink warning</b> is disabled.
Digital zoom	Continuous (  42)	When <b>Multi-shot 16</b> is selected, digital zoom is disabled.



### More Information



See "Notes on Digital Zoom" ( 131) for more information.

## Shooting Suited to Scenes (Scene Mode)

Camera settings are automatically optimized for the selected subject type. The following scene modes are available.







 Scene auto selector	 Portrait	 Landscape	 Sports
 Night portrait	 Party/indoor	 Beach	 Snow
 Sunset	 Dusk/dawn	 Night landscape	 Close-up
 Food	 Museum	 Fireworks show	 Copy
 Backlighting	 Panorama assist		

### Selecting a Scene Mode

- 1 Press the  button in shooting mode and press the multi selector  or  to select the scene mode.

The icon for the last scene mode selected is displayed. The default setting is  (Scene auto selector) (📖 52).



- 2 Press , press , , , or  to choose the desired scene, and then press the  button.

The display changes to that for the selected scene mode. For more information about features of scene modes, see page 54.



- 3 Frame the subject and take a picture.



### Image Mode



The **Image mode** setting (📖 37) can be changed by pressing the **MENU** button in scene mode. Change made to this setting applies to all shooting modes.



### Displaying a Description of Each Scene

Choose the desired scene type from the scene selection screen (step 2) and rotate the zoom control (📖 4) to **T** (🔍) to view a description of that scene. To return to the original screen, rotate the zoom control to **T** (🔍) again.

## Shooting in the Scene Mode Selected by the Camera (Scene Auto Selector)

By simply framing a picture, the camera automatically selects the optimum scene mode for simpler shooting. When a picture is framed in  (Scene auto selector) scene mode, the camera automatically adjusts settings for one of the following scene modes:

- Auto (general shooting)
- Landscape  54
- Night landscape  57
- Backlighting  60
- Portrait  54
- Night portrait  55
- Close-up  58

- 1 Press the  button in shooting mode and use the multi selector to select  (Scene auto selector) scene mode  51.

The camera enters scene auto selector scene mode.



- 2 Frame the subject and take a picture.

When the camera automatically selects a scene mode, the shooting mode icon changes to that for the scene mode currently enabled.

- |   |  |
|---|--|
|  : Auto            |  : Portrait       |
|  : Landscape       |  : Night portrait |
|  : Night landscape |  : Close-up       |
|  : Backlighting    |  |

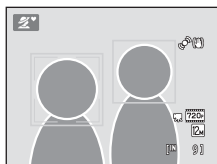

Press the shutter-release button halfway to set focus and exposure. When the subject is in focus, the active focus area glows green.



Press the shutter-release button the rest of the way down to take the picture.







### ✓ Notes on Scene Auto Selector Scene Mode

- Digital zoom is not available.
- Depending upon shooting conditions, the camera may not select the desired scene mode. Should this occur, switch to  (auto) mode (📖 22) or select the desired scene mode manually (📖 51).

### 🔍 Focusing in Scene Auto Selector Scene Mode

- When the camera detects a human face in scene auto selector scene mode, it focuses on that face. See “Face Detection” (📖 47) for more information.
- When the shooting mode indicator  or  (close-up) is displayed, the camera automatically selects the focus area (up to nine areas) containing the subject closest to the camera as same as when **Auto** is selected for **AF area mode** (📖 45).

### 🔧 Functions Available in Scene Auto Selector Scene Mode

-  **AUTO** (auto; default setting) and  (off) flash mode settings can be applied (📖 30). When  **AUTO** (auto) is applied, the camera automatically selects the optimum flash mode setting for the scene mode it has selected. When  (off) is applied, the flash does not fire, regardless of shooting conditions.
- The self-timer (📖 32) and exposure compensation (📖 34) settings can be adjusted.
- The macro mode button on the multi selector (📖 9, 33) is disabled.
- The **Image mode** setting (📖 37) can be changed by pressing the **MENU** button in scene auto selector scene mode. Changes made to the image mode setting apply to all shooting modes.

## Selecting a Scene Mode to Take Pictures (Features)

See “Shooting in the Scene Mode Selected by the Camera (Scene Auto Selector)” (📖 52) for more information on scene auto selector scene mode.

The following icons are used for descriptions in this section: ⚡, flash mode (📖 30); ⌚, self-timer (📖 32); 🌸, macro mode (📖 33); 📷, exposure compensation (📖 34).

### Portrait

Use this mode for portraits.

- The camera detects and focuses on a human face. See “Face Detection” (📖 47) for more information.
- If more than one face is detected, focus will be on the face closest to the camera.
- The camera softens skin tones (in up to three faces) by applying the skin softening function before saving images (📖 65).
- If no faces are detected, the camera focuses on the subject at the center of the frame.
- Digital zoom is not available.



\* Default setting can be modified.



### Landscape

Use this mode for vivid landscapes and cityscapes.

- Camera focuses at infinity. The focus area or focus indicator (📖 6) always glows green when the shutter-release button is pressed halfway. Note, however, that objects in the foreground may not always be in focus.
- AF-assist illuminator (📖 131) does not light.





\* Default setting can be modified.

 Use of a tripod is recommended in scene modes with which  is indicated. Set **Vibration reduction** (📖 129) to **Off** when using a tripod to stabilize the camera (except when using **Night landscape**).

### Sports

Use this mode for dynamic action shots that freeze the action in a single shot and record motion in a series of pictures. With continuous shooting, instantaneous movements in moving subjects can be captured clearly.

- The camera focuses on the subject in the center of the frame. The camera focuses continuously until the shutter-release button is pressed halfway to lock the focus.
- While the shutter-release button is held down, pictures are taken at rate of up to about 0.7 frames per second (fps) when image mode is set to  **4000 × 3000**. Shooting ends when the shutter-release button is released, or ten shots have been taken with the shutter-release button held down.
- Focus, exposure compensation, and white balance are fixed at the values determined with the first shot in each series.
- The frame rate with continuous shooting may vary depending upon the current image mode setting, the memory card used, or shooting condition.
- AF-assist illuminator ( 131) does not light.





			Off		Off		0.0*
---	---	---	-----	---	-----	---	------

\* Other settings can be selected.

### Night portrait

Use this mode for portraits taken at sunset or at night. The flash fires to light the portrait subject while preserving background lighting to achieve a natural balance between the main subject and background ambience.

- The camera detects and focuses on a human face. See "Face Detection" ( 47) for more information.
- If more than one face is detected, focus will be on the face closest to the camera.
- The camera softens skin tones (in up to three faces) by applying the skin softening function before saving images ( 65).
- If no faces are detected, the camera focuses on the subject at the center of the frame.
- Digital zoom is not available.



			Off <sup>2</sup>		Off		0.0 <sup>2</sup>
---	---	---	------------------	---	-----	---	------------------

<sup>1</sup> Fill flash with slow sync and red-eye reduction.

<sup>2</sup> Default setting can be modified.

## Shooting Suited to Scenes (Scene Mode)

### Party/indoor

Suitable for taking pictures in parties. Captures the effects of candlelight and other indoor background lighting.

- The camera focuses on the subject at the center of the frame.
- As images are easily affected by camera shake, hold the camera steadily. In dark surroundings, the use of a tripod is recommended. Set **Vibration reduction** (📖 129) to **Off** when using a tripod to stabilize the camera.



<sup>1</sup> Slow sync with red-eye reduction flash mode may be used. The default setting can be modified.

<sup>2</sup> Default setting can be modified.

### Beach

Captures the brightness of such subjects as beaches or sunlit expanses of water.

- The camera focuses on the subject at the center of the frame.



\* Default setting can be modified.



### Snow

Captures the brightness of sunlit snow.

- The camera focuses on the subject at the center of the frame.



\* Default setting can be modified.

: Use of a tripod is recommended in scene modes with which  is indicated. Set **Vibration reduction** (📖 129) to **Off** when using a tripod to stabilize the camera (except when using **Night landscape**).

### Sunset



Preserves the deep hues seen in sunsets and sunrises.

- Camera focuses at infinity. The focus area or focus indicator (📖 6) always glows green when the shutter-release button is pressed halfway. Note, however, that objects in the foreground may not always be in focus.
- AF-assist illuminator (📖 131) does not light.



\* Default setting can be modified.

### Dusk/dawn



Preserves the colors seen in the weak natural light before sunrise or after sunset.

- Camera focuses at infinity. The focus area or focus indicator (📖 6) always glows green when the shutter-release button is pressed halfway. Note, however, that objects in the foreground may not always be in focus.
- AF-assist illuminator (📖 131) does not light.



\* Default setting can be modified.

### Night landscape



Slow shutter speeds are used to produce stunning night landscapes.

- Camera focuses at infinity. The focus area or focus indicator (📖 6) always glows green when the shutter-release button is pressed halfway. Note, however, that objects in the foreground may not always be in focus.
- AF-assist illuminator (📖 131) does not light.
- Use of a tripod is recommended, but when **Vibration reduction** (📖 129) is set to **On**, the camera determines if a tripod is being used or if the camera is hand-held, and changes the shutter-speed appropriately, therefore night-time landscape shooting with reduced blurring is possible even when holding the camera by hand.
- When using a tripod in **Night landscape** mode, there is no need to set **Vibration reduction** to **Off**.













\* Default setting can be modified.

## Shooting Suited to Scenes (Scene Mode)

### Close-up

Photograph flowers, insects, and other small objects at close range.











- Macro mode ( 33) is enabled and the camera automatically zooms to the closest position at which it can focus.
- The closest distance at which the camera can focus varies depending on the zoom position. When the zoom is at a position where  and the zoom indicator glow green (to the left of ) , the camera can focus on subjects as close as 4 cm (1.6 in.) from the lens.  
When the zoom is fully zoomed out, the camera can focus on subjects as close as 2 cm (0.8 in.) from the lens.
- **AF area mode** is set to **Manual** ( 45). Press the  button and then press , , , or  to move the focus area manually to where the subject is. Press the  button again to lock the selected focus area. Flash mode and exposure compensation settings can be adjusted and the self-timer can be enabled while the focus area is locked.
- The camera focuses continuously until the shutter-release button is pressed halfway to lock the focus.
- As images are easily affected by camera shake, be sure that **Vibration reduction** ( 129) is enabled and hold the camera steadily.



\* Default setting can be modified. Note that the flash may be unable to light entire subject at distances of less than 50 cm (1 ft. 8 in.).

## Food

Use this mode when taking pictures of food.

- Macro mode (📖 33) is enabled and the camera automatically zooms to the closest position at which it can focus.
- The closest distance at which the camera can focus varies depending on the zoom position. When the zoom is at a position where  and the zoom indicator glow green (to the left of ) , the camera can focus on subjects as close as 4 cm (1.6 in.) from the lens. When the zoom is fully zoomed out, the camera can focus on subjects as close as 2 cm (0.8 in.) from the lens.
- Hue can be adjusted in the range of the slider displayed on the left in the monitor. Press the multi selector  to make the image more reddish, or  to make it more bluish. The selected hue adjustment setting is saved in the camera's memory even after the camera is turned off.
- AF area mode** is set to **Manual** (📖 45). Press the  button and then press , , , or  to move the focus area manually to where the subject is. Press the  button again to lock the selected focus area. Hue and exposure compensation settings can be adjusted and the self-timer can be enabled while the focus area is locked.
- The camera focuses continuously until the shutter-release button is pressed halfway to lock the focus.
- As images are easily affected by camera shake, be sure that **Vibration reduction** (📖 129) is enabled and hold the camera steadily.

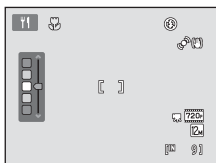

\* Default setting can be modified.

## Museum

Use indoors where flash photography is prohibited (for example, in museums and art galleries) or in other settings in which you do not want to use the flash.

- Camera focuses on the subject at the center of the frame.
- BSS (best shot selector) can be enabled (📖 42).
- As images are easily affected by camera shake, be sure that **Vibration reduction** (📖 129) is enabled and hold the camera steadily.
- AF-assist illuminator (📖 131) does not light.



\* Default setting can be modified.

## Shooting Suited to Scenes (Scene Mode)

### Fireworks show

Slow shutter speeds are used to capture the expanding burst of light from a firework.

- Camera focuses at infinity. The focus indicator (📖 6) always glows green when the shutter-release button is pressed halfway. Note, however, that objects in the foreground may not always be in focus.
- AF-assist illuminator (📖 131) does not light.



### Copy

Provides clear images of text or drawings on a white board or in print.

- Camera focuses on the subject at the center of the frame.
- Use macro mode (📖 33) to focus at short ranges.
- Colored text and drawings may not show up well.

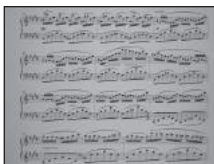

\* Default setting can be modified.



### Backlighting

Use when light is coming from behind the subject, throwing features or details into shadow. The flash fires automatically to “fill in” (illuminate) shadows.

- Camera focuses on the subject at the center of the frame.



\* Default setting can be modified.

 Use of a tripod is recommended in scene modes with which  is indicated. Set **Vibration reduction** (📖 129) to **Off** when using a tripod to stabilize the camera (except when using **Night landscape**).



 Panorama assist



Use when taking a series of pictures that will later be joined to form a single panorama using the supplied Panorama Maker 5 software. See “Shooting for a Panorama” (📖 62) for more information.

	 *		Off*		Off*		0.0*
---	---	---	------	---	------	---	------

\* Default setting can be modified.

## Shooting for a Panorama

The camera focuses on the subject at the center of the frame. Use a tripod for the best results. Set **Vibration reduction** (📖 129) to **Off** in setup menu (📖 120) when using a tripod to stabilize the camera.

- 1** Press the  button in shooting mode and use the multi selector to select  (**Panorama assist**) scene mode (📖 51).

Panorama direction icons are displayed to show the direction in which images will be joined.



- 2** Use the multi selector to choose the direction and press the  button.

Select the direction in which images will be joined in the completed panorama; right (▶), left (◀), up (▲), or down (▼).

The yellow panorama direction icon (▶▶) is displayed for the current direction and the direction is fixed when the  button is pressed. The icon changes to the white fixed direction ▶ icon.

If necessary, apply flash mode (📖 30), self-timer (📖 32), macro mode (📖 33), and exposure compensation (📖 34) settings with this step.

Press the  button again to choose a different direction.



- 3** Frame the first portion of the panorama scene and take the first picture.

One third of the image will be displayed as translucent.



- 4** Take the next picture.

Frame the next image so that one third of the frame overlaps the first image, and press the shutter-release button.

Repeat this process until the necessary number of images has been taken to complete the scene.



## 5 Press the **OK** button when shooting is complete.

The camera returns to step 2.



### **✓** Notes on Panorama Assist

- Flash mode, self-timer, macro mode, and exposure compensation settings cannot be adjusted after the first picture is taken. Images cannot be deleted, nor can zoom or **Image mode** setting (📖 37) be adjusted after the first picture has been taken.
- Shooting for the panorama series is terminated if the auto off function (📖 133) initiates standby mode during shooting. Setting the time allowed to elapse before the auto off function is enabled to a longer setting is recommended.

### **🔍** AE/AF-L Indicator

In **Panorama assist** scene mode, exposure, white balance, and focus for all images in a panorama are fixed at the values for the first image in each series.

When the first picture is taken, **AE/AF-L** is displayed to indicate that exposure, white balance, and focus are locked.



### **🔍** Panorama Maker 5

Install Panorama Maker 5 from the supplied ViewNX 2 CD.



Transfer images to a computer (📖 108) and use Panorama Maker 5 (📖 112) to join them in a single panorama.

### **🔍** More Information

See "Image/Sound File and Folder Names" (📖 146) for more information.

## Shooting Smiling Faces (Smart Portrait Mode)

At the default settings, the camera detects human faces and then automatically releases the shutter when a smile is detected (smile timer). The skin softening option can be used to smooth skin tones of human faces.

- 1 Press the  button in shooting mode, press the multi selector ▲ or ▼ to select , and press the  button.

The camera enters smart portrait mode.

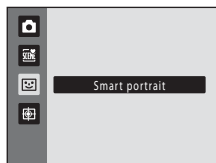

- 2 Frame a picture.

Point the camera at the subject.

When the camera detects a human face, a yellow double border (focus area) is displayed around that face. When focus is acquired on that face, the double border will turn green for a moment and focus is locked.

Up to three faces can be detected. When the camera detects more than one face, the double border is displayed around the face closest to the center of the frame, and single borders around the others.

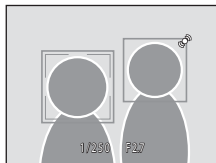

- 3 The shutter is automatically released.

If the camera detects that the face framed by the double border is smiling, **Smile timer** ( 66) is activated and the shutter is automatically released.

Each time the shutter is released, the camera repeats automatic shooting by face detection and smile detection.

- 4 Shooting ends.

To stop automatic shooting of smiling faces, either turn the camera off, set **Smile timer** to **off**, or press the  button and select another shooting mode.

## ✔ Notes on Smart Portrait Mode

- Digital zoom is not available.
- Under some shooting conditions, the camera may be unable to detect faces or detect smiles.
- See “Notes on Face Detection” (📖 48) for more information.

## ✔ Notes on Skin Softening

- More time than usual may be required to save an image when shooting with skin softening function.
- In some shooting conditions, facial skin tones may not be smoothed or parts other than face may be modified though the camera detects a face. If the desired results are not produced, set **Skin softening** to **Off** and shoot again.
- The skin softening level cannot be adjusted when the portrait or night portrait is selected in the scene mode.
- Skin softening can also be applied on saved images (📖 98).

## 🔪 Auto Power Off in Smile Timer Mode

When **Smile timer** is set to **On**, the auto power off function (📖 133) is activated and the camera turns off when either of the situations indicated below persists and no other operations are performed.

- The camera does not detect any faces.
- The camera detected a face, but cannot detect a smile.

## 🔪 When the Self-timer Lamp Blinks

When using smile timer, the self-timer lamp blinks when the camera detects a face and flickers immediately after the shutter is released.

## 🔪 Releasing the Shutter Manually

The shutter can also be released by pressing the shutter-release button. If no faces are detected, the camera focuses on the subject at the center of the frame.

## 🔪 Functions Available in Smart Portrait Mode

- Flash cannot be used when **Blink proof** is set to **On**. When **Blink proof** is set to **Off**, flash mode (📖 30) is set to **⚡AUTO** (auto) (can be modified).
- The self timer (📖 32) options can be applied when **Smile timer** is set to **Off**.
- Macro mode cannot be used.
- Exposure compensation (📖 34) is enabled.
- Press the **MENU** button to display the 😊 (smart portrait) menu and adjust **Image mode**, **Skin softening**, **Smile timer**, or **Blink proof** (📖 66).

## 🔪 More Information

See “Autofocus” (📖 27) for more information.

### Changing Smart Portrait Mode Settings

While using  (smart portrait) mode (📖 64), press the **MENU** button (📖 9) and then set the following options in the smart portrait menu.

- Use the multi selector to choose and apply settings (📖 9, 10).
- Press the **MENU** button to exit the menu.

#### Image mode

Choose the image mode (combination of image size and compression rate) at which images are saved (📖 37).

Changes made to the image mode setting apply to all shooting modes.

#### Skin softening

Enable skin softening. When the shutter is released, the camera detects one or more human faces (up to three), and processes the image to soften facial skin tones before saving the image.

The degree of skin softening applied can be selected from **High**, **Normal** (default setting), and **Low**. When **Off** is selected, the skin softening function is disabled.

- The current setting can be confirmed by the indicator displayed in the monitor with shooting (📖 6). No indicator is displayed when **Off** is selected. The effects of skin softening are not visible when framing pictures for shooting. Check the degree of skin softening performed in playback mode.

#### Smile timer

- **On** (default setting): The camera detects human faces and then automatically releases the shutter whenever a smile is detected.
- **Off**: The camera does not release the shutter automatically with smile detection. Press the shutter-release button to take a picture.
- When smile timer is enabled, an indicator is displayed in the monitor with shooting (📖 6). No indicator is displayed when **Off** is selected.

#### Blink proof

When **On** is selected, the camera automatically releases the shutter twice each time a picture is taken. Of the two shots, one in which the subject's eyes are open is saved.





- If the camera saved an image in which the subject's eyes may have been closed, the dialog shown on the right is displayed for a few seconds.
- Flash cannot be used when **On** is selected.
- The default setting is **Off**.
- The current setting is displayed in the monitor (📖 6). No indicator is displayed when **Off** is selected.



## Focusing on a Moving Subject (Subject Tracking Mode)

Use this mode to take pictures of moving subjects. By registering a subject, the camera can move the focus area automatically to track the subject.

At the default setting, once the camera detects a person's face it will automatically begin tracking that person (face priority tracking).

- 1 Press the  button in shooting mode, press the multi selector  or  to select , and press the  button.

The camera enters subject tracking mode and a white border is displayed at the center of the frame.

The flash mode ( 30) is set to  (off) (the setting can be changed).

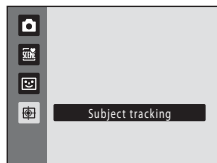

- 2 Register a subject.

When the camera detects a face in the frame, that face is automatically registered as the subject to be tracked ( 69).

When shooting non-human subjects, etc., while the white border is displayed in the center of the monitor, align the subject with that border and press the  button.

When the camera is unable to focus on the subject, the border will glow red. Change the composition and try registering the subject again.

When the subject is registered, a yellow border (focus area) is displayed around that subject and the camera begins tracking that subject.

To change the subject, press the  button to deregister the current subject.

If the camera cannot track the registered subject anymore, the focus area will disappear and the registration will be canceled. Register the subject again.



### 3 Press the shutter-release button to take a picture.

The camera focuses on the focus area when the shutter-release button is pressed halfway. The focus area will glow green and focus will be locked.

When the camera is unable to focus, the focus area will blink. Press the shutter-release button halfway again to focus.

If the shutter-release button is pressed halfway while the focus area is not displayed, the camera focuses on the subject at the center of the frame.

Press the shutter-release button all the way down to release the shutter.

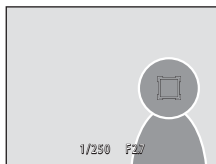

### ✓ Notes on Subject Tracking Mode

- Digital zoom is not available.
- Adjust zoom position, flash mode, exposure compensation, and menu settings prior to registering the subject. If any camera setting is changed after the subject has been registered, subject registration will be canceled.
- It may be impossible to register the desired subject, or the camera may be unable to track the registered subject or may begin tracking a different subject, if the subject is moving rapidly, if there is a significant amount of camera shake, or if the camera detects a similar subject. The camera's ability to accurately track the registered subject is also dependent upon the size and brightness of the subject.
- In some rare cases, subjects with which autofocus may not perform as expected (📖 27) may be out of focus despite the fact that the focus area glows green. Should this occur, switch to 📷 (auto) mode and set **AF area mode** (📖 45) to **Manual** or **Center**, refocus on another subject positioned at the same distance from the camera as the actual portrait subject, and use focus lock (📖 46).

### 🔧 Functions Available in Subject Tracking Mode

- Flash mode (📖 30) and exposure compensation (📖 34) settings can be adjusted.
- Self-timer (📖 32) and macro mode (📖 33) cannot be used.
- Press the **MENU** button to display the 📷 (subject tracking) menu and adjust **Image mode**, **Autofocus mode**, and **Face priority tracking** (📖 69).



## Changing Subject Tracking Mode Settings

While using  (subject tracking) mode (📖 67), press the **MENU** button (📖 9) and then set the following options in the subject tracking menu.

- Use the multi selector to choose and apply settings (📖 9, 10).
- Press the **MENU** button to exit the menu.

### Image mode

Choose the image mode (combination of image size and compression rate) at which images are saved (📖 37).

Changes made to the image mode setting apply to all shooting modes.

### Autofocus mode

Set **Autofocus mode** (📖 48) used for subject tracking mode (the default setting is **Full-time AF**).



When using subject tracking mode while set to **Full-time AF**, the camera continuously focuses once a subject is registered for subject tracking until the shutter-release button is pressed halfway to lock the focus. The sound of lens drive movement can be heard.

Changes made to the autofocus mode setting in this mode will not be applied to the autofocus mode setting in  (auto) mode. The autofocus mode setting applied in subject tracking mode is saved in the camera's memory even after the camera is turned off.



### Face priority tracking

When **On** is selected (default setting), if the camera detects a subject's face, that subject is automatically registered as the subject to be tracked, and subject tracking begins tracking that subject.

## Notes on Face Priority Tracking







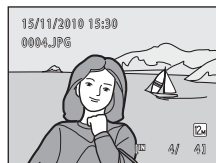

















- Only one subject can be tracked. If the camera detects multiple faces at the same time, the face closest to the center of the frame is tracked.
- When the frame includes more than one face, the face detected by the camera and registered as the subject to be tracked depends upon a variety of factors, including the direction in which the faces are looking.
- Depending on shooting conditions, such as whether or not the subject is facing the camera, the face may not be detected properly. Additionally, the camera may be unable to detect faces in the following situations:
  - When faces are partially hidden by sunglasses or otherwise obstructed
  - When faces take up too much or too little of the frame
- When the camera is unable to track the registered subject, press the  button to track again, or set **Face priority tracking** to **Off**, frame the picture so that the subject is inside the border in the center of the frame, and press the  button to register the subject again.







## Operations in Full-frame Playback Mode

Press the  (playback) button in shooting mode to enter playback mode and display images that have been captured ( 28).





The following operations are available in full-frame playback mode.



Function	Control	Description	
Select images		Press  ,  ,  , or  to display previous or next images. Press and hold  ,  ,  , or  to scroll quickly through images.	9
Switch to thumbnail display/calendar display mode (except during list by date mode)	<b>W</b> 	Rotate the zoom control to <b>W</b>  to display 4, 9, or 16 image thumbnails. Rotate the zoom control to <b>W</b>  with 16 thumbnails displayed to switch to calendar display.	72, 74
Select a different shooting date (list by date mode)	<b>W</b> 	Return to the list by date screen.	81
Playback zoom	<b>T</b> 	Rotate the zoom control to <b>T</b>  to enlarge the image up to 10x. Press the  button to return to full-frame playback mode.	75
Display shooting information		Display the histogram and the shooting information. Press the  button to return to full-frame playback.	71
Play back movies		Play back the movie currently displayed.	106
Delete images		Select a deletion method and delete images. When using auto sort mode (  78) or list by date mode (  81), images with the same category or shooting date can be deleted.	29
Display menus	<b>MENU</b>	Display the menu for the selected mode.	83
Switch to another playback mode		Press the  button to display the playback-mode selection menu and switch to auto sort mode or list by date mode.	77

Function	Control	Description	
Switch to shooting mode		Press the  button or the shutter-release button. Pressing the  (movie-record) button will also return the camera to shooting mode.	28
	 		
			

### Changing the Orientation (Vertical/Horizontal) of Images

Image orientation can be changed after taking a picture using **Rotate image** ( 90) in the playback menu ( 83).

### Displaying the Histogram and Shooting Information

Press the  button in full-frame playback mode to display the histogram and the shooting information (not possible with movies). Press the  button again to return to full-frame playback mode.

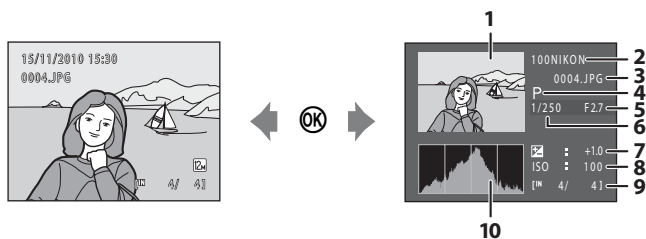

- |                                     |  |
|-------------------------------------|--|
| <b>1</b> Image                      | <b>6</b> Shutter speed                                   |
| <b>2</b> Folder name                | <b>7</b> Exposure compensation                           |
| <b>3</b> File name                  | <b>8</b> ISO sensitivity                                 |
| <b>4</b> Shooting mode <sup>1</sup> | <b>9</b> Current frame number/<br>total number of frames |
| <b>5</b> Aperture                   | <b>10</b> Histogram <sup>2</sup>                         |

<sup>1</sup> **P** is displayed as the shooting mode.

<sup>2</sup> A histogram is a graph showing the distribution of tones in the image. The horizontal axis corresponds to brightness, with dark tones to the left and bright tones to the right. The vertical axis shows the number of pixels.

## Viewing Multiple Images: Thumbnail Playback

Rotate the zoom control to **W** (📐) in full-frame playback mode (📖 70) to display images in “contact sheets” of thumbnail images (except in list by date mode).



The following operations are available while thumbnails are displayed.

Function	Control	Description	
Choose images		Press the multi selector ▲, ▼, ◀, or ▶.	9
Increase the number of images displayed/apply the calendar display	<b>W</b> (📐)	Rotate the zoom control to <b>W</b> (📐) to increase the number of image thumbnails displayed: 4 → 9 → 16. Rotate the zoom control to <b>W</b> (📐) in the 16-image thumbnail display to apply the calendar display (📖 74), and images can be found by the date on which they were captured. Rotate the zoom control to <b>T</b> (📷) to return to thumbnail display.	—
Decrease the number of images displayed	<b>T</b> (📷)	Rotate the zoom control to <b>T</b> (📷) to decrease the number of image thumbnails displayed: 16 → 9 → 4. Rotate the zoom control to <b>T</b> (📷) in 4-image thumbnail display to return to full-frame playback mode.	—
Delete images		Select a deletion method and delete images. When using auto sort mode (📖 78), images with the same category can be deleted.	29
Switch to full-frame playback mode		Press the <b>OK</b> button.	70
Switch to shooting mode		Press the  button or the shutter-release button. Pressing the  (movie-record) button will also return the camera to shooting mode.	28

### **Thumbnail Playback Mode Display**

When images marked using **Print set** (📖 84) or **Protect** (📖 88) are selected, the icons shown on the right are displayed with them. Movies are displayed as film frames.

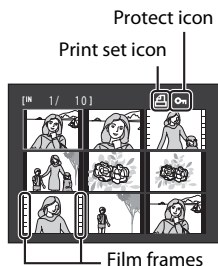

### **Thumbnail Display in Auto Sort Mode**

In auto sort mode (📖 78), the current image's category icon is displayed at the top-right of the monitor.

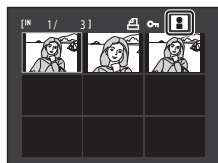

More on Playback

## Calendar Display

With playback display of 16 thumbnails (📖 72), rotate the zoom control to **W** (📐) to switch to calendar display.

Images can be selected for display based on the date on which they were captured. The dates on which images were captured are underlined in yellow.

The following operations are available in calendar display.

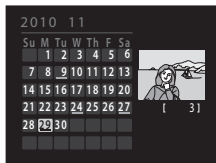

Function	Control	Description	📖
Select date		Press the multi selector ▲, ▼, ◀, or ▶.	9
Return to full-frame playback		The first image captured on the selected date is displayed full frame.	70
Return to thumbnail display	<b>T</b> (📐)	Rotate the zoom control to <b>T</b> (📐).	72

### ✓ Notes on Calendar Display

- Images captured when the camera's date is not set are treated as images captured on January 1, 2010.
- The 🗑️ button and MENU button are not available in calendar display.

### 📅 List by Date Mode

Only the images captured on the same date can be played back in list by date mode (📖 81). The list by date options (📖 82) are also available only for the images captured on the selected dates.

## Taking a Closer Look: Playback Zoom

Rotating the zoom control to **T** (Q) in full-frame playback mode (📖 70) enlarges display of the center portion of the current image.

- The guide displayed at bottom right shows the portion of the image currently displayed.

The following operations are available while image display is enlarged.



Function	Control	Description	📖
Zoom in	<b>T</b> (Q)	Zoom increases each time the zoom control is rotated to <b>T</b> (Q), to a maximum of 10x.	–
Zoom out	<b>W</b> (Q)	Zoom decreases each time the zoom control is rotated to <b>W</b> (Q). When the magnification ratio reaches 1x, the display returns to full-frame playback mode.	–
View other areas of image		Press the multi selector ▲, ▼, ◀, or ▶ to move the display area to other areas of the image.	9
Delete images		Select a deletion method and delete images. When using auto sort mode (📖 78) or list by date mode (📖 81), images with the same category or shooting date can be deleted.	29
Switch to full-frame playback		Press the <b>OK</b> button.	70
Crop image	<b>MENU</b>	Create a cropped copy with only the enlarged portion and save the copy as a separate file.	100
Switch to shooting mode		Press the  button or the shutter-release button. Pressing the  (movie-record) button will also return the camera to shooting mode.	28

## Images Captured with Face Detection

When zooming in (playback zoom) on an image captured using the face detection (📖 47) by rotating the zoom control to **T** (📷), the image will be enlarged with the face detected with shooting at the center of the monitor (except images captured with **Continuous**, **BSS**, and **Multi-shot 16** (📖 42)).









- If more than one face was detected, the image will be enlarged with the face on which focus was acquired at the center of the monitor. Press the multi selector ▲, ▼, ◀, or ▶ to display other detected faces.
- When the zoom control is rotated to **T** (📷) or **W** (📷) to adjust the zoom ratio, the center of the image, rather than the face, is displayed at the center of the monitor (normal playback zoom display).



# Playing Back Images by Category

The following playback modes can be selected.

	<b>Playback</b>	 70
Play back all images.		
	<b>Auto sort</b>	 78
Play back images and movies automatically sorted to the selected category with shooting.		
	<b>List by date</b>	 81
Play back images captured on the selected date.		

## 1 Press the button in playback mode.

The playback-mode selection menu is displayed.



## 2 Press the multi selector or to choose a playback mode.

To return to the current playback mode without switching playback modes, press the  button.











## 3 Press the button.

The camera enters the selected playback mode.

## Finding Images in Auto Sort Mode





Images and movies are automatically sorted to any of the following categories with shooting. When “**AUTO** auto sort mode” is selected, images and movies can be viewed by selecting the category to which they were sorted.

 Smile	 Portraits	 Food
 Landscape	 Dusk to dawn	 Close-ups
 Movie	 Retouched copies	 Other scenes

In full-frame playback mode, images of the same category can be played back ( 70) and edited ( 94).





When the **MENU** button is pressed, the auto sort menu ( 80) is displayed and images in the same category can be selected for viewing in a slide show, or applying print order or protection settings.

## Viewing Images in Auto Sort Mode

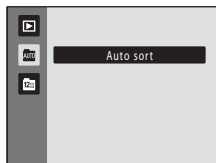
- 1 Press the  button in playback mode, press the multi selector  or  to select **AUTO**, and press the  button.

A list of categories is displayed.



- 2 Press the multi selector , , , or  to select a desired category.

For information about categories, see “Auto Sort Mode Categories” ( 79).







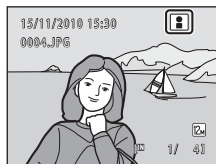
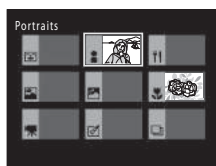



For information about operating the auto sort mode screen, see “Operations in Auto Sort Mode” ( 80).

Press the  button to display an image in the selected category in full-frame playback mode.

The icon of the category currently played back will be displayed at the top right of the screen.



## Auto Sort Mode Categories

Category	Description
 Smile	Images captured in smart portrait mode (📖 64) with the smile timer setting set to <b>On</b> .
 Portraits	Images captured in  (auto) mode (📖 22) with the face detection (📖 47). Images captured in <b>Portrait*</b> , <b>Night portrait*</b> , <b>Party/indoor</b> , and <b>Backlighting*</b> scene mode (📖 51). Images captured in smart portrait mode (📖 64) with the smile timer setting set to <b>Off</b> .
 Food	Images captured in <b>Food</b> scene mode (📖 51).
 Landscape	Images captured in <b>Landscape*</b> scene mode (📖 51).
 Dusk to dawn	Images captured in <b>Night landscape*</b> , <b>Sunset</b> , <b>Dusk/dawn</b> and <b>Fireworks show</b> scene mode (📖 51).
 Close-ups	Images captured in  (auto) mode with macro mode (📖 33). Images captured in <b>Close-up*</b> scene mode (📖 51).
 Movie	Movies (📖 101).
 Retouched copies	Copies created using editing function (📖 94).
 Other scenes	All other images that cannot be defined by the categories described above.

\* Images captured in scene auto selector scene mode (📖 52) are also sorted to the appropriate categories.

### Notes on Auto Sort Mode

- Up to 999 images and movie files can be sorted to each category in auto sort mode. If 999 images or movies have already been sorted to a specific category, new images and movies cannot be sorted to that category nor can they be displayed in auto sort mode. Display images and movies that could not be sorted to a category in normal playback mode (📖 28) or list by date mode (📖 81).
- Images or movies copied from the internal memory to a memory card, or vice versa (📖 93), cannot be displayed in auto sort mode.
- Images or movies saved by a camera other than the COOLPIX S5100 cannot be displayed in auto sort mode.

## Operations in Auto Sort Mode

The following operations are available in the category list screen (📖 78 step 2).

Function	Control	Description	📖
Select a category		Press the multi selector ▲, ▼, ◀, or ▶.	9
Switch to full-frame playback		Press the OK button to display the first image in the selected category.	70
Delete image		Press the 🗑️ button after selecting a category, and a confirmation dialog will be displayed. Choose <b>Yes</b> and press the OK button to delete all images sorted to that category.	29
Switch to another playback mode		Press the ▶ button to display the playback-mode selection menu.	77
Switch to shooting mode		Press the 📷 button or the shutter-release button. Pressing the ● (movie-record) button will also return the camera to shooting mode.	28

More on Playback

## Auto Sort Menu

Press the **MENU** button in full-frame playback mode or thumbnail playback mode in auto sort mode to apply the following menu options.





Quick retouch	→📖 96	Protect	→📖 88
D-Lighting	→📖 97	Rotate image	→📖 90
Skin softening	→📖 98	Small picture	→📖 99
Print set	→📖 84	Voice memo	→📖 91
Slide show	→📖 87		

## Viewing Images by Date (List by Date)

In “ list by date mode”, images captured on the same date can be played back. In full-frame playback mode, just as with normal playback mode, shooting information can be displayed, image display can be enlarged, images can be edited, and movies can be played back.

When the **MENU** button is pressed to display the list by date menu ( 82), all images captured on the same day can be selected for viewing in a slide show, or applying print order or protection settings.

### Viewing Images in List by Date Mode

- 1 Press the  button in playback mode, press the multi selector  or  to select , and press the  button.

The list by date screen is displayed.



- 2 Press the multi selector  or  to choose a date.

The camera lists up to 29 dates. If images exist for more than 29 dates, all images saved earlier than most recent 29 dates will be combined under **Others**.

For information about operating the list by date screen, see “Operations in List by Date Mode” ( 82).

When the  button is pressed, the first image captured on the selected date will be displayed full frame.

Rotate the zoom control to **W** () in full-frame playback mode or while displaying shooting information to return to the shooting date selection screen.

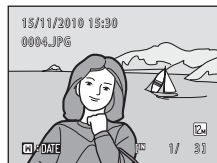
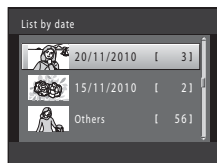











#### Notes on List by Date Mode

- The number of images captured on each day is displayed on the list by date screen. 9,000 images can be displayed in list by date mode. If more than 9,000 images are saved on a memory card, “\*\*” is displayed for the date containing the 9,001st image.
- Images captured when the camera’s date is not set are treated as images captured on January 1, 2010.

## Operations in List by Date Mode

The following operations are available in the list by date screen (📖 81 step 2).

Function	Control	Description	📖
Select date		Press the multi selector ▲ or ▼.	9
Switch to full-frame playback		Press the <b>OK</b> button to display the first image captured on the selected date. Rotate the zoom control to <b>W</b> (📐) while in full-frame playback mode to return to the list by date screen.	70
Delete image		Press the  button to delete all images captured on the selected date, and a confirmation dialog will be displayed. Choose <b>Yes</b> and press the <b>OK</b> button to delete all the images.	29
View list by date menu	<b>MENU</b>	Press the <b>MENU</b> button to display the list by date menu.	82
Switch to another playback mode		Press the  button to display the playback-mode selection menu.	77
Switch to shooting mode		Press the  button or the shutter-release button. Pressing the ● (movie-record) button will also return the camera to shooting mode.	28
			
			

## List by Date Menu











Press the **MENU** button in list by date mode to display the following menus for only the images captured on the specified date.

Quick retouch*	→ 📖 96	Protect	→ 📖 88
D-Lighting*	→ 📖 97	Rotate image*	→ 📖 90
Skin softening*	→ 📖 98	Small picture*	→ 📖 99
Print set	→ 📖 84	Voice memo*	→ 📖 91
Slide show	→ 📖 87		

\* After displaying the image in full-frame playback mode, press the **MENU** button.

## Playback Options: Playback Menu

The following options are available in the playback menu.

	<b>Quick retouch</b> <span style="float: right;">📖 96</span>
Easily create retouched copies in which contrast and saturation have been enhanced.	
	<b>D-Lighting</b> <span style="float: right;">📖 97</span>
Enhance brightness and contrast in dark portions of images.	
	<b>Skin softening</b> <span style="float: right;">📖 98</span>
Make facial skin tones softer.	
	<b>Print set</b> <span style="float: right;">📖 84</span>
Select images to print and the number of copies for each.	
	<b>Slide show</b> <span style="float: right;">📖 87</span>
View images saved in the internal memory or on a memory card in an automatic slide show.	
	<b>Protect</b> <span style="float: right;">📖 88</span>
Protect selected images from accidental deletion.	
	<b>Rotate image</b> <span style="float: right;">📖 90</span>
Change the orientation of images.	
	<b>Small picture</b> <span style="float: right;">📖 99</span>
Create a small copy of the current image.	
	<b>Voice memo</b> <span style="float: right;">📖 91</span>
Record voice memos for images.	
	<b>Copy</b> <span style="float: right;">📖 93</span>
Copy files between the internal memory and a memory card.	

### Displaying the Playback Menu

Press the  button to enter playback mode (📖 70).

Press the **MENU** button to display the playback menu.

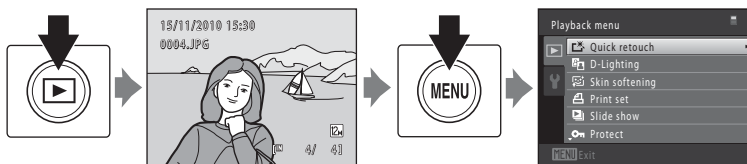

- Use the multi selector to choose and apply settings (📖 9).
- Press the **MENU** button to exit the playback menu.

## Print Set (Creating a DPOF Print Order)

▶ button (Playback mode) → MENU (Playback menu) → Print set

When printing images saved on the memory card using any of the following methods, the **Print set** option in the playback menu is used to create digital “print orders” for printing on DPOF-compatible devices.

- Inserting the memory card into a DPOF-compatible (📖 161) printer’s card slot
- Taking the memory card to a digital photo lab
- Connecting the camera to a PictBridge-compatible (📖 161) printer (📖 114). A print order can also be created for images saved in the internal memory if the memory card is removed from the camera.

- 1 Press the **MENU** button in playback mode.  
The playback menu is displayed.

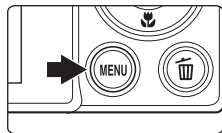

- 2 Use the multi selector to choose **Print set** and press the **OK** button.  
Proceed to step 4 when playing back in auto sort mode or list by date mode.

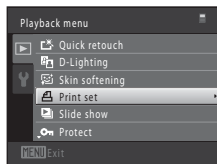

- 3 Choose **Select images** and press the **OK** button.

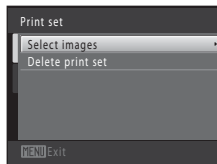

- 4 Choose images (up to 99) and the number of copies (up to nine) of each.  
Press the multi selector ◀ or ▶ to select images, and press ▲ or ▼ to specify the number of copies to be printed. Image selected for printing can be identified by the check mark (✔) and the numeral indicating the number of copies to be printed. If no copies have been specified for images, the selection is canceled.



Rotate the zoom control to **T** (📄) to switch to full-frame playback.  
Rotate the zoom control to **W** (📐) to switch back to 12-thumbnail display.  
Press the **OK** button when setting is complete.





## 5 Choose whether or not to print shooting date and photo information.

Choose **Date** and press the **OK** button to print the shooting date on all images in the print order.

Choose **Info** and press the **OK** button to print photo information (shutter speed and aperture) on all images in the print order.

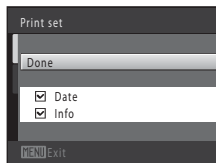
Choose **Done** and press the **OK** button to complete the print order.



Images selected for printing can be identified by the  icon displayed with playback.

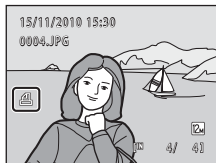

### Notes on Print Set

When a print order is created in auto sort mode or list by date mode, the screen shown below is displayed if images other than those in selected category or captured on the selected shooting date, have been marked for printing.

- Select **Yes** to add images in the selected category or captured on the selected shooting date, to the existing print order.
- Select **No** to remove print marking from previously marked images and restrict the print order to images in the selected category or captured on the selected shooting date.

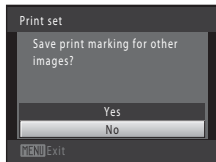

Auto sort mode

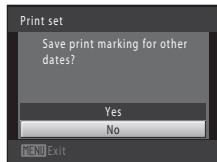

List by date mode

If the total number of the images in a print order exceeds 99, the screen shown below will be displayed.

- Select **Yes** to remove images previously added from the print order and restrict the print order to images just marked.
- Select **Cancel** to remove the images just added from the print order and restrict the print order to images previously marked.

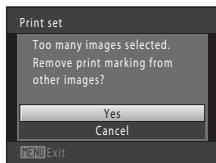

Auto sort mode

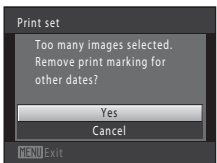

List by date mode

### ✔ Notes on Printing Shooting Date and Photo Information

When the **Date** and **Info** settings are enabled in the print set option, shooting date and photo information are printed on images when a DPOF-compatible (📖 161) printer that supports printing of shooting date and photo information is used.

- Photo information cannot be printed when the camera is connected directly to a printer, via the supplied USB cable, for DPOF printing (📖 119).
- Note that **Date** and **Info** settings are reset each time the **Print set** option is displayed.
- The date printed is that saved when the image was captured. Changing the camera's date using the **Date** option in the setup menu after an image has been captured has no effect on the date printed on the image.



### ✂ Canceling Existing Print Order

Select **Delete print set** in step 3 of "Print Set (Creating a DPOF Print Order)" (📖 84) and press the **OK** button to remove print marking from all images and cancel the print order.

### 👤 Date Imprint

When shooting date and time are imprinted on images using the **Date imprint** option (📖 128) in setup menu, images are saved with shooting date and time imprinted on the image when they are captured. Images with the date imprinted on them can be printed from printers that do not support printing of the date on images.

Only the date imprint date and time on images will be printed, even if **Print set** is enabled with **Date** selected in the print set screen.

## Slide Show

▶ button (Playback mode) → MENU (Playback menu) → Slide show

Play back images, saved in the internal memory or on a memory card, one by one in an automated “slide show.”

### 1 Use the multi selector to choose **Start** and press the **OK** button.

To change the interval between images, choose **Frame intvl**, select the desired interval time, and press the **OK** button before choosing **Start**.

To repeat the slide show automatically, choose **Loop** and press the **OK** button before choosing **Start**. The check mark (✓) will be added to the loop option when enabled.

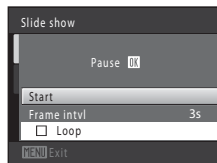

### 2 The slide show begins.

While the slide show is in progress, press the multi selector ▶ to display the next image or ◀ to display the previous image. Hold down either button to fast forward or rewind.

To end or pause the slide show, press the **OK** button.



### 3 End the slide show or restart it.

The screen shown on the right is displayed when the slide show has ended or is paused. Choose **End** and press the **OK** button to return to the playback menu. Choose **Restart** to play the slide show again.

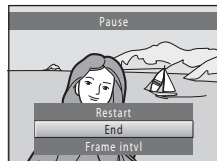

## Notes on Slide Show

- Only the first frame of movies included in a slide show is displayed.
- The maximum playback time is up to 30 minutes even if **Loop** is enabled (📖 133).

## Protect

 button (Playback mode) → MENU (Playback menu) →  Protect

Protect selected images from accidental deletion.

Select images to protect or cancel protection for previously protected images from the image selection screen. See “Selecting Images” ( 89) for more information.

Note that formatting the camera’s internal memory or the memory card will permanently delete protected files ( 134).

Protected images can be identified by the  icon in playback mode ( 7, 73).

## Selecting Images

When using one of the following features, a screen like that shown on the right is displayed when selecting images.

- Print set > **Select images** (📖 84)
- Protect (📖 88)
- Rotate image (📖 90)
- Copy > **Selected images** (📖 93)
- Welcome screen > **Select an image** (📖 122)
- Delete image > **Erase selected images** (📖 29)



Follow the procedures described below to choose the images.

### 1 Press the multi selector ◀ or ▶ to select an image.

Rotate the zoom control (📖 4) to **T** (🔍) to switch to full-frame playback or **W** (📐) to switch back to 12-thumbnail display.

Only one image can be selected for **Rotate image** and **Welcome screen**. Proceed to step 3.



### 2 Press ▲ or ▼ to select or deselect (or to specify the number of copies).



When an image is selected, a check mark (☑) is displayed with the image. Repeat steps 1 and 2 to select additional images.



### 3 Press the Ⓞ button to apply image selection.

When **Selected images** is selected, a confirmation dialog is displayed. Follow the instructions displayed in the monitor.

## Rotate Image

 button (Playback mode) → MENU (Playback menu) →  Rotate image

Specify the orientation in which saved images are displayed with playback. Still images can be rotated 90 degrees clockwise or 90 degrees counterclockwise. Images that were saved in portrait (“tall”) orientation can be rotated up to 180 degrees in either direction.

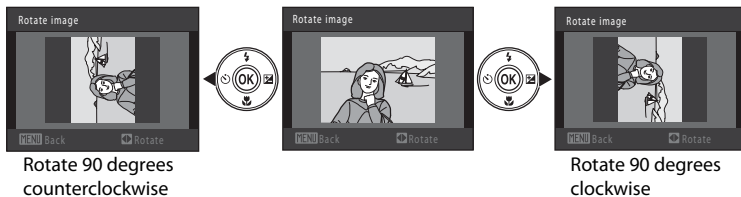

Select an image from the image selection screen ( 89). When the Rotate image screen is displayed, press the multi selector ◀ or ▶ to rotate the image 90 degrees.

More on Playback



Press the  button to finalize display orientation, and save orientation information with the image.

## Voice Memo

 button (Playback mode) → MENU (Playback menu) →  Voice memo

Use the camera's microphone to record voice memos for images.

### Recording Voice Memos

- 1 Display the desired image in full-frame playback mode (📖 70) or thumbnail playback mode (📖 72) and press the **MENU** button.

The playback menu is displayed.

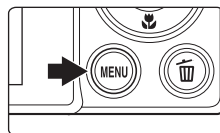

- 2 Use the multi selector to choose  **Voice memo** and press the **OK** button.

The screen for recording voice memos is displayed.

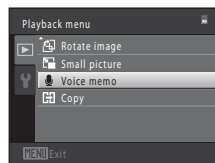

- 3 Press and hold the **OK** button to record a voice memo.

Recording ends after about 20 seconds or when the **OK** button is released.

Do not touch the microphone during recording.

During recording, **REC** and  blink in the monitor.

When recording ends, the voice memo playback screen is displayed. Follow the procedure in step 3 of "Playing Voice Memos" (📖 92) to play the voice memo.

Press the multi selector  before or after recording a voice memo to return to the playback menu. Press the **MENU** button to exit the playback menu.

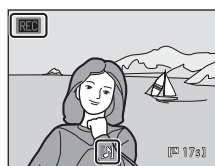
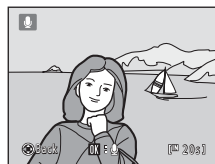



## More Information

See "Image/Sound File and Folder Names" (📖 146) for more information.

## Playing Voice Memos

Images for which voice memos have been recorded are indicated by  in full-frame playback mode.

- 1 Select the desired image in full-frame playback mode ( 70) or thumbnail playback mode ( 72) and press the **MENU** button.

The playback menu is displayed.

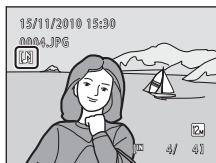
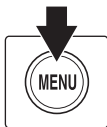

- 2 Use the multi selector to choose  **Voice memo** and press the **OK** button.

The voice memo playback screen is displayed.

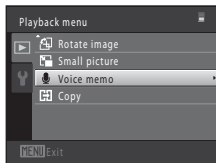

- 3 Press the **OK** button to play the voice memo.







Press the **OK** button again to stop playback.

Rotate the zoom control to **T** or **W** during playback to adjust playback volume.

Press the multi selector  before or after recording a voice memo to return the playback menu. Press the **MENU** button to exit the playback menu.



## Deleting Voice Memos

Select an image with a voice memo. Press the  button. Press the multi selector  or  to select **Current image** and press the **OK** button ( 29). When the confirmation dialog is displayed, press the multi selector  or  to choose  and press the **OK** button. Only the voice memo will be deleted.

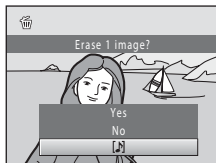

### Notes on Voice Memos

- When an image with a voice memo attached is deleted, both the image and its voice memo are deleted.
- If a voice memo already exists for the current image, it must be deleted before a new voice memo can be recorded.
- The COOLPIX S5100 is not able to record a voice memo for images captured with another make or model of digital camera.







## Copy (Copy Between Internal Memory and Memory Card)

 button (Playback mode) → MENU (Playback menu) →  Copy

Copy images between the internal memory and a memory card.

- 1 Use the multi selector to select a destination option to which images are copied and press the  button.

 → : Copy images from internal memory to memory card.

 → : Copy images from memory card to internal memory.

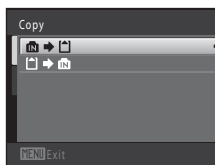



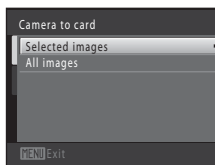

- 2 Select a copy option and press the  button.

**Selected images:** Copy images selected from the image selection screen ( 89).

**All images:** Copy all images.



### Notes on Copying Images

- JPEG-, AVI-, and WAV-format files can be copied. Files saved in any other format cannot be copied.
- If voice memos ( 91) are attached to images selected for copying, voice memos are copied with the images.
- Operation is not guaranteed with images captured with another make of camera or that have been modified on a computer.
- When images selected for a print order ( 84) are copied, print marking is not copied with images (copies will not be included in the print order). When protected images ( 88) are copied, the copies are also protected.
- Images or movies copied from the internal memory or a memory card cannot be displayed in auto sort mode ( 78).

### Memory contains no images. Message

If there are no images saved on a memory card inserted in the camera when playback mode is applied, the message **Memory contains no images.** will be displayed. Press the MENU button to display the copy option screen, and copy the images saved in the camera's internal memory to the memory card.

### More Information

See "Image/Sound File and Folder Names" ( 146) for more information.

## Editing Functions

Use the COOLPIX S5100 to edit images in-camera and save them as separate files (📖 146). The editing functions described below are available.

Editing function	Description
Quick retouch (📖 96)	Easily create retouched copies in which contrast and saturation have been enhanced.
D-Lighting (📖 97)	Create a copy of the current image with enhanced brightness and contrast, brightening dark portions of the image.
Skin softening (📖 98)	Make facial skin tones softer.
Small picture (📖 99)	Create a small copy of images suitable for use as e-mail attachments.
Crop (📖 100)	Crop a portion of the image. Use to zoom in on a subject or arrange a composition.

### ✔ Notes on Image Editing

- Images captured at an **Image mode** setting of **3968 x 2232** (📖 37) cannot be edited.
- The editing functions of this camera cannot be used for images captured with another make or model of digital cameras.
- If no face is detected in an image, a copy cannot be created using the skin softening function (📖 98).
- Edited copies created with this camera may not be displayed properly on another make or model of digital camera. It may also be impossible to transfer them to a computer using another make or model of digital camera.
- Editing functions are not available when there is not enough free space in the internal memory or on the memory card.

### 📎 Restrictions on Image Editing

When an edited copy is further modified with another editing function, check the following restrictions.

Editing function used	Editing function to add
Quick retouch D-Lighting	The skin softening, small picture, or crop function can be added. The quick retouch and D-Lighting functions cannot be used together.
Skin softening	The quick retouch, D-Lighting, small picture, or crop function can be added.
Small picture Crop	Another editing function cannot be added.

- Copies created with editing functions cannot be further edited with the same function used to create them.
- When combining the small picture or crop function and another editing function, use the small picture and crop functions after other editing functions have been applied.
- The skin softening function can be added to the image captured with skin softening (📖 66).



 **Original and Edited Images**

- Copies created with editing functions are not deleted if the original images are deleted. The original images are not deleted if copies created with editing functions are deleted.
- Edited copies are saved with the same shooting date and time as the original.
- Print marking (📖 84) and protect settings (📖 88) do not remain effective in edited copies.

# Image Editing

## Quick Retouch: Enhancing Contrast and Saturation

Quick retouch can be used to easily create retouched copies in which contrast and saturation have been enhanced. Copies created with the quick retouch function are saved as separate files.

- 1 Select the desired image in full-frame playback mode ( 70) or thumbnail playback mode ( 72) and press the **MENU** button.

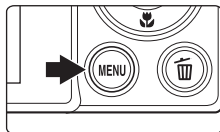

The playback menu is displayed.

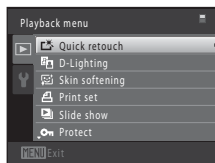

- 2 Use the multi selector to choose  **Quick retouch** and press the **OK** button.

The original version is displayed on the left and the edited version is displayed on the right.



- 3 Press the multi selector  or  to choose the degree of enhancement performed and press the **OK** button.

A new, edited copy is created.

To exit without saving the copy, press the **MENU** button.

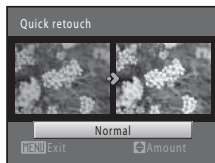

Copies created with the quick retouch function can be identified by the  icon displayed in playback mode.

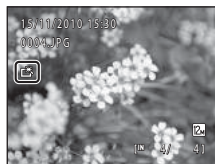



## More Information

See "Image/Sound File and Folder Names" ( 146) for more information.

## D-Lighting: Enhancing Brightness and Contrast

D-Lighting can be used to create copies with enhanced brightness and contrast, brightening dark portions of an image. Enhanced copies are saved as separate files.

- 1 Select the desired image in full-frame playback mode ( 70) or thumbnail playback mode ( 72) and press the **MENU** button.

The playback menu is displayed.

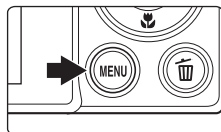

- 2 Use the multi selector to choose  **D-Lighting** and press the **OK** button.

The original version is displayed on the left and the edited version is displayed on the right.

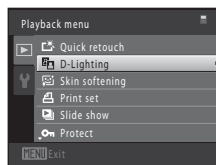

- 3 Choose **OK** and press the **OK** button.

A new, edited copy is created.

To exit without saving the copy, choose **Cancel** and press the **OK** button.

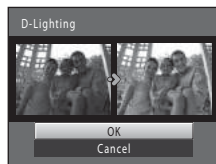

Copies created with the D-Lighting function can be identified by the  icon displayed in playback mode.

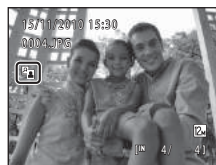



### More Information

See "Image/Sound File and Folder Names" ( 146) for more information.

## Skin Softening: Softening Skin Tones

The camera detects faces in images and creates a copy with softer facial skin tones. Copies created using the skin softening function are saved as separate files.

- 1 Select the desired image in full-frame playback mode ( 70) or thumbnail playback mode ( 72) and press the **MENU** button.

The playback menu is displayed.

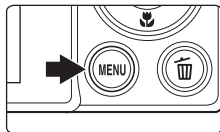



- 2 Use the multi selector to choose  **Skin softening** and press the **OK** button.

The screen for selecting the degree of softening is displayed.

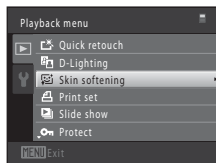
If no faces are detected in the image, an alert is displayed and the camera returns to the playback menu.



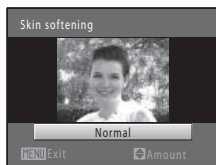

- 3 Press the multi selector  or  to choose the degree of softening and press the **OK** button.

The confirmation dialog is displayed with the face to which skin softening was applied enlarged at the center of the monitor. To exit without saving the copy, press the **MENU** button.



- 4 Check the preview of the copy.

Skin tones in up to 12 faces, in the order of that closest to the center of the frame, are softened.

If more than one face was softened, press the multi selector  or  to display a different face.

Press the **MENU** button to adjust the degree of softening. The monitor display returns to that shown in step 3.

When the **OK** button is pressed, a new, edited copy is created.

Copies created with the skin softening function can be recognized by the  icon displayed in playback mode.

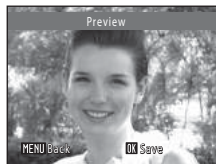



### Note on Skin Softening



Depending upon the direction in which faces are looking, or the brightness of faces, the camera may be unable to accurately recognize faces, or the skin softening function may not perform as expected.

### More Information

See "Image/Sound File and Folder Names" ( 146) for more information.

## **Small Picture: (Reducing Image Size)**

Create a small copy of the current image. This feature is useful for creating copies for display on Web pages or e-mail attachments. The  **640×480**,  **320×240**, and  **160×120** sizes are available. Small copies are saved as separate files with a compression ratio of 1:16.

- 1** Select the desired image in full-frame playback mode ( 70) or thumbnail playback mode ( 72) and press the **MENU** button.

The playback menu is displayed.

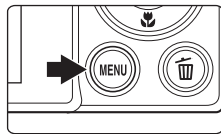

- 2** Use the multi selector to choose  **Small picture** and press the **OK** button.

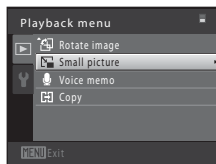

- 3** Choose the desired copy size and press the **OK** button.

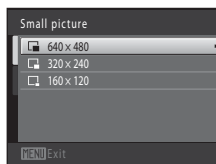

- 4** Choose **Yes** and press the **OK** button.

A new, small copy is created.

To exit without saving the copy, choose **No** and press the **OK** button.

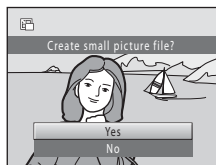

The copy is displayed with a gray frame.



## **More Information**

See "Image/Sound File and Folder Names" ( 146) for more information.

## ✂ Crop: Creating a Cropped Copy

Create a copy containing only the portion visible in the monitor when **MENU**  is displayed with playback zoom ( 75) enabled. Cropped copies are saved as separate files.

### 1 Rotate the zoom control to **T** (Q) in full-frame playback mode ( 70) to zoom in on the image.

To crop an image displayed in “tall” (portrait) orientation, zoom in on the image until the black bars displayed on the both sides of the monitor disappear. The cropped image will be displayed in landscape orientation.

To crop the image in its current “tall” (portrait) orientation, first use the **Rotate image** option ( 90) to rotate the image so that it is displayed in landscape orientation. Next, enlarge the image for cropping, crop the image, and then rotate the cropped image back to “tall” (portrait) orientation.

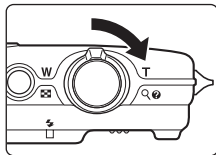

### 2 Refine copy composition.

Rotate the zoom control to **T** (Q) or **W** (Q) to adjust the zoom ratio.

Press the multi selector , , , or  to scroll the image so that only the portion to be copied is visible in the monitor.



### 3 Press the **MENU** button.

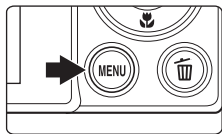



### 4 Use the multi selector to choose **Yes** and press the **OK** button.

A cropped copy is created.

To exit without saving the copy, choose **No** and press the **OK** button.



## Image Size

As the area to be saved is reduced, the image size (pixels) of the cropped copy is also reduced. When the image size of the cropped copy is 320 × 240 or 160 × 120, a gray frame is displayed around the image, and the small picture icon  or  is displayed in the left of the monitor in playback mode.

## More Information

See “Image/Sound File and Folder Names” ( 146) for more information.



## Recording Movies

High-definition movies with sound can be recorded.

- The maximum file size for a single movie is 4 GB and the maximum movie length for a single movie is 29 minutes, even when there is sufficient free space on the memory card for longer recording (📖 104).
- When **Movie options** (📖 104) is set to **720p HD 720p (1280 × 720)** (default setting) and the internal memory is used for recording, the maximum length for a single movie is four seconds.

### 1 Turn on the camera and be sure that it is in shooting mode.

Movies can be recorded in any shooting mode (📖 35).

The icon for the selected movie option is displayed. The default setting is **720p HD 720p (1280 × 720)** (📖 104).

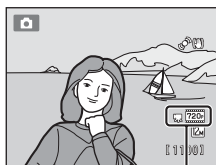

Movie option

### 2 Press the **●** (movie-record) button to start movie recording.

The camera focuses at the center of the frame. Focus areas are not displayed during recording.

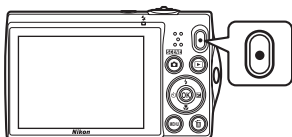

When **720p HD 720p (1280 × 720)** is selected for **Movie options**, monitor display changes to an aspect ratio of 16:9 with movie recording (the area indicated on the right is recorded).

The approximate remaining movie length is displayed during recording.

Recording stops automatically when the maximum movie length has been recorded.



### 3 Press the **●** (movie-record) button again to end recording.





#### ✔ Note on Saving Movies

After a movie has been recorded, it is not fully saved to the internal memory or memory card until monitor display returns to the shooting display. **Do not open the battery-chamber/memory card slot cover** before movies have been fully saved. Removing the memory card or the battery while a movie is being saved may result in loss of the movie data or damage to the camera or to the memory card.



### Recording Movies

- Memory cards with an SD Speed Class rating of 6 or faster are recommended when recording movies (📖 145). Movie recording may stop unexpectedly when memory cards with a lower Speed Class ratings are used.
- The angle of view (field of view) of movies recorded while **Movie options** is set to  **HD 720p (1280 x 720)** is narrower than that of still images.
- Optical zoom cannot be adjusted once movie recording begins.
- Rotate the zoom control during recording to enable digital zoom. Subjects can be magnified up to 2x the optical zoom ratio applied before movie recording began.
- There may be some degradation in image quality when digital zoom is used. When recording ends, digital zoom is disabled.
- The sounds of zoom control operation, autofocus lens drive movement and vibration reduction operation may be recorded.
- Smear (📖 144) visible in the monitor with movie recording will be recorded with movies. Avoiding bright objects such as the sun, reflections of the sun, and electric lights when recording movies is recommended.
- When playing movies, faint stripes may appear in scenes with blue skies, solid-colored walls, etc. This phenomenon occurs during the movie compression process and does not indicate a malfunction.

### Notes on Autofocus for Movie Recording

- When  **Single AF** (default setting) is selected for **Autofocus mode** in movie menu, focus is locked by pressing the  (movie-record) button to start recording (📖 105).
- Autofocus may not perform as expected (📖 27). Should this occur, try the following:
  1. Set **Autofocus mode** in the movie menu to  **Single AF** (default setting) before starting movie recording.
  2. Frame another subject positioned at the same distance from the camera as the intended subject in the center of the frame, press the  (movie-record) button to start recording, and then modify the composition.

### Functions Available with Movie Recording

- The exposure compensation, white balance, and color options settings for the current shooting mode are also applied with movie recording. When macro mode is enabled, movies of subjects closer to the camera can be recorded. Confirm settings before starting movie recording.
- The self-timer (📖 32) can be used. When the  (movie-record) button is pressed after the self-timer is enabled, the camera focuses at the center of the frame and starts movie recording after the specified two or ten seconds.
- The flash will not fire.
- Press the **MENU** button to select the  (movie) tab and adjust movie menu settings before starting movie recording (📖 103).

## Changing Movie Recording Settings

The following options can be adjusted from the movie menu.

### Movie options

104

Select an option for movie recording.

### Autofocus mode

105

Select how the camera focuses during movie recording.

## Displaying the Movie Menu

### 1 Press the MENU button in shooting mode.

The menu is displayed.

If the MENU button was pressed in scene mode, press the multi selector (📖 9) ◀ to display the tabs.

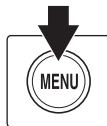

### 2 Press the multi selector ◀.

Tab selection is activated.



### 3 Press ▲ or ▼ to select the 📖 tab.

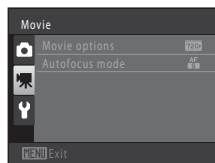

### 4 Press ▶ or the OK button.

The movie menu items can be selected.

Use the multi selector to choose and apply settings (📖 9).

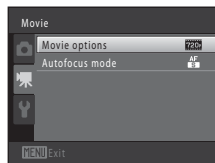

To exit the movie menu, press the MENU button or ◀ to select a different tab.



## Movie Options



Switch to shooting mode → MENU →  (Movie menu)  103 → Movie options

Select the desired movie option to record.

Option	Description
 HD 720p (1280 × 720) (default setting)	Movies with an aspect ratio of 16:9 are recorded. This option is suited to playback on a wide screen TV. Image size: 1280 × 720 pixels
 VGA (640 × 480)	Image size: 640 × 480 pixels
 QVGA (320 × 240)	Image size: 320 × 240 pixels

- The frame rate is approximately 30 frames per second in any options.

### Movie Options and Maximum Movie Length

Option	Internal memory (approx. 32 MB)	Memory card (4 GB) <sup>2</sup>
 HD 720p (1280 × 720)	9 s <sup>1</sup>	20 min
 VGA (640 × 480)	21 s	45 min
 QVGA (320 × 240)	55 s	1 h 50 min

All figures are approximate. The maximum movie length may vary by make of memory card.

<sup>1</sup> The maximum length for a single movie is four seconds.

<sup>2</sup> The maximum file size for a single movie is 4 GB and the maximum movie length for a single movie is 29 minutes, even when there is sufficient free space on the memory card for longer recording.



### More Information

See "Image/Sound File and Folder Names"  146 for more information.

## Autofocus Mode

Switch to shooting mode → MENU →  (Movie menu) (📖 103) → Autofocus mode

Select how the camera focuses in movie mode.

Option	Description
 <b>Single AF</b> (default setting)	Focus is locked when the  (movie-record) button is pressed to start recording. Select this option when the distance between the camera and the subject will remain fairly consistent.
 <b>Full-time AF</b>	Camera focuses continuously. Select this option when the distance between the camera and subject will change significantly during recording. Use of <b>Single AF</b> is recommended to prevent the sound of the camera focusing from interfering with recording.

# Movie Playback

In full-frame playback mode (📖 70), movies can be identified by the **Movie options** icon (📖 104). To play a movie, display it in full-frame playback mode and press the **OK** button.

Rotate the zoom control to **T** or **W** to adjust playback volume.

Playback controls are displayed at the top of the monitor. Press the multi selector ◀ or ▶ to choose a control. The operations described below are available.

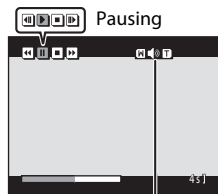

During playback

Volume indicator

Function	Icon	Description
Rewind	⏮	Hold down the <b>OK</b> button to rewind the movie.
Advance	⏭	Hold down the <b>OK</b> button to advance the movie.
Pause	⏸	Press the <b>OK</b> button to pause playback. The following operations can be performed while playback is paused using the controls displayed at the top in the monitor.
		Press the <b>OK</b> button to rewind the movie. Hold down the <b>OK</b> button for continuous rewinding.
		Press the <b>OK</b> button to advance the movie. Hold down the <b>OK</b> button for continuous advancing.
	▶	Press the <b>OK</b> button to resume playback.
End	⏹	Press the <b>OK</b> button to end movie playback and return to full-frame playback mode.

## ✔ Note on Playing Back Movies

The COOLPIX S5100 is not able to playback movies recorded with another make or model of digital camera.

## Deleting Movies

Select a movie and press the **Delete** button in full-frame playback mode (📖 70) or thumbnail playback mode (📖 72). A confirmation dialog is displayed. See "Deleting Unwanted Images" (📖 29) for more information.

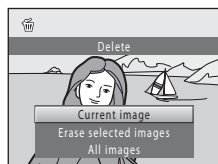

## Connecting to a TV

Connect the camera to a television using the supplied audio/video cable to play back images on a television.

### 1 Turn off the camera.

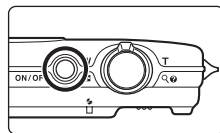

### 2 Connect the camera to the TV.

Connect the yellow plug to the video-in jack and the white plug to the audio-in jack on the TV.

When connecting the cable, be sure that the camera connector is properly oriented. Do not use force when connecting the cable to the camera. When disconnecting the cable, do not pull the connector at an angle.

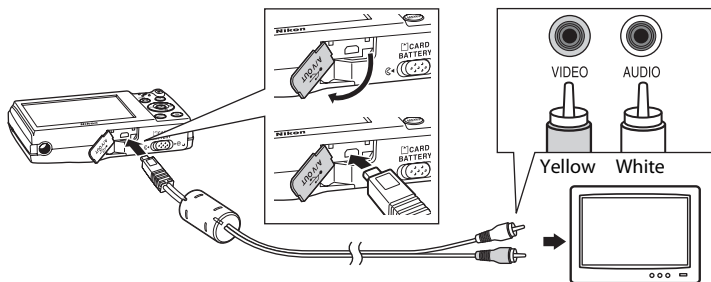

### 3 Tune the television to the video channel.

See the documentation provided with your television for details.

### 4 Hold down the button to turn on the camera.

The camera enters playback mode and images are displayed on the television.

While connected to the TV, the camera monitor will remain off.



### Video Mode

Be sure that the camera's video mode setting conforms to the standard used by your television. The video mode setting is specified from the **Video mode** (📖 135) option in the setup menu (📖 120).

## Connecting to a Computer

Use the supplied USB cable to connect the camera to a computer and copy (transfer) images to the computer.

### Before Connecting the Camera

#### Install the Software

Use the supplied ViewNX 2 CD and install the following software on the computer.

- ViewNX 2: Use the image transfer feature “Nikon Transfer 2” to save images that were captured with the camera on the computer. Saved images can be viewed and printed. Image and movie editing features are also supported.
- Panorama Maker 5: This software can join a series of images to create a single panorama image.

For more information on installing the software, refer to the *Quick Start Guide*.

#### Compatible Operating Systems

##### Windows

Windows 7 Home Basic/Home Premium/Professional/Enterprise/Ultimate, Windows Vista Home Basic/Home Premium/Business/Enterprise/Ultimate (Service Pack 2), or Windows XP Home Edition/Professional (Service Pack 3)

##### Macintosh

Mac OS X (version 10.4.11, 10.5.8, 10.6.3)

For information on the requirements for playing back high-definition movies, refer to “System Requirements” in the ViewNX 2 help information (📖 112).

Refer to the Nikon website for the latest information on operating system compatibility.

#### Note on Computer Connection

Disconnect other USB devices such as commercial USB chargers from the computer. Simultaneous connection of the camera and other USB devices to the computer could result in operation malfunction or excessive supply of power to the camera, causing damage to the camera or memory card. Refer to the documentation supplied with other USB devices for more information.



## ✓ Notes on Power Source

- When connecting the camera to a computer to transfer images, use a fully charged battery to prevent the camera from turning off unexpectedly.
- When the camera is connected to a computer via the supplied USB cable with **Auto** (default setting) selected for the **Charge by computer** option in the setup menu, the battery inserted into the camera is automatically charged using power supplied by the computer (113, 136).
- If the AC Adapter EH-62D (145) (available separately) is used, COOLPIX S5100 can be powered from an electrical outlet. Do not use any other make or model of AC adapter as they may cause the camera to overheat or malfunction.

## Transferring Images from a Camera to a Computer

- 1 Start the computer to which ViewNX 2 was installed.
- 2 Be sure that the camera is off.
- 3 Connect the camera to the computer using the supplied USB cable.

Be sure that connectors are properly oriented. Do not attempt to insert connectors at an angle, and do not use force when connecting or disconnecting the USB cable.

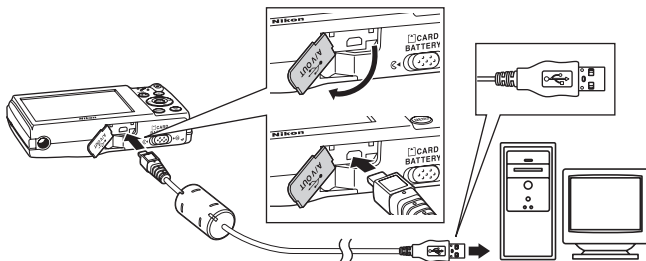

The camera is automatically turned on and the power-on lamp will light. The camera monitor will remain off.

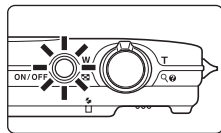

## ✓ Connecting the USB Cable

The connection may not be recognized if the camera is connected to the computer via a USB hub.

#### 4 Start the ViewNX 2 image transfer feature “Nikon Transfer 2” installed on the computer.

- **Windows 7**

When the **Devices and Printers** ► **S5100** screen is displayed, click **Change program** under **Import pictures and videos**. Select **Copy pictures to a folder on my computer.** in the **Change program** dialog and click **OK**.

Double-click **Copy pictures to a folder on my computer.** on the **Devices and Printers** ► **S5100** screen.

- **Windows Vista**

When the **AutoPlay** dialog is displayed, click **Copy pictures to a folder on my computer. using Nikon Transfer 2.**

- **Windows XP**

When the action selection dialog is displayed, select **Nikon Transfer 2 Copy pictures to a folder on my computer.**, and click **OK**.

- **Mac OS X**

Nikon Transfer 2 will start automatically when the camera is connected to the computer if **Yes** was selected in the **Auto-Launch setting** dialog when Nikon Transfer 2 was first installed.

- If charge for the battery inserted into the camera is low, the computer may not recognize the camera. If the camera is not recognized, images will not be transferred. When battery charging starts automatically using power supplied by the computer, wait until battery charge has reached a sufficient level to begin transfer.
- If there are a large number of images on the memory card, it may take some time for Nikon Transfer 2 to start.

#### 5 Confirm that the source device is displayed in the transfer options **Source** panel and click **Start Transfer**.

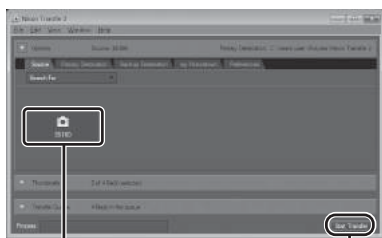

Source device

Start Transfer button

Any images that have not been transferred to the computer will be transferred (default setting of ViewNX 2).

ViewNX 2 starts automatically when the transfer is complete (default setting of ViewNX 2). Transferred images can be viewed.



For more information on using ViewNX 2, refer to the ViewNX 2 help information (📖 112).

## Disconnecting the Camera

Do not turn off the camera or disconnect the camera from the computer during transfer.

When transfer is complete, turn off the camera and disconnect the USB cable.

The camera turns off automatically if there is no communication with the computer for 30 minutes while the camera is connected via the USB cable.

## 🔋 Charging the Battery

The charge lamp slowly blinks green while the battery inserted into the camera is charging (📖 113).

### **Transferring Images Using a Computer's Card Slot or a Commercially-available Card Reader**

When the memory card is inserted into a computer's card slot or into a commercially-available card reader, the images can be transferred using "Nikon Transfer 2", the image transfer feature of ViewNX 2.

- Make sure that the memory card being used is supported by the card reader or other card reading device.
- To transfer images, insert the memory card into the card reader or card slot and follow the procedure from step 4 (📖 110).
- To transfer images saved in the camera's internal memory, the images must first be copied to a memory card using the camera (📖 93).

### **Starting ViewNX 2 or Nikon Transfer 2 Manually**

#### **Windows**

Choose **Start** menu > **All Programs** > **ViewNX 2** > **ViewNX 2**.

Double-clicking the **ViewNX 2** shortcut icon on the desktop will also start ViewNX 2.

#### **Mac OS X**

Open the **Applications** folder, open the **Nikon Software** > **ViewNX 2** folders in that order, and then double-click the **ViewNX 2** icon. Clicking the **ViewNX 2** icon on the Dock will also start ViewNX 2.

Click **Transfer** in the ViewNX 2 screen to start Nikon Transfer 2.

### **Viewing ViewNX 2 Help Information**

For more information on ViewNX 2 or Nikon Transfer 2, start ViewNX 2 or Nikon Transfer 2 and select **ViewNX 2 Help** from the **Help** menu.

### **Panorama Creation with Panorama Maker 5**

- Use a series of images captured in **Panorama assist** scene mode (📖 62) to create a single panorama photo with Panorama Maker 5.
- Panorama Maker 5 can be installed on a computer using the supplied ViewNX 2 CD.
- After installation is complete, follow the procedure described below to start Panorama Maker 5.

#### **Windows**

Choose **Start** menu > **All Programs** > **ArcSoft Panorama Maker 5** > **Panorama Maker 5**.

#### **Mac OS X**

Open **Applications** and double-click the **Panorama Maker 5** icon.

- For more information on using Panorama Maker 5, refer to the on-screen instructions and help information contained in Panorama Maker 5.

### **Image File Names and Folder Names**

See "Image/Sound File and Folder Names" (📖 146) for more information.

## Charging While Connecting to a Computer

When the **Charge by computer** option (📖 136) in the camera's setup menu is set to **Auto** (default setting), if the camera is connected to a computer using the USB cable, the battery inserted into the camera can be automatically charged depending on the ability of the computer to supply power.

See "Before Connecting the Camera" (📖 108) and "Transferring Images from a Camera to a Computer" (📖 109) for more information on connecting the camera to a computer.

### Charge Lamp

The following chart explains charge lamp status when the camera is connected to a computer.

Charge lamp	Description
Blinks slowly (green)	Battery charging.
Off	Battery not charging. If the charge lamp changes from slow blinking (green) to off while the power-on lamp is lit, charging is complete.
Flickers (green)	<ul style="list-style-type: none"> <li>The ambient temperature is not suited to charging. Charge the battery indoors with an ambient temperature of 5 °C to 35 °C (41 °F to 95 °F).</li> <li>A USB cable is not correctly connected or the battery is faulty. Reconnect the USB cable correctly or replace the battery.</li> <li>Computer is in sleep mode and does not supply power. Reboot a computer.</li> <li>The battery cannot be charged as computer's specifications or settings does not support power supply to the camera.</li> </ul>

### ✓ Notes on Charging with Connection to a Computer

- The battery cannot be charged, nor can data be transferred, when the camera is connected to a computer before the camera's display language and date and time have been set (📖 18). If the camera's clock battery (📖 124) has been exhausted, the date and time must be reset before the battery can be charged or images can be transferred with connection to a computer. In this case, use the Charging AC Adapter EH-68P (📖 14) to charge the battery and then set the camera's date and time.
- If the camera is turned off, charging will also stop.
- If a computer enters sleep mode while charging, charging will stop and the camera may be turned off.
- When disconnecting the camera from a computer, turn the camera off and then disconnect the USB cable.
- It may take longer to charge the battery with connection to a computer than with charging using the Charging AC Adapter EH-68P. Charging time increases when images are transferred while the battery is charging.
- When the camera is connected to a computer, an application installed on the computer, such as Nikon Transfer 2, may start. If the camera was connected to the computer for the sole purpose of charging the battery, exit the application.
- The camera turns off automatically if there is no communication with the computer for 30 minutes after the battery has finished charging.
- Depending upon computer specifications, settings, and power supply and allocation, it may be impossible to charge the battery inserted into the camera via computer connection.

## Connecting to a Printer

Users of PictBridge-compatible (📖 161) printers can connect the camera directly to the printer and print images without using a computer.

Follow the procedures below to print images.

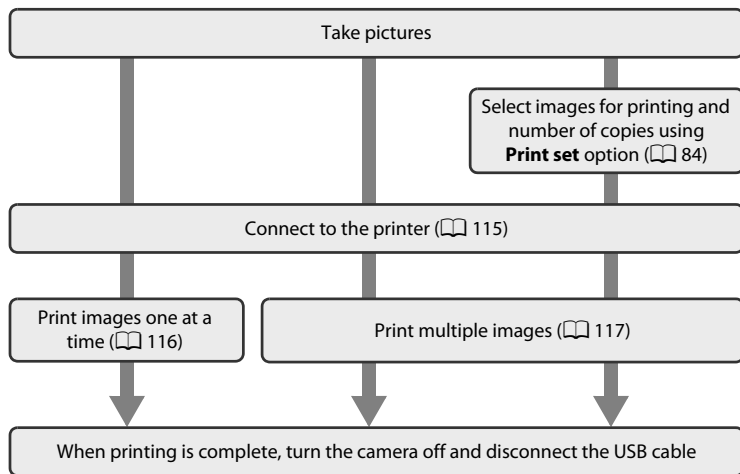

### ✓ Notes on Power Source

- When connecting the camera to a printer, use a fully charged battery to prevent the camera from turning off unexpectedly.
- If the AC Adapter EH-62D (available separately) is used, COOLPIX S5100 can be powered from an electrical outlet. Do not use any other make or model of AC adapters as they may cause the camera to heat up or malfunction.

### 🔍 Printing Images

In addition to printing images transferred to a computer from your personal printer and printing over a direct camera-to-printer connection, the following options are also available for printing images saved on the memory card:

- Inserting a memory card into a DPOF-compatible printer's card slot
- Taking a memory card to a digital photo lab

For printing using these methods, specify the images and the number of prints each to the memory card using the **Print set** option in the playback menu (📖 84).

## Connecting the Camera to a Printer

- 1 Turn off the camera.

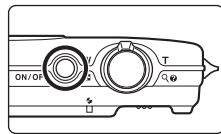

- 2 Turn on the printer.

Check printer settings.

- 3 Connect the camera to the printer using the supplied USB cable.

Be sure that connectors are properly oriented. Do not attempt to insert connectors at an angle, and do not use force when connecting or disconnecting the USB cable.

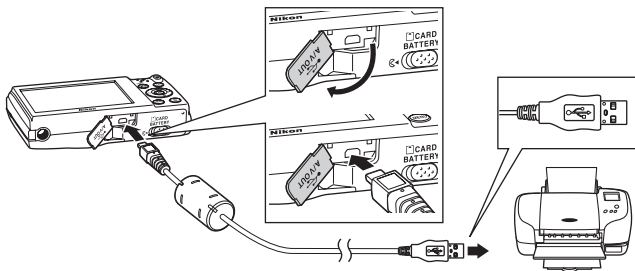

- 4 The camera is automatically turned on.

When properly connected, the **PictBridge** startup screen (①) will be displayed in the camera monitor, followed by the **Print selection** screen (②).

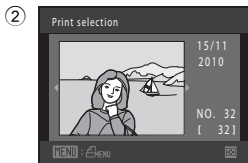
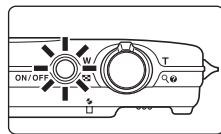

### ✔ If the PictBridge Startup Screen Is not Displayed

Turn the camera off and disconnect the USB cable. Set the **Charge by computer** option (📖 136) in the camera's setup menu to **Off** and reconnect the cable.

## Printing Images One at a Time

After properly connecting the camera to the printer (📖 115), follow the procedures described below to print an image.

- 1 Use the multi selector to choose the desired image and press the **OK** button.

Rotate the zoom control to **W** (📐) to display 12 thumbnails, and **T** (🔍) to switch back to full-frame playback.

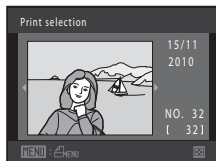

- 2 Choose **Copies** and press the **OK** button.

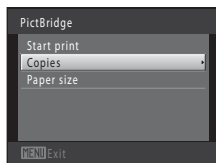

- 3 Choose the desired number of copies (up to nine) and press the **OK** button.

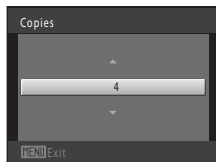

- 4 Choose **Paper size** and press the **OK** button.

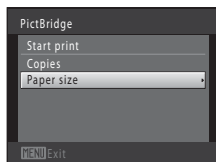

- 5 Choose the desired paper size and press the **OK** button.

To specify paper size using settings on the printer, choose **Default** in the paper size option.

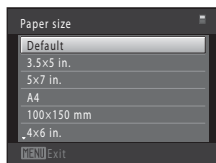



- 6** Choose **Start print** and press the **OK** button.

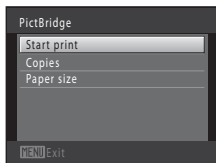

- 7** Printing begins.

Monitor display returns to the print selection screen shown in step 1 when printing is complete.

To cancel printing before all copies have been printed, press the **OK** button.

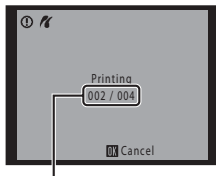

Current number of copies/  
total number of copies

## Printing Multiple Images

After properly connecting the camera to the printer (📖 115), follow the procedures described below to print multiple images.

- 1** When the **Print selection** screen is displayed, press the **MENU** button.

The **Print menu** screen is displayed.

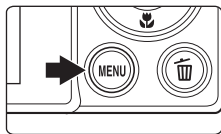

- 2** Use the multi selector to choose **Paper size** and press the **OK** button.

To exit the print menu, press the **MENU** button.

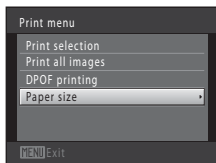

### 3 Choose the desired paper size and press the **OK** button.

To specify paper size using settings on the printer, choose **Default** in the paper size option.

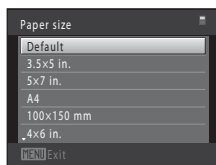

### 4 Choose **Print selection**, **Print all images**, or **DPOF printing** and press the **OK** button.

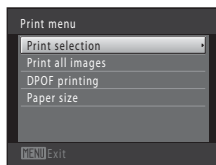

#### Print selection

Choose images (up to 99) and the number of copies (up to nine) of each.

- Press the multi selector ◀ or ▶ to select images, and press ▲ or ▼ to specify the number of copies to be printed.
- Images selected for printing can be identified by the check mark (☑) and the numeral indicating the number of copies to be printed. If no copies have been specified for images, the selection is canceled.
- Rotate the zoom control to **T** (Q) to switch back to full-frame playback or **W** (R) to display 12 thumbnails.
- Press the **OK** button when setting is complete.
- When the screen shown on the right is displayed, choose **Start print** and press the **OK** button to start printing. Choose **Cancel** and press the **OK** button to return to the print menu.

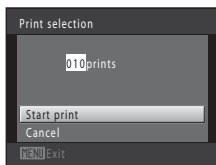

### Print all images

One copy each of all images saved in the internal memory, or on the memory card, is printed.

- When the screen shown on the right is displayed, choose **Start print** and press the **OK** button to start print. Choose **Cancel** and press the **OK** button to return to the print menu.

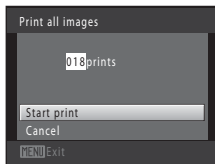

### DPOF printing

Print images for which a print order was created using the **Print set** option (84).

- When the screen shown on the right is displayed, choose **Start print** and press the **OK** button to start printing. Choose **Cancel** and press the **OK** button to return to the print menu.
- To view the current print order, choose **View images** and press the **OK** button. To print images, press the **OK** button again.

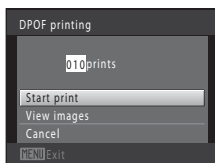

## 5 Printing begins.

Monitor display returns to the print menu shown in step 2 when printing is complete.

To cancel printing before all copies have been printed, press the **OK** button.

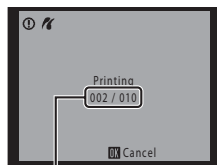















Current number of copies/  
total number of copies

### Paper Size

The camera supports the following paper sizes: **Default** (the default paper size for the printer connected to the camera), **3.5x5 in.**, **5x7 in.**, **100x150 mm**, **4x6 in.**, **8x10 in.**, **Letter**, **A3**, and **A4**. Only sizes supported by the printer will be displayed. To specify paper size using printer settings, choose **Default** in the paper size option.

## Setup Menu

The setup menu contains the following options.

<b>Welcome screen</b>	 122
Choose whether or not a welcome screen is displayed when the camera is turned on.	
<b>Date</b>	 123
Set camera clock and choose home and destination time zones.	
<b>Monitor settings</b>	 126
Adjust photo information display and monitor brightness settings.	
<b>Date imprint</b>	 128
Imprint shooting date and time on images.	
<b>Vibration reduction</b>	 129
Choose whether or not vibration reduction is enabled.	
<b>Motion detection</b>	 130
Enable or disable motion detection, which reduces the effects of subject movement and camera shake in still images.	
<b>AF assist</b>	 131
Enable or disable AF-assist illuminator.	
<b>Digital zoom</b>	 131
Enable or disable digital zoom.	
<b>Sound settings</b>	 132
Adjust sound settings.	
<b>Auto off</b>	 133
Set the amount of time that passes before the monitor turns off to save power.	
<b>Format memory/Format card</b>	 134
Format internal memory or memory card.	
<b>Language</b>	 135
Choose the language used for camera monitor display.	
<b>Video mode</b>	 135
Adjust settings necessary for connection to television.	
<b>Charge by computer</b>	 136
Choose whether or not to charge the camera battery when connecting to a computer via the USB cable.	
<b>Blink warning</b>	 137
Specify whether or not the camera detects human faces that have blinked with shooting using face detection.	

## Reset all

139

Restore camera settings to default values.

## Firmware version

141

Display camera firmware version.

## Displaying the Setup Menu

### 1 Press the MENU button.

The menu is displayed.

If the **MENU** button was pressed in scene mode, press the multi selector (📖 9) ◀ to display the tabs.

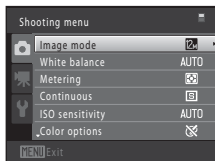
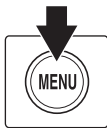

### 2 Press the multi selector ◀.

Tab selection is activated.

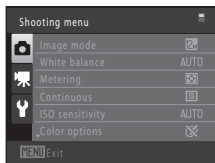

### 3 Press ▲ or ▼ to select the 🧑 tab.

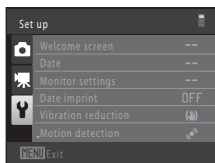

### 4 Press ▶ or the ⓧ button.

The setup menu items can be selected.

Use the multi selector to choose and apply settings (📖 9).

To exit the setup menu, press the **MENU** button or ◀ to select a different tab.

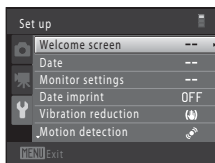

## Welcome Screen

MENU button →  (Setup menu) (📖 121) → Welcome screen

Choose whether or not a welcome screen is displayed when the camera is turned on.

### None (default setting)

The camera enters shooting or playback mode without displaying the welcome screen.

### COOLPIX

The camera displays a welcome screen and enters shooting or playback mode.

### Select an image

Displays an image selected for the welcome screen. When the image selection screen is displayed, select an image (📖 89) and press the  button.

- As the selected image is saved by the camera, it will be displayed when the camera is turned on even if the original image is deleted.
- Images captured at an **Image mode** (📖 37) setting of  **3968 × 2232**, and copies created at a size of 320 × 240 or smaller using the small picture (📖 99) or crop (📖 100) function, cannot be selected.







## Date

MENU button →  (Setup menu) (📖 121) → Date

Set the camera clock.

### Date



Set camera clock to current date and time. Use the multi selector to set the date and time in the date screen.

- Select an item: press  or  (changes between **D**, **M**, **Y**, hour, minute, **DMY** (the order in which the day, month, and year are displayed)).
- Edit the highlighted item: press  or .
- Finish changing the settings: choose the order in which the day, month, and year are displayed and press the  button or press  (📖 19).

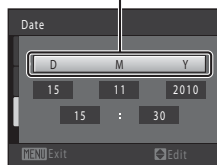
**DMY** (the order in which the day, month, and year are displayed)



### Time zone

 **Home time zone** can be specified and daylight saving is enabled or disabled. When the travel destination () is selected, the time difference (📖 125) between the travel destination and the home time zone () is automatically calculated and the date and time in the selected region are saved. This can be useful when travelling.

## Selecting Travel Destination Time Zone

- 1 Use the multi selector to choose **Time zone** and press the  button.

The **Time zone** screen is displayed.

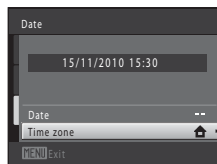

- 2 Choose  **Travel destination** and press the  button.

The date and time displayed in the monitor changes according to the region currently selected.

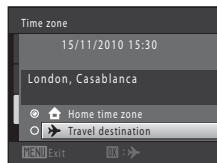

### 3 Press ►.

The travel destination screen is displayed.

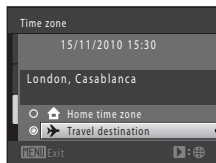

### 4 Press ◀ or ▶ to choose the travel destination time zone.

If daylight saving time is in effect, press ▲ to enable daylight saving time function. ☀ is displayed at the top of the monitor and the camera clock is advanced one hour. Press ▼ to disable the daylight saving time function.

Press the **OK** button to apply the travel destination time zone.

While the travel destination time zone is selected, the  icon will be displayed in the monitor when the camera is in shooting mode.

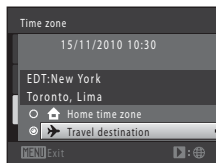
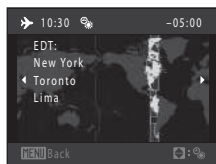

### ✔ Note on the Clock Battery

The camera clock is powered by the clock battery. The clock battery charges when the main battery is inserted or an AC adapter is connected, and can provide several days of backup power after about ten hours of charging.

### 📌 Home Time Zone

- To switch to the home time zone, choose **Home time zone** in step 2 and press the **OK** button.
- To change the home time zone, choose **Home time zone** in step 2, and complete steps 3 and 4.

### 📌 Daylight Saving Time

When daylight saving time starts or ends, turn the daylight saving time function on or off from the time zone selection screen displayed in step 4.

### 📌 Imprinting Date on Images

Enable date imprint from the **Date imprint** option (📖 128) in the setup menu after the date and time have been set. When the **Date imprint** option is enabled, images will be saved with shooting date imprinted on them.





 **Time Zones**

The camera supports the time zones listed below.

For time zones not listed below, set the camera clock to local time from the **Date** option.

UTC +/-	Location	UTC +/-	Location
-11	Midway, Samoa	+1	Madrid, Paris, Berlin
-10	Hawaii, Tahiti	+2	Athens, Helsinki, Ankara
-9	Alaska, Anchorage	+3	Moscow, Nairobi, Riyadh, Kuwait, Manama
-8	PST (PDT): Los Angeles, Seattle, Vancouver	+4	Abu Dhabi, Dubai
-7	MST (MDT): Denver, Phoenix	+5	Islamabad, Karachi
-6	CST (CDT): Chicago, Houston, Mexico City	+5.5	New Delhi
-5	EST (EDT): New York, Toronto, Lima	+6	Colombo, Dhaka
-4.5	Caracas	+7	Bangkok, Jakarta
-4	Manaus	+8	Beijing, Hong Kong, Singapore
-3	Buenos Aires, Sao Paulo	+9	Tokyo, Seoul
-2	Fernando de Noronha	+10	Sydney, Guam
-1	Azores	+11	New Caledonia
±0	London, Casablanca	+12	Auckland, Fiji

## Monitor Settings

MENU button →  (Setup menu) ( 121) → Monitor settings

Set the options below.

### Photo info

Choose information displayed in the monitor during shooting and playback mode. → ( 127)



### Brightness

Choose from five settings for monitor brightness. The default setting is **3**.

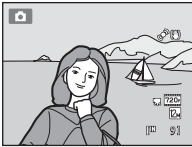
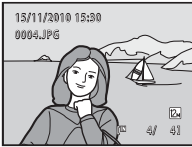

## Photo Info

Select whether or not the photo information is displayed in the monitor.

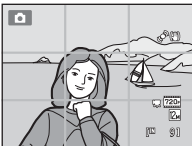
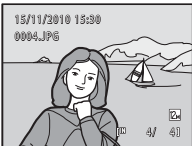
See “The Monitor” (📖 6) for information on indicators displayed in the monitor.

	Shooting mode	Playback mode
Show info		
Auto info (default setting)	Current settings and operational guides are displayed as in <b>Show info</b> above. If no operations are performed for a few seconds, the display changes to that with <b>Hide info</b> . Information will be displayed again when the next operation is performed.	
Hide info		
Framing grid	 In addition to information shown with <b>Auto info</b> above, a framing grid is displayed to help frame images in 📷 (auto) mode. In other shooting modes only the information shown with <b>Auto info</b> is displayed.	 The current settings or operation guide is displayed, as in <b>Auto info</b> above.

## Date Imprint (Imprinting Date and Time)

MENU button →  (Setup menu) ( 121) → Date imprint

The shooting date and time can be imprinted on the images with shooting, allowing the information to be printed even from printers that do not support date printing ( 86).



 **Date**

Date is imprinted on images.

 **Date and time**



Date and time are imprinted on images.

**OFF** **Off (default setting)**

Date and time are not imprinted on images.

The icon for the current setting is displayed in the monitor during shooting ( 6). However, when **Off** is selected, no icon is displayed.

### Notes on Date Imprint

- Imprinted dates form a permanent part of image data and cannot be deleted. The date and time cannot be imprinted on images after they have been captured.
- The date cannot be imprinted in the following situations:
  - Images captured in **Panorama assist** scene mode
  - Movies
- Dates imprinted at an **Image mode** setting ( 37) of **VGA 640 × 480** may be difficult to read. Choose an **Image mode** setting of **PC 1024 × 768** or larger when using date imprint.
- The date is saved using the format selected in the setup menu's **Date** item ( 18, 123).

### Date Imprint and Print Set

When printing from DPOF-compatible printers that support the printing of shooting date and photo information, the date and information can be printed without imprinting this information on them using settings in the **Print set** option ( 84).

## Vibration Reduction

MENU button →  (Setup menu) (📖 121) → Vibration reduction

Reduce the effects of camera shake while shooting. Vibration reduction effectively reduces blur, caused by slight hand movement known as camera shake, which commonly occurs when shooting with zoom applied or at slow shutter speeds. The effects of camera shake are reduced when recording movies, in addition to when taking still pictures.

Set **Vibration reduction** to **Off** when using a tripod to stabilize the camera during shooting.

### On (default setting)

Vibration reduction is enabled.

The camera detects and factors out panning movements when reducing camera shake. When the camera is panned horizontally, for example, vibration reduction reduces only vertical shake. If the camera is panned vertically, vibration reduction affects only horizontal shake.

### OFF Off

Vibration reduction is not enabled.

The current vibration reduction setting can be confirmed in the camera monitor with shooting (📖 6, 23). When **Off** is selected, no icon is displayed.

## Notes on Vibration Reduction

- Vibration reduction may take a few seconds to activate after the power is turned on, or the camera enters shooting mode from playback mode. Wait until the image of the monitor stabilizes before shooting.
- Due to characteristics of the vibration reduction function, images displayed in the camera's monitor immediately after shooting may be displayed blurry.
- Vibration reduction may be unable to completely eliminate the effects of camera shake in some situations.

## Motion Detection



MENU button →  (Setup menu) (📖 121) → Motion detection

Enable motion detection to reduce the effects of subject movement and camera shake when shooting still images.



### Auto (default setting)

When the camera detects subject movement or camera shake, the ISO sensitivity and shutter speed are automatically increased to reduce blurring. However, motion detection does not function in the following situations.

- When the flash fires
- In  (auto) mode, when **ISO sensitivity** (📖 43) is locked
- In  (auto) mode, when **Continuous** is set to **Multi-shot 16** (📖 42)
- In the following scene modes: **Sports** (📖 55), **Night portrait** (📖 55), **Night landscape** (📖 57), **Fireworks show** (📖 60), and **Backlighting** (📖 60) scene mode
- When subject tracking mode is selected

### OFF Off

Motion detection is not enabled.

The current motion detection setting can be confirmed in the camera monitor with shooting (📖 6, 23). The motion detection icon turns green when the camera detects camera shake and increases shutter speed. When **Off** is selected, no icon is displayed.

### Notes on Motion Detection

- Motion detection may be unable to completely eliminate the effects of subject movement and camera shake in some situations.
- Motion detection may not function if the subject exhibits significant movement or is too dark.
- The images captured using motion detection may be somewhat “grainy” in appearance.

## AF Assist

MENU button →  (Setup menu) (📖 121) → AF assist

Enable or disable AF-assist illuminator, which assists autofocus operation when the subject is dimly lit.

### Auto (default setting)

AF-assist illuminator will be used to assist the focus operation when the subject is dimly lit. The illuminator has a range of about 3.5 m (11 ft.) at the maximum wide-angle position and about 1.5 m (4 ft. 11 in.) at the maximum telephoto position. Note that for some scene modes or focus areas, AF-assist illuminator may not light.

### Off

AF-assist illuminator does not light. The camera may be unable to focus under dim lighting.

## Digital Zoom

MENU button →  (Setup menu) (📖 121) → Digital zoom

Enable or disable digital zoom.

### On (default setting)

When the camera is zoomed in to the maximum optical zoom position, rotating the zoom control to **T** (📷) triggers digital zoom (📖 25).



### Off

Digital zoom will not be activated (except when recording movies).

## Notes on Digital Zoom

- When digital zoom is in effect, the camera focuses at the center of the frame.
- Digital zoom cannot be used in the following situations.
  - When **Scene auto selector**, **Portrait**, or **Night portrait** is selected in scene mode
  - When smart portrait mode is selected
  - When subject tracking mode is selected
  - When **Continuous** is set to **Multi-shot 16**
- When digital zoom is in effect, **Metering** is set to **Center-weighted**.

## Sound Settings

MENU button →  (Setup menu) ( 121) → Sound settings

Adjust the following sound settings.

### Button sound

Select **On** (default setting) or **Off**. When **On** is selected, a beep will sound once when operations are completed successfully, twice when the camera acquires focus on the subject, and three times when an error is detected. Start-up sound will also play when the camera is turned on.

### Shutter sound



Select **On** (default setting) or **Off**.

Shutter sound cannot be heard in the following situation, even if **On** is selected.

- When **Continuous** is set to **Continuous**, **BSS**, or **Multi-shot 16**
- When **Sports** or **Museum** is selected in scene mode
- When **On** is selected for **Blink proof** in the smart portrait menu





## Auto Off

MENU button →  (Setup menu) ( 121) → Auto off

If no operations are performed for a specified amount of time, the monitor turns off and the camera enters standby mode ( 17).

Choose the time allowed to elapse before the camera enters standby mode from **30 s**, **1 min** (default setting), **5 min**, and **30 min**.

### When the Monitor Has Turned Off to Save Power



- When the camera is in standby mode, the power-on lamp blinks.
- If no operations are performed for another three minutes, the camera will turn off automatically.
- When the power-on lamp is blinking, pressing any of the following buttons will turn the monitor back on.
  - Power switch, shutter-release button,  button,  button, or  (movie-record) button

### Note on Auto Off

The time allowed to elapse before the camera enters standby mode is fixed in the following situations:

- When a menu is displayed: If auto off is set to **30 s** or **1 min**, it is extended to three minutes.
- During slide show playback: up to 30 minutes
- When the AC adapter EH-62D is connected: 30 minutes

## Format Memory/Format Card

MENU button →  (Setup menu) ( 121) → Format memory/Format card

Use this option to format the internal memory or a memory card.

### Formatting the Internal Memory

To format the internal memory, remove the memory card from the camera.

The **Format memory** option is displayed in the setup menu.

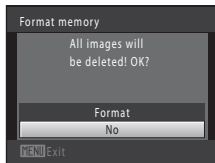

### Formatting a Memory Card

When a memory card is inserted in the camera, the **Format card** option is displayed in the setup menu.

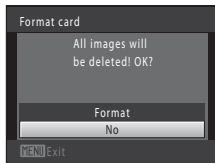

## Formatting Internal Memory and Memory Cards

- **Formatting the internal memory or memory cards permanently deletes all data.** Be sure to transfer important images to a computer before formatting.
- Do not turn the camera off or open the battery-chamber/memory card slot cover during formatting.
- Be sure to use this camera to format memory cards previously used in other devices the first time they are inserted into the COOLPIX S5100.

## Language

MENU button →  (Setup menu) (📖 121) → Language

Choose one of 24 languages for display of camera menus and messages.

Čeština	Czech
Dansk	Danish
Deutsch	German
English	(default setting)
Español	Spanish
Ελληνικά	Greek
Français	French
Indonesia	Indonesian
Italiano	Italian
Magyar	Hungarian
Nederlands	Dutch
Norsk	Norwegian



Polski	Polish
Português	Portuguese
Русский	Russian
Suomi	Finnish
Svenska	Swedish
Türkçe	Turkish
简体中文	Simplified Chinese
繁體中文	Traditional Chinese
日本語	Japanese
한글	Korean
ภาษาไทย	Thai
عربي	Arabic

## Video Mode

MENU button →  (Setup menu) (📖 121) → Video mode

Adjust settings for connection to a television. Choose from **NTSC** and **PAL**.

## Charge by Computer

MENU button →  (Setup menu) ( 121) → Charge by computer

Choose whether or not the battery inserted into the camera is charged when the camera is connected to a computer via the USB cable ( 113).

### Auto (default setting)

When the camera is connected to a computer that is running, the battery inserted into the camera is automatically charged using power supplied by the computer.

### Off

The battery inserted into the camera is not charged when the camera is connected to a computer.

## Notes on Connecting the Camera to a Printer

- The battery cannot be charged with connection to a printer, even if the printer complies with the PictBridge standard.
- When **Auto** is selected for **Charge by computer**, it may be impossible to print images with direct connection of the camera to some printers. If the **PictBridge** startup screen is not displayed in the monitor after the camera is connected to a printer and turned on, turn the camera off and disconnect the USB cable. Set **Charge by computer** to **Off** and reconnect the camera to the printer.

## Blink Warning

MENU button →  (Setup menu) (📖 121) → Blink warning

Specify whether or not the camera detects human subjects that have blinked using face detection (📖 47) when shooting in the following modes.

-  (auto) mode (when **Face priority** (📖 45) is selected for AF area mode option).
- **Scene auto selector** (📖 52), **Portrait** (📖 54), or **Night portrait** (📖 55) scene mode is selected.

### On

When the camera detects that one or more human subjects may have blinked in an image captured using face detection, the **Did someone blink?** screen is displayed in the monitor.

The face of the human subject that may have blinked when the shutter was released is framed by a yellow border. Should this occur, check the image and determine whether or not another image should be captured.

See “Operating the Blink Warning Screen” (📖 138) for more information.

### Off (default setting)

Blink warning is not enabled.

### Note on Blink Warning

The blink warning does not function at continuous settings of **Continuous**, **BSS**, or **Multi-shot 16**.

## Operating the Blink Warning Screen



When the **Did someone blink?** screen shown on the right is displayed in the monitor, the operations described below are available.

If no operations are performed within a few seconds, the camera automatically returns to shooting mode.







Function	Control	Description
Enlarge the detected face that blinked	<b>T</b> (Q)	Rotate the zoom control to <b>T</b> (Q).
Switch to full-frame playback	<b>W</b> (checkered flag)	Rotate the zoom control to <b>W</b> (checkered flag).
Select the face to be displayed		If the camera detects that more than one human subject blinked, press ◀ or ▶ to switch the display to another face.
Delete the image		Press the  button.
Switch to shooting mode		Press the  button or the shutter-release button.

## Reset All









MENU button →  (Setup menu) ( 121) → Reset all

When **Reset** is selected, the camera's settings will be restored to their default values.



## Basic Shooting Functions

Option	Default value
Flash mode (  30)	Auto
Self-timer (  32)	Off
Macro mode (  33)	Off
Exposure compensation (  34)	0.0

## Shooting Menu

Option	Default value
Image mode (  37)	 4000 × 3000
White balance (  39)	Auto
Metering (  41)	Matrix
Continuous (  42)	Single
ISO sensitivity (  43)	Auto
Color options (  44)	Standard color
AF area mode (  45)	Auto
Autofocus mode (  48)	Single AF

## Scene Mode

Option	Default value
Scene mode setting in the shooting-mode selection menu (  51)	Scene auto selector
Hue adjustment in Food mode (  59)	Center

**Smart Portrait Menu**

Option	Default value
Skin softening (📖 66)	Normal
Smile timer (📖 66)	On
Blink proof (📖 66)	Off

**Subject Tracking Menu**

Option	Default value
Autofocus mode (📖 69)	Full-time AF
Face priority tracking (📖 69)	On

**Movie Menu**

Option	Default value
Movie options (📖 104)	HD 720p (1280 x 720)
Autofocus mode (📖 105)	Single AF

**Setup Menu**

Option	Default value
Welcome screen (📖 122)	None
Photo info (📖 126)	Auto info
Brightness (📖 126)	3
Date imprint (📖 128)	Off
Vibration reduction (📖 129)	On
Motion detection (📖 130)	Auto
AF assist (📖 131)	Auto
Digital zoom (📖 131)	On
Button sound (📖 132)	On
Shutter sound (📖 132)	On
Auto off (📖 133)	1 min
Charge by computer (📖 136)	Auto
Blink warning (📖 137)	Off



## Others

Option	Default value
Paper size (📖 116, 117)	Default
Frame interval for Slide show (📖 87)	3 s

- Selecting **Reset all** also clears the current file number (📖 146) from memory. Numbering will continue from the lowest number available. To reset file numbering to "0001", delete all images saved in the internal memory or on the memory card (📖 29) before selecting **Reset all**.
- The following menu settings will remain unaffected when menus are reset with **Reset all**.

**Shooting menu:** Preset manual data (📖 40) acquired for **White balance**

**Setup menu:** **Date** (📖 123), **Language** (📖 135), and **Video mode** (📖 135)

## Firmware Version

MENU button → 🗑️ (Setup menu) (📖 121) → Firmware version

View the current camera firmware version.



# Maximizing Camera Life and Performance

To ensure continued enjoyment of this Nikon product, observe the following precautions when using or storing the device.

### **Keep dry**

The device will be damaged if immersed in water or subjected to high humidity.

### **Do not drop**

The product may malfunction if subjected to strong shock or vibration.

### **Handle the lens and all moving parts with care**

Do not apply force to the lens, lens cover, monitor, memory card slot, or battery chamber. These parts are easily damaged. Applying force to the lens cover could result in camera malfunction or damage to the lens. Should the monitor break, care should be taken to avoid injury caused by broken glass and to prevent the liquid crystal from the display touching the skin or entering the eyes or mouth.

### **Do not point the lens at strong light sources for extended periods**

Avoid pointing the lens at the sun or other strong light sources for extended periods when using or storing the camera. Intense light may cause deterioration of the CCD image sensor, producing a white blur effect in photographs.

### **Keep away from strong magnetic fields**

Do not use or store this device in the vicinity of equipment that generates strong electromagnetic radiation or magnetic fields. Strong static charge or the magnetic fields produced by equipment such as radio transmitters could interfere with the monitor, damage data saved on the memory card, or affect the product's internal circuitry.

### **Avoid sudden changes in temperature**

Sudden changes in temperature, such as when entering or leaving a heated building on a cold day, can cause condensation to form inside the device. To prevent condensation, place the device in a carrying case or a plastic bag before exposing it to sudden changes in temperature.

### **Turn the product off before removing or disconnecting the power source**

Do not remove the battery while the product is on, or while images are being saved or deleted. Forcibly cutting power in these circumstances could result in loss of data or in damage to product memory or internal circuitry.

 **The Battery**

- Check the battery level before using the camera and replace or charge the battery if necessary. Do not continue charging once the battery is fully charged as this will result in reduced battery performance. Whenever possible, carry a fully charged spare battery when taking pictures on important occasions.
- Do not use the battery at ambient temperatures below 0 °C (32 °F) or above 40 °C (104 °F).
- Charge the battery indoors with an ambient temperature of 5 °C to 35 °C (41 °F to 95 °F) before use.
- When charging the COOLPIX S5100 using the Charging AC adapter EH-68P or a computer, the charge capacity may decrease at ambient temperatures 45 °C to 60 °C (113 °F to 140 °F).
- The battery is not charged at ambient temperatures below 0 °C (32 °F) or above 60 °C (140 °F).
- Note that the battery may become hot during use; wait for the battery to cool before charging. Failure to observe these precautions could damage the battery, impair its performance, or prevent it from charging normally.
- On cold days, the capacity of batteries tends to decrease. Be sure that the battery is fully charged before heading outside to take pictures in cold weather. Keep spare batteries in a warm place and exchange as necessary. Once warmed, a cold battery may recover some of its charge.
- Dirt on the battery terminals can prevent the camera from functioning. Should the battery terminals become dirty, wipe them off with a clean, dry cloth before use.
- If the battery will not be used for some time, insert it in the camera and run it flat before removing it for storage. The battery should be stored in a cool location with an ambient temperature of 15 to 25 °C (59 to 77 °F). Do not store the battery in hot or extremely cold locations.
- Always remove the battery from the camera or optional battery charger when it is not being used. When inserted, minute amounts of current are drawn from the battery even when not in use. This may result in excessive draining of the battery and complete loss of function. Turning the camera on or off while the battery is exhausted can result in reduced battery life.
- Recharge the battery at least once every six months and completely exhaust it before returning it to storage.
- After removing the battery from the camera or optional battery charger, put the battery in the supplied battery case and store it in a cool place.
- A marked drop in the time a fully-charged battery retains its charge, when used at room temperature, indicates that the battery needs to be replaced. Purchase a new EN-EL10 battery.
- Replace the battery when it no longer holds a charge. Used batteries are a valuable resource. Please recycle used batteries in accordance with local regulations.

## Cleaning

Lens	Avoid touching glass parts with your fingers. Remove dust or lint with a blower (typically a small device with a rubber bulb attached to one end that is pumped to produce a stream of air out the other end). To remove fingerprints or other stains that cannot be removed with a blower, wipe the lens with a soft cloth, using a spiral motion that starts at the center of them and working toward the edges. If this fails, clean the lens using a cloth lightly dampened with commercial lens cleaner.
Monitor	Remove dust or lint with a blower. To remove fingerprints and other stains, clean the monitor with a soft, dry cloth, being careful not to apply pressure.
Body	Use a blower to remove dust, dirt, or sand, then wipe gently with a soft, dry cloth. After using the camera at the beach or other sandy or dusty environment, wipe off any sand, dust, or salt with a dry cloth lightly dampened with fresh water and dry thoroughly. <b>Note that foreign matter inside the camera could cause damage not covered by the warranty.</b>

Do not use alcohol, thinner, or other volatile chemicals.

## Storage

Turn the camera off when not in use. Be sure that the power-on lamp is off before putting the camera away. Remove the battery if the camera will not be used for an extended period. Do not store the camera with naphtha or camphor moth balls, or in any of the following locations:

- Next to equipment that produces strong electromagnetic fields, such as televisions or radios
  - Exposed to temperatures below  $-10^{\circ}\text{C}$  ( $14^{\circ}\text{F}$ ) or above  $50^{\circ}\text{C}$  ( $122^{\circ}\text{F}$ )
  - Places that are poorly ventilated or subject to humidity of over 60%
- To prevent mold or mildew, take the camera out of storage at least once a month. Turn the camera on and release the shutter a few times before putting the camera away again.

### Notes on the Monitor

- The monitor may contain a few pixels that are always lit or that do not light. This is a characteristic common to all TFT LCD displays, and does not indicate a malfunction. Images saved using the product will not be affected.
- White or colored streaks may be visible when bright subjects are framed in the monitor. This phenomenon, known as “smear,” occurs when extremely bright light strikes the image sensor; it is characteristic of image sensors and does not indicate a malfunction. Smear may also take the form of partial discoloration in the monitor during shooting. It does not appear in images saved with the camera except in the cases of movies and of images saved with **Multi-shot 16** selected for **Continuous**. When shooting in these modes, we recommend that you avoid bright subjects such as the sun, reflected sunlight, and electric lights.
- Images in the monitor may be difficult to see under bright lighting.
- The monitor is lit by an LED backlight. Should the monitor begin to dim or flicker, contact your Nikon-authorized service representative.

## Optional Accessories

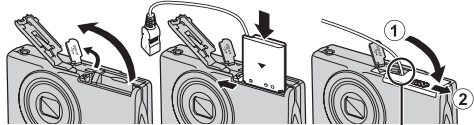
Rechargeable battery	Rechargeable Li-ion Battery EN-EL10
Charging AC adapter	Charging AC Adapter EH-68P*, EH-68P (AR)*
Battery charger	Battery Charger MH-63
AC adapter	<p>AC Adapter EH-62D</p>  <p>Connecting the EH-62D</p> <p>Check that the AC adapter cord has been inserted correctly into the battery chamber before closing the battery-chamber/memory card slot cover. If part of the cord has not been inserted into the chamber the cover may be damaged during closure.</p>
USB cable	USB Cable UC-E6
Audio/video cable	Audio Video Cable EG-CP14

\* When using in other countries, use a plug adapter (commercially available) as necessary. For more information about plug adapters, consult your travel agency.

## Approved Memory Cards

The following Secure Digital (SD) memory cards have been tested and approved for use in this camera.

Memory cards with an SD Speed Class rating of 6 or faster are recommended for recording movies. Movie recording may stop unexpectedly when memory cards with a lower Speed Class rating are used.

	SD memory card	SDHC memory card <sup>2</sup>
SanDisk	2 GB <sup>1</sup>	4 GB, 8 GB, 16 GB, 32 GB
TOSHIBA	2 GB <sup>1</sup>	4 GB, 8 GB, 16 GB, 32 GB
Panasonic	2 GB <sup>1</sup>	4 GB, 8 GB, 12 GB, 16 GB, 24 GB, 32 GB
Lexar	2 GB <sup>1</sup>	4 GB, 8 GB, 16 GB, 32 GB

<sup>1</sup> If the memory card will be used with a card reader or similar device, check that device supports 2 GB cards.

<sup>2</sup> SDHC compliant.

If the memory card will be used with a card reader or similar device, check that device supports SDHC.



- Contact the manufacturer for details on the above cards.



## Image/Sound File and Folder Names

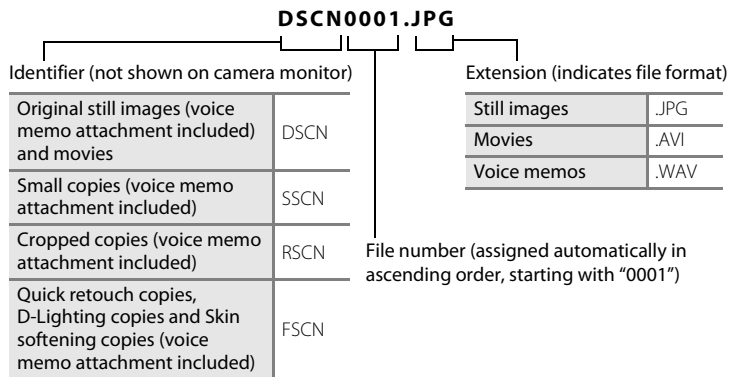









Images, movies, or voice memos are assigned file names as follows.











- Files are saved in folders named with a folder number followed by an identifier: "P\_" plus a three-digit sequential number for images captured in **Panorama assist** scene mode (e.g. "101P\_001";  62) and "NIKON" for all other images (e.g. "100NIKON"). When the number of files within a folder reaches 9999, a new folder will be created. File numbers will be assigned automatically starting with "0001."
- Voice memo file names have the same identifier and file number as the image to which the voice memo is attached.
- Files copied using **Copy>Selected images** are copied to the current folder, where they are assigned new file numbers in ascending order starting from the largest file number in memory. **Copy>All images** copies all folders from the source medium; file names do not change but new folder numbers are assigned in ascending order, starting from the largest folder number on the destination medium ( 93).
- A single folder can hold up to 200 images; if the current folder already contains 200 images, a new folder, named by adding one to the current folder name, will be created the next time an image is captured. If the current folder is numbered 999 and contains 200 images, or an image is numbered 9999, no further images can be captured until the internal memory or memory card is formatted ( 134), or a new memory card is inserted.

## Error Messages









The following table lists the error messages and other warnings displayed in the monitor, as well as the solutions for dealing with them.

Display	Problem	Solution	
 (blinks)	Clock not set.	Set date and time.	123
	Battery running low.	Prepare to charge or replace battery.	12, 14
 Battery exhausted.	Battery exhausted.	Charge or replace battery.	12, 14
 Battery temperature high	Battery temperature is high.	Turn off camera, and allow battery to cool down before resuming use. After five seconds, this message will disappear, the monitor will turn off, and the power-on lamp will blink rapidly. After the lamp blinks for three minutes, the camera will turn off automatically. Pressing the power switch also turns off the camera.	17
 ● (● blinks red)	Camera cannot focus.	<ul style="list-style-type: none"> <li>• Refocus.</li> <li>• Use focus lock.</li> </ul>	26, 27 46
 Please wait for the camera to finish recording.	Camera cannot perform other operations until saving is complete.	Wait until message clears from display automatically when saving is complete.	–
 Memory card is write protected.	Write-protect switch is in “lock” position.	Slide write-protect switch to “write” position.	21
 This card cannot be used.	Error accessing memory card.	<ul style="list-style-type: none"> <li>• Use approved card.</li> <li>• Check that terminals are clean.</li> <li>• Confirm that memory card is correctly inserted.</li> </ul>	145 20
 This card cannot be read.			20



















## Error Messages

Display	Problem	Solution	
<p> Card is not formatted. Format card? Yes No</p>	Memory card has not been formatted for use in COOLPIX S5100.	Formatting deletes all data saved on the memory card. Be sure to select <b>No</b> and make copies of any images which need to be kept before formatting the memory card. Select <b>Yes</b> and press the  button to format the memory card.	21
<p> Out of memory.</p>	Memory card is full.	<ul style="list-style-type: none"> <li>• Choose smaller image size.</li> <li>• Delete images.</li> <li>• Insert new memory card.</li> <li>• Remove memory card and use internal memory.</li> </ul>	37 29, 106 20 20
<p> Image cannot be saved.</p>	Error occurred while saving image.	Format internal memory or memory card.	134
	Camera has run out of file numbers.	Insert a new memory card or format internal memory or memory card.	146
	Image cannot be used for welcome screen.	<p>The following images cannot be registered as welcome screen.</p> <ul style="list-style-type: none"> <li>• Images captured at an <b>Image mode</b> setting of  <b>3968 x 2232</b></li> <li>• Images reduced to 320 x 240 size or smaller with cropping or small image editing</li> </ul>	122
	Insufficient space to save a copy.	Delete images from destination.	29
<p> Sound file cannot be saved.</p>	A voice memo cannot be attached to this file.	<ul style="list-style-type: none"> <li>• Voice memos cannot be attached to movies.</li> <li>• Select an image captured with this camera.</li> </ul>	– 92
<p> A blink was detected in the picture just taken.</p>	One or more portrait subjects may have blinked when the picture was taken.	Check the image in playback mode.	66, 70
<p> Image cannot be modified.</p>	Cannot edit selected image.	<ul style="list-style-type: none"> <li>• Select images that support editing function.</li> <li>• Movies cannot be edited.</li> </ul>	94 –



Display	Problem	Solution	
 Cannot record movie.	Time out error while saving movie on the memory card.	Choose memory card with faster write speed.	20
 Memory contains no images.	No images in the internal memory or memory card.	<ul style="list-style-type: none"> <li>Remove the memory card from the camera to play back images saved in the camera's internal memory.</li> <li>To copy image from internal memory to memory card, press the <b>MENU</b> button. The copy screen will be displayed and images in the internal memory can be copied to memory card.</li> </ul>	20 93
	No images are contained in the category selected in auto sort mode.	Select the category containing the sorted images.	79
 File contains no image data.	File not created with this camera.	File cannot be viewed on this camera. View file using a computer or the devices used to create or edit this file.	-
 This file cannot be played back.			
 All images are hidden.	No images available for a slide show.	-	87
 This image cannot be deleted.	Image is protected.	Disable protection.	88
 Travel destination is in the current time zone.	Destination in same time zone as home.	-	125

## Error Messages





Display	Problem	Solution	
Lens error 	Lens error.	Turn camera off and then on again. If error persists, contact retailer or Nikon-authorized service representative.	22
 Communications error	Error occurred during communication with printer.	Turn camera off and reconnect USB cable.	115
System error 	Error has occurred in camera's internal circuitry.	Turn camera off, remove and reinsert battery, and turn camera on. If error persists, contact retailer or Nikon-authorized service representative.	12, 17
 Printer error: check printer status.	Printer error.	Check printer. After solving the problem, select <b>Resume</b> and press the  button to resume printing.*	—
 Printer error: check paper	Specified size of paper is not loaded in printer.	Load the specified paper, select <b>Resume</b> , and press the  button to resume printing.*	—
 Printer error: paper jam	Paper has jammed in printer.	Remove the jammed paper, select <b>Resume</b> , and press the  button to resume printing.*	—
 Printer error: out of paper	No paper is loaded in printer.	Load the specified paper, select <b>Resume</b> , and press the  button to resume printing.*	—
 Printer error: check ink	Ink error.	Check ink, select <b>Resume</b> , and press the  button to resume printing.*	—
 Printer error: out of ink	Running out of ink or ink cartridge is empty.	Replace ink cartridge, select <b>Resume</b> , and press the  button to resume printing.*	—
 Printer error: file corrupt	An error caused by the image file has occurred.	Select <b>Cancel</b> and press the  button to cancel printing.	—

\* See the documentation provided with your printer for further guidance and information.

## Troubleshooting





If the camera fails to function as expected, check the list of common problems below before consulting your retailer or Nikon-authorized service representative.



### Display, Settings, and Power Supply





Problem	Cause/Solution	
Battery inserted in the camera cannot be charged.	<ul style="list-style-type: none"> <li>Close the battery-chamber/memory card slot cover.</li> </ul>	12
	<ul style="list-style-type: none"> <li>Confirm all connections.</li> </ul>	14
	<ul style="list-style-type: none"> <li><b>Off</b> is selected for <b>Charge by computer</b> in the setup menu.</li> </ul>	136
	<ul style="list-style-type: none"> <li>When charging by connecting the camera to a computer, battery charging stops when the camera is turned off.</li> </ul>	113
	<ul style="list-style-type: none"> <li>When charging by connecting the camera to a computer, battery charging stops when the computer is suspended (sleeping), and the camera may turn off.</li> </ul>	113
	<ul style="list-style-type: none"> <li>Depending upon computer specifications, settings, and status, charging the battery inserted in the camera may not be possible via computer connection.</li> </ul>	–
Camera cannot be turned on.	<ul style="list-style-type: none"> <li>Battery is exhausted.</li> </ul>	22
	<ul style="list-style-type: none"> <li>The camera cannot be turned on when the battery-chamber/memory card slot cover is open.</li> </ul>	12
	<ul style="list-style-type: none"> <li>The camera cannot be turned on while connected to an electrical outlet via the Charging AC Adapter.</li> </ul>	14
Monitor is blank.	<ul style="list-style-type: none"> <li>Camera is off.</li> </ul>	17
	<ul style="list-style-type: none"> <li>Standby mode for saving power: press the power switch, the shutter-release button,  button,  button, or  (movie-record) button.</li> </ul>	8, 11, 17
	<ul style="list-style-type: none"> <li>When flash lamp blinks, wait until flash has charged.</li> </ul>	31
	<ul style="list-style-type: none"> <li>Camera and computer are connected via USB cable.</li> </ul>	109
	<ul style="list-style-type: none"> <li>Camera and TV are connected via audio/video cable.</li> </ul>	107
Monitor is hard to read.	<ul style="list-style-type: none"> <li>Adjust monitor brightness.</li> </ul>	126
	<ul style="list-style-type: none"> <li>Monitor is dirty. Clean monitor.</li> </ul>	144
Camera turns off without warning.	<ul style="list-style-type: none"> <li>Battery is exhausted.</li> </ul>	22
	<ul style="list-style-type: none"> <li>Camera has turned off automatically to save power.</li> </ul>	133
	<ul style="list-style-type: none"> <li>Battery is cold.</li> </ul>	143
	<ul style="list-style-type: none"> <li>The camera turns off if the Charging AC Adapter is connected while the camera is on.</li> </ul>	14
	<ul style="list-style-type: none"> <li>The camera turns off if the USB cable connecting it to a computer or printer is disconnected. Reconnect the USB cable.</li> </ul>	109, 111, 115



## Shooting

Problem	Cause/Solution	
No image captured when the shutter-release button is pressed.	<ul style="list-style-type: none"> <li>• When camera is in playback mode, press the  button, the shutter-release button, or the  (movie-record) button.</li> <li>• When menus are displayed, press the <b>MENU</b> button.</li> <li>• Battery is exhausted.</li> <li>• When flash lamp blinks, flash is charging.</li> </ul>	8, 28  10  22 31
Camera cannot focus.	<ul style="list-style-type: none"> <li>• The intended subject is one with which autofocus does not perform well.</li> <li>• Set <b>AF assist</b> in the setup menu to <b>Auto</b>.</li> <li>• Turn camera off and then on again.</li> </ul>	27  131 17
Images are blurred.	<ul style="list-style-type: none"> <li>• Use flash.</li> <li>• Enable vibration reduction or motion detection.</li> <li>• Use <b>BSS</b> (Best Shot Selector).</li> <li>• Use tripod and self-timer.</li> </ul>	30 129, 130 42 32
Streaks of light or partial discoloration are visible in the monitor.	Smear occurs when extremely bright light strikes the image sensor. When shooting with <b>Continuous</b> set to <b>Multi-shot 16</b> and when recording movies, avoiding bright objects, such as the sun, reflections of the sun, and electric lights is recommended.	42, 144
Bright specks appear in images captured with flash.	Flash is reflecting off particles in air. Set the flash mode setting to  (off).	31
Flash does not fire.	<ul style="list-style-type: none"> <li>• The flash mode is set to  (off).</li> <li>• Scene mode with which the flash does not fire is selected.</li> <li>• <b>On</b> is selected for <b>Blink proof</b> in smart portrait menu.</li> <li>• Another function that restricts flash is enabled.</li> </ul>	30 54  66 49
Optical zoom cannot be used.	Optical zoom cannot be used while recording movies.	102
Digital zoom cannot be used.	<ul style="list-style-type: none"> <li>• <b>Digital zoom</b> is set to <b>Off</b> in the setup menu.</li> <li>• Digital zoom is not available in the following situations.                             <ul style="list-style-type: none"> <li>- When <b>Scene auto selector, Portrait</b>, or <b>Night portrait</b> scene mode is selected.</li> <li>- When shooting in smart portrait mode.</li> <li>- When shooting in subject tracking mode.</li> <li>- When <b>Continuous</b> is set to <b>Multi-shot 16</b>.</li> </ul> </li> </ul>	131  52, 54, 55 64 67 42

Problem	Cause/Solution	
<b>Image mode</b> not available.	Another function that restricts the <b>Image mode</b> option is enabled.	49
No sound when shutter is released.	<b>Off</b> is selected for <b>Sound settings&gt;Shutter sound</b> in setup menu. No sound is heard with some shooting modes and settings, even when <b>On</b> is selected.	132
AF-assist illuminator does not light.	<b>Off</b> is selected for the <b>AF assist</b> option in the setup menu. AF-assist illuminator may not light depending on the position of the focus area or the current scene mode, even when <b>Auto</b> is selected.	54-61, 131
Images appear smeared.	Lens is dirty. Clean lens.	144
Colors are unnatural.	White balance or hue is not adjusted properly.	39, 59
Randomly spaced bright pixels ("noise") appear in image.	<ul style="list-style-type: none"> <li>• The subject is dark, so shutter speed is too slow or ISO sensitivity is too high. Noise can be reduced by:                             <ul style="list-style-type: none"> <li>- Using flash.</li> <li>- Specifying a lower ISO sensitivity setting.</li> </ul> </li> <li>• When shooting landscapes at night using the <b>Scene auto selector</b> or <b>Night landscape</b> scene modes, noise may appear in captured images if the camera is hand-held. In these cases, use of a tripod is recommended.</li> </ul>	30 43 57
Images are too dark (underexposed).	<ul style="list-style-type: none"> <li>• The flash mode is set to  (off).</li> <li>• Flash window is blocked.</li> <li>• Subject is beyond flash range.</li> <li>• Adjust exposure compensation.</li> <li>• Increase ISO sensitivity.</li> <li>• Subject is backlit. Select <b>Backlighting</b> scene mode or set the flash mode setting to  (fill flash).</li> <li>• When shooting landscapes at night using the <b>Scene auto selector</b> or <b>Night landscape</b> scene modes, captured images may be dark if the camera is hand-held. In these cases, use of a tripod is recommended.</li> </ul>	30 24 30 34 43 30, 60 57
Images are too bright (overexposed).	Adjust exposure compensation.	34

Problem	Cause/Solution	
Unexpected results when flash set to  (auto with red-eye reduction).	When taking pictures with  (auto with red-eye reduction) or fill flash with slow sync and red-eye reduction in <b>Night portrait</b> scene mode, In-Camera Red Eye Fix may be applied to areas not affected by red-eye. Use any scene mode other than <b>Night portrait</b> , and change the flash mode to any setting other than  (auto with red-eye reduction) and try taking a picture again.	30, 55
Skin tones are not softened.	<ul style="list-style-type: none"> <li>In some shooting conditions, facial skin tones may not be smoothed.</li> <li>Use <b>Skin softening</b> in the playback menu for images containing four or more faces.</li> </ul>	65 98
Saving images takes time.	It may take more time to save images in the following situations. <ul style="list-style-type: none"> <li>When the noise reduction function is in operation</li> <li>When the flash mode is set to  (auto with red-eye reduction)</li> <li>When the skin softening function is applied while shooting</li> </ul>	31 31 54, 55, 66

## Playback

Problem	Cause/Solution	
File cannot be played back.	<ul style="list-style-type: none"> <li>File or folder was overwritten or renamed by computer or other make of camera.</li> <li>The COOLPIX S5100 is not able to play back movies recorded with another make or model of digital camera.</li> </ul>	– 106
Cannot zoom in on image.	Playback zoom cannot be used with movies, small pictures, or images that have been cropped to a size of 320 × 240 or smaller.	–
Cannot record or play back voice memos.	<ul style="list-style-type: none"> <li>Voice memos cannot be attached to movies.</li> <li>Voice memos cannot be attached to images captured with other cameras. Voice memos attached to images using another camera cannot be played back on this camera.</li> </ul>	106 91

Problem	Cause/Solution	
<p>Cannot use quick retouch, D-Lighting, skin softening, small picture, or crop.</p>	<ul style="list-style-type: none"> <li>• These options cannot be used with movies. 106</li> <li>• These options cannot be used with images captured at an <b>Image mode</b> setting of <b>69</b> <b>3968 × 2232</b>. 37</li> <li>• Select images that support quick retouch, D-Lighting, skin softening, small picture, or crop. 94</li> <li>• Camera is unable to edit images captured with other cameras. 94</li> </ul>	
<p>Images not displayed on television.</p>	<ul style="list-style-type: none"> <li>• Select the correct <b>Video mode</b> in the setup menu. 135</li> <li>• Memory card contains no images. Replace the memory card. Remove the memory card to play back images from the internal memory. 20</li> </ul>	
<p>The saved images are not displayed in auto sort mode.</p>	<ul style="list-style-type: none"> <li>• The desired image was sorted to a category other than the category currently displayed. 78</li> <li>• Images saved by a camera other than the COOLPIX S5100 and images copied using the <b>Copy</b> option cannot be displayed in auto sort mode. 79</li> <li>• Images saved in the internal memory or on the memory card may not be played back correctly if overwritten by a computer. –</li> <li>• Up to 999 images and movies in total can be added to each category. If the desired category already contains 999 images or movies in total, new images or movies cannot be added. 79</li> </ul>	
<p>Nikon Transfer 2 does not start when camera is connected.</p>	<ul style="list-style-type: none"> <li>• Camera is off. 17</li> <li>• Battery is exhausted. 22</li> <li>• USB cable is not correctly connected. 109</li> <li>• Camera is not recognized by the computer. –</li> <li>• Confirm system requirements. 108</li> <li>• Computer is not set to start Nikon Transfer 2 automatically. 112</li> </ul> <p>For more information on Nikon Transfer 2, refer to help information contained in ViewNX 2.</p>	
<p>The PictBridge startup screen is not displayed when the camera is connected to a printer.</p>	<p>With some PictBridge-compatible printers, the PictBridge startup screen may not be displayed and it may be impossible to print images when <b>Auto</b> is selected for the <b>Charge by computer</b> option in the setup menu. Set the <b>Charge by computer</b> option to <b>Off</b> and reconnect the camera to the printer.</p>	136



Problem	Cause/Solution	
Images to be printed are not displayed.	<ul style="list-style-type: none"> <li>• Memory card contains no images. Replace the memory card.</li> <li>• Remove the memory card to print images from the internal memory.</li> </ul>	20
Cannot select paper size with camera.	Paper size cannot be selected from the camera in the following situations, even when printing from a PictBridge-compatible printer: <ul style="list-style-type: none"> <li>• The printer does not support the paper sizes specified by the camera.</li> <li>• The printer automatically selects the paper size.</li> </ul>	116, 117 –

# Specifications

## Nikon COOLPIX S5100 Digital Camera

Type	Compact digital camera
Effective pixels	12.2 million
Image sensor	<sup>1</sup> /2.3-in. type CCD; approx. 12.39 million total pixels
Lens	5× optical zoom, NIKKOR lens
Focal length	5.0-25.0mm (angle of view equivalent to that of 28-140 mm lens in 35mm [135] format)
f/-number	f/2.7-6.6
Construction	7 elements in 6 groups
Digital zoom	Up to 2× (angle of view equivalent to that of approx. 280 mm lens in 35mm [135] format)
Vibration reduction	Lens shift
Autofocus (AF)	Contrast-detect AF
Focus range (from lens)	<ul style="list-style-type: none"><li>• [W]: Approx. 45 cm (1 ft. 6 in.) to ∞, [T]: Approx. 70 cm (2 ft. 4 in.) to ∞</li><li>• Macro mode: Approx. 2 cm (0.8 in.) to ∞ (wide-angle position)</li></ul>
Focus-area selection	Face priority, auto (9-area automatic selection), manual with 99 focus areas, center
Monitor	6.7 cm (2.7-in.), approx. 230k-dot, TFT LCD with anti-reflection coating and 5-level brightness adjustment
Frame coverage (shooting mode)	Approx. 100% horizontal and 100% vertical
Frame coverage (playback mode)	Approx. 100% horizontal and 100% vertical
Storage	
Media	Internal memory (approx. 32 MB), SD/SDHC memory card
File system	DCF, Exif 2.2, and DPOF compliant
File formats	Still pictures: JPEG Sound files (Voice Memo): WAV Movies: AVI (Motion-JPEG compliant)
Image size (pixels)	<ul style="list-style-type: none"><li>• 12M (High) [4000 × 3000 ★]</li><li>• 12M [4000 × 3000]</li><li>• 8M [3264 × 2448]</li><li>• 5M [2592 × 1944]</li><li>• 3M [2048 × 1536]</li><li>• PC [1024 × 768]</li><li>• VGA [640 × 480]</li><li>• 16:9 [3968 × 2232]</li></ul>
ISO sensitivity (Standard output sensitivity)	<ul style="list-style-type: none"><li>• ISO 100, 200, 400, 800, 1600, 3200</li><li>• Auto (auto gain from ISO 100 to 1600)</li><li>• Fixed range auto (ISO 100 to 400, 100 to 800)</li></ul>

<b>Exposure</b>	
Metering	224-segment matrix, center-weighted
Exposure control	Programmed auto exposure with motion detection and exposure compensation (–2.0 to +2.0 EV in steps of $\frac{1}{3}$ EV)
Range (  auto mode)	[W]: –1.1 to +16.4 EV [T]: 1.5 to 19 EV (exposure values achieved with automatic ISO sensitivity adjustment converted to ISO 100 values)
<b>Shutter</b>	
Speed	Mechanical and charge-coupled electronic shutter <ul style="list-style-type: none"> <li>• <math>\frac{1}{1500}</math>–8 s (when <b>ISO sensitivity</b> is set to 100, 200, 400)</li> <li>• <math>\frac{1}{1500}</math>–2 s (when <b>ISO sensitivity</b> is set to 800)</li> <li>• <math>\frac{1}{1500}</math>–1 s (when <b>ISO sensitivity</b> is set to <b>Auto</b>, 1600, 3200)</li> <li>• 4 s (<b>Fireworks show</b> scene mode)</li> </ul>
<b>Aperture</b>	
Range	Electronically-controlled ND filter (–3 AV) selection 2 steps (f/2.7 and f/7.6 [W])
<b>Self-timer</b>	Can be selected from 10 and 2 seconds duration
<b>Built-in flash</b>	
Range (approx.) (ISO sensitivity: Auto)	[W]: 0.5 to 6.0 m (1 ft. 8 in. to 19 ft.) [T]: 0.7 to 2.5 m (2 ft. 4 in. to 8 ft.)
Flash control	TTL auto flash with monitor preflashes
<b>Interface</b>	
Data transfer protocol	Hi-Speed USB MTP, PTP
<b>Video output</b>	Can be selected from <b>NTSC</b> and <b>PAL</b>
<b>I/O terminal</b>	Audio/video (A/V) output; digital I/O (USB)
<b>Supported languages</b>	Arabic, Chinese (Simplified and Traditional), Czech, Danish, Dutch, English, Finnish, French, German, Greek, Hungarian, Indonesian, Italian, Japanese, Korean, Norwegian, Polish, Portuguese, Russian, Spanish, Swedish, Thai, Turkish
<b>Power sources</b>	One Rechargeable Li-ion Battery EN-EL10 (supplied) AC Adapter EH-62D (available separately)
<b>Charging time</b>	Approx. 3 hours (when using Charging AC Adapter EH-68P/ EH-68P (AR) and when no charge remains)
<b>Battery life</b> (EN-EL10)	Still pictures*: Approx. 200 shots Movies: Approx. 1 h 40 min ( <b>HD 720p</b> )
<b>Tripod socket</b>	1/4 (ISO 1222)
<b>Dimensions (W × H × D)</b>	Approx. 97.1 × 56.9 × 21.6 mm (3.9 × 2.3 × 0.9 in.) (excluding projections)
<b>Weight</b>	Approx. 132 g (4.7 oz) (including battery and SD memory card)

## Specifications

### Operating environment

Temperature	0 to 40 °C (32 to 104 °F)
Humidity	Less than 85 % (no condensation)

- Unless otherwise stated, all figures are for a camera with a fully-charged Rechargeable Li-ion Battery EN-EL10 operated at an ambient temperature of 25 °C (77 °F).
- \* Based on Camera and Imaging Products Association (CIPA) standards for measuring the life of camera batteries. Measured at 23 (±2) °C (73 (±4) °F); zoom adjusted with each shot, flash fired with every other shot, image mode set to  4000 × 3000. Battery life may vary depending on shooting interval and length of time menus and images are displayed.

### Rechargeable Li-ion Battery EN-EL10

Type	Rechargeable lithium-ion battery
Rated capacity	DC 3.7 V, 740 mAh
Operating temperature	0 to 40 °C (32 to 104 °F)
Dimensions (W × H × D)	Approx. 31.5 × 39.5 × 6 mm (1.2 × 1.6 × 0.2 in.)
Weight	Approx. 15 g (0.5 oz) (excluding battery case)

### Charging AC Adapter EH-68P/EH-68P (AR)

Rated input	AC 100-240 V, 50/60 Hz, 0.065-0.04 A
Rated capacity	6.5–9.6 VA
Rated output	DC 5.0 V, 0.5 A
Operating temperature	0 to 40 °C (32 to 104 °F)
Dimensions (W × H × D)	EH-68P: Approx. 55 × 22 × 65 mm (2.2 × 0.9 × 2.6 in.) EH-68P (AR): Approx. 55 × 51.6 × 66 mm (2.2 × 2.0 × 2.6 in.)
Weight	EH-68P: Approx. 60 g (2.1 oz) EH-68P (AR): Approx. 65 g (2.3 oz)

## Specifications





















Nikon will not be held liable for any errors this manual may contain. The appearance of this product and its specifications are subject to change without notice.

## Supported Standards

- **DCF:** Design Rule for Camera File System is a standard widely used in the digital camera industry to ensure compatibility among different makes of camera.
- **DPOF:** Digital Print Order Format is an industry-wide standard that allows images to be printed from print orders saved on memory cards.
- **Exif version 2.2:** This camera supports Exchangeable image file format (Exif) version 2.2 for digital still cameras, a standard that allows information saved with photographs to be used for optimal color reproduction when images are output from Exif-compliant printers.
- **PictBridge:** A standard developed cooperatively by the digital camera and printer industries, allowing photographs to be output directly to a printer without connecting the camera to a computer.

# Index



## Symbols

- AE/AF-L 63
-  (Apply selection) button 9
-  (movie-record) button 8
- T (Tele) 25
- W (Wide) 25
-  Auto mode 22
-  Auto sort mode 78
- MENU button 9, 10, 36, 83, 121
-  Delete button 9, 29, 92, 106
-  Exposure compensation 34
-  Flash mode 30
-  Help 51
-  List by date mode 81
-  Macro mode 33
-  Playback button 8, 28
-  Playback mode 28
-  Playback zoom 75
-  Scene mode 51
-  Self timer 32
-  Setup menu 120
-  Shooting mode button 8
-  Smart portrait mode 64
-  Subject tracking mode 67
-  Thumbnail playback 72, 74



## A

- AC adapter 145
- AF area mode 45
- AF assist 131
- Aperture value 26
- Audio/video cable 107, 145
- Audio/video-in jack 107
- Auto 30, 39
- Auto mode 22
- Auto off 133
- Auto sort menu 80
- Auto sort mode 78
- Autofocus 33, 48, 105
- Autofocus mode 48, 69, 105
- AVI 146

## B

- Backlighting  60
- Battery 12, 14, 124
- Battery chamber 5
- Battery charger 16, 145
- Battery latch 12
- Battery level 22
- Battery-chamber/memory card slot cover 12, 20
- Beach  56
- Best shot selector 42
- Black-and-white 44
- Blink proof 66
- Blink warning 137, 138
- Brightness 126
- BSS 42
- Button sound 132

## C

- Calendar display 74
- Center-weighted 41
- Charge by computer 136
- Charge lamp 5, 15, 113
- Charger 14, 145
- Charging AC Adapter 14, 145
- Close-up  58
- Cloudy 39
- Color options 44
- Compression ratio 37
- Computer 108
- Connector cover 5
- Continuous 42
- Copy  60
- Copying images 93
- Crop 100
- Cyanotype 44

## D



- Date 18, 123
- Date imprint 128
- Daylight 39
- Daylight saving time 18, 124

Delete 29, 92, 106  
 Digital zoom 25, 131  
 Direct print 114  
 D-Lighting 97  
 DPOF 161  
 DPOF print 119  
 DSCN 146  
 Dusk/dawn  57

**E**

EH-68P/EH-68P (AR) 14  
 EN-EL10 12, 14  
 Exposure compensation 34  
 Extension 146  
 Eyelet for camera strap 5

**E**

Face detection 47  
 Face priority 45  
 Face priority tracking 69  
 File name 146  
 Fill flash 30  
 Fireworks show  60  
 Firmware version 141  
 Fixed range auto 43  
 Flash 30, 39  
 Flash lamp 31  
 Flash mode 30, 31  
 Flash off 30  
 Fluorescent 39  
 Focus 26, 45  
 Focus indicator 6  
 Focus lock 46  
 Folder name 146  
 Food  59  
 Format internal memory 134  
 Format memory card 21, 134  
 Formatting 21, 134  
 FSCN 146  
 Full-frame playback 28, 70  
 Full-time AF 48, 105

**H**

HD 720p 104  
 Help 51  
 Histogram 34, 71

**I**

Identifier 146  
 Image copy 93  
 Image mode 37, 38  
 Image size 37  
 Incandescent 39  
 Internal memory 20  
 Internal memory indicator 23  
 ISO sensitivity 31, 43

**J**

JPG 146

**L**

Landscape  54  
 Language 135  
 Lens 4, 158  
 Lens cover 4  
 List by date menu 82  
 List by date mode 81

**M**

Macro mode 33  
 Matrix 41  
 Memory capacity 22  
 Memory card 20, 145  
 Memory card slot 20  
 Metering 41  
 Microphone 4  
 Monitor 6, 144  
 Monitor settings 126  
 Motion detection 130  
 Movie length 104  
 Movie menu 103  
 Movie options 104  
 Movie playback 106  
 Movie recording 101  
 Movie-record button 8  
 Multi selector 9

Multi-shot 16 42

Museum  59

## N

Night landscape  57

Night portrait  55

Nikon Transfer 2 108, 109

Number of exposures remaining 22, 38

## O

Optical zoom 25

Optional accessories 145

## P

Panorama assist  61, 62

Panorama Maker 5 108, 112

Paper size 116, 117

Party/indoor  56

Photo info 126

PictBridge 114, 161

Playback 28, 72, 74, 75, 92, 106

Playback menu 83

Playback mode 28

Playback zoom 75

Portrait  54

Power 17, 18, 22

Power switch 8, 17, 18, 22

Power-on lamp 8, 17, 18, 22

Preset manual 40

Print 84, 116, 117

Print set 84

Print set date option 85, 86

Printer 114

Protect 88

## Q

Quick retouch 96

QVGA 104

## R

Rechargeable battery 145

Rechargeable Li-ion battery 12, 14, 145

Recording movies 101

Red-eye reduction 30, 31

Reset all 139

Rotate image 90

RSCN 146

## S

Scene auto selector  52

Scene mode 51, 54

Self-timer 32

Self-timer lamp 32, 65

Sepia 44

Setup menu 120

Shooting 22, 24, 26

Shooting information 71

Shooting menu 36

Shutter sound 132

Shutter speed 26

Shutter-release button 8, 11, 26

Single 42

Single AF 48, 105

Skin softening 66, 98

Slide show 87

Slow sync 30

Small picture 99

Smart portrait menu 66

Smart portrait mode 64

Smile timer 66

Snow  56

Sound settings 132

Speaker 4

Sports  55

SSCN 146

Standard color 44

Strap 11

Subject tracking menu 69

Subject tracking mode 67

Sunset  57

## T

Television 107

Thumbnail display 72

Thumbnail playback 72

Time difference 125

Time zone 123, 125



Tripod socket 5, 159

TV 107

## **U**

USB cable 109, 115, 145

USB/audio/video output connector 107,  
109, 115

## **V**

VGA 104

Vibration reduction 129

Video mode 135

ViewNX 2 108, 112

Vivid color 44

Voice memo 91

Volume 92, 106

## **W**

WAV 146

Welcome screen 122

White balance 39

## **Z**

Zoom control 8, 25, 106

Zoom in 25

Zoom out 25



A series of horizontal dashed lines for handwriting practice, spanning the width of the page.



# ***Nikon***

No reproduction in any form of this manual, in whole or in part (except for brief quotation in critical articles or reviews), may be made without written authorization from NIKON CORPORATION.



**NIKON CORPORATION**

---

© 2010 Nikon Corporation

CT0G02(11)  
6MM83811-02