

Nikon

DIGITAL CAMERA

COOLPIX S30

Reference Manual



En

Trademark Information

- Microsoft, Windows and Windows Vista are either registered trademarks or trademarks of Microsoft Corporation in the United States and/or other countries.
- Macintosh, Mac OS, and QuickTime are trademarks of Apple Inc., registered in the U.S. and other countries.
- Adobe and Acrobat are registered trademarks of Adobe Systems Inc.
- SDXC, SDHC and SD Logos are trademarks of SD-3C, LLC.
- PictBridge is a trademark.
- All other trade names mentioned in this manual or the other documentation provided with your Nikon product are trademarks or registered trademarks of their respective holders.

Introduction

Parts of the Camera and Basic Operations

The Basics of Shooting and Playback

Shooting Features

Playback Features

Recording and Playing Back Movies

General Camera Setup

Reference Section

Technical Notes and Index

Read This First

Thank you for purchasing the Nikon COOLPIX S30 digital camera. Before using the camera, please read the information in “For Your Safety” (📖 viii) and “<Important> Shockproof, Waterproof, Dustproof, Condensation” (📖 xv), and familiarize yourself with the information provided in this manual. After reading, please keep this manual handy and refer to it to enhance your enjoyment of your new camera.

Confirming the Package Contents

In the event that any items are missing, please contact the store where you purchased the camera.



COOLPIX S30
Digital Camera



Camera Strap

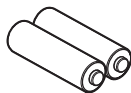

LR6/L40 (AA-size)
alkaline batteries (x2)¹

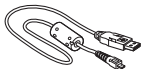

USB Cable UC-E16



Brush²



ViewNX 2 Installer CD



Reference Manual CD

- User's Manual: Getting to Know Your Digital Camera
- Warranty

¹ The included batteries are for trial use only.

² The brush is used for cleaning the waterproof packing.

- Accessories are not waterproof.
- A memory card is not included with the camera.

About This Manual





If you want to start using the camera right away, see “The Basics of Shooting and Playback” (📖 9).

To learn about the parts of the camera and basic operations, see “Parts of the Camera and Basic Operations” (📖 1).

Other Information

- Symbols and Conventions

To make it easier to find the information you need, the following symbols and conventions are used in this manual:

Icon	Description
	This icon indicates cautions and information that should be read before using the camera.
	This icon indicates notes and information that should be read before using the camera.
	These icons indicate other pages containing relevant information;  : "Reference Section",  : "Technical Notes and Index."

- SD, SDHC, and SDXC memory cards are referred to as "memory cards" in this manual.
- The setting at the time of purchase is referred to as the "default setting."
- The names of menu items displayed in the camera monitor, and the names of buttons or messages displayed on a computer monitor appear in bold.
- In this manual, images are sometimes omitted from monitor display samples so that monitor indicators can be more clearly shown.
- Illustrations and monitor content shown in this manual may differ from the actual product.

Information and Precautions

Life-Long Learning

As part of Nikon's "Life-Long Learning" commitment to ongoing product support and education, continually updated information is available online at the following sites:

- For users in the U.S.A.: <http://www.nikonusa.com/>
- For users in Europe and Africa: <http://www.europe-nikon.com/support/>
- For users in Asia, Oceania, and the Middle East: <http://www.nikon-asia.com/>

Visit these sites to keep up-to-date with the latest product information, tips, answers to frequently asked questions (FAQs), and general advice on digital imaging and photography. Additional information may be available from the Nikon representative in your area. Visit the site below for contact information:

<http://imaging.nikon.com/>

Use Only Nikon Brand Electronic Accessories

Nikon COOLPIX cameras are designed to the highest standards and include complex electronic circuitry. Only Nikon brand electronic accessories (including battery chargers and batteries) certified by Nikon specifically for use with this Nikon digital camera are engineered and proven to operate within the operational and safety requirements of this electronic circuitry.

THE USE OF NON-NIKON ELECTRONIC ACCESSORIES COULD DAMAGE THE CAMERA AND MAY VOID YOUR NIKON WARRANTY.

For more information about Nikon brand accessories, contact a local authorized Nikon dealer.

Before Taking Important Pictures

Before taking pictures on important occasions (such as at weddings or before taking the camera on a trip), take a test shot to ensure that the camera is functioning normally. Nikon will not be held liable for damages or lost profits that may result from product malfunction.

About the Manuals

- No part of the manuals included with this product may be reproduced, transmitted, transcribed, stored in a retrieval system, or translated into any language in any form, by any means, without Nikon's prior written permission.
- Nikon reserves the right to change the specifications of the hardware and software described in these manuals at any time and without prior notice.
- Nikon will not be held liable for any damages resulting from the use of this product.
- While every effort was made to ensure that the information in these manuals is accurate and complete, we would appreciate it were you to bring any errors or omissions to the attention of the Nikon representative in your area (address provided separately).

Notice Concerning Prohibition of Copying or Reproduction

Note that simply being in possession of material that was digitally copied or reproduced by means of a scanner, digital camera or other device may be punishable by law.

• **Items prohibited by law from being copied or reproduced**

Do not copy or reproduce paper money, coins, securities, government bonds or local government bonds, even if such copies or reproductions are stamped "Sample." The copying or reproduction of paper money, coins, or securities which are circulated in a foreign country is prohibited. Unless the prior permission of the government was obtained, the copying or reproduction of unused postage stamps or post cards issued by the government is prohibited.

The copying or reproduction of stamps issued by the government and of certified documents stipulated by law is prohibited.

• **Cautions on certain copies and reproductions**

The government has issued cautions on copies or reproductions of securities issued by private companies (shares, bills, checks, gift certificates, etc.), commuter passes, or coupon tickets, except when a minimum of necessary copies are to be provided for business use by a company. Also, do not copy or reproduce passports issued by the government, licenses issued by public agencies and private groups, ID cards and tickets, such as passes and meal coupons.

- **Comply with copyright notices**

The copying or reproduction of copyrighted creative works such as books, music, paintings, woodcut prints, maps, drawings, movies, and photographs is governed by national and international copyright laws. Do not use this product for the purpose of making illegal copies or to infringe copyright laws.

Disposing of Data Storage Devices

Please note that deleting images or formatting data storage devices such as memory cards or built-in camera memory does not completely erase the original image data. Deleted files can sometimes be recovered from discarded storage devices using commercially available software, potentially resulting in the malicious use of personal image data. Ensuring the privacy of such data is the user's responsibility.

Before discarding a data storage device or transferring ownership to another person, erase all data using commercial deletion software, or format the device and then completely refill it with images containing no private information (for example, pictures of empty sky). Care should be taken to avoid injury or damage to property when physically destroying data storage devices.

For Your Safety

To prevent damage to your Nikon product or injury to yourself or to others, read the following safety precautions in their entirety before using this equipment. Keep these safety instructions where all those who use the product will read them.



This icon marks warnings, information that should be read before using this Nikon product, to prevent possible injury.

WARNINGS

Turn off in the event of malfunction

Should you notice smoke or an unusual smell coming from the camera, remove the batteries immediately, taking care to avoid burns. Continued operation could result in injury. After removing or disconnecting the power source, take the equipment to a Nikon-authorized service representative for inspection.

Do not disassemble

Touching the internal parts of the camera could result in injury. Repairs should be performed only by qualified technicians. Should the camera break open as the result of a fall or other

accident, remove the batteries and then take the product to a Nikon-authorized service representative for inspection.

Do not use the camera in the presence of flammable gas

Do not use electronic equipment in the presence of flammable gas, as this could result in explosion or fire.

Handle the camera strap with care

Never place the strap around the neck of an infant or child.

 Keep out of reach of children

Particular care should be taken to prevent infants from putting the battery, brush, or other small parts into their mouths.

 Do not remain in contact with the camera or battery charger for extended periods while the devices are on or in use

Parts of the devices become hot. Leaving the devices in direct contact with the skin for extended periods may result in low-temperature burns.

 Observe caution when handling batteries

Batteries may leak or explode if improperly handled. Observe the following precautions when handling batteries for use in this product:

- Before replacing the batteries, turn the product off.
- Use only the batteries approved for use in this product (📖 11). Do not combine old and new batteries or batteries of different makes or types.
- If Nikon rechargeable Ni-MH batteries EN-MH2 (EN-MH2-B2 or EN-MH2-B4) are purchased separately, charge and use each of them as a set. Do not combine batteries from different pairs.
- The EN-MH2 rechargeable batteries are for use with Nikon digital cameras only, and are compatible with COOLPIX S30.
- Insert batteries in the correct orientation.
- Do not short or disassemble batteries or attempt to remove or break battery insulation or casing.
- Do not expose batteries to flame or to excessive heat.
- Do not immerse in or expose to water.
- Do not transport or store with metal objects such as necklaces or hairpins.
- Batteries are prone to leakage when fully discharged. To avoid damage to the product, be sure to remove the batteries when no charge remains.

- Discontinue use immediately should you notice any change in the batteries, such as discoloration or deformation.
- If liquid from damaged batteries comes in contact with clothing or skin, rinse immediately with plenty of water.

 **Observe the following precautions when handling the Battery Chargers (available separately)**

- Keep dry. Failure to observe this precaution could result in fire or electric shock.
- Dust on or near the metal parts of the plug should be removed with a dry cloth. Continued use could result in fire.
- Do not handle the power cable or go near the battery charger during lightning storms. Failure to observe this precaution could result in electric shock.
- Do not damage, modify, forcibly tug or bend the power cable, place it under heavy objects, or expose it to heat or flame. Should the insulation be damaged and the wires become exposed, take it to a Nikon-authorized service representative for inspection. Failure to observe these precautions could result in fire or electric shock.
- Do not handle the plug or battery charger with wet hands. Failure to observe this precaution could result in electric shock.
- Do not use with travel converters or adapters designed to convert from one voltage to another or with DC-to-AC inverters. Failure to observe this precaution could damage the product or result in overheating or fire.

Use appropriate cables

When connecting cables to the input and output jacks, use only the cables provided or sold by Nikon for the purpose, to maintain compliance with product regulations.

Handle moving parts with care

Be careful that your fingers or other objects are not pinched by the lens cover or other moving parts.

CD-ROMs

The CD-ROMs included with this device should not be played back on audio CD equipment. Playing CD-ROMs on an audio CD player could cause hearing loss or damage the equipment.

Observe caution when using the flash

Using the flash close to your subject's eyes could cause temporary visual impairment. Particular care should be observed if photographing infants, when the flash should be no less than 1 m (3 ft 4 in.) from the subject.

Do not operate the flash with the flash window touching a person or object

Failure to observe this precaution could result in burns or fire.

Avoid contact with liquid crystal

Should the monitor break, care should be taken to avoid injury caused by broken glass and to prevent liquid crystal from the monitor touching the skin or entering the eyes or mouth.

Turn the power off when using inside an airplane or the hospital

Turn the power off while inside the airplane during take off or landing. Follow the instructions of the hospital when using while in a hospital. The electromagnetic waves given out by this camera may disrupt the electronic systems of the airplane or the instruments of the hospital.

Notices

Notice for Customers in the U.S.A.

Federal Communications Commission (FCC) Radio Frequency Interference Statement

This equipment has been tested and found to comply with the limits for a Class B digital device, pursuant to Part 15 of the FCC rules. These limits are designed to provide reasonable protection against harmful interference in a residential installation. This equipment generates, uses, and can radiate radio frequency energy and, if not installed and used in accordance with the instructions, may cause harmful interference to radio communications. However, there is no guarantee that interference will not occur in a particular installation. If this equipment does cause harmful interference to radio or television reception, which can be determined by turning the equipment off and on, the user is encouraged to try to correct the interference by one or more of the following measures:

- Reorient or relocate the receiving antenna.
- Increase the separation between the equipment and receiver.
- Connect the equipment into an outlet on a circuit different from that to which the receiver is connected.
- Consult the dealer or an experienced radio/television technician for help.



Nikon

COOLPIX S30

CAUTIONS

Modifications

The FCC requires the user to be notified that any changes or modifications made to this device that are not expressly approved by Nikon Corporation may void the user's authority to operate the equipment.

Interface Cables

Use the interface cables sold or provided by Nikon for your equipment. Using other interface cables may exceed the limits of Class B Part 15 of the FCC rules.

Notice for customers in the State of California

WARNING

Handling the cord on this product will expose you to lead, a chemical known to the State of California to cause birth defects or other reproductive harm.

Wash hands after handling.

Nikon Inc.,
1300 Walt Whitman Road Melville,
New York 11747-3064 USA
Tel: 631-547-4200

Notice for customers in Canada

CAUTION

This Class B digital apparatus complies with Canadian ICES-003.

ATTENTION

Cet appareil numérique de la classe B est conforme à la norme NMB-003 du Canada.

Symbol for Separate Collection in European Countries

This symbol indicates that this product is to be collected separately.

The following apply only to users in European countries:

- This product is designated for separate collection at an appropriate collection point. Do not dispose of as household waste.
- For more information, contact the retailer or the local authorities in charge of waste management.



This symbol on the battery indicates that the battery is to be collected separately.

The following apply only to users in European countries:

- All batteries, whether marked with this symbol or not, are designated for separate collection at an appropriate collection point. Do not dispose of as household waste.
- For more information, contact the retailer or the local authorities in charge of waste management.



<Important> Shockproof, Waterproof, Dustproof, Condensation

- Make sure to read the following instructions as well as the instructions provided in “Caring for the Product” (P.2).

Notes About Shockproof Performance

This camera has passed Nikon’s in-house test (drop test from a height of 80 cm (32 in.) on a 5 cm (2 in.) thick plywood panel) compliant with MIL-STD 810F Method 516.5-Shock*.

This test does not guarantee the waterproof performance of the camera or that the camera will be free from damage or trouble under all conditions.

Changes in appearance, such as paint peeling off and deformation of the drop shock portion are not subject to the Nikon’s in-house test.

* U.S. Department of Defense test method standard.

This drop test drops 5 cameras in 26 directions (8 edges, 12 corners, and 6 faces) from a height of 122 cm (48 in.) to make sure that one to five cameras pass the test (if any defect is detected during the test, another five cameras are tested to make sure that the test criteria are satisfied for one to five cameras).

● Do not subject the camera to excessive shock, vibration or pressure by dropping or hitting it.

Failure to observe this precaution could cause water to seep inside the camera and result in camera malfunction.

- Do not use the camera deeper than 3 m (9.8 ft) underwater.
- Do not subject the camera to water pressure by exposing it to high-pressure running water.
- Do not sit down with the camera in the pocket of your trousers.
Do not forcibly stuff the camera into a bag.

Notes About Waterproof and Dustproof Performances

The camera is equivalent to IEC/JIS waterproof grade 8 (IPX8) and IEC/JIS dustproof grade 6 (IP6X) and enables shooting pictures underwater at a depth of 3 m (9.8 ft) for up to 60 minutes.*

This rating does not guarantee the waterproof performance of the camera or that the camera will be free from damage or trouble under all conditions.

* This rating indicates that the camera has been designed to withstand the specified water pressure for the specified period of time when the camera is used according to the methods defined by Nikon.

● If the camera is subjected to excessive shock, vibration or pressure by dropping or hitting it, the waterproof performance is not guaranteed.

- If the camera is exposed to shocks, it is recommended to consult your retailer or Nikon-authorized service representative to confirm the waterproof performance (charged service).
 - Do not use the camera deeper than 3 m (9.8 ft) underwater.
 - Do not subject the camera to water pressure by exposing it to rapid flowing water or waterfalls.
 - Your Nikon warranty may not cover troubles caused by water seeping inside the camera due to improper handling of the camera.
- The waterproof performance of this camera is designed to work for fresh water and seawater only.
- The inner portion of this camera is not waterproof. Water seeping inside the camera could cause a malfunction.
- Accessories are not waterproof.
- If liquids or water droplets come into contact with the outside of the camera or the inside of the battery-chamber/memory card slot cover, immediately wipe the liquids off with a soft dry cloth. Do not insert wet memory cards or batteries.
If the battery-chamber/memory card slot cover or internal cover is opened or closed under wet conditions near a waterfront or underwater, this could cause water to seep inside the camera or result in camera malfunction.
Do not open or close the covers with wet hands. This could cause water to seep inside the camera or result in camera malfunction.

- If a foreign substance adheres to the outside of the camera or the inside of the battery-chamber/memory card slot cover (such as the hinge, internal cover, memory card slot, and connectors), remove it immediately with a blower. If a foreign substance adheres to the waterproof packing inside the battery-chamber/memory card slot cover, remove it with the included brush. Do not use the included brush for anything other than cleaning the waterproof packing.
- If a foreign substance such as suntan oil, sunscreen lotion, hot spring, bath mix powder, detergent, soap, organic solvent, oil, or alcohol adheres to the camera, immediately wipe it off.
- Do not leave the camera in high-temperature conditions of 40°C (104°F) or more (in particular, a place exposed to direct sunlight, inside the cabin of a car, on a boat, on the beach, or near a heating device) for a long period of time. This could cause deterioration of the waterproof performance.

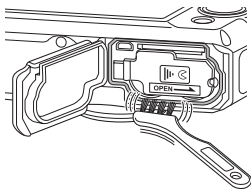

Before Using the Camera Underwater

1. Make sure that there are no foreign substances inside the battery-chamber/memory card slot cover or on the internal cover.

- Any foreign substances such as sand, dust or hair inside the battery-chamber/memory card slot cover or on the internal cover should be removed with a blower.
- Any liquid such as water droplets inside the battery-chamber/memory card slot cover or internal cover should be wiped off with a soft dry cloth.

2. Make sure that the waterproof packing (📖 3) at the entrance of the battery chamber is not cracked or deformed.

- The waterproof performance of waterproof packing may start to deteriorate after one year.

If the waterproof packing begins to deteriorate, consult your retailer or Nikon-authorized service representative.

3. Make sure that the internal cover and battery-chamber/memory card slot cover are firmly closed.

- Slide the cover until it clicks into place.

Notes About Using the Camera Underwater

Observe the following precautions to prevent water from seeping inside the camera.

- Do not dive into water deeper than 3 m (9.8 ft) with the camera.
- Do not continuously use the camera underwater for 60 minutes or more.
- Use the camera in the water temperature range from 0°C to 40°C (32°F to 104°F) when using it underwater.

Do not use the camera at hot springs.

- Do not open or close the battery-chamber/memory card slot cover underwater.
- Do not subject the camera to shock when using it underwater.

Do not jump into water with the camera or subject it to high water pressure conditions such as rapids or waterfalls.

- This camera does not float in water. Make sure not to drop the camera underwater.

Cleaning After Using the Camera Underwater

- After using the camera underwater, clean the camera within 60 minutes. If you leave the camera in wet conditions where salt particles or other foreign substances adhere to it, this could cause damage, discoloration, corrosion, a bad smell or deterioration of waterproof performance.
- Before cleaning the camera, thoroughly remove water droplets, sand, salt particles, or other foreign substances from your hands, body, and hair.
- It is recommended to clean the camera indoors to avoid a place where it could be exposed to water spray or sand.
- Do not open the battery-chamber/memory card slot cover until all foreign substances are washed off with water and all moisture is wiped off.

1. Keep the battery-chamber/memory card slot cover closed and wash off the camera with fresh water.

Lightly rinse the camera with tap water, or immerse the camera in a shallow basin filled with freshwater for about 10 minutes.

- If the buttons or switches do not operate properly, foreign substances may have adhered to the camera.
Foreign substances can cause the camera to malfunction; wash the camera thoroughly.

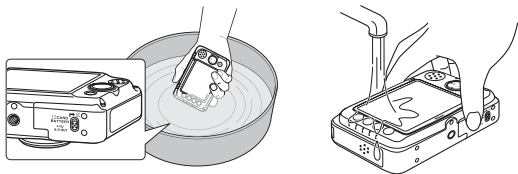

2. Wipe off water droplets with a soft cloth and dry the camera in the well-ventilated and shady place.

- Place the camera on a dry cloth to dry it.
Water will flow out from openings in the microphone or speakers.
- Do not dry the camera with hot air from a hair dryer or clothes dryer.
- Do not use chemicals (such as benzine, thinner, alcohol, or cleanser), soap, or neutral detergents.

If the waterproof packing or body of the camera becomes deformed, the waterproof performance will deteriorate.

3. After making sure that there are no water droplets on the camera, open the battery-chamber/memory card slot cover and internal cover, and gently wipe off any water remaining inside the camera with a dry soft cloth and use the blower to remove any foreign substances.

- If you open the covers before the camera is thoroughly dried, water droplets may fall on the memory card or batteries.
The water droplets may also seep inside the battery-chamber/memory card slot cover and internal cover (in locations such as waterproof packing, hinges, memory card slot, or terminals).
If that happens, wipe the water off with a dry soft cloth.
- If the covers are closed when the inside is wet, this could cause condensation or malfunction.
- If the microphone or speaker openings are clogged with water droplets, the sound may deteriorate or become distorted.
 - Wipe the water off with a dry soft cloth.
 - Do not puncture the microphone or speaker openings with a sharp implement. If the inside of the camera is damaged, the waterproof performance will deteriorate.

Notes About Operating Temperature and Humidity and Condensation

The operation of this camera has been tested at temperatures from 0°C to 40°C (32°F to 104°F).

- **Operating environmental conditions such as temperature and humidity may cause fogging (condensation) on the inside of the monitor, lens, or flash window. This is not a camera malfunction or defect.**

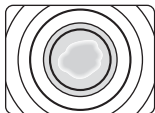

- **Environmental conditions that are likely to cause condensation inside of the camera**

Fogging (condensation) may occur on the inside of the monitor, lens, or flash window in the following environmental conditions where there are sharp temperature changes or high humidity.

- The camera is suddenly immersed in low temperature underwater from high temperature on land.
- The camera is moved from a cold place to a warm place, such as inside a building.
- The battery-chamber/memory card slot cover is open or closed in a high-humidity environment.

- **Clearing the fogging**

- Open the battery-chamber/memory card slot cover and internal cover after turning off the camera in a place where the ambient temperature is stable (avoid any place that has high temperature/high-humidity, sand or dust). To clear the fogging, remove the batteries and memory card, and leave the camera with the battery-chamber/memory card slot cover and internal cover open to allow the camera to adjust to the ambient temperature.
- If the fogging does not clear, consult your retailer or Nikon-authorized service representative.

















Table of Contents



































Introduction	ii
Read This First	ii
Confirming the Package Contents	ii
About This Manual	iii
Information and Precautions	v
For Your Safety	viii
WARNINGS	viii
Notices	xii
<Important> Shockproof, Waterproof,	
Dustproof, Condensation	xv
Notes About Shockproof Performance	xv
Notes About Waterproof and Dustproof	
Performances	xvi
Before Using the Camera Underwater	xvii
Notes About Using the Camera	
Underwater	xviii
Cleaning After Using the Camera	
Underwater	xviii
Notes About Operating Temperature and	
Humidity and Condensation	xxi













Parts of the Camera and Basic	
Operations	1
The Camera Body	2
Attaching the Camera Strap	4
The Monitor	5
Shooting Mode	5
Playback Mode	6
Using the Flexible Buttons	7

The Basics of Shooting and Playback	9
Preparation 1 Insert the Batteries	10
Applicable Batteries	11
Preparation 2 Insert a Memory Card	12
Internal Memory and Memory Cards	14
Approved Memory Cards	14
Preparation 3 Set the Display Language,	
Date, and Time	15
Step 1 Turn the Camera On	18
Turning the Camera On and Off	19
Step 2 Frame a Picture	20
Using the Zoom	21
Step 3 Focus and Shoot	22
The Shutter-release Button	23
Step 4 Play Back Images	25
Step 5 Delete Images	26

Shooting Features	29
📷 (Auto) Mode	30
Changing 📷 (Auto) Mode Settings	31
Change Colors	32
Decorate	35
Choose a Style (Shooting Suited to Scenes) ...	36
Changing Scene Mode Settings	36
Characteristics of Each Scene	37
Change Sounds	42
Using the Flash	44
Using the Self-timer	45
Using the Smile Timer	47

Changing the Size.....	49	Reference Section	 1
Image Types (Image Size and Quality).....	49	Editing Still Images.....	 2
Movie Types.....	50	Editing Features.....	 2
Movie AF	52	Change Colors.....	 4
Default Settings.....	53	Highlight Colors.....	 4
Features That Cannot Be Used		Decorate	 5
Simultaneously.....	54	Soften Pictures.....	 6
Focusing.....	56	Add Starbursts.....	 6
Using Face Detection.....	56	Add a Fisheye Effect	 7
Focus Lock.....	57	Add a Diorama Effect.....	 7
Using Skin Softening	58	Small Picture: Reducing the Size of an Image.....	 8
Playback Features.....	59	Crop: Creating a Cropped Copy.....	 9
Playback Zoom	60	Connecting the Camera to a TV (Viewing Images on a TV).....	 11
Thumbnail Display	61	Connecting the Camera to a Printer (Direct Print).....	 13
Features Available in Playback Mode (Playback Menu).....	62	Connecting the Camera to a Printer....	 14
Connecting the Camera to a TV, Computer, or Printer	64	Printing Individual Images.....	 16
Using ViewNX 2	66	Printing Multiple Images	 18
Installing ViewNX 2	66		
Transferring Images to the Computer	69		
Viewing Images.....	71		
Recording and Playing Back Movies....	73		
Recording Movies	74		
Playing Back Movies	77		
General Camera Setup.....	79		
The Setup Menu	80		

The Playback Menu		22
 Favorites		22
 Photo Albums		26
 Slide Show		27
 Choose by Date		29
 Rotate Pictures		30
 Print Order (Creating a DPOF Print Order)		31
 Copy (Copy Between Internal Memory and Memory Card)		33
 Exchange Messages		36
Erase		40
The Setup Menu		41
Welcome Screen		41
Date and Time		42
Brightness		42
Print Date (Imprinting Date and Time)		43
Electronic VR		44
Format Memory/Format Card		45
Language		46
Menu Background		47
Video Mode		47
Reset All		48
Battery Type		50
Firmware Version		50
File and Folder Names		51
Optional Accessories		53
Error Messages		54

Technical Notes and Index		1
Caring for the Product		2
The Camera		2
Batteries		5
Memory Cards		7
Cleaning and Storage		8
Cleaning		8
Storage		9
Troubleshooting		10
Specifications		17
Supported Standards		21
Index		22



Parts of the Camera and Basic Operations

This chapter describes the parts of the camera and also explains how to use basic camera features.

The Camera Body	2
Attaching the Camera Strap.....	4
The Monitor	5
Shooting Mode	5
Playback Mode	6
Using the Flexible Buttons	7

➔ If you want to start using the camera right away, see “The Basics of Shooting and Playback” (📖 9).

The Camera Body

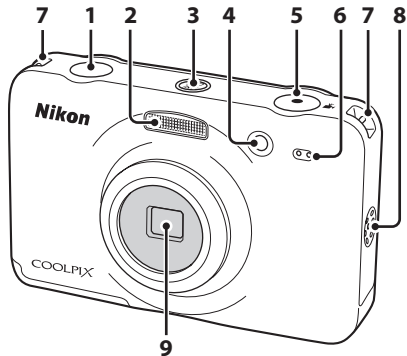

1	Shutter-release button.....	22
2	Flash.....	44
3	Power switch/power-on lamp.....	18
4	Self-timer lamp.....	45
5	● (▶ movie-record) button.....	74

6	Microphone.....	74
7	Eyelets for camera strap.....	4
8	Speaker.....	77
9	Lens (with protective glass)	

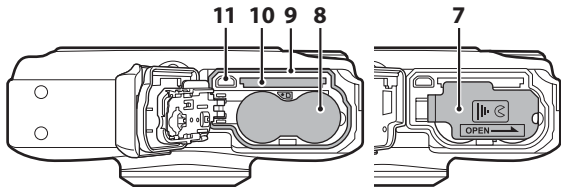
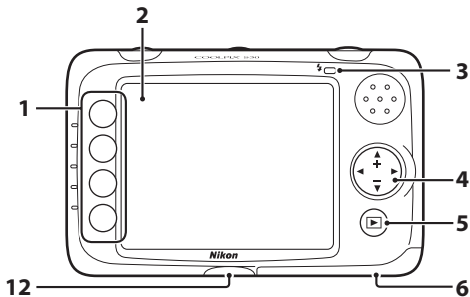

1	Flexible buttons.....	7, 31, 62, 80
2	Monitor	5
3	Flash lamp.....	44
4	Multi selector	
	+ : tele	21
	- : wide.....	21
5	▶ (shooting/playback mode) button.....	25
6	Battery-chamber/ memory card slot cover	10, 12

7	Internal cover.....	10, 12
8	Battery chamber	10
9	Waterproof packing	xvi, xvii
10	Memory card slot.....	12
11	USB/audio/video output connector	64
12	Tripod socket.....	19

Attaching the Camera Strap

Pass the strap through either the left or right strap eyelet and attach the strap.

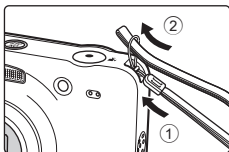

The Monitor

- The information that is displayed in the monitor during shooting and playback changes depending on the camera's settings and state of use.

Shooting Mode

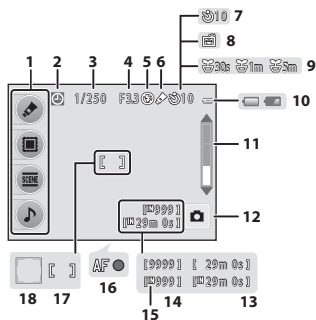

1	Flexible icons.....	7	10	Battery level indicator	18
2	"Date not set" indicator.....	17, 80,	11	Zoom indicator	21
3	Shutter speed	23	12	Shooting mode	30, 36
4	Aperture value.....	23	13	Movie length.....	76
5	Flash off icon	44	14	Number of exposures remaining.....	18
6	Change colors icon	32	15	Internal memory indicator	18
7	Self-timer indicator.....	45	16	Focus indicator	22
8	Smile timer.....	47	17	Focus area.....	20, 22
9	Shoot at intervals icon	39	18	Focus area (face detection)	20, 22

Playback Mode

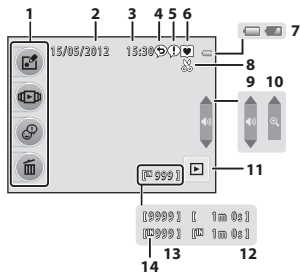

1	Flexible icons.....	7	8	Crop indicator	60,	9
2	Date of recording	15	9	Volume	78	
3	Time of recording.....	15	10	Switch to full-frame	61	
4	Message (reply).....	63	11	Playback mode	62	
5	Message	63	12	Movie/message length	63,	39
6	Favorite pictures indicator.....	63	13	Current image number	25	
7	Battery level indicator.....	18	14	Internal memory indicator	25	

If Information Is Not Displayed During Shooting Mode and Playback Mode

Apart from certain information such as the battery level, focus indicator, or focus area, information is not displayed if no operations are performed for several seconds. Information is displayed again when either a flexible button or the multi selector is pressed.

Using the Flexible Buttons

If you press a flexible button while the shooting screen or playback screen is displayed, the menu for the current mode is displayed. Once the menu is displayed, you can change various settings.

In this document, the flexible buttons are referred to as “flexible button 1” through “flexible button 4”, in order from top to bottom.

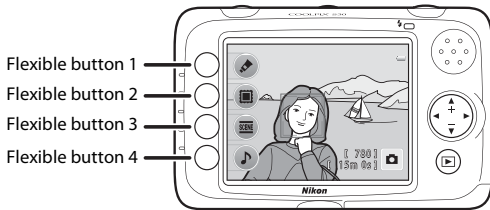

Shooting mode

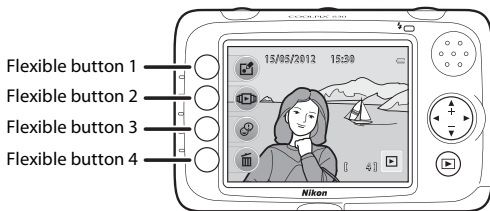

Playback mode



Selecting Items

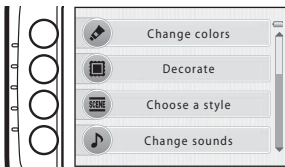

- To select an item, press the flexible button next to it.
- When  is displayed, press flexible button 1 to return to the previous screen. When  is not displayed, you can return to the previous screen by pressing the multi selector .

Shooting mode



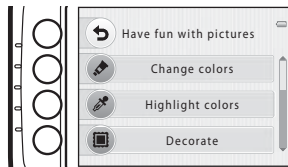

Playback mode

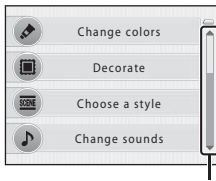

- When the menu content continues on another page, a guide indicating the page position is displayed. Press  or  to display other pages.



Press  or  to display other pages.

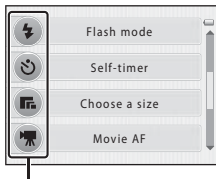

To select an item, press the flexible button next to the item.

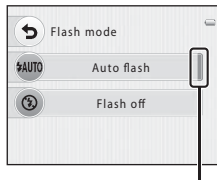

Displayed next to the last setting selected (including the default setting).



The Basics of Shooting and Playback

Preparation

Preparation 1 Insert the Batteries	10
Preparation 2 Insert a Memory Card	12
Preparation 3 Set the Display Language, Date, and Time.....	15



Shooting

Step 1 Turn the Camera On.....	18
Step 2 Frame a Picture	20
Step 3 Focus and Shoot	22



Playback

Step 4 Play Back Images	25
Step 5 Delete Images.....	26

Preparation 1 Insert the Batteries

The camera has a dual-cover system. Underneath the battery-chamber/memory card slot cover is an internal cover.

1 Open the battery-chamber/memory card slot cover and then the internal cover.

- Before opening the covers, hold the camera upside down to prevent the batteries from falling out.

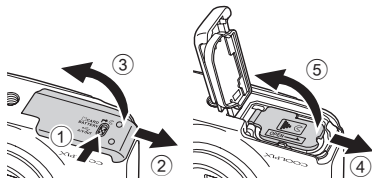

2 Insert the batteries.

- Confirm that the positive (+) and negative (-) terminals are oriented correctly as described on the label at the entrance of the battery chamber, and insert the batteries.

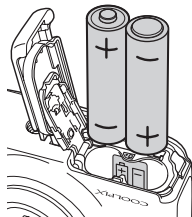

3 Close the internal cover and then the battery-chamber/memory card slot cover.

- While pushing down on the batteries with the internal cover, slide the cover toward the center of the camera. Pushing the cover without sliding it may damage the camera.

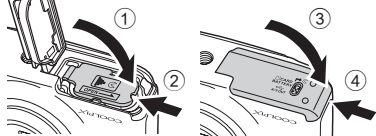

Applicable Batteries

- Two LR6/L40 (AA-size) alkaline batteries (batteries included)
- Two FR6/L91 (AA-size) lithium batteries
- Two EN-MH2 rechargeable Ni-MH (nickel metal hydride) batteries

✓ Removing the Batteries

- Turn the camera off and be sure that the power-on lamp and the monitor have turned off before opening the battery-chamber/memory card slot cover and internal cover.
- The camera, batteries, or memory card may be hot immediately after using the camera. Observe caution when removing the batteries or memory card.

✓ Notes About the Batteries

- Be sure to read and follow the warnings for the battery on page ix and in “Batteries” (🔋:5) before use.
- Do not combine old and new batteries or batteries of different makes or types.
- Batteries with the following defects cannot be used:

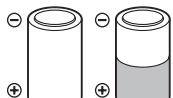

Batteries with peeling



Batteries with insulation that does not cover the area around the negative terminal

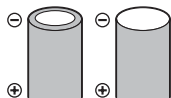

Batteries with a flat negative terminal

✓ Battery Type

By setting **Battery type** in the setup menu (📖 80) to match the type of batteries inserted in the camera, the batteries can perform more efficiently.

The default setting is the type of battery included with purchase. When any other type of battery is used, turn the camera on and change the setting.

🔪 Alkaline Batteries

Performance of alkaline batteries may vary greatly depending on the manufacturer. Choose a reliable brand.

Preparation 2 Insert a Memory Card

- 1** Turn off the camera and then open the battery-chamber/memory card slot cover and internal cover.

- When the camera turns off, the power-on lamp and the display turn off.
- Before opening the covers, hold the camera upside down to prevent the batteries from falling out.

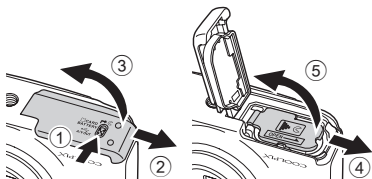

- 2** Insert a memory card.

- Slide the memory card in until it clicks into place.

✓ **Inserting a Memory Card**

Inserting a memory card upside down or backwards could damage the camera and the memory card. Be sure to check that the memory card is in the correct orientation.

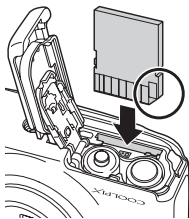

- 3** Close the internal cover and then the battery-chamber/memory card slot cover.

- While pushing down on the batteries with the internal cover, slide the cover toward the center of the camera. Pushing the cover without sliding it may damage the camera.

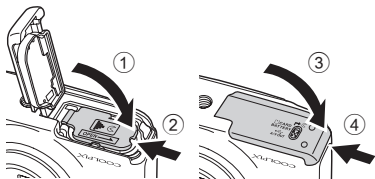

✔ Formatting a Memory Card

- The first time you insert a memory card that has been used in another device into this camera, be sure to format it with this camera.
- **All data stored on a memory card is permanently deleted when the card is formatted.** Be sure to save important images by transferring them to a computer before formatting.
- To format a memory card, insert the card into the camera, press any flexible button, and then select **Format card** (p.45) in the setup menu (p.80).

✔ Notes About Memory Cards

See "Memory Cards" (p.7) and the documentation included with your memory card for more information.

Removing the Memory Card

- Turn the camera off and be sure that the power-on lamp and the monitor have turned off before opening the battery-chamber/memory card slot cover and internal cover.
- Gently push the memory card into the camera (1) to partially eject the card, and then remove the card (2). Do not pull it at an angle.
- The camera, battery, and memory card may be hot immediately after using the camera. Observe caution when removing the battery or memory card.

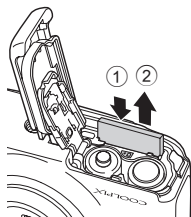

Internal Memory and Memory Cards

Camera data, including images and movies, can be saved in either the camera's internal memory (approximately 47 MB) or on a memory card. To use the camera's internal memory for shooting or playback, first remove the memory card.

Approved Memory Cards

The following Secure Digital (SD) memory cards have been tested and approved for use in this camera.

- Memory cards with an SD Speed Class rating of 6 or faster are recommended for recording movies. When using a memory card with a lower Speed Class rating, movie recording may stop unexpectedly.

	SD memory card	SDHC memory card ²	SDXC memory card ³
SanDisk	2 GB ¹	4 GB, 8 GB, 16 GB, 32 GB	64 GB
TOSHIBA	2 GB ¹	4 GB, 8 GB, 16 GB, 32 GB	64 GB
Panasonic	2 GB ¹	4 GB, 8 GB, 12 GB, 16 GB, 32 GB	48 GB, 64 GB
Lexar	–	4 GB, 8 GB, 16 GB, 32 GB	64 GB, 128 GB

¹ If the memory card will be used with a card reader or similar device, make sure that the device supports 2 GB cards.

² SDHC compliant. If the memory card will be used with a card reader or similar device, make sure that the device supports SDHC.

³ SDXC compliant. If the memory card will be used with a card reader or similar device, make sure that the device supports SDXC.

- Contact the manufacturer for details on the above cards. We cannot guarantee camera performance when using memory cards made by other manufacturers.



Preparation 3 Set the Display Language, Date, and Time

When the camera is turned on for the first time, the language-selection screen and the date and time setting screen for the camera clock are displayed.

1 Press the power switch to turn on the camera.

- When the camera is turned on, the power-on lamp (green) will light and then the monitor will turn on (the power-on lamp turns off when the monitor turns on).

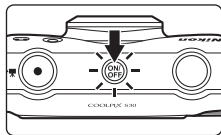

2 Press the multi selector ▲ or ▼ to display the desired language, and then press flexible button 2, flexible button 3, or flexible button 4.

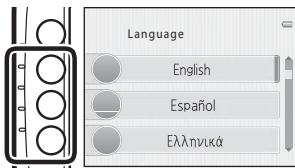

3 Press flexible button 3 (○ Yes).

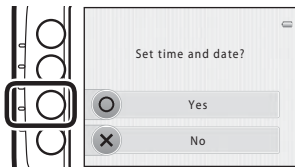

- 4** Use flexible buttons 2 to 4 to select the date format.

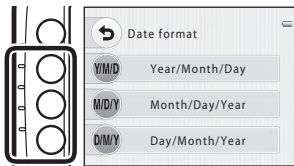

- 5** Press the multi selector ▲, ▼, ◀, or ▶ to set the date and time, and then press flexible button 4 (OK).

- Select an item: Press ▶ or ◀ (changes between **D**, **M**, **Y**, **hour**, and **minute**).
- Edit the date and time: Press ▲ or ▼.
- Confirm the setting: Select the **minute** setting and then press flexible button 4 (OK).
- Press flexible button 3 (☀) to enable daylight saving time. When the daylight saving time function is enabled, ☀ is displayed at the top of the monitor. Press flexible button 3 (☀) again to disable the daylight saving time function.

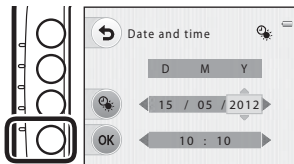

- 6** Press flexible button 3 (O Yes).

- The camera enters shooting mode and you can take pictures using (auto) mode (18).



Changing the Language Setting and the Date and Time Setting

- You can change the **Language** (🔧46) and **Date and time** (🔧42) settings in the **Y** setup menu (📖 80).
- You can enable and disable daylight saving time by selecting **Date and time** (🔧42) in the **Y** setup menu. When enabled, the clock moves forward one hour; when disabled, the clock moves back one hour.
- If you exit without setting the date and time, 📷 will flash when the shooting screen is displayed. If still images are taken without setting the date and time, the shooting date and time are not displayed during playback. Use the **Date and time** setting in the setup menu to set the date and time (📖 80, 🔧42).

The Clock Battery

- The camera's clock is powered by a backup battery that is separate from the camera's main battery.
- The backup battery charges when the main battery is inserted into the camera, and can provide several days of backup power after about ten hours of charging.
- If the camera's backup battery becomes exhausted, the date and time setting screen is displayed when the camera is turned on. Set the date and time again. → Step 3 of "Preparation 3 Set the Display Language, Date, and Time" (📖 15)

Imprinting the Shooting Date in Printed Images

- Set the date and time before shooting.
- You can permanently imprint the shooting date in images as they are captured by setting **Print date** (🔧43) in the setup menu (📖 80).
- If you want the shooting date to be printed without using the **Print date** setting, print using the ViewNX 2 software (📖 66).

Step 1 Turn the Camera On

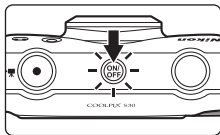

1 Press the power switch to turn on the camera.

- The monitor turns on.



2 Check the battery level indicator and the number of exposures remaining.

Battery Level Indicator

Display	Description
	Battery level high.
	Battery level low. Prepare to replace the batteries.
Battery exhausted.	Cannot take pictures. Replace the batteries.

Battery level indicator



Number of exposures remaining

Number of Exposures Remaining

The number of pictures that can be taken is displayed.

-  is displayed when no memory card is inserted in the camera, and images will be saved in the internal memory (approx. 47 MB).
- The number of exposures remaining depends on the amount of available memory in the internal memory or memory card, and also varies depending on the **Photos** setting, which determines image size and quality (📖 51).



Turning the Camera On and Off

- When the camera is turned on, the power-on lamp (green) will light and then the monitor will turn on (the power-on lamp turns off when the monitor turns on).
- To turn off the camera, press the power switch. When the camera turns off, the power-on lamp and the display turn off.
- Press and hold the  (shooting/playback mode) button to turn on the camera and switch to playback mode.

Power Saving Function (Auto Off)

- If no operations are performed for about three minutes, the monitor will turn off, the camera will enter standby mode, and the power-on lamp will flash. If no operations are performed for approximately another three minutes, the camera will turn off automatically.

While the camera is in standby mode, the monitor turns back on if you perform any of the following operations:

→ Press the power switch, shutter-release button,  (shooting/playback mode) button, or  (movie-record) button

- The camera will enter standby mode within 30 minutes while playing a slide show.

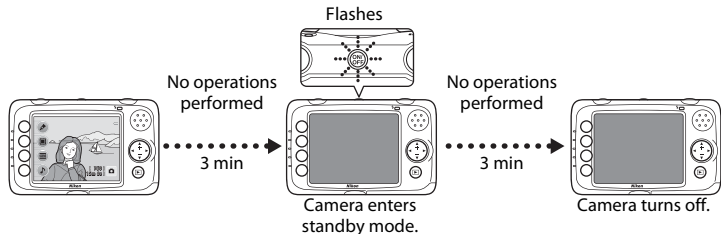

Step 2 Frame a Picture

1 Hold the camera steady.

- Keep fingers, hair, the camera strap, and other objects away from the lens, flash, and microphone.

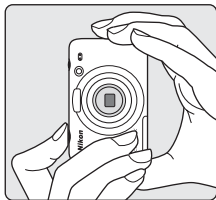
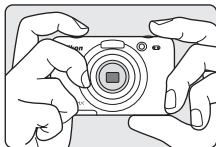

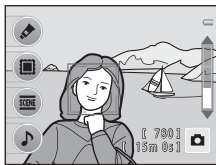

2 Frame the picture.

- When the camera detects a human face, that face is framed by a yellow double border (focus area).
- When shooting non-human subjects or when no faces are detected, the camera focuses on the subject in the center of the frame. Position the main subject near the center of the frame.



When Using a Tripod

We recommend using a tripod to stabilize the camera in the following situations.

- When shooting in dimly lit conditions with the flash mode ( 44) set to  **Flash off**
- When zooming in on the subject

Using the Zoom

Use the multi selector to activate optical zoom.

- To zoom in closer to the subject, press ▲.
- To zoom out and view a larger area, press ▼.

When you turn the camera on, the zoom moves to the maximum wide-angle position.

- The zoom indicator is displayed on the right side of the monitor when you press the multi selector.

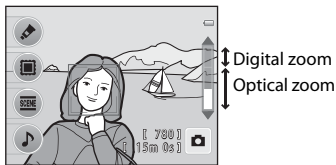
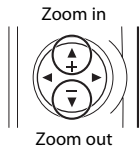

Digital Zoom

When the camera is zoomed in to the maximum optical zoom position, pressing ▲ activates the digital zoom.

Digital zoom can magnify the subject up to about 4x beyond the maximum magnification of the optical zoom.

- When you are using digital zoom, the camera focuses on the subject in the center of the frame and the focus area is not displayed.

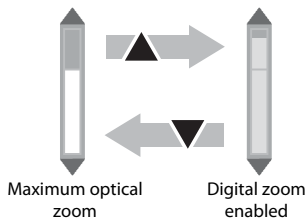

Digital Zoom and Interpolation

Unlike optical zoom, digital zoom uses a digital imaging process known as interpolation to magnify images, resulting in slight deterioration of picture quality depending on the **Photos** setting, which determines image size and quality (📖 49), and the digital zoom magnification.

Step 3 Focus and Shoot

1 Press the shutter-release button halfway (📖 23).

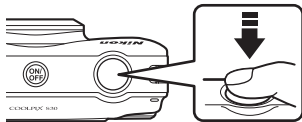

- When a face is detected:
The camera focuses on the face framed by the double border. When the subject is in focus, the double border glows green.
- When a face is not detected:
The camera focuses on the subject in the center of the frame. When the camera has focused, the focus area glows green.
- When you are using digital zoom, the camera focuses on the subject in the center of the frame and the focus area is not displayed. When the camera has focused, the focus indicator (📖 5) glows green.
- While the shutter-release button is pressed halfway, the focus area or focus indicator may flash in red. This indicates that the camera is unable to focus. Modify the composition and press the shutter-release button halfway again.





2 Press the shutter-release button the rest of the way down (📖 23).

- The shutter is released and the image will be saved to the memory card or internal memory.



The Shutter-release Button

<p>Press halfway</p>		<p>To set focus and exposure (shutter speed and aperture value), press the shutter-release button halfway, stopping when you feel resistance. Focus and exposure remain locked while the shutter-release button is pressed halfway.</p>
<p>Press all the way</p>		<p>While pressing the shutter-release button halfway, press the shutter-release button the rest of the way down to release the shutter and take a picture. Do not use force when pressing the shutter-release button, as this may result in camera shake and blurred images. Press the button gently.</p>

Notes About Saving Data

After taking pictures or recording a movie, the number of exposures remaining or the remaining recording time flashes while images or movies are being saved. **Do not open the battery-chamber/memory card slot cover or internal cover.** Image and movie data could be lost and the camera or memory card could be damaged.

Autofocus

The camera may not focus as expected in the following situations. In some rare cases, the subject may not be in focus despite the fact that the focus area or the focus indicator glows green:

- Subject is very dark
- Objects of sharply differing brightness are included in the scene (e.g. the sun behind the subject makes that subject appear very dark)
- No contrast between the subject and surroundings (e.g. a portrait subject, wearing a white shirt, is standing in front of a white wall)
- Several objects are at different distances from the camera (e.g. the subject is inside a cage)
- Subjects with repeating patterns (window blinds, buildings with multiple rows of similarly shaped windows, etc.)
- Subject is moving rapidly

In the situations noted above, try pressing the shutter-release button halfway repeatedly, or change the scene from **Point and shoot** to another scene.

Notes About Face Detection

See “Using Face Detection” (📖 56) for more information.

Flash

If the subject is dimly lit, the flash (📖 44) may fire when you press the shutter-release button all the way down.

To Make Sure You Do Not Miss a Shot

If you are concerned that you might miss a shot, press the shutter-release button all the way without first pressing it halfway.



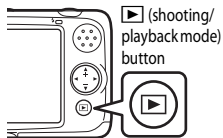

Step 4 Play Back Images

1 Press the (shooting/playback mode) button.

- The camera switches to playback mode and the last image saved will be displayed full-frame.



2 Use the multi selector to select an image to display.

- Display the previous image: 
- Display the next image: 
- Remove the memory card from the camera to play back images saved in the camera's internal memory.  is displayed near the current image number.
- To return to shooting mode, press the  (shooting/playback mode) button, shutter-release button, or the  (movie-record) button.





Current image number

Viewing Images

- Images may be displayed briefly at low resolution while being read from the memory card or internal memory.
- When images in which the face ( 56) was detected at the time of shooting are displayed, depending upon the orientation of the detected face, the images may be automatically rotated for playback display (except images captured using **Take a series of pictures** and **Shoot at intervals**).

More Information

- Playback Zoom →  60
- Thumbnail Display →  61
- Features Available in Playback Mode (Playback Menu) →  62

Step 5 Delete Images

- 1 Display the image you want to delete in the monitor and then press flexible button 4 (🗑️).



- 2 Press flexible button 2 or 3 to select the deletion method.

- 🗑️ **Erase this picture only:** Only the current image is deleted.
- 🗑️ **Erase selected pictures:** Multiple images can be selected and deleted (📖 27).
- To exit without deleting, press flexible button 1 (⏪).

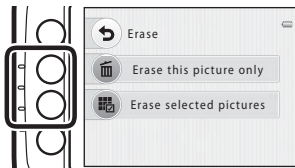

- 3 Press flexible button 3 (○ Yes).

- Deleted images cannot be recovered.
- To exit without deleting, press flexible button 4 (✕ No).

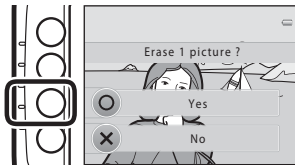

Selecting which images you want to delete

1 Press the multi selector ◀ or ▶ to select an image to be deleted, and then press flexible button 2 (✔).

- To undo the selection, press flexible button 2 again to remove the ✔ mark.
- Press flexible button 3 (RESET) to remove all the ✔ marks.
- Press the multi selector ▲ to switch to full-frame playback or ▼ to display thumbnails.

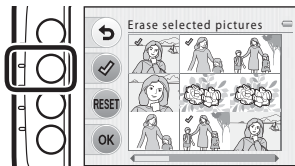

2 Add ✔ to all images that you want to delete and then press flexible button 4 (OK) to confirm the selection.

- A confirmation dialog is displayed. Follow the instructions displayed in the monitor.

✔ Notes About Deletion

- Deleted images cannot be recovered. Copy important images to a computer before deleting them from the camera.
- If you delete an image that has a recorded message attached, both the image and its messages are deleted (📖 63).
- Images that have been added to albums (📖 63) cannot be selected.



A series of ten horizontal dashed lines spanning the width of the page, intended for handwriting practice.





Shooting Features

This chapter describes  (auto) mode and the features that are available when shooting. You can adjust settings according to the shooting conditions and the kind of images you want to capture.

 (Auto) Mode	30
Change Colors	32
Decorate	35
Choose a Style (Shooting Suited to Scenes)	36
Change Sounds	42
Using the Flash	44
Using the Self-timer	45
Using the Smile Timer	47
Changing the Size	49
Movie AF	52
Default Settings	53
Features That Cannot Be Used Simultaneously	54
Focusing	56
Using Skin Softening	58

(Auto) Mode





The camera automatically selects the optimum scene mode when you frame a picture.











- The area of the frame that the camera focuses on varies depending on the composition of the picture.
- When the camera detects a human face, it focuses on that face ( 56). The skin softening feature makes the skin tones in human faces appear smoother ( 58).
- The flash may fire when shooting in low light.
- When shooting in low light, the use of a tripod is recommended.
- The camera does not detect the scene when the digital zoom is being used.

Notes About Motion Detection

In  (auto) mode, when the camera detects subject movement or camera shake, ISO sensitivity and shutter speed are increased to reduce blurring.

Changing (Auto) Mode Settings

When using  (auto) mode, the following settings can be changed.  **Flash mode**,  **Self-timer**, and  **Choose a size** can be used together with other features. → “Default Settings” (📖 53)



Option	Descriptions	
 Change colors	You can adjust brightness (exposure compensation), vividness, and hue when taking pictures.	32
 Decorate	You can add a frame around your images when taking pictures. Five different frames are available.	35
 Choose a style	Camera settings are optimized according to the scene that you select.	36
 Change sounds	Allows you to configure button sounds and the shutter sound.	42
 Flash mode	Allows you to set the flash mode.	44
 Self-timer	The camera's self-timer can release the shutter about ten seconds after you press the shutter-release button. You can also set the smile timer.	45
 Choose a size	You can select the size of Photos (still images) and Movies .	49, 50
 Movie AF	When AF-S Single AF (default setting) is selected, focus is locked when movie recording begins. When AF-F Full-time AF is selected, the camera focuses continuously while recording. When AF-F Full-time AF is selected, the sound of the camera focusing may be heard in recorded movies. If you want to prevent the sound of the camera focusing from being recorded, select AF-S Single AF .	52
 Set up	Displays the setup menu, where you can change a number of general settings.	80

Change Colors

You can adjust brightness (exposure compensation), vividness, and hue when taking pictures.



Enter shooting mode → any flexible button → flexible button 1 (👉 Change colors)

1 Press the multi selector ◀ or ▶ to select , , or .

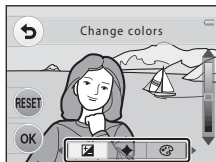
- : Brightness (exposure compensation)
- : Vividness (saturation)
- : Hue (white balance)



2 Adjust brightness, vividness, and hue.

- Use the multi selector as described below.
 - ▲▼: Press to move the slider. You can view the results on the monitor.
 - ◀▶: Press to switch between brightness, vividness, and hue.
- Refer to the following for more information.
 - " Adjusting Brightness (Exposure Compensation)" (📖 34)
 - " Adjusting Vividness (Saturation)" (📖 34)
 - " Adjusting Hue (White Balance)" (📖 34)
- Press flexible button 3 (RESET) to turn the effect off.

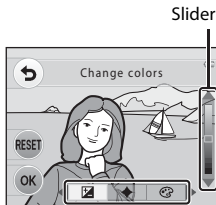

- 3** When you have finished making adjustments, press flexible button 4 (OK).

-  is displayed if you have adjusted any of the settings.

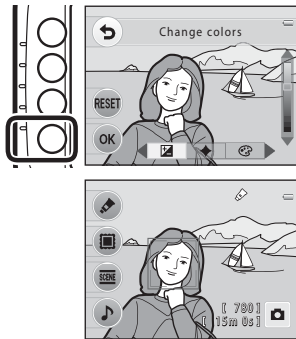

- 4** Press the shutter-release button to take a picture.

 **Notes About Change Colors**

- The brightness, vividness, and hue setting is saved in the camera's memory even after the camera is turned off.
- Some settings cannot be used with other functions ( 54).

Adjusting Brightness (Exposure Compensation)

You can adjust the overall brightness of the image.

- Move the slider up to make the subject brighter. Move the slider down to make the subject darker.

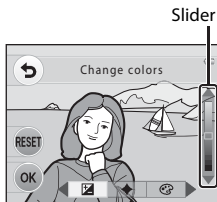

Adjusting Vividness (Saturation)

You can adjust the overall vividness of the image.

- Vividness increases as you move the slider up.
Vividness decreases as you move the slider down.

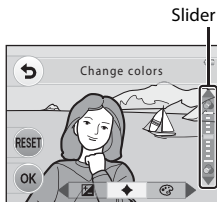

Adjusting Hue (White Balance)

You can adjust the overall hue of the image.

- Red increases as you move the slider up. Blue increases as you move the slider down.

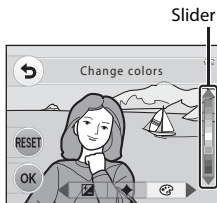

Decorate

You can add a frame around your images when taking pictures. Five different frames are available.

Enter shooting mode → any flexible button → flexible button 2 (🖼️ Decorate)

- The **Choose a size > Photos** setting is fixed at **Small (2 megapixels)**.

1 Press the multi selector ◀ or ▶ to select a frame, and then press flexible button 4 (OK).

- To cancel, press flexible button 1 (↶).
- You can press flexible button 3 (🗑️) to cancel the frame and return to shooting.

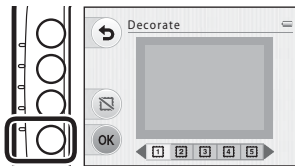

2 Frame the subject and take a picture.

- The frame will be added to the picture.

✓ Notes About Decorate

- The area that will be captured becomes smaller when a thicker frame is selected.
- When using borderless printing to print images that you have added frames to, the frames may not be printed.

📝 Decorate Settings

Some settings cannot be used with other functions (📖 54).

Choose a Style (Shooting Suited to Scenes)

When one of the following scenes is selected, camera settings are automatically optimized for the selected scene.

Enter shooting mode → any flexible button → flexible button 3  Choose a style → Select a scene

 Point and shoot ( 37) (default setting)	 Shoot close-ups ( 37)
 Shoot under water ( 38)	 Take a series of pictures ( 38)
 Shoot at intervals ( 39)	 Photograph food ( 39)
 Highlight colors ( 40)	 Take soft pictures ( 40)
 Create a diorama effect ( 41)	 Photograph fireworks ( 41)

Changing Scene Mode Settings

Depending on the scene, you can use the shooting menu to change settings for  **Flash mode** ( 44),  **Self-timer** ( 45), and  **Choose a size** ( 49). → “Default Settings” ( 53)

Notes About Choose a Style

Some settings cannot be used with other functions ( 54).

Characteristics of Each Scene

Point and shoot

Images are captured using  (auto) mode ( 30).

Shoot close-ups

Use this mode to photograph flowers, insects, and other small objects at close range.

- The camera automatically zooms to the closest position at which it can focus.
- The closest distance at which the camera can focus varies depending on the zoom position. When the zoom is set to a position where the zoom indicator glows green, the camera can focus on subjects as close as about 20 cm (7.9 in.) from the front of the protective glass. When the zoom is at the maximum wide-angle position, the camera can focus on subjects as close as about 5 cm (2 in.) from the front of the protective glass.
- The camera focuses on the area in the center of the frame. Use focus lock to frame the picture on an object not in the center of the frame ( 57).
- The camera focuses even when the shutter-release button is not pressed halfway. You may hear the sound of the camera focusing.
- The flash may be unable to light the entire subject at distances of less than 30 cm (1 ft).



Shoot under water

Use when taking pictures underwater.

- The closest distance at which the camera can focus varies depending on the zoom position. When the zoom is set to a position where the zoom indicator glows green, the camera can focus on subjects as close as about 20 cm (7.9 in.) from the front of the protective glass.

When the zoom is at the maximum wide-angle position, the camera can focus on subjects as close as about 5 cm (2 in.) from the front of the protective glass.

- The camera focuses on the subject in the center of the frame.
- Digital zoom cannot be used.
- See “<Important> Shockproof, Waterproof, Dustproof, Condensation” (📖 xv) for more information about using the camera underwater.
- The camera focuses even when the shutter-release button is not pressed halfway. You may hear the sound of the camera focusing.
- The flash may be unable to light the entire subject at distances of less than 30 cm (1 ft).



Take a series of pictures

The camera captures a series of still images that allow you to clearly see detailed movements in a moving subject.

- When the camera detects a human face, it focuses on that face (📖 56).
- If no faces are detected, the camera focuses on the subject in the center of the frame.
- Press and hold the shutter-release button all the way to capture images continuously. Up to 4 pictures are shot at a rate of about 1.5 frames per second (fps) (when **Choose a size > Photos** is set to **Large (10 megapixels)**).
- Focus, exposure, and hue are fixed at the values determined with the first image in each series.
- The frame rate with continuous shooting may vary depending upon the current **Photos** setting, the memory card used, or shooting condition.



🔫 Shoot at intervals

The camera can automatically capture still images at pre-determined intervals.

- Press flexible buttons 2 to 4 to set the shooting interval to **30s Shoot every 30 seconds**, **1m Shoot once a minute**, or **5m Shoot every 5 minutes**.
- The maximum number of images that can be captured depends on the selected interval.
 - Shoot every 30 seconds: 120 images
 - Shoot once a minute: 60 images
 - Shoot every 5 minutes: 12 images
- Images can be captured for up to one hour.
- When the camera detects a human face, it focuses on that face (📖 56).
- If no faces are detected, the camera focuses on the subject in the center of the frame.
- Press the shutter-release button all the way down to capture the first image. In between each shot, the monitor turns off and the power-on lamp flashes. The monitor automatically turns on again just before the next image is captured.
- Press the shutter-release button halfway to stop shooting.
- When using this feature, use a fully charged batteries to prevent the camera from turning off unexpectedly.

🍴 Photograph food

Use this mode when taking pictures of food.

- The camera automatically zooms to the closest position at which it can focus.
- The closest distance at which the camera can focus varies depending on the zoom position. When the zoom is set to a position where the zoom indicator glows green, the camera can focus on subjects as close as about 20 cm (7.9 in.) from the front of the protective glass. When the zoom is at the maximum wide-angle position, the camera can focus on subjects as close as about 5 cm (2 in.) from the front of the protective glass.
- You can adjust hue by pressing the multi selector ▲ or ▼. The hue setting is saved in the camera's memory even after the camera is turned off.
- The camera focuses on the area in the center of the frame. Use focus lock to frame the picture on an object not in the center of the frame (📖 57).
- The camera focuses even when the shutter-release button is not pressed halfway. You may hear the sound of the camera focusing.





Highlight colors

Keep one specified color in the image, and change the other colors to black and white.

- The closest distance at which the camera can focus varies depending on the zoom position. When the zoom is set to a position where the zoom indicator glows green, the camera can focus on subjects as close as about 20 cm (7.9 in.) from the front of the protective glass.

When the zoom is at the maximum wide-angle position, the camera can focus on subjects as close as about 5 cm (2 in.) from the front of the protective glass.

- Press the multi selector  or  to use the slider and select the color you want keep.
- The camera focuses on the area in the center of the frame. Use focus lock to frame the picture on an object not in the center of the frame ( 57).
- The camera focuses even when the shutter-release button is not pressed halfway. You may hear the sound of the camera focusing.
- The flash may be unable to light the entire subject at distances of less than 30 cm (1 ft).



Take soft pictures

Softens the image by adding a slight blur to areas outside of the guide displayed in the monitor.

- The camera focuses on the area in the center of the frame.
- The closest distance at which the camera can focus varies depending on the zoom position. When the zoom is set to a position where the zoom indicator glows green, the camera can focus on subjects as close as about 20 cm (7.9 in.) from the front of the protective glass.

When the zoom is at the maximum wide-angle position, the camera can focus on subjects as close as about 5 cm (2 in.) from the front of the protective glass.

- Digital zoom cannot be used.
- A guide is displayed in the monitor. Compose the shot so that the main subject is contained within the guide.
- The camera focuses even when the shutter-release button is not pressed halfway. You may hear the sound of the camera focusing.
- The flash may be unable to light the entire subject at distances of less than 30 cm (1 ft).

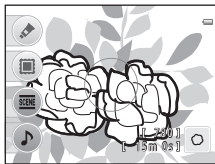

 Use of a tripod is recommended when using scene modes indicated with .

Create a diorama effect

Use this feature to make your images look like a miniature model. This effect is well-suited for images captured from a high vantage point with the main subject at the center of the image.

- The closest distance at which the camera can focus varies depending on the zoom position. When the zoom is set to a position where the zoom indicator glows green, the camera can focus on subjects as close as about 20 cm (7.9 in.) from the front of the protective glass.

When the zoom is at the maximum wide-angle position, the camera can focus on subjects as close as about 5 cm (2 in.) from the front of the protective glass.

- The camera focuses on the subject in the center of the frame.
- Digital zoom cannot be used.
- A guide is displayed in the monitor. Compose the shot so that the main subject is contained within the guide.
- The camera focuses even when the shutter-release button is not pressed halfway. You may hear the sound of the camera focusing.
- The flash may be unable to light the entire subject at distances of less than 30 cm (1 ft).

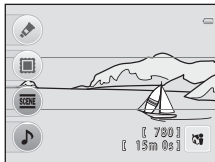

Photograph fireworks



Slow shutter speeds are used to capture the light from fireworks.

- Camera focuses at infinity.
- The focus indicator ( 5) always glows green when the shutter-release button is pressed halfway.



Change Sounds

Allows you to configure button sounds and the shutter sound. You can select one of eight different sounds, or turn sounds off.

Enter shooting mode → any flexible button → flexible button 4 (🎵 Change sounds)

📷 Button sound

A beep will sound once when the camera switches between shooting and playback modes or saves a setting, two times when the focus has been locked, and three times when an error is detected, and a welcome sound is played when the camera is turned on.

- Even when 📷 (standard sounds) is not selected, the camera beeps when the focus has been locked and when an error is detected, and the opening sound is heard.
- If you select 🚫, button sounds will not be heard.

📷 Shutter sound

Determines whether the shutter sound is heard when the shutter is released.

When using **Take a series of pictures** (📖 38) or when recording movies, the shutter sound is not heard.

1 Press the multi selector ◀ or ▶ to select 📷 or 📷, and then press ▲.

- 📷 Button sound
- 📷 Shutter sound
- Press flexible button 4 (OK) when 📷 or 📷 is selected to return to shooting.

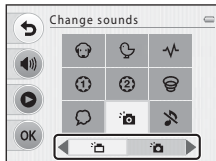

2 Press ▲, ▼, ◀, or ▶ to select a sound type and then press flexible button 4 (OK).

- 📷: Standard sounds
- 🔇: Sounds will not be heard.
- You can press flexible button 2 (🔇) to mute sounds temporarily and return to shooting. To turn sounds on, press flexible button 2 (🔊) when the **Change sounds** screen is displayed.
- Press flexible button 3 (🔊) to play the selected sound.
- Press flexible button 4 (OK) when the sound type is selected to return to step 1.

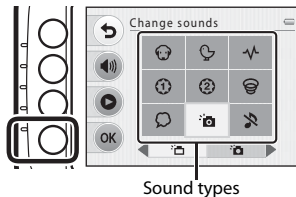

3 Press flexible button 4 (OK) to return to shooting.

Using the Flash

You can set the flash mode to match the shooting conditions.

Enter shooting mode → any flexible button → press ▼ → flexible button 1 (⚡ Flash mode) → flexible buttons 2-3

Available Flash Modes

⚡ AUTO Auto flash

The flash fires automatically when lighting is dim.

🚫 Flash off

The flash will not fire.

- We recommend using a tripod to stabilize the camera when shooting in dark surroundings.
- 🚫 is displayed in the shooting screen when this feature is enabled.

🔦 The Flash Lamp

The flash lamp indicates the status of the flash when you press the shutter-release button halfway.

- On: The flash fires when a picture is taken.
- Flashing: The flash is charging. The camera cannot take pictures.
- Off: The flash will not fire when a picture is taken.

If the battery is low, the monitor will turn off while the flash is charging.

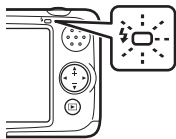

🔦 Effective Range of the Flash

The flash has a range of approx. 0.3 to 3.5 m (1 ft to 11 ft) at the maximum wide-angle zoom position and a range of approx. 0.5 to 2.0 m (1 ft 8 in. to 6 ft 7 in.) at the maximum telephoto zoom position.

🔦 The Flash Mode Setting

Some settings cannot be used with other functions (📖 54).

Using the Self-timer

The camera's self-timer can release the shutter about ten seconds after you press the shutter-release button. The self-timer is useful when you want to be in the picture you are taking, or when you want to avoid the effects of camera shake that occur when you press the shutter-release button. When using the self-timer, use of a tripod is recommended.

Enter shooting mode → any flexible button → press ▼ → flexible button 2 (🕒 Self-timer)

1 Press flexible button 2 (🕒 10 s).

- 🕒 is displayed.
- When 📷 **Smile timer** is selected, the camera uses face detection to detect a human face, and then automatically releases the shutter when a smile is detected (📖 47).

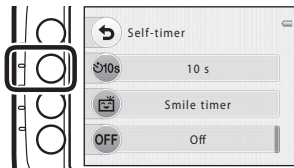

2 Frame the picture and press the shutter-release button halfway.

- Focus and exposure will be set.



3 Press the shutter-release button the rest of the way down.

- The self-timer starts, and the number of seconds remaining before the shutter is released is displayed in the monitor. The self-timer lamp flashes while the timer is counting down. About one second before the shutter is released, the lamp stops flashing and glows steadily.
- When the shutter is released, the self-timer will be set to **OFF off**.
- To stop the timer before a picture is taken, press the shutter-release button again.

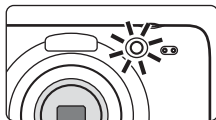

Notes About the Self-timer

Some settings cannot be used with other functions (54).

Using the Smile Timer

The camera can detect human faces and automatically release the shutter when a smile is detected.

Enter shooting mode → any flexible button → press ▼ → flexible button 2 (🕒 Self-timer)

1 Press flexible button 3 (📷 Smile timer).

- 📷 is displayed.

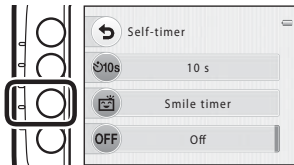

2 Frame the picture.

- When the camera detects a human face, a double border indicating the focus area is displayed around that face. When the camera has focused on that face, the double border will turn green for a moment and focus is locked.
- Up to three faces can be detected. When the camera detects more than one face, the double border (focus area) is displayed around the face closest to the center of the frame, and single borders are displayed around the other faces.

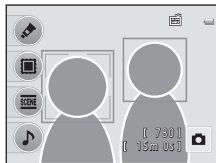

3 Wait for the subject to smile. Do not press the shutter-release button.

- If the camera detects the smiling face of the person framed by a double border, the shutter is automatically released.
- After the camera releases the shutter, it will continue to detect faces and smiles, and will release the shutter again if it detects a smiling face.

4 Shooting ends.

- You can turn off the smile timer manually by turning the camera off or by setting the self-timer to **Off**.

Notes About the Smile Timer

- Digital zoom cannot be used.
- Under some shooting conditions, the camera may be unable to detect faces or detect smiles.
- “Notes About Face Detection” → (📖 56)
- This feature cannot be used simultaneously with certain features. See “Features That Cannot Be Used Simultaneously” (📖 54) for more information.

Auto Off in Smile Timer Mode

When using smile timer, auto off (📖 19) will turn the camera off if no operations are performed in the following situations:

- The camera does not detect any faces.
- The camera detected a face, but cannot detect a smile.

When the Self-timer Lamp Flashes

When using smile timer, the self-timer lamp flashes when the camera detects a face, and flashes quickly immediately after the shutter is released.





Releasing the Shutter Manually

The shutter can also be released by pressing the shutter-release button. If no faces are detected, the camera focuses on the subject at the center of the frame.

More Information

“Autofocus” → (📖 24)

Changing the Size

You can select the size of  **Photos** (still images) and  **Movies** ( 50) using  **Choose a size** in the shooting menu.







Enter shooting mode → any flexible button → press ▼ → flexible button 3
( Choose a size)

Image Types (Image Size and Quality)

You can select the image size used when saving images.



Select the image type best suited to the manner in which images will be used and the capacity of the internal memory or memory card.

Image type	Size (pixels)	Description
 Large (10 megapixels) (default setting)	3648×2736	Images will be higher quality than  Medium (4 megapixels) . The compression ratio is approximately 1:4.
 Medium (4 megapixels)	2272×1704	Smaller size than  Large (10 megapixels) allows more images to be saved. The compression ratio is approximately 1:8.
 Small (2 megapixels)	1600×1200	Smaller size than  Medium (4 megapixels) allows more images to be saved. The compression ratio is approximately 1:8.

Movie Types

Select the desired movie type to record.

Larger image sizes and faster movie bitrates mean greater image quality and larger movie file sizes.

Movie type	Size (pixels)	Description
 Large (720p) (default setting)*	1280×720	Movies with an aspect ratio of 16:9 are recorded. <ul style="list-style-type: none">• Movie bitrate: Approx. 30 Mbps
 Small (640)	640×480	Movies with an aspect ratio of 4:3 are recorded. <ul style="list-style-type: none">• Movie bitrate: Approx. 10.7 Mbps

* When no memory card is inserted (i.e., when using the camera's internal memory), the setting is fixed at  **Small (640)**.

- The movie bitrate is the volume of movie data recorded per second.
- The frame rate is approximately 30 frames per second for all options.
- Maximum Movie Length →  76



More Information

File and Folder Names →  51

Number of Images That Can Be Saved

The following table lists the approximate number of images that can be saved in the internal memory and on a 4 GB memory card. Note that due to JPEG compression, the number of images that can be saved varies greatly depending on the composition of the image. In addition, this number varies depending on the make of the memory card, even when the memory cards have the same specified capacity.

Image type	Internal memory (approx. 47 MB)	Memory card ¹ (4 GB)	Print size ² (cm/in.)
■ Large (10 megapixels)	9	780	31 × 23/12 × 9
■ Medium (4 megapixels)	47	3820	19 × 14/7.5 × 5.6
■ Small (2 megapixels)	90	7240	13 × 10/5.3 × 4

¹ If the number of exposures remaining is 10,000 or more, the number of exposures remaining display shows "9999".

² Print size at an output resolution of 300 dpi. Print sizes are calculated by dividing the number of pixels by printer resolution (dpi) and multiplying by 2.54 cm (1 in.). However, at the same image size, images printed at higher resolutions will print smaller than the size indicated, and those printed at lower resolutions will print larger than the size indicated.

Movie AF

Select how the camera focuses in movie mode.

Enter shooting mode → any flexible button → press ▼ → flexible button 4 (Movie AF)

Option	Description
AF-S Single AF (default setting)	Focus is locked when the ● (movie-record) button is pressed to start recording. Select this option when the distance between the camera and the subject will remain fairly consistent.
AF-F Full-time AF	Camera focuses continuously. Select this option when the distance between the camera and subject will change significantly during recording. The sound of the camera focusing may be heard in the recorded movie. Use of Single AF is recommended to prevent the sound of the camera focusing from interfering with recording.

Default Settings

Default settings for features that can be used with **Choose a style** are described below.

	Flash (📖 44)	Self-timer (📖 45)
Shoot close-ups (📖 37)	📷	Off ¹
Shoot under water (📖 38)	📷	Off ¹
Take a series of pictures (📖 38)	📷 ²	Off ²
Shoot at intervals (📖 39)	📷AUTO	Off ²
Photograph food (📖 39)	📷 ²	Off ¹
Highlight colors (📖 40)	📷	Off ¹
Take soft pictures (📖 40)	📷AUTO	Off ¹
Create a diorama effect (📖 41)	📷	Off ¹
Photograph fireworks (📖 41)	📷 ²	Off ²

¹ Smile timer is not available.

² The setting cannot be changed.

Features That Cannot Be Used Simultaneously

Some shooting settings cannot be used with other functions.

Restricted function	Option	Descriptions
Change colors	Choose a style (📖 36)	When Choose a style is set to any setting other than Point and shoot , Change colors cannot be used.
Decorate	Choose a style (📖 36)	When Choose a style is set to any setting other than Point and shoot , Decorate cannot be used.
Shutter sound	Take a series of pictures (📖 38)	When Take a series of pictures is used for shooting, the shutter sound will not be heard.
Flash mode	Take a series of pictures (📖 38), Photograph food (📖 39), Photograph fireworks (📖 41)	Flash mode cannot be used when taking pictures using Take a series of pictures , Photograph food , or Photograph fireworks .
Smile timer	Shoot close-ups (📖 37), Shoot under water (📖 38), Photograph food (📖 39), Highlight colors (📖 40), Take soft pictures (📖 40), Create a diorama effect (📖 41)	Smile timer cannot be used when taking pictures using Shoot close-ups , Shoot under water , Photograph food , Highlight colors , Take soft pictures , or Create a diorama effect .
Choose a size	Decorate (📖 35)	When Decorate is selected, the Choose a size setting is fixed at ■ Small (2 megapixels) .
Digital zoom	Shoot under water (📖 38), Take soft pictures (📖 40), Create a diorama effect (📖 41)	The digital zoom cannot be used when taking pictures using Shoot under water , Take soft pictures , or Create a diorama effect .

Restricted function	Option	Descriptions
Electronic VR	Take a series of pictures (📖 38), Shoot at intervals (📖 39), Photograph fireworks (📖 41)	When Take a series of pictures , Shoot at intervals , or Photograph fireworks is used for shooting, electronic VR is disabled.

Focusing

Using Face Detection

When using the following shooting modes and settings, the camera uses face detection to automatically focus on human faces. If the camera detects more than one face, a double border is displayed around the face that the camera will focus on, and single borders are displayed around the other faces.

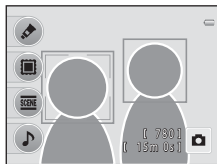

Shooting mode	Number of faces that can be detected	Focus area (double border)
 (auto) mode (📖 30)	Up to 12	The face closest to the camera
Take a series of pictures (📖 38) and Shoot at intervals (📖 39) when using Choose a style		
Smile timer (📖 47)	Up to 3	The face closest to the center of the frame

- If no faces are detected when the shutter-release button is pressed halfway, the camera will focus on the subject in the center of the frame.

Notes About Face Detection

- The camera's ability to detect faces depends on a variety of factors, including whether or not the subject is facing the camera. Additionally, the camera may be unable to detect faces in the following situations:
 - When faces are partially hidden by sunglasses or otherwise obstructed
 - When faces take up too much or too little of the frame
- When the frame includes more than one face, the faces detected by the camera and the face on which the camera focuses depend upon a variety of factors, including the direction in which the faces are looking.
- In some rare cases, such as those described in "Autofocus" (📖 24), the subject may not be in focus even though the double border turns green. Should this occur, use another mode, such as  (auto) mode, and try focus lock shooting (📖 57) by focusing on another subject that is the same distance from the camera.

Focus Lock

When the camera focuses on an object in the center of the frame, you can use focus lock to focus on an off-center subject.

The following describes the procedure when **Shoot close-ups** is selected.

1 Aim the camera so that the subject is in the center of the frame.

2 Press the shutter-release button halfway.

- Confirm that the focus area glows green.
- Focus and exposure are locked.

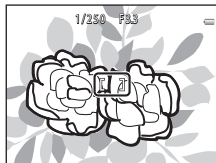

3 Continue holding down the shutter-release button halfway and recompose the picture.

- Be sure to maintain the same distance between the camera and the subject while the shutter-release button is pressed halfway.

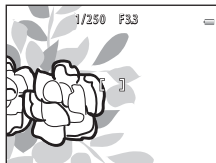

4 Press the shutter-release button the rest of the way down to take the picture.



Using Skin Softening

When the shutter is released when using  (auto), the camera detects one or more human faces (up to three), and processes the image to soften facial skin tones.

Notes About Skin Softening

- It may take more time than usual to save images after shooting.
- Under some shooting conditions, the desired skin softening results may not be achieved, or skin softening may be applied to areas of the image where there are no faces.

Playback Features

This chapter describes the features that are available when playing back images.

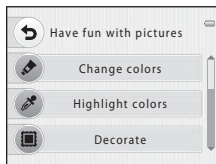
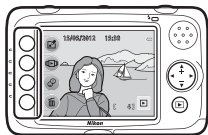

Playback Zoom	60
Thumbnail Display	61
Features Available in Playback Mode (Playback Menu) ...	62
Connecting the Camera to a TV, Computer, or Printer ...	64
Using ViewNX 2.....	66
Installing ViewNX 2.....	66
Transferring Images to the Computer	69
Viewing Images.....	71

Playback Zoom

Press the multi selector ▲ during full-frame playback mode (📖 25) to zoom in on the center of the image displayed in the monitor.

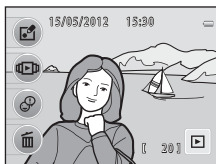

Image is displayed full-frame.

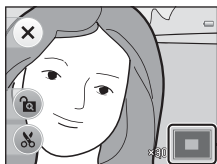

Image is zoomed in.

Displayed area guide

- You can change the zoom ratio by pressing the multi selector ▲ or ▼. Images can be zoomed up to approximately 10x.
- To move the displayed area, press flexible button 3 (🔒) to lock the zoom ratio, and then press the multi selector ▲, ▼, ◀, or ▶.
If you want to change the zoom ratio, press flexible button 3 (🔓) and then change the zoom ratio as desired.
- If you are viewing an image that was captured using face detection (📖 56), the camera zooms in on the face detected at the time of shooting (except when viewing an image captured using **Take a series of pictures** or **Shoot at intervals**). If the camera detected multiple faces when the image was captured, press ▲, ▼, ◀, or ▶ to display a different face. To zoom in on an area of the image where there are no faces, press flexible button 3 (🔓) and then press ▲.
- You can crop the image and save the displayed area of the image as a separate file by pressing flexible button 4 (📷) (🔗9).
- Press flexible button 1 (X) to return to full-frame playback mode.

Thumbnail Display

Press the multi selector ▼ in full-frame playback mode (📖 25) to display images in contact sheets of thumbnail images.

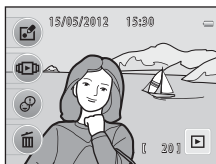

Full-frame Display

















Image Thumbnail Display

- You can view nine images on one screen, making it easy to find the image you want.
- Press the multi selector ◀ or ▶ to select an image, and then press ▲ to display that image full-frame.

Features Available in Playback Mode (Playback Menu)

When viewing images in full-frame playback mode or thumbnail playback mode, you can configure the following functions by pressing a flexible button (📖 7) to display the menu.

	Option	Descriptions	📖
Have fun with pictures ¹	🔧 Change colors ²	Four different colors are available.	👓4
	🔧 Highlight colors ²	Keep one specified color in the image, and change the other colors to black and white.	👓4
	🖼️ Decorate ²	You can add a frame to your pictures and save them as new images. Five different frames are available.	👓5
	🌀 Soften pictures ²	Soften the image by adding a slight blur around the center of the image.	👓6
	✨ Add starbursts ²	Produce star-like rays of light that radiate outward from bright objects such as sunlight reflections or street lights. This effect is suitable for night scenes.	👓6
	👁️ Add a fisheye effect ²	Make an image look as if it were captured with a fisheye lens. This effect is well-suited for images captured using Shoot close-ups .	👓7
	🏠 Add a diorama effect ²	Make an image look like a miniature scene captured in macro mode. This effect is well-suited for images captured from a high vantage point with the main subject at the center of the image.	👓7

	Option	Descriptions	
 View	 View ³	You can play back movies ( 77).	77
	 Favorites	You can sort images by adding your favorite images to albums. This makes it easier to find the images you are looking for. You can also protect selected images from accidental deletion.	 22
	 Photo albums ¹	You can display images similarly to a photo album.	 26
	 Slide show	Play back images, saved in the internal memory or on a memory card, one by one in an automated slide show.	 27
	 Choose by date	You can select a date and view images that were captured on that date.	 29
	 Rotate pictures ¹	Specify the orientation in which saved images are displayed during playback.	 30
	 Small picture ^{1,2}	Create a small copy of the current image. This feature is useful for creating copies for display on Web pages or for e-mail attachments.	 8
	 Print order ¹	When using a printer to print images saved on the memory card, you can use the Print order function to select which images are printed, and how many copies of each image are printed.	 31
	 Copy	Copy images between the internal memory and a memory card.	 33
	 Exchange messages ¹	You can add voice messages to your images.	 36
	 Erase	You can delete images.	 40

¹ Available when a still image is displayed.

² Images are edited and saved as separate files. Certain limitations apply when editing images. For example, you cannot apply the same editing feature multiple times to the same image (3).

³ Available when a movie is displayed.

Connecting the Camera to a TV, Computer, or Printer

You can enhance your enjoyment of images and movies by connecting the camera to a TV, computer, or printer.

- Before connecting the camera to an external device, make sure the remaining battery level is sufficient and turn the camera off. For information about the connection methods and subsequent operations, refer to the documentation included with the device in addition to this document.

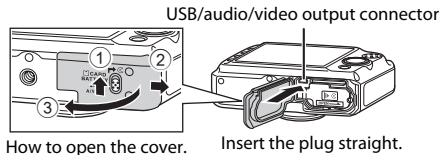

Viewing images on a TV

 11

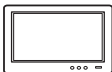

You can view the camera's images and movies on a TV.
Connection method: Connect the video and audio plugs of the optional Audio Video Cable EG-CP14 to the TV's input jacks.

Viewing and organizing images on a computer

 66



If you transfer images to a computer, you can perform simple retouching and manage image data in addition to playing back images and movies.

Connection method: Connect the camera to the computer's USB input jack with the included USB Cable.

- Before connecting to a computer, install ViewNX 2 on the computer using the included ViewNX 2 Installer CD-ROM. For information about using the ViewNX 2 Installer CD-ROM and transferring images to a computer, see page 66.

Printing images without using a computer

 14



If you connect the camera to a PictBridge-compatible printer, you can print images without using a computer.

Connection method: Connect the camera directly to the printer's USB input jack with the included USB Cable.

Using ViewNX 2

ViewNX 2 is an all-in-one software package which enables you to transfer, view, edit and share images.

Install ViewNX 2 using the ViewNX 2 Installer CD-ROM.



Installing ViewNX 2

- An Internet connection is required.

Compatible Operating Systems

Windows

- Windows 7 Home Basic/Home Premium/Professional/Enterprise/Ultimate (Service Pack 1)
- Windows Vista Home Basic/Home Premium/Business/Enterprise/Ultimate (Service Pack 2)
- Windows XP Home Edition/Professional (Service Pack 3)

Mac OS

- Mac OS X (version 10.5.8, 10.6.8, 10.7.2)

Refer to the Nikon website for the latest information on operating system compatibility.

1 Start the computer and insert the ViewNX 2 Installer CD-ROM into the CD-ROM drive.

- Mac OS: When the **ViewNX 2** window is displayed, double-click the **Welcome** icon.

2 Select a language in the language selection dialog to open the installation window.

- If the desired language is not available, click **Region Selection** to choose a different region and then choose the desired language (the **Region Selection** button is not available in the European release).
- Click **Next** to display the installation window.

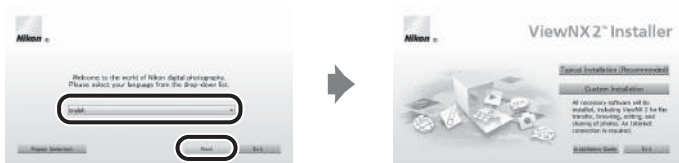

3 Start the installer.

- We recommend clicking **Installation Guide** in the installation window to check the installation help information and system requirements before installing ViewNX 2.
- Click **Typical Installation (Recommended)** in the installation window.

4 Download the software.

- When the **Software Download** screen is displayed, click **I agree - Begin download**.
- Follow the on-screen instructions to install the software.

5 Exit the installer when the installation completion screen is displayed.

- Windows: Click **Yes**.
- Mac OS: Click **OK**.

The following software is installed:

- ViewNX 2 (consisting of the three modules below)
 - Nikon Transfer 2: For transferring images to the computer
 - ViewNX 2: For viewing, editing, and printing transferred images
 - Nikon Movie Editor: For basic editing of transferred movies
- Panorama Maker 6 (for creating a single panorama photo using a series of separate images)
- QuickTime (Windows only)

6 Remove the ViewNX 2 Installer CD-ROM from the CD-ROM drive.

Transferring Images to the Computer

1 Choose how images will be copied to the computer.

Choose one of the following methods:

- **Direct USB connection:** Turn the camera off and ensure that the memory card is inserted in the camera. Connect the camera to the computer using the supplied USB Cable. Turn the camera on. To transfer images that are saved in the camera's internal memory, remove the memory card from the camera before connecting it to the computer.

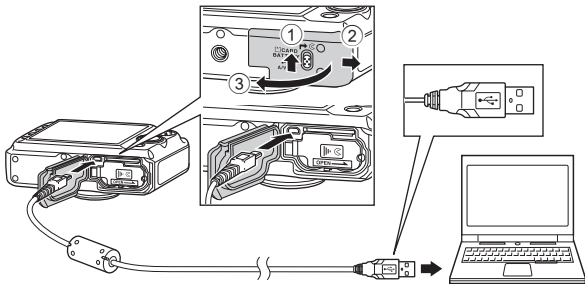

- **SD card slot:** If your computer is equipped with an SD card slot, the card can be inserted directly in the slot.
- **SD card reader:** Connect a card reader (available separately from third-party suppliers) to the computer and insert the memory card.

✓ Connecting the USB Cable

The connection may not be recognized if the camera is connected to the computer via a USB hub.

If a message is displayed prompting you to choose a program, select Nikon Transfer 2.

- **When using Windows 7**

If the dialog shown at right is displayed, follow the steps below to select Nikon Transfer 2.

- 1 Under **Import pictures and videos**, click **Change program**. A program selection dialog will be displayed; select **Import File using Nikon Transfer 2** and click **OK**.
- 2 Double-click **Import File**.



If the memory card contains a large number of images, it may take a while for Nikon Transfer 2 to start. Wait until Nikon Transfer 2 starts.

2 Transfer images to the computer.

- Confirm that the name of the connected camera or removable disk is displayed as the "Source" on the "Options" title bar of Nikon Transfer 2 (①).
- Click **Start Transfer** (②).

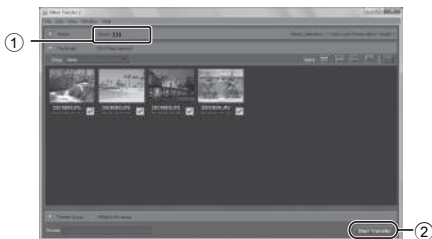

- At default settings, all the images on the memory card will be copied to the computer.

3 Terminate the connection.

- If the camera is connected to the computer, turn the camera off and disconnect the USB cable. If you are using a card reader or card slot, choose the appropriate option in the computer operating system to eject the removable disk corresponding to the memory card and then remove the card from the card reader or card slot.

Viewing Images

Start ViewNX 2.

- Images are displayed in ViewNX 2 when transfer is complete.
- Consult online help for more information on using ViewNX 2.

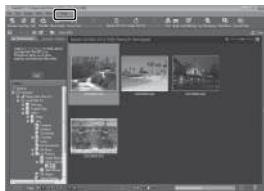

Starting ViewNX 2 Manually

- **Windows:** Double-click the **ViewNX 2** shortcut icon on the desktop.
- **Mac OS:** Click the **ViewNX 2** icon in the Dock.



A series of ten horizontal dashed lines spanning the width of the page, intended for handwriting practice.

Recording and Playing Back Movies

You can record movies by simply pressing the ● (📹 movie-record) button.

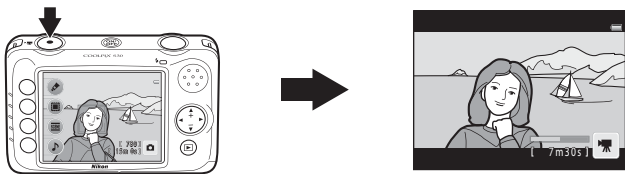

Recording Movies	74
Playing Back Movies.....	77

Recording Movies

You can record movies by simply pressing the **●** (▶ movie-record) button.

When no memory card is inserted (i.e., when using the camera's internal memory), the movie type (📖 50) setting is fixed at **Small (640)**. **Large (720p)** is not available.

1 Display the shooting screen.

- You can select the type of movies that will be recorded. The default setting is **Large (720p)** (1280×720) (📖 50).
- When recording movies, the angle of view (i.e., the area visible in the frame) is narrower compared to that of still images.

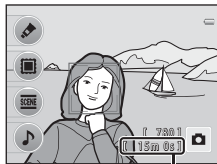

Maximum movie length

2 Press the **●** (▶ movie-record) button to start recording a movie.

- The camera focuses on the subject in the center of the frame. Focus areas are not displayed during recording.
- When **Large (720p)** (1280×720) is selected for movie type, monitor display changes to an aspect ratio of 16:9 with movie recording.
- 📖 is displayed while saving to the internal memory.

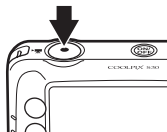

3 Press the **●** (▶ movie-record) button again to end recording.

✓ Notes About Saving Movies

After a movie has been recorded, it is not fully saved to the internal memory or memory card until monitor display returns to the shooting display. **Do not open the battery-chamber/memory card slot cover or internal cover** before movies have been fully saved. Removing the memory card or the battery while a movie is being saved may result in loss of the movie data or damage to the camera or to the memory card.

✓ Notes About Movie Recording



- Memory cards with an SD Speed Class rating of 6 or faster are recommended when recording movies (📖 14). Movie recording may stop unexpectedly when memory cards with a lower Speed Class rating are used.
- The optical zoom magnification ratio cannot be changed once recording starts.
- Use the multi selector ▲ or ▼ to operate digital zoom while recording movies. The zoom range is between the optical zoom magnification ratio before recording a movie and up to 4x.
- There may be some degradation in image quality when digital zoom is used. When recording ends, digital zoom turns off.
- The sounds of multi selector operation, autofocus lens drive movement, and aperture operation when brightness changes may be recorded.
- Smear (👁️:4) visible in the monitor with movie recording will be recorded with movies. Avoiding bright objects such as the sun, reflections of the sun, and electric lights is recommended.
- Depending on the distance to the subject or the amount of zoom applied, subjects with repeating patterns (fabrics, lattice windows, etc.) may have colored stripes (interference patterns, moiré, etc.) in them during movie recording and playback. This occurs when the pattern in the subject and the layout of the image sensor interfere with each other; it is not a malfunction.
- The camera may become warm when shooting movies for an extended period of time or when the camera is used in a hot area.

✓ Notes About Autofocus

Autofocus may not perform as expected (📖 24). Should this occur, try the following:

1. Before recording, set **Movie AF** in the shooting menu to **AF-S Single AF** (default setting) (📖 52).
2. Frame another subject—positioned at the same distance from the camera as the intended subject—in the center of the frame, press the ● (👁️ movie-record) button to start recording, and then modify the composition.

Maximum Movie Length

Movie type (📖 50)	Internal memory (approx. 47 MB)	Memory card (4 GB) ²
 Large (720p) (1280×720) (default setting)	.1	15 min
 Small (640) (640×480)	32 s	45 min

All figures are approximate. The maximum movie length may vary depending on the make of the memory card, even among memory cards of the same capacity.

- ¹ When no memory card is inserted (i.e., when using the camera's internal memory), the setting is fixed at  **Small (640)**.
- ² The maximum file size for a single movie is 4 GB and the maximum movie length for a single movie is 29 minutes, even when there is sufficient free space on the memory card for longer recording. When recording a movie, the remaining recording time that is displayed is the amount of recording time available for one movie.

Functions Available with Movie Recording

- The current setting for **Change colors** (📖 32), **Shoot close-ups** (📖 37), **Shoot under water** (📖 38), or **Photograph food** (📖 39), is applied when recording movies. Confirm settings before starting movie recording.
- The self-timer (📖 45) can be used. When the self-timer is enabled, the camera starts recording ten seconds after you press the  (movie-record) button.
- The flash will not fire.
- You can set the movie type and movie AF (📖 31) before you start recording a movie by pressing a flexible button.

Playing Back Movies

1 Press the  (shooting/playback mode) button to switch to playback mode.

2 Select a movie and then press flexible button 2 ().

- Movies can be identified by the movie length indicator ( 6).





3 Press flexible button 2 ( **View**).

- You can play movies.



Deleting movies

To delete a movie, select the desired movie in full-frame playback mode ( 25) and press flexible button 4 (.

Functions Available During Playback

You can use the flexible buttons to perform the following operations.

Paused



During playback

Volume indicator

Function	Icon	Description	
Rewind	⏮	Hold down the button to rewind the movie.	
Advance	⏩	Hold down the button to advance the movie.	
Pause	⏸	Press the button to pause playback. The following operations can be performed while playback is paused.	
		⏮	Press the button to rewind the movie. Hold down the button for continuous rewinding.
		⏩	Press the button to advance the movie. Hold down the button for continuous advancing.
		▶	Press the button to resume playback.
End	✕	Press the button to return to full-frame playback mode.	

Adjusting volume

Press the multi selector ▲ or ▼ during playback.

Notes About Playing Back Movies

The COOLPIX S30 is not able to play back movies recorded with another make or model of digital camera.

General Camera Setup

This chapter describes the various settings that can be adjusted in the **Y** setup menu.

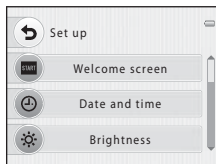













- See “Using the Flexible Buttons” (📖 7) for information about using the camera’s menus.
- For further details about each setting, refer to “The Setup Menu” in the Reference Section (🔍 41).

The Setup Menu

Enter shooting mode → any flexible button → press ▼ two times → flexible button 1 (👉 Set up)

The following settings can be changed in the setup menu by pressing flexible button 1 (👉 **Set up**) in the shooting menu.

Option	Description	
Welcome screen	Allows you to select whether or not the welcome screen is displayed when the camera is turned on.	 41
Date and time	Set the camera clock.	 42
Brightness	Allows you to adjust the brightness of the monitor.	 42
Print date	Allows you to imprint the shooting date and time on images.	 43
Electronic VR	Choose whether to use electronic VR (vibration reduction) when taking still pictures.	 44
Format memory/ Format card	Allows you to format the internal memory or the memory card.	 45
Language	Allows you to change the camera's display language.	 46
Menu background	Allows you to change the background used on the menu screen.	 47
Video mode	Allows you to adjust TV-connection settings.	 47
Reset all	Allows you to reset the camera's settings to their default values.	 48
Battery type	Change this setting to match the type of batteries that are inserted in the camera.	 50
Firmware version	Allows you to confirm the camera's firmware version.	 50



Reference Section

The Reference Section provides detailed information and hints about using the camera.

Shooting

Editing Still Images	2
Connecting the Camera to a TV (Viewing Images on a TV)	11
Connecting the Camera to a Printer (Direct Print)	13

Menu

The Playback Menu	22
The Setup Menu	41









Additional Information

File and Folder Names	51
Optional Accessories	53
Error Messages	54



Editing Still Images

Editing Features

Use the COOLPIX S30 to edit images in-camera and save them as separate files (📷51). The editing functions described below are available.

Editing function	Description
 Change colors (📷4)	Four different colors are available.
 Highlight colors (📷4)	Keep one specified color in the image, and change the other colors to black and white.
 Decorate (📷5)	You can add a frame to your pictures and save them as new images. Five different frames are available.
 Soften pictures (📷6)	Soften the image by adding a slight blur around the center of the image.
 Add starbursts (📷6)	Produce star-like rays of light that radiate outward from bright objects such as sunlight reflections or street lights. This effect is suitable for night scenes.
 Add a fisheye effect (📷7)	Make an image look as if it were captured with a fisheye lens. This effect is well-suited for images captured using Shoot close-ups (📖 37).
 Add a diorama effect (📷7)	Make an image look like a miniature scene captured in macro mode. This effect is well-suited for images captured from a high vantage point with the main subject at the center of the image.
 Small picture (📷8)	Create a small copy of images suitable for use on web sites or as e-mail attachments.
 Crop (📷9)	Crop a portion of the image. Use to zoom in on a subject or arrange a composition.

Notes About Image Editing

- This camera cannot edit images captured with another make or model of digital camera.
- Images created using **Photo albums** () cannot be edited.
- Editing functions other than **Small picture** cannot be added to images captured using **Decorate** () 35).
- Images cannot be cropped when played back using **View favorites** () 24).
- Edited copies created with this camera may not be displayed properly on another make or model of digital camera. It may also be impossible to transfer them to a computer using another make or model of digital camera.
- Editing functions are not available when there is not enough free space in the internal memory or on the memory card.



Restrictions on Image Editing

When an edited copy is further modified with another editing function, check the following restrictions.

Editing function used	Editing functions that can be added
Change colors, Highlight colors, Soften pictures, Add starbursts, Add a fisheye effect, Add a diorama effect	Decorate , Small picture , or crop can be added.
Decorate	Small picture can be added.
Small picture	Another editing function cannot be added.
Crop	Images can be edited using Decorate .

- Copies created with editing functions cannot be further edited with the same function used to create them.
- When combining the **Small picture** feature with another editing feature, use the other editing feature first, and apply the **Small picture** feature last.
- When combining the crop feature with another editing feature other than **Decorate**, apply the crop feature last.

Original and Edited Images

- Copies created with editing functions are not deleted if the original images are deleted. The original images are not deleted if copies created with editing functions are deleted.
- Edited copies are saved with the same shooting date and time as the original.
- If an image that has been marked for Print order () 31) or added to favorites () 23) is edited, the edited copy of the image will not be marked for Print order or added to favorites.

Change Colors

Enter playback mode → flexible button 1 (📷) → flexible button 2 (🖌️ Change colors)

Allows you to adjust image colors.

Press the multi selector ◀ or ▶ to select the desired setting, and then press flexible button 4 (OK).

- Four different settings are available.
 - 1 Vivid color (default setting): Use to achieve a vivid, photoprint effect.
 - 2 Black-and-white: Save images in black-and-white.
 - 3 Sepia: Save images in sepia tones.
 - 4 Cyanotype: Save images in cyan-blue monochrome.
- To cancel, press flexible button 1 (↶).

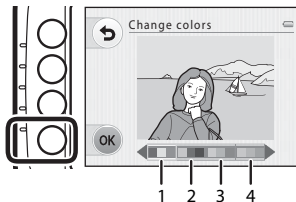

Highlight Colors

Enter playback mode → flexible button 1 (📷) → flexible button 3 (🖌️ Highlight colors)

Keep one specified color in the image, and change the other colors to black and white.

Press the multi selector ▲ or ▼ to select a color, and then press flexible button 4 (OK).

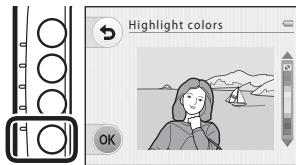

- To cancel, press flexible button 1 (↶).



More Information

"File and Folder Names" →  51

Decorate

Enter playback mode → flexible button 1 () → flexible button 4 ( Decorate)

You can add a frame around your images. Five different frames are available. The image size of the edited copy varies depending on the size of the original image, as described below.

- When the original image is 2M (1600×1200) or larger, the copy is saved at 2M (1600×1200).
- When the original image is smaller than 2M (1600×1200), the copy is saved at the same size as the original.

Press the multi selector ◀ or ▶ to select a frame, and then press flexible button 4 (OK).

- The frame will be added to the picture and saved as a new copy.
- To cancel, press flexible button 1 ()

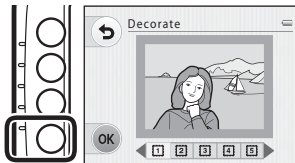



Notes About Decorate

- The frame is placed on top of the image and therefore replaces the area of the image underneath it. Thicker frames will cover up a larger area of the image.
- When using borderless printing to print images that you have added frames to, the frames may not be printed.

More Information

“File and Folder Names” →  51

Soften Pictures

Enter playback mode → flexible button 1 () → press ▼ → flexible button 2 ( Soften pictures)



Soften the image by adding a slight blur around the center of the image. You can choose one of three area guides displayed in the center.

Press the multi selector ◀ or ▶ to select a guide size, and then press flexible button 4 (OK).

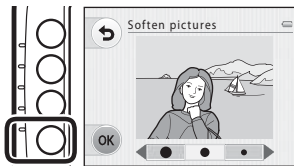
- To cancel, press flexible button 1 ()



Add Starbursts

Enter playback mode → flexible button 1 () → press ▼ → flexible button 3 ( Add starbursts)

Produce star-like rays of light that radiate outward from bright objects such as sunlight reflections or street lights. This effect is suitable for night scenes.

Confirm the effect and press flexible button 4 (OK).

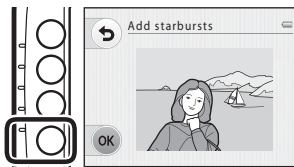

- To cancel, press flexible button 1 ()



More Information

"File and Folder Names" →  51

Add a Fisheye Effect

Enter playback mode → flexible button 1 () → press ▼ → flexible button 4 ( Add a fisheye effect)



Make an image look as if it were captured with a fisheye lens. This effect is well-suited for images captured using **Shoot close-ups** ( 37) in the shooting menu.

Confirm the effect and press flexible button 4 (**OK**).

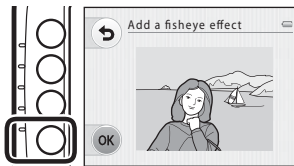
- To cancel, press flexible button 1 () .



Add a Diorama Effect

Enter playback mode → flexible button 1 () → press ▼ two times → flexible button 2 ( Add a diorama effect)

Make an image look like a miniature scene captured in macro mode. This effect is well-suited for images captured from a high vantage point with the main subject at the center of the image.

Confirm the effect and press flexible button 4 (**OK**).

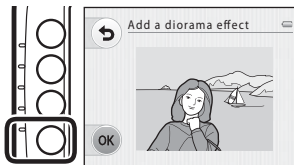

- To cancel, press flexible button 1 () .



More Information

"File and Folder Names" →  51

Small Picture: Reducing the Size of an Image

Enter playback mode → flexible button 2 () → press ▼ → flexible button 4 ( Small picture)

Create a small copy of the current image.

Press the multi selector ◀ or ▶ to select the size of the image and press flexible button 4 (**OK**).

- A new, edited copy is saved as a separate image with a compression ratio of 1:16.

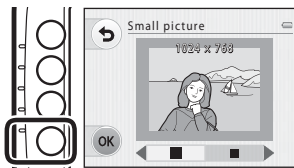

More Information

File and Folder Names →  51

✂ Crop: Creating a Cropped Copy

By pressing flexible button 4 (✂) when using playback zoom (📖 60), you can create a copy of the image that contains only the portion visible in the monitor.

- 1 Press the multi selector ▲ in full-frame playback mode (📖 25) to zoom in on the image.

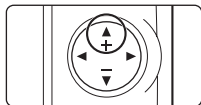

- To crop an image displayed in “tall” (portrait) orientation, zoom in on the image until the black bars displayed on the both sides of the monitor disappear. The cropped image will be displayed in landscape orientation. To crop the image in its current “tall” (portrait) orientation, first use the **Rotate pictures** option (🔄30) to rotate the image so that it is displayed in landscape orientation. Next, enlarge the image for cropping, crop the image, and then rotate the cropped image back to “tall” (portrait) orientation.

- 2 Refine copy composition.

- Press the multi selector ▲ or ▼ to zoom in or out.
- To move the displayed area, press flexible button 3 (🔒) to lock the zoom ratio, and then press the multi selector ▲, ▼, ◀, or ▶.

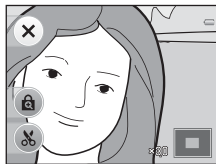

- 3 Press flexible button 4 (✂).

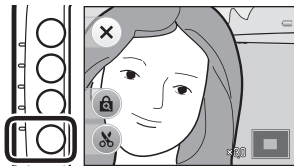

4 Press flexible button 3 (○ Yes).

- A new, cropped copy is saved as a separate image.

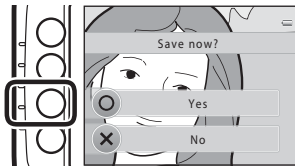



Image Size

As the area to be saved is reduced, the image size (pixels) of the cropped copy is also reduced.

More Information

File and Folder Names → 51

Connecting the Camera to a TV (Viewing Images on a TV)

Connect the camera to a TV using an optional audio/video cable (☞53) to play back images or movies on the TV.

1 Turn off the camera.

2 Connect the camera to the TV.

- Connect the yellow plug of the audio/video cable to the video-in jack and the white plug to the audio-in jack on the TV.

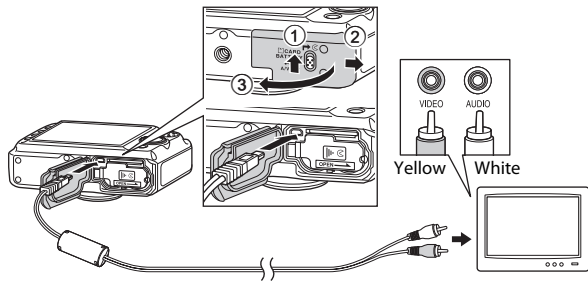

3 Set the TV's input to external video input.

- See the documentation provided with your TV for details.

4 Hold down the (shooting/playback mode) button to turn on the camera.

- The camera enters playback mode and images are displayed on the TV.
- While connected to the TV, the camera monitor will remain off.

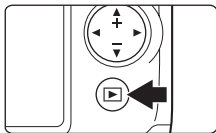

Notes About Connecting the Cable

When connecting the cable, be sure that the camera connector is properly oriented. Do not use force when connecting the cable to the camera. When disconnecting the cable, do not pull the connector at an angle.

If the Images Are Not Displayed on the TV

Be sure that the camera's **Video mode** ( 47) setting in the setup menu conforms to the standard used by your TV.

Connecting the Camera to a Printer (Direct Print)

Users of PictBridge-compatible (📷21) printers can connect the camera directly to the printer and print images without using a computer. Follow the procedures below to print images.

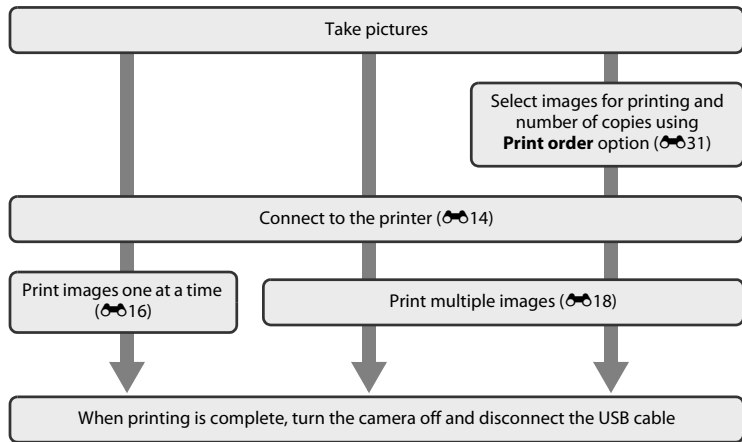

Notes About Power Source

When connecting the camera to a printer, use a fully charged battery to prevent the camera from turning off unexpectedly.

Printing Images

In addition to printing images transferred to a computer from your personal printer and printing over a direct camera-to-printer connection, the following options are also available for printing images saved on the memory card:

- Inserting the memory card into a DPOF-compatible printer's card slot
- Taking the memory card to a digital photo lab

For printing using these methods, specify the images and the number of prints each to the memory card using the **Print order** option in the playback menu (31).

Connecting the Camera to a Printer

1 Turn off the camera.

2 Turn on the printer.

- Check printer settings.

3 Connect the camera to the printer using the included USB cable.

- Be sure that connectors are properly oriented. Do not attempt to insert connectors at an angle, and do not use force when connecting or disconnecting the USB cable.

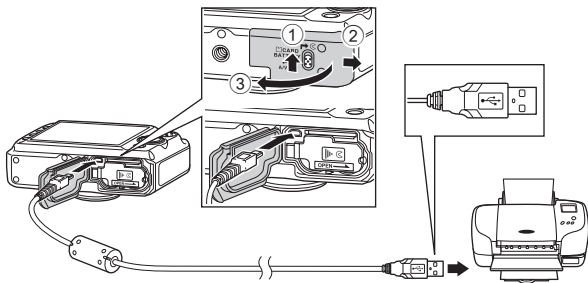

4 Turn on the camera.

- When properly connected, the **PictBridge** startup screen will be displayed in the camera monitor, followed by the **Print selection** screen.

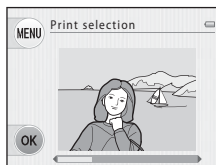

Printing Individual Images

After properly connecting the camera to the printer (🔗14), follow the procedures described below to print an image.

- 1 Press the multi selector ◀ or ▶ to select an image to be printed, and then press flexible button 4 (OK).
 - It is easier to select images if you press ▼ and switch to 9-image thumbnail display mode. Press ▲ to switch to full-frame playback mode.

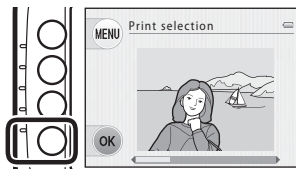

- 2 Press flexible button 3 (📄 Copies).

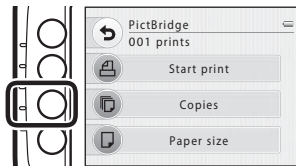

- 3 Select the desired number of copies (up to nine) and press flexible button 4 (OK).

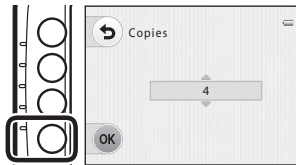

4 Press flexible button 4 (📄 **Paper size**).

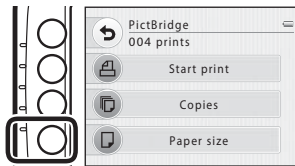

5 Select a paper size.

- To specify paper size using settings on the printer, press flexible button 2 (**Default**) in the paper size option.

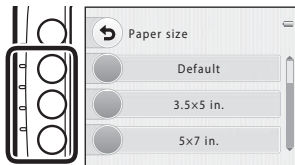

6 Press flexible button 2 (🖨️ **Start print**).

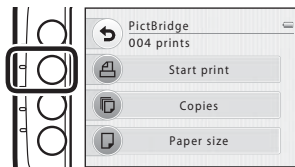

7 Printing begins.

- The screen returns to step 1 when printing is complete.

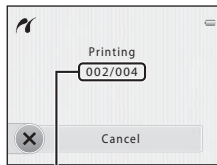

Current number of copies/
total number of copies

Printing Multiple Images

After properly connecting the camera to the printer (🔑14), follow the procedures described below to print multiple images.

- 1 When the **Print selection** screen is displayed, press flexible button 1 (MENU).

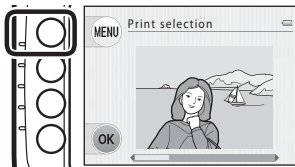

- 2 Press the multi selector ▼ and then press flexible button 2 (📄 Paper size).
 - To exit the print menu, press the flexible button 1 (🔑).

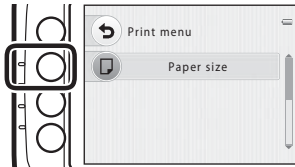

- 3 Select a paper size.
 - To specify paper size using settings on the printer, select flexible button 2 (Default) in the paper size option.

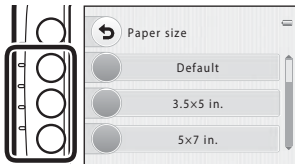

- 4** Press flexible button 2 (Print selection), flexible button 3 (Print all images), or flexible button 4 (DPOF printing).

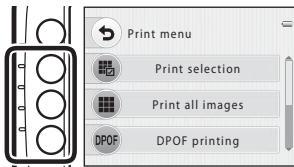

Print selection

Select images (up to 99) and the number of copies (up to nine) of each.

- Press the multi selector ◀ or ▶ to select images. Press flexible button 2 (+) or flexible button 3 (−) to set the number of copies for each.
- Images selected for printing are indicated by the check mark and the numeral indicating the number of copies to be printed. If no copies have been specified for images, the selection is canceled.
- Press ▲ to switch to full-frame playback mode and press ▼ to switch to thumbnail display mode (nine images).
- Press flexible button 4 (OK) when setting is complete.
- When the screen shown on the right is displayed, press flexible button 2 (Start print) to start printing. Press flexible button 1 (Return) to return to the **Print selection** screen. Press flexible button 3 (Cancel) to return to the print menu.

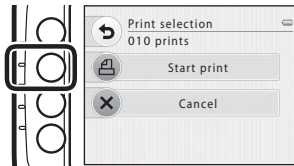
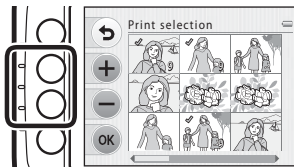

Print all images

One copy each of all images saved in the internal memory or on the memory card, is printed.

- When the screen shown on the right is displayed, press flexible button 2 (🖨️) to start printing. Press flexible button 1 (↩️) to return to the print menu.

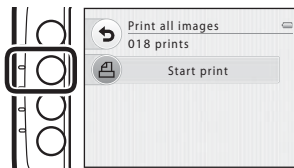

DPOF printing

Print images for which a print order was created using the **Print order** option (0-31).

- When the screen shown on the right is displayed, press flexible button 2 (🖨️) to start printing. Press flexible button 1 (↩️) to return to the print menu.
- To view the current print order, select **View images**. To start printing, press flexible button 4 (OK).

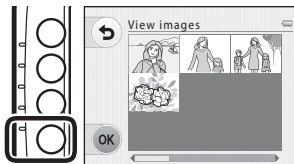

5 Printing begins.

- The screen returns to step 2 when printing is complete.

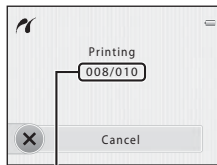

Current number of copies/
total number of copies



Paper Size

The camera supports the following paper sizes: **Default** (the default paper size for the printer connected to the camera), **3.5×5 in.**, **5×7 in.**, **100×150 mm**, **4×6 in.**, **8×10 in.**, **Letter**, **A3**, and **A4**. Only sizes supported by the printer will be displayed.

The Playback Menu

- See “Editing Still Images” (🔗2) for information about image editing features.

Favorites

Enter playback mode → flexible button 2 () → flexible button 2 ( Favorites)

You can sort your favorite images by adding them to albums. There are three albums available. After registering images, you can use **View favorites** to view those images easily.

- By using different albums for certain subjects or events, you can find your favorite images easily.
- The same image cannot be added to multiple albums.
- Up to 200 images can be added to each album.

Adding Images to Albums

- 1 Press flexible button 2 (📁 Add to favorites).

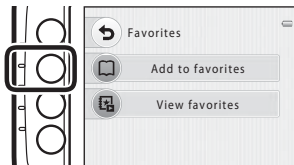

- 2 Press the multi selector ◀ or ▶ to select an image, and then press flexible button 2 (📁), flexible button 3 (📁), or flexible button 4 (📁).

- When an image that has already been added to an album is displayed, the same album cannot be selected. If you select another album, the image can be added only to the newly selected album.
- 📁, 📁, or 📁 is displayed when viewing images that have been added to an album.

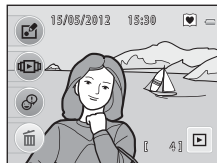
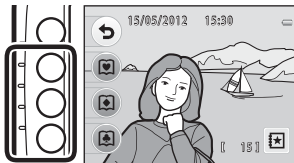

✓ Adding Images to Albums

When an image is added to an album, it is protected from accidental deletion. Note that formatting the camera's internal memory or the memory card (📁45) will permanently delete images that have been added to albums.

Playing Back Images in Albums

- 1** Press flexible button 3 (🖼️ **View favorites**).



- 2** Press flexible button 2 (🖼️), flexible button 3 (🖼️), or flexible button 4 (🖼️).



- 3** Play back the images in the selected album.

- Press the multi selector ◀ or ▶ to browse through the images.
- Only the first frame of movies is displayed.
- Press ▼ to switch to thumbnail display mode (nine images). Press ▲ in thumbnail display mode to return to full-frame playback mode.
- Press flexible button 4 (⌂) to return to the playback screen.



Removing Images from Albums

- 1 Press flexible button 3 (⌘*) in the screen shown in step 3 of “Playing Back Images in Albums” (6-24).

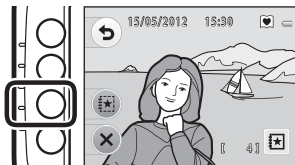

- Press ▼ to switch to 9-thumbnail display mode.
 - Press the multi selector ◀ or ▶ to select an image.
 - If you press flexible button 2 (✓), ✓ is added to the selected image. ✓ is displayed or removed each time you press flexible button 2 (✓).



- 2 Press flexible button 3 (○ Yes).

- The selected image is removed from the album.

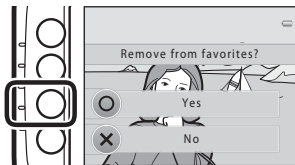





Photo Albums

Enter playback mode → flexible button 2 () → flexible button 3 ( Photo albums)

You can display images similarly to a photo album. Three different photo album designs are available.

1 Select an image and then press flexible button 4 (OK).

- The Image Selection Screen →  35
- Up to 20 images can be selected.
- You cannot select images that have already been added to photo albums.

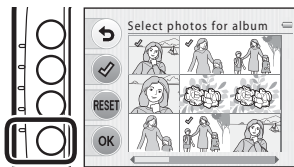

2 Press the multi selector ◀ or ▶ to select the desired photo album design and then press flexible button 4 (OK).

- Photo albums are displayed one page at a time. After all pages have been displayed, the camera returns to full-frame playback mode.
- To cancel before the photo album has been created, press flexible button 1 (✕).

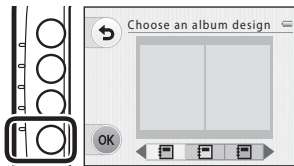

Notes About Photo Albums

- Movies cannot be selected.
- Images captured with another make or model of digital camera cannot be selected.
- Images created using **Photo albums** cannot be edited.

Slide Show

Enter playback mode → flexible button 2 (🔊) → flexible button 4 (🖼️ Slide show)

Play back images, saved in the internal memory or on a memory card, one by one in an automated “slide show.”

1 Press flexible button 3 (🖼️ **Choose pictures**).



2 Select images.

- **Choose from favorites:** Allows you to select images that have been added to albums. You can select images from **Favorites 1**, **Favorites 2**, and **Favorites 3**.
- **Choose by date:** Allows you to select images captured on the same day. Select a date from the calendar.
- **All pictures:** Plays back all images.

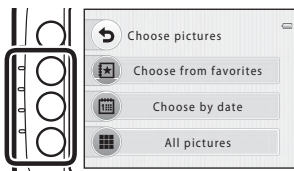

3 Press flexible button 4 (🖼️ **Choose a theme**).

4 Choose a playback theme.

- You can select **Pop art**, **Classic** (default setting), or **Zoom**.

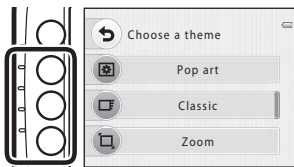

5 Press flexible button 2 (▶ Start).

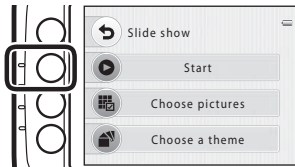

6 The slide show begins.

- To pause playback, press flexible button 4 (⏸). To exit, press flexible button 1 (⏪).
- While the slide show is in progress, press the multi selector ▶ to display the next image or ◀ to display the previous image. Hold down either button to fast forward or rewind.
- Press the multi selector ▲ or ▼ during playback to adjust the volume.



7 End the slide show or restart it.



- The screen shown on the right is displayed when the slide show is paused.
 - ✕: Returns to **View** screen.
 - ⏮: Displays the next image.
 - ⏪: Displays the previous image.
 - ▶: Resumes playback.



✓ Notes About Slide Show

- Only the first frame of movies is displayed.
- The maximum playback time is up to about 30 minutes (📖 19).

Choose by Date

Enter playback mode → flexible button 2 () → press ▼ → flexible button 2 ( Choose by date)

Use the multi selector ▲, ▼, ◀, or ▶ to select a date from the calendar and then press flexible button 4 (OK) to play back the images captured on the selected date.

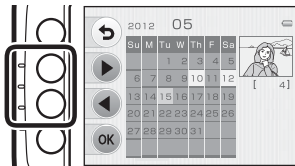

- The first image that was captured on the selected date is displayed.
Days containing images have a light gray background.
- Press flexible button 2 (◀) or 3 (▶) to display other months.



Notes About Choose By Date

- The 9,000 most recent images can be displayed.
- Images that were captured when the camera's date and time were not set are treated as images captured on January 1, 2012.
- Only the first frame of movies is displayed.



Rotate Pictures

Enter playback mode → select an image → flexible button 2 () → press ▼ → flexible button 3 () Rotate pictures)

Specify the orientation in which saved images are displayed during playback.

Still images can be rotated 90 degrees clockwise or 90 degrees counterclockwise.

Images that were saved in portrait ("tall") orientation can be rotated up to 180 degrees in either direction.

From the  **Rotate pictures** screen, press the multi selector ◀ or ▶ to select  or  and rotate the image 90 degrees.

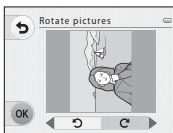

Rotate 90 degrees
counterclockwise

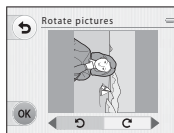
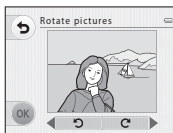

Rotate 90 degrees
clockwise

Press flexible button 4 (**OK**) to finalize display orientation, and save orientation information with the image.



Notes About Rotate Pictures

The camera cannot rotate images captured with another make or model of digital camera.

Print Order (Creating a DPOF Print Order)

Enter playback mode → flexible button 2 () → press ▼ two times → flexible button 2 ( Print order)



When printing images saved on the memory card using any of the following methods, the **Print order** option in the playback menu is used to create digital “print orders”.

- Inserting the memory card into a DPOF-compatible () printer's card slot.
- Taking the memory card to a digital photo lab.
- Connecting the camera to a PictBridge-compatible () printer (13). A print order can also be created for images saved in the internal memory if the memory card is removed from the camera.

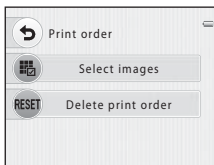
1 Press flexible button 2 (**Select images**).



2 Select images (up to 99) and the number of copies (up to nine) of each.

- Press the multi selector ◀ or ▶ to select images, and press flexible button 2 () or flexible button 3 () to set the number of copies for each.
- Images selected for printing are indicated by the check mark icon and the numeral indicating the number of copies to be printed. If no copies have been specified for images, the selection is canceled.
- Press ▲ to switch to full-frame playback and press ▼ to switch back to 9-thumbnail display.
- Press flexible button 4 (**OK**) when setting is complete.

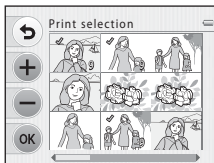

3 Select whether or not to print shooting date and shooting information.

- **Date:** print the shooting date on all images in the print order.
- **Info:** print shooting information (shutter speed and aperture value) on all images in the print order.
- **Date and Info** turn on and off each time you press the corresponding flexible button.
- Press flexible button 4 (**OK**) to complete the print order.

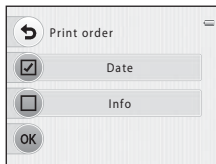

When Date is selected

✓ Notes About Printing Shooting Date and Shooting Information

When the **Date** and **Info** settings are enabled in the print order option, shooting date and shooting information are printed on images when a DPOF-compatible printer (🔗21) that supports printing of shooting date and shooting information is used.

- Shooting information cannot be printed when the camera is connected to a DPOF-compatible printer via the included USB cable.
- Note that **Date** and **Info** settings are reset each time the **Print order** option is displayed.
- The date printed is that saved when the image was captured.

Changing the **Date and time** setting in the setup menu after an image has been captured has no effect on the date printed on the image.



✎ Canceling Existing Print Order

Press **Delete print order** in step 1 (🔗31) of "🖨️ Print Order (Creating a DPOF Print Order)" to remove print marking from all images and cancel the print order.

✎ Print Date

When shooting date and time are imprinted on images using the **Print date** option (🔗43) in the setup menu, images are saved with shooting date and time imprinted on the image when they are captured. Images with the date imprinted on them can be printed from printers that do not support printing of the date on images.



Only the date and time imprinted on images with the print date option will be printed, even if the **Print order** date option is enabled.

Copy (Copy Between Internal Memory and Memory Card)

Enter playback mode → flexible button 2 () → press ▼ two times → flexible button 3 ( Copy)

Copy images between the internal memory and a memory card.

1 Select the copy source and destination.

-  **Camera to card:** Copy images from internal memory to memory card.
-  **Card to camera:** Copy images from memory card to internal memory.

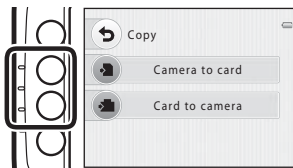

2 Select the copy method.

-  **Selected images:** Copy images selected from the image selection screen ( 35).
-  **All images:** Copy all images.

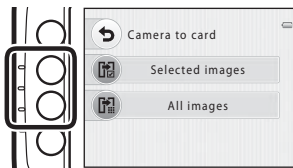

Notes About Copying Images

- JPEG-, AVI-, and WAV-format files can be copied.
- Operation is not guaranteed with images captured with another make of camera or that have been modified on a computer.
- When copying images for which **Print order** () options are enabled, the print order settings are not copied.

If “Memory contains no images.” Is Displayed

If a memory card that contains no images is inserted into the camera, **Memory contains no images.** will be displayed when the camera is switched to playback mode. You can copy images from the camera’s internal memory to the memory card by pressing any flexible button and then selecting **Copy**.

More Information

File and Folder Names → 51

The Image Selection Screen

When using one of the following features, a screen like that shown on the right is displayed when selecting images.

- **Photo albums > Select photos for album** (📖26)
- **Copy > Selected images** (🔍33)
- **Erase > Erase selected pictures** (📖 26)

Follow the procedures described below to select the images.

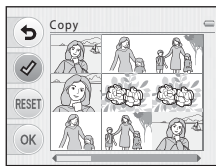

1 Press the multi selector ◀ or ▶ to select an image.

- Press ▲ to switch to full-frame playback and press ▼ to switch back to 9-thumbnail display.

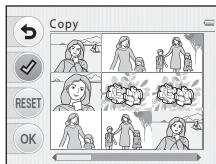

2 Use flexible button 2 or 3 to select or deselect (or to specify the number of copies).

- When an image is selected, a check mark (✓) is displayed with the image.
- ✓ is displayed or removed each time you press flexible button 2 (✓).
- Press flexible button 3 (RESET) to remove all the ✓ marks.
- Repeat steps 1 and 2 to select additional images.

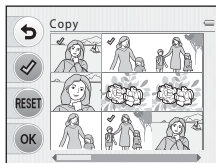

3 Press flexible button 4 (OK) to apply image selection.

- When **Selected images** is selected, a confirmation dialog is displayed. Follow the instructions displayed in the monitor.

Exchange Messages

Enter playback mode → select an image → flexible button 3 ()

You can record voice messages using the camera's microphone and attach the messages to your pictures.

- Up to two messages can be attached to each image.



Leave a Message

1 Press flexible button 2 (Leave a message).

- You cannot select this option if the image already has a message attached to it. → "Leave a Reply" ()



2 Press and hold flexible button 2 ()

- Recording begins. You can record a message for up to about 20 seconds.
- Release your finger from flexible button 2 () to stop recording.
- Do not touch the camera's microphone during recording.
- If battery power runs out, recording stops automatically.
- Press flexible button 4 (**OK**) in step 3 to save the message. You can re-record your message until you press flexible button 4.
- Press flexible button 3 () to play back the message.
- Press flexible button 1 () before or after recording a voice message to return to step 1.

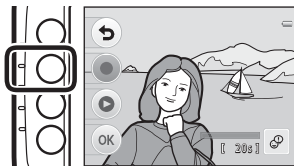

3 Press flexible button 4 (OK).

- "Message recorded" is displayed and the message is attached to the image.
- Images that have a recorded message are indicated by the  icon displayed during playback.

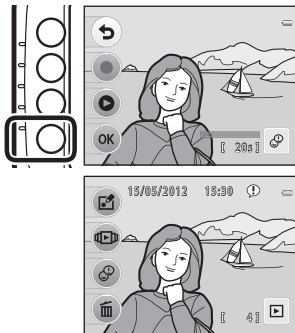

Leave a Reply

1 Press flexible button 3 (🗨️) **Leave a reply**.

- You cannot select this option if the image does not have a message attached to it. → “Leave a Message” (🗨️36)

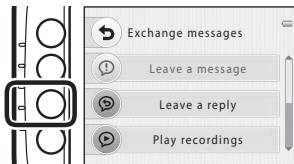

2 Press flexible button 2 (●).

- Once you start recording, the operations are the same as “Leave a Message” (🗨️36).
- Images that have a recorded reply are indicated by the 🗨️ icon displayed during playback.

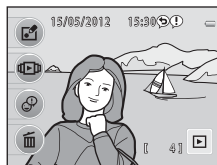
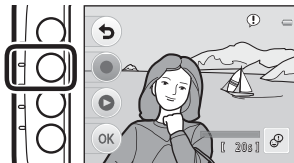

Play Recordings

Press flexible button 4 (▶ **Play recordings**).

- The camera plays the message. If a message and reply have been recorded, they are played back to back.
- Press flexible button 1 (⏸) to stop playback.
- Press the multi selector ▲ or ▼ during playback to adjust playback volume.
- If battery power runs out, playback stops automatically.



Erase Recordings

1 Press the multi selector ▼ and then press flexible button 2 (🗑 **Erase recordings**).

- If you select an image that has been added to an album (📁22), a confirmation message is displayed.
 - **Yes**: Remove the image from the album and display the screen shown in step 2.
 - **No**: Return to step 1.

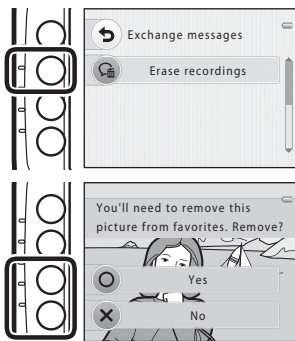

2 Press flexible button 3 (○ Yes) when the confirmation message is displayed.

- Only recordings are deleted. If both a message and a reply have been recorded, they will both be deleted.

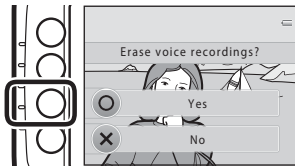

Notes About Exchange Messages

- When an image with messages attached is deleted, both the image and its messages are deleted.
- Messages cannot be recorded for an image that already has two messages attached to it. The current message must be deleted before a new message can be recorded.
- This camera cannot record messages for images captured with another make or model of digital camera.

More Information

File and Folder Names → 51

Erase

Enter playback mode → select an image → flexible button 4 (🗑️)



You can delete unwanted images (📖 26).

The Setup Menu

Welcome Screen

Enter shooting mode → any flexible button → press ▼ two times → flexible button 1 (Y Set up) → flexible button 2 (START) Welcome screen

Select whether or not the welcome screen is displayed when the camera is turned on.

Option	Description
 Off	The camera enters shooting or playback mode without displaying the welcome screen.
 On (default setting)	The camera displays animated welcome screen and then enters shooting or playback mode. How often you use the camera and how many pictures you have taken with the camera will affect the displayed characters.

Date and Time

Enter shooting mode → any flexible button → press ▼ two times → flexible button 1 (⏏ Set up) → flexible button 3 (🕒 Date and time)

Set the camera clock.

Option	Description
🕒 Date format	The available date formats are Year/Month/Day , Month/Day/Year , and Day/Month/Year .
🕒 Date and time	<p>Allows you to set the camera's clock to the current date and time. Use the multi selector to set each item displayed on the screen.</p> <ul style="list-style-type: none">• Select an item: Press ▶ or ◀ (changes between D, M, Y, hour, minute).• Edit the highlighted item: Press ▲ or ▼.• Apply the setting: Select the minute setting and then press flexible button 4 (OK).• When using the camera in an area where daylight saving time is in effect, press flexible button 3 (🕒) to adjust the camera's time for daylight saving time. When the daylight saving time function is enabled, 🕒 is displayed at the top of the monitor and the time will advance one hour. Press flexible button 3 (🕒) again to disable the daylight saving time function.

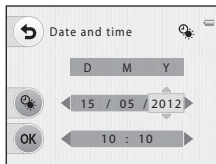

Brightness

Enter shooting mode → any flexible button → press ▼ two times → flexible button 1 (⏏ Set up) → flexible button 4 (🌞 Brightness)

Set the option below.

Option	Description
🌞 Brightness	Select from five settings for monitor brightness. The default setting is 3 .

Print Date (Imprinting Date and Time)

Enter shooting mode → any flexible button → press ▼ two times → flexible button 1 (P Set up) → press ▼ → flexible button 2 (DATE) Print date)

The shooting date can be imprinted on the images when shooting, allowing the information to be printed even from printers that do not support date printing (📷32).



Option	Description
 Date	Date is imprinted on images.
OFF Off (default setting)	Date is not imprinted on images.

Notes About Print Date

- Imprinted dates form a permanent part of image data and cannot be deleted. The date cannot be imprinted on images after they have been captured.
- The date is not imprinted on movies.
- The date is saved using the format selected in the setup menu's **Date and time** option (📖 15, 📷42).



Print Date and Print Order

When printing with a DPOF-compatible printer that can print the shooting date and shooting information, you can use the **Print order** option (📷31) to print this information in images, even if the **Print date** function was set to **Off** at the time of shooting.

Electronic VR

Enter shooting mode → any flexible button → press ▼ two times → flexible button 1 (👉 Set up) → press ▼ → flexible button 3 (👉 Electronic VR)

Choose whether to use electronic VR (vibration reduction) when taking still pictures.

Option	Description
 Auto	In the following conditions, electronic VR is applied and the effects of camera shake are reduced. <ul style="list-style-type: none">• When the flash mode is set to  Flash off• The shutter speed is slow• When the subject is dark
OFF Off (default setting)	Electronic VR is disabled.

Notes About Electronic VR

- Electronic VR is disabled while the flash is used.
- If the exposure period exceeds a certain period of time, electronic VR will not function.
- Electronic VR cannot be used when using the following scenes.
 - **Take a series of pictures** (📖 38)
 - **Shoot at intervals** (📖 39)
 - **Photograph fireworks** (📖 41)
- The effectiveness of electronic VR decreases as camera shake increases.
- The images captured may become somewhat grainy.

Format Memory/Format Card

Enter shooting mode → any flexible button → press ▼ two times → flexible button 1 (⏏ Set up) → press ▼ → flexible button 4 (📷 Format memory/📷 Format card)

Use this option to format the internal memory or a memory card.

Formatting the internal memory or memory cards permanently deletes all data.

Data that has been deleted cannot be recovered. Be sure to transfer important data to a computer before formatting.

Formatting the Internal Memory

To format the internal memory, remove the memory card from the camera. The **Format memory** option is displayed in the setup menu.

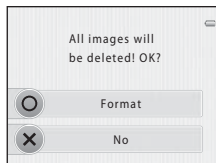

Formatting a Memory Card

When the memory card is inserted in the camera, the **Format card** option appears in the setup menu.

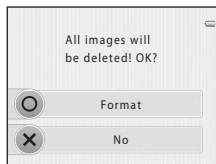

✓ Notes About Formatting Internal Memory and Memory Cards

- Do not turn the camera off or open the battery-chamber/memory card slot cover during formatting.
- The first time you insert a memory card that has been used in another device into this camera, be sure to format it with this camera.

Language

Enter shooting mode → any flexible button → press ▼ two times → flexible button 1 (⏏ Set up) → press ▼ two times → flexible button 2 (🗣 Language)

Select one of 29 languages for display of camera menus and messages.

Čeština	Czech
Dansk	Danish
Deutsch	German
English	(Default setting)
Español	Spanish
Ελληνικά	Greek
Français	French
Indonesia	Indonesian
Italiano	Italian
Magyar	Hungarian
Nederlands	Dutch
Norsk	Norwegian
Polski	Polish
Português (BR)	Brazilian Portuguese
Português (PT)	European Portuguese

Русский	Russian
Română	Romanian
Suomi	Finnish
Svenska	Swedish
Tiếng Việt	Vietnamese
Türkçe	Turkish
Українська	Ukrainian
عربي	Arabic
简体中文	Simplified Chinese
繁體中文	Traditional Chinese
日本語	Japanese
한국어	Korean
ภาษาไทย	Thai
हिन्दी	Hindi

Menu Background

Five different menu designs are available.

Enter shooting mode → any flexible button → press ▼ two times → flexible button 1 (⏏ Set up) → press ▼ two times → flexible button 3 (📺 Menu background)

Press the multi selector ◀ or ▶ to select the desired design and then press flexible button 4 (OK).

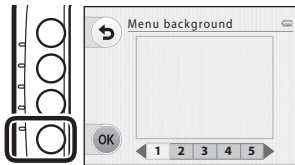

Video Mode

Enter shooting mode → any flexible button → press ▼ two times → flexible button 1 (⏏ Set up) → press ▼ two times → flexible button 4 (📺 Video mode)

Adjust settings for connection to a TV.

Select from **NTSC** and **PAL**.

Reset All

Enter shooting mode → any flexible button → press ▼ two times → flexible button 1 (☺ Set up) → press ▼ three times → flexible button 2 (CLEAR Reset all)

When flexible button 3 (○ Reset) is selected, the camera's settings will be restored to their default values.

Shooting Menu

Option	Default value
Adjustments made using Change colors (📖 32)	Center
Decorate (📖 35)	Frame 1
Choose a style (📖 36)	Point and shoot
Hue adjustment in Photograph food (📖 39)	Center
Button sounds in Change sounds (📖 42)	Standard sounds
Shutter sound in Change sounds (📖 42)	Standard sounds
Flash mode (📖 44)	Auto flash
Self-timer (📖 45)	Off
Choose a size (for still images) (📖 49)	■ Large (10 megapixels)
Choose a size (for movies) (📖 50)	When using a memory card: 📺 Large (720p) (1280×720)
Movie AF (📖 52)	Single AF

Setup Menu

Option	Default value
Brightness (🔍 42)	3
Print date (🔍 43)	Off
Electronic VR (🔍 44)	Off
Menu background (🔍 47)	1

Others

Option	Default value
Paper size (🔑17, 🔑18)	Default

- Selecting **Reset all** also clears the current file number (🔑51) from memory. Numbering will continue from the lowest number available for the internal memory or the memory card. To reset file numbering to "0001", delete all images saved in the internal memory or on the memory card (📖 26) before selecting **Reset all**.
- The following menu settings will remain unaffected when menus are reset with **Reset all**.



Setup menu:

Welcome screen (🔑41), **Date and time** (🔑42), **Language** (🔑46), **Video mode** (🔑47), and **Battery type** (🔑50)

Battery Type

Enter shooting mode → any flexible button → press ▼ two times → flexible button 1 (⏏ Set up) → press ▼ three times → flexible button 3 (🔋 Battery type)

To ensure that the camera shows the correct battery level (📖 18), select the type that matches the batteries currently in use.

Option	Description
 Alkaline (default setting)	LR6/L40 (AA-size) alkaline batteries
 COOLPIX (Ni-MH)	Nikon EN-MH2 rechargeable Ni-MH (nickel metal hydride) batteries
 Lithium	FR6/L91 (AA-size) lithium batteries

Firmware Version

Enter shooting mode → any flexible button → press ▼ two times → flexible button 1 (⏏ Set up) → press ▼ three times → flexible button 4 (Ver. Firmware version)

View the current camera firmware version.



File and Folder Names

Images, movies, and messages are assigned file names as follows.

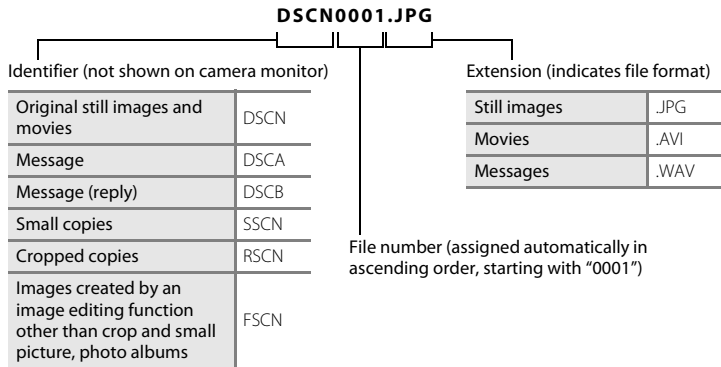

- Files are saved in folders named with a folder number followed by "NIKON" (e.g. "100NIKON"). When the number of files within a folder reaches 999, a new folder will be created (e.g., "101NIKON" is created after "100NIKON"). When the file numbers within a folder reach 9999, a new folder will be created. File numbers will be assigned automatically starting with 0001. When shooting, a new folder is created each time the camera's internal clock changes dates. Note however that if the date changes while shooting continuously with **Take a series of pictures** or **Shoot at intervals**, a new folder will not be created until shooting stops.
- Voice message file numbers are the same numbers as the images to which the messages are attached.

- Files copied using **Copy>Selected images** are copied to the current folder, where they are assigned new file numbers in ascending order starting from the largest file number in memory. **Copy>All images** copies all folders from the source medium; file names do not change but new folder numbers are assigned in ascending order, starting from the largest folder number on the destination medium (📷33).
- When the current folder is numbered 999 and the file numbers reach 9999, no further images can be captured until the internal memory or memory card is formatted (📷45), or a new memory card is inserted.

Optional Accessories





Rechargeable battery	Rechargeable Ni-MH batteries EN-MH2-B2 (set of two EN-MH2 batteries) ¹ Rechargeable Ni-MH batteries EN-MH2-B4 (set of four EN-MH2 batteries) ¹
Battery charger	Battery Charger MH-72 (includes two rechargeable Ni-MH batteries EN-MH2) ¹ Battery Charger MH-73 (includes four rechargeable Ni-MH batteries EN-MH2) ¹
USB cable	USB Cable UC-E16 ²
Audio/video cable	Audio Video Cable EG-CP14







¹ To charge EN-MH2 batteries, use only Battery Charger MH-72 or MH-73. Do not use these battery chargers to charge any other type of battery.





² Included with the camera at the time of purchase (📖 ii).

Accessories are not waterproof.

Error Messages

Display	Cause/Solution	
 (flashes)	Clock not set. Set date and time.	 42
Battery exhausted.	Replace the batteries.	10
Please wait for the camera to finish recording.	Wait until the image is saved and the message disappears from the display.	–
Memory card is write protected.	Write-protect switch is in “lock” position. Slide write-protect switch to “write” position.	–
This card cannot be used.	Error accessing memory card. <ul style="list-style-type: none">• Use approved card.• Check that terminals are clean.• Confirm that memory card is correctly inserted.	14
This card cannot be read.		12
Card is not formatted. Format card? Yes No	Memory card has not been formatted for use in this camera. Formatting deletes all data saved on the memory card. Be sure to select X No and make copies of any images which need to be kept before formatting the memory card. Select O Yes to format the memory card.	 7

Display	Cause/Solution	
Out of memory.	Memory card is full. <ul style="list-style-type: none"> • Change the setting for Choose a size > Photos. • Delete images. • Insert new memory card. • Remove memory card and use internal memory. 	49 26, 77 12 13
Image cannot be saved.	Error occurred while saving image. Format internal memory or memory card.	 45
	Camera has run out of file numbers. Insert a new memory card or format internal memory or memory card.	 51
	Insufficient space to save a copy. Delete images from destination.	26
Album is full. No further pictures can be added.	200 images have already been added to album. <ul style="list-style-type: none"> • Remove some images from album. • Add to other albums. 	 25  23
Image cannot be modified.	Cannot edit selected image. <ul style="list-style-type: none"> • Select images that support editing function. • Movies cannot be edited. 	 3 -
Cannot record movie.	Time out error while saving movie on the memory card. Select a memory card with faster write speed.	12, 14

Display	Cause/Solution	
Memory contains no images.	No images in the internal memory or memory card. <ul style="list-style-type: none"> Remove the memory card from the camera to play back images saved in the camera's internal memory. To copy images from the internal memory to the memory card, press any flexible button and select Copy in full-frame playback mode. 	13  33
File contains no image data.	File not created with this camera. File cannot be viewed on this camera. View file using a computer or the device used to create or edit this file.	-
All images are hidden.	No images available for a slide show.	 27
Lens error	Lens error. Turn camera off and then on again. If error persists, contact retailer or Nikon-authorized service representative.	18
Communications error	Error occurred during communication with printer. Turn camera off and reconnect USB cable.	 14
System error	Error has occurred in camera's internal circuitry. Turn camera off, remove and reinsert battery, and turn camera on. If error persists, contact retailer or Nikon-authorized service representative.	10, 19

Display	Cause/Solution	
Printer error: check printer status.	Printer error. Check printer. After solving the problem, press flexible button 3 (○ Resume) to resume printing.*	–
Printer error: check paper	Specified size of paper is not loaded in printer. Load the specified size of paper and then press flexible button 3 (○ Resume) to resume printing.*	–
Printer error: paper jam	Paper has jammed in printer. Remove the jammed paper and then press flexible button 3 (○ Resume) to resume printing.*	–
Printer error: out of paper	No paper is loaded in printer. Load the specified size of paper and then press flexible button 3 (○ Resume) to resume printing.*	–
Printer error: check ink	Ink error. Check ink and then press flexible button 3 (○ Resume) to resume printing.*	–
Printer error: out of ink	Running out of ink or ink cartridge is empty. Replace ink cartridge and then press flexible button 3 (○ Resume) to resume printing.*	–
Printer error: file corrupt	An error caused by the image file has occurred. Select flexible button 4 (✕ Cancel) to cancel printing.	–

* See the documentation provided with your printer for further guidance and information.



A series of ten horizontal dashed lines spanning the width of the page, intended for handwriting practice.



Technical Notes and Index

Caring for the Product	2
The Camera.....	2
Batteries.....	5
Memory Cards.....	7
Cleaning and Storage	8
Cleaning.....	8
Storage.....	9
Troubleshooting	10
Specifications	17
Supported Standards.....	21
Index	22

Caring for the Product

The Camera

To ensure safe and continued enjoyment of your Nikon camera, observe the following precautions and the precautions noted in “For Your Safety” (📖 viii-xiv) and “<Important> Shockproof, Waterproof, Dustproof, Condensation” (📖 xv-xxi) when using or storing your camera.

✔ **Do Not Subject the Product to Strong Shocks**

The product may malfunction if dropped or struck. Additionally, do not touch or apply force to the lens.

✔ **Do Not Allow Damp to Enter Inside the Camera**

COOLPIX S30 is provided with JIS/IEC protection class 8 (IPX8) equivalent waterproofing. If water seeps inside the camera, however, this could cause the components to rust and result in a high repair charge or the camera may not be repairable. After using the camera at the beach or underwater, make sure that the battery-chamber/memory card slot cover is firmly closed, and then immerse the camera in a shallow container filled with freshwater for ten minutes. After using the camera underwater, do not leave the camera wet for 60 minutes or more. This could cause deterioration of the waterproofing performance.

✔ **Prevent Water From Seeping Inside the Camera**

If the inside of the camera becomes wet, this could result in camera malfunction and the camera may not be repairable. To prevent water seeping (water submersion) accidents, be sure to observe the following cautions when using the camera.

- When the battery-chamber/memory card slot cover and internal cover are closed, make sure that the camera strap, hair, lint, dust, sand grains, other foreign substances, or dirt are not attached on the waterproofing packing and portions that make a contact with the waterproofing packing.
- Do not open or close the battery-chamber/memory card slot cover in areas exposed to water spray, high winds, dust or sand.

- When an external force is applied on the camera, it could become deformed or the airtight seals may become damaged and cause water to seep inside the camera. Do not place a heavy object on the camera, drop the camera, or apply excessive force on the camera.
- If water seeps inside the camera, immediately stop using the camera. Wipe off moisture from the camera, and at once take the camera to your Nikon-authorized service representative.

Shock and Vibration

Do not drop the camera, strike it against a hard object such as a rock, or throw it at a water surface. Do not leave the camera in an area subject to vibration. If the camera is subjected to excessive shock, this could result in camera malfunction or damage.

Maximum Depth

COOLPIX S30 is designed to withstand water pressure up to a depth of 3 m (9.8 ft) for approximately 60 minutes. At greater depth, water could seep inside the camera, resulting in camera malfunction.

Avoid Sudden Changes in Temperature

- Sudden changes in temperature, such as when entering or leaving a heated building on a cold day, can cause condensation to form inside the device. To prevent condensation, place the device in a carrying case or a plastic bag before exposing it to sudden changes in temperature.
- Do not expose the camera to high temperatures by leaving it on the beach or in direct sunlight before entering the water.

Keep away from Strong Magnetic Fields

Do not use or store this device in the vicinity of equipment that generates strong electromagnetic radiation or magnetic fields. Strong static charge or the magnetic fields produced by equipment such as radio transmitters could interfere with the monitor, damage data saved on the memory card, or affect the product's internal circuitry.

Do Not Point the Lens at Strong Light Sources for Extended Periods

Avoid pointing the lens at the sun or other strong light sources for extended periods when using or storing the camera. Intense light may damage the image sensor or other components, producing a white blur effect in photographs.

Turn the Camera off Before Removing the Batteries or Memory Card

Removing the batteries or memory card while the camera is on could damage the camera or memory card. If removed while the camera is saving or deleting data, data may be lost and the camera's memory or the memory card may be damaged.

Notes on the Monitor

- Monitors and electronic viewfinders are constructed with extremely high precision; at least 99.99% of pixels are effective, with no more than 0.01% being missing or defective. Hence while these displays may contain pixels that are always lit (white, red, blue, or green) or always off (black), this is not a malfunction and has no effect on images recorded with the device.
- Scraping or pressing on the surface of the monitor may result in damage or malfunction. Should the monitor break, care should be taken to avoid injury caused by broken glass and to prevent the liquid crystal from the display touching the skin or entering the eyes or mouth.
- Images in the monitor may be difficult to see under bright lighting.
- The monitor is lit by an LED backlight. Should the monitor begin to dim or flicker, contact your Nikon-authorized service representative.

Notes About Smear

White or colored streaks may be visible when bright subjects are framed in the monitor. This phenomenon, known as "smear," occurs when extremely bright light strikes the image sensor; it is characteristic of image sensors and does not indicate a malfunction. Smear may also take the form of partial discoloration in the monitor during shooting. It will not be seen in saved still images but may be seen in movies. When recording movies, we recommend that you avoid bright subjects such as the sun, reflected sunlight, and electric lights.

Batteries

Be sure to read and follow the warnings noted in “For Your Safety” (📖 viii-xiv) before use.

✔ Notes About Using Batteries

- Used batteries may overheat. Handle with caution.
- Do not use batteries beyond their recommended expiration date.
- Do not turn the camera on and off repeatedly if discharged batteries are inserted in the camera.

✔ Spare Batteries

We recommend carrying spare batteries depending on where you are shooting. It may be difficult to purchase batteries in certain areas.

✔ Charging Batteries

If using optional rechargeable batteries, charge the batteries before taking pictures. Batteries are not charged at the time of purchase.

Be sure to read and follow the warnings noted in the operating instructions included with the battery charger.

✔ Charging Rechargeable Batteries

- Do not mix batteries with different amounts of charge remaining, or batteries of a different make or model.
- When using EN-MH2 batteries with the COOLPIX S30, charge the batteries two at a time using Battery Charger MH-72. When using Battery Charger MH-73, charge the batteries two or four at a time. Use only Battery Charger MH-72 or MH-73 to charge EN-MH2 batteries.
- When using Battery Charger MH-72 or MH-73, only charge EN-MH2 batteries.

✔ Notes About EN-MH1 Rechargeable Batteries and Battery Charger MH-70/71

- You can also use EN-MH1 Ni-MH rechargeable batteries with this camera.
- Use only Battery Charger MH-70 or MH-71 to charge EN-MH1 batteries.
- When using Battery Charger MH-70 or MH-71, only charge EN-MH1 batteries.
- Set the **Battery type** setting (📖 80, 🔌 50) to **COOLPIX (Ni-MH)**.

Notes About Rechargeable Ni-MH Batteries

- If you repeatedly charge rechargeable Ni-MH batteries while they still have some charge remaining, the message **Battery exhausted.** may be displayed prematurely when using the batteries. This is due to the “memory effect,” in which the amount of charge the batteries can hold decreases temporarily. Use the batteries until there is no charge remaining and they will return to their normal behavior.
- Rechargeable Ni-MH batteries discharge even when not being used. We recommend charging the batteries just before using them.

Cold Environment Usage

Battery performance decreases in cold environments. When using the camera in cold environments, try not to let the camera and batteries become too cold. The camera may not function if you use discharged batteries in cold environments. Keep spare batteries warm and alternate between two sets of batteries. Batteries that cannot be used because they have become too cold can often be used again when they have been warmed up.

Battery Terminals

Dirt on the battery terminals can prevent the camera from functioning. Remove dirt from the terminals using a dry cloth.

Remaining Battery Charge

If you insert discharged batteries into the camera, the camera may indicate that the batteries have adequate charge remaining. This is a characteristic of batteries.

Recycling

Used batteries are a valuable resource. Please recycle used batteries in accordance with local regulations. Cover the battery terminals with tape when recycling.

Memory Cards

- Use only Secure Digital memory cards. Approved memory cards →  14
- Observe the precautions noted in the documentation included with your memory card.
- Do not affix labels or stickers to the memory card.
- Do not format the memory card using a computer.
- Before using a memory card with this camera, format the card using this camera if the card has been used with another device. Before using a new memory card, we recommend using this camera to format the card.
- Note that **formatting a memory card permanently deletes all images and other data on the memory card**. If there is data saved on the memory card that you wish to keep, copy that data to a computer before formatting.
- If the message **Card is not formatted. Format card?** is displayed when you insert a memory card, the memory card must be formatted. If there is data on the memory card that you do not want to delete, press flexible button 4 (**X No**). Copy that data to a computer before formatting. To format the memory card, press flexible button 3 (**O Yes**).
- Observe the following precautions while formatting the memory card, saving and deleting images, and copying images to a computer, otherwise data on the memory card itself may be damaged.
 - Do not open the battery-chamber/memory card slot cover or internal cover or remove the memory card or batteries.
 - Do not turn off the camera

Cleaning and Storage

Cleaning

Do not use alcohol, thinner, or other volatile chemicals.

Lens	When cleaning the lens, avoid touching it directly with your fingers. Remove dust or lint with a blower. To remove fingerprints, oil, or other grime that cannot be removed with a blower, wipe the lens with a soft, dry cloth or an eyeglass cleaning cloth, using a gentle spiral motion that starts in the center and moves toward the edges. Do not wipe forcefully or wipe with a rough cloth, otherwise the camera may be damaged or malfunction. If you still cannot remove the grime, wet a soft cloth with a commercial liquid lens cleaner and gently wipe off the grime.
Monitor	Remove dust or lint with a blower. To remove fingerprints, oil, or other grime, wipe the area with a soft, dry cloth or an eyeglass cleaning cloth. Do not wipe forcefully or wipe with a rough cloth, otherwise the camera may be damaged or malfunction.
Body	<ul style="list-style-type: none">• Remove dust or lint with a blower. Wipe with a soft, dry cloth.• After using the camera underwater or at the beach, gently wipe off any sand or salt with a soft cloth lightly dampened with fresh water and dry thoroughly.• If you handle the camera using hands where sunscreen lotion is applied, this could cause deterioration of the camera exterior. <p>Note that foreign matter inside the camera could cause damage not covered by the warranty.</p>



More Information

See "Notes About Waterproof and Dustproof Performances" (📖 xvi) and "Cleaning After Using the Camera Underwater" (📖 xviii) for more information.

Storage







Remove the batteries if the camera will not be used for an extended period. To prevent mold or malfunction and to ensure long, trouble-free use of the camera, we recommend you insert the batteries and operate the camera approximately once a month. Do not store the camera with naphtha or camphor moth balls, or in any of the following locations:





- Next to equipment that produces strong electromagnetic fields, such as televisions or radios
- Places that are exposed to temperatures below $-10\text{ }^{\circ}\text{C}$ ($14\text{ }^{\circ}\text{F}$) or above $50\text{ }^{\circ}\text{C}$ ($122\text{ }^{\circ}\text{F}$)
- Places that are poorly ventilated or subject to humidity of over 60%

Troubleshooting

If the camera fails to function as expected, check the list of common problems below before consulting your retailer or Nikon-authorized service representative.

Power, Display, Settings Issues







Problem	Cause/Solution	
Camera turns off without warning.	<ul style="list-style-type: none">• Battery is exhausted.• Camera has turned off automatically to save power.• The camera or battery have become too cold and cannot operate properly.	18 19  5
Monitor is blank.	<ul style="list-style-type: none">• Camera is off.• Battery exhausted.• Standby mode for saving power: press the power switch, the shutter-release button,  (shooting/playback mode) button, or  movie-record button.• When flash lamp flashes, wait until flash has charged.• Camera and computer are connected via USB cable.• Camera and TV are connected via audio/video cable.	19 18 2, 19 44 64, 69 64,  11
Monitor is hard to read.	<ul style="list-style-type: none">• Adjust monitor brightness.• Monitor is dirty. Clean monitor.	80,  42  8





Problem	Cause/Solution	
Date and time of recording are not correct.	<ul style="list-style-type: none"> If camera clock has not been set, "Date not set" indicator flashes during shooting and movie recording. Images and movies saved before clock is set are dated "00/00/0000 00:00" or "01.01.12 00:00" respectively. The shooting date and time of still images is not displayed during playback. Set the correct time and date from the Date and time option in the setup menu. Check camera clock regularly against more accurate timepieces and reset as required. 	15, 80,  42
Print date not available.	Time and date has not been set.	15, 80,  42
Date not imprinted on images even when Print date is enabled.	The date cannot be imprinted on movies.	80,  43
Screen for setting time and date is displayed when camera is turned on. Camera settings reset.	Clock battery is exhausted; all settings were restored to their default values.	15, 17
Camera becomes hot.	The camera may become hot when shooting movies for an extended period of time, or when the camera is used in a hot area; this is not a malfunction.	–



Characteristics of Digital Cameras

In extremely rare instances, unusual characters may appear in the monitor and the camera may stop functioning. In most cases, this phenomenon is caused by a strong external static charge. Turn the camera off, remove and replace the battery, then turn the camera on again. In the event of continued malfunction, contact your retailer or Nikon-authorized service representative. Note that disconnecting the power source as described above may result in the loss of any data not saved to internal memory or the memory card at the time the problem occurred. Data already saved will not be affected.

Shooting Issues









Problem	Cause/Solution	
Cannot switch to shooting mode.	Disconnect the USB cable.	64, 69,  14
No image captured when the shutter-release button is pressed.	• When camera is in playback mode, press the  (shooting/playback mode) button, the shutter-release button, or the  (movie-record) button.	25
	• When menus are displayed, press flexible button 1 () or the multi selector  .	7
	• Battery is exhausted.	18
	• When flash lamp flashes, flash is charging.	44
Camera cannot focus.	• Subject is too close. Try shooting with  (auto) mode or setting Choose a style to Shoot close-ups .	30, 37
	• The intended subject is one with which autofocus does not perform well.	24
	• Turn camera off and then on again.	19
Images are blurred.	• Use flash.	44
	• Use tripod and self-timer.	45



Problem	Cause/Solution	
Streaks of light or partial discoloration are visible in the monitor.	Smear occurs when extremely bright light strikes the image sensor. When recording movies, avoiding bright objects, such as the sun, reflections of the sun, and electric lights is recommended.	74,  4
Bright specks appear in images captured with flash.	Flash is reflecting off particles in air. Set the flash mode setting to  Flash off .	44
Flash does not fire.	<ul style="list-style-type: none"> • The flash mode is set to  Flash off. • Choose a style is set to a feature that disables the flash. 	44 53
Optical zoom cannot be used.	Optical zoom cannot be used while recording movies.	74
Digital zoom cannot be used.	When Choose a style is set to Shoot under water , Take soft pictures , or Create a diorama effect in the shooting menu, digital zoom cannot be used.	38, 40, 41
No sound when shutter is released.	<ul style="list-style-type: none"> • The shutter sound is turned off using Change sounds in the shooting menu. Even if the shutter sound is not turned off, the shutter sound is not heard depending on the shooting mode and current settings. • Do not block the speaker. 	42 2
Images appear smeared.	Lens is dirty. Clean lens.	 8
Colors are unnatural.	Hue does not match light source.	32, 39
Randomly spaced bright pixels ("noise") appear in image.	The subject is dark, so shutter speed is too slow or ISO sensitivity is too high. Noise can be reduced by using flash.	44

Problem	Cause/Solution	
Images are too dark (underexposed).	<ul style="list-style-type: none"> The flash mode is set to  Flash off. Flash window is blocked. Subject is beyond flash range. Adjust exposure compensation. 	44 20 44 34
Images are too bright (overexposed).	Adjust exposure compensation.	34
Saving images takes time.	<p>It may take more time to save images in the following situations.</p> <ul style="list-style-type: none"> When the noise reduction function is in operation, such as when shooting in a dark environment When the skin softening function is applied while shooting 	– 30, 58

Playback Issues

Problem	Cause/Solution	
File cannot be played back.	<ul style="list-style-type: none"> File or folder was overwritten or renamed by computer or other make of camera. This camera is not able to play back movies recorded with another make or model of digital camera. 	– 78
Cannot zoom in on image.	<ul style="list-style-type: none"> Playback zoom cannot be used with movies, small pictures, or images that have been cropped to a size of 320 × 240 or smaller. This camera may not be able to zoom in on images captured with another make or model of digital camera. 	–

Problem	Cause/Solution	
One of these features cannot be used: Change colors, Highlight colors, Decorate, Soften pictures, Add starbursts, Add a fisheye effect, Add a diorama effect, Small picture, or Crop	<ul style="list-style-type: none"> • These options cannot be used with movies. • Images created using Photo albums cannot be edited. • Editing functions other than Small picture cannot be added to images captured using Decorate. • Images cannot be cropped when played back using View favorites. • You cannot apply the same editing feature multiple times to the same image. • Camera is unable to edit images captured with other cameras. 	– 63,  26 35 63,  24 62,  2,  3 62,  2,  3
Cannot rotate image.	The camera cannot rotate images captured with another make or model of digital camera.	–
Images are not displayed on TV.	<ul style="list-style-type: none"> • Video mode is not correctly set in the setup menu. • Memory card contains no images. Replace the memory card. Remove the memory card to play back images from the internal memory. 	80,  47 12
Nikon Transfer 2 does not start when camera is connected.	<ul style="list-style-type: none"> • Camera is off. • Battery is exhausted. • USB cable is not correctly connected. • Camera is not recognized by the computer. • Confirm system requirements. • Computer is not set to start Nikon Transfer 2 automatically. For more information about Nikon Transfer 2, refer to help information contained in ViewNX 2. 	19 18 64, 69 – 66 69
Images to be printed are not displayed.	<ul style="list-style-type: none"> • Memory card contains no images. Replace the memory card. • Remove the memory card to print images from the internal memory. 	12

Problem	Cause/Solution	
Cannot select paper size with camera.	<p>Paper size cannot be selected from the camera in the following situations, even when printing from a PictBridge-compatible printer. Use the printer to select paper size.</p> <ul style="list-style-type: none"> • The printer does not support the paper sizes specified by the camera. • The printer automatically selects the paper size. 	<p>64,  17,  18 –</p>

Specifications

Nikon COOLPIX S30 Digital Camera

Type	Compact digital camera
Effective pixels	10.1 million
Image sensor	1/3-in. type CCD; approx. 10.44 million total pixels
Lens	3× optical zoom, NIKKOR lens
Focal length	4.1-12.3mm (angle of view equivalent to that of 29.1-87.3 mm lens in 35mm [135] format)
f/-number	f/3.3-5.9
Construction	6 elements in 5 groups
Digital zoom	Up to 4× (angle of view equivalent to that of approx. 349 mm lens in 35mm [135] format)
Vibration reduction	Electronic VR (still pictures)
Autofocus (AF)	Contrast-detect AF
Focus range (from the protective glass)	<ul style="list-style-type: none">• [W]: Approx. 30 cm (1 ft) to ∞, [T]: Approx. 50 cm (1 ft 8 in.) to ∞• Shoot close-ups, Shoot under water, Photograph food, Highlight colors, Take soft pictures, Create a diorama effect: Approx. 5 cm (2 in.) (wide-angle position) to ∞
Focus-area selection	Center, face detection
Monitor	6.7-cm (2.7-in.), approx. 230k-dot, TFT LCD with 5-level brightness adjustment
Frame coverage (shooting mode)	Approx. 98% horizontal and 98% vertical
Frame coverage (playback mode)	Approx. 100% horizontal and 100% vertical

Storage	
Media	Internal memory (approx. 47 MB), SD/SDHC/SDXC memory card
File system	DCF, Exif 2.3, and DPOF compliant
File formats	Still pictures: JPEG Messages: WAV Movies: AVI (Motion-JPEG compliant)
Image mode (image types)	<ul style="list-style-type: none"> • 10M [3648 × 2736] • 4M [2272 × 1704] • 2M [1600 × 1200]
ISO sensitivity (Standard output sensitivity)	Auto (auto gain from ISO 80 to 1600)
Exposure	
Metering	256-segment matrix, center-weighted (digital zoom less than 2×), spot (digital zoom 2× or more)
Exposure control	Programmed auto exposure with motion detection and exposure compensation (–2.0 to +2.0 EV in steps of $\frac{1}{3}$ EV)
Shutter	
Speed	<ul style="list-style-type: none"> • $\frac{1}{2000}$–1 s • 4 s (Choose a style is set to Photograph fireworks)
Aperture	
Range	2 steps (f/3.3 and f/9.3 [W])
Self-timer	Approx. 10 s, smile timer
Built-in flash	
Range (approx.) (ISO sensitivity: Auto)	[W]: 0.3 to 3.5 m (1 ft to 11 ft) [T]: 0.5 to 2.0 m (1 ft 8 in. to 6 ft 7 in.)
Flash control	TTL auto flash with monitor preflashes
Interface	
Data transfer protocol	MTP, PTP
Video output	Can be selected from NTSC and PAL

I/O terminal	Audio/video (A/V) output; digital I/O (USB)
Supported languages	Arabic, Chinese (Simplified and Traditional), Czech, Danish, Dutch, English, Finnish, French, German, Greek, Hindi, Hungarian, Indonesian, Italian, Japanese, Korean, Norwegian, Polish, Portuguese (European and Brazilian), Romanian, Russian, Spanish, Swedish, Thai, Turkish, Ukrainian, Vietnamese
Power sources	<ul style="list-style-type: none"> • Two LR6/L40 (AA-size) alkaline batteries • Two FR6/L91 (AA-size) lithium batteries • Two EN-MH2 rechargeable Ni-MH batteries (available separately)
Battery life	<p>Still pictures¹:</p> <ul style="list-style-type: none"> • Approx. 240 shots when using alkaline batteries • Approx. 700 shots when using lithium batteries • Approx. 410 shots when using EN-MH2 batteries <p>Movies:</p> <ul style="list-style-type: none"> • Approx. 50 min when using alkaline batteries (Large (720p)) • Approx. 3 h 45 min when using lithium batteries (Large (720p)) • Approx. 2 h 25 min when using EN-MH2 batteries (Large (720p)) <p>The maximum file size for a single movie is 4 GB and the maximum movie length for a single movie is 29 minutes, even when there is sufficient free space on the memory card for longer recording.</p>
Tripod socket	1/4 (ISO 1222)
Dimensions (W × H × D)	Approx. 101.9 × 64.8 × 39.4 mm (4.1 × 2.6 × 1.6 in.) (excluding projections)
Weight	Approx. 214 g (7.6 oz) (including battery and SD memory card)
Operating environment	
Temperature	0°C to 40°C (32°F to 104°F)
Humidity	85% and below (no condensation)
Waterproof	<p>JIS/IEC protection class 8 (IPX8) equivalent (under our testing conditions)</p> <p>Capacity to shoot pictures underwater up to a depth of 3 m (9.8 ft) and for 60 minutes</p>
Dustproof	JIS/IEC protection class 6 (IP6X) equivalent (under our testing conditions)

Shockproof

Cleared our testing conditions² compliant with MIL-STD 810F Method 516.5-Shock

- Unless otherwise stated, all figures are for a camera with fully-charged LR6/L40 (AA-size) alkaline batteries operated at an ambient temperature of 25°C (77°F). Data for lithium batteries apply when using two commercially available FR6/L91 (AA-size) Energizer(R) Ultimate Lithium batteries.
- ¹ Based on Camera and Imaging Products Association (CIPA) standards for measuring the life of camera batteries. Measured at 23 (±2)°C (73 (±4)°F); zoom adjusted with each shot, flash fired with every other shot, **Choose a size > Photos** set to **Large (10 megapixels)** (3648×2736). Battery life may vary depending on shooting interval and length of time menus and images are displayed.
The included batteries are for trial use only.
 - ² Dropped from a height of 80 cm (32 in.) onto a surface of 5 cm (2 in.) thick plywood (changes in appearance, such as paint peeling off and deformation of the drop shock portion and waterproof performance are not subject to the test). These tests do not guarantee that the camera will be free from damage or trouble under all conditions.



Specifications

- Nikon will not be held liable for any errors this manual may contain.
- The appearance of this product and its specifications are subject to change without notice.

Supported Standards

- **DCF:** Design Rule for Camera File System is a standard widely used in the digital camera industry to ensure compatibility among different makes of camera.
- **DPOF:** Digital Print Order Format is an industry-wide standard that allows images to be printed from print orders saved on memory cards.
- **Exif version 2.3:** Exchangeable image file format (Exif) version 2.3 for digital still cameras is a standard that allows information saved with photographs to be used for optimal color reproduction when images are output from Exif-compliant printers.
- **PictBridge:** A standard developed cooperatively by the digital camera and printer industries, allowing photographs to be output directly to a printer without connecting the camera to a computer.

Index

Symbols

Auto mode.....	18
Playback mode.....	25
Setup menu.....	80
(shooting/playback mode) button...	3
.AVI.....	51
.JPG.....	51
.WAV.....	51

A

Add a diorama effect.....	62, 2, 7
Add a fisheye effect.....	62, 2, 7
Add starbursts.....	62, 2, 6
Adding images to albums.....	23
Alkaline batteries.....	11
Aperture value.....	23
Audio/video cable.....	65, 11, 53
Audio/video-in jack.....	65, 11
Auto flash.....	44
Auto off.....	19
Autofocus.....	24

B

Battery.....	10, 17
Battery chamber.....	3
Battery charger.....	53
Battery level.....	18
Battery type.....	80, 50

Battery-chamber/memory card slot cover.....	3, 12
Brightness.....	34
Brush.....	ii
Button sound.....	42

C

Change colors.....	31, 32, 62, 2, 4
Change sounds.....	31, 42
Changing the size.....	49
Choose a size.....	31
Choose a style.....	31, 36
Choose by date.....	63, 29
Compression ratio.....	49
Computer.....	65, 69
Copying images.....	63, 33
Create a diorama effect	41
Crop.....	60, 9

D

Date and time.....	15, 80, 42
Date format.....	16, 42
Daylight saving time.....	16, 42
Decorate.....	31, 35, 62, 2, 5
Delete.....	26
Digital zoom.....	21
Direct print.....	65, 13
DPOF.....	21

DPOF print.....	20
DSCN.....	51
E	
Electronic VR.....	80, 44
EN-MH1.....	5
EN-MH2.....	11, 53
Erase.....	63, 40
Erase recordings.....	39
Exchange messages.....	63, 36
Exposure compensation.....	34
Extension.....	51
Eyelet for camera strap.....	2
F	
Face detection.....	56
Favorites.....	63, 22
File name.....	51
Firmware version.....	80, 50
Flash.....	2, 31, 44
Flash lamp.....	3
Flash mode.....	44
Flash off.....	44
Flexible buttons.....	7
Focus.....	22, 56
Focus indicator.....	5
Focus lock.....	57
Folder name.....	51
Format internal memory.....	80, 45
Format memory cards.....	13, 80, 45
Formatting.....	13, 80, 45
FSCN.....	51

Full-frame playback.....	25
Full-time AF.....	52
H	
Have fun with pictures.....	62
Highlight colors.....	40, 62, 2, 4
Hue.....	34
I	
Identifier.....	51
Imprinting date and time.....	17, 43
Internal cover.....	3
Internal memory.....	14
L	
Language.....	80, 46
Lens.....	2, 17
Lithium batteries.....	11
M	
Memory capacity.....	18
Memory card.....	12
Memory card slot.....	3, 12
Menu background.....	80, 47
Microphone.....	2
Monitor.....	3, 5, 8
Monitor brightness.....	80, 42
Movie AF.....	31, 52
Movie length.....	76
Movie playback.....	77
Movie recording.....	74
Multi selector.....	3

N

Nickel-metal hydride rechargeable batteries	11
Nikon Transfer 2	66, 68, 70
Number of exposures remaining ...	18, 51

O

Optical zoom	21
Optional accessories	53

P

Panorama Maker 6	68
Paper size	17, 18
Photo albums	63, 26
Photograph fireworks 	41
Photograph food 	39
PictBridge	65, 13, 21
Play recordings	39
Playback	25, 77
Playback menu	62, 22
Playback mode	25
Playback zoom	60
Playing back images in albums	24
Point and shoot 	37
Power	18, 19
Power switch/power-on lamp ...	2, 18, 19
Pressing halfway	23
Print	65, 16, 18, 31
Print date	17, 80, 43
Print order	63, 31
Print order date option	17, 32
Printer	65, 13

R

Rechargeable battery	53
Recording movies	74
Removing images from albums	25
Reset all	80, 48
Rotate pictures	63, 30
RSCN	51

S





Self-timer	31, 45
Self-timer lamp	2, 46
Set up	31
Setup menu	80
Shoot at intervals 	39
Shoot close-ups 	37
Shoot under water 	38
Shooting	20, 22
Shutter sound	42
Shutter speed	23
Shutter-release button	2, 22
Single AF	52
Slide show	63, 27
Small picture	63, 8
Smile timer	47
Soften pictures	62, 2, 6
Speaker	2
SSCN	51
Strap	4

T

Take a series of pictures 	38
Take soft pictures 	40

Thumbnail display	61
Tripod socket	3,  19
TV	65,  11

U

USB cable	64, 69,  15,  53
USB/audio/video output connector	3, 64, 69,  11,  13
Using skin softening	58

V

Video mode	80,  47
View	63
ViewNX 2	66, 68
Vividness	34
Volume	78

W

Welcome screen	80,  41
----------------------	--

Z

Zoom	21
Zoom in	21
Zoom out	21



A series of ten horizontal dashed lines spanning the width of the page, intended for handwriting practice.



A series of ten horizontal dashed lines spanning the width of the page, intended for handwriting practice.



A series of ten horizontal dashed lines spanning the width of the page, intended for handwriting practice.

Nikon

No reproduction in any form of this manual, in whole or in part (except for brief quotation in critical articles or reviews), may be made without written authorization from NIKON CORPORATION.

NIKON CORPORATION

© 2012 Nikon Corporation



CT2A01(11)
6MNA4911-01