

***Nikon***

DIGITAL CAMERA

# COOLPIX S6500

## Reference Manual





**En**



# Highlight Features of the COOLPIX S6500

Image editing effects that are fun and easy to apply while shooting

## **Quick effects** ..... **30, 39**

Create images with effects in three easy steps, simply by shooting, selecting, and saving. Thirty effects are available. Just as with a smartphone application, you can preview the results of each effect on the image and choose your favorite one to suit the scene or your mood. You can also apply effects to images later by pressing the  button during playback (33).

Autofocus function that automatically determines the subject

## **Target finding AF** ..... **75**

The **Target finding AF** function allows the camera to determine the main subject of the image, such as a person, flower, or small object. The camera automatically focuses on the subject, letting you freely compose the image without worrying about the focus. In addition, the camera automatically adjusts the focus area to match the size of the subject, ensuring a sharp focus on the intended subject.

Remotely controlling the camera using a smart device

## **Wi-Fi (wireless LAN) function** ..... **107**

The camera's built-in Wi-Fi (wireless LAN) function\* allows you to remotely release the shutter of the camera by operating a smart device that is wirelessly connected to the camera. The camera's monitor view is displayed on the screen of the wirelessly connected smart device, enabling you to remotely zoom the camera in or out on the subject. You can also transfer saved images from the camera to the smart device.

\* To use the Wi-Fi (wireless LAN) function, Wireless Mobile Utility must be installed on the smart device (108).

**Introduction**

**Parts of the Camera**

**The Basics of Shooting and Playback**

**Shooting Features**

**Playback Features**

**Recording and Playing Back Movies**

**General Camera Setup**

**Using the Wi-Fi (Wireless LAN) Feature**

**Reference Section**

**Technical Notes and Index**

# Read This First

Thank you for purchasing the Nikon COOLPIX S6500 digital camera. Before using the camera, please read the information in "For Your Safety" (📖viii-x) and familiarize yourself with the information provided in this manual. After reading, please keep this manual handy and refer to it to enhance your enjoyment of your new camera.

## About This Manual





If you want to start using the camera right away, see “The Basics of Shooting and Playback” (📖13).

To learn about the parts of the camera and information that is displayed in the monitor, see “Parts of the Camera” (📖1).

## Other Information

- Symbols and Conventions

To make it easier to find the information you need, the following symbols and conventions are used in this manual:

Symbol	Description
	This icon indicates cautions and information that should be read before using the camera.
	This icon indicates notes and information that should be read before using the camera.
	These icons indicate other pages containing relevant information;  : "Reference Section",  : "Technical Notes and Index."

- SD and SDHC/SDXC memory cards are referred to as "memory cards" in this manual.
- The setting at the time of purchase is referred to as the "default setting."
- The names of menu items displayed in the camera monitor, and the names of buttons or messages displayed on a computer monitor appear in bold.
- In this manual, images are sometimes omitted from monitor display samples so that monitor indicators can be more clearly shown.
- Illustrations and monitor content shown in this manual may differ from the actual product.

## Information and Precautions

### Life-Long Learning

As part of Nikon's "Life-Long Learning" commitment to ongoing product support and education, continually updated information is available online at the following sites:

- For users in the U.S.A.: <http://www.nikonusa.com/>
- For users in Europe and Africa: <http://www.europe-nikon.com/support/>
- For users in Asia, Oceania, and the Middle East: <http://www.nikon-asia.com/>

Visit these sites to keep up-to-date with the latest product information, tips, answers to frequently asked questions (FAQs), and general advice on digital imaging and photography. Additional information may be available from the Nikon representative in your area. Visit the site below for contact information:

<http://imaging.nikon.com/>

### Use Only Nikon Brand Electronic Accessories

Nikon COOLPIX cameras are designed to the highest standards and include complex electronic circuitry. Only Nikon brand electronic accessories (including battery chargers, batteries, Charging AC adapters, and AC adapters) certified by Nikon specifically for use with this Nikon digital camera are engineered and proven to operate within the operational and safety requirements of this electronic circuitry.

THE USE OF NON-NIKON ELECTRONIC ACCESSORIES COULD DAMAGE THE CAMERA AND MAY VOID YOUR NIKON WARRANTY.

The use of third-party rechargeable Li-ion batteries not bearing the Nikon holographic seal could interfere with normal operation of the camera or result in the batteries overheating, igniting, rupturing, or leaking.

For more information about Nikon brand accessories, contact a local authorized Nikon dealer.

**Holographic seal:** Identifies this device as an authentic Nikon product.



### Before Taking Important Pictures

Before taking pictures on important occasions (such as at weddings or before taking the camera on a trip), take a test shot to ensure that the camera is functioning normally. Nikon will not be held liable for damages or lost profits that may result from product malfunction.

## About the Manuals

- No part of the manuals included with this product may be reproduced, transmitted, transcribed, stored in a retrieval system, or translated into any language in any form, by any means, without Nikon's prior written permission.
- Nikon reserves the right to change the specifications of the hardware and software described in these manuals at any time and without prior notice.
- Nikon will not be held liable for any damages resulting from the use of this product.
- While every effort was made to ensure that the information in these manuals is accurate and complete, we would appreciate it were you to bring any errors or omissions to the attention of the Nikon representative in your area (address provided separately).

## Notice Concerning Prohibition of Copying or Reproduction

Note that simply being in possession of material that was digitally copied or reproduced by means of a scanner, digital camera or other device may be punishable by law.

### • **Items prohibited by law from being copied or reproduced**

Do not copy or reproduce paper money, coins, securities, government bonds or local government bonds, even if such copies or reproductions are stamped "Sample." The copying or reproduction of paper money, coins, or securities which are circulated in a foreign country is prohibited. Unless the prior permission of the government was obtained, the copying or reproduction of unused postage stamps or post cards issued by the government is prohibited.

The copying or reproduction of stamps issued by the government and of certified documents stipulated by law is prohibited.

### • **Cautions on certain copies and reproductions**

The government has issued cautions on copies or reproductions of securities issued by private companies (shares, bills, checks, gift certificates, etc.), commuter passes, or coupon tickets, except when a minimum of necessary copies are to be provided for business use by a company. Also, do not copy or reproduce passports issued by the government, licenses issued by public agencies and private groups, ID cards and tickets, such as passes and meal coupons.

### • **Comply with copyright notices**

The copying or reproduction of copyrighted creative works such as books, music, paintings, woodcut prints, maps, drawings, movies, and photographs is governed by national and international copyright laws. Do not use this product for the purpose of making illegal copies or to infringe copyright laws.

## Disposing of Data Storage Devices

Please note that deleting images or formatting data storage devices such as memory cards or built-in camera memory does not completely erase the original image data. Deleted files can sometimes be recovered from discarded storage devices using commercially available software, potentially resulting in the malicious use of personal image data. Ensuring the privacy of such data is the user's responsibility.

Before discarding a data storage device or transferring ownership to another person, erase all data using commercial deletion software, or format the device and then completely refill it with images containing no private information (for example, pictures of empty sky). Be sure to also replace any pictures selected for the **Select an image** option in the **Welcome screen** setting (📖104). Care should be taken to avoid injury or damage to property when physically destroying data storage devices.

# For Your Safety

To prevent damage to your Nikon product or injury to yourself or to others, read the following safety precautions in their entirety before using this equipment. Keep these safety instructions where all those who use the product will read them.

The consequences that could result from failure to observe the precautions listed in this section are indicated by the following symbol:



This icon marks warnings, information that should be read before using this Nikon product, to prevent possible injury.

## WARNINGS

### **Turn off in the event of malfunction**

Should you notice smoke or an unusual smell coming from the camera or Charging AC Adapter, unplug the Charging AC Adapter and remove the battery immediately, taking care to avoid burns. Continued operation could result in injury. After removing or disconnecting the power source, take the equipment to a Nikon-authorized service representative for inspection.

### **Do not disassemble**

Touching the internal parts of the camera or Charging AC Adapter could result in injury. Repairs should be performed only by qualified technicians. Should the camera or Charging AC Adapter break open as the result of a fall or other accident, take the product to a Nikon-authorized service representative for inspection, after

unplugging the product and/or removing the battery.

### **Do not use the camera or Charging AC Adapter in the presence of flammable gas**

Do not use electronic equipment in the presence of flammable gas, as this could result in explosion or fire.

 **Handle the camera strap with care**  
Never place the strap around the neck of an infant or child.

 **Keep out of reach of children**  
Particular care should be taken to prevent infants from putting the battery or other small parts into their mouths.

 **Do not remain in contact with the camera, battery charger, or AC adapter for extended periods while the devices are on or in use**

Parts of the devices become hot. Leaving the devices in direct contact with the skin for extended periods may result in low-temperature burns.

 **Observe caution when handling the battery**

The battery may leak, overheat, or explode if improperly handled. Observe the following precautions when handling the battery for use in this product:

- Before replacing the battery, turn the product off. If you are using the Charging AC Adapter/AC adapter, be sure it is unplugged.
- Use only a Rechargeable Li-ion Battery EN-EL19 (included). Charge the battery by using a camera that supports battery charging or by using a Battery Charger MH-66 (available separately). To charge the battery with the camera, use either Charging AC Adapter EH-70P (included) or the **Charge by computer** function.
- When inserting the battery, do not attempt to insert it upside down or backwards.
- Do not short or disassemble the battery or attempt to remove or break the battery insulation or casing.
- Do not expose the battery to flame or to excessive heat.
- Do not immerse in or expose to water.

- Put the battery in the battery case before transporting it. Do not transport or store with metal objects such as necklaces or hairpins.
- The battery is prone to leakage when fully discharged. To avoid damage to the product, be sure to remove the battery when no charge remains.
- Discontinue use immediately should you notice any change in the battery, such as discoloration or deformation.
- If liquid from the damaged battery comes in contact with clothing or skin, rinse immediately with plenty of water.

 **Observe the following precautions when handling the Charging AC Adapter**

- Keep dry. Failure to observe this precaution could result in fire or electric shock.
- Dust on or near the metal parts of the plug should be removed with a dry cloth. Continued use could result in fire.
- Do not handle the plug or go near the Charging AC Adapter during lightning storms. Failure to observe this precaution could result in electric shock.
- Do not damage, modify, forcibly tug or bend the USB cable, place it under heavy objects, or expose it to heat or flames. Should the insulation be damaged and the wires become exposed, take it to a Nikon-authorized service representative for inspection. Failure to observe these precautions could result in fire or electric shock.

- Do not handle the plug or Charging AC Adapter with wet hands. Failure to observe this precaution could result in electric shock.
- Do not use with travel converters or adapters designed to convert from one voltage to another or with DC-to-AC inverters. Failure to observe this precaution could damage the product or cause overheating or fire.

### **Use appropriate cables**

When connecting cables to the input and output jacks, use only the cables provided or sold by Nikon for the purpose, to maintain compliance with product regulations.

### **Handle moving parts with care**

Be careful that your fingers or other objects are not pinched by the lens cover or other moving parts.

### **CD-ROMs**

The CD-ROMs included with this device should not be played back on audio CD equipment. Playing CD-ROMs on an audio CD player could cause hearing loss or damage the equipment.

### **Observe caution when using the flash**

Using the flash close to your subject's eyes could cause temporary visual impairment. Particular care should be observed if photographing infants, when the flash should be no less than 1 m (3 ft 4 in.) from the subject.

### **Do not operate the flash with the flash window touching a person or object**

Failure to observe this precaution could result in burns or fire.

### **Avoid contact with liquid crystal**

Should the monitor break, care should be taken to avoid injury caused by broken glass and to prevent liquid crystal from the monitor touching the skin or entering the eyes or mouth.

### **Turn the power off when using inside an airplane or the hospital**

Turn the power off while inside the airplane during take off or landing. Follow the instructions of the hospital when using while in a hospital. The electromagnetic waves given out by this camera may disrupt the electronic systems of the airplane or the instruments of the hospital. Remove the Eye-Fi card, which can be the cause of the disruption, beforehand if inserted in the camera.

### **3D Images**

Do not continuously view 3D images recorded with this device for extended periods, whether on a television, monitor, or other display.

In the case of children whose visual systems are still maturing, consult a pediatrician or ophthalmologist prior to use and follow their instructions.

Prolonged viewing of 3D images may cause eye strain, nausea, or discomfort. Cease use should any of these symptoms occur and consult a physician if necessary.

# Notices

## Notices for Customers in the U.S.A.

### IMPORTANT SAFETY INSTRUCTIONS -

#### SAVE THESE INSTRUCTIONS.

#### **DANGER - TO REDUCE THE RISK OF FIRE OR ELECTRIC SHOCK, CAREFULLY FOLLOW THESE INSTRUCTIONS**

For connection to a supply not in the U.S.A., use an attachment plug adapter of the proper configuration for the power outlet if needed.

The power supply unit is intended to be correctly orientated in a vertical or floor mount position.

#### **Federal Communications Commission (FCC) Radio Frequency Interference Statement**

This equipment has been tested and found to comply with the limits for a Class B digital device, pursuant to Part 15 of the FCC rules. These limits are designed to provide reasonable protection against harmful interference in a residential installation. This equipment generates, uses, and can radiate radio frequency energy and, if not installed and used in accordance with the

instructions, may cause harmful interference to radio communications. However, there is no guarantee that interference will not occur in a particular installation. If this equipment does cause harmful interference to radio or television reception, which can be determined by turning the equipment off and on, the user is encouraged to try to correct the interference by one or more of the following measures:

- Reorient or relocate the receiving antenna.
- Increase the separation between the equipment and receiver.
- Connect the equipment into an outlet on a circuit different from that to which the receiver is connected.
- Consult the dealer or an experienced radio/television technician for help.



*Nikon*

COOLPIX S6500

### CAUTIONS

#### Modifications

The FCC requires the user to be notified that any changes or modifications made to this device that are not expressly approved by Nikon Corporation may void the user's authority to operate the equipment.

## Interface Cables

Use the interface cables sold or provided by Nikon for your equipment. Using other interface cables may exceed the limits of Class B Part 15 of the FCC rules.

## Notice for customers in the State of California

### WARNING

Handling the cord on this product will expose you to lead, a chemical known to the State of California to cause birth defects or other reproductive harm.

### ***Wash hands after handling.***

Nikon Inc.,  
1300 Walt Whitman Road  
Melville, New York 11747-3064  
USA  
Tel: 631-547-4200

## Notice for customers in Canada

### CAUTION

This Class B digital apparatus complies with Canadian ICES-003.

### ATTENTION

Cet appareil numérique de la classe B est conforme à la norme NMB-003 du Canada.

## Notices for customers in Europe

### CAUTIONS

### **RISK OF EXPLOSION IF BATTERY IS REPLACED BY AN INCORRECT TYPE.**

### **DISPOSE OF USED BATTERIES ACCORDING TO THE INSTRUCTIONS.**

This symbol indicates that this product is to be collected separately.



The following apply only to users in European countries:

- This product is designated for separate collection at an appropriate collection point. Do not dispose of as household waste.
- For more information, contact the retailer or the local authorities in charge of waste management.

This symbol on the battery indicates that the battery is to be collected separately.



The following apply only to users in European countries:

- All batteries, whether marked with this symbol or not, are designated for separate collection at an appropriate collection point. Do not dispose of as household waste.
- For more information, contact the retailer or the local authorities in charge of waste management.

# Wi-Fi (Wireless LAN Network)

This product is controlled by the United States Export Administration Regulations, and you are required to obtain permission from the United States government if you export or re-export this product to any country to which the United States embargoes goods. The following countries were subject to embargo: Cuba, Iran, North Korea, Sudan, and Syria. Since the target countries are subject to change, please contact the United States Department of Commerce for the latest information.

## **Restrictions on Wireless Devices**

The wireless transceiver included in this product conforms to wireless regulations in the country of sale and is not for use in other countries (products purchased in the EU or EFTA can be used anywhere within the EU and EFTA). Nikon does not accept liability for use in other countries. Users who are unsure as to the original country of sale should consult with their local Nikon service center or Nikon-authorized service representative. This restriction applies to wireless operation only and not to any other use of the product.

## **Notice for Customers in the U.S.A. and Canada**

### **Federal Communications Commission (FCC) and Industry of Canada (IC)**

#### **Declaration of Conformity**

This device complies with Part 15 of FCC Rules and Industry Canada licence-exempt RSS standard(s). Operation is subject to the following two conditions: (1) this device may not cause interference, and (2) this device must accept any interference, including interference that may cause undesired operation of this device.

#### **FCC/IC RF Exposure Statement**

This transmitter must not be co-located or operated in conjunction with any other antenna or transmitter.

The available scientific evidence does not show that any health problems are associated with using low power wireless devices. There is no proof, however, that these low power wireless devices are absolutely safe. Low power wireless devices emit low levels of radio frequency energy (RF) in the microwave range while being used. Whereas high levels of RF can produce health effects (by heating tissue), exposure of low-level RF that does not produce heating effects causes no known adverse health effects. Many studies of low-level RF exposures have not found any biological effects. Some studies have suggested that some biological effects might occur, but such findings have not been confirmed by additional research.

COOLPIX S6500 (FCC ID:CGJ5149EB/IC ID:4634A-5149EB) has been tested and found to comply with FCC/IC radiation exposure limits set forth for an uncontrolled environment and meets the FCC radio frequency (RF) Exposure Guidelines in Supplement C to OET65 and RSS-102 of the IC radio frequency (RF) Exposure rules. Please refer to the SAR test report that was uploaded to FCC website.

### **Declaration of Conformity**

Hereby, Nikon Corporation, declares that COOLPIX S6500 is in compliance with the essential requirements and other relevant provisions of Directive 1999/5/EC. The declaration of conformity may be consulted at [http://imaging.nikon.com/support/pdf/DoC\\_S6500.pdf](http://imaging.nikon.com/support/pdf/DoC_S6500.pdf).

## Precautions when Using Radio Transmissions

- Always keep in mind that radio transmission or reception of data is subject to interception by third parties. Note that Nikon is not responsible for data or information leaks that may occur during data transfer.
- The operating frequency band of this equipment is used by industrial, scientific, consumer and medical equipment including microwave ovens, premises radio stations for identifying mobile units used in the manufacturing lines of plants (radio stations requiring no license), and amateur radio stations (hereinafter referred to as "another station").
  1. Before using this equipment, confirm that another station is not being operated nearby.
  2. In the event of this equipment causing harmful radio wave interference with another station, promptly change the operating frequency or stop radio wave emission by turning off the power, etc.
  3. If you have further questions, contact a Nikon service center or Nikon authorized service representative.

## Personal Information Management and Disclaimer

- User information registered and configured on the product, including wireless LAN connection settings and other personal information, is susceptible to alteration and loss resulting from operational error, static electricity, accident, malfunction, repair or other handling. Always keep separate copies of important information. Nikon is not responsible for any direct or indirect damages or lost profits resulting from alteration or loss of content that is not attributable to Nikon.
- Before discarding this product or transferring it to another owner, perform **Reset all** in the setup menu (☐105) to delete all user information registered and configured with the product, including wireless LAN connection settings and other personal information.

# Table of Contents

















Introduction .....	ii
Read This First .....	ii
About This Manual .....	iii
Information and Precautions .....	v
For Your Safety .....	viii
WARNINGS .....	viii
Notices .....	xi
Wi-Fi (Wireless LAN Network) .....	xiii

Parts of the Camera .....	1
The Camera Body .....	2
Attaching the Camera Strap .....	5
Using Menus (the <b>MENU</b> Button) .....	6
The Monitor .....	8
Shooting Mode .....	8
Playback Mode .....	10























The Basics of Shooting and Playback .....	13
Preparation 1 Insert the Battery .....	14
Preparation 2 Charge the Battery .....	16
Preparation 3 Insert a Memory Card .....	18
Internal Memory and Memory Cards .....	19
Preparation 4 Setting the Display Language, Date, and Time .....	20
Step 1 Turn the Camera On .....	24
Turning the Camera On and Off .....	25
Step 2 Select a Shooting Mode .....	26
Available Shooting Modes .....	27

Step 3 Frame a Picture .....	28
Using the Zoom .....	29
Step 4 Focus and Shoot .....	30
The Shutter-release Button .....	31
Step 5 Play Back Images .....	32
Step 6 Delete Images .....	34

Shooting Features .....	37
 (Auto) Mode .....	38
Using Quick Effects .....	39
Scene Mode (Shooting Suited to Scenes) .....	40
To View a Description (Help Display) of Each Scene .....	41
Characteristics of Each Scene .....	41
Special Effects Mode (Applying Effects When Shooting) .....	51
Smart Portrait Mode (Capturing Images of Smiling Faces) .....	53
Using Skin Softening .....	55
Features That Can Be Set Using the Multi Selector .....	56
Available Features .....	56
Using the Flash (Flash Modes) .....	57
Using the Self-timer .....	60
Using Macro Mode .....	62
Adjusting Brightness (Exposure Compensation) .....	64
Default Settings .....	65

Features That Can Be Set with the <b>MENU</b> Button (Shooting Menu) .....	67
Options Available in the Shooting Menu .....	68
<b>Features That Cannot Be Used Simultaneously</b> .....	70
<b>Focusing</b> .....	73
Using Face Detection .....	73
Using Target Finding AF .....	75
Subjects Not Suitable for Autofocus .....	76
Focus Lock .....	77
<b>Playback Features</b> .....	79
Playback Zoom .....	80
Thumbnail Display, Calendar Display .....	81
Selecting Certain Types of Images for Playback .....	82
Available Playback Modes .....	82
Switching Between Playback Modes .....	83
<b>Features That Can Be Set with the <b>MENU</b> Button (Playback Menu)</b> .....	84
Connecting the Camera to a TV, Computer, or Printer .....	86
<b>Using ViewNX 2</b> .....	88
Installing ViewNX 2 .....	88
Transferring Images to the Computer .....	91
Viewing Images .....	93
<b>Recording and Playing Back Movies</b> .....	95
Recording Movies .....	96
Features That Can Be Set with the <b>MENU</b> Button (Movie Menu) .....	99
Playing Back Movies .....	100
<b>General Camera Setup</b> .....	103
Features That Can Be Set with the <b>MENU</b> Button (Setup Menu) .....	104
<b>Using the Wi-Fi (Wireless LAN) Feature</b> .....	107
Installing the Software on the Smart Device .....	108
Connecting the Smart Device to the Camera .....	109
<b>Reference Section</b> .....	 1
<b>Using Easy Panorama (Shooting and Playback)</b> .....	 2
Shooting with Easy Panorama .....	 2
Viewing Images Captured with Easy Panorama .....	 5
<b>Favorite Pictures Mode</b> .....	 6
Adding Images to Albums .....	 6
Playing Back Images in Albums .....	 7
Removing Images from Albums .....	 8
Changing the Favorites Album Icon .....	 9
<b>Auto Sort Mode</b> .....	 10
Auto Sort Mode Categories .....	 10
<b>List by Date Mode</b> .....	 12
<b>Viewing and Deleting Images Captured Continuously (Sequence)</b> .....	 13
Viewing Images in a Sequence .....	 13
Deleting Images in a Sequence .....	 15
<b>Editing Still Images</b> .....	 16

Editing Features .....	016	Smile Timer.....	058
Quick Effects .....	018	Blink Proof .....	059
Quick Retouch: Enhancing Contrast and Saturation.....	020	<b>The Playback Menu .....</b>	<b>060</b>
D-Lighting: Enhancing Brightness and Contrast .....	020	Print Order (Creating a DPOF Print Order) .....	060
Glamour Retouch: Enhancing Human Faces with Eight Effects.....	021	Slide Show .....	064
Small Picture: Reducing the Size of an Image.....	023	Protect .....	065
Crop: Creating a Cropped Copy .....	024	Rotate Image.....	068
<b>Connecting the Camera to a TV (Viewing Images on a TV) .....</b>	<b>026</b>	Voice Memo.....	069
<b>Connecting the Camera to a Printer (Direct Print) .....</b>	<b>029</b>	Copy (Copy Between Internal Memory and Memory Card).....	071
Connecting the Camera to a Printer .....	030	Sequence Display Options .....	073
Printing Individual Images.....	032	Choose Key Picture .....	073
Printing Multiple Images .....	034	<b>The Movie Menu .....</b>	<b>074</b>
<b>Editing Movies .....</b>	<b>038</b>	Movie Options.....	074
<b>The Shooting Menu (for  (Auto) Mode) .....</b>	<b>040</b>	Open with HS Footage .....	080
Image Mode Settings (Image Size and Quality) .....	040	Autofocus Mode .....	080
White Balance (Adjusting Hue) .....	042	Wind Noise Reduction .....	081
Continuous Shooting .....	045	<b>The Setup Menu .....</b>	<b>082</b>
ISO Sensitivity .....	049	Welcome Screen.....	082
Color Options .....	050	Time Zone and Date.....	083
AF Area Mode .....	051	Monitor Settings .....	086
Autofocus Mode.....	055	Print Date (Imprinting Date and Time) .....	088
Quick Effects .....	056	Vibration Reduction.....	090
<b>The Smart Portrait Menu .....</b>	<b>057</b>	Motion Detection.....	091
Skin Softening .....	057	AF Assist .....	092
		Digital Zoom .....	093
		Sound Settings.....	094
		Auto Off .....	095
		Format Memory/Format Card .....	096
		Language.....	098
		TV Settings .....	099

Charge by Computer.....		100
Blink Warning.....		102
Wi-Fi Options.....		104
Eye-Fi Upload.....		106
Reset All.....		107
Firmware Version .....		110
<b>File and Folder Names .....</b>		<b>111</b>
<b>Optional Accessories.....</b>		<b>113</b>
<b>Error Messages.....</b>		<b>114</b>
<hr/>		
<b>Technical Notes and Index.....</b>		<b>1</b>
<b>Maximizing Camera Life and Performance</b> .....		<b>2</b>
The Camera.....		2
The Battery .....		3
Charging AC Adapter .....		4
Memory Cards.....		5
<b>Cleaning and Storage.....</b>		<b>6</b>
Cleaning.....		6
Storage .....		6
<b>Troubleshooting .....</b>		<b>7</b>
<b>Specifications .....</b>		<b>17</b>
Approved Memory Cards.....		22
Supported Standards.....		23
<b>Index.....</b>		<b>25</b>



A series of ten horizontal dashed lines spanning the width of the page, intended for handwriting practice.



# Parts of the Camera



This chapter describes the parts of the camera and explains information that is displayed in the monitor.

<b>The Camera Body</b> .....	<b>2</b>
Attaching the Camera Strap.....	5
<b>Using Menus (the MENU Button)</b> .....	<b>6</b>
<b>The Monitor</b> .....	<b>8</b>
Shooting Mode.....	8
Playback Mode .....	10

➔ If you want to start using the camera right away, see “The Basics of Shooting and Playback” (📖 13).

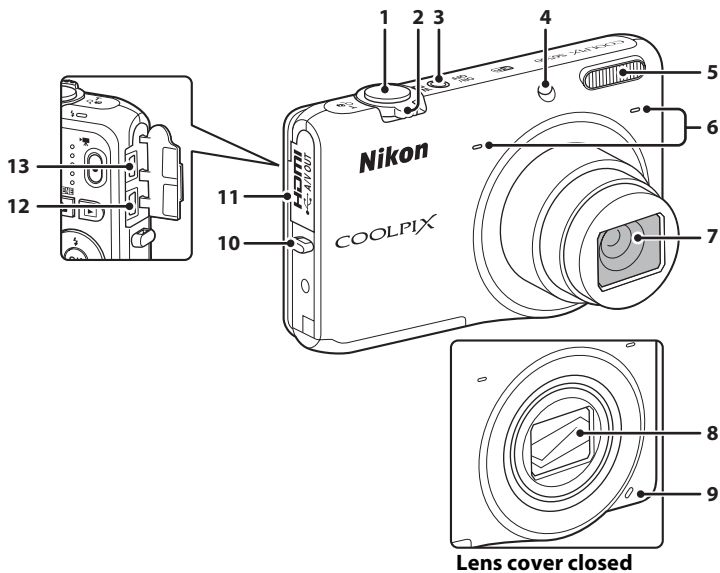





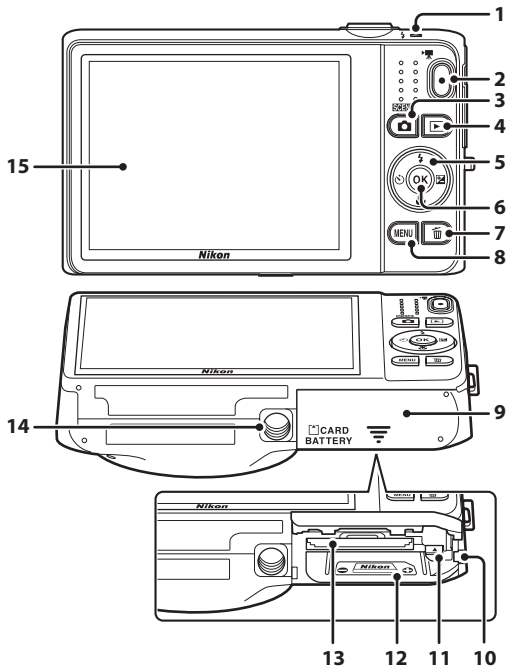

# The Camera Body



<b>1</b>	Shutter-release button.....	30
<b>2</b>	Zoom control.....	29
	<b>W</b> : wide-angle.....	29
	<b>T</b> : telephoto.....	29
	 thumbnail playback.....	81
	<b>Q</b> : playback zoom.....	80
	 help.....	41
<b>3</b>	Power switch/power-on lamp.....	24
<b>4</b>	Self-timer lamp.....	60
	AF-assist illuminator.....	104

<b>5</b>	Flash.....	57
<b>6</b>	Microphone (stereo).....	84, 96
<b>7</b>	Lens	
<b>8</b>	Lens cover	
<b>9</b>	Speaker.....	84, 100
<b>10</b>	Eyelet for camera strap.....	5
<b>11</b>	Connector cover.....	16, 86
<b>12</b>	HDMI micro connector (Type D).....	86
<b>13</b>	USB/audio/video output connector	
	.....	16, 86



<b>1</b>	Charge lamp.....17,  101 Flash lamp.....57	<b>9</b>	Battery-chamber/ memory card slot cover.....14, 15
<b>2</b>	 movie-record) button.....96	<b>10</b>	Power connector cover (for connection with optional AC adapter).....  113
<b>3</b>	 (shooting mode) button.....26	<b>11</b>	Battery latch .....14
<b>4</b>	 (playback) button.....32, 82	<b>12</b>	Battery chamber .....14
<b>5</b>	Multi selector.....6	<b>13</b>	Memory card slot.....18
<b>6</b>	 (apply selection) button .....6	<b>14</b>	Tripod socket
<b>7</b>	 (delete) button.....34,  70	<b>15</b>	Monitor.....8
<b>8</b>	<b>MENU</b> (menu) button.....6, 67, 84, 99, 104		

## Attaching the Camera Strap

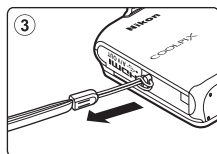
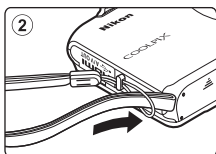
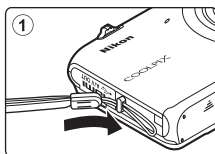

# Using Menus (the MENU Button)

Use the multi selector and **OK** button to navigate the menus.

## 1 Press the MENU button.

- The menu is displayed.

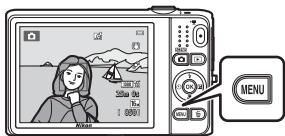

## 2 Press the multi selector ◀.

- The current menu icon is displayed in yellow.

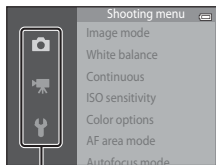

Menu icons

## 3 Press ▲ or ▼ to select the desired menu icon.

- The menu is changed.

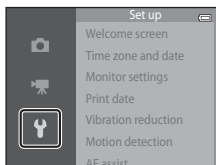

## 4 Press the OK button.

- The menu options become selectable.

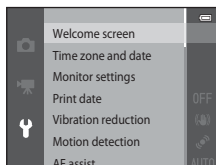

- 5** Press **▲** or **▼** to select a menu option.

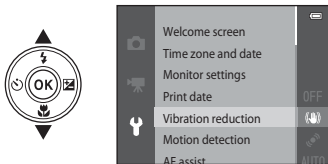

- 7** Press **▲** or **▼** to select a setting.

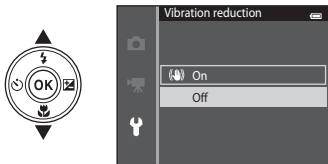

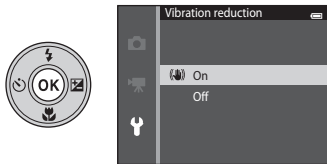

- 6** Press the **OK** button.
- The settings for the option you selected are displayed.



- 8** Press the **OK** button.
- The setting you selected is applied.
  - When you are finished using the menu, press the **MENU** button.



### Notes About Setting Menu Options

- Certain menu options cannot be set depending on the current shooting mode or the state of the camera. Unavailable options are displayed in gray and cannot be selected.
- When a menu is displayed, you can switch to shooting mode by pressing the shutter-release button,  (shooting mode) button, or  (movie-record) button.

# The Monitor





The information that is displayed in the monitor during shooting and playback changes depending on the camera's settings and state of use.

By default, information is displayed when the camera is first turned on and when you operate the camera, and turns off after a few seconds (when **Photo info** is set to **Auto info** in **Monitor settings** (104)).

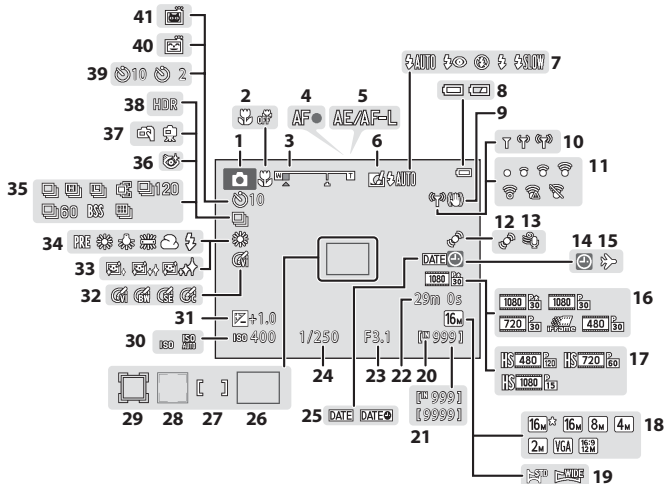
## Shooting Mode









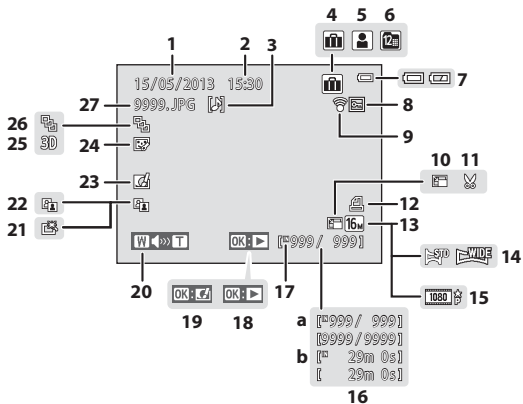









Parts of the Camera



<b>1</b>	Shooting mode.....	26, 27	<b>23</b>	Aperture value .....	30
<b>2</b>	Macro mode .....	62	<b>24</b>	Shutter speed .....	30
<b>3</b>	Zoom indicator .....	29, 62	<b>25</b>	Print date.....	104
<b>4</b>	Focus indicator.....	30	<b>26</b>	Focus area (target finding AF).....	30, 68
<b>5</b>	AE/AF-L indicator.....	49	<b>27</b>	Focus area (for manual or center) .....	68
<b>6</b>	Quick effects icon .....	69	<b>28</b>	Focus area (face detection, pet detection) .....	48, 53, 68
<b>7</b>	Flash mode.....	57	<b>29</b>	Focus area (subject tracking).....	68,  54
<b>8</b>	Battery level indicator .....	24	<b>30</b>	ISO sensitivity.....	68
<b>9</b>	Vibration reduction icon .....	104	<b>31</b>	Exposure compensation value .....	64
<b>10</b>	Wi-Fi communication indicator.....	105	<b>32</b>	Color options.....	68
<b>11</b>	Eye-Fi communication indicator .....	105	<b>33</b>	Skin softening.....	69
<b>12</b>	Motion detection icon .....	104	<b>34</b>	White balance mode .....	68
<b>13</b>	Wind noise reduction .....	99	<b>35</b>	Continuous shooting mode .....	68
<b>14</b>	“Date not set” indicator .....	22, 104,  114	<b>36</b>	Blink proof icon .....	69
<b>15</b>	Travel destination icon.....	22, 104,  83	<b>37</b>	Hand-held/tripod.....	42, 44
<b>16</b>	Movie options (normal speed movies) .....	99	<b>38</b>	Backlighting (HDR) .....	46
<b>17</b>	Movie options (HS movies) .....	99	<b>39</b>	Self-timer indicator .....	60
<b>18</b>	Image mode.....	68,  40	<b>40</b>	Smile timer .....	69
<b>19</b>	Easy panorama.....	47	<b>41</b>	Pet portrait auto release .....	48
<b>20</b>	Internal memory indicator.....	24			
<b>21</b>	Number of exposures remaining (still images) .....	24			
<b>22</b>	Movie recording time remaining .....	96			

# Playback Mode



<b>1</b>	Date of recording .....	20
<b>2</b>	Time of recording.....	20
<b>3</b>	Voice memo indicator .....	84,  69
<b>4</b>	Album icon in favorite pictures mode .....	82,  6
<b>5</b>	Category icon in auto sort mode .....	82,  10
<b>6</b>	List by date icon .....	82,  12
<b>7</b>	Battery level indicator .....	24
<b>8</b>	Protect icon.....	84,  65
<b>9</b>	Eye-Fi communication indicator .....	105,  106
<b>10</b>	Small picture icon .....	84,  23
<b>11</b>	Crop icon .....	80,  24
<b>12</b>	Print order icon .....	84,  60
<b>13</b>	Image mode.....	68,  40
<b>14</b>	Easy panorama.....	47
<b>15</b>	Movie options.....	99,  74
<b>16</b>	(a) Current image number/ total number of images.....	32
	(b) Movie length.....	100
<b>17</b>	Internal memory indicator .....	32
	Easy panorama playback guide .....	47,  5
<b>18</b>	Sequence playback guide .....	33
	Movie playback guide.....	100
<b>19</b>	Quick effects guide.....	33
<b>20</b>	Volume indicator.....	84, 100,  69
<b>21</b>	Quick retouch icon .....	84,  20
<b>22</b>	D-Lighting icon.....	84,  20
<b>23</b>	Quick effects icon .....	33, 39,  18
<b>24</b>	Glamour retouch icon.....	84,  21
<b>25</b>	3D image icon.....	49
<b>26</b>	Sequence display (when <b>Individual pictures</b> is selected).....	85,  73
<b>27</b>	File number and type.....	 111



A series of ten horizontal dashed lines spanning the width of the page, intended for handwriting practice.



# The Basics of Shooting and Playback

---

## Preparation

Preparation 1 Insert the Battery .....	14
Preparation 2 Charge the Battery .....	16
Preparation 3 Insert a Memory Card.....	18
Preparation 4 Setting the Display Language, Date, and Time .....	20

## Shooting

Step 1 Turn the Camera On.....	24
Step 2 Select a Shooting Mode.....	26
Step 3 Frame a Picture .....	28
Step 4 Focus and Shoot.....	30

## Playback

Step 5 Play Back Images .....	32
Step 6 Delete Images.....	34

# Preparation 1 Insert the Battery

- 1 Open the battery-chamber/memory card slot cover.

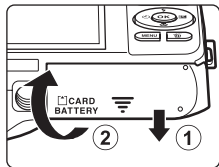

- 2 Insert the included EN-EL19 battery (rechargeable Li-ion battery).

- Use the battery to push the orange battery latch in the direction indicated by the arrow (1), and fully insert the battery (2).
- When the battery is inserted correctly, the battery latch will lock the battery in place.

Battery latch

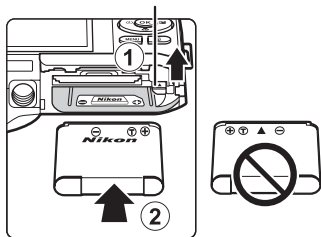

## **✓** Inserting the Battery Correctly

**Inserting the battery upside down or backwards could damage the camera.** Be sure to check that the battery is in the correct orientation.

- 3 Close the battery-chamber/memory card slot cover.

- Charge the battery before the first use or when the battery is running low. See "Preparation 2 Charge the Battery" (📖16) for more information.

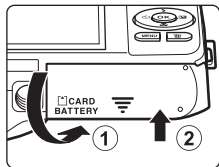

## Removing the Battery

Turn the camera off and be sure that the power-on lamp and the monitor have turned off before opening the battery-chamber/memory card slot cover.

To eject the battery, open the battery-chamber/memory card slot cover and slide the orange battery latch up in the direction indicated by the arrow (1). The battery can then be removed by hand (2). Do not pull it at an angle.

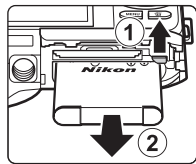

### High Temperature Caution

The camera, battery, and memory card may be hot immediately after using the camera. Observe caution when removing the battery or memory card.

### Notes About the Battery

Be sure to read and follow the warnings for the battery on page ix and in "The Battery" (Ⓕ3) before use.

# Preparation 2 Charge the Battery

## 1 Prepare the included Charging AC Adapter EH-70P.

If a plug adapter\* is included with your camera, attach the plug adapter to the plug on the Charging AC Adapter. Push the plug adapter firmly until it is securely held in place. Once the two are connected, attempting to forcibly remove the plug adapter could damage the product.

\* The shape of the plug adapter varies according to the country or region in which the camera was purchased. The Charging AC Adapter comes with the plug adapter attached in Argentina and Korea.

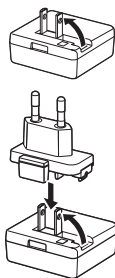

## 2 Make sure the battery is installed in the camera, and then connect the camera to the Charging AC Adapter in order of ① to ③.

- Keep the camera turned off.
- Be sure that plugs are properly oriented. Do not attempt to insert plugs at an angle, and do not use force when connecting or disconnecting the plugs.

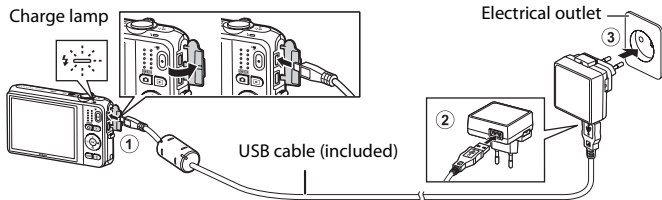

- The charge lamp slowly flashes green to indicate that the battery is charging.
- About 3 hours are required to charge a fully exhausted battery.
- When the battery has been completely charged, the charge lamp turns off.
- See "The Charge Lamp" (📖17) for more information.

- 3 Disconnect the Charging AC Adapter from the electrical outlet and then disconnect the USB cable.

## The Charge Lamp

Status	Description
Flashes slowly (green)	The battery is charging.
Off	The battery is not charging. When charging is complete, the charge lamp stops flashing green and turns off.
Flashes quickly (green)	<ul style="list-style-type: none"><li>• The ambient temperature is not suited to charging. Charge the battery indoors with an ambient temperature of 5°C to 35°C (41°F to 95°F).</li><li>• The USB cable or Charging AC Adapter is not properly connected, or there is a problem with the battery. Disconnect the USB cable or unplug the Charging AC Adapter and correctly connect it again, or change the battery.</li></ul>

### Notes About the Charging AC Adapter

Be sure to read and follow the warnings for the Charging AC Adapter EH-70P on page ix and in “Charging AC Adapter” (🔌:4) before use.

### Charging Using a Computer or Battery Charger

- You can also charge the Rechargeable Li-ion Battery EN-EL19 by connecting the camera to a computer (📖86, 🎧100).
- You can use the Battery Charger MH-66 (available separately; 🎧113) to charge the EN-EL19 without using the camera.

### Operating the Camera During Charging

If you press the power switch or hold down the  (playback) button while using the Charging AC Adapter to charge the battery in the camera, the camera turns on in playback mode and you can play back images. Shooting is not possible.

## Preparation 3 Insert a Memory Card

- 1 Be sure that the power-on lamp and the monitor are off and open the battery-chamber/memory card slot cover.
  - Be sure to turn off the camera before opening the cover.

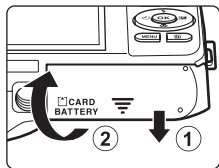

- 2 Insert the memory card.
  - Slide the memory card in until it clicks into place.

**✓ Inserting the Memory Card Correctly**  
*Inserting the memory card upside down or backwards could damage the camera and the memory card.* Be sure to check that the memory card is in the correct orientation.

Memory card slot

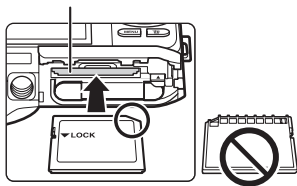

- 3 Close the battery-chamber/memory card slot cover.

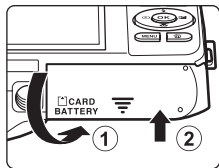

## ✔ Formatting Memory Cards

- The first time you insert a memory card that has been used in another device into this camera, be sure to format it with this camera.
- **All data stored on a memory card is permanently deleted when the card is formatted.**  
If there is data saved on the memory card that you wish to keep, copy that data to a computer before formatting.
- To format a memory card, insert the card into the camera, press the **MENU** button, and select **Format card** in the setup menu (📖104).

## ✔ Notes About Memory Cards

See “Memory Cards” (🔍5) and the documentation included with your memory card for more information.

## Removing Memory Cards

Turn the camera off and be sure that the power-on lamp and the monitor have turned off before opening the battery-chamber/memory card slot cover.

Gently push the memory card into the camera (①) to partially eject the card, and then remove the card (②). Do not pull it at an angle.

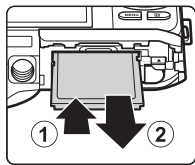

## ✔ High Temperature Caution

The camera, battery, and memory card may be hot immediately after using the camera. Observe caution when removing the battery or memory card.

## Internal Memory and Memory Cards

Camera data, including images and movies, can be saved in either the camera's internal memory (approximately 25 MB) or on a memory card. To use the camera's internal memory for shooting or playback, first remove the memory card.

## Preparation 4 Setting the Display Language, Date, and Time

When the camera is turned on for the first time, the language-selection screen and the date and time setting screen for the camera clock are displayed.

### 1 Press the power switch to turn on the camera.

- When the camera is turned on, the power-on lamp (green) will light and then the monitor will turn on (the power-on lamp turns off when the monitor turns on).

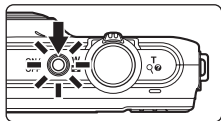

### 2 Press the multi selector ▲ or ▼ to select the desired language and press the **OK** button.

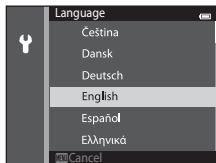

### 3 Press ▲ or ▼ to select **Yes** and press the **OK** button.

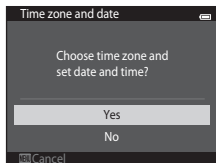

**4** Press ◀ or ▶ to select your home time zone and press the **OK** button.

- To enable daylight saving time, press ▲. When the daylight saving time function is enabled, ☀ is displayed above the map. To turn off the daylight saving time function, press ▼.

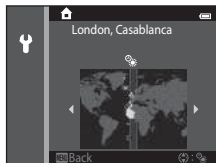

**5** Press ▲ or ▼ to select the date format and press the **OK** button or ▶.

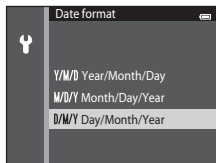

**6** Press ▲, ▼, ◀, or ▶ to set the date and time, and press the **OK** button.

- Select a field: Press ▶ or ◀ (changes between **D**, **M**, **Y**, hour, and minute).
- Edit the date and time: Press ▲ or ▼.
- Confirm the setting: Select the minute field and press the **OK** button or ▶.

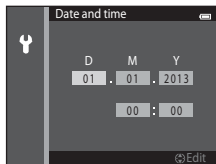





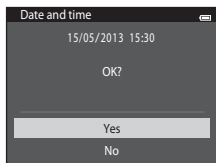





**7** Press ▲ or ▼ to select **Yes** and press the **OK** button.

- When settings are finished, the lens extends and the camera switches to shooting mode.





## Changing the Language Setting and the Date and Time Setting

- You can change these settings using the **Language** and **Time zone and date** settings in the  setup menu (104).
- You can enable or disable daylight saving time in the  setup menu by selecting **Time zone and date** followed by **Time zone**. Press the multi selector  and then  to enable daylight saving time and move the clock forward one hour; press  to disable daylight saving time and move the clock back one hour. When the travel destination () is selected, the time difference between the travel destination and the home time zone () is automatically calculated and the date and time in the selected region are saved at the time of shooting.
- If you exit without setting the date and time,  will flash when the shooting screen is displayed. Use the **Time zone and date** setting in the setup menu to set the date and time (104).

## The Clock Battery

- The camera's clock is powered by a built-in backup battery.  
The backup battery charges when the main battery is inserted into the camera or when the camera is connected to an optional AC adapter, and it can run the clock for several days after about ten hours of charging.
- If the camera's backup battery becomes exhausted, the date and time setting screen is displayed when the camera is turned on. Set the date and time again. See step 3 (20) of "Preparation 4 Setting the Display Language, Date, and Time" for more information.

## Imprinting the Shooting Date on Printed Images

- Set the date and time before shooting.
- You can permanently imprint the shooting date on images as they are captured by setting **Print date** in the setup menu (104).
- If you want the shooting date to be printed without using the **Print date** setting, print using the ViewNX 2 software (88).



A series of ten horizontal dashed lines spanning the width of the page, intended for handwriting practice.

# Step 1 Turn the Camera On

## 1 Press the power switch to turn on the camera.

- The lens extends and the monitor turns on.

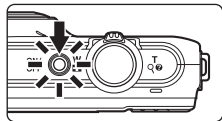

## 2 Check the battery level indicator and the number of exposures remaining.

### Battery level indicator

Display	Description
	The battery level is high.
	The battery level is low. Prepare to charge or replace the battery.
<b>Battery exhausted.</b>	The camera cannot take images. Recharge or replace with a fully charged battery.

### Battery level indicator

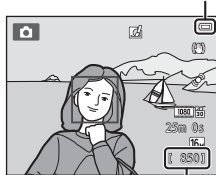

### Number of exposures remaining

### Number of Exposures Remaining

The number of images that can be taken is displayed.

- is displayed when no memory card is inserted in the camera, and images will be saved in the internal memory (approximately 25 MB).
- The number of exposures remaining depends on the amount of available memory in the internal memory or memory card, and also varies depending on the image quality and image size (determined by the image mode setting; 41).



## Turning the Camera On and Off

- When the camera is turned on, the power-on lamp (green) will light and then the monitor will turn on (the power-on lamp turns off when the monitor turns on).
- To turn off the camera, press the power switch. When the camera turns off, the power-on lamp and the display turn off.
- To turn the camera on in playback mode, press and hold the  (playback) button. The lens will not extend.

### Power Saving Function (Auto Off)

If no operations are performed for a while, the monitor will turn off, the camera will enter standby mode, and the power-on lamp will flash. If no operations are performed for approximately another three minutes, the camera will turn off automatically.

While the camera is in standby mode, the monitor turns back on if you perform any of the following operations:

- Press the power switch, shutter-release button,  (shooting mode) button,  (playback) button, or  (movie-record) button

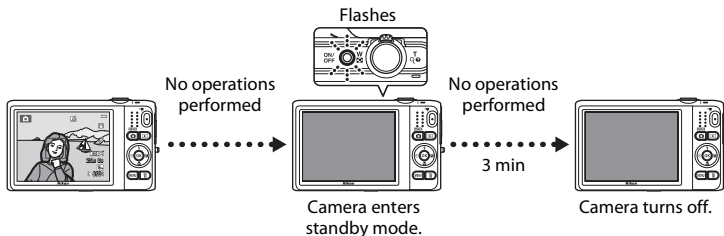

- The time that elapses before the camera enters standby mode can be changed using the **Auto off** setting in the setup menu (104).
- By default, the camera enters standby mode in about one minute when you are using shooting mode or playback mode.
- If you are using the optional AC Adapter EH-62G, the camera enters standby mode after 30 minutes (fixed).

### Notes About an AC Power Source

- You can use the AC Adapter EH-62G (available separately; 113) to supply power to the camera from an electrical outlet for taking images and playing back images.
- Do not, under any circumstances, use another make or model of AC adapter other than the EH-62G. Failure to observe this precaution could result in overheating or in damage to the camera.

## Step 2 Select a Shooting Mode

### 1 Press the button.

- The shooting mode selection menu, which allows you to select the desired shooting mode, is displayed.



### 2 Press the multi selector or to select a shooting mode and press the button.

-  (auto) mode is used in this example.
- The shooting mode setting is saved even after the camera is turned off.

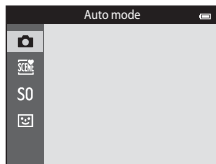

## Available Shooting Modes



### Auto mode

38

Used for general shooting. Settings can be adjusted in the shooting menu (📖68) to suit the shooting conditions and the type of shot you want to capture.



### Scene mode

40

Camera settings are optimized according to the scene that you select. When using scene auto selector, the camera automatically selects the optimum scene mode when you frame an image, making it even easier to take images using settings that suit the scene.

- To select a scene, first display the shooting mode selection menu and then press the multi selector ►. Select the desired scene by pressing ▲, ▼, ◀, or ▶, and then press the **OK** button.



### Special effects

51

Effects can be applied to images during shooting. Twelve different effects are available.

- To select an effect, first display the shooting mode menu and then press the multi selector ►. Select the desired effect by pressing ▲, ▼, ◀, or ▶, and then press the **OK** button.



### Smart portrait

53

When the camera detects a smiling face, you can take an image automatically without pressing the shutter-release button (smile timer). You can also use the skin softening option to smooth the skin tones of human faces.



## Changing the Shooting Settings

- See “Features That Can Be Set Using the Multi Selector” (📖56) for more information.
  - See “Using the Flash (Flash Modes)” (📖57) for more information.
  - See “Using the Self-timer” (📖60) for more information.
  - See “Using Macro Mode” (📖62) for more information.
  - See “Adjusting Brightness (Exposure Compensation)” (📖64) for more information.
- See “Features That Can Be Set with the **MENU** Button (Shooting Menu)” (📖67) for more information.
- See “Features That Can Be Set with the **MENU** Button (Setup Menu)” (📖104) for more information.

## Step 3 Frame a Picture

### 1 Hold the camera steady.

- Keep fingers, hair, the camera strap, and other objects away from the lens, flash, AF assist-illuminator, microphone, and speaker.
- When taking images in portrait ("tall") orientation, turn the camera so that the flash is above the lens.

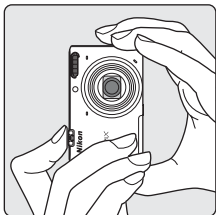
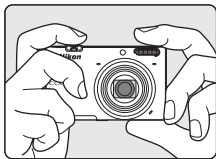

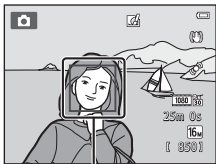

### 2 Frame the picture.

- Aim the camera at the desired subject.
- When the camera detects the main subject, the focus area is displayed (default setting).



Focus area

## When Using a Tripod

- We recommend using a tripod to stabilize the camera in the following situations.
  - When shooting in dim lighting or when the flash mode (58) is set to  (off)
  - When using the telephoto setting
- Set **Vibration reduction to Off** in the setup menu (104) when using a tripod to stabilize the camera during shooting.

## Using the Zoom

Use the zoom control to activate optical zoom.



- To zoom in closer to the subject, rotate the zoom control to **T** (telephoto).
- To zoom out and view a larger area, rotate the zoom control to **W** (wide-angle).

When you turn the camera on, the zoom moves to the maximum wide-angle position.

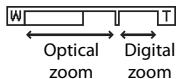
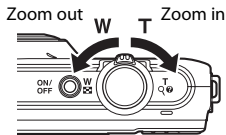
- A zoom indicator is displayed at the top of the monitor when the zoom control is rotated.
- Digital zoom, which allows you to further magnify the subject up to approximately 4× the maximum optical zoom ratio, can be activated by rotating and holding the zoom control to **T** when the camera is zoomed in to the maximum optical zoom position.



## Digital Zoom and Interpolation

While using digital zoom, the image quality decreases due to interpolation when the zoom is increased beyond the  position. Since the position of  moves to the right as the size of an image decreases, selecting a smaller image size in the image mode setting (64) allows you to zoom in further without decreasing the image quality due to interpolation.



# Step 4 Focus and Shoot

## 1 Press the shutter-release button halfway (📖31).

- When the camera detects the main subject, it focuses on that subject. When the subject is in focus, the focus area that is in focus lights in green (up to three areas). See “Using Target Finding AF” (📖75) for more information.
- When you are using digital zoom, the camera focuses on the subject in the center of the frame and the focus area is not displayed. When the camera has focused, the focus indicator (📖9) glows green.
- While the shutter-release button is pressed halfway, the focus area or focus indicator may flash red. This indicates that the camera is unable to focus. Modify the composition and press the shutter-release button halfway again.

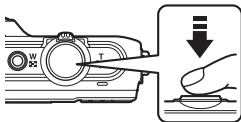

## 2 Press the shutter-release button the rest of the way down (📖31).

- The shutter is released and the image will be saved.



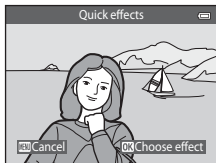

## 3 To apply an effect to the captured image, press the **OK** button.

- The screen for selecting an effect is displayed. See “Using Quick Effects” (📖39) for more information.
- When you press the **MENU** button or when no operations are performed for about five seconds, the monitor display returns to the shooting screen.
- To not display the screen shown on the right, set **Quick effects** to **Off** (📖69).



## The Shutter-release Button

<p>Press halfway</p> 	<p>To set focus and exposure (shutter speed and aperture value), press the shutter-release button lightly until you feel a slight resistance. Focus and exposure remain locked while the shutter-release button is pressed halfway.</p>
<p>Press all the way</p> 	<p>While pressing the shutter-release button halfway, press the shutter-release button the rest of the way down to release the shutter and take an image. Do not use force when pressing the shutter-release button, as this may result in camera shake and blurred images. Press the button gently.</p>

### ✓ Notes About Recording Images and Saving Movies

The indicator showing the number of exposures remaining or the indicator showing the maximum movie length flashes while images are being recorded or while a movie is being saved. **Do not open the battery-chamber/memory card slot cover or remove the battery or memory card** while an indicator is flashing. Doing this could result in loss of data, or in damage to the camera or the memory card.

### ✓ Notes About Focusing

See “Subjects Not Suitable for Autofocus” (📖76) for more information.

### 🔗 AF-assist Illuminator and Flash

If the subject is dimly lit, the AF-assist illuminator (📖104) may light when the shutter-release button is pressed halfway, and the flash (📖57) may fire when the shutter-release button is pressed all the way down.

### 🔗 To Make Sure You Do Not Miss a Shot

If you are concerned that you might miss a shot, press the shutter-release button all the way without first pressing it halfway.





## Step 5 Play Back Images

### 1 Press the (playback) button.

- The camera switches to playback mode and the last image saved will be displayed full-frame.





### 2 Use the multi selector to select an image to display.

- Display the previous image:  or 
- Display the subsequent image:  or 

Display the previous image



Display the next image

- Remove the memory card from the camera to play back images saved in the camera's internal memory.  is displayed near the current image number/total number of images display.
- To return to shooting mode, press the  button, the shutter-release button, or the  movie-record button.

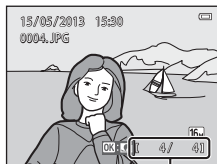

Current image number/  
total number of images

## Viewing Images

- Images may be displayed briefly at low resolution immediately after switching to the next or previous image.
- When images in which the face of a person (📖73) or a pet (📖48) was detected at the time of shooting are displayed in full-frame playback mode, depending upon the orientation of the detected face, the images may be automatically rotated for playback display (except images captured in a series).
- You can change the orientation of an image using **Rotate image** in the playback menu (📖84).
- Each series of images captured using continuous shooting is saved in a sequence, and by default, only the first image in the sequence (key picture) is displayed to represent them (📖85). Press the **OK** button to display them as individual images. Press **▲** to return to the key picture only display.

## Notes About the Quick Effects Function

- When **OK**:  is displayed in full-frame playback mode, you can press **OK** button to apply an effect to the image.
  - When the effect selection screen is displayed, press **◀** or **▶** to select an effect, press the **OK** button, and then select **Yes** in the confirmation dialog and press the **OK** button to save the image as a separate file.
- See “Quick Effects” (📖18) for more information.

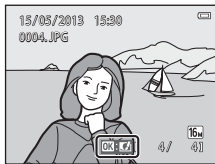



## More Information

- See “Playback Zoom” (📖80) for more information.
- See “Thumbnail Display, Calendar Display” (📖81) for more information.
- See “Selecting Certain Types of Images for Playback” (📖82) for more information.
- See “Features That Can Be Set with the **MENU** Button (Playback Menu)” (📖84) for more information.

## Step 6 Delete Images



- 1 Press the  button to delete the image currently displayed in the monitor.



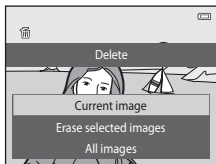

- 2 Press the multi selector  or  to select the desired deletion method and press the  button.

- **Current image:** Only the current image is deleted.
- **Erase selected images:** Multiple images can be selected and deleted. See "Operating the Erase Selected Images Screen" (p.35) for more information.
- **All images:** All images are deleted.
- To exit without deleting, press the **MENU** button.



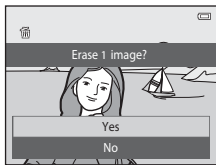

- 3 Press  or  to select **Yes** and press the  button.

- Deleted images cannot be recovered.
- To cancel, press  or  to select **No** and press the .



## Operating the Erase Selected Images Screen

**1** Press the multi selector ◀ or ▶ to select an image to be deleted, and then press ▲ to display .

- To undo the selection, press ▼ to remove .
- Rotate the zoom control () to **T** () to switch back to full-frame playback or **W** () to display thumbnails.





**2** Add  to all images that you want to delete and then press the **OK** button to confirm the selection.

- A confirmation dialog is displayed. Follow the instructions displayed in the monitor.

### Notes About Deletion

- Deleted images cannot be recovered. Copy important images to a computer or other media before deleting them from the camera.
- Protected images () cannot be deleted.

### Deleting Images in a Sequence

- If you press the  button and delete a key picture while only key pictures are displayed for sequences of images (), all images in the sequence, including the key picture, are deleted.
- To delete individual images in a sequence, press the **OK** button to display them one at a time and press the .

### Deleting the Last Image Captured While in Shooting Mode

When using shooting mode, press the  button to delete the last image that was saved.

### Selecting Certain Types of Images for Deletion

When using favorite pictures mode, auto sort mode, or list by date mode (), you can select images registered as favorites, images in a certain category, or images captured on a specific date for deletion.



A series of ten horizontal dashed lines spanning the width of the page, intended for handwriting practice.



# Shooting Features



This chapter describes the camera's shooting modes and the features that are available when using each shooting mode.

You can select shooting modes and adjust settings according to the shooting conditions and the kind of images you want to capture.

<b>📷 (Auto) Mode .....</b>	<b>38</b>
<b>Scene Mode (Shooting Suited to Scenes) .....</b>	<b>40</b>
<b>Special Effects Mode (Applying Effects When Shooting) .....</b>	<b>51</b>
<b>Smart Portrait Mode (Capturing Images of Smiling Faces) .....</b>	<b>53</b>
<b>Features That Can Be Set Using the Multi Selector.....</b>	<b>56</b>
Using the Flash (Flash Modes) .....	57
Using the Self-timer .....	60
Using Macro Mode .....	62
Adjusting Brightness (Exposure Compensation).....	64
<b>Features That Can Be Set with the MENU Button (Shooting Menu).....</b>	<b>67</b>
<b>Features That Cannot Be Used Simultaneously .....</b>	<b>70</b>
<b>Focusing .....</b>	<b>73</b>

## (Auto) Mode

Used for general shooting. Settings can be adjusted in the shooting menu (📖68) to suit the shooting conditions and the type of shot you want to capture.

Enter shooting mode →  (shooting mode) button →  (auto) mode → 

- You can change how the camera selects the area of the frame to focus on by changing the **AF area mode** setting (📖68).  
The default setting is **Target finding AF**.  
If the camera detects the main subject, it focuses on that subject.  
If no main subject is detected, the camera automatically selects one or more of the nine focus areas containing the subject closest to the camera. See “Using Target Finding AF” (📖75) for more information.

### Changing (Auto) Mode Settings

- Features that can be set using the multi selector (📖56): Flash mode (📖57), self-timer (📖60), macro mode (📖62), and exposure compensation (📖64)
- Features that can be set by pressing the **MENU** button (📖67): Options available in the auto shooting menu (📖68)



### Camera Settings That Cannot Be Used Simultaneously

Some settings cannot be used with other functions (📖70).

## Using Quick Effects

When in  (auto) mode, you can apply effects to images immediately after releasing the shutter.



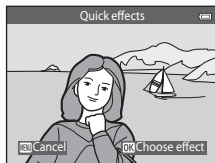

- The edited image is saved as a separate file with a different name (111).

### 1 Press the button when the image is displayed after it is taken in (auto) mode.

- When you press the **MENU** button or when no operations are performed for about five seconds, the monitor display returns to the shooting screen.
- To not display the screen shown on the right, set **Quick effects** to **Off** (69).



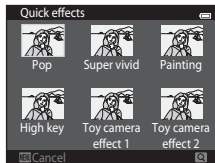

### 2 Press the multi-selector or to select the desired effect and press the button.

- Rotate the zoom control (3) to **T** (Q) to switch back to full-frame playback or **W** () to six-image thumbnail display.
- To exit without saving the edited image, press the **MENU** button. When a confirmation screen is displayed, select **Yes** and press the  button.
- See "Quick Effects" (18) for information about the effect types.











### 3 Select **Yes** and press the button.









































- A new, edited copy is created and the monitor display returns to the shooting screen.
- Copies created with the quick effects function are indicated by the  icon displayed during playback (10).

# Scene Mode (Shooting Suited to Scenes)









When one of the following scenes is selected, camera settings are automatically optimized for the selected scene.

Enter shooting mode →  (shooting mode) button →  (second icon from the top\*)  
→   , ,   → select a scene →  button

\* The icon of the last scene selected is displayed.

 Scene auto selector (default setting;  41)	 Portrait (  41)	 Landscape (  42)	 Sports (  42)
 Night portrait (  42)	 Party/indoor (  43)	 Beach (  43)	 Snow (  43)
 Sunset (  43)	 Dusk/dawn (  43)	 Night landscape (  44)	 Close-up (  44)
 Food (  45)	 Museum (  45)	 Fireworks show (  45)	 Black and white copy (  46)
 Backlighting (  46)	 Easy panorama (  47)	 Pet portrait (  48)	 3D photography (  49)

## Changing Scene Mode Settings

- Depending on the scene, the multi selector , , , and  can be used to set the corresponding features. See “Features That Can Be Set Using the Multi Selector” (56) and “Default Settings” (65) for more information.
- Features that can be set by pressing the **MENU** button (67): Image mode (image size and quality) (68, 40).

## To View a Description (Help Display) of Each Scene

Select the desired scene from the scene selection screen and rotate the zoom control (📖3) to **T** (🔍) to view a description of that scene. To return to the original screen, rotate the zoom control to **T** (🔍) again.

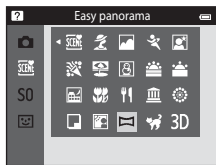

## Characteristics of Each Scene

### 📖 Scene auto selector

- When you point the camera at the subject, the camera automatically selects the optimum scene mode from the list below and adjusts the shooting settings accordingly.  
👤: Portrait, 🏞️: Landscape, 🌃: Night portrait, 🌃: Night landscape, 📷: Close-up, 📷: Backlighting, 📷: Other scenes
- The focus area depends on the composition of the image. When the camera detects a human face, it focuses on that face (📖73).
- When the camera selects 🌃 (night portrait), flash mode is fixed at fill flash with slow sync and red-eye reduction (when ⚡AUTO (auto) is selected) and the camera captures one image at a slower shutter speed.
- When the camera selects 🌃 (night landscape), flash mode is fixed at 🚫 (off), regardless of the setting made, and the camera captures one image at a slower shutter speed.
- Depending upon shooting conditions, the camera may not select the desired scene mode. Should this occur, switch to 📷 (auto) mode (📖26) or select the desired scene mode manually.
- Digital zoom cannot be used.

### 👤 Portrait

- When the camera detects a human face, it focuses on that face (📖73).
- If no faces are detected, the camera focuses on the subject in the center of the frame.
- The camera focuses even when the shutter-release button is not pressed halfway. You may hear the sound of the camera focusing.
- The camera softens skin tones of human faces by applying the skin softening function (📖55).
- Digital zoom cannot be used.





## Landscape

- The focus area or focus indicator (9) always glows green when the shutter-release button is pressed halfway.

## Sports

- The camera focuses on the area in the center of the frame.
- The camera focuses even when the shutter-release button is not pressed halfway. You may hear the sound of the camera focusing.
- Press and hold the shutter-release button all the way to capture up to 6 images continuously at a rate of about 2 fps (when image mode is set to 16M).
- Focus, exposure, and hue are fixed at the values determined with the first image in each series.
- The frame rate for continuous shooting may vary depending upon the current image mode setting, the memory card used, or shooting condition.

## Night portrait

- When the camera detects a human face, it focuses on that face (73).
- If no faces are detected, the camera focuses on the subject in the center of the frame.
- From the screen displayed after  **Night portrait** is selected, select **Hand-held** or **Tripod**.
- **Hand-held** (default setting):
  - When the  icon at the top left of the monitor lights in green, press the shutter-release button all the way to capture a series of images which will be combined into a single image and saved.
  - Once the shutter-release button is pressed all the way, hold the camera still until a still image is displayed. After taking an image, do not turn the camera off before the monitor switches to the shooting screen.
  - The angle of view (i.e., the area visible in the frame) seen in the saved image will be narrower than that seen in the monitor at the time of shooting.
  - If the subject moves while the camera is shooting continuously, the image may be distorted, overlapped, or blurred.
- **Tripod**: Select this option when using a tripod or other means to stabilize the camera during shooting.
  - Vibration reduction is disabled even when **Vibration reduction** (104) in the setup menu is set to **On**.
  - One image is captured at a slow shutter speed when the shutter-release button is pressed all the way.
- The camera softens skin tones of human faces by applying the skin softening function (55).
- Digital zoom cannot be used.

 Party/indoor

- The camera focuses on the area in the center of the frame.
- To avoid the effects of camera shake, hold the camera steady. Set **Vibration reduction** to **Off** in the setup menu (📖104) when using a tripod to stabilize the camera during shooting.

 Beach

- The camera focuses on the area in the center of the frame.

 Snow



- The camera focuses on the area in the center of the frame.

 Sunset





- The camera focuses on the area in the center of the frame.

 Dusk/dawn







- The focus area or focus indicator (📖9) always glows green when the shutter-release button is pressed halfway.

: Use of a tripod is recommended when using scene modes indicated with , because the shutter speed is slow. Set **Vibration reduction** to **Off** in the setup menu (📖104) when using a tripod to stabilize the camera during shooting.

## Night landscape

- The focus area or focus indicator (9) always glows green when the shutter-release button is pressed halfway.
- From the screen displayed after  **Night landscape** is selected, select **Hand-held** or **Tripod**.
- **Hand-held** (default setting): Select this option to produce shots with reduced blurring and noise even when the camera is hand-held.
  - When the  icon at the top left of the monitor lights in green, press the shutter-release button all the way to capture a series of images which will be combined into a single image and saved.
  - Once the shutter-release button is pressed all the way, hold the camera still until a still image is displayed. After taking an image, do not turn the camera off before the monitor switches to the shooting screen.
  - The angle of view (i.e., the area visible in the frame) seen in the saved image will be narrower than that seen in the monitor at the time of shooting.
- **Tripod:** Select this option when using a tripod or other means to stabilize the camera during shooting.
  - Vibration reduction is disabled even when **Vibration reduction** (104) in the setup menu is set to **On**.
  - One image is captured at a slow shutter speed when the shutter-release button is pressed all the way.
- Digital zoom cannot be used.

## Close-up

- Macro mode (62) is enabled and the camera automatically zooms to the closest position at which it can focus.
- You can move the focus area. To move the focus area, press the  button, and then press the multi selector , , , or . To change settings for any of the following functions, first press the  button to cancel focus-area selection, then change the settings as desired.
  - Flash mode
  - Self-timer
  - Exposure compensation
- The camera focuses even when the shutter-release button is not pressed halfway. You may hear the sound of the camera focusing.

## 🍴 Food

- Macro mode (📖62) is enabled and the camera automatically zooms to the closest position at which it can focus.
- You can move the focus area. To move the focus area, press the ⓧ button, and then press the multi selector ▲, ▼, ◀, or ▶.  
To change settings for any of the following functions, first press the ⓧ button to cancel focus-area selection, then change the settings as desired.
  - Hue
  - Self-timer
  - Exposure compensation
- The camera focuses even when the shutter-release button is not pressed halfway. You may hear the sound of the camera focusing.
- You can adjust hue by pressing the multi selector ▲ or ▼. The hue setting is saved in the camera's memory even after the camera is turned off.

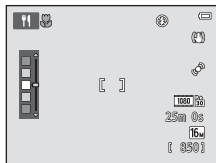

## 🏛️ Museum

- The camera focuses on the area in the center of the frame.
- The camera captures a series of up to ten images while the shutter-release button is held all the way down, and the sharpest image in the series is automatically selected and saved (BSS (Best Shot Selector)).
- The flash does not fire.

## 🎆 Fireworks show





- Camera focuses at infinity.
  - The focus indicator (📖9) always glows green when the shutter-release button is pressed halfway.
  - The shutter speed is fixed at about four seconds.
- 📵 Use of a tripod is recommended when using scene modes indicated with 📵, because the shutter speed is slow. Set **Vibration reduction** to **Off** in the setup menu (📖104) when using a tripod to stabilize the camera during shooting.



## Black and white copy

- The camera focuses on the area in the center of the frame.
- Use together with macro mode (62) when shooting subjects that are close to the camera.

## Backlighting

- The camera focuses on the area in the center of the frame.
- From the screen displayed after  **Backlighting** is selected, select **On** or **Off** to enable or disable the high dynamic range (HDR) function based on the type of image you want to take.
- **Off** (default setting): The flash fires to prevent the subject from being hidden in shadow.
  - When the shutter-release button is pressed all the way down, one image is captured.
- **On**: Use when taking images with very bright and dark areas in the same frame.
  - When the shutter-release button is pressed all the way, the camera shoots images continuously at high speed, and saves the following two images.
    - A non-HDR composite image
    - An HDR composite image in which the loss of details in highlights or shadows is minimized
  - The second image saved is an HDR composite image. If there is only enough memory to save one image, an image processed by D-Lighting (84) at the time of shooting, in which dark areas of the image are corrected, is the only image saved.
  - Once the shutter-release button is pressed all the way, hold the camera still until a still image is displayed. After taking an image, do not turn the camera off before the monitor switches to the shooting screen.
  - The angle of view (i.e., the area visible in the frame) seen in the saved image will be narrower than that seen in the monitor at the time of shooting.
  - Digital zoom cannot be used.

## Easy panorama

- Allows you to take a panorama image simply by moving the camera in the desired direction.
- The camera focuses on the area in the center of the frame when shooting starts.
- From the screen displayed after  **Easy panorama** is selected, select the shooting range from **Normal (180°)** or **Wide (360°)**.
- Press the shutter-release button all the way down, remove your finger from the button, and then slowly pan the camera horizontally. Shooting automatically ends when the camera captures the specified shooting range.
- The zoom position is fixed at wide-angle.
- If you press the  button when an image captured using easy panorama is displayed in full-frame playback mode, the image scrolls automatically.



See “Using Easy Panorama (Shooting and Playback)” ( 2) for more information.

## **Notes About Printing Panorama Images**





When printing panorama images, the entire image may not be able to be printed depending on the printer's settings. Additionally, printing may not be possible depending on the printer.

See the documentation provided with the printer or consult the digital photo lab for details.

## Pet portrait

- When you point the camera at a dog or cat, the camera detects the pet's face and focuses on it. By default, the shutter is automatically released when focus is acquired (pet portrait auto release).
- From the screen displayed after  **Pet portrait** is selected, select **Single** or **Continuous**.
  - **Single:** Images are captured one at a time.
  - **Continuous:** When focus is acquired on the detected face, the camera automatically releases the shutter 3 times. When you manually release the shutter, up to 6 images can be continuously taken while the shutter-release button is held down. The frame rate for continuous shooting is about 2 fps (when **Image mode** is set to  **4608x3456**).

### **Pet Portrait Auto Release**

- To change the **Pet portrait auto release** settings, press the multi selector .
    - : When the camera detects a pet face, it focuses on the face and then releases the shutter automatically.
    - **OFF:** The camera does not release the shutter automatically, even if a pet face is detected. Press the shutter-release button to release the shutter. The camera also detects human faces (73). If the camera detects a human face and a pet face in the same shot, it focuses on the pet face.
  - Pet portrait auto release turns off automatically when:
    - Five bursts have been taken.
    - Internal memory or the memory card is full.
- To resume shooting with **Pet portrait auto release**, press the multi selector  to turn it on again.

### **Focus Area**

- When the camera detects a face, a yellow double border (focus area) is displayed around the face, and the double border turns green when the camera has focused.
- When the camera detects more than one dog or cat face (up to five can be detected), the face displayed largest in the monitor is framed by a double border and the others by single borders.
- If no pet or human faces are detected, the camera focuses on the subject in the center of the frame.

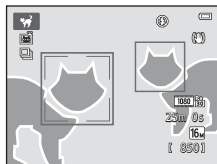

### **Notes About Pet Portrait**

- Digital zoom cannot be used.
- Depending on the distance of the pet from the camera, the speed of the pet's movement, the direction the pet is facing, the ambient brightness around its face, etc., the pet face may not be detected and other subjects may be displayed with a border.

### 3D 3D photography

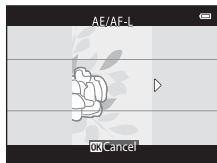

- The camera captures one image for each eye to simulate a three-dimensional image on a 3D-compatible TV or monitor.
- The focus area can be moved from the center of the frame to a different position. To move the focus area, before taking the first image, press the **OK** button, and then press the multi selector **▲**, **▼**, **◀**, or **▶**. To change settings for any of the following functions, first press the **OK** button to cancel focus-area selection, then change the settings as desired.
  - Macro mode
  - Exposure compensation
- After taking the first image by pressing the shutter-release button, move the camera horizontally to the right so that the subject is aligned with the guide in the monitor. The camera captures the second image automatically when it detects that they are aligned.
- The focus, exposure, and white balance are locked after the first shot, and **AE/AF-L** is displayed in the monitor.
- The angle of view (i.e., the area visible in the frame) seen in the saved image will be narrower than that seen in the monitor at the time of shooting.
- Images captured in this mode are saved at an image size of **25** (1920 × 1080).
- The two captured images are saved as a 3D image (MPO file). The first image (the left eye image) is also saved as a JPEG file.



### ✓ Notes About Taking 3D Images

- Moving subjects are not suited to 3D photography.
- Images have a less pronounced 3D feel as the distance between the camera and background is increased.
- Images may have a less pronounced 3D feel when the subject is dark or when the second image is not aligned precisely.
- Images captured under dim lighting may appear grainy with noise.
- The maximum telephoto zoom position is limited to an angle of view equivalent to that of 144.6 mm lens in 35mm [135] format.
- Shooting is canceled after the first shot if the **OK** button is pressed or the subject is not aligned with the guide within approximately ten seconds.
- If the camera does not take the second image and cancels the shooting even when you align the guide with the subject, try shooting with the shutter-release button.
- Movies cannot be recorded in 3D.

### **Playing Back 3D Images**







- 3D images cannot be played back in 3D on the camera monitor. Only the left eye image of a 3D image is displayed during playback.
- To view 3D images in 3D, a 3D-compatible TV or monitor is required. Use a 3D-compatible HDMI cable to connect the camera and these devices (86) for 3D viewing.
- When connecting the camera using an HDMI cable, set **TV settings** in the setup menu (104) as follows:
  - **HDMI: Auto** (default setting) or **1080i**
  - **HDMI 3D output: On** (default setting)
- When the camera is connected via HDMI and images are played back, it may take a while to display images when switching between 3D images and non-3D images. Playback zoom is not possible while images are played back in 3D.
- Refer to the documentation included with the TV or monitor for details on how to make the settings.

### **Caution for Viewing 3D Images**

When viewing 3D images on a 3D-compatible TV or monitor for an extended period of time, you may experience discomfort such as eye strain or nausea. Carefully read the documentation included with your TV or monitor to ensure proper use.









# Special Effects Mode (Applying Effects When Shooting)

Effects can be applied to images during shooting.

Enter shooting mode →  (shooting mode) button → **S0** (third icon from the top\*) →  → , , ,  → select an effect →  button

\* The icon of the last effect selected is displayed.

The following 12 effects are available.

Category	Description
<b>S0</b> Soft* (default setting)	Softens the image by adding a slight blur to the entire image.
<b>SE</b> Nostalgic sepia*	Adds a sepia tone and reduces the contrast to simulate the qualities of an old photograph.
 High-contrast monochrome	Changes the image to black and white and gives it sharp contrast.
 High key	Gives the entire image a bright tone.
 Low key	Gives the entire image a dark tone.
 Selective color	Creates a black and white image in which only the specified color remains.
<b>POP</b> Pop	Increases the color saturation of the entire image to create a bright look.
<b>VI</b> Super vivid	Increases the color saturation of the entire image and sharpens the contrast.
 Painting	Gives the image a painting-like appearance.
 Toy camera effect 1	Gives the entire image a yellowish hue and darkens the image periphery.
 Toy camera effect 2	Decreases the color saturation of the entire image and darkens the image periphery.
 Cross process	Gives the image a mysterious appearance based on a specific color.

\* The  **HS 480/4x** setting in **Movie options** (99) cannot be used with this setting. If you try to use both settings at the same time, only the setting made first is enabled.

- The camera focuses on the area in the center of the frame.
- When **Selective color** or **Cross process** is selected, press the multi selector ▲ or ▼ to select the desired color from the slider.

To change settings for any of the following functions, first press the **OK** button to cancel color selection, then change the settings as desired.

- Flash mode (📖57)
- Self-timer (📖60)
- Macro mode (📖62)
- Exposure compensation (📖64)

To return to the color selection screen, press the **OK** button again.

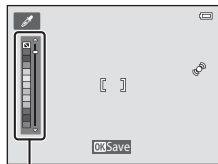



Slider

## Changing Special Effects Mode Settings

- Features that can be set using the multi selector (📖56): Flash mode (📖57), self-timer (📖60), macro mode (📖62), and exposure compensation (📖64)
- Features that can be set by pressing the **MENU** button (📖67): Image mode (image size and quality) (📖68, 📷40)

# Smart Portrait Mode (Capturing Images of Smiling Faces)

When the camera detects a smiling face, you can take an image automatically without pressing the shutter-release button (smile timer). You can use the skin softening option to smooth the skin tones of human faces.

Enter shooting mode →  (shooting mode) button →  Smart portrait mode →  button

## 1 Frame the image.

- Point the camera at a human face. See “Using Face Detection” (📖73) for more information.

## 2 Without pressing the shutter-release button, wait for the subject to smile.

- If the camera detects that the face framed by the double border is smiling, the shutter is automatically released. See “Smile timer” (📖69) for more information.
- After the camera releases the shutter, it will continue to detect faces and smiles, and will release the shutter again if it detects a smiling face.

## 3 End shooting.

- Any one of the following operations can be used to cancel smile detection and stop shooting.
  - Set **Smile timer** (📖69) to **Off**.
  - Press the  button and select a different shooting mode.
  - Turn the camera off.

### **Notes About Smart Portrait Mode**

- Digital zoom cannot be used.
- Under some shooting conditions, the camera may be unable to detect faces or detect smiles.
- See “Notes About Face Detection” (📖74) for more information.

### **Auto Power Off in Smile Timer Mode**

When **Smile timer** is set to **On (single)**, **On (continuous)**, or **On (BSS)**, the auto power off function (📖104) is activated and the camera turns off when either of the situations indicated below persists and no other operations are performed.

- The camera does not detect any faces.
- The camera detected a face, but cannot detect a smile.

### **When the Self-timer Lamp Flashes**

When using smile timer, the self-timer lamp flashes when the camera detects a face and flashes quickly immediately after the shutter is released.

### **Releasing the Shutter Manually**

The shutter can also be released by pressing the shutter-release button. If no faces are detected, the camera focuses on the subject at the center of the frame.

## **Changing Smart Portrait Mode Settings**

- Features that can be set using the multi selector (📖56): Flash mode (📖57), self-timer (📖60), and exposure compensation (📖64)
- Features that can be set by pressing the **MENU** button (📖67): Image mode (image size and quality) (📖68, 📖40), skin softening (📖69), smile timer (📖69), blink proof (📖69)

### **Camera Settings That Cannot Be Used Simultaneously**

Some settings cannot be used with other functions (📖70).

## Using Skin Softening

When the shutter is released while using one of the shooting modes listed below, the camera detects up to three human faces and processes the image to soften facial skin tones.

- **Scene auto selector** (📖41), **Portrait** (📖41), or **Night portrait** (📖42) scene mode is selected.
- Smart portrait mode (📖53)

Editing functions such as **Skin softening** can be applied to saved images by using **Glamour retouch** (📖84).

### Notes About Skin Softening

- It may take more time than usual to save images after shooting.
- Under some shooting conditions, the desired skin softening results may not be achieved, and skin softening may be applied to areas of the image where there are no faces.
- The skin softening level cannot be adjusted when shooting in **Portrait** or **Night portrait** scene mode, or when the camera selects one of these scenes while in scene auto selector scene mode.

# Features That Can Be Set Using the Multi Selector

When shooting, the multi selector ▲, ▼, ◀, and ▶ can be used to set the following features.

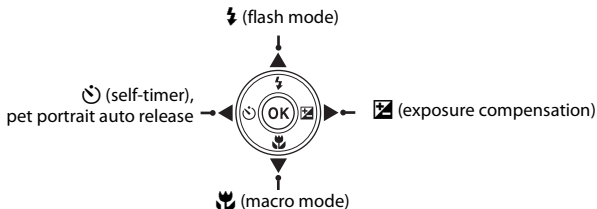

## Available Features

The features that are available vary with the shooting mode, as shown below.

- See "Default Settings" (📖65) for information about each mode's default settings.

	📷 (auto)	Scene	Special effects	Smart portrait
⚡ Flash mode (📖57)	✓	1	✓	✓ <sup>2</sup>
⌚ Self-timer (📖60)	✓		✓	✓ <sup>2</sup>
⌚ Pet portrait auto release (📖48)	–		–	–
🌸 Macro (📖62)	✓		✓	–
◻ Exposure compensation (📖64)	✓		✓	✓

<sup>1</sup> Varies by the scene. See "Default Settings" (📖65) for more information.

<sup>2</sup> Varies by the smart portrait menu setting. See "Default Settings" (📖65) for more information.

## Using the Flash (Flash Modes)

You can set the flash mode to match the shooting conditions.

- 1 Press the multi selector ▲ (⚡ flash mode).



- 2 Press ▲ or ▼ to select the desired mode and press the OK button.

- See “Available Flash Modes” (📖58) for more information.
- If a setting is not applied by pressing the OK button within a few seconds, the selection will be canceled.
- When ⚡AUTO (auto) is applied, ⚡AUTO is only displayed for a few seconds, regardless of the setting in **Monitor settings** (📖104).

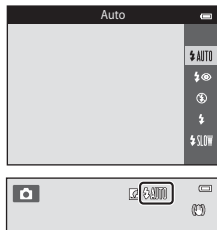

### ✓ The Flash Lamp

- The flash lamp indicates the status of the flash when you press the shutter-release button halfway.
  - On: The flash will fire when you press the shutter-release button all the way down.
  - Flashing: The flash is charging. The camera cannot take images.
  - Off: The flash will not fire when an image is taken.
- If the battery is low, the monitor will turn off in order to save power while the flash is charging.

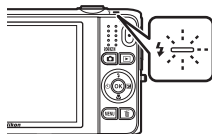

### 📎 Effective Range of the Flash

When ISO sensitivity is set to **Auto**, the flash has a range of 1.0 to 4.0 m (3 ft 4 in. to 13 ft) at the maximum wide-angle zoom position and a range of 1.5 to 2.0 m (5 ft to 6 ft 6 in.) at the maximum telephoto zoom position.

## Available Flash Modes

### AUTO Auto

The flash fires automatically when lighting is dim.

### Auto with red-eye reduction

Reduce red-eye in portraits caused by the flash (59).

### Off

The flash will not fire.

We recommend using a tripod to stabilize the camera when shooting in dark surroundings.

### Fill flash

The flash fires whenever an image is taken. Use to “fill-in” (illuminate) shadows and backlit subjects.





### SLOW Slow sync

Auto flash mode is combined with slow shutter speed.

Suited to evening and night portraits that include background scenery.

The flash illuminates main subject; slow shutter speeds are used to capture background at night or under dim lighting.

## The Flash Mode Setting

- The setting varies with the shooting mode. See “Available Features” (56) and “Default Settings” (65) for more information.
- Some settings cannot be used with other functions (70).
- The flash mode setting applied in  (auto) mode is saved in the camera’s memory even after the camera is turned off.



## Red-eye Reduction

This camera uses **Advanced Red-Eye Reduction** (In-Camera Red-Eye Fix).

If the camera detects red eye while saving an image, the affected area will be processed to reduce red-eye before the image is saved.

Note the following when shooting:

- More time than usual is required to save images.
- Red-eye reduction may not produce the desired results in all situations.
- In some cases, red-eye correction may be applied to areas of an image unnecessarily. In these cases, select another flash mode and take the image again.

## Using the Self-timer

The camera is equipped with a self-timer that releases the shutter ten seconds or two seconds after you press the shutter-release button. The self-timer is useful when you want to be in the image you are taking, and when you want to avoid the effects of camera shake that occur when you press the shutter-release button. When using the self-timer, use of a tripod is recommended. Set **Vibration reduction** to **Off** in the setup menu (📖104) when using a tripod to stabilize the camera during shooting.

**1** Press the multi selector ◀ (🕒 self-timer).



**2** Press ▲ or ▼ to select 🕒 10s or 🕒 2s and press the OK button.

- 🕒 **10s** (ten seconds): Use on important occasions, such as weddings.
- 🕒 **2s** (two seconds): Use to prevent camera shake.
- If a setting is not applied by pressing the OK button within a few seconds, the selection will be canceled.
- When the shooting mode is the **Pet portrait** scene mode, 📷 (pet portrait auto release) is displayed (📖48). The self-timer settings 🕒 **10s** and 🕒 **2s** cannot be used.

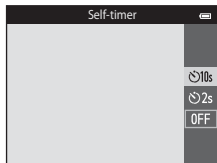

**3** Frame the image and press the shutter-release button halfway.

- Focus and exposure will be set.

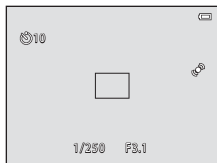

## 4 Press the shutter-release button the rest of the way down.

- The self-timer starts, and the number of seconds remaining before the shutter is released is displayed in the monitor. The self-timer lamp flashes while the timer is counting down. About one second before the shutter is released, the lamp stops flashing and glows steadily.
- When the shutter is released, the self-timer will be set to **OFF**.
- To stop the timer before an image is taken, press the shutter-release button again.

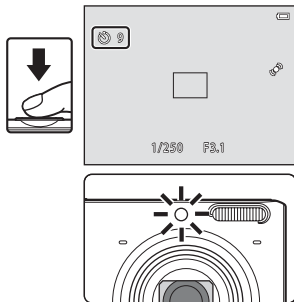

### Camera Settings That Cannot Be Used Simultaneously

Some settings cannot be used with other functions (70).

## Using Macro Mode

When using macro mode, the camera can focus on objects as close as approximately 8 cm (3.2 in.) from the front of the lens.

This feature is useful when taking close-up images of flowers and other small subjects.

- 1 Press the multi selector ▼ (🌸 macro mode).



- 2 Press ▲ or ▼ to select **ON** and press the **OK** button.

- The macro mode icon (🌸) is displayed.
- If a setting is not applied by pressing the **OK** button within a few seconds, the selection will be canceled.



- 3 Use the zoom control to set the zoom ratio to a position where 🌸 and the zoom indicator glow green.





- How close you can be to the subject when shooting depends on the zoom ratio. When the zoom ratio is set to a position where 🌸 and the zoom indicator glow green, the camera can focus on subjects as close as approximately 30 cm (1 ft) from the lens. When the zoom is at the maximum wide-angle position, (at the position where ▲ is displayed), the camera can focus on subjects as close as approximately 8 cm (3.2 in.) from the lens.

## Notes About Using the Flash

The flash may be unable to light the entire subject at distances of less than 1 m (3 ft 4 in.).





## Autofocus

When using macro mode in the  (auto) mode, you can focus without pressing the shutter-release button halfway by setting **Autofocus mode** (69) in the shooting menu (68) to **Full-time AF**.

When using other shooting modes, **Full-time AF** is turned on automatically when macro mode is turned on (except when using the **Pet portrait** scene mode).

You may hear the sound of the camera focusing.

## The Macro Mode Setting

- Macro mode cannot be used when using certain shooting modes. See “Default Settings” (65) for more information.
- Some settings cannot be used with other functions (70).
- The macro mode setting applied in  (auto) mode is saved in the camera’s memory even after the camera is turned off, and reapplied the next time  (auto) mode is selected.

# Adjusting Brightness (Exposure Compensation)

You can adjust overall image brightness.

- 1 Press the multi selector ► (☒ exposure compensation).



- 2 Press ▲ or ▼ to select a compensation value.

- To make the image brighter, apply positive (+) exposure compensation.
- To make the image darker, apply negative (–) exposure compensation.

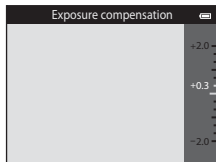

- 3 Press the **OK** button to apply the compensation value.

- If you do not press the **OK** button within a few seconds, the setting is applied and the menu disappears.
- When an exposure compensation value other than **0.0** is applied, the value is displayed with the ☒ indicator in the monitor.

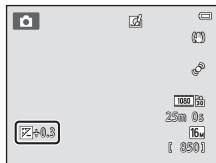

- 4 Press the shutter-release button to take an image.



































































- To turn off exposure compensation, return to step 1 and revert the value to **0.0**.











## Exposure Compensation Value





The exposure compensation value applied in  (auto) mode is saved in the camera's memory even after the camera is turned off.

## Default Settings

Default settings for each shooting mode are described below.

	Flash (  57)	Self-timer (  60)	Macro (  62)	Exposure compensation (  64)
 (auto)	 AUTO	Off	Off	0.0
SO (special effects)		Off	Off	0.0
 (smart portrait)	 AUTO <sup>1</sup>	Off <sup>2</sup>	Off <sup>3</sup>	0.0
Scene				
 (  41)	 AUTO <sup>4</sup>	Off	Off <sup>5</sup>	0.0
 (  41)	 	Off	Off <sup>3</sup>	0.0
 (  42)	 <sup>3</sup>	Off	Off <sup>3</sup>	0.0
 (  42)	 <sup>3</sup>	Off <sup>3</sup>	Off <sup>3</sup>	0.0
 (  42)	  <sup>6</sup>	Off	Off <sup>3</sup>	0.0
 (  43)	  <sup>7</sup>	Off	Off <sup>3</sup>	0.0
 (  43)	 AUTO	Off	Off <sup>3</sup>	0.0
 (  43)	 AUTO	Off	Off <sup>3</sup>	0.0
 (  43)	 <sup>3</sup>	Off	Off <sup>3</sup>	0.0
 (  43)	 <sup>3</sup>	Off	Off <sup>3</sup>	0.0
 (  44)	 <sup>3</sup>	Off	Off <sup>3</sup>	0.0
 (  44)	 <sup>3</sup>	Off	On <sup>3</sup>	0.0
 (  45)	 <sup>3</sup>	Off	On <sup>3</sup>	0.0
 (  45)	 <sup>3</sup>	Off	Off	0.0
 (  45)	 <sup>3</sup>	Off <sup>3</sup>	Off <sup>3</sup>	0.0 <sup>3</sup>
 (  46)	 <sup>3</sup>	Off	Off	0.0
 (  46)	 /  <sup>8</sup>	Off	Off <sup>3</sup>	0.0
 (  47)	 <sup>3</sup>	Off <sup>3</sup>	Off <sup>3</sup>	0.0

	Flash (  57)	Self-timer (  60)	Macro (  62)	Exposure compensation (  64)
 (  48)	 <sup>3</sup>	 <sup>9</sup>	Off	0.0
<b>3D</b> (  49)	 <sup>3</sup>	Off <sup>3</sup>	Off	0.0

- <sup>1</sup> Cannot be used when **Blink proof** is set to **On** or when **Smile timer** is set to **On (continuous)** or **On (BSS)**.
- <sup>2</sup> Can be set when **Smile timer** is set to **Off**.
- <sup>3</sup> The setting cannot be changed.
- <sup>4</sup> The camera automatically selects the flash mode appropriate for the scene it has selected.  (off) can be selected manually.
- <sup>5</sup> Cannot be changed. The camera enters macro mode when  is selected.
- <sup>6</sup> The setting cannot be changed. The flash mode setting is fixed at fill flash with red-eye reduction.
- <sup>7</sup> Slow sync with red-eye reduction flash mode may be used.
- <sup>8</sup> Flash is fixed at  (fill flash) when **HDR** is set to **Off**, and is fixed at  (off) when **HDR** is set to **On**.
- <sup>9</sup> Self-timer cannot be used. Pet portrait auto release can be turned on or off (48).

## Camera Settings That Cannot Be Used Simultaneously

Some settings cannot be used with other functions (70).

## Features That Can Be Set with the MENU Button (Shooting Menu)

The settings listed below can be changed by pressing the **MENU** button during shooting (📖6).

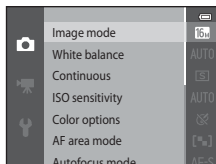
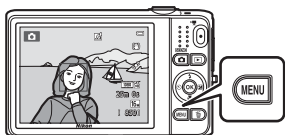







The settings that can be changed vary depending on the shooting mode, as shown below.







	Auto mode	Scene <sup>2</sup>	Special effects	Smart portrait
Image mode <sup>1</sup>	✓	✓	✓	✓
White balance	✓	-	-	-
Continuous	✓	-	-	-
ISO sensitivity	✓	-	-	-
Color options	✓	-	-	-
AF area mode	✓	-	-	-
Autofocus mode	✓	-	-	-
Quick effects	✓	-	-	-
Skin softening	-	-	-	✓
Smile timer	-	-	-	✓
Blink proof	-	-	-	✓

<sup>1</sup> The setting is also applied to other shooting modes.

<sup>2</sup> Additional settings are available for some scene modes. See “Characteristics of Each Scene” (📖41) for more information.

## Options Available in the Shooting Menu

Option	Description	
Image mode	Allows you to select the combination of image size and image quality used when saving images. The default setting is <b>16M 4608×3456</b> .	 40
White balance	Allows you to adjust white balance to suit the light source in order to make the colors in images match what you see with your eye. The available settings are <b>Auto</b> (default setting), <b>Preset manual</b> , <b>Daylight</b> , <b>Incandescent</b> , <b>Fluorescent</b> , <b>Cloudy</b> , and <b>Flash</b> .	 42
Continuous	Allows you to capture a series of images. The available settings are <b>Single</b> (default setting), <b>Continuous H</b> , <b>Continuous L</b> , <b>Pre-shooting cache</b> , <b>Continuous H: 120 fps</b> , <b>Continuous H: 60 fps</b> , <b>BSS</b> , and <b>Multi-shot 16</b> .	 45
ISO sensitivity	Allows you to control the camera's sensitivity to light. You can set sensitivity to <b>Auto</b> (default setting) or <b>Fixed range auto</b> , or lock the setting at <b>125</b> , <b>200</b> , <b>400</b> , <b>800</b> , <b>1600</b> , or <b>3200</b> . When ISO sensitivity is set to <b>Auto</b> , the camera sets the ISO sensitivity automatically, and <b>ISO</b> is displayed while shooting when ISO sensitivity increases. When <b>Fixed range auto</b> is selected, an ISO sensitivity range of either <b>ISO 125-400</b> or <b>ISO 125-800</b> can be selected.	 49
Color options	Allows you to change the color tones of images at the time of shooting. The available settings are <b>Standard color</b> (default setting), <b>Vivid color</b> , <b>Black-and-white</b> , <b>Sepia</b> , and <b>Cyanotype</b> .	 50
AF area mode	Allows you to determine how the camera selects the focus area that is used for autofocus; the available settings are <b>Face priority</b> , <b>Manual</b> , <b>Center</b> , <b>Subject tracking</b> , and <b>Target finding AF</b> (default setting).	 51

Option	Description	
Autofocus mode	<p>Allows you to select how the camera focuses.</p> <ul style="list-style-type: none"> <li>When <b>Single AF</b> (default setting) is selected, focus is locked when the shutter button is pressed halfway.</li> <li>When <b>Full-time AF</b> is selected, the camera focuses even when the shutter-release button is not pressed halfway. The sound of lens drive movement will be heard while the camera focuses.</li> </ul>	 55
Quick effects	<p>Allows you to enable or disable the quick effects function (39). The default setting is <b>On</b>.</p>	 56
Skin softening	<p>Allows you select the degree of the skin softening effect. When a setting other than <b>Off</b> is selected, the camera softens skin tones of human faces and then saves the images. The default setting is <b>Normal</b>.</p>	 57
Smile timer	<p>When a setting other than <b>Off</b> is selected, the camera detects human faces and then automatically releases the shutter whenever a smile is detected. Self-timer cannot be used with this feature.</p> <ul style="list-style-type: none"> <li>When <b>On (single)</b> is selected, a single image is taken whenever a smile is detected.</li> <li>When <b>On (continuous)</b> or <b>On (BSS)</b> (default setting) is selected, images are taken continuously whenever a smile is detected. The flash cannot be used. If <b>Blink proof</b> is set to <b>On</b>, the smile timer setting changes to <b>On (single)</b>.</li> </ul>	 58
Blink proof	<p>When <b>On</b> is selected, the camera automatically releases the shutter twice each time an image is taken. Of the two shots, one in which the subject's eyes are open is saved. The flash cannot be used. The default setting is <b>Off</b>.</p>	 59



### Camera Settings That Cannot Be Used Simultaneously

Some settings cannot be used with other functions (70).

# Features That Cannot Be Used Simultaneously

Some functions cannot be used with other menu options.

Restricted function	Option	Description
Flash mode	Continuous (📖68)	When a setting other than <b>Single</b> is selected, the flash cannot be used.
	Blink proof (📖69)	When <b>Blink proof</b> is set to <b>On</b> , the flash cannot be used.
	Smile timer (📖69)	When <b>On (continuous)</b> or <b>On (BSS)</b> is selected, the flash cannot be used.
Self-timer	Smile timer (📖69)	When <b>Smile timer</b> is used for shooting, the self-timer cannot be used.
	AF area mode (📖68)	When <b>Subject tracking</b> is selected, the self-timer cannot be used.
Macro mode	AF area mode (📖68)	When <b>Subject tracking</b> is selected, macro mode cannot be used.
Image mode	Continuous (📖68)	<b>Image mode</b> is set as follows depending on the continuous shooting setting: <ul style="list-style-type: none"><li>• <b>Continuous H: 120 fps: 16A</b> (image size: 640 × 480 pixels)</li><li>• <b>Continuous H: 60 fps: 1M</b> (image size: 1280 × 960 pixels)</li><li>• <b>Multi-shot 16: 5M</b> (image size: 2560 × 1920 pixels)</li></ul>
White balance	Color options (📖68)	When using <b>Black-and-white</b> , <b>Sepia</b> , or <b>Cyanotype</b> , the <b>White balance</b> setting is fixed at <b>Auto</b> .
Continuous	Self-timer (📖60)	If the self-timer is used when <b>Continuous</b> is set to <b>Pre-shooting cache</b> , the <b>Continuous</b> setting changes to <b>Single</b> .

Restricted function	Option	Description
ISO sensitivity	Continuous (📖68)	When <b>Pre-shooting cache, Continuous H: 120 fps, Continuous H: 60 fps, or Multi-shot 16</b> is selected, the <b>ISO sensitivity</b> setting is automatically specified according to the brightness.
AF area mode	White balance (📖68)	When a setting other than <b>Auto</b> is selected for <b>White balance</b> in <b>Target finding AF</b> mode, the camera does not detect the main subject.
Quick effects	Continuous (📖68)	<b>Quick effects</b> cannot be applied to images immediately after they are taken with continuous shooting.
Smile timer	Blink proof (📖69)	When the smile timer setting is set to <b>On (continuous)</b> or <b>On (BSS)</b> , it changes to <b>On (single)</b> if <b>Blink proof</b> is set to <b>On</b> .
Blink proof	Smile timer (📖69)	When <b>Blink proof</b> is set to <b>On</b> , it changes to <b>Off</b> if <b>Smile timer</b> is set to <b>On (continuous)</b> or <b>On (BSS)</b> .
Monitor settings	Quick effects (📖69)	When <b>Quick effects</b> is set to <b>On</b> , <b>Image review</b> is fixed at <b>On</b> .
Print date	Continuous (📖68)	When <b>Pre-shooting cache, Continuous H: 120 fps, Continuous H: 60 fps</b> is selected, date and time cannot be imprinted on images.

Restricted function	Option	Description
Motion detection	Continuous (📖68)	When a setting other than <b>Single</b> is selected, <b>Motion detection</b> is disabled.
	ISO sensitivity (📖68)	When the ISO sensitivity is set to any setting other than <b>Auto</b> , <b>Motion detection</b> is disabled.
	AF area mode (📖68)	When <b>Subject tracking</b> is selected, <b>Motion detection</b> is disabled.
	Smile timer (📖69)	When <b>On (continuous)</b> or <b>On (BSS)</b> is selected, <b>Motion detection</b> is disabled.
Blink warning	Continuous (📖68)	When a setting other than <b>Single</b> is selected, <b>Blink warning</b> is disabled.
Digital zoom	Continuous (📖68)	When <b>Multi-shot 16</b> is selected, digital zoom cannot be used.
	AF area mode (📖68)	When <b>Subject tracking</b> is selected, digital zoom cannot be used.
Shutter sound	Continuous (📖68)	When a setting other than <b>Single</b> is selected, the shutter sound is disabled.

### ✔ Notes About Digital Zoom

- Depending on the shooting mode or the current settings, digital zoom may not be available (📖93).
- When digital zoom is in effect, the camera focuses in the center of the frame.

# Focusing

This camera uses autofocus to focus automatically when shooting. The focus area varies depending on the shooting mode. Here, we will explain how to use focus areas and focus lock.

## Using Face Detection

In the following shooting modes, the camera uses face detection to automatically focus on human faces. If the camera detects more than one face, a double border is displayed around the face that the camera will focus on, and single borders are displayed around the other faces.

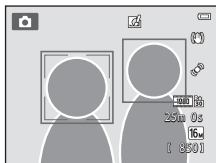



Shooting mode	Number of faces that can be detected	Focus area (double border)
When <b>AF area mode</b> (📖68) in <b>(auto) mode</b> (📖38) is set to <b>Face priority</b> .	Up to 12	The face closest to the camera
<b>Scene auto selector</b> (📖41), <b>Portrait</b> (📖41), or <b>Night portrait</b> (📖42) scene mode		
<b>Pet portrait</b> scene mode (when <b>Pet portrait auto release</b> is turned off) (📖48)	Up to 12 <sup>1</sup>	The face closest to the camera <sup>2</sup>
<b>Smart portrait mode</b> (📖53)	Up to 3	The face closest to the center of the frame

<sup>1</sup> If the camera detects both people and pets in the same shot, the camera can detect up to 12 faces.

<sup>2</sup> If the camera detects a human face and a pet face in the same shot, it focuses on the pet's face.

- If the shutter button is pressed halfway when no faces are detected:
  - In  (auto) mode, the camera selects one or more of the nine focus areas containing the subject closest to the camera.
  - When **Scene auto selector** is selected, the focus area changes depending on which scene the camera selects.
  - In **Portrait** and **Night portrait** scene modes or in smart portrait mode, the camera will focus on the area in the center of the frame.
  - In **Pet portrait** scene mode, the camera focuses on a pet face if one is detected. If no pet faces are detected, the camera focuses on the area in the center of the frame.
- You may hear the sound of the camera focusing.

### **Notes About Face Detection**

- The camera's ability to detect faces depends on a variety of factors, including the direction in which the faces are looking. Additionally, the camera may be unable to detect faces in the following situations:
  - When faces are partially hidden by sunglasses or otherwise obstructed
  - When faces take up too much or too little of the frame
- When the frame includes more than one face, the faces detected by the camera and the face on which the camera focuses depend upon a variety of factors, including the direction in which the faces are looking.
- In some rare cases, such as those described in "Subjects Not Suitable for Autofocus" (76), the subject may not be in focus even though the double border turns green. If the camera does not focus, try focus lock shooting (77).

## Using Target Finding AF

When **AF area mode** (📖68) in 📷 (auto) mode is set to **Target finding AF**, the camera focuses in the manner described below when you press the shutter-release button halfway.

- If the camera detects the main subject, it focuses on that subject. When the subject is in focus, the focus areas (up to three areas) that match up with the size of the subject light in green.

When human faces are detected, the camera automatically sets focus priority on one of them.

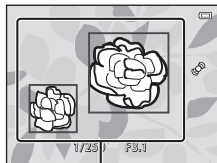

Focus areas

- If the camera does not detect the main subject, it automatically selects one or more of the nine focus areas containing the subject closest to the camera. When the subject is in focus, the focus areas that are in focus (up to nine areas) light in green.

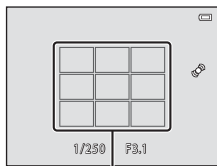

Focus areas

### ✔ Notes About Target Finding AF

- Depending on shooting conditions, the subject that the camera determines to be the main subject may vary.
- When **White balance** is set to any setting other than **Auto**, the camera does not detect the main subject.
- The camera may not detect the main subject appropriately in the following situations:
  - When the image shown in the monitor is very dark or bright
  - When the main subject lacks clearly defined colors
  - When the shot is framed so that the main subject is at the edge of the monitor
  - When the main subject is composed of a repeating pattern

## Subjects Not Suitable for Autofocus



The camera may not focus as expected in the following situations. In some rare cases, the subject may not be in focus despite the fact that the focus area or the focus indicator glows green:

- Subject is very dark
- Objects of sharply differing brightness are included in the scene (e.g. the sun behind the subject makes that subject appear very dark)
- No contrast between the subject and surroundings (e.g. a portrait subject wearing a white shirt is standing in front of a white wall)
- Several objects are at different distances from the camera (e.g. the subject is inside a cage)
- Subjects with repeating patterns (window blinds, buildings with multiple rows of similarly shaped windows, etc.)
- Subject is moving rapidly

In the situations noted above, try pressing the shutter-release button halfway to refocus several times, or focus on another subject positioned at the same distance from the camera as the actual desired subject, and use focus lock (📖77).

## Focus Lock

You can use focus lock to focus on off-center subjects when center is selected for AF area mode.

The following procedure describes how to use focus lock when using  (auto) mode with **AF area mode** () set to **Center**.

**1** Position the subject in the center of the frame.

**2** Press the shutter-release button halfway.

- Confirm that the focus area glows green.
- Focus and exposure are locked.

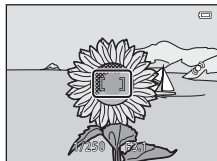

**3** Continue holding down the shutter-release button halfway and recompose the image.

- Be sure to maintain the same distance between the camera and the subject while the shutter-release button is pressed halfway.

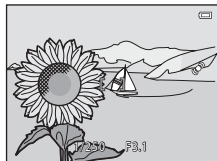

**4** Press the shutter-release button the rest of the way down to take the image.





A series of ten horizontal dashed lines spanning the width of the page, intended for handwriting practice.



# Playback Features

This chapter describes how to select certain types of images for playback as well as some of the features available when playing back images.

<b>Playback Zoom .....</b>	<b>80</b>
<b>Thumbnail Display, Calendar Display.....</b>	<b>81</b>
<b>Selecting Certain Types of Images for Playback.....</b>	<b>82</b>
<b>Features That Can Be Set with the MENU Button (Playback Menu).....</b>	<b>84</b>
<b>Connecting the Camera to a TV, Computer, or Printer .....</b>	<b>86</b>
<b>Using ViewNX 2.....</b>	<b>88</b>
Installing ViewNX 2.....	88
Transferring Images to the Computer .....	91
Viewing Images.....	93

# Playback Zoom

Rotating the zoom control to **T** (Q) in full-frame playback mode (📖32) zooms in on the center of the image displayed in the monitor.

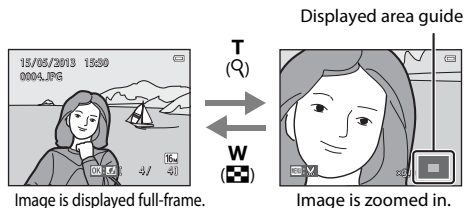

- You can change the zoom ratio by rotating the zoom control to **W** (📐) or **T** (Q). Images can be zoomed up to 10X.
- To view a different area of the image, press the multi selector ▲, ▼, ◀, or ▶.
- If you are viewing an image that was captured using face detection (📖73) or pet detection (📖48) function, the camera zooms in on the face detected at the time of shooting (except when viewing an image captured in a series). If the camera detected multiple faces when the image was captured, press ▲, ▼, ◀, or ▶ to display a different face. To zoom in on an area of the image where there are no faces, adjust the magnification rate and then press ▲, ▼, ◀, or ▶.
- You can crop the image and save the displayed area of the image as a separate file by pressing the **MENU** button (🔑24).
- Press the **OK** button to return to full-frame playback mode.

# Thumbnail Display, Calendar Display

Rotating the zoom control to **W** (📷) in full-frame playback mode (📖32) displays images as thumbnails.

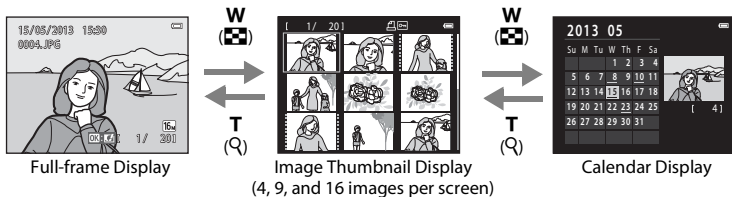

- You can view several images on one screen, making it easy to find the image you want.
- You can change the number of thumbnails displayed by rotating the zoom control to **W** (📷) or **T** (📷).
- Press the multi selector **▲**, **▼**, **◀**, or **▶** to select an image and then press the **OK** button to display that image full-frame.
- When 16 thumbnails are displayed, rotate the zoom control to **W** (📷) to switch to calendar display (except when in list by date mode).
- While using calendar display mode, press the multi selector **▲**, **▼**, **◀**, or **▶** to select a date and then press the **OK** button to display the first image captured on that day.

## 📅 Calendar Display

Images captured when the camera's date is not set are treated as images captured on January 1, 2013.

# Selecting Certain Types of Images for Playback

You can change the playback mode according to the type of images you want to view.

## Available Playback Modes



Play

32

All images are played back. When you switch from shooting mode to playback mode, this mode is selected.



Favorite pictures

6

Play back images added to an album. You must add images to an album before you can select this mode ( 85).



Auto sort

10

Images are automatically sorted into categories, such as portraits, landscapes, and movies.



List by date

12



Images captured on the selected date are played back.

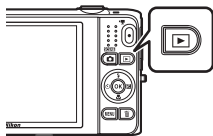

## Switching Between Playback Modes

- 1 When viewing images in full-frame playback mode or thumbnail playback mode, press the  button.

- The playback mode selection menu is displayed, from which you can select one of the available playback modes.







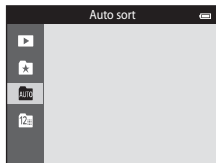

- 2 Press the multi selector  or  to select the desired mode and press the  button.

- If you select  **Play**, the playback screen is displayed.
- When an option other than  **Play** is selected, the album, category, or shooting date selection screen is displayed.
- To return to the current playback mode without switching playback modes, press the  button.













- 3 Select an album, category, or shooting date, and press the  button.







- For  favorite pictures, see 6.
- For  auto sort, see 10.
- For  list by date, see 12.
- Repeat from step 1 to select a different album, category, or shooting date.







## Features That Can Be Set with the MENU Button (Playback Menu)

When viewing images in full-frame playback mode or thumbnail playback mode, you can configure the menu operations listed below by pressing the **MENU** button (📖6).

When using favorite pictures (★), auto sort (AUTO), or list by date (📅) mode, the menu for the current playback mode is displayed.

Option	Description	
Quick retouch <sup>1,2</sup>	Allows you to create retouched copies in which contrast and saturation have been enhanced.	 20
D-Lighting <sup>1,2</sup>	Allows you to create copies with enhanced brightness and contrast, brightening dark portions of an image.	 20
Glamour retouch <sup>1,2</sup>	Detects faces in images and retouches detected faces using eight effects. The effect levels can be adjusted.	 21
Print order <sup>3,4</sup>	When using a printer to print images saved on the memory card, you can use the <b>Print order</b> function to select which images are printed, and how many copies of each image are printed.	 60
Slide show <sup>3</sup>	Allows you to view images saved in the internal memory or on a memory card in an automatic slide show.	 64
Protect <sup>3</sup>	Protects selected images from accidental deletion.	 65
Rotate image <sup>2,4</sup>	Specifies the orientation in which saved images are displayed during playback.	 68
Small picture <sup>1,2</sup>	Creates a small copy of images suitable for use as e-mail attachments.	 23
Voice memo <sup>2</sup>	Allows you to use the camera's microphone to record voice memos and attach them to images. You can also play back and delete voice memos.	 69
Copy <sup>5</sup>	Allows you to copy images between the internal memory and a memory card.	 71

Option	Description	
Sequence display options	Allows you to select whether to display only the key picture for a sequence of images captured continuously or to display the sequence as individual images.	 73
Choose key picture	Allows you to change the key picture for images captured in sequence (sequence of images;  33). When making this setting, first select an image from the sequence you want to change before pressing the <b>MENU</b> button.	 73
Favorite pictures	Allows you to add images to an album. This option is not displayed in favorite pictures mode.	 6
Remove from favorites	Allows you to remove images from an album. This option is displayed only in favorite pictures mode.	 8

- <sup>1</sup> Images are edited and saved as separate files. Certain restrictions apply (16, 17). For example, images captured with **Easy panorama** (47) or **3D photography** (49) cannot be edited, and the same editing feature cannot be applied multiple times.
- <sup>2</sup> This function is not available when only the key pictures are displayed for sequences of images. To use this function, press the  button to display the images in a sequence individually.
- <sup>3</sup> When using list by date mode, press the **MENU** button from the list of dates screen (12) to apply the same function to all images captured on the selected date.
- <sup>4</sup> This function is not available for images captured in **3D photography** scene mode (49).
- <sup>5</sup> This function is not displayed when using favorite pictures mode, auto sort mode, or list by date mode.

# Connecting the Camera to a TV, Computer, or Printer

You can enhance your enjoyment of images and movies by connecting the camera to a TV, computer, or printer.

- Before connecting the camera to an external device, make sure the remaining battery level is sufficient and turn the camera off. For information about the connection methods and subsequent operations, refer to the documentation included with the device in addition to this document.

How to open the connector cover.

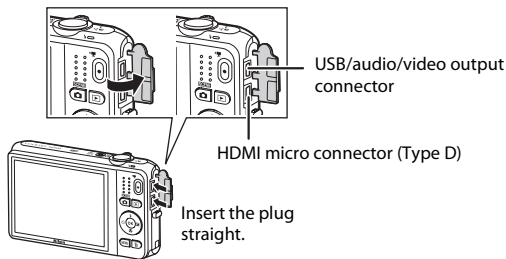

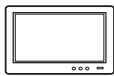

Images and movies captured with the camera can be viewed on a TV. Connection method: Connect the video and audio plugs of the included audio video cable to the TV's input jacks. Alternatively, connect a commercially available HDMI cable (Type D) to the TV's HDMI input jack.



If you transfer images to a computer, you can perform simple retouching and manage image data in addition to playing back images and movies.

Connection method: Connect the camera to the computer's USB port with the included USB cable.

- Before connecting to a computer, install ViewNX 2 on the computer using the included ViewNX 2 CD-ROM. For information about using the ViewNX 2 CD-ROM and transferring images to a computer, see page 88.
- If any USB devices that draw the power from the computer are connected, disconnect them from the computer before you connect the camera to it. Connecting the camera and other USB-powered devices to the same computer simultaneously may cause a camera malfunction or excessive power supply from the computer, which could damage the camera or memory card.



If you connect the camera to a PictBridge-compatible printer, you can print images without using a computer.

Connection method: Connect the camera directly to the printer's USB port with the included USB cable.

# Using ViewNX 2

ViewNX 2 is an all-in-one software package which enables you to transfer, view, edit and share images. Install ViewNX 2 using the included ViewNX 2 CD-ROM.



## Installing ViewNX 2

- An Internet connection is required.

## Compatible Operating Systems

### Windows

Windows 8, Windows 7, Windows Vista, Windows XP

### Macintosh

Mac OS X10.6, 10.7, 10.8

Refer to the Nikon website for details on system requirements, including the latest information on operating system compatibility.

# 1 Start the computer and insert the ViewNX 2 CD-ROM into the CD-ROM drive.

- Windows: If instructions for operating the CD-ROM are displayed in the window, follow the instructions to proceed to the installation window.
- Mac OS: When the **ViewNX 2** window is displayed, double-click the **Welcome** icon.

# 2 Select a language in the language selection dialog to open the installation window.

- If the desired language is not available, click **Region Selection** to choose a different region and then choose the desired language (the **Region Selection** button is not available in the European release).
- Click **Next** to display the installation window.

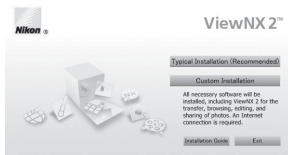

# 3 Start the installer.

- We recommend clicking **Installation Guide** in the installation window to check the installation help information and system requirements before installing ViewNX 2.
- Click **Typical Installation (Recommended)** in the installation window.

# 4 Download the software.

- When the **Software Download** screen is displayed, click **I agree - Begin download**.
- Follow the on-screen instructions to install the software.

---

## 5 Exit the installer when the installation completion screen is displayed.

- Windows: Click **Yes**.
- Mac OS: Click **OK**.

The following software is installed:

- ViewNX 2 (consisting of the three modules below)
  - Nikon Transfer 2: For transferring images to the computer
  - ViewNX 2: For viewing, editing, and printing transferred images
  - Nikon Movie Editor: For basic editing of transferred movies
- Panorama Maker (for creating a single panorama image of a landscape, etc. from a series of images that each capture a separate portion of the subject)

---

## 6 Remove the ViewNX 2 CD-ROM from the CD-ROM drive.

# Transferring Images to the Computer

## 1 Choose how images will be copied to the computer.

Choose one of the following methods:

- **Direct USB connection:** Turn the camera off and ensure that the memory card is inserted in the camera. Connect the camera to the computer using the included USB cable. The camera automatically turns on.  
To transfer images that are saved in the camera's internal memory, remove the memory card from the camera before connecting it to the computer.

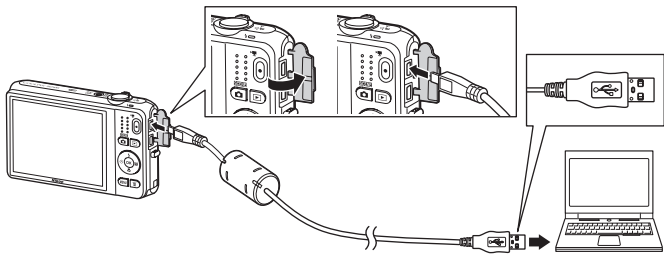

- **SD card slot:** If your computer is equipped with an SD card slot, the card can be inserted directly in the slot.
- **SD card reader:** Connect a card reader (available separately from third-party suppliers) to the computer and insert the memory card.

If a message is displayed prompting you to choose a program, select Nikon Transfer 2.

- **When using Windows 7**

If the dialog shown at right is displayed, follow the steps below to select Nikon Transfer 2.

- 1 Under **Import pictures and videos**, click **Change program**. A program selection dialog will be displayed; select **Import File using Nikon Transfer 2** and click **OK**.
- 2 Double-click **Import File**.



If the memory card contains a large number of images, it may take a while for Nikon Transfer 2 to start. Wait until Nikon Transfer 2 starts.

## ✓ Connecting the USB Cable

The connection may not be recognized if the camera is connected to the computer via a USB hub.

## 2 Transfer images to the computer.

- Confirm that the name of the connected camera or removable disk is displayed as the "Source" on the "Options" title bar of Nikon Transfer 2 (①).
- Click **Start Transfer** (②).

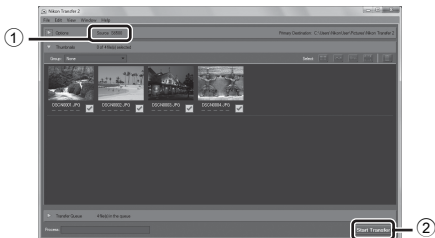

- At default settings, all the images on the memory card will be copied to the computer.

### 3 Terminate the connection.

- If the camera is connected to the computer, turn the camera off and disconnect the USB cable. If you are using a card reader or card slot, choose the appropriate option in the computer operating system to eject the removable disk corresponding to the memory card and then remove the card from the card reader or card slot.

## Viewing Images

### Start ViewNX 2.

- Images are displayed in ViewNX 2 when transfer is complete.
- Consult online help for more information on using ViewNX 2.



### Starting ViewNX 2 Manually

- **Windows:** Double-click the **ViewNX 2** shortcut on the desktop.
- **Mac OS:** Click the **ViewNX 2** icon in the Dock.



A series of ten horizontal dashed lines spanning the width of the page, intended for handwriting practice.

# Recording and Playing Back Movies

You can record movies by simply pressing the  movie-record button.

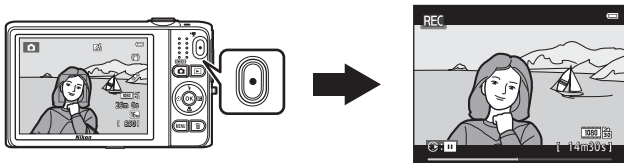

<b>Recording Movies</b> .....	<b>96</b>
Features That Can Be Set with the MENU Button (Movie Menu) .....	99
<b>Playing Back Movies</b> .....	<b>100</b>

# Recording Movies

You can record movies by simply pressing the **●** (▶ movie-record) button.

## 1 Display the shooting screen.

- The icon for the selected movie option is displayed. The default setting is **1080 1080★/30p** (📖99).

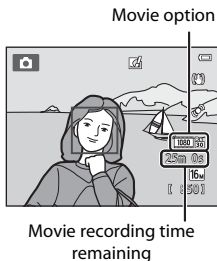

## 2 Press the **●** (▶ movie-record) button to start movie recording.

- The camera focuses on the subject in the center of the frame. Focus areas are not displayed during recording.



- When an option with 16:9 aspect ratio, such as **1080 1080★/30p**, is selected for **Movie options**, the monitor display changes to an aspect ratio of 16:9 with movie recording (the area indicated on the right is recorded).
- 1080 1080★/30p** is displayed while saving to the internal memory.
- Press the multi selector ▶ to pause recording (except when **iFrame 540/30p** is selected in **Movie options** or when HS movie recording; 📖99). Press ▶ again to resume recording.
- Recording automatically stops about five minutes after recording is paused or when the maximum movie length has been recorded.



## 3 Press the **●** (▶ movie-record) button again to end recording.

## ✔ Notes About Recording Images and Saving Movies

The indicator showing the number of exposures remaining or the indicator showing the maximum movie length flashes while images are being recorded or while a movie is being saved. **Do not open the battery-chamber/memory card slot cover or remove the battery or memory card** while an indicator is flashing. Doing this could result in loss of data, or in damage to the camera or the memory card.

## ✔ Notes About Movie Recording

- Memory cards with an SD Speed Class rating of 6 or faster are recommended when recording movies (▶:22). Movie recording may stop unexpectedly when memory cards with a lower Speed Class rating are used.
- There may be some degradation in image quality when digital zoom is used. When recording movies, the digital zoom can magnify the image up to 4× the maximum optical zoom ratio.
- When recording ends, digital zoom turns off.
- The sounds of zoom control operation, zoom, autofocus lens drive movement, vibration reduction, and aperture operation when brightness changes may be recorded.
- The following phenomena may be seen in the monitor while recording movies. These phenomena are saved in the recorded movies.
  - Banding may occur in images under fluorescent, mercury-vapor, or sodium-vapor lighting.
  - Subjects that move quickly from one side of the frame to the other, such as a moving train or car, may appear skewed.
  - The entire movie image may be skewed when the camera is panned.
  - Lighting or other bright areas may leave residual images when the camera is moved.
- Depending on the distance to the subject or the amount of zoom applied, subjects with repeating patterns (fabrics, lattice windows, etc.) may have colored stripes (interference patterns, moire, etc.) in them during movie recording and playback. This occurs when the pattern in the subject and the layout of the image sensor interfere with each other; it is not a malfunction.

## ✓ Camera Temperature

- The camera may become warm when shooting movies for an extended period of time or when the camera is used in a hot area.
- If the inside of the camera becomes extremely hot when recording movies, the camera will automatically stop recording after ten seconds.  
The amount of time remaining until the camera stops recording (🕒 10s) is displayed.  
After the camera stops recording, it turns itself off.  
Leave the camera off until the inside of the camera has cooled.

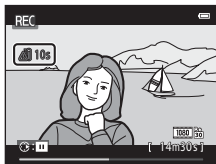

## ✓ Notes About Autofocus

Autofocus may not perform as expected (📖76). Should this occur, try the following:

1. Set **Autofocus mode** in the movie menu to **Single AF** (default setting) before starting movie recording.
2. Frame another subject—positioned at the same distance from the camera as the intended subject—in the center of the frame, press the ● (🎥 movie-record) button to start recording, and then modify the composition.

## 📎 Functions Available for Movie Recording





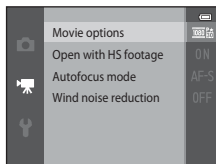

- The exposure compensation, white balance, and color options settings for the current shooting mode are also applied with movie recording. The tone that results from using scene mode (📖40) or special effects mode (📖51) is also applied to movies. When macro mode is enabled, movies of subjects close to the camera can be recorded. Confirm settings before starting movie recording.
- The self-timer (📖60) can be used. When the ● (🎥 movie-record) button is pressed after the self-timer is enabled, the camera focuses on the subject in the center of the frame and starts movie recording after the specified two or ten seconds.
- The flash will not fire.
- Press the **MENU** button to select the 🎥 (movie) menu icon and adjust movie menu settings before starting movie recording (📖99).
- If **Photo info** in the **Monitor settings** (📖104) in the setup menu is set to **Movie frame+auto info**, the area that will be visible in the movie can be confirmed before movie recording starts.

## Features That Can Be Set with the MENU Button (Movie Menu)

Enter shooting mode → MENU button →  menu icon →  button

The settings of the menu options listed below can be configured.



Option	Description	
Movie options	Select the movie type. Select normal speed to record movies at normal speed, or HS (high speed) to record movies that will be played in slow or fast motion.	 74
Open with HS footage	When you select an HS movie option in <b>Movie options</b> , choose from <b>On</b> (default setting) or <b>Off</b> to determine whether or not the camera records HS movies when movie recording starts. <ul style="list-style-type: none"><li>When <b>Off</b> is selected, the camera records a normal speed movie when recording starts.</li><li>Press the  button to switch back and forth between HS movie recording and normal speed movie recording.</li></ul>	 80
Autofocus mode	When <b>Single AF</b> (default setting) is selected, focus is locked when movie recording begins. When <b>Full-time AF</b> is selected, the camera focuses continuously while recording. When <b>Full-time AF</b> is selected, the sound of the camera focusing may be heard in recorded movies. If you want to prevent the sound of the camera focusing from being recorded, select <b>Single AF</b> . <ul style="list-style-type: none"><li>When an HS movie option is selected in <b>Movie options</b>, the setting is fixed at <b>Single AF</b>.</li></ul>	 80
Wind noise reduction	Set whether or not to reduce wind noise during movie recording. <ul style="list-style-type: none"><li>When an HS movie option is selected in <b>Movie options</b>, the setting is fixed at <b>Off</b>.</li></ul>	 81

# Playing Back Movies

Press the  button to enter playback mode.



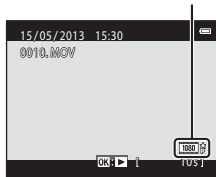

Movies are indicated by the movie options icon (99).

Press the  button to play back movies.

Movie options







## Deleting movies

To delete a movie, select the desired movie in full-frame playback mode (32) or thumbnail playback mode (81) and press the  button (34).

## Functions Available During Playback

Playback controls are displayed at the top of the monitor. Press the multi selector ◀ or ▶ to select a control. The operations described below are available.



Function	Icon	Description
Rewind	◀	Hold down the <b>OK</b> button to rewind the movie.
Advance	▶	Hold down the <b>OK</b> button to advance the movie.
Pause	⏸	Press the <b>OK</b> button to pause playback. The following operations can be performed while playback is paused using the controls displayed at the top in the monitor.
		 Press the <b>OK</b> button to rewind the movie one frame. Hold down the <b>OK</b> button for continuous rewinding.
		 Press the <b>OK</b> button to advance the movie one frame. Hold down the <b>OK</b> button for continuous advancing.
		 Press the <b>OK</b> button to resume playback.
	Press the <b>OK</b> button to display the movie edit screen, which allows you to cut out unwanted portions of a movie and save the desired portion.	
End	■	Press the <b>OK</b> button to return to full-frame playback mode.

## Adjusting volume

Rotate the zoom control (📖) during playback.



Volume indicator

## ✓ Notes About Playing Back Movies

The COOLPIX S6500 is not able to play back movies recorded with another make or model of digital camera.



A series of ten horizontal dashed lines spanning the width of the page, intended for handwriting practice.

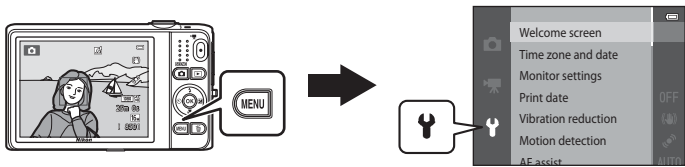

# General Camera Setup

This chapter describes the various settings that can be adjusted in the  setup menu.











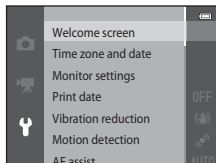



- For further details about each setting, refer to “The Setup Menu” in the Reference Section (82).











# Features That Can Be Set with the MENU Button (Setup Menu)

Press the MENU button →  (setup) menu icon →  button

The settings of the menu options listed below can be configured.



Option	Description	
Welcome screen	Allows you to select whether or not the welcome screen is displayed when the camera is turned on.	 82
Time zone and date	Allows you to set the camera clock.	 83
Monitor settings	Allows you to adjust photo information display, post-shooting image review, and monitor brightness settings.	 86
Print date	Allows you to imprint the shooting date and time on images.	 88
Vibration reduction	Allows you to select the vibration reduction setting used when shooting.	 90
Motion detection	Allows you to set whether or not the camera automatically increases the shutter speed to reduce blurring caused by camera shake if motion is detected when shooting still images.	 91
AF assist	Allows you to enable or disable the AF-assist illuminator.	 92
Digital zoom	Allows you to enable and disable digital zoom.	 93
Sound settings	Allows you to adjust sound settings.	 94
Auto off	Allows you to set the amount of time that passes before the monitor turns off to save power.	 95

Option	Description	
Format memory/ Format card	Allows you to format the internal memory or the memory card.	 96
Language	Allows you to change the camera's display language.	 98
TV settings	Allows you to adjust TV-connection settings.	 99
Charge by computer	When set to <b>Auto</b> (default setting), you can charge the camera's battery by connecting the camera to a computer (provided that the computer is able to supply power). <ul style="list-style-type: none"> <li>When charging by computer, it may take more time to charge the battery than when using the Charging AC Adapter EH-70P.</li> </ul>	 100
Blink warning	Allows you to set whether or not closed eyes are detected when taking images of people using face detection.	 102
Wi-Fi options	Allows you to configure the Wi-Fi (wireless LAN) settings to connect the camera and a smart device. See "Using the Wi-Fi (Wireless LAN) Feature" (  107) for more information.	 104
Eye-Fi upload	Allows you to set whether or not to enable the function for sending images to a computer using a commercially available Eye-Fi card.	 106
Reset all	Allows you to reset the camera's settings to their default values.	 107
Firmware version	View the current camera firmware version.	 110



A series of ten horizontal dashed lines spanning the width of the page, intended for handwriting practice.



# Using the Wi-Fi (Wireless LAN) Feature

## Functions that Can Be Performed Using Wi-Fi

You can perform the following functions if you install the dedicated software “Wireless Mobile Utility” on your smart device that runs on Android OS or iOS, and connect it to the camera.

### Take Photos

You can display the shooting screen of the camera on your smart device and operate the camera by remote control.\*

The pictures shot by remote control can be copied to your smart device.

\* Operations other than turning on and off the camera cannot be performed during remote control operation.



### View Photos

You can copy the pictures saved in the camera’s memory card to your smart device.

# Installing the Software on the Smart Device

- 1** Use your smart device to connect to Google Play Store, App Store or other online apps marketplace and search for “Wireless Mobile Utility.”
  - Check the user’s manual provided with your smart device for further details.
- 2** Check the description and other information and install the software.
  - For more information about how to operate the software, download the user’s manual from the website below.
    - Android OS: <http://nikonimglib.com/ManDL/WMAU/>
    - iOS: <http://nikonimglib.com/ManDL/WMAU-ios/>

# Connecting the Smart Device to the Camera

Press the MENU button →  menu icon → Wi-Fi options →  button

- 1 Press the multi selector to select the **Wi-Fi network** and press the  button.

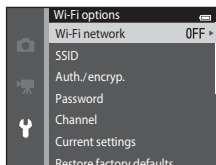

- 2 Select **On** and press the  button.

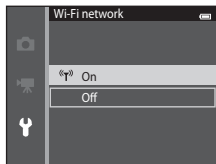

- SSID and the password are displayed.
- If no connection confirmation is received from the smart device within 3 minutes, the setting returns to **Off**.

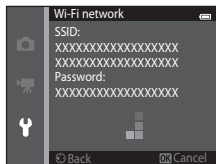

## 3 Set the Wi-Fi setting on the smart device to On.

- Check the user's manual provided with your smart device for further details.
- After the network name (SSID) that can be used for the smart device is displayed, select the SSID displayed on the camera.
- When the message for entering a password (📖110) is displayed, enter the password that is displayed on the camera.
- When the camera is successfully connected to a Wi-Fi network, the shooting screen is displayed with the Wi-Fi icon (📶9).



## 4 Start the dedicated software installed on the smart device.

- The screen for selecting "Take photos" or "View photos" is displayed.
- When the message "Cannot connect to camera." is displayed, retry the **Wi-Fi network** setting.

## To Terminate the Wi-Fi Connection

- Turn off the camera.
- Set the Wi-Fi setting on the smart device to Off.

### Notes About Wi-Fi Connection

- Set the **Wi-Fi network** to **Off** in a place where the use of radio waves is prohibited.
- When a memory card is not inserted in the camera, the Wi-Fi feature cannot be used. When Eye-Fi card (📷106) is inserted in the camera, the Wi-Fi feature cannot be used.
- When Wi-Fi is connected, **Auto off** is disabled.
- When the **Wi-Fi network** is set to **On**, the battery will drain faster than normal.
- The **Wi-Fi network** cannot be selected when the battery level indicator in the monitor indicates . In addition, if the battery level indicator indicates  while a Wi-Fi connection is established, the connection is terminated.

### Notes About Security Settings

If the camera is installed with the Wi-Fi feature without proper security settings (encryption and password), unauthorized third parties may access the network and cause harm. We strongly recommend performing the required security settings before using the Wi-Fi feature.

Use **Wi-Fi options** of the setup menu (📖105) to perform the security settings.



# Reference Section

The Reference Section provides detailed information and hints about using the camera.

## Shooting

---

Using Easy Panorama (Shooting and Playback) ..... 2

## Playback

---

Favorite Pictures Mode..... 6  
Auto Sort Mode ..... 10  
List by Date Mode ..... 12  
Viewing and Deleting Images Captured Continuously (Sequence) ..... 13  
Editing Still Images ..... 16  
Connecting the Camera to a TV (Viewing Images on a TV)..... 26  
Connecting the Camera to a Printer (Direct Print) ..... 29  
Editing Movies ..... 38

## Menu

---

The Shooting Menu (for (Auto) Mode)..... 40  
The Smart Portrait Menu..... 57  
The Playback Menu..... 60  
The Movie Menu ..... 74  
The Setup Menu..... 82









## Additional Information

---

File and Folder Names ..... 111  
Optional Accessories ..... 113  
Error Messages ..... 114

# Using Easy Panorama (Shooting and Playback)

## Shooting with Easy Panorama

Enter shooting mode →  (shooting mode) button →  (second icon from the top\*) →  → , , ,  →  (easy panorama) →  button



\* The icon of the last scene selected is displayed.

### 1 Choose **Normal (180°)** or **Wide (360°)** as the shooting range and press the button.

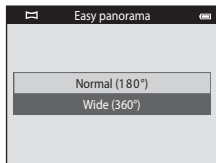
- When the camera is readied in the horizontal position, the image size (width × height) is as follows.
  - **Normal (180°)**: 4800 × 920 when moved horizontally, 1536 × 4800 when moved vertically
  - **Wide (360°)**: 9600 × 920 when moved horizontally, 1536 × 9600 when moved vertically
- When the camera is readied in the vertical position, the direction and the width and height are switched.



### 2 Frame the first edge of the panorama scene, and then press the shutter-release button halfway to focus.

- The zoom position is fixed at the maximum wide-angle position.
- A grid is displayed in the monitor.
- The camera focuses on the area in the center of the frame.
- Exposure compensation () can be set.
- If the focus and exposure are not correct, try using focus lock ()

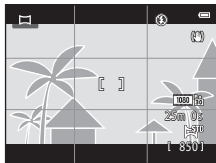

### 3 Press the shutter-release button all the way, and then remove your finger from the shutter-release button.

- ▷ is displayed to indicate the direction of camera movement.



### 4 Move the camera slowly and straight in one of the four directions, and begin shooting.

- When the camera detects which direction it is moving in, shooting begins.
- A guide indicating the current shooting position is displayed.
- When the shooting position guide reaches the edge, shooting ends.



Guide

### Example of camera movement

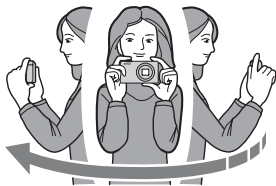

- The operator, without shifting the camera horizontally or vertically in an arc so that the guide travels from one edge to the other.
- Shooting stops if the guide does not reach the edge within about 15 seconds (when **Normal (180°)** is selected) or within about 30 seconds (when **Wide (360°)** is selected) after shooting starts.

## **Notes About Easy Panorama Shooting**

- The range of the image seen in the saved image will be narrower than that seen in the monitor at the time of shooting.
- If the camera is moved too quickly or shaken too much, or if the subject is too uniform (e.g. walls or darkness), an error may occur.
- If shooting is stopped before the camera reaches the half-way point in the panorama range, a panorama image is not saved.
- If more than half of the panorama range is captured but shooting ends before reaching the edge of the range, the range not captured is recorded and displayed in gray.

## Viewing Images Captured with Easy Panorama

Switch to playback mode ( 32 ), display an image captured using easy panorama in full-frame playback mode, and then press the **OK** button to display the short edge of the image using the entire monitor and automatically move (scroll) the displayed area.

- The image scrolls in the direction that was used when shooting.

Playback controls are displayed at the top of the monitor during playback. Press the multi selector ◀ or ▶ to choose a control, and then press the **OK** button to perform the following operations.

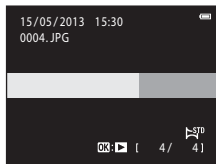

Function	Icon	Description	
Rewind	◀◀	Hold down the <b>OK</b> button to scroll backward quickly.	
Advance	▶▶	Hold down the <b>OK</b> button to scroll forward quickly.	
Pause	⏸	The following operations can be performed while playback is paused using the controls displayed at the top in the monitor.	
		◀◀	Hold down the <b>OK</b> button to rewind.
		▶▶	Hold down the <b>OK</b> button to scroll.
	▶	Resume automatic scrolling.	
End	■	Switch to full-frame playback mode.	

### ✓ Notes About Easy Panorama Scroll Playback

The COOLPIX S6500 may not be able to scroll the playback of, or zoom in on, easy panorama images captured with another make or model of digital camera.

# Favorite Pictures Mode

You can sort your images (except movies) into nine albums and add them as favorite pictures (added images are not copied or moved). After you add images to albums, you can choose to play back only the added images by using favorite pictures mode.







- By creating albums for certain subjects or events, you can find your favorite images easily.
- The same image can be added to multiple albums.
- Up to 200 images can be added to each album.

## Adding Images to Albums

Press the  button (playback mode) → MENU button → Favorite pictures →  button

- Images cannot be added to albums in favorite pictures playback mode.

**1** Press the multi selector  or  to choose an image and press .

- You can add  to multiple images. To remove , press .
- Rotate the zoom control () to **T** () to switch back to full-frame playback or **W** () to six-image thumbnail display.
- Press the  button to display the album selection screen.



## 2 Use the multi selector to select the desired album and press the **OK** button.

- The selected images are added and the camera switches to the playback menu.
- To add the same image to multiple albums, repeat from step 1.

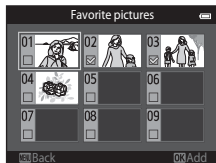

## Playing Back Images in Albums

Press the **▶** button (playback mode) → **▶** button → **Favorite pictures** → **OK** button

Use the multi selector to select an album and then press the **OK** button to play back the images that have been added to the selected album.

- The following operations are available from the album selection screen.
  - **MENU** button: Changes the album icon (🕶️9).
  - **🗑️** button: Deletes all images in the selected album.
- When viewing images in full-frame playback mode or thumbnail playback mode, press the **MENU** button to select a feature from the favorite pictures menu (📖84).

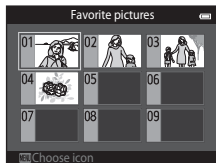

### **✓** Notes About Deletion

If an image is deleted while using favorite pictures mode, the image will not only be removed from the album, but the corresponding image file will also be permanently deleted from the internal memory or the memory card.

## Removing Images from Albums

Enter **F** Favorite pictures mode → select the album containing the image you want to remove → **OK** button → **MENU** button → Remove from favorites → **OK** button

**1** Press the multi selector **◀** or **▶** to choose an image and press **▲** to hide **F**.

- You can hide the **F** icons for multiple images. To display the icons again, press **▼**.
- Rotate the zoom control (**Ⓛ**) to **T** (**Q**) to switch back to full-frame playback or **W** (**Ⓢ**) to six-image thumbnail display.
- Press the **OK** button to display a removal confirmation screen.





**2** Select **Yes** and press the **OK** button.

- To cancel removal, select **No**.





## Changing the Favorites Album Icon

Press the  button (playback mode) →  button →  Favorite pictures →  button

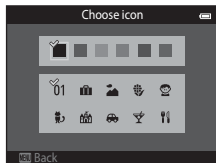
**1** Use the multi selector to select an album and press the **MENU** button.

**2** Press  or  to select an icon color and press the  button.



**3** Press , , , or  to select an icon and press the  button.

- The icon changes and the monitor display returns to the list of albums screen.

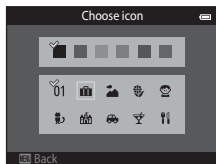





### **Notes About Album Icons**



- Set the album icons separately for the internal memory and for the memory card.
- To change the album icons for the internal memory, first remove the memory card from the camera.
- The default setting for the icon is the number icon (black).

# Auto Sort Mode

Images are automatically sorted into categories, such as portraits, landscapes, and movies.







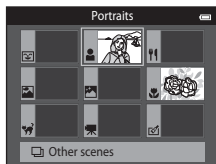





Press the  button (playback mode) →  button →  Auto sort →  button











Use the multi selector to select a category and then press the  button to play back the images in the selected category.

- The following operation is available while the category selection screen is displayed.
  -  button: Deletes all images in the selected category.
- When viewing images in full-frame playback mode or thumbnail playback mode, press the **MENU** button to select a feature from the auto sort menu (84).





## Auto Sort Mode Categories

Option	Description
 Smile	Images captured in smart portrait mode (  53) with the smile timer setting set to <b>On (single)</b> , <b>On (continuous)</b> , or <b>On (BSS)</b>
 Portraits	Images captured in  (auto) mode (  26) with face detection (  73) Images captured in <b>Portrait*</b> , <b>Night portrait*</b> , <b>Party/indoor</b> , or <b>Backlighting*</b> scene mode (  40) Images captured in smart portrait mode (  53) with the smile timer setting set to <b>Off</b>
 Food	Images captured in <b>Food</b> scene mode (  40)
 Landscape	Images captured in <b>Landscape*</b> scene mode (  40)
 Dusk to dawn	Images captured in <b>Night landscape*</b> , <b>Sunset</b> , <b>Dusk/dawn</b> , or <b>Fireworks show</b> scene mode (  40)

Option	Description
 Close-ups	Images captured in  (auto) mode with macro mode (  62) Images captured in <b>Close-up*</b> scene mode (  40)
 Pet portrait	Images captured in <b>Pet portrait</b> (  48) scene mode
 Movie	Movies (  96).
 Retouched copies	Copies created using editing functions (  16)
 Other scenes	All other images that cannot be defined by the categories described above

\* Images captured in scene auto selector scene mode (41) are also sorted into the appropriate categories.





## Notes About Auto Sort Mode

- Up to 999 images and movie files can be sorted into each category in auto sort mode. If 999 images or movies have already been sorted into a specific category, new images and movies cannot be sorted into that category nor can they be displayed in auto sort mode. You can play back images and movies that could not be sorted into a category by using normal playback mode (32) or list by date mode (12).
- Images and movies copied from the internal memory to a memory card, or vice versa, cannot be played back in auto sort mode (71).
- Images or movies saved by a camera other than the COOLPIX S6500 cannot be played back in auto sort mode.





# List by Date Mode

Press the  button (playback mode) →  button →  List by date →  button

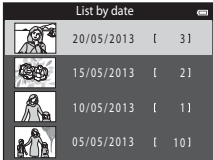
Use the multi selector to select a date and then press the  button to play back the images captured on the selected date.

- The first image that was captured on the selected date is displayed.
- The following operations are available while the shooting date selection screen is displayed.
  - **MENU** button: You can select one of the following functions in the list by date menu (84) and apply it to all images captured on the selected date.
    - print order, slide show, protect
  -  button: Deletes all images captured on the selected date.
- When viewing images in full-frame playback mode or thumbnail playback mode, press the **MENU** button to select a feature from the list by date menu (84).
- Calendar display (81) cannot be used in list by date mode.



List by date		
	20/05/2013	[ 31 ]
	15/05/2013	[ 2 ]
	10/05/2013	[ 1 ]
	05/05/2013	[ 10 ]

## Notes About List by Date Mode

- Up to 29 dates can be selected. If images exist for more than 29 dates, all images saved earlier than most recent 29 dates will be combined under **Others**.
- The 9,000 most recent images can be displayed in list by date mode.
- Images captured when the camera's date is not set are treated as images captured on January 1, 2013.

# Viewing and Deleting Images Captured Continuously (Sequence)

## Viewing Images in a Sequence



Each series of images captured using the following settings is saved in a sequence.

-  (auto) mode (📖38)
  - Continuous H
  - Continuous L
  - Pre-shooting cache
  - Continuous H: 120 fps
  - Continuous H: 60 fps
- Scene mode (📖40)
  - Sports
  - Pet portrait (when **Continuous** is selected)
- Smart portrait mode (📖53)
  - When **Smile timer** is set to **On (continuous)**

By default, only the first image of a sequence (key picture) is displayed to represent the images in the sequence in full-frame playback mode or thumbnail playback mode (📖81).

- When only the key picture is displayed for a sequence, the image cannot be zoomed in on.

When only the key picture is displayed for a sequence, press the  button to display each image in a sequence individually.

- To display the previous or next image, press the multi selector  or .
- To return to key picture only display, press the multi selector .
- To display images in a sequence as thumbnails, set **Sequence display options** to **Individual pictures** in the playback menu (🔧73).

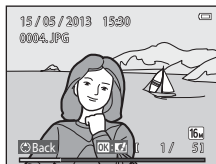

## **Sequence Display Options**

- Select **Sequence display options** ()73) in the playback menu to set all sequences to be displayed using their key pictures or to display them as individual images.
- Images captured continuously with cameras other than the COOLPIX S6500 cannot be displayed as a sequence.

## **Changing Key Picture in Sequence**

A sequence's key picture can be changed using **Choose key picture** ()73) in the playback menu.

## **Playback Menu Options Available When Using Sequence**

When the **MENU** button is pressed, the following menu operations are available for the images in that sequence.

- Quick retouch<sup>1</sup> ()20)
- Glamour retouch<sup>1</sup> ()21)
- Slide show ()64)
- Rotate image<sup>1</sup> ()68)
- Voice memo<sup>1</sup> ()69)
- Sequence display options ()73)
- Favorite pictures<sup>2</sup> ()6)
- D-Lighting<sup>1</sup> ()20)
- Print order<sup>2</sup> ()60)
- Protect<sup>2</sup> ()65)
- Small picture<sup>1</sup> ()23)
- Copy<sup>2</sup> ()71)
- Choose key picture ()73)

<sup>1</sup> This operation is not available when only a key picture is displayed. Display the images in the sequence individually and then press the **MENU** button.

<sup>2</sup> If the **MENU** button is pressed when only a key picture displayed, the same settings can be applied to all images in that sequence. Press the **MENU** button after displaying individual images to apply settings to each displayed image.

## Deleting Images in a Sequence

If **Sequence display options** (🔑73) in the playback menu is set to **Key picture only**, images to be deleted vary as described below. To display the screen for selecting the deletion method, press the 🗑️ button.

- If only key pictures are displayed for sequences when the 🗑️ button is pressed:
  - **Current image:** When a key picture is selected, all images in that sequence are deleted.
  - **Erase selected images:** When a key picture is selected in the erase selected images screen (📖35), all pictures in the sequence are deleted.
  - **All images:** All images are deleted, including the sequence represented by the currently displayed key picture.
- If the 🗑️ button has been pressed and each individual image in the sequence is displayed before pressing the 🗑️ button:  
Deletion methods change as follows.
  - **Current image:** The image currently displayed is deleted.
  - **Erase selected images:** When multiple images in the sequence are selected in the erase selected images screen (📖35), the selected images are deleted.
  - **Entire sequence:** All images in the sequence, including the image currently displayed, are deleted.

# Editing Still Images

## Editing Features

Use the COOLPIX S6500 to edit images in-camera and save them as separate files (📷111). The editing functions described below are available.

Editing function	Description
Quick effects (📷18)	Apply a variety of effects to images.
Quick retouch (📷20)	Easily create retouched copies in which contrast and saturation have been enhanced.
D-Lighting (📷20)	Create a copy of the current image with enhanced brightness and contrast, brightening dark portions of the image.
Glamour retouch (📷21)	Detect faces in images and retouch detected faces using eight effects. The effect levels can be adjusted.
Small picture (📷23)	Create a small copy of images suitable for use as e-mail attachments.
Crop (📷24)	Crop a portion of the image. Use to zoom in on a subject or arrange a composition.

### 📌 Notes About Image Editing

- The editing functions of COOLPIX S6500 cannot be used for images captured with another make or model of digital camera.
- Images captured using **Easy panorama** (📷47) or **3D photography** (📷49) cannot be edited.
- If no face is detected in an image, a copy cannot be created using the glamour retouch function (📷21).
- Edited copies created with COOLPIX S6500 may not be displayed properly on another make or model of digital camera. It may also be impossible to transfer them to a computer using another make or model of digital camera.
- Editing functions are not available when there is not enough free space in the internal memory or on the memory card.
- To edit an individual image in a sequence of images (📷13) when only the key picture is displayed, perform one of the procedures described below:
  - Press the **OK** button to display a sequence of images as individual images and select an image in the sequence.
  - Set **Sequence display options** (📷73) in the playback menu to **Individual pictures** to display them as individual images and select an image.



## Restrictions on Image Editing

When an edited copy is further modified with another editing function, check the following restrictions.

Editing function used	Editing functions to use
Quick effects Quick retouch D-Lighting	The glamour retouch, small picture, or crop function can be used.
Glamour retouch	The quick effects, quick retouch, D-Lighting, small picture, or crop function can be used.
Small picture Crop	Another editing function cannot be used.

- Copies created with editing functions cannot be further edited with the same function used to create them.
- When combining the small picture or crop function and another editing function, use the small picture and crop functions after other editing functions have been applied.
- Retouch effects such as the glamour retouch function's skin softening effect can be applied to images taken with the skin softening function ()57).

## Original and Edited Images

- Copies created with editing functions are not deleted if the original images are deleted. The original images are not deleted if copies created with editing functions are deleted.
- Edited copies are saved with the same shooting date and time as the original.
- Print order ()60) and protect settings ()65) do not remain effective in edited copies.

## Quick Effects

Select one of the 30 effects listed below. The effect results can be previewed on the screen shown in step 2 (📷 18).

Effect	Description
<b>Pop</b> and <b>Super vivid</b>	Mainly enhances the color saturation.
<b>Painting</b> , <b>High key</b> , <b>Toy camera effect 1</b> , <b>Toy camera effect 2</b> , <b>Low key</b> , <b>Cross process (red)</b> , <b>Cross process (yellow)</b> , <b>Cross process (green)</b> , and <b>Cross process (blue)</b>	Mainly adjusts hue and creates a different look for the image.
<b>Soft</b> , <b>Fisheye</b> , <b>Cross screen</b> , and <b>Miniature effect</b>	Processes images with a variety of effects.
<b>High-contrast monochrome</b> , <b>Sepia</b> , <b>Cyanotype</b> , and <b>Selective color</b> (12 colors)	Turns multicolor images into single color images. Selective color transforms all colors, except a specified color, to black and white.

**1** Display the image to which you want to apply an effect in full-frame playback mode and press the **OK** button.

- The effect selection screen is displayed.

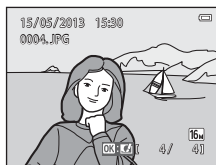

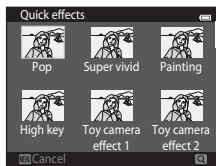

**2** Press the multi-selector **◀** or **▶** to select the desired effect and press the **OK** button.

- Rotate the zoom control (📷 3) to **T** (📷 9) to switch back to full-frame playback or **W** (📷 5) to six-image thumbnail display.
- To exit without saving the edited image, press the **MENU** button. When a confirmation screen is displayed, select **Yes** and press the **OK** button.







---



### 3 Select **Yes** and press the **OK** button.

- A new, edited copy is created.
- Copies created with the quick effects function are indicated by the  icon displayed during playback (10).

## Quick Retouch: Enhancing Contrast and Saturation



Press the  button (playback mode) → select an image → MENU button → Quick retouch →  button

Press the multi selector  or  to select the amount of effect applied and press the  button.

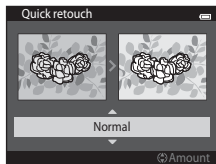

- The original version is displayed on the left and the edited version is displayed on the right.
- To exit without saving the copy, press .
- Copies created with the quick retouch function are indicated by the  icon displayed during playback (10).



## D-Lighting: Enhancing Brightness and Contrast



Press the  button (playback mode) → select an image → MENU button → D-Lighting →  button



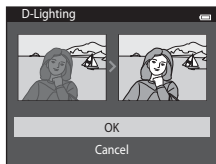

Use the multi selector to select **OK** and press the  button.

- The original version is displayed on the left and the edited version is displayed on the right.
- To exit without saving the copy, press .
- Copies created with the D-Lighting function are indicated by the  icon displayed during playback (10).









# Glamour Retouch: Enhancing Human Faces with Eight Effects

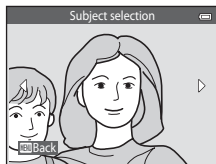







Press the  button (playback mode) → select an image → MENU button → Glamour retouch → 

- 1 Press the multi selector , , , or  to select the face that you want to retouch and press the .

- When only one face is detected, proceed to step 2.



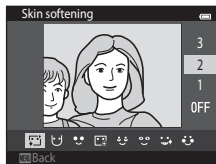

- 2 Press the multi selector  or  to select the effect, press  or  to select the effect level, and press the .

- You can simultaneously apply multiple effects from the list below. Adjust the settings for all effects before pressing the  button.
  -  (skin softening),  (small face),  (big eyes),  (brighten faces),  (hide eye bags),  (whiten eyes),  (whiten teeth),  (redden cheeks)
- Press the MENU button to return to the screen for selecting a face.



- 3 Preview the result and press the .

- To change the settings, press  to return to step 2.
- To exit without saving the edited image, press the MENU button. When a confirmation screen is displayed, select **Yes** and press the .

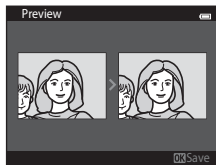

## 4 Select **Yes** and press the **OK** button.

- A new, edited copy is created.
- Copies created with the glamour retouch function are indicated by the  icon displayed during playback (10).

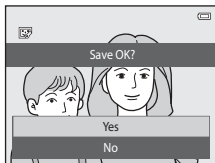





### **Notes About Glamour Retouch**

- Only one human face per image can be edited using the glamour retouch function.
- Depending upon the direction in which faces are looking, or the brightness of faces, the camera may be unable to accurately recognize faces, or the glamour retouch function may not perform as expected.
- If no faces are detected in the image, a warning is displayed and the screen returns to the playback menu.
- The glamour retouch function is available only for images captured when the ISO sensitivity is 1600 or lower.

Note that the ISO sensitivity may automatically exceed 1600 when **Continuous** ()45 is set to **Pre-shooting cache, Continuous H: 120 fps, Continuous H: 60 fps, or Multi-shot 16**.

## Small Picture: Reducing the Size of an Image



Press the  button (playback mode) → select an image → MENU button → Small picture →  button

**1** Press the multi selector  or  to select the desired copy size and press the  button.

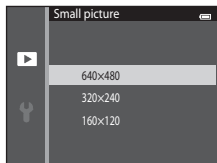
- The available sizes are **640×480**, **320×240** and **160×120**.
- Images taken at an image mode setting of  **4608×2592** are saved at 640×360 pixels. Proceed to step 2.



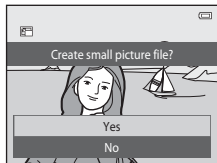

**2** Select **Yes** and press the  button.

- A new, small copy is created (compression ratio of approximately 1:16).
- Copies created with the small picture function are displayed at a smaller size with the  icon during playback (11).









## Crop: Creating a Cropped Copy

Create a copy containing only the portion visible in the monitor when  is displayed with playback zoom () enabled. Cropped copies are saved as separate files.

**1** Enlarge the image for cropping ()

**2** Refine copy composition.



- Rotate the zoom control to **T** () or **W** () to adjust the zoom ratio.
- Press the multi selector , , , or  to scroll the image so that only the portion to be copied is visible in the monitor.

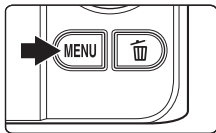

**3** Press the **MENU** button.



**4** Use the multi selector to select **Yes** and press the  button.

- A cropped copy is created.
- Copies created with the crop function are indicated by the  icon displayed during playback ()



## Image Size

As the area to be saved is reduced, the image size (pixels) of the cropped copy is also reduced. When the image size of the cropped copy is 320 × 240 or 160 × 120, the image is displayed at a smaller size during playback.

## Cropping the Image in Its Current “Tall” Orientation

Use the **Rotate image** option (68) to rotate the image so that it is displayed in landscape orientation. After cropping the image, rotate the cropped image back to “tall” orientation. The image displayed in “tall” orientation can be cropped by zooming in on the image until the black bars displayed on the both sides of the monitor disappear. The cropped image is displayed in landscape orientation.

# Connecting the Camera to a TV (Viewing Images on a TV)

Connect the camera to a TV to play back images or movies on the TV. If your TV is equipped with an HDMI jack, a commercially available HDMI cable can be used to connect the camera to the TV.

- 1 Turn off the camera.

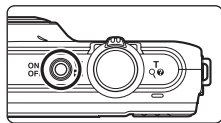

- 2 Connect the camera to the TV.

## When using the included audio/video cable

Connect the yellow plug to the video-in jack and the white and red plugs to the audio-in jacks on the TV.

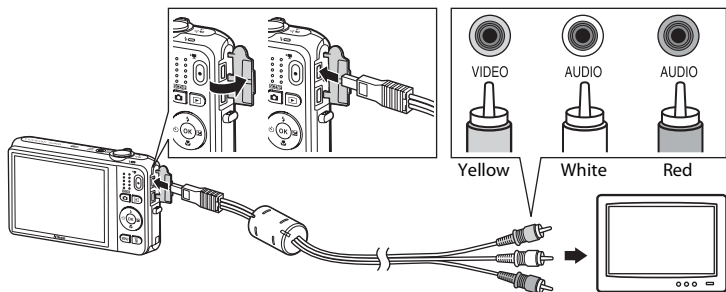

### When using a commercially available HDMI cable

Connect the plug to the HDMI jack on the TV.

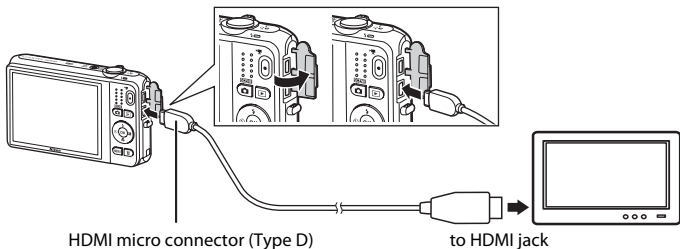

## 3 Set the TV's input to external video input.

- See the documentation provided with your TV for details.

## 4 Hold down the button to turn on the camera.

- The camera enters playback mode and images are displayed on the TV.
- While connected to the TV, the camera monitor will remain off.

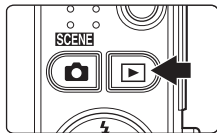

### Notes About Connecting the HDMI Cable

An HDMI cable is not included. Use a commercially available HDMI cable to connect the camera to a high-definition TV. The output terminal on this camera is an HDMI micro connector (type D). When purchasing an HDMI cable, be sure that the device end of the cable is an HDMI micro connector.

### Notes About Connecting the Cable

When connecting the cable, be sure that the plug is properly oriented. Do not force the plug into the camera. When disconnecting the cable, do not pull the plug at an angle.

## **If Images Are Not Displayed on the TV**

Be sure that the camera's video mode setting in the **TV settings** (0099) under the setup menu conforms to the standard used by your TV.

## **Using a TV Remote Control (HDMI Device Control)**

The remote control of an HDMI-CEC-compatible TV can be used to control playback.

It can be used instead of the camera's multi selector and zoom control to select images, start and pause movie playback, switch between full-screen playback mode and four-image thumbnail display, etc.

- Set the **HDMI device control** setting (0099) of **TV settings** to **On** (default setting) and then connect the camera and TV using an HDMI cable.
- Aim the remote control at the TV when operating it.
- Refer to the TV's operating instructions for information about the TV's HDMI-CEC compatibility.

# Connecting the Camera to a Printer (Direct Print)

Users of PictBridge-compatible (📷23) printers can connect the camera directly to the printer and print images without using a computer.

Follow the procedures below to print images.

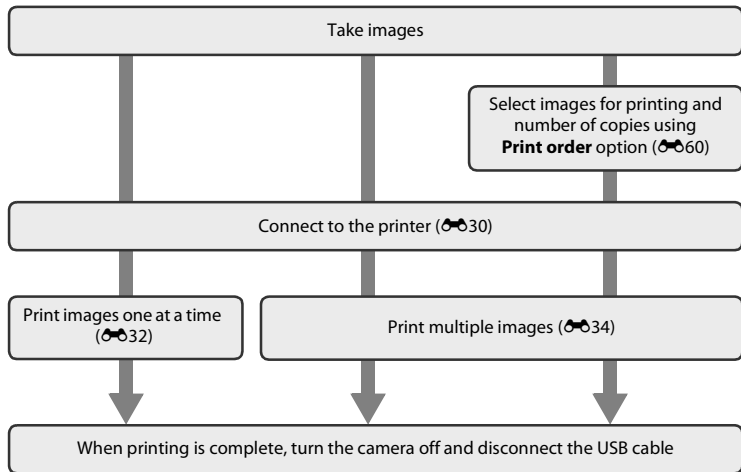

## ✔ Notes About Power Source

- When connecting the camera to a printer, use a fully charged battery to prevent the camera from turning off unexpectedly.
- If the AC Adapter EH-62G (available separately) is used, COOLPIX S6500 can be powered from an electrical outlet. Do not use any other make or model of AC adapter as it may cause the camera to heat up or malfunction.

# Connecting the Camera to a Printer

- 1 Turn off the camera.

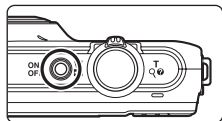

- 2 Turn on the printer.

- Check printer settings.

- 3 Connect the camera to the printer using the included USB cable.

- Be sure that plugs are properly oriented. Do not attempt to insert plugs at an angle, and do not use force when connecting or disconnecting the plugs.

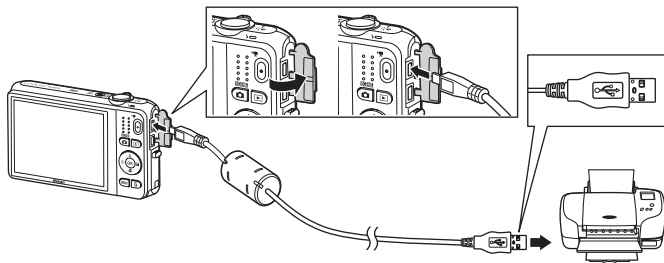

## 4 The camera is automatically turned on.

- When properly connected, the **PictBridge** startup screen (①) will be displayed in the camera monitor, followed by the **Print selection** screen (②).

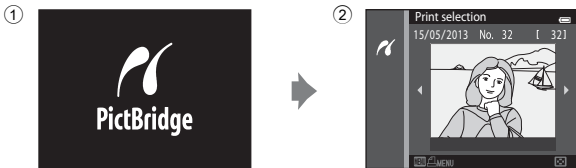
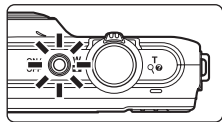

### ✔ If the PictBridge Startup Screen Is not Displayed

Turn the camera off and disconnect the USB cable. Set the **Charge by computer** option (🔑100) in the camera's setup menu to **Off** and reconnect the cable.

### 🔑 Printing Images

Images saved on a memory card can be printed by transferring the images to a computer or connecting the camera directly to a printer. The following printing methods are also available:

- Inserting a memory card into a DPOF-compatible printer's card slot
- Taking a memory card to a digital photo lab

For printing using these methods, specify the images and the number of prints each to the memory card using the **Print order** option in the playback menu (🔑60).

## Printing Individual Images

After properly connecting the camera to the printer (📷30), follow the procedures described below to print an image.

**1** Use the multi selector to select the desired image and press the **OK** button.

- Rotate the zoom control to **W** (🖼️) to display six thumbnails, and **T** (📷) to switch back to full-frame playback.



**2** Select **Copies** and press the **OK** button.

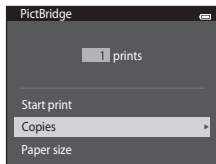

**3** Select the desired number of copies (up to nine) and press the **OK** button.



**4** Select **Paper size** and press the **OK** button.

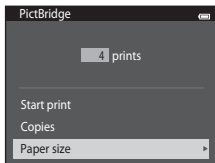

**5** Select the desired paper size and press the **OK** button.

- To specify paper size using settings on the printer, select **Default** in the paper size option.

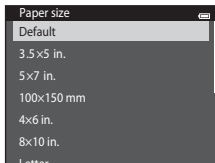

**6** Select **Start print** and press the **OK** button.

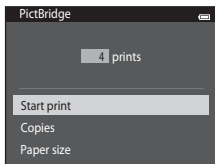

**7** Printing begins.

- Monitor display returns to the print selection screen shown in step 1 when printing is complete.

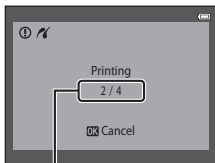

Current number of copies/  
total number of copies

## Printing Multiple Images

After properly connecting the camera to the printer (🔌30), follow the procedures described below to print multiple images.

- 1 When the **Print selection** screen is displayed, press the **MENU** button.

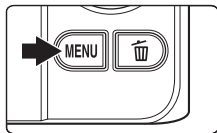

- 2 Use the multi selector to select **Paper size** and press the **OK** button.

- To exit the print menu, press the **MENU** button.

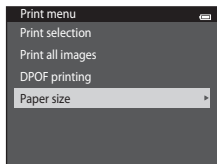

- 3 Select the desired paper size and press the **OK** button.

- To specify paper size using settings on the printer, select **Default** in the paper size option.

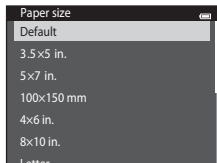

- 4** Select **Print selection**, **Print all images**, or **DPOF printing** and press the **OK** button.

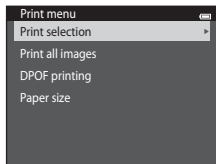

### Print selection

Select images (up to 99) and the number of copies (up to nine) of each.

- Press the multi selector ◀ or ▶ to select images, and press ▲ or ▼ to specify the number of copies to be printed.
- Images selected for printing are indicated by the  icon and the numeral indicating the number of copies to be printed. If no copies have been specified for images, the selection is canceled.
- Rotate the zoom control to **T** (Q) to switch back to full-frame playback or **W** (R) to display six thumbnails.
- Press the **OK** button when setting is complete.
- When the screen shown on the right is displayed, select **Start print** and press the **OK** button to start printing.  
Select **Cancel** and press the **OK** button to return to the print menu.

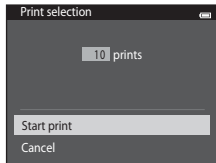

## Print all images

One copy each of all images saved in the internal memory, or on the memory card, is printed.

- When the screen shown on the right is displayed, select **Start print** and press the **OK** button to start print. Select **Cancel** and press the **OK** button to return to the print menu.

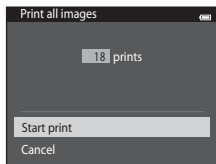

## DPOF printing

Print images for which a print order was created using the **Print order** option (60).

- When the screen shown on the right is displayed, select **Start print** and press the **OK** button to start printing. Select **Cancel** and press the **OK** button to return to the print menu.

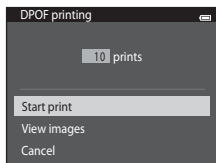

- To view the current print order, select **View images** and press the **OK** button. To print images, press the **OK** button again.

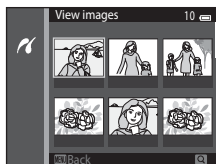

## 5 Printing begins.

- Monitor display returns to the print menu shown in step 2 when printing is complete.

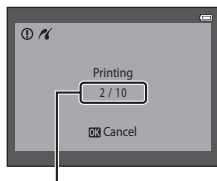

Current number of copies/  
total number of copies

### Paper Size

The camera supports the following paper sizes: **Default** (the default paper size for the printer connected to the camera), **3.5×5 in.**, **5×7 in.**, **100×150 mm**, **4×6 in.**, **8×10 in.**, **Letter**, **A3**, and **A4**. Only sizes supported by the printer will be displayed.

# Editing Movies

The desired portions of a recorded movie can be saved as a separate file.

**1** Play back the desired movie and pause at the start point of the portion that is to be extracted (📖100).

**2** Press the multi selector ◀ or ▶ to choose the 🗑️ control, and then press the Ⓞ button.

- The movie edit screen is displayed.

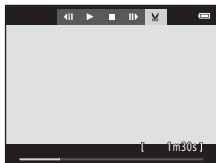

**3** Press ▲ or ▼ to choose the 🗑️ control (choose start point).

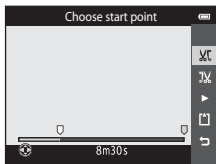

- When editing begins, the frame where playback was paused is the start point.
- Press ◀ or ▶ to move the start point to the point where you want the movie to start.
- To cancel editing, press ▲ or ▼ to choose ↶ (return), and press the Ⓞ button.

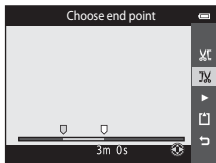

**4** Press ▲ or ▼ to choose the 🗑️ control (choose end point).

- Press ◀ or ▶ to move the end point on the right edge to the point where you want the movie to end.
- Select ▶ (preview) and press the Ⓞ button to play back the specified portion of the movie that will be saved. While the preview is playing, rotate the zoom control to adjust the volume. While the preview is playing back, press the Ⓞ button again to stop playback.





**5** When the settings are finished, press ▲ or ▼ to choose  **Save** and press the  button.

**6** Choose **Yes** and press the  button.

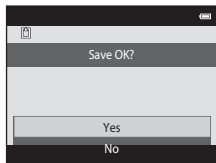
- The edited movie is saved.



### **Notes About Movie Editing**

- Movies recorded using  **iFrame 540/30p** () cannot be edited.
- Use a sufficiently charged battery to prevent the camera from turning off during editing. When the battery level display is , movie editing is not possible.
- A movie that was created by editing cannot be trimmed again. To trim another area of the movie, select and edit the original movie.
- Movies are trimmed in one-second intervals, therefore the actual trimmed portion of the movie may differ slightly from the selected start and end points. Movies cannot be trimmed so that they are less than two seconds long.
- Editing functions are not available when there is not enough free space in the internal memory or on the memory card to save the edited copies.

### **More Information**

See “File and Folder Names” () for more information.

# The Shooting Menu (for (Auto) Mode)

## Image Mode Settings (Image Size and Quality)

Enter shooting mode → MENU button → Image mode →  button

You can select the combination of image size and compression ratio that is used when saving images.

The higher the image mode setting, the larger the size at which it can be printed, but the number of images that can be saved (41) is reduced.



Option <sup>1</sup>	Compression ratio	Aspect ratio (horizontal to vertical)	Print size <sup>2</sup> (cm/in.)
<b>16M*</b> 4608×3456★	Approx. 1/4	4:3	Approx. 39 × 29/15 × 11.5
<b>16M</b> 4608×3456 (default setting)	Approx. 1/8	4:3	Approx. 39 × 29/15 × 11.5
<b>8M</b> 3264×2448	Approx. 1/8	4:3	Approx. 28 × 21/11 × 8
<b>4M</b> 2272×1704	Approx. 1/8	4:3	Approx. 19 × 14/7.5 × 5.6
<b>2M</b> 1600×1200	Approx. 1/8	4:3	Approx. 13 × 10/5.3 × 4
<b>VGA</b> 640×480	Approx. 1/8	4:3	Approx. 5 × 4/2 × 1.5
<b>12M</b> 4608×2592	Approx. 1/8	16:9	Approx. 39 × 22/15 × 8.5

<sup>1</sup> The total number of pixels captured, and the number of pixels captured horizontally and vertically.

Example: **16M 4608×3456** = approx. 16 megapixels, 4608 × 3456 pixels

<sup>2</sup> Print size at an output resolution of 300 dpi. Print sizes are calculated by dividing the number of pixels by printer resolution (dpi) and multiplying by 2.54 cm (1 in.). However, at the same image size, images printed at higher resolutions will print smaller than the size indicated, and those printed at lower resolutions will print larger than the size indicated.

## Notes About Image Mode

- The setting is also applied to other shooting modes.
- Some settings cannot be used with other functions ((70)).
- The image mode cannot be selected in **3D photography** ((49)) or **Easy panorama** ((47)) scene mode.

## Number of Images That Can Be Saved

The following table lists the approximate number of images that can be saved on a 4 GB memory card. Note that due to JPEG compression, the number of images that can be saved may vary greatly depending on the image content, even when using memory cards with the same capacity and the same image mode setting.

In addition, the number of images that can be saved may vary depending on the make of the memory card.

Image mode	Number of images that can be saved (4 GB)
<b>16M*</b> 4608×3456 ★	440
<b>16M</b> 4608×3456 (default setting)	890
<b>8M</b> 3264×2448	1740
<b>4M</b> 2272×1704	3500
<b>2M</b> 1600×1200	6660
<b>VGA</b> 640×480	26300
<b>16-9 12M</b> 4608×2592	1180







- If the number of exposures remaining is 10,000 or more, the number of exposures remaining display shows "9999".
- To check the number of images that can be saved in the internal memory (approx. 25 MB), remove the memory card from the camera, and then check the number of remaining exposures displayed in the monitor when shooting.

## White Balance (Adjusting Hue)

Select  (auto) mode → MENU button → White balance →  button

The color of light reflected from an object varies with the color of the light source. The human brain is able to adapt to changes in the color of the light source, with the result that white objects appear white whether seen in the shade, direct sunlight, or under incandescent lighting. Digital cameras can mimic this adjustment by processing images according to the color of the light source. This is known as “white balance.” For natural colors, select a white balance setting that matches the light source before shooting.

Although **Auto** (default setting) can be used under most types of lighting, white balance can be adjusted to suit the sky conditions or light source and achieve more natural color tones in the image.

Option	Description
<b>AUTO</b> Auto (default setting)	White balance is automatically adjusted to suit lighting conditions.
<b>PRE</b> Preset manual	Useful when shooting under unusual lighting (  43).
 Daylight	White balance adjusted for direct sunlight.
 Incandescent	Use under incandescent lighting.
 Fluorescent	Use under fluorescent lighting.
 Cloudy	Use when taking images under overcast skies.
 Flash	Use with the flash.

The current setting can be confirmed in the monitor when shooting (9). No icon is displayed when **Auto** is selected.

## Using Preset Manual

The preset manual option is used with mixed lighting or to compensate for light sources with a strong color cast when the desired effect has not been achieved with white balance settings like **Auto** and **Incandescent** (for example, to make images shot under a lamp with a red shade look as though they had been shot under white light).

Use the procedure below to measure the white balance value under the lighting used during shooting.

**1** Place a white or gray reference object under the lighting that will be used during shooting.

**2** Display the shooting menu (📖6, 68), use the multi selector to select **Preset manual** in the **White balance** menu, and press the **OK** button.

- The camera zooms in to the position for measuring white balance.

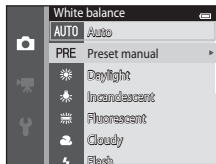

**3** Select **Measure**.

- To apply the most recently measured white balance value, select **Cancel** and press the **OK** button. The white balance setting will not be measured again and the most recently measured value will be set.

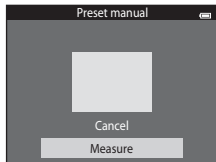

- 4** Frame the reference object in the measuring window.

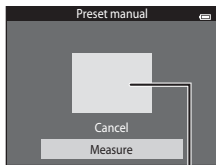

Measuring window

- 5** Press the **OK** button to measure a new white balance value.

- The shutter is released and the new white-balance value for preset manual is set. No image is saved.

**✓ Notes About White Balance**

- Some settings cannot be used with other functions (📖70).
- Set the flash to **🚫** (off) when white balance is set to any setting other than **Auto** and **Flash** (📖57).











**✓ Notes About Preset Manual**

A value for flash lighting cannot be measured with **Preset manual**. When shooting using the flash, set **White balance** to **Auto** or **Flash**.

## Continuous Shooting

Select  (auto) mode → MENU button → Continuous →  button

Change settings to continuous or BSS (Best Shot Selector).

Option	Description
 Single (default setting)	One image is taken each time the shutter-release button is pressed.
 Continuous H	While the shutter-release button is held all the way down, images are captured continuously at a rate of about 10 fps (when image mode is set to  <b>4608x3456</b> ). Shooting ends when the shutter-release button is released, or 7 images have been captured.
 Continuous L	While the shutter-release button is held all the way down, up to 6 images are captured continuously at a rate of up to about 2 fps (when image mode is set to  <b>4608x3456</b> ). Shooting ends when the shutter-release button is released.
 Pre-shooting cache	Pre-shooting cache makes it easy to capture perfect moments by saving images from before the shutter-release button was pressed all the way. Pre-shooting cache shooting begins when the shutter-release button is pressed halfway, and continues when the shutter-release button is pressed all the way (  48). <ul style="list-style-type: none"><li>• Frame rate: Up to 18 fps</li><li>• Number of frames: Up to 5 frames (including up to two frames captured in the pre-shooting cache)</li></ul> Shooting ends when the shutter-release button is released or when the maximum number of frames has been shot.
 <b>120</b> Continuous H: 120 fps	Each time the shutter-release button is pressed all the way, 50 frames are captured at a speed of about 1/125 s or faster. Image mode is fixed at  (image size: 640 × 480 pixels).
 <b>60</b> Continuous H: 60 fps	Each time the shutter-release button is pressed all the way, 25 frames are captured at a speed of about 1/60 s or faster. Image mode is fixed at  (image size: 1280 × 960 pixels).

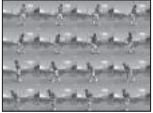
Option	Description
<b>BSS</b> BSS (Best Shot Selector)	The “Best Shot Selector” is recommended when shooting with the flash off or the camera zoomed in, or in other situations in which inadvertent motion can result in blurred images. When BSS is on, the camera takes up to ten images while the shutter-release button is held down. The sharpest image in the series is automatically selected and saved.
 Multi-shot 16	Each time the shutter-release button is pressed, the camera takes 16 shots at a rate of about 30 fps and arranges them in a single image. <ul style="list-style-type: none"> <li>• Image mode is fixed at <b>5.4</b> (image size: 2560 × 1920 pixels).</li> <li>• Digital zoom cannot be used.</li> </ul> 

The current setting can be confirmed in the monitor when shooting (9). No icon is displayed when **Single** is selected.

## ✔ Notes About Continuous Shooting

- When a setting other than **Single** is selected, flash cannot be used. Focus, exposure, and white balance are fixed at the values determined with the first image in each series.
- It may take some time to save the images after shooting. The amount of time it takes to finish saving the images depends on the number of images, image mode, the write speed of the memory card, etc.
- When ISO sensitivity increases, noise may appear in captured images.
- The frame rate for continuous shooting may vary depending upon the current image mode setting, the memory card used, or shooting condition.
- When **Continuous** is set to **Pre-shooting cache**, **Continuous H: 120 fps**, **Continuous H: 60 fps**, or **Multi-shot 16**, banding or variance in brightness or hue may occur in images that were captured under lighting that flickers at high speeds, such as fluorescent, mercury-vapor, or sodium-vapor lighting.
- Some settings cannot be used with other functions (📖70).

## ✔ Notes About BSS



**BSS** is suited for shooting stationary subjects. BSS may not produce the desired results if the subject moves or the composition changes.

## 📎 Images Captured in Continuous Shooting Mode

Each time images are captured using **Continuous H**, **Continuous L**, **Pre-shooting cache**, **Continuous H: 120 fps**, or **Continuous H: 60 fps**, the captured images are saved as a “sequence” (📖13).

## Pre-shooting Cache

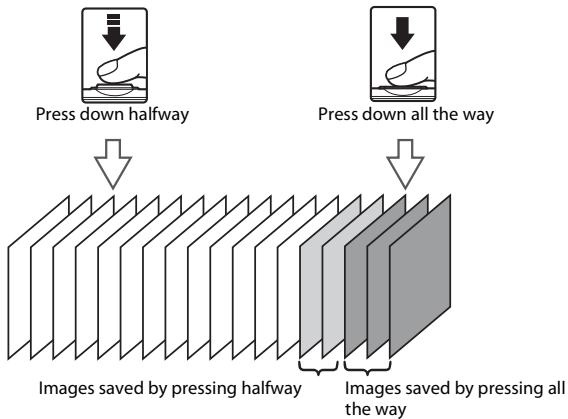

When **Pre-shooting cache** is selected, shooting begins when the shutter-release button is pressed halfway for 0.5 seconds or longer, and images captured before the shutter-release button is pressed all the way are saved along with images captured after the shutter-release button is pressed all the way. Up to two images can be saved in the pre-shooting cache.

The pre-shooting cache setting can be confirmed in the monitor when shooting (9). The pre-shooting cache icon () lights in green while the shutter-release button is pressed halfway.





- If the number of exposures remaining is less than five, shooting with the pre-shooting cache is not possible. Before shooting, check that there are five or more exposures remaining.

## More Information

- See "Subjects Not Suitable for Autofocus" (76) for more information.
- See "Viewing and Deleting Images Captured Continuously (Sequence)" (13) for more information.

# ISO Sensitivity

Select  (auto) mode → MENU button → ISO sensitivity → 



When ISO sensitivity is increased, less light is needed when taking images.

Higher ISO sensitivity allows darker subjects to be captured. Additionally, even with subjects of similar brightness, images can be taken at faster shutter speeds, and blurring caused by camera shake and subject movement can be reduced.



- Although higher ISO sensitivity is effective when shooting darker subjects, shooting without the flash, shooting while using the zoom, etc., images may contain noise.

Option	Description
<b>AUTO</b> Auto (default setting)	Sensitivity is ISO 125 when there is sufficient lighting; the camera compensates by raising sensitivity to a maximum of ISO 1600 when lighting is dim.
 Fixed range auto	Select the range in which the camera automatically adjusts ISO sensitivity, from <b>ISO 125-400</b> or <b>ISO 125-800</b> . The camera will not increase sensitivity beyond the maximum value in the selected range. Set the maximum value for ISO sensitivity for effective control over the amount of “grain” that appears in images.
125, 200, 400, 800, 1600, 3200	Sensitivity is locked at the specified value.



The current setting can be confirmed in the monitor when shooting (9).

- When **Auto** is selected, the  icon is not displayed at ISO 125, but is displayed if the ISO sensitivity automatically increases to more than 125.
- When **Fixed range auto** is selected,  and the maximum value for ISO sensitivity is displayed.





## Notes About ISO Sensitivity

- Some settings cannot be used with other functions (71).
- **Motion detection** (91) does not function when the ISO sensitivity is set to any setting other than **Auto**.

## Color Options

Select  (auto) mode → MENU button → Color options →  button

Make colors more vivid or save images in monochrome.



Option	Description
 Standard color (default setting)	Use for images exhibiting natural color.
 Vivid color	Use to achieve a vivid, “photoprint” effect.
 Black-and-white	Save images in black-and-white.
 Sepia	Save images in sepia tones.
 Cyanotype	Save images in cyan-blue monochrome.

The current setting can be confirmed in the monitor when shooting (9). When **Standard color** is selected, no icon is displayed. Color tones shown in the monitor during shooting change according to the selected color option.

### Notes About Color Options





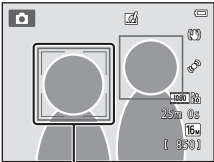
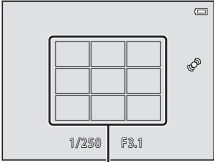

Some settings cannot be used with other functions (70).

## AF Area Mode

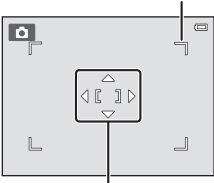
Select  (auto) mode → MENU button → AF area mode → 

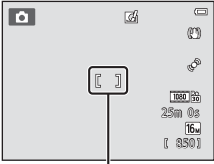
Use this option to determine how the camera selects the focus area for autofocus.

Option	Description
 Face priority	<p>When the camera detects a human face, it focuses on that face. See “Using Face Detection” (p.73) for more information. If more than one face is detected, the camera focuses on the face closest to the camera.</p>  <p>Focus area</p> <p>When taking images of subjects other than people, or framing a subject with which no face is detected, the camera will automatically select the focus area (up to nine areas) containing the subject closest to the camera. When the shutter-release button is pressed halfway, the focus areas that are in focus (up to nine areas) selected by the camera will be displayed in the monitor.</p>  <p>Focus areas</p>



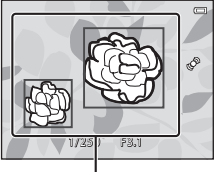

Option	Description	
<p><b>[] Manual</b></p>	<p>Select one of 99 focus areas in the monitor. This option is suited to situations in which the intended subject is relatively still and not positioned in the center of the frame. Press the multi selector <b>▲</b>, <b>▼</b>, <b>◀</b>, or <b>▶</b> to move the focus area to where the subject is, and take an image. To cancel focus area selection and adjust flash, macro mode, self-timer, and exposure compensation settings, press the <b>OK</b> button. To return to the focus area selection screen, press the <b>OK</b> button again.</p>	<p><b>Selectable focus area</b></p>  <p><b>Focus area</b></p>
<p><b>[] Center</b></p>	<p>The camera focuses on the subject in the center of the frame. The focus area is always displayed in the center of the screen.</p>	 <p><b>Focus area</b></p>
<p><b> Subject tracking</b></p>	<p>Use this function to take images of moving subjects. Register the subject on which the camera will focus. The focus area will automatically move to track the subject. See “Using Subject Tracking” (54) for more information.</p>	

Option	Description
<p> Target finding AF (default setting)</p>	<p>When the camera detects the main subject, it focuses on that subject. See "Using Target Finding AF" (📖75).</p>  <p style="text-align: center;">Focus areas</p>

### Notes About AF Area Mode



- When digital zoom is in effect, focus will be on the center of the screen regardless of the **AF area mode** setting.
- Autofocus may not perform as expected (📖76).
- Some settings cannot be used with other functions (📖70).

## Using Subject Tracking

Select  (auto) mode → MENU button → AF area mode →  button →  Subject tracking →  button → MENU button

Use this mode to focus on a subject that is moving when taking images. When you register a subject, subject tracking begins and the focus area automatically follows the subject.

### 1 Register a subject.

- Align the subject that you want to register with the white border in the center of the monitor and press the  button.
- When the camera is unable to focus on the subject, the border will glow red. Change the composition and try registering the subject again.
- When the subject is registered, a yellow border (focus area) is displayed around that subject and the camera begins tracking that subject.
- To cancel subject registration, press the  button.
- If the camera can no longer track the registered subject, the focus area will disappear and the registration will be canceled. Register the subject again.

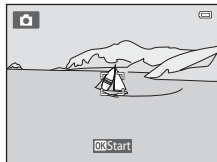

### 2 Press the shutter-release button fully to take the image.

- The camera focuses on the focus area when the shutter release button is pressed halfway. The focus area will glow green and focus will be locked.
- If the shutter-release button is pressed halfway while the focus area is not displayed, the camera focuses on the area in the center of the frame.

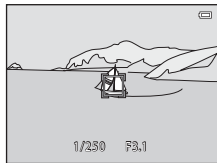

### Notes About Subject Tracking

- Adjust zoom position, flash mode, exposure compensation, and menu settings prior to registering the subject.
- Subject tracking may not be possible in certain shooting conditions.
- Digital zoom cannot be used.

## Autofocus Mode

Select  (auto) mode → MENU button → Autofocus mode →  button



Select how the camera focuses.

Option	Description
<b>AF-S</b> Single AF (default setting)	The camera focuses when the shutter-release button is pressed halfway.
<b>AF-F</b> Full-time AF	The camera focuses continuously until the shutter-release button is pressed halfway. Use with moving subjects. The sound of lens drive movement will be heard while the camera focuses.





### **Autofocus Mode for Movie Recording**

Autofocus mode for movie recording can be set with **Autofocus mode** () in the movie menu.

## Quick Effects

Select  (auto) mode → MENU button → Quick effects →  button

Enable or disable the quick effects function.

Option	Description
 On (default setting)	In  (auto) mode, press the  button immediately after releasing the shutter to display the effect selection screen and use the quick effects function (  39).
Off	Disables the quick effects function (during shooting).

The current setting can be confirmed in the monitor when shooting (9). No indicator is displayed when **Off** is selected.

### Notes About Quick Effects

This function cannot be used with some functions (70).

# The Smart Portrait Menu

- See “Image Mode Settings (Image Size and Quality)” (📷40) for information about **Image mode**.

## Skin Softening





Enter shooting mode → 📷 (shooting mode) → 😊 Smart portrait → OK button → MENU button → Skin softening → OK button

Enable skin softening.





Option	Description
⬆️ High	When the shutter is released, the camera detects one or more human faces (up to three), and processes the image to soften facial skin tones before saving the image. You can select the amount of effect that is applied.
⬆️ Normal (default setting)	
⬆️ Low	
Off	Turns skin softening off.

The current setting can be confirmed in the monitor when shooting (📖9). No indicator is displayed when **Off** is selected. The effects of skin softening are not visible when framing images for shooting. Check the degree of skin softening performed in playback mode.

## Smile Timer

Enter shooting mode →  (shooting mode) →  Smart portrait →  button → MENU button → Smile timer →  button

The camera detects human faces and then automatically releases the shutter whenever a smile is detected.





Option	Description
 On (single)	Whenever a smile is detected, the camera takes one image.
 On (continuous)	Whenever a smile is detected, the camera captures up to 5 images continuously and saves them all. The flash cannot be used. <ul style="list-style-type: none"><li>• Continuous shooting speed: Approx. 3.3 fps (when image mode is set to  <b>4608x3456</b>)</li></ul>
 <b>BSS</b> On (BSS) (default setting)	Whenever a smile is detected, the camera captures up to 5 images continuously and saves the one that best captured the smile. The flash cannot be used. <ul style="list-style-type: none"><li>• Continuous shooting speed: Approx. 3.3 fps (when image mode is set to  <b>4608x3456</b>)</li></ul>
Off	Turns the smile timer off.

The current setting can be confirmed in the monitor when shooting (9). No icon is displayed when **Off** is selected.



### Camera Settings That Cannot Be Used Simultaneously

Some settings cannot be used with other functions (70).

## Blink Proof

Enter shooting mode →  (shooting mode) →  Smart portrait →  button → MENU button → Blink proof → 

The camera automatically releases the shutter twice each time an image is taken. Of the two shots, one in which the subject's eyes are open is saved.

Option	Description
 On	Enables blink warning. Flash cannot be used when <b>On</b> is selected. If the camera saved an image in which the subject's eyes may have been closed, the dialog shown on the right is displayed for a few seconds. 
Off (default setting)	Turns the blink warning off.

The current setting can be confirmed in the monitor when shooting (9). No icon is displayed when **Off** is selected.

### Camera Settings That Cannot Be Used Simultaneously

This function cannot be used with some functions (70).

# The Playback Menu

- See “Editing Still Images” (📷16) for information about image editing features.
- See “Favorite Pictures Mode” (📷6) for information about **Favorite pictures** and **Remove from favorites**.

---

## Print Order (Creating a DPOF Print Order)

Press the  button (playback mode) → MENU button → Print order →  button

When printing images saved on the memory card using any of the following methods, the **Print order** option in the playback menu is used to create digital “print orders” for printing on DPOF-compatible devices.

- Inserting the memory card into a DPOF-compatible (📷23) printer’s card slot.
- Taking the memory card to a digital photo lab.
- Connecting the camera to a PictBridge-compatible (📷23) printer (📷29). A print order can also be created for images saved in the internal memory if the memory card is removed from the camera.

### 1 Use the multi selector to select **Select images** and press the button.

- In favorite pictures, auto sort, or list by date mode, the screen shown on the right is not displayed. Proceed to the step 2.

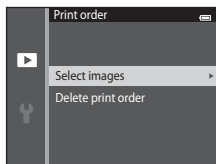

## 2 Select images (up to 99) and the number of copies (up to nine) of each.

- Press the multi selector ◀ or ▶ to select images, and press ▲ or ▼ to specify the number of copies to be printed.
- Images selected for printing are indicated by the 🖨️ icon and the numeral indicating the number of copies to be printed. If no copies have been specified for images, the selection is canceled.
- Rotate the zoom control to **T** (🔍) to switch to full-frame playback. Rotate the zoom control to **W** (📐) to switch back to six-thumbnail display.
- Press the **OK** button when setting is complete.



## 3 Select whether or not to print shooting date and shooting information.

- Select **Date** and press the **OK** button to print the shooting date on all images in the print order.
- Select **Info** and press the **OK** button to print shooting information (shutter speed and aperture value) on all images in the print order.
- Select **Done** and press the **OK** button to complete the print order.
- Images selected for printing are indicated by the 🖨️ icon during playback (📖10).

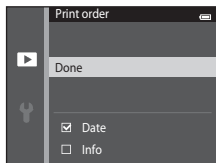

## ✓ Notes About Print Order

- Print orders cannot be created for images captured in **3D photography** scene mode.
- When a print order is created in favorite pictures mode, auto sort mode, or list by date mode, the screen shown below is displayed if images other than those in the selected album, category, or shooting date have been marked for printing.
  - If you select **Yes**, print order settings for other images are not changed and only the current print order settings are changed.
  - Select **No** to remove print marking from previously marked images and restrict the print order to images in the selected category or captured on the selected shooting date.

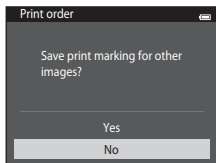

Favorite pictures mode or  
auto sort mode

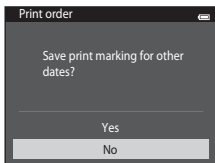

List by date mode

If the total number of the images in a print order exceeds 99, the screen shown below will be displayed.

- Select **Yes** to remove images previously added from the print order and restrict the print order to images just marked.
- Select **Cancel** to remove the images just added from the print order and restrict the print order to images previously marked.

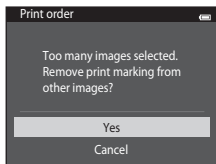

Favorite pictures mode or  
auto sort mode

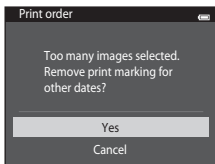

List by date mode

## ✓ Notes About Printing Shooting Date and Shooting Information

When the **Date** and **Info** settings are enabled in the print order option, shooting date and shooting information are printed on images when a DPOF-compatible (🔗23) printer that supports printing of shooting date and shooting information is used.

- Shooting information cannot be printed when the camera is connected to a DPOF-compatible printer via the included USB cable (🔗36).
- Note that **Date** and **Info** settings are reset each time the **Print order** option is displayed.
- The date printed is that saved when the image was captured.

Changing the camera's date using the **Date and time** or **Time zone** in the **Time zone and date** option in the setup menu after an image has been captured has no effect on the date printed on the image.



## 🔗 Canceling Existing Print Order

Select **Delete print order** in step 1 of "Print Order (Creating a DPOF Print Order)" (🔗60) and press the **OK** button to remove print marking from all images and cancel the print order.

## 🔗 Print Date

Using the **Print date** option (🔗88) in the setup menu, shooting date and time can be imprinted on images at the time of shooting. Images with the date imprinted on them can be printed from printers that do not support printing of the date on images.



Only the date and time imprinted on images with the print date option will be printed, even if the **Print order** date option is enabled.

## Slide Show

Press the  button (playback mode) → MENU button → Slide show →  button



Play back images, saved in the internal memory or on a memory card, one by one in an automated “slide show.”

### 1 Use the multi selector to select **Start** and press the button.

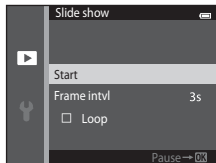
- To change the interval between images, select **Frame intvl**, select the desired interval time, and press the  button before selecting **Start**.
- To repeat the slide show automatically, select **Loop** and press the  button before selecting **Start**. The check mark () will be added to the loop option when enabled.





### 2 The slide show begins.

- While the slide show is in progress, press the multi selector  to display the next image or  to display the previous image. Hold down either button to fast forward or rewind.
- To end or pause the slide show, press the  button.







### 3 Choose End or Restart.

- The display at right appears when the last slide is displayed or the show is paused. Highlight  and press the  button to return to Step 1, or select  to restart the show.





## Notes About Slide Show

- Only the first frame of movies included in a slide show is displayed.
- When **Key picture only** is selected as the method to display sequences (13), only the key picture is displayed.
- Images captured using **Easy panorama** (47, 2) are displayed full-frame when played in a slide show. They do not scroll.
- The maximum playback time is up to 30 minutes even if **Loop** is enabled (95).

---



## Protect

Press the  button (playback mode) → MENU button → Protect →  button

Protects selected images from accidental deletion.

Select images to protect or cancel protection for previously protected images from the image selection screen. See “The Image Selection Screen” (66) for more information.

Note that formatting the camera’s internal memory or the memory card will permanently delete protected files (96).

Protected images are indicated by the  icon during playback (11).

## The Image Selection Screen

When using one of the following features, a screen like that shown on the right is displayed when selecting images.

- Print order > **Select images** (🔗60)
- Protect (🔗65)
- Rotate image (🔗68)
- Copy > **Selected images** (🔗71)
- Choose key picture (🔗73)
- Favorite pictures (🔗6)
- Remove from favorites (🔗8)
- Welcome screen > **Select an image** (🔗82)
- Delete image > **Erase selected images** (📖34)

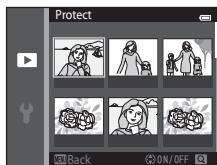

Follow the procedures described below to select the images.

### 1 Press the multi selector ◀ or ▶ to select an image.

- Rotate the zoom control (📖3) to **T** (🔍) to switch to full-frame playback or **W** (📺) to switch back to six-thumbnail display.
- Only one image can be selected for **Rotate image**, **Choose key picture**, and **Welcome screen**. Proceed to step 3.

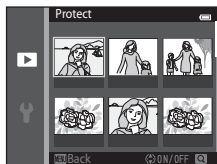

### 2 Press ▲ or ▼ to select or deselect (or to specify the number of copies).

- When an image is selected, an icon is displayed below the image. Repeat steps 1 and 2 to select additional images.



---



### 3 Press the button to apply image selection.

- When **Selected images** is selected, a confirmation dialog is displayed. Follow the instructions displayed in the monitor.

## Rotate Image

Press the  button (playback mode) → MENU button → Rotate image →  button

Specify the orientation in which saved images are displayed during playback. Still images can be rotated 90 degrees clockwise or 90 degrees counterclockwise.

Select an image from the image selection screen (66). When the Rotate image screen is displayed, press the multi selector  or  to rotate the image 90 degrees.

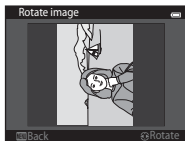

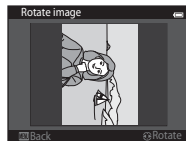

Rotate 90 degrees  
counterclockwise





Rotate 90 degrees  
clockwise

Press the  button to finalize display orientation, and save orientation information with the image.

### Notes About Image Rotation

- Images captured with another make or model of digital camera or captured with **3D photography** (49) cannot be rotated on the COOLPIX S6500.
- Images captured in sequence cannot be rotated when only the key pictures are displayed for them. First display the images individually, and then rotate the desired image (13).



## Voice Memo

Press the  button (playback mode) → select an image → **MENU** button → Voice memo →  button

Use the camera's microphone to record voice memos for images.

- The voice memo recording screen is displayed for images that do not have a voice memo, and the voice memo playback screen is displayed for images that have a voice memo (i.e., images that display  in full-frame playback mode).

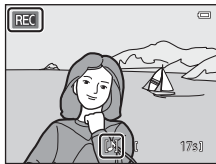

## Recording Voice Memos

- Press and hold the  button to record a voice memo (up to 20 seconds).
- Do not touch the microphone during recording.
- During recording, **REC** and  flash in the monitor.
- When recording ends, the voice memo playback screen is displayed.
- Press the multi selector  before or after recording a voice memo to return to the playback menu. Press the **MENU** button to exit the playback menu.





## Playing Voice Memos



 is displayed for images with a voice memo when in full-frame playback mode.

- Press the  button to play the voice memo. Press the button again to stop playback.
- Rotate the zoom control during playback to adjust playback volume.
- Press the multi selector  before or after playing back a voice memo to return to the playback menu. Press the **MENU** button to exit the playback menu.





## Deleting Voice Memos

Press the  button while the screen described in “Playing Voice Memos” (69) is displayed.

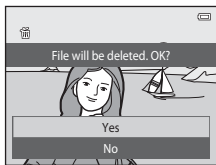
When the confirmation dialog is displayed, press the multi selector  or  to select **Yes** and press the  button. Only the voice memo will be deleted.





### Notes About Voice Memos

- When an image with a voice memo attached is deleted, both the image and its voice memo are deleted.
- You cannot delete voice memos attached to protected images (65).
- Voice memos cannot be recorded for an image that already has a voice memo attached to it. The current voice memo must be deleted before a new voice memo can be recorded.
- The COOLPIX S6500 cannot record voice memos for images captured with another make or model of digital camera.
- Voice memos cannot be recorded for images captured in sequence when only the key pictures are displayed for sequences of images. First display the images individually, and then record voice memos (13).

### More Information

See “File and Folder Names” (111) for more information.

# Copy (Copy Between Internal Memory and Memory Card)

Press the  button (playback mode) → MENU button → Copy →  button

Copy images between the internal memory and a memory card.

**1** Use the multi selector to select a destination option to which images are copied and press the  button.

- **Camera to card:** Copy images from internal memory to memory card.
- **Card to camera:** Copy images from memory card to internal memory.

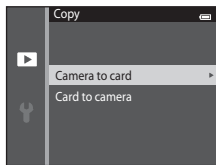



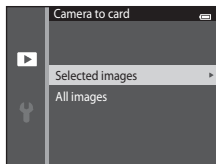

**2** Select a copy option and press the  button.



- **Selected images:** Copy images selected from the image selection screen (66).
- **All images:** Copy all images.



## Notes About Copying Images

- JPEG-, MOV-, WAV-, and MPO-format files can be copied. Files saved in any other format cannot be copied.
- If voice memos () are attached to images selected for copying, the voice memos are copied with the images.
- Operation is not guaranteed with images captured with another make of camera or that have been modified on a computer.
- When copying images for which **Print order** () options are enabled, the print order settings are not copied. However, when copying images for which **Protect** () is enabled, the protect setting is copied.
- Images or movies copied from the internal memory or a memory card cannot be displayed in auto sort mode ()
- If an image added to an album () is copied, the copied image is not added to the album.

## Notes About Copying Images in a Sequence

- If you select a key picture of a sequence in **Selected images** when only the key picture is displayed for the sequence () , all images in the sequence are copied.
- If you press the **MENU** button and select **Current sequence** after you press the  button and display images in a sequence as individual images, all images in the sequence are copied.
- If you press the  button and display images in a sequence as individual images, only **Card to camera** (memory card to internal memory) image copy is available.

## If “Memory contains no images.” Is Displayed



If a memory card that contains no images is inserted into the camera, **Memory contains no images.** will be displayed when the camera is switched to playback mode. Press the **MENU** button to select **Copy** in the playback menu and copy the images saved in the camera’s internal memory to the memory card.

## More Information





See “File and Folder Names” () for more information.

## Sequence Display Options



Press the  button (playback mode) → MENU button → Sequence display options →  button



Choose the method used to display a series of images shot continuously (sequence) ()13) when viewing them in full-frame playback mode ()32) and in thumbnail playback mode ()81).

Settings are applied to all sequences, and the setting is saved in the camera's memory even if the camera is turned off.

Option	Description
 Individual pictures	Set all images in all sequences to be displayed individually.  is displayed on the playback screen (  )11).
 Key picture only (default setting)	Set all sequences to be displayed using their key pictures only.

## Choose Key Picture

Press the  button (playback mode) → select an image in a sequence → MENU button → Choose key picture →  button

When **Sequence display options** is set to **Key picture only**, the key picture displayed in full-frame playback mode ()32) and thumbnail playback mode ()81) can be set for each sequence of images.

- When changing this setting, before pressing the MENU button, first select the desired sequence using full-frame playback mode or thumbnail playback mode.
- When the key picture selection screen is displayed, select an image. See “The Image Selection Screen” ()66) for more information.

# The Movie Menu





## Movie Options

Enter shooting mode → MENU button →  menu icon → Movie options →  button

Select the desired movie option to record.

Select normal speed movie options to record at normal speed, or HS movie options () to record in slow or fast motion. Larger image sizes and higher bitrates produce greater image quality and larger movie file sizes.

### Normal Speed Movie Options

Option	Image size (recorded pixels) Aspect ratio (horizontal to vertical)	Bitrate
 1080★/30p (default setting)	1920×1080 16:9	Approx. 18 Mbps
 1080/30p	1920×1080 16:9	Approx. 12 Mbps
 720/30p	1280×720 16:9	Approx. 9 Mbps
 iFrame 540/30p*	960×540 16:9	Approx. 24 Mbps
 480/30p	640×480 4:3	Approx. 2.9 Mbps

\* iFrame is a format supported by Apple Inc.

Movies recorded with this option cannot be edited ()38).

When recording movies to the internal memory, recording may stop unexpectedly in some shooting conditions. When recording movies of important events, recording to a memory card (Class 6 or higher) is recommended.

- The frame rate is approximately 30 fps for all options.



## Frame Rate and Bitrate

- The frame rate is the number of frames per second.
- The movie bitrate is the volume of movie data recorded per second. Variable bitrate (VBR) encoding is used to automatically adjust the bitrate depending on the subject being recorded. When recording movies of a subject with large amounts of motion, the file size increases.

## HS Movie Options

Recorded movies are played back in fast or slow motion.

See “Recording Movies in Slow Motion and Fast Motion (HS Movie)” (📷77).

Option	Image size (recorded pixels) Aspect ratio (horizontal to vertical)	Description
HS 480/4x	640x480 4:3	1/4-speed slow motion movies are recorded. <ul style="list-style-type: none"> <li>• Max. recording time*: 10 seconds (playback time: 40 seconds)</li> </ul>
HS 720/2x	1280x720 16:9	1/2-speed slow motion movies are recorded. <ul style="list-style-type: none"> <li>• Max. recording time*: 30 seconds (playback time: 1 minute)</li> </ul>
HS 1080/0.5x	1920x1080 16:9	2x speed fast motion movies are recorded. <ul style="list-style-type: none"> <li>• Max. recording time*: 2 minutes (playback time: 1 minute)</li> </ul>

- \* While recording movies, the camera can be switched between normal speed movie recording and slow motion or fast motion movie recording. The maximum recording time shown here refers only to the portion of the movie that is recorded in slow motion or fast motion.



## Notes About HS Movie





- Sound is not recorded.
- Zoom position, focus, exposure, and white balance are locked when movie recording starts.
- The HS 480/4x setting cannot be used with **Soft** or **Nostalgic sepia** in special effects mode (📖51). If you try to use both settings at the same time, only the setting made first is enabled. Even if you first select **Soft** or **Nostalgic sepia** in special effects mode and then switch to another shooting mode and select HS 480/4x, the movie options setting automatically changes to HS 720/2x when you return to special effects mode and select **Soft** or **Nostalgic sepia**.

## **Movie Options and Maximum Movie Length**

The table below shows the approximate total movie length that can be saved on a 4 GB memory card, for each movie option.

Note that the actual movie length and file size may vary depending on the content of the movie or on subject movement, even when using memory cards with the same capacity and the same movie option setting.

In addition, the maximum movie length may vary depending on the make of the memory card.

Movie options	Maximum Movie Length (4 GB)*
 1080★/30p (default setting)	25 min
 1080/30p	40 min
 720/30p	50 min
 iFrame 540/30p	15 min
 480/30p	2 h 40 min



\* Individual movie files cannot exceed 4 GB in size or 29 minutes in length, even when there is sufficient free space on the memory card for longer recording.

The maximum movie length for a single movie is displayed on the shooting screen.





Recording may end before either limit is reached if camera temperature becomes elevated.

- To check the movie length of a movie that can be recorded in the internal memory (approx. 25 MB), remove the memory card from the camera, and then check the maximum recording time displayed in the monitor when shooting.

## Recording Movies in Slow Motion and Fast Motion (HS Movie)



Enter the shooting mode → MENU button →  menu icon → Movie options →  button

HS (high speed) movies can be recorded. The portions of the movie recorded using HS movie can be played back in slow motion at 1/4 or 1/2 of the normal playback speed, or in fast motion at twice the normal playback speed.

**1** Press  or  to select an HS movie option (75) and press the  button.

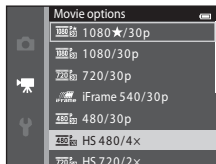
- After applying the option, press the MENU button to return to the shooting screen.



**2** Press the  ( movie-record) button to start recording.

- Movie recording starts in HS mode when the **Open with HS footage** checkbox in the movie menu is checked.

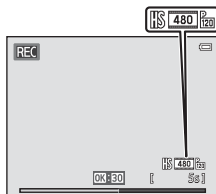

When recording HS movies

- Movie recording starts at normal speed when the **Open with HS footage** checkbox in the movie menu is not checked. Press the **OK** button to switch to HS movie recording at the point where the camera should record for slow motion or fast motion playback.

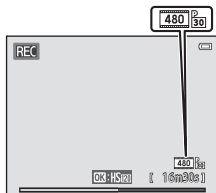

When recording normal speed movies

- When an HS movie reaches the maximum length for HS movies (75), or when the **OK** button is pressed, the camera switches to normal speed movie recording. The camera switches between normal speed movie recording and HS movie recording each time the **OK** button is pressed.
- When recording HS movies, the maximum movie length display changes and displays the remaining movie length for HS movie recording.
- The movie options icon changes when switching between HS movie recording and normal speed movie recording.

### 3 Press the **OK** (movie-record) button to end recording.

## HS Movie

Recorded movies are played back at about 30 frames per second.

When **Movie options** ( 74) is set to  $\frac{480 \text{ P}}{120 \text{ F}}$  **HS 480/4x** or  $\frac{720 \text{ P}}{60 \text{ F}}$  **HS 720/2x**, movies that can be played back in slow motion can be recorded. When set to  $\frac{1080 \text{ P}}{15 \text{ F}}$  **HS 1080/0.5x**, movies that can be played back in fast motion at a speed two times faster than normal speed can be recorded.

### Portions recorded at $\frac{480 \text{ P}}{120 \text{ F}}$ **HS 480/4x**:

High-speed recording is possible for up to ten seconds, and the captured portion is played back in slow motion at a speed four times slower than normal speed.

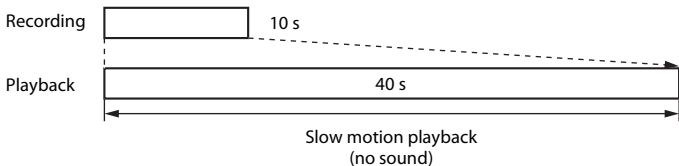

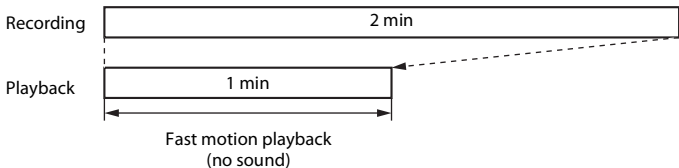

### Portions recorded at $\frac{1080 \text{ P}}{15 \text{ F}}$ **HS 1080/0.5x**:

A movie of up to two minutes in length is recorded when shooting for the purpose of high-speed playback. Playback is two times faster.



## Open with HS Footage

Enter shooting mode → MENU button →  menu icon → Open with HS footage →  button

Select whether the camera records normal speed movies or HS movies (slow motion or fast motion movies) when movie recording starts.

Option	Description
On (default setting)	Record HS movies when movie recording begins.
Off	Record normal speed movies when movie recording begins. Press the  button to switch to HS movie recording at the point where the camera should record for slow motion or fast motion playback.

## Autofocus Mode

Enter shooting mode → MENU button →  menu icon → Autofocus mode →  button

Select how the camera focuses in movie mode.

Option	Description
AF-S Single AF (default setting)	Focus is locked when the  button is pressed to start recording. Select this option when the distance between the camera and the subject will remain fairly consistent.
AF-F Full-time AF	Camera focuses continuously. Select this option when the distance between the camera and subject will change significantly during recording. The sound of the camera focusing may be heard in the recorded movie. Use of <b>Single AF</b> is recommended to prevent the sound of the camera focusing from interfering with recording.

- When an HS movie option is selected in **Movie options**, the setting is fixed at **Single AF**.

## Wind Noise Reduction

Enter shooting mode → MENU button →  menu icon → Wind noise reduction →  button

Allows you to reduce wind noise during movie recording.

Option	Description
 On	Reduces the sound produced when wind passes over the microphone. Use when recording movies in locations with strong winds. Other sounds may become difficult to hear during playback.
Off (default setting)	Wind noise reduction is not enabled.







- The current setting can be confirmed in the monitor when shooting (9). No icon is displayed when **Off** is selected.
- When an HS movie option is selected in **Movie options**, the setting is fixed at **Off**.

# The Setup Menu

## Welcome Screen

Press the MENU button →  menu icon → Welcome screen →  button

Allows you to configure the welcome screen that is displayed when you turn on the camera.

Option	Description
None (default setting)	The camera enters shooting or playback mode without displaying the welcome screen.
COOLPIX	The camera displays a welcome screen and enters shooting or playback mode.
Select an image	<p>Displays an image selected for the welcome screen. When the image selection screen is displayed, select an image () and press the  button.</p> <ul style="list-style-type: none"><li>As the selected image is saved in the camera, it will be displayed when the camera is turned on even if the original image is deleted.</li><li>Images captured at an <b>Image mode</b> () setting of  <b>4608×2592</b>, images captured using <b>Easy panorama</b> or <b>3D photography</b>, and copies created at a size of 320 × 240 or smaller using the small picture () or crop () function, cannot be selected.</li></ul>

## Time Zone and Date

Press the MENU button → Y menu icon → Time zone and date → OK button

Set the camera clock.

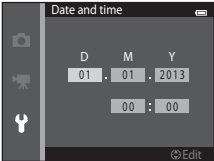
Option	Description	
Date and time	<p>Set camera clock to current date and time. Use the multi selector to set the date and time in the date screen.</p> <ul style="list-style-type: none"><li>• Select an item: Press the multi selector ▶ or ◀ (changes between <b>D</b>, <b>M</b>, <b>Y</b>, hour, and minute).</li><li>• Edit the date and time: Press ▲ or ▼.</li><li>• Apply the setting: Select the minute setting and press the OK button.</li></ul>	
Date format	The available date formats are <b>Year/Month/Day</b> , <b>Month/Day/Year</b> , and <b>Day/Month/Year</b> .	
Time zone	<b>Home time zone</b> (🏠) can be specified and daylight saving time can be enabled or disabled. When <b>Travel destination</b> (📍) is selected, the time difference between the travel destination and the home time zone (🏠) is automatically calculated and the date and time in the selected region are saved. This can be useful when travelling.	

### Selecting the Travel Destination Time Zone

- 1 Use the multi selector to select **Time zone** and press the OK button.

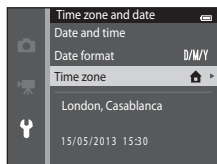

## 2 Select **Travel destination** and press the button.

- The date and time displayed in the monitor changes according to the region currently selected.

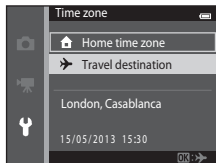



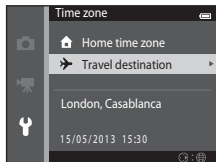

## 3 Press .

- The travel destination screen is displayed.





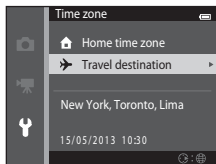
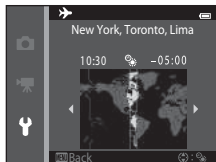

## 4 Press or to select the travel destination time zone.

- If daylight saving time is in effect, press  to enable daylight saving time function.  is displayed above the map and the camera clock is advanced one hour. Press  to disable the daylight saving time function.
- Press the  button to apply the travel destination time zone.
- If the time zone that you want to select is not available, set the appropriate time in **Date and time**.
- While the travel destination time zone is selected, the  icon will be displayed in the monitor when the camera is in shooting mode.



### **Home Time Zone**

- To switch to the home time zone, select  **Home time zone** in step 2 and press the  button.
- To change the home time zone, select  **Home time zone** in step 2 and perform the same procedure as for  **Travel destination** to set the home time zone.

### **Daylight Saving Time**

When daylight saving time starts or ends, turn the daylight saving time function on or off from the time zone selection screen displayed in step 4.

### **Imprinting Date on Images**

Enable the **Print date** option (88) in the setup menu after the date and time have been set. When the **Print date** option is enabled, images will be saved with shooting date imprinted on them.

# Monitor Settings



Press the MENU button →  menu icon → Monitor settings →  button

Set the options below.

Option	Description
Photo info	Select information displayed in the monitor during shooting and playback.
Image review	This setting determines whether or not the captured image is displayed immediately after shooting. The default setting is <b>On</b> .
Brightness	Select from five settings for monitor brightness. The default setting is <b>3</b> .

## Photo Info

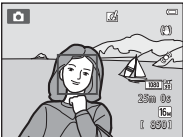
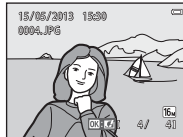
Select whether or not the photo information is displayed in the monitor.

	Shooting mode	Playback mode
Show info		
Auto info (default setting)	Current settings and operational guides are displayed as in <b>Show info</b> . If no operations are performed for a few seconds, the information is hidden as in <b>Hide info</b> . Information will be displayed again when the next operation is performed.	
Hide info		

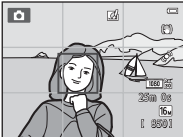
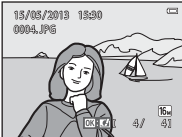
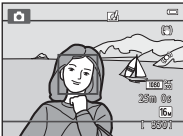
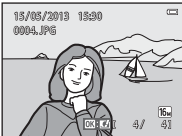
	Shooting mode	Playback mode
Framing grid+auto info	 <p>In addition to information shown with <b>Auto info</b>, a framing grid is displayed to help frame images. It is not displayed when recording movies.</p>	 <p>The current settings or operation guide is displayed as in <b>Auto info</b>.</p>
Movie frame+auto info	 <p>In addition to information shown with <b>Auto info</b>, a frame is displayed before recording begins that represents the area that will be captured when recording movies. It is not displayed when recording movies.</p>	 <p>The current settings or operation guide is displayed as in <b>Auto info</b>.</p>

## ✓ Notes About Monitor Settings

When **Quick effects** (🔌56) is set to **On**, **Image review** is fixed at **On**.

## 🔋 Battery Level

When the battery level is low, 🔋 is always displayed regardless of the **Photo info** setting.

## Print Date (Imprinting Date and Time)

Press the **MENU** button → **Y** menu icon → Print date → **OK** button





The shooting date and time can be imprinted on the images when shooting, allowing the information to be printed even from printers that do not support date printing (📷63).



Option	Description
<b>DATE</b> Date	Date is imprinted on images.
<b>DATE</b> 🕒 Date and time	Date and time are imprinted on images.
<b>Off</b> (default setting)	Date and time are not imprinted on images.

The current print date setting is indicated by an icon when shooting (📷9). No indicator is displayed when **Off** is selected.



## Notes About Print Date

- Imprinted dates form a permanent part of image data and cannot be deleted. The date and time cannot be imprinted on images after they have been captured.
- The date cannot be imprinted in the following situations:
  - When using **Night portrait** (when **Hand-held** is selected), **Night landscape** (when **Hand-held** is selected), **Easy panorama**, or **3D photography** scene mode
  - When the continuous shooting setting (68) is set to **Pre-shooting cache**, **Continuous H: 120 fps**, or **Continuous H: 60 fps**
  - When shooting movies
- Dates imprinted at an **Image mode** setting (40) of **VGA 640×480** may be difficult to read. Select an **Image mode** setting of **2M 1600×1200** or larger when using print date.
- The date is saved using the format selected in the setup menu's **Time zone and date** item (20, 83).

## Print Date and Print Order

When printing with a DPOF-compatible printer that can print the shooting date and shooting information, you can use the **Print order** option (60) to print this information on images, even if the **Print date** function was set to **Off** at the time of shooting.

## Vibration Reduction

Press the MENU button →  menu icon → Vibration reduction →  button

Reduce the effects of camera shake while shooting. Vibration reduction effectively reduces blur, caused by slight hand movement known as camera shake, which commonly occurs when shooting with zoom applied or at slow shutter speeds. The effects of camera shake are reduced when recording movies, in addition to when taking still images.

Set **Vibration reduction** to **Off** when using a tripod to stabilize the camera during shooting.

Option	Description
 On (default setting)	Vibration reduction is enabled.
Off	Vibration reduction is disabled.

The current setting can be confirmed in the monitor when shooting (9). No icon is displayed when **Off** is selected.



















### Notes About Vibration Reduction

- After turning on the camera or after switching from playback mode to shooting mode, wait for the shooting mode screen to be displayed completely before taking images.
- Due to characteristics of the vibration reduction function, images displayed in the camera's monitor immediately after shooting may be displayed blurry.
- Vibration reduction may be unable to completely eliminate the effects of camera shake in some situations.
- When **Tripod** is selected in **Night landscape** or **Night portrait** scene mode, vibration reduction is turned off.

## Motion Detection

Press the **MENU** button →  menu icon → Motion detection →  button

Enable motion detection to reduce the effects of subject movement and camera shake when shooting still images.

Option	Description
 Auto (default setting)	<p>When the camera detects subject movement or camera shake, the ISO sensitivity and shutter speed are automatically increased to reduce blurring.</p> <p>However, motion detection does not function in the following situations:</p> <ul style="list-style-type: none"><li>• When the flash fires</li><li>• When <b>Continuous</b> () is set to any setting other than <b>Single</b> in  (auto) mode</li><li>• When <b>ISO sensitivity</b> () is set to any setting other than <b>Auto</b> in  (auto) mode</li><li>• When <b>AF area mode</b> () is set to <b>Subject tracking</b> in  (auto) mode</li><li>• In the following scene modes: <b>Sports</b> (), <b>Night portrait</b> (), <b>Dusk/dawn</b> (), <b>Night landscape</b> (), <b>Museum</b> (), <b>Fireworks show</b> (), <b>Backlighting</b> (), <b>Easy panorama</b> (), <b>Pet portrait</b> (), and <b>3D photography</b> ()</li><li>• When <b>Smile timer</b> () is set to <b>On (continuous)</b> or <b>On (BSS)</b> in smart portrait mode</li></ul>
Off	Motion detection is disabled.



The current setting can be confirmed in the monitor when shooting ()

When the camera detects camera shake or subject movement, it increases shutter speed and the motion detection icon turns green. No icon is displayed when **Off** is selected.



### Notes About Motion Detection

- Motion detection may be unable to completely eliminate the effects of subject movement and camera shake in some situations.
- Motion detection may not function if the subject exhibits significant movement or is too dark.
- The images captured using motion detection may be somewhat “grainy” in appearance.



## AF Assist

Press the MENU button →  menu icon → AF assist →  button



Enable or disable AF-assist illuminator, which assists autofocus operation when the subject is dimly lit.

Option	Description
<b>AUTO</b> Auto (default setting)	AF-assist illuminator will be used to assist the focus operation when the subject is dimly lit. The illuminator has a range of about 3.0 m (9 ft 10 in.) at the maximum wide-angle position and about 2.0 m (6 ft 6 in.) at the maximum telephoto position. Note that for some scene modes (such as <b>Museum</b> (  45) and <b>Pet portrait</b> (  48)) or focus areas, the AF-assist illuminator may not light even when <b>Auto</b> is selected.
Off	AF-assist illuminator does not light. The camera may be unable to focus under dim lighting.





# Digital Zoom

Press the MENU button →  menu icon → Digital zoom →  button

Enable or disable digital zoom.

Option	Description
On (default setting)	When the camera is zoomed in to the maximum optical zoom position, rotating the zoom control to <b>T</b> (  ) triggers digital zoom (  29).
Off	Digital zoom will not be activated.

## Notes About Digital Zoom

- When digital zoom is in effect, the camera focuses on the area in the center of the frame.
- Digital zoom cannot be used in the following situations.
  - When **Continuous** () is set to **Multi-shot 16** in  (auto) mode
  - When **AF area mode** () is set to **Subject tracking** in  (auto) mode
  - When **Scene auto selector**, **Portrait**, **Night portrait**, **Night landscape**, **Backlighting** (when **HDR** is set to **On**), **Easy panorama**, **Pet portrait**, or **3D photography** is selected in scene mode
  - When smart portrait mode is selected

## Sound Settings

Press the **MENU** button →  menu icon → Sound settings →  button



Adjust the following sound settings.

Option	Description
Button sound	Select <b>On</b> (default setting) or <b>Off</b> . When <b>On</b> is selected, a beep will sound once when operations are completed successfully, twice when the camera acquires focus on the subject, and three times when an error is detected. Start-up sound will also play when the camera is turned on.
Shutter sound	Select <b>On</b> (default setting) or <b>Off</b> . The shutter sound is disabled when using a continuous shooting mode or setting, or when recording movies, even if <b>On</b> is selected.

### Notes About Sound Settings

Button sounds and the shutter sound are disabled when using the **Pet portrait** scene mode.

## Auto Off



Press the **MENU** button →  menu icon → Auto off →  button

If no operations are performed for a specified amount of time, the monitor turns off and the camera enters standby mode (📖25).

This setting determines the amount of time that passes before the camera enters standby mode. You can select **30 s**, **1 min** (default setting), **5 min**, or **30 min**.



### When the Monitor Has Turned Off to Save Power

- When the camera is in standby mode, the power-on lamp flashes.
- If no operations are performed for approximately another three minutes, the camera will turn off automatically.
- When the power-on lamp is flashing, pressing any of the following buttons will turn the monitor back on:  
Power switch, shutter-release button,  button,  button, or  (▶🎬 movie-record) button



### Notes About Auto Off

- The time that passes before the camera enters standby mode is fixed in the following situations:
  - When a menu is displayed: Three minutes minimum (or **5 min** or **30 min**, if these settings are selected)
  - During slide show playback: Up to 30 minutes
  - When the AC adapter EH-62G is connected: 30 minutes
  - When an audio video cable or HDMI cable is connected: 30 minutes
- The camera does not enter standby mode when transferring images using an Eye-Fi card.

## Format Memory/Format Card

Press the MENU button →  menu icon → Format memory/Format card →  button

Use this option to format the internal memory or a memory card.

**Formatting the internal memory or memory cards permanently deletes all data. Data that has been deleted cannot be restored.** Be sure to transfer important images to a computer before formatting.

### Formatting the Internal Memory

To format the internal memory, remove the memory card from the camera. The **Format memory** option is displayed in the setup menu.

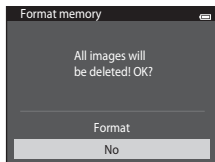

### Formatting Memory Cards

A memory card can be formatted when it is inserted in the camera. The **Format card** option is displayed in the setup menu.

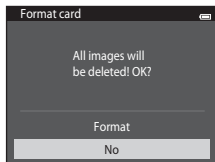

## **Notes About Formatting Internal Memory and Memory Cards**

- Album icon settings () are reset to their default settings (number icons) when the internal memory or memory card is formatted.
- Do not turn the camera off or open the battery-chamber/memory card slot cover during formatting.
- The first time you insert a memory card that has been used in another device into this camera, be sure to format it with this camera.

# Language

Press the **MENU** button → **Y** menu icon → **Language** → **OK** button

Select one of 34 languages for display of camera menus and messages.

<b>Čeština</b>	Czech
<b>Dansk</b>	Danish
<b>Deutsch</b>	German
<b>English</b>	(default setting)
<b>Español</b>	Spanish
<b>Ελληνικά</b>	Greek
<b>Français</b>	French
<b>Indonesia</b>	Indonesian
<b>Italiano</b>	Italian
<b>Magyar</b>	Hungarian
<b>Nederlands</b>	Dutch
<b>Norsk</b>	Norwegian
<b>Polski</b>	Polish
<b>Português (BR)</b>	Brazilian Portuguese
<b>Português (PT)</b>	European Portuguese
<b>Русский</b>	Russian
<b>Română</b>	Romanian

<b>Suomi</b>	Finnish
<b>Svenska</b>	Swedish
<b>Tiếng Việt</b>	Vietnamese
<b>Türkçe</b>	Turkish
<b>Українська</b>	Ukrainian
<b>عربي</b>	Arabic
<b>বাংলা</b>	Bengali
<b>简体中文</b>	Simplified Chinese
<b>繁體中文</b>	Traditional Chinese
<b>हिन्दी</b>	Hindi
<b>日本語</b>	Japanese
<b>한국</b>	Korean
<b>मराठी</b>	Marathi
<b>فارسی</b>	Persian
<b>தமிழ்</b>	Tamil
<b>తెలుగు</b>	Telugu
<b>ภาษาไทย</b>	Thai

## TV Settings

Press the **MENU** button → **Y** menu icon → **TV settings** → **OK** button

Adjust settings for connection to a TV.

Option	Description
Video mode	Select from <b>NTSC</b> and <b>PAL</b> .
HDMI	Select a resolution for HDMI output from <b>Auto</b> (default setting), <b>480p</b> , <b>720p</b> , or <b>1080i</b> . When <b>Auto</b> is selected, the option best suited to the TV to which the camera is connected is automatically selected from <b>480p</b> , <b>720p</b> , or <b>1080i</b> .
HDMI device control	Select whether or not the camera can receive signals from a TV that supports the HDMI-CEC standard when it is connected to the TV via HDMI. When <b>On</b> (default setting) is selected, the TV's remote control can be used to control the camera during playback. See "Using a TV Remote Control (HDMI Device Control)" (28) for more information.
HDMI 3D output	Set the method used to output 3D images captured with this camera to HDMI devices. Select <b>On</b> (default setting) to play back 3D images in 3D.



### HDMI and HDMI-CEC

HDMI (High-Definition Multimedia Interface) is a multimedia interface. HDMI-CEC (HDMI-Consumer Electronics Control) allows compatible devices to inter-operate.

## Charge by Computer

Press the **MENU** button → **Y** menu icon → **Charge by computer** → **OK** button

Select whether or not the battery inserted in the camera is charged when the camera is connected to a computer via the USB cable (📖86).

Option	Description
<b>AUTO</b> Auto (default setting)	When the camera is connected to a computer that is running, the battery inserted into the camera is automatically charged using power supplied by the computer.
Off	The battery inserted into the camera is not charged when the camera is connected to a computer.

### ✔ **Notes About Charging with Connection to a Computer**

- The battery cannot be charged, nor can data be transferred, when the camera is connected to a computer before the camera's display language and date and time have been set (📖20). If the camera's clock battery (📖22) has been exhausted, the date and time must be reset before the battery can be charged or images can be transferred with connection to a computer. In this case, use the Charging AC Adapter EH-70P (📖16) to charge the battery and then set the camera's date and time.
- If the camera is turned off, charging will also stop.
- If the computer enters sleep mode while charging, charging will stop and the camera may turn off.
- When disconnecting the camera from the computer, turn the camera off and then disconnect the USB cable.
- About 3 hours and 15 minutes are required to charge a fully exhausted battery. Charging time increases when images are transferred while the battery is charging.
- When the camera is connected to a computer, an application installed on the computer, such as Nikon Transfer 2, may start. If the camera was connected to the computer for the sole purpose of charging the battery, exit the application.
- The camera turns off automatically if there is no communication with the computer for 30 minutes after the battery has finished charging.
- Depending upon computer specifications, settings, and power supply and allocation, it may be impossible to charge the battery using a computer connection while it is inserted into the camera.

## Notes About Connecting the Camera to a Printer



- The battery cannot be charged with connection to a printer, even if the printer complies with the PictBridge standard.
- When **Auto** is selected for **Charge by computer**, it may be impossible to print images with direct connection of the camera to some printers. If the PictBridge startup screen is not displayed in the monitor after the camera is connected to a printer and turned on, turn the camera off and disconnect the USB cable. Set **Charge by computer** to **Off** and reconnect the camera to the printer.

## The Charge Lamp

The following chart explains charge lamp status when the camera is connected to a computer.

Status	Description
Flashes slowly (green)	Battery charging.
Off	Battery not charging. If the charge lamp changes from slow flashing (green) to off while the power-on lamp is lit, charging is complete.
Flashes quickly (green)	<ul style="list-style-type: none"><li>• The ambient temperature is not suited to charging. Charge the battery indoors with an ambient temperature of 5°C to 35°C (41°F to 95°F).</li><li>• The USB cable is not connected correctly, or the battery is faulty. Make sure the USB cable is connected correctly and replace the battery if necessary.</li><li>• The computer is in sleep mode and is not supplying power. Wake up the computer.</li><li>• The battery cannot be charged because the computer cannot supply power to the camera due to the computer's settings or its specifications.</li></ul>

## Blink Warning

Press the MENU button →  menu icon → Blink warning →  button

Select whether or not the camera detects human subjects that have blinked using face detection (73) when shooting in the following modes:

-  (auto) mode (when **Face priority** (51) is selected for AF area mode option)
- **Scene auto selector** (41), **Portrait** (41), or **Night portrait** (42) scene mode

Option	Description
On	When the camera detects that one or more human subjects may have blinked in an image captured using face detection, the <b>Did someone blink?</b> screen is displayed in the monitor. The face of the human subject that may have blinked when the shutter was released is framed by a yellow border. Should this occur, check the image and determine whether or not another image should be captured. See “The Blink Warning Screen” (  103) for more information.
Off (default setting)	Blink warning is disabled.

### Notes About Blink Warning







The blink warning does not function at continuous settings other than **Single** (45).

## The Blink Warning Screen



When the **Did someone blink?** screen shown on the right is displayed in the monitor, the operations described below are available.

If no operations are performed within a few seconds, the camera automatically returns to shooting mode.



Function	Control	Description
Enlarge the detected face that blinked	<b>T</b> (Q)	Rotate the zoom control to <b>T</b> (Q).
Switch to full-frame playback	<b>W</b> (checkered flag)	Rotate the zoom control to <b>W</b> (checkered flag).
Select the face to be displayed		If the camera detects that more than one human subject blinked, press ◀ or ▶ to switch the display to another face.
Delete the image		Press the  button.
Switch to shooting mode		Press the  button or the shutter-release button.
		

## Wi-Fi Options

Press the **MENU** button →  menu icon → Wi-Fi options →  button

Configure the Wi-Fi (wireless LAN) settings to connect the camera and a smart device.

Option	Description
Wi-Fi network	When wirelessly connecting the camera and a smart device, set <b>Wi-Fi network</b> to <b>On</b> . The default setting is <b>Off</b> . See “Using the Wi-Fi (Wireless LAN) Feature” (□107) for more information.
SSID	Change the SSID. The SSID configured here is displayed on the smart device. Set a 1- to 24-character alphanumeric SSID.
Auth./encrypt.	Select whether or not to encrypt the communications between the camera and the connected smart device. Communications are not encrypted when <b>Open</b> (default setting) is selected.
Password	Set the password. Set a 8- to 16-character alphanumeric password.
Channel	Select the channel used for wireless connections.
Current settings	Display the current settings.
Restore factory defaults	Restore the Wi-Fi settings to their default values.

## Operating the Text Input Keyboard

- Press the ▲, ▼, ◀, or ▶ to select alphanumeric characters. Press the OK button to enter the selected character in the text field and move the cursor to the next space.
- To move the cursor in the text field, select ← or → on the keyboard, and press the OK button.
- To delete one character, press the ✖ button.
- To apply the setting, select ↵ on the keyboard and press the OK button.

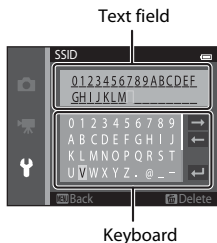





### ✓ Notes About Wi-Fi Network

**Wi-Fi network** cannot be selected in the following situations:

- When an HDMI, USB or audio/video cable is connected to the camera
- When no memory card is inserted in the camera
- When an Eye-Fi card is inserted in the camera
- When the battery level indicator in the monitor indicates 

## Eye-Fi Upload

Press the **MENU** button →  menu icon → Eye-Fi upload →  button





Option	Description
 <b>Enable</b> (default setting)	Upload images created by the camera to a preselected destination.
 <b>Disable</b>	Images will not be uploaded.

### **Notes About Eye-Fi Cards**

- Note that images will not be uploaded if signal strength is insufficient even if **Enable** is selected.
- Select **Disable** where wireless devices are prohibited.
- Refer to the instruction manual of your Eye-Fi card for more information. In the event of malfunction, contact the card manufacturer.
- The camera can be used to turn Eye-Fi cards on and off, but may not support other Eye-Fi functions.
- The camera is not compatible with the endless memory function. When it is set on a computer, disable the function. If the endless memory function is enabled, the number of images taken may not be displayed correctly.
- Eye-Fi cards are for use only in the country of purchase. Observe all local laws concerning wireless devices.
- Leaving the setting as **Enable** will result in the battery being depleted in a shorter period of time.

### **Eye-Fi Communication Indicator**

The communication status of the Eye-Fi card in the camera can be confirmed in the monitor (9).





- : **Eye-Fi upload** is set to **Disable**.
-  (lights): Eye-Fi upload enabled; waiting to begin upload.
-  (flashes): Eye-Fi upload enabled; uploading data.
- : Eye-Fi upload enabled but no images available for upload.
- : An error occurred. The camera cannot control the Eye-Fi card.

## Reset All









Press the **MENU** button →  menu icon → Reset all →  button

When **Reset** is selected, the camera's settings will be restored to their default values.

### Basic Shooting Functions

Option	Default value
Flash mode (  57)	Auto
Self-timer (  60)	Off
Macro mode (  62)	Off
Exposure compensation (  64)	0.0

### Shooting Menu

Option	Default value
Image mode (  40)	 4608×3456
White balance (  42)	Auto
Continuous (  45)	Single
ISO sensitivity (  49)	Auto
Color options (  50)	Standard color
AF area mode (  51)	Target finding AF
Autofocus mode (  55)	Single AF
Quick effects (  56)	On

## Scene Mode

Option	Default value
Scene mode setting in the shooting mode selection menu (📖40)	Scene auto selector
Night portrait (📖42)	Hand-held
Night landscape (📖44)	Hand-held
Hue adjustment in food mode (📖45)	Center
HDR in backlighting scene mode (📖46)	Off
Easy panorama (📖47)	Normal (180°)
Continuous shooting in pet portrait mode (📖48)	Continuous
Pet portrait auto release in pet portrait mode (📖48)	

## Special effects mode

Option	Default value
Special effects mode setting in the shooting mode selection menu (📖51)	Soft

## Smart Portrait Menu

Option	Default value
Skin softening (👁️57)	Normal
Smile timer (👁️58)	On (BSS)
Blink proof (👁️59)	Off

## Movie Menu

Option	Default value
Movie options (👁️74)	1080★/30p
Open with HS footage (👁️80)	On
Autofocus mode (👁️80)	Single AF
Wind noise reduction (👁️81)	Off

## Setup Menu

Option	Default value
Welcome screen (🔍82)	None
Photo info (🔍86)	Auto info
Image review (🔍86)	On
Brightness (🔍86)	3
Print date (🔍88)	Off
Vibration reduction (🔍90)	On
Motion detection (🔍91)	Auto
AF assist (🔍92)	Auto
Digital zoom (🔍93)	On
Button sound (🔍94)	On
Shutter sound (🔍94)	On
Auto off (🔍95)	1 min
HDMI (🔍99)	Auto
HDMI device control (🔍99)	On
HDMI 3D output (🔍99)	On
Charge by computer (🔍100)	Auto
Blink warning (🔍102)	Off
Wi-Fi network (🔍104)	Off
SSID (🔍104)	NikonS6500xxxxxxxx
Auth./encryp. (🔍104)	Open
Password (🔍104)	NikonCoolpix
Channel (🔍104)	1
Eye-Fi upload (🔍106)	Enable

## Others

Option	Default value
Paper size (Fn32, Fn34)	Default
Frame interval for Slide show (Fn64)	3 s
Sequence display options (Fn73)	Key picture only

- Selecting **Reset all** also clears the current file number (Fn111) from memory. Numbering will continue from the lowest number available. To reset file numbering to "0001", delete all images saved in the internal memory or on the memory card (Fn34) before selecting **Reset all**.
- The following menu settings will remain unaffected when menus are reset with **Reset all**.  
**Shooting menu:** Preset manual data (Fn43) acquired for **White balance**  
**Playback menu:** **Choose key picture** (Fn73)  
**Setup menu:** **Time zone and date** (Fn83), **Language** (Fn98), and **Video mode** (Fn99) under **TV settings**  
**Others:** Favorite album icon (Fn9)

---

## Firmware Version

Press the MENU button → Y menu icon → Firmware version → OK button

View the current camera firmware version.

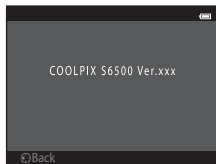

# File and Folder Names

Images, movies, or voice memos are assigned file names as follows.

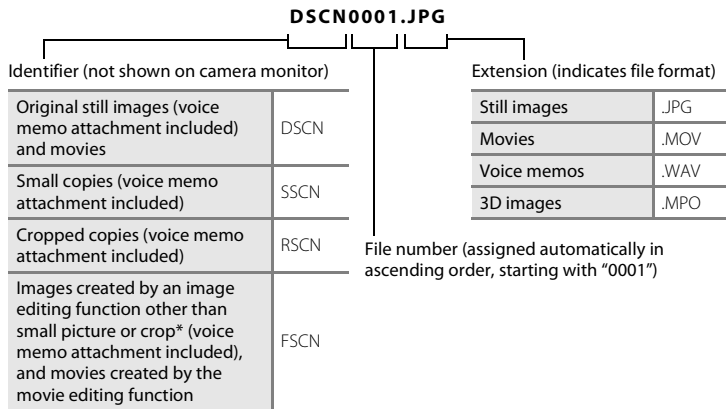

\* Including images edited using the quick effects function (📖39) in 📷 (auto) mode



- Files are saved in folders named with a folder number followed by "NIKON" (e.g. "100NIKON"). When the number of files within a folder reaches 9999, a new folder will be created. File numbers will be assigned automatically starting with "0001".
- Voice memo file names have the same identifier and file number as the image to which the voice memo is attached.
- Files copied using **Copy>Selected images** are copied to the current folder, where they are assigned new file numbers in ascending order starting from the largest file number in memory. **Copy>All images** copies all folders from the source medium; file names do not change but new folder numbers are assigned in ascending order, starting from the largest folder number on the destination medium (🔗71).



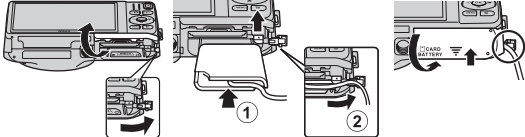

- A single folder can hold up to 200 images; if the current folder already contains 200 images, a new folder, named by adding one to the current folder name, will be created the next time an image is captured. If the current folder is numbered 999 and contains 200 images, or an image is numbered 9999, no further images can be captured until the internal memory or memory card is formatted (📷96), or a new memory card is inserted.













# Optional Accessories







Battery charger	Battery Charger MH-66 (Charging time when no charge remains: Approx. 1 h 50 min)
AC adapter	<p data-bbox="327 177 664 194">AC Adapter EH-62G (connect as shown)</p>  <p data-bbox="327 401 930 515">Be sure that the power connector cord has been properly aligned in power connector and battery chamber grooves before closing the battery-chamber/memory card slot cover. If part of the cord runs out of the grooves, the cover or cord may be damaged when the cover is closed.</p>



# Error Messages





Display	Cause/Solution	
 (flashes)	Clock not set. Set date and time.	 83
Battery exhausted.	Charge or replace battery.	14, 16
Battery temperature is elevated. The camera will turn off.	Battery temperature is high. Turn off camera, and allow battery to cool down before resuming use. After five seconds, this message will disappear, the monitor will turn off, and the power-on lamp will flash quickly. After the lamp flashes for three minutes, the camera will turn off automatically. Pressing the power switch also turns off the camera.	25
The camera will turn off to prevent overheating.	Inside of the camera has become hot. Turn off camera, and allow battery to cool down before resuming use.	–
<b>AF</b> ● (● flashes red)	Camera cannot focus. <ul style="list-style-type: none"><li>• Refocus.</li><li>• Use focus lock.</li></ul>	30, 76 77
Please wait for the camera to finish recording.	Camera cannot perform other operations until saving is complete. Wait until message clears from display automatically when saving is complete.	–
Memory card is write protected.	Write-protect switch is in "lock" position. Slide write-protect switch to "write" position.	–









Display	Cause/Solution	
Not available if Eye-Fi card is locked.	Write-protect switch of Eye-Fi card is in “lock” position. Slide the write-protect switch to “write” position.	–
	Error accessing Eye-Fi card. <ul style="list-style-type: none"> <li>• Check that terminals are clean.</li> <li>• Confirm that Eye-Fi card is correctly inserted.</li> </ul>	18
This card cannot be used.	Error accessing memory card. <ul style="list-style-type: none"> <li>• Use approved card.</li> </ul>	18,  22
This card cannot be read.	<ul style="list-style-type: none"> <li>• Check that terminals are clean.</li> <li>• Confirm that memory card is correctly inserted.</li> </ul>	
Card is not formatted. Format card? Yes No	Memory card has not been formatted for use in COOLPIX S6500. Formatting deletes all data saved on the memory card. If you need to keep copies of any images, make sure to select <b>No</b> and save the copies to a computer or other medium before formatting the memory card. Select <b>Yes</b> and press the  button to format the memory card.	 5
Out of memory.	Memory card is full. <ul style="list-style-type: none"> <li>• Select smaller image size.</li> <li>• Delete images.</li> <li>• Insert new memory card.</li> <li>• Remove memory card and use internal memory.</li> </ul>	68,  40 34, 100 18 19

Display	Cause/Solution	
	Error occurred while saving image. Format internal memory or memory card.	 96
	Camera has run out of file numbers. Insert a new memory card or format internal memory or memory card.	 96,  111
Image cannot be saved.	Image cannot be used for welcome screen. The following images cannot be registered as welcome screen. <ul style="list-style-type: none"> <li>• Images captured at an <b>Image mode</b> setting of  <b>4608x2592</b></li> <li>• Images captured using <b>Easy panorama</b> and <b>3D photography</b></li> <li>• Images reduced to 320 x 240 size or smaller with cropping or small image editing</li> </ul>	 82
	Insufficient space to save a copy. Delete images from destination.	34
Album is full. No further pictures can be added.	200 images have already been added to album. <ul style="list-style-type: none"> <li>• Remove some images from album.</li> <li>• Add to other albums.</li> </ul>	 8  6
Sound file cannot be saved.	A voice memo cannot be attached to this file. <ul style="list-style-type: none"> <li>• Voice memos cannot be attached to movies.</li> <li>• Select an image captured with this camera.</li> </ul>	–  70
A blink was detected in the picture just taken.	One or more portrait subjects may have blinked when the image was taken. Check the image in playback mode.	32,  59
Image cannot be modified.	Cannot edit selected image. <ul style="list-style-type: none"> <li>• Select images that support editing function.</li> <li>• Movies cannot be edited.</li> </ul>	 17 –
Cannot record movie.	Time out error while saving movie on the memory card. Select memory card with faster write speed.	18,  22

Display	Cause/Solution	
Memory contains no images.	No images in the internal memory or memory card. <ul style="list-style-type: none"> <li>Remove the memory card from the camera to play back images saved in the camera's internal memory.</li> <li>To copy the images saved in the camera's internal memory to the memory card, press the <b>MENU</b> button to select <b>Copy</b> in the playback menu.</li> </ul>	19  71
	No images have been added to the selected album. <ul style="list-style-type: none"> <li>Add images to the album.</li> <li>Select an album to which images are added.</li> </ul>	 6  7
	No images are contained in the category selected in auto sort mode. Select the category containing the sorted images.	 10
File contains no image data.	File not created with this camera. File cannot be viewed on this camera.	-
This file cannot be played back.	View file using a computer or the devices used to create or edit this file.	-
All images are hidden.	No images available for a slide show.	 64
This image cannot be deleted.	Image is protected. Disable protection.	 65
Travel destination is in the current time zone.	Destination in same time zone as home.	-

Display	Cause/Solution	
Unable to create panorama.	Could not shoot using easy panorama.	
Unable to create panorama. Pan the camera in one direction only.	Shooting with easy panorama may not be possible in the following situations. <ul style="list-style-type: none"> <li>• When shooting does not end after a certain amount of time.</li> <li>• When the camera is moved too fast.</li> <li>• When the camera is not moved properly in the panorama direction.</li> </ul>	 2
Unable to create panorama. Pan the camera more slowly.		
Shooting failed	When taking 3D images, the first shot could not be successfully taken. <ul style="list-style-type: none"> <li>• Try shooting again.</li> <li>• In some shooting conditions, such as when the subject is moving, dark, or low in contrast, shooting may not be possible.</li> </ul>	49
Failed to take second shot	When taking 3D images, the second shot could not be successfully taken after the first shot. <ul style="list-style-type: none"> <li>• Try shooting again. After taking the first shot, move the camera horizontally and frame the subject so that it is aligned with the guide.</li> <li>• In some shooting conditions, such as when the subject is moving, dark, or low in contrast, the second shot may not be taken.</li> </ul>	49
Failed to save 3D image	Failed to save the 3D images. <ul style="list-style-type: none"> <li>• Try shooting again.</li> <li>• Delete unnecessary images.</li> <li>• 3D images may not be created depending on the shooting conditions, such as when the subject is moving, dark, or low in contrast, and they cannot be saved.</li> </ul>	49 34 –

Display	Cause/Solution	
The memory card has been removed. Wi-Fi is now disabled.	The memory card in the camera was removed while the camera and the smart device were wirelessly connected. The wireless connection has been aborted. Insert the memory card and establish a connection again.	109
No access	Could not receive the communication signal from the smart device. Set <b>Wi-Fi network</b> to <b>On</b> in <b>Wi-Fi options</b> in the setup menu, and wirelessly connect the camera and smart device again.	109,  104
Could not connect	Failed to establish the connection while receiving the communication signals from the smart device. Select a different channel in <b>Channel</b> in <b>Wi-Fi options</b> in the setup menu and establish the wireless connection again.	109,  104
Wi-Fi connection terminated.	An HDMI, USB or audio/video cable was connected to the camera while the camera and smart device were wirelessly connected, the battery level became low, or the connection was aborted due to poor connectivity. Disconnect the cable and establish the wireless connection again.	109,  104
Lens error	Lens error. Turn camera off and then on again. If error persists, contact retailer or Nikon-authorized service representative.	24
Communications error	Error occurred during communication with printer. Turn camera off and reconnect USB cable.	 30
System error	Error has occurred in camera's internal circuitry. Turn camera off, remove and reinsert battery, and turn camera on. If error persists, contact retailer or Nikon-authorized service representative.	14, 25

Display	Cause/Solution	
Printer error: check printer status.	Printer error. Check printer. After solving the problem, select <b>Resume</b> and press the  button to resume printing.*	–
Printer error: check paper	Specified size of paper is not loaded in printer. Load the specified paper size, select <b>Resume</b> , and press the  button to resume printing.*	–
Printer error: paper jam	Paper has jammed in printer. Remove the jammed paper, select <b>Resume</b> , and press the  button to resume printing.*	–
Printer error: out of paper	No paper is loaded in printer. Load the specified paper size, select <b>Resume</b> , and press the  button to resume printing.*	–
Printer error: check ink	Ink error. Check ink, select <b>Resume</b> , and press the  button to resume printing.*	–
Printer error: out of ink	Running out of ink or ink cartridge is empty. Replace ink cartridge, select <b>Resume</b> , and press the  button to resume printing.*	–
Printer error: file corrupt	An error occurred with the image file to be printed. Select <b>Cancel</b> and press the  button to cancel printing.	–

\* See the documentation provided with your printer for further guidance and information.



# Technical Notes and Index

<b>Maximizing Camera Life and Performance .....</b>	<b>2</b>
The Camera.....	2
The Battery.....	3
Charging AC Adapter.....	4
Memory Cards.....	5
<b>Cleaning and Storage.....</b>	<b>6</b>
Cleaning.....	6
Storage.....	6
<b>Troubleshooting.....</b>	<b>7</b>
<b>Specifications.....</b>	<b>17</b>
Approved Memory Cards .....	22
Supported Standards.....	23
<b>Index.....</b>	<b>25</b>

# Maximizing Camera Life and Performance

## The Camera

To ensure continued enjoyment of this Nikon product, observe the precautions described below in addition to the warnings in “For Your Safety” (📖viii-x) when using or storing the device.

### ✔ **Do Not Drop**

The product may malfunction if subjected to strong shock or vibration.

### ✔ **Handle the Lens and All Moving Parts with Care**

Do not apply force to the lens, lens cover, monitor, memory card slot, or battery chamber. These parts are easily damaged. Applying force to the lens cover could result in camera malfunction or damage to the lens. Should the monitor break, care should be taken to avoid injury caused by broken glass and to prevent the liquid crystal from the display touching the skin or entering the eyes or mouth.

### ✔ **Keep Dry**

The device will be damaged if immersed in water or subjected to high humidity.

### ✔ **Avoid Sudden Changes in Temperature**

Sudden changes in temperature, such as when entering or leaving a heated building on a cold day, can cause condensation to form inside the device. To prevent condensation, place the device in a carrying case or a plastic bag before exposing it to sudden changes in temperature.

### ✔ **Keep away from Strong Magnetic Fields**

Do not use or store this device in the vicinity of equipment that generates strong electromagnetic radiation or magnetic fields. Strong static charge or the magnetic fields produced by equipment such as radio transmitters could interfere with the monitor, damage data saved on the memory card, or affect the product’s internal circuitry.

## **Do Not Point the Lens at Strong Light Sources for Extended Periods**

Avoid pointing the lens at the sun or other strong light sources for extended periods when using or storing the camera. Intense light may cause deterioration of the image sensor, producing a white blur effect in photographs.

## **Turn the Product off Before Removing or Disconnecting the Power Source**

Do not remove the battery while the product is on, or while images are being saved or deleted. Forcibly cutting power in these circumstances could result in loss of data or in damage to product memory or internal circuitry.

## **Notes About the Monitor**

- Monitors and electronic viewfinders are constructed with extremely high precision; at least 99.99% of pixels are effective, with no more than 0.01% being missing or defective. Hence while these displays may contain pixels that are always lit (white, red, blue, or green) or always off (black), this is not a malfunction and has no effect on images recorded with the device.
- Images in the monitor may be difficult to see under bright lighting.
- The monitor is lit by an LED backlight. Should the monitor begin to dim or flicker, contact your Nikon-authorized service representative.

## **The Battery**

Be sure to read and follow the warnings in "For Your Safety" (viii-x) before use.

- Check the battery level before using the camera and replace or charge the battery if necessary. Do not continue charging once the battery is fully charged as this will result in reduced battery performance. Whenever possible, carry a fully charged spare battery when taking images on important occasions.
- Do not use the battery at ambient temperatures below 0°C (32°F) or above 40°C (104°F).
- Charge the battery indoors with an ambient temperature of 5°C to 35°C (41°F to 95°F) before use.
- When charging the battery inserted into the COOLPIX S6500 using the Charging AC Adapter EH-70P or a computer, the battery is not charged at battery temperatures below 0°C (32°F) or above 45°C (113°F).

- Note that the battery may become hot during use; wait for the battery to cool before charging. Failure to observe these precautions could damage the battery, impair its performance, or prevent it from charging normally.
- On cold days, the capacity of batteries tends to decrease. If an exhausted battery is used at a low temperature, the camera will not turn on. Be sure that the battery is fully charged before heading outside to take images in cold weather. Keep spare batteries in a warm place and exchange as necessary. Once warmed, a cold battery may recover some of its charge.
- Dirt on the battery terminals can prevent the camera from functioning. Should the battery terminals become dirty, wipe them off with a clean, dry cloth before use.
- If the battery will not be used for some time, insert it in the camera and completely exhaust it before removing it for storage. The battery should be stored in a cool location with an ambient temperature of 15°C to 25°C (59°F to 77°F). Do not store the battery in hot or extremely cold locations.
- Always remove the battery from the camera or optional battery charger when it is not being used. When inserted, minute amounts of current are drawn from the battery even when not in use. This may result in excessive draining of the battery and complete loss of function. Turning the camera on or off while the battery is exhausted can result in reduced battery life.
- Recharge the battery at least once every six months and completely exhaust it before returning it to storage.
- After removing the battery from the camera or optional battery charger, put the battery in the included battery case and store it in a cool place.
- A marked drop in the time a fully-charged battery retains its charge, when used at room temperature, indicates that the battery needs to be replaced. Purchase a new EN-EL19 battery.
- Replace the battery when it no longer holds a charge. Used batteries are a valuable resource. Please recycle used batteries in accordance with local regulations.

## Charging AC Adapter

Be sure to read and follow the warnings in “For Your Safety” (□□viii-x) before use.

- The Charging AC Adapter EH-70P is for use only with compatible devices. Do not use with another make or model of device.
- The EH-70P is compatible with AC 100-240 V, 50/60 Hz electrical outlets. When using in other countries, use a plug adapter (commercially available) as necessary. For more information about plug adapters, consult your travel agency.

- Do not, under any circumstances, use another make or model of AC adapter other than Charging AC Adapter EH-70P or USB-AC adapter. Failure to observe this precaution could result in overheating or in damage to the camera.

## Memory Cards

- Use only Secure Digital memory cards. See “Approved Memory Cards” (🔍:22) for recommended memory cards.
- Observe the precautions noted in the documentation included with your memory card.
- Do not affix labels or stickers to the memory card.
- Do not format the memory card using a computer.
- The first time you insert a memory card that has been used in another device into this camera, be sure to format it with this camera. We recommend formatting new memory cards with this camera before using them with this camera.
- Note that **formatting a memory card permanently deletes all images and other data on the memory card**. If there is data saved on the memory card that you wish to keep, copy that data to a computer before formatting.
- If the message **Card is not formatted. Format card?** is displayed when the camera is turned on, the memory card must be formatted. If there is data on the memory card that you do not want to delete, select **No** and press the  button. Copy that data to a computer before formatting. To format the memory card, select **Yes**.
- Observe the following precautions while formatting the memory card, saving and deleting images, and copying images to a computer, otherwise data or the memory card itself may be damaged.
  - Do not open the battery-chamber/memory card slot cover or remove the memory card or battery.
  - Do not turn off the camera.
  - Do not disconnect the AC adapter.

# Cleaning and Storage

## Cleaning

Do not use alcohol, thinner, or other volatile chemicals.

Lens	Avoid touching glass parts with your fingers. Remove dust or lint with a blower (typically a small device with a rubber bulb attached to one end that is pumped to produce a stream of air out the other end). To remove fingerprints or other stains that cannot be removed with a blower, wipe the lens with a soft cloth, using a spiral motion that starts at the center of them and working toward the edges. If this fails, clean the lens using a cloth lightly dampened with commercial lens cleaner.
Monitor	Remove dust or lint with a blower. To remove fingerprints and other stains, clean the monitor with a soft, dry cloth, being careful not to apply pressure.
Body	Use a blower to remove dust, dirt, or sand, then wipe gently with a soft, dry cloth. After using the camera at the beach or other sandy or dusty environment, wipe off any sand, dust, or salt with a dry cloth lightly dampened with fresh water and dry thoroughly. <b>Note that foreign matter inside the camera could cause damage not covered by the warranty.</b>

## Storage

Turn the camera off when not in use. Be sure that the power-on lamp is off before putting the camera away. Remove the battery if the camera will not be used for an extended period. Do not store the camera with naphtha or camphor moth balls, or in any of the following locations:

- Next to equipment that produces strong electromagnetic fields, such as televisions or radios
- Exposed to temperatures below  $-10^{\circ}\text{C}$  ( $14^{\circ}\text{F}$ ) or above  $50^{\circ}\text{C}$  ( $122^{\circ}\text{F}$ )
- Places that are poorly ventilated or subject to humidity of over 60%



To prevent mold or mildew, take the camera out of storage at least once a month. Turn the camera on and release the shutter a few times before putting the camera away again.









For storing the battery, follow the precautions in “The Battery” (🔋:3) in “Maximizing Camera Life and Performance” (🔋:2).





# Troubleshooting

If the camera fails to function as expected, check the list of common problems below before consulting your retailer or Nikon-authorized service representative.







## Power, Display, Settings Issues









Problem	Cause/Solution	
The camera is on but does not respond.	Wait for recording to end. If the problem persists, turn the camera off. If the camera does not turn off, remove and reinsert the battery or batteries or, if you are using an AC adapter, disconnect and reconnect the AC adapter. Note that although any data currently being recorded will be lost, data that have already been recorded will not be affected by removing or disconnecting the power source.	25,  113
Battery inserted in the camera cannot be charged.	<ul style="list-style-type: none"><li>• Confirm all connections.</li><li>• <b>Off</b> is selected for <b>Charge by computer</b> in the setup menu.</li><li>• When charging by connecting the camera to a computer, battery charging stops if the camera is turned off.</li><li>• When charging by connecting the camera to a computer, battery charging stops if the computer is suspended (sleeping), and the camera may turn off.</li><li>• Depending upon computer specifications, settings, and status, charging the battery inserted in the camera may not be possible via computer connection.</li></ul>	16 105,  100 105  105  –
Camera cannot be turned on.	Battery is exhausted.	24









Problem	Cause/Solution	
Camera turns off without warning.	<ul style="list-style-type: none"> <li>• Battery is exhausted.</li> <li>• The camera automatically turns off to save power if no operations are performed for an extended period of time.</li> <li>• The camera or battery have become too cold and cannot operate properly.</li> <li>• The camera turns off if the Charging AC Adapter is connected while the camera is on.</li> <li>• The camera turns off if the USB cable connecting it to a computer or printer is disconnected. Reconnect the USB cable.</li> <li>• Inside of the camera has become hot. Leave the camera off until the inside of the camera has cooled, and then try turning it on again.</li> </ul>	24 104  3 16 86, 91,  30 –
Monitor is blank.	<ul style="list-style-type: none"> <li>• Camera is off.</li> <li>• Standby mode for saving power: press the power switch, the shutter-release button,  button,  button, or  (movie-record) button.</li> <li>• When flash lamp flashes, wait until flash has charged.</li> <li>• Camera and computer are connected via USB cable.</li> <li>• Camera and TV are connected via audio/video cable or HDMI cable.</li> </ul>	25 2, 25 57 86, 91 86,  26
Monitor is hard to read.	<ul style="list-style-type: none"> <li>• Adjust monitor brightness.</li> <li>• Monitor is dirty. Clean monitor.</li> </ul>	104,  86  6







Problem	Cause/Solution	
Date and time of recording are not correct.	<ul style="list-style-type: none"> <li>If camera clock has not been set, "Date not set" indicator flashes during shooting and movie recording. Images and movies saved before clock is set are dated "00/00/0000 00:00" or "01/01/2013 00:00" respectively. Set the correct time and date from the <b>Time zone and date</b> option in the setup menu.</li> <li>The camera clock is not as accurate as ordinary watches or clocks. Periodically compare the time of the camera clock with that of a more accurate timepiece and reset as required.</li> </ul>	20, 104,  83
No indicators displayed in monitor.	<b>Hide info</b> is selected for <b>Photo info</b> in <b>Monitor settings</b> in the setup menu.	104,  86
<b>Print date</b> not available.	<b>Time zone and date</b> has not been set in the setup menu.	20, 104,  83
Date not imprinted on images even when <b>Print date</b> is enabled.	<ul style="list-style-type: none"> <li>The current shooting mode is one that does not support <b>Print date</b>.</li> <li>The date cannot be imprinted on movies.</li> </ul>	104,  89
Screen for setting time zone and date is displayed when camera is turned on.	Clock battery is exhausted; all settings were restored to their default values.	20, 22
Camera settings reset.		
Monitor turns off, and the power-on lamp flashes quickly.	Battery temperature is high. Turn off camera and allow battery to cool down before resuming use. After the lamp flashes for three minutes, the camera will turn off automatically. Pressing the power switch also turns off the camera.	25
Camera becomes hot.	The camera may become hot when used for an extended period of time to shoot movies or send images using an Eye-Fi card, or when used in a hot environment; this is not a malfunction.	-

## Shooting Issues







Problem	Cause/Solution	
Cannot switch to shooting mode.	<ul style="list-style-type: none"> <li>• Disconnect HDMI cable or USB cable.</li> <li>• The camera cannot be switched to shooting mode while connected to a power outlet via the Charging AC Adapter.</li> </ul>	86, 91,  26,  30 17
No image captured when the shutter-release button is pressed.	<ul style="list-style-type: none"> <li>• When camera is in playback mode, press the  button, the shutter-release button, or the  (movie-record) button.</li> <li>• When menus are displayed, press the <b>MENU</b> button.</li> <li>• Battery is exhausted.</li> <li>• When flash lamp flashes, flash is charging.</li> </ul>	2, 32  6 24 57
Cannot take 3D images.	In some shooting conditions, such as when the subject is moving, dark, or low in contrast, the second shot may not be taken or the 3D image may not be saved.	–
Camera cannot focus.	<ul style="list-style-type: none"> <li>• Subject is too close. Try shooting using macro mode, or the <b>Scene auto selector</b> or <b>Close-up</b> scene mode.</li> <li>• The intended subject is one with which autofocus does not perform well.</li> <li>• Set <b>AF assist</b> in the setup menu to <b>Auto</b>.</li> <li>• Turn camera off and then on again.</li> </ul>	41, 44, 62  76  104,  92 25







Problem	Cause/Solution	
Images are blurred.	<ul style="list-style-type: none"> <li>• Use flash.</li> <li>• Increase the ISO sensitivity value.</li> <li>• Enable vibration reduction or motion detection.</li> <li>• Use <b>BSS</b> (Best Shot Selector).</li> <li>• Use a tripod to stabilize the camera when shooting (using the self-timer at the same time is more effective).</li> </ul>	57 68 104 45, 68,  45 60
Bright specks appear in images captured with flash.	Flash is reflecting off particles in air. Set the flash mode setting to  (off).	58
Flash does not fire.	<ul style="list-style-type: none"> <li>• The flash mode is set to  (off).</li> <li>• A scene mode with which the flash does not fire is selected.</li> <li>• <b>On</b> is selected for <b>Blink proof</b> in smart portrait menu.</li> <li>• <b>On (continuous)</b> or <b>On (BSS)</b> is selected for <b>Smile timer</b> in smart portrait menu.</li> <li>• Another function that restricts flash is enabled.</li> </ul>	57 65 69 67 70
Digital zoom cannot be used.	<ul style="list-style-type: none"> <li>• <b>Digital zoom</b> is set to <b>Off</b> in the setup menu.</li> <li>• Digital zoom cannot be used in the following situations.               <ul style="list-style-type: none"> <li>- When <b>Scene auto selector, Portrait, Night portrait, Night landscape, Backlighting</b> (when <b>HDR</b> is set to <b>On</b>), <b>Easy panorama, Pet portrait</b>, or <b>3D photography</b> is selected in scene mode</li> <li>- When smart portrait mode is selected</li> <li>- When <b>Continuous</b> in the shooting menu is set to <b>Multi-shot 16</b></li> <li>- When <b>AF area mode</b> (51) in the shooting menu is set to <b>Subject tracking</b></li> </ul> </li> </ul>	104,  93 40 53 68,  45 67,  51





Problem	Cause/Solution	
<b>Image mode</b> not available.	Another function that restricts the <b>Image mode</b> option is enabled.	70
No sound when shutter is released.	<b>Off</b> is selected for <b>Sound settings &gt; Shutter sound</b> in setup menu. No sound is produced with some shooting modes and settings, even when <b>On</b> is selected.	104,  94
AF-assist illuminator does not light.	<b>Off</b> is selected for the <b>AF assist</b> option in the setup menu. AF-assist illuminator may not light depending on the position of the focus area or the current scene mode, even when <b>Auto</b> is selected.	104,  92
Images appear smeared.	Lens is dirty. Clean lens.	 6
Colors are unnatural.	White balance or hue is not adjusted properly.	45, 68,  42
Randomly spaced bright pixels ("noise") appear in image.	The subject is dark, so shutter speed is too slow or ISO sensitivity is too high. Noise can be reduced by: <ul style="list-style-type: none"> <li>Using flash.</li> <li>Specifying a lower ISO sensitivity setting.</li> </ul>	57 68,  49
Images are too dark (underexposed).	<ul style="list-style-type: none"> <li>The flash mode is set to  (off).</li> <li>Flash window is blocked.</li> <li>Subject is beyond flash range.</li> <li>Adjust exposure compensation.</li> <li>Increase ISO sensitivity.</li> <li>Subject is backlit. Select <b>Backlighting</b> scene mode or set the flash mode setting to  (fill flash).</li> </ul>	57 28 57 64 68,  49 46, 57
Images are too bright (overexposed).	Adjust exposure compensation.	64

Problem	Cause/Solution	
Unexpected results when flash set to  (auto with red-eye reduction).	When taking images with  (auto with red-eye reduction) or fill flash with slow sync and red-eye reduction in <b>Night portrait</b> scene mode, In-Camera Red Eye Fix may be applied to areas not affected by red-eye in rare cases. Use any scene mode other than <b>Night portrait</b> , and change the flash mode to any setting other than  (auto with red-eye reduction) and try taking an image again.	42, 57
Skin tones are not softened.	<ul style="list-style-type: none"> <li>• In some shooting conditions, facial skin tones may not be softened.</li> <li>• For images containing four or more faces, try using the <b>Skin softening</b> effect in <b>Glamour retouch</b> in the playback menu.</li> </ul>	53 84,  21
Saving images takes time.	<p>It may take more time to save images in the following situations.</p> <ul style="list-style-type: none"> <li>• When the noise reduction function is in operation, such as when shooting in a dark environment.</li> <li>• When the flash mode is set to  (auto with red-eye reduction).</li> <li>• When shooting in <b>Night landscape</b>, <b>Night portrait</b>, or <b>Backlighting</b> (when <b>HDR</b> is set to <b>On</b>) scene mode</li> <li>• When the skin softening function is applied while shooting.</li> <li>• When using continuous shooting mode</li> </ul>	– 59 42, 44, 46 41, 42, 69 68,  45
A ring-shaped belt or rainbow-colored stripe appears in the monitor or images.	When shooting with backlighting or when a very strong light source (such as sunlight) is in the frame, a ring-shaped belt or rainbow-colored stripe (ghosting) may occur. Change the position of the light source, or frame the image so that the light source does not enter the frame and try again.	–

## Playback Issues

Problem	Cause/Solution	
File cannot be played back.	<ul style="list-style-type: none"> <li>File or folder was overwritten or renamed by computer or other make of camera.</li> <li>The COOLPIX S6500 is not able to play back movies recorded with another make or model of digital camera.</li> </ul>	– 101
Cannot zoom in on image.	<ul style="list-style-type: none"> <li>Playback zoom cannot be used with movies, small pictures, or images that have been cropped to a size of 320 × 240 or smaller.</li> <li>3D images cannot be enlarged when the camera is connected via HDMI and they are played back in 3D.</li> <li>The COOLPIX S6500 may not be able to zoom in on images captured with another make or model of digital camera.</li> </ul>	– 49 –
Cannot record voice memos.	<ul style="list-style-type: none"> <li>Voice memos cannot be attached to movies.</li> <li>Voice memos cannot be attached to images captured with other cameras. Voice memos attached to images using another camera cannot be played back on this camera.</li> </ul>	– 84,  69
Cannot use quick retouch, D-Lighting, glamour retouch, small picture, or crop.	<ul style="list-style-type: none"> <li>Editing functions used for still images are not available for movies.</li> <li>Confirm the conditions that are required for editing images.</li> <li>Camera is unable to edit images captured with other cameras.</li> </ul>	– 84,  16,  17 84,  16,  17
Cannot rotate image.	The COOLPIX S6500 cannot rotate images captured with another make or model of digital camera, or ones captured with <b>3D photography</b> .	–

Problem	Cause/Solution	
<p>Images are not displayed on TV.</p>	<ul style="list-style-type: none"> <li>• <b>Video mode</b> or <b>HDMI</b> is not correctly set in the <b>TV settings</b> setup menu.</li> <li>• Cables are connected to the HDMI micro connector (Type D) and to the USB/audio/video output connector simultaneously.</li> <li>• Memory card contains no images. Replace the memory card. Remove the memory card to play back images from the internal memory.</li> </ul>	<p>105, 99</p> <p>86, 91, 26, 30 19</p>
<p>Album icons are reset to their default icons, images added to albums cannot be displayed in favorite pictures mode.</p>	<p>Data saved in the internal memory or on the memory card may not be played back correctly if overwritten by a computer.</p>	<p>–</p>
<p>The saved images are not displayed in auto sort mode.</p>	<ul style="list-style-type: none"> <li>• The desired image was sorted into a category other than the category currently displayed.</li> <li>• Images saved by a camera other than the COOLPIX S6500 and images copied using the <b>Copy</b> option cannot be displayed in auto sort mode.</li> <li>• Images saved in the internal memory or on the memory card may not be played back correctly if overwritten by a computer.</li> <li>• Up to 999 images and movies in total can be added to each category. If the desired category already contains 999 images or movies in total, new images or movies cannot be added.</li> </ul>	<p>82, 10</p> <p>82, 10</p> <p>–</p> <p>82, 10</p>

Problem	Cause/Solution	
Nikon Transfer 2 does not start when camera is connected to a computer.	<ul style="list-style-type: none"> <li>• Camera is off.</li> <li>• Battery is exhausted.</li> <li>• USB cable is not correctly connected.</li> <li>• Camera is not recognized by the computer.</li> <li>• Confirm system requirements.</li> <li>• Computer is not set to start Nikon Transfer 2 automatically. For more information about Nikon Transfer 2, refer to help information contained in ViewNX 2.</li> </ul>	25 24 86, 91 – 88 93
The PictBridge startup screen is not displayed when the camera is connected to a printer.	With some PictBridge-compatible printers, the PictBridge startup screen may not be displayed and it may be impossible to print images when <b>Auto</b> is selected for the <b>Charge by computer</b> option in the setup menu. Set the <b>Charge by computer</b> option to <b>Off</b> and reconnect the camera to the printer.	105,  100
Images to be printed are not displayed.	<ul style="list-style-type: none"> <li>• Memory card contains no images. Replace the memory card.</li> <li>• Remove the memory card to print images from the internal memory.</li> <li>• Images captured using <b>3D photography</b> cannot be printed.</li> </ul>	18 19 49
Cannot select paper size with camera.	Paper size cannot be selected from the camera in the following situations, even when printing from a PictBridge-compatible printer. Use the printer to select paper size. <ul style="list-style-type: none"> <li>• The printer does not support the paper sizes specified by the camera.</li> <li>• The printer automatically selects the paper size.</li> </ul>	86,  33,  34 –

# Specifications

## Nikon COOLPIX S6500 Digital Camera

Type	Compact digital camera
Number of effective pixels	16.0 million
Image sensor	<sup>1</sup> /2.3-in. type CMOS; approx. 16.79 million total pixels
Lens	NIKKOR lens with 12× optical zoom
Focal length	4.5-54.0 mm (angle of view equivalent to that of 25-300 mm lens in 35 mm [135] format)
f/-number	f/3.1-6.5
Construction	8 elements in 8 groups (1 ED lens element)
Digital zoom magnification	Up to 4× (angle of view equivalent to that of approx. 1200 mm lens in 35mm [135] format)
Vibration reduction	Lens shift
Motion blur reduction	Motion detection (still pictures)
Autofocus (AF)	Contrast-detect AF
Focus range	<ul style="list-style-type: none"><li>• [W]: Approx. 50 cm (1 ft 8 in.)–∞,</li><li>  [T]: Approx. 1.5 m (5 ft)–∞</li><li>• Macro mode: Approx. 8 cm (3.2 in.)–∞ (wide-angle position) (All distances measured from center of front surface of lens)</li></ul>
Focus-area selection	Face priority, manual with 99 focus areas, center, subject tracking, target finding AF
Monitor	7.5 cm (3-in.), approx. 460k-dot, TFT LCD with anti-reflection coating and 5-level brightness adjustment
Frame coverage (shooting mode)	Approx. 99% horizontal and 99% vertical (compared to actual picture)
Frame coverage (playback mode)	Approx. 99% horizontal and 99% vertical (compared to actual picture)

<b>Storage</b>		
Media	Internal memory (approx. 25 MB), SD/SDHC/SDXC memory card	
File system	DCF, Exif 2.3, DPOF, and MPF compliant	
File formats	Still pictures: JPEG 3D images: MPO Sound files (Voice Memo): WAV Movies: MOV (Video: H.264/MPEG-4 AVC, Audio: AAC stereo)	
Image size (pixels)	<ul style="list-style-type: none"> <li>• 16M (High) [4608 × 3456★]</li> <li>• 16M [4608 × 3456]</li> <li>• 8M [3264 × 2448]</li> <li>• 4M [2272 × 1704]</li> <li>• 2M [1600 × 1200]</li> <li>• VGA [640 × 480]</li> <li>• 16:9 [4608 × 2592]</li> </ul>	
ISO sensitivity (Standard output sensitivity)	<ul style="list-style-type: none"> <li>• ISO 125-1600</li> <li>• ISO 3200 (available when using Auto mode)</li> </ul>	
<b>Exposure</b>		
Metering mode	Matrix, center-weighted (digital zoom less than 2×), spot (digital zoom 2× or more)	
Exposure control	Programmed auto exposure and exposure compensation (-2.0 – +2.0 EV in steps of $\frac{1}{3}$ EV)	
<b>Shutter</b>		Mechanical and CMOS electronic shutter
Speed	<ul style="list-style-type: none"> <li>• <math>\frac{1}{2000}</math>-1 s</li> <li>• <math>\frac{1}{4000}</math> s (maximum speed during high-speed continuous shooting)</li> <li>• 4 s (<b>Fireworks show</b> scene mode)</li> </ul>	
<b>Aperture</b>		Electronically-controlled ND filter (-2 AV) selection
Range	2 steps (f/3.1 and f/6.2 [W])	
Self-timer	Can be selected from 10 s and 2 s	

<b>Flash</b>	
Range (approx.) (ISO sensitivity: Auto)	[W]: 0.5–4.0 m (1 ft 8 in.–13 ft) [T]: 1.5–2.0 m (5 ft–6 ft 6 in.)
Flash control	TTL auto flash with monitor preflashes
<b>Interface</b>	
Data transfer protocol	MTP, PTP
Video output	Can be selected from NTSC and PAL
HDMI output	Can be selected from Auto, 480p, 720p, and 1080i
I/O terminal	Audio/video (A/V) output; digital I/O (USB) HDMI micro connector (Type D) (HDMI output)
Supported languages	Arabic, Bengali, Chinese (Simplified and Traditional), Czech, Danish, Dutch, English, Finnish, French, German, Greek, Hindi, Hungarian, Indonesian, Italian, Japanese, Korean, Marathi, Norwegian, Persian, Polish, Portuguese (European and Brazilian), Romanian, Russian, Spanish, Swedish, Tamil, Telugu, Thai, Turkish, Ukrainian, Vietnamese
Power sources	One Rechargeable Li-ion Battery EN-EL19 (included) AC Adapter EH-62G (available separately)
Charging time	Approx. 3 h (when using Charging AC Adapter EH-70P and when no charge remains)
<b>Battery life<sup>1</sup></b>	
Still pictures	Approx. 150 shots when using EN-EL19
Movies (actual battery life for recording) <sup>2</sup>	Approx. 25 min when using EN-EL19
Tripod socket	1/4 (ISO 1222)
Dimensions (W × H × D)	Approx. 95.4 × 58.3 × 26.3 mm (3.8 × 2.3 × 1.1 in.) (excluding projections)
Weight	Approx. 153 g (5.4 oz) (including battery and SD memory card)

<b>Operating environment</b>	
Temperature	0°C–40°C (32°F–104°F)
Humidity	85% or less (no condensation)
<b>Wi-Fi (Wireless LAN)</b>	
Standards	IEEE 802.11b/g/n (standard wireless LAN protocol)
Communications protocols	IEEE 802.11b: DBPSK/DQPSK/CCK IEEE 802.11g: OFDM IEEE 802.11n: OFDM
Range (line of sight)	Approx. 10 m (11 yd)
Operating frequency	2412–2462 MHz (1–11 channels)
Data rates (actual measured values)	IEEE 802.11b: 5 Mbps IEEE 802.11g: 20 Mbps IEEE 802.11n: 20 Mbps
Security	WPA2
Access protocols	Infrastructure

- Unless otherwise stated, all figures assume a fully-charged battery and an ambient temperature of 23 ±3°C (73.4 ±5.4°F) as specified by the Camera and Imaging Products Association (CIPA).
- <sup>1</sup> Figures based on the Camera and Imaging Products Association (CIPA) standards for measuring the endurance of camera batteries. Performance for still pictures measured under the following test conditions: **16m 4608x3456** selected for **Image mode**, zoom adjusted with each shot, and flash fired with every other shot. Movie recording time assumes that **1080 60p 1080★/30p** is selected for **Movie options**. Figures may vary with use, the interval between shots, and the length of time menus and images are displayed.
- <sup>2</sup> Individual movie files cannot exceed 4 GB in size or 29 minutes in length. Recording may end before this limit is reached if camera temperature becomes elevated.

## Rechargeable Li-ion Battery EN-EL19

Type	Rechargeable lithium-ion battery
Rated capacity	DC 3.7 V, 700 mAh
Operating temperature	0°C–40°C (32°F–104°F)
Dimensions (W × H × D)	Approx. 31.5 × 39.5 × 6 mm (1.3 × 1.6 × 0.3 in.) (excluding projections)
Weight	Approx. 14.5 g (0.5 oz) (excluding battery case)

## Charging AC Adapter EH-70P

Rated input	AC 100–240 V, 50/60 Hz, 0.07–0.044 A
Rated output	DC 5.0 V, 550 mA
Operating temperature	0°C–40°C (32°F–104°F)
Dimensions (W × H × D)	Approx. 55 × 22 × 54 mm (2.2 × 0.9 × 2.2 in.) (excluding plug adapter) For Argentina: Approx. 55 × 59 × 63 mm (2.2 × 2.4 × 2.5 in.) For Korea: Approx. 55 × 59 × 66.5 mm (2.2 × 2.4 × 2.7 in.)
Weight	Approx. 47 g (1.7 oz) (excluding plug adapter) For Argentina and Korea: Approx. 72 g (2.6 oz)

### Specifications

- Nikon will not be held liable for any errors this manual may contain.
- The appearance of this product and its specifications are subject to change without notice.

## Approved Memory Cards

The following Secure Digital (SD) memory cards have been tested and approved for use in this camera.

- Memory cards with an SD Speed Class rating of 6 or faster are recommended for recording movies. When using a memory card with a lower Speed Class rating, movie recording may stop unexpectedly.

	SD memory card	SDHC memory card <sup>2</sup>	SDXC memory card <sup>3</sup>
SanDisk	2 GB <sup>1</sup>	4 GB, 8 GB, 16 GB, 32 GB	64 GB, 128 GB
TOSHIBA	2 GB <sup>1</sup>	4 GB, 8 GB, 16 GB, 32 GB	64 GB
Panasonic	2 GB <sup>1</sup>	4 GB, 8 GB, 16 GB, 32 GB	64 GB
Lexar	–	4 GB, 8 GB, 16 GB, 32 GB	64 GB, 128 GB

<sup>1</sup> If the memory card will be used with a card reader or similar device, make sure that the device supports 2 GB cards.

<sup>2</sup> SDHC compliant.

If the memory card will be used with a card reader or similar device, make sure that the device supports SDHC.



<sup>3</sup> SDXC compliant.

If the memory card will be used with a card reader or similar device, make sure that the device supports SDXC.



- Contact the manufacturer for details on the above cards. We cannot guarantee camera performance when using memory cards made by other manufacturers.

## Supported Standards

- **DCF:** Design Rule for Camera File System is a standard widely used in the digital camera industry to ensure compatibility among different makes of camera.
- **DPOF:** Digital Print Order Format is an industry-wide standard that allows images to be printed from print orders saved on memory cards.
- **Exif version 2.3:** Exchangeable image file format (Exif) version 2.3 for digital still cameras is a standard that allows information saved with photographs to be used for optimal color reproduction when images are output from Exif-compliant printers.
- **PictBridge:** A standard developed cooperatively by the digital camera and printer industries, allowing photographs to be output directly to a printer without connecting the camera to a computer.

### AVC Patent Portfolio License

This product is licensed under the AVC Patent Portfolio License for the personal and non-commercial use of a consumer to (i) encode video in compliance with the AVC standard ("AVC video") and/or (ii) decode AVC video that was encoded by a consumer engaged in a personal and non-commercial activity and/or was obtained from a video provider licensed to provide AVC video. No license is granted or shall be implied for any other use. Additional information may be obtained from MPEG LA, L.L.C.

See <http://www.mpegla.com>.

## Trademark Information

- Microsoft, Windows and Windows Vista are either registered trademarks or trademarks of Microsoft Corporation in the United States and/or other countries.
- Macintosh, Mac OS, and QuickTime are trademarks of Apple Inc., registered in the U.S. and other countries. The iFrame logo and the iFrame symbol are trademarks of Apple Inc.
- Adobe and Acrobat are registered trademarks of Adobe Systems Inc.
- SDXC, SDHC and SD Logos are trademarks of SD-3C, LLC.
- PictBridge is a trademark.
- HDMI, HDMI logo and High-Definition Multimedia Interface are trademarks or registered trademarks of HDMI Licensing LLC.

## HDMI

- Wi-Fi and the Wi-Fi logo are trademarks or registered trademarks of the Wi-Fi Alliance.
- Android and Google Play are trademarks or registered trademarks of Google, Inc.
- All other trade names mentioned in this manual or the other documentation provided with your Nikon product are trademarks or registered trademarks of their respective holders.

## FreeType License (FreeType2)

- Portions of this software are copyright (c) 2013 The FreeType Project ("[www.freetype.org](http://www.freetype.org)"). All rights reserved.

## MIT License (Harfbuzz)

- Portions of this software are copyright (c) 2013 The Harfbuzz Project ("<http://www.freedesktop.org/wiki/Software/HarfBuzz>"). All rights reserved.





















# Index

## Symbols















Auto mode.....	26, 38
Scene mode.....	40
<b>SO</b> Special effects mode.....	51
Smart portrait mode.....	53
Playback mode.....	32, 82
Favorite pictures mode.....	82,
Auto sort mode.....	82,
List by date mode.....	82,
Setup menu.....	104
<b>T</b> (Telephoto).....	29
<b>W</b> (Wide-angle).....	29
Playback zoom.....	80
Thumbnail display.....	81
Help.....	41
Shooting mode button.....	5, 26
Playback button.....	5, 32
(movie-record) button.....	5, 96
<b>MENU</b> button.....	6, 67, 84, 99, 104
Delete button.....	34,
Flash mode.....	57
Self-timer.....	60
Macro mode.....	62
Exposure compensation.....	64
<b>AE/AF-L</b> .....	49

## Numerics









3D photography <b>3D</b> .....	49
3D pictures.....	49
<b>A</b>	
AC adapter.....	25,
AF area mode.....	68,
AF assist.....	3, 104,
Album.....	
Aperture value.....	31
Audio/video cable.....	87,
Audio/video-in jack.....	87,
Auto flash.....	58
Auto mode.....	26, 38
Auto off.....	25, 104,
Auto sort menu.....	84,
Auto sort mode.....	82,
Autofocus	
.....	63, 69, 99,
.....	
Autofocus mode	
.....	69, 99,
.....	
<b>B</b>	
Backlighting .....	46
Battery.....	14, 16, 22
Battery chamber.....	5
Battery charger.....	17,
Battery latch.....	14

Battery level indicator.....	24
Battery-chamber/memory card slot cover .....	5, 14, 18
Beach 	43
Best Shot Selector.....	45, 
Black and white copy 	46
Black-and-white .....	68, 
Blink proof.....	69, 
Blink warning.....	105, 
Brightness .....	104, 
BSS.....	45, 
Button sound.....	
<b>C</b>	
Charge by computer .....	105, 
Charge lamp.....	5, 17
Charger.....	16, 
Charging AC Adapter .....	16
Choose key picture ...	85,  , 13, 
Close-up 	44
Color options .....	68, 
Compression ratio .....	
Computer.....	87, 91
Connector cover.....	3
Continuous .....	68, 
Copying images.....	84, 
Crop.....	
Cross process 	51
Cyanotype .....	68, 

**D**

Date .....	20, 104, 
Date and time .....	20, 104, 
Date format.....	21, 
Daylight.....	
Daylight saving time.....	21, 22, 
Delete.....	34,  , 
Digital zoom .....	104, 
Direct print .....	87, 
D-Lighting.....	84, 
DPOF .....	
DPOF print.....	
DSCN.....	
Dusk/dawn 	43

**E**

Easy panorama 	47, 
Easy panorama playback.....	47, 
EH-70P.....	16
EN-EL19.....	14, 16
Exposure compensation.....	64
Extension.....	
Eye-Fi upload.....	105, 
Eyelet for camera strap.....	3
<b>E</b>	
Face detection .....	73
Face priority.....	68, 
Favorite pictures .....	85, 
Favorite pictures menu .....	84, 

Favorite pictures mode.....	82,	HDMI cable.....		26									
File name.....		111	HDMI device control.....		99								
Fill flash.....	58	HDMI micro connector.....	3	HDR.....	46								
Fireworks show	45	Help.....	41	High key	51								
Firmware version.....	105,	110	High-contrast monochrome	51	High-speed continuous.....	68,	45						
Fixed range auto.....		49	HS movie.....	99,	75,	77							
Flash.....	3, 57	I	Identifier.....		111	Image copy.....		71					
Flash lamp.....	5, 57	Image mode.....	68,	40	Image review.....	104,	86						
Flash mode.....	57, 58	Image size.....	68,	40	Imprinting date and time.....		88						
Flash off.....	58	Internal memory.....	19	Internal memory indicator	9, 11, 24, 32, 96	ISO sensitivity.....	68,	49					
Focus.....	30, 68,	51	J	JPG.....		111	L	Landscape	42				
Focus area.....	30	Image review.....	104,	86	Language.....	105,	98	Lens.....	3,	17			
Focus indicator.....	9	Image size.....	68,	40	Imprinting date and time.....		88	Lens cover.....	3	List by date menu.....	84,	12	
Focus lock.....	77	Internal memory.....	19	Internal memory indicator	9, 11, 24, 32, 96	ISO sensitivity.....	68,	49	J	JPG.....		111	
Folder name.....		111	ISO sensitivity.....	68,	49	J	JPG.....		111	L	Landscape	42	
Food	45	Format internal memory.....	105,	96	Format memory cards	19, 105,	96	Formatting.....	19, 105,	96	FSCN.....		111
Format internal memory.....	105,	96	Format memory cards	19, 105,	96	Formatting.....	19, 105,	96	FSCN.....		111	Full-frame playback.....	32
Format memory cards	19, 105,	96	Formatting.....	19, 105,	96	FSCN.....		111	Full-time AF.....	69, 99,	55,	80	
Formatting.....	19, 105,	96	FSCN.....		111	Full-frame playback.....	32	Full-time AF.....	69, 99,	55,	80		
FSCN.....		111	Full-frame playback.....	32	Full-time AF.....	69, 99,	55,	80					
Full-frame playback.....	32	G	Glamour retouch.....	84,	21								
Full-time AF.....	69, 99,	55,	80										
H	HDMI.....		99	HDMI 3D output.....		99							

List by date mode.....	82,
Low key	51
<b>M</b>	
Macro mode.....	62
Memory capacity.....	24
Memory card.....	18
Memory card slot.....	18
Microphone.....	3
Monitor.....	5, 8,
Monitor settings.....	104,
Motion detection.....	104,
MOV.....	
Movie editing.....	101,
Movie length.....	96,
Movie menu.....	99,
Movie options.....	99,
Movie playback.....	100
Movie recording.....	96,
MPO.....	
Multi selector.....	5, 6
Multi-shot 16.....	
Museum	45
<b>N</b>	
Night landscape	44
Night portrait	42
Nikon Transfer 2.....	90, 92
Nostalgic sepia <b>SE</b> .....	51

Number of exposures remaining.....	24,
<b>O</b>	
Open with HS footage.....	99,
Optical zoom.....	29
Optional accessories.....	
<b>P</b>	
Painting	51
Panorama Maker.....	90
Paper size.....	
Party/indoor	43
Pet portrait auto release.....	48
Pet portrait	48
Photo info.....	104,
PictBridge.....	87,
Playback.....	32, 100,
Playback menu.....	84,
Playback mode.....	32, 82
Playback zoom.....	80
Pop <b>POP</b> .....	51
Portrait	41
Power.....	24, 25
Power switch.....	3, 24, 25
Power-on lamp.....	3, 24, 25
Preset manual.....	
Pre-shooting cache.....	68,
Pressing halfway.....	31

Print .....	84,	32,	34,	60
Print date.....	22, 104,	88		
Print order.....	84,	60		
Print order date option .....	22,	61,	63	
Printer.....	87,	29		
Protect.....	84,	65		

## Q

Quick effects.....	33, 39,	18,	56	
Quick retouch.....	84,	20		

## R

Rechargeable Li-ion battery.....	14, 16			
Recording movies.....	96,	74		
Recording slow motion movies .....	99,	75,	77	
Red-eye reduction.....	58			
Remove from favorites .....	85,	8		
Reset all .....	105,	107		
Rotate image .....	84,	68		
RSCN.....	111			

## S

Scene auto selector	41			
Scene mode .....	40, 41			
Selective color	51			
Self-timer.....	60			
Self-timer lamp .....	3, 61			
Sepia.....	68,	50		

Sequence display options .....	85,	13,	73	
Setup menu.....	104			
Shooting.....	26, 28, 30			
Shooting menu .....	68,	40		
Shooting mode.....	26			
Shutter sound.....	94			
Shutter speed.....	31			
Shutter-release button .....	3, 30			
Single.....	68,	45		
Single AF.....	69, 99,	55,	80	
Skin softening.....	55, 69,	57		
Slide show .....	84,	64		
Slow sync .....	58			
Small picture .....	84,	23		
Smart portrait menu.....	67,	57		
Smart portrait mode.....	53			
Smile timer .....	69,	58		
Snow	43			
Soft <b>SO</b> .....	51			
Sound settings.....	104,	94		
Speaker.....	3			
Special effects mode.....	51			
Sports	42			
SSCN.....	111			
Standard color.....	68,	50		
Strap.....	5			
Subject tracking .....	68,	54		

Sunset  43

Super vivid VI ..... 51

## I

Target finding AF..... 68, 75, 53

Time difference ..... 104, 83

Time zone ..... 22, 83

Toy camera effect 1 1 ..... 51

Toy camera effect 2 2 ..... 51



Tripod socket ..... 5, 19

TV ..... 87, 26

TV settings ..... 105, 99

## U

USB cable ..... 86, 91, 30

USB/audio/video output connector  
..... 86, 91, 26, 29

## V

Vibration reduction..... 104, 90

Video mode ..... 99

ViewNX 2 ..... 88

Vivid color ..... 68, 50

Voice memo ..... 84, 69

Volume ..... 101, 69

## W

WAV ..... 111

Welcome screen ..... 104, 82

White balance ..... 68, 42

Wi-Fi options..... 105, 107, 104

Wind noise reduction..... 99, 81

Wireless LAN..... 105, 107, 104

## Z

Zoom ..... 29

Zoom control..... 3, 29

Zoom in..... 29

Zoom out ..... 29



No reproduction in any form of this manual, in whole or in part (except for brief quotation in critical articles or reviews), may be made without written authorization from NIKON CORPORATION.

**NIKON CORPORATION**

© 2013 Nikon Corporation



YP2L03(11)  
6MN09511-03