

NOKIA
Nseries

Nokia N79

© 2008 Nokia. All rights reserved.

DECLARATION OF CONFORMITY

CE 0434 

Hereby, NOKIA CORPORATION declares that this RM-348 product is in compliance with the essential requirements and other relevant provisions of Directive 1999/5/EC. A copy of the Declaration of Conformity can be found at http://www.nokia.com/phones/declaration_of_conformity/.

Nokia, Nokia Connecting People, Nseries, N79, N-Gage, Navi and Visual Radio are trademarks or registered trademarks of Nokia Corporation. Nokia tune is a sound mark of Nokia Corporation. Other product and company names mentioned herein may be trademarks or tradenames of their respective owners.

Reproduction, transfer, distribution, or storage of part or all of the contents in this document in any form without the prior written permission of Nokia is prohibited.

This software is based in part of the work of the FreeType Team. This product is covered by one or more of the following patents: United States Patent 5,155,805, United States Patent 5,325,479, United States Patent 5,159,668, United States Patent 2232861 and France Patent 9005712.

US Patent No 5818437 and other pending patents. T9 text input software Copyright © 1997-2008. Tegic Communications, Inc. All rights reserved.

symbian

This product includes software licensed from Symbian Software Ltd ©1998-2008. Symbian and Symbian OS are trademarks of Symbian Ltd.



Java
POWERED

Java and all Java-based marks are trademarks or registered trademarks of Sun Microsystems, Inc.

Portions of the Nokia Maps software are ©1996-2008 The FreeType Project. All rights reserved.

This product is licensed under the MPEG-4 Visual Patent Portfolio License (i) for personal and noncommercial use in connection with information which has been encoded in compliance with the MPEG-4 Visual Standard by a consumer engaged in a personal and noncommercial activity and (ii) for use in connection with MPEG-4 video provided by a licensed video provider. No license is granted or shall be implied for any other use. Additional information, including that related to promotional, internal, and commercial uses, may be obtained from MPEG LA, LLC. See <http://www.mpegla.com>

Nokia operates a policy of ongoing development. Nokia reserves the right to make changes and improvements to any of the products described in this document without prior notice.

TO THE MAXIMUM EXTENT PERMITTED BY APPLICABLE LAW, UNDER NO CIRCUMSTANCES SHALL NOKIA OR ANY OF ITS LICENSORS BE RESPONSIBLE FOR ANY LOSS OF DATA OR INCOME OR ANY SPECIAL, INCIDENTAL, CONSEQUENTIAL OR INDIRECT DAMAGES HOWSOEVER CAUSED.

THE CONTENTS OF THIS DOCUMENT ARE PROVIDED "AS IS". EXCEPT AS REQUIRED BY APPLICABLE LAW, NO WARRANTIES OF ANY KIND, EITHER EXPRESS OR IMPLIED, INCLUDING, BUT NOT LIMITED TO, THE IMPLIED WARRANTIES OF MERCHANTABILITY AND FITNESS FOR A PARTICULAR PURPOSE, ARE MADE IN RELATION

TO THE ACCURACY, RELIABILITY OR CONTENTS OF THIS DOCUMENT. NOKIA RESERVES THE RIGHT TO REVISE THIS DOCUMENT OR WITHDRAW IT AT ANY TIME WITHOUT PRIOR NOTICE.

Reverse engineering of any software in the Nokia device is prohibited to the extent permitted by applicable law. Insofar as this user guide contains any limitations on Nokia's representations, warranties, damages and liabilities, such limitations shall likewise limit any representations, warranties, damages and liabilities of Nokia's licensors.

The availability of particular products and applications and services for these products may vary by region. Please check with your Nokia dealer for details, and availability of language options.

Export controls

This device may contain commodities, technology or software subject to export laws and regulations from the US and other countries. Diversion contrary to law is prohibited.

FCC/INDUSTRY CANADA NOTICE

Your device may cause TV or radio interference (for example, when using a telephone in close proximity to receiving equipment). The FCC or Industry Canada can require you to stop using your telephone if such interference cannot be eliminated. If you require assistance, contact your local service facility. This device complies with part 15 of the FCC rules. Operation is subject to the following two conditions: (1) This device may not cause harmful interference, and (2) this device must accept any interference received, including interference that may cause undesired operation. Any changes or modifications not expressly approved by Nokia could void the user's authority to operate this equipment.

/Issue 1

Contents

Safety	11	Transfer content.....	24
About your device.....	11	Synchronise, retrieve, or send content.....	25
Network services.....	12	Display indicators.....	26
Get started	14	Shortcuts.....	27
Keys and parts (front).....	14	Lock the keypad.....	28
Keys and parts (back and sides).....	15	Navi™ wheel.....	28
Insert SIM card and battery.....	15	Multimedia menu.....	29
Switch the device on.....	16	Mobile Search.....	29
Charge the battery.....	17	Headset.....	30
Attach wrist strap.....	17	Volume and loudspeaker control.....	31
Antenna locations.....	17	Offline profile.....	31
Get connected	18	Fast downloading.....	32
Find help	19	Web browser	33
Instructions inside - In-device help.....	19	Browse the web.....	33
Get started.....	19	Browser toolbar.....	34
Nokia support and contact information.....	19	Navigate pages.....	35
Additional applications.....	19	Web feeds and blogs.....	35
Software updates.....	20	Widgets.....	35
Application Update.....	20	Content search.....	36
Settings.....	21	Download and purchase items.....	36
Access codes.....	21	Bookmarks.....	36
Prolong battery life.....	22	Empty the cache.....	37
Free memory.....	23	End the connection.....	37
Your device	24	Connection security.....	38
Welcome.....	24	Web settings.....	38
Nokia Switch.....	24	Connections	40
		Wireless LAN.....	40
		About WLAN.....	40

WLAN connections.....	40	Landmarks.....	54
WLAN wizard.....	41	GPS data.....	55
WLAN internet access points.....	41	Route guidance.....	55
Operating modes.....	42	Retrieve position information.....	56
Connection manager.....	42	Trip meter.....	56
Active data connections.....	42	Maps.....	57
Available WLAN networks.....	42	About Maps.....	57
Bluetooth connectivity.....	43	Browse maps.....	58
About Bluetooth connectivity.....	43	Download maps.....	59
Settings.....	43	Find a place.....	60
Security tips.....	44	Extra services for Maps.....	61
Send data using Bluetooth connectivity.....	44	Navigation.....	61
Pair devices.....	45	Traffic information.....	63
Receive data using Bluetooth connectivity.....	45	Guides.....	63
Block devices.....	46	Music folder.....	64
Remote SIM mode.....	46	Music player.....	64
USB.....	46	Play a song or a podcast episode.....	64
PC connections.....	47	Music menu.....	65
Personalise your device.....	48	Playlists.....	65
Change the look of your device.....	48	Podcasts.....	66
Changeable back cover.....	48	Home network with music player.....	66
Audio themes.....	49	Transfer music to your device.....	67
Set tones in Profiles.....	49	Transfer music from PC.....	67
3-D tones.....	50	Transfer with Windows Media Player.....	67
Modify the standby mode.....	51	Nokia Music Store.....	68
Modify the main menu.....	51	FM transmitter.....	69
Positioning (GPS).....	52	About the FM transmitter.....	69
About GPS.....	52	Play a song using FM transmitter.....	70
Assisted GPS (A-GPS).....	52	FM transmitter settings.....	70
Hold your device correctly.....	53	Nokia Podcasting.....	70
Tips on creating a GPS connection.....	53	Podcasting settings.....	70
Position requests.....	54	Search podcasts.....	71

Directories.....	72	Camera settings.....	86
Downloads.....	72	Still image camera settings.....	86
Play and manage podcasts.....	73	Colour and lighting settings.....	87
Radio applications.....	73	Video settings.....	87
FM radio.....	73	Photos.....	89
Listen to the radio.....	74	About Photos.....	89
View visual content.....	75	View images and videos.....	89
Saved stations.....	75	View and edit file details.....	90
FM radio settings.....	75	Organise images and videos.....	90
Nokia Internet Radio.....	75	Active toolbar.....	91
Listen to internet radio stations.....	75	Albums.....	91
Favourite stations.....	76	Tags.....	91
Search for stations.....	76	Slide show.....	92
Station directory.....	77	TV-out mode.....	92
Internet radio settings.....	77	Edit images.....	94
Camera.....	78	Image editor.....	94
About the camera.....	78	Crop image.....	94
Activate the camera.....	78	Reduce red-eye.....	94
Image capture.....	78	Useful shortcuts.....	94
Still image camera indicators.....	78	Edit videos.....	95
Active toolbar.....	79	Print images.....	95
Capture images.....	80	Image print.....	95
Location information.....	81	Printer selection.....	95
After taking a picture.....	81	Print preview.....	96
Flash.....	82	Print settings.....	96
Scenes.....	82	Print online.....	96
Capture images in a sequence.....	82	Share images and videos online.....	96
You in the picture—self-timer.....	83	Gallery.....	98
Tips on taking good photographs.....	83	Main view.....	98
Video recording.....	84	Sounds.....	98
Video capture indicators.....	84	Streaming links.....	99
Record videos.....	85	Presentations.....	99
After recording a video.....	85		

Home network.....	100	Rate a player.....	114
About home network.....	100	Send messages.....	114
Important security information.....	101	N-Gage settings.....	114
Settings for home network.....	101	Messaging.....	116
Set sharing on and define content.....	102	Messaging main view.....	116
View and share media files.....	102	Write text.....	117
Copy media files.....	103	Traditional text input.....	117
Home synchronisation.....	103	Predictive text input.....	117
Synchronise media files.....	103	Tips on text input.....	118
Synchronisation settings.....	104	Change the writing language.....	118
Define incoming files.....	104	Edit text and lists.....	118
Define outgoing files.....	105	Write and send messages.....	118
Nokia Video Centre.....	106	Messaging inbox.....	120
View and download video clips.....	106	Receive messages.....	120
Video feeds.....	107	Multimedia messages.....	120
My videos.....	107	Data, settings, and web service messages.....	121
Transfer videos from your PC.....	108	Message reader.....	121
Video centre settings.....	108	Mailbox.....	121
N-Gage.....	110	Define the e-mail settings.....	121
About N-Gage.....	110	Open the mailbox.....	122
N-Gage views.....	110	Retrieve e-mail messages.....	122
Get started.....	111	Delete e-mail messages.....	123
Create a player name.....	111	Disconnect from the mailbox.....	123
Start a game.....	111	View messages on a SIM card.....	123
Track your progress.....	112	Messaging settings.....	123
Play with friends.....	112	Text message settings.....	124
Play and manage games.....	112	Multimedia message settings.....	124
Edit profile details.....	113	E-mail settings.....	125
Connect with other players.....	113	Manage mailboxes.....	125
Find and add friends.....	113	Connection settings.....	125
View friend information.....	113	User settings.....	126
Sort the friends list.....	114	Retrieval settings.....	126
		Automatic retrieval settings.....	127

Web service message settings.....	127	Contacts (phonebook).....	141
Cell broadcast settings.....	127	Save and edit names and numbers.....	141
Other settings.....	128	Manage names and numbers.....	141
Make calls.....	129	Default numbers and addresses.....	141
Voice calls	129	Add ringing tones for contacts.....	142
Options during a call.....	129	Copy contacts.....	142
Voice and video mailboxes.....	130	SIM services.....	142
Answer or decline a call.....	130	SIM contacts.....	142
Make a conference call.....	130	Fixed dialling.....	143
Speed dial a phone number.....	131	Manage contact groups.....	143
Call waiting.....	131	Media folder.....	144
Voice dialling.....	131	RealPlayer	144
Make a video call.....	132	Play video clips.....	144
Options during a video call.....	133	Stream content over the air.....	144
Answer or decline a video call.....	134	RealPlayer settings.....	145
Video sharing.....	134	Adobe Flash Player.....	145
Video sharing requirements.....	134	Licences.....	145
Settings.....	134	Recorder.....	146
Share live video or video clips.....	135	Time management.....	147
Accept an invitation.....	136	Clock	147
Log.....	136	Alarm clock.....	147
Recent calls.....	136	World clock.....	147
Call duration.....	137	Calendar.....	147
Packet data.....	137	Create a calendar entry.....	147
Monitor all communication events.....	137	Calendar views.....	148
Internet calls.....	139	Manage calendar entries.....	149
About internet calls.....	139	Office folder.....	150
Activate internet calls.....	139	Quickoffice.....	150
Make internet calls	139	Quickword.....	150
Blocked contacts.....	140	Quicksheet.....	150
Manage internet call services.....	140	Quickpoint.....	150
Internet call settings.....	140		

Quickmanager.....	151	Restore original settings.....	166
Notes.....	151	Positioning settings.....	166
Adobe reader.....	151	Phone settings.....	166
Converter.....	151	Call settings.....	166
Zip manager.....	152	Call divert.....	168
Applications folder.....	153	Call barring.....	168
Calculator.....	153	Network settings.....	168
Application manager.....	153	Connection settings.....	169
Install applications and software	154	Data connections and access points.....	169
Remove applications and software.....	155	Access points.....	170
Settings.....	155	Create a new access point.....	170
Tools folder.....	157	Create access point groups.....	170
File manager.....	157	Packet data access points.....	171
About File manager.....	157	WLAN internet access points.....	172
Find and organise files.....	157	Packet data settings.....	173
Edit memory card.....	157	Wireless LAN settings.....	173
Back up files on a memory card.....	157	SIP settings.....	174
Voice commands.....	157	Configurations.....	174
Sync.....	158	Access point name control.....	174
Device manager.....	159	Application settings.....	174
Speech	159	Troubleshooting.....	175
Settings.....	161	Enhancements.....	179
General settings.....	161	Battery and charger information.....	180
Personalisation settings.....	161	Battery and charger information.....	180
Enhancement settings.....	162	Nokia battery authentication guidelines.....	181
Navi wheel settings.....	163	Authenticate hologram.....	181
Sensor settings.....	163	What if your battery is not authentic?.....	182
Security settings.....	163	Care and maintenance.....	183
Phone and SIM.....	163	Disposal.....	184
Certificate management.....	164		
Security module.....	166		

Additional safety information.....	185
Small children.....	185
Operating environment.....	185
Medical devices.....	185
Implanted medical devices.....	185
Hearing aids.....	186
Vehicles.....	186
Potentially explosive environments.....	187
Emergency calls.....	187
CERTIFICATION INFORMATION (SAR).....	188
Index.....	189

Safety

Read these simple guidelines. Not following them may be dangerous or illegal. Read the complete user guide for further information.



SWITCH ON SAFELY

Do not switch the device on when wireless phone use is prohibited or when it may cause interference or danger.



ROAD SAFETY COMES FIRST

Obey all local laws. Always keep your hands free to operate the vehicle while driving. Your first consideration while driving should be road safety.



INTERFERENCE

All wireless devices may be susceptible to interference, which could affect performance.



SWITCH OFF IN RESTRICTED AREAS

Follow any restrictions. Switch the device off in aircraft, near medical equipment, fuel, chemicals, or blasting areas.



QUALIFIED SERVICE

Only qualified personnel may install or repair this product.



ENHANCEMENTS AND BATTERIES

Use only approved enhancements and batteries. Do not connect incompatible products.



ENHANCEMENTS

Use only approved enhancements. Do not connect incompatible products.



WATER-RESISTANCE

Your device is not water-resistant. Keep it dry.

About your device

The wireless device described in this guide is approved for use on the (E)GSM 850, 900, 1800,1900, and UMTS 900, 2100 MHz networks. Contact your service provider for more information about networks.

When using the features in this device, obey all laws and respect local customs, privacy and legitimate rights of others, including copyrights.

Copyright protection may prevent some images, music, and other content from being copied, modified, or transferred.

Your device supports several methods of connectivity. Like computers, your device may be exposed to viruses and other harmful content. Exercise caution with messages, connectivity requests, browsing, and downloads. Only install and use services and other software from trustworthy sources that offer adequate security and protection against harmful software, such as applications that are Symbian Signed or have passed the Java Verified™ testing. Consider installing antivirus and other security software on your device and any connected computer.

Your device may have preinstalled bookmarks and links for third-party internet sites. You may also access other third-party sites through your device. Third-party sites are not affiliated with Nokia, and Nokia does not endorse or assume liability for them. If you choose to access such sites, you should take precautions for security or content.



Warning: To use any features in this device, other than the alarm clock, the device must be switched on. Do not switch the device on when wireless device use may cause interference or danger.

The office applications support common features of Microsoft Word, PowerPoint, and Excel (Microsoft Office 2000, XP, and 2003). Not all file formats can be viewed or modified.

Remember to make back-up copies or keep a written record of all important information stored in your device.

When connecting to any other device, read its user guide for detailed safety instructions. Do not connect incompatible products.

The images in this guide may differ from your device display.

Network services

To use the device you must have service from a wireless service provider. Many of the features require special network features. These features are not available on all networks; other networks may require that you make specific arrangements with your service provider before you can use the network services. Using network services involves transmission of data. Check with your service provider for details about fees in your home network and when roaming on other networks. Your service provider can give you instructions and explain what charges will apply. Some networks may have limitations that affect how you can use network services. For instance, some networks may not support all language-dependent characters and services.

Your service provider may have requested that certain features be disabled or not activated in your device. If so, these features will not appear on your device menu. Your device may also have a special configuration such

as changes in menu names, menu order, and icons.
Contact your service provider for more information.

This device supports WAP 2.0 protocols (HTTP and SSL) that run on TCP/IP protocols. Some features of this device, such as MMS, web browsing, and e-mail, require network support for these technologies.

Get started

Keys and parts (front)

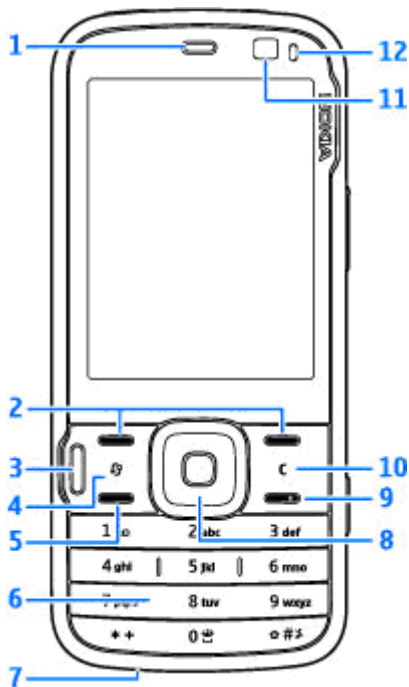

- 1 — Earpiece
- 2 — Selection keys
- 3 — Multimedia key
- 4 — Menu key 
- 5 — Call key
- 6 — Numeric keypad
- 7 — Microphone
- 8 — Navi™ wheel; hereafter referred to as the scroll key.
- 9 — End key
- 10 — Clear key C
- 11 — Secondary camera
- 12 — Light sensor

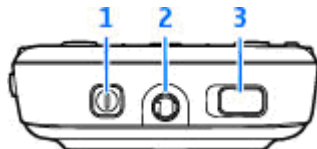

- 1 — Power key
- 2 — Nokia AV Connector for compatible headsets and headphones

3 — Key lock switch for locking and unlocking the keys

Keys and parts (back and sides)

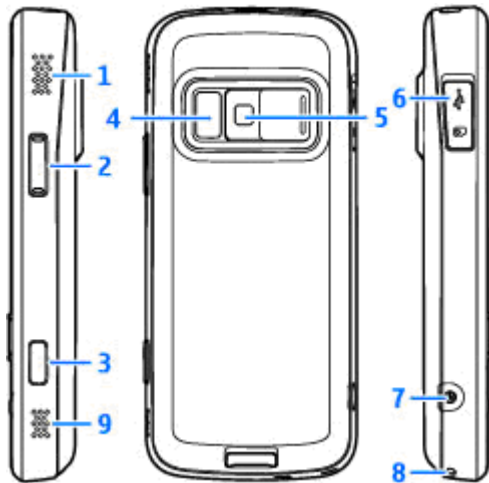

1 and 9 — Stereo speaker with 3-D sound effect
 2 — Zoom/Volume key
 3 — 2-stage capture key for auto-focus, still image capture, and video recording

4 — Flash and video light

5 — Main camera for high resolution (up to 5 megapixels) image capture and video recording

6 — Memory card slot for a compatible microSD card and Micro USB connector to connect to a compatible PC

7 — Charger connector

8 — Hole for a wrist strap

Insert SIM card and battery

Always switch the device off and disconnect the charger before removing the battery.

1. With the back of the device facing you, press and hold the release button and lift up the cover.

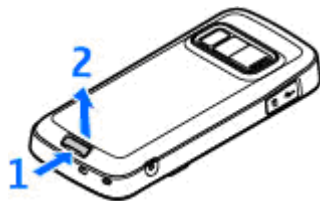

2. Insert the SIM card into the card holder. Ensure that the contact area on the card is facing down.
3. Insert the battery.
4. To replace the cover, direct the top locking catch toward its slot, and press down until the cover locks into place.

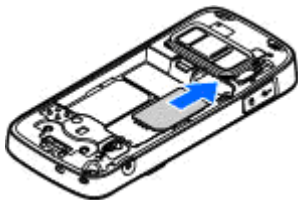

Remove SIM card

To remove the SIM card, slide the latch to the direction of the arrow.

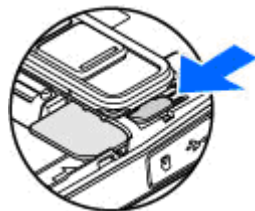
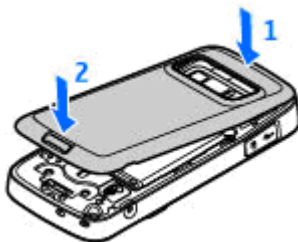

Switch the device on

1. Press and hold the power key.

2. If the device asks for a PIN code or lock code, enter it, and press the left selection key. The factory setting for the lock code is **12345**. If you forget the code and your device is locked, your device will require service and additional charges may apply. For more information, contact a Nokia Care point or your device dealer.



Charge the battery

1. Connect a compatible charger to a wall outlet.
2. Connect the power cord to the device. If the battery is completely discharged, it may take a while before the charging indicator starts scrolling.
3. When the battery is fully charged, the charging indicator stops scrolling. Disconnect the charger from the device, then from the wall outlet.



Tip: Disconnect the charger from the wall outlet when the charger is not in use. A charger that is connected to the outlet consumes power even when it is not connected to the device.

Attach wrist strap

1. Remove the back cover.
2. Thread a wrist strap, and tighten it.

3. Replace the cover.

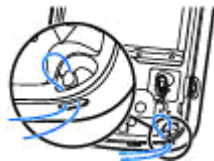

Antenna locations

Your device may have internal and external antennas. As with any radio transmitting device, avoid touching the antenna area unnecessarily while the antenna is transmitting or receiving. Contact with such an antenna affects the communication quality and may cause the device to operate at a higher power level than otherwise needed and may reduce the battery life.

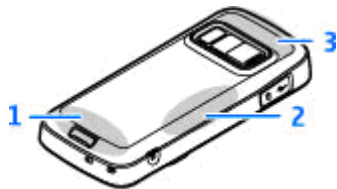

- 1 — Cellular antenna
- 2 — FM transmitter antenna
- 3 — Bluetooth and wireless LAN antenna, and GPS receiver

Get connected

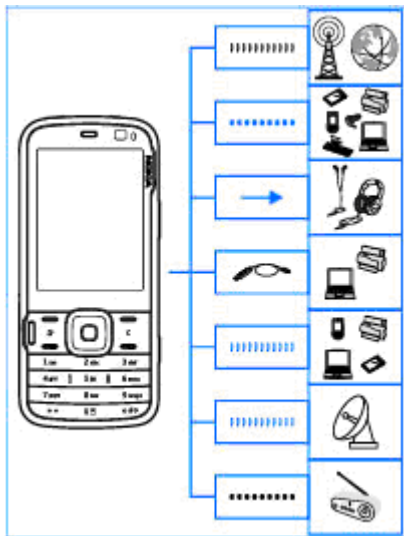

Your device supports the following connectivity methods:

- 2G and 3G networks





- Bluetooth connectivity — to transfer files and connect to compatible enhancements. [See "Bluetooth connectivity", p. 43.](#)
- Nokia AV connector (3.5 mm) — to connect to compatible headsets, headphones, or home stereo sets
- USB data cable — to connect to compatible devices, such as printers and PCs. [See "USB", p. 46.](#)
- Wireless LAN (WLAN) — to connect to the internet and WLAN enabled devices. [See "Wireless LAN", p. 40.](#)
- GPS — to receive transmissions from GPS satellites to measure your location. [See "Positioning \(GPS\)", p. 52.](#)
- FM transmitter — to listen to songs in your device through compatible FM receivers, such as car radios or home stereo sets. [See "Play a song using FM transmitter", p. 70.](#)

Find help

Instructions inside - In-device help

Your device contains instructions to help you use it.

When an application is open, to access the help text for the current view, select **Options** > **Help**. To open help from the main menu, select **Tools** > **Utilities** > **Help**, and the relevant application.

You can find links to related topics at the end of the help text. To make the instructions easier to read, you can change the size of the text. If you click on an underlined word, a short explanation is displayed. Help uses the following indicators:  shows a link to a related help topic.  shows a link to the application being discussed. When you are reading the instructions, to switch between help and the application that is open in the background, press and hold  , or select the application link .



Tip: To place Help in the main menu, select **Tools** > **Utilities**, highlight **Help**, and select **Options** > **Move to folder** and the main menu.

Get started

See the get started guide for keys and parts information, instructions for setting up the device and for other essential information.

Nokia support and contact information

Check www.nseries.com/support or your local Nokia website for the latest guides, additional information, downloads, and services related to your Nokia product.

If you need to contact customer service, check the list of local Nokia Care contact centres at www.nokia.com/customerservice.

For maintenance services, check your nearest Nokia Care point at www.nokia.com/repair.

Additional applications

There are various applications provided by Nokia and different third-party software developers that help you do more with your device. These

applications are explained in the guides that are available on the product support pages at www.nseries.com/support or your local Nokia website.

Software updates

Nokia may produce software updates that offer new features, enhanced functions, and improved performance. You may be able to request these updates through the Nokia Software Updater PC application. Software updates may not be available for all products or their variants. Not all operators may endorse the latest software versions available.

To update the device software, you need the Nokia Software Updater application and a compatible PC with Microsoft Windows 2000, XP, or Vista operating system, broadband internet access, and a compatible data cable to connect your device to the PC.



Warning: If you install a software update, you cannot use the device, even to make emergency calls, until the installation is completed and the device is restarted. Be sure to back up data before accepting installation of an update.

The size of a software update is approximately 5-10 MB using your device and 100 MB using a PC.

The download and installation may take up to 20 minutes with Device manager and up to 30 minutes with Nokia Software Updater.

To get more information and to download the Nokia Software Updater application, visit www.nokia.com/softwareupdate or your local Nokia website.

If software updates over the air are supported by your network, you may also be able to request updates through the device.

Your device may be able to periodically check for new software updates with Nokia Software Checker. Press , and select **Tools > SW checker**.



Tip: To check the software version in your device, enter ***#0000#** in the standby mode.

Application Update

Press , and select **Applications > App. update**.

With Application Update, you can check the available updates for applications and download them to your device.

After updating your device software using Application Update, the instructions in the user guide or the helps may not be up to date.

To download the available updates, select **Options > Start update**.

To unmark updates, scroll to them, and press the scroll key.

To view information on an update, select **Options > View details**.

To change the settings, select **Options > Settings**.

Settings

Your device normally has MMS, GPRS, streaming, and mobile internet settings automatically configured, based on your network service provider information. You may have settings from your service providers already installed in your device, or you may receive or request the settings from the network service providers as a special message.

You can change the general settings in your device, such as language, standby mode, display, and keypad lock settings. [See "Settings", p. 161.](#)

Access codes

If you forget any of the access codes, contact your service provider.

- Personal identification number (PIN) code — This code protects your SIM card against unauthorised use. The PIN code (4 to 8 digits) is usually supplied with the SIM card. After three consecutive incorrect PIN code entries, the code is blocked, and you need the PUK code to unblock it.
- UPIN code — This code may be supplied with the USIM card. The USIM card is an enhanced version of the SIM card and is supported by UMTS mobile phones.
- PIN2 code — This code (4 to 8 digits) is supplied with some SIM cards, and is required to access some functions in your device.
- Lock code (also known as security code) — The lock code helps you to protect your device against unauthorised use. You can create and change the code, and set the device to request the code. Keep the new code secret and in a safe place separate from your device. If you forget the code and your device is locked, your device will require service and additional charges may apply. For more information, contact a Nokia Care point or your device dealer.
- Personal unblocking key (PUK) code and PUK2 code — These codes (8 digits) are required to change a blocked PIN code or PIN2 code, respectively. If the codes are not supplied with the SIM card, contact the operator whose SIM card is in your device.

- UPUK code — This code (8 digits) is required to change a blocked UPIN code. If the code is not supplied with the USIM card, contact the operator whose USIM card is in your device.

Prolong battery life

Many features in your device increase the demand on battery power and reduce the battery life time. To save battery power, note the following:

- Features that use Bluetooth technology, or allowing such features to run in the background while using other features, increase the demand on battery power. Turn Bluetooth technology off when you do not need it.
- Features that use wireless LAN (WLAN), or allowing such features to run in the background while using other features, increase the demand on battery power. WLAN on your Nokia device switches off when you are not trying to connect, not connected to an access point, or not scanning for available networks. To further reduce battery consumption, you can specify that your device does not scan, or scans less often, for available networks in the background. [See "Wireless LAN", p. 40.](#) When **Scan for networks** is set to **Never**, the WLAN availability icon is not shown in the standby mode. However, you can still

manually scan for available WLAN networks and connect to WLAN networks as usual.

- If you have set **Packet data connection** to **When available** in connection settings, and there is no packet data coverage (GPRS), the device periodically tries to establish a packet data connection. To prolong the operating time of your device, select **Packet data connection > When needed**.
- The Maps application downloads new map information when you scroll to new areas on the map, which increases the demand on battery power. You can prevent the automatic download of new maps. [See "Maps", p. 57.](#)
- If the signal strength of the cellular network varies much in your area, your device must scan for the available network repeatedly. This increases the demand on battery power.

If the network mode is set to dual mode in the network settings, the device searches for the UMTS network. To only use the GSM network, press , and select **Tools > Settings > Phone > Network > Network mode > GSM**.

- The backlight of the display increases the demand on battery power. In the display settings, you can change the time-out after which the backlight is switched off, and adjust the light sensor that observes lighting conditions

and adjusts the display brightness. Press **⌘**, and select **Tools > Settings > General > Personalisation > Display and Light time-out or Brightness**.

- Leaving applications running in the background increases the demand on battery power. To close the applications you do not use, press and hold **⌘**, scroll to an application in the list, and press **C**.

Pressing **C** does not close Music player. To close Music player, select it from the list and **Options > Exit**.

- To turn on the power save mode, press the power key, and select **Activate power saving**. To turn off the power save mode, press the power key, and select **Deactivate power saving**. You may not be able to change the settings of certain applications when the power save mode is turned on.

Free memory

To view how much memory different data types consume, press **⌘**, and select **Tools > File mgr.**, the desired memory, and **Options > Details > Memory**.

To remove data you no longer need, use File manager or go to the respective application. You can remove the following:

- Messages in the folders in Messaging and retrieved e-mail messages from the mailbox
- Saved web pages
- Contact information
- Calendar notes
- Applications shown in Application manager that you do not need
- Installation files (.sis or .six) of applications you have installed. Transfer the installation files to a compatible PC.
- Images and video clips in Photos. Back up the files to a compatible PC using Nokia Nseries PC Suite.

Your device

Welcome

When you switch on your device for the first time, the Welcome application is displayed.

Select from the following:

- **Sett. wizard** — to configure various settings, such as e-mail. For more information on the Settings wizard application, see the guides available at the Nokia product support pages or your local Nokia website.
- **Switch** — to transfer content, such as contacts and calendar entries, from a compatible Nokia device. [See "Transfer content", p. 24.](#)

There may also be a demonstration about your device available in the Welcome application.

To access the Welcome application later, press , and select **Tools > Utilities > Welcome**. You can also access the individual applications from their menu locations.

Nokia Switch

Transfer content

You can use the **Switch** application to copy content such as phone numbers, addresses, calendar items, and images from your previous Nokia device to your Nokia N79 using Bluetooth connectivity.

The type of content that can be transferred depends on the model of the device from which you want to transfer content. If that device supports synchronisation, you can also synchronise data between the devices. Your Nokia N79 notifies you if the other device is not compatible.

If the other device cannot be switched on without a SIM card, you can insert your SIM card in it. When your Nokia N79 is switched on without a SIM card, the offline profile is automatically activated, and transfer can be done.

Transfer content for the first time

1. To retrieve data from the other device for the first time, on your Nokia N79, select **Switch** in the Welcome application, or press , and select **Tools > Utilities > Switch**.

2. Select the connection type you want to use to transfer the data. Both devices must support the selected connection type.
3. If you select Bluetooth, connect the two devices. To have your device search for devices with Bluetooth connectivity, select **Continue**. Select the device from which you want to transfer content. You are asked to enter a code on your Nokia N79. Enter a code (1-16 digits), and select **OK**. Enter the same code on the other device, and select **OK**. The devices are now paired. [See "Pair devices", p. 45.](#)

Some earlier Nokia devices may not have the Switch application. In this case, the Switch application is sent to the other device as a message. To install the Switch application on the other device, open the message, and follow the instructions on the display.

4. From your Nokia N79, select the content you want to transfer from the other device.
When the transfer has started, you can cancel it and continue later.

Content is transferred from the memory of the other device to the corresponding location in your Nokia N79. The transfer time depends on the amount of data to be transferred.

Synchronise, retrieve, or send content

After the first transfer, select from the following to start a new transfer, depending on the model of the other device:

 to synchronise content between your Nokia N79 and the other device, if the other device supports synchronisation. The synchronisation is two-way. If an item is deleted in one device, it is deleted in both. You cannot restore deleted items with synchronisation.

 to retrieve content from the other device to your Nokia N79. With retrieval, content is transferred from the other device to your Nokia N79. You may be asked to keep or delete the original content in the other device, depending on the device model.

 to send content from your Nokia N79 to your other device

If **Switch** cannot send an item, depending on the type of the other device, you can add the item to the **Nokia folder** to **C:\Nokia** or **E:\Nokia** in your Nokia N79. When you select the folder to transfer, the items are synchronised in the corresponding folder in the other device, and vice versa.

Use shortcuts to repeat a transfer

After a data transfer, you can save a shortcut with the transfer settings to the main view to repeat the same transfer later.

To edit the shortcut, scroll to it, and select **Options** > **Shortcut settings**. You can, for example, create or change the name of the shortcut.

A transfer log is shown after every transfer. To view the log of the last transfer, scroll to a shortcut in the main view, and select **Options** > **View log**.

Handle transfer conflicts

If an item to be transferred has been edited in both devices, the device attempts to merge the changes automatically. If this is not possible, there is a transfer conflict. Select **Check one by one**, **Priority to this phone**, or **Priority to other phone** to solve the conflict. For further instructions, select **Options** > **Help**.

Display indicators

 The device is being used in a GSM network (network service).

3G The device is being used in a UMTS network (network service).

 You have one or more unread messages in the **Inbox** folder in Messaging.

 You have received new e-mail in the remote mailbox.

 There are messages waiting to be sent in the **Outbox** folder.

 You have missed calls.

 The ringing type is set to silent, and the message alert tone and e-mail alert tone are set to off.

 A timed profile is active.

 The device keypad is locked.

 A clock alarm is active.

2 The second phone line is being used (network service).

 All calls to the device are diverted to another number (network service). If you have two phone lines, a number indicates the active line.

 Your phone is connected to a network via wireless LAN or UMTS (network service) and ready for an internet call.

 A compatible microSD card is in the device.

 A compatible headset is connected to the device.



 FM transmitter is active but not transmitting.



 FM transmitter is active and transmitting.



 A compatible TV out cable is connected to the device.



 A compatible text phone is connected to the device.

D A data call is active (network service).

 A GPRS packet data connection is active (network service).  indicates the connection is on hold and  that a connection is available.

 A packet data connection is active in a part of the network that supports EGPRS (network service).  indicates the connection is on hold and  that a connection is available. The icons indicate that EGPRS is available in the network, but your device is not necessarily using EGPRS in the data transfer.

 A UMTS packet data connection is active (network service).  indicates the connection is on hold and  that a connection is available.

 High-speed downlink packet access (HSDPA) is supported and active (network service).  indicates the connection is on hold and  that a connection is available. [See "Fast downloading", p. 32.](#)

 You have set the device to scan for wireless LANs, and a wireless LAN is available (network service). [See "About WLAN", p. 40.](#)

 A wireless LAN connection is active in a network that has encryption.

 A wireless LAN connection is active in a network that does not have encryption.

 Bluetooth connectivity is on. [See "Bluetooth connectivity", p. 43.](#)

 Data is being transmitted using Bluetooth connectivity. When the indicator is blinking, your device is trying to connect with another device.

 A USB connection is active.

 Synchronisation is in progress.

Shortcuts

When in the menus, instead of using the scroll key, you can use the number keys, #, and * to quickly access the applications. For example, in the main menu, press **2** to open Messaging or **#** to open the application or folder in the corresponding location in the menu.

To switch between open applications, press and hold . Leaving applications running in the background increases the demand on battery power and reduces the battery life.

To view your multimedia content, press the multimedia key.

To start a web connection (network service), in the standby mode, press and hold **0**.

In many applications, to view the most common option items () , press the scroll key.

To change the profile, press the power key, and select a profile.

To switch between the General and Silent profiles, in the standby mode, press and hold #.

To call your voice mailbox (network service), in the standby mode, press and hold 1.

To open a list of last dialled numbers, in the standby mode, press the call key.

To use voice commands, in the standby mode, press and hold the right selection key.

To remove an application from the menu, select it, and press C. Some applications may not be removed.

Lock the keypad

When the device or keypad is locked, calls may be possible to the official emergency number programmed into your device.

To lock and unlock the keys, use the lock switch at the top of the device, next to the power key.

To set the keypad to lock automatically after a time-out, press , and select **Tools > Settings > General > Security > Phone and SIM card > Keypad autolock period**.

To illuminate the keypad in low-light conditions, briefly press the power key.

Navi™ wheel

Hereafter referred to as scroll key.

Use the Navi wheel to move around the menus and lists (up, down, left, or right). Press the scroll key to select the action shown on top of the key or to show the most used options .

To turn the Navi wheel setting on or off, press , and select **Tools > Settings > General > Navi wheel > Navi wheel**.

When the Navi wheel setting is switched on in the settings, you can scroll quickly through Photos, Music Player, Nokia Video Centre, Contacts, and Messaging lists, or the multimedia menu.

1. Move the tip of your finger gently around the rim of the scroll key clockwise or anticlockwise. Keep moving your finger until scrolling starts on the display.
2. To continue scrolling, slide your finger around the rim of the scroll key clockwise or anticlockwise.



Sleep mode indicator

The inner rim of the Navi wheel illuminates slowly when the device is in the sleep

mode. The light varies periodically as if the device was breathing. To switch off the illumination, press , and select **Tools > Settings > General > Navi wheel > Breathing**.

Multimedia menu

With the multimedia menu, you can access your most frequently used multimedia content. The selected content is shown in the appropriate application.

1. To open or close the multimedia menu, press the multimedia key.
2. To browse the tiles, scroll left or right, or, if the Navi wheel setting is set on, slide your finger on the rim of the scroll key.

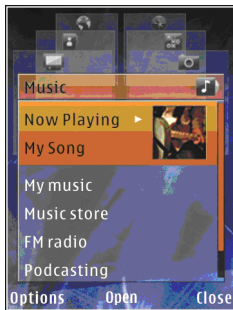

The tiles are the following:

- **TV & video** — View your last watched video clip, video clips stored on your device, or access video services.

- **Music** — Enter Music player and the Now playing view, browse your songs and playlists, or download and manage podcasts.
 - **Images** — View your most recently taken images, start a slide show of your images or video clips, or view media files in albums.
 - **Maps** — View your favourite locations in the Maps application.
 - **Internet** — View your favourite web links in the browser.
 - **Contacts** — Add your own contacts, send messages, or make voice calls. To add a new contact to an empty position on the list, press the scroll key, and select a contact. To send a message, in the multimedia menu, select a contact, and **Options > Send text message** or **Send multimedia msg.**
3. To scroll up or down in a tile, press the scroll key up or down. To select items, press the scroll key.

To change the order of the tiles, select **Options > Arrange tiles**.

To return to the multimedia menu from an open application, press the multimedia key.

Mobile Search

Press , and select **Search**.

You can also access Mobile Search directly from the active standby mode, if that has been activated in the settings.

Use Mobile Search to access internet search engines and to find and connect to local services, websites, images, and mobile content. You can also search content in your device, such as calendar entries, e-mail, and other messages.

Web search (network service)

1. In the Search main view, select **Search the Internet**.
2. Select a search engine.
3. Enter your text to search.
4. Press the scroll key to start the search.

My content search

To search content in your device, in the main view, enter your text to the search field. The search results are displayed on the screen as you write.

Headset

You can connect a compatible headset or compatible headphones to your device. You may need to select the cable mode.



Warning: When you use the headset, your ability to hear outside sounds may be affected. Do not use the headset where it can endanger your safety.

Some headsets come in two parts, a remote control unit and headphones. A remote control unit has a microphone and keys to answer or end a phone call, adjust the volume, and play music or video files. To use the headphones with a remote control unit, connect the unit to the Nokia AV Connector (3.5 mm) in the device, then connect the headphones to the unit.

To make handsfree phone calls, use a headset with a compatible remote control unit, or use the microphone on the device.

To adjust the volume during a call, use the volume key on the device or, if available, on the headset. Some headsets have multimedia volume controls that can only be used to adjust the volume for music or video playback.

You can also connect a compatible TV-out cable to the Nokia AV Connector (3.5 mm) of your device.



Do not connect products that create an output signal as this may cause damage to the device. Do not connect any voltage source to the Nokia AV Connector.

When connecting any external device or any headset, other than those approved by Nokia for use with this device, to the Nokia AV Connector, pay special attention to volume levels.

Volume and loudspeaker control



Warning: Listen to music at a moderate level. Continuous exposure to high volume may damage your hearing. Do not hold the device near your ear when the loudspeaker is in use, because the volume may be extremely loud.

To increase or decrease the volume level when you have an active call or are listening to a sound, use the volume key.

The built-in loudspeaker allows you to speak and listen from a short distance without having to hold the device to your ear.



To use the loudspeaker during a call, press **Loudsp..**

To turn off the loudspeaker, press **Handset**.

Offline profile

To activate the offline profile, press the power key briefly, and select **Offline**. Or, press **Ⓜ**, and select **Tools > Profiles > Offline**.

The offline profile lets you use the device without connecting to the wireless network. When you activate the offline profile, the connection to the wireless network is turned off, as indicated by **X** in the signal strength indicator area. All wireless RF signals to and from the device are prevented. If you try to send messages, they are placed in the outbox to be sent later.

When the offline profile is active, you can use your device without a SIM card.



Important: In the offline profile you cannot make or receive any calls, or use other features that require cellular network coverage. Calls may still be possible to the official emergency number programmed into your device. To make calls, you must first activate the phone function by changing profiles. If the device has been locked, enter the lock code.

When you have activated the offline profile, you can still use the wireless LAN, for example, to read your e-mail or browse on the internet. Remember to

comply with any applicable safety requirements when establishing and using a wireless LAN connection. You can also use Bluetooth connectivity while in the offline profile.

To leave the offline profile, press the power key briefly, and select another profile. The device re-enables wireless transmissions (providing there is sufficient signal strength).

Fast downloading

High-speed downlink packet access (HSDPA, also called 3.5G, indicated by **3.5G**) is a network service in UMTS networks and provides high-speed data downloads. When HSDPA support in the device is activated and the device is connected to a UMTS network that supports HSDPA, downloading data such as messages, e-mail, and browser pages through the cellular network may be faster. An active HSDPA connection is indicated by . [See "Display indicators", p. 26.](#)

You can activate or deactivate support for HSDPA in the device settings. [See "Packet data settings", p. 173.](#)

For availability and subscription to data connection services, contact your service provider.

HSDPA only affects the download speed; sending data to the network, such as messages and e-mail, is not affected.

Web browser

With the Web browser, you can view hypertext markup language (HTML) web pages on the internet as originally designed. You can also browse web pages that are designed specifically for mobile devices, and use extensible hypertext markup language (XHTML), or the wireless markup language (WML).

To browse the web, you need to have an internet access point configured in your device.

Browse the web

Press , and select **Web**.



Shortcut: To start the browser, press and hold **0** in the standby mode.



Important: Use only services that you trust and that offer adequate security and protection against harmful software.



Important: Only install and use applications and other software from trusted sources, such as applications that are Symbian Signed or have passed the Java Verified™ testing.

To browse a web page, in the bookmarks view, select a bookmark, or enter the address in the field () , and press the scroll key.

Some web pages may contain material, such as graphics and sounds, that requires a large amount of memory to view. If your device runs out of memory while loading such a page, the graphics on the page are not shown.

To browse web pages without graphics, to save memory, select **Options** > **Settings** > **Page** > **Load content** > **Text only**.

To enter a new web page address you want to visit, select **Options** > **Go to web address**.



Tip: To visit a web page saved as a bookmark in the bookmarks view, while browsing, press **1**, and select a bookmark.

To retrieve the latest content of the page from the server, select **Options** > **Navigation options** > **Reload**.

To save the web address of the current page as a bookmark, select **Options** > **Save as bookmark**.

To view snapshots of the pages you have visited during the current browsing session, select **Back**

(available if **History list** is set on in the browser settings and the current page is not the first page you visit). Select the page you want to go to.

To save a page while browsing, select **Options** > **Tools** > **Save page**.

You can save pages and browse them later when offline. You can also group pages into folders. To access the pages you have saved, select **Options** > **Bookmarks** > **Saved pages**.

To open a sublist of commands or actions for the page that is open, select **Options** > **Service options** (if supported by the web page).



To prevent or allow the automatic opening of multiple windows, select **Options** > **Window** > **Block pop-ups** or **Allow pop-ups**.

Shortcuts while browsing

- Press **1** to open your bookmarks.
- Press **2** to search for keywords on the current page.
- Press **3** to return to the previous page.
- Press **5** to list all open windows.
- Press **8** to show the page overview of the current page. Press **8** again to zoom in and view the desired section of the page.
- Press **9** to enter a new web address.

- Press **0** to go to the home page (if defined in settings).
- Press ***** and **#** to zoom in or out on the page.



Tip: To return to the standby mode with the browser open in the background, press  twice or the end key. To return to the browser, press and hold , and select the browser.

Browser toolbar

The browser toolbar helps you select frequently used functions of the browser.

To open the toolbar, press and hold the scroll key on an empty spot on a web page. To move within the toolbar, scroll left or right. To select a feature, press the scroll key.

In the toolbar, select from the following:

- **Frequently used links** — View a list of the web addresses you visit frequently.
- **Page overview** — See an overview of the current web page.
- **Find** — Search for keywords within the current page.
- **Reload** — Refresh the page.
- **Subscribe to web feeds** (if available) — View a list of available web feeds on the current web page, and subscribe to a web feed.

Navigate pages

Mini Map and page overview help you navigate web pages that contain a large amount of information.

When Mini Map is set on in the browser settings and you scroll through a large web page, Mini Map opens and shows an overview of the web page you browse.

To set Mini Map on, select **Options > Settings > General > Mini map > On**.

To move in Mini Map, scroll left, right, up, or down. When you find the desired location, stop scrolling. Mini Map disappears and leaves you at the selected location.

When you are browsing a web page that contains a large amount of information, you can also use **Page overview** to view what kind of information the page contains.

To show the page overview of the current page, press **8**. To find the desired spot on the page, scroll up, down, left, or right. Press **8** again to zoom in and view the desired section of the page.

Web feeds and blogs

Web feeds are xml files on web pages that are used by the weblog community and news organisations to share the latest headlines or text, for example,

news feeds. Blogs or weblogs are web diaries. Most of the web feeds use RSS and Atom technologies. It is common to find web feeds on web, blog, and wiki pages.

The Web application automatically detects if a web page contains web feeds.

To subscribe to a web feed, select **Options > Subscribe to web feeds**.

To view the web feeds to which you have subscribed, in the bookmarks view, select **Web feeds**.

To update a web feed, select it and **Options > Refresh**.

To define how the web feeds are updated, select **Options > Settings > Web feeds**.

Widgets

Your device supports widgets. Widgets are small, downloadable web applications that deliver multimedia, news feeds, and other information, such as weather reports, to your device. Installed widgets appear as separate applications in the **Applications** folder.

You can download widgets using the Download! application or from the web.

The default access point for widgets is the same as in the web browser. When active in the background, some widgets may update information automatically to your device.

Using widgets may involve the transmission of large amounts of data through your service provider's network. Contact your service provider for information about data transmission charges.

Content search

To search for keywords, phone numbers, or e-mail addresses within the current web page, select **Options** > **Find** and the desired option. To go to the previous match, scroll up. To go to the next match, scroll down.



Tip: To search for keywords within the page, press 2.

Download and purchase items

You can download items such as ringing tones, images, operator logos, themes, and video clips. These items can be provided free of charge, or you can purchase them. Downloaded items are handled by the respective applications in your device, for

example, a downloaded photo can be saved in Photos.



Important: Only install and use applications and other software from trusted sources, such as applications that are Symbian Signed or have passed the Java Verified testing.

To download an item:

1. Select the link.
2. Select the appropriate option to purchase the item (for example, **Buy**).
3. Carefully read all the information provided.
4. To continue or cancel the download, select the appropriate option (for example, **Accept** or **Cancel**).

When you start a download, a list of ongoing and completed downloads from the current browsing session is displayed.

To modify the list, select **Options** > **Downloads**. In the list, scroll to an item, and select **Options** to cancel ongoing downloads, or open, save, or delete completed downloads.

Bookmarks

The bookmarks view opens when you open the Web application. You can select web addresses from a list

or from a collection of bookmarks in the **Recently visited pages** folder. You can also enter the URL address of the web page you want to visit directly into the field (📄).

📄 indicates the starting page defined for the default access point.

You can save URL addresses as bookmarks while browsing on the internet. You can also save addresses received in messages to your bookmarks and send saved bookmarks.

To open the bookmarks view while browsing, press **1**, or select **Options > Bookmarks**.

To edit the details of a bookmark, such as the title, select **Options > Bookmark manager > Edit**.

In the bookmarks view, you can also open other browser folders. The Web application allows you to save web pages during browsing. In the **Saved pages** folder, you can view the content of the pages you have saved offline.

Web also keeps track of the web pages you visit during browsing. In the **Recently visited pages** folder, you can view the list of visited web pages.

In **Web feeds**, you can view saved links to web feeds and blogs to which you have subscribed. Web feeds are commonly found on major news organisation web pages, personal weblogs, online communities that offer the latest headlines, and

article summaries. Web feeds use RSS and Atom technologies.

Empty the cache

The information or services you have accessed are stored in the cache memory of the device.

A cache is a memory location that is used to store data temporarily. If you have tried to access or have accessed confidential information requiring passwords, empty the cache after each use. The information or services you have accessed are stored in the cache.

To empty the cache, select **Options > Clear privacy data > Cache**.

End the connection

To end the connection and view the browser page offline, select **Options > Tools > Disconnect**; or to end the connection and close the browser, select **Options > Exit**.

To take the browser to the background, press the end key once. To end the connection, press and hold the end key.

To delete the information the network server collects about your visits to various web pages, select **Options > Clear privacy data > Cookies**.

Connection security

If the security indicator (🔒) is displayed during a connection, the data transmission between the device and the internet gateway or server is encrypted.

The security icon does not indicate that the data transmission between the gateway and the content server (or the place where the requested resource is stored) is secure. The service provider secures the data transmission between the gateway and the content server.

Security certificates may be required for some services, such as banking services. You are notified if the identity of the server is not authentic or if you do not have the correct security certificate in your device. For more information, contact your service provider.

Web settings

Press , and select **Web**.

Select **Options** > **Settings** and from the following:

General settings

- **Access point** — Change the default access point. Some or all access points may be preset for your device by your service provider; you may not be able to change, create, edit, or remove them.

- **Homepage** — Define the home page.
- **Mini map** — Set Mini Map on or off. [See "Navigate pages", p. 35.](#)
- **History list** — While browsing, to select **Back** to see a list of the pages you have visited during the current browsing session, set **History list** on.
- **Security warnings** — Hide or show security notifications.
- **Java/ECMA script** — Enable or disable the use of scripts.

Page settings

- **Load content** — Select whether you want to load images and other objects while browsing. If you select **Text only**, to load images or objects later during browsing, select **Options** > **Tools** > **Load images**.
- **Screen size** — Select between full screen and the normal view with the options list.
- **Default encoding** — If text characters are not shown correctly, you can select another encoding according to language for the current page.
- **Block pop-ups** — Allow or block automatic opening of different pop-ups while browsing.
- **Automatic reload** — If you want the web pages to be refreshed automatically while browsing, select **On**.
- **Font size** — Define the font size that is used for web pages.

Privacy settings

- **Recently visited pages** — Enable or disable automatic bookmark collecting. If you want to continue saving the addresses of the visited web pages into the **Recently visited pages** folder, but hide the folder from the bookmarks view, select **Hide folder**.
- **Form data saving** — If you do not want the data you enter to different forms on a web page to be saved and used the next time you open the page, select **Off**.
- **Cookies** — Enable or disable the receiving and sending of cookies.

Web feed settings

- **Automatic updates** — Define whether you want the web feeds to be updated automatically and how often you want to update them. Setting the application to retrieve web feeds automatically may involve the transmission of large amounts of data through your service provider's network. Contact your service provider for information about data transmission charges.
- **Acc. point for auto-update** — Select the desired access point for updating. This option is only available when **Automatic updates** is on.

Connections

Your device offers several options to connect to the internet or to another compatible device or PC.

Wireless LAN

Your device supports wireless local area network (WLAN). With WLAN, you can connect your device to the internet and compatible devices that have WLAN.

About WLAN

To use WLAN, it must be available in the location, and your device must be connected to the WLAN. Some WLANs are protected, and you need an access key from your service provider to connect to them.

Some places, like France, have restrictions on the use of wireless LAN. Check with your local authorities for more information.

Features that use WLAN, or that are allowed to run in the background while using other features, increase the demand on battery power and reduce the battery life.

Your device supports the following WLAN features:

- IEEE 802.11b/g standard

- Operation at 2.4 GHz
- Wired equivalent privacy (WEP) with keys up to 128 bits, Wi-Fi protected access (WPA), and 802.1x encryption methods. These functions can be used only if they are supported by the network.

WLAN connections

To use WLAN, you must create an internet access point (IAP) for WLAN. Use the access point for applications that need to connect to the internet. [See "WLAN internet access points", p. 41.](#)



Important: Always enable one of the available encryption methods to increase the security of your wireless LAN connection. Using encryption reduces the risk of unauthorised access to your data.

A WLAN connection is established when you create a data connection using a WLAN internet access point. The active WLAN connection ends when you end the data connection.

You can use WLAN during a voice call or when packet data is active. You can only be connected to one

WLAN access point device at a time, but several applications can use the same internet access point. When the device is in the offline profile, you can still use WLAN (if available). Remember to comply with any applicable safety requirements when establishing and using a WLAN connection.



Tip: To check the unique media access control (MAC) address that identifies your device, enter ***#62209526#** in the standby mode.

WLAN wizard

The WLAN wizard helps you to connect to a WLAN and manage your WLAN connections.

The WLAN wizard shows the status of your WLAN connections in the active standby mode. To view the available options, scroll to the row showing the status, and select it.

If the search finds WLANs, for example, **WLAN network found** is displayed, to create an internet access point (IAP) and start the web browser using this IAP, select the status and **Start Web browsing**.

If you select a secured WLAN network, you are asked to enter the relevant passcodes. To connect to a hidden network, you must enter the correct network name (service set identifier, SSID). To create a new access point for a hidden WLAN, select **New WLAN**.

If you are connected to a WLAN, the IAP name is displayed. To start the web browser using this IAP, select the status and **Continue Web browsing**. To end the connection in the WLAN, select the status and **Disconnect WLAN**.

If WLAN scanning is off and you are not connected to any WLAN, **WLAN scanning off** is displayed. To set scanning on and search for available WLANs, select the status and press the scroll key.

To start a search for available WLANs, select the status and **Search for WLAN**. To set WLAN scanning off, select the status and select **WLAN scanning off**.

To access the WLAN wizard application in the menu, press , and select **Tools > WLAN wiz.**

WLAN internet access points

Press , and select **Tools > WLAN wiz.**

Select **Options** and from the following:

- **Filter WLAN networks** — Filter out WLANs in the list of found networks. The selected networks are filtered out the next time the application searches for WLANs.
- **Details** — View the details of a network shown in the list. If you select an active connection, the connection details are displayed.
- **Define access point** — Create an internet access point (IAP) in a WLAN.

- **Edit access point** — Edit the details of an existing IAP.

You can also use connection manager to create internet access points. See "[Active data connections](#)", p. 42.

Operating modes

There are two operating modes in WLAN: infrastructure and ad hoc.

The infrastructure operating mode allows two kinds of communication: wireless devices are connected to each other through a WLAN access point device, or wireless devices are connected to a wired LAN through a WLAN access point device.



In the ad hoc operating mode, devices can send and receive data directly with each other.

Connection manager

Active data connections

Press , and select **Tools > Connectivity > Conn. mgr. > Active data connections**.

In the active data connections view, you can see the open data connections:

-  data calls
-  packet data connections

WLAN connections





Note: The actual invoice for calls and services from your service provider may vary, depending on network features, rounding off for billing, taxes, and so forth.

To end a connection, select **Options > Disconnect**. To close all open connections, select **Options > Disconnect all**.

To view the details of a connection, select **Options > Details**.

Available WLAN networks

Press , and select **Tools > Connectivity > Conn. mgr. > Available WLAN networks**.

The available WLAN view shows a list of WLANs within range, their network mode (infrastructure or ad hoc), and signal strength indicator.  is shown for networks with encryption, and  if your device has an active connection in the network.

To view the details of a network, select **Options > Details**.

To create an internet access point in a network, select **Options > Define access point**.

Bluetooth connectivity

About Bluetooth connectivity

You can make a wireless connection to other compatible devices, such as mobile phones, computers, headsets, and car kits, with Bluetooth connectivity.

You can use the connection to send images, video clips, music and sound clips, and notes, transfer files from your compatible PC, and print images with a compatible printer.

Since devices with Bluetooth wireless technology communicate using radio waves, they do not need to be in direct line-of-sight. However, they must be within 10 metres (33 feet) of each other, although the connection may be subject to interference from obstructions such as walls or from other electronic devices.

This device is compliant with Bluetooth Specification 2.0 supporting the following profiles: Generic Audio/Video Distribution Profile, Advanced Audio Distribution Profile, Audio/Video Remote Control Profile, Basic Imaging Profile, Basic Printing Profile, Dial-up Networking Profile, File Transfer Profile, Hands-Free Profile, Headset Profile, Human Interface Device Profile, Object Push Profile, SIM Access Profile, Synchronization Profile, Serial Port Profile, and Phonebook Access Profile. To ensure

interoperability between other devices supporting Bluetooth technology, use Nokia approved enhancements for this model. Check with the manufacturers of other devices to determine their compatibility with this device.

Features using Bluetooth technology increase the demand on battery power and reduce the battery life.

When the device is locked, you cannot use Bluetooth connectivity.

Settings

Press , and select **Tools** > **Bluetooth**.

When you open the application for the first time, you are asked to define a name for your device. You can change the name later on.

Select from the following:

- **Bluetooth** — To make a wireless connection to another compatible device, first set Bluetooth connectivity **On**, then establish a connection. To switch off Bluetooth connectivity, select **Off**.
- **My phone's visibility** — To allow your device to be found by other devices with Bluetooth wireless technology, select **Shown to all**. To set a time after which the visibility is set from shown to hidden, select **Define period**. To hide your device from other devices, select **Hidden**.

- **My phone's name** — Edit the name shown to other devices with Bluetooth wireless technology.
- **Remote SIM mode** — To enable another device, such as a compatible car kit enhancement, to use the SIM card in your device to connect to the network, select **On**. [See "Remote SIM mode", p. 46.](#)

Security tips

Press , and select **Tools > Bluetooth**.

When you are not using Bluetooth connectivity, to control who can find your device and connect to it, select **Bluetooth > Off** or **My phone's visibility > Hidden**.

Do not pair with or accept connection requests from an unknown device. This protects your device from harmful content.

Send data using Bluetooth connectivity

Several Bluetooth connections can be active at a time. For example, if you are connected to a compatible headset, you can also transfer files to another compatible device at the same time.

1. Open the application where the item you want to send is stored. For example, to send an image to another compatible device, open Photos.
2. Select the item and **Options > Send > Via Bluetooth**.

Devices with Bluetooth wireless technology that are within range are displayed. Device icons are as follows:

 computer

 phone

 audio or video device

 other device

To interrupt the search, select **Stop**.

3. Select the device with which you want to connect.
4. If the other device requires pairing before data can be transmitted, a tone sounds, and you are asked to enter a passcode. [See "Pair devices", p. 45.](#)

When the connection is established, **Sending data** is displayed.



Tip: When searching for devices, some devices may show only the unique address (device address). To find the unique address of your device, enter ***#2820#** in the standby mode.

Pair devices

To pair with compatible devices and view your paired devices, in the main view of Bluetooth connectivity, scroll right.

Before pairing, create your own passcode (1 to 16 digits), and agree with the owner of the other device to use the same code. Devices that do not have a user interface have a factory-set passcode. The passcode is used only once.

1. To pair with a device, select **Options > New paired device**. Devices that are within range are displayed.
2. Select the device, and enter the passcode. The same passcode must be entered on the other device as well.
3. Some audio enhancements connect automatically to your device after pairing. Otherwise, scroll to the enhancement, and select **Options > Connect to audio device**.

Paired devices are indicated by  in the device search.

To set a device as authorised or unauthorised, scroll to the device, and select from the following options:

- **Set as authorised** — Connections between your device and the authorised device can be made without your knowledge. No separate acceptance or authorisation is needed. Use this



status for your own devices, such as your compatible headset or PC or devices that belong to someone you trust.  indicates authorised devices in the paired devices view.

- **Set as unauthorised** — Connection requests from this device must be accepted separately every time.

To cancel a pairing, scroll to the device, and select **Options > Delete**.

If you want to cancel all pairings, select **Options > Delete all**.

Receive data using Bluetooth connectivity

When you receive data through Bluetooth connectivity, a tone sounds, and you are asked if you want to accept the message. If you accept,  is displayed, and the item is placed in the Inbox folder in Messaging. Messages received through Bluetooth connectivity are indicated by .



Tip: If your device notifies you that the memory is full when you try to receive data through Bluetooth connectivity, change memory card as the memory where the data is stored.

Block devices

Press , and select **Tools** > **Bluetooth**.

To block a device from establishing a Bluetooth connection to your device, scroll right to open **Paired devices**. Select a device you want to block and **Options** > **Block**.

To unblock a device, scroll right to **Blocked devices**, select a device, and **Options** > **Delete**. To unblock all blocked devices, select **Options** > **Delete all**.

If you reject a pairing request from another device, you are asked if you want to block all future connection requests from this device. If you accept the query, the remote device is added to the list of blocked devices.

Remote SIM mode

Before the remote SIM mode can be activated, the two devices must be paired and the pairing initiated from the other device. When pairing, use a 16-digit passcode, and set the other device as authorised.

To use the remote SIM mode with a compatible car kit enhancement, activate Bluetooth connectivity, and enable the use of the remote SIM mode with your device. Activate the remote SIM mode from the other device.

When the remote SIM mode is on in your device, **Remote SIM mode** is displayed in the standby mode. The connection to the wireless network is turned off, as indicated by  in the signal strength indicator area, and you cannot use SIM card services or features requiring cellular network coverage.

When the wireless device is in the remote SIM mode, you can only use a compatible connected enhancement, such as a car kit, to make or receive calls. Your wireless device will not make any calls while in this mode, except to the emergency numbers programmed into your device. To make calls from your device, you must leave the remote SIM mode. If the device is locked, enter the lock code to unlock it.

To leave the remote SIM mode, press the power key, and select **Exit remote SIM mode**.

USB

Press , and select **Tools** > **Connectivity** > **USB**.

To have the device ask the purpose of the connection each time a compatible data cable is connected, select **Ask on connection** > **Yes**.

If **Ask on connection** is set to off or you want to change the mode during an active connection,

select **USB connection mode** and from the following:

- **PC Suite** — Use Nokia PC applications such as Nokia Nseries PC suite, and Nokia Software Updater.
- **Mass storage** — Transfer data between your device and a compatible PC. Use this mode also for downloading maps with the Nokia Map Loader PC application.
- **Image transfer** — Print images on a compatible printer.
- **Media transfer** — Synchronise music with Windows Media Player.

PC connections

You can use your device with a variety of compatible PC connectivity and data communications applications. With Nokia Nseries PC Suite you can, for example, transfer images between your device and a compatible PC.

For information on Apple Macintosh support and connecting your device to an Apple Macintosh device, visit www.nseries.com/mac.

Personalise your device

You can personalise your device by changing the standby mode, main menu, tones, themes, or font size. Most of the personalisation options, such as changing the font size, can be accessed through the device settings.

Change the look of your device

Press , and select **Tools > Settings > General > Personalisation > Themes**.

Use Themes to change the look of the display, such as the wallpaper and icons.

To change the theme that is used for all the applications in your device, select **General**.

To preview a theme before activating it, select **Options > Preview**. To activate the theme, select **Options > Set**. The active theme is indicated by .

The themes on a compatible memory card (if inserted) are indicated by . The themes on the memory card are not available if the memory card is not inserted in the device. If you want to use the

themes saved in the memory card without the memory card, save the themes in the device memory first.

To change the layout of the main menu, select **Menu view**.

To open a browser connection and download more themes, in **General**, select **Download themes** (network service). Use only services that you trust and that offer adequate security and protection against harmful software.

To have a wallpaper image or a slide show of changing images as the background in the standby mode, select **Wallpaper > Image** or **Slide show**.

To change the background of the call bubble shown when a call comes in, select **Call image**.

Changeable back cover

When you change the back cover of the device, the theme on the display changes to match the colour of the cover.

To change the theme automatically, you must have a compatible back cover that supports theme change.

To select, whether you want the theme to change automatically, press , and select **Tools** > **Settings** > **General** > **Personalisation** > **Themes** > **Theme switch**.

Audio themes

Press , and select **Tools** > **Settings** > **General** > **Personalisation** > **Themes** > **Audio theme**.

In Audio themes, you can select a sound scheme such as 'Space' to cover all device events, such as calling, battery low, and mechanical events. The sounds can be tones, synthesised voice tags, or a combination of both.

Select the sound scheme you want to use in **Active audio theme**. Note that activating an audio theme changes all your previous sound settings. If you want to return to using the default tones, select audio theme 'Nokia'.

You can change the sounds for different events individually by selecting one of the sound groups, for example, **Menu events**.

To add 3-D effects to the audio theme, select **Options** > **3-D ringing tones**. See "[3-D tones](#)", p. 50.

To change the language that is used for the synthesised voice tag, select **Options** > **Set Speech language**.

If you have changed the tones of individual events, you can save the theme by selecting **Options** > **Save theme**.

Set sounds for events

To set the sound of an individual event to silent, open an event group, select the event, and change it to **Silent**.

To set a synthesised voice tag as the sound for an event, open an event group, select the event, and **Speech**. Enter the desired text, and press **OK**. **Speech** is not available if you have set **Say caller's name** on in **Profiles**.

Set tones in Profiles

Press , and select **Tools** > **Profiles**.

You can use profiles to set and customise the ringing tones, message alert tones, and other tones for different events, environments, or caller groups.

To change the profile, select a profile, and **Options** > **Activate**, or press the power key in the

standby mode. Scroll to the profile you want to activate, and select **OK**.



Tip: To switch between the general and silent profiles in the standby mode, press and hold #.

To modify a profile, scroll to the profile, and select **Options** > **Personalise**. Scroll to the setting you want to change, and press the scroll key to open the choices. Tones stored on a compatible memory card (if inserted) are indicated with .

If you want to set a profile to be active a certain time, select **Options** > **Timed**. When the set time expires, the profile changes back to the previously active one. When a profile is timed,  is displayed in the standby mode. The Offline profile cannot be timed.

In the tones list, select **Download sounds** (network service) to open a list of bookmarks. You can select a bookmark and open a connection to a web page to download more tones.

If you want the caller's name to be spoken when your device rings, select **Options** > **Personalise** > **Say caller's name** > **On**. The caller's name must be found in Contacts.

To create a new profile, select **Options** > **Create new**.

3-D tones

Press , select **Tools** > **Utilities** > **3-D tones**.

With 3-D tones, you can enable three-dimensional sound effects for ringing tones. Not all ringing tones support 3-D effects.

To enable the 3-D effects, select **3-D ringing tone effects** > **On**. To change the ringing tone, select **Ringing tone** and the desired ringing tone.

To change the 3-D effect that is applied to the ringing tone, select **Sound trajectory** and the desired effect.

To modify the effect, select from the following settings:

- **Trajectory speed** — Scroll left or right to adjust the speed at which sound moves from one direction to another. This setting is not available for all ringing tones.
- **Reverberation** — Select the type of echo.
- **Doppler effect** — Select **On** to have the ringing tone sound higher when you are closer to your device, and lower when you are farther away. When you get closer to the device, the ringing tone seems to become higher, and lower when you move away from it. This setting is not available for all ringing tones.

To listen to the ringing tone with the 3-D effect, select **Options** > **Play tone**. If you enable the 3-D

tones but do not select any 3-D effect, stereo widening is applied to the ringing tone.

To adjust the ringing tone volume, select **Tools > Profiles > Options > Personalise > Ringing volume**.

Modify the standby mode

To change the look of the standby mode, press , and select **Tools > Settings > General > Personalisation > Standby mode > Standby theme**. The active standby display shows application shortcuts, and events from applications such as calendar and player.

To change the selection key shortcuts or the default shortcut icons in the active standby mode, select **Tools > Settings > General > Personalisation > Standby mode > Shortcuts**. Some shortcuts may be fixed, and you cannot change them.

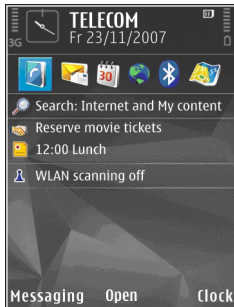

To change the clock shown in the standby mode, press , and select **Applications > Clock > Options > Settings > Clock type**.

You can also change the standby mode background image or what is shown in the power saver in the device settings.



Tip: To check whether there are applications running in the background, press and hold . To close the applications you do not use, scroll to an application in the list, and press **C**. Leaving applications running in the background increases the demand on battery power.

Modify the main menu

To change the main menu view, in the main menu, press  and select **Tools > Settings > General > Personalisation > Themes > Menu view**. You can change the main menu to be shown as **Grid**, **List**, **Horseshoe**, or **V-shaped**.

To rearrange the main menu, in the main menu, select **Options > Move**, **Move to folder**, or **New folder**. You can move applications used less frequently into folders and place applications that you use more often into the main menu.

Positioning (GPS)

You can use applications such as Maps and GPS data to find out your location, or measure distances and coordinates. These applications require a GPS connection.

About GPS

The Global Positioning System (GPS) is a worldwide radio navigation system that includes 24 satellites and their ground stations that monitor the operation of the satellites. Your device has an internal GPS receiver.

A GPS terminal receives low-power radio signals from the satellites and measures the travel time of the signals. From the travel time, the GPS receiver can calculate its location to the accuracy of metres.

The coordinates in the GPS are expressed in degrees and decimal degrees format using the international WGS-84 coordinate system.

The Global Positioning System (GPS) is operated by the government of the United States, which is solely responsible for its accuracy and maintenance. The accuracy of location data can be affected by adjustments to GPS satellites made by the United States government and is subject to change with

the United States Department of Defense civil GPS policy and the Federal Radionavigation Plan. Accuracy can also be affected by poor satellite geometry. Availability and quality of GPS signals may be affected by your location, buildings, natural obstacles, and weather conditions. The GPS receiver should only be used outdoors to allow reception of GPS signals.

Any GPS should not be used for precise location measurement, and you should never rely solely on location data from the GPS receiver and cellular radio networks for positioning or navigation.

To enable or disable different positioning methods, such as Bluetooth GPS, press , and select **Tools > Settings > General > Positioning > Positioning methods**.

Assisted GPS (A-GPS)

Your device also supports Assisted GPS (A-GPS).

A-GPS is a network service.

Assisted GPS (A-GPS) is used to retrieve assistance data over a packet data connection, which assists in calculating the coordinates of your current location

when your device is receiving signals from satellites.

When you activate A-GPS, your device receives useful satellite information from an assistance data server over the cellular network. With the help of assisted data, your device can obtain the GPS position faster.

Your device is preconfigured to use the Nokia A-GPS service, if no service provider-specific A-GPS settings are available. The assistance data is retrieved from the Nokia A-GPS service server only when needed.

You must have an internet access point defined in the device to retrieve assistance data from the Nokia A-GPS service over a packet data connection. To define an access point for A-GPS, press , and select **Tools > Settings > General > Positioning > Positioning server > Access point**. A wireless LAN access point cannot be used for this service. Only a packet data internet access point can be used. Your device asks for the internet access point when GPS is used for the first time.

Hold your device correctly

The GPS receiver is located on the back of the device. When using the receiver, make sure that you do not cover the antenna with your hand.



Establishing a GPS connection may take from a couple of seconds to several minutes. Establishing a GPS connection in a vehicle may take longer.

The GPS receiver draws its power from the device battery. Using the GPS receiver may drain the battery faster.

Tips on creating a GPS connection

If your device cannot find the satellite signal, consider the following:

- If you are indoors, go outdoors to receive a better signal.
- If you are outdoors, move to a more open space.

- Ensure that your hand does not cover the GPS antenna of your device. See "[Hold your device correctly](#)", p. 53.
- If the weather conditions are bad, the signal strength may be affected.
- Some vehicles have tinted (athermic) windows, which may block the satellite signals.

Check satellite signal status

To check how many satellites your device has found, and whether your device is receiving satellite signals, press , and select **Tools** > **Connectivity** > **GPS data** > **Position** > **Options** > **Satellite status**. Or, in the Maps application, select **Options** > **Map view** > **GPS info**.

If your device has found satellites, a bar for each satellite is shown in the satellite info view. The longer the bar, the stronger the satellite signal. When your device has received enough data from the satellite signal to calculate the coordinates of your location, the bar turns black.

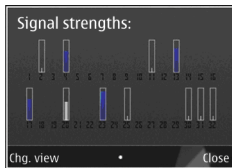

Initially your device must receive signals from at least four satellites to be able to calculate the coordinates of your location. When the initial

calculation has been made, it may be possible to continue calculating the coordinates of your location with three satellites. However, the accuracy is generally better when more satellites are found.

Position requests

You may receive a request from a network service to receive your position information. Service providers may offer information about local topics, such as weather or traffic conditions, based on the location of your device.

When you receive a position request, a message is displayed showing the service that is making the request. Select **Accept** to allow your position information to be sent or **Reject** to deny the request.

Landmarks

Press , and select **Tools** > **Connectivity** > **Landmarks**.

With Landmarks, you can save the position information of specific locations in your device. You can sort the saved locations into different categories, such as business, and add other information to them, such as addresses. You can use

your saved landmarks in compatible applications, such as **GPS data** and **Maps**.

GPS coordinates are expressed in degrees and decimal degrees format using the international WGS-84 coordinate system.

To create a new landmark, select **Options** > **New landmark**. To make a positioning request for your current location, select **Current position**. To enter the position information manually, select **Enter manually**.

To edit or add information to a saved landmark (for example, a street address), scroll to a landmark, and select **Options** > **Edit**. Scroll to the desired field, and enter the information.

You can sort your landmarks into preset categories, and create new categories. To edit and create new landmark categories, scroll right in Landmarks, and select **Options** > **Edit categories**.

To add a landmark to a category, scroll to the landmark in Landmarks, and select **Options** > **Add to category**. Scroll to each category to which you want to add the landmark, and select it.

To send one or several landmarks to a compatible device, select **Options** > **Send**, and the method. Your received landmarks are placed in the **Inbox** folder in Messaging.

GPS data

GPS data is designed to provide route guidance information to a selected destination, position information about your current location, and traveling information, such as the approximate distance to the destination and approximate duration of travel.

Press , and select **Tools** > **Connectivity** > **GPS data**.

The coordinates in the GPS are expressed in degrees and decimal degrees format using the international WGS-84 coordinate system.

To use GPS data, the GPS receiver of your device must initially receive position information from at least four satellites to calculate the coordinates of your location. When the initial calculation has been made, it may be possible to continue calculating the coordinates of your location with three satellites. However, the accuracy is generally better when more satellites are found.

Route guidance

Press , and select **Tools** > **Connectivity** > **GPS data** > **Navigation**.

Start the route guidance outdoors. If started indoors, the GPS receiver may not receive the necessary information from the satellites.

Route guidance uses a rotating compass on the device display. A red ball shows the direction to the destination, and the approximate distance to it is shown inside the compass ring.

Route guidance is designed to show the straightest route and the shortest distance to the destination, measured in a straight line. Any obstacles on the route, such as buildings and natural obstacles, are ignored. Differences in altitude are not taken into account when calculating the distance. Route guidance is active only when you move.

To set your trip destination, select **Options** > **Set destination** and a landmark as the destination, or enter the latitude and longitude coordinates. Select **Stop navigation** to clear the destination set for your trip.

Retrieve position information

Press , and select **Tools** > **Connectivity** > **GPS data** > **Position**.

In the position view, you can view the position information of your current location. An estimate of the accuracy of the location is displayed.

To save your current location as a landmark, select **Options** > **Save position**. Landmarks are saved locations with more information, and they can be used in other compatible applications and transferred between compatible devices.

Trip meter

The trip meter has limited accuracy, and rounding errors may occur. Accuracy can also be affected by availability and quality of GPS signals.

Press , and select **Tools** > **Connectivity** > **GPS data** > **Trip distance**.

Select **Options** > **Start** to activate trip distance calculation, and **Stop** to deactivate it. The calculated values remain on the display. Use this feature outdoors to receive a better GPS signal.

Select **Reset** to set the trip distance and time and average and maximum speeds to zero, and to start a new calculation. Select **Restart** to set the odometer and total time to zero.

Maps

About Maps

Press  , and select **Maps**.

With Maps, you can see your current location on the map, browse maps for different cities and countries, search for addresses and different points of interest, plan routes from one location to another, view traffic details, and save locations as favourites and send them to compatible devices.

You can also purchase extra services, such as guides, a turn-by-turn Drive & Walk navigation service with voice guidance, and a traffic information service.

Maps uses GPS. [See "Positioning \(GPS\)", p. 52.](#) You can define the positioning methods used with your device in the device settings. [See "Positioning settings", p. 166.](#) For the most accurate location information, use either the internal GPS or a compatible external GPS receiver.

When you use Maps for the first time, you may need to define an internet access point for downloading map information for your current location. To change the default access point later, in Maps, select **Options > Tools > Settings > Internet >**

Network destination (shown only when you are online).

When you browse a map in Maps, the map data for the area is automatically downloaded to your device through the internet. A new map is downloaded only if you scroll to an area which is not covered by maps already downloaded. Some maps may be pre-loaded on the memory card in your device.

You can download more maps to your device using Nokia Map Loader PC software. [See "Download maps", p. 59.](#)



Tip: You can also download maps by using a wireless LAN connection.

Downloading maps may involve the transmission of large amounts of data through your service provider's network. Contact your service provider for information about data transmission charges.

If you want the Maps application to establish an internet connection automatically when you start the application, in Maps, select **Options > Tools > Settings > Internet > Go online at start-up > Yes.**

To receive a note when your device registers to a network outside your home cellular network, select **Options > Tools > Settings > Internet > Roaming warning > On** (shown only when you are online). Contact your network service provider for details and roaming costs.

Almost all digital cartography is inaccurate and incomplete to some extent. Never rely solely on the cartography that you download for use in this device.

Browse maps

The map coverage varies by country.

When you open the Maps application, Maps zooms in to the location that was saved from your last session. If no position was saved from the last session, the Maps application zooms in to the capital city of the country you are in based on the information the device receives from the cellular network. At the same time, the map of the location is downloaded, if it has not been downloaded during previous sessions.

Your current location

To establish a GPS connection and zoom in to your current location, select **Options > My position**, or press **0**. If the power saver turns on while the device

is attempting to establish a GPS connection, the attempt is interrupted.

A GPS indicator  is shown on the display. One bar is one satellite. When the device tries to find a satellite, the bar is yellow. When the device receives enough data from the satellite to establish a GPS connection, the bar turns green. The more green bars, the stronger the GPS connection.

When the GPS connection is active, your current location is indicated on the map with .

Move and zoom

To move on the map, scroll up, down, left, or right. The map is oriented towards north by default. The compass rose displays the orientation of the map and rotates during navigation when the orientation changes.

When you browse the map on the display, a new map is automatically downloaded if you scroll to an area which is not covered by maps already downloaded. These maps are free of charge, but downloading may involve the transmission of large amounts of data through your service provider's network. For

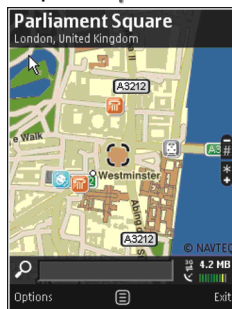

more information on data transmission charges, contact your service provider.

The maps are automatically saved on a compatible memory card (if inserted and set as the default maps storage).

To zoom in or out, press * or #. Use the scale bar to estimate the distance between two points on the map.

Adjust the map view

To define the metric system used in the maps, select **Options > Tools > Settings > Map > System of measurement > Metric or Imperial**.

To define what kinds of points of interest are shown on the map, select **Options > Tools > Settings > Map > Categories** and the desired categories.

To select whether you want to view maps in 2-D mode, 3-D mode, as satellite image, or hybrid, select **Options > Map mode > Map, Map 3D, Satellite, or Hybrid**. Satellite images may not be available for all geographic locations.

To define whether you want the map view to be a day view or a night view, select **Options > Tools > Settings > Map > Colours > Day mode or Night mode**.

To adjust other internet, navigation, routing, and general map settings, select **Options > Tools > Settings**.

Download maps

When you browse a map on the display in Maps, a new map is automatically downloaded if you scroll to an area which is not covered by maps already downloaded. You can view the amount of transferred data from the data counter (kB) shown on the display. The counter shows the amount of network traffic when you browse maps, create routes, or search for locations online. Downloading maps data may involve the transmission of large amounts of data through your service provider's network. Contact your service provider for information about data transmission charges.

To prevent the device from automatically downloading maps through the internet, for example, when you are outside your home cellular network, or other map related data required by the extra services, select **Options > Tools > Settings > Internet > Go online at start-up > No**.

To define how much memory card space you want to use for saving maps or voice guidance files, select **Options > Tools > Settings > Map > Maximum memory use > Max. memory card use**. This option is available only when a compatible memory card is inserted and set as the default maps storage. When the memory is full, the oldest map

data is deleted. The saved maps data can be deleted using Nokia Map Loader PC software.

Nokia Map Loader

Nokia Map Loader is PC software that you can use to download and install maps from the internet to a compatible memory card. You can also use it to download voice files for turn-by-turn navigation.

To use Nokia Map Loader, you must first install it to a compatible PC. You can download the PC software from the internet at www.nokia.com/maps. Follow the instructions on the screen.

You must use the Maps application and browse maps at least once before using Nokia Map Loader. Nokia Map Loader uses the Maps history information to check the version of map data to be downloaded.

After you have installed the PC software to your PC, to download maps, do the following:

1. Connect your device to the PC by using a compatible USB data cable. Select **Mass storage** as the USB connection mode.
2. Open Nokia Map Loader in your PC. Nokia Map Loader checks the version of map data to be downloaded.
3. Select the maps or voice guidance files you want, and download and install them to your device.



Tip: Use Nokia Map Loader to save on mobile data transfer fees.

Find a place

To search for a location or point of interest by keyword, in the main view, enter the name of the place or the desired keyword in the search field, and select **Search**.

To import a location address from your contact information, select **Options > Select from Contacts**.

To use a location on the map, for example, as a starting point for a nearby search, to plan a route, view its details, or start navigation (extra service), press the scroll key, and select the desired option.

To browse through places and attractions by categories in your area, select **Options > Search**, and a category. If you search by an address, you must enter the city and country. You can also use an address you have saved to a contact card in Contacts.

To save a location as a favourite place, in the desired location, press the scroll key, select **Add to My places**, enter a name for the place, and select **OK**. You can also save the location to a route or a collection. To view your saved places, select **Options > Favourites > My places**.

To send a saved place to a compatible device, in the Places view, press the scroll key, and select **Send**. If you send the place in a text message, the information is converted to plain text.

To take a screen shot of your location, select **Options > Tools > Save map screen shot**. The screen shot is saved in Photos. To send the screen shot, open Photos, and select the send option from the active toolbar or the options menu, and the method.

To view your browsing history, places you have viewed on a map, and routes and collections you have created, select **Options > Favourites**, and the desired option.

Plan a route

To plan a route to a destination, scroll to the desired destination, press the scroll key, and select **Add to route**. The location is added to the route.

To add more locations to the route, select **Options > Add route point**. The first selected stopover is the starting point. To change the order of the stopovers, press the scroll key, and select **Move**.

Extra services for Maps

You can purchase a licence and download different kinds of guides, such as city and travel guides, for

different cities to your device. You can also purchase a licence for a turn-by-turn Drive & Walk navigation service with voice guidance, and a traffic information service to use it in Maps. A navigation licence is region specific (region selected when purchasing the licence), and it can be used only on the selected area. The downloaded guides are automatically saved to your device.

The licence you purchase for a guide or navigation can be transferred to another device, but the same licence can only be active in one device at a time.

To view and update your licences, select **Options > Extras > My licenses**.

Traffic and guide information and related services are generated by third parties independent of Nokia. The information may be inaccurate and incomplete to some extent and is subject to availability. Never rely solely on the aforementioned information and related services.

Downloading and using extra services may involve the transmission of large amounts of data through your service provider's network. Contact your service provider for information about data transmission charges.

Navigation

To purchase a Drive & Walk navigation service with voice guidance or Walk navigation only, select

Options > Extras > Drive & Walk or Walk. You can pay for the service through an accepted credit card or have the amount charged to your phone bill (if supported by your cellular network service provider).

Drive navigation

To purchase a Drive & Walk navigation service, select **Options > Extras > Drive & Walk**.

When you use drive navigation for the first time, you are prompted to select the language of the voice guidance and download the voice guidance files of the selected language. You can also download voice guidance files using Nokia Map Loader. [See "Download maps", p. 59.](#)

To change the language later, in the Maps main view, select **Options > Tools > Settings > Navigation > Voice guidance** and a language, and download the voice guidance files for the selected language.

Walk navigation

To purchase a Walk navigation service, select **Options > Extras > Walk**.

Walk navigation differs from drive navigation in many ways: The walking route ignores any possible limitations to car navigation, such as one-way streets and turn restrictions, and includes areas such as pedestrian zones and parks. It also

prioritises walkways and smaller roads, and omits highways and motorways. The length of a walking route is limited to a maximum of 50 kilometres (31 miles) and the travelling speed to a maximum of 30 km/h (18 miles/h). If the speed limit is exceeded, navigation stops and is resumed once the speed is back within limits.

Turn-by-turn navigation or voice guidance are not available for Walk navigation. Instead, a big arrow shows the route and a small arrow at the bottom of the screen points directly to destination. Satellite view is only available for Walk navigation.

Navigate to the desired destination

To start navigation to the desired destination with GPS, select any location on the map or in a results list, and **Options > Drive to or Walk to**.

To switch between different views during navigation, scroll left or right.

To stop navigation, press **Stop**.

To select navigation options, press **Options** during navigation. If driving navigation is active, a menu view with various options is displayed.

Some keypad keys correspond to the options in the view. For example, press **2** to repeat a voice command, **3** to switch between day mode and night mode, and **4** to save the current place.

Traffic information

To purchase a licence for a real-time traffic information service, select **Options > Extras > Traffic info**. The service provides information about traffic events that may affect your travel. Downloading extra services may involve the transmission of large amounts of data through your service provider's network. Contact your service provider for information about data transmission charges.

To view information about traffic events that can cause delays or prevent you from reaching the destination, select **Options > Traffic info**. The events are shown on the map as warning triangles and line indicators. You can use automatic rerouting to avoid them.

To view more information about an event and the possible rerouting options, press the scroll key.

To update the traffic information, select **Update traffic info**. To define how often the traffic information is updated automatically, select **Options > Tools > Settings > Navigation > Traffic info update**.

To automatically create an alternative route in case of a traffic event that would cause delays or prevent you from reaching the destination, select **Options > Tools > Settings > Navigation > Reroute due to traffic > Automatic**.

Guides

To purchase and download different kinds of guides, such as city and travel guides, for different cities to your device, select **Options > Extras > Guides**.

The guides provide information about attractions, restaurants, hotels, and other points of interest. The guides must be downloaded and purchased before use.

To browse a downloaded guide, on the **My guides** tab in Guides, select a guide and a subcategory (if available).

To download a new guide to your device, in Guides, select the desired guide and **Download > Yes**. The purchase process starts automatically. You can pay for the guides using an accepted credit card or have the amount charged to your phone bill (if supported by your cellular network service provider).

To confirm the purchase, select **OK** twice. To receive a confirmation of the purchase through e-mail, enter your name and e-mail address, and select **OK**.

Music folder

Music player



Warning: Listen to music at a moderate level. Continuous exposure to high volume may damage your hearing. Do not hold the device near your ear when the loudspeaker is in use, because the volume may be extremely loud.

Music player supports file formats such as AAC, AAC+, eAAC+, MP3, and WMA. Music player does not necessarily support all features of a file format or all the variations of file formats.

You can also use Music player to listen to podcast episodes. Podcasting is the method for delivering audio or video content over the internet using either RSS or Atom technologies for playback on mobile devices and PCs.

You can transfer music from other compatible devices to your device. [See "Transfer music to your device", p. 67.](#)

Play a song or a podcast episode

To open Music player, press , and select **Music** > **Music player**.



Tip: You can access the Music player from the multimedia menu.

You may have to refresh the music and podcast libraries after you have updated the song or podcast selection in your device. To add all available items to the library, in the Music player main view, select **Options** > **Refresh library**.

To play a song or a podcast episode, do the following:

1. Select categories to navigate to the song or podcast episode you want to hear. If the Navi wheel setting is set on in the settings, to browse the lists, slide your finger on the rim of the scroll key.
2. To play the selected files, press the scroll key.

To pause playback, press the scroll key; to resume, press the scroll key again. To stop playback, scroll down.

To fast forward or rewind, press and hold the scroll key to the right or left.

To go to the next item, scroll right. To return to the beginning of the item, scroll left. To skip to the previous item, scroll left again within 2 seconds after a song or podcast has started.

To switch random play (⏮) on or off, select **Options > Shuffle**.

To repeat the current item (⏮), all items (⏮), or to switch repeat off, select **Options > Repeat**.

If you play podcasts, shuffle and repeat are automatically switched off.

To adjust the volume, press the volume key.

To modify the tone of the music playback, select **Options > Equaliser**.

To modify the balance and stereo image or to enhance bass, select **Options > Audio settings**.

To view a visualisation during playback, select **Options > Show visualisation**.

To return to the standby mode and leave the player playing in the background, press the end key, or to

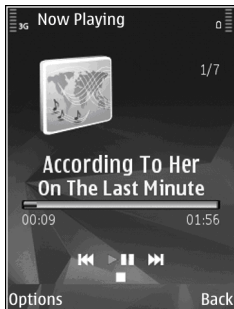

switch to another open application, press and hold **⏻**.

To close the player, select **Options > Exit**.

Music menu

Press **⏻**, and select **Music > Music player**.

The music menu shows the available music. To view all songs, sorted songs, playlists, or podcasts in the music menu, select the desired option.

When the Music player is playing in the background, to open the Now playing view, press and hold the multimedia key.

Playlists

Press **⏻**, and select **Music > Music player**.

To view and manage playlists, in the music menu, select **Playlists**.

To view details of the playlist, select **Options > Playlist details**.

Create a playlist

1. Select **Options > Create playlist**.
2. Enter a name for the playlist, and select **OK**.
3. To add songs now, select **Yes**; or to add the songs later, select **No**.

4. If you select **Yes**, select artists to find the songs you want to include in the playlist. Press the scroll key to add items.

To show the song list under an artist title, scroll right. To hide the song list, scroll left.

5. When you have made your selections, select **Done**.

If a compatible memory card is inserted, the playlist is saved to the memory card.

To add more songs later, when viewing the playlist, select **Options > Add songs**.

To add songs, albums, artists, genres, and composers to a playlist from the different views of the music menu, select an item and **Options > Add to playlist > Saved playlist** or **New playlist**.

To remove a song from a playlist, select **Options > Remove**. This does not delete the song from the device; it only removes it from the playlist.

To reorder songs in a playlist, scroll to the song you want to move, and select **Options > Move**. To grab songs and drop them to a new position, use the scroll key.

Podcasts

Press , and select **Music > Music player > Podcasts**.

The podcast menu displays the podcasts available in the device.

Podcast episodes have three states: never played, partially played, and completely played. If an episode is partially played, it plays from the last playback position the next time it is played. If an episode is never played or completely played, it plays from the beginning.

Home network with music player

You can play content stored in your Nokia device remotely on compatible devices in a home network. You can also copy files from your Nokia device to other devices that are connected to the home network. Home network must be configured first. [See "About home network", p. 100.](#)

Play a song or a podcast remotely

1. Press , and select **Music > Music player**.
2. Select categories to navigate to the song or podcast episode you want to hear. Slide your finger around the rim of the scroll key to browse the lists.
3. Select the desired song or podcast and **Options > Play > Via home network**.
4. Select the device in which the file is played.

Copy songs or podcasts wirelessly

To copy or transfer media files from your device to another compatible device in a home network, select a file and **Options** > **Copy to home network**. Content sharing does not have to be switched on in the home network settings. See "[Set sharing on and define content](#)", p. 102.

Transfer music to your device

You can transfer music from a compatible PC or other compatible devices using a compatible USB data cable or Bluetooth connectivity.

PC requirements for music transfer:

- Microsoft Windows XP operating system (or later)
- A compatible version of the Windows Media Player application. You can get more detailed information about Windows Media Player compatibility from your device's product pages on the Nokia website.
- Nokia Nseries PC Suite 2.1 or later

Windows Media Player 10 may cause playback delays to WMDRM technology protected files after they have been transferred to your device. Check Microsoft support website for a hotfix to Windows Media Player 10 or get a newer compatible version of Windows Media Player.

Transfer music from PC

You can use the following methods to transfer music:

- To view your device on a PC as a mass memory device where you can transfer any data files, make the connection with a compatible USB data cable or Bluetooth connectivity. If you are using a USB cable, select **Mass storage** as the connection mode. A compatible memory card must be inserted in the device.
- To synchronise music with Windows Media Player, connect a compatible USB data cable and select **Media transfer** as the connection mode. A compatible memory card must be inserted in the device.

To change the default USB connection mode, press , and select **Tools** > **Connectivity** > **USB** > **USB connection mode**.

Transfer with Windows Media Player

Music synchronisation functions may vary between different versions of the Windows Media Player application. For more information, see the corresponding Windows Media Player guides and help. The following instructions are for Windows Media Player 11.

Manual synchronisation

With manual synchronisation, you can select the songs and playlists that you want to move, copy, or remove.

1. After your device is connected with Windows Media Player, select your device in the navigation pane on the right, if more than one device is connected.
2. In the left navigation pane, browse the music files on your PC which you want to synchronise.
3. Drag and drop songs to the **Sync List** on the right.

You can see the amount of available memory in your device above the **Sync List**.

4. To remove songs or albums, select an item in the **Sync List**, right-click, and select **Remove from list**.
5. To start the synchronisation, click **Start Sync**.

Automatic synchronisation

1. To activate the automatic synchronisation function in Windows Media Player, click the **Sync** tab, select **Nokia Handset > Set Up Sync...**, and check the **Sync this device automatically** check box.
2. Select the playlists you want to synchronise automatically in the **Available playlists** pane, and click **Add**.

The selected items are transferred to the **Playlists to sync** pane.

3. To finalise the setup for automatic synchronisation, click **Finish**.

When the **Sync this device automatically** check box is checked and you connect your device to the PC, the music library in your device is automatically updated based on the playlists you select for synchronisation in Windows Media Player. If no playlists have been selected, the whole PC music library is selected for synchronisation. If there is not enough free memory in your device, Windows Media Player selects manual synchronisation automatically.

To stop automatic synchronisation, click the **Sync** tab, and select **Stop Sync to 'Nokia Handset'**.

Nokia Music Store

In the Nokia Music Store (network service) you can search, browse, and purchase music to download to your device. To purchase music, you first need to register for the service.

To check the Nokia Music Store availability in your country, visit music.nokia.com.

To access the Nokia Music Store, you must have a valid internet access point in the device.

To open Nokia Music Store, press , and select **Music > Music store**.

To find more music in different categories of the music menu, select **Options > Find in Music store**.

Nokia Music Store settings

The availability and appearance of the music store settings may vary. The settings may also be predefined and not editable. If the settings are not predefined, you may be asked to select the access point to use when connecting to the music store. To select the access point, select **Default access point**.

In the music store, you may be able to edit the settings by selecting **Options > Settings**.

FM transmitter

About the FM transmitter

The availability of this feature may vary by country.

At the time of printing, the FM transmitter part of this equipment is intended to be used in the following countries: Belgium, Czech Republic, Denmark, Estonia, Finland, Germany, Iceland, Liechtenstein, Luxembourg, Norway, Portugal, Romania, Slovenia, Spain, Switzerland, Sweden, and the United Kingdom. For the latest information



and the list of non-European countries where the FM transmitter can be used, see www.nseries.com/fmtransmitter. Before using the feature in a foreign country, see www.nseries.com/fmtransmitter to check if use is permitted.

With the FM transmitter, you can play songs in your device through any compatible FM receiver, such as a car radio or a home stereo system.

The operating distance of the FM transmitter is up to a maximum of 3 metres (10 feet). The transmission may be subject to interference due to obstructions, such as walls, other electronic devices, or from public radio stations. The FM transmitter may cause interference to nearby FM receivers operating on the same frequency. To avoid interference, always search for a free FM frequency on the receiver before using the FM transmitter.

The FM transmitter cannot be used at the same time as the FM radio of your device.

The operating frequency range of the transmitter is from 88.1 to 107.9 MHz.

When the transmitter is on and transmitting sound,  is displayed in the standby mode. If the transmitter is on, but not transmitting anything,  is displayed and a periodic tone sounds. If the transmitter is not transmitting anything for several minutes, it switches off automatically.

Play a song using FM transmitter

To play a song stored in your device through a compatible FM receiver, do the following:

1. Press , and select **Music > Music player**.
2. Select a song or a playlist to be played.
3. In the Now playing view, select **Options > FM transmitter**.
4. To activate the FM transmitter, set **FM transmitter** to **On**, and enter a frequency that is free from other transmissions. For example, if the frequency 107.8 MHz is free in your area and you tune your FM receiver to it, you must also tune the FM transmitter to 107.8 MHz.
5. Tune the receiving device to the same frequency, and select **Options > Exit**.

To adjust the volume, use the volume function in the receiving device. Listen to music at a moderate level. Continuous exposure to high volume may damage your hearing.

To deactivate the FM transmitter, select **Options > FM transmitter**, and set **FM transmitter** to **Off**.

If music is not played for several minutes, the transmitter switches off automatically.

FM transmitter settings

Press , and select **Music > FM transmitter**.

To activate the FM transmitter, select **FM transmitter > On**.

To set a frequency manually, select **Frequency** and enter the desired value.

To list the previously used frequencies, select **Options > Last frequencies**.

Nokia Podcasting

With the Nokia Podcasting application (network service), you can search, discover, subscribe to, and download podcasts over the air, and play, manage, and share audio and video podcasts with your device.

Podcasting settings

Before using Nokia Podcasting, set your connection and download settings.

The recommended connection method is WLAN. Check with your service provider for terms and data service fees before using other connections. For example, a flat rate data plan can allow large data transfers for one monthly fee.

Connection settings

To edit the connection settings, press , and select **Music > Podcasting > Options > Settings > Connection**.

Define the following:

- **Default access point** — Select the access point to define your connection to the internet.
- **Search service URL** — Define the podcast search service to be used in searches.

Download settings

To edit the download settings, press , and select **Music > Podcasting > Options > Settings > Download**.

Define the following:

- **Save to** — Define the location where you want to save your podcasts.
- **Update interval** — Define how often podcasts are updated.
- **Next update date** — Define the date of the next automatic update.
- **Next update time** — Define the time of next automatic update.

Automatic updates only occur if a specific default access point is selected and Nokia Podcasting is running. If Nokia Podcasting is not running, the automatic updates are not activated.

- **Download limit (%)** — Define the size of the memory that is used for podcast downloads.
- **If limit exceeds** — Define what to do if the downloads exceed the download limit.

Setting the application to retrieve podcasts automatically may involve the transmission of large

amounts of data through your service provider's network. Contact your service provider for information about data transmission charges.

To restore the default settings, select **Options > Restore default** in the settings view.

Search podcasts

Search helps you to find podcasts by keyword or title.

The search engine uses the podcast search service you set up in **Podcasting > Options > Settings > Connection > Search service URL**.

To search for podcasts, press , select **Music > Podcasting > Search**, and enter the desired keywords.



Tip: Search looks for podcast titles and keywords in descriptions, not specific episodes. General topics, such as football or hip-hop, usually give better results than a specific team or artist.

To subscribe to marked channels and add them to your podcasts, select **Subscribe**. You can also add a podcast by selecting one.

To start a new search, select **Options > New search**.

To go the website of the podcast, select **Options > Open web page** (network service).

To see the details of a podcast, select **Options** > **Description**.

To send selected podcasts to another compatible device, select **Options** > **Send**.

Directories

Directories help you to find new podcast episodes to which to subscribe.

To open directories, press , and select **Music** > **Podcasting** > **Directories**.

Contents of the directories change. Select the desired directory folder to update it (network service). The colour of the folder changes, when the update is complete.

Directories can include top podcasts listed by popularity or themed folders.

To open the desired folder topic, select it and **Open**. A list of podcasts is displayed.

To subscribe to a podcast, select the title, and **Update**. After you have subscribed to episodes of a podcast, you can download, manage, and play them in the podcasts menu.

To add a new directory or folder, select **Options** > **New** > **Web directory** or **Folder**. Select a title, URL of the .opml (outline processor markup language) file, and **Done**.

To edit the selected folder, web link, or web directory, select **Options** > **Edit**.

To import an .opml file stored on your device, select **Options** > **Import OPML file**. Select the location of the file, and import it.

To send a directory folder as a multimedia message or using Bluetooth connectivity, select the folder and **Options** > **Send**.

When you receive a message with an .opml file using Bluetooth connectivity, open the file to save the file into the **Received** folder in directories. Open the folder to subscribe to any of the links to add to your podcasts.

Downloads

After you have subscribed to a podcast, from directories, search, or by entering a URL, you can manage, download, and play episodes in **Podcasts**.

To see the podcasts you have subscribed to, select **Podcasting** > **Podcasts**.

To see individual episode titles (an episode is a particular media file of a podcast), select the podcast title.

To start a download, select the episode title. To download or to continue to download selected or

marked episodes, select **Download**. You can download multiple episodes at the same time.

To play a portion of a podcast during download or after partial downloading, select the podcast and **Options > Play preview**.

Fully downloaded podcasts can be found in the **Podcasts** folder, but are not shown until the library is refreshed.

Play and manage podcasts

To display the available episodes from the selected podcast, in **Podcasts**, select **Open**. Under each episode, you see the file format, the size of the file, and time of the upload.

When the podcast is fully downloaded, to play the full episode, select it and **Play**.

To update the selected podcast or marked podcasts, for a new episode, select **Options > Update**.

To stop the updating, select **Options > Stop update**.

To add a new podcast by entering the URL of the podcast, select **Options > New podcast**. If you do not have an access point defined or if during packet data connection you are asked to enter a user name and password, contact your service provider.

To edit the URL of the selected podcast, select **Options > Edit**.

To delete a downloaded podcast or marked podcasts from your device, select **Options > Delete**.

To send the selected podcast or marked podcasts to another compatible device as .opml files as a multimedia message or by Bluetooth connectivity, select **Options > Send**.

To update, delete, and send a group of selected podcasts at once, select **Options > Mark/Unmark**, mark the desired podcasts, and select **Options** to choose the desired action.

To open the website of the podcast (network service), select **Options > Open web page**.

Some podcasts provide the opportunity to interact with the creators by commenting and voting. To connect to the internet to do this, select **Options > View comments**.

Radio applications

Press , select **Music > Radio**, and **Visual Radio** or **Internet radio**.

FM radio

You can use the radio as a traditional FM radio and automatically tune into and save stations. If you tune into stations that offer the Visual Radio service

(network service), you will see information related to the radio programme on the display.

The radio supports Radio Data System (RDS) functionality. Radio stations supporting RDS may display information, such as the name of the station. If activated in the settings, RDS also attempts to scan for an alternative frequency for the currently playing station, if the reception is weak.

When you open the radio for the first time, a wizard helps you to save local radio stations (network service).

If you cannot access the Visual Radio service, the operators and radio stations in your area may not support Visual Radio.

Listen to the radio

The FM radio depends on an antenna other than the wireless device antenna. A compatible headset or enhancement needs to be attached to the device for the FM radio to function properly.



Press , and select **Music > Radio > Visual Radio**.

The quality of the radio broadcast depends on the coverage of the radio station in that particular area.

You can make a call or answer an incoming call while listening to the radio. The radio is muted when there is an active call.

To start a station search, select  or .

To change the frequency manually, select **Options > Manual tuning**.

If you have saved radio stations in your device, to go to the next or previous saved station, select  or .

To adjust the volume, use the volume key.



Warning: Listen to music at a moderate level. Continuous exposure to high volume may damage your hearing. Do not hold the device near your ear when the loudspeaker is in use, because the volume may be extremely loud.

To listen to the radio using the loudspeaker, select **Options > Activate loudspeaker**.

To view available stations based on location, select **Options > Station directory** (network service).

To save the station to which you are currently tuned to your station list, select **Options > Save station**.

To open the list of your saved stations, select **Options > Stations**.

To return to the standby mode while listening to the FM radio in the background, select **Options > Play in background**.

View visual content

To check availability and costs and to subscribe to the service, contact your service provider.

To view available visual content when listening to a saved station that has a visual service ID, select **Options > Start visual service**.

Saved stations

To open the list of your saved stations, select **Options > Stations**.

To listen to a saved station, select **Options > Station > Listen**. To view available visual content for a station with Visual Radio service, select **Options > Station > Start visual service**.

To change station details, select **Options > Station > Edit**.

FM radio settings

Press , and select **Music > Radio > Visual Radio > Options > Settings**

- **Alternative frequencies** — To automatically search for alternative frequencies if the reception is weak, select **Auto scan on**.
- **Auto-start service** — To start Visual Radio automatically when you select a saved station that offers Visual Radio service, select **Yes**.
- **Access point** — Select the access point used for the data connection when using Visual radio

service. You do not need an access point to use the application as an FM radio.

- **Current region** — Select the region where you currently are. This setting is displayed only if there is no network coverage when you start the application.

Your device can display the identity name of the FM station to which you are tuned if the name is being transmitted by the station.

Nokia Internet Radio

With the Nokia Internet Radio application (network service), you can listen to available radio stations on the internet. To listen to radio stations, you must have a WLAN or packet data access point defined in your device. Listening to the stations may involve the transmission of large amounts of data through your service provider's network. The recommended connection method is WLAN. Check with your service provider for terms and data service fees before using other connections. For example, a flat rate data plan can allow large data transfers for a set monthly fee.

Listen to internet radio stations

Press , and select **Music > Radio > Internet radio**.



Warning: Listen to music at a moderate level. Continuous exposure to high volume may damage your hearing. Do not hold the device near your ear when the loudspeaker is in use, because the volume may be extremely loud.

To listen to a radio station on the internet, do the following:

1. Select a station from your favourites or the station directory, or search stations by their name from the Nokia Internet Radio service.

To add a station manually, select **Options** > **Add station manually**. You can also browse for station links with the Web application. Compatible links are automatically opened in the Internet Radio application.

2. Select **Listen**.

The Now playing view opens displaying information about the currently playing station and song.

To stop the playback, press the scroll key; to resume, press the scroll key again.

To adjust the volume, use the volume key.

To view station information, select **Options** > **Station information** (not available if you have saved the station manually).

If you are listening to a station saved in your favourites, scroll left or right to listen to the previous or next saved station.

Favourite stations

To view and listen to your favourite stations, press , and select **Music** > **Radio** > **Internet radio** > **Favourites**.

To add a station manually to favourites, select **Options** > **Add station manually**. Enter the web address of the station and a name that you want to appear in the favourites list.

To add the currently playing station to favourites, select **Options** > **Add to Favourites**.

To view station information, to move a station up or down in the list, or to delete a station from the favourites, select **Options** > **Station** and the desired option.

To view only stations beginning with particular letters or numbers, start entering the characters. Matching stations are displayed.

Search for stations

To search for radio stations in the Nokia Internet Radio service by their name, do the following:

1. In the application main view, select **Search**.
2. Enter a station name or the first letters of it in the search field, and select **Search**.

Matching stations are displayed.

To listen to a station, select it, and **Listen**.

To save a station to your favourites, select it, and **Options** > **Add to Favourites**.

To make another search, select **Options** > **Search again**.

Station directory

Press , and select **Radio** > **Internet radio** > **Station directory**.

The station directory is maintained by Nokia. If you want to listen to internet radio stations outside the directory, add station information manually or browse for station links on the internet with the Web application.

Select how you want the available stations to be sorted:

- **Browse by genre** — View the available radio station genres.
- **Browse by language** — View the languages in which there are stations broadcasting.
- **Browse by country** — View the countries in which there are stations broadcasting.
- **Top stations** — View the most popular stations in the directory.

Internet radio settings

Press , and select **Music** > **Radio** > **Internet radio** > **Options** > **Settings**.

To select the default access point to connect to the network, select **Default access point** and from the available options. Select **Always ask** if you want the device to ask for the access point every time you open the application.

To change the connection speeds for different connection types, select from the following:

- **GPRS connection bitrate** — for GPRS packet data connections
- **3G connection bitrate** — for 3G packet data connections
- **Wi-Fi connection bitrate** — for WLAN connections

The quality of the radio broadcast depends on the selected connection speed. The higher the speed, the better the quality. To avoid buffering, use the highest quality only with high speed connections.

Camera

About the camera

Your Nokia N79 has two cameras. The main, high-resolution camera, is on the back of the device. The secondary, lower resolution camera is on the front. You can use both cameras to capture images and record videos.

Your device supports an image capture resolution of 2592x1944 pixels. The image resolution in this guide may appear different.

The images and video clips are saved in Photos.

[See "Photos", p. 89.](#) The produced images are in the JPEG format. Video clips are recorded in the MPEG-4 file format with the .mp4 file extension, or in the 3GPP file format with the .3gp file extension (sharing quality). [See "Video settings", p. 87.](#)

To free memory for new images and video clips, transfer files to a compatible PC using a compatible USB data cable, for example, and remove the files from your device. The device informs you when the memory is full. You can then free up memory in the current storage or change the memory in use.

You can send images and video clips in a multimedia message, as an e-mail attachment, or by using other

connection methods, such as Bluetooth connectivity or a wireless LAN connection. You can also upload them to a compatible online album. [See "Share images and videos online", p. 96.](#)

Activate the camera

To activate the main camera, open the lens cover. To activate the main camera when the lens cover is already open and the camera is active in the background, press and hold the capture key.

To close the main camera, close the lens cover.

Keep a safe distance when using the flash. Do not use the flash on people or animals at close range. Do not cover the flash while taking a picture.

Image capture

Still image camera indicators

The still image camera viewfinder displays the following:

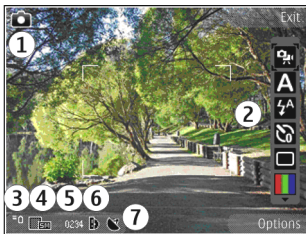

- 1 — Capture mode indicator
- 2 — Active toolbar (not displayed during image capture). [See "Active toolbar", p. 79.](#)
- 3 — Battery charge level indicator
- 4 — Image resolution indicator
- 5 — Image counter (the estimated number of images you can capture using the current image quality setting and memory)
- 6 — The device memory (📁) and memory card (💾) indicators, which show where images are saved
- 7 — GPS signal indicator. [See "Location information", p. 81.](#)

Active toolbar







The active toolbar provides you with shortcuts to different items and settings before and after capturing an image or recording a video. Scroll to items, and select them by pressing the scroll key.

You can also define when the active toolbar is visible on the display.

The settings in the active toolbar return to the default settings after you close the camera.

To view the active toolbar before and after capturing an image or recording a video, select **Options** > **Show toolbar**. To view the active toolbar only when you need it, select **Options** > **Hide toolbar**. To activate the active toolbar when it is hidden, press the scroll key. The toolbar is visible for 5 seconds.

In the active toolbar, select from the following:

-  to switch between the video mode and the image mode
- A** to select the scene
-  to switch the video light on or off (video mode only)
- 4A** to select the flash mode (images only)
-  to activate the self-timer (images only). [See "You in the picture—self-timer", p. 83.](#)
-  to activate the sequence mode (images only). [See "Capture images in a sequence", p. 82.](#)
-  to select a colour effect
-  to show or hide the viewfinder grid (images only)
-  to adjust white balance

 to adjust the exposure compensation (images only)

 to adjust sharpness (images only)

 to adjust contrast (images only)

 to adjust light sensitivity (images only)

The icons change to reflect the current setting.

Saving the captured image may take longer if you change the zoom, lighting, or colour settings.

See ["After taking a picture", p. 81](#). See ["After recording a video", p. 85](#). The active toolbar in Photos has different options. See ["Active toolbar", p. 91](#).

Capture images

When capturing an image, note the following:

- Use both hands to keep the camera still.
- The quality of a digitally zoomed image is lower than that of a nonzoomed image.
- The camera goes into the battery saving mode if there are no keypresses for a moment. To continue capturing images, press the capture key.

To capture an image, do the following:

1. If the camera is in the video mode, select the image mode from the active toolbar.

2. To lock the focus on an object, press the capture key halfway down (main camera only, not available in landscape or sport scene. See ["Active toolbar", p. 79](#)). A green locked focus indicator appears on the display. If the focus was not locked, a red focus indicator appears. Release the capture key, and press it halfway down again. You can also capture an image without locking the focus.

3. To capture an image, press the capture key. Do not move the device before the image is saved and the final image appears on the screen.

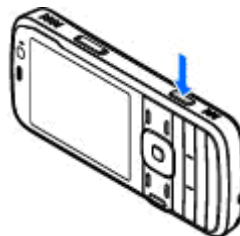

To zoom in or out when capturing an image, use the zoom key in your device.

To activate the front camera, select **Options** > **Use secondary camera**. To capture an image, press the scroll key. To zoom in or out, scroll up or down.



To leave the camera open in the background and use other applications, press . To return to the camera, press and hold the capture key.

Location information

You can automatically add capture location information to the file details of the captured material. For example, in the Photos application you can then view the location where an image was captured.

To add location information to all captured material, in Camera, select **Options** > **Settings** > **Record location** > **Yes**.

Location information indicators at the bottom of the display:

-  — Location information unavailable. GPS stays on in the background for several minutes. If a satellite connection is found and the indicator changes to  within that time, all the images and video captured during that time are tagged based on the received GPS positioning information.
-  — Location information is available. Location information is added to the file details.



[See "Still image camera settings", p. 86.](#)

Files with location information are indicated by  in the Photos application.



After taking a picture

After you take a picture, select from the following options in the active toolbar (available only if **Show**

captured image is enabled in the still image camera settings):

- If you do not want to keep the image, select **Delete** .
- To send the image using a multimedia message, e-mail, or other connection methods, such as Bluetooth connectivity, press the call key, or select **Send** . [See "Write and send messages", p. 118.](#)

If you are in a call, select **Send to caller** .

- To add the image to an album, select **Add to album** .
- To view information about the image, select **Details** .
- To send the image to a compatible online album, select  (available only if you have set up an account for an album). [See "Share images and videos online", p. 96.](#)

To zoom in an image after taking it, select **Options** > **Go to Photos** to open the image, and use the zoom key on the side of your device.

To use the image as wallpaper in the active standby mode, select **Options** > **Set as wallpaper**.

To set the image as a call image for a contact, select **Options** > **Assign to contact**.

To return to the viewfinder to capture a new image, press the capture key.

Flash

The flash is available only in the main camera.

Keep a safe distance when using the flash. Do not use the flash on people or animals at close range. Do not cover the flash while taking a picture.

The camera of your device has a dual LED flash for low light conditions.

Select the desired flash mode from the active toolbar: **Automatic** (⚡A), **Red-eye** (👁), **On** (⚡), and **Off** (🚫).

Scenes

Scenes are only available in the main camera.

A scene helps you to find the right colour and lighting settings for the current environment. The settings of each scene have been set according to a certain style or environment.

The default scene in the image mode is **Auto**, and in the video mode **Automatic** (both indicated with A).

To change the scene, in the active toolbar, select **Scene modes** and a scene.

To make your own scene suitable for a certain environment, scroll to **User defined**, and select **Options** > **Change**. In the user defined scene you can adjust different lighting and colour settings. To copy the settings of another scene, select **Based on scene mode** and the desired scene. To save the changes and return to the scenes list, press **Back**. To activate your own scene, scroll to **User defined**, press the scroll key, and select **Select**.

Capture images in a sequence

The sequence mode is available only in the main camera.

To set the camera to capture images in sequence (if enough memory is available), in the active toolbar, select **Sequence mode**.

To start capturing images in a quick sequence, select **Burst**, and press and hold the capture key. The device captures images until you release the key or until the memory runs out. If you press the capture key briefly, the device captures six image in a sequence.

To capture two or more images in defined intervals, select the desired time interval. To capture the images, press the capture key. To stop capturing images, select **Cancel**. The number of images taken depends on the available memory.

The captured images are shown in a grid on the display. To view an image, press the scroll key. If you used a time interval, only the last captured image is shown on the display. You can view the other images in the Photos application.

You can also use the sequence mode with the self-timer.

To return to the sequence mode viewfinder, press the capture key.

To switch off the sequence mode, in the active toolbar, select **Sequence mode** > **Single shot**.

You in the picture—self-timer

The self-timer is available only in the main camera. Use the self-timer to delay the capture so that you can include yourself in the picture.

To set the self-timer delay, in the active toolbar, select **Self timer** > **2 seconds**, **10 seconds**, or **20 seconds**.

To activate the self-timer, select **Activate**. The device beeps when the timer is running and the quadrangle blinks just before the image capture. The camera takes the picture after the selected delay elapses.

To switch off the self-timer, in the active toolbar, select **Self timer** > **Off**.



Tip: In the active toolbar, select **Self timer** > **2 seconds** to keep your hand steady when taking a picture.

Tips on taking good photographs

Picture quality

Use the appropriate picture quality. The camera has several picture quality modes. Use the highest setting to make sure that the camera produces the best picture quality available. Note however, that better picture quality requires more storage space. For multimedia message (MMS) and e-mail attachments it may be necessary to use the smallest picture quality mode optimised for MMS sending. You can define the quality in the camera settings. [See "Still image camera settings", p. 86.](#)

Background

Use a simple background. For portraits and other pictures with people, avoid having your subject in front of a cluttered, complex background that may distract attention from the subject. Move the camera, or the subject, when these conditions cannot be met. Move the camera closer to the object to take clearer portraits.

Depth

When shooting landscapes and sceneries, add depth to your pictures by placing objects in the

foreground. If the foreground object is too close to the camera, it may be blurred.

Lighting conditions

Changing the source, amount, and direction of light can change photographs dramatically. Here are some typical lighting conditions:

- Light source behind the subject. Avoid placing your subject in front of a strong light source. If the light source is behind the subject or visible in the display, the resulting picture may have weak contrast, may be too dark, and may contain unwanted light effects.
- Sidelit subject. Strong side light gives a dramatic effect but may be too harsh, resulting in too much contrast.
- Light source in front of the subject. Harsh sunlight may cause the subjects to squint their eyes. The contrast may also be too high.
- Optimal lighting is found in situations where there is plenty of diffused, soft light available, for example, on a bright, partially cloudy day or on a sunny day in the shadow of trees.

Video recording

Video capture indicators

The video viewfinder displays the following:

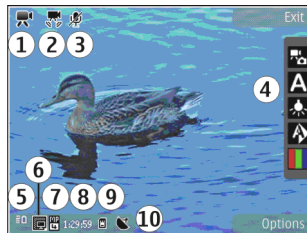

- 1 — Capture mode indicator
- 2 — Video stabilisation on indicator [See "Video settings", p. 87.](#)
- 3 — Audio mute on indicator
- 4 — Active toolbar (not displayed during recording). [See "Active toolbar", p. 79.](#)
- 5 — Battery charge level indicator
- 6 — Video quality indicator. To change this setting, select **Options** > **Settings** > **Video quality**.
- 7 — Video clip file type
- 8 — Available recording time. When you are recording, the current video length indicator also shows the elapsed and remaining time.
- 9 — The location to which the video clip is saved.
- 10 — GPS signal indicator. [See "Location information", p. 81.](#)

To display all viewfinder indicators, select **Options** > **Show icons**. Select **Hide icons** to

display only the video status indicators, and during the recording, the time remaining, zoom bar when zooming, and the selection keys.

Record videos

1. If the camera is in the image mode, select the video mode from the active toolbar.
2. To start recording, press the capture key. The red record icon (●) is displayed and a tone sounds.
3. To pause recording at any time, press **Pause**. Select **Continue** to resume. If you pause recording and do not press any key within one minute, the recording stops.
To zoom in or out of the subject, use the zoom key in your device.
4. To stop recording, press the capture key. The video clip is automatically saved in Photos. The maximum length of a video clip is approximately 30 seconds with sharing quality and 90 minutes with other quality settings.

To activate the front camera, select **Options** > **Use secondary camera**. To start recording a video, press the scroll key. To zoom in or out, scroll up or down.

After recording a video

After you record a video clip, select from the following options in the active toolbar (available only if **Show captured video** is set to **On** in the video settings):

- To immediately play the video clip you just recorded, select **Play** (▶).
- If you do not want to keep the video, select **Delete** (🗑).
- To send the video clip using a multimedia message, e-mail, or other connection methods, such as Bluetooth connectivity, press the call key, or select **Send** (✉). See "[Write and send messages](#)", p. 118. See "[Send data using Bluetooth connectivity](#)", p. 44. This option is not available during a call. You may not be able to send video clips saved in the MPEG-4 file format in a multimedia message.

You can also send the video clip to a person you are talking to. Select **Send to caller** (✉) (only available during a call).

- To add the video clip to an album, select **Add to album** (📁).
- To view information about the video clip, select **Details** (📄).
- To upload the video clip to a compatible online album, select (🌐) (only available if you have set up

an account for a compatible online album). [See "Share images and videos online", p. 96.](#)

- To return to the viewfinder to record a new video clip, press the capture key.

Camera settings

There are two kinds of settings for the camera: setup settings and main settings. The setup settings return to the default settings after you close the camera, but the main settings remain the same until you change them again. To adjust the setup settings, use the options in the active toolbar. [See "Colour and lighting settings", p. 87.](#) To change the main settings, in the image or video mode, select **Options** > **Settings**.

Still image camera settings

To change the main settings, in the image mode, select **Options** > **Settings** and from the following:

- **Image quality** — Set the resolution (main camera only). The better the image quality, the more memory the image consumes.
- **Add to album** — Save the image to an album in Photos.
- **Record location** — To add GPS location coordinates to each image file, select **Yes**. Receiving a GPS signal may take time or the signal

may not be available. [See "Location information", p. 81.](#)

- **Show captured image** — Select whether to view the captured image after it is taken or to continue image capturing immediately.
- **Default image name** — Define the default name for the captured images.
- **Extended digital zoom** — The setting is only available in the main camera. **On (continuous)** allows the zoom increments to be smooth and continuous between digital and extended digital zoom, **On (paused)** allows the zoom increments to pause at the digital and extended digital step point, and **Off** allows a limited amount of zoom while retaining the image resolution. Use the extended zoom only when getting closer to the subject is more important than the final image quality. The overall quality of a digitally zoomed image is always lower than that of an unzoomed image.
- **Capture tone** — Set the tone that sounds when you capture an image.
- **Memory in use** — Select where to store your images.
- **Rotate image** — Select whether you want images that are captured when the device is held upright to be rotated when you open them in Gallery.
- **Restore camera settings** — Restore the camera settings to default values.

Colour and lighting settings

In the active toolbar, select from the following:

- **Flash mode** (🔦) (image only) — Select the desired flash mode.
- **Colour tone** (🎨) — Select a colour effect.
- **Switch video light on** or **Switch video light off** (💡) — Switch the video light on or off (video mode only).
- **White balance** (🌞) — Select the current lighting condition. This allows the camera to reproduce colours more accurately.
- **Exposure compensation** (±0) (image only) — If you are shooting a dark subject against a very light background, such as snow, adjust the exposure to +1 or +2 to compensate for the background brightness. For light subjects against a dark background, use -1 or -2.
- **Sharpness** (🔍) (image only) — Adjust the sharpness of the image.
- **Contrast** (📊) (image only) — Adjust the difference between the lightest and darkest parts of the image.
- **Light sensitivity** (ISO) (image only) — Increase the light sensitivity in low light conditions to avoid too dark images.

The screen display changes to match the settings you make.

The available settings vary depending on the selected camera.

The setup settings are shooting-mode specific. Switching between the modes does not reset the defined settings.

The setup settings return to the default settings when you close the camera.

If you select a new scene, the colour and lighting settings are replaced by the selected scene. You can change the setup settings after selecting a scene if needed.

Video settings

To change the main settings, in the video mode, select **Options** > **Settings** and from the following:

- **Video quality** — Set the quality of the video clip. Select **Sharing**, if you want to send the video clip using a multimedia message. The clip is recorded with QCIF resolution, in 3GPP format, and the size is limited to 300 kB (approximately 30 seconds). You may not be able to send video clips saved in the MPEG-4 format in a multimedia message.
- **Record location** — To add GPS location coordinates to each file, select **Yes**. Receiving the GPS signal may take time or the signal may not be available. [See "Location information", p. 81.](#)
- **Video stabilisation** — Reduce the effects of the camera shaking when recording a video.

- **Audio recording** — Select whether to record sound.
- **Add to album** — Add the recorded video clip to an album in Photos.
- **Show captured video** — Select to view the first frame of the recorded video clip after the recording stops. To view the entire video clip, select **Play** from the active toolbar (main camera) or **Options > Play** (secondary camera).
- **Default video name** — Enter the default name for captured video clips.
- **Memory in use** — Select where you want to store your video clips.
- **Restore camera settings** — Restore the camera settings to default values.

Photos

About Photos

Press , select **Photos** and from the following:

- **Captured** — to show all the photos and videos you have taken
- **Months** — to show photos and videos categorised by the month they were taken
- **Albums** — to show the default albums and those you have created
- **Tags** — to show tags you have created for each item
- **Downloads** — to show items and videos downloaded from the web or received via MMS or email
- **All** — to view all items
- **Share online** — to post photos or videos to the web

Files stored on your compatible memory card (if inserted) are indicated with .

To open a file, press the scroll key. Video clips open and play in Video centre. [See "Nokia Video Centre", p. 106.](#)

To copy or move files to another memory location, select a file, **Options** > **Move and copy**, and from the available options.

View images and videos

Press , select **Photos** and one of the following:

- **All** — View all images and videos.
- **Captured** — View images captured and video clips recorded with the camera of your device.
- **Downloads** — View downloaded video clips and video clips saved in Video centre.

Images and video clips can also be sent to you in a multimedia message, as an e-mail attachment, or through Bluetooth connectivity. To be able to view a received image or video clip in Photos, you must first save it.

The images and video clip files are in a loop and ordered by date and time. The number of files is displayed. To browse the files one by one, scroll left or right. To browse files in groups, scroll up or down. Or, if the Navi wheel setting is activated, to browse the files, slide your finger on the rim of the scroll key.

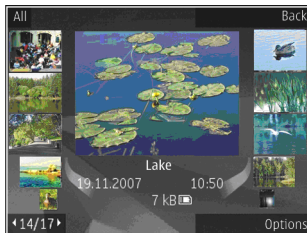

To open a file, press the scroll key. When an image opens, to zoom in the image, press the zoom key on the side of your device. The zooming ratio is not stored permanently.

To edit a video clip or an image, select **Options** > **Edit**. [See "Edit images", p. 94.](#)

To see where an image marked with  was captured, select **Options** > **Show on map**.

To print your images on a compatible printer, or to store them on a compatible memory card (if inserted) for printing, select **Options** > **Print**. [See "Image print", p. 95.](#) To move images to an album for later printing, select **Options** > **Add to album** Print later.

View and edit file details

To view and edit image or video properties, select **Options** > **Details** and from the following:

- **Tags** — Contains currently used tags. Select **Add** to add more tags to the current file. [See "Tags", p. 91.](#)
- **Description** — To add a free-form description of the file, select the field.
- **Location** — This field displays the GPS location information, if available.
- **Title** — This field contains a thumbnail image of the file and the current file name. To edit the name, select the field.
- **Albums** — Displays in which albums the current file is located.
- **Resolution** — Displays the size of the image in pixels.
- **Duration** — Displays the length of the video.
- **Usage rights** — Select **View** to view the DRM rights of this file. [See "Licences", p. 145.](#)

Organise images and videos

You can organise files in Photos as follows:

- To view items in the Tags view, add tags to them. [See "Tags", p. 91.](#)
- To view items by months, select **Months**.

- To create an album to store items, select **Albums > Options > New album**.

To add an image or a video clip to an album in Photos, select the item and **Add to album** from the active toolbar. [See "Albums", p. 91.](#)

To delete an image or video clip, select the image and **Delete** from the active toolbar.



Active toolbar

The active toolbar is available only when you have selected an image or a video clip in a view.

In the active toolbar, scroll up or down to different items, and select them by pressing the scroll key. The available options vary depending on the view you are in and whether you have selected an image or a video clip.

To hide the toolbar, select **Options > Hide icons**. To activate the active toolbar when it is hidden, press the scroll key.

Select from the following:

-  to play the selected video clip
-  to send the selected image or video clip
-  to upload the selected image or video clip to a compatible online album (only available if you have set up an account for a compatible online album). [See "Share images and videos online", p. 96.](#)

 to add the selected item to an album

 to manage tags and other properties of the selected item

 to delete the selected image or video clip

Albums

With albums, you can conveniently manage your images and video clips. To view the albums list in Photos, select **Albums** in the main view.

To create a new album in the albums view, select **Options > New album**.

To add a picture or a video clip to an album in Photos, scroll to a picture or video clip, and select **Options > Add to album**. A list of albums opens. Select the album to which you want to add the picture or video clip. The item you added to the album is still visible in **Photos**.

To remove a file from an album, open the album, scroll to the file, and select **Options > Remove from album**.

Tags

Use tags to categorize media items in Photos. You can create and delete tags in Tag manager. Tag

manager shows the tags currently in use and the number of items associated with each tag.

To open Tag manager, select an image or video clip and select **Options > Details > Tag manager**.

To create a tag, select **Options > New tag**.

To view the list in most frequently used order, select **Options > Most used**.

To view the list in alphabetical order, select **Options > Alphabetical**.

To see the tags you have created, select **Tags** in the Photos main view. The size of the tag name corresponds to the number of items the tag is assigned to. Select a tag to view all the images associated with the tag.

To assign a tag to an image, select an image and select **Options > Add tags**.

To remove an image from a tag, open a tag and select **Options > Remove from tag**.

Slide show

To view your images as a slide show, select an image and **Options > Slide show > Start > Play forwards** or **Play backwards** to start the slide show. The slide show starts from the selected file.

To view only the selected images as a slide show, select **Options > Mark/Unmark > Mark** to mark images, and **Options > Slide show > Start > Play forwards** or **Play backwards** to start the slide show.

Select from the following:

- **Continue** — to resume the slide show, if paused
- **End** — to close the slide show

To browse the images, scroll left or right.

Before starting the slide show, adjust the slide show settings. Select **Options > Slide show > Settings**, and from the following:

- **Music** — to add sound to the slide show.
- **Song** — to select a music file from the list
- **Delay between slides** — to adjust the tempo of the slide show
- **Transition** — to make the slide show move smoothly from one slide to another, and zoom in and out in the images randomly

To adjust the volume during the slide show, use the volume key in your device.

TV-out mode

To view the captured images and video clips on a compatible TV, use a Nokia Video Connectivity Cable.

Before viewing the images and video clips on TV, you may need to configure the TV-out settings for the applicable TV system and TV aspect ratio. [See "Enhancement settings", p. 162.](#)

You cannot use the TV as the camera viewfinder in TV-out mode.

To watch images and video clips on TV, do the following:

1. Connect a Nokia Video Connectivity Cable to the video input of a compatible TV.
2. Connect the other end of the Nokia Video Connectivity Cable to the Nokia AV Connector of your device.
3. You may need to select the cable mode.
4. Press , select **Gallery** and browse for the file you want to view.

The images are shown in the image viewer, and the video clips are played in Video centre.

All audio, including the active calls, stereo video clip sound, key tone, and ringing tone is routed to the TV when the Nokia



Video Connectivity Cable is connected to the device. You can use the device microphone normally.

For all applications other than the folders in **Photos**, the TV screen displays what is displayed on the screen of your device.

The opened image is displayed in full-screen on the TV. When you open an image in the thumbnail view while it is viewed on the TV, zooming in is not available.

When you open a highlighted video clip, Video centre starts playing the video clip on the device display and the TV screen. [See "RealPlayer", p. 144.](#)

You can view images as a slide show on TV. All items in an album or marked images are displayed on the TV in full-screen while the selected music plays. [See "Slide show", p. 92.](#)

The quality of the TV image may vary due to different resolution of the devices.

Wireless radio signals, such as incoming calls, may cause interference in the TV image.

Edit images

Image editor

To edit the pictures after taking them or the ones already saved in Photos, select **Options** > **Edit**. The image editor opens.

To open a grid where you can select different edit options indicated by small icons, select **Options** > **Apply effect**. You can crop and rotate the image; adjust the brightness, colour, contrast, and resolution; and add effects, text, clip art, or a frame to the picture.

Crop image

To crop an image, select **Options** > **Apply effect** > **Crop**, and a predefined aspect ratio from the list. To crop the image size manually, select **Manual**.

If you select **Manual**, a cross appears in the upper left corner of the image. Use the scroll key to select the area to crop, and select **Set**. Another cross appears in the lower right corner. Again select the area to be cropped. To adjust the first selected area, select **Back**. The selected areas form a rectangle that forms the cropped image.

If you select a predefined aspect ratio, select the upper left corner of the area to be cropped. To resize

the highlighted area, use the scroll key. To freeze the selected area, press the scroll key. To move the area within the picture, use the scroll key. To select the area to be cropped, press the scroll key.

Reduce red-eye

To reduce red-eye in an image, select **Options** > **Apply effect** > **Red eye reduction**.

Move the cross onto the eye, and press the scroll key. A loop appears on the display. To resize the loop to fit the size of the eye, use the scroll key. To reduce the redness, press the scroll key. When you have finished editing the image, press **Done**.

To save the changes and return to the previous view, press **Back**.

Useful shortcuts

You can use the following shortcuts when editing images:

- To view a full-screen image, press *. To return to the normal view, press * again.
- To rotate an image clockwise or counterclockwise, press **3** or **1**.
- To zoom in or out, press **5** or **0**.
- To move on a zoomed image, scroll up, down, left, or right.

Edit videos

The video editor supports .3gp and .mp4 video file formats, and .aac, .amr, .mp3, and .wav audio file formats. It does not necessarily support all features of a file format or all the variations of file formats.

To edit video clips in Photos, scroll to a video clip, select **Options** > **Edit**, and from the following:

- **Merge** — to add an image or a video clip to the beginning or the end of the selected video clip
- **Change sound** — to add a new sound clip, and to replace the original sound in the video clip.
- **Add text** — to add text to the beginning or the end of the video clip
- **Cut** — to trim the video and mark the sections you want to keep in the video clip

To take a snapshot of a video clip, in the cut video view, select **Options** > **Take snapshot**. In the thumbnail preview view, press the scroll key, and select **Take snapshot**.

Print images

Image print

To print images with Image print, select the image you want to print, and the print option in Photos, camera, image editor, or image viewer.

Use Image print to print your images using a compatible USB data cable, or Bluetooth connectivity. You can also print images using wireless LAN. If a compatible memory card is inserted, you can store the images to the memory card, and print them using a compatible printer.

You can only print images that are in .jpeg format. The pictures taken with the camera are automatically saved in .jpeg format.

Printer selection

To print images with Image print, select the image and the print option in Photos, camera, image editor, or image viewer.

When you use Image print for the first time, a list of available compatible printers is displayed. Select a printer. The printer is set as the default printer.

To use a printer compatible with PictBridge, connect the compatible data cable before you select the print option, and check that the data cable mode is set to **Image print** or **Ask on connection**. [See "USB", p. 46](#). The printer is automatically displayed when you select the print option.

If the default printer is not available, a list of available printers is displayed.

To change the default printer, select **Options** > **Settings** > **Default printer**.

Print preview

After you select the printer, the selected images are displayed using predefined layouts.

To change the layout, scroll left or right to browse through the available layouts for the selected printer. If the images do not fit on a single page, scroll up or down to display the additional pages.

Print settings

The available options vary depending on the capabilities of the printing device you selected.

To set a default printer, select **Options** > **Default printer**.

To select the paper size, select **Paper size**, the size of paper from the list, and **OK**. Select **Cancel** to return to the previous view.

Print online

With Print online, you can order prints of images online directly to your home or to a store where you can pick them up. You can also order different products with the selected image, such as mugs or mouse pads. The available products depend on the service provider.

For more information on the application, see the guides available at the Nokia product support pages or your local Nokia website.



Share images and videos online

You can share images and video clips in compatible online albums, weblogs, or in other compatible online sharing services on the web. You can upload content, save unfinished posts as drafts and continue later, and view the content of the albums. The supported content types may vary depending on the service provider.

To share images and videos online, you must have an account with an online image sharing service. You can usually subscribe to such a service on the web page of your service provider. Contact your service provider for more information.

Using this service may involve the transmission of large amounts of data through your service provider's network. Contact your service provider for information about data transmission charges.

The recommended connection method is WLAN.

To upload a file from Photos to the online service, press , and select **Photos**. Select an album, scroll to the desired file, and select **Options** > **Send** > **Post to web**, or select the file and  from the active toolbar.







For more information on the application and compatible service providers, see the Nokia product support pages or your local Nokia website.

Gallery

To access your images, video clips, and songs, or store and organise sound clips and streaming links, press , and select **Applications > Media > Gallery**.

Main view

Press , and select **Applications > Media > Gallery**, and from the following:

- **Photos**  — to view images and videos in Photos. [See "About Photos", p. 89.](#)
- **Video clips**  — to view videos in Video centre
- **Songs**  — to open Music player. [See "Music player", p. 64.](#)
- **Sound clips**  — to listen to sound clips
- **Streaming links**  — to view and open streaming links
- **Presentations**  — to view presentations

You can browse and open folders and copy and move items to folders. You can also create albums and copy and add items to albums. [See "Albums", p. 91.](#)

Files stored on your compatible memory card (if inserted) are indicated with .

To open a file, press the scroll key. Video clips, RAM files, and streaming links open and play in Video centre, and music and sound clips in Music player.

To copy or move files to the memory card (if inserted) or to device memory, select a file and **Options > Move and copy > Copy** and from the available options.

Sounds

This folder contains all the sounds you have created with the Recorder application or downloaded from the web.

To listen to sound files, press , select **Applications > Media > Gallery > Sound clips** and a sound file. To pause the playback, press the scroll key.

To fast-forward or rewind, scroll right or left.

To download sounds, select the download link.

Streaming links

To open streaming links, press **9**, and select **Applications > Media > Gallery > Streaming links**. Select a link, and press the scroll key.

To add a new streaming link, select **Options > New link**.

Presentations

With presentations, you can view SVG (scalable vector graphics) files, such as cartoons and maps. SVG images maintain their appearance when printed or viewed with different screen sizes and resolutions.

To view SVG files, press **9**, and select **Applications > Media > Gallery > Presentations**. Scroll to an image, and select **Options > Play**. To pause playing, select **Options > Pause**.

To zoom in, press **5**. To zoom out, press **0**.

To rotate the image 90 degrees clockwise or counterclockwise, press **1** or **3**, respectively. To rotate the image 45 degrees, press **7** or **9**.

To switch between full and normal screen, press *****.

Home network

About home network

Your device is compatible with Universal Plug and Play (UPnP) and certified by Digital Living Network Alliance (DLNA). You can use a wireless LAN (WLAN) access point device or a WLAN router to create a home network. Then you can connect compatible UPnP devices that support WLAN to the network. Compatible devices may be your mobile device, a compatible PC, sound system, or television, or a compatible wireless multimedia receiver connected to a sound system or a television.

To use the WLAN function of your device in a home network, you must have a working WLAN home connection setup and have other UPnP enabled home devices to connect to the same home network. [See "Wireless LAN", p. 40.](#)

After setting up your home network you can share photos, music, and video with your friends and family at home. You are also able to store your media to a media server or retrieve media files from a compatible home server. You can play music stored in your Nokia N79 using a DLNA certified home stereo system, controlling the playlists and volume levels directly from your Nokia N79. You can

also view images captured with the camera of your Nokia N79 on a compatible TV screen, all controlled with the Nokia N79 over WLAN.

The home network uses the security settings of the WLAN connection. Use the home network feature in a WLAN infrastructure network with a WLAN access point device and encryption enabled.

You can share and synchronise media files in your mobile device with other compatible UPnP devices using the home network. To enable the home network functionality and manage the settings, press , and select **Tools > Connectivity > Home media**. You can also use the home network to view, play, and copy compatible media files to and from your mobile device. [See "View and share media files", p. 102.](#)

Your device is connected to the home network only if you accept a connection request from another compatible device, or select the option to view, play, or copy media files on your device or search for other devices.

Important security information

When you configure your WLAN home network, enable an encryption method on your access point device, then on the other devices you intend to connect to your home network. Refer to the documentation of the devices. Keep any passcodes secret and in a safe place separate from the devices.

You can view or change the settings of the WLAN internet access point in your device. [See "Access points", p. 170.](#)

If you use the ad hoc operating mode to create a home network with a compatible device, enable one of the encryption methods in **WLAN security mode** when you configure the internet access point. [See "Connection settings", p. 169.](#) This step reduces the risk of an unwanted party joining the ad hoc network.

Your device notifies you if another device attempts to connect to it and the home network. Do not accept connection requests from an unknown device.

If you use WLAN in a network that does not have encryption, switch off sharing your files with other devices, or do not share any private media files. [See "Settings for home network", p. 101.](#)

Settings for home network

To share media files saved in Photos with other UPnP compatible and DLNA certified devices through WLAN, you must create and configure your WLAN home internet access point, then configure the settings for home network in the Home media application. [See "WLAN internet access points", p. 41.](#)[See "Connection settings", p. 169.](#)

The options related to home network are not available in applications before the settings in the Home media application have been configured.

When you access the Home media application for the first time, the setup wizard opens and helps you define the home network settings for your device. To use the setup wizard later, in the Home media main view, select **Options > Run wizard**, and follow the instructions on the display.

To connect a compatible PC to the home network, on the PC, you must install the related software. You get the software from the CD-ROM or DVD-ROM supplied with your device, or you can download it from the device support pages on the Nokia website.

Configure settings

To configure the settings for home network, select **Tools > Connectivity > Home media > Options > Settings** and from the following:

- **Home access point** — Select **Always ask** if you want the device to ask for the home access point every time you connect to the home network, **Create new** to define a new access point that is used automatically when you use the home network, or **None**. If your home network does not have WLAN security settings enabled, you get a security warning. You can continue and switch the WLAN security on later; or cancel defining the access point and first switch on the WLAN security. [See "Access points", p. 170.](#)
- **Device name** — Enter a name for your device that is shown to the other compatible devices in the home network.
- **Copy to** — Select the memory where you want to save copied media files.

Set sharing on and define content

Select **Tools > Connectivity > Home media > Share content** and from the following:

- **Content sharing** — Allow or deny sharing media files with compatible devices. Do not set content sharing on before you have configured all the other settings. If you set content sharing on, the other UPnP compatible devices in the home network can view and copy your files you have selected for sharing in **Images & video**, and use

playlists you have selected in **Music**. If you do not want the other devices to access your files, set content sharing off.

- **Images & video** — Select media files for sharing with other devices, or view the sharing status of images and videos. To update the content of the folder, select **Options > Refresh content**.
- **Music** — Select playlists for sharing with other devices, or view the sharing status and content of playlists. To update the content of the folder, select **Options > Refresh content**.

View and share media files

To share your media files with other UPnP compatible devices in the home network, set content sharing on. [See "Set sharing on and define content", p. 102.](#) If content sharing is off in your device, you can still view and copy the media files stored in another home network device if it is allowed by the other device.

Show media files stored in your device

To show your images, videos, and sound clips in another home network device, such as a compatible TV, do the following:

1. In Photos, select an image or a video clip; or in Gallery, select a sound clip, and **Options > Show via home network**.

2. Select a compatible device in which the media file is shown. The images are shown both in the other home network device and your device, and the video clips and sound clips are played only in the other device.
3. To stop sharing, select **Options** > **Stop showing**.

Show media files stored in the other device

To show media files that are stored on another home network device in your device (or in a compatible TV, for example), do the following:

1. Press , and select **Tools** > **Connectivity** > **Home media** > **Browse home**. Your device starts the search of other compatible devices. Device names start to appear on the display.
2. Select a device from the list.
3. Select the type of media you want to view from the other device. The available file types depend on the features of the other device.
To search files with different criteria, select **Options** > **Find**. To sort the found files, select **Options** > **Sort by**.
4. Select the media file or folder you want to view.
5. Press the scroll key, and select **Play** or **Show**, and **On device** or **Via home network**.
6. Select the device in which you want to show the file.

To adjust the volume when playing a video or sound clip, scroll left or right.

To stop sharing the media file, select **Back** or **Stop** (available when playing videos and music).



Tip: You can print images saved in Photos through a home network with a UPnP compatible printer. See "[Image print](#)", p. 95. Content sharing does not have to be switched on.

Copy media files

To copy or transfer media files from your device to another compatible device, such as a UPnP compatible PC, select a file in Photos and **Options** > **Move and copy** > **Copy to home network** or **Move to home net..** Content sharing does not have to be switched on.

To copy or transfer files from the other device to your device, select a file in the other device and the desired copying option from the options list. Content sharing does not have to be switched on.

Home synchronisation

Synchronise media files

You can synchronise the media files in your mobile device with those in your home devices. Make sure

that your mobile device is within range of your home WLAN and the home network has been set up.

To set up home synchronisation, select  > **Tools** > **Connectivity** > **Home media** > **Home sync**, and complete the wizard.

To run the wizard later, in Home synchronisation main view, select **Options** > **Run wizard**.

To manually synchronise content in your mobile device with content in your home devices, select **Sync now**.

Synchronisation settings

To change the synchronisation settings, select **Options** > **Synchronisation settings**, and from the following:

- **Synchronisation** — Set automatic or manual synchronisation.
- **Source devices** — Select the source devices for synchronisation.
- **Memory in use** — View and select the memory used.
- **Memory manager** — To be informed when the device is running out of memory, select **Ask when full**.

Define incoming files

To define and manage lists for incoming media files, press , and select **Tools** > **Connectivity** > **Home media** > **Home sync** > **From home** > **Options** > **Open**.

To define the kinds of files you want to transfer to your device, select them from the list.

To edit the transfer settings, select **Options** > **Edit** and from the following:

- **List name** — Enter a new name for the list.
- **Shrink images** — Shrink images to save memory.
- **Amount** — Define the maximum number or total size of the files.
- **Starting with** — Define the download order.
- **From** — Define the date of the oldest file you want to download. Only available for images and video clips.
- **Until** — Define the date of the latest file you want to download. Only available for images and video clips.

For music files you can also specify the genre, artist, album, and track you want to download, and the source device used for downloading.

To browse files in a specific category in your device, select a file type and **Options** > **Show files**.

To create a predefined or customised list for incoming files, select **Options** > **New list**.

To change the priority order of the lists, select **Options** > **Change priority**. Select the list you want to move and **Grab**, move the list to the new location, and select **Drop** to place it there.

Define outgoing files

To specify which types of files in your device to synchronise with your home media devices and how to synchronise them, press , and select **Tools** > **Connectivity** > **Home media** > **Home sync** > **To home** > **Options** > **Open**. Select the media type, **Options**, corresponding settings, and from the following:

- **Target devices** — Select target devices to synchronise with or disable synchronisation.
- **Keep on phone** — Select **Yes** to keep the media content in your device after synchronisation. With images, you can also select whether to keep the original or a scaled version of it in your device. Selecting the original size consumes more memory.

Nokia Video Centre

With Nokia Video Centre (network service), you can download and stream video clips over the air from compatible internet video services using packet data or WLAN. You can also transfer video clips from a compatible PC to your device and view them in Video Centre.

Using packet data access points to download videos may involve the transmission of large amounts of data through your service provider's network. Contact your service provider for information about data transmission charges.

Your device may have predefined services.

Service providers may provide free content or charge a fee. Check the pricing in the service or from the service provider.

View and download video clips

Connect to video services

1. Press , and select **Video centre**.

2. To connect to a service, select **Video directory** and the desired video service from the service catalogue.



Tip: You can access the video services on the **TV & video** tile in the multimedia menu.

View a video clip

To browse the content of installed video services, select **Video feeds**.

To select a video clip, use the scroll key. The content of some video services is divided into categories; to browse video clips, select a category. To search for a video clip in the service, select **Video search**. Search may not be available in all services.

To view information about the selected video clip, select **Options > Video details**.

Some video clips can be streamed over the air, but others must be first downloaded to your device. To download a video clip, select **Options >**

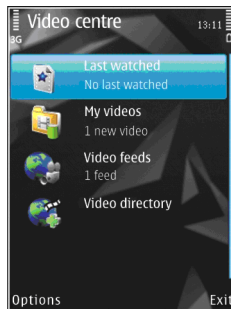

Download. Downloads continue in the background if you exit the application. The downloaded video clips are saved in **My videos**. To stream a video clip or view a downloaded one, select **Options > Play**. When the video clip is playing, to control the video player, use the scroll key and the selection keys. To adjust the volume, press the volume key.

Schedule downloads

Setting the application to download video clips automatically may involve the transmission of large amounts of data through your service provider's network. Contact your service provider for information about data transmission charges. To schedule an automatic download for video clips in a service, select a category and **Options > Schedule downloads**. Video centre automatically downloads new video clips daily at the time you define.

To cancel scheduled downloads for a category, select **Manual download** as the download method.

Video feeds

The content of the installed video services is distributed using RSS feeds. You can view and manage your feeds in **Video feeds**.

To check your current feed subscriptions, select **Options > Feed subscriptions**.

To refresh the content of all feeds, select **Options > Refresh feeds**.

To subscribe to new feeds, select **Options > Add feed**. Select **Via Video directory** to select a feed from the services in the video directory, or **Add manually** to add a video feed address.

To view the videos available in a feed, scroll to it, and press the scroll key.

To view information about a video, select **Options > Feed details**.

To update the contents of the current feed, select **Options > Refresh list**.

To manage your account options for a given feed, if available, select **Options > Manage account**.

To remove a feed from your subscriptions, select **Options > Remove feed**. You may not be able to remove some preinstalled feeds.

My videos

My videos is a storage place for all videos in the Video centre application. You can list downloaded videos and video clips recorded with the device camera in separate views. To open My videos, press , and select **Video centre > My videos**.

To open folders and view video clips, use the scroll key. To control the video player when the video clip

is playing, use the scroll key and the selection keys. To adjust the volume, press the volume key.

To turn sound on or off, select **Options > Mute or Unmute**.

To view file details, select **Options > Video details**.

To play a downloaded video clip in the home network, select **Options > Show via home network**. Home network must be configured first. [See "About home network", p. 100.](#)

To move video clips to other folders in your device, select **Options > Move to folder**.

To create a new folder, select **New folder**.

To move video clips to a compatible memory card, select **Options > Move to memory card**.

Transfer videos from your PC

Transfer your own video clips to Video centre from compatible devices using a compatible USB data cable. Video centre will display only the video clips which are in a format supported by your device.

1. To view your device on a PC as a mass memory device where you can transfer any data files, make the connection with a USB data cable.

2. Select **Mass storage** as the connection mode. A compatible memory card needs to be inserted in the device.
3. Select the video clips you want to copy from your PC.
4. Transfer the video clips to **E:\My Videos** in the memory card.

The transferred video clips appear in the **My videos** folder in Video centre. Video files in other folders of your device are not displayed.

Video centre settings

In the Video centre main view, select **Options > Settings** and from the following:

- **Video service selection** — Select the video services you want to appear in Video centre. You can also view the details of a video service.
- **Default access points** — Select **Always ask** or **User-defined** to choose the access points used for the data connection. Using packet data access points to download files may involve the transmission of large amounts of data through your service provider's network. Contact your service provider for information about data transmission charges.

- **Parental control** — Activate the parental lock for video services, if the service provider has set age limits for videos.
- **Thumbnails** — Select whether to download and view thumbnail images in video feeds.

N-Gage

About N-Gage

N-Gage is a mobile gaming platform available for a range of compatible Nokia mobile devices. You can access N-Gage games, players, and content through the N-Gage application on your device. You can also download games and access some features on your computer at www.n-gage.com.

With N-Gage, you can download and buy games, and play them by yourself or with friends. You can download game trials to try out new games, and buy the ones you like. N-Gage also provides a way to keep in touch with other players, and to track and share your scores and other gaming achievements.

To use N-Gage, you need a GPRS or 3G connection. You can also use WLAN if available. You also need the connection to access online features such as downloading games, game licenses, multiplayer gaming, or chat. You also need the connection to participate in online or multiplayer games, or to send messages to other players.

All N-Gage services, where connection to N-Gage servers is required, such as game file downloading, game purchase, online games, multiplayer gaming,

creating a player name, chat, and messaging, involve transmission of large amounts of data.

Your service provider will charge for data transfer. For more information about data transfer plans, contact your mobile service provider.

N-Gage views

The N-Gage application consists of five different parts.

 Home opens when you start the N-Gage application. You can start playing or resume the game you played last, check your current N-Gage points, find more games, read your messages, or connect with an N-Gage friend who is available to play.

 In My games, you can play and manage games you have downloaded to your device. You can install and delete games, rate and review games you have played, and recommend them to your N-Gage friends.

 In My profile, you can manage your profile information and details, and keep a record of your N-Gage gaming history.

 In My friends, you can invite other N-Gage players to your friends list, and see if they are online and available to play. You can also send messages to your N-Gage friends.

 In Showroom, you can find information about N-Gage games, including screenshots and player reviews. You can also try out new games by downloading game trials, or enhance your gaming experience with game extras for games already on your device.

Get started

Create a player name

You can download, purchase, and play games without a player name, but creating one is recommended. A player name enables you to participate in the N-Gage community, connect with other players, and share your gaming achievements, recommendations, and reviews. You also need a player name to transfer your profile details and N-Gage points to another device.

When you start the N-Gage application and connect to the N-Gage service for the first time, you are prompted to create an N-Gage player name. You can connect to the network, for example, by setting your availability by selecting **Options > Set Availability > Available to Play**.

If you already have an N-Gage player name, select I have an account, and enter your user name and password to log in.

To create a new player name:

1. Select Register New Account.
2. Enter your date of birth, desired player name, and password. If the player name is already in use, N-Gage suggests a list of available similar names.
3. To register your player name, enter your details, read and accept the terms and conditions, and select **Register**.

You can also create your player name on the N-Gage website at www.n-gage.com.

When you have created a player name, edit your settings and personal information in the private tab in My profile.

Data transfer charges may apply for player name creation on your device.

Start a game

To start playing the game you last played, go to Home, and select **Start Game**.

To resume a paused game, select **Options > Resume Game**.

Track your progress

To view your current N-Gage points, go to Home, and select **Track My Progress**.

Play with friends

To connect with N-Gage players on your friends list and to invite them to a game, select **Play With Friends**. N-Gage suggests a friend to play with based on your previous gaming history and the availability of your N-Gage friends.

To find a different friend to play with, select **Options > View My Friends**.

This item is not displayed if your friends list is empty. [See "Connect with other players", p. 113.](#)

Play and manage games

To play and manage the games downloaded and installed on your device, select **My Games**. The games are sorted by the last-played date with the most recent first.

There are five possible types of games in My games:

- **Full games** — These are games you have purchased with a full licence. There may be several licence types available, depending on the game and your region.

- **Trial games** — These are full game files to which you have access only for a limited time or which have limited content. When the trial expires, you must purchase a licence to unlock the full game and continue. These games are marked with a trail banner.
- **Demo games** — These are smaller sections of the game with only a very limited set of features and levels. These games are marked with a demo banner.
- **Full expired** — These are games that you have purchased with a limited licence, which is now expired. These games are marked with a clock and an arrow.
- **Not available** — These are full games which you have removed, or which you have downloaded but the installation was not completed. These games are shown as unavailable in the games list. Also, games installed on the memory card are shown as unavailable when the memory card has been removed.

If a game extra has been downloaded but not fully installed, the respective game graphic is also unavailable and the game cannot be played until the game extra has been installed.

Edit profile details

To edit your public profile details, select **Options** > **Edit Profile**, open the public tab, and select from the following:

- **Icon** — Add an image to represent you. When you change the icon, N-Gage shows a list of all the images in your device Gallery that can be used as the icon. Select the image you want from the list, or use the search to find it.
- **Motto** — Add a short personal message. To edit the text, select **Change**.
- **Favorite Game(s)** — Enter the names of your favourite games.
- **Device Model** — The model number of your device. This is defined automatically and cannot be edited.
- **Show Location** — Select whether to display your city and country in your public profile. You can change your location in the private tab.

After you update your profile, log in to the service with your player name to ensure that the changes you made to your profile are synchronised with the N-Gage server.

Connect with other players

To connect with other N-Gage players and to manage your Friends list, go to My friends. You can

search for a particular N-Gage player, invite them to your Friends list, and then see which of your friends are online and available to play. You can also send and receive private messages and game recommendations.

Find and add friends

To invite an N-Gage player to your friends list, enter the player's player name to the **Add a Friend** field in the friends list. Add a message to the invitation, if needed. To send the invitation, select **Send**. If the player accepts the invitation, the player appears on your friends list.

If you do not have any N-Gage friends and want to meet other players, go to N-Gage Arena at www.n-gage.com, and visit the chatrooms and forums.

View friend information

To view information about a friend, such as the friend's current N-Gage points or the most recently played games, scroll to the player on your friends list. You must be online and connected to the N-Gage service to see the current online status of your friends.

The indicator next to the player name shows the friend's availability.

You can send private messages to your N-Gage friends even if you are unavailable or offline.

Sort the friends list

To sort your friends by availability, player name, or N-Gage points, select **Options** > **Sort Friends By**.

Rate a player

To rate a player, scroll to the player on your friends list, and select **Options** > **Rate Player**. You can give a player a rating from one to five stars. The rating you give affects the player's reputation in the community.

Send messages

In My Friends, you can exchange private messages with players in your Friends List. If your Friend is currently logged in to the N-Gage service, the Friend can respond to your message and you can chat one-on-one, similar to instant messaging.

To view new messages received from an N-Gage Friend, scroll to the friend on your Friends list, and select **Options** > **View Message**. Read messages are deleted automatically when you exit N-Gage.

To view Game recommendations, select **Options** > **View Recommendation**. Game recommendations are deleted automatically a week after you receive them.

To send a message to a N-Gage Friend, scroll to the Friend on your Friends List, and select **Options** >

Send Message. The maximum size of a Private Message is 115 characters. To send the message, select **Submit**.

You need a GPRS, 3G, or wireless LAN connection to be able to use the messaging feature. Data transfer charges may apply. For more information, contact your mobile service provider.

N-Gage settings

To change your N-Gage settings, select **Options** > **Edit Profile** and scroll to the Private tab. To edit the settings throughout the N-Gage application, select **Options** > **N-Gage Settings**.

Select from the following:

- **Player Name** — You can edit the Player Name only until you log in to the network for the first time. After that, you cannot edit it.
- **Personal Settings** — You can define personal details, which are not shown in your public profile, and subscribe to the N-Gage newsletter. You can also define whether you want to receive notifications from your N-Gage Friends while you are playing games.
- **Connection Settings** — You can allow N-Gage to connect to the network automatically when needed, and define your preferred access point and the data transfer limit that triggers an alert.

- **Account Details** — Your purchase preferences. When you purchase a game, you are asked if you want to save your billing details, including your credit card number, for faster purchasing in the future.

Messaging



Only devices that have compatible features can receive and display multimedia messages. The appearance of a message may vary depending on the receiving device.

Messaging main view

Press , and select **Messaging** (network service).



To create a new message, select **New message**.



Messaging contains the following folders:

-  **Inbox** — Received messages, except e-mail and cell broadcast messages, are stored here.
-  **My folders** — Organise your messages into folders.



Tip: To avoid rewriting messages that you send often, use texts in the **Templates** folder in **My folders**. You can also create and save your own templates.

-  **New mailbox** — Connect to your remote mailbox to retrieve your new e-mail messages, or view your previously retrieved e-mail messages offline.
-  **Drafts** — Draft messages that have not been sent are stored here.

-  **Sent** — The last messages that have been sent, excluding messages sent using Bluetooth connectivity, are stored here. You can change the number of messages to save in this folder.
-  **Outbox** — Messages waiting to be sent are temporarily stored in the outbox, for example, when your device is outside network coverage.
-  **Reports** — You can request the network to send you a delivery report of the text messages and multimedia messages you have sent (network service).



To enter and send service requests (also known as USSD commands), such as activation commands for network services, to your service provider, select **Options** > **Service commands** in the Messaging main view.

Cell broadcast (network service) allows you to receive messages on various topics, such as weather or traffic conditions, from your service provider. For available topics and relevant topic numbers, contact your service provider. In the Messaging main view, select **Options** > **Cell broadcast**.

Cell broadcast messages cannot be received in UMTS networks. A packet data connection may prevent cell broadcast reception.

Write text

Your device supports traditional text input and predictive text input. With predictive text, you can enter any letter with a single keypress. Predictive text input is based on a built-in dictionary to which you can add new words.

When you write text,  is displayed when you write text using traditional text input and  when using predictive text input.

Traditional text input

Press a number key (1–9) repeatedly until the desired character appears. There are more characters available for a number key than are printed on the key.

If the next letter is located on the same key as the present one, wait until the cursor appears (or scroll right to end the time-out period), and enter the letter.

To insert a space, press **0**. To move the cursor to the next line, press **0** three times.

Predictive text input

With predictive input, you can enter any letter with a single keypress. Predictive text input is based on a built-in dictionary to which you can add new words.

1. To turn predictive text input on for all editors in the device, quickly press **#** twice. To turn predictive text input on or off in the general settings, press , and select **Tools > Settings > General > Personalisation > Language > Predictive text**.
2. To write the desired word, press the keys **2–9**. Press each key only once for one letter. For example, to write "Nokia" when the English dictionary is selected, press **6** for N, **6** for o, **5** for k, **4** for i, and **2** for a.

The word suggestion changes after each keypress.

3. When you finish writing the word correctly, scroll right to confirm it, or press **0** to add a space.

If the word is not correct, press ***** repeatedly to view the matching words the dictionary has found one by one.

If the **?** character is shown after the word, the word is not in the dictionary. To add a word to the dictionary, select **Spell**, enter the word using traditional text input, and select **OK**. The word is

added to the dictionary. When the dictionary is full, a new word replaces the oldest added word.

4. Start writing the next word.

Tips on text input

To insert a number in the letter mode, press and hold the desired number key.

To switch between the different character modes, press #.

To delete a character, press C. To delete more than one character, press and hold C.

The most common punctuation marks are available under 1. To scroll them through one by one, if you use traditional text input, press 1 repeatedly. If you use predictive text input, press 1, and then * repeatedly.

To open a list of special characters, press and hold *.



Tip: To select several special characters from the special characters list, press 5 after each highlighted character.

Change the writing language

When you are writing text, you can change the writing language. For example, if you are writing text using a non-Latin alphabet and want to write

Latin characters, such as e-mail or web addresses, you may need to change the writing language.

To change the writing language, select **Options** > **Writing language** and a writing language that uses Latin characters.

After changing the writing language, for example, if you press 6 repeatedly to reach a specific character, changing the writing language gives you access to characters in a different order.

Edit text and lists

To copy and paste text, while pressing and holding #, scroll left or right to highlight text. To copy the text to the clipboard, while still holding #, select **Copy**. To insert the text into a document, press and hold #, and select **Paste**.

To mark an item in a list, scroll to it, and press #.

To mark multiple items in a list, press and hold # while you scroll up or down. To end the selection, stop scrolling, and release #.

Write and send messages

Press , and select **Messaging**.

Before you can create a multimedia message or write an e-mail, you must have the correct

connection settings in place. [See "Define the e-mail settings", p. 121.](#)

The wireless network may limit the size of MMS messages. If the inserted picture exceeds this limit the device may make it smaller so that it can be sent by MMS.

Check the size limit of e-mail messages with your service provider. If you attempt to send an e-mail message that exceeds the size limit of the e-mail server, the message is left in the Outbox folder, and the device attempts to resend it periodically. Sending an e-mail requires a data connection, and continuous attempts to resend the e-mail may increase your phone bill. In the Outbox folder, you can delete such a message, or move it to the Drafts folder.

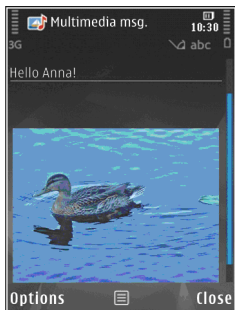

1. Select **New message** > **Message** to send a text or multimedia message (MMS), **Audio message** to send a multimedia message that includes one sound clip, or **E-mail** to send an e-mail message.
2. In the To field, press the scroll key to select recipients or groups from contacts, or enter the recipient's phone number or e-mail address. To

add a semicolon (;) that separates the recipients, press *. You can also copy and paste the number or address from the clipboard.

3. In the Subject field, enter the subject of the e-mail. To change the fields that are visible, select **Options** > **Message header fields**.
4. In the message field, write the message. To insert a template or note, select **Options** > **Insert** > **Insert text** > **Template**, or **Note**.
5. To add a media object to a multimedia message, select **Options** > **Insert content**, the object type or source, and the desired object. To insert a business card, slide, note, or some other file to the message, select **Options** > **Insert content** > **Insert other**.
6. To capture an image or record a video clip or sound for a multimedia message, select **Options** > **Insert** > **Insert image** > **New**, **Insert video clip** > **New**, or **Insert sound clip** > **New**.
7. To add an attachment to an e-mail, select **Options** and the attachment type. E-mail attachments are indicated by .
8. To send the message, select **Options** > **Send**, or press the call key.



Note: The message sent icon or text on your device screen does not indicate that the message is received at the intended destination.

Your device supports text messages beyond the limit for a single message. Longer messages are sent as two or more messages. Your service provider may charge accordingly. Characters with accents or other marks, and characters from some language options, take up more space, and limit the number of characters that can be sent in a single message.

You may not be able to send video clips that are saved in the MP4 file format or that exceed the size limit of the wireless network in a multimedia message.







Tip: You can combine images, video, sound, and text to a presentation and send it in a multimedia message. Start to create a multimedia message, and select **Options > Insert > Insert presentation**. The option is shown only if **MMS creation mode** is set to **Guided** or **Free**. See "[Multimedia message settings](#)", p. 124.

Messaging inbox

Receive messages

Press , and select **Messaging > Inbox**.

In the **Inbox** folder,  indicates an unread text message,  an unread multimedia message,  an unread audio message, and  data received through Bluetooth connectivity.



When you receive a message,  and **1 new message** are shown in the standby mode. To open the message, select **Show**. To open a message in Inbox, scroll to it, and press the scroll key. To reply to a received message, select **Options > Reply**.

Multimedia messages



Important: Exercise caution when opening messages. Messages may contain malicious software or otherwise be harmful to your device or PC.

You may receive a notification that a multimedia message is waiting in the multimedia message centre. To start a packet data connection to retrieve the message to your device, select **Options > Retrieve**.

When you open a multimedia message () you may see an image and a message.  is shown if sound is included, or  if video is included. To play the sound or the video, select the indicator.

To see the media objects that have been included in the multimedia message, select **Options > Objects**.

If the message includes a multimedia presentation,  is displayed. To play the presentation, select the indicator.

Data, settings, and web service messages

Your device can receive many kinds of messages that contain data, such as business cards, ringing tones, operator logos, calendar entries, and e-mail notifications. You may also receive settings from your service provider or company information management department in a configuration message.

To save the data from the message, select **Options** and the corresponding option.

Web service messages are notifications (for example, news headlines) and may contain a text message or a link. For availability and subscription, contact your service provider.

Message reader

With Message reader you can listen to text, multimedia, and audio messages and e-mail.

To change the message reading settings in the Speech application, select **Options** > **Speech**. [See "Speech", p. 159.](#)

To listen to new messages or e-mail, in the standby mode, press and hold the left selection key until Message reader starts.

To listen to messages from your Inbox or e-mail from your Mailbox, select a message and **Options** > **Listen**. To stop the reading, press the end key.

To pause and continue the reading, press the scroll key. To skip to the next message, scroll right. To replay the current message or e-mail, scroll left. To skip to the previous message, scroll left in the beginning of the message. To adjust the volume, scroll up or down.

To view the current message or e-mail in text format without the sound, select **Options** > **View**.

Mailbox

Define the e-mail settings



Tip: To define your mailbox settings, press , and select **Messaging** > **Mailboxes**.

To use e-mail, you must have a valid internet access point (IAP) in the device and define your e-mail settings correctly. [See "Access points", p. 170.](#) [See "E-mail settings", p. 125.](#)

You must have a separate e-mail account. Follow the instructions given by your remote mailbox and internet service provider (ISP).

If you select **New mailbox** in the Messaging main view and have not set up your e-mail account, you are prompted to do so. To start creating the e-mail settings with the mailbox guide, select **Start**.

When you create a new mailbox, the name you give to the mailbox replaces **New mailbox** in the Messaging main view. You can have up to six mailboxes.

Open the mailbox

Press , and select **Messaging** and a mailbox.

When you open the mailbox, the device asks if you want to connect to the mailbox (**Connect to mailbox?**).

To connect to your mailbox and retrieve new e-mail headings or messages, select **Yes**. When you view messages online, you are continuously connected to a remote mailbox using a data connection.

To view previously retrieved e-mail messages offline, select **No**.

To create a new e-mail message, select **New message** > **E-mail** in the Messaging main view or **Options** > **Create message** > **E-mail** in your mailbox. [See "Write and send messages", p. 118.](#)

Retrieve e-mail messages

Press , and select **Messaging** and a mailbox.

If you are offline, select **Options** > **Connect** to start a connection to the remote mailbox.



Important: Exercise caution when opening messages. Messages may contain malicious software or otherwise be harmful to your device or PC.

1. When you have an open connection to a remote mailbox, select **Options** > **Retrieve e-mail** > **New** to retrieve all new messages, **Selected** to retrieve only selected messages, or **All** to retrieve all messages from the mailbox.
To stop retrieving messages, select **Cancel**.
2. To close the connection and view the e-mail messages offline, select **Options** > **Disconnect**.
3. To open an e-mail message, press the scroll key. If the e-mail message has not been retrieved and you are offline, you are asked if you want to retrieve this message from the mailbox.

To view e-mail attachments, open the message, and select the attachment field indicated by . If the indicator is unavailable, the message has not been retrieved to the device; select **Options** > **Retrieve**.

To retrieve e-mail messages automatically, select **Options > E-mail settings > Automatic retrieval**. See "[Automatic retrieval settings](#)", p. 127.

Setting the device to retrieve e-mail automatically may involve the transmission of large amounts of data through your service provider's network. Contact your service provider for information about data transmission charges.

Delete e-mail messages

Press , and select **Messaging** and a mailbox.

To delete the contents of an e-mail message from the device while still retaining it in the remote mailbox, select **Options > Delete**. In **Delete e-mail from:**, select **Phone only**.

The device mirrors the e-mail headings in the remote mailbox. Although you delete the message content, the e-mail heading stays in your device. If you want to remove the heading as well, you must first delete the e-mail message from your remote mailbox, then make a connection from your device to the remote mailbox again to update the status.

To delete an e-mail from the device and the remote mailbox, select **Options > Delete > Phone and server**.

To cancel deleting an e-mail from the device and server, scroll to an e-mail that has been marked to

be deleted during the next connection , and select **Options > Restore**.

Disconnect from the mailbox

When you are online, to end the data connection to the remote mailbox, select **Options > Disconnect**.

View messages on a SIM card

Press , and select **Messaging**.

Before you can view SIM messages, you must copy them to a folder in your device.

1. In the Messaging main view, select **Options > SIM messages**.
2. Select **Options > Mark/Unmark > Mark or Mark all** to mark messages.
3. Select **Options > Copy**. A list of folders opens.
4. To start copying, select a folder and **OK**. To view the messages, open the folder.

Messaging settings

The settings may be preconfigured in your device, or you may receive them in a message. To enter settings manually, fill in all fields marked with **Must be defined** or an asterisk.

Some or all message centres or access points may be preset for your device by your service provider, and you may not be able to change, create, edit, or remove them.

Text message settings

Press , and select **Messaging** > **Options** > **Settings** > **Text message**.

Select from the following:

- **Message centres** — View a list of all text message centres that have been defined.
- **Message centre in use** — Select which message centre to use to deliver text messages.
- **Character encoding** — To use character conversion to another encoding system when available, select **Reduced support**.
- **Receive report** — Select whether the network sends delivery reports on your messages (network service).
- **Message validity** — Select how long the message centre resends your message if the first attempt fails (network service). If the message cannot be sent within the validity period, the message is deleted from the message centre.
- **Message sent as** — Contact your service provider to learn if your message centre is able to convert text messages into these other formats.

- **Preferred connection** — Select the connection to use.
- **Reply via same centre** — Select whether you want the reply message to be sent using the same text message centre number (network service).

Multimedia message settings

Press , and select **Messaging** > **Options** > **Settings** > **Multimedia message**.

Select from the following:

- **Image size** — Define the size of the image in a multimedia message.
- **MMS creation mode** — If you select **Guided**, the device informs you if you try to send a message that may not be supported by the recipient. If you select **Restricted**, the device prevents you from sending messages that may not be supported. To include content in your messages without notifications, select **Free**.
- **Access point in use** — Select which access point is used as the preferred connection.
- **Multimedia retrieval** — Select how you want to receive messages. To receive messages automatically in your home cellular network, select **Auto in home netw..** Outside your home cellular network, you receive a notification that there is a message to retrieve in the multimedia message centre.

Outside your home cellular network, sending and receiving multimedia messages may cost you more.

If you select **Multimedia retrieval** > **Always automatic**, your device automatically makes an active packet data connection to retrieve the message both in and outside your home cellular network.

- **Allow anonymous msgs.** — Select whether you want to reject messages from an anonymous sender.
- **Receive adverts** — Define whether you want to receive multimedia message advertisements.
- **Receive reports** — Select whether you want the status of the sent message to be shown in the log (network service).
- **Deny report sending** — Select whether you want to prevent your device from sending delivery reports of received messages.
- **Message validity** — Select for how long the message centre resends your message if the first attempt fails (network service). If the message cannot be sent within this time period, the message is deleted from the message centre.

E-mail settings

Manage mailboxes

Press , and select **Messaging** > **Options** > **Settings** > **E-mail**.

To select which mailbox you want to use to send e-mail, select **Mailbox in use** and a mailbox.

To remove a mailbox and its messages from your device, select **Mailboxes**, scroll to the desired mailbox, and press **C**.

To create a new mailbox, in **Mailboxes**, select **Options** > **New mailbox**. The name you give to the new mailbox replaces **New mailbox** in the Messaging main view. You can have up to six mailboxes.

Select **Mailboxes** and a mailbox to change the connection settings, user settings, retrieval settings, and automatic retrieval settings.

Connection settings

Press , and select **Messaging** > **Options** > **Settings** > **E-mail** > **Mailboxes**, a mailbox, and **Connection settings**.

To edit the settings for the e-mail you receive, select **Incoming e-mail**, and from the following:

- **User name** — Enter your user name given to you by your service provider.
- **Password** — Enter your password. If you leave this field blank, you are prompted for the password when you try to connect to your remote mailbox.

- **Incoming mail server** — Enter the IP address or host name of the mail server that receives your e-mail.
- **Access point in use** — Select an internet access point (IAP). See "[Access points](#)", p. 170.
- **Mailbox name** — Enter a name for the mailbox.
- **Mailbox type** — Defines the e-mail protocol that your remote mailbox service provider recommends. The options are **POP3** and **IMAP4**. This setting cannot be changed.
- **Security** — Select the security option used to secure the connection to the remote mailbox.
- **Port** — Define a port for the connection.
- **APOP secure login** (for POP3 only) — Use with the POP3 protocol to encrypt the sending of passwords to the remote e-mail server while connecting to the mailbox.

To edit the settings for the e-mail you send, select **Outgoing e-mail** and from the following:

- **My e-mail address** — Enter the e-mail address given to you by your service provider.
- **Outgoing mail server** — Enter the IP address or host name of the mail server that sends your e-mail. You may only be able to use the outgoing server of your service provider. Contact your service provider for more information.

The settings for **User name**, **Password**, **Access point in use**, **Security**, and **Port** are similar to the ones in **Incoming e-mail**.

User settings

Press , and select **Messaging > Options > Settings > E-mail > Mailboxes**, a mailbox, and **User settings**.

Select from the following:

- **My name** — Enter your own name. Your name replaces your e-mail address in the recipient's device when the recipient's device supports this function.
- **Send message** — Define how e-mail is sent from your device. Select **Immediately** for the device to connect to the mailbox when you select **Send message**. If you select **During next conn.**, e-mail is sent when the connection to the remote mailbox is available.
- **Send copy to self** — Select whether you want to send a copy of the e-mail to your own mailbox.
- **Include signature** — Select whether you want to attach a signature to your e-mail messages.
- **New e-mail alerts** — Select whether you want to receive the new e-mail indications (a tone, a note, and a mail indicator) when new mail is received.

Retrieval settings

Press , and select **Messaging > Options > Settings > E-mail > Mailboxes**, a mailbox, and **Retrieval settings**.

Select from the following:

- **E-mail retrieval** — Define which parts of the e-mail are retrieved: **Headers only**, **Size limit** (POP3), or **Msgs. & attachs.** (POP3).
- **Retrieval amount** — Define how many new e-mail messages are retrieved to the mailbox.
- **IMAP4 folder path** (for IMAP4 only) — Define the folder path for folders to be subscribed.
- **Folder subscriptions** (for IMAP4 only) — Subscribe to other folders in the remote mailbox, and retrieve content from those folders.

Automatic retrieval settings

Press , and select **Messaging > Options > Settings > E-mail > Mailboxes**, a mailbox, and **Automatic retrieval**.

Select from the following:

- **E-mail notifications** — To automatically retrieve the headings to your device when you receive new e-mail in your remote mailbox, select **Auto-update** or **Only in home netw..**
- **E-mail retrieval** — To automatically retrieve the headings of new e-mail messages from your remote mailbox at defined times, select **Enabled** or **Only in home netw..** Define when and how often the messages are retrieved.

E-mail notifications and **E-mail retrieval** cannot be active at the same time.

Setting the device to retrieve e-mail automatically may involve the transmission of large amounts of

data through your service provider's network. Contact your service provider for information about data transmission charges.

Web service message settings

Press , and select **Messaging > Options > Settings > Service message**.

Select whether you want to receive service messages. If you want to set the device to automatically activate the browser and start a network connection to retrieve content when you receive a service message, select **Download messages > Automatically**.

Cell broadcast settings

Check the available topics and related topic numbers with your service provider.

Press , and select **Messaging > Options > Settings > Cell broadcast**.

Select from the following:

- **Reception** — Select whether you want to receive cell broadcast messages.
- **Language** — Select the languages in which you want to receive messages: **All**, **Selected**, or **Other**.
- **Topic detection** — Select whether the device automatically searches for new topic numbers,

and saves the new numbers without a name to the topic list.

Other settings

Press , and select **Messaging** > **Options** > **Settings** > **Other**.

Select from the following:

- **Save sent messages** — Select whether you want to save a copy of the text messages, multimedia messages, or e-mail that you send to the **Sent** folder.
- **Number of saved msgs.** — Define how many sent messages are saved to the sent folder at a time. When the limit is reached, the oldest message is deleted.
- **Memory in use** — Select the memory where you want to save your messages.

Make calls

Voice calls

1. In the standby mode, enter the phone number, including the area code. To remove a number, press **C**.

For international calls, press * twice for the + character (which replaces the international access code), and enter the country code, area code (omit the leading zero if necessary), and phone number.

2. To make the call, press the call key.
3. To end the call (or to cancel the call attempt), press the end key.

Pressing the end key always ends a call, even if another application is active.

To make a call from Contacts, press , and select **Contacts**. Scroll to the desired name, or enter the first letters of the name to the search field. To call the contact, press the call key. If you have saved several numbers for a contact, select the desired number from the list, and press the call key.

Options during a call

To adjust the volume during a call, use the volume key on the side of your device. You can also use the scroll key. If you have set the volume to **Mute**, select **Unmute** first.

To send an image or a video clip in a multimedia message to the other participant of the call, select **Options > Send MMS** (in UMTS networks only). You can edit the message and change the recipient before sending. Press the call key to send the file to a compatible device (network service).

To put an active voice call on hold while answering another incoming call, select **Options > Hold**. To switch between the active and the held call, select **Options > Swap**.

To send DTMF tone strings (for example, a password), select **Options > Send DTMF**. Enter the DTMF string or search for it in Contacts. To enter a wait character (w) or a pause character (p), press * repeatedly. To send the tone, select **OK**. You can add DTMF tones to the phone number or DTMF fields in a contact card.



Tip: When you have only one active voice call, to put the call on hold, press the call key. To activate the call, press the call key again.

During an active call, to route the sound from the handset to the loudspeaker, select **Options** > **Activate loudspeaker**. If you have attached a compatible headset with Bluetooth connectivity, to route the sound to the headset, select **Options** > **Activate handsfree**. To switch back to the handset, select **Options** > **Activate handset**.

To end an active call and replace it by answering the waiting call, select **Options** > **Replace**.

If you have several calls active, to end them all, select **Options** > **End all calls**.

Many of the options that you can use during a voice call are network services.

Voice and video mailboxes

To call your voice or video mailbox (network services, video mailbox available only in the UMTS network), press and hold **1** in the standby mode, and select **Voice mailbox** or **Video mailbox**.

To change the phone number of your voice or video mailbox, press **9**, and select **Tools** > **Utilities** > **Call mailbox**, a mailbox, and **Options** > **Change**

number. Enter the number (obtained from your network service provider), and select **OK**.

Answer or decline a call

To answer the call, press the call key.

To mute the ringing tone of an incoming call, select **Silence**.

If you do not want to answer a call, press the end key. If you activate the **Call divert** > **Voice calls** > **If busy** function in phone settings to divert calls, declining an incoming call also diverts the call.

When you select **Silence** to mute the ringing tone of an incoming call, you can send a text message without rejecting the call, informing the caller that you cannot answer the call. Select **Options** > **Send message**. To set up this option and write a standard text message, select **Tools** > **Settings** > **Phone** > **Call** > **Reject call with message**.

Make a conference call

1. Make a call to the first participant.
2. To make a call to another participant, select **Options** > **New call**. The first call is put on hold.

- When the new call is answered, to join the first participant in the conference call, select **Options > Conference**.

To add a new person to the call, repeat step 2, and select **Options > Conference > Add to conference**. Your device supports conference calls between a maximum of six participants, including yourself.

To have a private conversation with one of the participants, select **Options > Conference > Private**. Select a participant, and select **Private**. The conference call is put on hold on your device. The other participants can still continue the conference call. After you finish the private conversation, select **Options > Conference** to return to the conference call.

To drop a participant, select **Options > Conference > Drop participant**, scroll to the participant, and select **Drop**.

- To end the active conference call, press the end key.

Speed dial a phone number

To activate the feature, press , and select **Tools > Settings > Phone > Call > Speed dialling**.

To assign a phone number to one of the number keys (2-9), press , and select **Tools > Utilities > Speed dial**. Scroll to the key to which you want to assign the phone number, and select **Options > Assign**. 1 is reserved for the voice or video mailbox, and for starting the web browser.

To call in the standby mode, press the assigned key and the call key.

Call waiting

You can answer a call while you have another call in progress. To activate call waiting, select **Settings > Phone > Call > Call waiting** (network service).

To answer the waiting call, press the call key. The first call is put on hold.

To switch between the two calls, select **Swap**. To connect an incoming call or a call on hold with an active call and to disconnect yourself from the calls, select **Options > Transfer**. To end the active call, press the end key. To end both calls, select **Options > End all calls**.

Voice dialling

Your device supports enhanced voice commands. Enhanced voice commands are not dependent on the speaker's voice, so do not need to record voice

tags in advance. The device creates a voice tag for the entries in contacts, and compares the spoken voice tag to it. The voice recognition in the device adapts to the main user's voice to recognise the voice commands better.

The voice tag for a contact is the name or nickname that is saved on the contact card. To listen to the synthesised voice tag, open a contact card, and select **Options** > **Voice tag details** > **Play voice tag**.

Make a call with a voice tag



Note: Using voice tags may be difficult in a noisy environment or during an emergency, so you should not rely solely upon voice dialling in all circumstances.

When you use voice dialling, the loudspeaker is in use. Hold the device at a short distance away when you say the voice tag.

1. To start voice dialling, in the standby mode, press and hold the right selection key. If a compatible headset with the headset key is attached, press and hold the headset key to start voice dialling.
2. A short tone sounds, and **Speak now** is displayed. Say clearly the name or nickname that is saved on the contact card.

3. The device plays a synthesised voice tag for the recognised contact in the selected device language, and displays the name and number. If you do not want to call that contact, select **Next** within 2.5 seconds to view a list of other matches or **Quit** to cancel voice dialling.

If several numbers are saved under the name, the device selects the default number if it has been set. If not, the device selects the first available number in a contact card.

Make a video call

When you make a video call (network service), you can see a real-time, two-way video between you and the recipient of the call. The live video image, or video image captured by the camera in your device is shown to the video call recipient.

To be able to make a video call, you must have a USIM card and be in the coverage of a UMTS network. For availability of and subscription to video call services, contact your network service provider.

A video call can only be made between two parties. The video call can be made to a compatible mobile device or an ISDN client. Video calls cannot be made while another voice, video, or data call is active.

Icons

 You are not receiving video (the recipient is not sending video or the network is not transmitting it).

 You have denied video sending from your device. To send a still image instead, select **Tools > Settings > Phone > Call > Image in video call**.

Even if you denied video sending during a video call, the call is still charged as a video call. Check the pricing with your service provider.

1. To start a video call, enter the phone number in the standby mode, or select **Contacts** and a contact.
2. Select **Options > Call > Video call**.

The secondary camera on the front is used by default for video calls. Starting a video call may take a while. **Waiting for video image** is shown. If the call is not successful (for example, video calls are not supported by the network, or the receiving device is not compatible), you are asked if you want to try a normal call or send a text or multimedia message instead.

The video call is active when you see two video images, and hear the sound through the loudspeaker. The call recipient may deny video sending () , in which case you only hear the sound and may see a still image or a grey background graphic.

3. To end the video call, press the end key.

Options during a video call

To change between showing video or hearing only sound, select **Options > Enable**, or **Disable** and the desired option.

To use the main camera to send video, select **Options > Use main camera**. To switch back to the secondary camera, select **Options > Use secondary camera**.

To take a snapshot of the video you are sending, select **Options > Send snapshot**. Video sending is paused and the snapshot is shown to the recipient. The snapshot is not saved. Press **Cancel** to resume sending video.

To zoom your image in or out, select **Options > Zoom**.

To route the audio to a compatible headset with Bluetooth connectivity attached to your device, select **Options > Activate handsfree**. To route the audio back to the loudspeaker of your device, select **Options > Activate handset**.

To change the video quality, select **Options > Video preference**. **Normal quality** is framerate 10 fps. Use **Clearer detail** for small, static details. Use **Smoother motion** for moving images.

To adjust the volume during a video call, use the volume key on the side of the device.

Answer or decline a video call

When a video call arrives,  is displayed.

To answer the video call, press the call key. **Allow video image to be sent to caller?** is displayed. To start sending live video image, select **Yes**.

If you do not activate the video call, you only hear the sound of the caller. A grey screen replaces the video image. To replace the grey screen with a still image captured by the camera in your device, select **Tools > Settings > Phone > Call > Image in video call**.

To end the video call, press the end key.

Video sharing

Use video sharing (network service) to send live video or a video clip from your mobile device to another compatible mobile device during a voice call.

The loudspeaker is active when you activate Video sharing. If you do not want to use the loudspeaker for the voice call while you share video, you can also use a compatible headset.

Video sharing requirements

Video sharing requires a UMTS connection. For more information on the service, UMTS network availability, and fees associated with using this service, contact your service provider.

To use video sharing you must do the following:

- Ensure that your device is set up for person-to-person connections.
- Ensure you have an active UMTS connection and are within UMTS network coverage. If you move outside the UMTS network during a video sharing session, the sharing stops while your voice call continues.
- Ensure that both the sender and recipient are registered to the UMTS network. If you invite someone to a sharing session and the recipient's device is not within UMTS network coverage, does not have video sharing installed, or person-to-person connections set up, the recipient does not receive invitations. You receive an error message that indicates that the recipient cannot accept the invitation.

Settings

To set up video sharing, you need person-to-person and UMTS connection settings.

Person-to-person connection settings

A person-to-person connection is also known as a Session Initiation Protocol (SIP) connection. The SIP profile settings must be configured in your device before you can use video sharing. Ask your service provider for the SIP profile settings, and save them in your device. Your service provider may send you the settings or give you a list of the needed parameters.

To add a SIP address to a contact card:

1. Press , and select **Contacts**.
2. Open the contact card (or start a new card for that person).
3. Select **Options > Add detail > Share video**.
4. Enter the SIP address in the format `username@domainname` (you can use an IP address instead of a domain name).

If you do not know the SIP address for the contact, you can use the phone number of the recipient, including the country code, to share video (if supported by the network service provider).

UMTS connection settings

To set up your UMTS connection:

- Contact your service provider to establish an agreement for you to use the UMTS network.

- Ensure that your device UMTS access point connection settings are configured properly.

Share live video or video clips

During an active voice call, select **Options > Share video**:

1. To share live video during the call, select **Live video**.

To share a video clip, select **Recorded clip** and the clip you want to share.

You may need to convert the video clip into a suitable format to be able to share it. If **Clip must be converted for sharing. Continue?** is shown, select **OK**.

2. Your device sends the invitation to the SIP address. If the recipient has several SIP addresses or phone numbers including the country code saved in **Contacts**, select the desired address or number. If the SIP address or phone number of the recipient is not available, enter the address or number of the recipient including the country code, and select **OK** to send the invitation.



Sharing begins automatically when the recipient accepts the invitation.

Options during video sharing

-  to zoom the video (available for sender only)

 to adjust the brightness (available for sender only)

 or  to mute or unmute the microphone

 or  to switch the loudspeaker on and off

 to switch to full screen mode (available for receiver only)

- To end the sharing session, select **Stop**. To end the voice call, press the end key. When you end the call, video sharing also ends.

To save the live video you shared, select **Save** when prompted. The shared video is saved in Photos.

If you access other applications while you are sharing a video clip, the sharing is paused. To return to the video sharing view and to continue sharing, in the active standby mode, select **Options** > **Continue**.

Accept an invitation

You cannot receive invitations when you are outside UMTS network coverage.

When someone sends you a video sharing invitation, your device rings and the sender's name or SIP address are displayed. To accept the invitation, select **Accept**.

To reject the invitation, select **Reject**, or press the end key. Pressing the end key also ends the voice

call. The sender receives a message that you rejected the invitation.

When you receive a video clip, to mute the sound of the clip, select **Mute**.

To end video sharing, select **Stop**. Video sharing also ends if the active voice call ends.

Log

The log stores information about the communication history of the device. The device registers missed and received calls only if the network supports these functions, the device is switched on, and within the network service area.

Recent calls

Press , and select **Tools** > **Log**.

To view missed, received, and dialed voice calls, select **Recent calls**. The device registers missed and received calls only if the network supports these functions, the device is switched on, and within the network service area.

To clear all recent call lists, select **Options** > **Clear recent calls**. To clear one of the call registers, open the register you want to erase, and select **Options** > **Clear list**. To clear an individual event, open a register, scroll to the event, and press **C**.

Call duration

Press , and select **Tools** > **Log**.

To view the approximate duration of received and dialled calls, select **Call duration**.



Note: The actual invoice for calls and services from your service provider may vary, depending on network features, rounding off for billing, taxes, and so forth.

To clear call duration timers, select **Options** > **Clear timers**. For this you need the lock code.

Packet data

Press , and select **Tools** > **Log**.

To check the amount of data sent and received during packet data connections, select **Packet data**. For example, you may be charged for your packet data connections by the amount of data sent and received.

Monitor all communication events

Press , and select **Tools** > **Log** > **Recent calls**.

Icons in the log are as follows:

 Incoming

 Outgoing

 Missed communication events

To open the general log where you can monitor all voice calls, text messages, or data and wireless LAN connections registered by the device, scroll right. Subevents, such as a text message sent in more than one part and packet data connections, are logged as one communication event. Connections to your mailbox, multimedia messaging centre, or web pages are shown as packet data connections.

To add an unknown phone number from the log to your contacts, select **Options** > **Save to Contacts**.

To filter the log, select **Options** > **Filter** and a filter.

To erase the contents of the log, recent calls register, and messaging delivery reports permanently, select **Options** > **Clear log**. Select **Yes** to confirm. To remove a single event from one of the recent calls logs, press **C**.

To set the log duration, select **Options** > **Settings** > **Log duration**. If you select **No log**, all the log contents, recent calls register, and messaging delivery reports are permanently deleted.



Tip: In the details view, you can copy a phone number to the clipboard, and paste it into a text message, for example. Select **Options** > **Use number** > **Copy**.

To view how much data is transferred and how long a certain packet data connection lasts, scroll to an incoming or outgoing event indicated by **Pack.**, and select **Options** > **View details**.

Internet calls

About internet calls

With the internet call service (network service), you can make and receive calls over the internet.

Internet calls can be established between computers, between mobile phones, and between a VoIP device and a traditional telephone.

To be able to use the service, you must subscribe to the service, and have a user account.

To make or receive an internet call, you must be in the service area of a wireless LAN, and connected to an internet call service.

Activate internet calls

To make or receive internet calls, contact your service provider to receive the internet call connection settings. When the settings have been installed, a new tab for internet calls appears in **Contacts**.

To connect to an internet call service, your device must be in a network service area.

1. To activate your internet call service, open **Contacts**.

2. Scroll to the internet calls tab, and select **Options > Activate service**.

To search for available wireless LAN connections, select **Options > Search for WLAN**.



Tip: When you have activated an internet call service, you can make an internet call from all applications where you can make a regular voice call.

Make internet calls

When you have activated the internet call feature, you can make an internet call from all applications where you can make a regular voice call, such as **Contacts** or the **Log**. For example, in **Contacts**, scroll to the desired contact, and select **Options > Call > Internet call**.

To make an internet call in the standby mode, enter the phone number or internet address, and press the call key.

To make an internet call to an internet address that does not start with a digit, press any number key when the device is in the standby mode, then press **#** for a few seconds to clear the display and to

switch the device from the number mode to the letter mode. Enter the internet address, and press the call key.

Blocked contacts

Blocked contacts are prevented from seeing your online status.

To add contacts to your blocked contacts list, select the contact and **Options** > **Block contact**.

To unblock a contact, scroll to it, and select **Options** > **Unblock**. When you unblock a contact, you allow the contact to see your online status.

To see your blocked contacts, open **Contacts**. Scroll to the internet calls tab, and select **Options** > **View blocked list**.

Manage internet call services

To view or edit internet communication settings, select **Connectivity** > **Net settings** and from the following:

- **Add new service** — to add a new internet call service
- **Advanced settings** — to view or edit advanced call settings

Internet call settings

To view or edit internet call settings, select **Options** > **Contacts**. Scroll to the internet calls tab, and select **Options** > **Settings**.

Select from the following:

- **Service connectivity** — Select the destination settings for internet call connectivity, and edit destination details.
To change a destination, scroll to the service, and select **Change**.
- **Availability requests** — Select whether to automatically accept all incoming presence requests without a confirmation query.
- **Service information** — To view technical information about the selected service.
- **Advanced settings** — Set advanced settings for the service, such as security settings.

Contacts (phonebook)

In Contacts, you can save and update contact information, such as phone numbers, home addresses, or e-mail addresses of your contacts. You can add a personal ringing tone or a thumbnail image to a contact card. You can also create contact groups, which allow you to send text messages or e-mail to many recipients at the same time.

Save and edit names and numbers

1. Press , and select **Contacts** > **Options** > **New contact**.
2. Fill in the fields that you want, and select **Done**.

To edit contact cards, scroll to a contact, and select **Options** > **Edit**. You can also search for the desired contact by entering the first letters of the name to the search field.

To attach an image to a contact card, open the contact card, and select **Options** > **Add image**. The image is shown when the contact calls.

Manage names and numbers

To add a contact to a group, select **Options** > **Add to group** (shown only if you have created a group).

To check to which groups a contact belongs, select the contact and **Options** > **Belongs to groups**.

To delete a contact card, select a card, and press **C**.

To delete several contact cards at the same time, select **Options** > **Mark/Unmark** to mark the desired contact cards, and press **C** to delete.

To send contact information, select a card, **Options** > **Send**, and the desired option.

To listen to the voice tag assigned to the contact, select a contact card and **Options** > **Voice tag details** > **Play voice tag**.

Default numbers and addresses

Press , and select **Contacts**.

You can assign default numbers or addresses to a contact card. In this way if a contact has several numbers or addresses, you can easily call or send a

message to the contact to a certain number or address. The default number is also used in voice dialling.

1. In the contacts list, select a contact.
2. Select **Options** > **Defaults**.
3. Select a default to which you want to add a number or an address, and select **Assign**.
4. Select a number or an address you want to set as a default.

The default number or address is underlined in the contact card.

Add ringing tones for contacts

Press , and select **Contacts**.

To define a ringing tone for a contact or a contact group:

1. Press the scroll key to open a contact card or go to the groups list, and select a contact group.
2. Select **Options** > **Ringing tone**.
3. Select the ringing tone you want to use.

When a contact or group member calls you, the device plays the selected ringing tone (if the caller's phone number is sent with the call and your device recognises it).

To remove the ringing tone, select **Default tone** from the list of ringing tones.

Copy contacts

When you open **Contacts** for the first time, the device asks if you want to copy names and numbers from the SIM card to your device.

To start copying, select **OK**.

If you do not want to copy the SIM contacts to your device, select **Cancel**. The device asks if you want to view the SIM contacts in the contacts directory. To view the contacts, select **OK**. Contacts opens, and you can see names stored on your SIM card marked with .

SIM services

For availability and information on using SIM card services, contact your SIM card vendor. This may be the service provider or other vendor.

SIM contacts

To add the names and numbers stored on the SIM card to the contacts list in Contacts, select **Options** > **Settings** > **Contacts to display** > **SIM memory**. You can add and edit SIM contacts, or call them.

The numbers you save in Contacts are not automatically saved to your SIM card. To save numbers to the SIM card, in Contacts, select a contact and **Options > Copy > SIM memory**.

Fixed dialling

To restrict calls from your device to selected phone numbers, in Contacts, select **Options > Fixed dial contacts**. You need your PIN2 code to activate and deactivate fixed dialling or edit your fixed dialling contacts.

When fixed dialling is activated, calls may be possible to the official emergency number programmed into your device.

To view the list of fixed dialling numbers, select **Options > SIM numbers**. This option is only shown if supported by your SIM card.

To add new numbers to the fixed dialling list, select **Options > New SIM contact**.

When you use fixed dialling, packet data connections are not possible, except when sending text messages over a packet data connection. For this, the message centre number and the recipient's phone number must be included on the fixed dialling list.

Manage contact groups

Create contact groups

1. In Contacts, scroll right to open the groups list.
2. Select **Options > New group**.
3. Write a name for the group or use the default name, and select **OK**.
4. Select the group and **Options > Add members**.
5. Scroll to a contact, and press the scroll key to mark each contact you want to add.
6. Select **OK**.

To rename a group, select **Options > Rename**, enter the new name, and select **OK**.

Remove members from a group

1. In the groups list, select the group you want to modify.
2. Scroll to the contact, and select **Options > Remove from group**.
3. To remove the contact from the group, select **Yes**.

Media folder

RealPlayer

With RealPlayer, you can play video clips or stream media files over the air without saving them to the device first.

RealPlayer supports files with extensions such as .3gp, .mp4, or .rm. However, RealPlayer does not necessarily support all file formats or all the variations of file formats.

Play video clips

Press , and select **Applications > Media > RealPlayer**.

To play a saved media file, select **Video clips**, a clip, and **Play**.

To list previously played files, in the application main view, select **Recently played**.

To adjust the volume, use the volume key.

After you select a media file, select **Options** and from the following:

- **Send** — Send a file using a multimedia message, e-mail, or other connection methods, such as Bluetooth connectivity.

- **Use video** — Assign a video to a contact or set it as a ringing tone.
- **Mark/Unmark** — Mark items in the list to send or delete multiple items at the same time.
- **View details** — View details of the selected item, such as format, resolution, and duration.
- **Settings** — Edit the settings for video playback and streaming.

Stream content over the air

Many service providers require you to use an internet access point (IAP) for your default access point. Other service providers allow you to use a WAP access point.

In RealPlayer, you can only open an `rtsp://` URL address. However, RealPlayer plays a .ram file if you open an HTTP link to it in a browser.

To stream content over the air (network service), in RealPlayer or Photos, select a streaming link saved in the **Streaming links** folder. You can also receive a streaming link in a text message or multimedia message, or open a link on a web page. Before live content begins streaming, your device connects to

the site and starts loading the content. The content is not saved in your device.

RealPlayer settings

Press , and select **Applications > Media > RealPlayer**.

You may receive RealPlayer settings in a special message from the service provider. For more information, contact your service provider.

Select **Options > Settings** and from the following:

- **Video** — Select whether video clips are played in full screen or in the normal view, and whether the clips are automatically repeated after they finish playing.
- **Streaming** — Select whether to use a proxy server, change the default access point, and set the port range used when connecting. Contact your service provider for the correct settings.

Advanced settings

To edit the advanced settings, in the settings view, select **Streaming > Network > Options > Advanced settings**.

To select the bandwidth used for a network, select the network setting and the desired value.

To edit the bandwidth yourself, select **User defined**.

Adobe Flash Player

Press , and select **Applications > Media > Flash Player**.

Use Adobe Flash Player to view, play, and interact with compatible flash files made for mobile devices.

To open a flash file, select it, and **Open**.

Licences

To view digital rights licences, press , and select **Applications > Media > Licences**.

Digital rights management

Content owners may use different types of digital rights management (DRM) technologies to protect their intellectual property, including copyrights. This device uses various types of DRM software to access DRM-protected content. With this device you can access content protected with WMDRM 10, OMA DRM 1.0, and OMA DRM 2.0. If certain DRM software fails to protect the content, content owners may ask that such DRM software's ability to access new DRM-protected content be revoked. Revocation may also prevent renewal of such DRM-protected content already in your device. Revocation of such DRM software does not affect the use of content protected with other types of DRM or the use of non-DRM-protected content.

Digital rights management (DRM) protected content comes with an associated activation key that defines your rights to use the content.

If your device has OMA DRM-protected content, to back up both the activation keys and the content, use the backup feature of Nokia Nseries PC Suite. Other transfer methods may not transfer the activation keys which need to be restored with the content for you to be able to continue the use of OMA DRM-protected content after the device memory is formatted. You may also need to restore the activation keys in case the files on your device get corrupted.

If your device has WMDRM-protected content, both the activation keys and the content will be lost if the device memory is formatted. You may also lose the activation keys and the content if the files on your device get corrupted. Losing the activation keys or the content may limit your ability to use the same content on your device again. For more information, contact your service provider.

Some activation keys may be connected to a specific SIM card, and the protected content can be accessed only if the SIM card is inserted in the device.

In the main view, select from the following:

- **Valid licences** — View licences that are connected to media files or whose validity period has not begun.

- **Invalid licences** — View licences that are not valid; the time period for using the media file is exceeded or there is a protected media file in the device but no connected activation key.
- **Not in use** — View licences that have no media files connected to them in the device.

To buy more usage time for a media file, select an invalid licence and **Options** > **Get new licence** (web service messages must be enabled). See "[Web service message settings](#)", p. 127.

To view details of an activation key, scroll to it, and press the scroll key.

Recorder

Press , and select **Applications** > **Media** > **Recorder**.

With Recorder, you can record voice memos and telephone conversations.

The recorder cannot be used when a data call or GPRS connection is active.

To record a telephone conversation, open Recorder during a voice call. Both parties hear a tone every 5 seconds during recording.

Time management

Clock

Alarm clock

Press , and select **Applications** > **Clock**.

To view your active and inactive alarms, scroll right to the alarm tab. To set a new alarm, select **Options** > **New alarm**. Define the repetition, if needed. When an alarm is active,  is shown.

To turn off the sounding alarm, select **Stop**. To stop the alarm for a certain time period, select **Snooze**. If your device is switched off when an alarm is due, your device switches itself on and starts sounding the alarm tone.



Tip: To define the time period after which the alarm sounds again when you set it to snooze, select **Options** > **Settings** > **Alarm snooze time**.

To cancel an alarm, select **Options** > **Remove alarm**.

To change the time, date, and clock type settings, select **Options** > **Settings**.

To automatically update the time, date, and time zone information to your device (network service),

in the settings, select **Automatic time update** > **On**.

World clock

Press , and select **Applications** > **Clock**.

To view the time in different locations, scroll right to the world clock tab. To add locations to the list, select **Options** > **Add location**. You can add a maximum of 15 locations to the list.

To set your current location, scroll to a location, and select **Options** > **Set as current location**. The location is displayed in the clock main view, and the time in your device is changed according to the selected location. Ensure that the time is correct and matches your time zone.

Calendar

Create a calendar entry

Press , and select **Applications** > **Calendar**.

1. To add a new calendar entry, scroll to the desired date, and select **Options** > **New entry** and one of the following:

- **Meeting** — to remind you of an appointment that has a specific date and time
- **Meeting request** — to create and send a new meeting request. You must have a mailbox set up for sending requests. [See "Manage mailboxes", p. 125.](#)
- **Memo** — to write a general entry for a day
- **Anniversary** — to remind you of birthdays or special dates (entries are repeated annually)
- **To-do** — to remind you of a task that must be done by a specific date

2. Fill in the fields. To set an alarm, select **Alarm** > **On**, and enter the alarm time and date.

To add a description for an entry, select **Options** > **Add description**.

3. To save the entry, select **Done**.



Tip: In the day, week, or month calendar view, press any key (1-0). An appointment



entry opens, and the characters you enter are added to the subject field. In the to-do view, a to-do note entry opens.

When the calendar alarm sounds, select **Silence** to turn off the sound. The reminder text stays on the screen. To stop the calendar alarm, select **Stop**. To set the alarm to snooze, select **Snooze**.



Tip: To define the time period after which the calendar alarm sounds again when you set it to snooze, press , and select **Applications** > **Calendar** > **Options** > **Settings** > **Alarm snooze time**.

Calendar views

To change the starting day of the week or the view that is shown when you open the calendar, select **Options** > **Settings**. In the settings, you can also modify the calendar alarm tone, alarm snooze time, and the title for the week view.

To go to a certain date, select **Options** > **Go to date**. To jump to today, press #.

To switch between the month view, week view, day view, and to-do view, press *.

To send a calendar note to a compatible device, select **Options** > **Send**.

If the other device is not compatible with Coordinated Universal Time (UTC), the time

information of received calendar entries may not be displayed correctly.

Manage calendar entries

To delete several events at a time, go to the month view, and select **Options** > **Delete entry** > **Before date** or **All entries**.

To mark a task as completed, scroll to it in the to-do view, and select **Options** > **Mark as done**.

You can synchronise your calendar with a compatible PC using Nokia Nseries PC Suite. When creating a calendar entry, set the desired synchronisation option.

Office folder

Quickoffice

With the Quickoffice applications, you can view .doc, .xls, .ppt, .pps, and .txt documents and download software. Not all file formats or features are supported. Apple Macintosh is not supported.

To view a file, press , and select **Applications > Office > Quickoffice**. Select the location from which you want to view files, browse to the desired folder, and select a file.

The files open in the respective applications depending on the file format.

To download software using Quickmanager, in the main view, select **Quickmanager**; or, when browsing files, scroll to the Quickmanager tab.

If you experience problems with the Quickoffice applications, visit www.quickoffice.com, or send e-mail to supportS60@quickoffice.com.

Quickword

With Quickword, you can view Microsoft Word documents with your device.

Quickword supports documents saved in .doc and .txt formats created with Microsoft Word 97,

2000, XP, and 2003. Not all variations or features of the file formats are supported.

To upgrade to a version of Quickword that supports editing, when you have a file open, select **Options > Updates and upgrades**. The upgrade is chargeable.

Quicksheet

With Quicksheet, you can view Microsoft Excel files with your device.

Quicksheet supports spreadsheet files in .xls format created with Microsoft Excel 97, 2000, XP, or 2003. Not all variations or features of the file formats are supported.

To upgrade to a version of Quicksheet that supports editing, when you have a file open, select **Options > Updates and upgrades**. The upgrade is chargeable.

Quickpoint

With Quickpoint, you can view Microsoft PowerPoint presentations with your device.

Quickpoint supports presentations saved in .ppt and .pps formats created with Microsoft PowerPoint 2000, XP, and 2003. Not all variations or features of the file formats are supported.

To upgrade to a version of Quickpoint that supports editing, when you have a file open, select **Options > Updates and upgrades**. The upgrade is chargeable.

Quickmanager

With Quickmanager, you can download software, including updates, upgrades, and other useful applications. You can pay for the downloads by phone bill or credit card.

Notes

Press , and select **Applications > Office > Notes**.

To write a note, start entering the text. The note editor opens automatically.

To open a note, scroll to it, and select **Open**.

To send a note to other compatible devices, select **Options > Send**.

To delete a note, press **C**.



Tip: To delete several notes, select **Options > Mark/Unmark** to mark the notes, and press **C**.

To synchronise or to define synchronisation settings for a note, select **Options > Synchronisation > Start** or **Settings**.

Adobe reader

Press , and select **Applications > Office > Adobe PDF**.

With Adobe reader, you can read PDF documents with your device; search for text in the documents; modify settings, such as zoom level and page views; and send PDF files using e-mail.

Converter

Press , and select **Applications > Office > Converter**.

With Converter, you can convert measures from one unit to another.

The converter has limited accuracy, and rounding errors may occur.

1. In the Type field, select the measure you want to use.
2. In first Unit field, select the unit from which you want to convert.

3. In the next Unit field, select the unit to which you want to convert.
4. In the first Amount field, enter the value you want to convert. The other Amount field changes automatically to show the converted value.

Convert currency

Select **Type** > **Currency**. Before you can make currency conversions, you must select a base currency and add exchange rates. The default base currency is **Home**. The rate of the base currency is always 1.

1. Select **Options** > **Currency rates**.
2. The default name for the currency items is **Foreign**. To rename a currency, select **Options** > **Rename currency**.
3. Add the exchange rates for the currencies, and press **Done**.
4. In the second Unit field, select the currency to which you want to convert.
5. In the first Amount field, enter the value you want to convert. The other Amount field changes automatically to show the converted value.

To change the base currency, select **Options** > **Currency rates**, a currency and **Options** > **Set as base currency**.

When you change base currency, you must enter new exchange rates because all previously set exchange rates are cleared.

Zip manager

Press , and select **Applications** > **Office** > **Zip**.

With Zip manager, you can create new archive files to store compressed .zip files; add single or multiple compressed files or directories to an archive; set, clear, or change the archive password for protected archives; and change settings, such as compression level and file name encoding.

Applications folder

Calculator

Press , and select **Applications** > **Calculator**.

This calculator has limited accuracy and is designed for simple calculations.

To make a calculation, enter the first number of the calculation. Select a function such as add or subtract from the function map. Enter the second number of the calculation, and select =.

The calculator performs operations in the order they are entered. The result of the calculation remains in the editor field and can be used as the first number of a new calculation.

To save the results of a calculation, select **Options** > **Memory** > **Save**. The saved result replaces the previously stored result in the memory.

To retrieve the results of a calculation from the memory and use them in a calculation, select **Options** > **Memory** > **Recall**.

To view the last saved result, select **Options** > **Last result**. Exiting the Calculator application or switching off the device does not clear the memory.

You can recall the last saved result the next time you open the Calculator application.

Application manager

With Application manager, you can see the software packages installed in your device. You can view details of installed applications, remove applications, and define installation settings.

Press , and select **Applications** > **App. mgr.**.

You can install two types of applications and software to your device:





- J2ME applications based on Java technology with the extension .jad or .jar
- Other applications and software suitable for the Symbian operating system with the extension .sis or .sisx

Only install software specifically designed for your device: Nokia N79. Software providers will often refer to the official model number of this product: N79-1.

Install applications and software

You can transfer installation files to your device from a compatible computer, download them during browsing, or receive them in a multimedia message, as an e-mail attachment, or using other connectivity methods, such as Bluetooth connectivity. You can use Nokia Application Installer in Nokia PC Suite to install an application to your device.

Icons in Application manager indicate the following:

-  .sis or .sisx application
-  Java application
-  application not fully installed
-  application installed in the memory card



Important: Only install and use applications and other software from trusted sources, such as applications that are Symbian Signed or have passed the Java Verified testing.

Before installation, note the following:

- To view the application type, version number, and the supplier or manufacturer of the application, select **Options** > **View details**. To display the security certificate details of the application, in **Details**, scroll to **Certificates**,

and select **View details**. See "[Certificate management](#)", p. 164.

- If you install a file that contains an update or repair to an existing application, you can only restore the original application if you have the original installation file or a full backup copy of the removed software package. To restore the original application, remove the application, and install the application again from the original installation file or the backup copy.

The .jar file is required for installing Java applications. If it is missing, the device may ask you to download it. If there is no access point defined for the application, you are asked to select one. When you are downloading the .jar file, you may need to enter a user name and password to access the server. You obtain these from the supplier or manufacturer of the application.

To install an application or software:

1. To locate an installation file, press , and select **Applications** > **App. mgr.**. Alternatively, search installation files using File manager, or open a message in **Messaging** > **Inbox** that contains an installation file.
2. In Application manager, select **Options** > **Install**. In other applications, scroll to the installation file, and select it to start the installation.

During installation, the device shows information about the progress of the installation. If you install an application without a digital signature or certification, the device displays a warning. Continue installation only if you are sure of the origin and contents of the application.

To start an installed application, locate it in the menu, and select it. If the application does not have a default folder defined, it is installed in the **Applications** folder in the main menu.

To see which software packages are installed or removed and when, select **Options > View log**.



Important: Your device can only support one antivirus application. Having more than one application with antivirus functionality could affect performance and operation or cause the device to stop functioning.

After you install applications to a compatible memory card, installation files (.sis, .sisx) remain in the device memory. The files may use large amounts of memory and prevent you from storing other files. To maintain sufficient memory, use Nokia Nseries PC Suite to back up installation files to a compatible PC, then use the file manager to remove the installation files from the device memory. If the .sis file is a message attachment, delete the message from the Messaging inbox.

Remove applications and software

Press **⌘**, and select **Applications > App. mgr.**. Scroll to a software package, and select **Options > Remove**. Select **Yes** to confirm.

If you remove software, you can only reinstall it if you have the original software package or a full backup of the removed software package. If you remove a software package, you may no longer be able to open documents created with that software.

If another software package depends on the software package that you removed, the other software package may stop working. Refer to the documentation of the installed software package for details.

Settings

Press **⌘**, and select **Applications > App. mgr.**. Select **Options > Settings** and from the following:

- **Software installation** — Select whether Symbian software that has no verified digital signature can be installed.
- **Online certificate check** — Select to check the online certificates before installing an application.
- **Default web address** — Set the default address used when checking online certificates.

Some Java applications may require that a message be sent or a network connection be made to a specific access point to download extra data or components. In the Application manager main view, scroll to an application, and select **Options** > **Open** to change settings related to that specific application.

Tools folder

File manager

Press , and select **Tools** > **File mgr..**

About File manager

With File manager, you can browse, manage, and open files on your device, memory card, or a compatible external drive.

To map or delete drives, or to define settings for a compatible remote drive connected to your device, select **Options** > **Remote drives**.

The available options depend on the memory you select.

Find and organise files

To find a file, select **Options** > **Find**. Enter a search text that matches the file name.

To move and copy files and folders, or to create new folders in the memory, select **Options** > **Organise**, and the desired option.

To sort files, select **Options** > **Sort by**, and the desired category.

Edit memory card

These options are available only if a compatible memory card is inserted in the device.

To rename or format a memory card, select **Options** > **Memory card options**.

To password protect a memory card, select **Options** > **Memory card password**.

To remove the memory card safely without any loss of data, select **Options** > **Remove memory card**.

Back up files on a memory card

To back up files, select the file types you want to back up on a memory card, and **Options** > **Back up now**. Ensure that your memory card has enough free memory for the files that you have chosen to back up.

Voice commands

Press , and select **Tools** > **Utilities** > **Voice comm..**

You can use enhanced voice commands to control your device. [See "Voice dialling", p. 131.](#)

To activate enhanced voice commands to start applications and profiles, press and hold the right selection key in the standby mode.

To use enhanced voice commands, press and hold the right selection key in the standby mode, and speak a voice command. The voice command is the name of the application or profile displayed in the list.

To edit the voice commands, in the Voice commands application, select an item, such as an application or a profile, and **Edit**.

To listen to the synthesised voice tag, select **Options** > **Playback**.

To remove a voice command that you added manually, select **Options** > **Remove voice command**.

Select **Options** > **Settings** and from the following:

- **Synthesiser** — to switch on or off the synthesiser that plays recognised voice tags and commands in the selected device language
- **Playback volume** — to adjust the playback volume for the voice commands
- **Recognition sensitivity** — to adjust how easily the synthesiser recognises speech. If the sensitivity is set too high, it may not accept commands because of background noise.

- **Command verification** — to select whether the spoken command is accepted manually, by voice, or automatically
- **Remove voice adapts.** — to reset voice recognition learning, for example, when the main user of the device has changed

Sync

Press , and select **Tools** > **Sync**.

Sync enables you to synchronise your notes, calendar entries, text and multimedia messages, browser bookmarks, or contacts with various compatible applications on a compatible computer or on the internet.

You may receive synchronisation settings in a special message from your service provider.

A synchronisation profile contains the necessary settings for synchronisation.

When you open the application, the default or previously used sync profile is displayed. To modify the profile, scroll to a sync item and select **Mark** to include it in the profile or **Unmark** to leave it out.

To manage sync profiles, select **Options** and the desired option.

To synchronise data, select **Options** > **Synchronise**. To cancel synchronisation before it finishes, select **Cancel**.

Device manager

Press , and select **Tools > Utilities > Device mgr.**.

Use Device manager to connect to a server and receive configuration settings for your device, to create new server profiles, or to view and manage existing server profiles.

You may receive server profiles and different configuration settings from your service providers and company information management department. These configuration settings may include connection and other settings used by different applications in your device.

Scroll to a server profile, and select **Options** and from the following:

- **Start configuration** — Connect to the server and receive configuration settings for your device.
- **New server profile** — Create a server profile.

To delete a server profile, scroll to it, and press **C**.

Speech

With Speech, you can set the language, voice, and voice properties for the message reader.

Press , and select **Tools > Utilities > Speech.**

To set the language for the message reader, select **Language**. To download additional languages to your device, select **Options > Download languages**.



Tip: When you download a new language, you must download at least one voice for that language.

To set the speaking voice, select **Voice**. The voice depends on the selected language.

To set the speaking rate, select **Speed**.

To set the speaking volume, select **Volume**.

To view details of a voice, scroll right to the voice tab, scroll to the voice, and select **Options > Voice details**. To listen to a voice, scroll to the voice, and select **Options > Play voice**.

To delete languages or voices, scroll to the item and select **Options > Delete**.

Message reader settings

To change the message reader settings, scroll to the **Settings** tab, and define the following:

- **Language detection** — turn automatic reading language detection on or off.
- **Continuous reading** — turn continuous reading of all selected messages on or off.
- **Speech prompts** — select whether the message reader inserts prompts in messages.

- **Audio source** — select whether you want to listen to the message through the loudspeaker or the device.

Settings

Some settings may be preset for the device by your service provider, and you may not be able to change them.

General settings

In general settings, you can edit the general settings of your device or restore the device to original default settings.

You can adjust time and date settings also in the clock. [See "Clock", p. 147.](#)

Personalisation settings

Press , and select **Tools** > **Settings** > **General** > **Personalisation**.

You can edit settings related to the display, standby mode, and general functions of your device.

Themes allows you to change the look of the display.

Voice commands opens the settings for the Voice commands application. [See "Voice commands", p. 157.](#)

Tones allows you to change the tones of the calendar, clock, and currently active profile.

Display

- **Light sensor** — Scroll left or right to adjust the light sensor that observes the lighting conditions and adjusts the brightness of the display. The light sensor may cause the display to flicker in low light.
- **Font size** — Adjust the size of the text and icons on the display.
- **Power saver time-out** — Select the time-out period after which the power saver is activated.
- **Welcome note / logo** — The welcome note or logo is displayed briefly each time you switch on the device. Select **Default** to use the default image, **Text** to write a welcome note, or **Image** to select an image from Photos.
- **Light time-out** — Select a time-out after which the backlight of the display is switched off.

Standby mode

- **Shortcuts** — Assign shortcuts to the selection keys to be used in the standby mode and select which applications are shown in the active toolbar.

If the active standby is set off, you can assign keypad shortcuts for the different presses of the scroll key.

- **Change Menu view** — Select **Horizontal icon bar** to view a horizontal toolbar and the content from different applications on the screen. Select **Vertical icon bar** to view a vertical toolbar on the screen. The content from different applications is hidden. To display the content, select a shortcut and press the scroll key left. Select **Basic** to switch off active toolbar.
- **Operator logo** — This setting is only available if you have received and saved an operator logo. Select **Off** if you do not want the logo to be shown.

Language

Changing the settings for the phone language or writing language affects every application in your device until you change these settings again.

- **Phone language** — Change the language of the display text in your device. This also affects the format used for date and time and the separators used, for example, in calculations. **Automatic** selects the language according to the information on your SIM card. After you change the language, the device restarts.
- **Writing language** — Change the writing language. This affects the characters available

when writing text and the predictive text dictionary used.

- **Predictive text** — Set predictive text input on or off for all editors in the device. The predictive text dictionary is not available for all languages.

Enhancement settings

Press , and select **Tools > Settings > General > Enhancement**.

Some enhancement connectors indicate which type of enhancement is connected to the device. [See "Display indicators", p. 26.](#)

The available settings depend on the type of enhancement. Select an enhancement and from the following:

- **Default profile** — Set the profile that you want activated each time you connect a certain compatible enhancement to your device.
- **Automatic answer** — Select whether you want the device to answer an incoming call automatically after 5 seconds. If the ringing type is set to **Beep once** or **Silent**, automatic answer is disabled.
- **Lights** — Set whether lights remain on after the time-out.

TV-out settings

To change the settings for a TV-out connection, select **TV-Out** and from the following:

- **Default profile** — Set the profile that you want activated each time you connect a Nokia Video Connectivity Cable to your device.
- **TV screen size** — Select the aspect ratio of the TV: **Normal** or **Widescreen** for widescreen TVs.
- **TV system** — Select the analogue video signal system that is compatible with your TV.
- **Flicker filter** — To improve image quality on the screen of your TV, select **On**. The flicker filter may not diminish image flicker on all TV screens.

Navi wheel settings

Press , and select **Tools > Settings > General > Navi wheel**.

Navi wheel

When the Navi wheel setting is set on, you can browse through files and lists in certain applications by sliding your finger on the rim of the scroll key. When the Navi wheel setting is set off, to move up, down, left, or right, press the scroll key in the desired direction.

Breathing

The rim around the Navi wheel illuminates slowly when the device is in sleep mode. To switch off the illumination, press , and select **Tools > Settings > General > Navi wheel > Breathing**.

Sensor settings

In most applications, the display rotates automatically between the portrait and landscape modes based on the orientation of the device.

To change the setting for automatic display rotation, select **Settings > General > Sensor settings > Turning control** and whether you want the display to rotate automatically.

To ensure that the automatic display rotation works, hold the device in an upright position.

Automatic rotation does not work if you change the display rotation setting manually in an application. When you exit the application, automatic rotation is activated again.

Security settings

Phone and SIM

Press , and select **Tools > Settings > General > Security > Phone and SIM card** and from the following:

- **PIN code request** — When active, the code is requested each time the device is switched on. Deactivating the PIN code request may not be allowed by some SIM cards.
- **PIN code, PIN2 code, and Lock code** — You can change the PIN code, PIN2 code, and lock code.

These codes can only include the numbers from 0 to 9.

If you forget the PIN or the PIN2 code, contact your service provider. If you forget the lock code, contact a Nokia Care point or your service provider. [See "Access codes", p. 21.](#)

Avoid using access codes similar to the emergency numbers to prevent accidental dialling of the emergency number.

- **Keypad autolock period** — Select whether the keypad is locked when your device has been idle for a certain period of time.



Tip: To lock or unlock the keypad manually, press the left selection key, then *.

- **Phone autolock period** — To avoid unauthorised use, you can set a time-out after which the device automatically locks. A locked device cannot be used until the correct lock code is entered. To turn off the autolock period, select **None**.



Tip: To lock the device manually, press the power key. A list of commands opens. Select **Lock phone**.

In the offline or flight profiles, you may need to unlock the device and change to the calling profile before making a call.

- **Lock if SIM card changed** — You can set the device to ask for the lock code when an unknown SIM card is inserted into your device. The device maintains a list of SIM cards that are recognised as the owner's cards.
- **Closed user group** — You can specify a group of people to whom you can call and who can call you (network service).

When calls are limited to closed user groups, calls may be possible to the official emergency number programmed into your device.

- **Confirm SIM services** — You can set the device to display confirmation messages when you are using a SIM card service (network service).

Certificate management

Press , and select **Tools > Settings > General > Security > Certificate management**.

Digital certificates do not guarantee safety; they are used to verify the origin of software.

In the certificate management main view, you can see a list of authority certificates that are stored in your device. Scroll right to see a list of personal certificates, if available.

Digital certificates should be used if you want to connect to an online bank or another site or remote server for actions that involve transferring confidential information. They should also be used if you want to reduce the risk of viruses or other

malicious software and be sure of the authenticity of software when downloading and installing software.



Important: Even if the use of certificates makes the risks involved in remote connections and software installation considerably smaller, they must be used correctly in order to benefit from increased security. The existence of a certificate does not offer any protection by itself; the certificate manager must contain correct, authentic, or trusted certificates for increased security to be available. Certificates have a restricted lifetime. If "Expired certificate" or "Certificate not valid yet" is shown, even if the certificate should be valid, check that the current date and time in your device are correct.

View certificate details—check authenticity

You can only be sure of the correct identity of a server when the signature and the validity period of a server certificate have been checked.

You are notified if the identity of the server is not authentic or if you do not have the correct security certificate in your device.

To check certificate details, scroll to a certificate, and select **Options** > **Certificate details**. The validity of the certificate is checked, and one of the following notes may be displayed:

- **Certificate not trusted** — You have not set any application to use the certificate.
- **Expired certificate** — The certificate validity period has ended.
- **Certificate not valid yet** — The certificate validity period has not yet begun.
- **Certificate corrupted** — The certificate cannot be used. Contact the certificate issuer.

Change the trust settings

Before changing any certificate settings, you must make sure that you really trust the owner of the certificate and that the certificate really belongs to the listed owner.

Scroll to an authority certificate, and select **Options** > **Trust settings**. Depending on the certificate, a list of the applications that can use the selected certificate is shown. For example:

- **Symbian installation: Yes** — The certificate is able to certify the origin of a new Symbian operating system application.
- **Internet: Yes** — The certificate is able to certify servers.
- **App. installation: Yes** — The certificate is able to certify the origin of a new Java™ application.

Select **Options** > **Edit trust setting** to change the value.

Security module

Press , and select **Tools > Settings > General > Security > Security module**.

To view or edit a security module (if available), scroll to it, and press the scroll key.

To view detailed information about a security module, scroll to it, and select **Options > Security details**.

Restore original settings

Press , and select **Tools > Settings > General > Factory settings**.

You can reset some of the settings to their original values. To do this, you need the lock code.

After resetting, the device may take a longer time to power on. Documents and files are unaffected.

Positioning settings

Press , and select **Tools > Settings > General > Positioning**.

Positioning methods

- **Integrated GPS** — Use the integrated GPS receiver of your device.
- **Assisted GPS** — Use Assisted GPS (A-GPS) to receive assistance data from an assistance data server. [See "Assisted GPS \(A-GPS\)", p. 52.](#)

- **Bluetooth GPS** — Use a compatible external GPS receiver with Bluetooth connectivity.
- **Network based** — Use information from the cellular network (network service).

Positioning server

To define an access point, and positioning server for A-GPS, select **Positioning server**. The positioning server may be preset by your service provider, and you may not be able to edit the settings.

Notation settings

To select which measurement system you want to use for speeds and distances, select **Measurement system > Metric** or **Imperial**.

To define in which format the coordinate information is shown in your device, select **Coordinate format**, and the desired format.

Phone settings

In phone settings, you can edit settings related to phone calls and network.

Call settings

Press , and select **Tools > Settings > Phone > Call**.

- **Send my caller ID** — You can set your phone number to be displayed to (Yes) or hidden from

- (No) the person to whom you are calling, or the value may be set by your service provider when you make a subscription (**Set by network**) (network service).
- **Send my internet call ID** — You can set your internet caller ID to be displayed to or hidden from the person to whom you are calling.
 - **Call waiting** — To be alerted for incoming calls (network service) while you are in a call, select **Activate**. To check whether the function is activated, select **Check status**.
 - **Internet call waiting** — To be notified of a new incoming internet call while you have a call in progress, select **Activated**.
 - **Internet call alert** — To be alerted for incoming internet calls, select **On**. If you select **Off**, you are not alerted, but you receive a notification if you missed a call.
 - **Reject call with message** — To send a text message to a caller informing why you could not answer the call, select **Yes**.
 - **Message text** — Write a text to be sent in a text message when you reject a call.
 - **Image in video call** — If video is not sent during a video call, you can select a still image to be displayed instead.
 - **Automatic redial** — Select **On**, and your device makes a maximum of 10 attempts to connect the call after an unsuccessful call attempt. To stop automatic redialling, press the end key.
 - **Show call duration** — Activate this setting if you want the length of a call to be displayed during the call.
 - **Summary after call** — Activate this setting if you want the length of a call to be displayed after the call.
 - **Speed dial** — Select **On**, and the numbers assigned to the number keys (2 to 9) can be dialled by pressing and holding the key. [See "Speed dial a phone number", p. 131.](#)
 - **Anykey answer** — Select **On**, and you can answer an incoming call by briefly pressing any keypad key, except the power key.
 - **Line in use** — This setting (network service) is shown only if the SIM card supports two subscriber numbers, that is, two phone lines. Select which phone line you want to use for making calls and sending text messages. Calls on both lines can be answered irrespective of the selected line. If you select **Line 2** and have not subscribed to this network service, you are not able to make calls. When line 2 is selected, **2** is shown in the standby mode.
 - **Line change** — To prevent line selection (network service), select **Disable** if supported by your SIM card. To change this setting, you need the PIN2 code.

Call divert

Press , and select **Tools > Settings > Phone > Call divert**.

Call divert allows you to divert incoming calls to your voice mailbox or another phone number. For details, contact your service provider.

To activate call divert, select **Activate**. To check whether the option is active, select **Check status**.

Several diverting options can be active at the same time. When all calls are diverted,  is shown in the standby mode.

Call barring and call diverting cannot be active at the same time.

Call barring

Press , and select **Tools > Settings > Phone > Call barring**.

Call barring (network service) allows you to restrict the calls that you make or receive with the device. For example, you can restrict all outgoing international calls or incoming calls when you are abroad. To change the settings, you need the barring password from your service provider.

Call barring and call diverting cannot be active at the same time.

When calls are barred, calls may be possible to certain official emergency numbers.

Voice call barring

Select the desired barring option, and set it on (**Activate**) or off (**Deactivate**), or check whether the option is active (**Check status**). Call barring affects all calls, including data calls.

Internet call barring

To select whether anonymous calls are allowed from the internet, set **Anonymous call barring** on or off.

Network settings

Your device can automatically switch between the GSM and UMTS networks. The GSM network is indicated with  in the standby mode. The UMTS network is indicated with **3G**.

Press , and select **Tools > Settings > Phone > Network** and from the following:

- **Network mode** — Select which network to use. If you select **Dual mode**, the device uses the GSM or UMTS network automatically, according to the network parameters and the roaming agreements between the wireless service providers. For details and roaming costs, contact your network service provider. This option is shown only if supported by the wireless service provider.

A roaming agreement is an agreement between two or more service providers to enable the users of one service provider to use the services of other service providers.

- **Operator selection** — Select **Automatic** to let the device to search for and select one of the available networks, or **Manual** to manually select the network from a list. If the connection to the manually selected network is lost, the device sounds an error tone and asks you to reselect a network. The selected network must have a roaming agreement with your home cellular network.
- **Cell info display** — Set the device to indicate when it is used in a cellular network based on microcellular network (MCN) technology and to activate cell info reception.

Connection settings

In connection settings, you can edit access points and other connectivity settings.

You can also edit settings for Bluetooth connectivity in the Bluetooth connectivity application. [See "Settings", p. 43.](#)

You can also edit settings for data cable connections in the USB application. [See "USB", p. 46.](#)

Data connections and access points

Your device supports packet data connections (network service), such as GPRS in the GSM network. When you use your device in GSM and UMTS networks, multiple data connections can be active at the same time, and access points can share a data connection. In the UMTS network, data connections remain active during voice calls.

You can also use a WLAN data connection. Only one connection in one wireless LAN can be active at a time, but several applications can use the same internet access point.

To establish a data connection, an access point is required. You can define different kinds of access points, such as the following:

- MMS access point to send and receive multimedia messages
- Internet access point (IAP) to send and receive e-mail and connect to the internet







Check the type of access point you need with your service provider for the service you want to access. For availability and subscription to packet data connection services, contact your service provider.

Access points

Create a new access point

Press , and select **Tools > Settings > Connection > Destinations**.

You may receive access point settings in a message from a service provider. Some or all access points may be preset for your device by your service provider, and you may not be able to change, create, edit, or remove them.

When you open one of the access point groups (, , , , , ), you can see the access point types:

 indicates a protected access point

 indicates a packet data access point

 indicates a WLAN access point



Tip: You can create internet access points in a wireless LAN with the WLAN wizard.

To create a new access point, select  **New access point**. The device asks to check for available connections. After the search, connections that are already available are shown and can be shared by a new access point. If you skip this step, you are asked to select a connection method and to define the settings needed.

To edit the settings of an access point, open one of the access point groups, select an access point and

Edit. Follow the instructions from your service provider.

- **Connection name** — Enter a name for the connection.
- **Data bearer** — Select the data connection type.

Depending on the data connection you select, only certain setting fields are available. Fill in all fields marked with **Must be defined** or with a red *. Other fields can be left empty, unless your service provider has instructed otherwise.

To use a data connection, your service provider must support this feature, and if necessary, activate it for your SIM card.

Create access point groups

Press , and select **Tools > Settings > Connection > Destinations**.

Some applications allow you to use access point groups for network connection.

To avoid selecting a single access point every time the device makes a network connection, you can create a group that contains various access points to connect to that network and define the order in which the access points are used.

For example, you can add wireless LAN (WLAN) and packet data access points to an internet access point group and use the group for browsing the web. If you give WLAN the highest priority, the device



connects to the internet through WLAN if available and through packet data if not.

To create a new access point group, select **Options > Manage > New destination**.

To add access points to an access point group, select the group and **Options > New access point**. To copy an existing access point from another group, select the group, an existing access point, and **Options > Organise > Copy to other dest..**

To change the priority order of access points within a group, select an access point and **Options > Organise > Change priority**.

Packet data access points

Press , and select **Tools > Settings > Connection > Destinations > New access point**, and follow the instructions on the screen. Or, open one of the access point groups, select an access point marked with , and select **Edit**.

Follow the instructions from your service provider. Select from the following:

- **Access point name** — You obtain the access point name from your service provider.
- **User name** — The user name may be needed to make a data connection, and is usually provided by the service provider.
- **Prompt password** — If you must enter the password every time you log in to a server, or if



you do not want to save your password in the device, select **Yes**.

- **Password** — A password may be needed to make a data connection and is usually provided by the service provider.
- **Authentication** — Select **Secure** to always send your password encrypted or **Normal** to send your password encrypted when possible.
- **Homepage** — Depending on the access point you are setting up, enter the web address or the address of the multimedia message centre.

Select **Options > Advanced settings** and from the following:

- **Network type** — Select the internet protocol type to transfer data to and from your device. The other settings depend on the selected network type.
- **Phone IP address** (for IPv4 only) — Enter the IP address of your device.
- **DNS addresses** — Enter the IP addresses of the primary and secondary DNS servers, if required by your service provider. To obtain these addresses, contact your internet service provider.
- **Proxy server address** — Enter the address of the proxy server.
- **Proxy port number** — Enter the port number of the proxy server.

WLAN internet access points

Press , and select **Tools > Settings > Connection > Destinations > New access point**, and follow the instructions on the screen. Or, open one of the access point groups, select an access point marked with , and select **Edit**.

Follow the instructions from your WLAN service provider.

- **WLAN network name** — Select **Enter manually** or **Search for networks**. If you select an existing network, **WLAN network mode** and **WLAN security mode** are determined by the settings of its access point device.
- **Network status** — Define whether the network name is displayed.
- **WLAN network mode** — Select **Ad-hoc** to create an ad hoc network and to allow devices to send and receive data directly; a WLAN access point device is not needed. In an ad hoc network, all devices must use the same **WLAN network name**.
- **WLAN security mode** — Select the encryption used: **WEP**, **802.1x** (not for ad hoc networks), or **WPA/WPA2**. If you select **Open network**, no encryption is used. The WEP, 802.1x, and WPA functions can be used only if the network supports them.

To enter the settings for the selected security mode, select **WLAN security settings**.

Security settings for WEP

- **WEP key in use** — Select the wired equivalent privacy (WEP) key number. You can create up to four WEP keys. The same settings must be entered on the WLAN access point device.
- **Authentication type** — Select **Open** or **Shared** for the authentication type between your device and the WLAN access point device.
- **WEP key settings** — Enter **WEP encryption** (length of the key), **WEP key format** (**ASCII** or **Hexadecimal**), and **WEP key** (the WEP key data in the selected format).

Security settings for 802.1x and WPA/WPA2

- **WPA/WPA2** — Select the means of authentication: **EAP** to use an extensible authentication protocol (EAP) plug-in, or **Pre-shared key** to use a password. Complete the appropriate settings:
 - **EAP plug-in settings** — Enter the settings as your service provider instructs.
 - **Pre-shared key** — Enter a password. The same password must be entered on the WLAN access point device.
- **WPA2 only mode** — Only WPA2 enabled devices are allowed to establish a connection in this mode.

Advanced WLAN settings

Select **Options** > **Advanced settings** and from the following:

- **IPv4 settings** — Enter the IP address of your device, the subnet IP address, the default gateway, and the IP addresses of the primary and secondary DNS servers. Contact your internet service provider for these addresses.
- **IPv6 settings** — Define the type of DNS address.
- **Ad-hoc channel (only for Ad-hoc)** — To enter a channel number (1-11) manually, select **User defined**.
- **Proxy server address** — Enter the address for the proxy server.
- **Proxy port number** — Enter the proxy port number.

Packet data settings

Press , and select **Tools** > **Settings** > **Connection** > **Packet data**.

The packet data settings affect all access points using a packet data connection.

- **Packet data connection** — If you select **When available** and you are in a network that supports packet data, the device registers to the packet data network. Starting an active packet data connection (for example, to send and receive e-mail) is quicker. If there is no packet data

coverage, the device periodically tries to establish a packet data connection. If you select **When needed**, the device uses a packet data connection only if you start an application or action that needs it.

- **Access point** — The access point name is needed to use your device as a packet data modem to a compatible computer.
- **High speed packet access** — Enable or disable the use of HSDPA (network service) in UMTS networks.

Wireless LAN settings

Press , and select **Tools** > **Settings** > **Connection** > **Wireless LAN**.

- **Show WLAN availability** — Select whether  is displayed in the standby mode when a wireless LAN is available.
- **Scan for networks** — If you set **Show WLAN availability** to **Yes**, select how often the device searches for available wireless LANs and updates the indicator.

To view advanced settings, select **Options** > **Advanced settings**. Changing wireless LAN advanced settings is not recommended.

SIP settings

Press , and select **Tools > Settings > Connection > SIP settings**.

Session Initiation Protocol (SIP) settings are needed for certain network services using SIP. You may receive the settings in a special text message from your service provider. You can view, delete, or create these setting profiles in SIP settings.

Configurations

Press , and select **Tools > Settings > Connection > Configurations**.

You may receive trusted server settings from your service provider in a configuration message. You can save view or delete these settings in configurations.

Access point name control

Press , and select **Tools > Settings > Connection > APN control**.

With the access point name control service, you can restrict packet data connections and allow your device to use only certain packet data access points.

This setting is only available if your SIM card supports the access point control service.

To set the control service on or off or to change the allowed access points, select **Options** and the

corresponding option. To change the options, you need your PIN2 code. Contact your service provider for the code.

Application settings

To edit the settings of some of the applications in your device, press , and select **Tools > Settings > Applications**.

To edit the settings, you can also select **Options > Settings** in each application.

Troubleshooting

To view frequently asked questions about your device, visit the product support pages at www.nseries.com/support.

Q: What is my password for the lock, PIN, or PUK codes?

A: The default lock code is **12345**. If you forget the lock code, contact your device dealer. If you forget a PIN or PUK code, or if you have not received such a code, contact your network service provider. For information about passwords, contact your access point provider, for example, a commercial internet service provider (ISP) or network service provider.

Q: How do I close an application that is not responding?

A: Press and hold . To close an application, scroll to it, and press **C**. Pressing **C** does not close Music player. To close Music player, select it from the list, and **Options > Exit**.

Q: Why do images look smudgy?

A: Ensure that the camera lens protection windows are clean.

Q: Why do missing, discoloured, or bright dots appear on the screen every time I turn on my device?

A: This is a characteristic of this type of display. Some displays may contain pixels or dots that remain on or off. This is normal, not a fault.

Q: Why can't my device establish a GPS connection?

A: Find more information about GPS, GPS receiver, satellite signals, and location information in this user guide. [See "Positioning \(GPS\)", p. 52.](#)

Q: Why can't I find my friend's device while using Bluetooth connectivity?

A: Check that both devices are compatible, have activated Bluetooth connectivity, and are not in hidden mode. Check also that the distance between the two devices is not over 10 metres (33 feet) and that there are no walls or other obstructions between the devices.

Q: Why can't I end a Bluetooth connection?

A: If another device is connected to your device, you can end the connection from the other device or deactivate Bluetooth connectivity in your device.

Press , and select **Tools > Bluetooth > Bluetooth > Off**.

Q: Why can't the other device see the files stored on my device in the home network?

A: Make sure that you have configured the home network settings, content sharing is turned on in your device, and the other device is UPnP compatible.

Q: What can I do if my home network connection stops working?

A: Switch off the wireless LAN (WLAN) connection from your compatible PC and your device, and switch it on again. If this does not help, restart your compatible PC and your device. If the connection still does not work, reconfigure the WLAN settings in both your compatible PC and device. [See "Wireless LAN", p. 40. See "Connection settings", p. 169.](#)

Q: Why can't I see my compatible PC in my device in the home network?

A: If you are using a firewall application in your compatible PC, check that it allows home media server to use the external connection (you can add Home media server to the firewall application's exceptions list). Check from the firewall settings that the firewall application allows traffic to the following ports: 1900, 49152, 49153, and 49154. Some WLAN access point devices have a built-in

firewall. In such cases, check that the firewall in the access point device does not block traffic to the following ports: 1900, 49152, 49153, and 49154. Check that the WLAN settings are the same in your device and compatible PC.

Q: Why can't I see a wireless LAN (WLAN) access point even though I know I'm within its range?

A: The WLAN access point may use a hidden service set identifier (SSID). You can only access networks that use a hidden SSID if you know the correct SSID, and have created a WLAN internet access point for the network on your Nokia device.

Q: How do I switch wireless LAN (WLAN) off on my Nokia device?

A: The WLAN on your Nokia device switches off when you are not connected or trying to connect to another access point, or not scanning for available networks. To further reduce battery consumption, you can specify that your Nokia device does not scan, or scans less often, for available networks in the background. WLAN switches off in between background scans.

To change the background scan settings:

1. Press , and select **Tools > Settings > Connection > Wireless LAN**.

2. To increase the background scan time interval, adjust the time in **Scan for networks**. To stop background scans, select **Show WLAN availability** > **Never**.
3. To save your changes, press **Back**.

When **Show WLAN availability** is set to **Never**, the WLAN availability icon is not shown in the standby mode. However, you can still manually scan for available WLAN networks, and connect to WLAN networks as usual.

Q: How can I save my data before deleting it?

A: To save data, use Nokia Nseries PC Suite to synchronise with or to make a back-up copy of all data to a compatible computer. You can also send data using Bluetooth connectivity to a compatible device. You can also store data on a compatible memory card.



Q: What do I do if the memory is full?

A: Delete items from the device memory or mass memory. If your device displays the note **Not enough memory to perform operation. Delete some data first.** or **Memory low. Delete some data from phone memory.** when you are deleting several items at the same time, delete items one by one, beginning with the smallest items. See "[Free memory](#)", p. 23.

Q: Why can't I select a contact for my message?

A: The contact card does not have a phone number, an address, or an e-mail address. Press , select **Contacts**, the relevant contact, and edit the contact card.

Q: How can I end the data connection when the device starts a data connection again and again?

A: The device may be trying to retrieve a multimedia message from the multimedia message centre. To stop the device from making a data connection, press , and select **Messaging** > **Options** > **Settings** > **Multimedia message** > **Multimedia retrieval** and **Manual** to have the multimedia messaging centre save messages to be retrieved later, or **Off** to ignore all incoming multimedia messages. If you select **Manual**, you receive a notification when you have a new message in the multimedia message centre. If you select **Off**, the device does not make any network connections related to multimedia messaging. To set the device to use a packet data connection only if you start an application or action that needs it, press , and select **Tools** > **Settings** > **Connection** > **Packet data** > **Packet data connection** > **When needed**. If this does not help, switch the device off, and switch it on again.

Q: Why do I have problems connecting the device to my PC?

A: Ensure that you have the latest version of Nokia Nseries PC Suite and that it is installed and running on your compatible PC. For further information on how to use Nokia Nseries PC Suite, see the Nokia Nseries PC Suite help or visit the Nokia support pages.

Q: Can I use my device as a fax modem with a compatible PC?

A: You cannot use your device as a fax modem. However, with call diverting (network service), you can divert incoming fax calls to a fax number.

Enhancements



Warning: Use only batteries, chargers, and enhancements approved by Nokia for use with this particular model. The use of any other types may invalidate any approval or warranty, and may be dangerous.

For availability of approved enhancements, please check with your dealer. When you disconnect the power cord of any enhancement, grasp and pull the plug, not the cord.

Battery and charger information

Battery and charger information

Your device is powered by a rechargeable battery. The battery intended for use with this device is BL-6F . Nokia may make additional battery models available for this device. This device is intended for use when supplied with power from the following chargers: AC-5, AC-8, DC-1, DC-8, DC-9 . The exact charger model number may vary depending on the type of plug. The plug variant is identified by one of the following: E, EB, X, AR, U, A, C, or UB.

The battery can be charged and discharged hundreds of times, but it will eventually wear out. When the talk and standby times are noticeably shorter than normal, replace the battery. Use only Nokia approved batteries, and recharge your battery only with Nokia approved chargers designated for this device. Use of an unapproved battery or charger may present a risk of fire, explosion, leakage, or other hazard.

If a battery is being used for the first time or if the battery has not been used for a prolonged period, it may be necessary to connect the charger, then

disconnect and reconnect it to begin charging the battery. If the battery is completely discharged, it may take several minutes before the charging indicator appears on the display or before any calls can be made.

Always switch the device off and disconnect the charger before removing the battery.

Unplug the charger from the electrical plug and the device when not in use. Do not leave a fully charged battery connected to a charger, since overcharging may shorten its lifetime. If left unused, a fully charged battery will lose its charge over time.

Always try to keep the battery between 15°C and 25°C (59°F and 77°F). Extreme temperatures reduce the capacity and lifetime of the battery. A device with a hot or cold battery may not work temporarily. Battery performance is particularly limited in temperatures well below freezing.

Do not short-circuit the battery. Accidental short-circuiting can occur when a metallic object such as a coin, clip, or pen causes direct connection of the positive (+) and negative (-) terminals of the battery. (These look like metal strips on the battery.) This might happen, for example, when you carry a spare battery in your pocket or purse. Short-

circuiting the terminals may damage the battery or the connecting object.

Do not dispose of batteries in a fire as they may explode. Batteries may also explode if damaged. Dispose of batteries according to local regulations. Please recycle when possible. Do not dispose as household waste.

Do not dismantle, cut, open, crush, bend, deform, puncture, or shred cells or batteries. In the event of a battery leak, do not allow the liquid to come in contact with the skin or eyes. In the event of such a leak, flush your skin or eyes immediately with water, or seek medical help.

Do not modify, remanufacture, attempt to insert foreign objects into the battery, or immerse or expose it to water or other liquids.

Improper battery use may result in a fire, explosion, or other hazard. If the device or battery is dropped, especially on a hard surface, and you believe the battery has been damaged, take it to a service centre for inspection before continuing to use it.

Use the battery only for its intended purpose. Never use any charger or battery that is damaged. Keep your battery out of the reach of small children.

Nokia battery authentication guidelines

Always use original Nokia batteries for your safety. To check that you are getting an original Nokia battery, purchase it from an authorised Nokia dealer, and inspect the hologram label using the following steps:

Successful completion of the steps is not a total assurance of the authenticity of the battery. If you have any reason to believe that your battery is not an authentic, original Nokia battery, you should refrain from using it, and take it to the nearest authorised Nokia service point or dealer for assistance. Your authorised Nokia service point or dealer will inspect the battery for authenticity. If authenticity cannot be verified, return the battery to the place of purchase.

Authenticate hologram

1. When you look at the hologram on the label, you should see the Nokia connecting hands symbol from one angle and the Nokia Original Enhancements logo when looking from another angle.



2. When you angle the hologram left, right, down and up, you should see 1, 2, 3 and 4 dots on each side respectively.



What if your battery is not authentic?

If you cannot confirm that your Nokia battery with the hologram on the label is an authentic Nokia battery, please do not use the battery. Take it to the nearest authorised Nokia service point or dealer for assistance. The use of a battery that is not approved by the manufacturer may be dangerous and may result in poor performance and damage to your device and its enhancements. It may also invalidate any approval or warranty applying to the device.

To find out more about original Nokia batteries, visit www.nokia.com/battery.

Care and maintenance

Your device is a product of superior design and craftsmanship and should be treated with care. The following suggestions will help you protect your warranty coverage.

- Keep the device dry. Precipitation, humidity, and all types of liquids or moisture can contain minerals that will corrode electronic circuits. If your device does get wet, remove the battery, and allow the device to dry completely before replacing it.
- Do not use or store the device in dusty, dirty areas. Its moving parts and electronic components can be damaged.
- Do not store the device in hot areas. High temperatures can shorten the life of electronic devices, damage batteries, and warp or melt certain plastics.
- Do not store the device in cold areas. When the device returns to its normal temperature, moisture can form inside the device and damage electronic circuit boards.
- Do not attempt to open the device other than as instructed in this guide.
- Do not drop, knock, or shake the device. Rough handling can break internal circuit boards and fine mechanics.
- Do not use harsh chemicals, cleaning solvents, or strong detergents to clean the device.
- Do not paint the device. Paint can clog the moving parts and prevent proper operation.
- Use a soft, clean, dry cloth to clean any lenses, such as camera, proximity sensor, and light sensor lenses.
- Use only the supplied or an approved replacement antenna. Unauthorised antennas, modifications, or attachments could damage the device and may violate regulations governing radio devices.
- Use chargers indoors.
- Always create a backup of data you want to keep, such as contacts and calendar notes.
- To reset the device from time to time for optimum performance, power off the device and remove the battery.

These suggestions apply equally to your device, battery, charger, or any enhancement. If any device

is not working properly, take it to the nearest authorised service facility for service.

Disposal

 The crossed-out wheeled-bin symbol on your product, literature, or packaging reminds you that all electrical and electronic products, batteries, and accumulators must be taken to separate collection at the end of their working life. This requirement applies to the European Union and other locations where separate collection systems are available. Do not dispose of these products as unsorted municipal waste.

By returning the products to collection you help prevent uncontrolled waste disposal and promote the reuse of material resources. More detailed information is available from the product retailer, local waste authorities, national producer responsibility organizations, or your local Nokia representative. For the product Eco-Declaration or instructions for returning your obsolete product, go to country-specific information at www.nokia.com.

Additional safety information

Small children

Your device and its enhancements may contain small parts. Keep them out of the reach of small children.

Operating environment

This device meets RF exposure guidelines when used either in the normal use position against the ear or when positioned at least 1.5 centimetres (5/8 inch) away from the body. When a carry case, belt clip, or holder is used for body-worn operation, it should not contain metal and should position the device the above-stated distance from your body.

To transmit data files or messages, this device requires a quality connection to the network. In some cases, transmission of data files or messages may be delayed until such a connection is available. Ensure the above separation distance instructions are followed until the transmission is completed.

Parts of the device are magnetic. Metallic materials may be attracted to the device. Do not place credit cards or other magnetic storage media near the

device, because information stored on them may be erased.

Medical devices

Operation of any radio transmitting equipment, including wireless phones, may interfere with the functionality of inadequately protected medical devices. Consult a physician or the manufacturer of the medical device to determine if they are adequately shielded from external RF energy or if you have any questions. Switch off your device in health care facilities when any regulations posted in these areas instruct you to do so. Hospitals or health care facilities may be using equipment that could be sensitive to external RF energy.

Implanted medical devices

Manufacturers of medical devices recommend that a minimum separation of 15.3 centimetres (6 inches) should be maintained between a wireless device and an implanted medical device, such as a pacemaker or implanted cardioverter defibrillator, to avoid potential interference with the medical device. Persons who have such devices should:

- Always keep the wireless device more than 15.3 centimetres (6 inches) from the medical device when the wireless device is turned on.
- Not carry the wireless device in a breast pocket.
- Hold the wireless device to the ear opposite the medical device to minimise the potential for interference.
- Turn the wireless device off immediately if there is any reason to suspect that interference is taking place.
- Read and follow the directions from the manufacturer of their implanted medical device.

If you have any questions about using your wireless device with an implanted medical device, consult your health care provider.

Hearing aids

Some digital wireless devices may interfere with some hearing aids. If interference occurs, consult your service provider.

Vehicles

RF signals may affect improperly installed or inadequately shielded electronic systems in motor vehicles such as electronic fuel injection systems, electronic antiskid (antilock) braking systems, electronic speed control systems, and air bag

systems. For more information, check with the manufacturer, or its representative, of your vehicle or any equipment that has been added.

Only qualified personnel should service the device or install the device in a vehicle. Faulty installation or service may be dangerous and may invalidate any warranty that may apply to the device. Check regularly that all wireless device equipment in your vehicle is mounted and operating properly. Do not store or carry flammable liquids, gases, or explosive materials in the same compartment as the device, its parts, or enhancements. For vehicles equipped with an air bag, remember that air bags inflate with great force. Do not place objects, including installed or portable wireless equipment in the area over the air bag or in the air bag deployment area. If in-vehicle wireless equipment is improperly installed and the air bag inflates, serious injury could result.

Using your device while flying in aircraft is prohibited. Switch off your device before boarding an aircraft. The use of wireless teledevices in an aircraft may be dangerous to the operation of the aircraft, disrupt the wireless telephone network, and may be illegal.

Potentially explosive environments

Switch off your device when in any area with a potentially explosive atmosphere, and obey all signs and instructions. Potentially explosive atmospheres include areas where you would normally be advised to turn off your vehicle engine. Sparks in such areas could cause an explosion or fire resulting in bodily injury or even death. Switch off the device at refuelling points such as near gas pumps at service stations. Observe restrictions on the use of radio equipment in fuel depots, storage, and distribution areas; chemical plants; or where blasting operations are in progress. Areas with a potentially explosive atmosphere are often, but not always, clearly marked. They include below deck on boats, chemical transfer or storage facilities and areas where the air contains chemicals or particles such as grain, dust, or metal powders. You should check with the manufacturers of vehicles using liquefied petroleum gas (such as propane or butane) to determine if this device can be safely used in their vicinity.

Emergency calls



Important: This device operates using radio signals, wireless networks, landline networks, and user-programmed functions. If your device supports voice calls over the internet (internet calls), activate both the internet calls and the cellular phone. The device will attempt to make emergency calls over both the cellular networks and through your internet call provider if both are activated. Connections in all conditions cannot be guaranteed. You should never rely solely on any wireless device for essential communications like medical emergencies.

To make an emergency call:

1. If the device is not on, switch it on. Check for adequate signal strength. Depending on your device, you may also need to complete the following:
 - Insert a SIM card if your device uses one.
 - Remove certain call restrictions you have activated in your device.
 - Change your profile from offline or flight profile mode to an active profile.
2. Press the end key as many times as needed to clear the display and ready the device for calls.

3. Enter the official emergency number for your present location. Emergency numbers vary by location.
4. Press the call key.

When making an emergency call, give all the necessary information as accurately as possible. Your wireless device may be the only means of communication at the scene of an accident. Do not end the call until given permission to do so.

CERTIFICATION INFORMATION (SAR)

This mobile device meets guidelines for exposure to radio waves.

Your mobile device is a radio transmitter and receiver. It is designed not to exceed the limits for exposure to radio waves recommended by international guidelines. These guidelines were developed by the independent scientific organisation ICNIRP and include safety margins designed to assure the protection of all persons, regardless of age and health.

The exposure guidelines for mobile devices employ a unit of measurement known as the Specific Absorption Rate or SAR. The SAR limit stated in the ICNIRP guidelines is 2.0 watts/kilogram (W/kg) averaged over 10 grams of tissue. Tests for SAR are

conducted using standard operating positions with the device transmitting at its highest certified power level in all tested frequency bands. The actual SAR level of an operating device can be below the maximum value because the device is designed to use only the power required to reach the network. That amount changes depending on a number of factors such as how close you are to a network base station. The highest SAR value under the ICNIRP guidelines for use of the device at the ear is 1.40 W/kg.

Use of device accessories and enhancements may result in different SAR values. SAR values may vary depending on national reporting and testing requirements and the network band. Additional SAR information may be provided under product information at www.nokia.com.

Index

A

- access codes 21
- access points 41, 170
 - groups 170
- accessories
 - See *enhancements*
- active standby mode 51, 161
- active toolbar 81
 - in camera 79
 - in Photos 91
- address book
 - See *contacts*
- alarm clock 147
- alarm, calendar note 148
- albums, media 91
- anniversary notes 147
- answering calls 130
- antennas 17
- application manager 153
- applications 153
 - updating 20
- assisted GPS (A-GPS) 52
- attachments 120, 122
- audio messages 118
- audio themes 49

- auto-update for time/
date 147

B

- back cover
 - changing 48
- backing up device
memory 157
- backlight time-out 161
- battery
 - power saver setting 161
 - saving power 22
- birthday notes 147
- blogs 35
- Bluetooth connectivity
 - blocking devices 46
 - device address 44
 - device visibility 43
 - low memory 45
 - pairing devices 45
 - receiving data 45
 - security 44
 - sending data 44
 - settings 43
 - switching on/off 43
- bookmarks 36
- brightness, display 161

browser

- bookmarks 36
- browsing pages 33, 35
- cache memory 37
- downloads 36
- security 38
- settings 38
- widgets 35

C

- cable connection 46
- cache memory 37
- calculator 153
- calendar 147
- call log 137
- call waiting 131
- calls 129
 - answering 130
 - conference 130
 - duration of 137
 - internet calls 139
 - options during 129
 - recording 146
 - rejecting 130
 - settings 166
- camera
 - colour 87

- flash 82
- image quality 86
- imaging mode 80
- indicators 78
- lighting 87
- location information 81
- options 81
- scenes 82
- self-timer 83
- sequence mode 82
- settings 86
- video mode 85
- video quality 87
- cell broadcast messages 116**
- certificates 164**
- character encoding 118**
- charts**
 - spreadsheet 150
- clipboard, copying to 118**
- clock 51, 147**
- computer connections 47**
 - See also *data connections*
- conference calls 130**
- configuration**
 - See *settings*
- connection manager 42**
- contact information 19**
- contacts**
 - copying 142
 - default information 141

- deleting 141
- editing 141
- groups 143
- images in 141
- names and numbers 141
- ringing tones 142
- saving 141
- sending 141
- synchronising 158
- voice tags 141
- converter 151**
- copying text to clipboard 118**
- copyright protection 145**
- currency**
 - converter 151
- customer service 19**
- D**
- data connections**
 - cable 46
 - device manager 159
 - PC connectivity 47
 - synchronisation 158
- date and time 147**
- declining calls 130**
- device manager 159**
- dialled numbers 136**
- dismissing calls 130**
- display settings 161**

- DLNA 100**
- document applications 150**
- downloads 36**
- DRM (digital rights management) 145**
- duration of calls 137**
- E**
- e-mail messages 121**
- end all calls option 131**
- enhancement settings 162**
- Excel, Microsoft 150**
- F**
- factory settings, restoring 166**
- feeds, news 35**
- file manager 157**
- Flash Player 145**
- FM radio 73**
- FM transmitter 69**
 - playing songs 70
 - settings 70
- font settings 161**
- G**
- gallery**
 - sounds 98
 - streaming links 99
- games 110**

general information 19
GPS

position requests 54

GPS (Global Positioning System) 52

grid view of menus 51

H

headset 30

help application 19

home network 66, 100

copying files 103

sharing content 102

home synchronisation

incoming files 104

setting up 103

settings 104

HSDPA (high-speed downlink packet access) 32

I

IAPs (internet access points) 41

images

editing 94

printing 95, 96

sharing online 96

inbox, message 120

indicators and icons 26

installation of applications 154

internet call services

managing 140

internet calls 139

activating 139

blocking contacts 140

making 139

settings 140

internet connection 33

See also *browser*

internet radio

favourites 76

listening 75

settings 77

station directory 77

J

J2ME Java application support 153

Java scripts/

applications 153

K

keyguard 28, 164

keypad 28, 164

L

landmarks 54

language settings 162

licences 145

light settings 161

list view of menus 51

location information 52

lock code 21

locking

keypad 164

locking keypad 28

loudspeaker 31

M

mailbox

e-mail 121

video 130

voice 130

main menu 51

Maps 57

media

Flash Player 145

music player 64

radio 73

RealPlayer 144

streaming 144

voice recorder 146

meeting notes 147

meetings, setting up 147

memo notes 147, 151

memory

clearing 23

web cache 37

message reader 121
selecting voice 159

messages

e-mail 121
folders for 116
icon for incoming 120
multimedia 120
settings 123
voice 130

Mini Map 35

MMS (multimedia message service) 118, 120

multimedia menu 29

multimedia messages 118, 120

music player 64

playlists 65
transferring music 67

muting sound 130

my numbers 141

N

N-Gage 110

settings 114

N-Gage views 110

Navi wheel 28

navigation tools 52

network settings 168

news feeds 35

Nokia contact information 19
notes 151

O

offline mode 31

operator logo 162

options menu for calls 129

outbox, message 116

P

packet data connection

access point settings 171
counters 137
settings 173

page overview 35

PDF reader 151

personal certificates 164

personalisation 48, 161

phonebook

See *contacts*

photographs

See *camera*

Photos

active toolbar 85
organising files 90

photos

editing 94
file details 90
red-eye 94

tags 91

viewing 89

PictBridge 95

PIN code 21

PIN2 code 21

playing

messages 121

podcasting

directories 72
downloads 72
playing 73
searching 71
settings 70

positioning information 52

positioning settings 166

power saver 161

PowerPoint, Microsoft 150

predictive text entry

mode 117

presentations

multimedia 150

presentations,

multimedia 99, 121

printing

images 95

product support pages 19

profiles

offline restrictions 31

proxy settings 171

PUK codes 21

punctuation, text entry 118

Q

Quickmanager 151

Quickpoint 150

Quicksheet 150

Quickword 150

R

Radio

settings 75

radio 73

RDS (Radio Data System) 73

RealPlayer 144

recording

calls 146

sounds 146

recording video clips 85

red-eye removal 94

redial feature 167

rejecting calls 130

remote mailbox 121

remote SIM mode 46

ringing tones 49, 50

roaming 168

S

scenes, image and video 82

screen settings 161

scroll key 28

security

certificates 164

web browser 38

WEP 172

WPA 172

security code 21

security module 166

self-timer, camera 83

sensor

settings 163

sent messages folder 116

service commands 116

service messages 121

setting wizard 24

settings

access point name

control 174

access points 170

applications 174

Bluetooth connectivity 43

call barring 168

call divert 168

calls 166

camera 86

certificates 164

configuration 174

display 161

FM radio 75

FM transmitter 70

home network 101

internet calls 140

internet radio 77

language 162

Navi wheel 163

network 168

packet data 173

packet data access

points 171

personalisation 161

podcasting 70

positioning 166

RealPlayer 145

SIP 174

standby 161

tv-out 162

Video centre 108

video sharing 134

web browser 38

WLAN 173

WLAN internet access

points 172

shared video 134

shooting modes, camera 82

signature, digital 165

SIM card

messages 123

SIM card security 163

SIP 174

slide show 92

SMS (short message service) 118
software applications 153
software update 20
songs 64
sounds 49
speaker phone 31
special characters, text entry 118
Speech 159
speed dialling 131
standby mode 51, 161
streaming links 99
streaming media 144
support 19
Symbian applications 153
synchronisation
 settings 104
synchronisation of data 158

T

text entry 117
text messages
 receiving and reading 120
 replying to 120
 sending 118
 settings 124
 SIM messages 123
themes 48
time and date 147

time zone settings 147
time-out for backlight 161
tones 49
 ring settings 50
 settings 161
toolbar 79, 91
transferring data 24
transferring music 67
troubleshooting 175
trust settings 165
TV configuration 162
tv-out mode 92

U

unlocking keypad 28, 164
UPIN code 21
UPnP (Universal Plug and Play architecture) 100
UPUK code 21
USB cable connection 46
useful information 19

V

video calls 132, 134
 options during 133
Video Centre 106
Video centre
 downloading 106
 viewing 106

video clips
 shared 134
video settings 87
Visual Radio 73
voice applications 157
voice calls
 See *calls*
voice commands 131, 157
voice recorder 146
volume controls 31

W

wallpaper 48
web connection 33
web logs 35
week settings, calendar 148
welcome 24
welcome note 161
WEP 172
widgets 35
wireless LAN (WLAN) 40
wireless LAN settings 173
Word, Microsoft 150
world clock 147
WPA 172
wrist strap 17

Z

zip manager 152
zooming 80, 85