

COMMANDO SERVICE NOTES

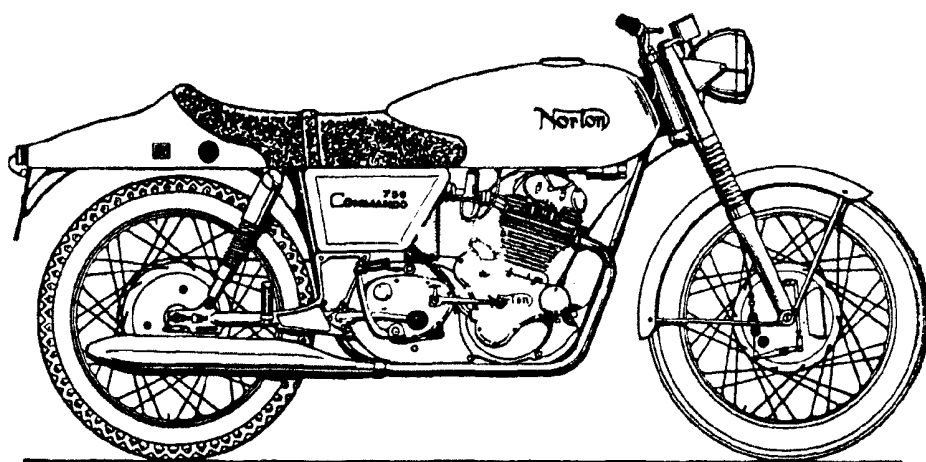

COMPLETE WITH ELECTRIC START

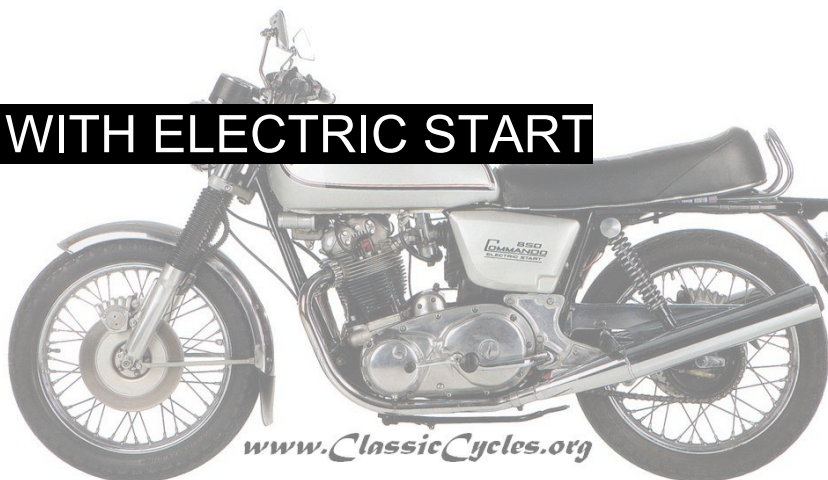

CONTENTS

Introduction and Spares Officers	2
Engine numbers-model changes	3
Group 1 :-- Crank assembly including pistons, camshaft and timing gear.	4
Group 2:-- Barrels, gaskets and head parts.	7
Group 3: -- Timing cover, all therein and rocker feed.	10
Group 4:-- Crankcases, breathing and main bearings.	13
Groups 5, 6, 7:-- Gearbox.	15
Group 8:-- Primary case and clutch.	18
Group 9:-- Carburetors.	21
Group 10:-- Engine mountings.	22
Group 11:-- Frame. swinging arm and suspension.	24
Group 12:-- Footrest plates.	27
Group 13:-- The oil tank.	28
Groups 14, 15, 16:-- Forks and front wheel.	29
Group 17:-- Rear hub, brake and sprocket.	30
Group 18:-- Handlebar controls.	31
Groups 19, 21-24, 28:-- Handlebars, side panels, front mudguard, scats, rear mudguard, tanks and instruments.	32
Group 20:-- Exhaust systems.	32
Groups 25, 26, 27:-- Electrics.	32
Group 29:-- The tool kit.	32
Addendum	33
Further model changes	33
Engine, main bearings, timing chest contents, ex valves	34
Pushrods Primary chain case, Clutch slip	34
Clutch drag, Alternators, Electric start	35
Gearbox, Kick start pawl, The pawl spring	36-37
Go-faster mods etc. wheels and brakes, Frame parts and handling	38
Service Release N3,13 Camshafts	39
Some tuning tips	40
Carburetor setting	41
Carburetion	42
Oil	43

SERVICE NOTES ON THE NORTON COMMANDO

Covering all models up to and including Mk. III

Original Text: T. R. Stevens

Collation: AI Osborn

These service notes are based on the parts list and are intended to supplement it and the workshop manual. They were written by Mr. T. R. Stevens for the club magazine Roadholder, and appeared in it from Sept/Oct '74 to May/June '77, he group numbers referring to the groups in the parts list. When collating these notes I have taken the opportunity to edit and update them where time and experience have dictated improvements. Further assistance from T.R.S. and Mr L. Emery being used, while not inconsiderable extra notes have been added by our President Mr. J. Hudson.

Mr T. R. Stevens was Quality Engineer and then Service Engineer at Norton Villiers Andover 1970-74, he is at present lecturer in Motorcycle Engineering at Merton Technical College.

John Hudson worked with the Norton Development Shop from 23rd January 1955, initially as a fitter tester, finally leaving the NVT complex in the summer of 1976 at its abolition. Voted as Life Honorary Member of the Club and President for the second time in Sept 1970.

Les Emery, member of NOC since 1971, rose to National Committee in 1973 as Membership Secretary. He then took charge of the spares scheme with regard to the twin cylinder machines.

AI Osborn joined the Club in 1970 rising to National Committee level as Assistant Editor in 1972, later becoming Chairman from 1974-77.

SPARES SERVICE

Les Emery. 37 Albion Street. Rugeley. Staffs. Tel: (09984) 3974.

T.R.S, Test-rides a Fastback.

Diagram; by T.R.S. and Richard Graham (North London).

Front cover:- 1971 Fastback

Rear cover:- 1972 Fastback. now with Roadster upswept exhaust system.

The opinions contained (in these service notes are entirely -those of the authors. They have no endorsement from any Norton factory, N.V.T., Norton Andover. or any such organization.

Notes in italics have been added for this edition by Alan Osborn, 9 Chapel Road, W. Ealing. London, W.13, from whom further copies are available.

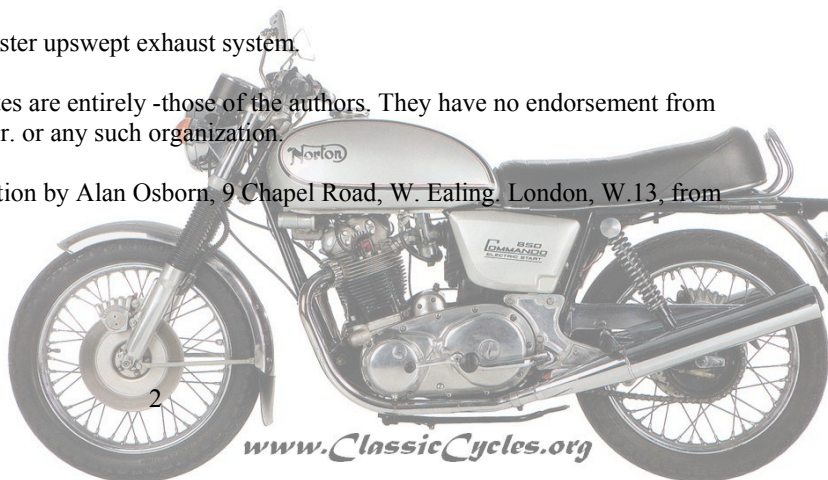

THE MOST SIGNIFICANT CHANGES IN THE MANY COMMANDO MODELS

Engine Nos.

- 126,125 FIRST COMMANDO, 17E(3 'G4. Silver tank, panels and frame-orange (!1 seat. Green blob on tank.
- 131,180 Now called FASTBACK, Conventional color scheme. Gusset below head-stock replaced by horizontal bracing tube (under tank). (The first frames broke).
- 131,257 First "S" type made for American market. Smaller rounded (Roadster type) tank. High level parallel PIPES left hand side, with reverse cone shape silencers. Points on the end of the cam shaft, REV. counter drive inboard. Six volt coils with ballast resistor, 1971.
- 133,668 FASTBACK receives "S" type technical mods. Points, coils, etc. 135,140 First ROADSTER with low pipes, upswept silencers, reverse cone absorption type.
- 139,571 FASTBACK Mk II fitted with Roadster exhaust system.
- 142,534 Mk II ROADSTER, Mk 111 FASTBACK, same 4:10 tyres on both wheels. Fork gaiters and F/bed type yokes dropped, bare chrome stanchions introduced. Lucas h/bar lever switches introduced and indicators. Centre stand mounted on g/box Shock absorber fitted in rear wheel.
Jan, '72 Consecutive engine numbers which had continued since W.W. II abandoned. New system and numbers introduced.
- 200,001 FASTBACK Mk. IV, ROADSTER Mk. IV. New crankcase castings, with breather behind c/case (not from end of camshaft). First double roller main bearings.
- 200,976 First COMBAT engine. Compression ration raised to 10:1 by machining head, double S camshaft fitted. Black barrel-. 32mm carbs. Disc brake right hand side behind fork leg, Models now 'Fastback' and 'Roadster.'
- 212,278 INTERSTATE. Larger black or blue (5 gal) tank, seat longer. Low level Interstate silencers. (Most Combat engines were later modified to standard engine specification and stronger main bearings fitted, i.e. Superblends (barreled rollers). Small sump plug introduced, later models with car type oil filter. 16H type (pre-war) front brake shoes with speedo drive clearance no longer used in Commando rear wheel. (Shame!).
- 220,000 COMBAT engine abandoned but 32mm carbs retained. Roadster Mk. V, Interstate Mk. V only. No more Fastbacks. Black instrument pods.
- 230,000 Square rear light. Different fork geometry. Box section head steady. 230,935 Last 750 COMMANDO (unless you know better.)
- 300,001 April '73, first 850 Mk. I. Barrel fixings altered, bronze clutch plates fitted, balance pipe in exhaust pipes. Strengthened swinging arm. larger sump plug reintroduced.
- 306,591 Mk. IA. Larger, quiet air box and annular discharge (bean can) silencers. Candy apple red tank also available. Chain guard plastic extension added. 2nd gear ratio raised by one tooth (to reduce noise readings).
- 307,091 Slimmer Interstate tank, 4 1/2 gals approx.
- 307,311 850 Mk. IIA. Improved paint, 30mm ports but 32mm carbs (for flexibility). Various small detail mods., such as mud flaps, third sleeve gear bush added. Black and blue tanks dropped, red and a few "traditional" silver tanks. Fork gaiters reintroduced and lower bars. Tach drive oil leak reduced (supposedly).
- 309,600 Larger, stronger kick start.

GROUP 1.- Crank assembly inc. pistons, camshaft and timing gear

CON RODS: Con rods don't usually give trouble -- the unbushed little-end never wears and trouble at the big end can usually be traced to a fault elsewhere, particularly running out of oil. Rods should be free from nicks and deep scratches especially up the sides from the bolt holes. Fatigue life can be improved by shot-peening, but this is only important for racing where stresses are much increased.

John Hudson: I have never seen dural rods shot-peened at the work:. For racing they were polished all over and if the steel caps did not match the contour of the outside of the rod they were filed to shape before polishing.

Everyone misses a very important point in Norton con rod bolts -as supplied they have a razor sharp edge on the underside of the head and this should be carefully filed off and the bolt rotated in lathe chuck or drilling machine and the head polished with emery tape. Otherwise, the turning torque of the Phillidas nut causes this sharp edge to scrape a shaving of dural off the side of the eccentric recess in the rod as the bolt is pulled down which, of course, then remains under the head of the bolt and prevents its seating and tightening properly. This can have happened on original assembly at the works, so whenever bolts are removed from the rods, check that there is not already a shaving in the bottom of the recess. > >

BIG ENDS: Big ends wear very slowly if oil is cared for. After a main bearing job the shells should be changed because the hard bits of bearing circulating with the oil become embedded in the soft shells and can score the crank. At the same time, of course. the crank should be dismantled and all the sludge scraped out.

CRANKSHAFTS: When having a crank reground specify in writing the size you want and the radius between the crank pins and the webs (0.090in Rad, 2.25mm) then check that the work has been carried out properly before reassembling.

Crank breakages can generally be placed to a radius too small-and not necessarily on a reground crank. New cranks have broken at fairly low mileages because of tight radii - particularly around the drive-side main bearing. Even cracks across the webs can start at the junction of the crankpin and web. Be careful too, when removing main bearing inners by the traditional chisel method - nicks in the crank are just as bad as tight radii. Rig end bolts need not be replaced, unless you are going racing; a tried and tested bolt is better than a new one which might fail.

Nuts should be used once only and not over tightened (or under tightened) If a nut comes off or a bolt breaks, it is usually due to lack of lubrication - - you will see that the rod around the big end eye is brown in color if this is the case, because -the hem generated when the oil supply ceased burns oil mist into the rod. The hammering after the big end has gone will break bolts or loosen nuts very quickly, so -if you should have a motor nip up, always check the oil supply before re-starting--there must be oil both in the tank and returning properly. Oil can be there but the pump seized or an oilway blocked, and to continue would soon result in your own exploded view.

Before reassembling check the fit of the small timing pinion on the crank -the crank can be eased with emery cloth until this is an easy push fit. The oil pump worm will hold it tight and it will make the next rebuild much quicker, as you won't have to remember to whom you last lent your extractor (or where you borrowed one . . .).



IDLER GEAR SPINDLE: The spindle for the idler gear (that's the one that is both sprocket and pinion) should be tight in the cases. If not, dry the cases off thoroughly and warm with a blowlamp before refitting the spindle with a drop or two of "Bearing fit" loctite. If it has been turning and will push in cold, copper plate it to a thou or two of interference and try again (Have about five thou plated on and rub down to the required size with worn-out emery. Nickel or chrome are too hard to rub down like this and must be ground to size). The oil hole goes underneath with the slot in the outer end horizontal.

This spindle has been slack on my 1970 motor for yonks to no ill effect. Makes cam chain tension a bit awkward to get right though. Case cracked open about 3/16in and a dabble and tug with a bent bicycle spoke (the same one I use for push rod aligning) usually gets the problem sorted.

CAMSHAFTS: The later camshafts are tufrided—a process which gives hardness without losing toughness. It can be recognized by an even brownish grey color all over the shaft. Many dealers may still have earlier shafts on which the cams are bright and these are not so good, so if you are after a cam, shop around. Avoid the SS cam like the plague—it is nothing but trouble in a road bike and is slower than the ordinary cam (which was, after all, the grind used for those 650 production wins at Thruxton -- you remember, in the good old days when Notions won races). It is a good plan to ease the end of the cam where the sprocket fits, so that this too can be pulled off easily -the next time. Never hammer the cam nut tight without a cutaway timing cover or all your work getting the idler spindle tight will be undone. Even pressure is sufficient and will cause no trouble.

A box spanner is preferable here, as the nut is shallow and slightly recessed ; a ring will tend to slip.

The "SS" cam mentioned here is the Commando SS cam or double S as used in the Combat engine (Interstate) as opposed to the Commando standard cam which stemmed from the 650 SS profile mentioned. Referred to as the "SS" because of its origin. This standard cam profile is as used on tire Atlas as well, and is now reverted to for the 850s.

CAM BUSHES: If you are unlucky enough to have a pair of cases with steel cam bushes (they are bronze faced, but can be recognized by the X-shaped oil grooves in the bronze surface of the bush), you must use bronze faced thrust washers each side of the timing side crankcase. Break off the tabs which locate the washers in the hole alongside the bush or they will break off in use. They are exactly the right size to drop into the crankcase and pass up the oil return to the oil pump, "is seizes the pump, stops the oil supply, and within a very few yards the evidence disappears through the bottom of the crankcases. There is no sump filter on the 1972 crankcases, and these are the ones with the steel bushes. Very clever,

Further if; the steel cam bushes with "X" oil grooves, or scrolling - these may be used with a plain or scrolled camshaft. On no account fit a plain camshaft in plain bushes. Plain bushes were fitted to early engines and are now being used again.

PISTONS: Don't buy new pistons with a slot under the oil control ring. This slot was deleted to avoid the top coming off the piston when the revs were kept up towards 7,000. Of course, the slotted pistons are OK for the man who never goes over 5,000 rpm. The later type are identified as Combat Pistons in the parts list, but the only difference is this slot—the compression height of combat (non slotted) and standard (slotted) pistons is identical. The higher ratio of the Combat engine was achieved by planning 40 thou off the cylinder head.

Atlas pistons will fit straight into the 750 Commando giving the lower

Atlas ratio (a bit more under a Combat head) but use Hepolite Atlas pistons and try to get those without the slot. It's not so critical with Atlas pistons because the combustion pressures are less and generally the chap who fits Atlas pistons doesn't go wailing about at 7,000 rpm all day.

A final point about pistons early Commando pistons had a three piece oil control ring where the central part was U shaped in cross section. Later pistons, both slotted and combat, have a 3 piece oil ring of which the central part is circular in cross section, the two sides of the pressing are bent over until they meet. The two types of ring are not interchangeable as the depth of the groove for the oil ring is deeper in (the newer pistons). The old type rings are more difficult to fit in the bore than the new ones, and aren't so good at oil control, so that's another reason for avoiding early-type pistons.

Rings last, on average, 25 - 30,000 miles. At this mileage the bores shouldn't be worn significantly and new rings will restore your oil consumption. If the bores are worn enough at this mileage it needs boring then change your brand of oil (or, dare I say it, change your oil).

Greater ring wear will occur without air cleaners and also not having chrome top rings (often two cast rings are supplied). In these cases oil consumption can get as high as 100 mpp when the handle is -well wrung". Only tip 10 70,00 before new rings and 40,000 between rebores.

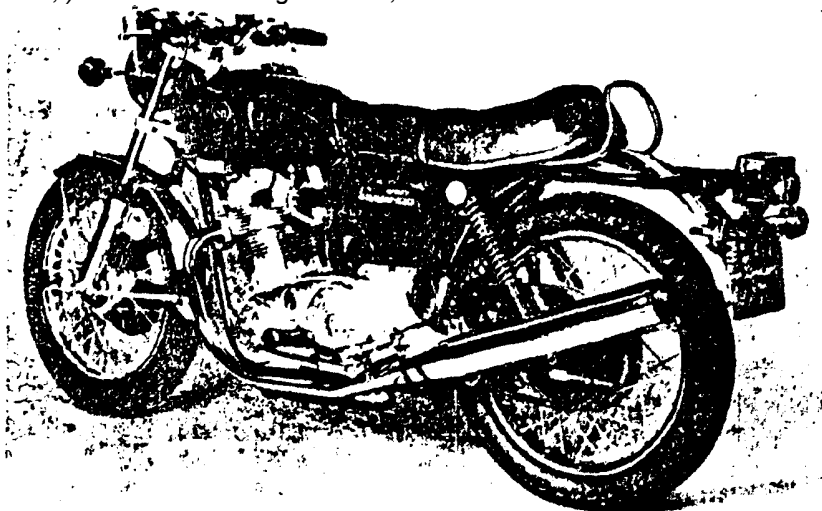

The 850 Mk 11A Roadster, complete with 'bean cans'.
STOP PRESS:

CLUTCH PLATES: If you change any early 750 clutch to phosphor bronze plates (although you'd do better by changing the oil to Castrolite first, it's also cheaper) then you'll also need the hardened clutch centre as well to help stop the bronze plates from notching in the centre. Part No. 063979 (Page 20).
GEARBOX 2ND GEAR: From Engine No. 306591 a new pair of 2nd gears were added 064639 and 064640 fully interchangeable with previous pairs 040418/040019 on no account mix the gears, pairs only. The reason for the change? The factory said 'to provide a more graduated set of ratios' actually it was to up the ratios therefore lower the revs in 2nd gear to pass noise restrictions!



GROUP 2:- Barrels, gaskets and head parts

CYLINDER BASE GASKET: This was deleted from Mk. I and II 850, plastic gasket such as Loctite, Hermetite RTV or similar silicone compound being used. A gasket was again introduced, part no. 0638 12, on the Mk. III as people filled the oil drain with RTV, causing lots of trouble. Removing the gasket puts the compression ratio up by approx 0.3 of a ratio, see table. The 850 gasket can be used on the 750 but not vice versa as the cylinder apertures aren't big enough. 750 base gasket is part no. NM24249 or Q67869.

The silver and black 750 barrels are identical dimensionally and incidentally, the studs all round the base are exactly the same positions on the 850, so you can build a 750 using 850 crankcases, but not the other way round, because the holes for the downward extensions of the barrel aren't big enough.

CYLINDER HEAD GASKET: This is where the complications start! There are plain composition, aluminum, copper and eyeletted composition gaskets for the 750 (and copper-asbestos, if you go back far enough!). The composition gaskets are about .028in thick in use, the copper gaskets are about 0.040in and the aluminum 0.080in thick. I will leave you to work out what these do to the compression ratio with the various heads available. Whatever compression ratio I wanted, I would use an eyeletted gasket. The others are all suspect. *(Mine has been perfectly satisfactory on standard compression i.e. 8.9:1. Anyway the eyeletted one did cost 3 or 4 times as much)*. The plain composition causes pre-ignition, because the reinforcing wires glow at the end, and then blow. The aluminum gasket squeezes out almost as quickly as -the custard in a vanilla slice-so you can hardly keep up with tightening the head bolts. They also spread into the push-rod holes and rub them away (even if they don't rub them from new). Copper and aluminum seem incapable of maintaining an oil-tight joint around the push-rod holes. *A smear of RTV in this area can help.*

J.H.: I cannot agree that the plain composition gasket causes pre-ignition-it was used on 10,000 engines (650 and 750) before the 1st Commando and gave no trouble; part no. 25324 on the 6.50 and 25318 on the 750. It came in with the spigotless cylinder barrel on the 650 and 750 at engine no. 114870, and the 1st Commando was 126125.»

Cylinder heads exist in an even greater variety. There are as standard, 30mm, 32mm, and tapered 30-32mm inlet ports, three different chamber depths, varying in stages of 0.020in from the gasket face, for the 750 and at least two for the 850, and I'm not counting the 750 short-stroke head which only fits on the 850 barrel and is only around in small numbers. Someday, someone will issue a chart of all the heads, gaskets and pistons you can use and what compression they will produce, but it's not going to be me! The only real way to find what you've got is to use a burette in the traditional manner.

The threads in the heads are, in general, BSF and Whitworth, and the exhaust ports are 1 15/16th x 14 tpi.

CHANGE IN COMPRESSION RATIO

With reference to four different cylinder heads and three head gaskets that have been in use on Commandos.

All numbers are compression ratios: I. Figures in brackets are compression ratios with base gasket removed. Loctite plastic gasket being used instead.

Part No.	HEADS	Port Dia.	Compo 30thou	GASKETS
	Types			1mm Cu 2mm Al
060988	STD 1968/72	30mm	8.9 (9.2)	8.7 (9.0) 8.1 (8.3)
063327	'Combat' 1972	32mm	9.7 (10)	9.5 (9.8) 8.7 (9.0)
064048	STD 1972/73	32mm	8.9 (9.2)	8.7 (9.0) 8.1 (8.3)
064097	STD 1972/73	32mm	9.3 (9.6)	9.1 (9.4) 8.5 (8.6)

VALVE GUIDES: Everyone should know that the inlet valve guide must have an oil seal to help reduce oil consumption. The 750 guides are too thin and when fitted right, collapse inwards slightly and give a belt-mouthed condition from new. That's why the 850 guides are so much thicker, and they are also ground on the outside to give good finish and concentricity (Hence the circlip, instead of a flange). If a 750 guide works loose and facilities permit, bore out to the 850 size and use the larger guides if you can get them. Some dealers sell bronze guides for 750's and 850's; the best material is hiduminium aluminum bronze Phosphor bronze in better than cast iron for conductivity and coefficient of expansion, but worse for wear.

VALVES: The latest valves are stellited at the end (V263, V264), yes, both of them but they're not identified because it's difficult to roll a number on satellite. Earlier valves have the part number on, but beware -- pattern valves also have no numbers. The latest bits should be in a box, in pairs, but of course, they could run out of boxes ...

All I date say about valve spring seals and insulating washers is-leave them as they are, to suit the head you've got. Many combat engines were made with cog-bound valve 'springs, and this was cured (bodged?) by omitting the insulating washers from the inlet valves, which don't get so hot and sometimes grinding the valve spring seats thinner to get a minimum of 0.050in movement of the valve at full lift. Not so critical with the standard cam, which has less lift. but if you're not sure check before you run the engine-you can check with the engine in the frame, if you must, by making sure that on full lift for each valve there is still fifty thou of lift available. (f there isn't, you'll have cam wear, bent pushrods and broken valve springs, depending on how bad it is. Apart from this instance, the only thing that breaks valve springs is not having the right ones.

PUSHRODS: Pushrod ends occasionally come loose, but will run happily like this for a While-but keep your eye on the rocker adjustment. (To retain loose pushrod ends lightly centre pop the ally, then with a dob o/ Locktite gently tap end cap back.) For those who insist on using planed heads, or combat heads, without compression plates, the pushrods should be shortened to restore rocker geometry. Take as much off the pushrods as you did off the standard head, and remember that Combat heads (marked C on top) have 0.040in planed off already, but that the factory "forgot" to alter the rods, when the combat design was finalized. Rods are shortened by pulling one end off (easier after having rods in the freezer first) and removing the desired amount of alloy from the middle bit. The cam followers have a brazed-on stellite foot and should be bevelled on both sides to let the oil by. Check new ones, to be sure they're not still full of casting sand. The Domiracer had thinner followers, with the pushrods going to the bottom-much lighter, and worth a thought for racing. If you fit a different cam, be sure it doesn't foul the cam-follower locating plates, and if you have the base circle ground, check that the plates allow the followers to fall far enough, 750s only.

It is possible incidentally. to remove the head and barrel from any Commando as an assembly and the pushrods should stay in place, so it's possible to Woe the head and barrel inside so you can locate the pushrods in the com fort of the sitting-room and take the assembly out in the rain to fit it. But not on the 850s.

ROCKERS: The rockers can be lightened a bit, but not much, and it's useful to check that the valve end strikes the valve centrally (some don't) - the arm can be bent slightly to give this condition. The adjusters are 9/32in BSF x 26 tpi, so one flat of ;he squared adjuster is almost exactly 0. in case you can't afford a set of feeler gauges. In spite of the English thread sizes, some bikes have }in A.F. instead of 3/16in Whit hexagons for the adjusters, so watch



it, (A.F, stands for American Fred, by the way, a fact first mentioned in the Vincent Owners magazine.) *(I thought it stood for Awkward F----r!)*

ROCKER SPINDLES: The rocker spindles are fitted with the oil flats outwards -away from the holes in the rockers --because otherwise too much oil swamps the head. The rocker spindle locating plates always seemed to me to be a very complicated way of avoiding a simple die casting, but there's nothing much to say about them except that they usually weep a bit.

HEAD BOLTS AND NUTS: Nothing extraordinary, either, about these. except -- the nut holding the head down at the back. on all engines, is 3/8in x 26 tpi, but the similar nuts on the base flange of the latest 750's (those with the breather at the back of the crankcase) are tapped 3/8in x 24 tpi (American Fred, again!). and by the time you've realized this, the threads have so thoroughly jammed together that the nut and the stud are both ruined. Ask your local dealer if he stocks either . . . You will note that the size of both nuts from the outside is 1in Whitworth to add to the confusion.

EXHAUST THREADS: The exhaust threads in the cylinder head cannot be stripped using the standard nuts and the large service C ring-the fins on the nuts bend first. If the nuts aren't tightened enough, an pre-delivery, they will loosen and the lock rings enable you to carry on like this so that the threads wear, and will subsequently strip.

To stop my exhaust rings coming undone I use two short pieces of steel wire bent into loops about 2in long x 1/2in width connected to each end of a 3in x 4 spring a-la stop light switch, This is looped over the fins of the clamp rings, making sure it is tending to tighten them Maybe even another small loop of wire to retain the device to the rev counter cable so if one end comes adrift the device isn't lost in the bushes!

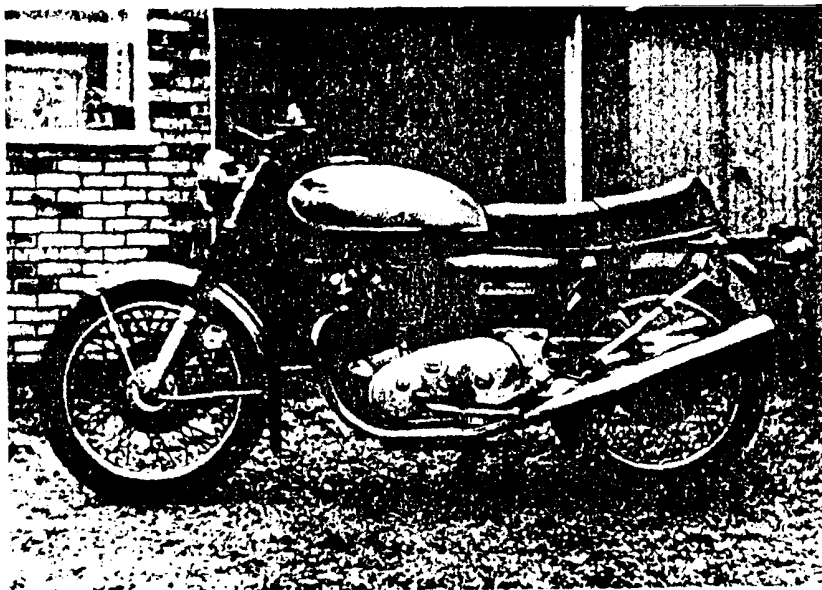

The 850 Mk IIA of Hill Nicol, Bury .St. Edmunds, The tin covers on the rear suspension ran only he an improvement while skimming the chrome off of the disc is a personal choice.

GROUP 3:- Timing cover, all therein and rocker feed

TIMING COVER: Not a part that's been messed about with much by the designer chappies. If you ever need a new one don't forget the oilway plug on the feed to the pressure release valve and of course the two oil seals. The middle seal (crankshaft) goes with die garter where you can't see it, and has a circlip. The other one (camshaft points protection) has the garter visible and relies on friction• holding it in place, so a smear of silicone RTV might reduce the possibility of a weep into the points, (The garter is the spring thing that presses on the edge of the seal to make it work.) While we're on the subject, later points oil seals are red and better but won't cope with engine breathing which is all awry. The 850 has a breather where the mag used to be but you can't do this to a 750 without making holes in the timing side crankcase. The oil normally drains through the main bearing, mainly (!) and if the crankcase has to breathe the other way through the same place the oil level in the timing case rises until the points seal can't cope. See section on Breathing.

If you have a persistent oil leak into the points and the seal is O.K. there are two other possible causes (at least). There have been timing covers which were porous (how unusual, I hear you say) but-porous between the inside and the points lead hole. This can be cared by enlarging the hole if necessary to 5/16in (0.3125in=7.938mm, say 8.00mm) and inserting a thin sleeve of your own manufacture, or of Norton manufacture if you can get one. Stick the sleeve in with plastic gasket or the afore-mentioned sticky substance. The other cause is use of an incorrect (i.e. Dominator) or spurious timing cover gasket, which does not include the hole for the points lead or hole for oil feed to pumpfitting a Dommie gasket will empty the oil tank into the sump. You CANNOT FIT an early type, of timing cover to the early Commando although it looks the same with the r/counter on the side. The proper Commando gasket is thick -a bit thicker than the average cornflakes packet and they don't leak oil. The paper ones are spurious, or Dominator or Atlas (early).

Timing cover screws; die one long screw goes in the deep hole nearest the pressure release, and the short ones go where the little bulges stick out around the cover. The flat headed sort are early ones, Whitworth thread (1/4in x 20 tpi) : later bikes, 1972 on have domed heads, w identify the UNC threads (} x 20 tpi--well I never!). Proper names for the heads are "cheese" and "fillster". A set of socket screws from your local friendly dealer, Wassel item, is well worthwhile. Except that being nickel plated the inside of the hole goes rusty so smear them with grease. Stainless is best but dearest.

POINTS COVER: The points plate types are many and various-the latest have two screws to lock the points gap and two screws to position each set of points and are somewhat easier to ad just The contacts which had one big point and one small point-presumably to reduce unsprung weight (the latest ones have bath points the same size again!)- rapidly wear into one another and give erratic timing. They also demand a rather special type of feeler gauge not available from Uncle Joseph. You should all by now be using the "new improved" type of auto advance unit recognized by having the outer spring posts bent up from the backing plate rather than thin bits of metal spot-welded on afterwards. They really are much better-the pity of it all is that they were not available years ago, say, when the Jubilee was about. Don't be tempted to use any A.T.D. from a B.S.A, or Triumph even if it does advance the right way, the range and the spring poundage (ounceage'?) may still be wrong. The B.S.A, A65L one works O.K. ft will give 30' retard. not 24" though, great for tickovers. If you are a well built fellow don't heave too hard on the points plate screws-especially the plate fixing screws themselves. Broken screws can be difficult to remove (they are 2BA but you can drill and tap new holes a bit further round if you're careful. Next time try B.S.A_ -Triumph clamping



screws which have 4BA spanner size but the right 2BA threads (B.S.A. number 40.0683 ==Triumph E7680) being smaller you might remember not to heave so hard. Finally the points cover has a little hole which is to let oil/water out and therefore goes at the bottom. Boyer or RITA electronic ignition cures all!

OIL PUMP: The oil pump takes a long time to wear out, but when the mains go it's a good idea to recondition it, as all those bits of bearing have to go through the oil pump on their way to the tank-full instructions are given for this operation in the workshop manual. Usually, you'll be glad to know, no new parts are required. If you have changed the cover, the gasket, or the oil pump, check that the little conical black rubber on the pump is just compressed-it shouldn't be possible to push the cover quite home by hand. If the cover is very proud, check that there aren't too many shims on the oil pump under the black rubber. They tend to stick together and not get noticed. For the hat few years these shims haven't been used, a paper washer between the oil pump and the crankcase is used instead. I have heard of engines which ran quite successfully for a while without the rubber seal-because somebody forgot it (no it wasn't me)-the theory is that the centrifugal whirling of the crankshaft forces oil out into the big ends and draws oil into the crank. The output from the pump is enough to drench the hole so that air isn't drawn in. No oil goes to the rocker gear, though, as this requires pressure.

Mention of pressure brings me to another point-the fitting of oil pressure gauges. On the Commando (and for similar reasons. most bikes) an oil pressure gauge is more of a liability than an asset. It is of necessity, fitted on the feed side where any failure of pipe or gauge is disastrous to engine and rider--it's touch and go whether the engine seizes before or after you fall off with oil on the back wheel. On the Commando this failure could be caused by engine vibration in the same way that early rocker pipes failed. (We're coming to that.) The other reason that a pressure gauge isn't much good is really twofold. At high speeds and high oil temperatures the pressure can drop to nothing on the gauge because the pump can hardly keep up with the rate the stuff is flying out of the big ends. The centrifugal force can keep the pressure at the big ends above the danger point, so there's no real panic--but the gauge would inspire you with horror. Then of course if you did seize an oil pump by the time you noticed that the pressure had dropped the big ends would have gone (. . . through the hole in the crankcase, with average N.O.C. luck!). If you want an interesting gauge to frighten yourself with, but, which is inherently safer and can give useful information, fit an oil temperature gauge in the oil tank. Let me know what it reads as you change into top for the Mountain Mile on both the fourth or fifth lap! The latest Racing Nortons (we can't call them J.P. Nortons any more as they've stopped the bikes from smoking) had a new type of oil pump-I wonder if this is because the ordinary pump can't keep up?

ROCKER FEED PIPES: Rocker feed pipes are fitted with 3 identical banjo bolts (5/16W spanner size) and copper washers, which won't leak if properly annealed. Do this by heating on a gas flame and allowing to cool. Quenching gives no real advantage, except speed, unless you quench in very dilute battery acid as this saves having to scrub the scale off. (Don't use this acid in a battery afterwards though). The banjo bolt has holes in the sides and up the middle, so avoid plastic gasket here because if Loctite gets in the threads the bolt may break when you next try to remove it. Position the rocker pipe so that it cannot rub on the head steady, the frame or the gearbox cradle. 850 rocker pipes have reinforcement to avoid chaffing. It would be useful to keep an eye on these rubbing points, as the rocker pipe runs at big end pressure and the slightest hole can rapidly lose you all your oil, your big ends, your crankcases.... This makes it particularly important to know that the early all metal rocker feed pipes failed regularly, and I would certainly recommend anyone

to use the later black plastic type. White plastic examples were used on the production racers; they are equally good. Watch out incidentally for Dunstall banjo bolts which have a restrictor to prevent over oiling-used in the days before inlet guide oil seals to reduce oil consumption. Remember that the head is oil cooled as well as air cooled. I/ you must use early all metal feeds (perhaps on your all standard Dommi) their please use Tinmans solder and flux from your hardware shoppee, not electronic flux cured solder, as it isn't strong enough. Similarly, for any repairs or alterations to tire nil feed/return banjo at back of liming chest.

ODD ITEMS

Head gaskets Don't forget to aneal the copper one on first and every re-use. Heat to red all over quench in water.

Shimming: Equal gap both sides cuts down low frequency shaking.

Head gaskets: Some people when following the Service Manual find that a replaced blowing head gasket goes again within 100 miles or so, the reason being omission to re-tighten the head bolts after 50 miles.

Clutch drag: Following the Service Manual has you putting engine oil into the primary case, this tends to cling onto the clutch plates causing drag. After a good clean of the plates, refilling with Castrolite or similar lightweight oil is preferred.

Worn exhaust, port threads: these are very often caused by allowing the nuts to come loose, but they are stopped from failing out by those rattley tab washers. The whole issue then vibrates and clatters, knocking out the threads. Cure for worn threads can be to have sleeves fitted, but a very much recommended method is steel helicoils ; the thread is then better than new.

Any trouble with sleeve gear bushes can he checked as follows: check primary chain tension with a finger and with other hand haul tip and down on rear chain. Any change in primary chain tension spells trouble If there are rumbles when clutch is operated it could be clutch centre bearing going dodgy.

DRILL 3/8 Holes
HERE

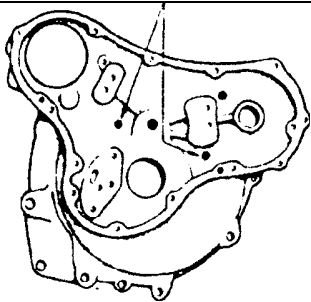

Diagram 4, Timing side crankcase showing holes for 850 breathing, See page 14.

FORK YOKES: 750 - - Engine Nos. 221545-221644 and 230536230685, 850 - all. All these had the revised steering geometry by new (850) frame 064140. Also new fork yokes 004078 (lower) 064080 (upper with stem) the yokes must be used in pairs. Do not mix old and new ones. The factory re-release states also do not fit old yokes to late frame or vice versa. T.R.S. states this was due to lack of knowledge of the effect. See Page 24



GROUP 4:- Crankcases, breathing and main bearings

CRANKCASES: In comparison with the fairly clever design of the Norton head, the crankcases are well, not to put too blunt a point on it, unsophisticated. It has been said that they only serve to keep the oil in and they're not very good at that!

Anyone who has read "Tuning for Speed" will remember that bosses on crankcases ought to go all the way across, not just halfway, even when the engine is not used as a stress-bearing part of the structure. On the Commando, there are two such bosses at the front, where the isolastic bolts on, and three at the back, which hold the gearbox cradle (and an assortment of shorter bosses and stud holes, all of different lengths and not one going right across!).

The three back bolts simply hold the gearbox cradle, but when you think about it, you will realize that they take all the pull from the primary chain when driving and on the over-run and they take the load when you put the back brake on. These forces combine with those from the out-of-balance of the engine (which also constantly change in magnitude and direction) to give the crankcases and the through bolts a particularly hard time. This will show in any of several ways.

Early engines before engine 200,000 were mostly fitted with studs and nuts all made of mild steel and infernal serrated washers. (Yes, infernal-as well as internal!) These washers are jokingly referred to as "shakeproof", but I can think of no instance in engineering where serrated washers couldn't be replaced by something better. Here where the load is constantly varied, they serve only to dig into the gearbox cradle and the back of the nut, until they have loosed one from the other when disaster follows. At the same time, the serrations serve to let salt water into the hole, and this can seize the studs into the case. Plain washers, lock-nuts and high tensile bolts were introduced later, to eliminate some of these faults, and I would strongly advise any one still with the early type to change. Use Nyloc nuts, though, not the all-metal type used on production, as you can chock and tighten them much more easily and they don't gall and seize on the bolt when you want the engine out. The top rear bolt seems to be the one which is the most stressed and even if the bolts themselves do not loosen the crankcases may well crack around the LH end of the boss. Look at the corner of the machining where the boss meets the crankcase-I have seen more cases cracked here than anywhere else. The cure is to apply a dollop of weld, just like the weld on Peter's bike, and for the same reason. If you don't weld the crack up it will only spread very slowly. Very little oil will ooze out of the grey line produced, and I have seen machines do 10,000 miles in this condition without disaster occurring. They weren't racing machines, though!

Finally, that oil leak between the top rear boss and the base of the barrels. Any 750 owner will show you the one I mean, If you take a used pair of crankcases apart-any crankcases, not just the Nortons, you may see areas of the joint face which are a dark grey color, compared with the original bright machined finish everywhere else. This effect occurs when the faces in contact have been moving in relation to one another-a process known as shuttling. You get the same thing with crankshaft assemblies where they shuffle (and they do!). The only type of gasket compound I know, which will stand this sort of movement is the silicone rubber type, Hermetite RTV, or Dow Corning RTV (Room Temperature Vulcanising) or in France. CAF 4 or Loctite plastic gasket 275. When glueing and bolting up the crankcases, incidentally, always put suitable bolts and spacers into every bolt-hole, to clamp the case up solid while the gasket compound sets-so that it sets in the condition it will be in when the engine is finally in the frame. This applies to all cases and all gasket compounds (although if I catch any of you using Red Hermetite anywhere on

any Norton, or any other proper motorcycle, you will have to write out 100 times, "This is the Twentieth Century").

As well as salt water getting into stud threads, Gunk is another culprit; regular Gunk cleans all the oil and grease away so eventually they'll get water in and seize, barrel studs being a prime example.

MAIN BEARINGS: There are, so far, only two types of bearing I would recommend anyone to use in any Norton twin (5)D up anyway). "These bearings are both Superblend Roller Bearings-one from Ransome and Marles, Norton No: 063906, and one from F.A.G., Norton No: 064118. Either should be used in 500-750 engines; the factory reckon only to use the F.A.G. bearings in the 830s There will be some end float with the double roller-bearing set up which previously was controlled by the ball-bearing in the timing side-this should be between 10 and 30 thou (0.25-0.75mm), but don't worry if it's not, as long as there is some float. The outer rings of the bearings are glued in at the factory by Loctite Bearing Fit, so there's no reason why you shouldn't use it too, as long as you make sure that the rings are hard home before the glue sets, not when you find you haven't got any end float! Only use bearings with one of the following nos: NJ306E (E is very important, NJ306 is weaker) or 6 MRJA30. The 6 may be hand engraved on the bearing. The timing side bearing need not be a particularly tight fit on the crank. Again don't use just any roller bearings, these ones are barrelled to allow crankshaft whip. Another number is NJ306E MI, (Harder.)

BREATHING: The pre 200,000 motors had a timed breather which was so small it wasn't really much good. The 200,000 series had a right angle joint at the bottom rear of the crankcase, joined to the oil tank by a bit of washing machine hose. This system was, if anything, worse than before---at high r.p.m., more oil went up the breather than up the scavenge pipe. Don't be tempted to replace the rubbery hose pipe with plastic on 200,000 series motors-I have seen a nylon reinforced pipe melted by the hot oil going up it! The other oil differences on late 750s are the elimination of the sump filters, and the resiting of the oil pick-up at the front of the sump. I will never know why the filter was eliminated but was put back on the 850.

The 830 breather is much better than both earlier systems, but really you need 830 cases to make it work, so that you get good oil return from the sump and a filter, but you can get good results by fitting a pipe of about 1/2 in bore into the back of the timing chamber where the magneto used to go (in the days when Lucas ignition systems were guaranteed for two years, including points wear). The pipe should stick through the case about ;in and slope downwards, so that oil running down the inside of the case doesn't get carried up the pipe with the air going out. Oil runs down from the inlet valve as well as sloshing about from the timing gear. How you fit the pipe is up to you; you can't just buy the bits and slap them in. It is also necessary to drill holes in the timing side crankcase-try and get a look in an 830 timing cover and copy the size and position and I don't recommend drilling the holes without dismantling the engine; no Malcolm, put that brace and bit down immediately! See Diagram 4, page 12

Oil leaks from the rev. counter drive can be a problem; try using two O rings at the same time and try grinding a scroll on the spindle so that it tends to screw the oil out again, but remember, steel and aluminum needs lubrication, so if no oil gets up there it will seize up and wear out the gear cut on the camshaft, so don't overdo the pressure on the O ring. The later 830 has a modified type with the O ring at the outer end, and it's supposed to be both better and interchangeable as an assembly. Not so, L. Em.

Final consolation of the late 750 owners, without sump filters-there is a magnetic drain plug which has a chance of catching any bits (if metal on the way to the pump-unless the metal is aluminum, brass or bronze).



GROUPS 5, 6, 7:- Gearbox

THE GEARBOX: This area is, I suppose, that with the most history behind it-for a start it is generally referred to as the AMC gearbox as it was introduced when Nortons were fairly new to the AMC empire and shortly afterwards it found -its way onto the AJS and Matchless heavyweight range, Before that, Nortons had a box with similar gears and an oval horizontal cover; this is known as the Norton-Burman box and takes us back to about 1947. Before that even, almost identical gears were used in a box with an upright outer cover -the positive stop mechanism was in the upwards bulge and before the war this upwards extension had a separate lid of its own. This was the Sturmey Archer box, also used by other makes such as Brough Superior. Sturmey Archer were a Nottingham firm, as were Broughs and they are now part of the Raleigh organization. One sign of the antiquity of the design is the use of cycle threads for studs and nuts. When you think that the AMC box was designed to cope with 30 bhp from a 500cc machine, it is not surprising that on 828cc machines giving about twice the power the reliability of the box is not what it should be.

SHELL, CLUSTER, SPROCKETS: The main items to note are: Gearbox Shell with Bushes and Studs-often this part is supplied without bushes or without studs or completely bare. The shell should arrive with seven studs, two dowels and two bronze bushes already fitted. Don't throw away the old case before removing at least the studs, as cycle thread studs have something in common with Rocking Horse substance. The ends that screw in the case is BSF-just in case you need a helicoil they are easier to find. Nothing wrong with the BSF threads, or cycle for that matter, in the right place. Better than this UNF nonsense any day.

SLEEVE GEAR & LAYSHAFT T BEARINGS: These two components are very close together and the metal between them can crack-this will allow bearing rotation and gradual wear of the case. The bearings sometimes rotate anyway; this can be recognized by a polished, not ground. surface on the outside of the bearing when it is removed. No real cure-Loctite sometimes works and is much better than centre-punching the case where the bearing fits (aaargh!) and much less complicated than having the outer race of the bearing plated oversize. One of the first things to go on an 828--or even on many 745's, is the layshaft bearing in the case. First symptom of this is a kickstart shaft which moves round on its own and springs back to dig you in the shin. At the same time you may get jumping out of gear. As there is next to no side load fit a roller bearing equivalent, NJ203C3 If all else fails (which it easily can, once a bearing goes) you can remove the layshaft completely and carry on in top gear only-make the change at the top of a long hill though, as the kickstart will be inoperative. The other fault which can cause the kickstarter to go round on its own a failure of the kickstarter pawl-we're coming to that!

Sleeve gear bushes are always coming loose-sometimes the outer bush moves inwards to the centre of the sleeve gear-then all you need do is to Loctite a new bush in the end. Leave the old one in and it will prevent the new one moving inwards, i.e. fit three bushes in your 750 or a 850. Sometimes the bush moves outwards and gradually mills itself away on the sharp edges of the circlip which locates the clutch. That's worse because eventually the bush disappears completely and all the pull of the back chain comes on the sleeve gear bearing. No wonder the bearings come loose. Often the first sign of sleeve gear bushes going -is striking "gold" in gearbox or primary drive oil, watch it! Here the answer is to buy two new bushes and a clutch location shim (060894 or O60895). Push both bushes-Loctited on the outside--into the sleeve gear the middle one stops the outer from moving in-and then put the shim loose on the shaft to avoid -the bush wearing on the circlip even if it does move. It is an advantage to grind the outer edge of the shim so it will pass through the hole in

the primary case (or file or even clip it away with tinsnips to about half the radial thickness).

J.H.: I believe layshaft bail bearing failures are more frequent when:-

1. The 22T gearbox sprocket is used as on 850s and
2. Every failure I have seen has been a Portuguese SKF bearing.

In Birmingham they insisted on Hoffmann 117 bearings being used here but, of [course](#), as Tim rightly points out we did not have so much power. Even so, the Hoffmann bearing--now RHP---would probably stand up better to present 850 conditions.

It seems to me very unfortunate that they did not change Commando gear ratios by using alternative engine sprockets, because with a larger engine sprocket and retaining say, a 19T on the gearbox (as was standard on all Norton Nortons from Model 50 to Atlas and Manx) the speed of the box would be increased without such a heavy journal load on -the bearings and tooth loading on the pinions themselves. > >

Any rider of an 850 Commando in particular, but 750 also, should stop immediately if he feels the slightest sudden roughness in the intermediate gears especially if the kickstarter flies back because this is a sure indication of layshaft bearing failure.

As well as the sprockets listed (19T to 24T) there are 17T for Matchless and 16T for sidecar scrambling--available from your local friendly. This o-rings us to the kickstart pawl. These break. Only sometimes and much less often on recent machines than on 1970 and 1971 bikes. Recent pawls are cast from steel (by lost wax process, by the way) and have an M on the side: they are much more reliable. If the pawl does break, the side bits of the T shape wedge in the bottom gear pinion and the kickstart is carried down on its own and can then stay down--waiting for you to go round a right hander. If the kickstart flies up again there is no reason why it shouldn't happen again--or the bits can get between any of the other gears--rather to the detriment of the abaft straightness and freedom from broken teeth and broken cases. So, for whatever reason the kickstart plays up--don't just carry on. You can get the covers off at the roadside with the too! kit and a large brinck--the long black spanner is 15/16in at the large end--not exactly 1in Whitworth, but only 0.0175in too big, and in these circumstances no one will argue about 17 thou. That's to get the mainshaft nut off. Of course, you can get -the clutch operating housing unscrewed with the brick and a tyre lever. Brutal, but inevitable there's no special tool unless you make your own special tube using a piece of 1 1/2in LD. tube and filing as per diag 1. To use the tube you'll have to remove the roller and operating lever. This part must be screwed up with the cot in the housing in line with the cable hole in the cover, so mark the position before unscrewing it. If it is not lined up correctly the clutch operation becomes stiff because the cable has to go round too many corners.

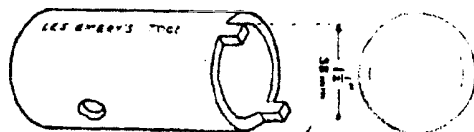
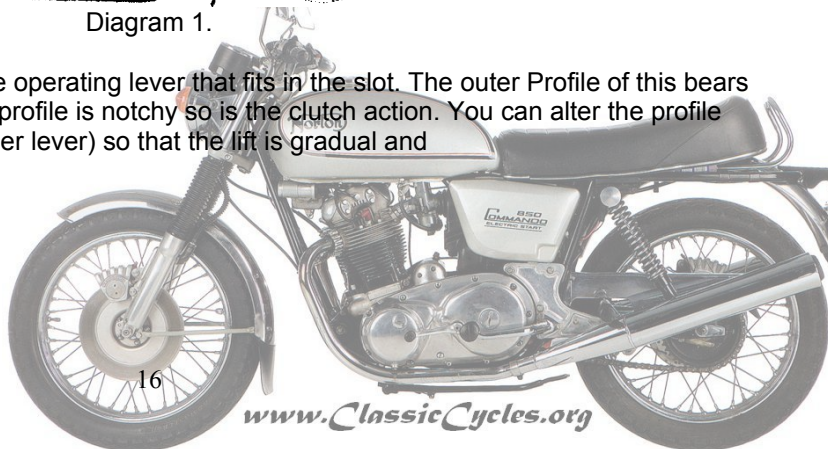

Diagram 1.

Another cause of stiff clutch action is the operating lever that fits in the slot. The outer profile of this bears on the roller in the end of the slot and if profile is notchy so is the clutch action. You can alter the profile with a grinding wheel (or by trying another lever) so that the lift is gradual and



smooth; finish with a stone or emery. After a while the ball gets flats on it they are very cheap, so polish the operating lever and a new ball, and a nylon lined cable and you should have the clutch the envy of others (except Vincent Owners).

There are pattern kickstarts about with the top retained by a cap and roll-pin instead of the thread and nut which is standard (as this fitting is similar to Ducati kickstarts I suspect that the pattern parts originate somewhere in the middle of the Mediterranean). Problem is-the pattern parts often foul the exhaust pipe, making starting difficult. The 825 starter is a different shape at the bend and is about 1 in longer and will fit the 745 making starting on told mornings a bit easier.

Diagram 2.

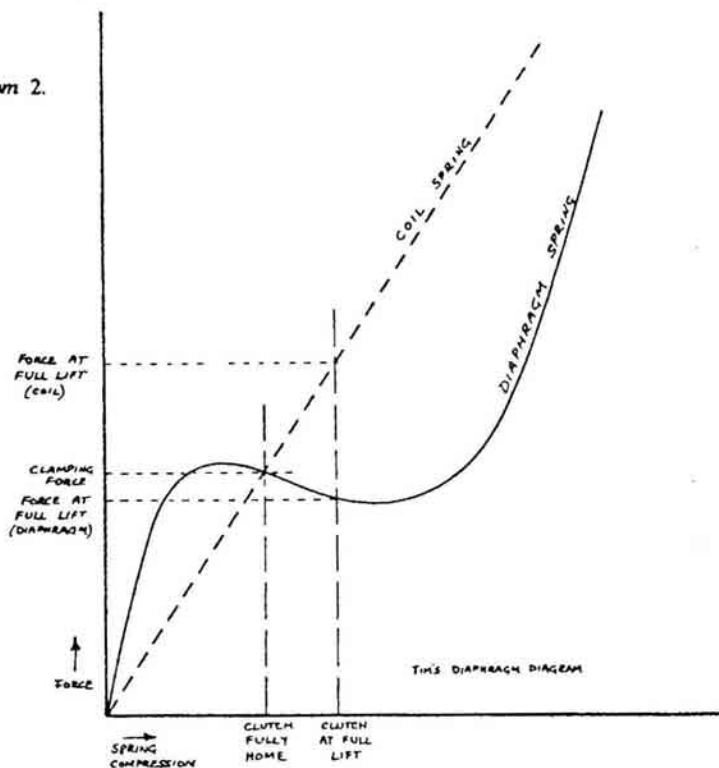

STOP PRESS: At the last minute a number of ex factory service releases have come to life. Here and in other odd corners are the basic facts of importance. **HEAD GASKETS.** If there is any trouble keeping the copper one, especially, oiltight then a smear of Silicon RTV or Plastic Gasket on both surfaces will help, especially around the push rod tunnels but do be very careful not to block the oil drain hole. Similarly when using Silicon Clag as substitute for a base gasket don't block the oil drain hole it can cause disasters.

CON ROD NUTS should only be used once we are told correctly, but new assemblies when supplied have nuts to retain the big end cap for machining. Therefore these nuts have been used once. so discard these nuts and use the new ones that should be supplied with the rod.

REAR WHEEL SPACER: This was made of improved material as Part No. 065290 to overcome the early soft ones' loosening the wheel spindle while in service! P.S. For interest sake the rear spindle nut and dummy axle nut should be done up to 80 ft/lbs i.e., lots.

GROUP 8:- Primary case and clutch

PRIMARY CASE: There is a commonly held opinion that all Commando primary chain cases leak oil. In many cases, oil drops from the lowest part of the case--just where the joint is. Sometimes this oil collects from the rear chain --oil flings from the chain onto the cast cover over the gearbox sprocket--then down the back of the case. The chain case can leak, though, especially if the wrong number of washers is fitted on the centre bolt before the inner case is fitted. Or washers left out, the case then buckles anti cracks. Leaks nil especially at the front, the alternator is then off concentricity, touches overheats, burns out etc. 1 know, . . . So check correct washers when you next take the inner case off, allowing for the gasket as well. When the new washers or shims are set so that the case is not distorted--you can check on assembly by offering up the case and trying to rock it, If it rocks about a horizontal axis you have too many washers on the bolt--if it rocks about a vertical axis you need another washer or two. The washers come in two thicknesses, thick and thin, and you can get it near enough by combinations--or any old flat tin washer. Our continental friends can use 10mm washers as long as Ogrin isn't looking. If the outer cover of the chain case is difficult to fit try pulling one of the steel dowels out--but not both as this would enable the outer to swivel round and mess up the timing scale location. Leaks, if they are (here. can be cured with our old favorite Silicone clag--R TV. Now for what goes on inside--

The position and adjustment of the shims behind the clutch and alternator is all in the workshop manual, but they don't tell you about the exploding alternator rotor. Norton dealer Jean Souper at Mantgeron (near Paris---Jean being French, is a feller!) has a row of exploded rotors in his workshop,;--there is over a yard of them stuck over the door. He is only one of many dealers who could tell the same story, but perhaps they haven't all got magnetic lintels. What happens is this--the engine as it rotates produces considerable torsional vibration--not just due to the firing pulses but also the fact that every revolution the pistons come to a dead halt together and then rush along at about 100 mph together, twice. This is not very good for alternators. The centre of the rotor is made of hexagonal bar, the magnets are placed round it and then a grey substance made of melted down carburetors is poured round them. When you shake such an assembly 14,000 times a minute (twice every rev, see) and whirl it round at the same time, the magnets can start to fly outwards. The first sign can be a tendency of the strobe mark to wobble about when strobing the machine. Another symptom is a smear of grey-black dust outwards on the rotor from the back of the centre washer, If you examine the rotor carefully in this condition you will detect that the magnets are slightly proud of the aluminum between them----only just enough to feel with a finger nail. Next step is for the magnets to move further out, and then the rotor makes a noise very similar to failed main bearings. Just in case any reader has no experience of main failure (his is a low pitched rumbling noise, the same under load as on the over-run, and in bad cases audible on kicking-over the motor. Once the rotor has got this bad it will rapidly use up all the clearance inside the stator, and then seize. This can cause any of the following:

1. The hexagonal centre can spin free in the rotor, leaving the rest stuck around the inside of the stator by magnetism. -the red light in the headlight will come on (no charge) but you can get home on what's left in the battery. Perhaps the real purpose of that red light is to tell you your rotor has exploded.
2. The rotor can seize in the stator and bring the engine to a sudden halt. You can then only restart by removing the seized alternator and substitute a spacer to hold the engine sprocket on--but it's worth a try without the engine nut if the tapers are O.K. and you take it steady.



3. The rotor can seize in the stator and twist the end of the crankshaft. Then the tapers have got to be good. The woodruff key gets cut in half, if you are lucky.

4. The whole lot can seize and go round with the motor, taking the studs out of the back of the primary chain case. (So if you see your wiring harness all disappearing down the hole at the back of the chain case accompanied by a crunching noise you'll know what has happened--the wires are wrapped round the crankshaft like a bobbin!)

Now the good news---they are not all like that! About 1974 Uncle Joseph, patron saint of the British bike owner, started to weld the magnets to the centers-and they are identified by a little W about 1/2 in high stamped on the centre. I have never seen one of these exploded.

In the meantime-keep an eye on your rotors, remember Lucas stuff is guaranteed for a year-by Lucas, not Norton, and don't buy any rotor not stamped with a W, Pt. No. 54202275.

I've never seen the W but the welded rotor is also numbered 54201143 and is also recognized by the centre sleeve, half steel half alloy, an welded one. all steel on normal rotor.

THE CLUTCH: An ordinary coil spring, as used on most other clutches, gets progressively harder to squash as it is compressed from the free position. The clutch needs a certain spring force to prevent it from slipping, and with this conventional spring action the force to lift the clutch gets greater and greater as the plates are separated and the springs compressed. This means the muscles in your left hand have more and more to do as the clutch plates are separated. With a big bike, i.e. lots of torque, so strong springs, this can be hard work.

A diaphragm spring doesn't rely on the torsion of a coil of wire, but as it is compressed the metal in the centre of the spring is compressed and the outer edge is stretched. The load to compress the clutch goes up as the "flat" position is approached, and as the plate goes through the flat position the load drops again for a bit and then rises again as the spring begins to become conical the other way. If the dimensions are chosen to use the force as it starts to fall to hold the clutch together and prevent slip the force needed to lift the clutch actually gets less as the plates are separated-so-you don't need such a strong left arm. See diag. 2, which (I hope) shows how the force at full lift is greater than the damping force for a coil spring, but less than the clamping force for a diaphragm spring, as the plates are separated from the clamped to the free position.

How the diaphragm spring actually produces this miraculous effect is difficult to explain-but it's the same effect as when you take a steel tape measure-the sort made of curved thin steel strip-and bend it back on itself -it becomes stiff, and then, with a click, goes easy. You can get the same effect by putting a Commando spring on the floor and treading on the middle. Support the spring in a clutch drum so there's room for it to go well over centre. If you are about 15 stone you will feel the clutch suddenly go over centre with a sort of click as you put your weight on it-unfortunately if you are only 8 stone you will have to find a friend of the same dimensions so you can do it together. Or obtain a pair of lead wellies. Here endeth the lesson.

The clutch itself has had one or two interesting modifications over the years. To start with the friction plates were steel with postage stamps of cork compound stuck on both sides. The life and reliability of these plates was good (nor so, in some cases, when the postage stamps all fall off and stick together in one place : the results are interesting clutch slips and drags and will not clear) but eventually the edges of the plates would dig into the splines on the centre. This made the clutch hard to free-off as the plates got stuck in their notches, Then the solid cardboard-I mean friction material-plates were introduced and the notching problem disappeared, but another problem

appeared, read on.

The drum itself is made of case-hardened steel, and with many more splines than the centre so there is no tendency for the plain steel plates to notch into the drum. The innermost friction surface on early clutches was a separate steel plate located by two tiny little roll-pins in blind holes in the back of the drum. Once the clutch was together this was O.K, but if the pins came loose (as they did) it was almost impossible to put the thing together and locate the backplate properly. It was also impossible because of the hardness to drill through the roll-pin holes so that proper rivets could be fitted--unless you had access to fancy equipment for spark erosion, but it is possible to tack-weld the back plate in position if you grind a couple of notches in the edge of the plate so you can get in with arc-welding equipment without spoiling the splines. Later the drums avoid the problem by having the back plate held in with three rivets to start with. John Hudson has advised that there is no need to re-rivet or weld this plate in, just remove the remains of the pins and let the plate do its own thing, quite safe.

The main problem with the later solid friction plates was the reduction in friction when they eventually became oil soaked and glazed--so the clutch slipped at maximum torque. This could be relieved by grooving the plate surface radially--six grooves each side, with the corner of a square file (or the edge of a grinding wheel if you are in a hurry--but DON'T breathe the resulting dust). Wash the plates in petrol and be prepared to do it again at 10,000 mile intervals. I have never seen a worn out Commando clutch--even with slip you have enough drive to get home. Those of you with scientific inclinations can look again at 'the diaphragm spring diagram to appreciate that a bit of wear on the plates actually increases the clamping load slightly --whereas with coil springs the load drops quickly as the plates wear, aggravating any tendency to slip.

The 828cc models (and the very last 745cc models) have bronze plates so that they can be thinner and get more in, increasing the torque capacity. Even so, they tend to form a sticky slippery surface in time and need to be washed off occasionally.

One queer thing which does happen is this. If the alternator starts to come loose the clutch will tend to slip at the same time. I suspect that this is because of the extra snatching-vibration caused by the loose rotor, which lowers the effective friction. Just as a brick won't slide down a plank but will start to slide if you drum on the end of the plank with a hammer. Anyone got any other theory?

CARBURETTORS: continued from page 21

all the oil off the bore, mixing with the oil, and getting down the exhaust pipe ready to split the silencer when a spark gets in from the other cylinder. Both these things should be done if the head gasket blows--and if possible it helps to jack the exhaust valve open slightly to relieve the compression--do this by over tightening the rocker adjuster on that cylinder--but not by more than a turn or so or the valve may hit the piston. Ah, happy days. . . . If you have twin cables all the way and twin pull throttle, to be recommended as cable life is considerably lengthened. then to run on one cylinder just remove the cable outer end stop on the offensive side. For Boyer/Rita a owners removing a coil lead isn't advisable so a spare plug wired /taped to earth with plug cap fitted to let spark go in fret air is recommended. No need to remove the original plug, as it doesn't food the engine and stops the ingress of dirt/grit on the suck stroke.



GROUP 9:- Carburetors

CARBURETTORS: The carbs themselves are the traditional Amal deal: they work quite well but don't last very long-the slides rattle about in the bodies, a fault exaggerated by the fact that the engine shakes about anyway. Viton (synthetic rubber) tipped needles with brass bodies are better in the float chamber than the nylon white ones originally fitted, but even so Amal will not guarantee that the carbs will not flood when left standing So always turn your petrol off so that you don't fill the engine up with the precious liquid-not only a waste of petrol but can also cause bent con-rods, blown head gaskets, and disastrous fires when you next try to start the engine.

One thing which some owners do have difficulty with is synchronizing the carbs. Go about it this way:

1. Set the ignition up with nice clean points and a good ATD unit so that everything is as Uncle Joseph intended.
2. Go for a ride of about 10 miles to warm everything up.
3. Screw out the throttle stop screws a bit on each side to make sure the slides aren't hanging on the cable. As you do this the tickover should slow down and stop. Now screw the screws back in to get the tickover right again, and try the effect of altering the pilot screws (the horizontal ones) about 1 turn at a time each way to get the best (fastest) tickover on each cylinder. Get each cylinder pulling equally hard by ensuring that the puffs of exhaust are about equal, and finally check that the machine stops in the same time when you hold each set of points open with a screwdriver (A more civilized method than pulling the plug-caps off alternately). If one cylinder carries on when you do this, but the other cylinder stops quickly when you try that side, the first cylinder is obviously working harder, and needs the slide lowering a touch.
4. When all is to your satisfaction, switch off, park the bike in a draught so it cools off. and go and have a Castletown Ale.
5. Now make sure that both slides open together-this is the difficult bit, but there is a dodge-if you put a finger against the end of the slide-stop screws (the ones that angle upwards) you can feel the slide lift and fall as the throttle is opened and closed. Go on, try it, but don't press too hard as it does need a certain degree of sensitivity of the finger ends. I suppose those of you who are bricklayers may have difficulty, but those who only wield a piece of chalk should find it no problem. The clever bit lies in the fact that it is possible to put a finger and a thumb against both screws at the same time (so you can tell which carb is opening first), by standing on the right of the machine and leaning over the tank with your left hand, reach under the pair of carbs with your palm upwards, you should be able to rest a thumb on one screw and the end of a finger on the other, leaving the other hand to open and close the throttle. Difficult with a hot engine-hence the recommendation of the Castletown Ale. Property set up in this way the bike should stay set up until the carbs are next disturbed. The screw adjuster in the cable(s) is not a tickover adjuster but to cut down cable inner/outer slack when run (pulled) in.

One last thing about carbs. If ever it is necessary to ride a bike on one cylinder (silence all you Model 18 owners I mean one that has more than one cylinder to start with). the best procedure is to prevent both sparks and petrol from reaching the dead cylinder. Don't just take off the plug lead, but remove one low tension wire from the coil instead-this saves the coil from destroying itself-and take out the drain plug of the carb and stuff bits of rag up inside to hold the float shut-thus preventing petrol getting into the cylinder. Washing

Continues on page 20

GROUP 10:- Engine mountings

ENGINE MOUNTINGS: This is the part of the bike which sets the Commando apart from other machines, for although rubber engine mounts are used in all cars and bikes made by BMW, Sunbeam, Suzuki, MZ, Villiers and many others, nobody else had gone to such lengths to ensure that the swinging arm is mounted on the engine plates, thus avoiding the chain pull problem. The first two firms mentioned cheated rather by using a transmission which was not affected by rubber mounting the engine, and most of the others have not got the enormous out of balance forces from a long stroke large parallel twin.

Isolastic mounting was developed as a way of producing a lighter, smoother motorcycle by spending as little as possible on research and development. Once the development had reached a stage where the system worked it was put into production, and from 1968 to the electric start models we have all been stuck with an under-engineered system, along with all the other bits and pieces like valve clearances, points clearances, ignition timing, primary chain tension, cam chain tension, rear chain tension. clutch clearance, front brake adjustment and rear brake adjustment. The problem is further complicated by the strangeness of the system-the average dealer still does not know how it works-and the feeble way in which it was constructed. A .010in clearance has to be maintained in an assembly of unplated steel washers and two bits of soft plastic situated directly behind the front wheel, and covered with a loose-fitting plastic tube so that the rain and grit which gets in cannot get out again.

Let's have a look at what there is.

The head steady up to the 850 was a single piece pressing with an S bend in the middle. This bend was strengthened by a tip each side which was stretched in the pressing operation and had cracks in it from new. Cracks and alternating stress mean fatigue, and so the head steady breaks right across the middle. The head steady supports the engine when the back wheel is twisted either way, when cornering, for instance. Please, all of you, fit the later box section 850 head steady; it does not break, and it resists the twisting much better. Part no: 064179 or 065459.

Never mind what the factory fits, the three socket screws and the six 1/2in A.F. nuts should each be fitted with one plain flat washer only. "Shakeproof" washers are an abomination because they allow water down the threads so that the screws seize into the head.

While the head steady is off, check the tightness of the rubbers in the frame using, if necessary a pair of slip-joint pliers on the steel part of the rubber mounting nearest the head.

The best for the front mounting is to take it right off and fit the Mark III unit which has threaded adjustment rather than shims, but as this would be expensive you can get reasonable life by using bronze impregnated PTFE mounting washers instead of the plain yellow polyurethane ones. The early bikes (pre 1973) had buffer rubbers which were not located on the centre sleeve, and which always tended to work over to one side, affecting the way in which the engine moves in the frame. If this happens and the rubber becomes very loose on the centre tube they must be replaced, but if they are still reasonably tight you can keep them apart by using a bit of garden hose or by binding the centre tube with insulating tape to form shoulders to locate them. More recently the buffers were located by circlips and do not therefore wander. You have to take the end rubbers out to see what goes on inside; to do this hold the mounting assembly in one hand, and insert the centre bolt about 1 in. Use the bolt to prize the end rubber out-go on, you won't hurt it, but watch it does not finish up on next door but one's pigeon loft, it can be persuaded back in without the recommended special tool by lubricating the outside of the rubber with brake fluid, Castrol R or rubber grease, and prodding it with a suitable blunt instrument until the rubber is about 1/16in (1.5mm) below the edge of the outer case. Smother the shims and so on with rubber grease or silicone

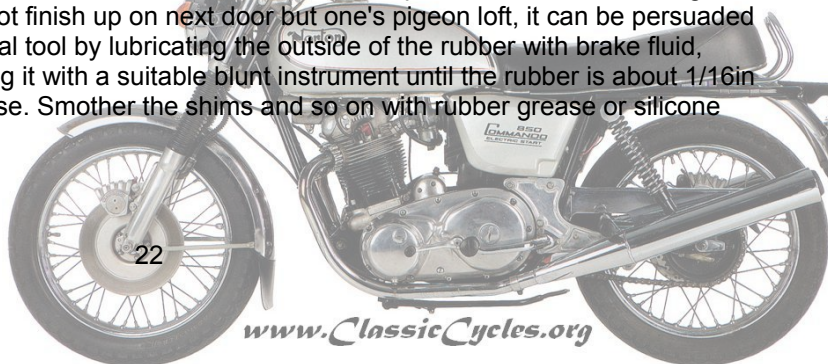

grease (not ordinary grease-as it will attack the rubbers and cause them to swell, although I know of riders who use ordinary grease and it does not seem to do much harm. A fairly thin sticky grease is best. Vaseline a not a good lubricant (Not in this context anyway). Then surround the lot with one of the later type rubber gaiters each end, not the shiny PVC ones used on 750's.

Treat the back unit the same way when the opportunity presents itself, but as the back unit is wider, higher, better protected, and, you, will agree, harder to get at, it does not go wrong so quickly.

Engine bolts should be bolts not studs, the washers should be plain. and the nuts should be Nyloc or plain. Here again no star washers and no all metal locking nuts as they cannot be check tightened.

The centre stand is a joke. Having said that, I know of a 750 which has done 50.000 miles on the same stand. Well, off the same stand, if you see what I mean. O(course the prop stand is worn out. The 850 stand is stronger at the pivots and the cross tube, and is, theoretically, available as a kit to fit 750's. Part no. 064874 is what you should ask for.

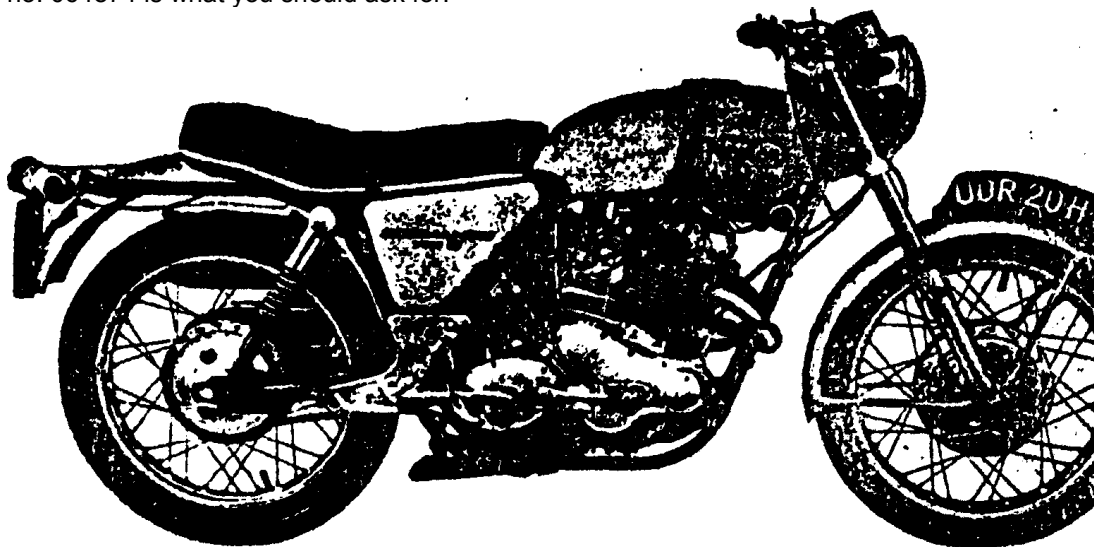

The 'S' type made for the Americans and one of the faster early models (1970). Note the lack of cush drive rear hub (bolt up as Dommie), and the T.L.S. front brake. Both exhaust pipes up the left side made a beautiful sound.

Photo credit: Motor Cycle

STOP PRESS:

OIL IN TIMING CASE. When re-starting a post '72 engine which is completely dry, pour oil into the inlet rocker cover so that it drains down to oil the aiming chain.

CARRIER: Fittings on the bolt that is also .the top suspension bolt, check here for } inch of clearance between carrier and spring collar.

REAR SUSPENSION UNITS: On models with Engine Nos. 750 200000-255509 and 850 300000-305500 there were a few faults in construction, in that the centre tube of the rubber ferrules is too short allowing the whole assembly 4o be -locked up solid when the bolt is fully tightened. There should be sufficient gaps between the frame and -the suspension unit to allow free movement. It there is any doubt change both suspension units in case of weakening.

ISOLASTIC SHIMMING: The gap in this assembly should be reduced to 0.005 inch or even less, as long as some movement exists all is satisfactory. although never lock the shimming up solid as this breaks the frame and/or the head steady. A broken head steady should never be repaired by welding or such Fit the later box section one.

GROUP 11:- Frame, swinging arm and suspension

FRAME: Now all is to be revealed: the green eyed monster which appeared at the 1967 Show had a frame with a tubular spine like all Commandos since, but without the smaller horizontal tube below it. Instead it had a gusset plate wrapped round between the spine and the steering head, and they used to break at the junction of the gusset and spine, along with the two front down tubes. This was; caused by our old favorite, metal fatigue---due to the nodding of the front end of the frame all the time the front brake isn't on. The process ably assisted by the stiff, short travel forks, and the unbalanced front wheel. The credit for putting the matter right, putting the tube in, goes to Ken Sprayson of Reynolds Tube. Later frames don't break (not there, anyway).

Almost every year the frame was changed-it went something like this:1968 First frame, gusseted, centre stand an frame.

- 1969 Bracing tube added, Featherbed-type side stand. 1970 Centre stand tube strengthened (it still twisted).
- 1971 Centre stand removed from frame--side stand on a peg held by the smallest circlip in the world (it fell off).
- 1972 Side stand bolted on.
- 1973 Steering head angle (rake) change from 27 to 28° (yokes also changed). 1974 Reinforced G6771 rear loop-gusset as continuation of inside rear damper mounting.
- 1975 Epoxy paint standardized-previously a thin coat of vaguely black varnish covered the rust.

In any case where a new frame is needed I would recommend the early 850 type frame (although the change-over is a bit complicated for a pre-1971 model with Featherbed-type yokes and adjustable steering bearings). The steering is more positive at high speed with 850 geometry, but to get the greatest benefit you also need the 850 yokes (but the 750 type will fit and give the desirable increased trail).

It may be appropriate to say a few words about high speed weaves.

1. The worst machines are 750s from 1971-1973 with top boxes and wide handlebars.
2. Light, short riders on their own are most often affected.
3. Dunlop TT 100 tyres cause more problems, than Avons.
4. I have never had problems with any bike brought back to the works with handling problems, even hands off at 100 mph, so it is a personal thing, too.
5. The ONLY time I have been worried by the handling of any Commando was a Fastback with a 3.25 x 19 front and 4.00 x 18 rear trials tyre with about 8 psi. At about 90 mph it showed an unnerving tendency for the rear wheel to run alongside the front one. Worse, it couldn't make up its mind which side it wanted to be.

All you can do if the bike shows this tendency is to SLOW DOWN, but DONT tighten your grip on the bars. -There's quite a lot going on with gyroscopic forces centrifugal forces, tyre drag, and the built-in self-centering provided by the trail-so leave them to get on with it without the complication of extra heave-ho from the bars.

A few further points on fire high-speed handling or otherwise of fire Commando. Initially a disclaimer: I have only ridden a Commando for about half a mile, therefore I do not know the problem at first hand the following are facts that I have picked up from years of associating with Norton owners:

A run down of the facts affecting Commando wobbles not covered by Mr. Steven's oration. All points on the Commando have to be set correctly the bike is critical to any maladjustments Tyres intuit be to the correct pressures, balanced. and in line with each other. Tyres must be of the same breed ; do not mix Avon and Dunlop. A 3.60 front tyre is recommended for better steering and "the racer's edge". The rear tyre of 4.10 section should be on a

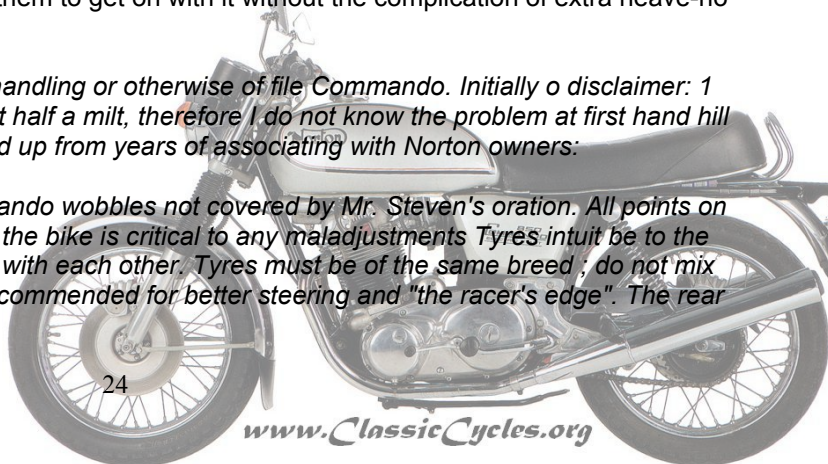

WM3 rim as per Dunlop recommendations: this gives a greater road tread contact area.

Correct shimming is essential. Rear springs are 126lb standard wear, 150lb springs have hertz known to improve matters Weight should be kept as for forward as possible by living low or flat bars; a tank top bag or Swagman pannier bag is ideal for touring. Tri-point screens have an adverse effect while a small handlebar fairing has been known to improve matters. That is about all I have come across (VIVE LA FEATHERBED).

Commandos are not the only bikes to show this phenomenon pay a little attention to the above details could improve your situation. You can fit a steering damper.

Finally, overheard at a Tim and Mary Stevens coffee evening: "Does your Quackersicki weave at high speeds?" "No, but it is quite good at knitting around town."

SWINGING ARM: The later 850 type is reinforced around the junction tube but the real problem is the very poor location of the spindle in the gearbox cradle. The spindle is held by one ;in screw--in fact this one screw holds the back wheel in. (I know because I once lost that miserable little screw at speed and the spindle came out. Don't ask me what happened--we managed to stay between the Armco barriers--and if you look in the hedge about 20 miles this side of Vienna you'll see an ash tree with a branch missing. The repair held till we got to the long suffering German Norton distributor in Darmstadt. An oversize spindle is available-Part No: 064077. It is 0.005in oversize (0.13mm) and by the time you find the hole is too big, five thou is usually about right although you may have to ream the centre of the cradle as the wear occurs mainly at the ends. If you can't get an oversize spindle have the old one hard chromium plated and ground down to the size you want, When it fits the centre tube properly you can hold it in place more firmly using a good strong pair of car exhaust clamps--the type which are made of a thick U bolt and a steel pressing. Fit these round the tube and with any luck you will be able to compress the tube onto the spindle and hold it in place. Not a proper engineering job, but then again neither is, it to start with. -I he bronze bushes should be reamed to about 0.0005in (0.013mm) clearance together using a sharp reamer. Then they will be better than new. Possibly a better way is to obtain a new (?) gearbox cradle or to install a second hand one that isn't worn, should you be able to find either of these items.

Any attempt to alter the piddly little 5BA rod which holds the end covers on would be an improvement--exercise your ingenuity but remember the result must be oil tight. Grease will clog the bushes. EP90 is the stuff. or 140 if you can find it.

JOHN HUDSON: I do not quite agree with Tim on this although I always respect what he says. The largest bearing area was provided by the original spindle and bushes and there was nothing radically wrong with the piddly little rod retaining the end caps. What was wrong was the fitting of a grease nipple. They did not even stamp the word "OIL" on the outer end cap and naturally anyone seeing a grease nipple is going to use a grease gun and a high pressure one breaks the pin.

From the centre bore of the spindle a 1/16in hole at each end feeds oil downwards to each bush in the rear fork, both spindle and bush is plain-no scroll--so that once grease enters the tiny holes they are blocked until the spindle is withdrawn and thoroughly cleaned out. Anyone finding grease in here should remove the outer end cap with rod. take out the 1/4in UNF locating screw in the centre of the cross tube in the rear engine plate and try and withdraw the spindle to clean it. If it has not already seized it will probably come out fairly easily by screwing in a spare front isolastic mounting bolt

(With a '71 or later machine on its centre stand you could take out the front bolt on the machine itself as there is practically no weight on it so long as the head steady has not been removed). Screw this into the end of the spindle.

The first modification on Mk 11A 850s whilst it retained the stupid $\frac{1}{2}$ in locating screw for the spindle, has less bearing area because bushes and spindle are shorter and neither has it the 1 / 16in oil feed holes. Still worse, hardly any oil was put in at the works, the feed wicks are very tight in the spindle bore so that any oil; which might be in the centre of the spindle is unlikely to reach the disc wicks which are under the core plugs and which are intended to feed oil to the outer edge of each bush.

The second modification on Mk III at long last secures the spindle in the engine plate cross tube with two cotter pins--bicycle crank type-but the other faults, tight wicks and no oil remain.

An improvement is to drill the centre of the offside core plug 13/64in, tapping size far 1/4in BSF (26T) or 1/4in UNF (28T). Use a pilot drill, say 1/8in, first so that the Rapping drill does not drill oversize; tap the hole. By screwing an $\frac{1}{2}$ in set screw against a suitable washer and spacer you can pull the core plug out, take out the disc wick and run a drill, the 13/64in will do, down the middle of the feed wick and put a similar hole in the centre of the disc wick. With a Wesco or similar pressure oil can you can now inject oil through the right hand wick into the spindle centre where it will pass along to the nearside wicks. Replace the disc wick and refit the core plug--it will tighten in if you fit it as before, nut convex side out, and expand it with a hammer and suitable soft drift. Complete the job by fitting a short 1/4in cheese head set screw and fiber washer. Then periodical oiling with a Wesco is all that is necessary. I know NVT say SAE140 or EP90 but I use engine oil if nothing else available -any is better than none at all!!

Finally, referring once again to the original set-up which has the grease nipple. Having dismantled the parts and got rid of all grease, a small Tecalemit grease gun will operate with oil but must have the grease cleared out first. Mine works well and I used it at Andover and still do at Parkroad. Care must be taken however as these will build up a high enough pressure to blow the end cap off also.

Failing this get a friend to hold the machine as far over to the left as possible--footrest rubber on ground-but not weight of machine on it!!! Remove the grease nipple and -inject oil with Wesco can.> >

REAR SUSPENSION UNITS don't usually give much trouble, but many owners prefer 150lb (sidecar) spring in place of the 126lb springs fitted standard. This helps the handling in a strange way-and it also helps the dampers if you fit the Girling covers over the units at the same time. More than doubles the life of the units, or fit rubber gaiters.

The early black curved chainguard was better for the chain and in styling -it was fitted on pre-1971 Fastbacks-but if you can't find one, the later 850s had a plastic effort which slotted onto the end of the alleged chainguard to stop the oil from spraying all up your hack and all over your luggage.

As a word of warning, there are two ways of breaking a Commando frame (well three, if you count the pave at MIRA).

1. Have the rear isolastic mounting too tight-this will break the frame where the tubes from the seat knobs downwards meet the gussets for the battery carrier.
2. Put a carrier on the back without supports to the pillion footrests.)f this doesn't break the rear loop it will bend it downwards, and then it will break when you try and straighten it. Watch out for carriers which foul the top of the damper unit-this can break off the damper eye with interesting consequences.

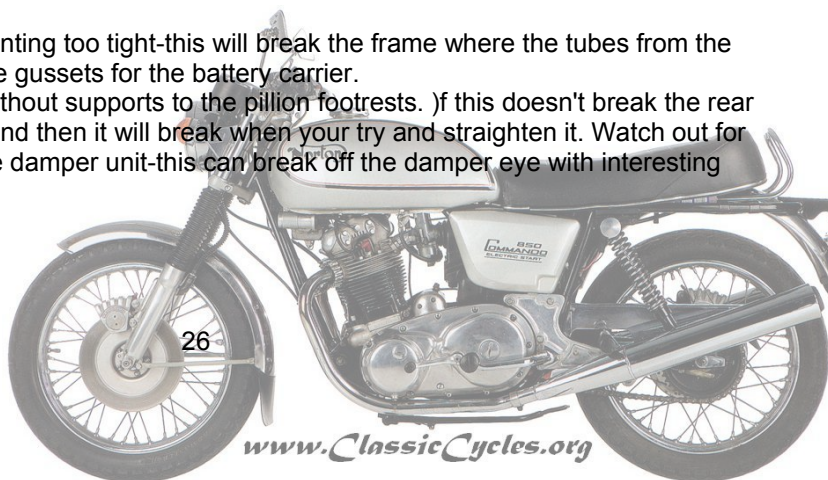

GROUP 12:- Footrest plates

FOOTREST PLATES: The most over-engineered part of the machine-not that there is much competition for the honor. They are forged from aluminum alloy and are unbreakable, Even if the plates arc bent until one end touches the other they will not break. For Concours rebuilders the catalogue is not strictly accurate--as well as the spacers between the frame and the side-plates there are extra ;in washers on the 3/8in bolts. This was to cock the plates outwards at the rear to avoid a snarl-up of the rear brake cable and the silencer studs.

The two plates differ only in the Zener Diode hole in the right hand plate -on electric start models there are even diodes in each plate-and the only threads are those for the three footrest studs. These are 5/16 x 20 UNC in the holes, and for a brief period, instead of using studs and nuts, bolts were fitted in these holes. Much neater. The studs were UNF at the outer end except for the right hand rear bolt-which was always a bolt, and which was deliberately made too long so the earth lead for the Zener could be attached to its inside end. The Zener earth requires a 5/ 16in UNC nut, the only one on the whole bike-but if you lose it a 5/16in Whitworth nut will fit. Very common on coach bolts and gutter fittings.

THE FOOTRESTS: as all of you who have ever had a Commando know, break off. Early examples are brazed into the hangers, and were messy to put right because re-brazing spoilt the chrome and buying a new one spoilt the bank balance. Later footrests were screwed in, and broke off just below the surface. The thread is 7/ 16in x 20 UNF but it is best to drill out the thread in the hanger completely so that in the event of a breakage you can fit the new bit at the roadside without resorting to spark erosion. You all do carry spare pegs, don't you? You can get the rubber off the broken peg using the screwdriver in the tool kit-poke the screwdriver down into the gap and dribble petrol (or washing up liquid) down inside. Then make sure no one is looking and hammer the screwdriver into the other end of the rubber. It doesn't do the screwdriver any good-but you will only destroy the end you hit, o hit the Philips end because it doesn't fit the crosshead screws all over the bike anyway. They're Posidrive.

A further idea on footpegs is a modified peg like that in Diag. 3. This has been tested in a 50 m.p.h. slide. What happens is that the peg is allowed to bend under a heavy fall, If it breaks off (it the constriction completely then the stub is easily removed with a spanner. No locknut is needed as it is done up tight and the constriction also stops the rubber from falling off.

There was a spring made, but fitted as standard only on some police bikes, which would prevent the brake pedal digging in the road if the cable were to break. The cables don't break, but if you are worried and you can't find a suitable spring, cut a slice from an FSIE tube and slide it over the footrest and pedal. Best thing that could happen to an FSIE, to have its tyres removed to mend Nortons. If you remove the clevis and clip from the cable end, refit the head of the clevis on the inside so that if the clip should fail and fall off the clevis can't fall out.

Diagram 3.

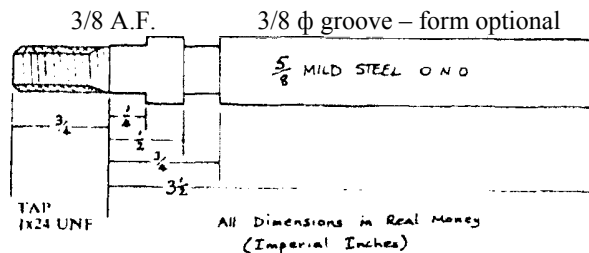

GROUP 13:- The oil tank

THE OIL TANK is not over engineered. The mounting rubbers fail regularly because:

1. They are under strain due to the mudguard fouling the hoses and connections.
2. They are not oil proof.
3. They are usually fitted twisted.

If they are left broken the oil tank can't fall out but as the tank flops about the strain falls on the bottom fixing which can split out of the tank bottom. (Then the stain falls on the garage floor.) About the chain oiler the least said the better, but I suppose it does stop one side of the carrier going rusty.

THE OIL FILTER is fitted on the return from the engine to tank, not as shown in the parts list, so that there is no tendency for a clogged filter to starve the oil supply. The element is interchangeable with elements from Citroen 2CV cars and Simca 1100s-the Simca unit is a bit longer than the Citroen job but the thread and so-on are identical. Fancy a Commando having metric threads!

STOP PRESS:

OIL: For those interested in monograde oils, SAE 40 SE or SD is preferable, if you can get it, to multigrade (20w/50) (SAE 30 SE/SD for below 0°C. SAE 50 SE/SD for above 32°C ambient.) normal multigrade would be preferable to a cheap monograde as it would be without the additives denoted by The SE or SD. Running in will take up to 1200 miles on a monograde before full 'economical' oil consumption can be expected.

PANNIER & TOP BOX WEIGHTS: The factory recommends no more than 25 lbs. in the top box. No more than 40 lbs. in panniers (evenly distributed) or 40 lbs. total to maintain factory tic-signed handling stability (nicely put!).

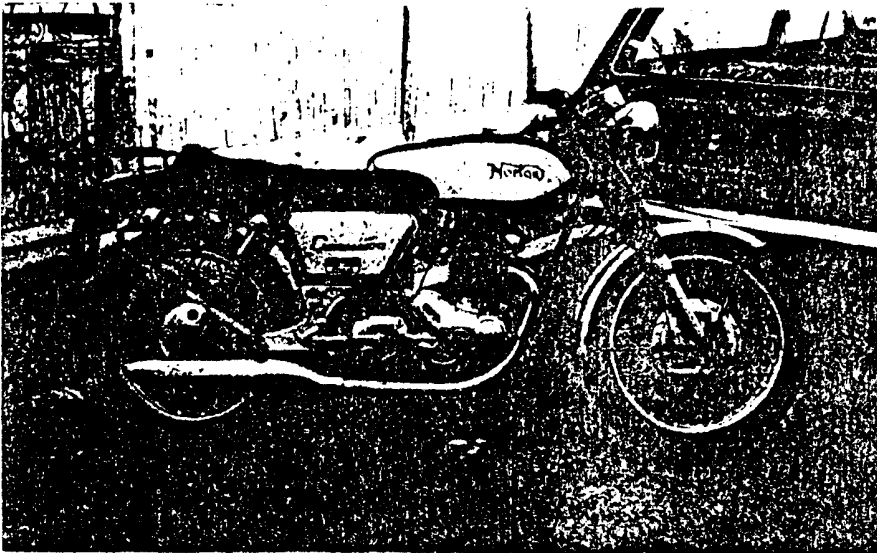

A fine example of the 1971 Fastback, only a few of which had the two-tone tank. Owned by Paul Bennett



GROUPS 14, 15 and 16:- Forks and front wheel, including front brake

FORKS AND FRONT WHEEL,: The Norton Roadholder front fork achieved an enviable reputation in the early days of telescopic forks, due to a certain extent to a better clamping of the wheel spindle than some competitive designs, especially the forks on the first post-war Triumphs. The reputation lives on even though technology has proceeded over the last thirty years to give performance about as good as can be expected from telescopic designs. Designs used by B.M.W., Marzocchi, Ceriani and many others—notably not from Japan—are very well respected, but the poor old Norton fork has slipped slowly further and further back until it is debatably the most old-fashioned telescopic fork in use. There is one modern feature, in which the Commando is ahead even of the most prestigious machines—the steering bearings. Simply it is this—I have had to do with one or two Commandos in my time but never have I heard of head races which wore out. One or two damaged in accidents, yes; on, and I am only talking of the 1971 on models—the early ones had what are best described as featherbed type yokes and cups and cones which were abysmal. The bearings themselves are quite ordinary scaled ball bearings, doing a job for which they are not really best suited, that is taking an end load. So why do they last so well? Simple really—think for a minute why head bearings fail. There can only be three reasons, accidents excepted.

- (a) They are too tight. It is difficult not to overadjust the adjustable type because one doesn't know just when to stop and this bruises the tracks.
- (b) They are too loose. This can be due to settlement after fitting and puts all the load on two or three balls.
- (c) The wet gets in, causing rust and fretting corrosion.

For once then, they got it right: bearings which can't be fitted too loose, or tight and which are sealed on both sides to stop the wet getting in, and, equally important, to stop the grease getting out.

The best thing to put in Norton Teles is Automatic Transmission Fluid, but if this allows too much topping then try Castrol Shockol or even the original "Castrolite". Don't use less than the recommended disposable plastic cupful in each side (160cc) or you'll get even more than your share of topping. Seals wear due to oil getting out, mixing with road grit, grinding the seal and the chrome away. It is the ultimate folly to take the gaiters off. The latest gaiters will fit all post 1970 machines and should be compulsory. Or use Montesa gaiters—slightly slimmer.

There has been a kit for use in the handling department. A steering damper made in the land of the rising sun. Kit No: 064247, but it didn't help much. One other kit that was also available was the 063412 which converted drum brake to disc. I'm afraid it', all down to one's own codging these days.

You should all know the story of the front brake, position—originally fitted behind the right hand leg. For some exceedingly technical reason this caused all the bikes to pull to the left, and made most of them so bad that you couldn't steer the machine hands-off. Nortons which wouldn't steer hands off! And no-one complained. Well, actually, about a dozen people did, but there wasn't anything that could be done about it. Anyway, later it was found that if you take the forks out of the yokes and swap them over the brake finishes up in front of the left hand leg and the machine then steers O.K. No, I can't explain it either. This is not the safest thing to do because there is a grave danger (that is, a danger which might lead to the grave) that the bearing

locking ring will unscrew if the rotation of the wheel is reversed. Do it by all means, but make up some way of securely locking the bearing ring.

There isn't much that can be done to prevent the inside pad wearing rapidly in wet weather. The factory did make a scraper effort to fit beneath the caliper but it made a vile noise and didn't work very well. Perhaps swapping the logs over cures this too. Life of 3.000 miles is to be expected, so if you are going abroad take a spare pair of pads. It can rain over there, too-we've just returned from the F.I.M. rally and we must have had a dozen thunderstorms in the month.

Don't forget to change brake seals, hoses and fluid about every three years at least. as the rubber simply does not last for ever. The drum front brake is simply not worth bothering with-there are some good ones about but there are a lot more bad ones. Ask the Lancs. Constabulary what they thought of the drum brakes on their Interpols.

STOP PRESS:

FRONT WHEEL BEARING LOCKRING: Part No. 066612 to be used as such when reversing front brake to lefthand side.

FRONT DRUM BRAKES: I could write a volume here. Some twin leading shoes did work well, mostly the early ones. I had a later one. Some mods to get it working or least reliably. The centre hole is often too large, allowing the brake plate to flop about. This can be bushed down, possibly with phosphor bronze or such. There was a service sheet at one time which gave advice on how to cut a hole in the bottom edge of the plate to let the water out!! Why let it in I ask? Even with the blanking plate in the air (water) scoop rain still hits it and goes sideways into the brake. I had the whole scoop removed and welded over: success.

Now the linings you can benefit from by fitting are. AM4 green racing, but they have to be fitted by an expert and machined exactly to the drum site. Also make sure they have the leading edge well cut back 1in or more as they do tend to grab, especially first grab in the morning due to the dampness in/on the linings/drum.

There was also a brake stiffening kit. This necessitated replacing the two cams and pivot points, a hammer, drift and vice job, but from reports I've received this was well worth it, specially with standard linings. Wouldn't like to combine it with AM4 though, might be too much.

GROUP 17:- Rear hub, brake and sprocket

JOHN HUDSON: The other weak point which I think has not been mentioned is the one-piece double row ball bearing in the rear sprocket and brake drum on 1971 models up to the introduction of the Mk III. This bearing is still the Hoffmann (now RHP) 117DR but it tends to be neglected, tucked away as it is in the centre of the brake drum. It does of course have to take by -itself all the driving load which it cannot share with the two single row bearings in the wheel. It is retained in the brake drum boss by a circlip which is concealed by a felt washer retainer, felt washer and plain steel washer and these three have to be prised or levered out before the state of bearing and circlip can be determined. Sometimes the eyes of the circlip break off in service and sometimes the circlip itself comes out when brake shoe retaining set screws can rub on the inside of the brake drum.

When the three washers mentioned have been removed extra grease can be worked into the bearing if its condition seems O.K. otherwise. With the circlip out, drive lightly on the opposite end of the dummy spindle and all parts will come out of the brake drum including inner felt and plain steel washer.

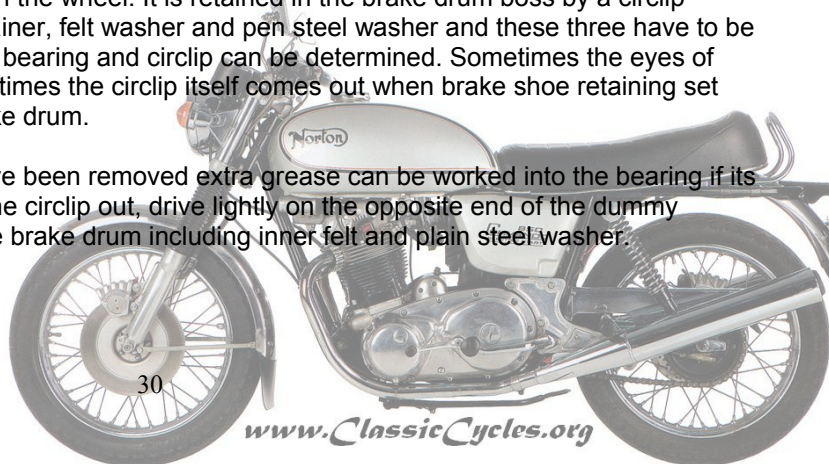

GROUP 18:- Handlebar controls

There are many variations in these bits and pieces which may not be obvious to the naked thingy:

THE BRAKE AND CLUTCH LEVERS: Started off with good old fashioned steel levers-but there are also two types of the later Lucas pattern. Early alloy levers were almost flat on their front surfaces. Later levers were rounded to make it easier to pull in the clutch (!) and to match the rounded hydraulic lever: they are much more comfortable. Later still (1973) the clamp brackets were altered to move the pivot away from the handlebar grip-making it for the first time possible to use clutch and dipswitch at the same time. Previously if you could reach the switch your fingers were so near the clutch pivot that you had virtually no leverage. Even later the plastic switch levers were lengthened to make operation even easier-you can't get the bits separately to update your machine, but if you are buying complete switches get the latest type; they are completely interchangeable. I shouldn't have to tell you that if you have a penchant for an indicator switch on the left hand side you can simply swap the complete units over without disconnecting anything but the 8 screws which hold them to the bars, but then you will have to get used to operating the front brake, dipswitch, horn and headlamp flasher with your right hand (and sometimes all at once). One of the horn or headlamp wires can be connected instead to the red and white (starter) connection in the other unit, but the other button separates a connection (the kill button) rather than making one. If you are a genius with a soldering iron you can do it. . . .

I am now going to say something which seems fairly obvious. If the throttle cable breaks, stop at once. This is because the ferrule between the cable and the clamp can fall out in the road and then you really are stuck. This can even happen if the throttle just sticks-especially if the single cable freezes in the outer- so it's best to tape the ferrule to the end of the cable. This also helps to stop the rain getting in. A twin pull twist grip with two cables all the way without midway adjusters is very much recommended. Slops all breakages and is easier to adjust i.e. one adjuster on carb. top.

CLUTCH CABLE: Was originally a plain cable-with the new alloy levers the free length was changed slightly, the inner was lined with the cheapest possible nylon, and the nipple was changed to a brass rather than a separate steel component. This was the old story, good news and bad news, again. The nylon was an improvement, but tends to bunch up under the ferrule at the handlebar end, making the action stiffer and stiffer. Pull off the ferrule, cut about 1/4in (oh all right, 6mm) off the nylon and push the ferrule on again. Don't try it with wire cutters or you'll nick the cable, use the bread knife. You can't do much about the brass nipple-but beware, as soon as the solder is worn off the surface the brass will grate on the aluminium, and this flexing will soon break off the cable flush with the nipple. Only cure is a steel nipple, but no-one makes them because steel is much more difficult to solder, so you must find a brass nipple like the one on the other end of the clutch cable and make a loose nipple to take it. Or use the bits off a pre 1971 Commando, or even a proper Norton.

Warning to all featherbed riders who try to use a Commando front brake cable because it's got a switch in or any other reason. The threads for the adjusters are different-used to be 5/16 CEI (cycle=26 tpi) changed to 5/16 UNF (24 tpi) just to catch you out. Silly.

If you find the master cylinder won't fit with your style of handlebars, you might get some relief by swapping the stop switch and hose over--or miss the switch out altogether and block the spare hole with a 3/4in. UNF set screw. (If overcome by patriotism you'll have to use an oil tank drain plug part no: 060668.)

GROUPS 19, 21-24, and 28:- Handlebars, side panels, front mudguard, seats, rear mudguard, tank and instruments

All straight forward, no comments.

GROUP 20:- Exhaust systems

Not much to say about exhaust systems-I have already had a go about port threads. Don't use mutes in the straight through silencer ends, if they are brazed in file them out again even if it takes all weekend. They will put fiat spots in the carburetion and make the whole plot nasty to ride. From a silencer point of view the long-cone-and-short-reverse-cone type of silencer is just the same as the shortish-cone -and -long ish-reverse -cone type, but the cylindrical type with a black end is much quieter and DOES NOT REDUCE THE POWER. Officially, you need different pipes for each type of silencer, but with a bit of initiative it's surprising what can be done.

I won't say anything about side covers and their fittings because they are, to use an expression used only under extreme provocation by our President, rather pisspotical.

Mudguards and tanks all straightforward.

GROUPS 25, 26, and 27:- Electrics

As string does not conduct electricity, change the H.T. leads for proper ones made of real metal. Chop the ends of the metal battery strap off to stop it from poking a hole in the capacitor. If you are tired of messing about with points and auto advances, fit a RITA ignition kit-from John Carpenter, Mistral Engineering, 63A Turner Road, London E17, an excellent bit of kit.

The harness has got three spare wires in it so that Interplods can flatten their batteries more quickly than us ordinary mortals, and on ordinary machines they are not connected at either end. They go from the headlamp to just behind the head steady, and are colored purple and green, brown and black, and brown and purple. If you need a spare bit of wire at the roadside you can use these-but it means unwinding the harness tape to get at them.

Be careful that the negative battery terminal MUST NOT touch earth anywhere, because this will short out without going through the fuse, and will melt the earth wires (the red ones) throughout the whole wiring harness. Makes a mess and a smell. You can get Halogen bulbs part no. 457 to fit in the old style headlamp lens, but it's a bit antisocial as the cut of on dip isn't good enough. Better to go all the way and get the complete unit-Lucas part 54526114, or any 7in Quartz unit from a reputable maker. Wipac Quad Optic, an excellent chap unit. Cibie Z beam is another good choice.

GROUP 29:- The tool kit

There is one useful modification that you ought to make, to the Allen key. It won't St the screws which are most likely to come undone-the ones holding the manifolds to the head. You must shorten the short end to just before the bend, and if you can, bend the ,long bit away slightly in the middle-so the result is a slightly S-shaped Allen key. Then not only will the short end go into the heads of the screws, but the long end will miss the nut holding the -inlet rocker cover on.

If you find yourself with a spare weekend and a grindstone, here are one or two other useful modifications. Round off all the corners of the tappet adjusting spanner, so that it won't mark the edges of the hole. Grind metal off the sides and outer edges of the 9/16 A.F. spanner so it will fit into the clip holding the chainguard. Finally thin down the points of the 1/2in A.F. so that it will only take you an hour to adjust your primary chain.

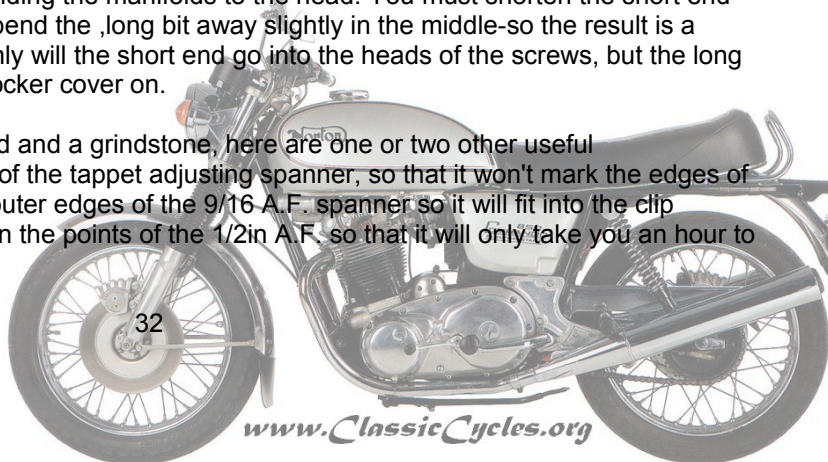

COMMANDO SERVICE NOTES- MK III ADDENDUM

These additional notes cover all models and the Mk III and have been put together by me from the experiences of the club members, so are perhaps not as exhaustive or full as the previous notes written by TRS. Some more facts on the SS camshaft have come to light from Colin Braddick who used to race Commandos in the days of the Production racer and these have been added. Thanks this time must go to a few club members who have managed to note any problems and a few answers, and Les Emery, John Switzman, John Hudson and Tim R. Stevens for their help in various ways. Al. Osborn.

COMMANDO MODIFICATION LIST Engine (COURTESY OF USNOA)

No.	Modifications
128646	New type sleeve gear and layshaft pinion tooth form.
129897	Rear wheel security bolt and MK2 type frame.
130979	'APEX' oil control ring (3 bits not 5).
132576	Fiber clutch friction plates, (not cork postage stamps).
133488	3rd gears in stronger material.
134108	First engine built in Wolverhampton works. all engines with suffix 'P' built at Plumstead Matchless London factory.
134738	'Hylomar' (Rolls Royce) sealing compound, (they still leaked-not R.R. machining).
136618	Starter motor blanking plate fitted (for original starter to fit in old magneto recess).
140061	Plastic rocker feed pipe.
141783	1st-'71 model-non-adjustable steering head hearings.
146584	New type "S.E." oil control ring.
147730	Rear brake drums screwed and riveted.
147846	Toughened kickstart pawl.
148895	Modified inlet valve guide (for oil seals).
149670	Oil seat fitted to inlet guide.
150120	Oil pump paper gasket fitted.
151175	Increased chamfer on cam followers to increase oil drain from head.
152000	Rear drum strengthening webs.
152499	Replaceable foot rest pegs.
153150	Riveted clutch back plate.
153124	Tachometer housing gasket.
153362	Chaincase outer incorporating cap 'O' rings, not leather washers.
200000	Revised shape handlebar levers (Tomaselli). 1) shape not flat.
200000	Commando (std) cylinder head with increased inlet guide support (deleting two NM23392 heat insulating washers). Oil feed return pipes 162200 commonized for spares (17in).
200708	Cam follower locating plate modified to accommodate 1972 combat camshaft.
200976	First Combat engine (interim pistons with oil slots).
201778	Clutch plate "scrolled" groove.
202116	Master switch replaces 39565 (now 4 terminal) with associated headlamp and main harness. Stops headlamp working when parked.
202341	Valve spring bottom seat washer thinned to accommodate cylinder head variations (tip to 202666), stops coil bound springs.
202666	Cylinder head amended to accommodate std NMT2073 heat insulating washers (ie reverted to 060966 (1971), canceling above mod engine 200000).
202760	Revised front brake lever (disc-master cylinder).
203136	Front drum brake support plate introduced.
203200	Steel petrol tank (Roadster) and side covers, not GRP.
203884	Copper sealing washers introduced under rocker spindle plate bolts, and not before time.

ENGINE

MAIN BEARINGS: What again I hear you groan? A small point, quite often with the super-blend, the inner race, especially on the timing side, comes loose on the crankshaft; this does not seem to be detrimental in any way, so do not worry about it. The next time things are apart down there a blob of Retainer Loctite is recommended. Clean both surfaces with Carbon tetrachloride or similar (Evostick Cleaner) degreasant (not petrol, it leaves a faint oily film) and use Loctite-601 green Retainer fit, this is some four times stronger than the 641 yellow Bearing fit. Bearing fit 641 is for use up to four thou. gaps, 601 for use up to six thou gaps. While the ultimate is Studlock 270, stronger than 601 but it needs a minimum gap of two thou. and will fill up to 10 thou. This pulled the hooks off of Les Emery's bearing puller. Tee Hee!

J.H. Surely R does not matter if the inner race on the timing side is a free fit on the shaft as it is secured endwise by the oil pump driving worm when this is properly tightened.>>

Yes, but carrying out modifications to slacken timing gear (as per page 4 last para), and having bearing inner loose has caused odd faults when the oil pump worm nut has loosened, odd ticking noises and even an apparently seized engine when the timing gear came loose and jammed on the oil pump. All up tight as original would be preferable here. Al Oz.

TIMING CHAIN TENSIONER: Do not overtighten chain as this can rip up the rubber surface of the tensioner, the metal underneath is not hardened !!! **CAMSHAFTS:** Have still been known to be of an inferior hardness, check followers or replace them when replacing camshaft.

REV. COUNTER DRIVE: Leaking! Possibly changing to a 750 unit can cure it. A 750cc housing with an 850cc drive spindle gives 'O' ring seal. **EXHAUST VALVES:** It's not unknown for these to get bent, one cure suggested is to fit racing NIMONIC 80A, once available from Gus Kuhn. This can also be caused by keeping oil level up to maximum level-the oil is then sucked through the air filters and cokes valve stems up causing exhaust valves especially to stick in the guides.

PUSHRODS: On Combat engines or any engine which has had a significant amount machined off the head (my 750 racer had over fin off) the pushrods must be shortened by the same amount and both ends of the rod may need attention, otherwise, you could find the end cap contacts the radius on the reduced diameter of the rod. On the head make sure the head gasket does not protrude into the pushrod tunnel, or the pushrods will wear away. Some Mark III models have a casting 'Flash' which protrudes into the pushrod tunnel, causes rubbing of push-rods, and ultimately failure of the camshaft. When the head is removed it is well worth clearing out the push-rod tunnels with a large round file, this only takes five minutes since the alloy is easy to remove, and should restore sensible camshaft life.

PRIMARY CHAIN CASE: A rattle -in here at low revs, especially after the bike has been standing for some time, maybe on its side stand, is usually due to the Primary Chain hydraulic tensioner not having enough range to cope with a partially worn Primary Chain, so it thrashes around and hits the case. The only cure is a new chain even though it may have only done 20,000 miles or so. On Les Emery's racer they use "much stronger" tensioner springs to cure this problem.

J.H. I never heard that the hydraulic tensioner 'did not have enough range'? It loses its 'prime' if left standing and will often re-prime itself when the machine is next run. If not, remove outer half of case and squirt some more oil in collecting trough and push piston up and down by hand. We did this with new bikes after standing for long periods and it always worked, >>

CLUTCH SLIP: A part from the "cures" already noted, this can be corrected by machining away the centre 1/4in from the phosphor bronze surface of the plates, (both sides) so giving greater pressure on the remaining surface and

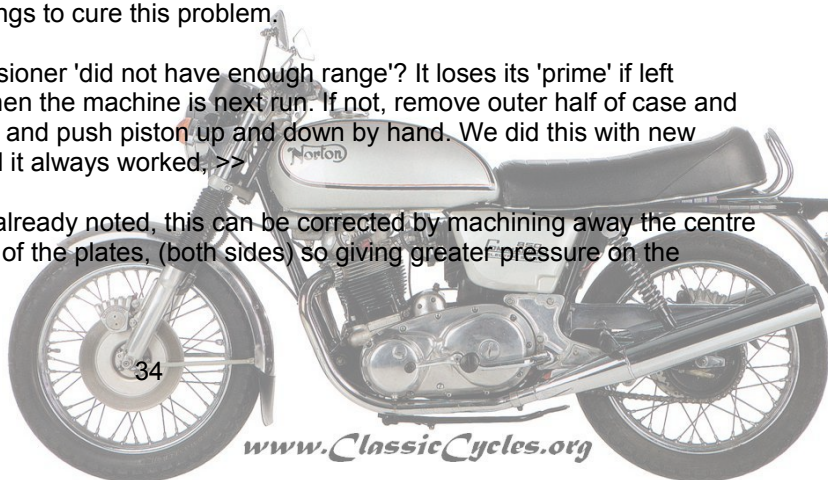

slightly larger mean radius. This may increase wear marginally but in any case the bronze plates wear immeasurably so the life will now drop to only a few million miles ... My fiber clutch plates have done 100,000 miles and are not noticeably worn. Thick oil and antifriction additives promote clutch slip, so if any one is still using engine oil in the Primary Chain case then they should read page 12 again. So use SAE 20 or even ATF if clutch slip is a problem. Castrol GP 10-40 4-stroke oil can be useful if that is all that is available but do not use it in your engine, it is too thin, only meant for Castrol's profits and electric start Hondas.

CLUTCH DRAG: Yet another cause is for gearbox oil to travel down the pushrod tube by virtue of the clutch push-rod acting as a pump, when it bends under load. Clue, cut a ¼ inch out of centre of the push-rod and fit a ¼ inch ball bearing.

A notched clutch centre can be partially cured by installing two bronze or fiber plates together, thus using the un-worn part of the clutch centre, this will make the clutch operation much lighter, but could also aggravate clutch slip, but well worth a try if you've a spare plate.

ALTERNATORS: The rotor/stator gap of 8 thou. minimum is harder to achieve on the Mk I11 but it is essential or the rotor will rub and the overheating will cause stator to burn out and disintegrate, this applies to all models in fact. If lacking gap use a half round file and carefully file away moulding compound and iron laminations of stator until an eight thou. feeler gauge will travel all the way round between rotor and stator. While considering alternators the Mk III is fitted with a high output 180W RM23 stator that needs two Zener diodes, this can be fitted to earlier models if desired or even the RM24 (even higher output at low speed) 180W 3-phase alternator will fit both models, but the 3-phase will need a different rectifier and a new pair of matched Zener diodes fitted. Full details from Al Osborn or Les Emery.

J.H. Alternator: on Mark III the rotor stator clearance can be affected by the chaincase/engine plate stud which, unlike the other models, has an adjuster nut which can be used to push the chaincase in or out and affect the fore and aft clearance between rotor and stator. That is at the 3 o'clock and 9 o'clock positions. If the rotor/stator are too close top and bottom then this will not affect it, but I have never had to resort to the filing you mention.

To gain clearance at 9 o'clock slacken the 3/8in Nyloc nut (9/16in AF spanner) in the chaincase and screw up the plain jin nut behind the inner case to push the case outwards slightly and re-tighten the Nyloc. Reverse the procedure for more clearance at 3 o'clock. > >

(Note from T.R.S.-have it your own way if you will, but this won't give you such a smooth tickover or even plod.)

ELECTRIC START: In most cases about one of the biggest space wasters ever. A cheap supply of brushes is Lucas set 251108 (4 brush set) a bit of cutting is needed, but at today's prices it is worth it. There has been a four brush conversion set available from the United States but rather expensive at \$75 from Cycle Sports (summer 1979). The new electric start Triumph Bonneville already has this mod. Parts are thus for a straight swop type modification: -

1. Frame field, 58-241, MGL2101 A is the motor body.
2. Brush plate, 36-863, MGL1033B replaces the 2-brush plate.
3. Spring set, 50-335, MGD18SS.

Cycle Sports, 2355 El Camino Real, Santa Clara, California or pester a Prestolite Dealer that these parts do exist, or questions to Robert Marshall, 1924 Kentucky Street, Redwood City, California 94061, USA. The kill button is often overlooked when in a non-running situation, as it is often hardly ever used it soon corrodes and becomes intermittent. Suggestion is to by-pass the reconnection under the tank. This is especially so for the 750s and early Lucas H/Bar switches.

Sprag clutch inside engine sprocket and boss on large drive gear surfaces could do with fine emery (all emerys are fine! a spare joke) or "wet 'n dry" grade 600 to break up polish and give some grip.

Starter Sprag Unit. problems encountered by time member are that this unit will function for weeks or pack tip first time the starter is used and even if tile starter is not used. in that the sprags in the unit lam in the outer ring. this causes the retaining ring spring to bend. 'I he unit can he stripped and spring straightened when it might break or even :t new spring might do the mine again. Fitting new sprag units and even new engine sprocket do not help. Les Emery seems to think the spur wheel might he worn.

GEARBOX: The layshaft ball hearing has a sell' destruct mode in the order of 10.000 miles mainly due to higher torque through gearbox. caused primarily by the 22T gearbox sprocket giving loo high a ratio. So as well as tile roller hearing replacement NJ203C3 it is ;advisable to lower the gearing to 21T or even a 20T gearbox sprocket (see page lf, fur further details). If old ball hearing is worn or has collapsed you must replace layshaft hush in kickstart. Sometime in its later Commando life the 3rd gear and 4th gears were changed not in ratio but in teeth pitch mid profile. and supposedly in strength. These gears must he kept in pairs and will not singularly interchange with earlier gears; you cannot get it too wrong, as the y w ill not actually go into the gearbox. The only external difference is by measurement the later ones being 10 thou bigger.

KICKSTARTER PAWL: Seems to be made of very soft material in some models so if poking into gearbox have a new pawl to hand with an "M" stamped on it. New kick-start pawls should be checked for hardness, ie a file should not make any impression, In one rare (hopefully 1 case the kick start pawl jammed in its closed position so that kicking down gave no connection to gearbox or engine at all, Again, a file would not relieve this situation a grinder is needed.

INTERSTATE TANK: For the silver paint Opel silver 115 is a good match.

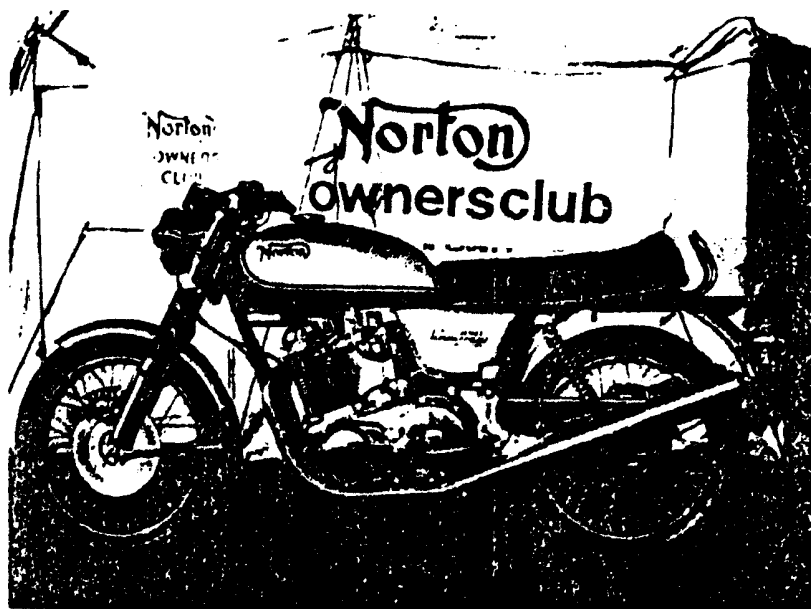

The MK III Interstate in traditional silver with black and red lining



THE PAWL SPRING: This is the first item to suspect if you attempt to change gear and the lever has no effect or apparent connection into the box. The spring quite often wears and breaks (carry a spare one) and when you replace it with a new one you will more than likely have it 'set' the spring as follows to ensure a good gear change: with the outer gearbox cover in your hand and the lever mechanism and ratchet assembled the pawl spring must sit on its rest plate (part of gear lever stop plate) it must then either just touch or just clear the pawl with its double cranked leg downward. Most important with the pawl central in the pawl spring an imaginary line through the centre of the pawl must be at right angles to the centre of its operating arm. This only has to be a fraction out for a poor gear change, either up or down to result.

To check you have got it right, replace gearbox cover and lever. Put machine on its centre stand and a block so that the rear wheel is off the ground, then rotate the wheel until a position of the gears can be found when you can change through most of the gears with the rear wheel anti gears stationary. Now, starting at 1st gear, select 2nd carefully and as the gear lever returns to its neutral position a click should be heard (pawl selecting next ratchet). Repeat this through the gears although no click will be heard from third to fourth as there is no gear after fourth. Repeat this changing down, a click will be heard each time a change is made and there is another gear to follow.

If you get this result one way only then you have a bias in the pawl spring and it will have to be set slightly the other way.

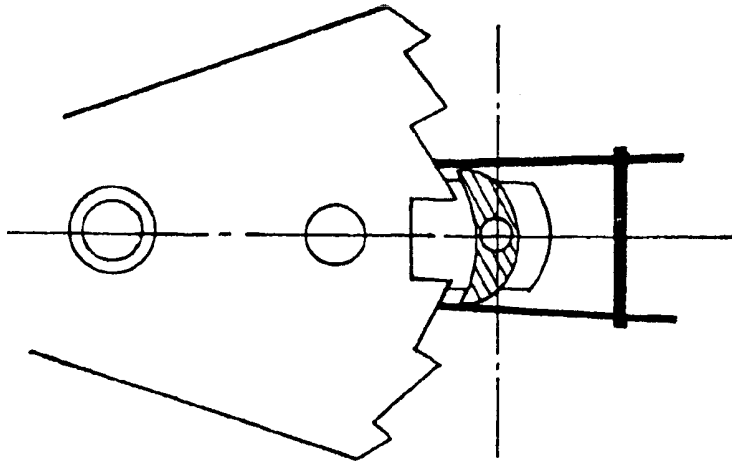

GO-FASTER MODS, SILENCERS AND AIRBOXES

As previously mentioned the black cap annular discharge silencers do not significantly reduce power, but they must be kept with the balanced exhaust pipes. If you want to fit earlier separate pipes then you must fit the earlier reverse cone silencers. The reverse cones can be fitted onto the balanced pipes but with a slight loss in power. What did restrict performance was the black plastic air box, remove this for a 750 type one to gain performance.

Mother lower performance factory modification was the restriction in the inlet valve throat often down to 29mm, re open to 32mm all through.

750 single pipes can be made to tuck in better.

WHEELS AND BRAKES

WHEELS: Rust from front disc tends to fly off on to the chrome rim and stick there, Clean it off before it imbeds itself. Single rot', wheel bearing retainer is said in manual to have a left-hand thread--not always true, Rear wheel bearings tend to disintegrate, suggestion is for an improved roller bearing, as the original are not scaled type. Rear axle material appears inadequate in most cases. (I broke one once at 80--quite fun TRS) Some rear bearings are the sealed type.

REAR DISC CALIPER: Needs yearly dismantling and cleaning out, (not a bad idea for all hydraulics). Disc pads, especially rear, could benefit by a dab of silicone grease on their rear (non friction surface). The front brake can be improved by refitting in the back of fork leg as in Mk 1 and MK (I. Master cylinder on handle bar, if there is fluid leak due to the poor seals, do replace them as it has been known for fluid to get the wrong side of piston and LOCK front brake on! (I cannot see how this could possibly happen even though I worked for Lockheed for four years TRS). On dismantling the rear master cylinder and unscrewing the two body halves which have a right-hand thread, there is a locking alien grub screw below the surface of the body, lost in the muck to be removed first. Some rear wheel retainers have a right-hand thread. This has worked loose a few times, allowing the cush drive back plate to rattle. The last time it started rattling I tried to tighten it up but found it was already tight. The problem seems to be that the steel bearing retainer has worn into the alloy cush drive centre. This is because the retainer is screwed up solid but the cush drive centre moves in its rubbers.

On re-assembly of master cylinder take care, as you screw the two halves together. a fraction too far and the push-rod begins to operate the master cylinder, whose first move is to block up the return hole for brake fluid, when in use heat expand-, brake fluid which cannot return to reservoir, therefore pressure builds up in the system, which applies the brake! It can be very embarrassing stuck in the middle of the road with a locked back brake, I know!

TWIN LEADING SHOE FRONT BRAKE: The effectiveness of this brake can further be increased by the manufacture of a longer operating arm. i.e. the one with the cable connection. If this is done without the brake stiffening kit. the flexing of the brake cams in the bushes hinders any advantage, so add 1/2 inches to the brake operating lever after fitting the brake stiffening kit.

FRAME PARTS AND HANDLING

HANDLING: An improvement is to fit the Norvil head steady, it will fit under the Interstate tank, but a bit of juggling is needed to fit it under the Roadster tank. Norvil head steadys are rare and complex though. The Norvil head-steady whilst improving handling will, when shimmed up correctly, cause more vibration to be transmitted through the frame. A "half-measure" is to reduce the shimming of the unit, but the Mark III head-steady is adequate for normal road use.

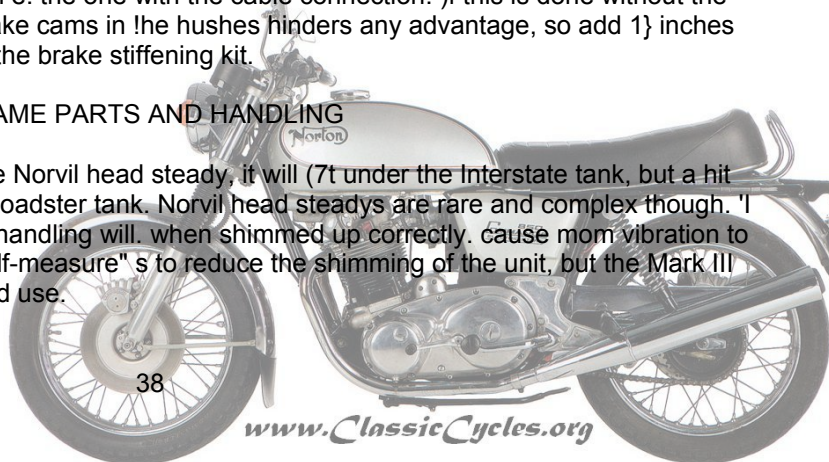

ISOLASTICS: The front Mk III units can be fitted to any/all of the earlier models but the centre tube has to be shortened so that both ends are the same length, preferably by machining (as opposed to hack saw) to keep the ends square. The rear Mk III unit is not really worth the effort and expense of fitting. The adjuster rods for the Isolastic have been known to rust up so a check-strip and grease would be advisable.

SWINGING ARM LUBRICATION: The "sealing for life" of these units is not adequate so modification can be made to allow lubrication: - Remove right-hand end cap, remove spindle and all wicks except far left wick, Drill right-hand end cover and tap ; UNF to take a grease nipple. Right-hand disc wick needs } hole through middle as well. Drill two 1/8 in holes diagonally right through spindle 1/2 in from each end. Replace spindle disc wick with hole, and end cap with nipple and fill assembly with light oil (Castrolite) from grease gun. Lubricate regularly. Castrolite is not always available in which case a useable alternative, especially in primary chaincases, is Castrol 4 stroke oil (made for Hondas) GP 10-40.

SERVICE RELEASE No. N3/13: (Camshaft Interchangeability on 1974 and 1971 Commando (all models). Camshaft/Crankcases/Cylinder heads and valves are affected.)

Following the introduction of new crankcases with modified breathing, together with the introduction of the Combat "SS" type crankshaft, there are now several possible combinations of crankcases and camshafts. In addition, where it is desired to fit the high performance "SS" type crankshaft to a Pre-1972 engine there are problems, with cam lobe clearance at the crankcase oil fling shroud, In addition, problems can arise due to valve head diameter, valve stem and spring length discrepancies, particularly where an early "non Combat" cylinder head is fitted.

It is also essential to fit tappet locating plates 063092 to accommodate the increased lift on both "SS" and "SSS" camshafts.

The part numbers and applications of the various components are tabled below

Cam Part Number	Identification Stamped on	Journal Type	Use Part Number	Comments
061084	S	Scrolled	061084	Standard 1971 plain bushes
062608	S	Plain	061084	Standard 1972 scrolled bushes
062671	SS	Plain	063536+	Combat 1972 scrolled bushes
062807	SS	Scrolled	063536+	Combat 1972 plain bushes
063536*	SS	Scrolled	063536+	Combat 1972 plain bushes
063537*	SS	Plain	063536+	Combat 1972 scrolled bushes
TW0302	SSS	Scrolled	063761+	Original NVPS camshaft, plain bushes
063453*	5SS	Plain	063376+	Variant TX0302 scrolled bushes
063761*	SS\$	063537	063761+	Variant TX0302 plain bushes

Use scrolled journal camshafts prior to Engine Number 204048 with plain bushes NMT2036 & NMT2037. Use plain or scrolled journal camshafts subsequent to Engine Number 204049 with scrolled bushes 062600.

Note: Scrolled condition camshafts only will be supplied against order for the above camshafts.

'Surface treatment

+Conversion from standard cams to Combat condition requires the following

- Cylinder head 063327 to provide 10:1 compression ratio.
- Solid skirt Combat pistons (063348 L.H. 063349 RH, Std.)--See Service Release N.2/4 for oversizes.
- Combat valves - inlet 063283, exhaust 063282.
- Standard valve springs NM22838 outer, NM22839 inner using spring seat and spacers to provide 0.050 in. (1.27mm) clearance at full lift.

+e) Conversion to "SSS" specification - as Combat from standard

--- no further action required for Combat.

SOME TUNING TIPS FROM C. BRADDICK

"DOUBLES" CAMSHAFT: This was definitely the most troublesome cam produced but probably the most powerful on sale to the Public. The problem associated with it were: -

1. Overlap-this was so large that with the lightest over-revving (missed gear usually the cause) the Valves touched each other and bent. Singular remedy is to reduce the overall diameter of the make heads.
2. Coil bound spring, ie. due to cam lift-using standard springs, collars, cups and insulating washers and springs do get coil bound. On NO ACCOUNT remove the heat insulating washers as heat anneals springs. Coil-bound springs break very quickly and this can go undetected for a long time save for a misfire at 4,500 plus. The proper way to overcome this problem is to re-machine the collet recess in the valve further up the stem by about 1/16th of an inch (1.5mm), this has another advantage, it reduced the spring preload of the valve on the valve seat. This gives the whole valve train a much easier life and makes things run much easier. A high preload is totally unnecessary. The only way to get the BEST results from a "double S" cam is to have the head re-machined full sphere with re-angled inlet valves (as originally done by Paul Dunstall and now by Mick Hemmings). The valves still need re-machining though. HIGH-SPEED WEAVING: Worn rear tyres also have the effect of producing high speed weaving. Do not ask why, but it was consistent in racing that the rear tyre had to be kept with plenty of tread on it otherwise the bike shook its head. Worn rear tyre affects handling at all speeds and fitting a new one restores handling instantly. Fit 3.60x19 on front, not 4.10x19.

REAR SUSPENSION UNITS: If you have got a good-handling bike and never carry a passenger then use 100 lb springs on the hardest setting, absolutely essential! Getting gas shocks definitely improve handling and are worth considering which replacement is due.

FOOTNOTES

OIL-TANK: On my production racing Commando the handling was so good that on left-hand corners I could lean the bike so far that the oil ran out of the oil tank breather tube, down the rubber tube and onto the back tyre--alleviated by changing the oil tank breathing system.

(Cannot understand this--centrifugal force affects oil ;,s well as bikes so solo cornering has no effect on level. Perhaps your new system "as just better? T.R.S.)

If the oil tank is over filled it will pump out oil through the air filter.

CLUTCH: Check for buckled driving plates causes "fir. (Solid steel ones) and that, when using solid Ferodo driven plates, the thick pressure plate is used. If the thin one from the 850 bronze clutch is used--clutch slip. Instead of a 750 type pressure plate you can try doubling up one of the plain or friction plates, depending on how worn your clutch is and therefore how much extra room there is.

ROCKERS: Take the springs out and replace with phosphor bronze or steel spacers and by adjusting the spacer and shims get the rocker end dead central on the valve. This is a tedious process but essential for efficient running, i.e. for racer and wong artist.

CRANKCASES: When bolting crankcases together it is essential that there are no 'tight' spots when the crank is rotated. I have seen this and it is caused by: (a) bearing mis-alignment--a piece of aluminium or grit trapped behind the bearing outer race is all that is required to throw it off line; (h) mis-aligned crank cases caused by burrs, grit etc on the mating faces. Essential to check this on new cases.

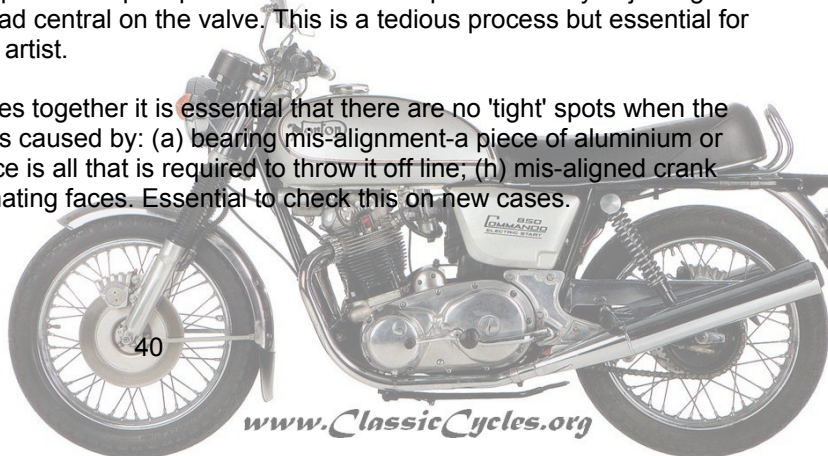

CARBURETTORS: The twin carb tuning does not go far enough! To ensure both sides lift together at precisely the same time use a mirror placed against the air filter, in place of the rubber unions. Then by looking back from near the handlebars you can clearly see the slides. Yet another way to ensure that the slides lift together, once you have each carb set to give even tickover, is to remove the float bowls and main jets and watch the needles rise and fall. A much better tuning sequence is: --- (I used this on all my racers and it is 100 per cent effective):

1. As per booklet.
2. Ensure that both slides totally disappear into the carb body at exactly the same time. This ensures that "full-bore" is truly what it means. (It is possible to do the tuning as on page? I and yet for one slide to lag behind the other.)
3. Close throttle and ensure that both slides lift off their stops at exactly the same time. Adjust using the throttle stop screws. Ensure that there is cable slack at the twist grip. We now have the situation where the sliders are in exact unison.
4. Go for a ride and warm up the engine.
5. Adjust the air screws to get an even tickover irrespective of the rpm.
6. If the rpm is too high, lower both throttle stop screws the same amount, a little at a time until the correct rpm is achieved. If the rpm is too low reverse the process.
7. Go for another ride to cool off the engine (it would have got hotter whilst making the adjustments) and recheck.

I adjusted my carbs by removing the float bowls and watching the needles and later had them checked with vacuum gauges and they were dead right-so it is accurate.

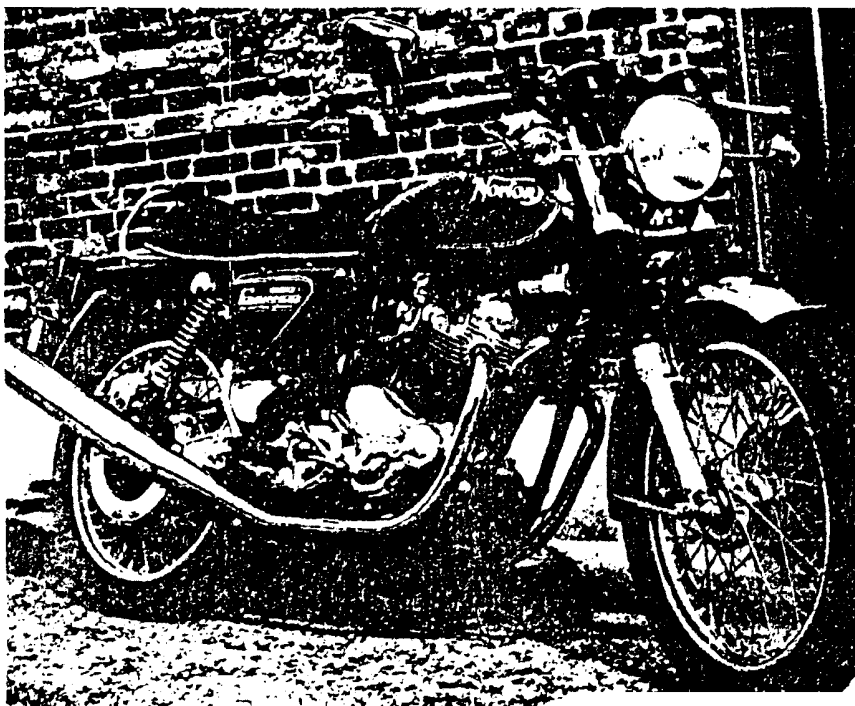

The prize winning Mk III Roadster of Bob Slater, featured at club rally and record cover

CARBURATION

The Technical Advice' questions on carburetion, at times, seem endless, along with the strange ideas some people have on the subject. A few basic facts, based on the Mk I Concentric; the main jet size is not that important and does not wear out! It starts to have an effect from 90mph plus, so if you don't cruise above 80mph (which is illegal anyway) then an error of 10 per cent, or possibly more, will not be noticed. The 220 or ex-works setting can be left alone. If you must fiddle then err on the larger, richer side. Now the needle jet and needle. This is about the most important on a Norton, especially as the needle jet has a very short life for accurate carburetion, often less than 10,000 miles. Starting point is 106 with the needle position as ex-works settings, to be checked 60-70 with the engine pulling, i.e. slightly uphill for at least ½ mile then engine and plugs checked. Sooty, richness, lower needle. or replace needle jet and start again, white, hot, weakness, raise needle. The slide does not seem to wear so as to affect the mixture greatly, usually just rattles, but can cause erratic running just above tick-over. Slide to be checked at 40mph with engine pulling for ½ mile as above. Richness, fit a higher number slide (½ sizes): weakness, lower number to richen it. Pilot air screw for tick-over mixture only, and possibly pick up too. Unfortunately the N7Y plug (suitable for all riding, up to hard racing) tends to look reasonably correct even if the carburetion is a bit out. Other symptoms to look for; 1, Good acceleration in a particular hand but rough cruising, which clears the instant the throttle is opened - Richness, finally leads to fouled plugs. 2, Poor acceleration, spitting back, pinking (sounds like small ball bearings rushing around on top of piston) and overheating - weakness. Soon melts plugs and holes pistons. Do check ignition timing. if points, and correct it before checking carburetion. Removal of air filter will weaken mixture, also noisier silencers can weaken it. The Viton tipped brass float needles do wear out, causing intermittent flooding. also caused by a damaged float-bowl-to-body gasket. Every third needle jet replace the needles as well. If you must remove the chokes do plug up the hole in the carb top, there is a screw available, this falls out and gets lost, chewing gum, electrical tape over a piece of wood. plasting padding, but a nut and bolt might drop into the carb and engine. ! ?? urgh.

AMAL CONCENTRIC SETTINGS FOR NORTON COMMANDOS, EX-WORKS

Year	Model	Carb. No.	Main jet	Slide	Needle pos'n,	Needle jet
1969	Commando	930/30-31	220	3	2	106
1970	Commando	930/46-47	180	3	2) 06
1971/j72	Commando	930/68-69	220	3	2	106
1973	Combat	932J26-27	230	3	1	106
1973	Commando	930/82-83	220	3	2	106
1973	Combat	932/26-27	230	3	1	106
1973	Roadster	932/29-30	260	3 ½	1	106
1973	Interstate	932/31-32	230	3 ½	2 or 3	106
1974	850 Mk 1	932/29-30	260	3 ½	1	106
1974	Mk 1A	932/31-32	230	3 ½	2 or 3	106
1974	Mk 2	932J29-30	260	3 ½	1	106
1974	Mk 2	932/35-36	260	3 ½	3	106
1974	Mk 2A	932/31-32	230	3 ½	2 or 3	106
1974	Mk 2A	932/133-34	220	3 ½	2	106
1975	Mk 3	932/33-34	230	3 ½	1 or 2	106



OIL

Further note, and explanations to the notes on page 28. When the Norton twin cylinder engine came about in 1949 we had monograde oils only, therefore the design took this into account. The oil lubricated the parts and helped with the cooling, especially the cylinder head. The dirt from Combustion would usually end up in the oil tank its sludge, to be re-circulated in varying degrees. Not a marvellous state to be in. In winter we used an SAE 30 and in summer, 40.

In time the oil companies came up with "Multigrades" by adding viscosity improvers, i.e. we had a 20 grade oil at 0°C which has additives which stop it becoming thinner than a 50 grade at 100°F also we have further additives such as detergents. The advantages here are not quite what they seem. The detergents hold the dirt in suspension, i.e. it continues to circulate and do its 'thing', the only real advantage here is that at least most of the contaminants and rubbish come out with the next oil change. The real advantage that can be gained is by fitting an oil filter, as on the Interstate- in 1973. This allows some extension of oil change periods, but not too far because of the viscosity improvers. When these break down after a few thousand miles we are left with a 20 grade base oil. Not clever stuff. Not at 110 at 110 anyway. (° and mph, that is.)

Also as the multigrade is based for cars with a lower BHP/litre ratios and water cooled motor, the temperatures are reasonable with the additives lasting up to 100°C (but air cooled. high BHP/litre engines can easily generate 130°C in the oil tanks while big end-, can be 50°C higher. What value our multigrade now? Some of the additives are also highly volatile! Another point is high piston and ring speeds, these tend to shear these additives also.

What can you do? Use a heavy duty monograde 30 in winter, 50 summer as page 28. fit an oil filter and keep to regular oil changes, certainly don't lengthen the oil change periods. The camshaft apexes have most pressure exerted on them and these are usually the first signs of trouble with oil, when premature wear sets in outside the normal soft camshaft wear on especially the Mark III. Finally a 20/50 or 15/50 multigrade is preferable to a cheap non-HD monograde (keep to 2,000 mile oil changes), also not recommended is the Castrol 4 stroke Motor Cycle oil known as GP. This is a 10/40W especially for Hondas, i.e. engine oil has to circulate around the clutch and they have electric starters and monetary wise are more important than Nortons in the motor cycle world.

Most engines seem to survive on the multigrade despite the above, multigrade does more with regard to durability and quick-warm-ups

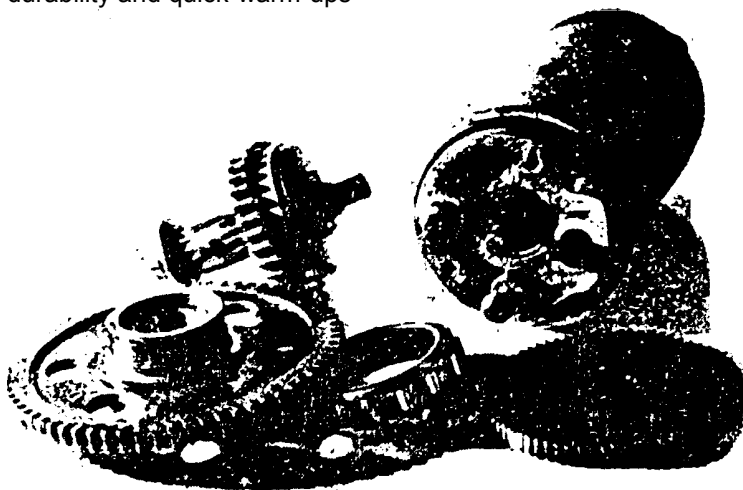

Well it fills a spare!



Keep polishing

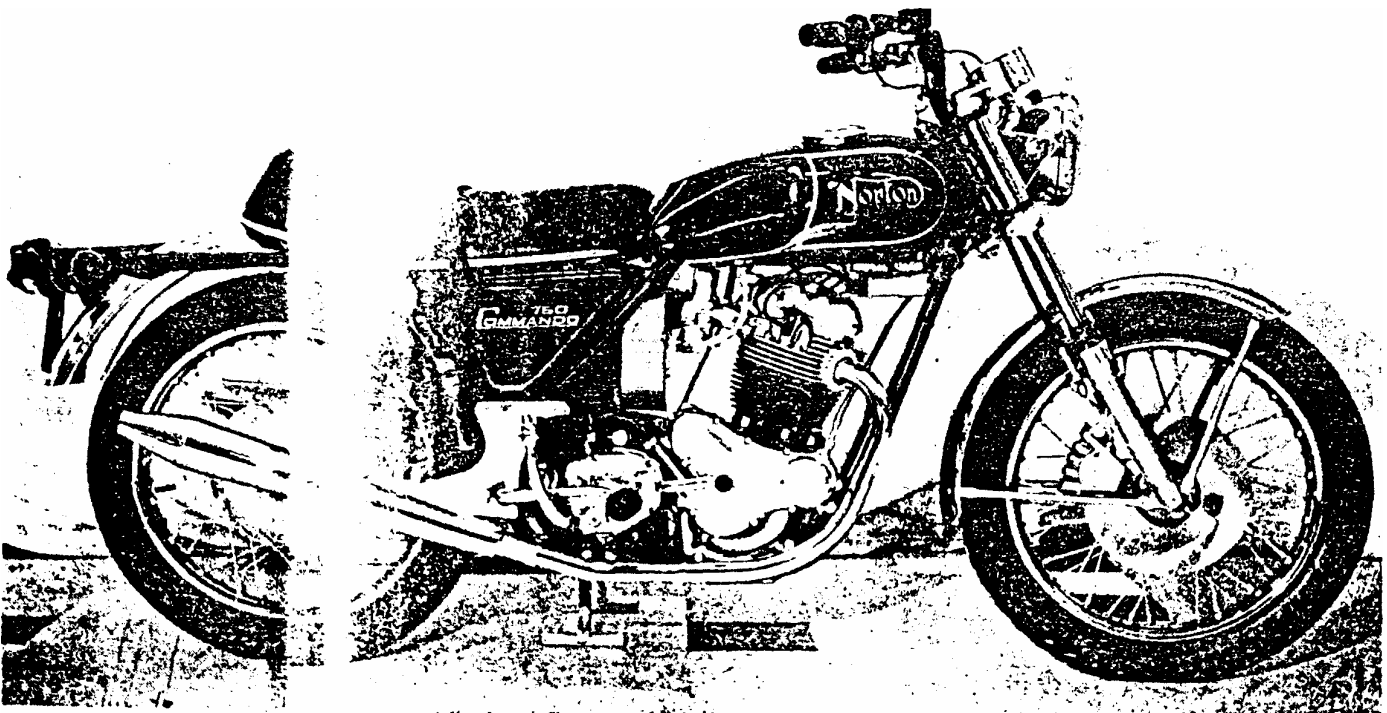

The Roadster again fitted with Combat motor.
Interesting to compare this with the type of 1970. (Page 23).
Photo credit: Motor Cycle.

Classic Cycles Technical Resources
PARTS & ACCESSORIES

Click on links below

[*Motorcycle Parts & Accessories*](#)

[*Dirt Bike Parts & Accessories*](#)

[*Cruiser Motorcycle Parts & Accessories*](#)

[*Japanese Motorcycle OEM Parts & Online Schematics*](#)

[*Save Up to 45% on Motorcycle Tires*](#)

[*JC Whitney Motorcycle Parts & Accessories*](#)

[*Motorcycle Gear Closeout Sale*](#)

[*Free Shipping On All Mini Bikes*](#)

[*Cycle Gear Free Shipping*](#)

[*Mega Motor Madness*](#)



[*www.ClassicCycles.org*](http://www.ClassicCycles.org)